

Solid state display is multicolored 88
ROM's simplify mathematical tasks 104
A move toward military plastic-packaged IC's 127

\$1.00 A McGraw-Hill Publication

May 11, 1970

Electronics®

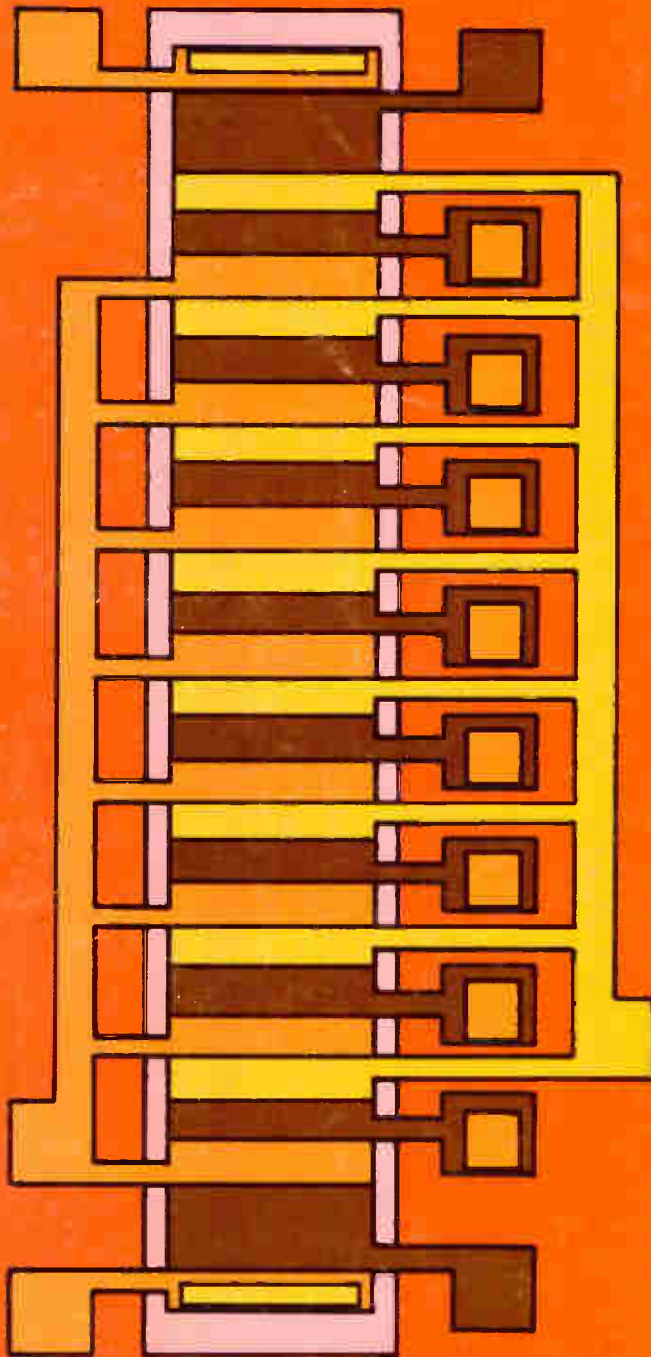

**A new look
and greater
versatility
for MOS
technology**

142 KSS956 44R 02-71
R KISSLER
BASIC COMM ELEC
BOX 956
MOSES LAKE WA 98837

Suppose you wanted an Automatic RLC Bridge

that could measure up to 2 M Ω resistance, 2000 H inductance, and 0.2 F capacitance, plus equivalent series resistance and leakage current. A bridge with 5-digit resolution for reactance and resistive readouts, automatic decimal point and units of measurement; a 20-measurements-per-second capa-

bility; 120-Hz and 1-kHz test frequencies; 5-terminal connections to preserve a basic 0.1% accuracy; a built-in 0 to 3-V bias or external bias to 600 V; optional remote programmability and data output.

And prices that start at \$4,215. (in U.S.A.)

Where could you possibly find such a bridge?



1683 Automatic RLC Bridge by **GENERAL RADIO**



West Concord, Mass. 01781 Tel: (617) 369-4400 Europe: Postfach 124, CH 8034 Zurich, Switzerland

Circle 900 on reader service card

If you only see this

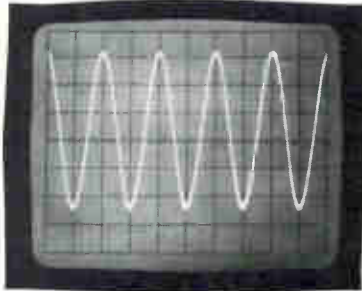

Conventional scope display of 5 MHz signal appears undistorted →

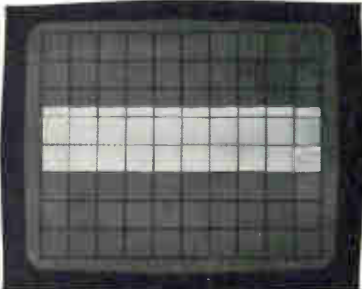

Conventional scope display barely shows 10 kHz AM of 30 MHz carrier →

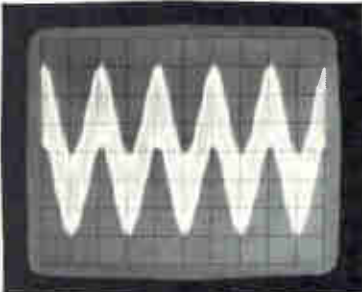

Conventional scope display merely shows "fuzzy" sine wave →

look what you're missing.

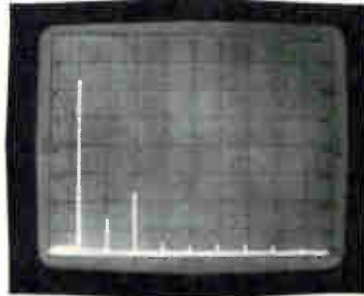

but spectrum analyzer display shows 2nd harmonic 50dB down and 3rd at -40 dB.

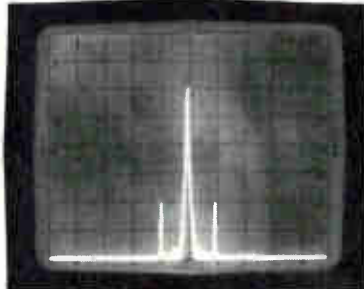

but spectrum analyzer shows sidebands 40 dB down; i.e., 2% AM.

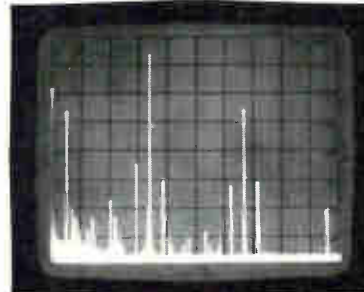

but spectrum analyzer identifies parasitic oscillations.



You're missing the wealth of information you need for *complete* signal analysis.

There's only one lab tool that fully characterizes oscillators, mixers, modulators, amplifiers, filters and systems, both in design and test stages. This tool is an HP spectrum analyzer, the oscilloscope that operates in the frequency domain.

One of the analyzers covers the 1 kHz to 110 MHz range; the other goes from 500 kHz to 1250 MHz. Because frequency response is flat, each provides absolute amplitude calibration — and you can read out in dBm or volts (down to < -120 dBm or $0.1 \mu\text{V}$). The > 70 dB distortion-free dynamic range permits you to measure signals with very wide amplitude differences. You can sweep the entire frequency range, then reduce the scan to zoom in for a closeup of any portion down to .0002% of the initial sweep. Selectable bandwidths provide resolution as high as 50 Hz in the 110 MHz instrument and 300 Hz in the 1250 MHz unit.

So why struggle with half the picture in circuit design? The 8553B 110 MHz

RF section costs \$2100; the 8554L 1250 MHz RF section \$3300. Use either of them with the 8552A IF unit (\$2050) and a 141T Variable Persistence Display for high resolution (\$1700) and you have all the frequency information you need for the complete story in circuit design. Ask your HP field engineer for an applications brochure on this universal lab tool for circuit design and measurement. Or write to Hewlett-Packard, Palo Alto, California 94304; Europe: 1217 Meyrin-Geneva, Switzerland.

04006

HEWLETT  PACKARD

SIGNAL ANALYZERS

Guess the price of HP's new counter



Clues:

it averages time intervals to 10 picoseconds
it has a built-in 0.05% integrating DVM
it's dc to 50 MHz, CW or burst
its counter and DVM are easily programmable

Surprise: \$1550. That modest amount buys a Hewlett-Packard timer/counter that does things universal counters never did before. For example, it averages time intervals as short as 0.15 nanoseconds. So you can resolve to 10 picoseconds on repetitive signals.

That modest sum also buys a counter with a built-in integrating digital voltmeter. So it's the only counter that can measure internal trigger level settings or other inputs with DVM precision. Now you can measure 10 to 90% rise times, half power points and other voltage-dependent time intervals. That means unprecedented simplicity, for example, in propagation

delay measurements. The counter also features four integration times. As a DVM, it provides three voltage ranges, 60 dB noise rejection and 0.05% accuracy.

Even without these exclusive features, the 5326's are real bargains. They count to 50 MHz direct with seven-digit resolution (eight digits optional), measure period and multiple period average and scale input frequencies by any power of 10 up to 10^8 . They measure ratio and they totalize.

With programming and BCD output options, the 5326's fit easily into systems applications. Counter and DVM are DTL programmable through a common connector.

You can get all of these benefits in the 5326B for \$1550, or buy the same counter, less the DVM, in the 5326A for \$1195. Any way you look at the 5326 A or B—either is a great counter value. Your local field engineer has all the facts about HP's new IC counter line. Give him a call or write to Hewlett-Packard, Palo Alto, California 94304; Europe: 1217 Meyrin-Geneva, Switzerland.

HEWLETT  PACKARD
ELECTRONIC COUNTERS

Features

Probing the News

- 127 **Solid state:** Plastic IC's get foot in military door
135 **Advanced technology:** Submillimeter spectrum, waves of the future?

U.S. Reports

- 41 **Manufacturing:** Value-added tariff rule appears safe
41 **Advanced technology:** Efficient blue emission for diodes
42 **Communications:** Billion-bit satellite uplink
44 **Lasers:** Use in h-f multichannel data recording
44 **Government:** Awacs delayed again; agency proposed for basic research
48 **Medical electronics:** Artificial kinesthetic sense; strain-gage transducer does 15 jobs
51 **Instrumentation:** 150-foot-accurate Navsat receiver
52 **Patents:** IBM vs. Xerox

Electronics International

- 65 **Germany:** Traffic reports in every car
66 **Germany:** On the stands and in the air at Hanover
67 **Great Britain:** Packing in the bits—10,000 strong
68 **France:** Aerospace fallout—another electret mike
69 **France:** Split intervals

New Products

- 143 **In the spotlight**
143 **Hard-copy display terminals** center of attraction at SJCC
150 **Instruments review**
150 **Self-calibrating digital voltmeter**
155 **Subassemblies review**
155 **Boosting power supply's efficiency**
158 **Midispeed printer with miniprice**
163 **Data handling review**
163 **A digital filter that's programable**
167 **The all-integrated d-c converter**
168 **Minicomputer priced at \$2,500**
175 **Industrial electronics review**
175 **No warmup for laser interferometer**
179 **Semiconductor review**
179 **ROM can be programed in field**
182 **New materials**

Articles

- Displays** 88 **Seeing colors in a semiconductor display**
Monolithic solid state displays are being built that emit many colors rather than just one; key is phosphor coating of light-emitting GaAs diodes
Allen M. Barnett and Frederick K. Heumann, General Electric Co.
- Memory technology** 94 **Etching memories in batches**
Potential for batch fabrication exists with etched permalloy memories; permalloy toroids, copper conductors make up the memory plane
Donald F. O'Brien, Laboratory for Electronics Inc.
- Circuit design** 100 **Designer's casebook**
▪ Comparator increases rate meter's response
▪ Monostable protected against 60-hertz pickup
▪ One-shot generates wide range of periods
- Memory technology** 104 **Making small ROM's do math quickly, cheaply and easily**
Combining lookup-table and equivalent-function techniques with ROM's averts need for huge single-memory capacity
Al Hemel, Communication Products Corp.
- Advanced technology** 112 **MOS technique points way to junctionless devices**
Semiconductor's substrate handles data for memory, display; simpler construction promises high capacity, low cost
Laurence Altman, Electronics' staff
- ## Departments
- | | | | |
|----|--------------------------|-----|--------------------------|
| 4 | Editorial Comment | 43 | Index of Activity |
| 5 | Readers Comment | 63 | International Newsletter |
| 6 | Who's Who in this issue | 77 | Washington Newsletter |
| 12 | Who's Who in electronics | 184 | New Books |
| 22 | Meetings | 187 | Technical Abstracts |
| 33 | Electronics Newsletter | 190 | New Literature |

Electronics

Editor-in-Chief: Donald Christiansen

Senior staff editors

Technical: Stephen E. Scrupski

News: Robert Henkel

International: Arthur Erikson

Assistant managing editors: H. Thomas

Maguire, Howard Wolff, William Buccl,

Richard Gundlach, Frederick Corey

Special projects editor: Roger Kenneth Field

Senior staff writer: John Johnsrud

Reader Communications manager: John D. Drummond

Department editors

Senior associate editor: Joseph Mittleman;

Advanced technology: Laurence Altman; Com-

munications: Leon M. Magill; Computers: Wal-

lace B. Riley, George Weiss; Design theory:

Joseph Mittleman; Instrumentation: Owen

Doyle; Military/Aerospace: Alfred Rosenblatt;

New Products: William P. O'Brien; Solid state:

George Watson, Stephen Wm. Fields.

Copy editors: Edward Flinn, William S. Weiss

Assistant art director: Charles Ciatto

Production editors: Susan Hurlburt, Arthur C.

Miller; Editorial research: Virginia Mundt; Edi-

torial secretaries: Claire Goodlin, Bernice

Pawliak, Barbara Razulis, Vickie Green, Terri

O'Neill.

Field editors

Boston: James Brinton, manager; Gail Farrell;

Los Angeles: Lawrence Curran, manager; Ralph

Selph; New York: Peter Schuyten; San Fran-

cisco: Stephen Wm. Fields, Marilyn Howey;

Washington: Ray Connolly, manager; Robert

Westgate, Lois Vermillion; Frankfurt: John

Gosch; London: Michael Payne; Paris: Arthur

Erikson; Tokyo: Charles Cohen

Reprints: Virginia Mundt; Circulation: Isaaca Siegel

Publisher: Dan McMillan

Assistant to the publisher: Wallace C. Carmichael

May 11, 1970

Where Swedish engineers shop

● The buying-selling pattern in electronics components and equipment is changing. It is becoming truly international in scope, a trend that was made clear at the Instruments and Measurements Show held in Stockholm in mid-April. The idea of the show, when it was initiated in the 1940's, was to give Swedish electronics companies an opportunity to show off their wares to Swedish technologists. But today, foreign exhibitors outnumber Swedish exhibitors by six to one. This year the U.S. was the leader with 446 firms represented. England followed with 252. In all some 24 countries were represented—even Liechtenstein.

It's equally clear why there were so many buying technologists among the estimated 26,000 people who attended the show. As one Swedish engineer put it, "It's a long way from Stockholm to the IEEE show in New York." Not many Swedish firms can afford even to send their engineers to the Paris Components Show. Similar restrictions apply to companies in almost every other European country—hence the growing popularity of exhibitions like the Paris show and West Germany's Electronica.

At the Stockholm exhibit, nominally an instruments show, the engineers found an array of goods ranging from components through instruments and systems. An engineer from General Instruments' Scottish plant—where some of GI's MIS circuits are both designed and manufactured—said, "We're here to sell to the Swedish calculator market." GI was not alone; the visitor could view the latest in IC's from National Semiconductor, Signetics, Fairchild, ITT and others. Hughes was there with information on its MOS capability. ITT Components showed a veritable supermarket

of componentry, ranging from connectors through IC's. Attendees also could roam through an amply stocked Hewlett-Packard exhibit, or examine gear from Tektronix, Teradyne, Fluke, and Rohde and Schwarz.

But the U.S. manufacturers by no means completely overshadowed the local makers. SAAB (Sweden) was showing its marine automation gear. Schlumberger (France) had an impressive display of instruments. The Philips booth was heavily trafficked; a just-introduced compact sampling scope with a bandwidth of 1,700 megahertz was touted by its Swedish maker, Svenska Philips, as much cheaper than U.S.-made scopes having the same frequency range. The giant Swedish firm ASEA was emphasizing computer systems and process control, including equipment for automatic testing of electrical components, gear for monitoring and controlling paper, glass, and steel manufacture, monitoring nuclear power plants, and—with smaller computers like the PDP-8—acquiring weather data, tracking robot targets, and supervising electric power systems. Because ship building is an important Swedish industry, marine automation is a potentially lucrative market for firms like SAAB and ASEA. The Swedish Ship Research Foundation has ordered a computer system from ASEA to be installed aboard the 210,000-ton supertanker Sea Sovereign, the largest ship of the Swedish merchant fleet. The computer is to control the engines from the bridge, handle combustion control, data logging, steering, and carry out navigational functions. It will also do hull-strain calculations, and provide a self-test function.

Neighboring Finland was represented at the Stockholm exhibit by, among other firms, Nokia Electronics, makers of

Published every other Monday by McGraw-Hill, Inc. Founder: James H. McGraw 1860-1948. Publication office 99 North Broadway, Albany, N. Y. 12202; second class postage paid at Albany, N. Y. and additional mailing offices.

Executive, editorial, circulation and advertising addresses: Electronics, McGraw-Hill Building, 330 W. 42nd Street, New York, N. Y. 10036. Telephone (212) 971-3333. Teletype TWX N. Y. 710-581-4235. Cable address: MCGRAW HILL N. Y.

Subscriptions solicited only from those professionally engaged in electronics technology. Subscription rates: qualified subscribers in the United States and possessions and Canada, \$8.00 one year, \$12.00 two years, \$16.00 three years; all other countries \$25.00 one year. Non-qualified subscribers in the U.S. and possessions and Canada, \$25.00 one year; all other countries \$50.00. Air freight service to Japan \$50.00 one year. Single copies: United States and possessions and Canada, \$1.00; all other countries, \$1.75.

Officers of McGraw-Hill Publications Company: Joseph H. Allen, President; John R. Emery, J. Elton Tuohig, Senior Vice Presidents; Gordon L. Jones Jr., Group Vice President; Vice Presidents: John R. Callahan, Editorial; John M. Wolden, Marketing; David G. Jensen, Manufacturing; Jerome D. Luntz, Planning & Development; Robert F. Marshall, Administration; Robert M. Wilhelm, Finance; Director of Circulation: Ralph Blackburn.

Officers of the Corporation: Shelton Fisher, President and Chief Executive Officer; John J. Cooke, Senior Vice President and Secretary; Gordon W. McKinley, Vice President and Treasurer. Title © registered in U.S. Patent Office; © Copyright 1970 by McGraw-Hill, Inc. All rights reserved. The contents of this publication may not be reproduced either in whole or in part without the consent of copyright owner.

Subscribers: The publisher, upon written request to our New York office from any subscriber, agrees to refund that part of the subscription price applying to copies not yet mailed. Please send change of address notices or complaints to Fulfillment Manager; subscription orders to Circulation Manager, Electronics at address below. Change of address notices should provide old as well as new address, including postal zip code number. If possible, attach address label from recent issue. Allow one month for change to become effective.

Postmaster: Please send form 3579 to Fulfillment Manager, Electronics, P.O. Box 430, Hightstown, New Jersey 08520.

Readers Comment ▶



gear for telecommunication systems, pcm equipment, data transmission and radio links, and automation and process control systems. Nokia is using IC's heavily in such instruments as data loggers and multi-channel pulse analyzers.

Those who closely examined the Scandinavian equipment at the show—as well as that from other European countries—saw plenty of TO cans and dual-in-line packages bearing familiar symbols like the map of Texas and the batwing “M.” It is understandable that Swedish gear should incorporate “foreign” components—particularly IC's, since the semiconductor art is still in its infancy in the Scandinavian countries. ASEA's affiliate, Hafo, for example, is just beginning to supply some IC's, mostly thick-film hybrids.

If the value added by Swedish firms to their final products is small in the component area, it is considerable in system and software design. But even at that some entire subsystems from outside Sweden are incorporated into the end product. For example, Digital Equipment Corp's PDP-8 is the heart of most of ASEA control systems based on small computers, and the ASEA system 1700, built into most of the firm's larger process computer systems, is, in fact, the Control Data Corp.'s System 1700.

So it is easy to see that visitors to the Swedish show would be eager, but selective, shoppers—exhibiting strong interest in U.S. components that they might design into next-generation equipment, examining the instruments carefully regardless of where they were made, and keeping a sharp eye out for subsystems they might incorporate into larger systems, at least until they are able to produce them locally.—D.C. ●

McGraw-Hill News Service

Director: Arthur L. Moore; Atlanta: Fran Ridgway; Chicago: Robert E. Lee; Cleveland: Arthur Zimmerman; Dallas: Marvin Reid; Detroit: James Wargo; Houston: Barbara LaRoux; Los Angeles: Michael Murphy; San Francisco: Margaret Drossel, Tyler Marshall; Seattle: Ray Bloomberg; Washington: Charles Gardner, James Canan, Herbert W. Cheshire, Seth Payne, Warren Burkett, William D. Hickman; Bonn: Robert F. Ingersoll; Brussels: James Smith; Hong Kong: Kate Mattock; London: John Shinn; Mexico City: Gerald Parkinson; Milan: Jack Star; Moscow: Jack Winkler; Paris: Robert E. Farrell, Stewart Toy; Tokyo: Mike Mealey

Tantalizing

To the Editor:

I found a real teaser in your rosy picture of the Toulouse transistor model [Feb. 16, p. 72]. While there are numerous applications noted, I have looked in vain to find a reference to where we can obtain details of the equations that have been developed. It would seem as though there should be some material on the equations either in the open literature or in available reports.

C.S. Iden

Delco Radio division
General Motors Corp.
Kokomo, Ind.

▪ Some details of the equations behind the Toulouse transistor model were published last month in Volume 1, Proceedings of the International Conference on Advanced Microelectronics, which was held in Paris, April 1-10. The paper, “Identification du Comportement des Transistors Bipolaires in Commutation,” was authored by G. Rey, K. Lemaire, J.P. Bailbe, and J.P. Daubonne. The proceedings is published by Editions Chiron, 13 Rue Charles Lecoq, Paris 15.

No spinoff

To the Editor:

Your article “Elegantly flat” [March 30, p. 46] mentions that Autotelic Industries is a spinoff of International Scanning Devices of Fort Erie, Ontario. This is not the case. No connection exists between Autotelic and International Scanning, with which we compete directly in the flat-screen field.

Frank V. Tagliarino

Vice president,
Autotelic Industries Ltd.
Fort Erie, Ontario

▪ Autotelic was formed by former executives of International Scanning, and the two companies are indeed separate and in competition with each other.

Voltage typo

To the Editor:

In the new product caption on the BRH/T300 and 600 series, single-phase bridges [April 13, p. 173], there was a misprint. The voltage types should have been 50 to 1,500 volts rather than 10 to 2,500 volts that appeared in the caption.

David L. Mohn

Vice president,
Silicon Products group
Rectifier Components Corp.
Freeport, N.Y.

▪ A gremlin crept in and did the dirty work on the voltages.



The Air Traffic Control System Of Central America

uses Farinon radio and multiplex systems for reliable telephone circuits.

So do 16 US government agencies, 45 US telephone companies of all sizes, 36 communications agencies of other governments, and the Volta Aluminum Company of Ghana . . . among 223 others.

Farinon has won a world-wide reputation for performance, reliability, economy and all-around engineering judgment.

Write for our catalog of radio, microwave and multiplex equipment, accessories and services.

Farinon

Farinon Electric, 935 Washington St., San Carlos, Cal. 94070

Who's Who in this issue



Barnett Heumann Gidley

Two's company—and in the case of the article that starts on page 88, the two are authors Allen M. Barnett and Frederick K. Heumann, and the company is GE. Barnett and Heumann are, respectively, physicist and physical chemist at GE's R&D center. Also shown is Gerald B. Gidley, who prepared the devices described in the article.

Laurence Altman's been busy. *Electronics'* advanced technology editor, who wrote the April 13 cover story on millimeter-wave communications, also is the author of the article on junctionless MOS devices that starts on page 112 of this issue. Altman joined *Electronics* last September after spending several years in industry.



O'Brien

Doctors and computers were the early companions of Donald O'Brien, who wrote the article that starts on page 94: he's done research on developing data processing for the life sciences at the Harvard Medical School. He's now a senior engineer at Laboratory for Electronics.



Hemel

Never one to be tied down too long in one specialty, Al Hemel, author of the article that starts on page 104, has let variety spice his life. Starting in relays and IC design, he's gone to logic circuits at Communication Products Corp.

FREE ALL YOU NEED TO KNOW ABOUT SERIES 54/74 TTL CIRCUITS.

272 pages of data list specs, illustrate logic diagrams, give test conditions for

- 54/74 STANDARD CIRCUITS
- 54H/74H HIGH SPEED CIRCUITS
- 54/74 MSI COMPLEX ARRAYS



WANT THEM RIGHT AWAY? FILL OUT AND MAIL THE COUPON TODAY.

YES! Send me the 54/74 handbooks I've checked.

Standard Circuits—88 page handbook
EB25640A.

High Speed Circuits—88 page handbook
EB25645.

MSI Complex Arrays—96 page handbook
EB25655.

Name _____

Title _____

Company _____

Address _____

City _____

State _____ Zip _____

MAIL TO:
TECHNICAL LITERATURE SERVICE
SPRAGUE ELECTRIC COMPANY
35 MARSHALL STREET
NORTH ADAMS, MASS. 01247



Circle Reader Service Number 514
for 54/74 Standard Circuit Handbook

Circle Reader Service Number 515
for 54H/74H High Speed Circuit Handbook

Circle Reader Service Number 516
for MSI Complex Array Handbook.

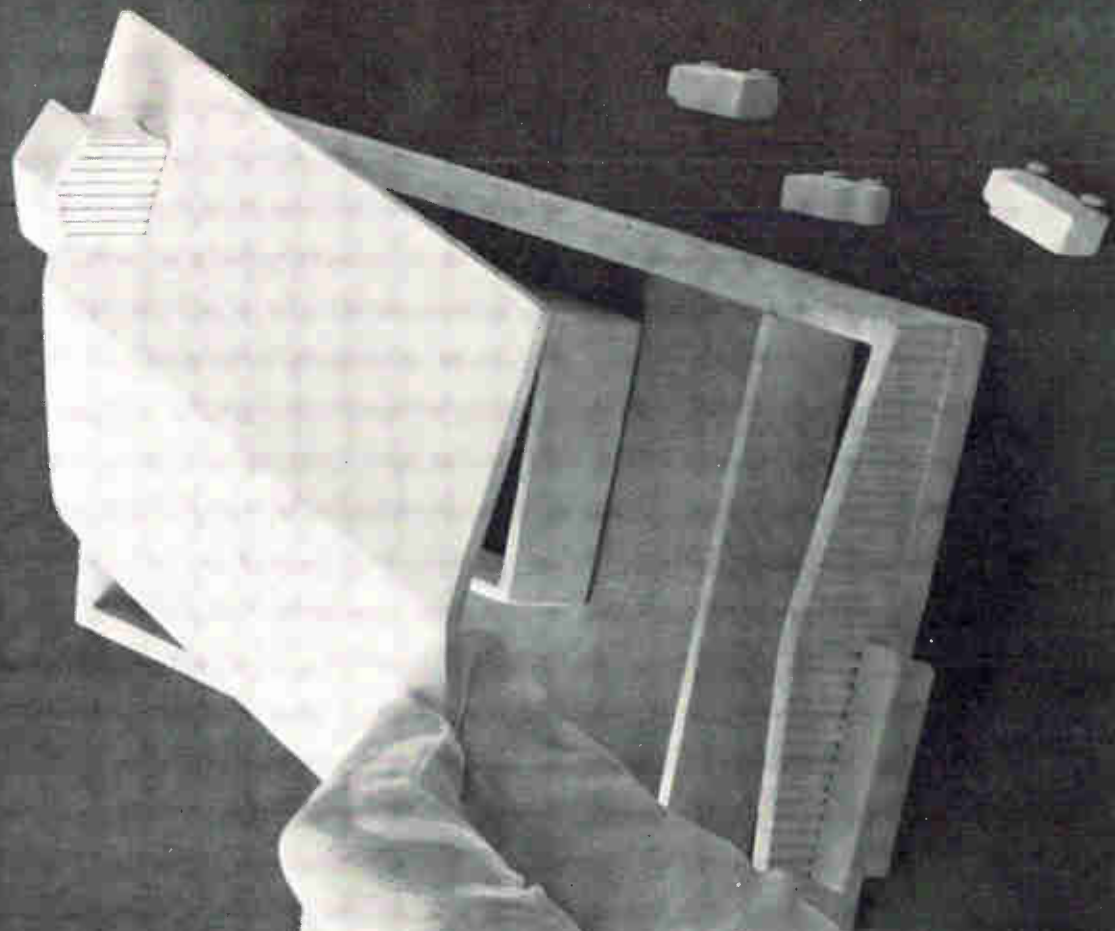

**TOP
NORPLEX
LINTPICKER**

The Lint-Pickers open a new plant!

And look what's in it for you!



When demand exceeds supply, something's got to be done. And UOP Norplex did it.

To meet your growing needs for laminates, we've opened our new, all-modern, 50,000-square-foot plant in Franklin, Indiana.

Adding to the production capabilities of our large plants in LaCrosse and Black River Falls, Wisconsin, this centrally-located facility will also speed up service on the Norplex laminates you depend on: multi-layer, copper-clad and unclad.

This new plant features the most modern laminating equipment and the finest technology in the industry. And you can be sure Norplex at Franklin will carry on the "Lint-Picker" tradition of continuing research and complete quality control.

UOP Norplex is a division of Universal Oil Products Company, a half-billion dollar company busy making life better through research and product innovation around the world.

Write for our latest catalog. It's designed to help engineers select the right laminates for every need.

<i>Main Office and Plant</i>	<i>Franklin Office and Plant</i>
Norplex Drive	P.O. Box 186—Route 31 North
LaCrosse, Wisconsin 54601	Franklin Industrial Park
608/784-6070	Franklin, Indiana 46131
	317/736-6106



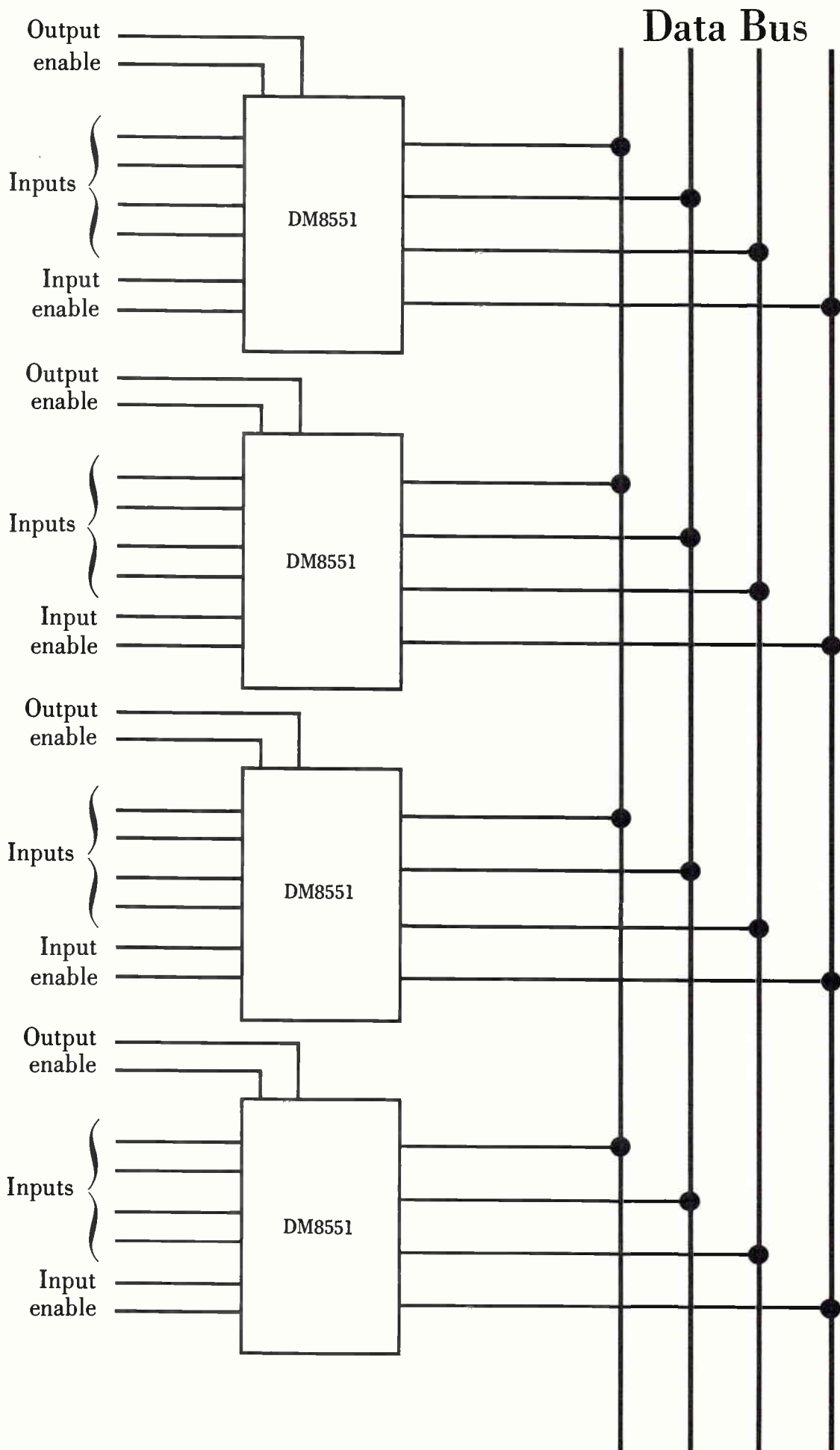

Tri-state Bus-line

There's a third state in a TTL databus with our DM8551. Conventional low impedance logical 1, logical 0 and a high impedance state you can use as a logical "neutral." The 8551 gives you the high impedance characteristics of an open collector output with the high drive of TTL. It makes it possible to design mini-computers as bus-organized systems totally TTL. Direct coupling. Shorter lines. TTL all the way.

DM8551 — Bus-OR'd Quad D — operates synchronously from a common clock. This element has the further advantage of input data acceptance without controlling the clock. Specifically designed for use in bit serial and bit parallel applications. Controlling the third state makes it possible to connect the output of the 8551 directly to the output of other 8551s. You can impede the output of all devices except the one you select, logically.

Take it from National. The 8551 is a new concept in TTL and something else in a databus. TTL/MSI, logically from National Semiconductor. Write for App Notes and specs. 2900 Semiconductor Drive, Santa Clara, California 95051. (408) 732-5000. Telex: 346-353 Cables: NATSEMICON.

National/TTL MSI

JUST OFF THE PRESS!

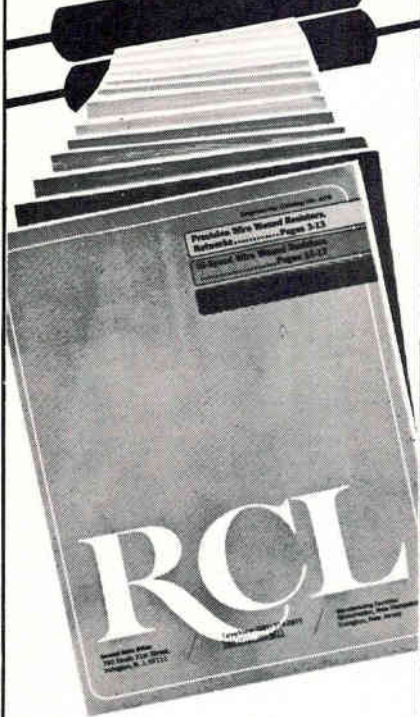

RCL's NEW RESISTOR CATALOG

the industry's most extensive and most accurate compilation of engineering information on wire-wound resistors

PRECISION/HI-SPEED POWER/WIRE-WOUND RESISTORS

including: beryllium oxide core power resistors . . . 22 special temperature coefficients from -50 PPM to +6000 PPM . . . sub-miniature precision resistors . . . ladder and summing networks.

Write for your free copy today!

RCL

ELECTRONICS, INC.
700 South 21st Street
Irvington, New Jersey 07111

Who's Who in electronics



Hemmes

Fourteen years ago, Robert A. Hemmes was sweating over the completion of his master's thesis at MIT on a servo-mechanical stabilization system for high-speed railroad trains.

Although his thesis suffered the fate of most such degree requirements—it passed into oblivion—it strongly influenced his career. Today, Hemmes is responsible for \$20 million in research, development, and demonstration projects—including high-speed trains—for the Department of Transportation. As assistant administrator for research in DOT's Urban Mass Transportation Administration, Hemmes has been challenged by Secretary John A. Volpe to transform the once-static office of program management "into one dedicated to dynamism" in seeing projects through to completion.

High hopes. Hemmes' goal is to find new ideas, hardware, applications, and techniques that will improve transportation and reduce transportation needs with more efficient scheduling, dual-mode vehicles and route changes. However, in line with the Administration's tight budget policy, UMTA's fiscal 1971 R&D budget was slashed one-third from the previous year's \$30 million.

Where does he see the major opportunities for the electronics industry in UMTA's future? In the application of components and sys-

tems proved successful elsewhere to help solve public transportation problems.

After graduating from the U. S. Naval Academy in 1948, Hemmes served six years as a naval officer, including destroyer-mine sweeper duty in the Korean war. After his hitch, he returned to college and received his master's degree in 1956 in aeronautical and electrical engineering at MIT, where he also worked on applied mechanics for weapons systems.

Hemmes then rejoined the Navy Department—this time as a civilian employee—in its Bureau of Aeronautics in Washington, where he worked on bomb-delivery systems for two years. In 1958, he became an assistant professor of civil engineering at George Washington University and two years later went to Stanford University. At Stanford, Hemmes—then an associate professor—applied engineering techniques to economic industrial planning and earned a doctorate in industrial engineering.

Earlier this year Carlos Villarreal, UMTA administrator and an old friend of Hemmes' from their days at both Stanford and the Naval Academy, asked Hemmes to join him at DOT and help the nation's sorely beset cities save and improve their transportation systems.

Switch. Congress and business have criticized UMTA in the past for being long on studies and short on action. The 45-year-old Hemmes began to change this image immediately after he joined DOT in February at an annual salary of \$30,714. His first task was to request progress reports on research projects under way or planned, to determine if too much effort was being spent in any one area—information which had not been readily available before. In addition, UMTA in fiscal '71 will spend more for demonstration projects (\$11.5 million) than for all of R&D together (\$8.5 million). In 1969, \$3.7 million in the \$18.3 total budget was spent for demonstrations, and this year \$11 million was approved in the \$30 million budget.

Apart from larger responsibili-

NEW!

Is 0 x 0 really zero in your multiplier?

Accurate Analog Computing with Magnetic Multipliers

Product Accuracy
1%
Absolute

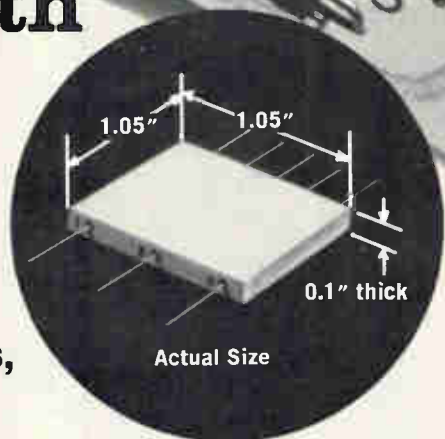

Flat Pak magnetic modulators, analog multipliers, demodulators mount directly on IC cards.

- Flat Pak design only 0.1" thick
- Zero Hysteresis
- No external pots

Product accuracy 1% absolute or 2 MV whichever is greater over the temperature range of -55°C to +125°C

- Hybrid assemblies mount directly on IC cards.
- Space saver design, typical dim. 0.1" thick x 1.0" x 0.75".
- Rugged design, extreme reliability. MTBF design goal 0.25 per million hours.
- Extremely low drift over -55° to +125°C range.
- Not affected by high intensity nuclear radiation.
- No external nulling or offset adjustments.
- No additional components or temperature compensation required.
- No external operational amplifiers required.
- ± 15 V DC power supply unless otherwise specified.
- Linearity: Better than 1% absolute or 2MV whichever is greater.
- Analog Multiplying Functions:

- ±DC X ±AC = AC
- ±DC X ±DC = ±DC
- AC X AC = AC
- ±DC X AC = ±DC
- AC X AC = ±DC

As an Analog Multiplier of a Bipolar DC signal times an AC signal, the output **product accuracy** is 1% of point, or 2 MV, whichever is greater over a dynamic range of 10,000:1 in each quadrant.

- Parameters over the temperature range of -55°C to +125°C :
- 1) Product accuracy 1% of point or 2 MV whichever is greater
 - 2) Zero Point Drift: ... Less than 2 MV of in phase component
 - 3) Gain Slope Stability: Less than 2% change
 - 4) Dynamic range and output wave quality independent of temperature variations
 - 5) Distortion: Less than 1%

Typical input/output parameters:
 X Signal: 0 to ±5V
 Y Signal: 0 to ±5V
 Output: 0 to 5V RMS across 5KΩ or greater

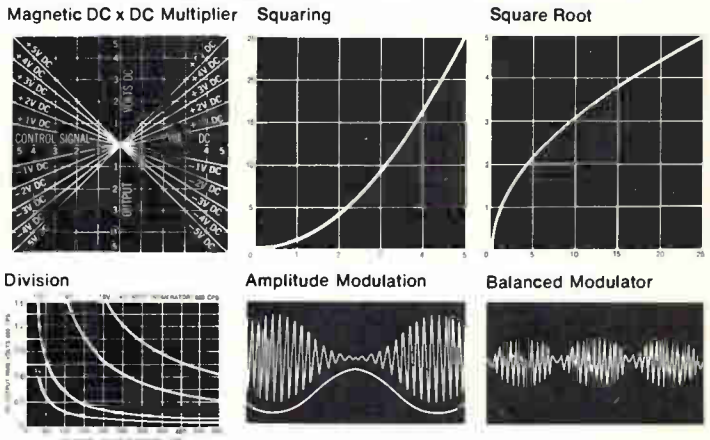

MAGNETIC MULTIPLIERS

Dynamic Product Range
80 db

Magnetic Modulators

Dynamic Range:
60 db

→ **GM INC.** → There is No Substitute for Reliability
GENERAL MAGNETICS, INC.
 135 Bloomfield Avenue, Bloomfield, New Jersey 07003

Overshadows All—

The Pan Man

SURVEILLANCE RECEIVING SYSTEM

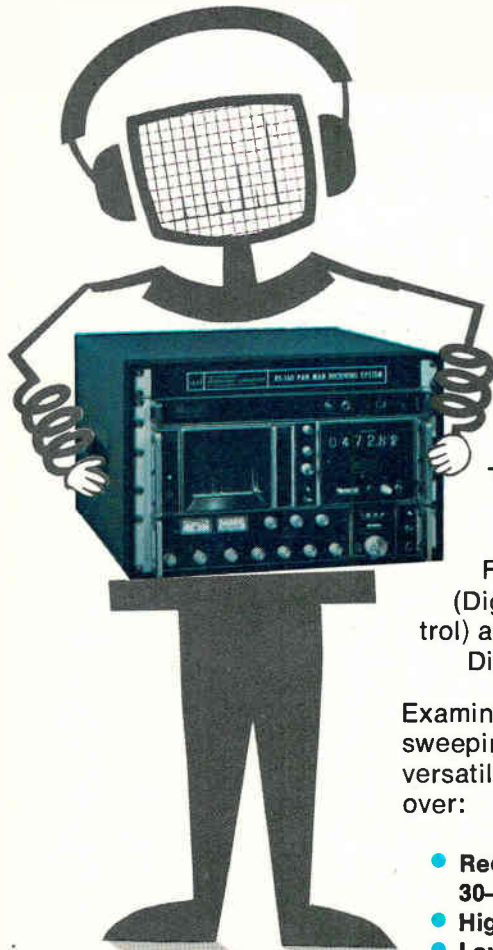

Without the shadow of a doubt, the WJ-RS-160 is unique in the surveillance receiver field. Especially now with the extension of its frequency range to 1000 MHz—covering 30–1000 MHz with six plug-in tuners.

The system consists of the Type 205 Sweeping and Manual Receiver, the DRO-308 six-digit Frequency Readout with DAFC (Digital Automatic Frequency Control) and the SM-7301 five-inch Signal Display with beam intensification.

Examine these attributes for a low-cost sweeping receiver that is compact and versatile, then write, call or hurry on over:

- Receives AM, FM, pulse signals 30–1000 MHz
- High dynamic range
- Low noise
- High spurious signal rejection
- Digital readout of tuned frequency with DAFC
- Versatile for airborne, ship, mobile and fixed site applications
- Compact: only 8¾ inches high by 19 inches wide
- Costs a fraction of what you'd expect

World's Largest Selection of Receiving Equipment for Surveillance, Direction-Finding and Countermeasures

CEI DIVISION



WATKINS-JOHNSON

6006 EXECUTIVE BOULEVARD, ROCKVILLE, MARYLAND 20852 • (301) 881-3300

Who's Who in electronics

ties, Hemmes finds the biggest differences between campus and government life—aside from the responsibility—to be the personal demands of the public to which he must respond and the lack of time to think about his programs. However, he now finds it easier to get access to principal figures in transportation policy, government, and politics and is excited about his potential to influence national policy and participate in the creation and direction of a major new national program aimed at solving urban transit problems.

Hemmes, his wife, the former Alexandra Ossipoff of Honolulu, Hawaii, and their three children reside in McLean, Va., a suburb of Washington.

Of the roughly 5,000 systems installed worldwide or on order from Honeywell's Computer and Communications group, about a third originate in the Computer Control division. That section is expected to grow by half again this year, and Robert C. Baron, its new head of



Baron

engineering, says: "My job is to see that this growth is implemented."

The 36-year-old Baron joined the

O.D. .021 ± .002
I.D. .012 $\begin{smallmatrix} +.002 \\ -.001 \end{smallmatrix}$



Counterbore .007 ± .001
Length .745 ± .005



Diameter .250 ± .003
± .003 on all dimensions



Thickness ± .0025



Hole .138 ± .002



I.D. .222 ± .004



Hole .094 ± .001
Thickness .070 ± .002

AlSiMag[®]

BRAND

PRECISION "AS FIRED" CERAMICS



Hole .0215 ± .0015
O.D. .045 ± .001



Grooves ± .003
Slot .020 ± .002
Thickness .180 ± .003



Hole .040 x .051 $\begin{smallmatrix} +.002 \\ -.000 \end{smallmatrix}$
Thickness .031 ± .002



Square Depression ± .002



Hole 1.145 ± .005
Thickness .360 ± .003



End View



30 holes .010 diameter



Angles ± 30°



Counterbore Diameter
.102 ± .001



Length .800 ± .005



O.D. .359 ± .002
Hole diameter ± .001



Wall Thickness .009

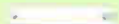

Hole Center .040 ± .001



Shank .216 ± .002

Illustrations approximately actual size. Significant "as fired" tolerances noted. Materials include alumina, steatite, Forsterite, beryllia and special compositions.

AlSiMag[®] ceramics offer you more materials, more processes, more engineering know-how . . . and the ability to hold certain critical dimensions to close tolerances "as fired".

CODE IDENT. NO. 70371

American Lava Corporation **3M**
COMPANY

PHONE 615/265-3411 • CHATTANOOGA, TENNESSEE 37405, U.S.A. A SUBSIDIARY OF

For service, contact American Lava representatives in Offices of Minnesota Mining and Manufacturing Company in these cities (see your local telephone directory): Boston: Needham Heights, Mass. • Chagrin Falls, Ohio • Chicago: Elmhurst, Illinois • Dallas, Tex. • Indianapolis, Ind. • Laurens, S. C. • Los Angeles, Calif. • Metropolitan New York: Ridgefield, N. J. • Up-State New York and Canada: Phoenix, N. Y. • Orange, Conn. • Philadelphia, Penn. • St. Louis: Lee's Summit, Mo. • South San Francisco, Calif. • Tempe, Ariz. • International: c/o American Lava Corporation, Chattanooga, Tenn. 37405, U.S.A., TELEX 558432

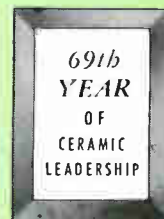

Circle 15 on reader service card

precision fix on performance.

FP SERIES ATTENUATORS

Each attenuator pad is individually calibrated at two frequencies—30 MHz and 1 GHz—Series FP-50 and FP-75 are color coded individually in standard resistor color code. Both the 50-ohm FP-50 and 75-ohm FP-75 are available in a wide variety of connectors, or in any combination of those connectors.

PRICES

FP-50: BNC, TNC—\$12.50; Type N, \$16.00.
FP-75: BNC, TNC, Type F—\$12.50; 70-ohm Type N—\$18.00.



KEY SPECIFICATIONS

Frequency Range:
Model FP-50, DC–2 GHz
Model FP-75, DC–1.2 GHz

Calibration Accuracy:
Model FP-50, ± 0.1 db;
Model FP-75, ± 0.2 db

Power Handling Capacity:
1 watt average, 1000 watts peak

ZM SERIES MINIMUM LOSS PADS



50/75 Ω 50/93 Ω
75/93 Ω 50/600 Ω

• **Frequency Range:**
Up to 1000 MHz

• **Connectors:**
Any combination of BNC, TNC, Type N, or Type F
Price: \$10.00

ALL MODELS AVAILABLE FROM STOCK. SPECIAL CUSTOMER DESIGNS SHIPPED WITHIN TWO DAYS AFTER RECEIPT OF ORDER.



Texscan CORPORATION

2446 NORTH SHADELAND AVENUE
INDIANAPOLIS, INDIANA 46219

Who's Who in electronics

division in 1960 as project manager, data automation, for three Mariner satellites after a stint at Epsco Inc. as a project engineer. In succession he became manager of the Semiconductor Techniques Laboratory, manager of the Module and Memory divisions, and head of digital products. Baron also found time to write several books and some 20 papers on spacecraft systems and circuit design while working his way through the chairs.

Support. In his new post, Baron is responsible for R&D for the entire product line and must "see that CCD is supported by its engineering efforts." To this end he has organized the division's engineering section, creating the new multiple post of chief engineer. There are six—one each in the areas of information systems (including communications and time sharing), the minicomputer, the Series 32 computer, digital products, controllers, and data acquisition and control. Each of these engineers gets a budget and a set of goals for the year, and is in charge of all engineering and programming involved in his area.

Creating the job of chief engineer, says Baron, "enables us to devote one man per business area, and guarantee that there's someone to worry about it." With a corresponding post in the marketing sector, a one-to-one relationship between engineering and marketing has been established. Moreover, Baron feels the reorganization "will focus on the success of our engineering efforts in specific areas and give the chief engineers more authority." The surge in ideas for new products appears to bear this out.

Several hundred of the division's nearly 3,000 employees work on new products, resulting in "a flood of new product plans," says Baron. Products in several new areas are being evaluated but he won't talk about them—"We don't know which will pay off," he says. However, he does note that several new products will be released each week throughout the year by the Computer Control division, with most of them in computer control applications for the minicomputer and time-sharing systems.

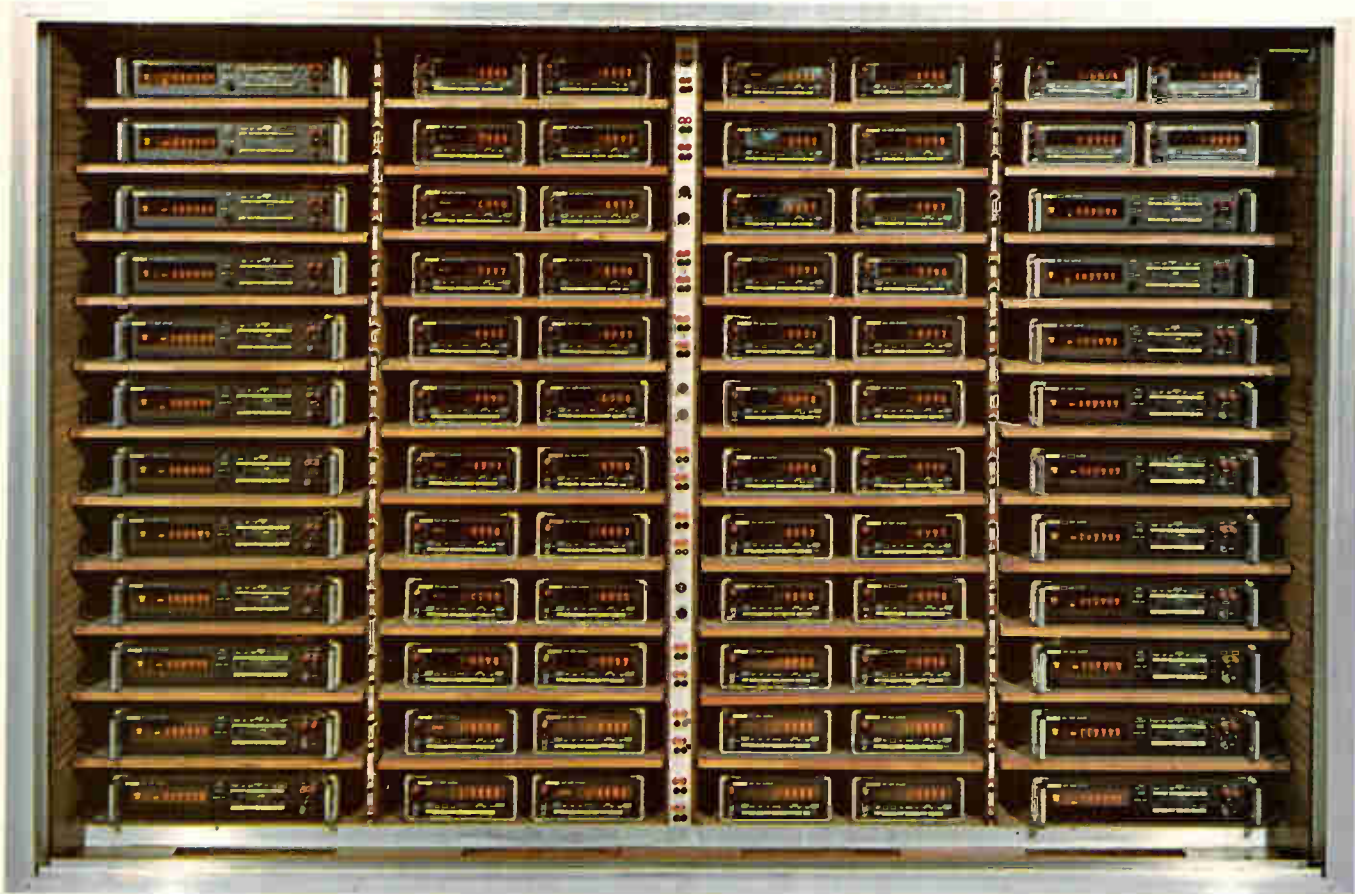

The seven day glitch killer

Every seven days we put another run of new Fluke digital voltmeters in the Fluke "hot box." Here, by continuously cycling the input voltage and "baking in" the instrument at 122°F, we catch the glitches and bugs caused by long term operation in a hot environment.

The "seven day glitch killer" is, of course, only one of the many check-out steps we go through. We control the critical parts by manufacturing all of our own resistors and printed circuit boards and by 100 percent dynamic testing of all active components.

Further, the new Fluke DVM's are designed from the ground up to give you long trouble-free life, low maintenance, and outstanding technical performance. For instance, the Model 8300A has only one-fifth as many components as comparable DVM's. And it's built to work in an 80 percent relative humidity.

In other words, the glitches go before you get the instrument. Another typical Fluke trick.

Model 8100A 0.02% Digital Multimeter with complete portability for only \$695.



Model 8300A Digital Voltmeter with total built-in systems capability for only \$1295.



Fluke, Box 7428, Seattle, Washington 98133. Phone: (206) 774-2211. TWX: 910-449-2850/In Europe, address Fluke Nederland (N.V.), P.O. Box 5053, Tilburg, Holland. Phone: (04250) 70130. Telex: 884-50237/In the U.K., address Fluke International Corp., Garnett Close, Watford, WD2 4TT. Phone: Watford, 27769. Telex: 934583.

One of the nicest things about our new MSI Multiplexer

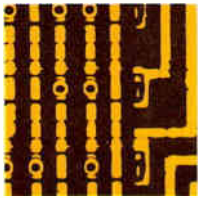

Even multiplexers can't escape the advantages of MSI family planning. (When we plan a family, we plan a *complete* family.) Here's proof: The 9322. Our third extremely versatile MSI multiplexer. A high-speed, quad two-input device that consists of four multiplexing circuits with common select and enable logic. Each circuit contains two inputs and one output.

Of course, the 9322 is ideal for moving data from a group of registers to a common output buss. But, being a very versatile device, it has many other applications. For example, it can be used to generate any four functions of two variables.

This latest addition to our MSI family gives us a well-rounded multiplexer capability. In addition to the 9322, we have the 9309 dual four-input multiplexer and the 9312 eight-input multiplexer which feature complementary outputs.

All three devices offer on-chip select logic decoding, fully buffered outputs, typical through delay of 9ns, and complete compatibility with Fairchild DT μ L, LPDT μ L, TT μ L and MSI families.

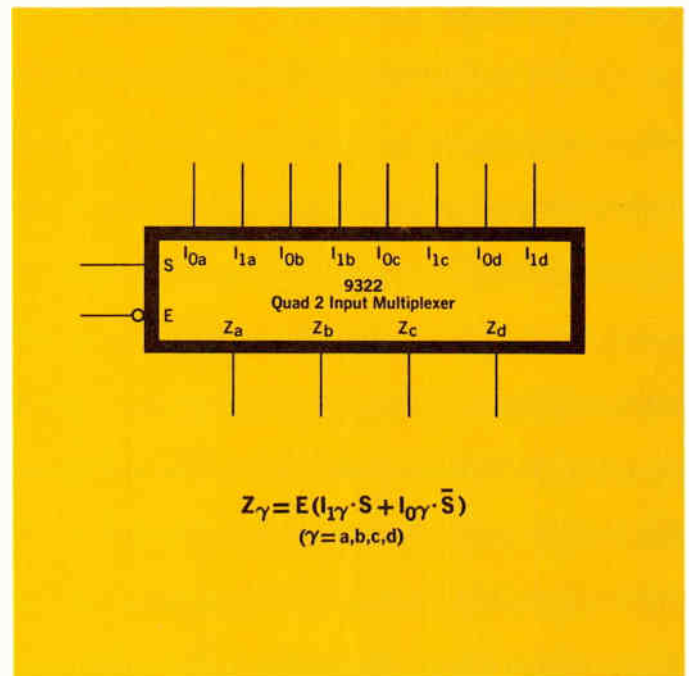

To order MSI Multiplexers, call your Fairchild Distributor and ask for:

PART NUMBER	PACKAGE	TEMPERATURE RANGE	PRICE		
			(1-24)	(25-99)	(100-999)
U6B930951X	DIP	-55°C to +125°C	\$15.80	\$12.70	\$10.60
U6B930959X	DIP	0°C to + 75°C	7.90	6.35	5.30
U4L930951X	Flat	-55°C to +125°C	17.40	14.00	11.70
U4L930959X	Flat	0°C to + 75°C	8.70	7.00	5.85
U6B931251X	DIP	-55°C to +125°C	15.80	12.70	10.60
U6B931259X	DIP	0°C to + 75°C	7.90	6.35	5.30
U4L931251X	Flat	-55°C to +125°C	17.40	14.00	11.70
U4L931259X	Flat	0°C to + 75°C	8.70	7.00	5.85
U6B932251X	DIP	-55°C to +125°C	15.80	12.70	10.60
U6B932259X	DIP	0°C to + 75°C	7.90	6.35	5.30
U4L932251X	Flat	-55°C to +125°C	17.40	14.00	11.70
U4L932259X	Flat	0°C to + 75°C	8.70	7.00	5.85

is the family it comes from.

We put together a family plan by taking systems apart. All kinds of digital systems. Thousands of them.

First we looked for functional categories. We found them. Time after time, in a clear and recurrent pattern, seven basic categories popped up: Registers. Decoders and demultiplexers. Counters. Multiplexers. Encoders. Operators. Latches.

Inside each of the seven categories, we sifted by application. We wanted to design the minimum number of devices that could do the maximum number of things. That's why, for example, Fairchild MSI registers can be used in storage, in shifting, in counting and in conversion applications. And you'll find this sort of versatility throughout our entire MSI line.

Finally, we studied ancillary logic requirements and packed, wherever possible, our MSI devices with input and output decoding, buffering and complementing functions. That's why Fairchild MSI reduces—in many cases eliminates—the need for additional logic packages.

The Fairchild MSI family plan. A new approach to MSI that's as old as the industrial revolution. It started with functional simplicity, extended through multi-use component parts, and concluded with a sharp reduction in add-ons. Simplicity. Versatility. Compatibility. Available now. In military or industrial temperature ranges. In hermetic DIPs and Flatpaks. From any Fairchild Distributor.

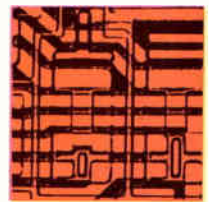

OPERATORS
9304 – Dual Full Adder/Parity Generator



LATCHES
9308 – Dual 4-Bit Latch
9314 – Quad Latch

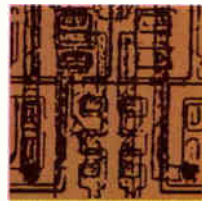

REGISTERS
9300 – 4-Bit Shift Register
9328 – Dual 8-Bit Shift Register

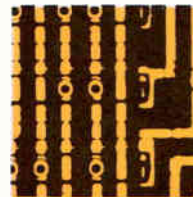

MULTIPLEXERS
9309 – Dual 4 Input Digital Multiplexer
9312 – 8-Input Digital Multiplexer
9322 – Quad 2-Input Digital Multiplexer

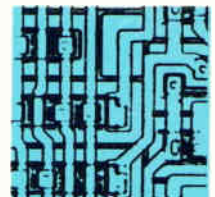

DECODERS AND DEMULTIPLEXERS
9301 – One-Of-Ten Decoder
9315 – One-Of-Ten Decoder/Driver
9307 – Seven-Segment Decoder
9311 – One-Of-16 Decoder
9317 – Seven-Segment Decoder/Driver
9327 – Seven-Segment Decoder/Driver

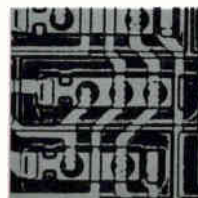

ENCODERS
9318 – Priority 8-Input Encoder

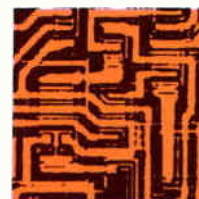

COUNTERS
9306 – Decade Up/Down Counter
9310 – Decade Counter
9316 – Hexadecimal Counter

FAIRCHILD
SEMICONDUCTOR

Film-Mets? Wirewounds? Or Cermet?

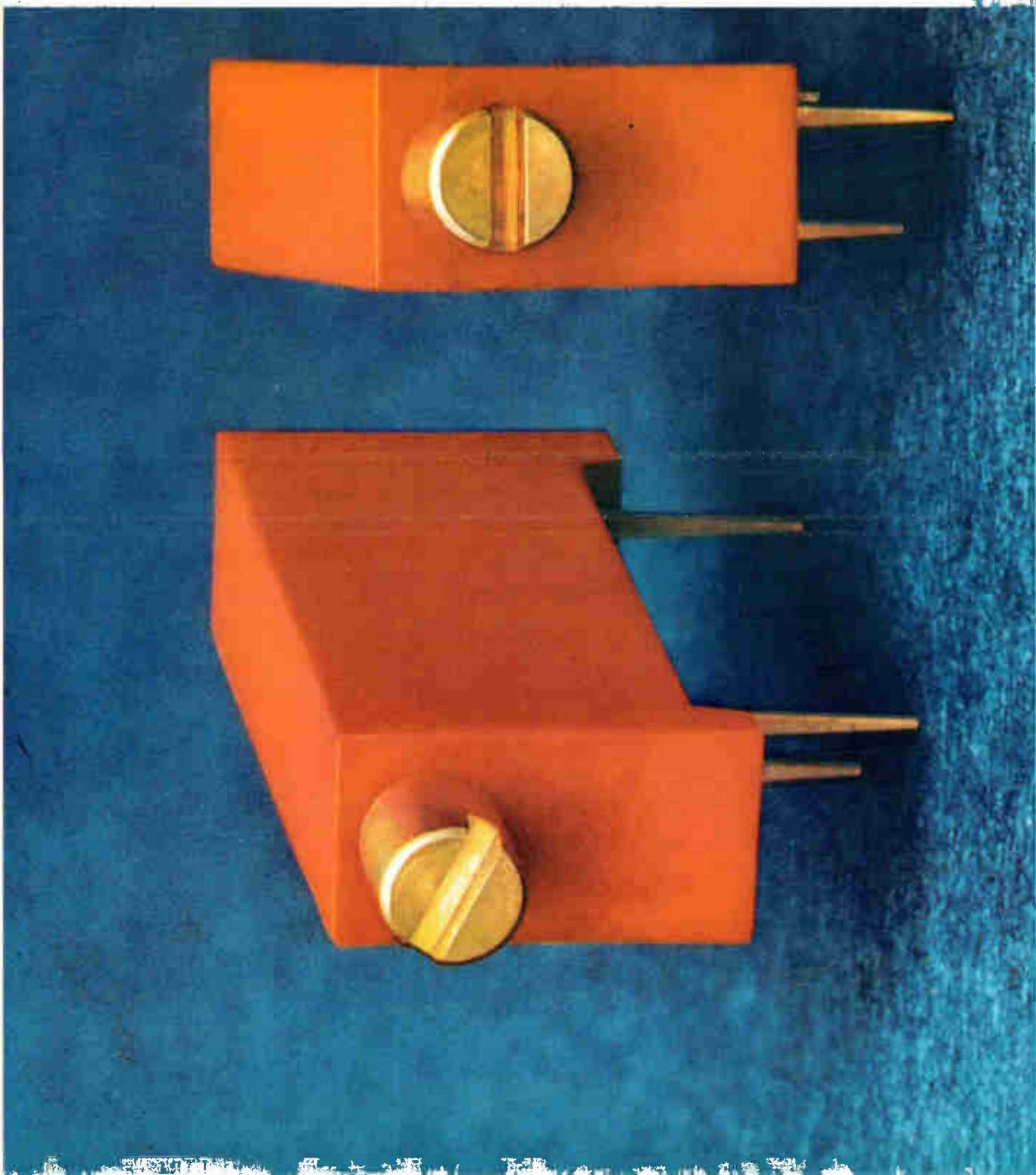

What our extra choice means to you.



It ends circuit design compromise.

Because now you can get the perfect match between design needs and trimmer performance.

Suppose you need infinite resolution, lowest noise characteristics and maximum contact setability. Then Film-Met™ would be your best choice.

But if it's infinite resolution and the widest resistance ranges you're after, then cermets would be best.

And of course, good old wirewounds still reign

supreme in lowest temperature coefficient of resistance and lowest contact resistance variation.

Only Amphenol has all three types—and in all the popular military and commercial sizes.

But you'll need more specs than this to determine the best trimmer for your application.

So send today for your free catalog. Or call your nearest Amphenol distributor. Amphenol Controls Division, Janesville, Wisconsin 53545.



AMPHENOL
THE BUNKER-RAMO CORPORATION

Circle 21 on reader service card

AIR TRAFFIC CONTROL



TOTAL ELECTRONIC
SYSTEMS CAPABILITY.
SPECIALISTS IN
TIME/FREQUENCY,
RADAR AND
DATA SYSTEMS
OFFERING RAPID
GROWTH.



P. O. BOX 222, BUFFALO, N. Y. 14226

22 Circle 22 on reader service card

Meetings

Calling all communicators

All roads for communications engineers will lead to San Francisco June 8-10 for the International Conference on Communications. Speakers will come from Australia, Austria, Belgium, Chile, France, England, Italy, Japan, the Netherlands, Mexico, Germany, Switzerland, Canada, and the U.S.

The conference, in the San Francisco Hilton, will consist of 48 technical sessions and 259 papers. The conference planners have set aside a session for late papers, and they indicate that a Russian delegation may present a group of papers on communications in the USSR.

The 259 papers will cover data transmission, telephone systems, radio systems—including microwave, millimeter waves, and lasers—computer communications, switching systems, antennas, circuit theory, and satellite operations. The emphasis of ICC, according to Allen Peterson, conference technical chairman, is on data communications as related to computers and data transmission.

Interface. The highlight session is a panel on communications for the communities of man and will focus on the problems of communicating technology to society. Panelists will be F.L. Bates of the University of Georgia, C. Cherry of the Imperial College of Science and Technology of London, H. Haymerle, Austria's ambassador to the United Nations, and H.E. Hoelscher of the University of Pittsburgh.

The session on regional communications satellite systems and technology will include a paper by a group from Stanford University on a low-cost educational tv receiver terminal. Another paper focuses on a multiple-beam antenna for regional communication satellites, while a third deals with Australia's domestic satellite communication system.

Computers will receive a good deal of the coverage, and a session featuring new approaches is the one on voice response from computers. IBM and Bell Labs will have papers. A session on computer com-

munication systems will explore data switching adaptive decision feedback equalizers, and a two-wire d-c baseband system for two-way simultaneous data transmission at high speeds.

Lasers. The sessions on millimeter waves will present papers on the capacity and limitation of these high-frequency systems with special emphasis on point-to-point communication. Laser communications will also be discussed. Among the papers of interest: a CO₂ laser system for space communication, avalanche diode oscillators, system considerations for millimeter-wave space communications, and millimeter-wave relay.

A session presented by IBM of France will highlight the IBM 2750 telephone system. Other sessions on customer telephone systems will hear papers on a new Stromberg-Carlson PABX and common-control key telephone system.

For further information, contact Allen Peterson, Stanford University, Palo Alto, Calif.

Packing it in at MIT

With the growth in large-scale monolithic circuitry, the device package has become a cause of controversy—and as LSI devices grow larger, some experts expect trouble predicting where the device ends and the subassembly begins. At the outside, the 1970's will be a period of flux for packaging engineers. And so nobody east of Chicago who's working with electronic packaging should miss the first annual Eastern Electronics Packaging Conference. It is to be held at MIT, June 8 and 9.

Conference chairman Jack J. Staller, president of the Microsystems Technology Corp., hopes for controversy, and he'll probably get it. Men holding almost any point of view on almost every aspect of packaging from device encapsulation to back-panel wiring and in-

(Continued on p. 24)

TI's quiet revolution in MSI value

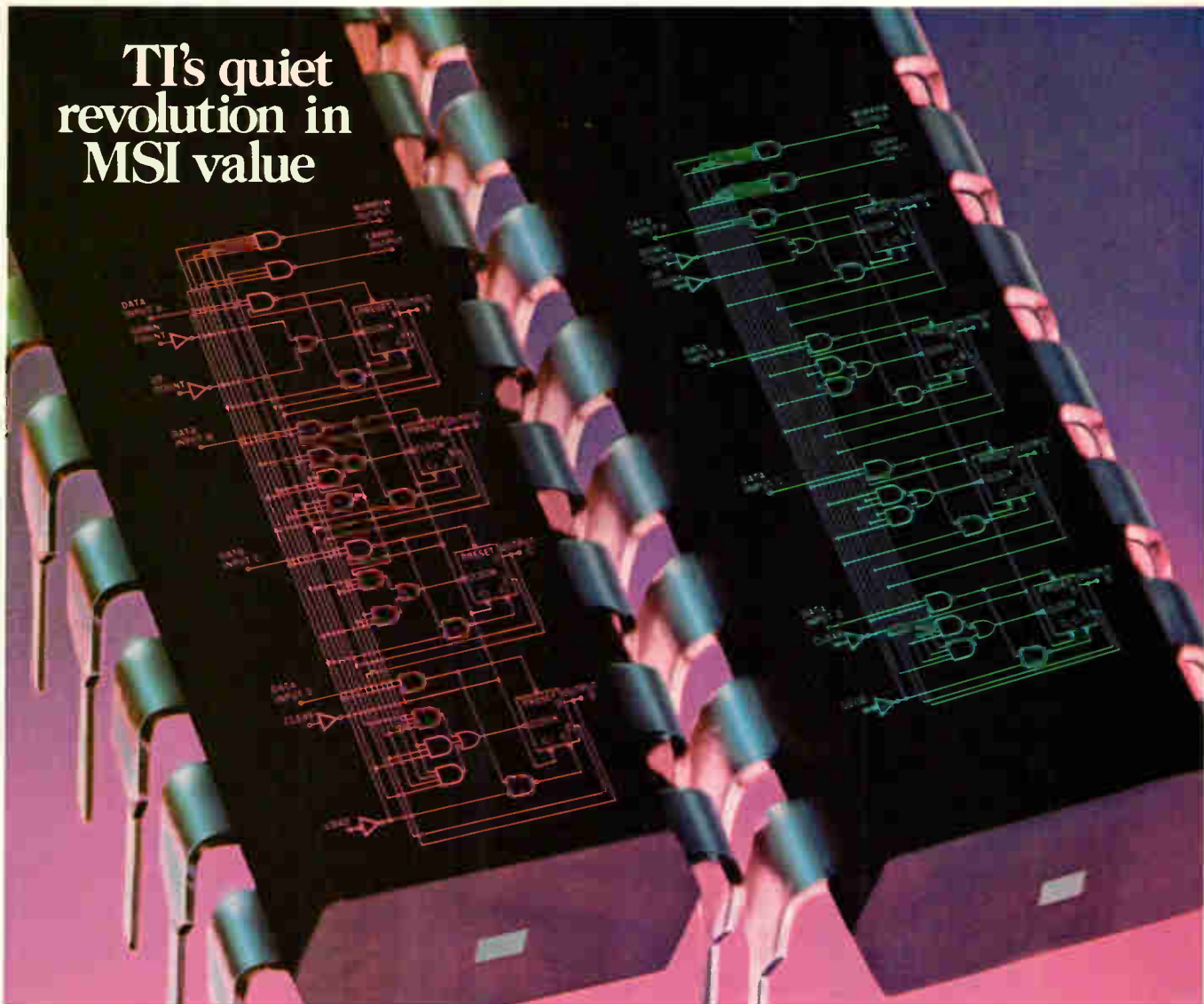

Your choice in up/down counters is up. And the price is down.

Count on TI to introduce new TTL/MSI counters priced at about a third of what you usually pay.

The SN54/74192 is a BCD 4-bit up/down counter. The SN54/74193 is a binary 4-bit up/down counter. In 100-999 quantities, the SN74192 and SN74193 both sell for a down-to-earth \$7.70, plastic DIP. That's the lowest price going—brought down by TI's big yields and manufacturing know-how.

And these counters are ready now for immediate delivery. That's

why you may want to order them instead of the equivalent DM8560 and DM8563. Not to mention the price.

These 54/74 devices are virtually universal counters. They are synchronous and fully presettable. They may be cascaded to n bits, and have fully independent clear. Propagation delay is 27 ns typ; count frequency is 32 MHz typ. You can choose the full military temperature range of -55°C to 125°C or the industrial range of 0°C to

70°C ...in either plastic or ceramic DIPs.

Be one-up on up/down counters. Send now for the new 184-page supplement to our TTL catalog. Circle 280 on the Reader Service Card or write Texas Instruments Incorporated, P.O. Box 5012, M.S. 308, Dallas, Texas 75222. That's where the quiet revolution is going on. Or see your authorized TI Distributor.



TEXAS INSTRUMENTS INCORPORATED



Champagne quality RFI/EMC filters at beer prices

A toast! May you and your products benefit from finer, lower-cost filters from Captor Corporation. Captor combines knowledgeable application engineering with a quality assurance program that extends through every manufacturing step from order entry to final packaging. Costs are closely controlled because production is geared to a specific electronic components family: miniature RFI/EMC filters, communications and security filters, and custom designed filters and assemblies. Captor's new environmentally conditioned plant is designed expressly for fast, efficient manufacture of this integrated product line. Write for our capabilities brochure today and drink in the whole story.

**CAPTOR**
CORPORATION
Electronics Division

5040 Dixie Highway, Tipp City, Ohio 45371, Phone: (513) 667-8484

Meetings

(Continued from p. 22)

dustrial design will speak.

From the gun. This isn't one of those conferences that lets you ignore its first session. At this one—a panel—Robert McMahon of Lincoln Laboratory will participate as head of the IEEE Computer Packaging subgroup and at the same time is sure to have to defend his beam-lead substrate device-packaging concepts. On the same panel are men who will hit most other definitions of packaging: W.J. Allen of Raytheon will cover sophisticated packaging for aerospace systems; D. Hartman of Hughes will talk about his work in automated design, p-c-board layout, and artwork generation; Glen Madland, once with Motorola and now president of his own Microtronic Technology Inc., will show how the closing gap between device and subassembly is changing the entire mechanical aspect of electronic design.

In Session 2, packaging of hybrids and IC arrays is the topic. Session 3 will tell how some in industry are hooking these devices together into subassemblies. Session 4 will discuss subassembly interconnection. And Session 5 will concentrate on the most important topic to any company after the above areas have been explored: design and production automation.

The gamut. So, if your interests run to hybrid microelectronics already judged by NASA good enough for the Grand Tour deep space probes (D. A. Graybill, General Dynamics, in Session 2); or to MIT's view of the impact of LSI packaging on the physical design of systems (Jacob H. Martin of the C. Stark Draper Laboratories, also in Session 2); or to the many trade-offs between wired interconnections and multilayer p-c boards—as in Session 3—plan to stay all day Monday.

Tuesday's sessions include a paper on applying microwave stripline principles to high-speed logic interconnections by Tore N. Anderson, Winchester Electronics, in Ses-

(Continued on p. 26)

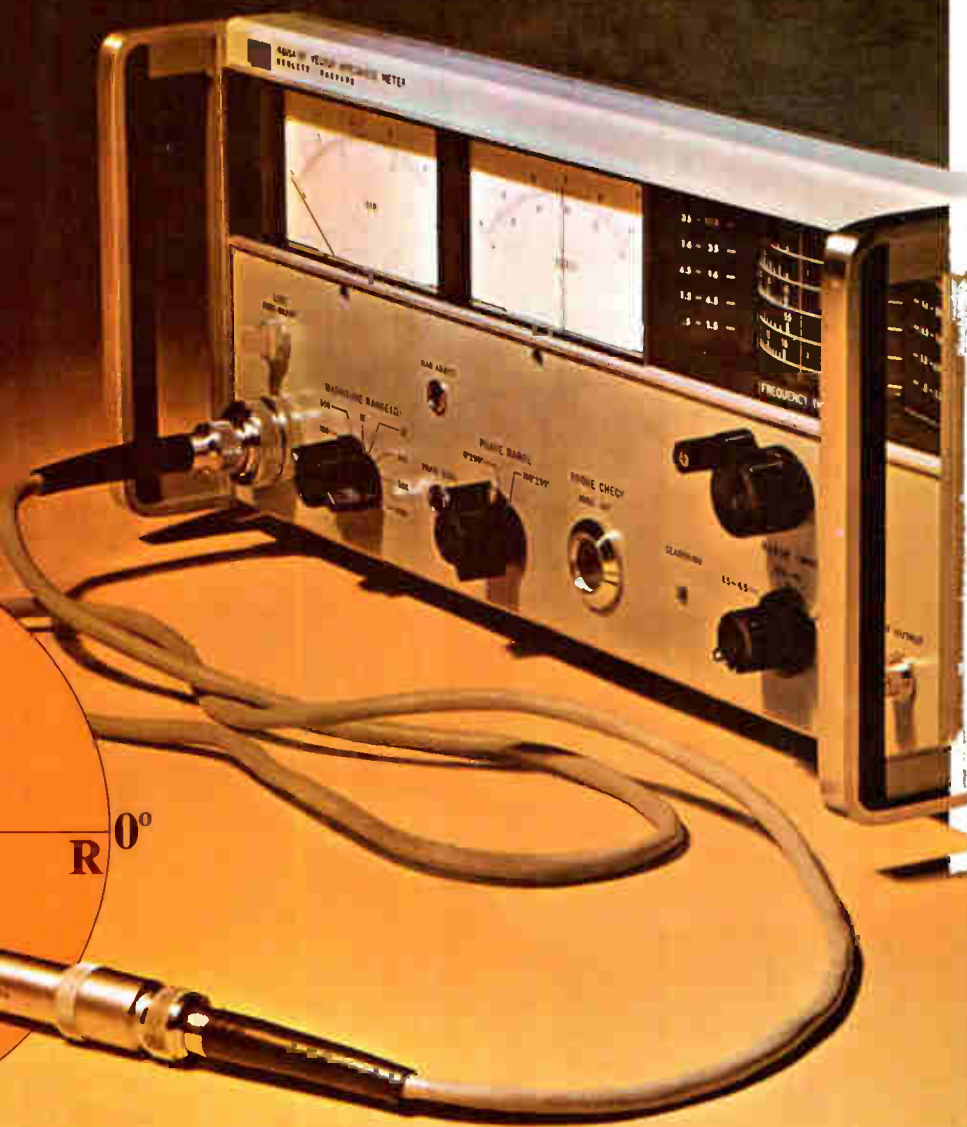
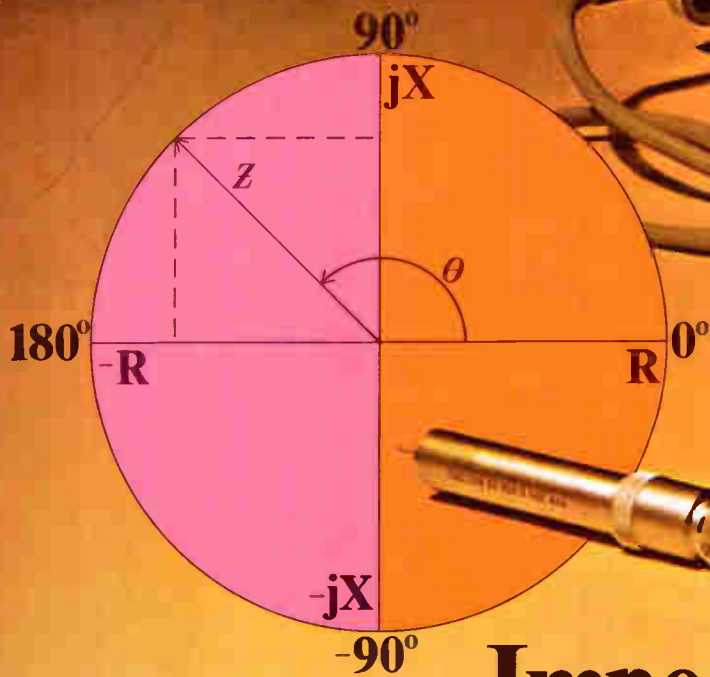

Impedance Measurement goes full circle

The HP 4815A RF Vector Impedance Meter will conveniently measure complex impedance over the entire impedance domain. You get instant, direct readout of impedance magnitude from 1 ohm to 100K ohms and phase angle from 0 to 360°, over a frequency range of 500 kHz to 108 MHz. Now you can easily measure impedances with negative real parts, often present in feedback amplifiers with small phase margin. To measure impedance at multiple frequencies, simply set the frequency, probe, and read. No nulling and balancing, as with conventional bridge measurements.

A convenient probe lets you measure directly in active circuits to determine driving point impedance under actual operating conditions, with minimum residual effects. For example, amplifier input or output impedance can be continuously monitored while bias, feedback, load, and frequency are varied. In-circuit measurements for determining loop gain and phase margin can also be made.

The 4815A is also ideal for evaluating passive devices, such as components and networks. Use it to characterize transformers, resonant circuits, transmission lines, filters, and crystals. You can measure at

actual operating frequencies and make network adjustments while impedance parameters are monitored. For example, antenna/transmission line matching networks can be quickly adjusted. Price: \$2650.

To learn more about how easy it is to use impedance for evaluating circuits and components, request Application Note 86 and a special impedance issue of the HP Journal. If you would like to discuss a particular application, call your local HP field engineer or write: Hewlett-Packard, 100 Locust Ave., Berkeley Heights, N.J. 07922. In Europe: 1217 Meyrin-Geneva, Switzerland.

THE New GENERATION SCR

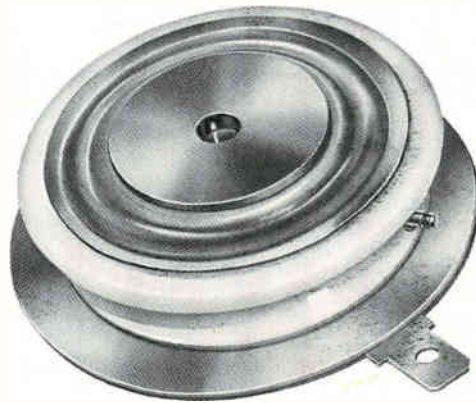

DISC PACKAGED REGENERATIVE GATE SCR's

Operation to 20 KHz with low switching losses
⊕ di/dt capability to 800 A/μsec. ⊕ low power gate drive ⊕ dv/dt capability to 500 V/μsec.
⊕ 175 and 370 amperes RMS ⊕ turn-off time capability to 10 μsec. ⊕ also available in stud type package to 470 amperes RMS.

For additional information and application assistance, write or call National Electronics, Inc., a varian subsidiary, Geneva, Ill. 60134, phone (312) 232-4300.

NATIONAL ELECTRONICS, INC.
a varian subsidiary

*1969 COMPETITION WINNER
Cited by Industrial Research Inc.
as one of the 100 most
significant technical products of the year.*

A NATIONAL® exclusive.
Patent No. 3,486,088



Meetings

(Continued from p. 24)

sion 4. Also in the fourth session is a paper by Loral's Allan Chertoff and James Foti dealing with an extension on their quick-turnaround approach to chip interconnection—only this time dealing with a quick-turnaround subassembly interconnection approach.

For further information contact, Jack J. Staller, President, Microsystems Technology Corp., 53 B St., Burlington, Mass. 01803

Calendar

Electronic Components Conference, IEEE and the Electronic Industries Association; Statler-Hilton Hotel, Washington, May 13-15.

Medical Electrical Safety, IEEE, Group on Engineering in Medicine and Biology; Marriott Motor Hotel, Philadelphia, May 15.

Packaging Industry Technical Conference, IEEE; Cherry Hill Inn, N.J., May 19-21.

Materials for Optical Systems, Optical Society of America; Kresge Auditorium, Little Theater, Massachusetts Institute of Technology, Cambridge, May 20-21.

Information Display Evolution and Advances, Society for Information Display; Statler Hilton Hotel, New York, May 26-28.

Society of Automotive Engineers Spring Meeting; Roosevelt Hotel, New Orleans, May 27-28.

Conference on Precision Electromagnetic Measurements, IEEE; National Bureau of Standards, Boulder, Colo., June 2-5.

Silicon Device Processing, American Society for Testing and Materials; National Bureau of Standards, Gaithersburg, Md., June 2-3.

National Cable Television Association Convention; Palmer House Hotel, Chicago, June 7-10.

Eastern Electronics Packaging Conference, IEEE; Massachusetts Institute of Technology, Cambridge, June 8-9.

International Conference on Communications, IEEE; San Francisco Hilton Hotel, June 8-10.

P. C. board courtesy of
Monitor Systems
an Aydin Company

Pick your own happy ending.

All good things, including circuit boards, must come to an end.

That's where we come in. We've got the happy ending patented.

Four times. (Pat. nos. 2,248,686; 2,294,056; 3,182,276; 3,208,026.)

In all the configurations you need. Four plug styles. Ten receptacle styles. For direct staking, or with their own insulator. With or without card guides. With or without guide pins. With any number of contacts (up to 135, on one triple-decker receptacle).

Every one meets Mil-E-5400 including the new revision "K", which makes metal-to-metal contacts mandatory.

Our Varicon™ metal-to-metal contacts are patented — and famous, in their quiet way. Because, in millions of operating hours, not one has failed.

The Varicon contacts have a unique fork-like design, with four large, coined, mating surfaces that form a firm gas-tight seal. Even after being mated for years, they remain clean and unoxidized. They have, and

keep, a low contact resistance and high current capacity. And they're exceptionally resistant to shock and vibration.

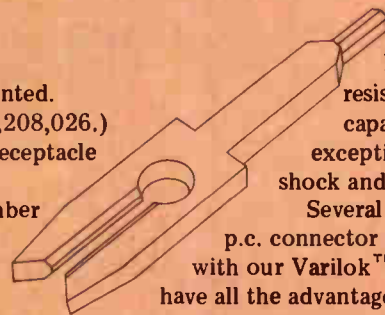

Several members of our p.c. connector family come with our Varilok™ contact. These have all the advantages of the Varicon contacts — except that you can insert and remove them from the receptacle yourself.

They're available by the handful for small scale production and on 1800-contact reels for use with automatic crimping equipment.

They're all described in our printed circuit connector guide. To get your copy, write, wire, call or TWX us. Elco Corporation, Willow Grove, Pa. 19090. (215) 659-7000. TWX 510-665-5573.



ELCO Printed Circuit
Connectors

Circle 27 on reader service card

**The world's most unpre
now has the most
reliable terminations.**

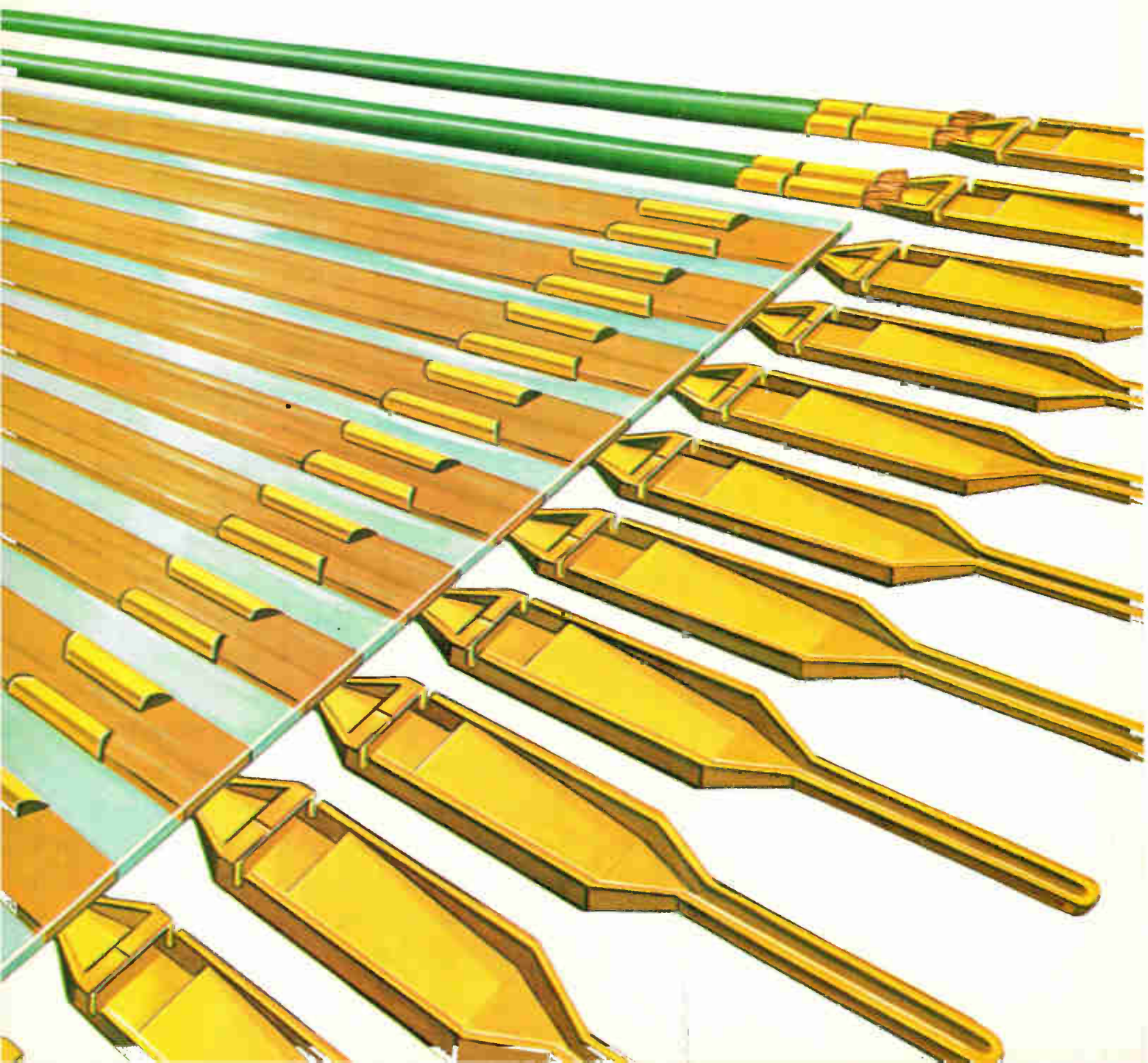

pared flat cable

We completely eliminated all flat cable preparation. And replaced it with a Mechanical Termination Technique.

One crimp for each conductor path. That's all it takes to terminate flat cable with our unique method. And it makes absolutely no difference if you crimp on the contacts at the ends of the cable or the middle. Our automatic machine does both. At money-saving speeds.



We displace the insulation, then crimp. The contacts we use are "U" shaped. The edges are sharp enough to penetrate the cable insulation.



These legs straddle the conductor, and are then rolled 180° to pierce the insulation again. This displacement makes reliable positive contact. Two protruding lances on the under side of the "U" pierce the insulation from the other side. The result is four metal-to-metal-to-metal gastight area contacts in each termination with no deforming effects on the conductor.

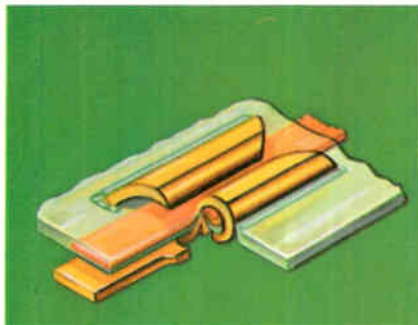

Up to 3,400 terminations an hour. Honest. With a 29 position cable you can really get 3,400 finished terminations an hour. With a 19 position cable you get 2,700. Absolutely no cable preparations — just cut and terminate. It's all done automatically with our precision engineered machine that you can use in your own plant.



Three types of contacts. Crimp snap-in contacts. Square pins .025 inch. And flat tabs for welding or flow soldering to PC boards or components. They can all be crimped to the cable at the ends or any point along its length.

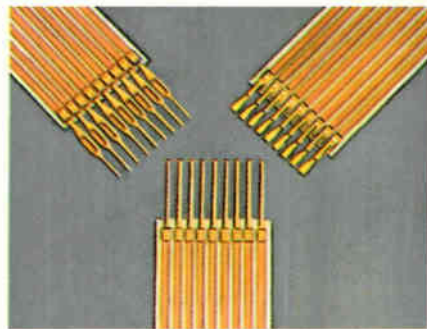

Application. These same pins and sockets can be snapped into housings for the following applications: cable to cable connector, cable to printed circuit board connectors and cable to basic back panel grids commonly used in point-to-point wiring systems. All the above applications can be accomplished with either flat cable or round wire.

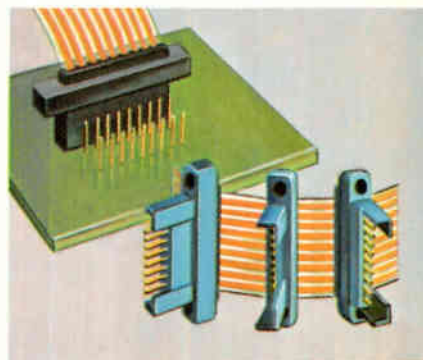

Your costs go down as fast as the crimps. Just let the machine do its job and you'll get the lowest installed costs of any flat cable termination method.

For AMP's Flexible Cable Connector Catalog write **Industrial Division, AMP Incorporated, Harrisburg, Pa. 17105.**

AMP
INCORPORATED



1400V, 5.0A transistors. Delivering now, in quantity.

The Kokomoans' new DTS 802 and 804 NPN triple diffused silicon high energy transistors are here. You can order them from your Delco Radio distributors now in sample or production quantities. They were specially designed for high voltage inductive switching from rectified 3 phase 220 line, and magnetic deflection circuits in large screen color TV receivers.

They've been application-tested from production lots by

prospective users with stringent reliability requirements. They do the job. And their energy handling capability is verified by Delco Pulse Energy Testing.

The high energy reliability of Delco silicon power transistors has earned them a reputation for survival in the toughest switching jobs. It's a built-in advantage, vitally important where circuits are subject to transients or fault conditions.

Now you can simplify the design of high energy circuits with reduced size, weight, and component cost. Convert HV tube circuits to solid state reliability without the complexity associated with high current, low voltage devices. And fewer components mean higher reliability.

For prices and delivery or additional data on Delco's new DTS 802 and 804 contact us or your nearest Delco Radio distributor.

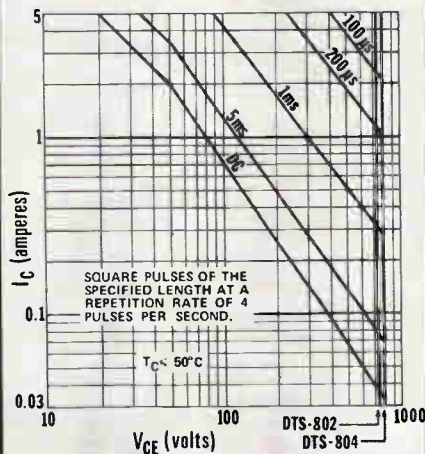

SAFE OPERATING CURVES

PARAMETER	DTS-802	DTS-804
Collector to emitter voltage (V_{CEX})	1200V max.	1400V max.
Collector to emitter voltage (V_{CE0})	1000V max.	1000V max.
Sustaining voltage ($V_{CEO\ sus}$)	750V min.	800V min.
Emitter to base voltage (V_{EBO})	5V max.	5V max.
Collector current (I_C) continuous	5A max.	5A max.
h_{FE} , $I_C = 3.5A$, $V_{CE} = 5V$	2.2 min.	2.2 min.
*P.E.T.; $I_C = 7A$, $V_{CE} = 200V$, $t_p = 300\ \mu\text{sec}$, duty cycle <4%	420 mJ min.	420 mJ min.

***Pulse Energy Test**

Available in solid copper JEDEC TO-3 package.

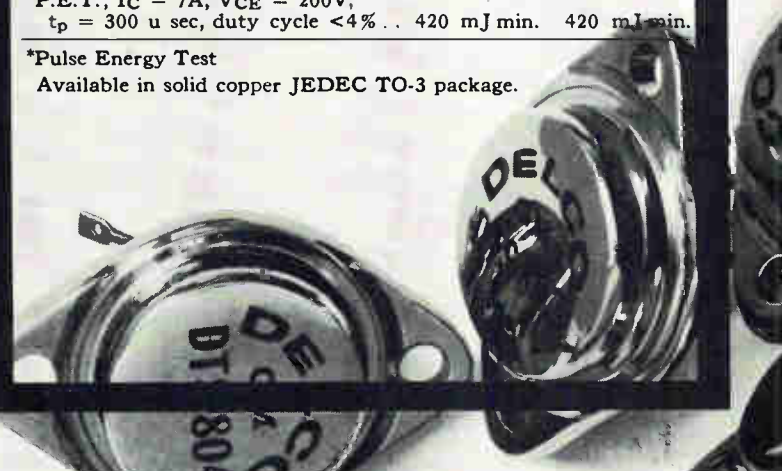

From these Delco Semiconductor distributors.

- ALA., BIRMINGHAM • Forbes Distributing Co., Inc. (205)-251-4104
- ARIZ., PHOENIX • Sterling Electronics, Inc. (602)-258-4531
• Hyer/Cramer Electronics, Inc. (602)-263-1112
- CAL., LOS ANGELES • Kierulff Electronics, Inc. (213)-685-5511
• Radio Products Sales, Inc. (213)-748-1271
- CAL., PALO ALTO • Kierulff Electronics, Inc. (415)-968-6292
- CAL., SAN DIEGO • Milo of California, Inc. (714)-232-8951
- COLO., COLORADO SPRINGS • L. B. Walker Radio Co. (303)-636-1661
- COLO., DENVER • L. B. Walker Radio Co. (303)-935-2406
• Hyer/Cramer Electronics Inc. (303)-758-2100
- FLA., MIAMI • Mountain Electronics, Subsidiary of Avnet, Inc., (305)-634-4556
- FLA., WEST PALM BEACH • Mountain Electronics, Subsidiary of Avnet, Inc., (305)-833-5701
- ILL., ROSEMONT • F-J-R/Midwest, Inc. (312)-678-8560
- ILL., SKOKIE • Merquip Electronics, Inc. (312)-282-5400
- IND., INDIANAPOLIS • Graham Electronics Supply, Inc. (317)-634-8486
- MD., BALTIMORE • Radio Electric Service Co. (301)-823-0070
- MASS., NEWTON • The Greene Shaw Co., Inc. (617)-969-8900
- MICH., KALAMAZOO • Electronic Supply Corp. (616)-381-4624
- MICH., ROMULUS (Detroit) • Harvey Radio Co. (313)-729-5500
- MINN., MINNEAPOLIS • Stark Electronics Supply Co. (612)-332-1325
- MO., KANSAS CITY • Walters Radio Supply, Inc. (816)-531-7015
- MO., NO. KANSAS CITY • ECI Semiconductors, Inc. (816)-221-2400
- MO., ST. LOUIS • Electronic Components for Industry Co. (314)-647-5505
- N.J., CLIFTON • Eastern Radio Corporation (201)-471-6600
- N.M., ALBUQUERQUE • Hyer/Cramer Electronics Inc. (505)-265-5767
• Sterling Electronics Inc. (505)-247-2486
- N.Y., BINGHAMTON • Federal Electronics, Inc. (607)-748-8211
- N.Y., NEW YORK • Harvey Radio Co., Inc. (212)-582-2590
- N.Y., WOODBURY, L.I. • Harvey Radio Company, Inc. (516)-921-8700
- OHIO, CINCINNATI • United Radio, Inc. (513)-761-4030
- OHIO, CLEVELAND • The W. M. Pattison Supply Co., Industrial Electronics Division (216)-441-3000
- OHIO, DAYTON • F-J-R/Ohio, Inc. (513)-278-9411
- OKLA., OKLAHOMA CITY • Radio, Inc. (405)-235-1551
- OKLA., TULSA • Radio, Inc. (918)-587-9123
- PENN., PHILADELPHIA • Almo Electronics, Division of Sterling Electronics (215)-676-6000
- PENN., PITTSBURGH • RPC Electronics (412)-782-3770
- S.C., COLUMBIA • Dixie Radio Supply Co., Inc. (803)-253-5333
- TEXAS, DALLAS • Adleta Electronics Company (214)-742-8257
- TEXAS, FORT WORTH • Adleta Electronics Co. (817)-336-7446
- TEXAS, HOUSTON • Harrison Equipment Co., Inc. (713)-224-9131
- UTAH, SALT LAKE CITY • Hyer/Cramer Electronics Inc. (801)-487-3681
- VA., RICHMOND • Meridian Electronics, Inc., a Sterling Electronics Company (703)-353-6648
- WASH., SEATTLE • Kierulff Electronics, Inc. (206)-763-1550
- WASH., TACOMA • C & G Electronics Co. (206)-272-3181
- CANADA, ONT., SCARBOROUGH • Lake Engineering Co., Ltd. (416)-751-5980

Kokomo's Regional Headquarters, Union, New Jersey • 07083, Box 1018 Chestnut Station, (201) 687-3770 ■ Santa Monica, Calif. • 90401, 726 Santa Monica Blvd., (213) 870-8807 ■ Chicago, Illinois • 60656, 5151 N. Harlem Avenue, (312) 775-5411 ■ Kokomo, Ind. 46901, 700 E. Firmin, (317) 459-2175 Home Office ■ *Office includes field lab and resident engineer for application assistance.

THE KOKOMOANS ARE IN POWER
DELCO RADIO
DIVISION OF GENERAL MOTORS
KOKOMO, INDIANA



MARK OF EXCELLENCE

Introducing the DATA-PAC family: Compatible from logic modules to minicomputers.

If you build digital systems, make life easy for yourself. Look into Honeywell's DATA-PAC family of digital products.

There are logic modules. Core memory systems. Controllers. Minicomputers. Analog interface modules. Hardware. Power Supplies. Accessories.

Every DATA-PAC product is compatible logically, electrically, and mechanically. Which lets you do something unique: pick precisely the items you need,

join them, attach the cables . . . and go.

You use common documentation. You don't have to select or design different power supplies and interfaces. You get your system together quickly, easily, economically. And just the way you planned it.

Our new DATA-PAC Family Brochure gives you all the facts. Write for it today. But whatever you do, consider the alternative: Honeywell, Computer Control Division, Framingham, Massachusetts 01701.

The Other Computer Company:
Honeywell

Circle 32 on reader service card



Electronics Newsletter

May 11, 1970

Air Force may ask for proposals on I/CNI study

The Integrated Communications, Navigation, and Identification approach to avionics may take a step toward hardware development this month, according to Col. Waldo E. Bertoni, chief of the communications unit for the Air Force Electronic Systems Division. If fiscal year 1970 funds can be released, ESD will quickly request proposals for a six-month study for what is called U/CNI (for Unified/CNI). Bertoni isn't putting a price tag on the multicontractor study effort, but allows nine months for evaluation afterward, and implies that it may be possible to ask for bids on prototype hardware late in 1971 or early in 1972.

Meanwhile the low-cost CNI system [*Electronics*, July 21, 1969, p. 115] proposed as a technology demonstrator is said to have proven unnecessary. "Just about every technique we need is already or almost on the shelf," says Bertoni.

During the briefings that led to the junking of the so-called thin-thread CNI, ESD also may have found the way to phase in CNI without massive dumping of existing avionics. Project manager Lt. Col. Thronton Doss says U/CNI probably would use a time-division multiplexed sampling system to tap the output of each avionic black box in quick succession, and then transmit their outputs to the ground digitally.

Viatron cuts payroll in drive for profit

While denying rumors that its backers are pressing it—and announcing a price rise—Viatron has released 294 nonproduction personnel—including 22 engineers. Also, all employee members of the board of directors have taken 25% pay cuts. The reason, according to executive vice president Joseph Spiegel: the company is determined to turn a profit this month.

"No one critical to product development or production has been let go," says Spiegel. As for the cash-flow rumors, he adds: "We have no senior debt, and there's plenty of cash in the bank." He also points out that those who leave will take their stock options with them. Still, Viatron, whose System 21 display terminal was designed to lease for \$39 a month in its simplest configuration, lost \$9.47 million on sales of less than \$1 million during the year ended last October.

Viatron's vendors appear to be taking the news in stride. One MOS supplier says that Viatron "almost does business COD—none of this 120-day accounts-receivable stuff."

Meanwhile, Viatron is gearing to produce more than 850 data entry consoles in May; March production was 613 units. Spiegel says backlog is rising at about 15% per month. And at the Spring Joint Computer Conference, the firm showed a TTL-prototype of its new 16-bit 2140/2150 computer. Insiders say Viatron came within one wafer of showing an all-LSI machine; reason is that Viatron still is zeroing in on self-aligned-gate processing. Probe yields are running about 40%—"embarrassingly low," according to Jay R. O'Donald, array engineering manager—but rising fast toward the target of 70%.

TRW lists MIC's putting out 10 watts

TRW's Semiconductor division is extending its power-at-frequency technology from discretely into microwave integrated circuits. The division will announce a line of standard hybrid power-amplifier modules within the next two months, probably including six or seven devices ranging in output up to 10 watts at 2 gigahertz. Gains as high as 23 decibels

Electronics Newsletter

have already been achieved, with a 20% bandwidth, in units being made for custom applications.

TRW Semiconductor officials believe they are first into production with outputs up to 10 watts in microwave IC's and add that the forthcoming standard units will be the first on the market, ahead of developmental efforts under way at RCA [*Electronics*, April 14, 1969 p. 100] and Texas Instruments. Small-quantity prices will be about \$1,000, but they'll drop "well below that" for 100 or more, one spokesman says. He sees the power MIC amplifiers being used in telemetry, industrial microwave communications, and phased-array radar.

SAM-D flying right on course

Apparently recovered from last fall's Pentagon rumblings about technical difficulties, the Raytheon Co. says that the SAM-D missile development phase is right on schedule. There had been a budget cut caused by slippage in the program [*Electronics*, Nov. 10, 1969, p. 63], but House slashes were restored later.

Floyd Wimberly, the Raytheon vice president who heads the SAM-D program, says that only a minor hitch in range instrumentation last month at White Sands prevented the firing of the first locked-fin propulsion test vehicle. By autumn, he adds, the missile should be in test with fins unlocked for aerodynamic and control checks.

Also, the SAM-D phased array radar antenna—a horn-lens combination with about 6,000 individual phase shifters—exceeded performance targets for gain, side lobe suppression, and monopulse null depth in its very first test. Thus, integration of the radar, guidance, and computer systems at Raytheon's Bedford laboratories also is on time. Wimberly expects a demonstration of the system's electronics by next spring.

Raytheon and the Army already are beginning to work out the detailed engineering development of the SAM-D; Wimberly predicts that the largely digital system will use as few as 40 interchangeable IC modules to keep spares and maintenance overhead as low as possible and operational readiness well above 90%.

NASA budget still unsure

NASA has far from won its budget ballgame with Congress, despite the surprisingly small \$30 million token cut made by the House last month. The House voted to authorize \$3.6 billion for the space agency in fiscal 1971—\$268 million more than the amount sought by the Administration. NASA didn't really expect to get the nearly \$300 million added by the House Committee on Science and Astronautics and is unsure how the full House cuts of \$14.5 million for the expanded Apollo program and \$15.5 million from the larger Space-Flight Operations program might affect them.

The Senate version of the bill may not get to the floor until the week of May 11, because of more pressing business—chiefly the Senate's concern over U.S. involvement in Cambodia. However, last month the Senate Aeronautical and Space Sciences Committee cut the Administration's \$3.3 billion request by \$17 million.

Game of the name

RCA finally has the right to call its video playback system "SelectaVision" after reaching a friendly agreement with Telemedia Systems. Telemedia, which owns the name "Selectivision," had claimed infringement by RCA.

Sylvania ushers in the Golden Age of connectors.



With two new off-the-shelf



Now we can give you quick delivery even on connectors that used to be considered custom jobs.

Our first new line of PC-card edge connectors runs from 12 to 100 contacts with .125" contact spacing.

Our second gives you 36 to 100 contacts with .100" contact spacing.

For any connector in these lines, you can choose either gold-plated bellows contacts or gold-dot contacts which we've been making reliably for years.

No other manufacturer gives you this freedom of choice of contacts throughout a complete line in the same moldings.

With these connectors, we even manage to save

custom lines.

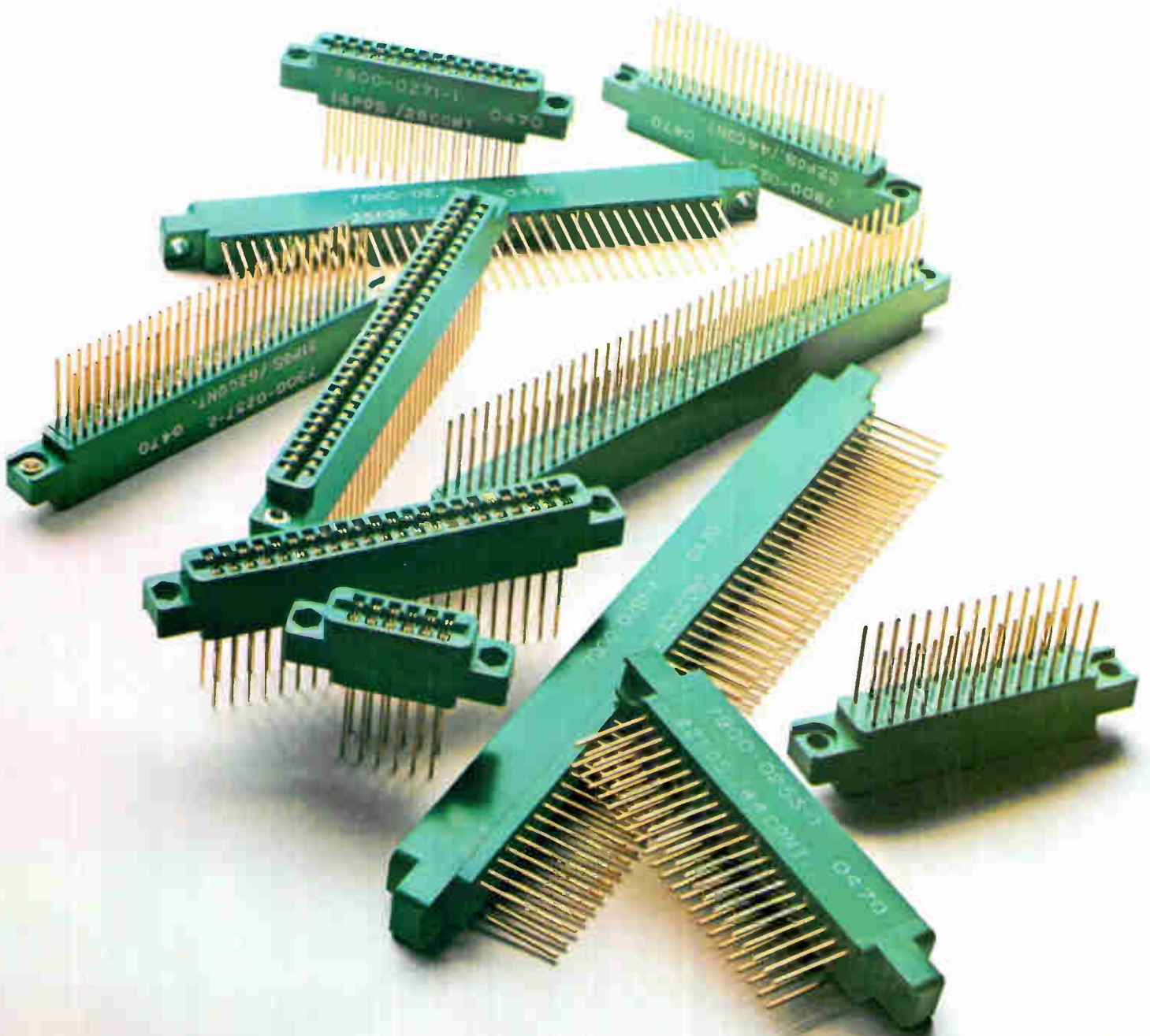

you money. Tooling costs are on the house. And if you choose gold-dot contacts, they'll cost you less.

Our new connectors—including the gold-dot types—are designed to meet Mil Spec C21097B. Which means they're designed to give you 500 or more trouble-free insertions. We're able to hold the locus point on contact tails within .010" radius

of true position, so you won't have any trouble with your programmed wiring machines.

The main thing is—we've speeded up the process of getting you good connectors.

And that's as good as gold.

Even the oddballs are conventional.

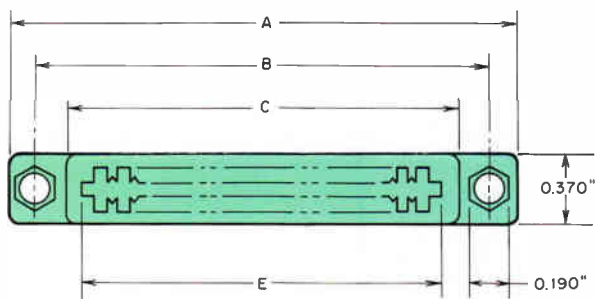

.125" Contact Centers
(Rated for 800 volts DC)

Number of pairs/contacts	Dimensions					
	A	B	C	D	E	F
6/12	1.555	1.295	1.035	.875	.875	.625
10/20	2.055	1.795	1.535	1.375	1.375	1.125
14/28	2.555	2.295	2.035	1.875	1.875	1.625
15/30	2.680	2.420	2.160	2.000	2.000	1.750
18/36	3.055	2.795	2.535	2.375	2.375	2.125
22/44	3.555	3.295	3.035	2.875	2.875	2.625
28/56	4.305	4.045	3.785	3.625	3.625	3.375
31/62	4.680	4.420	4.160	4.000	4.000	3.750
35/70	5.180	4.920	4.660	4.500	4.500	4.250
40/80	5.805	5.545	5.285	5.125	5.125	4.875
44/88	6.305	6.045	5.785	5.625	5.625	5.375
49/98	6.930	6.670	6.410	6.250	6.250	6.000
50/100	7.055	6.795	6.535	6.375	6.375	6.125

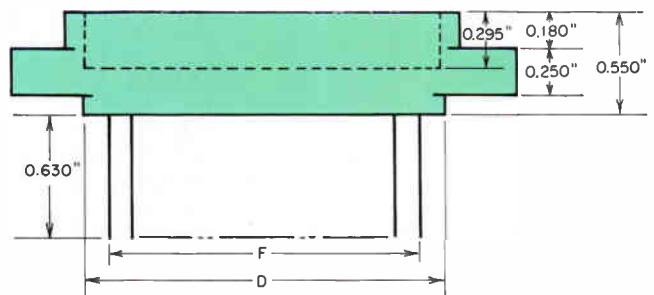

.100" Contact Centers
(Rated for 600 volts DC)

Number of pairs/contacts	Dimensions					
	A	B	C	D	E	F
18/36	2.635	2.375	2.060	1.950	1.900	1.700
20/40	2.835	2.575	2.260	2.150	2.100	1.900
22/44	3.035	2.775	2.460	2.350	2.300	2.100
25/50	3.335	3.075	2.760	2.650	2.600	2.400
28/56	3.635	3.375	3.060	2.950	2.900	2.700
30/60	3.835	3.575	3.260	3.150	3.100	2.900
31/62	3.935	3.675	3.360	3.250	3.200	3.000
35/70	4.335	4.075	3.760	3.650	3.600	3.400
36/72	4.435	4.175	3.860	3.750	3.700	3.500
40/80	4.835	4.575	4.260	4.150	4.100	3.900
43/86	5.135	4.875	4.560	4.450	4.400	4.200
44/88	5.235	4.975	4.660	4.550	4.500	4.300
49/98	5.735	5.475	5.160	5.050	5.000	4.800
50/100	5.835	5.575	5.260	5.150	5.100	4.900

Some technical details

Read between the lines for oddball connectors, such as 19/38 or 46/92. We supply these, too.

Connectors are designed for use with .062"-thick printed circuit cards. They are rated at 3 amps, voltage drop not to exceed 30 mV at rated current. Temperature range: -65 to +125°C.

Connector bodies of diallyl phthalate. Choice of bifurcated gold-plated bellows or gold-dot contacts. Choice of mounting holes: with or without bushing. Choice of plastic or metal polarizing keys.

For more information, write to: Sylvania Precision Materials, Parts Division, Warren, Pa. 16365.

SYLVANIA
GENERAL TELEPHONE & ELECTRONICS



D/A Converters: Make or buy?

Three things to think about...

1

LOW INITIAL COST — \$55

This completely self contained 10 bit D/A converter costs just \$55 in 100 quantities and includes DTL/TTL compatible input switches, resistor ladder network, precision reference and output amplifier* with tracking gain resistors ... a complete D/A converter in a miniature 0.4"H package for \$55 (100 pieces). The DAC 10-H settles the make/buy question once and for all!

*Model MDA 10-H is also available for 300 ns settling times (does not include output amplifier).

2

GUARANTEED PERFORMANCE

You just unpack the DAC 10-H and plug it in. No external trim pots, output amplifier or other components are required ... apply $\pm 15V$ power and your input signals. DAC-10 H is ready to go, with performance tested and guaranteed. No debugging, no trimming, no missed deadlines. Speaking of performance, compare the features with the alternative modular converters in the adjacent chart. DAC-10 H is clearly the Best Buy for all applications where up to 10-bit resolution and accuracy, moderate speed, and input logic flexibility are required.

3

INSTANT AVAILABILITY

Delivery is normally from stock. That means no lost circuit design time, no parts inventory, no manufacturing delays, no production slippages. Evaluation samples are instantly available, too ... just contact the applications engineering staff at Analog Devices or your local sales office. Evaluate the DAC-10-H in your circuit against your requirements. Find out for yourself that the new DAC-10 H is the answer!

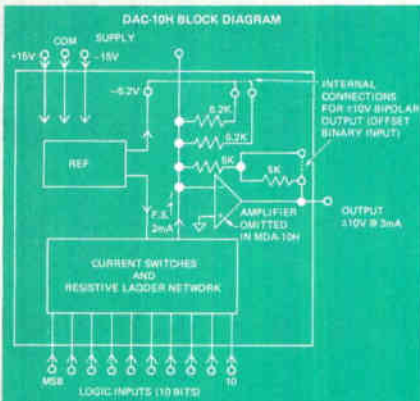

	ANALOG DEVICES	BECKMAN	FAIRCHILD	SPRAGUE
MODEL	DAC 10-H	845†	μ A722†	UM1500†
BITS	10	8	10	10
REFERENCE	Yes	Yes	Yes	No
OUTPUT AMP	Yes, (741)	Yes, (741)	No	No
RESISTOR NETWORK	Yes	Yes	No*	Yes
CODE	Binary or BCD	Binary only	Binary or BCD	Binary only
POWER SUPPLY	$\pm 15V$	$\pm 15V$	$\pm 6V$	+3V, -20V
PRICE (1-9)	\$75.	\$75.	\$75.*	\$79.

*Plus resistor network @ \$31 in 100 quantity
†Based on published data as of 15 Jan. '70

SPECIFICATIONS

Resolution: 10 bits binary
Accuracy: $\pm \frac{1}{2}$ LSB (0.05%)
Data Inputs: TTL or DTL Compatible
Output Voltage: Unipolar models: 0V to -10V
Bipolar models: $\pm 5V$; $\pm 10V$

Amplifier Output Current: 5mA
Settling Time to .05%: 20 μ s (MDA - 10H: 300 ns)
Linearity: $\pm \frac{1}{2}$ LSB
Temp. Coefficient: ± 50 ppm/ $^{\circ}C$ (0 $^{\circ}$ to 70 $^{\circ}C$)
Power Requirement: $\pm 15V$ @ 25mA

Comprehensive data sheets with complete specifications and applications information are available. Evaluation samples may also be arranged. Contact Analog Devices or your local sales office.



205/536-1969	303/781-4967	317/846-2593	514/683-3621	613/224-1221
206/767-3870	305/424-7932	412/371-9449	516/692-6100	617/492-6000
213/595-1783	305/565-7029	414/465-1550	518/372-6649	713/622-2820
214/231-4846	312/774-1452	415/941-4874	602/274-6682	716/695-1001
215/643-2440	313/886-2280	416/247-7454	604/926-3411	913/831-2888
216/261-5440	314/725-5361	512/732-7176	607/748-0509	918/622-3753
301/588-1595	315/454-9314	513/426-5551	612/881-6386	919/924-1971



ANALOG DEVICES, INC. • 221 Fifth Street • Cambridge, Massachusetts 02142 • (617) 492-6000

Circle 39 on reader service card

YT19 system cabinet, holds all the equipment shown (except teletypewriter) with room to spare.

CD51 controller-digitizer with programmable gain, controls 1024 channels, 10ns aperture time.

TE33 teletypewriter with paper tape reader and punch. (Includes controller.)

CF16 minicomputer with a 4K x 16-bit memory (expandable to 24K) and four different I/O modes. (Includes software.)

Optionally available: MR50 high-level multiplexer and associated channels (approximately \$2400 extra), if you want to mix high and low level signals. Also 10, 12 or 15-bit D to A converters for closed loop systems, and a variety of other off-the-shelf instruments and options to solve virtually any data acquisition problem.

PE20 peripheral controller for CD51/DM40 combination.

OP50 multiplexer switch card contains 8 switches with screw terminals. Each DM40 accommodates up to 16 such cards. Switch cards with other terminal types also available.

OP59 power supply for up to eight DM40s.

DM40 low-level differential multiplexer accepts up to 128 input signals (optionally expandable to 1024) in the range $\pm 2.5\text{mV}$ to $\pm 10\text{V}$ full scale, at a rate up to 20kHz, and with a CMR of 120db at DC.

All instruments and interfaces will be cabinet mounted and functionally tested together prior to delivery. If you're in a hurry, call (213) 679-4511, ext. 3668 or 3391.

XDS
Xerox Data Systems
El Segundo, California

The last reason you should buy our data acquisition system is the price: \$21,600.

Value-added tariff appears home safe

Despite political appeal in killing schedule that protects U.S.-made parts assembled abroad, trade-balance factors are likely to stave off repeal

The politics of repealing Section 807 of the U.S. tariff schedule has definite appeal, but the economic realities do not. Thus, the controversial section—which assesses a duty only on the value added to a product made of American-made parts but assembled outside the U.S.—is not in serious trouble despite the sound and fury being generated at the current Tariff Commission hearings in Washington. Politically, it may be expedient to support repeal of 807 and garner the labor vote, but the value-added provision contributes too much to a steadily diminishing favorable trade balance to make repeal economically desirable.

Nevertheless, organized labor is pushing strongly for repeal in hearings before the Tariff Commission and Congress. Though support of labor's position is noticeably absent within the Nixon Administration, unions believe they have a strong champion in Rep. Wilbur Mills (D., Ark.), the powerful chairman of the House Ways and Means Committee. However, Capitol Hill insiders contend Mills' heart isn't in it.

With it. Though the specter of protectionism rises more frequently now in Congress whenever the issue of international trade comes up, a large majority of the members fully realize that they are living in an era of the multinational corporation and that offshore assembly of unfinished goods is playing a positive role in the nation's economy. Under Section 807 last year, some \$339 million worth of goods came into the country, a large proportion of which were electronics ranging from integrated circuits to tv receivers.

The Electronic Industries Association stands firm on retaining 807

because with labor accounting for 50% of component cost, it can mean 25% less than the cost of domestic production. The only duty on products returned to the U.S. is on value added—mostly labor. Labor costs in underdeveloped countries where products are being assembled run between 10 and 40 cents an hour, says the AFL-CIO.

Organized labor charges that the basic idea behind EIA's support of 807 is company profits, not reduction of prices to consumers. The International Union of Electrical Workers, the International Business Equipment Workers, and the International Association of Machinists and Aerospace Workers, in a joint statement to the Tariff Commission, say that in such products as color tv, the "suggested retail prices are often three to four times as much as the cost of the product landed in the U.S." In addition, American multinational corporations, through licensing agreements and joint ventures, have licensed much of the "important technology that has enabled their Japanese competitors to outcompete them in the U.S. market."

The unions cited some 20 domestic electronics plants that have shut down—they made tv's, radios, tape recorders, semiconductors, IC's, tv tuners, and computer assemblies—because the so-called runaway plants made them unnecessary. Among these are Zenith in Chicago, whose tv sets are being made in Taiwan; Westinghouse at Edison, N.J., whose color tv's are being made in Japan and Canada; Transatron, Fairchild Camera & Instrument, General Instrument, Motorola, Cornell Dubilier, and Erie Technological Products, whose semiconductors and IC's are being made in Taiwan, Hong Kong, Mex-

ico, Okinawa, and Portugal; and Sperry Rand, with computer assemblies being produced in West Germany and Japan. "Such firms should not be further rewarded with tariff-duty exemptions," the unions assert.

Advanced technology

The blues

If Thomas Edison could hear that his little incandescent bulbs will be replaced by diodes that emit in all colors and are capable of lasting more than a decade, he'd probably approve. True, such devices are not yet here. But their time may be near at hand now that RCA says it has solved the problem of obtaining efficient blue emission, mostly by improving materials.

The story is an evolutionary one. Red came first. Reasonably efficient red emission from gallium-arsenide-phosphide (GaAsP) diodes was achieved several years ago, but with this material other colors were not possible. Next came gallium phosphide (GaP). Depending on the dopants, GaP could emit red or green light. Still no blue. At that time it was generally agreed that practical blue emission called for a new approach.

Covering. Not long ago that approach was found—a new technique that used simple GaAs infrared light-emitting diodes covered with special phosphor materials. Through the multistep absorption of infrared photons, such a light-emitting system could be tailored to emit red, green, or blue. And equally important, the emission of all three primary colors opens the door to any color by sim-

U.S. Reports

ple mixing on the same phosphor.

Still all was not rosy. Although several laboratories were working with this method—GE, Bell, RCA, and others—the efficiency for blue emission remained discouragingly low, primarily due to the inefficient process by which the phosphor converts i-r light to blue light in comparison to red and green.

In fact, to get reasonably bright continuous outputs in blue at room temperature, the diodes had to be operated at current density levels so high that life expectancy was low and much heat was dissipated.

Now, RCA feels it has made a significant advance in the whole process of upconversion using the phosphors. In the light-emitting business as long as anyone, RCA claims to have succeeded in obtaining a blue source that operates continuously with an estimated brightness of about 60 foot-lam-

berts, a level that can be seen clearly in normal room illumination. What's important is that this brightness is achieved by using the old, but simple, GaAs light-emitting diode running at only about 50 amperes per square centimeter. At this modest current density no special diode heat sinking is required. What's more, green emission obtained by the same process is even brighter—several thousand foot-lamberts.

Elevated. In the upconversion process, the i-r light emitted from the GaAs diode is absorbed in the phosphor and upconverted to yield visible light of the desired color. Two of the lower energy photons yield one higher energy photon for red or green emission, or three of the absorbed photons yield one even more energetic photon if blue emission is desired. The efficiency of the i-r visible light conversion

process and the emitted color depends on the rare-earth dopant used with the phosphor host.

RCA's results are particularly impressive because relatively low-cost, high-volume GaAs diodes are used instead of the more exotic compounds. Besides, there's no known semiconductor compound capable of being made into a p-n junction to yield even more moderately efficient blue emission.

Communications

Building bits

Commercial communications satellites receive data on several channels from ground transmitters, amplify it, and beam it back to the receiving point. However, the Communications Satellite Corp. would like to use only one carrier for the uplink to the satellite to conserve bandwidth and eliminate the intermodulation-distortion problems caused by multiple channels.

Engineers at Motorola's Government Electronics division have developed and operated a 1-billion-bit-per-second pulse-code-modulated communications link that would give Comsat all it needs and then some. And the L-band gigabit data link, which Motorola senior engineer Carl Ryan says is a first in the industry, would put all the data on one uplink carrier.

Part way. Ryan, in charge of Motorola's wideband data-processing group, holds a patent on the multiplier circuitry that is one of the key components in the data link. He says existing data links go as high as about 800 megabits per second, but Motorola isn't stressing just gigabit capability. Ryan says the technology embodied in the data link, which was operated publicly for the first time at the IEEE National Telemetry Conference in Los Angeles late last month, is economically feasible for anyone needing data rates greater than 50 megabits per second.

A gigabit-a-second capability is probably twice what Comsat needs in the next three years, but there have been requirements approach-

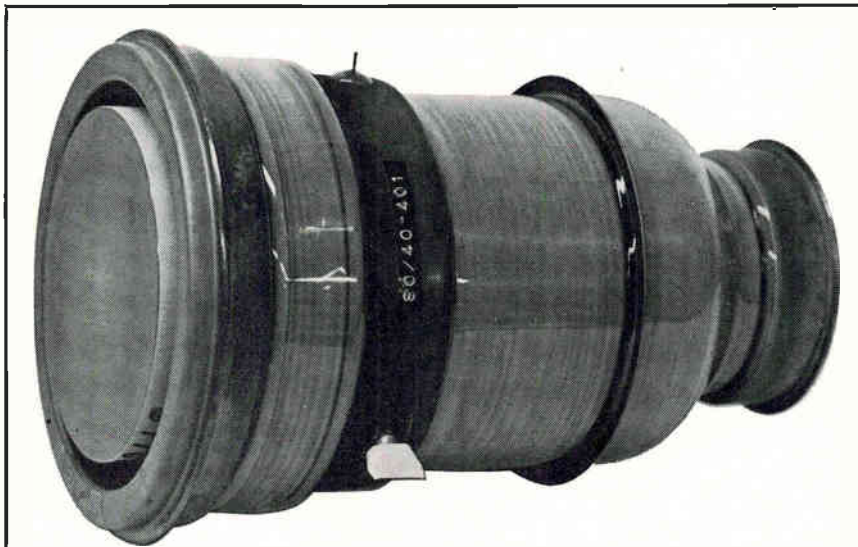

Zoom tube. While communications systems and computers are helping law enforcement agencies now [Electronics, April 27, p. 115], technology holds out the promise of giving even more help to lawmen in the near future. The Army's night vision lab at Ft. Belvoir, Va., has declassified two variable magnification image intensifier tubes built by Varian/EMI—a cooperative venture between Varian Associates and Great Britain's Electrical and Musical Industries. Varian/EMI is planning to market the tubes to industrial-commercial users. The tubes are high-resolution gated zoom intensifiers that amplify low-light level scenes imaged on their fiber-optic faceplate. The model VLI-105 has an 80-mm diameter input and a 25-mm output; the VLI-106 has an 80-mm input and a 40-mm output. Variable magnification (zoom), which is accomplished electrically rather than mechanically, allows the entire input image to be displayed on the output screen, or only 25 mm or 40 mm of the input image or anything between can be displayed.

May 11, 1970

Electronics Index of Activity

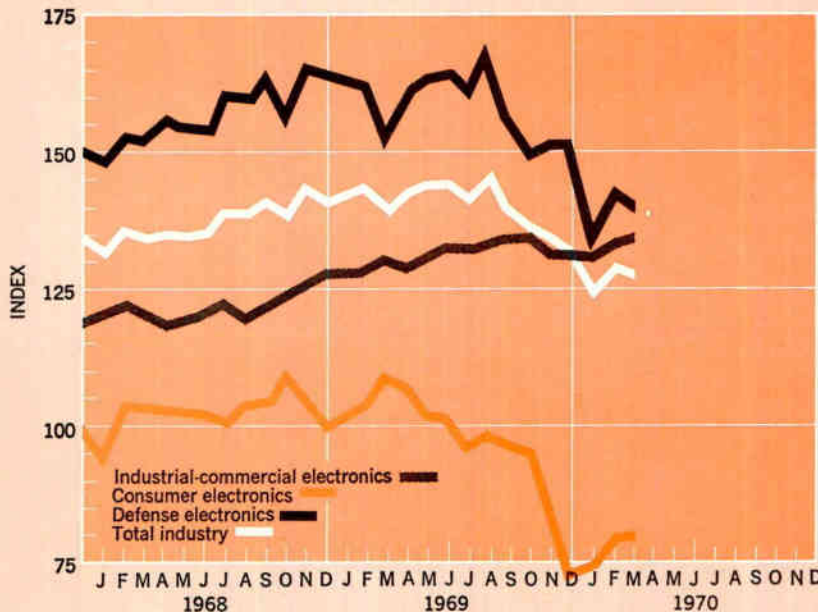

Segment of Industry	Mar. 1970	Feb. 1970*	Mar. 1969
Consumer electronics	80.3	79.7	110.8
Defense electronics	141.2	143.9	164.9
Industrial-commercial electronics	135.1	134.6	129.9
Total industry	128.6	129.9	145.5

Total electronics production in March ended a three-month rise by edging downward 1.3 index points to 128.6. The decline also added to the drop from March 1969—16.9 points.

While two of the three index areas showed March increases, they were not enough to offset the 2.7-point sag in defense electronics to 141.2 from February's revised 143.9. Consumer electronics moved up 0.6 point to 80.3 from 79.7. This was the consumer area's third month-to-month increase in a row. Industrial-commercial also rose fractionally—0.5 point to 135.1 from February's 134.6—for the fourth month in succession.

Indexes chart pace of production volume for total industry and each segment. The base period, equal to 100, is the average of 1965 monthly output for each of the three parts of the industry. Index numbers are expressed as a percentage of the base period. Data is seasonally adjusted. * Revised.

ing that rate. Ryan says Motorola had a request for quotations for a 630-megabit system a year ago. He feels the beauty of the Motorola equipment is that the firm developed the functional blocks critical for high-data-rate pcm in a modular fashion so that they can be tailored to the customer's needs.

Although the system accepts either wideband analog signals or high-data-rate digital signals, the potential customer that Ryan seems interested in now would have wideband analog inputs. This could be real-time photography for reconnaissance applications; the system could handle 12 to 15 television channels. Ryan says it can accommodate almost any kind of analog input up to about 40 megahertz in bandwidth. But it could also accept, say, 10,000 digitized voice channels.

Hybrids. The critical portions of the system, which Motorola builds itself, are made with three basic

kinds of hybrid integrated circuits: a wide-band video amplifier, a wideband multiplier and signal switch, and phase-detector circuits. The video amplifier and multiplier have bandwidths greater than 1,000 Mhz; the phase-detector circuits use hot-carrier diodes and transformers, and Ryan says, "We can get 2,000-Mhz bandwidth out of these, but the components can be bought. What we've done is made them compatible with our micro-strip transmission-line construction techniques." The Government Electronics division pioneered the technology embodied in the multiplier and signal switch in 1965, and has been refining it ever since to boost the bandwidth to today's level.

These are the building blocks that go into the digital multiplexer and four-phase modulator that are the critical boxes in getting gigabit data rates out of the airborne or spaceborne transmitter portion of

the Motorola system. If the input is analog, Motorola also would build the analog-to-digital converter, but the up-converter and traveling - wave - tube amplifier needed for the transmitter can be bought outside.

The receiver, which would probably be ground equipment, consists of a preamplifier, down-converter, an intermediate-frequency amplifier, four-phase modulator, and a matched-filter network. The portions where the basic building blocks are used again are the four-phase modulator and the matched-filter bit synchronizer. In addition, the digital demultiplexer and d-c converter uses the phase/detector circuits in its serial-to-parallel conversion function.

Forth and back. A parallel-to-serial converter in the transmitter's digital multiplexer can handle eight channels of data. Actually there are two sets of four channels each, which are multiplexed by emitter-

U.S. Reports

coupled-logic (MECL 3) gates into two channels, each with 500 megabits, which are then reclocked to get a timing accuracy of 0.2 nanoseconds. They then go to the four-phase modulator, which puts the data into one channel, sends it to the up-converter and on to the twt amplifier, through the antenna, and to the ground receiver. There the preamplifier, down-converter, and i-f amplifier massage the data before it's sent to the four-phase modulator. At that point the opposite sequence to that in the transmitter takes place—in the four-phase modulator, matched-filter network, and digital demultiplexer.

Ryan says the cost per bit of data transmission, especially from a satellite, would be much cheaper with the gigabit link than with conventional pcm systems. He says a 10-megabit setup might cost \$1 million, and even if the Motorola system costs twice that, it offers 100 times the data rate.

Lasers

Opening the window

For high-speed data recording, the oscilloscope and camera have serious limitations. If the sweep rate is fast enough to display the leading edge of a pulse or the detail in high-frequency data, the sweep

time usually would be so short that very little data can be displayed and photographed. In fact, one of the best h-f scopes on the market today has a display window of only 100 nanoseconds when operating at a scan rate fast enough to resolve 100-megahertz data.

The Resalab Corp.'s Scientific division in Menlo Park, Calif., thinks it has overcome the problem with a new laser system for multichannel h-f data recording. Called Resacord, the Resalab system is capable of recording up to 25 channels simultaneously on the same time base with a rise time of 3.5 nsec and a frequency response of 100 Mhz. What's more, the system has a record window of 20 microseconds—100 times longer than most scopes.

Complex. The recorder consists of a pulsed argon laser, a system of beam splitters that provides the multichannel capability, an electro-optical modulator for each data channel, and a special camera that records the intensity-modulated laser beams on photographic film. The camera, which is evacuated during operation, contains a single-sided mirror that rotates at 2,500 rps. This provides the scan to sweep the modulated laser beams across a length of 16-mm photographic film.

Data reduction is accomplished with a companion system consisting of a computer-driven micro-

densitometer that scans each track of data in 4-micron increments at 4,000 increments per second, and digitizes the data for storage on magnetic tape. The computer then analyzes or correlates the data as desired. Or, the data can be displayed on an x-y plotter. Resalab says that its system stores 1,200 data tracks every eight hours.

Systems delivered thus far have eight-channel capacity—six for data, one for timing, and one for recording an unmodulated beam from the laser. This unmodulated trace is scanned during readout for variations in laser intensity.

Not limited. An important feature of Resalab's system is that the length of the record window is not limited to 20 μ sec. Other record windows (and resultant rise times) available by slowing the mirror's rotation: 29 μ sec with 4.4 nsec rise, 72.5 μ sec with 9 nsec, 159 μ sec with 18 nsec, and 333 μ sec with 35 nsec.

The system also offers accuracy of ± 400 volts, a bandwidth of 30 kilohertz to 100 Mhz, a film capacity of 100 frames, and an interval between recording of 60 seconds.

Another version, now in development, will use a scanning technique much like that of a video tape recorder to produce a continuous recording capability. Instead of scanning a finite length of film, the beams will scan across the film at an angle, with an overlap between the end of one scan and the beginning of the next.

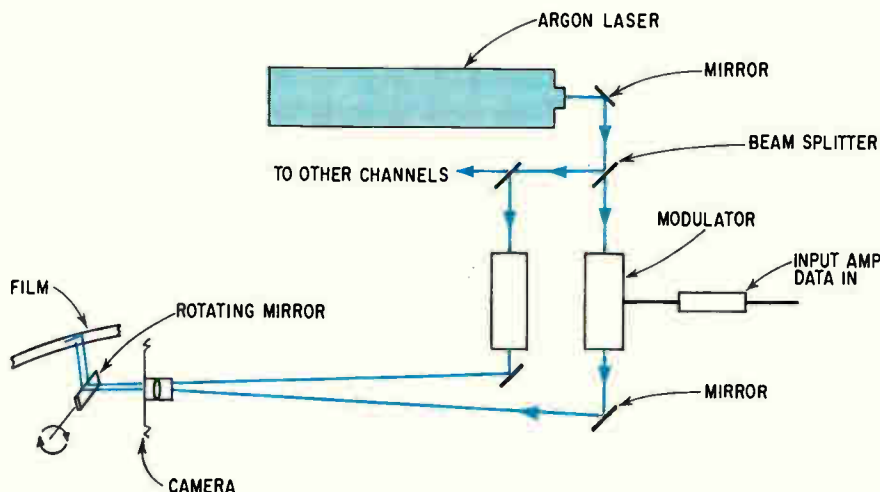

Rapid reader. Multichannel recorder (two channels are shown) uses incoming data to intensity-modulate argon laser beam which exposes density-modulated image on 16-mm film.

Government

Awacs delayed—again

There is at least one Air Force officer who believes that Awacs doesn't stand for Airborne Warning and Control System at all. He claims it's an acronym for A Wild and Crazy System—and he questions if it will ever fly. That question is being asked more frequently in Washington following the latest delay in contractor selection for Awacs, a program that was initiated in 1963.

Still sensitive to Congressional

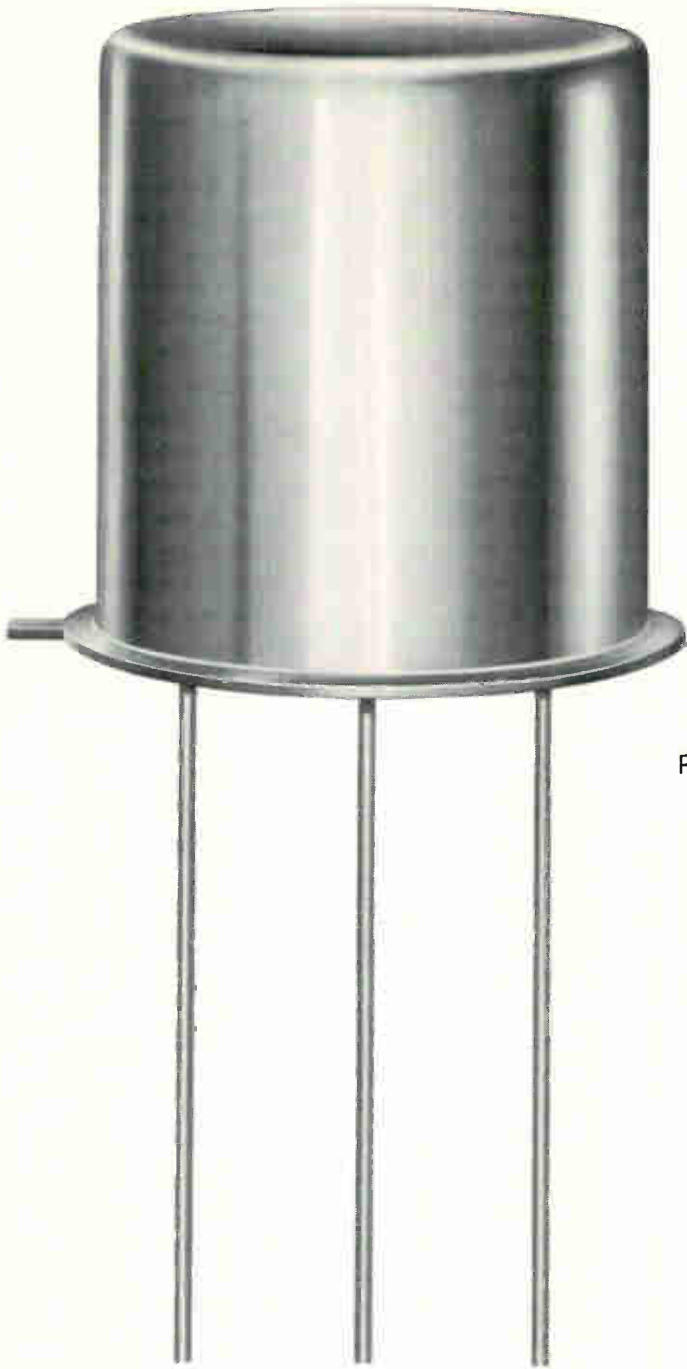

**Behind this disguise
are 1001 ways to
build a more precise
timing circuit at
no extra cost**

The U13T1 Series

PUT

PROGRAMMABLE UNIJUNCTION TRANSISTOR

**Typical Unitrode reliability
in a hermetically-sealed
package suitable for
military use at only
90¢ each in lots of 100.**

■ Functionally equivalent to standard unijunction transistors with the advantage that external resistors can be used to program η , R_{BB} , I_p , and I_V , depending on the designer's needs.

■ Completely planar passivated, hermetically sealed TO18 type package.

■ Even long time-delay designs are more precise, because the PUT's low guaranteed I_p of 150 nA allows use of larger timing resistors and smaller capacitors.

■ For pulse and timing circuits, SCR trigger circuits, relaxation oscillators, and sensing circuits.

IN STOCK, READY TO DELIVER NOW • SEND FOR YOUR FREE SAMPLES AND CIRCUIT DESIGN GUIDE

For fast action call Pete Jenner collect . . . today!

From the
SSPI Product
Group



A product of the wide ranging semi-conductor technology of

UNITRODE

580 Pleasant St., Watertown, Massachusetts 02172 • (617) 926-0404

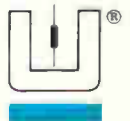

U.S. Reports

criticism of high cost overruns and poor management controls on a variety of programs—notably the Air Force's C-5A supertransport—the Defense Department held up selection of an Awacs contractor at the last minute and told the Air Force to draw up a tighter contract. That action by the new Defense Systems Acquisition Review Council (DSARC) headed by Deputy Secretary David Packard, will push back the choice of a contractor to July at the earliest—the Air Force says it will have to solicit new bids based on the new document from Boeing and McDonnell Douglas, the two prime competitors.

Cost plus. Packard's DSARC told the Air Force that its proposed contract "would not provide the degree of management control and flexibility deemed necessary during the development phase of the system." So the Air Force says it plans to use "the more conventional cost-type contract with appropriate incentive provisions."

For the subsequent production phase, the Air Force plans a fixed-price, incentive-fee award with "not-to-be-exceeded ceiling prices." As for the competing Westinghouse and Hughes radars, the Air Force says it plans "appropriate incentives and/or award-fee arrangements" for the prime "to motivate the contractor to achieve radar performance as close to the objective as is economically feasible."

Preliminary tests of the radar—to be mounted in a big "mushroom" atop the fuselage of either a DC-9-62 or a Boeing 707-320C—indicate that better integration of radar, computers, displays, and communications are needed. But the Air Force has another, larger problem with Awacs. Congress again is raising the more fundamental question of whether Awacs is truly essential. In the view of one Senate Armed Services Committee insider, "The Air Force has gotten along without it for seven years now, and the need for continental air defense diminishes every year."

Thinking big. The Air Force successfully fought that battle earlier by expanding the Awacs function to provide a tactical mission in addition to its strategic defense role.

And the Air Force thought it made its Awacs case by pointing out that an airborne lookdown capability is essential to detection and tracking of low-level bombers carrying standoff air-to-surface missiles.

Now that the Air Force has persuaded Packard that it needs Awacs, there is no question that an award will go through this summer. However, some Air Force sources are beginning to suspect that the frequently delayed system may be jinxed, and that eventually a hostile Congress will prevent Awacs from ever getting into production even though the Soviet Union already has its system airborne.

Shaping science

The research community contends it is in far more difficult straits than defense contractors when it comes to finding new sources of Federal funds, and the contention appears valid. Where military-hardware makers began to feel the fiscal pinch some 18 months ago, researchers argue that they have been faced with a 30% drop in U. S. support over the past four years when measured in what Presidential science adviser Lee DuBridge calls "real dollars."

Indeed, the DuBridge scientific demeanor gave way to some very strong emotion in his latest declaration that cuts in science funding, coupled with a decentralized and inefficient system of Federal support, threaten to "destroy or call a moratorium on knowledge."

New agency. One Capitol Hill answer to the problem has just come from Emilio Q. Daddario's House subcommittee on science, research, and development, which calls for immediate establishment of a new independent agency to handle all basic research support excepting mission-oriented efforts such as defense and space. It would be called Niras for National Institutes of Research and Advanced Studies [*Electronics*, Aug. 18, 1969, p. 56].

As predicted when Rep. Daddario (D., Conn.) began looking into the problem last summer, his

proposal calls for incorporating the National Science Foundation into a subcabinet department made up of three institutes, two of which would incorporate basic physics and electronics efforts. The Niras institutes would include:

▶ Natural sciences, composed of NSF research programs, Federal science information programs, and a National Institute of Ecology.

▶ Education, made up of education programs of the NSF and the Office of Education, training programs of the National Institutes of Health and other units of the Department of Health, Education and Welfare, and institutional support of the OE, HEW, NSF, and the Defense Department.

▶ Arts, humanities, and social studies, comprising the National Foundation of the Arts and Humanities and a new National Institute of Social Sciences incorporating NSF programs.

No rescue. Though Daddario's concept has been modified from a year ago when there were rumbles that the House's resident science expert was talking of a Cabinet-level department of science—a concept DuBridge opposes—there is little current evidence that the plan will translate into legislation despite an initial favorable reaction among much of the scientific community. The problem: the Nixon Administration is conducting its own study of Federal support of science through its Commission on Executive Reorganization headed by Litton Industries' Roy L. Ash.

The Administration has already proposed a national federation of higher education and is expected to disclose new plans for funding health sciences plus restructuring of environmental agencies—each of which will affect science-support policy. And, apart from the obvious politics that a Republican Administration is unlikely to support a program developed by a Democratic Congressman, Daddario has already indicated he won't be around to push his program with his announcement of plans to run for Governor of Connecticut this fall.

Regardless of what DuBridge says about the desirability of cen-

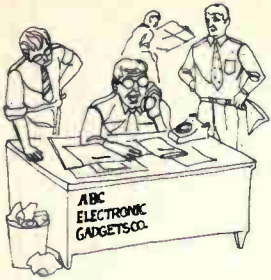

**Call RCA
for tunnel
diodes.
They're stable,
they're available
off the shelf.**

RCA tunnel diodes offer prime advantages of immediate availability plus remarkable stability proved by over a million device-hours of testing.

Note these outstanding characteristics: low capacitance, high I_p/I_v ratios, mechanical ruggedness, improved thermal resistance, uniformity — all achieved through an RCA process of epitaxially-grown junctions. Check the chart for key parameters.

Added features: the gold-plated leads require no pretinning for soldering efficiency. And the package lends itself well for high-volume PC-board mounting operations. Use RCA tunnel diodes especially in your high-speed switching and high-frequency signal-processing applications.

See your local RCA Representative for more information. Or call your RCA Distributor—he's fully stocked. Special selections are yours if you need them. For technical data on specific types, write: RCA Electronic Components, Commercial Engineering, Section ESN-2 Harrison, New Jersey 07029. In Europe: RCA International Marketing S.A., 2-4 rue du Lièvre, 1227 Geneva, Switzerland.

Type	I_p (mA)		I_p/I_v	C (pF)		tr (ps)
	Min.	Max.		Min.	Max.	
40561	4.5	5.5	6/1	25		1800
40562	9	11	6/1	25		900
40563	18	22	6/1	30		600
40564	45	55	6/1	40		350
40565	90	110	6/1	40		150
40566	4.75	5.25	8/1	15		1200
40567	9.5	10.5	8/1	15		600
40568	19	21	8/1	20		400
40569	47.5	52.5	8/1	25		200
40570	95	105	8/1	25		100
40571	4.75	5.25	8/1	8		600
40572	9.5	10.5	8/1	8		300
40573	19	21	8/1	10		200
40574	47.5	52.5	8/1	12		100

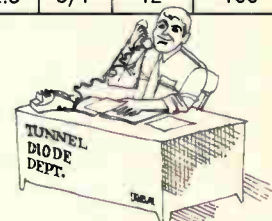

U.S. Reports

tral funding for science, there is no indication that it has White House support. If anything, such support is most unlikely at this point.

Medical electronics

Sensitive approach

The same sort of mental deduction that allows a listener to spot a sound source "between" stereo speakers has been adapted to the so-called Boston Arm to give amputees an artificial kinesthetic sense, and thus, much better control over the position of the arm.

Kinesthetic sense is not considered one of the common five senses; rather it's the product of the brain's correlation of nerve impulses from joints, muscles, skin tissue, and the like. As a result, this mental "signal processing" enables us to place our hands with accuracy even though we can't see them—we are aware of our arm's position even though it may be behind our back.

Location. By contrast, the Boston Arm uses electromagnetic impulses emitted by the biceps and triceps to control the motors which move it. Although in one sense the arm is controlled by the nervous system through these muscles, there's nothing to aid positioning except sight, or the sound of the arm's small motors. Amputees couldn't use the Boston Arm in the dark, or out of sight, and at other times they were preoccupied with the arm's operation, at the expense of reflexive acts, conversation, and other skills that require concentration.

While a graduate student at the Massachusetts Institute of Technology, David S. Alles, now a scientist at Bell Labs in Allentown, Pa., thought he saw a solution to the problem. By studying the physiology of the upper arm Alles found that the brain could process tactile inputs in the same way it processes audible ones: by placing two vibrating transducers a few inches apart, he discovered it was possible to move a phantom signal between them by varying the frequency, amplitude, or time of the

signals applied at each transducer.

Then another MIT graduate student, Stephen D. Reimers, proved it worked. He used two logarithmic potentiometers in the artificial elbow to vary input to two amplifiers which in turn powered two tiny torque motors placed a few inches apart at the stump. As the elbow moved, the transducers were fed varying amounts of 100-hertz energy at about 100 bursts per minute. The transducers moved back and forth on the skin to minimize bone or deep tissue pickup which might be uncomfortable or interfere with the arm's electromagnetic control sensors.

Feeling. The effect on the amputee was like being stroked on the skin between the two transducers corresponding to elbow's position. Reimers also found no interference with the electromagnetic pickups used to detect flexing of the biceps and triceps.

In about 9,000 tests, the arm proved to be as easy to position accurately as mechanical arms even though the amputee couldn't see the arm in action, or hear the soft whine of its motors. Formerly it had been only about half as accurate. But instead of becoming accustomed to the arm in less than an hour, amputees needed about a day to get full use from the artificial kinesthesia—but nobody felt this was a bad tradeoff.

Now, according to MIT mechanical engineering professor Robert W. Mann, some undergraduate students have begun "product improvement" by replacing the torquer with smaller, less energy demanding piezo-electric transducers.

According to Mann "we used a man-machine system approach to close a servo loop by putting the computational power of the brain between the tactile transducers and the muscle sensors."

Next move

A strain-gage transducer whose output can control up to 15 household appliances may make it pos-

sible for quadriplegics to turn on lights or operate an electric wheel chair. The transducer, developed by Tufts University researchers, takes advantage of most quadriplegics' ability to still control their biceps. For those quadriplegics lacking such control, however, the transducer will not provide any help.

The device, measuring just 1½ by ½ by ½ inches, consists of a thin flexible beam to which are attached two strain gages, one above and one below the center. When one gage extends, the other contracts. At either end of the beam are two small cylinders touching the skin. The whole transducer is encapsulated in silastic and taped to the shoulder of the quadriplegic.

Words. The relative motion between two points on the skin can be controlled by slight movements of the body, and the transducer produces analog voltage signals proportional to these deflections of the skin. The signals go to a relay logic module with flip-flops and a logic tree, so that different degrees of deflection cause the transducer to produce, in turn, different four-bit words.

The logic module has a row of four lights, all of which are off when the skin is relaxed. If the patient moves his shoulder forward, the second light goes on; if he moves forward a little more the third light. In all, there are 16 states possible when turning four lights on and off; when all are on, all previous commands are erased, leaving 15 words to control 15 appliances. So far, William J. Crochetiere of Tufts' Department of engineering graphics and design, working with quadriplegic student William Powell, has controlled up to eight appliances with the transducer.

"It takes only 10 minutes to learn how to control the transducer; the big part is memorizing the vocabulary of positions and lights with which to control the appliances," says Crochetiere.

Wire barrier. Right now the patient's mobility is limited by the wiring that connects the transducer to the logic module. "We're work-

The Only UHF Planar Triodes That Guarantee 20 dB Gain Up to 1000 MHz with Intermodulation Better Than -52 dB*



The outstanding linearity of our triodes allows the engineer to design TV transmitters and translators with the visual and sound carriers amplified through the same tube—exceeding FCC and CCIR specifications. 20 dB gain also permits driving these tubes with an all solid state exciter. All ceramic and metal construction assures long-life and reliability under severe environmental conditions. Thousands are in field use today at very low operational cost. These triodes are part of the most comprehensive line of UHF tubes available, ranging in output power up to 25 kW at 1000 MHz. A range of coaxial cavities is also available for UHF operation and assures the optimum performance of our tubes. For specific information please write or call your nearest Cain & Company representative, or contact us directly.

RATINGS	TH306	TH328
Heater Voltage (V)	5	5
Heater Current (A)	1.9	5
Anode Voltage (KV)	1.6	2
Anode Current (MA)	130	250
Power Output (W)	35	100
Intermodulation Level (3 tone test) (dB)	< 52	< 52

*Three Tone Test



THOMSON-CSF

Thomson-CSF Electron Tubes, Inc./50 Rockefeller Plaza/New York, N.Y./10020

(212) 245-3900

IMOS:

(THE INDUSTRY'S FIRST ION-IMPLANTED MOS DEVICES)

Because our MOS integrated circuits are ion-implanted, they can handle 20 MHz data. And they're pin compatible with P-channel MOS.

Ion-implantation gives them ultimate automatic gate registration without process complications.

Example: our HDSR2164

dual 64-bit TTL compatible shift register. It's loaded with Tomorrow features. Like greater than 10 MHz operation. Low clock capacitance (typically, 25pf) and low power dissipation (typically 0.1 mW per bit per MHz at operating frequencies over 10 MHz). And it's priced at \$24.95 per unit in quantities over 100 pieces.

For literature, data sheets, and name of nearest distributor, please write: Hughes MOS Division, 500 Superior Avenue, Newport Beach, CA 92663.

HUGHES

HUGHES AIRCRAFT COMPANY
MOS DIVISION

HUGHES STANDARD MOSINC DEVICES

COUNTERS

HCTR0107: Reversible Decade Counter with Seven-Segment Decoder and Drivers @ \$12.50
HCTR0507: Seven Stage Binary Counter, 7 Outputs, @ \$7.00
HCTR0201: RST Flip-Flop @ \$1.65
HCTR0102: Commercial/Entertainment Binary Divider @ \$0.80

STATIC SHIFT REGISTERS

HSSR2016: Dual-16 Bit @ \$5.95
HSSR2064: Dual-64 Bit @ \$16.00

DYNAMIC SHIFT REGISTERS

HDSR3066: Triple-64 Bit @ \$17.50
HDSR4064: Quad-64 Bit @ \$23.50

ION-IMPLANTED MOS (IMOS) SHIFT REGISTERS

HDSR2164: 10 MHz/ Dual-64 Bit Dynamic Shift Register @ \$24.95
LISR0064: 20 MHz/ 64 Bit Dynamic Shift Register @ \$35.00 (1 up)

MULTIPLEXERS

HMUX1756: 4 Bit D-to-A Converter @ \$39.80
HMUX1784: 4 Bit D-to-A Converter @ \$39.80
HMUX2542: Dual 2-Bit Commutator @ \$29.95
HMUX2641: 4-Bit Commutator @ \$29.95

LOGIC ELEMENTS

HLOG2304: Triple 3, Dual 2 NOR Gates @ \$4.00
HLOG2306: Dual J-K Flip-Flop @ \$4.00

MULTIPLES

HMUL 1444: General Purpose Quad @ \$10.25
HMUL1445: General Purpose Quad @ \$14.75
HMUL1884: Quad Dual-Switch @ \$16.25
HMUL2661: Six-Channel Switch @ \$15.75

DUALS

HDSW8550: High Level Switch @ \$5.60
HDIG8551: Amplifier @ \$7.45

DISCRETES

HDGP1000: General Purpose Switch @ \$0.70
HDGP1001: General Purpose 30-ohm Switch @ \$0.80
HDIG1030: General Purpose @ \$3.10
HDIG1886: Electrometer @ \$3.55
HDSW2106: Low-Resistance, 20-ohm Switch @ \$4.40
HDSW3005: General Purpose Low-Leakage Switch @ \$3.30
HDSW8318: General Purpose Switch @ \$2.75
HDSW8348: General Purpose 50-ohm Switch @ \$4.10

SUBSYSTEMS

HSUB0525: TV Sync Circuit @ \$15.00
HSUB5021: Differential Digital Analyzer @ \$18.00

COMPLEMENTARY MOS

LCOS4007: Dual Complementary Pair plus Inverter @ \$20.00 (1 up)

Note: All prices for 100 and over quantities except as noted.

SAMPLE KITS

#1 Electrometers @ \$9.75 each
#2 Switches @ \$21.90 each
#3 Multiplexers @ \$149.75 each
#4 Counters @ \$33.56 each

ing on replacing this with a telemetry system," says Crochetiere; "then the patient could tool around his apartment in his electric wheel chair and control appliances from any point." He hopes to solve this problem by the fall.

The transducer and logic module could also be used by stroke victims and the elderly with restricted mobility, and a control circuit has been developed that can control a d-c motor to move an artificial limb clockwise or counterclockwise. Limbs such as the Boston Arm are controlled by electromyography (EMG), which Crochetiere feels is awkward. The new skin transducer can be worn under clothing and the bulge it makes is hardly noticeable. However, Crochetiere says it is not as natural to use as EMG and he thinks "the optimal prosthetic will have hybrid controls," that is a blend of EMG and cutaneous sensors.

Instrumentation

Making room

Oceanographic vessels, usually jammed with both scientific personnel and equipment, need precise position location for correlation of gathered data. This sometimes means leaving a scientist ashore because an operator for the navigation satellite receiver and other equipment must be taken along.

To help avoid this tradeoff, Magnavox has developed a 150-foot-accuracy integrated Transit navigation satellite receiver/computer that derives its position from signals transmitted by the Navy's Transit satellites, declassified and renamed Navsat in 1967. The unit, called the MX 706, measures only 8¾ inches by 15½ inches by 26 inches.

Both the receiver and the computer, which is a 16-bit system having 8,000 words of core memory and a 2-microsecond cycle time, are rated for military specifications and housed in the same box. The controls, including an 11-key key-

board, are on the front panel.

Less man. According to Michael Simmons Jr., navigation product manager, the two-channel MX 706 uses computer software to do most of the digital processing and minimizes the operator's role.

A standard navigation program, consisting of 8,000 words, is automatically loaded from a magnetic tape cassette inside the cabinet when the operator presses a front-panel switch. The program loading also executes an immediate self-test to verify that the magnetic tape reader, computer, and receiver front panel are functional malfunctions are displayed as alphanumeric error codes on one of three front-panel Nixie displays. The operator can also initiate a test that automatically locks the receiver on an internal test-generator signal and checks for proper operation of the receiver, computer, and interface.

Staff engineer John F. Clark says the 706 gets substantially more accuracy than other receivers by having shorter interval doppler counts. The Navsat sends a message every two minutes, and transmits a word describing the orbit of the satellite every 4.2 seconds. To date, most receiver systems have collected, processed, and reduced satellite data and done doppler counting in the receiver itself. Typically, the doppler counting has been done in two minutes. By contrast, the 706 takes a 50-hertz bit rate from the satellite and, after digitizing, puts out the rate to the computer every 20 milliseconds. The computer sorts the data and accumulates doppler counts during 23-second periods.

Clark claims this results in four-fold improvement over the 600-foot accuracies of earlier receivers, while minimizing errors due to ship's motion.

Sticking around. Unlike most receivers, which sweep a relatively wide fixed window of frequencies during a signal-acquisition search, the 706 search window can be computer-controlled to avoid spurious signals and minimize acquisition time. If a satellite lock is lost, the receiver would stay in the vicinity of where the lock was lost and step

Are you thinking Hughes is big in electronics?



Good thinking.

Because Hughes put a lot of innovative thought into making better gas and solid state lasers (RS 293), micro-circuit production equipment (RS 294), high vacuum equipment (RS 295), semi-automatic wire terminating and harness laying equipment (RS 296), N/C positioning tables and systems (RS 297), and FACT Flexible Automatic Circuit Testers (RS 298).



Circle appropriate Reader Service (RS) number.

U.S. Reports

in the direction of the satellite doppler frequency; there is no need for a wide-sweep search mode.

By using software for most of the digital processing and formulating of the 6,100 bits in each two-minute satellite message, Magnavox has eliminated the need for the conventional digital buffer between the receiver and the computer. And as a result, Magnavox has cut more than 500 integrated circuits from the receiver.

The equipment features three Nixie displays that can provide, with one-second updates, either present time, latitude and longitude, or the last satellite position fix. By pushing a panel button, the operator can also display the expected time rise of the next satellite pass, elevation angle at closest approach, and an identification code telling which satellite it will be. The frequency to which each receiver is tuned can also be displayed, both as a trouble shooting aid for the receiver and as an indication of where the satellite is in its pass. The satellite signals are typically from 26 to 40 kilohertz below 400 megahertz depending on where it is in its pass from horizon to horizon.

One cloud on those horizons is the likelihood that the current two-hour wait between satellite sightings will not be shortened. Originally to have been a 15-satellite system, Navsat has only four birds in orbit.

Patents

IBM vs. Xerox

Have you heard the story about IBM turning down the chance to buy the Xerox Corp. because IBM questioned the potential of copying machines?

It's a Wall Street saw so well worn that it's no longer funny. Of course, it never was funny to IBM, which has finally decided to challenge Xerox on its own ground. And even less amused is Xerox, which has filed for a Federal injunction against IBM charging violation of 22 patents.

IBM, except for denying that its copier infringes any Xerox patents, is saying characteristically little. It does counter only with the contention that its copier uses an organic chemical photoconductor for which IBM received a patent in 1969. A search of U. S. Patent Office files shows the photoconductor absorbs light in the ultraviolet spectrum, but is insensitive to longer wavelengths for color. According to the record, an electrostatic charge is left on a photoconductive surface, such as a selenium drum, through light exposure.

Hardware. Of the 22 Xerox patents allegedly infringed, however, Patent Office records show most dealing with equipment inventions, rather than concepts. For example, one of the patents Xerox mentions is an infrared heater. It brings image powder to fusing temperature while at the same time heating the paper so it can act as a heat source in the fusing process. The heater was used by IBM in each of three examples presented to the Patent Office when application for the photoconductive composition was filed in 1966. Xerox obtained a patent on the i-r fuser in June 1969—six months before the IBM patent was granted.

In the three examples given by IBM to validate its photoconductor invention, IBM used Xerox equipment. However, it has since patented its own heat fuser.

In addition to alleged infringement of patent involving the i-r fuser and its power sources, and transport for moving the image-bearing material, Xerox alleges infringement of these patents:

▶ An illumination system wherein a vapor control center in a fluorescent lamp is heated by an element which maintains the center at a given temperature when the lamps are de-energized. The vapor control-center patent also includes a scanning station and a radiation image projection system.

▶ Electrographic copying apparatus, including rotation plate, scanning lens, and an image-transfer process using a powder image.

▶ Also, patents on developing, sheet-handling control, paper feed, an image fusing device, powder fil-

ter and plate-cleaning apparatus, copy-counting system, and sheet-stripping apparatus.

For the record

Stretch. There's a good chance the magnetic-tape rehabilitation facility at NASA's Goddard Space Flight Center in Greenbelt, Md., may be expanded. A NASA-SFC report on the magnetic-tape program at Goddard should be ready in a few weeks. NASA reports it has increased the flow of analog and digital tapes from scientists and experiments, after all meaningful information had been extracted and placed in the National Space Science Data Center, in response to recommendations of a recent General Accounting Office review. GAO said that "because of its [Goddard's] limited capacity for rehabilitating tapes, Goddard was not realizing the potential savings possible from greater use of rehabilitated tape." As of Oct. 31, 1969, GAO said, about 110,000 reels of tape awaited rehabilitation. NASA requires annually about 203,000 reels of analog tape and 219,000 reels of digital tape. New tapes cost about \$20 per reel for analog and \$11 for digital, while the cost to rehabilitate tape is only \$4.63 in-house and about \$1 more when done outside.

Biggie. If the proposed Bureau of Public Roads' demonstration project of the Electronic Route Guidance System in Washington [*Electronics*, April 27, p. 74] is a success, and a large-scale operating system is okayed, the winning contractor may get an initial award worth \$15 million. BPR officials told the House Appropriations Committee that the initial installation and operating costs for instrumenting 1,000 intersections—which would provide service on all primary traffic arteries and some collector streets—are estimated at \$15 million. According to these officials, "This estimate is for a dynamic version: one which is capable of considering congestion, weather,

400 Hz Solid State Relays

for military & commercial aircraft

Originators



TO-5 Relays

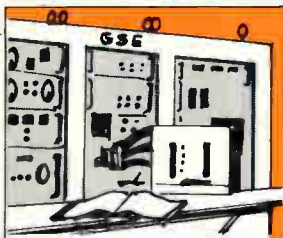
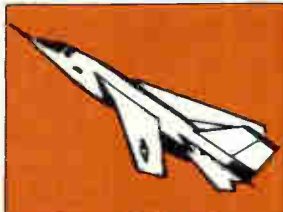

Solid State Relay

The originators of TO-5 relays announce another first! Solid state relays that meet or exceed all categories of MIL-STD 704A. Transient protected on input and output. Features include an ultra-sensitive "coil" (compatible with 5 volt logic systems, such as TTL), and a zero-voltage switching option to minimize RFI. They can switch over 5 KW, resistive or inductive loads (50-500 Hz). Extremely high reliability and maintenance-free operation

make them ideal for aircraft control and power system applications. Three input "coil" ranges are available, 3-8 VDC, 7-85 VDC and 90-230 VAC. Features include low contact resistance (50 milliohms typical) and contacts capable of withstanding overloads 1000% above ratings. Lack of moving contacts prevents arcing, permitting switching in explosive atmospheres, controlling motors, solenoid valves, actuators, transformers, etc.

The high contact surge rating is ideal for lighting control systems (5000 watts of tungsten lamps can be switched). For complete technical data on our 400 Hz Series 6 Solid State Relays and solutions to your 400 Hz power switching problems, contact

**TELEDYNE
RELAYS**

3155 West El Segundo Blvd. • Hawthorne, Calif. 90250
Telephone (213) 679-2205

More Aces for the Bridge Game

VOLTAGES
50 THRU 600 PRV

1.5 AMPERE



Type W
Body: .375" Dia x 9/32" High

3 AMPERE



KBPC — Thru-hole mounting
Body: .75" Sq x .25" High
KBPC2 — Threaded insert
Body: 1.0" Sq x .5" High

5 AND 10 AMPERE



5A — Type KBH5
10A — Type KBH
Thru-hole mounting for #8 screw
Body: 1 1/8" Sq x 7/16" High

THREE-PHASE
5 AND 10 AMPERE



5A — Type 3KBH5
10A — Type 3KBH
Two thru-holes for mounting #8 screw
Body: 3" L x 1" W x 5/16" H

1.5 and 3 Amperes immediately available from your authorized General Instrument Distributor.

Write for GI's "Full House" Condensed Catalog and detail bulletins to: General Instrument Corporation, Semiconductor Assembly Division, 65 Gouverneur Street, Newark, New Jersey 07104.



U.S. Reports

etc., and routing traffic more uniformly over the entire highway network." They added that annual operating costs, including central-computer facilities, communications, maintenance, and staff, may be \$3 million.

Dangers. NASA's Marshall Space Flight Center has issued requests for quotations for studies on potential nuclear hazards of the proposed space base and on future lunar explorations. Forty-five firms were asked to submit bids by May 12 on the 12-month, \$400,000 space-base study to identify the possible hazards and to recommend approaches for either their elimination or reduction to acceptable risk levels. Bids were scheduled to be returned May 5 for the 11-month, \$300,000 moon study, which will consider the temporary moon bases, shelters, surface drills and other tools, equipment, and flying and surface roving vehicles for missions beyond Apollo 19 if and when they are approved.

Nimbus award. Gulton Industries' Data Systems division has been awarded a \$1.6 million contract by the Commerce Department's Environmental Science Services Administration to build an infrared temperature-profile radiometer for the Nimbus-E weather satellite, scheduled for a 1972 launch. The radiometer's small field of view—35 kilometers square—will permit more reliable soundings of the atmosphere's temperatures from the spacecraft down to the earth's surface in partly cloudy areas and will measure the distribution of water vapor in the atmosphere. Earlier similar instruments aboard Nimbus 3 and 4 had larger fields of view—approximately 225 km square—which made it difficult to measure the different temperatures through a cloud cover over the earth.

Downcurve. The Zenith Radio Corp. has reported lower sales and earnings for the first quarter of 1970. Earnings for the three months were \$6,066,000, or 32 cents per share. This was down from the record first quarter earnings of \$11,-

966,000, or 63 cents per share in 1969. Sales for the period of \$128,555,000 were down from the record 1969 first quarter of \$185,469,000. Joseph S. Wright, chairman, said the slowdown in business activity continued to be particularly evident in consumer electronics where unit sales to dealers of color and black-and-white television, phonographs, and radios were down sharply from the year earlier.

Far-sighted? When it comes to investing in the future, the American businessman is no slouch. Overall, industry plans to spend \$82.3 billion for new plants and equipment in 1970—9% more than it did last year. This, according to McGraw-Hill's annual survey of businessmen's plans for plant and equipment investments, is due to industry's optimistic expectation that it will need additional capacity in the years ahead despite the economy's current slump. Electronics-related industries, however, are showing mixed reactions when it comes to spending. Instrumentation houses, extremely bullish, plan on spending 24% more than they did in 1969, whereas the aerospace industry is expected to spend 20% less than in the previous year. Outlays for electrical machinery, on the other hand, will rise about 12% over what they were last year. This year's buzzword is ecology, with industry spending reaching nearly \$2.3 billion for pollution-control equipment, much of it going into the coffers of electronics firms.

Precedent. After a jury trial in the 98th U.S. District Court in Austin, Texas, Magnavox has been ordered to pay the Charles Partlow family \$212,000 in damages caused by a fatal tv-set fire resulting from a defective flyback transformer. The decision, according to Tom C. Davis of Austin, lawyer for the plaintiffs, is significant because it's the first such award granted by a jury. The ruling was that the television set was defective when it left the manufacturer's possession and thus Magnavox, rather than the maker of the faulty transformer, was responsible for the two deaths caused by the fire.

Most engineers know ADC Products has designed over 3000 different filters.

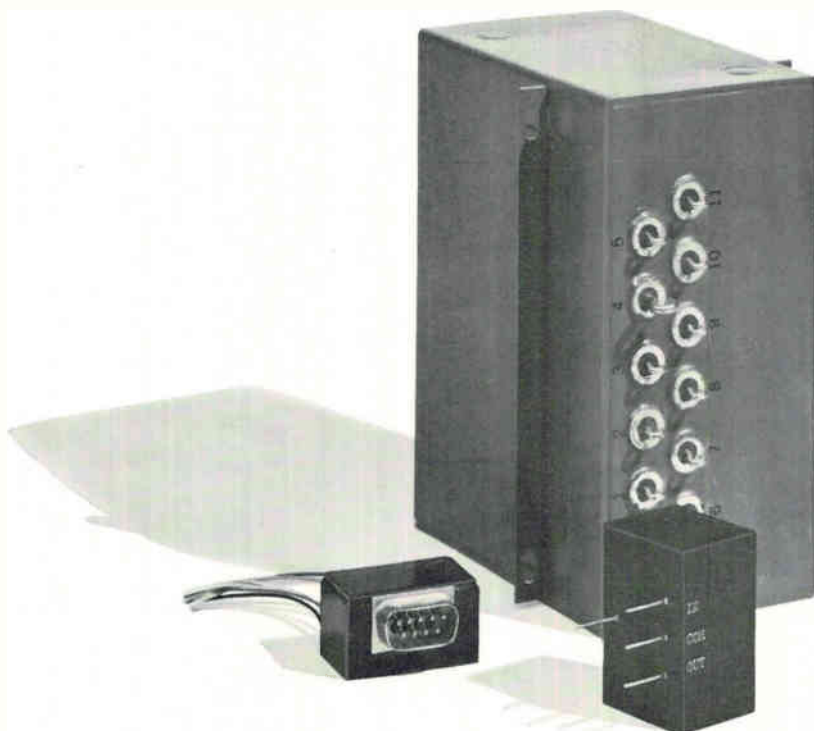

But do you know... ADC Products makes 19,897 different transformers, 2,863 different jacks, plugs, jack panels and allied components, plus power supplies, solid state relays, pre-wired jack fields and even complete communications sub-systems?



One of the finest, most knowledgeable filter design departments in the country is just one reason why ADC Products has designed and built 3,512 different custom filters . . . to date. Another reason is the use of computer design and analysis techniques to help optimize design and performance. At ADC Products, state-of-the-art design is an everyday thing, and we can show you the 3,512 designs to prove it!

But modern techniques extend beyond design. Every filter is built by modern methods using the newest materials and the latest techniques in a high-reliability manufacturing program. Why not see if this kind of capability can go to work on your problems? Write ADC Products today for more information and a free guide to filter design.



ADC PRODUCTS
A DIVISION OF MAGNETIC CONTROLS CO.

4900 West 78th Street, Minneapolis, Minnesota 55435
(612) 929-7881

764.8267	z temporary
3.326 845 815	y accumulator
33.50	x keyboard

Dynamic range 10^{-99} to 10^{99} , nearly 200 decades. Observation of math operations on 3 displayed registers. Up to 32 more registers for data storage.



Complex and vector arithmetic simplified with coordinate transformation keys, rectangular-to-polar and vice-versa, in milliseconds.



Trig functions covering all quadrants and any size angle in degrees or radians.



Introducing the HP 9100B to give you a choice of basic calculators. Provides additional internal memory and programming capability.



Program from the keyboard. Record and store up to 392-step programs on credit-card size magnetic cards for repeated use.



Edit programs easily. Single-step through programs to check and debug. Address an individual step and make corrections without re-entering the entire program.



Branching and looping flexibility provided by "IF" keys expands programming capability. Single-key direct sub-routine call.

New Time-Saver Statistical Problems

Almost every discipline makes extensive use of statistics. The HP STAT-PAC is a package of programs covering nine frequently used statistical areas. It gives you instant access to HP System 9100. Start your emancipation from the laborious reduction of statistics—send in this coupon for information, or a demonstration. Price \$19.50.

Please send info on new HP STAT-PAC
I use statistics in _____
_____ discipline.

Please have a salesman arrange a demonstration.

Please send general info on HP System 9100.

Name _____

Position _____

Firm _____

Phone _____

Address _____

City _____

State _____

Zip _____

The Emancipator...

start of the small computing system!



090/1A

HEWLETT  **PACKARD**

HP CALCULATOR SYSTEM 9100

It all starts with the HP 9100A calculator... and grows from there. In capability... not in size.

In fact, you can fit the entire HP System 9100 on your desk. It's the personal computing system that puts immediate answers to big computing problems right at your fingertips.

If a picture is worth a thousand numbers, add a plotter. See the solutions being plotted as fast as your problem is being solved.

Need printouts? Get the quiet printer that operates in an office or lab environment without disturbing you, or your neighbors.

You also get an extensive and growing library of applications oriented programs.

But the HP System 9100 is not resting on its laurels. Now you have a choice of basic calculators for your small computing system.

HP is adding the 9100B calculator for those of you who want even more memory and programming power.

The addition of 16 more storage registers doubles the programmable memory to 392 program steps. And, the

ability to call subroutines directly gives you more efficient use of this extra memory.

Just pick the calculator that best suits your needs. Plug in the peripherals and you are ready to go. The computing power of your basic system can continue to grow to meet your changing requirements. Additions, like the upcoming memory extender, will be compatible with either calculator.

Stretch your computing dollar with the personal computing system that has learned to live on a small budget. Put this system to work for you now. Just call your local HP Calculator Salesman, he will have the HP System 9100 on your desk faster than you thought possible.

Or, write to Hewlett-Packard, P.O. Box 301, Loveland, Colorado 80537. In Europe: 1217 Meyrin-Geneva, Switzerland. Prices: HP 9100A Calculator \$4400; HP 9100B Calculator \$4900. Peripherals; HP 9120A Printer \$975; HP 9125A X-Y Plotter \$2475. Lease/rental programs start as low as \$1.50/computing hour, based on average usage.

Circle 57 on reader service card

A quick guide to magnetic drives: torque transmitters that work when other methods won't.

Magnetic drives offer you some relatively inexpensive solutions to difficult torque transmission problems. For instance, a magnetic drive can transmit torque through a non-magnetic barrier without using any mechanical connection. And because the system completely eliminates seals, it eliminates problems of leakage, maintenance and contamination.

3 basic types of magnetic drives.

1) *Synchronous drives* are equivalent to a shaft connection. Two basic arrangements are axial and radial. Axial drives consist of two Indox magnets or two Alnico side pole rotor magnets. Axial thrust is a maximum at zero load and diminishes as more torque is applied.

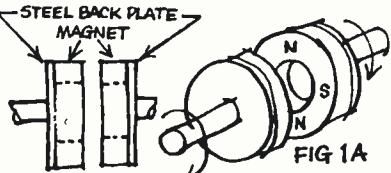

Radial drives consist of two ring magnets and have no axial thrust. Because of starting in-

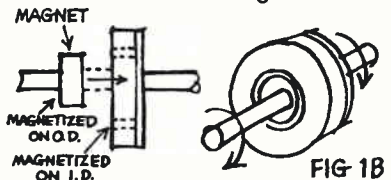

ertia, the outer magnet normally drives the inner one. When the maximum torque of a synchronous drive is exceeded, the driven member stops. This can offer important protection in event of overloading. And you never have to replace shear pins or worn frictional surfaces.

2) *Eddy current drives* use the field of a rotating permanent magnet to induce eddy currents in a conducting material.

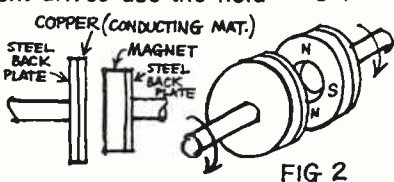

Interaction between these currents and the magnetic field gives rise to the torque of the coupling. Torque varies with the relative speed of the members. Eddy current drives use driven members of aluminum or copper in the form of cups, tubes or discs depending upon the configuration needed.

3) *Hysteresis drives* use the magnetic field of a rotating permanent magnet to drive the material of the hysteresis member through its hysteresis loop. The unit is syn-

chronous provided the maximum torque isn't exceeded. Beyond this point the torque is independent of the slip speed and remains constant.

Hysteresis drives operate at close gaps. But unlike eddy current drives, hysteresis drives transmit constant torque.

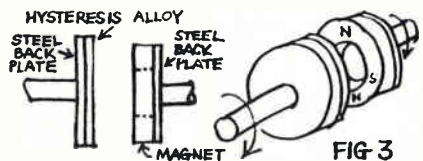

Design aids available free.

The basic factors to consider in magnetic drive design include:

- radial or axial gap configuration
- relationship of torque to slip speed
- ambient operating temperature
- non-magnetic material through which torque must be transmitted
- maximum torque to be transmitted
- critical nature of the alignment.

We're anxious to help answer your questions. And we would like to send you some useful aids that include graphic presentations of important factors in magnetic drive design. Just write Indiana General, Magnet Products, Valparaiso, Ind. 46383.



a division of Electronic Memories & Magnetics Corporation

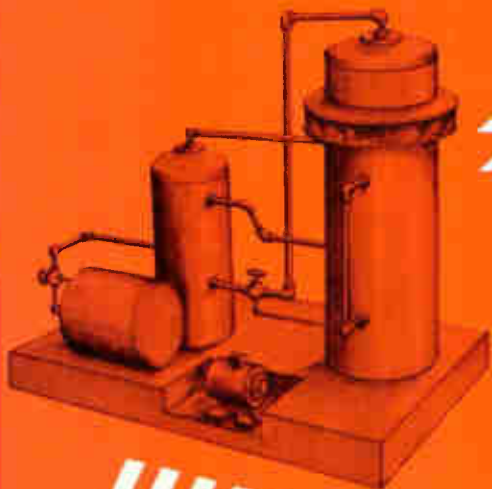

Tie one on

... to your IBM 1800, GE-PAC 4020,
PRODAC-2000, EMR 6100, PDP-8/9/15
... or whatever.

VIDAR can take half the load off of your process control computer. VIDAR's analog input wares (hard and soft) tie your thermocouples, RTD's, flow meters, strain gages, tachometers and all the rest right into your computer. If you're looking for an intelligent scanning process monitor, you'll want VIDAR's 5206 D-DAS™ with built-in mini-computer. It handles process data. It displays — even alarms — and reports periodic engineering data. It answers your big computer's requests on how things are coming . . . relieving it for control strategy and reports.

Best of all — it comes with the powerful compact ready-written 80-program VIDAC real-time data acquisition software which accomplishes most data acquisition "front-end" tasks in only 4K to 8K of core.

Let us tell you how and where VIDAR has lowered cost and improved the capability of industrial process control systems. Data acquisition — supervisory control — or DDC . . . let VIDAR tie one on and take half the load.

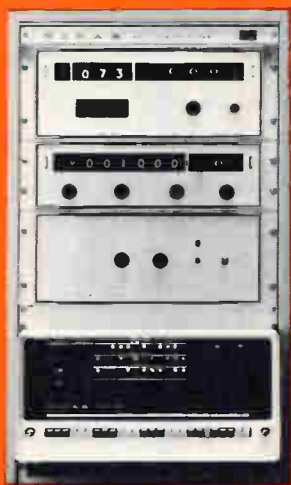

Circle 59 on reader service card

VIDAR®

77 Ortega Avenue, Mountain View, Calif. 94040 (415) 961-1000

the automatic-measurement people

Second-source 7400 T²L with a difference.

We can make immediate deliveries on all these digital devices, but that's not the whole story. These are Philco® 7400 Series T²L circuits with Cerdip proved hermetic packaging—the T²L package of the future . . . today.

There's more to the story too . . . like the extra glassivation step that protects the circuit against damage, and gives an added measure of reliability; and clamp diode inputs for greater noise immunity and freedom from ringing.

All the items listed are in stock now, with 7 more MSI types due in the immediate future, and 10 more scheduled in the months ahead.

So for immediate deliveries, call on us — we're the reliable alternate source for Series 7400 circuits. Write or call Philco-Ford Corporation, Microelectronics Division, Bipolar Products Marketing, Blue Bell, Pa. 19422. Telephone (215) 646-9100.

DEVICE	DESCRIPTION	DEVICE	DESCRIPTION	DEVICE	DESCRIPTION
PD7400	Quad 2 Input Pos. Nand Gate	PD7440	Dual 4 Input Pos. Nand Buffer	PD7472	JK Master Slave Flip-Flop
PD7401	Quad 2 Input Pos. Nand Gate with Open Collector Output	PD7450	Expandable Dual 2 Wide 2 Input And-Or-Invert Gate	PD7473	Dual JK Master Slave Flip-Flop
PD7402	Quad 2 Input Pos. NOR Gate	PD7451	Dual 2 Wide Input And-Or-Invert Gate	PD7474	Dual D Type Edge Triggered Flip-Flop
PD7404	Hex Inverter	PD7453	Expandable 4 Wide 2 Input And-Or-Invert Gate	PD7475	Quad Bistable Latch
PD7405	Hex Inverter with Open Collector Output	PD7454	4 Wide 2 Input And-Or-Invert Gate	PD7476	Dual JK Master Slave Flip-Flop with Preset and Clear
PD7410	Triple 3 Input Pos. NOR Gate	PD7460	Dual 4 Input Expander	PD7482	2 Bit Binary Full Adder
PD7420	Dual 4 Input Pos. Nand Gate	PD7470	JK Flip-Flop	PD7483	4 Bit Binary Full Adder
PD7430	8 Input Pos. Nand Gate			PD7491A	8 Bit Shift Register

The better idea people in bipolar products.

PHILCO 

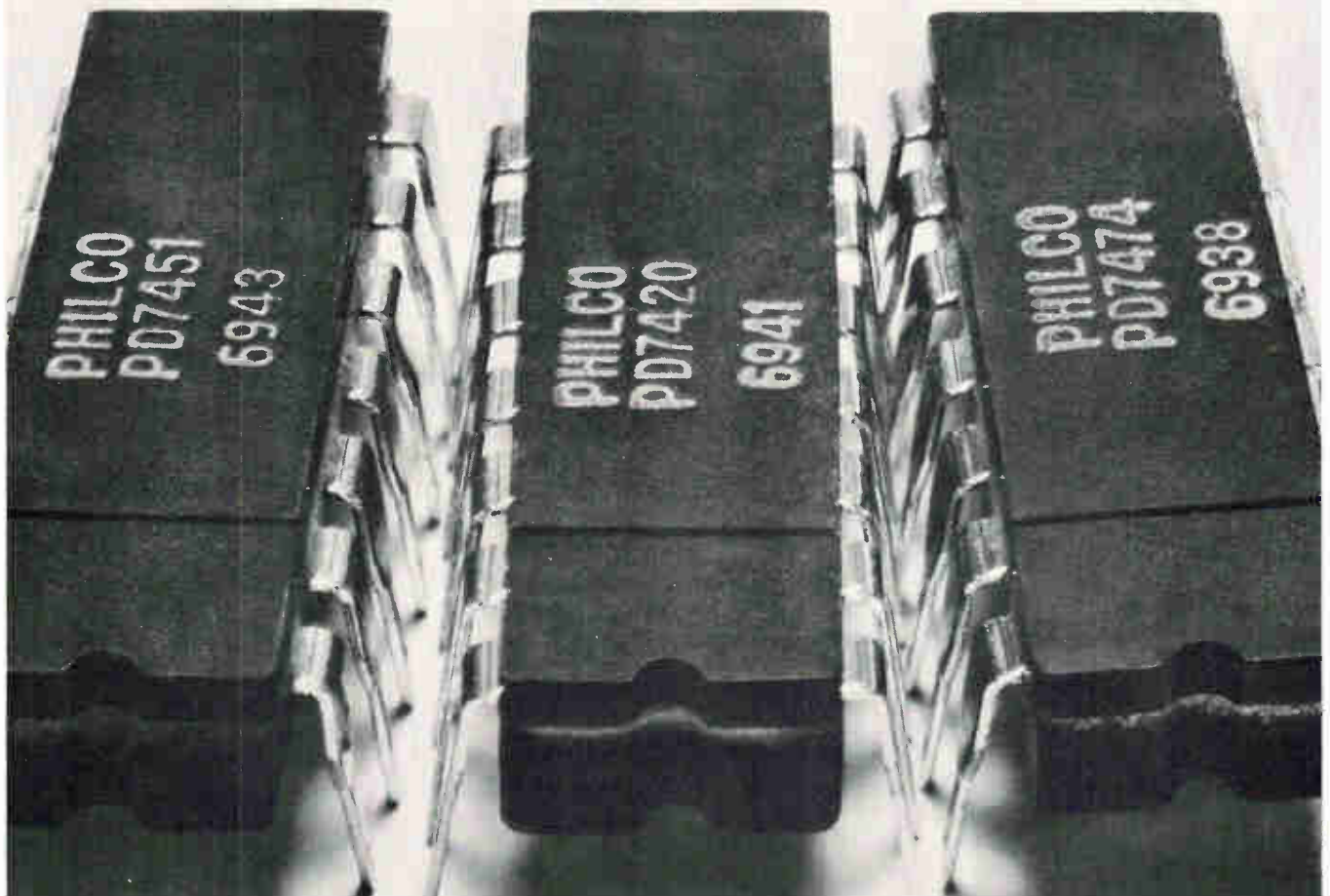

Tackle box

Contains a full line of work-together electronic materials to tackle any job.

The coupon below nets you complete data on the full line of Owens-Illinois vitreous and crystallizing materials . . . basic ingredients for all microcircuit devices.

All from a single source. All job-matched to work together. All high yielding — prepared from high quality materials to assure proper functioning of any microcircuit device you'd like to tackle.

We'll also rush you an Owens-Illinois technical representative. He'll help you select and apply the materials best suited to your needs. Just fill out the coupon.

OWENS-ILLINOIS
ELECTRONIC MATERIALS
Toledo, Ohio 43601

Package Sealants. Ten types. For hermetically sealing micro-electronic packages.



Thick Film Pastes. Three conductor, three dielectric. Lowest K-value, highest Q-factor on market.



Substrate Glazes. Seven types. For glazes or insulating films.



Sputtering Targets. Three types of sputtering target glass. Thin, smooth dielectric films.



Preform Materials. Sintered ground glasses, bead and connector forms. Tailored thermal expansion.



Glazed Package Parts. Custom glazing by Owens-Illinois available for your ceramic package parts.



OWENS-ILLINOIS, INC.,
Electronic Materials, Customer Service Mgr.,
Dept. T-5, P.O. Box 1035, Toledo, Ohio 43601

Please send me literature on:

- | | |
|--|---|
| <input type="checkbox"/> Package Sealants | <input type="checkbox"/> Glazed Package Parts |
| <input type="checkbox"/> Substrate Glazes | <input type="checkbox"/> Thick Film Pastes |
| <input type="checkbox"/> Sputtering Targets | <input type="checkbox"/> Preform Materials |
| <input type="checkbox"/> Have a technical representative call. | |

Name _____ Title _____

Company _____

Address _____

City _____ State _____ Zip _____

IT'S SUPERFLEXIBLE

a
new kind
of
HELIAX®

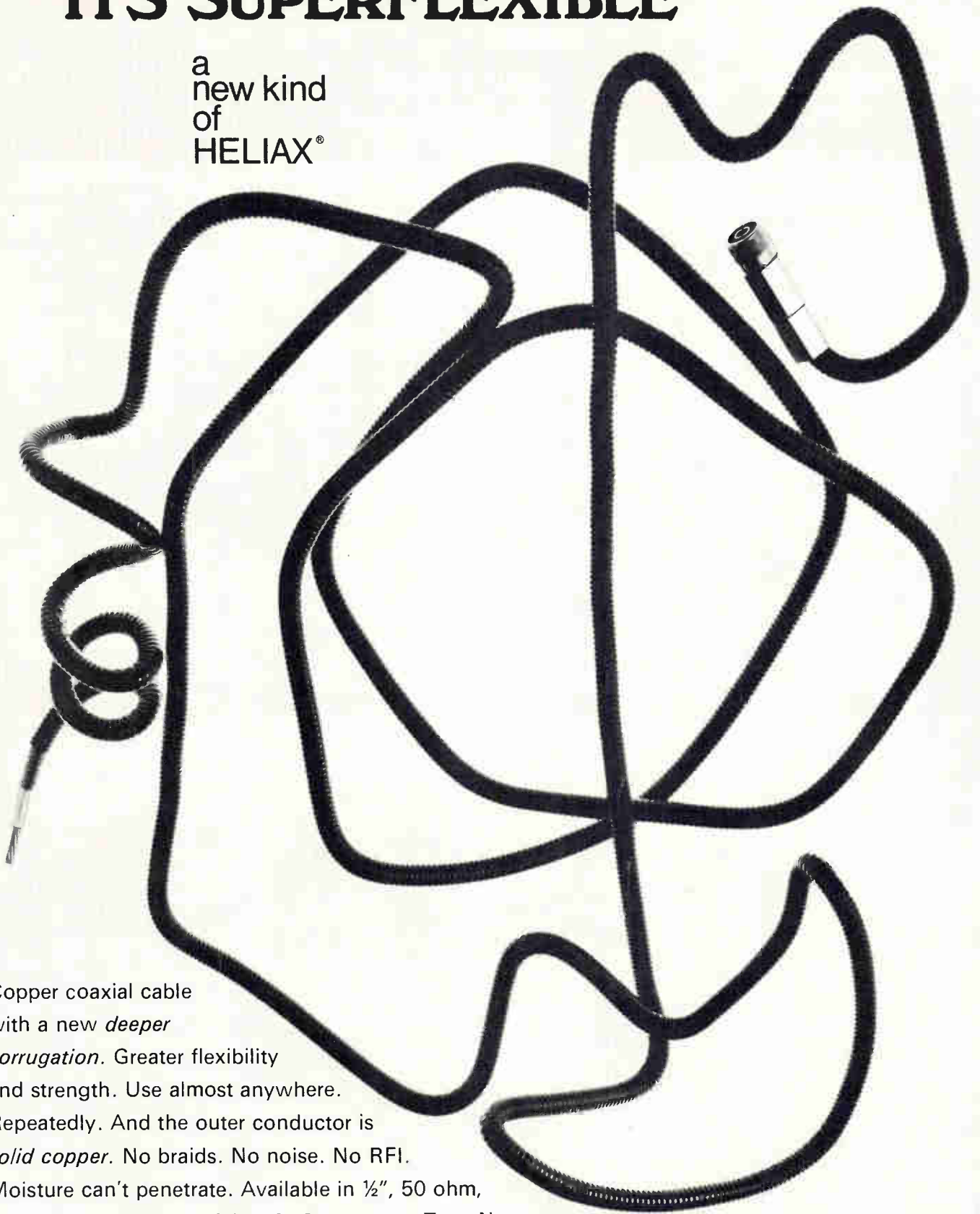

Copper coaxial cable with a new *deeper corrugation*. Greater flexibility and strength. Use almost anywhere. Repeatedly. And the outer conductor is *solid copper*. No braids. No noise. No RFI. Moisture can't penetrate. Available in 1/2", 50 ohm, foam dielectric, Type FSJ4-50. Connectors, Type N or GR-874. Like a sample? Communicate with Andrew.

12-68



ANDREW

CONTACT THE NEAREST ANDREW OFFICE OR ANDREW CORPORATION, 10500 W. 153rd STREET, ORLAND PARK, ILLINOIS 60462
Circle 62 on reader service card

International Newsletter

May 11, 1970

Chinese utilize approved frequency for its satellite

Mainland China may not be a member of the International Telecommunications Union (ITU), but it's acting like one. When China launched its first space satellite, it picked 20.009 megahertz as the broadcast frequency for its anthem, "The East is Red." The frequency is one earmarked by the ITU for space research and selected so as not to interfere with spectrum users in other countries. Though the signal is easily received with relatively simple equipment, the frequency is one that has difficulty penetrating the ionosphere in daylight hours.

But military-communications specialists, who have already dubbed the satellite Chicom 1, suspect the Chinese didn't launch more than 380 pounds of space hardware just to play a tape recording. Thus, they are monitoring the satellite carefully to determine if other frequencies are being used by China for clandestine research. Though sources say it will take some time, perhaps weeks, to make a final determination of the satellite's mission, no disclosure by U.S. intelligence is expected.

The satellite's size suggests to U.S. officials that there are more experiments on board than just a recorder, and that data from these will need to be telemetered to earth. Not ruled out is the possibility of reconnaissance gear since Chicom 1's elliptical orbit, with its 68.5° inclination to the equator, will send it over many major cities.

What favorably impresses Washington officials is China's voluntary demonstration of frequency cooperation by using an ITU-specified frequency in its first space venture. Some spectrum authorities feared that spectrum chaos could result if China had not gone along with the ITU.

West German firm plans multilingual tv sound system

With an eye on wide-open markets in many multilingual countries, researchers at Standard Elektrik Lorenz, an ITT subsidiary in West Germany, are hard at work on a 12-channel tv sound system. All 12 channels, each in a different language, can be transmitted synchronously with one video channel. And 24 channels can be transmitted in special cases.

The 12 audio signals, with a 13-megahertz bandwidth, and the video signal are transmitted as an integrated unit, which can be recorded on magnetic tape and sent over cable to an antenna. Current communications satellites that transmit video signals in frequency-modulated form are capable of receiving and retransmitting the integrated signal. The audio signals, time compressed by a factor of 1 to 385, are inserted between individual pictures in the 12 empty lines which normally constitute the no-transmission period between pictures.

Although Lorenz calls this system a proposal, predevelopment work already has been done. The system, using discrete components, is operating in the lab and further work is being done on incorporating MOS techniques into the system. The big obstacle now is not technical, but political—getting international tv authorities to agree on standards.

Philips gears up for cassette vtr's

The Philips group is all set for a big push into the low-priced cassette video recorder market. Starting around the middle of next year, Philips will offer three basic vtr's for consumer applications. One, designed only for playback of black-and-white programs, will probably sell for between \$275 and \$330. The second, for playback of color programs, will range between \$385 and \$412. The third unit, complete with a built-in receiv-

International Newsletter

ing portion, and with a recording and playback system for both monochrome and color, will be priced at about \$550.

The Philip vtr's use a pocketbook-size cassette containing 0.5-inch magnetic tape that's good for 60 minutes. With the most expensive unit, it's possible to record one program while watching another.

Agreements on basic standards and dimensions for the equipment have already been made between Philips and other European electronics producers. These firms include West Germany's AEG-Telefunken, Grundig Werke, Blaupunkt and Loewe-Opta, and Italy's Zanussi. More companies are expected to reach similar agreements with Philips soon.

BBC radio goes digital

Now that tests with television sound signals have shown the British Broadcasting Corp. that it's perfectly feasible to distribute sound from studio to transmitters in digital form [*Electronics*, Feb. 16, p. 69], the corporation plans to digitize its radio broadcasting network. A distribution technique that BBC has been developing will be tested operationally next year.

The change is intended to improve the quality of all sound broadcasting, but its biggest effect will be on the quality and simplicity of stereo distribution. At present, the BBC rents audio-band a-m cable links from the Post Office, but these deteriorate with time, and it's been difficult to arrange properly matched channels for stereo distribution. The corporation's plan is to carry a number of digitized sound channels time-division-multiplexed onto wideband tv-type distribution links. It believes this will provide stable, well-matched stereo carriers. In parallel with this work, the corporation is developing digital tape recorders which have a better signal-to-noise performance than present recorders, and hence improve input quality to the distribution system.

Another step in Japan's European push

Mitsubishi Electric is going to apply the domino theory to push its computer invasion of Europe. First to be attacked is the rich West German market. Once a solid sales base is established there, the Japanese company will start promoting its wares in the rest of Europe. Mitsubishi, with European headquarters in Hamburg, is now setting up a network of computer sales and service organizations throughout the country.

Starting towards the end of this year, Mitsubishi will offer two medium-sized computers—the Melcom 83 and the Melcom 84—to German customers. Both machines use magnetic-disk storage units for 10,000 words, expandable to 100,000 words, a feature which is unusual for medium-sized computers. The 83 model, complete with tape-punching and reading equipment, will sell for roughly \$17,900 and the 84 for about \$22,900.

On the wing to Switzerland: the A-7 Corsair

It now looks as if the A-7 Corsair II will be the Swiss Air Force's next-generation combat jet. The U.S. aircraft has been recommended—over the Italian Fiat G-91—by a defense committee that has been looking at possible replacements for Switzerland's obsolescent complement of British-built fighters.

If it comes, the order will be big. The Swiss Federal Government, which must implement the committee's decision, has earmarked \$300 million for the next line of aircraft. Until the Corsairs come, the French-built Mirage III will remain the front-line combat jet.

Electronics New subscription application

Please start my one year subscription — 26 issues — for only \$8!

CHECK HERE FOR 3 Years \$16 — Saves me \$8!

FOREIGN RATES ON REQUEST

Payment Enclosed

Bill Me

Bill My Company

SUBSCRIPTION INCLUDES 1,200-PAGE ANNUAL BUYERS' GUIDE ISSUE

Name _____ Title _____

Please Fill In All Spaces

Company _____

Company address _____

City _____ State _____ Zip code 

Specific Product _____ or Service _____
manufactured _____ performed _____

Are you involved in the specification of electronic or allied products? Yes No

Please check your department or function:

Design Research, development Production, operation, maintenance

Other (please describe) _____

Above rates apply only to those professionally engaged in electronics technology.

51120

All others, \$25 per year.

Electronics New subscription application

Please start my one year subscription — 26 issues — for only \$8!

CHECK HERE FOR 3 Years \$16 — Saves me \$8!

FOREIGN RATES ON REQUEST

Payment Enclosed

Bill Me

Bill My Company

SUBSCRIPTION INCLUDES 1,200-PAGE ANNUAL BUYERS' GUIDE ISSUE

Name _____ Title _____

Please Fill In All Spaces

Company _____

Company address _____

City _____ State _____ Zip code 

Specific Product _____ or Service _____
manufactured _____ performed _____

Are you involved in the specification of electronic or allied products? Yes No

Please check your department or function:

Design Research, development Production, operation, maintenance

Other (please describe) _____

Above rates apply only to those professionally engaged in electronics technology.

51120

All others, \$25 per year.

First Class

Permit No. 42

Hightstown, N. J.

Business reply mail

No postage stamp necessary if mailed in the United States

Postage will be paid by McGraw-Hill, Inc.

Electronics

P. O. Box 514

Hightstown, N. J. 08520

Subscription department

First Class

Permit No. 42

Hightstown, N. J.

Business reply mail

No postage stamp necessary if mailed in the United States

Postage will be paid by McGraw-Hill, Inc.

Electronics

P. O. Box 514

Hightstown, N. J. 08520

Subscription department

West Germans roll out radio system for snarled motorists and traffic

Schaub-Lorenz's Infar interrupts car radios and tape equipment with pilot tone, allowing ultrashortwave receiver to pick up road-condition broadcasts

Broadcasts about road and traffic conditions can do a lot to ease traffic jams by warning motorists to use alternate routes. But such broadcasts can only be really effective if every motorist in a certain area gets the message. The alert must get through even if the driver is tuned to the wrong station, listening to his car's tape system, or riding in a car with no standard audio equipment at all.

A system that can get the word through despite these obstacles has been demonstrated by Schaub-Lorenz, a West German subsidiary of the International Telephone and Telegraph Corp. and a big entertainment-electronics producer there. The new system is in the running for adoption by the nation's Fourth Radio Program, which will be set aside for traffic reports.

The operation of the Schaub-Lorenz system is simple. Together with a news and musical program, the station operating on the traffic channel sends out a 19-kilohertz pilot frequency, an inaudible tone. When traffic information is to be broadcast, this pilot tone is switched off for the duration of the announcement. The initial tone interruption cuts out the channel to which the driver may be listening and cuts in the traffic channel. This channel is received by a small additional ultrashortwave receiver in the car. The pilot tone can also cut out tape equipment.

Zone of silence. However, unwanted channel switching would occur if the car travels through a zone of radio silence, such as a tunnel or high-rise building area. To prevent such unwanted switch-

ing, Schaub-Lorenz engineers established a second criterion. The carrier of the traffic radio station must be present before channel switching can take place. This is done by a simple AND circuit: there's a voltage only when the pilot tone is interrupted and the carrier of the traffic station is present. Thus, Schaub-Lorenz dubbed its systems Infar, the acronym of the German words for "information broadcasting by automatic radio".

The company has high hopes that Infar will be introduced on a country-wide basis, and this may well occur within two or three years. The firm also sees a big future ahead for Infar in other countries like Italy, Holland, France and Sweden—countries that are considering setting aside a channel specifically for traffic information.

Infar has several important strong points. For one thing, the system is easy to implement because it

is compatible with existing radio-transmission standards. For example, the 19-khz pilot tone need not be specially produced at the station. A pilot tone is already being used in stereo broadcasting.

Kept simple. Another advantage is that the additional electronics gear required in the car can be held to a relatively low cost. The Infar unit is nothing but an ultrashortwave receiving unit whose design can be kept simple since it need only operate in the 100- to 104-Mhz range and, thus, requires no expensive band filters. For tuning, some fixed or pretuned circuit arrangement, or an electronic tuning scheme, is feasible in any future mass-produced Infar units. Furthermore, it doesn't require a low-frequency portion or a loudspeaker. Infar operates into the low-frequency and loudspeaker portion of the regular car receiver.

Other parts of the Infar unit—the AND circuit for example—could be

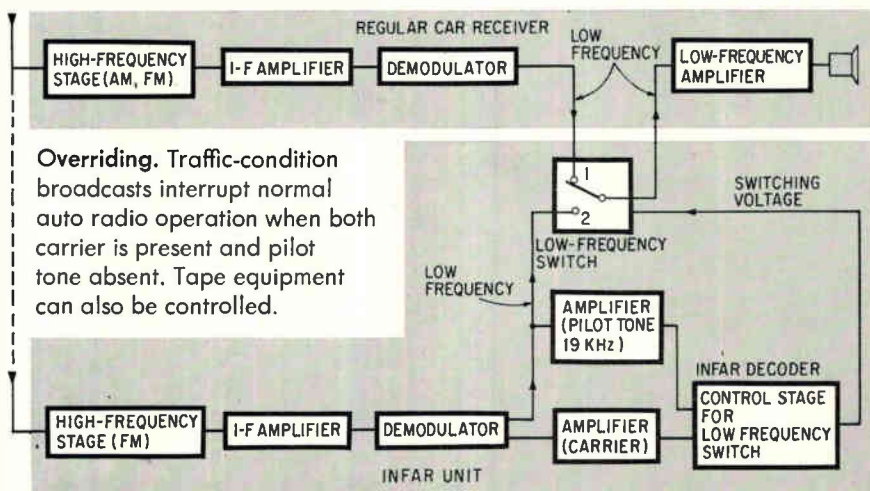

based on integrated circuits, and this would further keep costs down. Schaub-Lorenz figures that once the Infar unit is mass-produced, it could well sell for less than \$30.

What about those drivers who don't want to bother with a car radio? The Infar unit itself can come complete with a low-frequency portion and a loudspeaker. The unit would sound off only when the pilot tone is interrupted. For traffic bulletins to come through the unit would of course have to be on whenever the ignition is on.

West Germany

On the stands . . .

If they were looking for breakthroughs in semiconductors and similar devices, visitors at this month's Hanover Fair might have done well to just stay at home. Semiconductor houses, both European and American, appear to be little inclined to stir up the market with any significant new advances with their order books bulging, plants working at full capacity, and a \$50 million-plus market for IC's in sight for West Germany alone—much higher than expected.

True enough, Hanover this spring

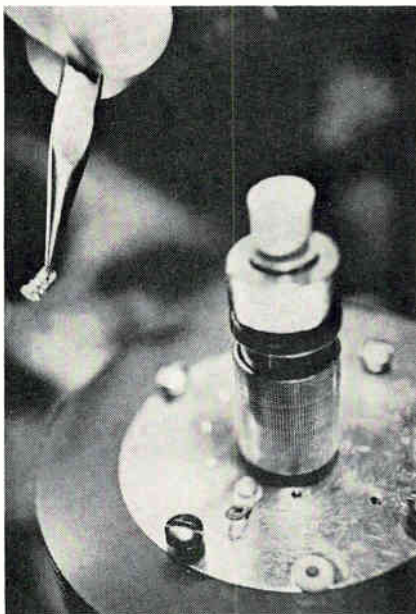

Link-up. Gunn diode, being mounted in heat sink, is heart of videophone link.

did present some interesting devices, such as 1-nanosecond emitter-coupled logic and new linear IC's for consumer electronic applications.

Gear. But whatever was lacking in the semiconductor field was more than made up by new communications systems and instruments—some of them rated as world firsts. For example, one eye-opening communications system demonstrated at Hanover was a Gunn-oscillator microwave link intended for video telephone transmissions, a system which its developer, West Germany's Siemens AG, says is the first ever that's built around Gunn devices. Also of note was a new type of flexible waveguide that AEG-Telefunken has designed for production model Concorde, the French-British supersonic airliner.

Instrument designers, too, showed up with equipment hot out of their labs. For example, Rohde and Schwarz, West Germany's top-ranking instrument maker debuted new frequency analyzers featuring a dynamic range of up to 100 decibels. And Great Britain's Microwave and Electronics Ltd. rushed onto the scene with a microwave sweep generator so hot that the company didn't even have specification sheets ready. The sweep generator offers plug-in YIG-tuned Gunn oscillators for first time in a sweep generator.

The Siemens video link is a four-channel system that uses two Gunn elements at each terminal, one in the outgoing video channel and the other in the outgoing audio channel. The maximum power each oscillator delivers is 50 milliwatts.

The 20-mw average power of each Gunn oscillator is amplitude-modulated. With a modulation of 50%, the output power of an oscillator thus varies between 10 and 30 mw. This power is fed to a pair of bandpass filters whose output is combined in another bandpass filter. The combined video-audio signal goes to a hybrid coupler and then to a small parabolic antenna.

Wavy. AEG-Telefunken's new flexible waveguide, based on the firm's present flexible lines, was especially made for the Concorde. In that plane, high-frequency en-

ergy must be carried over a 30-foot distance from the antenna at the tip of the plane's tilting nose to weather-radar equipment just below the cockpit. The new flexible waveguide, called E 100 is laid out for a frequency range from 8.5 to 10.0 gigahertz. It can handle peak power of 150 kilowatts and has a vswr of less than 1.03 for each of its two sections. Its attenuation is less than 0.98 db.

In the instruments field, the big attention-getters at the Rohde and Schwarz stand were the company's three new frequency analyzers of the FAT series. Besides their high dynamic voltage range—up to 100 db or 0.1 microvolt to 30 volts—the instruments are noted for their versatility. They can be used for Fourier analysis, frequency measurements, voltage and noise measurements, analysis of acoustic phenomena and vibrations, and, in conjunction with a built-in mixer, for sideband measurements up to 300 megahertz.

The new British sweep generator, the star attraction at the stands of Microwave and Electronics Ltd. features a range from 250 Mhz to 40 Ghz. The instrument, model 1000/1020, is unusual in that it can take either YIG-tuned Gunn oscillators, conventional backward-wave oscillators or transistor oscillators as plug-in energy sources. For low-power, 6- to 12-Ghz measuring and test applications, engineers will want the YIG-tuned Gunn oscillators, an energy source with a lifetime of 20,000 hours, according to the company.

. . . and in the air

Judging from the lineup of planes at the Hanover Air Show earlier this month the West German aircraft industry is about to take off into the blue. Indeed, although aerospace sales—\$400 million for 1970—won't be significantly higher than last year's, overall prospects are better than ever before.

For the first time, three projects are on the industry's drawing boards simultaneously: the Airbus A300B, the Franco-German large-

aircraft venture; the VFW 614, the German business jet; and the multirole combat aircraft that the Germans, French, and Italians intend to build. All three projects stand a pretty good chance of being continued through the serial production stage. What's more, the Germans and the French are now dickering about a jet trainer.

In addition, the spacecraft sector has gotten some whopping orders, for this sector's share of total aerospace sales is roughly 20% this year. Two West German aerospace firms have landed nearly \$75 million in satellite contracts [*Electronics*, Apr. 13, p. 69]. Also the German-French Symphonie, communications satellite is taking on shape. And if the Bonn government should decide to participate in some sort of post-Apollo program with the U.S., more orders will fall to the industry.

Gearing up. Optimism, on the rise after many years of relative calm in the industry, prevails in much of the avionics sector. Companies, although still up against some fierce competition from other Western countries, notably the U.S. and Great Britain, are gearing up to provide the equipment that's needed. Of this, there was plenty of evidence at Hanover.

For example, Teldix GmbH, a joint subsidiary of AEG-Telefunken and the Bendix Corp., showed up with a new stabilization system intended for the Symphonie satellite. The system is designed to hold the satellite stable enough for an antenna-ground-station alignment that deviates by no more than 0.3°. The system is essentially a momentum wheel whose rotational speed is controllable between 2,700 and 3,300 rpm.

The Teldix wheel, the first to go into a commercial satellite, is essentially a brushless d-c motor designed as a spoked-type wheel and installed in a hermetically sealed, evacuated housing. Rotation control is by optoelectronics effects. Light from three gallium-arsenide diodes is interrupted by small cams connected to the wheel. Photo-transistors sense the resulting light intensity and control power to the motor's stator.

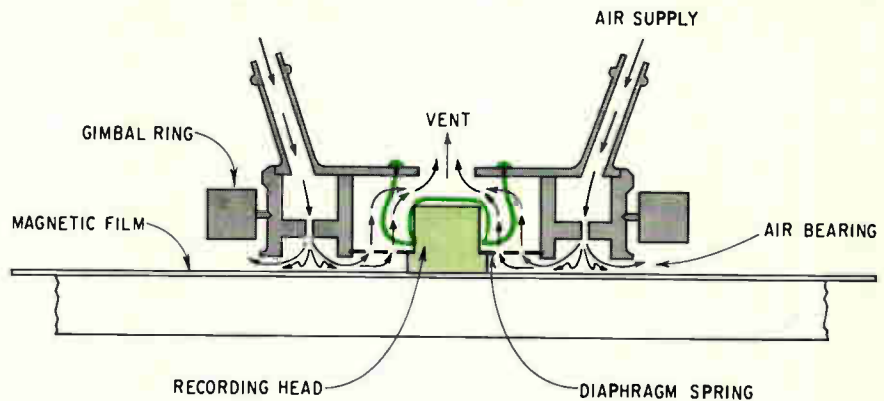

Hovering. Recording head in ICL 10,000-bit-per-inch system rides on disk with a loading controlled by pumped air. Wear-resistant material coats the disk.

Great Britain

Packing them in

Tomorrow's computers are going to need magnetic-disk memories of very high capacity, and Britain's International Computers Ltd. is well on its way to achieving packing densities of 10,000 bits per inch. Company researchers have attained such densities by using compressed air to maintain head-to-disk separation, cobalt-phosphorus recording material and a rhodium wear-resistant surface.

On any disk file, the maximum number of bits that can be packed into an inch of track depends on the thickness of the recording surface, the width of the gap in the recording head, and the distance between the moving recording surface and the stationary head.

Reducing surface thickness and recording-head gap width below present levels is not difficult, so the practical limit is set by the minimum distance necessary for the head to clear the disk surface. Using a modern flying head in the research lab, the separation can be reduced to around 1 micron at the trailing edge—at the expense of high risk of rapid wear due to contact with dust and high spots on the disk. In practice a separation of 2 or 3 microns is used.

Gave it up. ICL's approach is to abandon altogether the search for the smallest possible flying separation, and instead to run the head deliberately in contact with the disk surface. The two men who

have developed the system, Ian Turner and Alan Terry, claim that the problems of wear and instability can be overcome by designing a special suspension for the recording head and using a wear-resistant coating over the recording surface. The separation can't be eliminated altogether because the coating will be about 0.1 micron thick. Turner believes that other factors, such as lack of perfect geometrical conformity between the contacting surfaces, minute and unavoidable rounding of the corners of the recording head at the gap, and aerodynamic effects will add up to an effective separation around 0.5 micron.

Nevertheless, this makes it possible to use a much smaller gap in the recording head—0.9 microns—and a very thin layer—0.3 microns—of cobalt-phosphorus as the recording medium, which all adds up to the big improvement in bit density. The wear-resistant coating is rhodium, 0.1 micron thick. The two say that a wear life of well over a billion passes of one track has been achieved at a surface speed of 1,000 inches per second.

The system is an integrated whole, but the main novelty is in the head and its carrier. To keep specific pressures between head and disk surface to a minimum, the contact face of the nickel-zinc ferrite head is as large as possible and cube shaped. Mass has been kept down to 0.1 gram to keep inertia low for following imperfections of the disk surface closely, but with minimal damage. Total

load against the surface is 5 grams, which is controlled by balancing pumped air pressure and spring pressure in the head carrier.

Carrying. The head is carried in the middle of a beryllium-copper diaphragm spring, which pushes the head against the disk. The spring in turn is mounted in the center of a hollow brass ring, which has holes facing the disk. Another spring pushes the ring towards the disk. Tubes feed air at 20 pounds per square inch into the ring. Escaping through the holes, the air maintains the ring at a closely controlled height above the disk. Terry says the system is not sensitive to minor variations in air pressure. He also points out that the head doesn't crash if the disk stops.

France

Acoustic fallout

Research in reducing the noise of aircraft engines has produced a neat bit of electronics fallout: an electret microphone smaller than a collar-button, the low cost and high performance of which should offer new solutions to sound reproduction problems in areas ranging from medical to consumer products.

The midget microphone was developed by the French government's big aerospace research lab—the Office National d'Etudes et de Recherches Aérospatiales (ONERA)—which needed an accurate means of studying minute pressure fluctuations in the gases that roar through jet engines.

These pressure variations are a major cause of engine noise, which ONERA engineers hope to reduce by design changes in engine compressor vanes. Redesigning means measuring how vanes and gas streams interact, and a good way to take readings is to tie a mike to a vane during an engine run.

Rugged test. Finding a microphone rugged enough to take such punishment was a major problem. It had to work under temperatures up to several hundred degrees C. and pressure fluctuations up to 160 decibels. Either condition is enough

to destroy any commercial microphone researchers could find.

Moreover, the microphone had to be thin enough to fit flush with the surface of the vanes, only about a quarter of an inch thick. Otherwise, the flow resistance of the microphone would falsify readings.

The high voltage needs of ordinary dynamic microphones prompted ONERA engineers to turn to electret-effect devices, developed after the pioneering work of G.M. Sessler and J.E. West of the Bell Telephone Laboratories. Developing a suitable electret microphone required considerable innovation, since those developed by Bell Labs, Japan's Sony and others will work only up to 100 db.

ONERA engineers jumped this hurdle by designing a field effect transistor into the microphone to act as an impedance adapter.

Using this arrangement, an initial ONERA microphone, 7 millimeters in diameter by 5 mm long, gave a sensitivity of 200 millivolts at 134 db—several times higher, say ONERA designers, than the microphone Sony put in a commercial tape recorder.

The latest, button-shaped French electret microphone measures only 5 mm in diameter by a scant 1.5 mm thick. Its sensitivity, of course, is lower: only 10 mv at 134 db. But engineers say some proprietary improvements in the microphone's electrode—which they hope to patent shortly—should push sensitivity up to 100 mv.

Easy on ears. The microphone's transistor helps push a clean signal through the 150-foot wire necessary to protect researchers from high engine noise levels.

The microphone has a frequency range of 10 hertz to 100 kilohertz. It covers amplitudes of 110 to 190 db, with a linear response to somewhat beyond 160 db.

ONERA will start looking soon for companies interested in manufacturing the microphones under license. ONERA sees medicine and ultrasonics as two areas of likely early applications. Because the microphone does not require high manufacturing precision, in mass production—around 100,000 units—it should cost under \$4.

In the interval

Measuring minuscule time intervals is a growing preoccupation of researchers in a variety of fields—from nuclear physics to laser design.

A number of highly precise—and highly expensive—instruments exist for measuring time intervals in the millisecond range. But all measure only one or two intervals. Researchers with a string of phenomena to measure have had to buy a string of instruments. And at \$5,000 and up each, the investment can mount quickly.

At the biennial Mesucora measuring instruments show, being held in Paris later this month, France's Thomson-CSF will unveil what its designers claim is the world's first multiple-interval timer.

It can measure up to 64 intervals of 1 msec each, arriving one after the other on a single coaxial cable or through separate inputs. Resolution, depending on the model, goes up to 100 picoseconds. And the unit's price range, from \$10,000 to \$16,000, starts at only double that of some instruments offering one-interval measurements.

New wrinkles. Moreover, the French unit offers some new wrinkles not found on competing machines. An optional semiconductor-memory drawer, which pulls out of the instrument's front panel, can record measurements in dangerous or difficult locations—an explosives testing range, for example. Battery-powered and small enough to fit in a researcher's coat pocket, the semipermanent memory, based on MOS integrated circuits, can play back a series of test measurements at a later date.

The meter's calculating circuitry is contained in another modular drawer that can be replaced by other drawers capable of measuring different numbers of intervals at varying degrees of precision. Four different drawers are currently available.

Thomson-CSF developed the interval timer for France's Atomic Energy Commission. The company now hopes to sell it to private research laboratories, in the U. S. as well as in France.

The hunt is on!

(Beware of the Grope.)

How to keep the Grope from bagging your prospects without them lifting a finger.

The Grope preys on people who don't know where to find what they're hunting for . . . turning their search for you into a jungle hunt.



The Grove footprint goes in all directions, like you without the Yellow Pages.

But you can put one over on the Grope, if you don't spread yourself thin. Cover your territories . . . all of them, by listing yourself in the surrounding area Yellow Pages.

You see, a lot of your prospects that are nearby, use a nearby Yellow Pages. And, if you're not there they miss out on you and you on them.

So play it smart and list yourself in the surrounding area Yellow Pages. After all, why try for some of the customers some of the time, when you can try for all of the customers all of the time!



The Yellow Pages



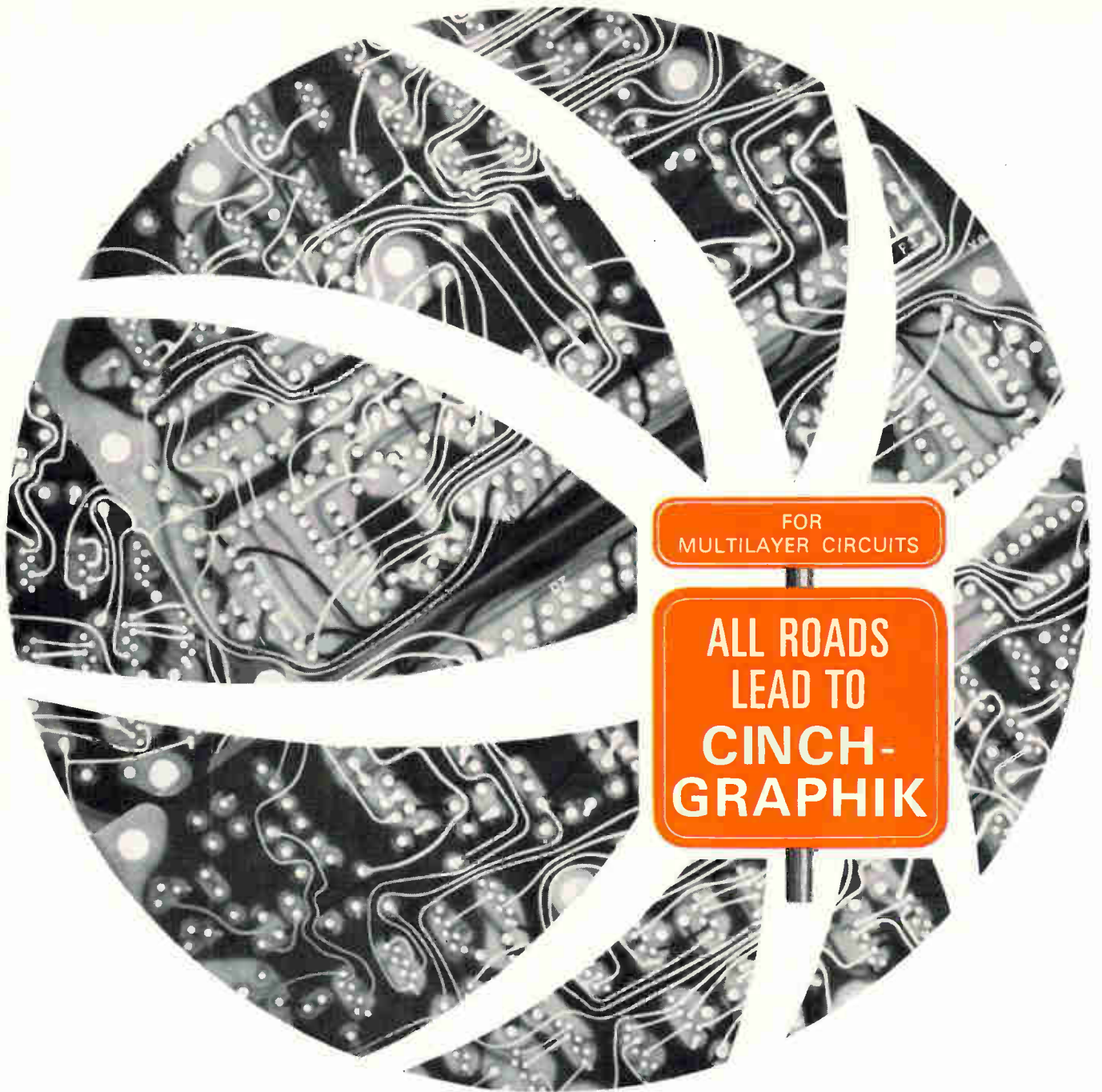

FOR
MULTILAYER CIRCUITS

ALL ROADS
LEAD TO
**CINCH-
GRAPHIK**

For multilayer or precision double sided boards with plated-thru holes,—in volume—the place to go is Cinch-Graphik—the world's largest independent producer of precision circuits.

For information on the capabilities and automated facilities of Cinch-Graphik, contact your local Cinch Electronics Group District office or Cinch-Graphik, 200 South Turnbull Canyon Road, City of Industry, California, 91744. Phone (213) 333-1201.

CINCH-GRAPHIK

The Tung-Sol® development that created a whole new set of digital display standards

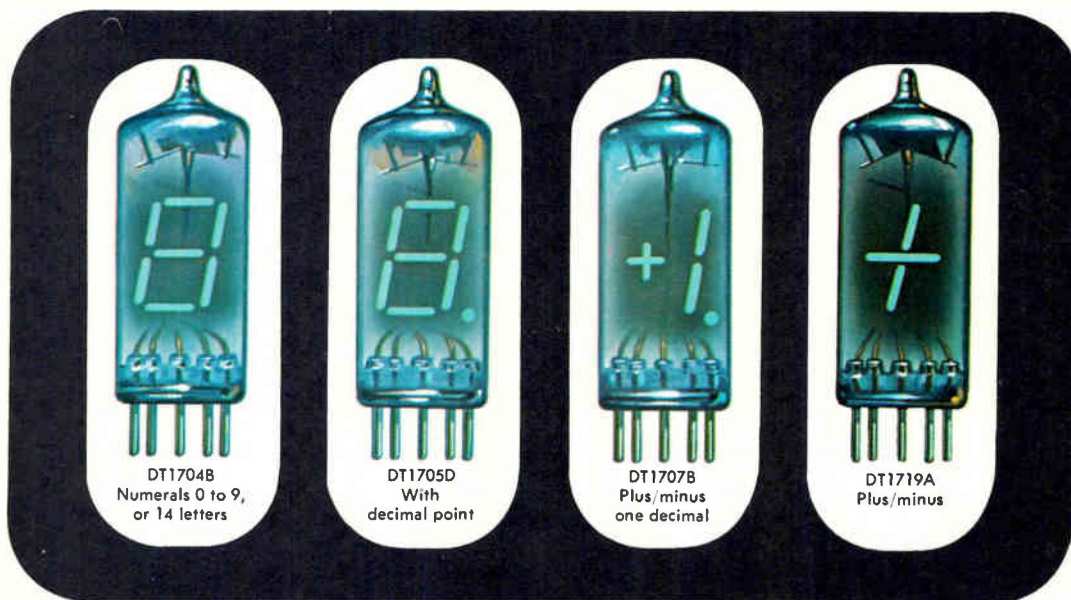

STANDARD CONFIGURATIONS

Low-voltage, low-power drain (25 V and 1.6 V) permits battery-operated applications. Standard miniature tube base. Inexpensive logic/driver requirements. Meets MIL specs. Space-age-type segmented character. Single plane display. Standard alphanumeric, or special symbols. Optimum visibility under ambient light conditions. Common filters provide unlimited color selection for identification, or to heighten contrast. Circuit-board mounting, with solderable-lead option. Write, or phone for detailed technical information and pricing.

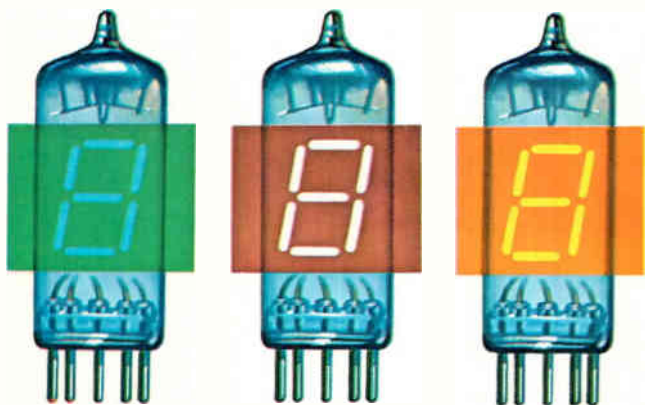

Standard filters provide color variation

DIGNAC S/GTM

VACUUM FLUORESCENT DISPLAY

**TUNG-SOL DIVISION
WAGNER ELECTRIC CORPORATION**

630 W. Mt. Pleasant Avenue
Livingston, N.J. 07039

TWX: 710-994-4865

Phone: (201) 992-1100; (212) 732-5426

Trademark TUNG-SOL Reg. U.S. Pat. Off.
and Marcas Registradas

Any chips off the new IC?

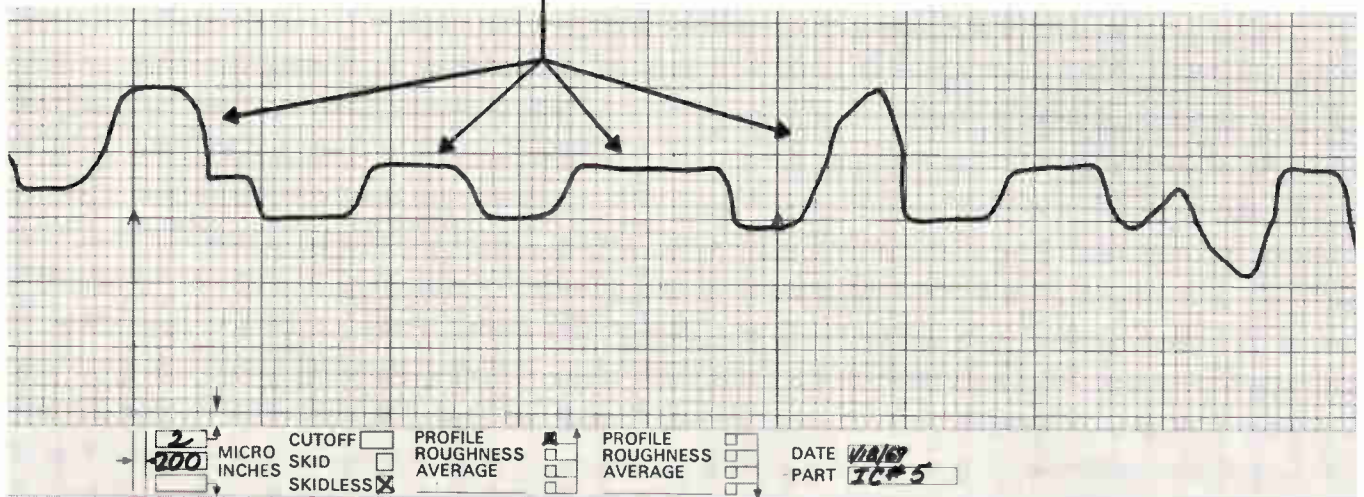
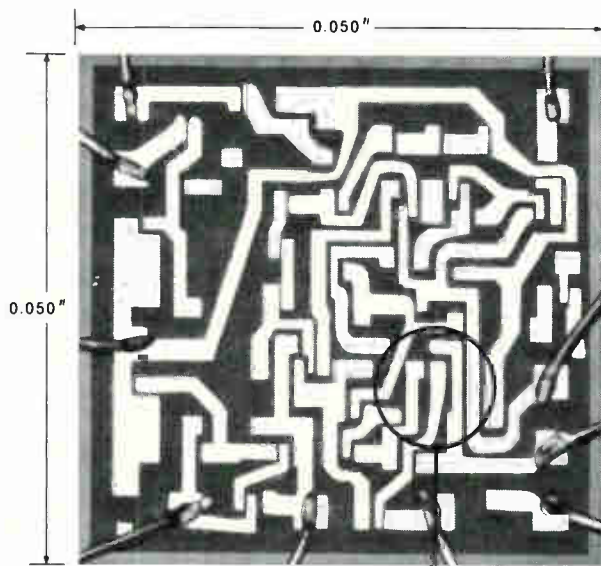

Non-destructive Clevite Surfalyzer tells you for sure. Shows deposit thickness, steps and true surface profile of a 0.050" diameter IC on a chart 3 feet long! And we haven't scratched the surface!

Never will either.

The stylus of the Surfalyzer adds the required light touch to surface measurement—glides across delicate circuit deposits at just 0.05 grams. Picks up the slightest imperfection . . . provides an undistorted view of the IC surface.

Note the extra-wide rectilinear channel. And the engineered chart paper that allows actual dimensional measurement of deposit on substrate. And the razor-sharp smudge-

proof trace. It's all part of our plan to provide IC manufacturers and suppliers with the most accurate, easy-to-read, easy-to-use surface recording system.

Have we done it? You be the judge. Write for complete details and the name of your nearest distributor. There's one close by waiting to demonstrate this extraordinary test equipment. Gaging and Control Division, Gould Inc., 4601 N. Arden Drive, El Monte, California 91731. Tel. (213) 442-7755.

Clevite Surfalyzer 150
Surface Measurement System

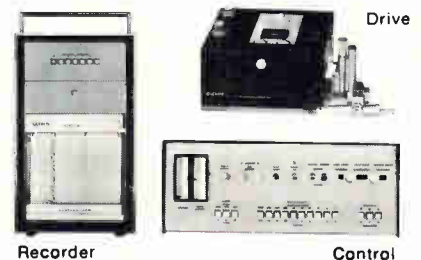

GOULD CLEVITE

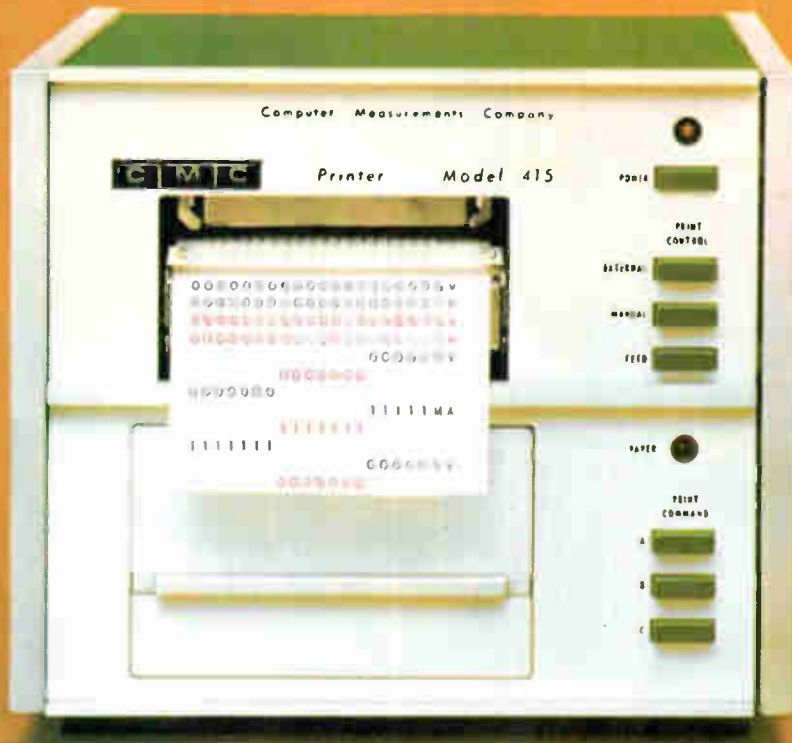

*Now take a peek
at the world's
greatest printer...*



Outclasses the competition ten ways!

This new GMC Model 415 Printer is so good, we don't want to obscure the facts with advertising rhetoric, so here are ten reasons why the 415 is your best buy:

1. The mechanical printing mechanism is good for more than 5,000,000 cycles without an adjustment, is replaceable in the field, and provides legibility of an electric typewriter.
2. Floating decimal point and automatic zero suppression are standard features.
3. Line capacity from 7 to 21 columns is offered; and red/black printing with color selection by numerical field is provided.
4. Internal programming is included to allow printing any input data character into any printed column.
5. Controls can be programmed remotely.
6. Unique "print-command" feature allows priority control over the 3 input channels
7. Prints 3 lines-per-second—more speed than needed for
8. Full IC design provides accurate reliable performance, and IC sockets make maintenance easier.
9. Measuring only 8½" w x 7½" h x 17½" d, this handsome, lightweight instrument is designed for a vast diversity of data logging applications.
10. And to top it all—this great little printer sells for as low as \$1295!

For the full specs, circle the reader service number; and for a demonstration, contact your local CMC representative.

COMPUTER MEASUREMENTS



A DIVISION OF NEWELL INDUSTRIES

12970 Bradley / San Fernando, Calif. 91342 / (213) 367-2161 / TWX 910-496-1487

Buckbee-Mears etches metal on glass masters that can be used and reused and reused...

*We call them
the Unscratchables.*

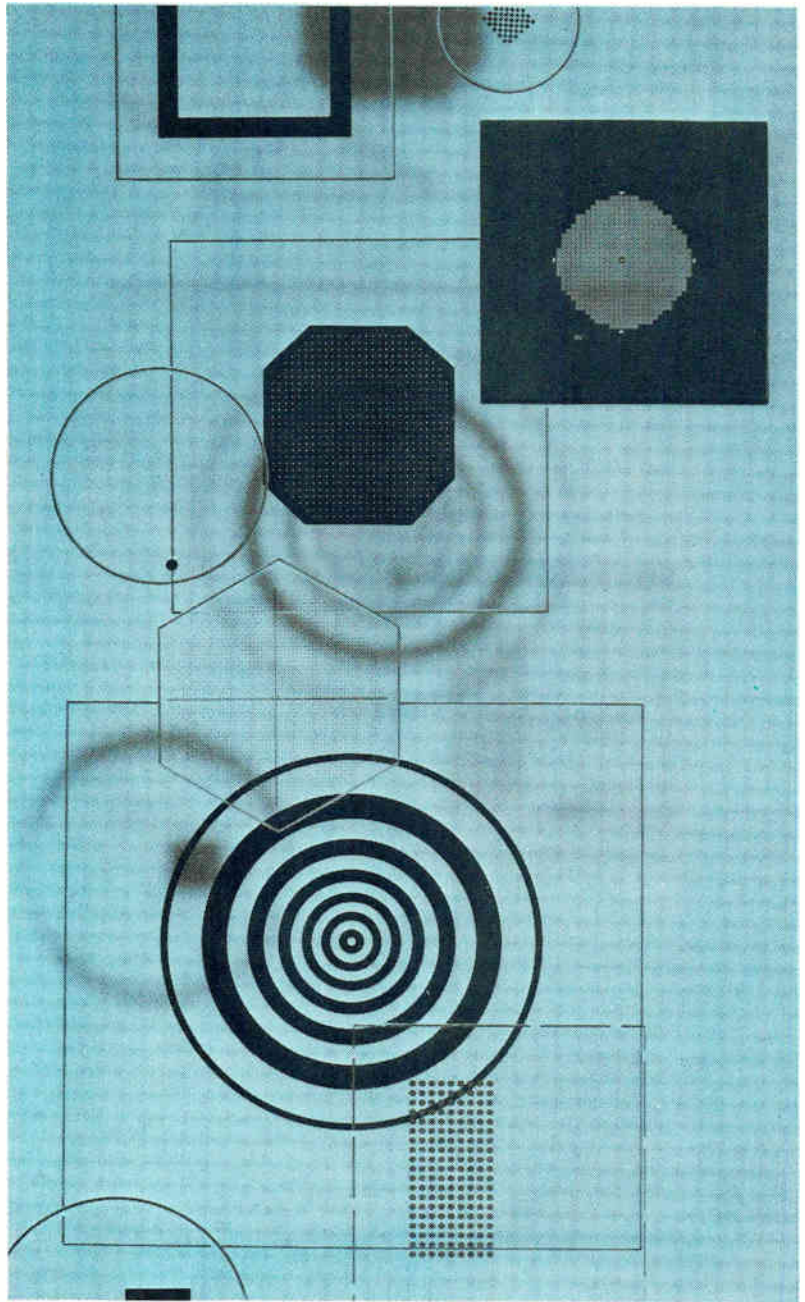

Up to now the only kind of glass master available for tooling had an emulsion coating that usually scratched after one or two uses. Costs to replace these emulsion masters were extremely high, and the production downtime to change masters was equally expensive.

Buckbee-Mears scientists have solved this problem by creating a way to etch metal on glass. Our metal on glass masters can be used over and over. The danger of scratching is eliminated.

The metals we etch include chrome, Ni-200 and copper. Copper on glass masters can be produced in sizes up to 24" x 32". Chrome and Ni-200 masters are available in a 2" x 2" size or smaller.

Buckbee-Mears will produce chrome or nickel masks to your specifications with tolerances of \pm two microns on

any line width or on-center measurement. Small copper on glass masters can be etched to ± 0.0005 " (line widths up to ± 0.002 " on large masters). On-center specifications for small size masters are \pm two microns; ± 0.0005 " for large size masters.

Buckbee-Mears' new metal on glass masters can be used in a variety of production situations where a photomechanical operation is involved, including printed circuits, semi-conductors, integrated circuits and photoetching.

Solving your problems through improved photomechanical production techniques is our business. Buckbee-Mears has the most complete photoetching capabilities in the world.

For more information, call or write Bill Amundson, industrial sales manager. Phone 612-227-6371.

PRECISION METAL AND GLASS ETCHING • ELECTRO FORMING • AUTOMATED DESIGN
bmc
SAINT PAUL, MINNESOTA 55101

BUCKBEE-MEARS COMPANY

TRY TO MATCH THIS

for size and reliability

you can't!

For their size, Type BB resistors pack a tremendous power dissipating ability. Rated 1/8 watt at 70°C in a 0.0004375 cu. in. volume.

And miniaturization has not reduced reliability. Tests prove it. They satisfy the highest level—the S level—of the latest MIL-R-39008 Established Reliability Specifications in all resistance values.

The key is hot molding—the Allen-Bradley way. A-B developed and built the machines. Only A-B uses them. They're fully automatic. Built-in precision control. A high degree of uniformity. Predictable performance from resistor to resistor—year after year.

For immediate delivery at factory prices call your authorized A-B industrial electronics distributor. Or write Marketing Dept., Electronics Division, Allen-Bradley Co., 1201 South Second St., Milwaukee, Wis. 53204. Export Office: 1293 Broad St., Bloomfield, N.J., U.S.A. 07003. In Canada: Allen-Bradley Canada Limited.

© Allen-Bradley Company 1969



ALLEN - BRADLEY
QUALITY ELECTRONIC COMPONENTS

EC69-80



Exclusive

Only A-B Type BB
RCRO5 meets MIL-R-39008
ER (established reliability)
for 1/8-watt resistors
at the S level.
Shown actual size.

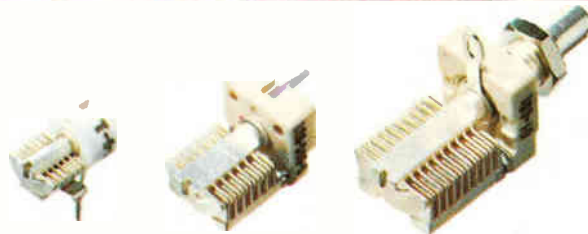

TYPE: T
 Mtg. Area: 0.1 sq. in.
 Q: > 2000 @ 150 MHz
 pF: 1.3-5.4 to 1.9-15.7
 TC: plus 30 ± 15 ppm/°C

TYPE: U
 Mtg. Area: 0.2 sq. in.
 Q: > 2000 @ 150 MHz
 pF: 1.2-4.2 to 2.4-24.5
 TC: plus 45 ± 15 ppm/°C

TYPE: V
 Mtg. Area: 0.3 sq. in.
 Q: > 2000 @ 150 MHz
 pF: 1.4-13 to 2.2-34
 TC: plus 50 ± 20 ppm/°C

It takes brass to machine capacitors like these.

Johnson precision machines each rotor and stator for these compact capacitors from a single, solid brass extrusion. The benefits are outstanding mechanical stability and electrical uniformity. As a result, you get consistently high performance from every Johnson capacitor. You can rely on them for exceptionally high Q, low temperature coefficients and uniform minimum and maximum values. All at a cost probably lower than what you are now paying.

Return the coupon today for more complete information on the famous Johnson line of machined plate air variable capacitors. Or, perhaps you have a unique need. Our en-

gineers will be glad to work with you. Call (507) 835-2050.

E. F. JOHNSON COMPANY / 3004 Tenth Ave. S.W. / Waseca, Minn. 56093

- Please send new 1970 Capacitor Catalog (702-01)
- Specific interest: _____

NAME _____ TITLE _____

FIRM _____

ADDRESS _____

CITY _____ STATE _____ ZIP _____



E. F. JOHNSON COMPANY

Washington Newsletter

May 11, 1970

417 R&D programs cut by Pentagon . . .

A Pentagon review of its 6,615 research and development projects—following a Congressional ban on nonmilitary R&D—has eliminated 417 programs. They amount to 6% of the total and would have been worth \$8.25 million in fiscal 1971. The Defense Department is disqualifying 183 research projects from future funding and will not finance another 221 studies and 13 development programs planned for next year.

The unannounced action resulted from an amendment proposed by Senate Majority Leader Mike Mansfield (D., Mont.) that was tacked on to the fiscal 1970 Defense Appropriations bill requiring that all DOD research meet a military requirement.

Biggest loser among the services was the Navy, which was told to drop nearly 9% of its 2,495 programs—a loss of nearly \$4.5 million.

Much of the total cut, according to insiders, is tied to Project Themis, a program started by former Defense Secretary Robert S. McNamara to develop a broader geographical distribution of R&D expertise throughout the nation by providing universities with seed money.

. . . but NSF could fund some projects

Some of the R&D projects dropped by the Pentagon under the ban on nonmilitary research could be picked up by the National Science Foundation. This is said to be one of the reasons why the National Academy of Sciences, which has overlapping membership with the NSF, turned down the Defense Department's request for a review of the programs that were cut. The Pentagon was trying to get the academy to participate in its attempts to justify program reviews. Another reason for the academy's refusal, according to stories making the rounds, is the "subjective interests" of some of its members. Instead, the Congressional economic watchdog, the General Accounting Office, is reviewing the DOD program cuts and will later report to Capitol Hill.

The National Science Foundation has an extra \$10 million bankroll in its fiscal 1971 budget request which it could use to pick up the funding on some of the canceled DOD research.

Airlines set to go with time-frequency collision avoidance

RCA may have waited too long to unveil its radio interrogation and response system that it calls Secant—separation control of aircraft by nonsynchronous techniques [*Electronics*, April 13, p. 46]. This is indicated by acceptance of first technical specifications for a time-frequency collision avoidance system by the airlines electronic engineering committee of Aeronautical Radio Inc., and by a Washington briefing scheduled for May 12 by the Air Transport Association. The ATA will brief government and industry executives on its final report of systems tests. RCA will report on its system at the ATA-sponsored meeting, but one official says the company will have to demonstrate that Secant has "stupendous merit and is fantastically better" for the airlines to drop their nine-year investment in time-frequency CAS and wait until the new system is available—estimated by RCA to be 1973 or 1974.

Competing time-frequency systems developed by McDonnell Douglas, Bendix and a joint Sierra Research and Wilcox Electric effort will reportedly cost substantially more than Secant, but they will give a pilot instructions for evasive maneuvers rather than merely warn him, as Secant does, that an aircraft is in his vicinity.

Washington Newsletter

Army wants to buy Tacfire hardware in 1971 for TOS

Army documents show that the **Combat Development Command** expects **Litton Industries'** tactical fire direction system equipment—due to its modularity—to satisfy many of the component requirements for the tactical operations system, and that procurement of TOS is planned for September 1971. This would appear to write off the hopes of Control Data Corp., which still is pushing its 18-pound Alpha computer for the TOS. **However, Control Data believes it is still in the TOS picture.**

The command's plans for what it calls TOS-75 as an integral part of its Army-75 program still needs approval by the Department of the Army. CDC completed its TOS-75 study in March. On approval of its plans, the command says, **engineering development of TOS-peculiar hardware will be undertaken.** Though the Army now hopes to field an operational system by June of 1974, that date may slip.

Cryoelectronics: 1980's power source?

The Federal Power Commission is supporting development of cryoelectronic power transmission as a means of avoiding blackouts while meeting rising urban power requirements. The fact that power companies are now considering the use of niobium transmission lines supercooled to -425°F for high-voltage a-c could take some of the sting out of the anti-pollution forces, which are opposed to the construction of new power plants in urban areas.

Union Carbide's Linde division has demonstrated the feasibility of superconducting transmission through niobium tubes immersed in liquid helium. Capacity of an extremely pure niobium cable is estimated to be 25 times that of a conventional cable, indicating that one 20-inch pipe system could handle up to 10,000 megavolt-amps at 345 kilovolts—more power than is currently consumed by all of New York City.

Harsha charges Army with reprisal against bidder

Rep. William H. Harsha (R., Ohio) charges the Army Electronics Command with "reprisals" against an unnamed small electronics company which, he claims, sought to underbid the Admiral Systems Corp. for production of 191 tactical AN/GSH-6 recorder/reproducers for high-speed burst transmissions. Harsha contends that the small firm's unsolicited bid opened the sole-source procurement to competition and shaved two-thirds of the \$1 million cost.

An award for the 300-words-per-minute Morse code recorder and reproducer was made late last March to the lowest of five bidders, Raycomm Industries of Freehold, N.J., for \$333,000. Admiral's \$377,000 bid was second. Harsha alleges that ECOM's Chicago office initially certified falsely that the Army had an "urgent" requirement for the AN/GSH-6 and should buy 200 units for \$1 million from Admiral as "the only known source who can meet the required delivery schedule."

Stress performance as standards guide

Commercial and industrial product standards eventually will be based on uniform performance criteria rather than specification standards, predicts Lewis M. Branscomb, director of the National Bureau of Standards. Moreover, he sees the time when products will be labeled with hours of mean life. Such labeling already is near at hand: the Federal Trade Commission plans to order light-bulb makers to take this kind of action.

Although Branscomb's forecast is being construed as a response to the demands of consumer interests, one Capitol Hill aide sees the NBS director's comments as "a spinoff from the military-industrial complex."

TRIAL and ERROR

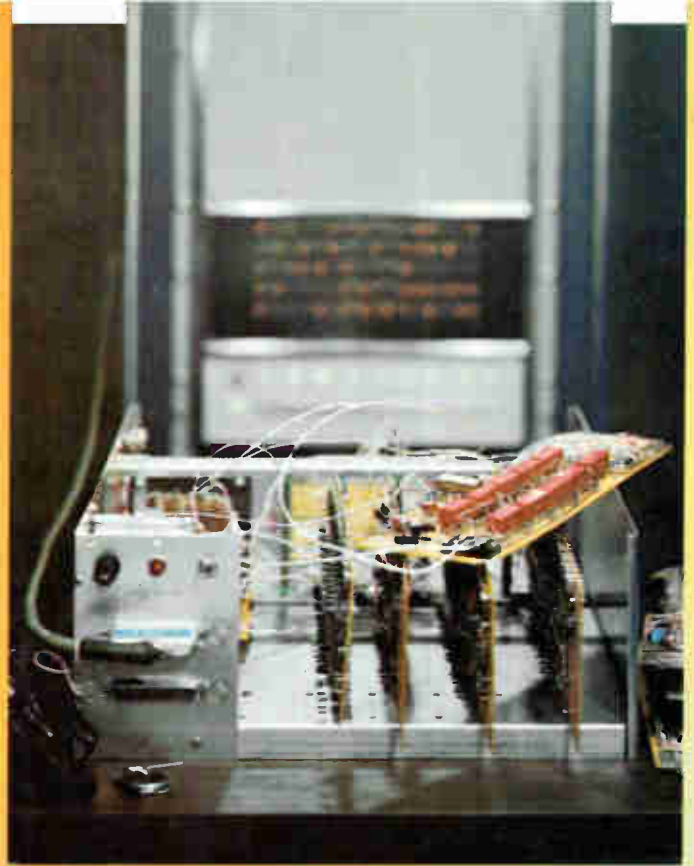

eliminated with digitally controlled power



HEWLETT  PACKARD

POWER SUPPLIES

100 Locust Avenue, Berkeley Heights
New Jersey 07922 • (201) 464-1234

21006

... The most advanced instrument for automatic test systems ... designed to save you engineering time and money. HP Digitally Controlled Power Sources are more than digital-to-analog converters with output power capability, they include added "system-oriented" functions ... Internal Storage to increase computer operating efficiency; Isolation to break ground loops; Bipolar Amplification for fast up and down programming; Programmable Current Limit to protect sensitive loads; Pre-Interfaced at the factory to match your computer ... All this is in a single compact package. Outputs from -100V to $+100\text{V}$, currents up to 1A. \$1,800.

Digitally Controlled Power Brochure available upon request.

G U A R A N T E E

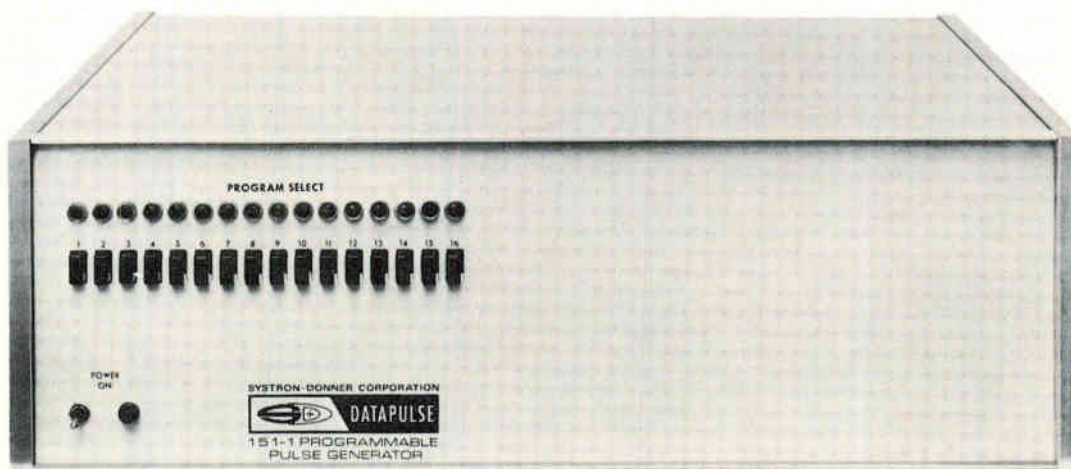

If your new Datapulse 150 series pulse generator doesn't pay for itself in 90 days, we'll take it back.

If your pulse generator just sits on your work bench and you reach over now and then to turn a knob or two—the Series 150 is not for you.

But, if you're like everybody else, your pulse generator is part of some test set-up. You perform several different tests and you repeat them several times. **You can't afford anything else.**

HERE'S WHY!

Rep Rate to 50 MHz—Delay and Duration from 10 nanoseconds to 10 milliseconds—Pulse Amplitude to ± 10 volts with top and baseline anywhere from + to -10 volts—Transitions take less than 5 nanoseconds.

The Model 151 sets all parameters with **one punch** of a button. You pocket all the dollars you used to spend for manual set-up time.

The Model 152 does the same thing—and transition times are variable out to 10 microseconds.

The Model 153 sets all parameters from digital input information if you already have a semi-automatic or automatic system.

The Model 154 adds variable transitions again.

Optional automatic sequencing and/or parallel manual control round out the picture to give you a choice of 16 different units. Let one of them pay for itself in your test set-up. After that, the time saved is pure profit.

Prices start as low as \$1,000.

For more information, address Datapulse Division, Systron-Donner Corporation, 10150 W. Jefferson Blvd., Culver City, California 90230. Phone 213-836-6100 or TWX 910-340-6766.

DATAPULSE
DIVISION

SYSTRON  DONNER

BRAND-REX PRESENTS

BUCK ROGERS

IN THE 25th CENTURY

TRAPPED IN ORBIT AROUND MARS, DR. HUER HASTENED TO COMPLETE HIS NEW DEFENSE SYSTEM TO WARD OFF THE BAND OF ATTACKING TIGER MEN...

IF I CAN GET THIS CENTRAL CONTROL SYSTEM RIGGED IN TIME IT WILL SET UP AN INVISIBLE BARRIER AROUND OUR SPACE SHIP THAT EVEN THE TIGER MEN CAN'T PENETRATE... BUT I'M STUMPED. WHERE WILL WE GET ALL THE SPECIALIZED WIRE WE NEED TO WRAP THIS COMPUTER'S BACK PANEL?

THIS LOOKS LIKE A JOB FOR **BRAND-REX** WIRE. IT'S TOUGH STUFF. LUCKILY SPACE SCOUT SHIPS ALWAYS CARRY AN AMPLE SUPPLY.

INCREDIBLE, BUCK. THERE ARE 11 DIFFERENT KINDS OF **BRAND-REX** BACK PANEL WIRES HERE! AND LOOK AT ALL THE COLORS!

SOMETHING FOR EVERY OCCASION, DOC. HERE'S THE **KYNAR** WIRE WE NEED.

SHORTLY...

THE INVISIBLE SHIELD IS WORKING!

LOOKS LIKE **BRAND-REX'S** BACK PANEL WIRE IS THE REAL HERO OF THIS TALE. AND NO WONDER. **BRAND-REX** OFFERS MORE DIFFERENT WAYS TO WRAP UP A BACK PANEL THAN ANYONE ELSE IN THE UNIVERSE.

SO REMEMBER, EARTHFOLKS: THE NAME **BRAND-REX** MEANS WIRE AND CABLE THAT'S WAY AHEAD OF ITS TIME. TODAY PRACTICALLY EVERY MAJOR PROCESSING UNIT AND ITS PERIPHERAL EQUIPMENT USE AT LEAST ONE KIND OF **BRAND-REX** BACK PANEL WIRE. WHY NOT SEND FOR THE NEW **BRAND-REX** SPECIFICATION BR-212D AND GET A FULL COLOR BUCK ROGERS WIRE WRAP WALL CHART FREE! JUST WRITE TO:

BRAND-REX DIVISION

AMERICAN ENKA CORP., WILLIMANTIC, CONN. 06226
THE PLANET EARTH

BRAND-REX, WAY AHEAD IN WIRE AND CABLE



Our wet tantalums are sharp...

When you need a capacitor that won't wash out under pressure, latch onto a Mallory liquid electrolyte tantalum capacitor . . . the wet anode.

It's tops for capacitance/voltage product per unit volume. Has the lowest current leakage of any capacitor. And the broadest temperature range to boot . . . -55°C up to $+200^{\circ}\text{C}$, depending on type.

Just name the assignment. We've got a wet anode to match. Examples . . . low-profile-geometry/large-CV-product styles. High-voltage styles up to 900 volts. And extremely low-leakage styles for extremely low-current circuits.

A capacitor-application information form is available to help you determine which one is right for you. Send for it today. Standard items, of course, are available from your Mallory distributor.

MALLORY

MALLORY CAPACITOR COMPANY

a division of P. R. MALLORY & CO. INC.
3029 E. Washington St., Indianapolis, Indiana 46206; Telephone: 317-636-5353

Electrical and electronic components • sequence timers • metallurgical products • batteries

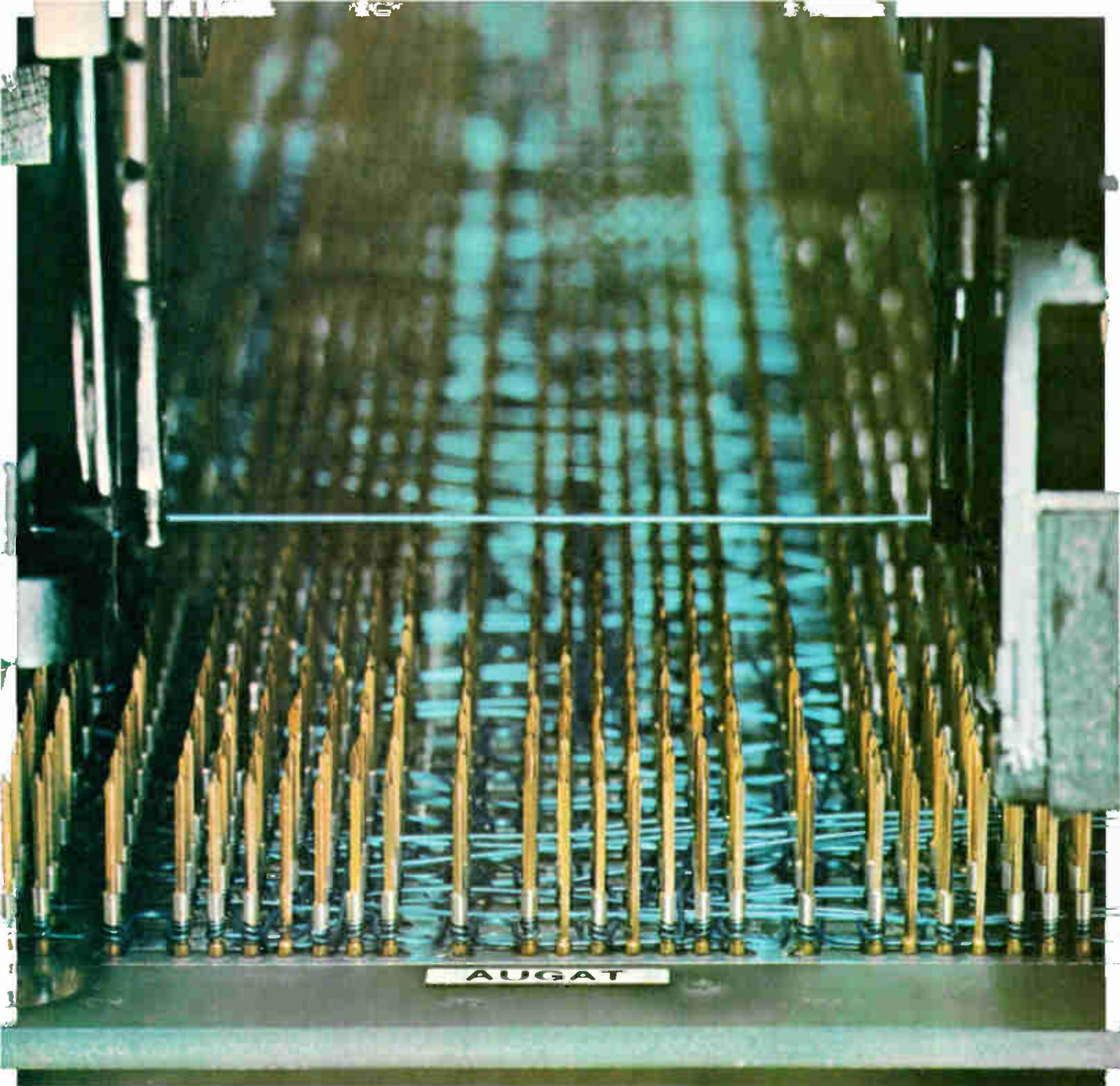

Teamwork pays off

Complete Wire Wrapped IC Panels . . . One Source Responsibility

Augat and **Raytheon** are working together to cut your costs and turnaround time.

Augat . . . pacesetter in top quality IC packaging panels. Raytheon . . . most experienced and largest in wire wrapping service facilities. This unbeatable team is now delivering complete wire wrapped packaging panels, unmatched in versatility and quality. And Augat wraps it all up with single source responsibility.

Saves you time and money.

No setup charge for tooling or computer programming on any cataloged panels. Nominal charge, one time per card, to produce drive deck from wire list.

Simply furnish wire list with panel order.

Contact: Augat Inc., 33 Perry Ave., Attleboro, Mass. 02703.

Tel: (617) 222-2202

AUGAT_{INC.}

Circle 83 on reader service card

ultrasonically assembled

at General Electric



This Acoustaform console is spot welded—ultrasonically. Progressive designers at G. E. Audio Products Department in Decatur, Illinois, specified ultrasonic assembly for strong, fast welds which won't mar the beauty of the assimilated wood-grain finish. Ultrasonic assembly eliminates clamping, curing, staples, nails and screws. It reduces rejects and increases production.

If you're assembling thermoplastics, or are thinking of switching from wood to plastics, consider the advantages of ultrasonic welding, inserting, staking and spot welding. Find out more about ultrasonic assembly. Write for bulletin S-889. Send unassembled parts or prints for a free evaluation.

Technical centers in major cities.

Overseas offices: Paris; Geneva; Frankfurt; Soest, N.V.; Tokyo.

 **BRANSON SONIC POWER COMPANY** 77 Eagle Road, Danbury, Conn. 06810

The mind easer...



- You never worry about what it's doing to the circuit
- You forget about zero adjusting forever

The Digilin Type 340 Digital Multimeter eliminates the two major causes of multimeter fretting in one low-cost, high-performance meter. First, the exclusive new Digilin Input Amplifier Technique (patent pending) does away with circuit loading *throughout* the test function. Forget about transient noise creeping in when impedance drops during the measurement cycle—a worry that always nags you when such input techniques as dual slope integration and chopper-stabilized ampli-

fiers are used. The 340 never disturbs the circuit ever. And with a 340, you'll never short another lead and adjust for zero again. Before every measurement cycle, the 340 does it for you—automatically, precisely, leaving no doubt about whether it was done right.

Only with Digilin do you get these features, and the 3½-digit, 0.1%-accuracy Digilin 340 gives you lots more: Award winning design (1969 WESCON Industrial Design Competition) • Automatic

polarity • Pushbutton ranging • High visibility, no-blink display • only 3 pounds • Assured reliability by Digilin 100-hour burn-in and factory test. \$345 complete in single units. Need battery-powered flexibility? Digilin 341 with same features plus battery supply at \$395. Digilin Type 340. The mind easer. It's an eye pleaser, too.

Get more information—or no-obligation demonstration. Call or write Digilin today. Digilin Inc., 6533 San Fernando Rd., Glendale, California 91201. Tel. 213-246-8161.



There isn't another like it. A 1/4-inch, single-pole, six position, 28-vdc. Helipot switch for PC boards.

Beckman INSTRUMENTS, INC.

HELIPOT DIVISION

Fullerton, California 92634

INTERNATIONAL SUBSIDIARIES: AMSTERDAM; CAPE TOWN;
GENEVA; GLENROTHES, SCOTLAND; LONDON; MEXICO CITY;
MUNICH; PARIS; STOCKHOLM; TOKYO; VIENNA

Model 374H \$3.00 (1-9 pieces)

Model 374 \$2.75 (1-9 pieces)



Article Highlights

**Red, yellow and green
in a semiconductor
alphanumeric display
page 88**

A promising approach to a mass market for solid state alphanumeric displays is based on a silicon-doped gallium arsenide diode that emits infrared light. A key feature is a phosphor coating that converts the i-r to visible light—and in a variety of colors. The materials don't cost much, and fabrication costs should decline once monolithic processing methods have been perfected.

**Etching memories
in batches
page 94**

Etched permalloy technology applies the techniques of semiconductor manufacturing to batch-fabricated memories. A pattern of conductors is etched on a copper-clad epoxy board, then successive layers of permalloy, insulation, and copper are deposited and etched to make an array of toroids with interweaved conductors. The technique offers better yield, easier handling, simplified testing, and miniaturization.

**Making small ROM's
do math quickly,
cheaply, and easily
page 104**

The familiar lookup-table approach can be combined with equivalent-function techniques to make small, inexpensive read-only memories perform mathematical functions in a computer. This combination offers speed and efficiency, while the use of multiple, readily available small ROM's averts the need for having an enormous capacity contained in a single memory.

**Greater versatility
for MOS devices
page 112**



High density and ease of fabrication have led more and more integrated-circuit designers to metal oxide semiconductors. Now a new class of MOS devices has been developed that offers a density of up to 200,000 elements per square inch. Called charge-coupled devices, the new chips hold out the promise of junctionless devices for memories and imaging: since circuit functions are performed directly in the semiconductor itself, the devices do not require p- or n-type diffusions for processing of information.

Coming

Flat-screen display

Flat-screen display schemes have encountered some difficulty in obtaining adequate brightness and simpler addressing. Now a new approach uses a sort of light amplifier and a glow discharge technique that are integral to a screen whose overall thickness is only 0.010 inch.

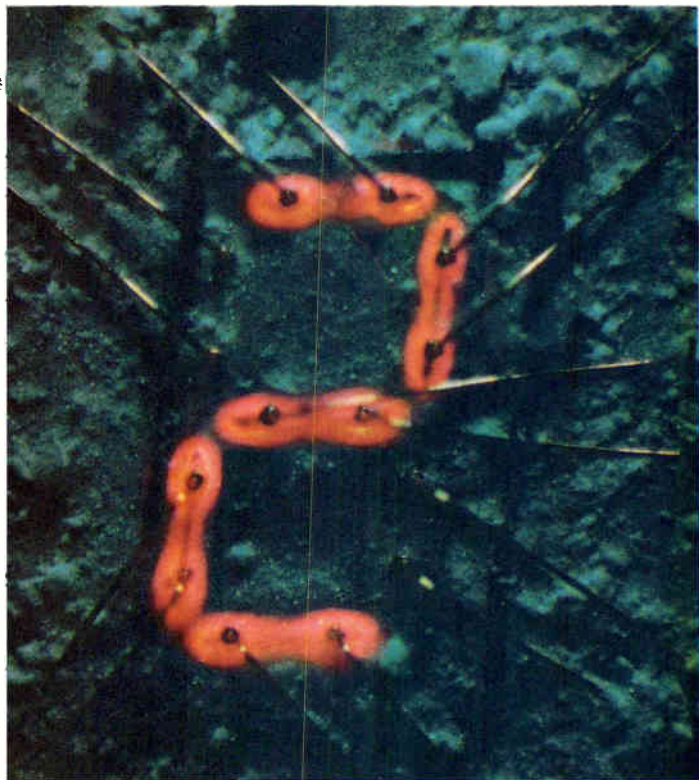
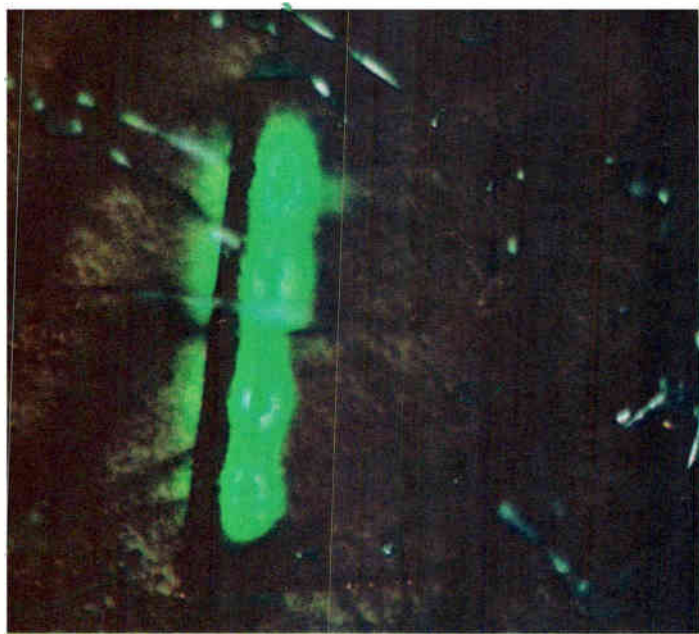

Seeing red, yellow and green in a semiconductor alphanumeric display

GE's *Allen M. Barnett* and *Fred K. Heumann* are fabricating monolithic solid state displays that can emit many hues rather than one, which is the norm; key to multicolored approach is phosphor coating of light-emitting GaAs diodes; this technique holds out the promise of low cost

● A choice of colors in a semiconductor alphanumeric display would permit color coding of data displays and allow for a wider range of individual preference. Unfortunately, light-emitting diodes up to now have been too inefficient at wavelengths other than red. However, an LED structure under development at General Electric Co.'s Research and Development Center at Schenectady, N.Y. may change all that. Depending on the way it's energized, the LED emits red, orange, yellow, or pale green light, and, in a slightly different version, bright green. GE has built numeric characters with the technique, and devices with letter as well as number capability are expected to follow.

But variety of color is only part of the story, according to Allen Barnett and Fred Heumann, two scientists who have worked on the new display. The GE LED is made with gallium arsenide, whose processing techniques are better understood and far more advanced than those for gallium arsenide phosphide or gallium phosphide, the materials used in currently available LED's [*Electronics*, March 2, page 126 and March 30, page 134]. In addition, GaAs is available in larger quantities, larger wafers and at lower cost than the other two materials.

GE has already built its multicolor LED displays in monolithic form. But these devices are primitive—and no different from many commercially available

LED's—in that power is supplied through wires individually bonded to each diode in the array. Barnett and Heumann feel that the full potential of the approach won't be realized until contact metalization can be deposited in a batch process, as in integrated circuits.

Fortunately, GE is close to achieving a true planar configuration that would permit this type of metalization. This would lead to a low-price mass market, in the view of GE scientists. Displays of numbers are expected to be designed into home appliances, cars, perhaps even home telephone links to computers by the late 1980's. This would be in addition to the more conventional uses in industrial displays, laboratory instruments, and business machines.

Barnett feels that the major potential for the new technology is in character and information display; he includes simple graphical applications such as curve tracing in the latter category. "Low bulk, low voltage, fantastic reliability is what the semiconductor offers here," he says. He doesn't see color television as a goal in the foreseeable future—the cathode-ray tube is inexpensive and performs well in this application.

Essentially, the display consists of a semiconductor diode surrounded by a layer of phosphor material. The diode emits infrared radiation, and the phosphor converts this into visible radiation.

Heumann points out that GaAs is the most economical light-emitting semiconductor material available, not excepting silicon carbide. The phosphor materials cost less than one cent per character since only milligrams are needed. The cost of materials for the display, in other words, is extremely small.

Despite the advanced state of its technology, GaAs has been largely ignored as a display material because it emits in the infrared. But with the addition of a phosphor to convert the infrared to visible radiation, and with the doping of the GaAs with silicon to make it more efficient, GaAs becomes a usable display material. GE is getting 6% external efficiency from its Si-doped planar structures in converting electrical power into infrared light. For the diode-phosphor combination, the luminous efficiency ranges from 0.07 to 0.35 lumens per watt, depending on the color of the output. GaAsP displays—unquestionably the most popular today—have luminous efficiency of 0.07 to 0.14 lumens per watt, so GaAs-phosphor displays are at least as good as

Two-step technique of light generation – emission of infrared by a gallium arsenide diode and conversion of infrared to visible radiation by a phosphor – permits various display colors

GaAsP and 2½ times better at their best. GaP can be more efficient—luminous efficiencies of 0.6 to 3.6 lumens per watt have been reported—but its poorly developed materials technology is a serious drawback.

A recent development at Bell Telephone Laboratories indicates that GaAs may have an even better position. Bell researchers have reported finding a phosphor (barium yttrium fluoride) that gives an eight times improvement over previous diode-phosphor combinations, for a net luminous efficiency more than 16 times greater than that of GaAsP devices. (The work at Bell Labs is on discrete point-source light emitters, not on complete monolithic characters as at GE.)

In another recent development, RCA has reported achieving blue emission at reasonable efficiency, thus adding another color to the GaAs-phosphor spectrum. [See U.S. Reports in this issue.]

As the phosphor for its green-emitting display, GE uses lanthanum trifluoride doped with erbium as an activator and ytterbium as a sensitizer. The Yb atoms increase the capture cross-section of the material for the i-r photons, and energy absorbed excites green emission from the Er atoms in a two-step process.

For LaF₃, the visible output under i-r stimulation is centered at 5,400 angstroms, which is conveniently near the peak of the eye's response. There is also a small amount of emission in the red.

For the tunable red-yellow phosphor, GE relies on yttrium oxychloride, which has peaks in the red at 6,600 Å and in the green at 5,400 Å, and an insignificant emission in the blue. By varying the pulse width, the relative amounts of red and green emission can be regulated to produce outputs ranging from red through orange and yellow to pale green.

This tuning can be accomplished because the rise times for the two peaks are markedly different: the red rises more slowly than the yellow. Thus, the emission is essentially red with a steady current, bright yellow with 2 millisecond pulses, and pale green with 100 microsecond pulses. The brightness is about 50 foot-lamberts at an average current of 50 milliamperes. The peak pulse current for the yellow emission is 625 ma at a 40 megahertz pulse repetition rate. At the same frequency, the pale green emission requires 12.5 amperes peak current, which is impractical for most applications.

Visible-light-emitting diodes based on infrared-to-visible converting phosphors have had an interesting history. Study of these phosphors started in 1959. Initially, the conversion efficiencies were low, but in 1966, three groups of investigators discovered that the addition of a sensitizer to the phosphor resulted in a great improvement. And in 1968, R.A. Hewes and J.F. Sarver of GE's Lighting Research Laboratory reported an efficient infrared-to-visible converting phosphor consisting of LaF₃ activated with erbium and sensitized with ytterbium.² This phosphor absorbs at 9,750 angstroms and emits at 5,400.

Ralph Potter at the same laboratory noticed that the absorption peak roughly corresponded to the emission peak of GaAs lasers and light emitters. The phosphor was then sent to Simeon Galginaitis at GE's R&D center, who applied it to a Si-doped GaAs diode with emission corresponding roughly to the phosphor's absorption band. The first results were disappointing, but after Galginaitis and Heumann worked on the efficiency of the infrared emission, they were able to produce the first visible-light-emitting diode based on a GaAs-phosphor system.³ [Reference 3 contains a complete bibliography of the phosphor development.]

This work was followed by an investigation at Bell Labs which eventually resulted in the factor-of-eight improvement in efficiency of green light emission with

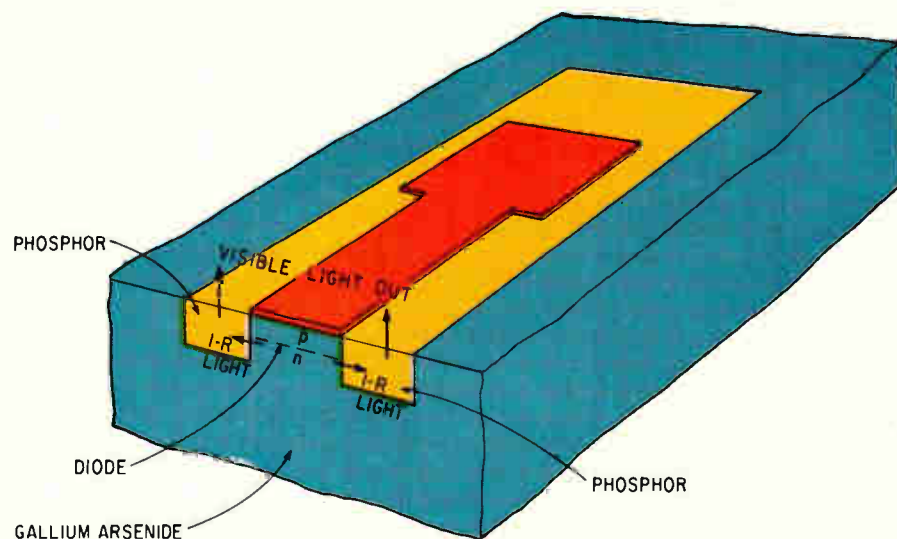

Construction. Moat around GaAs diode contains phosphor which absorbs infrared light and converts it to visible light. Seven such moat-diode segments are formed on a GaAs chip to make a single alphanumeric character.

BaYF₅ phosphor.⁴ Bell Labs also developed a green-to-red tunable phosphor using Y₃OCl₇. Unlike the GE tunable phosphor, this Bell Labs phosphor is changed from green to red by increasing the current.

The net result of the work has been numeric character displays, monolithic and multicolor. But Barnett and Heumann feel they've only scratched the surface.

The present form of the display is a 1/7-inch-high seven-segment figure-eight arrangement. Each segment is dumbbell shaped and surrounded by the phosphor material. The GE researchers settled on dumbbell-shaped segments after experimenting with all manner of shapes—serpentine, square, rectangular, and round. They found that their final choice gave the most uniform light emission at the least current.

The characters are made, 60 at a time, on a wafer of the GaAs. The base material is a tin- or Si-doped GaAs wafer with n-type resistivity. On this is grown epitaxially an n layer and then a p-type layer of Si-doped GaAs, thus forming a p-n junction.⁵ (Silicon can make the material n or p depending on conditions.)

The next step is to lap the p surface until the p-layer thickness is reduced to 0.002 inch, then diffuse zinc into it to reduce the sheet conductivity of the surface. Next, a 4,000 Å-thick layer of gold is sputtered on, and a 2,000 Å layer of nickel is electroplated on that. These metals are alloyed into the GaAs to form

Two-step. Energy diagram shows how dopants in lanthanum fluoride phosphor convert incident infrared light to visible. Ytterbium (Yb) acts as a sensitizer; it aids in absorbing infrared radiation from the GaAs diode at 9,700 angstroms. This trapped energy is transferred to erbium (Er) at two levels. When the upper Er level has been excited, the atoms relax and give off green light at 5,200 and 5,400 angstroms. Other phosphors operate by a similar mechanism.

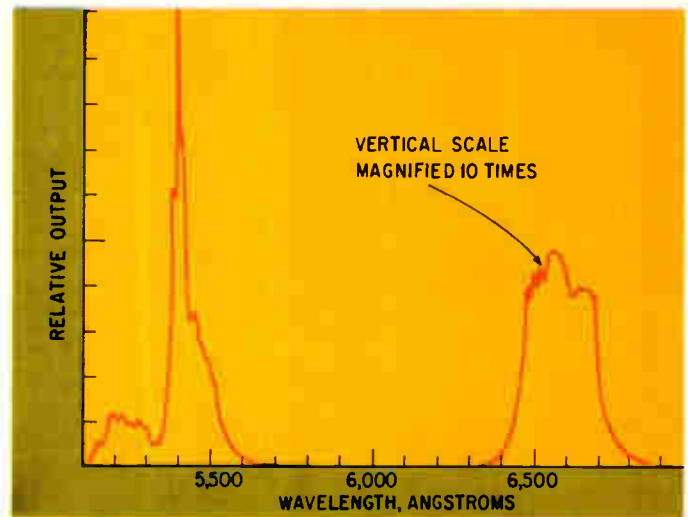
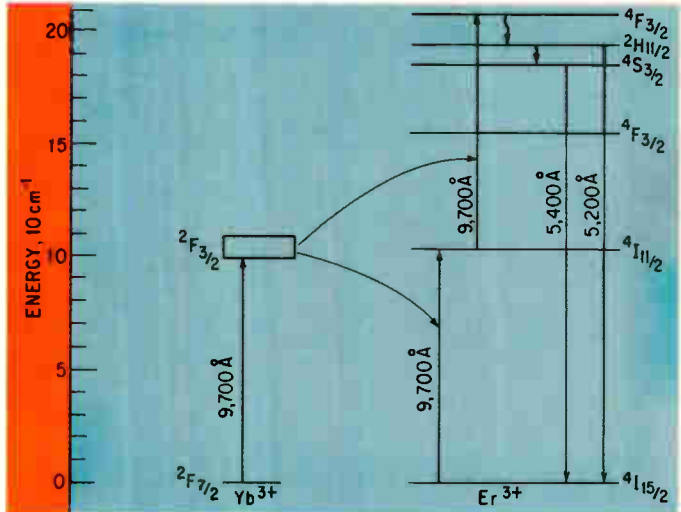

Peaks. Most of the output from lanthanum fluoride is at 5,400 angstroms, corresponding to the color green. There is an insignificant amount in the red at 6,600 angstroms.

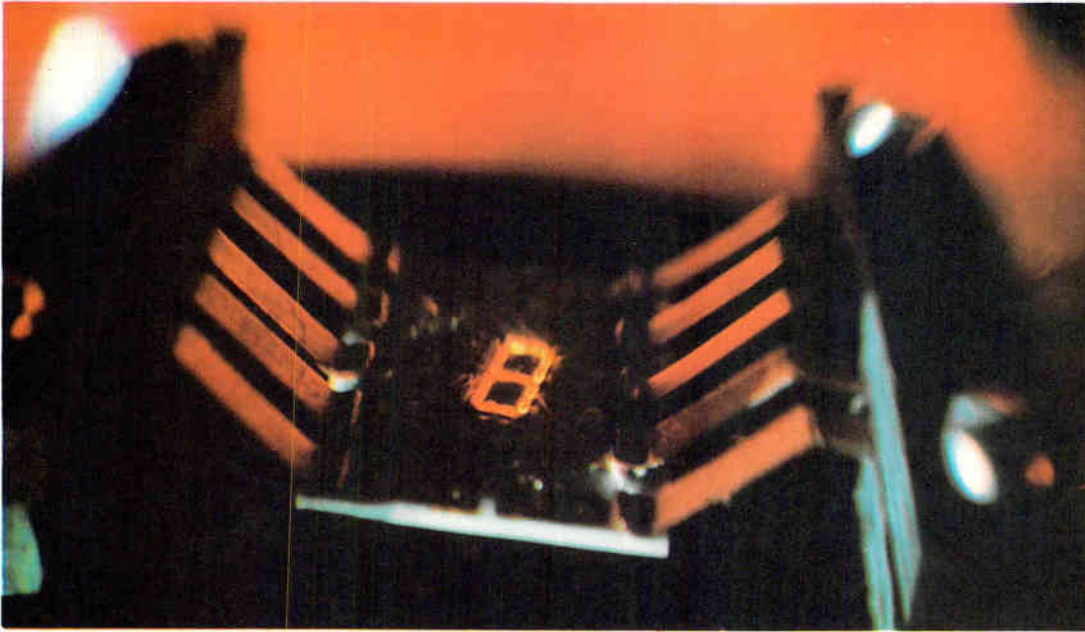

Color combination. By applying different pulse widths to different segments, a character can light up in different colors simultaneously.

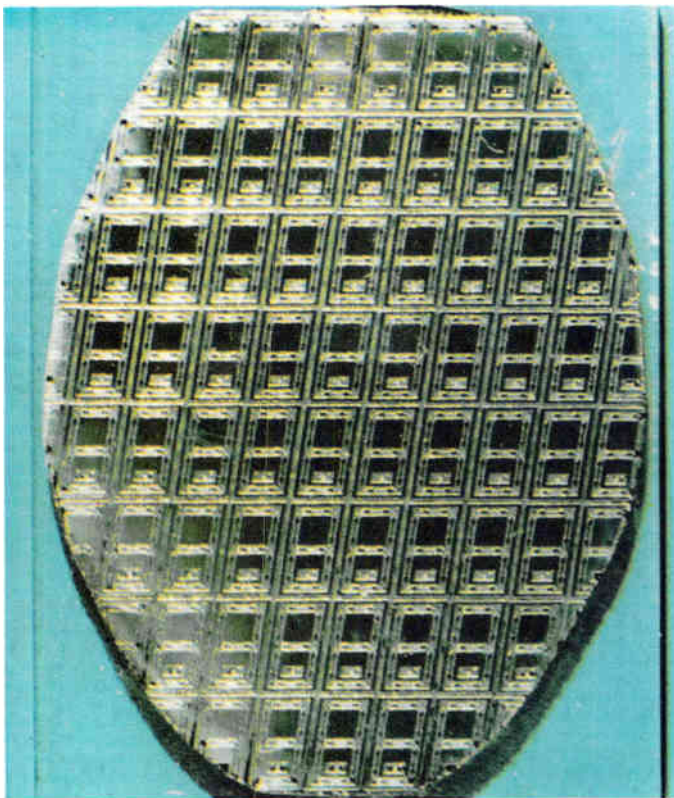

Monolith. GaAs wafer yields 60 chips containing 1/7 inch-high characters. Dumbbell shape of individual diode segments is evident in this view.

electrical contacts.

Photolithography comes next: the wafer is coated with photoresist and exposed to a mask containing the desired pattern for the light emitter and phosphor moat. Within the pattern, the photoresist, nickel, gold, and 60 microns of the GaAs are etched away. After wire bonding, the phosphor is applied.

Barnett describes the LED structure as a buried mesa; the phosphor is surrounded by GaAs walls, and these trap the infrared light within the phosphor, intensifying and sharpening the appearance of the alphanumeric character. Barnett and Heumann have experimented with exposed-mesa LED structures and found that the character had a smeared appearance.

Operating the display in a pulsed mode takes advantage of the fact that light output increases with the square of input current. Therefore, by driving the diode with a high intermittent current, the net output is greater than if it were driven by an equivalent non-varying current. Barnett and Heumann have achieved best results with 2 to 2½ millisecond pulses repeated at a 40 hertz rate. At 50-millamperes average current per display element and 1.3 volts, these pulses give 100 foot-lamberts of light—four times greater than if a constant 50 ma were used. This average current is approximately the same as required to drive a GaAsP display, but the voltage is lower, Barnett claims. The

Experimental. Array of infrared-emitting diodes was built to demonstrate the feasibility of complex display matrixes in GaAs.¹ Diodes are in a 9 by 9 matrix, addressable by rows and columns. Spacing is 0.50 inch between diodes. Each diode has memory; that is, once it has been addressed, it stays on. The phosphor can't be used with this device to convert the infrared light to visible because the efficiency is too low. For successful excitation of the phosphor, the efficient emission of Si-doped GaAs is needed.

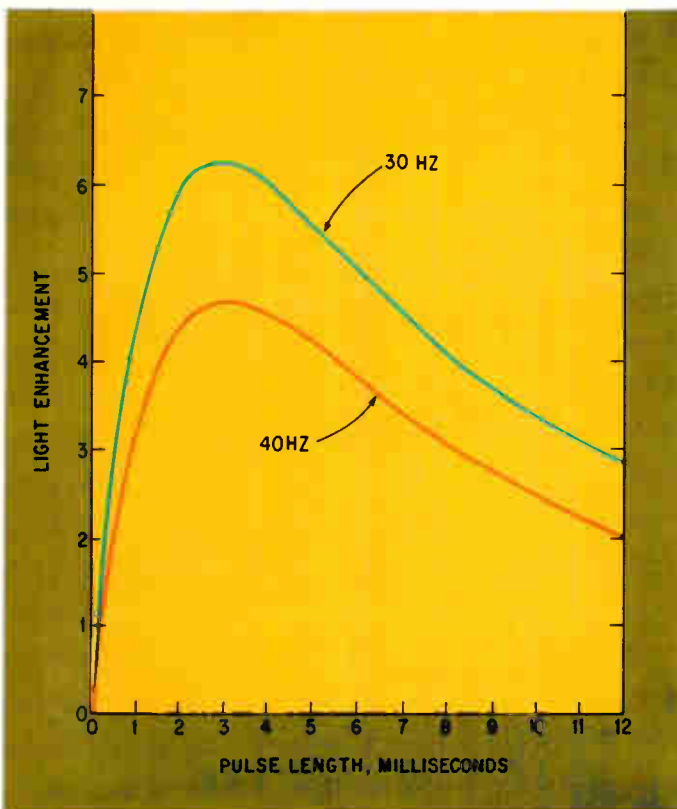
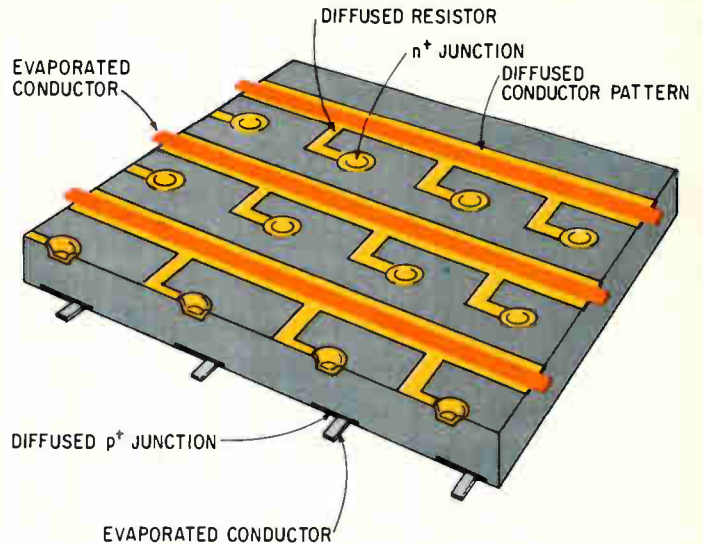

Enhancement. Pulsed operation provides a brighter display than d-c operation for the same average current. For 2 millisecond pulses at 40 hertz, the improvement is fourfold. At 30 hz the improvement would be even greater, but the display would have a noticeable flicker.

light output relative to constant excitation would be even greater if a slow 30 hz repetition rate were used, but the display would flicker perceptibly.

With the yttrium oxychloride display, the pulse width affects the color of the light output. At d-c, the output is red. When the same display is fed 1 msec pulses at the same average power, the output is yellow. And when some segments in a character are driven with d-c and others with pulses, the viewer sees different colors in the same alphanumeric. The 40 hz pulse repetition rate is just about ideal, but the display can be operated at much higher rates with only minor effects on performance.

The relatively slow response time of the LaF₃ phosphor could possibly pose a problem in strobing techniques now advocated for multicharacter alphanumeric displays. These techniques can require rather high pulse rates. [*Electronics*, March 2, pp. 120, 126, and 132]. The other phosphors may be fast enough to present no difficulty. However, for a single line of seven-segment characters the response of LaF₃ is entirely adequate, regardless of the number of characters in the line. Similar segments on each character would be energized simultaneously so that at the 40 hz repetition rate, the maximum pulse width would be about 3.7 msec. This is quite compatible with the 2.5 msec pulse width that works best for LaF₃.

In other character configurations, such as a matrix of light-emitting dots, higher scanning frequencies may be necessary. It may be possible in such cases to use combinations of current pulses of shorter duration but of greater energy. ●

References

1. A.M. Barnett and R.E. Glusick, "The Light-Emitting-Switch Integrated-Circuit Display," *IEEE Trans. on Solid State Circuits*, SC-4, pp. 346-354, 1968.
2. R.A. Hewes and J.F. Sarver, "Energy Transfer Between Yb³⁺ and Er³⁺ or Tm³⁺ in LaF₃ with Applications to Infrared Excited Visible Luminescence," *Bull. Am. Phys. Soc.*, series II, no. 13, pp. 687-688, 1968.
3. S.V. Galginaitis and G.E. Fenner, "A Visible Light Source Utilizing a GaAs Electroluminescent Diode and a Stepwise Excitable Phosphor," in *Gallium Arsenide, Proc. 2nd Intl. Symposium Inst. of Phys. and Phys. Soc.*, pp. 131-135, London, 1968.
4. L.F. Johnson, J.E. Geusic, H.J. Guggenheim, T. Kushida, S. Singh, and L.V. Van Uitert, "Comments on Materials for Efficient Infrared Conversion," *Appl. Phys. Lett.* 15, pp. 48-54, 1969.
5. H. Rupprecht, J.M. Woodall, K. Konnerth, and D.G. Pettit, "Efficient Electroluminescence from GaAs Diodes at 300°K," *Appl. Phys. Lett.*, 9, pp. 221-223, 1966.



Potential for batch fabrication exists with etched permalloy memories, says *Donald F. O'Brien* of Laboratory for Electronics; permalloy toroids and copper conductors turned out by the thousands make up the memory plane

Etching memories in batches

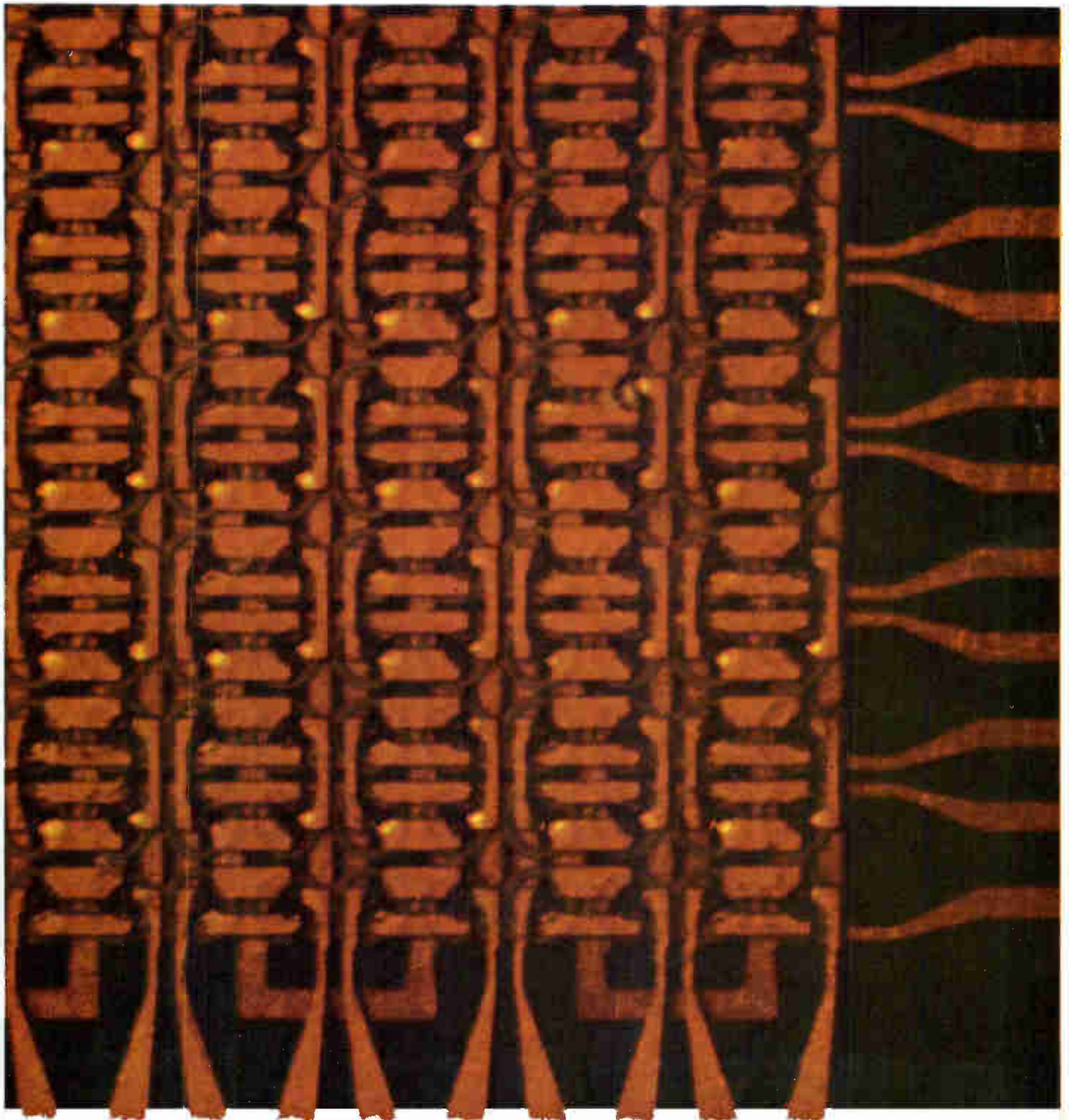

● What batch fabrication does for semiconductors, it can do for memories—improve yield, simplify handling and testing, and lead to extensive miniaturization. Specifically, in the case of etched permalloy memories, the fabrication step, when executed at the level of complete planes rather than at the level of individual elements, produces several thousand bits of memory at a clip.

In addition to this prime advantage, etched-permalloy technology carries with it certain particular good points that arise from the materials used, the memory's physical structure, and the way it's put together. Permalloy's magnetic properties are well known, and closed flux structures can be formed, thereby avoiding air gaps and insuring high output levels. Also, the memory lends itself to the formation of proven organizations, such as the 3-D layout for ferrite-core stacks. The permalloy structure is a monolithic structure and needs no external support. Furthermore, it is made in much the same way as multilayer printed-circuit boards.

In operation, the memory is economical and it is mechanically rugged. It holds up over the full military temperature range in the presence of radiation. Other features include very little power dissipation, and densely packed and nonvolatile data. In addition, employing the memory elements as nonlinear mixers of two frequencies delivers a nondestructive readout capability;

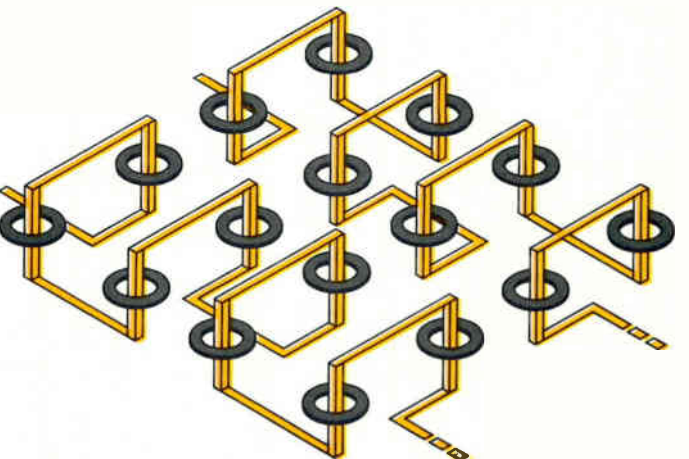
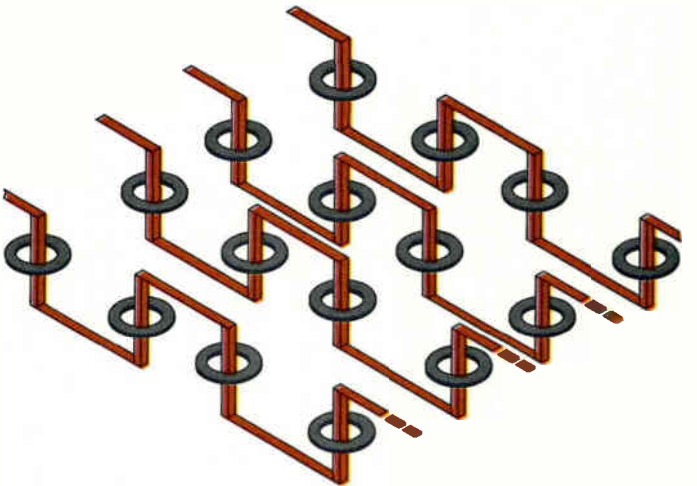
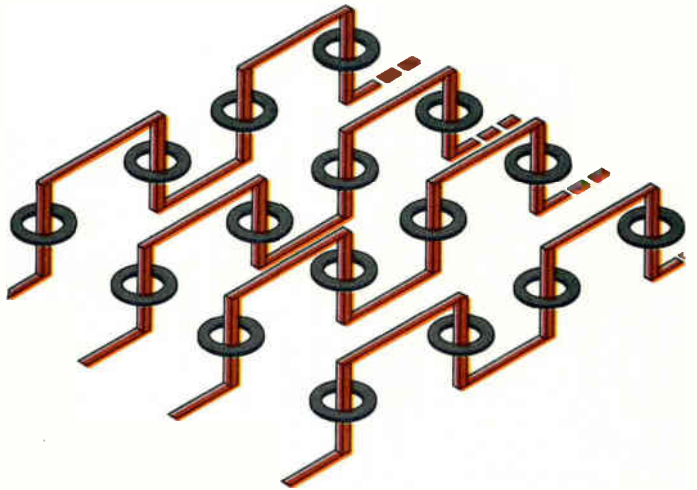

Zigzag. These drawings show the convolutions of the individual copper conductors in an etched permalloy plane.

Batched. In this enlarged photograph, the individual permalloy toroids are visible, threaded by copper conductors that act as drive and sense wires. The permalloy and copper were etched from continuous layers deposited on an epoxy board (dark brown background).

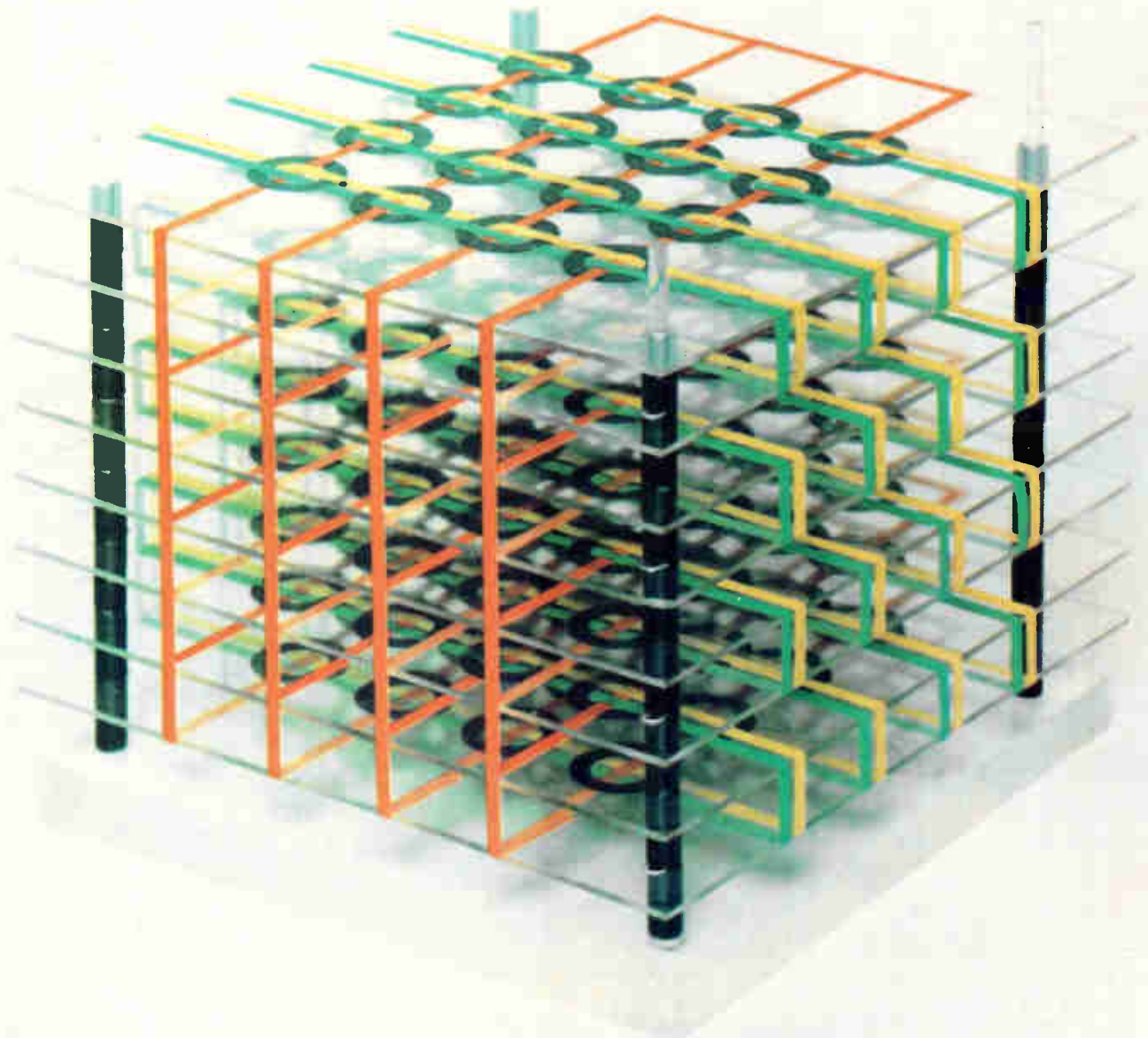

Folded. This linear-select mockup illustrates the interconnections in an etched-permalloy stack, arranged for maximum signal output and minimum noise.

Changing of the guard

While this manuscript was in preparation, Laboratory for Electronics Inc., sold its proprietary interest in the etched permalloy technology to Cambridge Memories Inc., Newtonville, Mass. The latter organization is developing the technology further.

This is the 18th installment, and the 40th article, in *Electronics'* continuing series on memory technology, which began in the Oct. 28, 1968, issue.

is reproduced photographically by a step-and-repeat process while being reduced to its finished size. The stringent accuracy— ± 0.0002 inch accuracy across a 12-inch square, horizontally and vertically—maintained during reduction forced LFE to construct a special camera that at the time was well ahead of the state of the art. Today, comparable cameras are in common use by integrated-circuit mask makers.

After an inspection verifies accuracy and registration, the pattern of the first conductor level is etched on an ordinary copper-clad epoxy board. In the photo on page 94, the darkest brown is the underlying epoxy; the next-darkest pattern is the conductors made in this first etch.

Additional applications of epoxy cover the copper pattern. A layer of photoresist is added, exposed, and etched to make a large number of holes in groups of three. Each group lies directly over the ends of the etched conductors.

Now, a thin sheet of permalloy containing 1% molybdenum, added to boost its magnetic properties, is laid on the epoxy layer, which insulates the permalloy from the etched copper. Etching the permalloy leaves a pattern of toroids, 23 mils outside diameter and 17 mils inside diameter, visible as grayish-brown circles in the photo. Each toroid surrounds a group of three holes.

Next, the toroid layer is filled in with epoxy; this surface then receives a coating of photoresist. The holes are etched for the second time through several layers of epoxy and photoresist to the copper. These holes are then filled to the top with copper by successive steps of electroless deposition and electroplating. Thus, the path for electrical contact runs through copper "mesas" to a final solid layer of copper. This top layer is bonded, with plenty of heat and pressure, to insure contact with all mesas—nearly 250,000 on the largest planes. Etching this layer of copper produces the top layer of conductors—the lightest color in the photo.

The copper conductors of the completed plane are checked for continuity and short circuits. The usual magnetic tests performed on any magnetic memory verify the plane's ability to accept data written into it, to resist disturbances by noise and half-select current pulses, and to read out the data accurately upon request. Only a few significant tests are carried out during fabrication: registration is checked visually, and the permalloy is checked for magnetic properties before deposition.

Actually, the process involves over 40 steps whose end product is an array of permalloy toroids "threaded" with three sets of conductors—all visible in the photo and separately diagramed on page 95. One set passes up through the first toroid in a north-south column. A second set passes down through the first toroid in an east-west row. These two correspond respectively to the x and y selection lines. The third set, a combined sense and inhibit line for 3-D operation, serves two rows at once as it passes from left to right across the array, as shown in the photo.

Two typical examples of completed planes are shown on the top of page 98. The smaller of these contains 2,048 toroids wired in a linear-select organization for a low-power avionics application. Diodes, in the solder pads visible in the photo, prevent sneak currents from generating false outputs from unselected words.

The larger plane in the photo contains about 83,000

the phase of the output corresponds to the stored data.

Building the memory basically involves the successive depositions of copper and permalloy on a polymeric supporting medium, with intermediate steps that etch toroidal storage elements from the permalloy, and drive and sense conductors from the copper. The finished planes can then be assembled into stacks, using another batch-fabrication process developed by the former Electronics division of Laboratory for Electronics Inc. The technique was applied in the production of a random-access mass memory and a low-power avionics memory. Both have proven to be feasible.

However, the memory's principal limitations are slow speed and small output signals. Twice as long as those of ferrite cores, the memory's cycles can be shortened only by going to a considerably more expensive form of permalloy and more complex and expensive drive circuits. But, at the same time, because of its lower speed, the memory dissipates only about a tenth of the power of a ferrite-core array and requires much smaller drive currents. As for its small outputs, special sense-amplifier circuits can detect them, or, in the case of 2-D organization, an increased drive current can produce a larger output.

At the outset, five different patterns are drawn at 125 times actual size; they must register perfectly. Representing only a small portion of the plane, the artwork

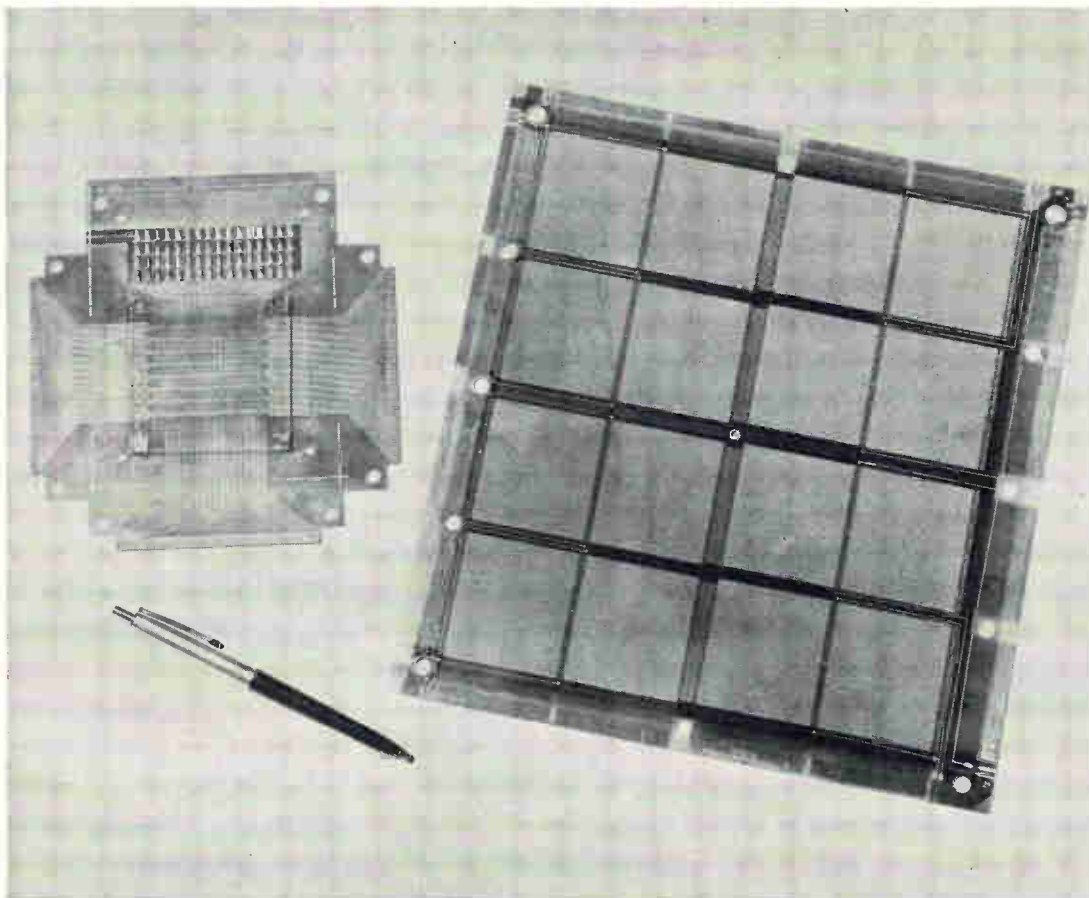

Large and small. Two typical etched-permalloy planes contain 2,048 toroids (left) and nearly 83,000 (right) for linear-select organizations. Larger plane includes a substantial number of redundant toroids.

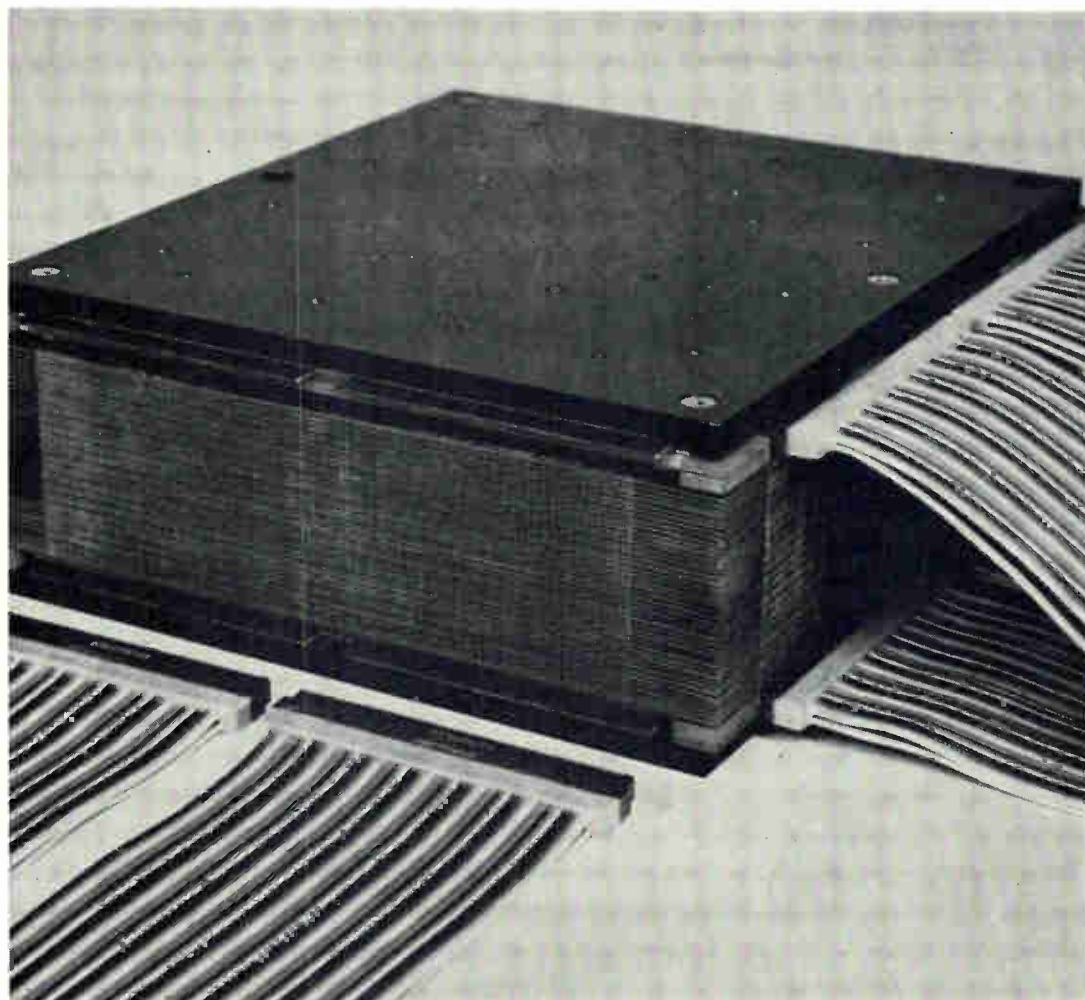

Stacked. Batch-fabrication also applies to stacks of etched-permalloy planes. Specially drawn wire fits notches precut in the sides of the stack, thus interconnecting corresponding etched conductors.

toroids in a square array, 288 on a side. The photo on page 94 is an enlargement of a portion of this plane. Several redundant lines in each direction can be pressed into service, should any toroids or any connections between mesas and etched conductors turn out to be bad.

Interconnecting these planes into stacks also takes advantage of a batch-fabrication process. First, all the planes are placed in contact with one another in the same registration as they will be in the completed stack. Then a diamond wheel cuts notches, 12 mils deep, in the ends of the conductors. Fifteen-mil spacers are inserted between the planes, and specially drawn wire, cut to lengths equal to the height of the stack, is inserted in the notches. The wire's cross-section fits the notches exactly. Finally, the four edges of the entire stack are solder-dipped. This completes the assembly of stacked permalloy planes, except for the attachment of connectors to the soldered wires for cables that fed the drive and sense circuits.

Two feasibility models of etched permalloy memories have been built. One of these is a low-power avionics version for Wright-Patterson Air Force Base, under contract AF 33(615)-2838. The other is a mass memory for the Rome Air Development Center built under contract AF 30(602)-3826.

In the low-power avionics version, 1,024 words of 32 bits each are stored; the cycle time is 2 microseconds.

Its organization is linear select, or 2-D, in a folded arrangement shown on page 96. In this mockup, a single horizontal orange strap between the front and rear edges contains a single four-bit word, isolated with the aid of diodes not shown here. The toroids switch like ferrite cores. Data stored in the toroid is read out through the green and yellow sense lines—one pair of sense lines per bit—and detected with differential amplifiers. Two sense lines for each bit pass in opposite directions through the toroid to reinforce the signal detected by the amplifier, while canceling the noise.

The output signal of etched permalloy, especially in the 2-D organization, is only a millivolt or so, compared to 10 to 15 mv for plated wires and as much as 80 mv for ferrite cores. This problem can be overcome by employing a read overdrive in the 2-D organization, at the expense of part of the technology's low-power advantage; or by using more sophisticated sense amplifier designs that can reliably detect such small signals, in either 2-D or 3-D organization. There's still a third possibility for 3-D that was tried out in the mass memory version, which contains 1.3 million bits and can read out any word nondestructively in 20 usec.

For nondestructive readout this memory uses each core as a nonlinear mixer; a-c currents of 1 megahertz and 600 kilohertz are sent into the selected x and y lines respectively, and the sum frequency, 1.6 Mhz, is detected on the sense line. The phase of the sum frequency, determined over 10 or more cycles of the a-c signal, denotes the state of the core. This reading technique makes small output signals easier to detect, permits speeds closer to those attainable with ferrite cores, and allows nondestructive readout as well. This idea was first proposed in 1954 by Bernard Widrow, then at the Lincoln Laboratory of MIT. However, in conventional memories the phase of the a-c readout can't be reliably determined because the coupling capacitance between drive lines varies too much. The technique works in the etched permalloy stack because the etching technique controls the coupling capacitance much more closely.

Problems still remaining in this technology include simplifying the organization, refining the design and fabrication for large-scale production, developing reliable miniaturized connectors, and refining the drive and sense circuits.

In the mass memory built for the Air Force, each x and y line had a switch at each end; two switches had to close before a line could be selected. Ordinarily every unselected switch has a small amount of leakage, and a substantial amount of coupling occurs between drives lines when the two-frequency a-c drive is used. Using two switches reduced the leakage to a point where spurious signals didn't appear on the sense line. Experiments indicated that a conventional one-switch selection scheme could be developed, with the line ends opposite the switches connected to a common bus.

The density and smallness of etched permalloy memories aggravate even further the always difficult task of designing connectors with contacts that are sufficiently close together and have sufficiently low resistance and high reliability. And of course, as in any technology, small design changes are often necessary when a product goes into production, and there's always room for peripheral circuit improvement. ●

Designer's casebook

Designer's casebook is a regular feature in Electronics. Readers are invited to submit novel circuit ideas and unusual solutions to design problems. Descriptions should be clear. We'll pay \$50 for each item published.

Comparator increases rate meter's response

By Donald Wasserman and Glenn Parker

Perkin-Elmer Corp., Norwalk, Conn.

Some low-frequency rate meters, such as those used for pulse counting, produce an output voltage proportional to the repetition rate of an input pulse train. This proportional output may interfere with a reading if ripple is associated with the pulses. A larger time constant to smooth the ripple results in poorer response time. Adding a simple comparator circuit to the integrator improves the measurement response time of the rate meter.

Transistors Q_1 and Q_2 make up the comparator, comparing the voltage developed across C_1 to that across C_2 . The voltage developed across C_1 results

from the pulses arriving at the input from the output of the preceding monostable multivibrator stage (not shown here). Essentially, capacitor C_1 responds fast, while C_2 filters the ripple.

If, for example, the input repetition rate should slow down, the voltage across C_1 will decrease, turning Q_2 on. Capacitor C_2 then discharges quickly through the low-impedance path of Q_2 to ground, until the voltage across C_2 is about equal to that of C_1 . The output emitter follower, Q_3 , follows the change in voltage across C_2 and delivers the meter readout.

Similarly, if the input rate should speed up, the voltage on C_1 would rise, turning Q_1 on, providing charging current to capacitor C_2 through the low-impedance path of Q_1 , until the voltage across C_2 is again about equal to that on C_1 .

Diode D_1 helps reduce the voltage-comparison dead band between C_1 and C_2 . And since high-beta transistors are used, R_1 can be made large enough to render negligible the current it contributes to C_1 through D_1 .

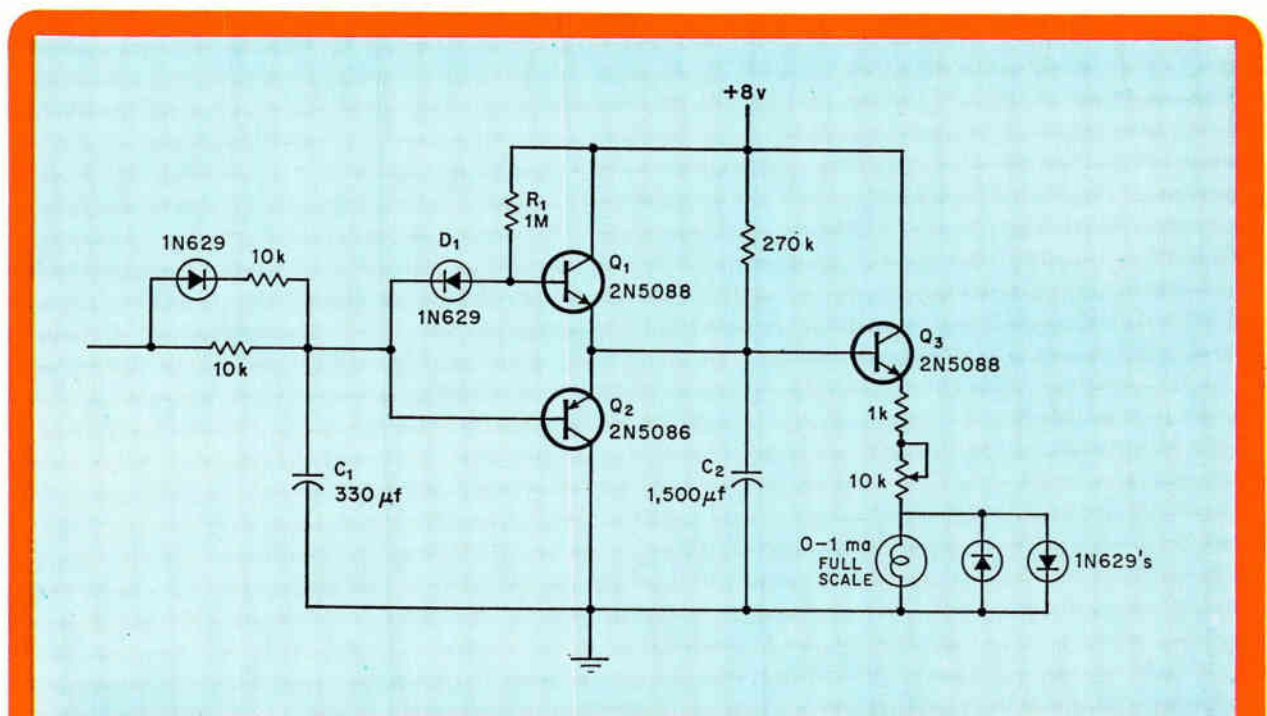

Balancing act. If the input rate should speed up or slow down, capacitor C_2 will follow C_1 's voltage by charging or discharging rapidly through Q_1 and Q_2 . The output emitter follower delivers a voltage proportional to the repetition rate of the input pulse train.

One-shot generates wide range of periods

By Seymour Bell

University of Michigan, Ann Arbor

Gating a pulse generator with a bistable multivibrator produces a large variation in the time constants, and thus in the pulse width, of a monostable multivibrator. The combined circuit generates pulse widths of less than one tenth to greater than 100 seconds.

Essentially, the circuit consists of the bistable multivibrator, a transistor gate, the pulse generator, and a pulse shaper. In the bistable's normal state, transistor Q_1 is on and Q_2 off. A positive voltage thus appears at the base of the transistor gate, Q_3 , forcing it on. While Q_3 is on, the pulse generator's

timing capacitor C short circuits keeping the pulse generator off.

A negative trigger pulse applied to the input of the bistable multivibrator starts the action of the monostable circuit. Transistor Q_1 switches off, turning Q_2 on, which, in turn, switches Q_3 off. When Q_3 turns off, the timing capacitor starts charging through the resistor network, R , towards the 12-volt supply. The unijunction transistor fires when its critical voltage is reached. The pulse out of the unijunction is shaped by Q_6 and fed back to the bistable, which then returns to its normal state and awaits the next trigger pulse. The action of the bistable shuts off the pulse generator.

The pulse generator determines the time constant of the overall circuit. The upper limit of the time constant is determined by the combined leakage of Q_3 and timing capacitor C , and by the gain of Q_4 . The time constant can be multiplied by a factor of 2 for each toggling flip-flop inserted in series between the points marked X—the output of the pulse shaper and the input to the bistable.

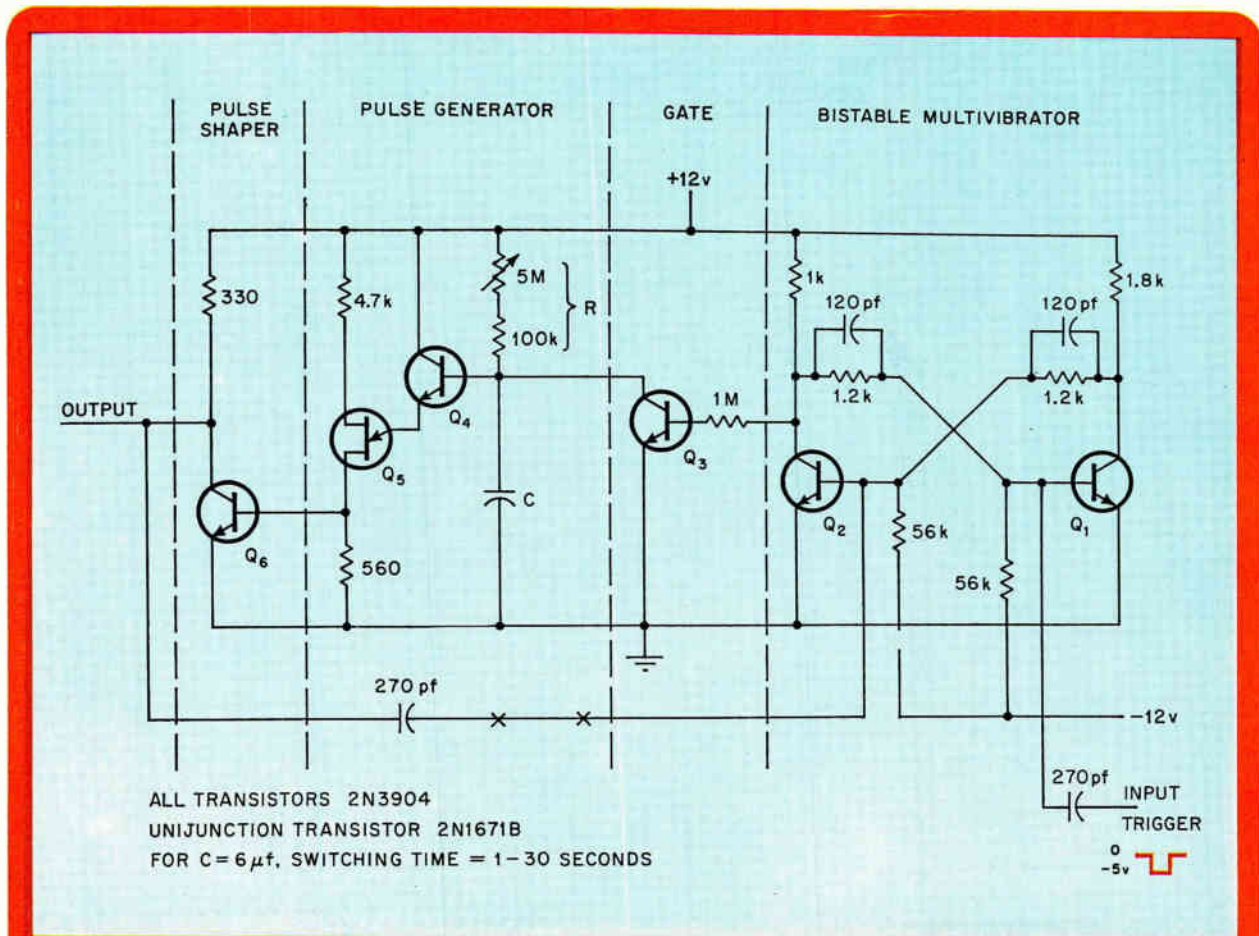

Variable. The wide range of time constants from the monostable circuit results from the longer period provided by the unijunction pulse generator. A negative input trigger flips the bistable circuit, which turns on the pulse generator. The output pulse is then fed back and turns off the bistable.

New 15 MHz scope: two guns, two delay lines.

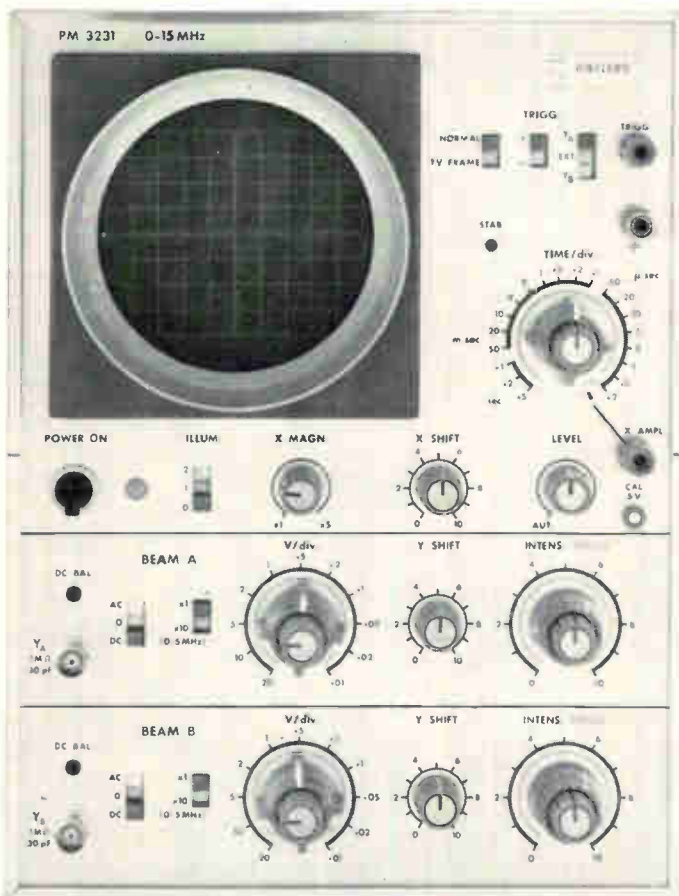

More of the Unbeatable
Philips Scopes

PM 3200
10 MHz, 2mV/div
\$495

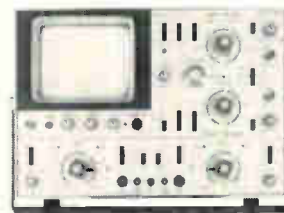

PM 3250
50 MHz: 1mV
Dual Trace
\$1995

Compare specs. Compare prices.
PM 3231 costs only \$1,050. PM 3231 is a new general-purpose scope incorporating all the features needed for accurate pulse measurement.

PM 3231 is a new scope, a new design. It uses delay lines and advanced components like FET's. It has two guns which are essential if you want to know where and when you're triggering. Time-shared beam switching can lead to misleading results.

For example, feed this same signal to



both channels on a time-shared scope and you might see this, a fact we'd gladly demonstrate.

PM 3231 uses delay lines which are essential if you want to see leading edges properly.

Other features include triggering from either channel. And drift is feedback and virtually eliminated. (at max. sensitivity less than 1/4 div/24 hours).

So, if bandwidth permits, and 15 MHz does, you should think real two-gun, not dual trace.

For information, contact:
Philips Electronic Instruments, 750 S.
Fulton Avenue, Mt. Vernon, N.Y. 10550.

**PHILIPS
ELECTRONIC
INSTRUMENTS**

750 S. FULTON AVE., MT. VERNON, N.Y. 10550
A DIVISION OF PEPI, INC.

Making small ROM's do math quickly, cheaply and easily

Albert Hemel of Communication Products Corp. shows how combining lookup-table and equivalent-function techniques with ROM's averts the need for huge single-memory capacity

● A team of techniques, some old and some new, can become the winning combination for making inexpensive and widely available read-only memories perform mathematical functions. The three members of this team are the familiar lookup-table approach that contains all possible combinations of a given mathematical function or arithmetic operation; the inexpensive read-only memories made possible by large-scale integration technology; and the equivalent-function approach wherein a large number is represented by the sum of several smaller numbers prior to implementation of the mathematical process.

The lookup table is basic to the new technique. However, instead of trying to store the complete table in a single memory, which in some cases would require a capacity exceeding 1 million bits, several smaller, off-the-shelf ROM's are used. The combination replaces the usual mass of gates and flip-flops ordinarily used to perform mathematical functions. Furthermore, the combination is fast—the lookup table-ROM approach involves only the delay through the memory and its associated gates. The method can be used for addition, subtraction, multiplication, and division as well as for computing exponential powers and square roots.

Multiplication is one of the simplest operations that can be carried out with a read-only memory. Basically, multiplication is repeated addition; that's exactly what

a desk calculator does. One of the numbers to be multiplied—the multiplicand—is added to itself as many times as the other number—the multiplier—specifies. Automatic desk calculators can take certain shortcuts; the simplest is multiplying by 10 merely by shifting the multiplicand to the right one digit position. To multiply by 27, for example, instead of adding the multiplicand 27 times, the machine adds it 7 times, shifts it right, and adds it twice more. To multiply by 207 the process would be the same except that the multiplicand would be shifted two places to the right; no addition would occur after the first shift because of the 0 in the multiplier.

Conventional logic arrays multiply in the same way, with one important difference: since they work with numbers in binary notation, the multiplicand is never added more than once following each shift. All the multiplier's digits are either 1 or 0; an addition occurs for a 1. But another shift is made immediately for a 0. This shifting-and-adding sequence is time consuming.

In any multiplication, whether decimal or binary, the number of digits in the product equals either the sum of the number of digits in multiplier and multiplicand, or that sum less one.

Therefore in a straightforward lookup table the number of bits per word must equal twice the above sum. Suppose the table contains all possible products of two four-bit numbers. Four input lines would be required for each

Multiplier. Four read-only memories and five monolithic four-bit adders can multiply two eight-bit numbers cheaper than can conventional sequential logic. Lighter and heavier tints refer, respectively, to less and more significant bits in the result.

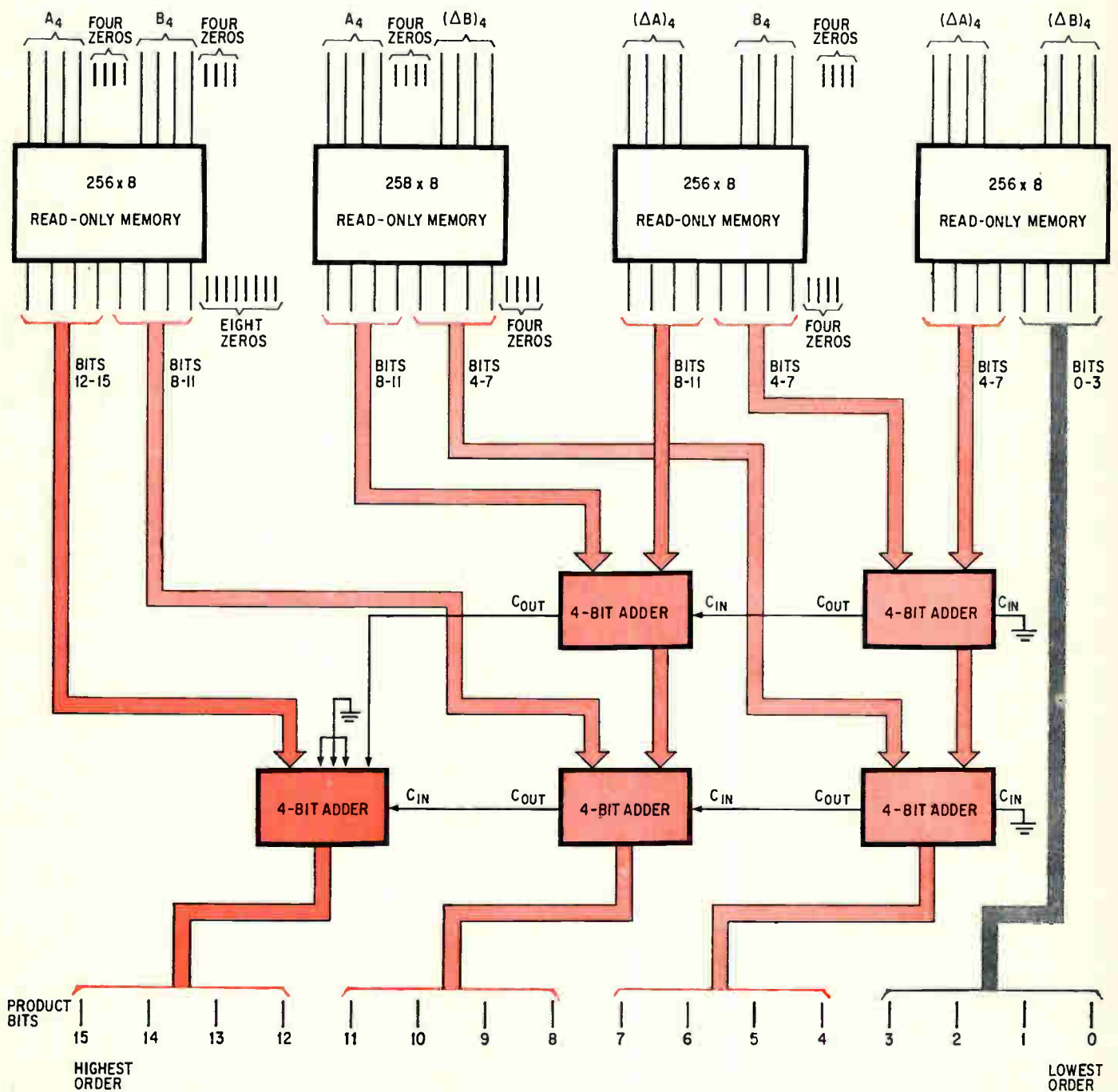

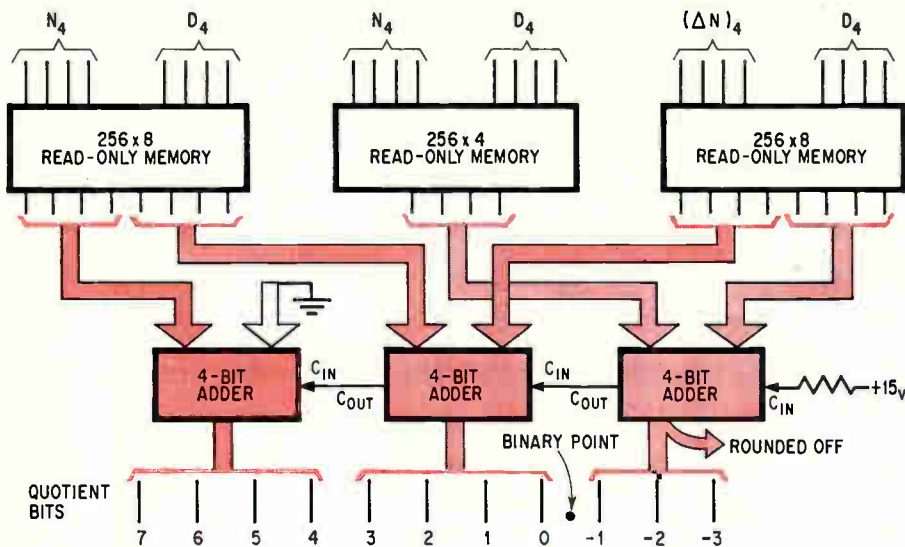

Divider. Three ROM's and three four-bit adders quickly and efficiently find the quotient of an eight-bit dividend and a four-bit divisor with accuracy out to 11 places.

number to be multiplied, or eight in all. These eight lines can carry $2^8 = 256$ different combinations of binary signals; each combination represents the address of one word in the memory. The memory's capacity would be 2,048 bits; since the product of two four-bit numbers can be as long as eight bits, the bit count in the memory would be $256 \times 8 = 2,048$.

This straightforward lookup table is as good as any method for performing a simple four-bit multiplication. But if the numbers are longer than four bits, the size of the memory grows very quickly. Thus, for two five-bit numbers, the word count is 1,024 and the output must be 10 bits long; total bit count is $1,024 \times 10 = 10,240$. For two six-bit numbers the total is $4,096 \times 12 = 49,152$. And for eight-bit numbers it is $65,536 \times 16$ —more than a million bits.

No single memory with a million-bit capacity is available now, nor is one expected soon. If many small memories are interconnected to achieve this size, the cost becomes prohibitive.

But an equivalent lookup-table multiplier that works just as well as the big table can be built with much smaller memories. To design such a multiplier, represent each of the factors to be multiplied, A_8 and B_8 , as the sum of two smaller numbers: one is simply the last four bits of the given number, the other is the first four bits followed by four 0's. Thus:

$$A_8 = A_4 + (\Delta A)_4$$

$$A_4 = \text{XXXX}0000$$

$$(\Delta A)_4 = \text{XXXX}$$

Each X represents a binary 0 or 1. The other factor, B_8 , is subdivided the same way.

With these numbers the original multiplication can be reconstructed as the sum of several four-bit multiplications:

$$\begin{aligned} A_8 B_8 &= [A_4 + (\Delta A)_4][B_4 + (\Delta B)_4] \\ &= [A_4 B_4] + [A_4 (\Delta B)_4] + [(\Delta A)_4 B_4] + [(\Delta A)_4 (\Delta B)_4] \end{aligned}$$

These four products and their sum can be implemented in four 2,048-bit ROM's and five four-bit adders—all standard off-the-shelf items. They are manufactured by several companies, such as American Microsystems, Texas Instruments, Electronic Arrays Inc., Fairchild Semiconductor, and National Semiconductor. The multiplier shown on page 105 uses National's 256-by-8-bit MM 523, and also the Texas Instruments SN 7483 four-bit adders. Furthermore, the result appears at the outputs of the adders within one microsecond after the signals arrive at the memories' inputs.

These metal oxide semiconductor memories are used with adders built with transistor-transistor logic. This combination requires a 7.5 kilohm resistor to be connected between each memory output and a -12 -volt supply. And, if TTL circuits are to drive the memories, each memory input should be connected through a pullup resistor to a $+12$ -volt supply. In this case, every input is used twice, so the pullup resistors' value should be 3.75—half the normal value. Similar considerations to insure that the necessary current is available apply to the other designs described in this article—7.5 k ohms for inputs used only once, 3.75 k for inputs used twice, and 2.5 k for those used three times.

Each of the four memories has eight inputs and eight outputs, as in the simple example described earlier; but here the eight outputs are grouped into two sets of four. Each of these sets corresponds to one of four four-bit groupings in the 16-bit product. If the product bits are numbered 0 to 15, with bit 0 the least significant and the furthest right, the groupings in the product

... multiplication and division are performed economically by breaking down the factors into the sums of two smaller numbers ...

are bits 0-3, 4-7, 8-11, and 12-15.

The trailing 0's are not connected (for the inputs A_4 and B_4) as on page 105. However, they determine which of the four-bit groupings applies to a particular memory's output. The memory whose inputs are the $(\Delta A)_4$ and $(\Delta B)_4$ isn't concerned with any trailing 0's, so its outputs contribute to bit grouping 0-3 and 4-7 in the product. None of the other memories contributes to bits 0-3, so no adder is required for this output.

Four trailing 0's are associated with the inputs, and therefore with the outputs, of the two intermediate memories. These 0's are not connected to the memory, but they correspond to bits 0-3, so that the memories' actual outputs correspond to bits 4-7 and 8-11. The three memories that have at least one delta input produce a total of three contributions to bits 4-7; these three groups are combined in two four-bit adders to produce bits 4-7 of the product.

Finally, the last memory, which has no delta inputs, has eight trailing 0's appended to its outputs—four carried through from each of the two inputs. These correspond to bits 0-7, so that the memory's outputs are associated with bits 8-11 and 12-15. Therefore there are three memories whose outputs correspond to bits 8-11; these three groups are combined in two more four-bit adders to produce bits 8-11 of the product.

The four remaining outputs of the last memory alone would make up bits 12-15 of the product, except for the possibility of a carry bit from the lower-order adders. To incorporate this carry bit into the product, the fifth adder is required; like all the others, it has two four-bit inputs and one carry input. But it doesn't utilize all of its inputs. One of the four-bit inputs takes bits 12-15 from the last memory; the input carry takes the carry output from one of the lower adders. So far, the procedure is conventional. But there's another carry from another lower adder that has to be accounted for, and no other four-bit input. So the carry is connected to the least significant of the unused inputs, and the other three are grounded to hold them to 0. This is a rather profligate use of logic, and would never be economical except where integrated circuits are used. But it's less expensive to throw in another four-bit adder than to work up a special design from the individual IC gates.

A similar approach can be applied to division. When an eight-bit number, N_8 , is to be divided by a four-bit

divisor, D_4 , the quotient could be thought of as four bits long—division is the inverse of multiplication, and the product of two four-bit numbers has eight bits. But with no restrictions on the divisor's magnitude, a full eight bits must be allowed for the quotient—in case the divisor is 0001, for example. Furthermore, there may be a remainder. To cover this contingency, the following example is set up for an 11-bit quotient, designated Q_{11} ; the choice of 11 bits will be explained later. Of these 11 bits, three are to the right of the binary point, which corresponds to the decimal point in decimal notation; these three bits thus represent a binary fraction. Mathematically, the example $Q_{11} = N_8/D_4$ may be expressed as $xxxxxxxxx = xxxxxxxx/xxxx$ where the x 's again represent either 1's or 0's in binary notation.

In a straightforward lookup table, the divisor and the dividend would require a total of 12 inputs, and the memory would contain $2^{12} = 4,096$ words of 11 bits each, or a total of 45,056 bits.

But if the 8-bit numerator is subdivided in the same way as the numbers in the multiplication example, the problem may be restated

$$Q_{11} = \frac{[N_4 + (\Delta N)_4]}{D_4} = \frac{N_4}{D_4} + \frac{(\Delta N)_4}{D_4}$$

where N_4 and $(\Delta N)_4$ are defined in the same way as

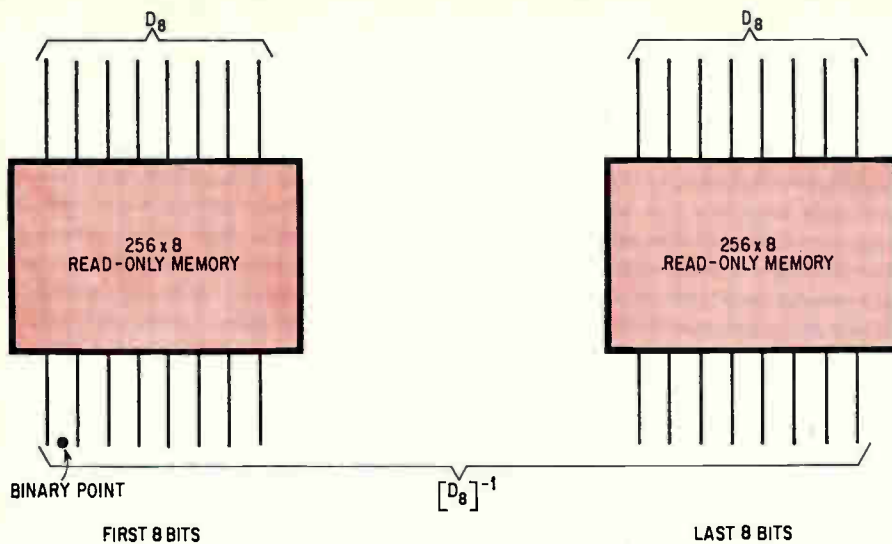

Inverter. With a large divisor, it may be easier to multiply the reciprocal than to divide directly. Reciprocals can be easily obtained directly from two ROM's.

the representations they correspond to in the multiplication example. Each of the two subsidiary quotients can be implemented with a 256-word ROM, but there's a catch that isn't found in multiplication.

In general, both quotients may have remainders that cannot be completely specified in a binary fraction 11 bits long—just as the fraction $3/32$ cannot be completely specified in three decimal places. When the quotients are added together to make Q_{11} , since both of them may have been rounded off, they may create a cumulative error that makes the last bit position in the sum incorrect. To compensate, therefore, the two subsidiary quotients are implemented with an extra fractional bit—a fourth bit to the right of the binary point instead of three. Then, the lowest-order of these four bits is discarded at the output of the adder to provide the desired 11-bit accuracy.

Thus the N_4/D_4 portion of the final quotient can be implemented with a read-only memory of 256 words of 12 bits each. As shown on page 106, this is easily accomplished by using standard memories of eight-bit and four-bit word lengths connected in parallel. Typical ROM's such as National's MM523 can be used for the eight-bit word lengths, and the MM521 for the four-bit word. And just one additional eight-bit memory can be used for the N_4/D_4 portion. Since this N_4 dividend consists of only four bits, the necessary accuracy, four

places to the right of the binary point, is attained with only eight bits. The total is 5,120 bits with this technique, compared to 45,056 for the straightforward approach.

The 20 outputs from the three memories are combined in three four-bit adders in much the same way as was done in multiplication. One of the adders handles the four fractional bits and another the four low-order bits to the left of the binary point. A third adder is necessary for the four highest-order bits; it serves the same purpose as the fifth adder did in multiplication—to handle the effect of a carry from the other adders into these bits.

Ordinarily, when several small adders are used for summing large numbers, as in this example, the input carry to the least significant adder is held at zero with a ground connection; such a connection is shown in the diagram for multiplication, and also could be used in the division example. But in division, the lowest order bit is included only to prevent a cumulative rounding error, and is discarded in the final quotient. One convenient rule that can be applied to binary rounding is to add 1 to the lowest-order bit that is retained if the highest-order discarded bit is 1; this corresponds to the decimal rule to add 1 to the last digit if the highest-order discarded digit is five or more. This upward rounding can be insured by connecting the lowest input carry to a positive voltage, or leaving it disconnected, rather than grounding it. Either alternative holds the carry to a 1.

When the denominator is large, multiplying by the divisor's reciprocal may be easier than dividing directly. Finding the reciprocal of a binary number is not the same as complementing; it is the result of dividing the number into unity, and in general it will have a large remainder. Consequently, for accuracy, the reciprocal should have more bits than the original number. The diagram above illustrates in a general way how an eight-bit denominator is inverted using two 256-word-by-eight bit ROM's to produce a reciprocal value that's accurate to 16 binary places. When inverting larger numbers, whose leading bit is always 1, the reciprocal's leading bits are always 0. Then one of the two memories can be made smaller or eliminated altogether.

The four-bit adders used in the multiplication and division schemes, as well as subtractors, may themselves be implemented with read-only memories. The two operations are identical, except that in subtraction, one of

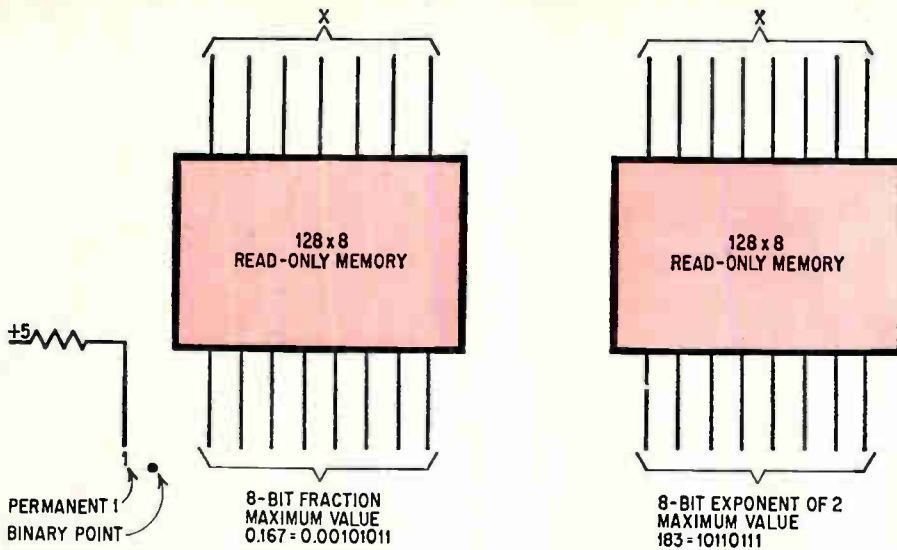

Exponential. Two ROM's can generate values of exponential functions over a wide range. One gives the fractional value, or mantissa—a characteristic of 1 always is used—and the other yields the exponent in a floating-point notation referred to the base 2.

the numbers involved is complemented before beginning the operation—its complement is used as part of the ROM address. However, there is little advantage in using ROM's, since integrated-circuit adders are readily available at low cost. But it's interesting to note some of the peculiarities that occur when addition is performed with this scheme.

It appears that an addition lookup table, containing the sums of pairs of four-bit numbers, would have the same number of entries—the same number of ROM words—as a table containing the products of such pairs. But this is not so. The adder table must allow for an input carry.

Thus a total number of nine input bits is needed for a four-bit adder—four for each 4-bit number and one for the carry. These nine bits address $2^9 = 512$ words, compared to 256 in the multiplication table. The greater number of words is partially offset by the fact that the sum contains no more than five bits, including an output carry. Thus the total number of bits in a ROM serving as a four-bit adder is $512 \times 5 = 2,560$, compared with the four-bit multiplier's 2,048 bits.

But just as in multiplication and division, the equivalent-function approach can simplify the adder design. For example, if a four-bit addition is considered as two two-bit additions, each with its own input carry, then the total number of input bits to each adder is five. This requires only $2^5 = 32$ words of three bits each, including an output carry, for each adder. The two adders then would require 64 words, and the output carry of one could be connected directly to the other's input carry. These 64 words thus could be packaged in a single unit containing only 192 bits, which is much less than the earlier 2,560 bits.

Raising values to an exponential power also works out quite conveniently with ROM's. Because the exponential function is one of the more rapidly increasing functions—exceeded among common functions only by the factorial—the outputs of a ROM containing values of the exponential should be expressed in floating-point notation—for example, e^{10} expressed in floating-point notation is 2.2026×10^4 , instead of 22,026.

However, floating-point notation need not be in the conventional power-of-10 format. In binary notation, powers of two are more convenient; the above example in binary is thus

$$\begin{aligned} e^{1010} &= 101011000001010 \\ &= 1.01011000001010 \times 2^{14} \\ &= 1.01011000 \times 2^{1110} \end{aligned}$$

Here the exponent of e is 10 in binary form; its value is expressed in binary form as a 15-bit number. This is finally expressed in base-2 floating-point notation as 1 followed by a 14-bit binary fraction, multiplied by 2^{14} . This fraction is shown above with the exponent in both a decimal and true binary floating-point format. In the latter, the fraction is rounded off to eight binary places.

Base-2 floating-point notation has two major advantages: it need not be reconverted into binary form for use in a system containing the function table, and its most significant bit is always 1. The latter permits this bit to be "free"—wired permanently outside the memory, rather than stored in it.

An exponential-function table containing values of e^x , where x is accurate to seven bits, can be stored in two ROM's, each containing 128 words of eight bits each, as shown above. One of the memories, which could be National's MM 522 or equivalent, would produce the fractional part of the exponential value accurate to eight bits; the other would produce the exponent part of the function expressed in floating-point form. The input ranges from e^0 to e^{127} and the output from 1 to $1.167 \times$

2^{183} or, in binary, to $1.00101011 \times 2^{10110111}$.

Such numbers aren't often encountered in practical applications. A more useful implementation might permit the 128 input values to range for example, from 0 to 63.5 in 0.5 steps; or to 31.75 in 0.25 steps; or to 7.9375 in 0.0625 steps, with successively higher resolution, depending on the position of the binary point. These correspond respectively to maximum output values of 1.528×2^{91} , 1.748×2^{45} , 1.870×2^{22} , and 1.368×2^{11} . In binary notation these are, respectively

$$1.10000111 \times 2^{1011011}$$

$$1.10111111 \times 2^{101101}$$

$$1.11011110 \times 2^{10110}$$

$$1.01011110 \times 2^{1011}$$

Any one of these versions would use the 128-word-by-eight-bit ROM for the binary fraction and a 128-word memory with a word length of four to seven bits for the exponent.

If an exponential function with both a wide range and high resolution is required, seven bits may not be sufficient for the input. This presents the same problem encountered in setting up a multiplication table for the product of two eight-bit numbers—it requires a much larger ROM than is practical.

But the solution to this problem is similar to that for multiplication—the exponent is divided into two parts

$$\epsilon^x = \epsilon^{(y + \Delta y)} = (\epsilon^y)(\epsilon^{\Delta y})$$

where, in the same manner as before, y contains all the higher-order bits of x followed by a string of 0's, and Δy contains the low-order bits of x . The two individual exponential functions are generated with two ROM's each. When the two exponential functions found in this way are combined, their bases, including the permanent high-order 1, are multiplied, and their exponents are added.

An exponential function of a constant other than ϵ can be obtained in the same way; it requires only that the read-only memories be programmed with the proper values. But if the base of the exponential function is itself a variable, a very simple process is available for calculating its value. The process is based on the equivalence

$$A^x = 2^{x(\log_2 A)}$$

This equivalence holds true, of course, for any logarithmic base, including ϵ and 10; but 2 is used because it permits multiplication by a power of two by merely shifting the binary point, analogous to multiplication by a power of 10 in decimal notation.

The process requires that six ROM's be used—one to provide $\log_2 A$, four to multiply this log by x , and one to provide one of two subdivisions of $x(\log_2 A)$. These two subdivisions, in general, can be an integer part N and a fraction part F . With these subdivisions, the above equivalence equation becomes

$$A^x = 2^{x(\log_2 A)} = 2^{(N + F)} = (2^N)(2^F)$$

In this product, the number 2^F can be obtained from

the sixth ROM, and the factor 2^N represents a shift of the binary point N places to the right.

For example, suppose $A = 7$ and $x = 3$. The value of $7^3 = 343$, but in terms of the equivalence, the steps are

$$7^3 = 2^{3(\log_2 7)} = 2^{3(2.807)} = 2^{8.421} = 2^8(2^{0.421})$$

These are expressed in decimal notation for clarity; but in practice, of course, they would be in binary. The factor $2^{0.421} = 2^{0.0110110} = 1.01010111$; the factor 2^8 calls for the binary point to shift 8 places to the right, giving 101010111, which is equivalent to 343 in decimal notation.

For extracting square roots or higher roots, these combinational techniques won't work; there is no easy way to subdivide a large number into two parts, find the square root of each part, and then recombine the results. There are two complicated ways to go about it; one based on the binomial theorem; the other based on the Taylor series. But both are of limited value in practical applications.

However, the reverse process of finding the square or other fixed power of a number is quite easy with the ROM technique. The squares of all eight-bit numbers contain a maximum of 16 bits, which can be stored in a ROM of 256 words by 16 bits, yielding a total bit count of 4,096.

The ease of the method points the way to an iterative search technique for calculating square roots by trial and correction. The iterative search for the eight bit root, R_8 , of a given 16-bit number, N_{16} , begins with using a trial root of $R_8 = 0$ as the address to the ROM storing all the squares. This trial root is then successively increased until the memory produces a number equal to or greater than the given number N_{16} ; that trial root is the true root.

This process is fastest, on the average, if the most significant bit of the trial root is changed first from 0 to 1. If the output of the memory then exceeds the given number N_{16} , the most significant bit returns to 0; otherwise, it remains at 1. The same procedure then is used with the other bits of R_8 . The circuits to control this sequence of trial roots and to compare the memory's successive outputs with the given number N_{16} can be made from standard IC flip-flops and comparators.

A rounding error often will occur if the ROM stores

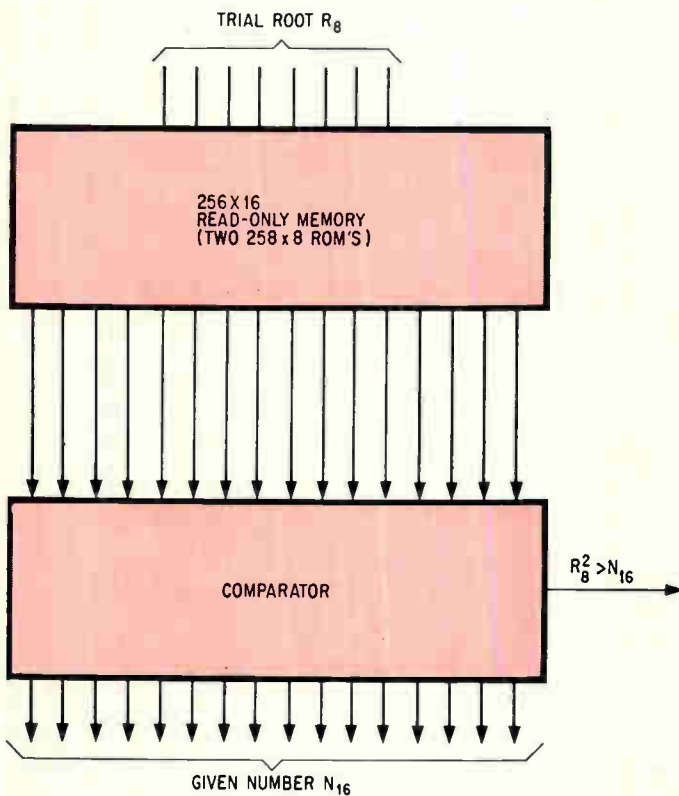

Extractor. This scheme for obtaining square roots depends primarily on squaring a series of trial roots using a small ROM until a number is found that comes sufficiently close to the original number.

the squares of the trial roots R_8 . Suppose, for example, the number whose root to be found is 280—in 16-position binary, this is 0000 0001 0001 1000. The successive eight-bit trial roots for this 16-bit number are 1000 0000; 0100 0000; 0010 0000; 0001 0000; 0001 1000; 0001 0100; 0001 0010; 0001 0001; in decimal they would be stated 128, 64, 32, 16, 24, 20, 18, 17. The squares of each of the first three trial roots are greater than 280; but the square of 16 is only 256. So the 1 is retained in the fourth position and 1's are tried in successively less significant positions until the last, corresponding to 17. This result is correct in this case, because the actual square root of 280 is 16.7332, correctly rounded off to 17. But if the number whose root was to be calculated were 270, the same successive trial roots would be used. The result, however, would be incorrectly rounded off because the actual square root of 270 is 16.4317. This should be rounded off to 16.

To avoid this rounding error, the ROM can be programmed to store $(R_8 - \frac{1}{2})^2$ instead of R_8^2 . These two numbers differ by $(R_8 - \frac{1}{4})$ but the former differs from $(R_8 - 1)^2$ by $(R_8 - \frac{3}{4})$. Thus the memory's output will always be closer to the true square of R_8 than to the square of $(R_8 - 1)$. Using the same method of successive approximations, with an $(R_8 - \frac{1}{2})^2$ ROM, as was described above for an R_8^2 ROM, $(280)^{\frac{1}{2}}$ will be found to be 17 and $(270)^{\frac{1}{2}}$ will be 16.

An alternative procedure that would work just as well would be to begin with the largest possible trial root, 111111, and change successive bits to 0 beginning at the most significant bit until the memory's output is less than the given number. With this alternative procedure, the memory should store $(R_8 + \frac{1}{2})^2$ to prevent the rounding error. ●

Bibliography

- Radiation Inc., Application Note, Integrated Diode Matrixes, February, 1967.
- John L. Nichols, "A logical next step for read-only memories," *Electronics*, June 12, 1967, p. 111.
- Floyd Kvamme, "Standard read-only memories simplify complex logic design," *Electronics*, Jan. 5, 1970, p. 88.
- National Semiconductor Corp., data sheets, MM521, MM522, MM523, and DM8200.
- National Semiconductor Corp., Application Note #12, Digital Comparator.
- Texas Instruments Inc., data sheets SN7401, SN7405, SN7474, and SN7483.

New MOS technique points way to junctionless devices

Semiconductor's substrate handles data for memory and display; simple device construction promises increased capacity, reduced size and eventual low cost, reports Electronics' *Laurence Altman*

● Increased circuit complexity and simplified fabrication techniques are the goals pursued by designers of integrated circuits. And in line with these goals, the design trend in recent years has been toward metal oxide semiconductor construction because it requires fewer fabrication steps and permits more elements on a chip than does bipolar technology. Now a new MOS class of devices, developed by Bell Laboratories in Murray Hill, N.J., offers even higher density than conventional MOS—up to 200,000 elements per square inch. Called charge-coupled devices (CCD), they are simpler to fabricate than conventional MOS; they do not require p- or n-type diffusions to process information since circuit functions are performed directly in the semiconductor itself.

CCD's can provide memory, logic, delay line, and imaging functions. The inventors, W.S. Boyle and G.E. Smith, say CCD technology is so new that it's difficult to predict its impact. But the device's higher bit density, more reliable operation, and potentially lower cost could change the face of MOS technology.

Stated most directly, the charge-coupled devices create and store minority carriers or their absence in potential wells—spacially defined regions where depletion is momentarily deepened—at the interface of a homogeneous semiconductor and oxide insulator. Once stored, the charges coupled to the potential well can be moved over the surface of the semiconductor simply by

moving the potential well. The process of injecting a charge into a semiconductor, transferring it via potential wells along the surface of the semiconductor, and then detecting it or its absence at some other location at some later time forms the basis of the circuit operations. And this entire operation could be done without windows in the semiconductor—no p-n junctions, no difficult diffusions, and fewer etchings. Any suitable semiconductor-insulator system will work.

The device operates as an array of MOS capacitors by passing an injected charge from one capacitor to another. A d-c biasing potential is applied to the metal electrode of the MOS capacitor, forming a uniform depletion layer at the semiconductor-insulator interface. A storage voltage greater than the bias voltage is then applied to the electrode of the capacitor to form a potential well at that location. When minority carriers or holes are introduced into the silicon substrate—say, from a light image incident on the bottom of the substrate—these holes will collect in this potential well at the semiconductor surface. This charge may be transferred to an adjacent capacitor by applying a transfer voltage such that a still deeper potential well is formed at that location. After the transfer, the voltage on the first capacitor is returned to the d-c biasing potential and the voltage on the second reduced to the storage voltage. This process can now be repeated to move

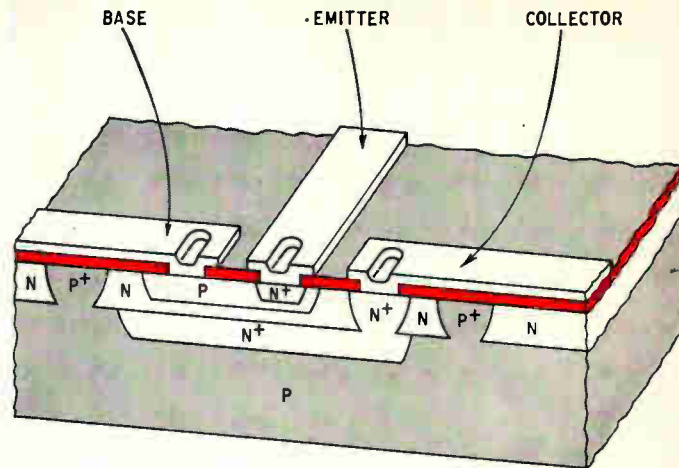

BIPOLAR ELEMENT

the charge over the surface of the device.

Detection can be accomplished without junctions in a number of ways, for example, by sensing the capacitance change due to the presence or absence of charge.

Moving carriers on the surface of a semiconductor leads immediately to shift register applications. Since the time for transfer of charge is less than a microsecond, shift registers at better than megahertz rates are possible. In addition, storage is possible because once a potential well is formed there is a fairly long time constant (in seconds) before it fills up with minority carriers that are thermally generated in the semiconductor substrate.

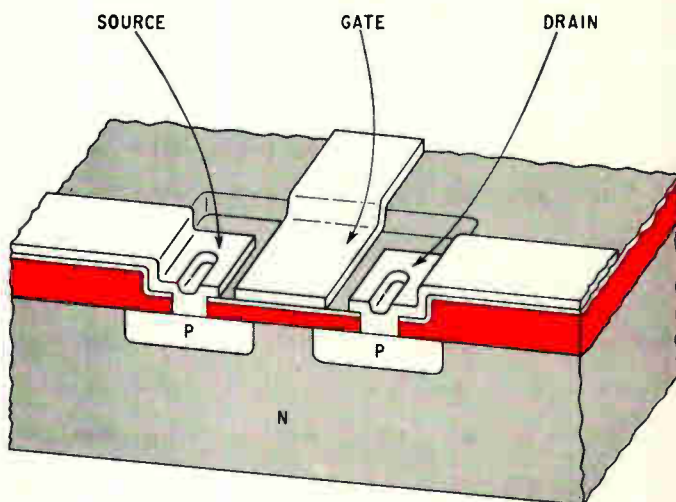

MOS ELEMENT

Imaging devices can be made by depositing a two-dimensional array of electrodes on the oxide insulator. Under suitable voltages this array forms a corresponding array of potential wells. When an image is projected on the underside of the semiconductor—the target area—the holes created by the light will diffuse toward the electrode side of the device. There, they can be stored in the potential wells created by the negatively charged electrodes. The image can then be read out by the shift-register action. This aspect of the technology is currently being pursued by a group of Bell Laboratory scientists including G. F. Amelio and M. F. Tompset who are actively exploring the potential of CCD devices for video applications.

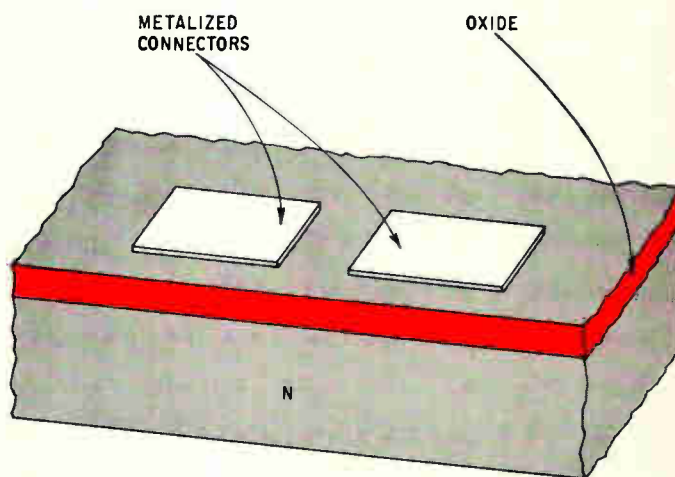

CCD ELEMENT

It's simple. Devices should be cheaper with CCD construction. A bipolar transistor requires about 16 diffusions, photoetchings and oxidations. MOS elements provide some simplification, requiring about eight steps. CCD's on the other hand should need less processing than standard MOS.

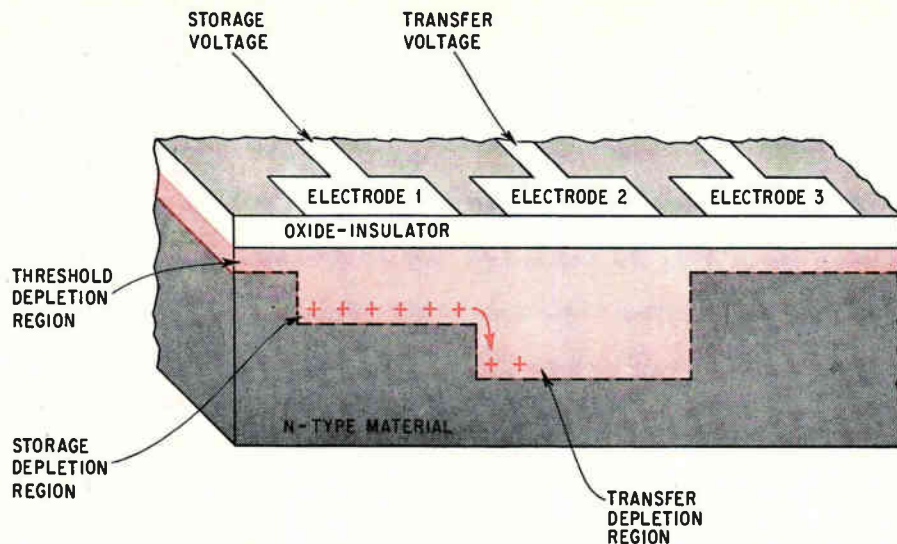

Essentially a three-layered structure, CCD construction, based on standard MOS techniques, is remarkably simple. Oxidizing the surface of a semiconductor wafer forms a thin insulator, on which is deposited a metal pattern of conductors and electrodes. A thicker oxide layer may be required under the conductor to prevent depletion layers from forming under the beam lead connections running to the electrode pattern.

Compare this to standard bipolar and MOS technology. A bipolar transistor circuit used in a shift register needs about 16 fabricating steps, including several critical p- and n-type diffusions. An insulated-gate field effect transistor (IG FET) for the same memory, constructed by MOS techniques, takes at least eight processing steps, two of which are critical impurity diffusions. And this is in addition to source, gate and drain contacts. Thus, by comparison with the steps required for bipolar and conventional MOS devices, the simple CCD structure could reduce fabrication by a factor of 2 and 4 respectively, leading to lower fabrication cost per unit area.

But lower construction costs are not the whole story—with CCD's there's a dramatic reduction in size compared to transistor shift registers. This leads to a significant increase in information handling capability (bit density) for a given chip size. A typical IG FET dynamic shift register requires 20 square mils per bit—six FET's are generally needed to process one bit of information. In comparison, using the same photolithographic specifications, the new CCD's could require as little as 2.5 square mils of substrate real estate to process one bit. This factor of almost 10 will show up as a considerable cost saving if CCD's are used in place of FET's.

Alternately, a given chip can process ten times the information using CCD methods. When one realizes that on a one-square-inch chip of silicon at least 200,000 bits of information can be handled, with room left over for associated circuitry, the potential of this new technology becomes apparent just for memory applications alone.

But the ramifications of this new MOS technique go deeper than the immediate advantages of size, cost, and capacity. There also is a great advantage in the flexibility of material that could be used. Up to now,

many materials other than silicon that exhibit special desirable properties have been largely ignored because p- or n-type diffusions were difficult with them. Now these materials could be considered in charge-coupled devices. Materials with high bandgap energies and high mobility, and which are compatible with other insulating layers, could be utilized for their special properties. Thus far only silicon has been tried by Bell in their experimental devices. But if, for example, a longer storage time were desirable, a larger bandgap material could be used in order to reduce the thermally generated currents which flow into the depletion region.

Bell's early work with their CCD's—n-type silicon-silicon dioxide structures—uses typical MOS device parameters. The oxide thickness was 1200 Angstroms and the substrate had a resistivity of 10 ohms-centimeters. With CCD's, efficient transportation of charge along the oxide-silicon interface requires an interface free of defects to avoid undesirable surface states. But these interface criteria are roughly the same as those required by IG FET's and thus are reasonably well characterized.

The operation of the device can be illustrated by considering just two electrodes on the oxide. A negative bias voltage applied across the n-type substrate must be greater than the threshold voltage required to form a uniform depletion region at the substrate-insulator

The movement. Charges are moved between electrodes 1 and 2 by applying a transfer voltage larger than the storage voltage to the receiving electrode. Both storage and transfer voltages must be larger than the threshold voltage necessary to cause depletion.

Good display. A two-dimensional array of electrodes on a CCD structure forms a configuration suitable for imaging. In the storage mode, the quantity of charge accumulating at each storage electrode (shown in varying shades of tint) corresponds to the intensity of the image incident on the substrate. The storage voltage, V_s , greater than bias voltage, V_b , forms the potential wells that trap the charge. In the transfer mode, a transfer voltage, V_t greater than V_s shifts the charge one space, resulting in a pulse at the output whose amplitude corresponds to the quantity of the charge. Hence, the output is a series of pulses whose envelope is the video analog of the image.

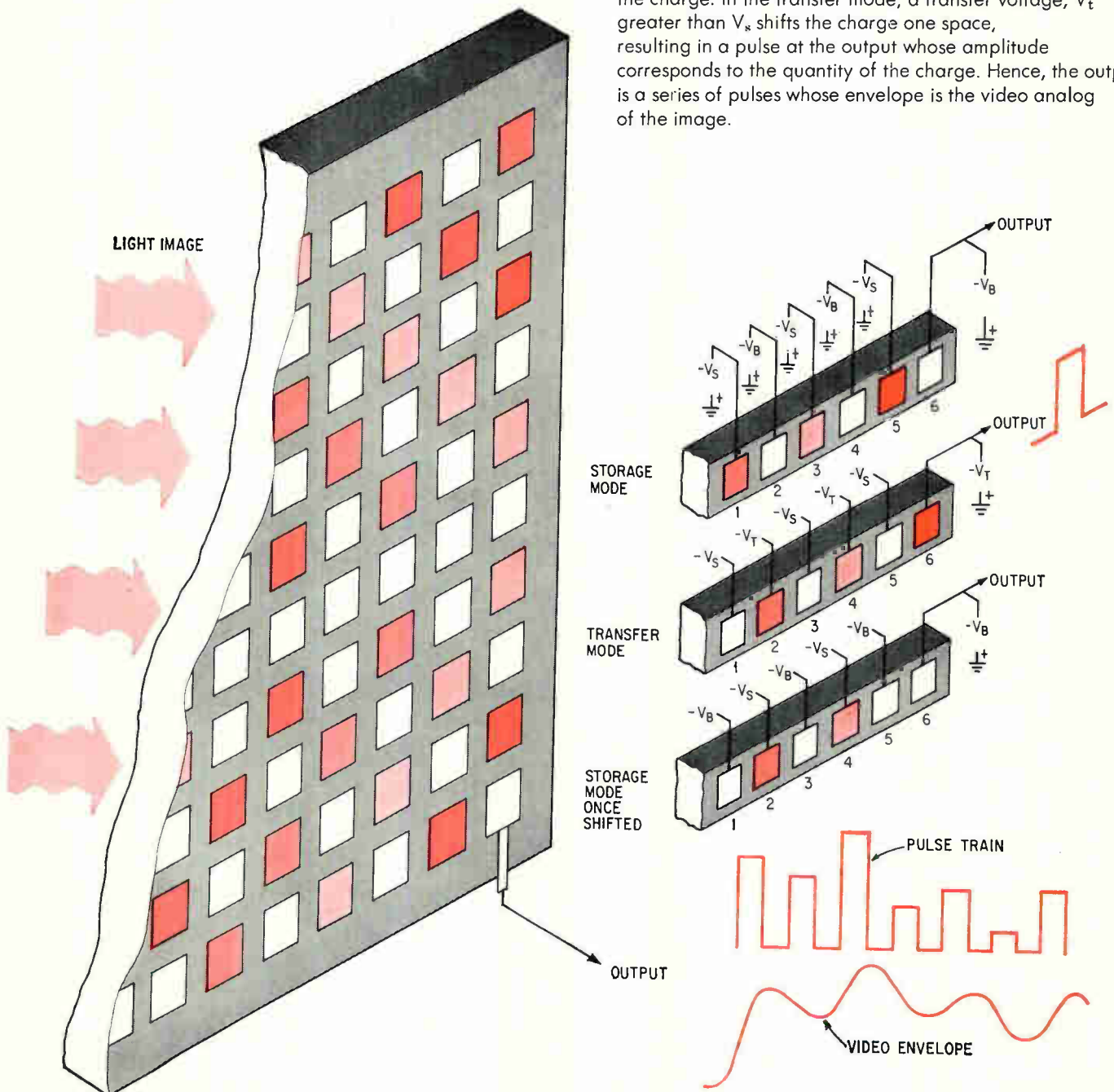

Phase three. Storage conditions are set up (top) by applying a storage voltage, $-V_2$ to every fourth of a series of electrodes. The potential wells that form at these points hold the charge. The charge or its absence is transferred to adjacent electrodes (middle) by applying a transfer voltage, V_3 , to those electrodes. With the charges transferred, (bottom) initial conditions are once again restored.

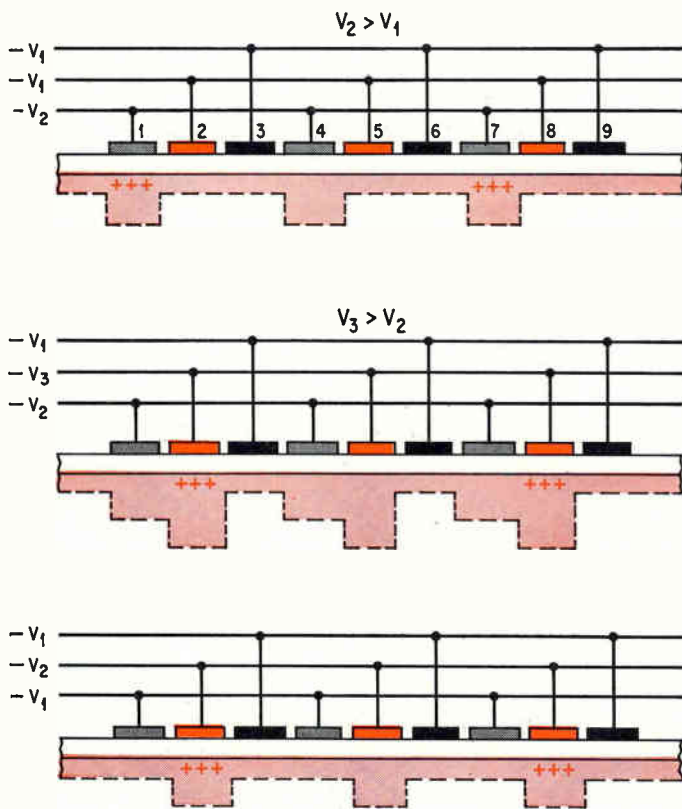

interface. Applying a more negative voltage (storage voltage) to electrode 1 creates a still larger negative region in the substrate directly under that electrode. This deeper depletion region at that point spatially defines the potential well. This is the storage mode of the device; it can now receive and store charges (minority carriers) created in the semiconductor from a suitable source. Since minority carriers in n-type silicon are holes—which are positively charged—and since the electrode is negative with respect to the substrate, these positively-charged holes are attracted towards the negative electrode and held in the potential well under that electrode.

The transfer mode—the next operation—creates a condition that moves the charge to the second adjacent electrode. This movement is accomplished by applying a still more negative voltage (the transfer voltage) to electrode 2, digging a still deeper potential well under that electrode. Now the holes being stored under electrode 1, attracted to the deeper well, transfer to the new electrode.

Initial storage conditions are regained by removing the storage voltage on electrode 1 and reducing the transfer voltage on electrode 2 to the storage voltage. Once the charges are stored under electrode 2, the transfer process can be repeated on another adjacent electrode until the charges are moved across the substrate. Thus, with just two voltages, charges can be transferred from point to point across the device.

In actual transfer operation, voltages would be applied to an equally spaced array of conductors. To minimize connections, every third electrode is connected to a common conductor as shown in the composite figure on the left. Initially, a storage voltage, $-V_2$, is applied to one series of electrodes, say 1, 4, 7, etc., (top), and a smaller bias voltage, $-V_1$, is applied to the other electrodes. The only restriction here is that all applied voltages be greater than the threshold voltage required for depletion.

The voltage $-V_2$ forms potential wells under electrodes 1, 4, 7, etc. Thus charges injected into the semiconductor are attracted to those regions. Consider that the injection is accomplished in such a manner that charges are placed under electrodes 1 and 7 and none under electrode 4.

In the next stage of operation a transfer voltage, $-V_3$ ($V_3 > V_2$) is applied to the next series of electrodes 2, 5, 8, etc., (middle). Because the potential wells will be greater under those electrodes, charges under electrodes 1 and 7 and the absence of charge under electrode 4 will shift one place. Then initial storage conditions are re-established (bottom) by reducing $-V_3$ to the storage potential $-V_2$, and by reducing the voltage on the other electrodes to $-V_1$. In this manner charges or their absence can be transferred along the device and circuit functions performed.

In any operational sequence the transfer voltages must be applied and manipulated in a time shorter than the storage time of a potential well. After that time minority carriers thermally generated in the semiconductor will begin to move into the wells. This storage time is approximately the ratio of charge, Q , to the thermally generated current, I_d , required to supply the equilibrium charge density Q , or $t_0 = Q/I_d$. The thermal current, which results from generation-recombination

centers in the depletion region at the semiconductor-insulator interface, is small enough in most semiconductors so that t_0 is large and no time restriction results in practice. In fact, storage times in the order of seconds can be achieved, whereas transfer-voltage clock rates are in megahertz for typical applications.

After transfer, detection of the charge or its absence must be made. Two methods are available: change of capacitance as a function of stored charge, and change of electrode-surface potential with charge.

In the devices built and tested by Bell, both detection methods—capacitance and potential—offered equally attractive results. As detailed in two papers appearing in the April, 1970 Bell System Technical Journal, these parameters, as well as depletion-layer changes, were measured as a function of the fraction of charge transferred to the total charge available. For 100% transfer, the capacitance changed at each electrode by a factor of approximately 3, the potential by a factor of 8, and the depletion depth by a factor of 5. Since these quantities are strong functions of charge transfer, the most convenient one could be used. In these tests, transfer voltages (gate voltages) of approximately 10 volts were used, a level readily attainable from silicon technology.

A knowledge of the surface potential is also required to design a structure that insures complete transfer of charge, since as charge flow from one electrode to another, the potential drops on the receiving electrode and rises on the other. To insure that charge will not flow back, the applied voltages on any two adjacent electrodes must therefore be chosen so that the potential of the one giving up the charge must always be lower than the electrode receiving the charge.

But regardless of the method used to detect the charge at each electrode, two interrelated quantities—the transfer time and transfer efficiency—are crucial in the operation of the device. The transfer time is the time for charge to make the trip between adjacent electrodes, while the efficiency is the fraction of charge transferred. In Bell's tests the charge-transfer efficiency has been found to be as high as 98%, and this quantity is the only limit on the number of transfers before the train of pulses must be regenerated.

This small amount of residual charge will add to subsequent signals and hence degrade the output. The charge is left behind because of trapping surface states whose time constant (time to empty) is comparable to the clock period (time to transfer). At present the entire subject of surface states and its affect on charge transfer are not well understood and must await future exploration. In any case the high efficiency of charge transfer in CCD's minimizes the problem of residual charge.

The circulation of charges between electrodes in an array forms the basis of all applications. A shift register can readily be constructed with the addition of a charge generator at the input and a detector at the output. Several methods of generation are possible: forward biased p-type diffusion in the n-silicon, surface avalanching in an MOS structure, or radiation-induced electron-hole pair creation are examples. Detection circuits could use a reverse biased p-n junction or Schottky barrier diodes.

The CCD shift registers can be used in any application where the conventional MOS shift register is now used—in computers, as logic and memory circuits, as

Testing. Bell evaluated CCD's by using an avalanche pulsing capacitor, P_0 , which supplies holes to the other electrode capacitors along the line. As each MOS unit capacitor is pulsed by the supply generators, a charging and discharging spike is observed at the oscilloscope, which is proportional to the charge flow.

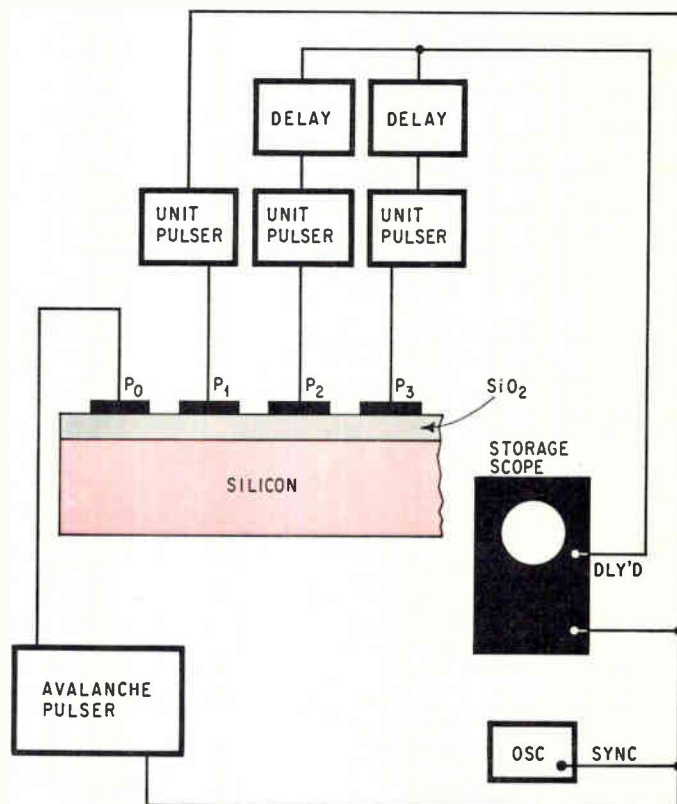

Major shifts. Bell's experimental 24-electrode, 8-bit dynamic shift register, using a new simplified MOS charge-coupled technology, forms the basis of all applications. It can be used to construct a recirculating memory or a variable delay line. When its electrodes are arranged in a two-dimensional array, it can perform image and display functions, thus promising video applications.

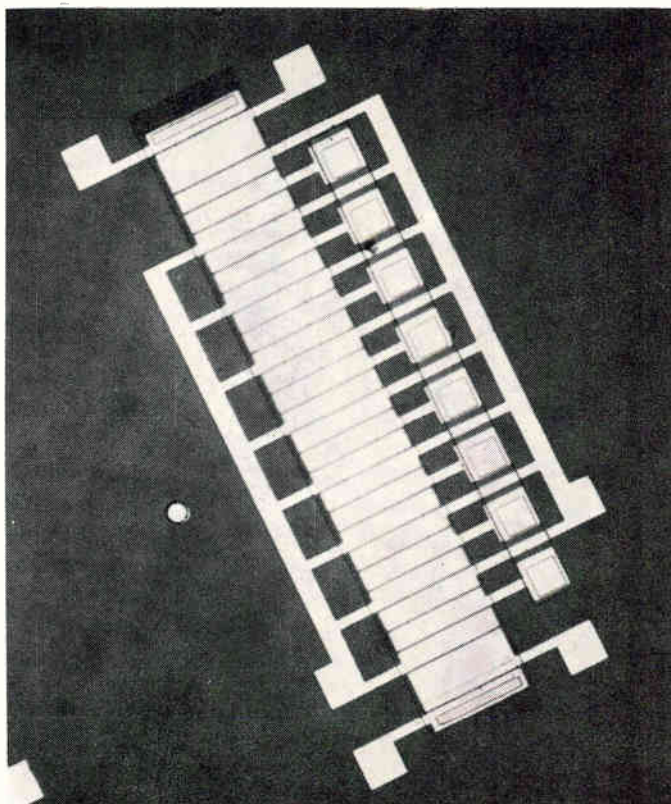

switching and holding circuits in high-capacity communication systems, as gates for relays in any number of applications. But CCD's are far more versatile than conventional MOS shift registers. Not only is a factor of ten size reduction available, or a factor of ten increase in bit density, but the output signal—a series of pulses whose separation in time corresponds to the spatial separation of the storage electrodes in the array—can readily be put back into the device and recirculated. This storage facility allows the same pulse train to be further manipulated at a later time. For example, it can be compared with another train of pulses for coding, or for delay gate circuits.

This manipulation and recirculation also provides the essential elements of a digital delay line, where total delay times up to the storage-time constant (in seconds) are available. Moreover, the delay time is variable; by changing the clock rate on the transfer voltages, charge can be transferred between electrodes at a higher or lower rate. Thus, one device only fractions of an inch in area could produce variable delay times from microseconds up to hundreds of milliseconds or longer simply by changing the clock frequency. This variable delay-line capability could make the new CCD a strong competitor to the recently developed but more complex acoustic surface-wave technology.

However, depending on the transfer efficiency, there is an upper limit on the length of the line before regeneration is required. But once regenerated, the signal is available to drive another circuit, or it can be recirculated to another line on the same chip, or recirculated and stored in the same line to be used later. This forms the building block from which arbitrarily large shift registers can be made.

Besides shift register devices, Bell is very interested in developing charge-coupled image and display devices. This is particularly attractive to Bell for possible application in Picturephone since the CCD could have strong advantages in size, cost and reliability over silicon-target image tubes.

In CCD's, imaging is accomplished by placing voltages of equal magnitude on all storage electrodes in a two dimensional array. The underside of the silicon serves as the target area. When an image is focused on this surface, light is absorbed in the n-type silicon, creating electron-hole pairs, the number of which depends upon the intensity of the light at that point. Since the holes will be attracted to the nearest potential well, the charge accumulating under each electrode is proportional to the intensity of light falling on the underside of the silicon at that point. This is the storage mode of the image device.

Transfer is made in the normal way, by changing voltages on adjacent electrodes until all the charges are shifted off the silicon substrate. The signal detected at the end of the line is a pulse train whose individual pulse amplitudes are the analog of the light intensity. The time between the pulses corresponds to the electrode configuration on the substrate surface. Thus a monitor synched to this signal will reproduce the image on a time scale. Furthermore, the envelope of the pulse train, which represents the image intensity, is the video response of the signal. And most important, the storage time is much larger than the video frame time, thus making the device feasible. ●

start with this .01% DC DVM



Model 3600

The New Ballantine Model 3600 DC Digital Voltmeter is packed full of the features that only the oldest, most respected leader in voltage measuring techniques could offer.

- High Accuracy . . . $\pm .01$ of indication, $\pm .01$ full scale, ± 1 digit
 - Options like remote programming, BCD Outputs, Internal Calibration Voltage
 - 100% overrange capability
 - $4\frac{1}{2}$ digit display, 100 microvolt resolution
 - Dual slope integration measurement technique
 - Modular interface capability
- Price \$695

add this 10 MHz AC Converter with 10 mV Full Scale Sensitivity



Model 3571

Enjoy the full measure of a DVM system that will satisfy your most demanding AC and DC needs. The Model 3571 AC Converter Module is packed with performance features like:

- Highest Operational Bandwidth currently available in any AC DVM . . . 30 Hz to 10 MHz
- High Input Impedance . . . 10 Megohms on all ranges
- 10 millivolt full scale sensitivity, 1 microvolt resolution
- All front panel controls remotely programmable

Now it's a Ballantine DVM System



Model
3600/3571

Quality and solidly engineered user benefits make the Model 3600/3571 DVM System a new concept in voltage measurement . . . the solution to all your voltage measuring tasks. Your Ballantine DVM can never be obsolete because additional Converter Modules are easily added to make this one of the most advanced voltage measuring systems available.

Write for your copy of our new catalog sheet on the Model 3600/3571 —
The Singer Company, Instrumentation Division, Boonton, New Jersey 07005 or your nearest Field Sales Representative. *In Europe contact:* Singer Sewing Machine Company, Instrumentation Division, P.O. Box 301, 8034 Zurich, Switzerland. Tel: (051) 47 25 10

SINGER

INSTRUMENTATION

How AO fiber optic light guides solve illumination problems.

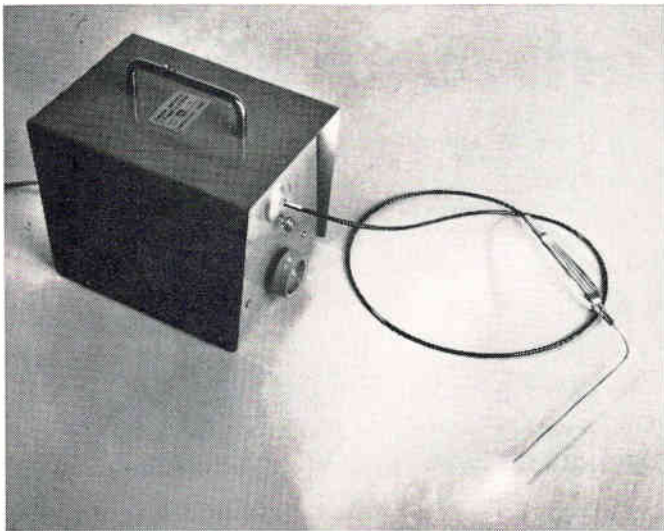

Transmit "cold" light like other forms of energy—by flexible routing to remote or inaccessible locations, hazardous areas, or any abnormal environment.

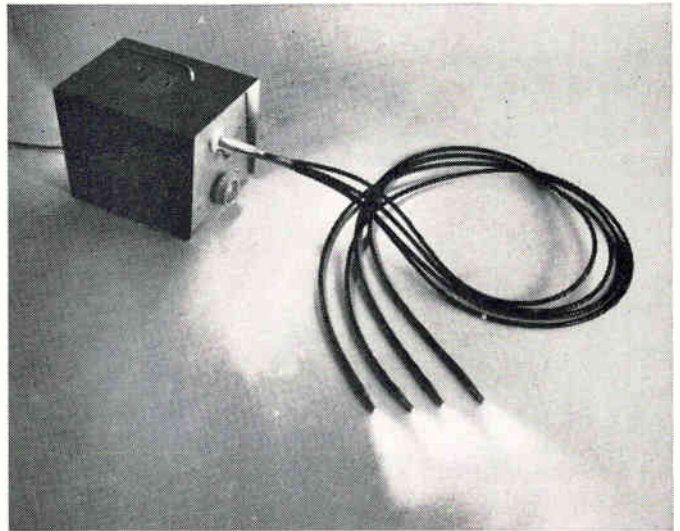

Supply multiple illumination from a single light source, with multi-branched light guides.

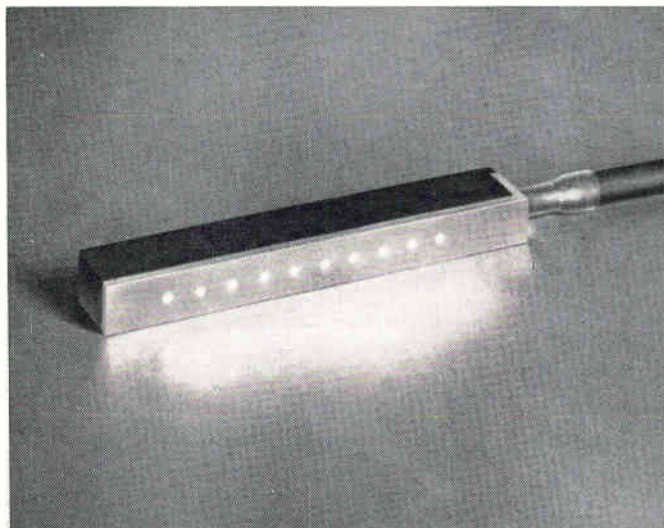

Simplify lighting problems by eliminating lens systems, multiple lamps, complex electrical circuitry.



Provide input-output geometry conversions such as round-to-square, round-to-slit, etc.

These are only a few of the ways in which American Optical fiber optic light guides are used to help solve illumination problems. Specific applications range from mark sense readout to electro-optical sensing in data processing, circuit verification, fire control, null detection, light pens, spot illumination, and many others.

Simple, reliable, economical. AO fiber optic light guides are simple, passive elements which remain extremely reliable under normal vibration, temperature or humidity changes, or other environmental fluctuations. This results in long service life with minimum maintenance.

Standard and custom light guides from American Optical have light transmission ranges from 400 to 1500 millimicrons. Standard light guides are

available in bundle sizes from .020" to 1/4", with 30 to 6000 fibers, lengths up to 72", plastic or stainless steel tips, and PVC sheaths. Custom light guides can be supplied in any length desired, with special end tips, sheaths, diameters, input-output face configurations, and branchings.

A leader in optics since 1833, American Optical Corporation brings a great breadth of related experience to the technology of fiber optics. Our versatility in fiber optics is unmatched by any other manufacturer. In fact, AO scientists already hold more than 200 important patents or patents pending in this relatively new field.

For Fiber Optics Data Kit, write to:

 **AMERICAN OPTICAL CORPORATION**

FIBER OPTICS • SOUTHBRIDGE, MASSACHUSETTS 01550

©TM Registered by American Optical Corporation

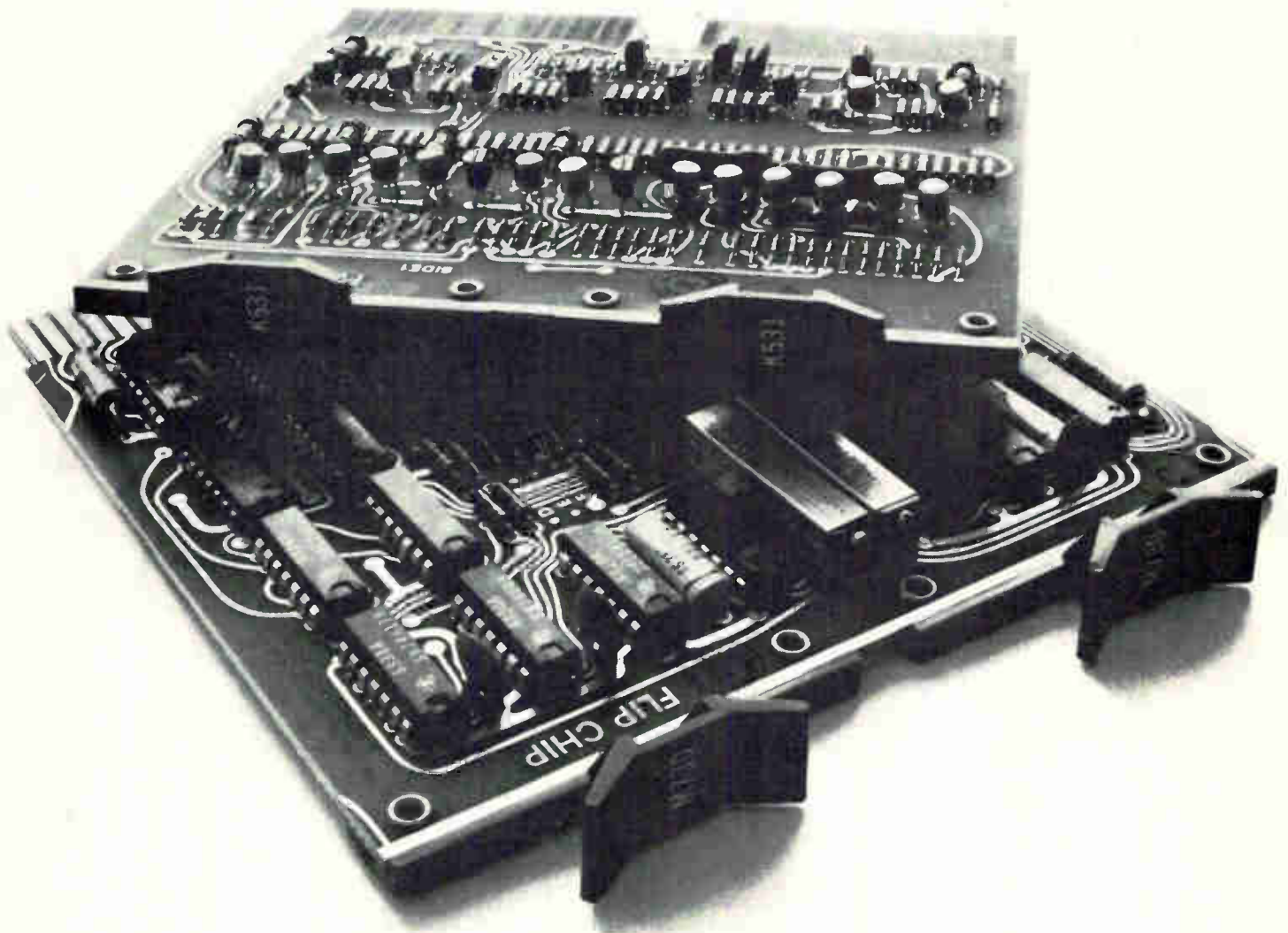

The tortoise and the hare

Sometimes, you want all the speed you can get. Interfacing a computer, for instance. Or building an instrument that measures, or tracks, or controls events that require that speed. Digital offers a full line of hare modules... M-series, that fly at 10 MHz.

But sometimes, you want something a lot slower. For general laboratory control, or to replace old-fashioned relays, or to control a machine. Designing them slow means that you can also design them immune from electrical noise. Digital has a full line of tortoise modules as well... K-series, that crawl at 100 KHz.

Each series is physically, electrically, and logically compatible. 100 modules in M-series. 70 modules in K-series. Each comes with a full line of hardware, power supplies, plug-in boards, cabinets, racks, and so forth. Each comes with Digital's guarantee. Each comes with the

knowledge that Digital uses them in their own computers and controllers.

Two free books describe them completely—module by module and function by function. Write.

DIGITAL EQUIPMENT CORPORATION, Maynard, Massachusetts, Telephone: (617) 897-5111 / ALABAMA, Huntsville / CALIFORNIA, Anaheim, Los Angeles, and Palo Alto / COLORADO, Denver / CONNECTICUT, New Haven / DISTRICT OF COLUMBIA, Washington (College Park, Md.) / FLORIDA, Cocoa / GEORGIA, Atlanta / ILLINOIS, Chicago / MASSACHUSETTS, Cambridge and Maynard / MICHIGAN, Ann Arbor / MINNESOTA, Minneapolis / MISSOURI, St. Louis / NEW JERSEY, Parsippany and Princeton / NEW MEXICO, Albuquerque / NEW YORK, Centereach (L.I.), New York City, and Rochester / NORTH CAROLINA, Chapel Hill / OHIO, Cleveland and Dayton / PENNSYLVANIA, Philadelphia and Pittsburgh / TENNESSEE, Knoxville / TEXAS, Dallas and Houston / UTAH, Salt Lake City / WASHINGTON, Seattle / AUSTRALIA, Brisbane, Melbourne, Perth, and Sydney / CANADA, Edmonton, Alberta, Carleton Place, Ottawa, Toronto, Ontario, and Montreal, Quebec / ENGLAND, London, Manchester, and Reading / FRANCE, Paris / GERMANY, Cologne and Munich / HOLLAND, The Hague / ITALY, Milan / JAPAN, Tokyo / SWEDEN, Stockholm / SWITZERLAND, Geneva.



digital
MODULES · COMPUTERS

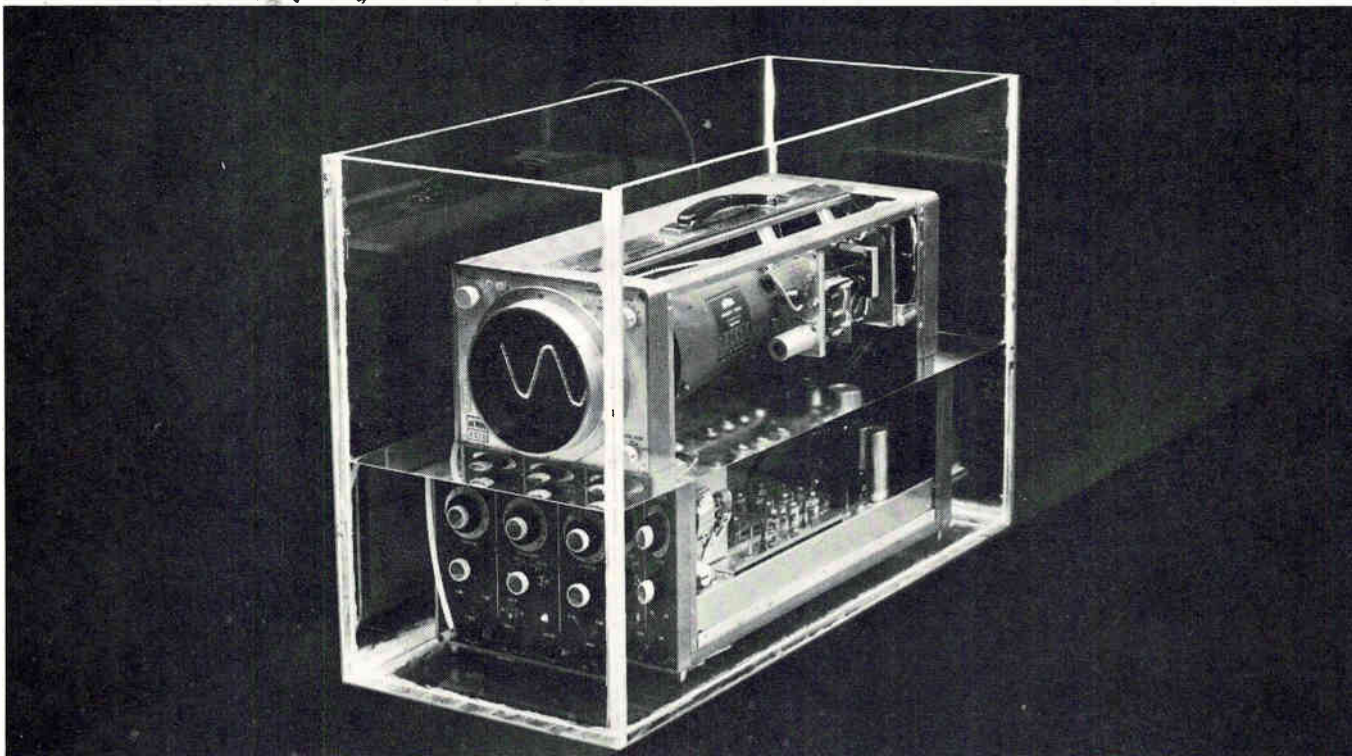

This oscilloscope is alive and well in a bath of FREON® TF cleaning agent.

That's compatibility.

If this FREON fluorocarbon cleaning agent won't damage the wide variety of materials used in a sensitive oscilloscope, that's compatibility. In fact, FREON cleaning agents are compatible with most materials of construction used in the electronics and aerospace industries.

If your product has to be cleaned thoroughly, safely and efficiently, there are five more reasons why you should be using FREON solvents:

1. Low Boiling Point (under 120°F). Ideal for low-

temperature vapor degreasing. Cooling time eliminated. No damage to heat-sensitive parts. Low heat passage to work environment.

2. Complete Wetting and Penetration. High density combined with low surface tension lifts soils and floats away trapped contaminants.

3. Chemically Pure and Stable. No need for acid acceptance and scratch tests. No inhibitors needed. Parts dry residue-free.

4. Lower Overall Cleaning Costs. FREON is recoverable for reuse indefinitely. Power requirements low in vapor degreasing. Fewer production rejects. Save labor by cleaning complete assembly instead of separate parts.

5. Safe. Nonflammable, non-explosive, low in toxicity.

If you have a cleaning problem or are looking for an improved cleaning system, write today to Du Pont Company, Room 8826, Wilmington, Delaware 19898.



FREON
Cleaning Agents

Multiple choice MOS in one pass.

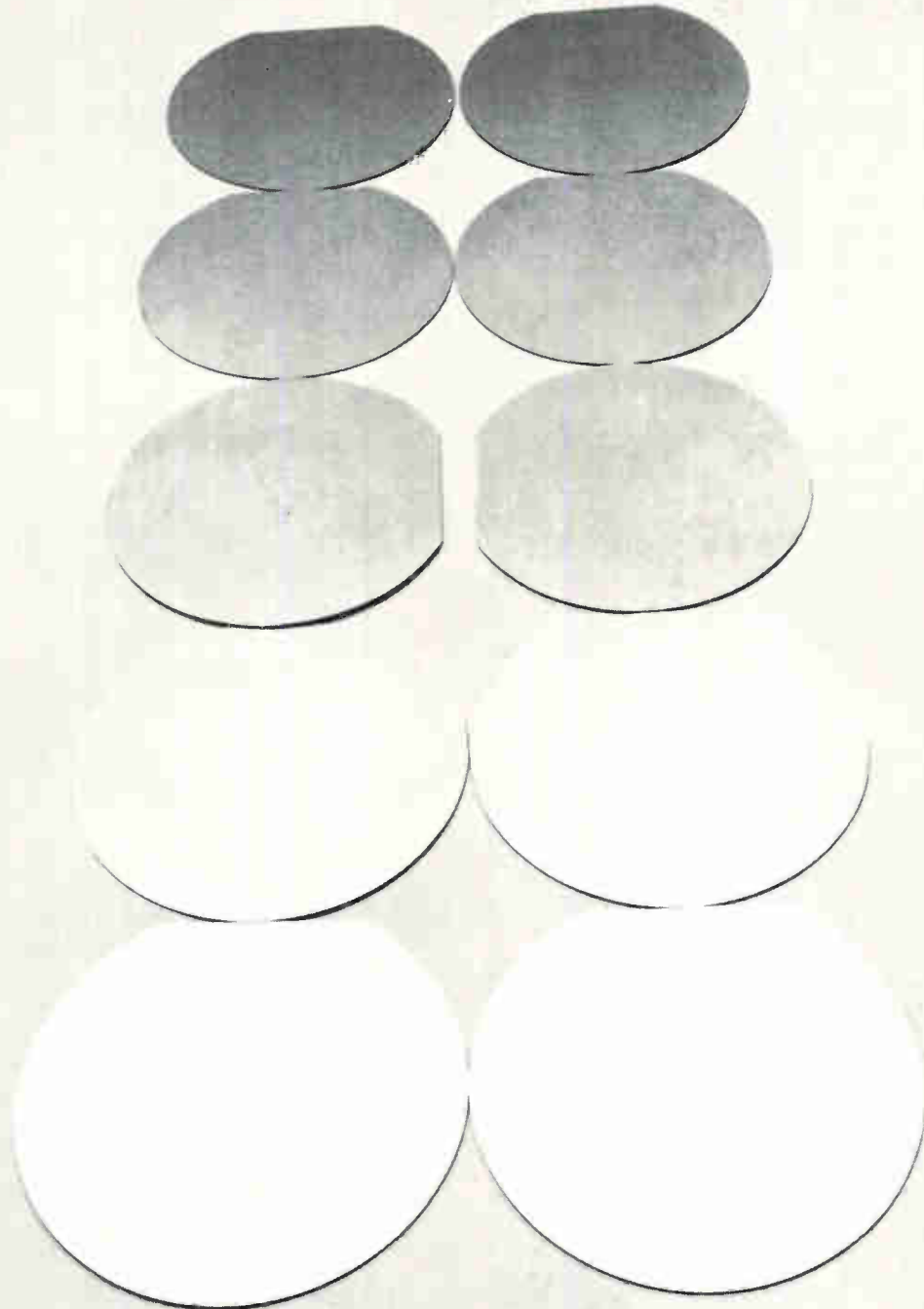

Deposit any sequence of silicon dioxide, silicon nitride and polycrystalline silicon. Without wafer handling. Without removal from the reactor chamber.

Layer these films in any combination. Build the most advanced MOS circuits, even silicon gate technologies. With the AMN-700 series of vapor deposition systems. The first non-RF powered, high-temperature, cold wall reactors for the deposition of dielectric films.

The AMN-700 can handle up to twenty 2" wafers per station, producing films of unparalleled uniformity. Typical thickness variation is less than $\pm 5\%$ wafer-to-wafer within a run. Typical properties of Si_3N_4 films deposited in the AMN series are: etch rate (HF) 4-6 $\text{\AA}/\text{sec}$; deposition rate 100-500 $\text{\AA}/\text{minute}$; refractive index 2.0. Operating

temperatures range from 650° to 900°C.

There is no RFI noise. That makes the AMN-700s completely compatible with diffusion processing and testing operations. Call collect for immediate requirements.

Applied Materials Technology, Inc., 2999 San Ysidro Way, Santa Clara, California 95051, (408) 738-0600 Telex: 34-6332 • 63 Route 206, Somerville, N. J. 08876, (201) 722-3300 Telex: 83-3439 • In Europe: Advanced Semi-

conductor Materials, Wokingham, U. K. Bilthoven, Netherlands; München, West Germany. In Japan: Kanematsu-Gosho, Tokyo.



applied materials

NOW... A NEW AND EXPANDED MANUFACTURING SYSTEM FOR HIGH TECHNOLOGY INDUSTRIES

...by Hamilton Precision Metals

• COMPUTER • INSTRUMENT • TELECOMMUNICATION • BUSINESS MACHINE

The Precision Metals Division of Hamilton Watch Company is now geared to meet the requirements of computer, instruments, telecommunication and business machine manufacturers—as well as other high technology industries—with high-quality precision strip, foil and wire processing, precision Photoforming® and parts assembly.

Hamilton's metals technology includes precision rolling of ultrathin strip and foil and wire drawing in pure metals, commercial alloys and proprietary metals with highly specialized properties. This facility also includes heat-treating and annealing to provide the physical or magnetic properties required.

Photoformed parts are produced from the precision-rolled strip and foil in high volume, meeting the most rigid shape and dimensional specifications. Parts are manufactured by modern, high-production equipment in the most advanced chemical etching facility featuring "ultraclean" production conditions.

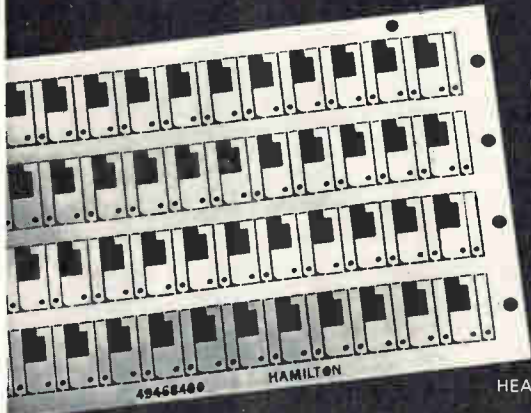
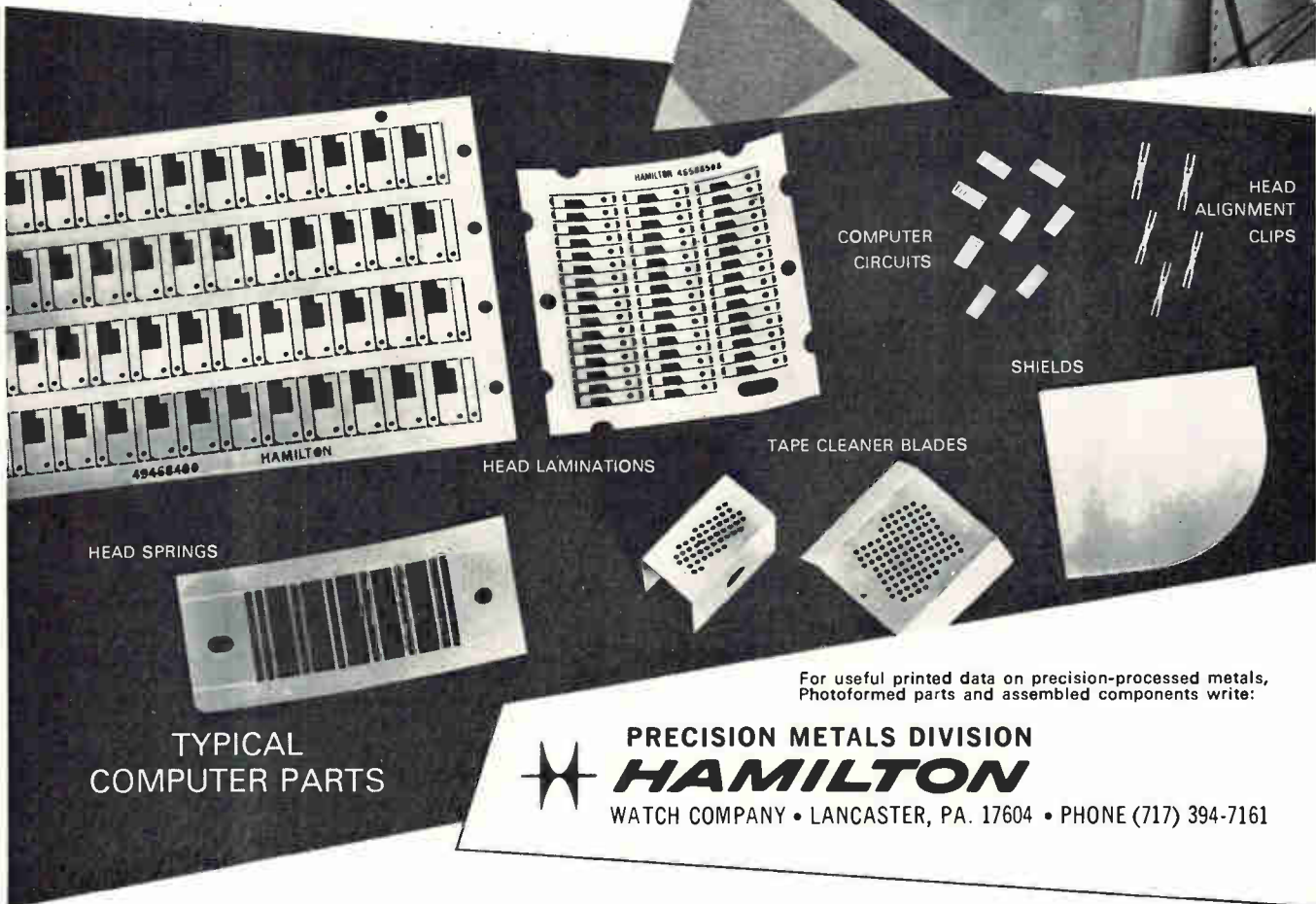
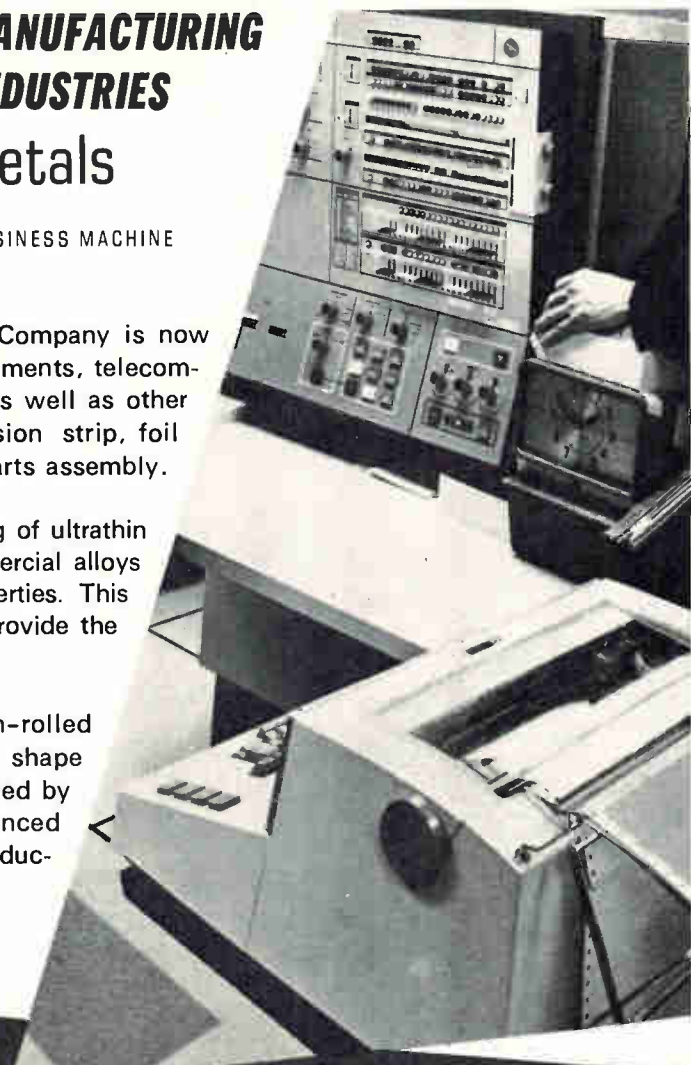

HEAD SPRINGS

TYPICAL COMPUTER PARTS

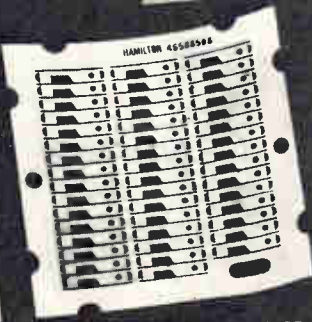

HEAD LAMINATIONS

COMPUTER CIRCUITS

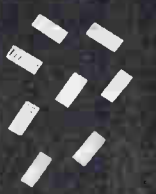

SHIELDS

HEAD ALIGNMENT CLIPS

TAPE CLEANER BLADES

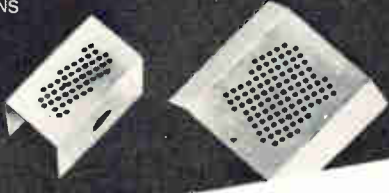

For useful printed data on precision-processed metals, Photoformed parts and assembled components write:



PRECISION METALS DIVISION
HAMILTON

WATCH COMPANY • LANCASTER, PA. 17604 • PHONE (717) 394-7161

Look who has the popular new size at a popular price.

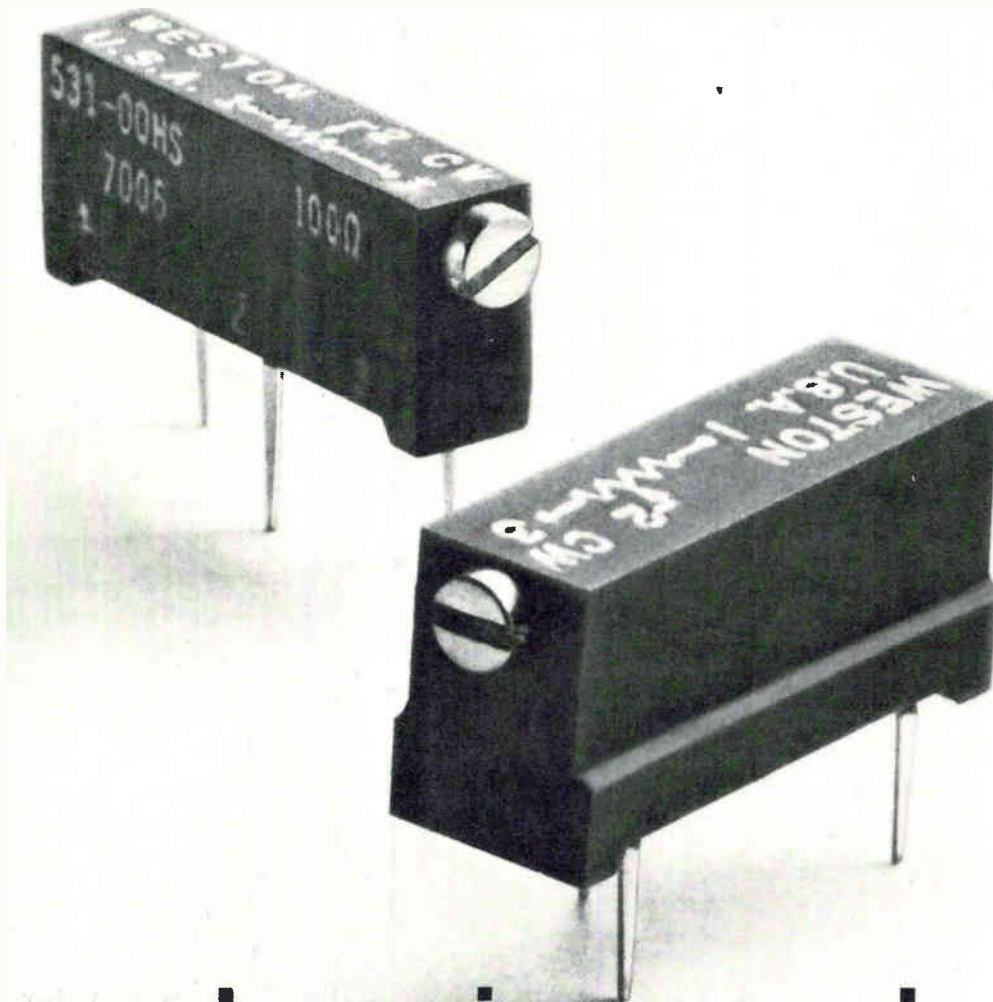

Cermet or wirewound.

Now it's no longer necessary to settle for less than the best.

These popular new Weston $\frac{3}{4}$ " rectangular series 530-533 combine the famous features of our Squaretrim® potentiometer line—high quality, wide temperature range, precision tolerance, low noise, 15 turn adjustability with slip clutch protection—in a case size that's rapidly becoming industry's number one choice. In addition to standard models,

sealed equivalents are available for protection against water, cleaning solvents, flux and encapsulating compounds. Units are priced as low as \$1.30*.

Cermet series 532 and 533 come in standard resistance values to one megohm. Those who prefer wirewounds may order series 530 and 531 in standard values from 10 ohms to 35K. Both cermet and wirewound models are available with tab mounting

centers of either .10" or .20".

However you choose, you're clearly a winner with Weston's 530-533 rectangular trimmers. Write or phone today for sample units and complete data.

WESTON COMPONENTS
DIVISION, Archbald, Pennsylvania
18403, Weston Instruments, Inc.

a Schlumberger Company

WESTON®

*100 quantity unit price for standard models.
100 quantity unit price for sealed models is \$1.63.

Tektronix *expands* . . .

. the valued plug-in concept

The New Tektronix 7000-Series Oscilloscope System does more of what a plug-in oscilloscope is intended to do. With four plug-in flexibility, and new operator convenience, you make more measurements with fewer errors and less effort.

Tektronix single and dual plug-in oscilloscopes proved the value of the modular approach to solving measurement problems. Now the added ability to *simultaneously* use multiple plug-ins—with similar or widely different features—makes the plug-in concept even more valuable. Tektronix 7000-Series Oscilloscopes offer bandwidths up to 150 MHz, four plug-in flexibility, and mainframe versatility, to display more measurement data in a single setup than any other oscilloscope system. Multiple plug-ins minimize the loss of valuable time and the inconvenience caused by having to repeatedly interchange plug-ins to solve a measurement problem. If you wish, start with only one horizontal and one vertical plug-in and add more as your measurement requirements change.

Some features which widen the performance spectrum of today's plug-ins are: dual trace, 105 MHz at 5 mV/div (four trace, 105 MHz with two units) • differential, 100,000:1 CMRR at 10 μ V/div • differential comparator, 100 MHz at 1 mV/div and DC offset accurate to 0.1% • random or sequential sampling, 25 ps t. (depending upon the sampling head) • two new single-trace amplifiers, 150 MHz at 5 mV/div • current amplifier, 105 MHz at 1 mA/div • and the 14th New Plug-In, 7B52 TIME BASE with CALIBRATED mixed sweep.



Convenience is another outstanding feature of the 7000-Series Oscilloscopes. Auto Scale-Factor Readout labels the CRT with time/div, volts or amps/div, invert and uncal symbols and corrects the readout for probes and magnifiers. Color-keyed panels, lighted push-button controls, peak-to-peak auto triggering, and trace-identify switches on probe tips and plug-in panels are just a few of the many convenience features which mean faster, easier measurement with fewer errors.

Your Tektronix Field Engineer will gladly discuss with you the complete VERSATILITY, FLEXIBILITY and CONVENIENCE of the NEW 7000-Series Oscilloscope System. Contact him locally or write: Tektronix, Inc., P. O. Box 500, Beaverton, Oregon 97005. See your 1970 Tektronix Catalog for specifications and descriptions of the entire 7000-Series including the NEWEST: 7503, DC-to-90 MHz, three plug-in oscilloscope and the 7B52 Mixed-Sweep Time Base.

Prices of instruments shown:

7704 150-MHz Four Plug-In Oscilloscope	\$2500
7A16 150-MHz Single-Trace Amplifier	\$ 600
7A14 105-MHz Current Amplifier	\$ 575
7B71 Delaying Sweep Time Base	\$ 685
7B70 Delayed Sweep Time Base	\$ 600
Blank Plug-In Panel, order 016-0155-00	\$ 6

U.S. Sales Prices FOB Beaverton, Oregon

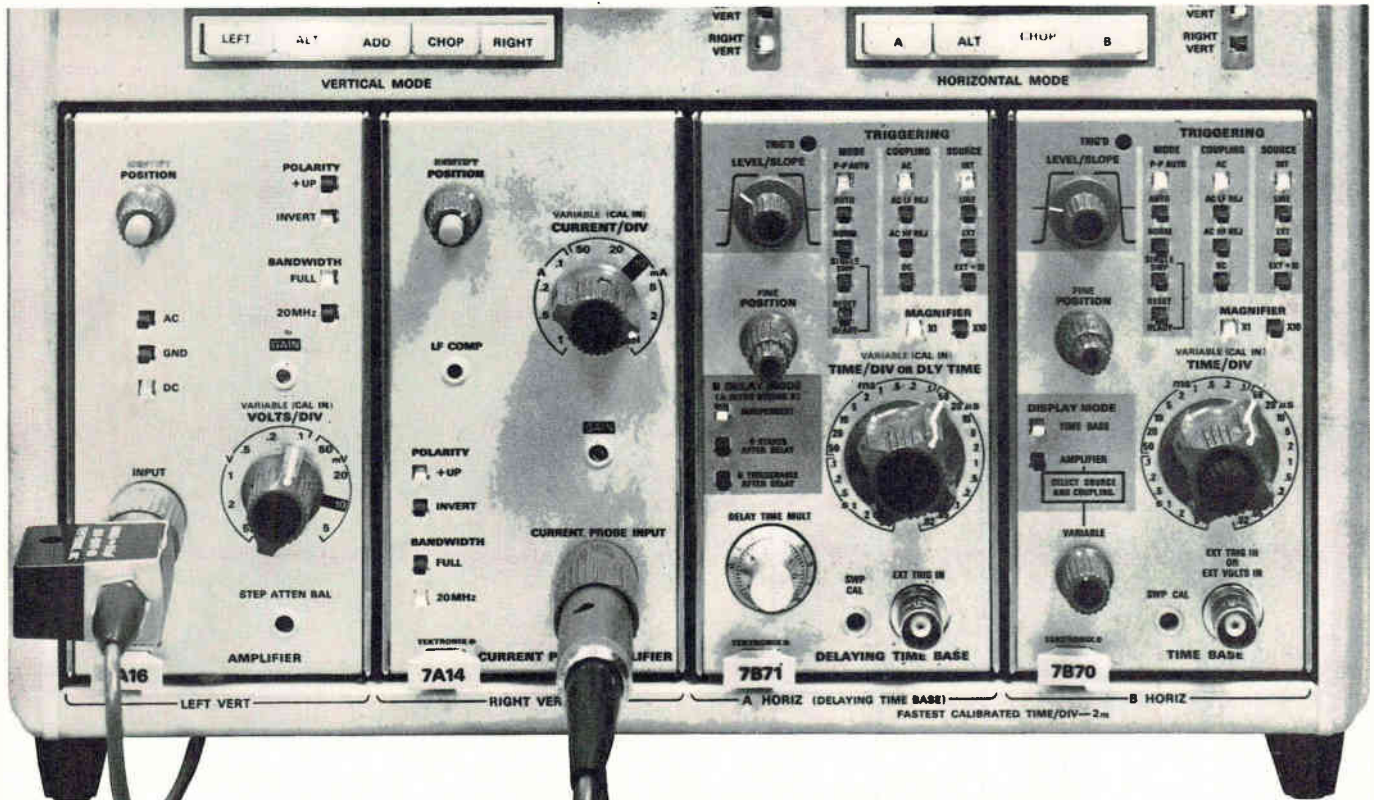

 **Tektronix, Inc.**
committed to progress in waveform measurement

Plastic IC's get foot in military door

Though tough new set of tests proposed by RADC officials is just a first step, manufacturers hope it will lead to lifting of military ban on plastic packages

By Lawrence Curran

Electronics' staff

Manufacturers of plastic-packaged integrated circuits, who have long been pressing military reliability specialists to accept their devices, have a new bone to chew on. Many of these vendors have been asking the military to settle on standard tests for plastics, contending if they knew what users wanted, they could make IC's to withstand reasonable environments [*Electronics*, May 12, 1969, p. 147].

The bone was tossed last month at the IEEE Reliability Physics Symposium in Las Vegas. There, Joseph Brauer, chief of the solid state applications section in the Rome Air Development Center's reliability branch, proposed a set of tests for plastic-packaged microcircuits (see tables p. 128) that could pave the way for acceptance of plastics by the military services for all but applications demanding the highest reliability [*Electronics*, April 27, p. 33]. These high-reliability, or Class A applications include such hardware as Minuteman ICBM and Apollo spacecraft circuitry.

IC makers have been pushing for acceptance of plastic packages because of their low cost vis-a-vis hermetically sealed units. And in some cases plastic-packaged IC's resist shock and vibration better than their sealed-can counterparts.

But until last month, the military had insisted that plastics couldn't qualify for use in military equipment. RADC, the focal point for considerable vendor-user controversy over plastic reliability in recent years, actually banned plastics. Some impurities inherent in certain plastics or resulting from plas-

tic processing steps can degrade chips. As a result of the package's permeability, these impurities—whether gases and vapors outside the package or chemicals generated within—have adversely affected reverse-current leakage and space-charge buildup. And shrinkage sometimes resulting from curing or solvent evaporation can cause stresses severe enough to fracture IC interconnection wires.

Brauer and his associates at RADC emphasize that the proposal of the tests in itself doesn't constitute military acceptance of plastics. Rather, Brauer says, the qualification and screening procedures they embody mean that "we've proposed that the services lift the statutory ban on plastics and use those that pass the tests." And Brauer quickly adds that even the devices that pass these tests still won't be accepted for Class A applications as they're defined in the recently distributed Mil-M-38510, the general specification for microcircuits that relies heavily on test methods in Mil-Std-883.

Mil-M-38510 doesn't explicitly describe Class A, B, and C applications. But Class A uses are those in which the military considers high reliability "absolutely imperative," Brauer explains. Maintenance on Class A hardware is considered either impossible or prohibitively expensive. For Class B applications in which reliability is deemed "vital," maintenance is possible, but it's either difficult or expensive.

Class C applications are those in which "we're still concerned about reliability," Brauer says, "but a

moderate amount of maintenance and downtime can be tolerated."

Selective risk. The tests proposed at the Las Vegas symposium didn't develop overnight; they're the result of months of work by an ad hoc committee within the Department of Defense Research and Engineering that includes representatives from all the services and NASA. Brauer thinks it's time to see if plastics can qualify. "We're now willing to take a risk on a selective basis," he observes.

Most of the test procedures are taken from Mil-Std-883, but some are modifications and others are additions tailored for the failures peculiar to plastics. For example in the Group B lot sampling tests, the salt atmosphere portion (Subgroup 4) with end-point electrical parameters has been extended to 48 hours instead of 24 hours provided in 883. And the test falls into Group C in 883 as originally written, and doesn't include end-point electrical parameters.

RADC experience has shown that silicone resins do well on everything but salt-atmosphere exposure. "Otherwise, silicones might be able to pass these tests soon," Brauer maintains. Epoxies, on the other hand, encounter trouble much sooner than silicones in moisture and pressure-cooker testing, but last for months on salt-spray tests, Brauer points out. Phenolic resins withstand pressure-cooker tests, but fail badly on all other counts, Brauer says.

In the proposed Group B lot-sampling tests, the biased moisture life test with end-point electrical

Proposed tests for plastic-encapsulated microcircuits

Green blocks indicate modification of Mil-Std-883 test procedures; red, new additions. Numbered test methods—2010, 1080, 5005, etc.—refer to 883. 10XX means that a complete number has yet to be assigned to a new test method. "LTPD" stands for Lot Tolerance Percent Defective, and numbers under that heading in the Group B and C tests refer to a table in 883 on how many defective parts are allowed in a lot.

100% screens

Screen	Class B		Class C	
	Method	Conditions	Method	Conditions
Internal visual before encapsulation ¹	2010	Test Condition B	2010	Test Condition B
Stabilization bake	1008	24 hrs. minimum, Test Condition C, 150 ± 25°C	1008	24 hrs. minimum, Test Condition C, 150 ± 25°C
Temperature cycling	1010	Test Condition C	1010	Test Condition C
Burn-in test	1015	168 hrs. at 125°C	not required	
Final electrical tests		<ul style="list-style-type: none"> ▶ Static tests <ul style="list-style-type: none"> • at 25°C • at maximum, minimum operation temperature² ▶ Functional tests ▶ Dynamic tests at 25°C 		<ul style="list-style-type: none"> ▶ Static tests <ul style="list-style-type: none"> • at 25°C • at maximum, minimum operation temperature² ▶ Functional tests at 25°C
Qualification or quality conformance inspection	5005	per applicable document	5005	per applicable document
External visual inspection ³	2009			

¹ To be accomplished prior to encapsulation with all applicable criteria of Method 2010.

² Test is required to establish continuity of microcircuit bonds and connections at specified temperature extremes. Detail specification shall contain sufficient static tests for screening to establish continuity from all used external leads to the die or substrate. An alternative to using static parameter tests for this purpose can be a continuity test (threshold) program which establishes continuity from all used external leads to the internal microcircuit elements.

³ Unless otherwise specified, external visual inspection need not include measurement of physical dimensions.

Group B tests—sampling of each lot

Test	Methods	Conditions	Class B LTPD	Class C LTPD
Subgroup 1				
▶ Visual and mechanical	2008	Test Condition B, per documented design and construction	1 device, no failure	1 device, no failure
▶ Bond strength	2011	Test Conditions B, C, D, or F, as applicable	7	10
Subgroup 2				
▶ Marking permanency	2008	Test Condition B, paragraph 3.2.1	4 devices, no failures	4 devices, no failures
▶ Physical dimensions	2008	Test Condition A	15	20
▶ Lead fatigue	2004	Test Condition B ₂	15	20
Subgroup 3				
▶ Radiography ¹	2012	One view, normal to die or substrate criteria as specified temperature, 260 ± 10°C, with age	15	20
▶ Solderability	2003	as specified in procurement document	15	15
Subgroup 4				
▶ Salt atmosphere	1009	Test Condition B	15	15
▶ End-point electrical parameter		as specified in procurement document	15	15
Subgroup 5				
▶ Biased moisture life	10XX	85°C at 85% relative humidity with minimum power bias for 1,000 hrs. minimum as specified in procurement document	10	15
▶ End-point electrical parameter		as specified in procurement document		

Subgroups 1, 2, and 3 may use electrical rejects. Subgroup 4 samples may be used in Subgroup 5 tests.

¹ Radiographic acceptance criteria include precautions against lead frame shift, foreign particles, lead dress, and encapsulant voids.

Group C tests—periodic sampling

Test	Methods	Conditions	Class B LTPD	Class C LTPD
Subgroup 1				
▶ Steady-state reverse bias	1005	Test Condition A, 160 hrs. at 150°C, minimum as specified in procurement document	7	15
▶ End-point electrical parameters		as specified in procurement document		
Subgroup 2				
▶ High-temperature storage	1008	150°C minimum, 1,000 hrs. minimum storage as specified in procurement document	10	15
▶ End-point electrical parameters		as specified in procurement document		
Subgroup 3				
▶ Thermal shock	1011	Test Condition B for a minimum of 15 cycles	10	10
▶ Temperature cycling	1010	Test Condition C for 10 cycles		
▶ Monitored temperature cycling	10XX	1 cycle ranging from -65° to +150°C		
Subgroup 4				
▶ Moisture resistance or biased moisture life	1004 or 10XX	With minimum power bias for 3,024 hrs. as specified in procurement document	15	None
▶ End-point electrical parameters		as specified in procurement document		

Single sample may be used for all subgroups. Tests within any subgroup must be conducted in the order shown. Initial device qualification shall be to tighten inspection levels as defined in Appendix B of Mil-M-38510 and Mil-S-19500.

parameters included is not specified anywhere in Mil-Std-883; it's specifically used to help check the plastic package's history of poor moisture resistance. This procedure, maintained for 1,000 hours at 85°C. and 85% relative humidity, is the only one in the proposed series that Texas Instruments' Stephen Baird, who welcomes the proposed tests, says borders on being a stress trial rather than a use-condition test. Baird is plastic reliability and technology consultant in quality and reliability assurance within the components group.

Obstacle course. Other parts of the tests that are either more stringent applications of Mil-Std-883 procedures or newly devised obstacles for plastics are these:

▶ The portion of the static tests done at maximum and minimum operating temperatures in the final electrical tests set forth in the 100% screens. This is a Class A test condition in 883 but is proposed for Class B and C applications to assure that there are no intermittent bonds at the temperature extremes.

▶ The radiography test in Subgroup 3 of the Group B tests. This is part of the 100% screens for Class A devices in 883 and is included here to check for foreign matter inside the package after encapsulation.

▶ Test Condition A in Subgroup 1 of the Group C tests. This differs from 883 in boosting the duration from 72 hours to 160 hours.

▶ The monitored temperature cycle in Subgroup 3 of Group C. This is a new test intended to pinpoint where electrical opens occur across the temperature range.

▶ Subgroup 4 of Group C. Test Method 1004 is part of Group C in 883, but bias is optional; here, bias is mandatory. Also, most moisture-resistance tests for hermetically sealed IC's are done for only 240 hours; RADC officials feel 3,024 hours is necessary for plastics.

Fine tuning. "No one will have plastic devices that pass all these tests right away," Baird asserts. "It will take more attention to detail in processing, but I think everyone is close enough so that it will be a matter of fine tuning."

Baird says he's 80% confident that TI's current epoxy-encapsulated IC's can pass the tests because TI performs all of the tests

**FROM
CANADIAN MARCONI COMPANY
A NEW CONCEPT
IN TELECOMMUNICATIONS**

**ONLY \$300 (OR LESS)
PER CHANNEL-END
INCLUDING ALL
COMMON AND LINE-
INTERFACE EQUIPMENT**

Canadian Marconi Company with their MCS 6900 PCM microwave communication system has dramatically reduced the cost of telecommunications systems and, at the same time, has significantly increased application flexibility and reliability.

In the MCS 6900 the use of common equipment has been radically changed. All functions required to pulse code modulate input audio to Bell T1 performance standards and to demodulate incoming PCM signals are performed by a single module, the channel unit. In addition, each channel unit contains A/D and D/A conversion circuits, and telephone line interface and signalling circuit sub-modules.

The result -- you add a *complete* voice channel whenever you want, simply by inserting channel units at less than 50% the cost required for comparable systems.

Use of identical rather than common circuitry also increases reliability by a quantum step -- the danger of losing a block of channels, as is possible with other PCM or FDM systems, is negligible with the MCS 6900.

Developed from field proved military equipment, the MCS 6900 will provide you with all the advantages, and more, of other existing systems -- *and at a fraction of their cost.*

Write today for complete information to the Telecommunications Division, Canadian Marconi Company, 2442 Trenton Ave., Montreal 301, Quebec, Canada or call 514 - 343-3411.



MASTHEAD UNIT



GROUND UNIT

CANADIAN MARCONI COMPANY 
TELECOMMUNICATIONS DIVISION

design inspirations

*Prices shown are single lot.
Inquire about quantities.

Keyboard Switch Bank

Utilizes reliable reed switches. Mechanical lockout feature allows simplified circuitry. 11 keys 0-9 and period. SB-033

Circle 508

28.50 *



ELFIN® Readout Neon Indicator

Single plane 9-segment neon for brighter, wider viewing. 0.41" dia. Has mount for PC wiring. Displays 0-9, +, -, some alpha & decimal. Long-life operation. MG-19. \$4.95

2.99 each, in 1000 lots

Circle 509

Transistorized Neon Logilite

4.85 *

Neon pilot operates from low-voltage 5VDC supply. Self-contained transistorized generator provides hi-voltage to excite neon. Bushing 3/8". LVN-ML.

Circle 510



4.35* Miniature 1/2" Rotary Switches

Original adjustable-stop miniatures with improved features. 500 mA @ 125 VAC. Non-shorting. Up to 4 poles on single deck. Solid silver terminals & contacts. MRA-1-10.

Circle 511

Remote Control Relay

For safe, shock-free remote control circuit operation. Compact plastic case. 115 VAC input 5A capability. FR-101.

3.85 *

Circle 512



Locking Toggle Switches

Accident-proof mini switches have toggles locking in position to guard against human errors. Interchangeable colored handles. SPDT. 6A @ 125 VAC. MSTL-106D

3.15*

Circle 513

Immediate Deliveries on Above Items

ALCO®

ELECTRONIC PRODUCTS, INC.

Lawrence, Massachusetts 01843

now in its own reliability evaluation program. Sylvania, while it has been working with plastic packages for years, is singing the praises of its ceramic package, which it says is almost as cheap as a plastic unit.

Donald Russell, manager of IC quality assurance and reliability at Sylvania Semiconductor's Woodburn, Mass., division, believes RADC officials have shown in their test proposals that they're still highly suspicious of plastics. Says Russell, "I think Brauer has shown by the tests and their duration that he has very little confidence in plastic-packaged IC's. The moisture-resistance tests are very tough. The tests aren't new, but they're grouped together as an assurance of something significant to him. He's saying he's still not confident." But Russell admits that although Brauer has "built a fairly severe obstacle course, he's not being unreasonable. He's just trying to write specs so the military will have reliable equipment."

Brauer, no stranger to controversy, seems genuinely interested in having a method of qualifying plastics for military use, at least partly to determine if the units ultimately can give the military a cost advantage over hermetically sealed devices. Says he, "It wouldn't surprise me to see devices pass these tests now—from vendors that are serious about plastics."

Cost-conscious. One IC user in a large electronics firm's defense group says, flatly, "There won't be any cost savings with plastics, even if they do qualify. A couple of screenings and you'll push the cost to the point where they won't be competitive, especially with the price of ceramics coming down. And there'd have to be a hell of a cost advantage before we'd use plastics."

This source is dismayed that RADC has proposed the tests. He knows of no firm that has qualified hermetically sealed devices under Mil-M-38510, "and all of a sudden, Brauer is talking about plastics. Either he has finally knuckled under to pressure from the TI's and Motorola's or he's designed tests that are so tough he knows nobody can pass them."

Another user who is skeptical of plastics, and who probably won't

be swayed by the RADC-proposed tests is Stanley Stuhlbarg, manager of the hybrid circuits department at the Bedford, Mass., laboratories of Raytheon's Missile Systems division. "If at the end of a year plastic units under test are performing perfectly under extreme conditions and data is published, maybe I could afford to use them. Nothing in the way of an accelerated test could do this." And even after a year, Stuhlbarg says, he would want to see an analysis of why the devices succeeded. "For instance, maybe water evaporates before it gets to the IC because of heat from junctions. We need reasons, not just results. If the reasons for passing are good, people will begin to believe in plastic packages."

Confidence. The vendors react differently. Signetics' Richard McCoy, director of reliability programs, is convinced his firm's production silicone packages can pass all but the salt-atmosphere test. But he adds, "We now have a way to modify the package to pass that test, but we don't know if it's the most economical solution. We're confident we can meet the spec with a production process in about three months." He doesn't believe the salt-atmosphere test is a "real-world" test, however.

McCoy isn't worried about Signetics devices failing the biased moisture-life tests in Subgroup 5 of Group B lot-sampling. Nor does he seem concerned about Subgroup 4 of Group C—the moisture resistance or biased moisture-life tests—although he's not wild about doing the biased moisture-life tests for each lot. "These are bad from an inventory standpoint—for both plastic and hermetic devices."

General Instrument Corp. officials, who are just embarking on an R&D program to put MOS devices in plastic, say they've established their own reliability criteria for plastics. These include almost all the tests RADC has put forth, except Subgroup 5 of Group B (biased moisture life) and Subgroup 4 of Group C (moisture resistance or biased moisture life tests). Al Musto, manager for reliability assurance, and Albert Adell, director of quality assurance and reliability in the Microelectronics division, both say GI likely will include these two tests in its pro-

NEW AUTO-POLARITY FET V-O-M SPEEDS TESTING

You've probably imagined the convenience and time-saving you'd enjoy if you could just clip one of the V-O-M leads to ground or to the chassis, and have your meter always read upscale regardless of the polarity of any other terminal you touched.

No need to imagine it any more . . . you can see it and try it right now at your Triplet distributor. Called the Triplet Model 602, it's probably the most convenient V-O-M ever built. Its convenience goes well beyond the auto-polarity feature, though . . . to AC and DC measurements from 10 mV to 1000 V in 8 ranges at 11 megohms DC and 10 megohms AC input resistance . . . AC and DC from 0.02 to 1000 mA in 4 ranges . . . resistances from 0.2 ohms to 1000 megohms in 6 ranges. And with an accuracy of 3% on voltage measurements, and a rugged suspension-type meter movement, the Model 602 has what it takes to make your job easier.

This great new V-O-M is only **\$100** suggested USA user net. For more information, or for a free, no-obligation demonstration, call your local Triplet distributor or your Triplet sales representative. Triplet Corporation, Bluffton, Ohio 45817.

TRIPLETT

The World's most complete line of V-O-M's . . . choose the one that's just right for you.

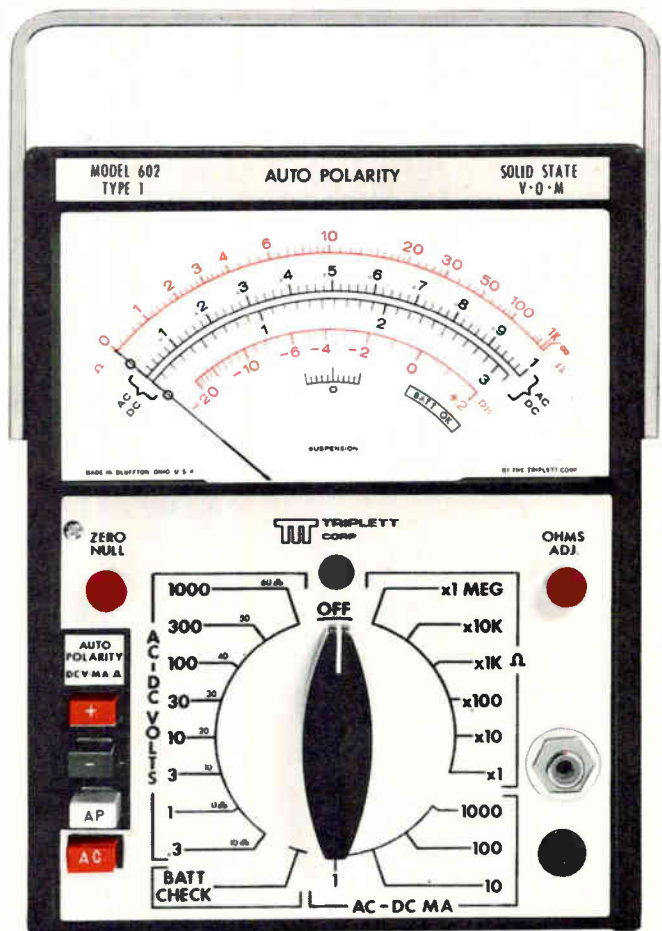

1. Auto Polarity . . . convenient and time-saving; creates memory and suppressed scale.
2. High sensitivity (.3V AC and DC) at constant 11 megohms input resistance.
3. Simplified scale with only 2 arcs for 24 AC/DC ranges.

How fast is GE's new helium leak detector?

Let your fastest operator show you

Manufacturers of electronic components asked us to help cut down leak test time.

So General Electric engineers designed a new leak detector to do the job.

It's the LC-40 Mass Spectrometer Helium Leak Detector, which offers unmatched testing speed in a general purpose leak detector. The LC-40 achieves this by combining the highest net pumping speed of any leak detector on the market (for equivalent sensitivities), with fast recovery from leaks. This combination pays off in a time-to-test of only seconds.

Complementing this test-time capability is a new simplified control system, which permits the operator to complete a test merely by loading the test piece and flipping a single switch. Results are instantly displayed on a meter.

But the LC-40 detector isn't just fast. It includes such performance-proven features as all-solid-state circuitry for dependable service; burnout-resistant thoria-coated iridium filament, exclusive with GE; all-welded stainless steel high vacuum system; high sensitivity (5×10^{-11} atmo. cc/sec He), a new source design to eliminate background signals, and many other significant advances.

Although ideally suited for high-speed production testing, the unit also can be used for general purpose applications. If you would like to learn more about General Electric's new LC-40 Mass Spectrometer Leak Detector, write General Electric Company, Analytical Measurement Business Section, 4MX, 25 Federal Street, West Lynn, Mass., 01905

268-41



GENERAL  ELECTRIC

gram. Both agree they are the stiffest obstacles laid down by RADC.

Charles Gray wouldn't recommend plastic-packaged IC's to Fairchild Semiconductor military customers. He says that after screening plastics, the price difference vis-a-vis hermetics would be so small that the customer should use the hermetic unit. But Gray, who is Fairchild's director of reliability and quality assurance for IC's, agrees that a specification for plastics is needed, and says RADC's proposed screens are generally reasonable, even though some of them exceed the maximum ratings of some devices. Although not all of Fairchild's plastic units would pass the tests today, Gray says, "We are making the best devices we know how to make, and if a standard comes out, we'll want to come as close as we can."

Fighting the bonds. Gray says the industry is opposing the bond strength test (Group B, Subgroup 1) even for hermetic devices—"and it is infinitely more difficult to remove plastic and measure bond strength." Gray acknowledges that the salt-atmosphere test is more stringent than that for hermetics. He questions whether even hermetic devices can pass it. He's opposed to the 3,024 hours of moisture resistance or biased moisture-life tests in Group C., Subgroup 4: "that's four months and that's a long time. The manufacturing process or design may change. Evolutionary changes occur faster than the test time; it could take nine months to get any products shipped."

One source at a firm that makes plastic-packaged IC's puts the vendor's view on the economics of screened hermetics vs. screened plastics this way. He says that most companies have two hermetically sealed ceramic package types for IC's—essentially a military/grade package and a commercial/grade unit. This source says that when someone compares a 40-cent plastic to a 50-cent hermetic, "this is not the hermetic that's sold to the military. The Mil hermetic might cost as much as \$1 before testing, so you should compare a \$2 ceramic against a \$1.42 plastic." He says \$1 worth of testing would be added to the ceramic's basic \$1 price vs. about \$1.02 in testing costs added to the plastic unit's tag.

Shift registers by the bucket!

A black bucket is tipped over, spilling a large quantity of small, dark, rectangular integrated circuits (shift registers) onto a light-colored surface. The chips are piled up in a large, conical shape, with some scattered further away. The bucket is positioned in the upper left quadrant of the image.

Our largest customer gets about 10,000,000 bits of shift register every month—and he makes only a small dent in our capacity.

Intel can deliver thousands of dual 100-bit shift registers right from stock. We can get you production quantities of custom dynamic registers (big as 1,000 bits) faster than any other source. And the reason we can move so fast in high volume is the new high-yield technology that Intel pioneered — **silicon gate MOS**.

Our dual 100's perform vastly better than others on the market. Clock input capacitance is a tiny 35 pF (about one-third that of other registers). Power supply current is only 15 mA at 10 volts (producing about half the power dissipation of others). And clock rate can be as high as 2 MHz.

Price is remarkably low due to Intel's unusually high yields. Dual 100's cost about \$4 per device (2¢ per bit) when you order in moderate production quantities.

For immediate delivery contact your local Intel distributor, Cramer Electronics or Hamilton Electro Sales. Ask about Intel Models 1406, 1407, 1506 and 1507. Or phone us collect at (415) 961-8080.

Intel is in high-volume production at 365 Middlefield Rd., Mountain View, California 94040.

**intelTM
delivers.**

Now you're down to no reasons not to buy **Fairchild trimming pots**

- QUALITY.** Better than MIL requirements
- PRICE.** Cost less
- DELIVERY.** Immediate

Fairchild trimming potentiometers meet — and in the most important ways exceed — MIL-R-22097C and 27208B requirements and they cost less to boot. And now these great wirewound and film trimmers are available *off-the-shelf*. That leaves no reasons not to call or wire Fairchild today for complete specs and prices.

Here are some of the many types available:

High resolution wirewounds. RT11 and RT12. Eighteen resistance ranges

from 10 ohms to 175K. Longer element for higher resolution, fewer parts, fewer connections, low noise, keeps performing in rigorous environmental conditions.

Infinite resolution Film pots®. RJ11 and RJ12. 18 resistance ranges in metal film from 10 ohms to 1 megohm. Low temperature coefficient you could get only in wirewounds before, circuit control 10 to 20 times better than wirewounds. Holds setting in extreme operating conditions. Low contact resistance

variation (noise in wire types). Low inductance lets you use Film pots in high frequency applications.

Commercial-industrial grade Film pots also available in 1¼" narrow rectangular, ¾" rectangular, and ¼" round. Also MIL grade ¾" square RJ24C type.

See your Fairchild Controls representative or contact us at 5625 Kearny Villa Road, San Diego, California 92123. (714) 279-5600. Unless you like waiting. Or paying more.

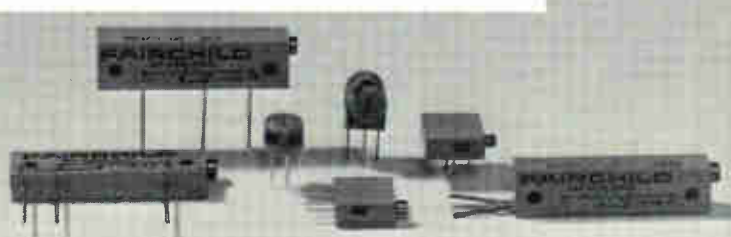

FAIRCHILD
CONTROLS

A DIVISION OF FAIRCHILD CAMERA AND INSTRUMENT CORPORATION

Submillimeter spectrum Waves of the future?

Although scientific interest is being whetted by potential for high-capacity, long-range communications, much more money and research are needed to create practical systems

by Laurence Altman

Electronics staff

Man's last frontier of electromagnetic transmission is beginning to be explored with increasing interest by scientists and engineers. The frontier is the submillimeter wave spectrum that falls within the region of roughly 1 millimeter (300 gigahertz) on the low end to about 10 microns at the optical extreme. But more than just scientific curiosity is whetting researchers' interest—this frequency band may provide new horizons in compact, high-capacity, long-range communications systems, and sophisticated radar gear.

Research effort and money spent so far have been small. But work on developing sources of submillimeter wave energy and detection is picking up. The work is proceeding from both ends—the millimeter people are working on higher frequency semiconductor generation, while the laser researchers are trying to convert the optical frequencies downward into the far-infrared.

The work does not suffer from a lack of diversity. Government-directed installations like Lincoln Laboratories at MIT, say for example, are involved in millimeter and far-infrared frequency mixing in semiconductors to achieve emission in the submillimeter band. The National Bureau of Standards in Boulder, Colo., long active in short-wavelength research, is refining its techniques to include the wavelengths between 2 millimeters and 50 microns. Bell Laboratories has become active in nonlinear

optics in the submillimeter region, and a scientist at Tohoku University in Sendai, Japan, has managed to obtain submillimeter-wave difference frequencies using nonlinear crystals in conjunction with a ruby laser. Moreover, the triatomic gas lasers, such as water vapor, hydrogen-carbon-nitrogen, hydrogen sulphide and sulphur dioxide, have shown oscillations in the submillimeter wave region. Most recently an SO₂ system has emitted strong lines around 151 microns.

This is interesting and significant work, but the fact remains that at present there is no practical source of energy whose primary emission lies in the submillimeter wave region. And detectors are non-existent outside the research labs and likely to remain so for some time. Furthermore, it is agreed: development will require a large outlay of man-hours and money.

This has led some scientists to wonder: are we climbing the mountain simply because it's there? Is it worth it?

Dr. Arthur Oliner, director of the Microwave Research Institute at Brooklyn Poly thinks it is. He points out that the trend in electronics is to higher frequency and smaller systems, and the natural expansion will be into the millimeter and submillimeter band where standard circuit techniques can be applied.

M. L. Skolnik, a systems radar specialist from the National Research Laboratory in Washington, takes another view. He feels that

the microwave spectrum still hasn't been fully utilized for practical radar and communications systems. Although some systems exist above X-band, they're largely experimental and far from trouble free. Above the Ku band (up to 20 Ghz) there aren't even any experimental system models. And with precious little development money around, Skolnik wonders why it should be put into millimeter and submillimeter waves when it could be better spent in areas yielding more immediate results.

But clearly, submillimeter waves offer greater information-handling capacity than do lower-frequency systems—five to 10 times the capacity of the largest millimeter-wave systems being planned. A 500-Ghz carrier, for example, could accommodate over 10,000 video channels, or a million separate voice channels. Or a submillimeter carrier in the far-infrared region could transmit about 10⁹ data bits per second, the entire memory capacity of the largest computer being developed. And although optical frequencies offer even greater capacity, some researchers question whether lasers are practical.

Problems, problems. Many lasers still have stability problems, especially the gas lasers. Solid-state lasers are not much more attractive as rugged sources—they require large power supplies, pumping lamps, and costly mirrors. The semiconductor laser eventually may prove the most useful, at least for low-power applications, but at present, room-temperature c-w operation is not feasible.

More important, all gas and solid state lasers suffer from the inherent difficulty of modulating their optical beams with electrical information signals, a clear requirement for useful communications. Although electro-optical modulators such as potassium dihydrogen phosphate (KDP) or lithium niobate, or liquid Kerr and Pockels cells, do provide the answer to laser-beam modulation in theory, in practice they suffer from large insertion loss, poor beam separation (crosstalk) and unreliability. In contrast, submilli-

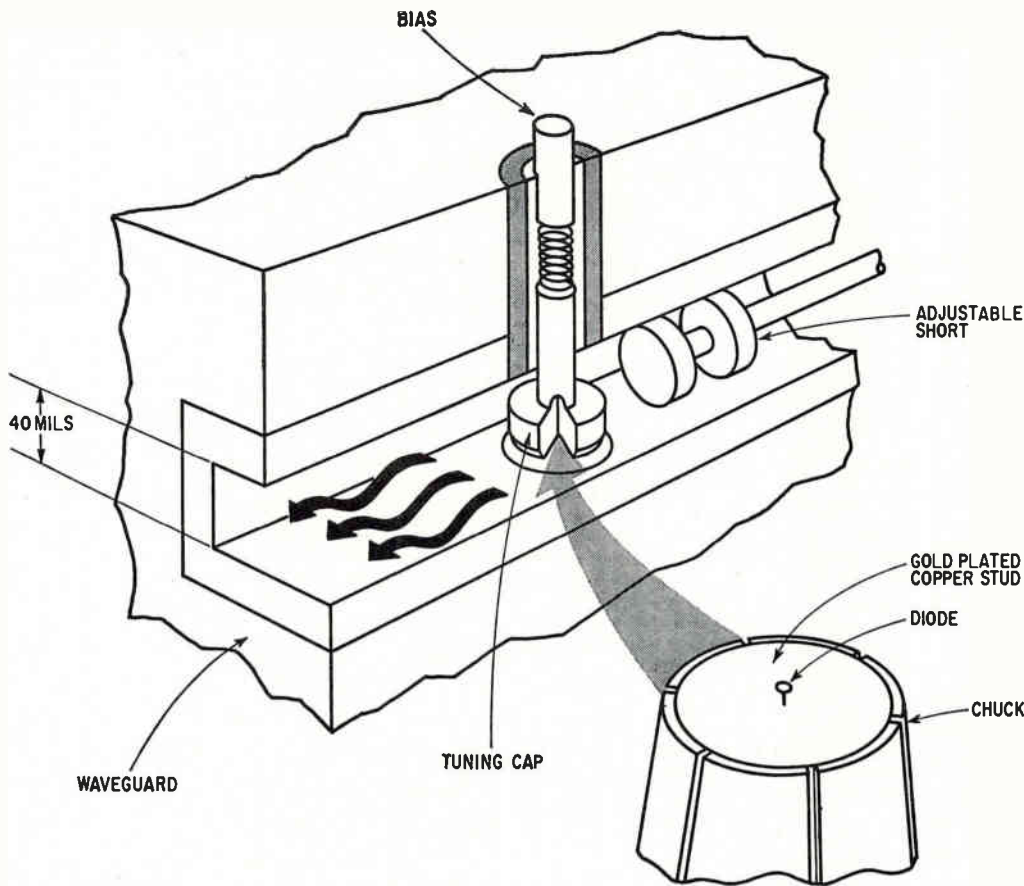

The better Impatt. This Bell silicon Impatt diode can operate continuously at frequencies in the 150-GHz range with output approaching 50 milliwatts thanks to abrupt shallow junctions and improved heat sinking. Further refinements could lead to the first primary source of emission in the submillimeter-wave region. Bell uses cap tuning in the oscillator circuit. A metal cap consisting of a short cylindrical metal block whose diameter is approximately a half-wavelength encloses the diode, which is mounted on the wide side of a standard waveguide.

meter transmission most likely will use conventional cavity modulating techniques, and at the same time provide almost the capacity of infrared optical systems—a strong point in its favor.

Size of transmitting and receiving instruments is another consideration. Submillimeter wave lengths offer convenient dimensions for system components— inches instead of feet for millimeter waves, and angstroms for optical emission. Submillimeter antennas can be six inches long and cavities and waveguides three or four inches on a side. Yet, optical wavelengths are so short that a workably-sized laser cavity leads to multimode emission, which not only wastes space, but results in noise problems from mode conversion. In contrast, submillimeter wave sources won't suffer from multimode generation—wavelengths are about the same order of magnitude in size as the dimensions of the devices.

In addition to being single mode, submillimeter wave transmission lends itself to standard IC techniques, while optical transmission requires an entire new circuit technology using light fibers. And al-

though there are a few integrated optics programs at several laboratories—Bell Laboratories is the most active—which are attempting to develop optical circuits on miniature substrates, their results are tentative.

To achieve submillimeter-wave emission from the millimeter end, researchers are using two semiconductor approaches: diodes operating in the avalanche (Impatt) mode, and bulk devices operating in the Gunn and limited-space-charge accumulation (LSA) mode. Of these, the most promising is a new silicon Impatt diode developed by Bell Laboratories.

Built to oscillate in the 100-GHz range—the upper end of Bell's proposed millimeter wave communication system [*Electronics*, April 13, p. 96] the silicon Impatt diode is proving an increasingly valuable source at higher frequencies. Although not yet operating in the submillimeter band, Bell scientists are advancing millimeter-wave junction technology, and are now able to achieve continuous emission at frequencies up to 150 GHz at powers of 30 milliwatts and higher, sufficient for many applications.

Junctions. Operation of an Impatt diode at these frequencies required a very abrupt junction. Lower-frequency Impatt diodes are fabricated with gradual junctions, where the active region is spread out over a fairly wide band. In contrast, higher-frequency operation requires very abrupt junctions which results in generation of high energy, high current density, and large quantities of heat.

With computer-aided designs and flip-chip heat-sinking methods, Bell scientists were able to achieve the required junction conditions. In the fabricating process, boron is diffused into a shallow epitaxial layer only 0.5 micron thick. And equally important, the diffusion process yielded very high donor densities—as great as 1.5 to 3.0 x 10¹⁷ per square centimeter.

Most significantly, the high-frequency is not achieved at the expense of efficiency. In the 100-150 GHz range, efficiency exceeded 3% (at 111 GHz), with output approaching 100 milliwatts. At 150 GHz, efficiency exceeds 1% and will rise when heat sinking is improved further. What's more, pulsed operation with these abrupt-junction

SUPPLIED THE ECONOMICAL WAY
THRU DISTRIBUTORS

BUSS QUALITY

FUSES

SMALL DIMENSION

FUSES and FUSEHOLDERS

For dependable protection of all types of Electronic and Electrical Circuits and Devices.

The complete line of BUSS quality fuses includes fast-acting and slow-blowing types, visual-indicating/alarm-activating types, miniature and subminiature sizes, and Tron rectifier fuses for the protection of various solid state devices. Ratings range from 1/500 to 1000 amps.

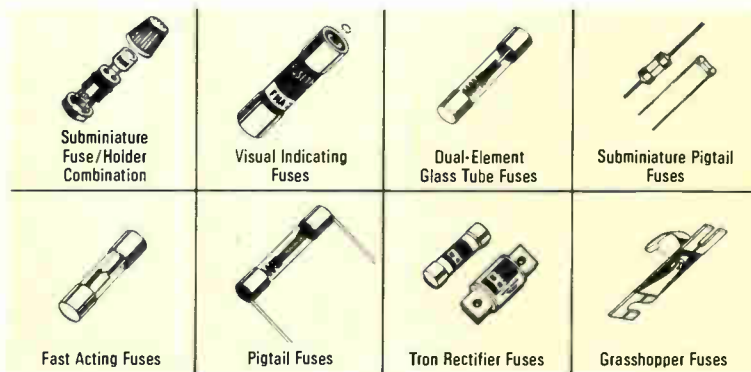
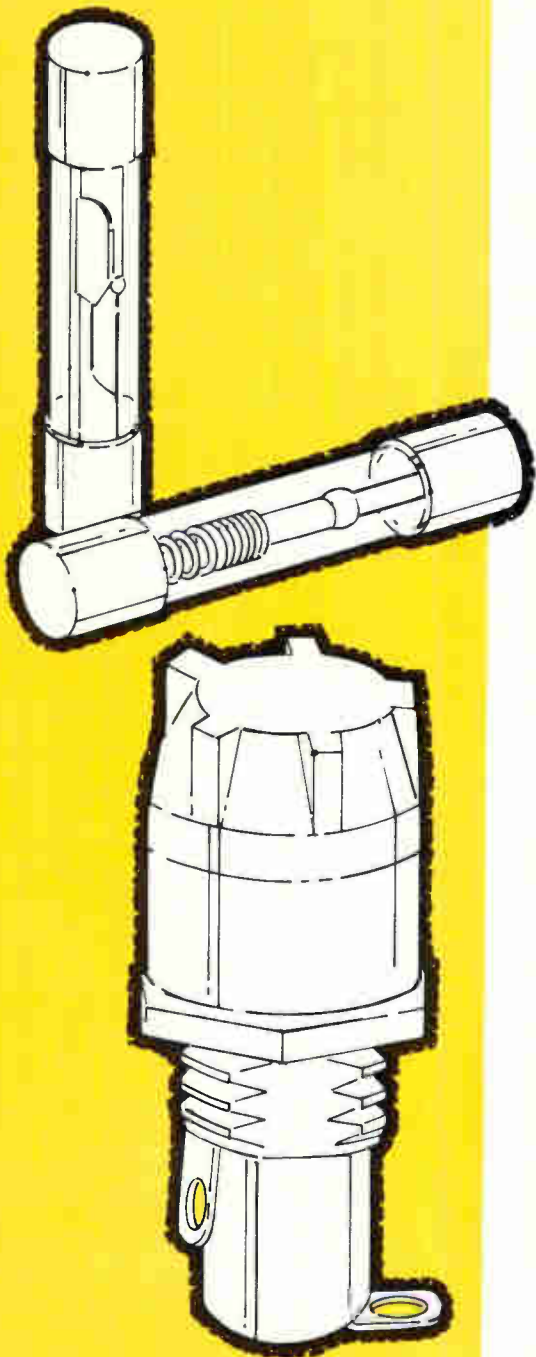

The comprehensive line of BUSS quality fuseholders includes in-line and panel-mounted types, available in standard or space-saving sizes, and covers lamp-indicating, alarm-activating, and RF interference-shielded types. There is also a full line of fuse-blocks and related mounting hardware, available with solder, screw, or quick-connect terminals.

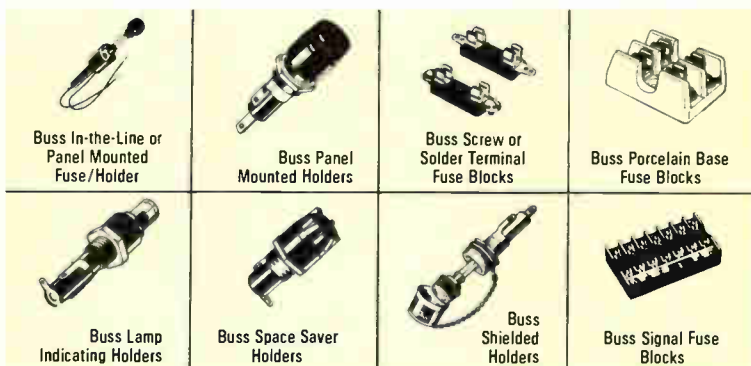

Write for BUSS Bulletin SFB.

BUSSMANN MFG. DIVISION, McGraw-Edison Co., ST. LOUIS, MO. 63107



Our Red Badge of Courage

A new standard for the industry:
Redcor Modules, Instruments,
and IC Tester are warranted
forever. Return them and we'll
repair or replace them in 10 days.

R REDCOR CORPORATION
C Telephone: (213) 348-5892

Impatts have yielded frequencies as high as 350 Ghz, well within the submillimeter range. But at present, pulsed duty cycles are too low to provide useful emissions.

Limits. But even with Impatts, achieving continuous emission at submillimeter-wave frequencies is not a certainty. As the frequency of emission is increased, with a corresponding decrease in wavelength, the dimensions of the device also must decrease for oscillation to occur. This restriction already is severe at 150 Ghz, where junction areas are on the order of nearly 10^{-6} cm². At higher frequencies, dimensions are so small in the active area that skin currents result in a sudden drop in c-w output, now observed at about 200 Ghz. There is a serious question whether this condition can ever be overcome, since it results directly from device geometry.

Optics. Achieving submillimeter-wave frequencies from the optical end of the spectrum requires using either molecular lasers operating directly in the far infrared, or a laser emitting at optical frequencies in conjunction with a nonlinear material or other mixing technique to obtain the lower frequencies.

Sulphur dioxide lasers at submillimeter frequencies may provide a suitable source. But work with these devices is still in the early stage and many problems involving stability and efficiency still must be worked out. However, emission at various locations in the submillimeter waveband has been detected; this at least indicates that a primary source of millimeter energy may be available from the laser.

Another approach is to use nonlinear materials such as KDP and lithium niobate in conjunction with laser emission to realize submillimeter waves. These nonlinear optical techniques have been used in the visible and near-infrared regions, but work at lower frequencies is only just beginning. For example, Bell Laboratories has mixed two c-w signals from a hydrogen-carbon-nitrogen (HCN) laser in lithium niobate, and has detected a beat at 73.5 Ghz. But here, conversion efficiency is extremely low—total laser power is typically a few hundred watts

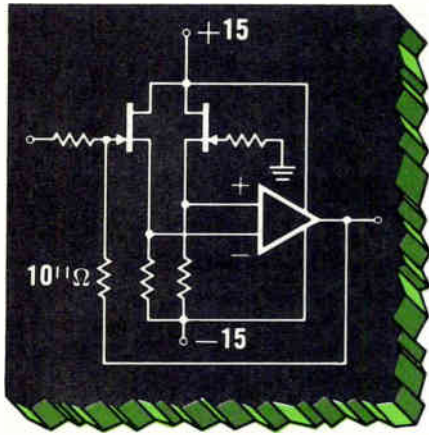

SUB-PICOAMP I_{in} FOR DIFF AMPS WITH FETS

Are these your requirements?— Less than 1 pA I_{in} and low noise (for electrometer, Op Amp, or diff amp) or high slew rate (for sample and hold). Use FETs at the input in either long-tailed pair or differential source follower circuits. Another possibility—the temperature compensated source follower for unbalanced circuits.

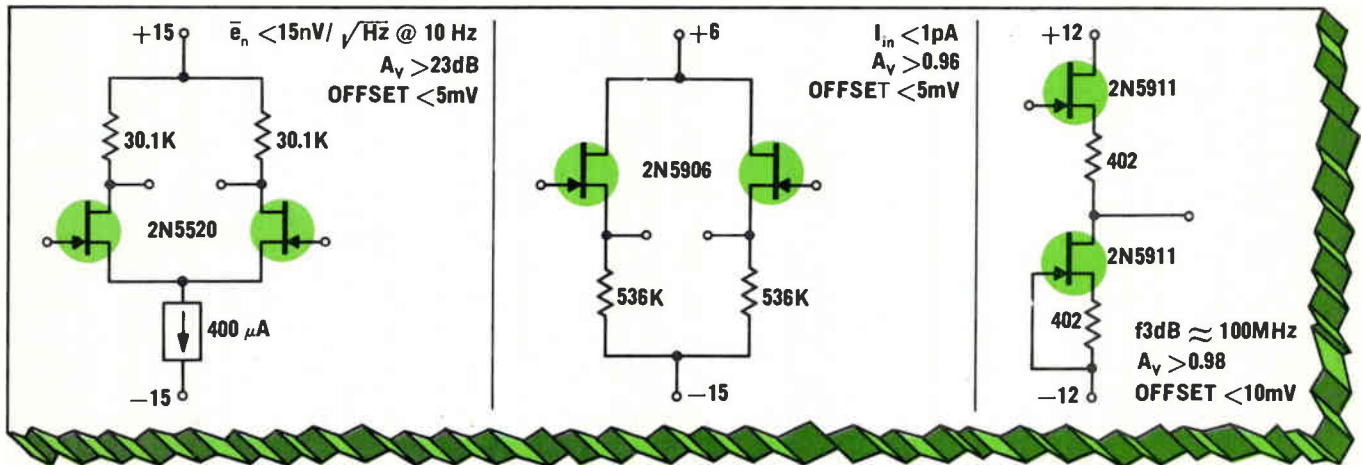

Siliconix assumes no responsibility for circuits shown, nor does it represent or warrant that they do not infringe any patents.

Which FETs to use? ■ General Purpose: 2N5196-99; ■ Low Noise: 2N5515-24; ■ Low Leakage: 2N5902-09; ■ Wide Band and/or High Gain: 2N5911-12.

For more information and applications assistance write or call any of the numbers below.

New York: Sy Levine (516) 796-4680
 New England: Al La Croix (617) 762-8114
 Ft. Worth/Dallas: Charlie Williams (214) 231-8151
 St. Louis: Jim Spicer (314) 291-3616
 Minneapolis: Ed Koelgen (612) 920-4483
 Southern California: Dave Ferran (213) 420-1307
 Northern California: Chuck Brush (408) 246-8000



Siliconix incorporated

2201 Laurelwood Road • Santa Clara • California 95054
 Telephone (408) 246-8000 Extension 201 • TWX: 910-338-0227
 In Europe: Siliconix Limited, Saunders Way, Sketty, Swansea, Great Britain

Service...Engineering...Experience

MAKE THE **BIG** DIFFERENCE
BETWEEN A YOKE SPECIALIST
AND A YOKE SUPPLIER



Syntronic Yoke Specialists have more yoke knowledge and provide more engineering assistance than anyone else in the field.

The most extensive line of deflection yokes available is offered by Syntronic... in production quantities or custom designed to special requirements. See the BIG Difference for yourself the next time you specify a yoke.

1" ID 12 oz. Single Gap
Shielded Dynamic/Static
Focus Coil

syntronic INSTRUMENTS, INC.
100 Industrial Road, Addison, Illinois Phone 312, 543-6444

Circle 205 on reader service card

DIGITAL TV



CVI video sampling instruments allow your computer to "look" at practically anything. High accuracy bandwidth compression of conventional television signals opens new doors to data processing in research and industrial applications. Let us tell you about some of our unique video devices.

COLORADO VIDEO, INCORPORATED
P.O. Box 928 • Boulder, Colo. 80302 • Phone (303) 444-3972

cvi

Video Data Acquisition • Processing • Display • Transmission

140 Circle 140 on reader service card

while the observed millimeter wave power falls in the range 10^{-12} to 10^{-16} watt.

Other nonlinear materials may prove to be more efficient. Besides lithium niobate and KDP, GaAs, cadmium disulphide, and crystalline silicon dioxide are transparent at discrete lines falling in the sub-millimeter waveband. Work here may provide more efficient conversions. Another material, single-crystal tellurium, also is under consideration as a nonlinear medium. Experimenters at the University of Illinois in Urbana are working with far-infrared second-harmonic generation and mixing using a water-vapor laser as the source and tellurium as the converter. But again, observed efficiencies in these early experiments have been very low.

Detection doubts. As uncertain as submillimeter wave generation is at the present time, submillimeter detection, the other half of the system, is even more tentative. Far infrared detection using pyroelectric detectors—devices showing thermal responses to high-frequency energy incident on their junction—are interesting lab devices, but their response is so low that more extended use is not feasible. The Josephson junction—making use of the current flow through a barrier or mechanically weak junction between two superconductors—also can be used to detect submillimeter wave energy, but it also has an extremely low response.

Another group of laboratory detectors in the submillimeter band are the n-indium antimonide devices. When cooled to near 1°K, n-InSb will yield a small photoconductive current when submillimeter energy is incident on it. Essentially a noise signal, the magnitude of the signal is in the order of 10^{-12} to 10^{-13} watts, clearly not useful outside the laboratory. Signal enhancement can be obtained with application of a magnetic field. Known as the photo-induced Hall effect, preliminary experimental results conducted in Japan showed that the overall response of n-InSb detectors can be improved by a factor of from two to six by this technique. Nevertheless it still yields a detection signal much too small for anything but experimental purposes.

Circle 141 on reader service card →

IN 1963, WAVETEK

BEGAT

THE FIRST SOLID-STATE 1 MHz FUNCTION GENERATOR. IN 1964, WAVETEK

BEGAT

THE FIRST VOLTAGE CONTROLLED GENERATOR. IN 1965, WAVETEK

BEGAT

THE FIRST PROGRAMMABLE VOLTAGE CONTROLLED GENERATOR. IN 1966, WAVETEK

BEGAT

THE FIRST SWEEP/TRIGGER VCG. IN 1967, WAVETEK

BEGAT

THE FIRST PUSHBUTTON DIGITAL VCG. IN 1968, WAVETEK

BEGAT

THE FIRST 0.01 % PROGRAMMABLE WAVEFORM GENERATOR. IN 1969, WAVETEK

BEGAT

THE FIRST 2 MHz FUNCTION GENERATORS WITH OSCILLATOR SPECS AND PRICES.
AND, IN 1970, WAVETEK

BEGAT



THE MODEL 142—THE FIRST 10 MHz VOLTAGE CONTROLLED GENERATOR THAT IS ALSO AN OSCILLATOR, A PULSE GENERATOR, AND A SIGNAL GENERATOR THAT SELLS FOR ONLY \$595.

WAVETEK MARCHES ON!

P. O. Box 651, San Diego, Calif. 92112 (714) 279-2200 TWX 910-335-2007

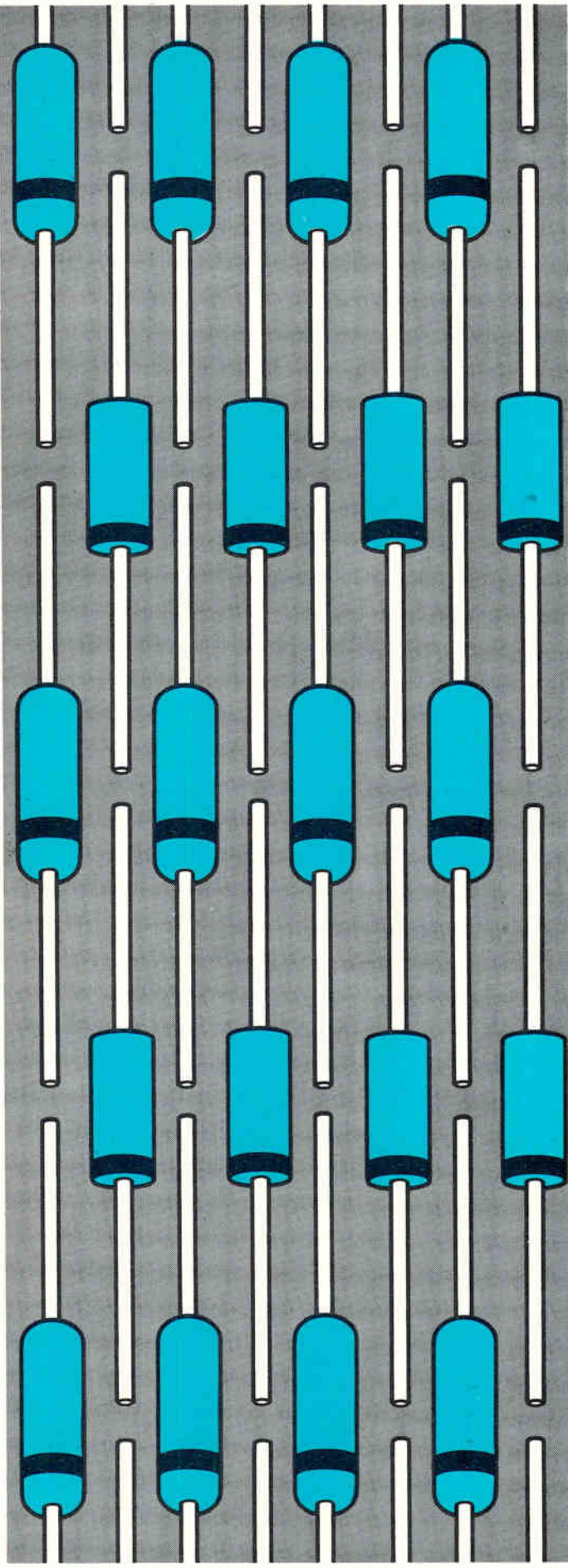

SAVE delivery and price worries on all your rectifier orders

It's easy to order rectifiers with confidence that they'll be delivered on time. Order them from ITT.

There's plenty of variety. Peak reverse voltages range from 50 to 1000 V. at average rectified current as high as 1 amp.

You can select a hermetically sealed package for highest reliability, or a new plastic package for economy and high moisture resistance.

You can count on timely delivery, because you'll be dealing with one of the world's largest diode and rectifier manufacturers. Volume capability such as that means delivery dates that will be honored. You'll even like the high marking legibility on ITT's exclusive blue packages. You can save your eyesight and deliveries, too.

To save price worries, always make sure you get ITT's quote* **before** ordering.

*Call our Diode Information Center for up-to-the-minute price and availability on all ITT Diode and rectifier products: Area code 617-688-1881

We can save
you something!

semiconductors **ITT**

ITT Semiconductors is a division of International Telephone and Telegraph Corporation, 3301 Electronics Way, West Palm Beach, Florida 33407, Phone 305/842-2411. Factories in Florida • Massachusetts • England • France • Germany • Portugal • Australia

Hard-copy display terminal makers starting to probe wide-open market

Initial entries at Spring Joint Computer Conference show various approaches, but considerable design and development work still must be finished; photoconductors, fiber optics, and lenses help improve speed, resolution

By George Weiss

Electronics staff

A half-dozen companies showed up at the Spring Joint Computer Conference in Atlantic City this month with hard-copy output crt terminals, and this was interpreted by some as a top-of-the-iceberg phenomenon.

If true, the iceberg is top-heavy. Indeed, there is plenty of design and development work going on below the level of product introduction, but the problems are formidable and there is no indication that the marketplace will soon be flooded with products.

At IBM, for example, marketing officials say it will take a technical breakthrough to obtain the kind of cost-performance ratio needed by users of interactive time-sharing cathode-ray tube terminals; and Xerox planners think such equipment could be nearly 10 years away.

Meanwhile, there is no dearth of potential users. Among those who are anxious to push a button and get hard copy within seconds from desktop, self-contained crt display terminals are stock brokers, airlines, hospitals, schools, and banks.

The consensus among marketing officials is that 20% to 30% of the crt terminals bought in the near future will include hard-copy requirements, and that the over-all cathode-ray tube terminal market is increasing at a rate that ap-

proaches 50% each year.

At the SJCC, terminals in various stages of design refinement were demonstrated by A. B. Dick, Tektronix, Photophysics Data Systems, Computer Optics, and the Hazeltine Corp.

In addition, Control Data expects to announce a model later this month; Graphic Data Inc. of Burlington, Mass., is developing a unit; and so is Evans and Sutherland of Salt Lake City.

A. B. Dick uses the hard-copy method it knows best—the electrostatic printer with a zinc-oxide coated paper. The company fo-

cused on the clarity of the image produced by the crt. “The printer can resolve 500 lines per inch,” says Glen Gerlach, manager of engineering applications, “but the conventional 10-inch monitor can only resolve 525 lines over its entire face. This is a resolution of roughly 50 lines, so the resolution of the monitor is far lower than the printing process.” But Gerlach claims good copies are received from crt’s with 80 characters on a line, for up to 40 lines, where the characters are about 1/8-inch high. Gerlach feels fiber optics and flat-faced screen are too expensive



By itself. Of all the new hard copy crt terminals on the market, only Photophysics' 45 Data Terminal is self-contained; both printing process and crt are housed in desktop-size cabinet.

TRYGON lab power supplies are...

Full Range
Bench and Rack
Precision
Power Supplies
to 320 VDC,
up to 150A.

**FOR
IMMEDIATE
DELIVERY**

- Auxiliary features important to varied application
- Single, dual and triple outputs
- Field proven high quality and reliability

Write today for your copy of Trygon's
1970 Power Supply Handbook

 **TRYGON POWER SUPPLIES**

111 Pleasant Avenue, Roosevelt, New York 11575
Tel: 516-378-2800 TWX: 510-225-3664
Trygon GmbH 8 Munchen 60, Haideiweg 20, Germany

... several terminals can be linked as slave units over video lines to reduce costs ...

and sophisticated and could price themselves out of a large part of the market.

A. B. Dick's electrostatic printer accommodates a 460-ft. roll of paper that can be turned into 1,000 copies at about 1½¢ per square foot. The paper, which runs about twice as fast as the usual electrostatic paper, retails for \$12 a role; the printing process toner costs about \$8 and lasts for two roles. Gerlach says the printing cost is about one-third of a photographic process.

But the speed of the process may not measure up to the heavy demands that will be placed on crt terminals. The Model 975 Videograph Display Unit, as the terminal is called, can produce hard-copy outputs in 10 to 15 seconds, depending on the brightness of the image.

The crt terminal is mounted on top of the printer; a fixed lens directs the image from the faceplate onto the paper. When the print button is pressed, the intensity of the crt image is increased and the paper is advanced. A special toner provides a black-on-white hard copy from the reverse image that appears on the crt.

Any size monitor can be used with the 975 and adjustment is made by changing the position of the lens with respect to the crt and the hard copy. Depending on the location of the lens, the display can be enlarged or reduced.

Summer debut. Hazeltine uses the same approach as A. B. Dick but its terminal has a keyboard that makes it interactive with a central processing unit. Hazeltine's hard copy is produced at about the same cost and speed as A. B. Dick's. Its Model 1760 displays 32 lines of 55 characters each with a standard tv tube. Hazeltine has been working on the project for about a year and a half, and hopes to get the exposure time down to 2 or 3 seconds. The system will be available in late summer and will sell for \$5,000, not including the printer.

Several terminals can be linked as slave units over video lines resulting in reduced system costs.

The slave units would contain the tube and deflection circuitry without additional electronics. The customer can buy the remote terminal as a stand-alone unit or he can line up any number of monitors with an interactive time-sharing terminal. When the operator desires a hard copy of the display, he presses a button on his console and one of the slave units can be flashed to produce the hard-copy output. Meanwhile, the operator can continue working from the crt terminal.

Self-contained. The Photophysics 45 Data Terminal is the only self-contained unit on the market. It houses both the printing process and the crt's in one desktop-size cabinet.

The image on an internal crt is projected onto a photoconductive plate through a lens. The photoconductor converts the light signal from the crt into an amplified electrical signal. The photoconductor produces a negative charge; it's transferred to paper, which is specially treated and contains both conductive and dielectric layers. Under this negative-producing technique the white on black of the crt image produces a black-on-white image on the hard copy output.

Exposure time takes less than a quarter of a second, and the copy is ready in about 5 seconds. Additional copies can be made in 2 seconds.

"Once the negative charge is placed in the paper, it's no longer light-sensitive," says Guy Marlor, vice president. "You can put the paper in your pocket and walk around with it for a day and then develop it." This simplifies the terminal requirements—only the section where the paper comes in contact with the photoconductor has to be kept light tight.

The charge put on the paper is negative, so when the paper is passed through the toner bath, the positive toner particles adhere to the surface of the paper producing the image.

One disadvantage is the size of the hard-copy output—5 inches

STATE OF THE ART SEMINARS FOR ENGINEERS AND SCIENTISTS

Here's an opportunity to engage in short programs that will review many of the latest advances and engineering techniques in your field . . . presented by RCA Institutes.

LOGIC DESIGN	Minneapolis	5/18-22
	Washington, D. C.	6/1-5
	Chicago	6/15-19
	Albuquerque	7/27-31
	Montreal	8/24-28
	Detroit	8/31-9/4
DIGITAL SYSTEMS ENGINEERING	Cleveland	5/11-15
	Boston	5/18-22
	Montreal	6/1-5
	Denver	6/22-26
	New York	7/6-10
	Washington, D. C.	7/13-17
	San Francisco	7/20-24
	San Diego	7/27-31
	Huntsville, Ala.	8/3-7
	Chicago	8/10-14
Houston	8/24-28	
DIGITAL COMMUNICATIONS	Albuquerque	5/18-22
	Houston	6/1-5
	San Francisco	6/15-19
	Boston	6/22-26
	Los Angeles	6/22-26
	Huntsville, Ala.	7/6-10
	Minneapolis	7/13-17
	Syracuse, N. Y.	7/27-31
	Washington, D. C.	8/10-14
New York	8/24-28	
INTEGRATED CIRCUITS	San Francisco	5/20-22
	San Diego	5/25-27
	Detroit	6/8-10
	Rochester	6/29-7/1
	Montreal	7/6-8
	Houston	7/13-15
	Pittsburgh	7/27-29
	Clark, N. J.	8/3-5
	San Francisco	8/10-14
	Los Angeles	8/17-19

Above schedule subject to change

RCA

RCA Institutes, Inc. Dept. E-50
Institute for Professional Development
Central & Terminal Avenues, Clark, N. J. 07066

For free descriptive brochure, please check the seminar in which you are interested.

- Logic Design Integrated Circuits
 Digital Communications Digital Systems Engineering

Name _____ Title _____

Company _____

Address _____

City _____ State _____ Zip _____

BELL & HOWELL

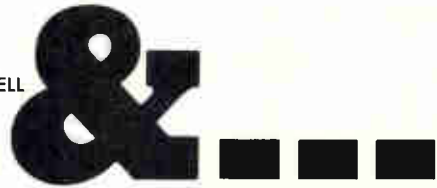

Circle 206 on reader service card

FOR EXCELLENCE IN TERMINATION HARDWARE SPECIFY GRAYHILL



Test Clips

Test Clips

Adjustable tension, threaded studs or plug in bases, various sizes.



Push Posts

Push Posts

Plunger action lets you connect and disconnect quickly and easily, assures positive contact.



Stand-Off Insulators

Binding Posts

Screw type or spring loaded, banana plug or stud mounting, single or multiple units, with various colors for circuit identification.



Binding Posts

Stand-Off Insulators

High dielectric strength, low loss insulation, low moisture absorption, various mounting styles.



Sockets

Sockets

Lamp or transistor, various colors, various mountings including printed circuit.



Plastic Molded Parts

Custom Molded Parts

Tight tolerances provide you with "assembly ready" units. Thermosetting plastics to meet most specifications.

For your Grayhill Engineering
Catalog offering complete technical
data—contact



523 Hillgrove Avenue
LaGrange, Illinois 60525
Area Code 312, Phone 354-1040

... the Difference Between Excellent and Adequate

$H_{(BEEP)}P_{(BEEP)}$
will really
choke on
our new 1018.

Yep.
It's the only
instrument yet
that measures
single or multiple
microwave
pulses.



Attach our new Model 1018 Log/Lin RF Peak Power Meter to any pulsed microwave system. Instantly you get a digital measurement of single or multiple microwave pulses as short as 350 nanoseconds. Independent

of pulse shape, PRF or pulse width. BCD output is system compatible. Write for a data sheet.



Pacific Measurements, Inc.,
940 Industrial Avenue,
Palo Alto, California 94303.
We gotta be better.

PACIFIC
MEASUREMENTS

... fiber optics best for sharp characters ...

square, against the 8½ x 11 size in the other units. However, the data terminal can display up to 1,000 characters, 25 lines of 40 characters each, as well as charts and graphs.

Marlor says that the current 5-by-5-inch photoconductor will be made larger—10 x 12—in future units designed for larger prints. The crt terminal is priced at \$9,950. The print module sells for between \$3,000 and \$3,500. Delivery is scheduled to begin in November.

Light bundles. Computer Optics says fiber optic bundles appear to offer the best method for reproducing sharp characters. Its CO:70, an alphanumeric crt display ter-



Light pipes. Computer Optics' CO:70 crt terminal uses fiber optics to project display onto faceplate.

minal, can display 3,000 characters in both upper and lower case. Each fiber is 6-8 microns in diameter and acts as a tiny light pipe, projecting the display onto the surface of the faceplate, beyond the edge of the crt.

"Because of the distance between the crt and the faceplate, the image would get dispersed if it weren't for the fiber optics," says Fred Crawford, designer of the system, called the Video Image Processor. The VIP includes a standard office copier to generate hard copy on 8½ x 11-inch sheets in less than 10 seconds. The crt is tied up 2 seconds; the rest of the time is for developing. Computer Optics hopes to offer by next year a printer that can be shared among many crt's.

The price range for the VIP will vary depending on the crt display

Tips on cooling off hot semiconductors

See how other circuit designers use IERC heat sinks/dissipators to hold junction temperatures below rated maximums, improve circuit performance and reliability

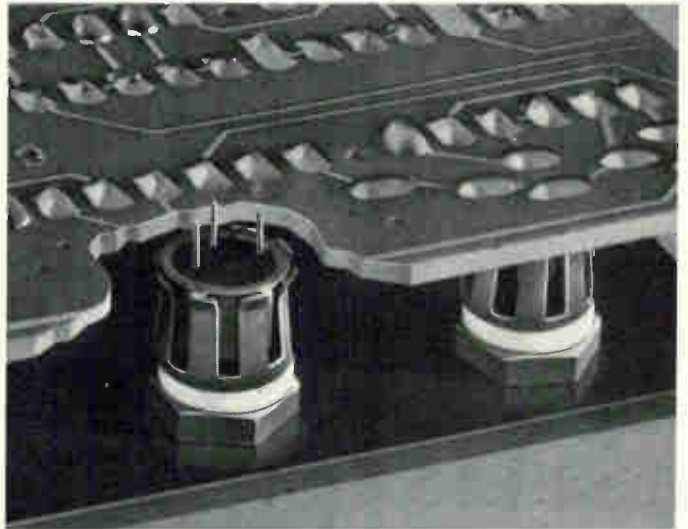
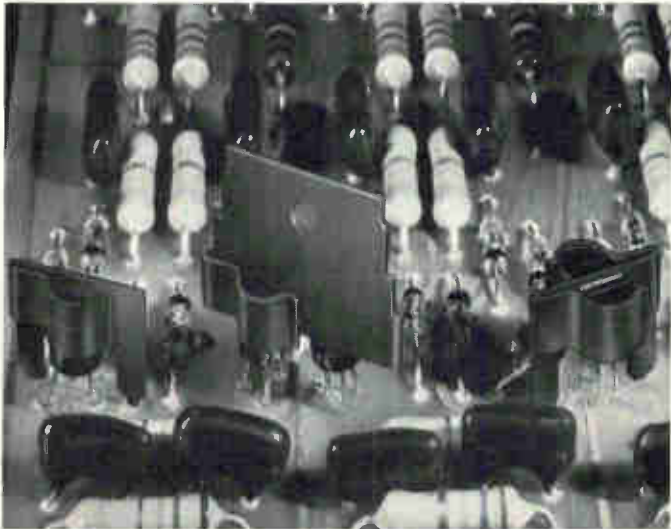

R097's, R097A's, X20's (D-Style) and other lead mounted, low power "plastic" transistors can be operated at up to 65% more power with IERC dissipators. They cost only pennies, provide excellent retention in severe environments, reduce failures from solder heat during assembly. 5 different styles; both single and dual models.

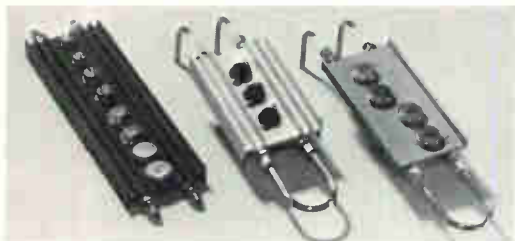

Replace elaborate forced air cooling systems for power devices. IERC fluid cooled systems provide up to 1,000 watts of dissipation in less than 45 cu. in. Parallel or series flow; open or closed loop systems. All standard mounting hole patterns; specials, too. Lengths from 6" to 3' standard.



TO3's, TO66's, TO15's and other case-mounted devices can be operated with many times more power when mounted in UP's. In still air, the staggered fingers dissipate by radiation and convection. In forced air, turbulence moves the air around each finger. Efficient in any direction. Outperforms extrusions dramatically.

For low capacitance between transistor and chassis, use IERC Thermal Links with BeO washers. BeO has the thermal conductivity of aluminum, yet cuts capacitance up to 2/3rds. Excellent dissipators and retainers. Each size fits a complete JEDEC case diameter range for TO5's and TO18's. Dual and quad models also.

Is yours a special heat problem? Talk to the thermal specialists at IERC. They have the problem solving experience to come up with a practical, low cost solution.



Free 4-page Short Form Catalog. Complete ordering and pricing information on the world's broadest line of heat sinks/dissipators and retainers for lead and case mounted semiconductors.

Heat Sinks/Dissipators



The Low-Cost TAPE RECORDER

with the high-cost features

- 8 Channels
- 4 Tape Speeds
- FM or Audio Plug-Ins
- 10½" Reels, ¼" Tape
- \$1725 Less Plug-Ins



We call this recorder our Model A. It will provide clean, low-noise recordings of DC signals from 0 to 1 Kc. Or, it will record audio signals up to 10 Kc. FM or Audio plug-ins may be intermixed in any manner. It will expand or compress time-base by eight times. At the low 15/16 ips speed it will easily record overnight while you sleep.

The instrument features wide-deviation FM for low noise, front panel zero off-set capability, built-in erase, built-in speaker, full monitoring provision for operation with confidence, and a three-motor, Crown transport of proven durability and performance. There are no clutches, brakes or similar friction elements whatever. The drive system (a motor, belt and flywheel) is accurate to 0.2% and is as reliable and economical as it is simple.

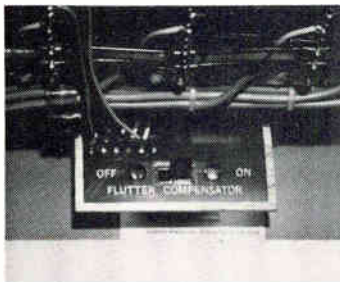

Low Noise at 15/16 ips.

Our recorder is low in price, but not in performance. For example, we achieve a S/N of 43 db at 15/16 when using the built-in flutter compensator shown here. It works at all four speeds and produces performance that would be expected of much more costly recorders. It uses channel 7 as a reference to compensate the remaining seven channels. Or it can be switched off to allow data recording on all eight channels.

Versatility and Economy in Our 4 Speed Plug-In.

The plug-in shown here typifies a design that combines quality and economy. First, we put all the record/playback electronics (except preamps) in the plug-in so you buy only what you need. Then we put a speed switch on each plug-in and ask you to flip each switch to change speeds. This considerable simplification cuts the cost. We use precision components and integrated circuits in the electronics to achieve simplicity and eliminate internal adjustments. We use conservative carrier frequencies and bandwidths to assure clean recordings with non-instrumentation grade tape. Plug-ins cost from \$85.00 to \$195.00 per channel.



If you are going to buy a recorder, ask to see ours. Then decide.

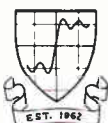

A. R. VETTER CO.

P. O. Box 143, Rebersburg, Pa. 16872

Telephone (814) 349-5461

... dry heat for fast
hard-copy developing ...

unit, which can either be a slave or an interactive terminal. The display price ranges from \$2,025 to \$9,250, and the printer from \$5,000 to \$15,000. Discounts on OEM quantities will be available when the units go into production during the last quarter of this year.

Scanner. Tektronix also sees the combination of crt's and fiber optics as the best method to avoid light dispersion between tube and faceplate. The hard-copy unit can be used with the Tektronix 611 and

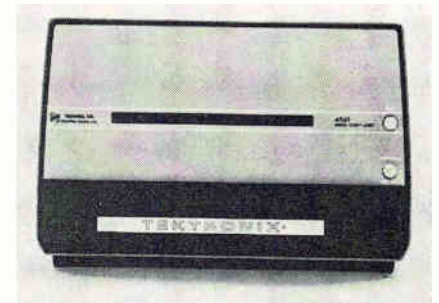

More light pipes. Tektronix also uses fiber optics for character faceplate resolution.

4002 display models, or with the company's new graphic terminal, the 4005. The hard-copy machine is priced at \$3,750.

The Tektronix unit employs a scanning technique. The master crt is scanned by an intensity-modulated beam, and the output signal is amplified and then fed to the fiber-optic crt. 3M type 77 paper is pulled across the screen, exposed, and then heat-developed. The first 8-by-11-inch copy can be made in 18 seconds, and each additional copy takes 10 seconds.

Graphic Data Inc. of Burlington, Mass. also uses a dry-heat process for hard-copy developing. The company says it yields faster and better quality reproduction than electrostatic methods. The cost per copy is 8 to 10 cents and the unit's initial cost is a low \$1,500. Company spokesman claim that heat can serve as a process variable to help adapt the system to several crt consoles and optical systems. First units will be available by the end of this year.

Algorithmic

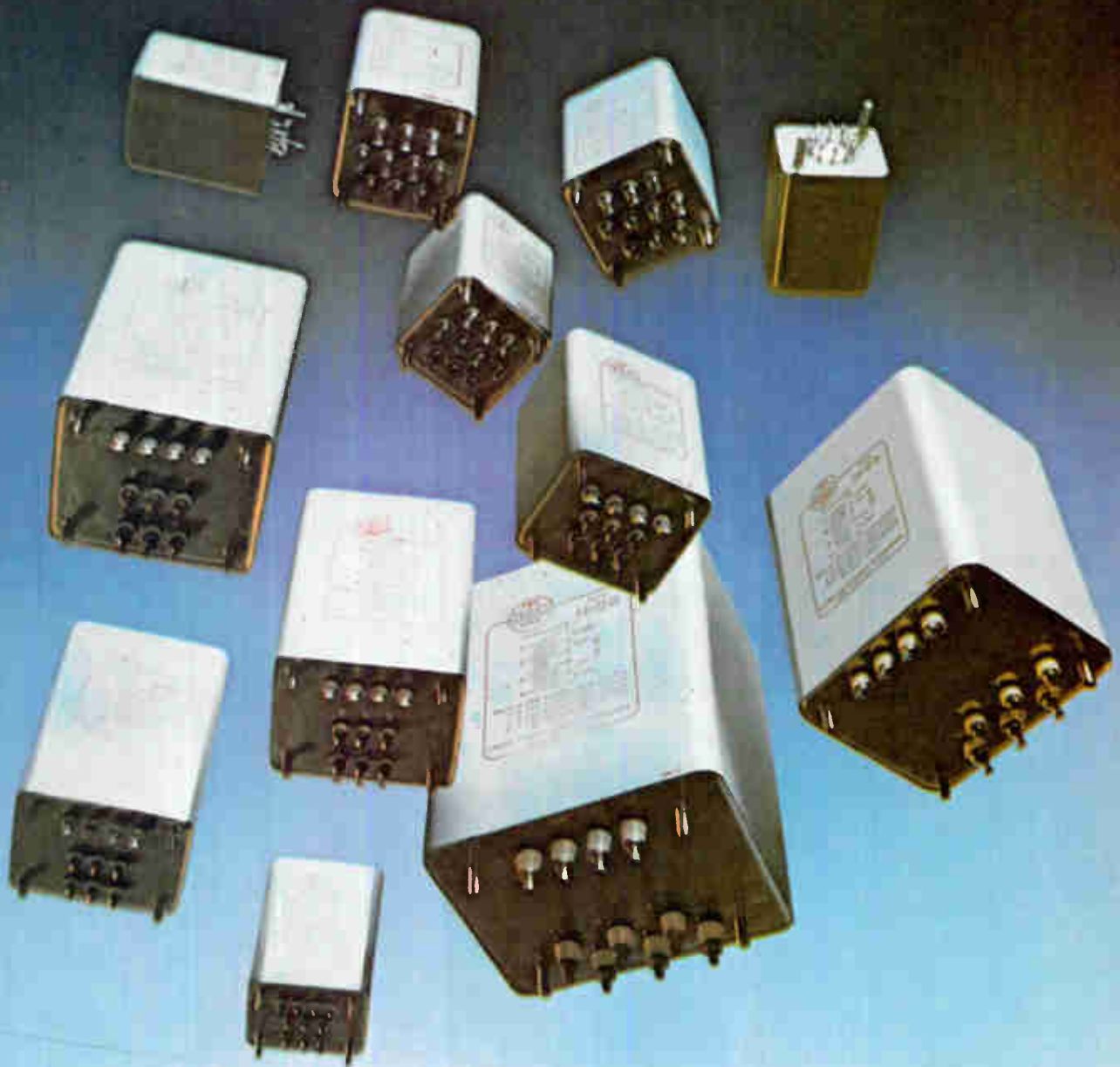

You're looking at 1,056 UTC Power Transformers!

Each of these 12 units has 11 secondary outputs plus 4 primary variations—in military and industrial ratings—resulting in a total of 1,056 different transformers. This algorithm (or calculation) is one way of demonstrating the flexibility available with UTC's Universal Transistor Supply Transformer Series.

Designs include 60 and 400 Hz types. Voltages are from 6 to 106 v. Currents range from .02 to 23 amps. All are hermetically sealed in drawn MIL-Type metal cases and are manufactured and guaranteed to complete MIL-T-27C specifications. Pages 32 and 33 of UTC's 1969 catalog

spell out the specs for 1,056 power supplies.

With transformer flexibility like this, you can simplify breadboarding—meet almost every transistor power supply requirement. You can also avoid the costs and delays of special designs—immediately complete many production runs.

Check your local distributor for off-the-shelf delivery or United Transformer Company, Division of TRW Inc., 150 Varick St., New York, N.Y. 10013.

TRW
UNITED TRANSFORMER COMPANY

Digital voltmeter calibrates itself

Once a minute, instrument connects its input to a built-in reference and adjusts itself back to the specified accuracy—0.001%

Don't try to put a sticker on the LM 1490 each time it gets calibrated; you could wear out your tongue. The 1490, a d-c digital voltmeter from the Solartron Electronic Group Ltd., continually calibrates itself.

Therefore, this high-accuracy instrument can go onto a factory floor, into an airplane or any place else a measurement has to be taken

outside the constant-temperature environment of a standards laboratory. And it's ready to work at rated accuracy as soon as it's turned on.

The 1490 has all the specifications — 100-nanovolt sensitivity, 0.001% accuracy, six ranges—and the price—\$4,460 in the United Kingdom—of a high-performance dvm. It autoranges, changes polar-

ity, and can be remotely controlled. But self-calibrating is the feature that Solartron engineers are counting on to make the instrument sell. "We look on it as a portable standards room," says John Bloomfield, chief development engineer.

Plugged into the meter's mainframe is the reference source that does the calibrating. Once a minute the 1490 disconnects itself from the

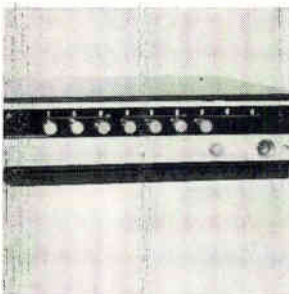

Frequency synthesizer model 1165 is a highly stable sine-wave oscillator and tunable frequency standard. A total frequency range of 10 khz to 160 Mhz in 100-hz steps plus 1×10^{-9} /day stability, phase modulation capability, and remote programability are available in both master (\$5,900) and slave (\$5,300) units. General Radio Co., 300 Baker Ave., West Concord, Mass. [361]



Line noise generator 3020 serves a dual purpose. It generates a controlled line transient similar to rectifier or scr noise on the a-c line, as well as measuring line noise up to 1 kv peak. Noise amplitude and position are continuously adjustable and a sweep mode is provided for scanning noise pulse over 360°. Beckman Instruments Inc., Harbor Blvd., Fullerton, Calif. [362]

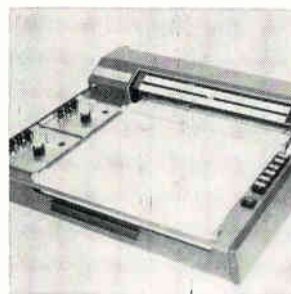

Strip-chart recorders designated Speedomax XL series offer advanced circuitry and finger-tip ease of operation. For fast readability, the black calibration of indicating scales is set against a contrasting yellow field. Pen response is as fast as $\frac{1}{3}$ sec full-scale; accuracy, $\pm 0.25\%$ of span. Prices start at \$800. Leeds & Northrup, Summertown Pike, North Wales, Pa. 19454 [363]

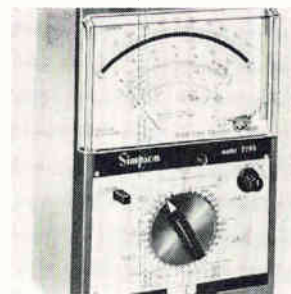

Solid state, FET-input multimeter model 2795 is battery operated. The unit has 68 switch-selectable functions. It is temperature compensated over a range of 0° to 50°C, with a rated accuracy of $\pm 1\%$ for both a-c and d-c. It features 10 megohm input impedance on a-c and d-c ranges above 10 v and negligible voltage drop. Simpson Electric Co., 5200 W. Kinzie St., Chicago 60644 [364]

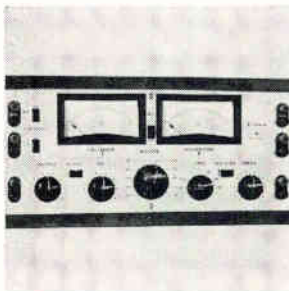

Intermodulation distortion analyzer was developed to meet production-line requirements for high quality audio components. It features accurate measuring capability through 0.01%, and guarantees a residual intermodulation level of less than 0.005%, with 7 full-scale ranges from 100% to 0.1%. Crown Int'l Radio & Electronics Corp., W. Mishawaka Rd., Elkhart, Ind. 48514 [365]

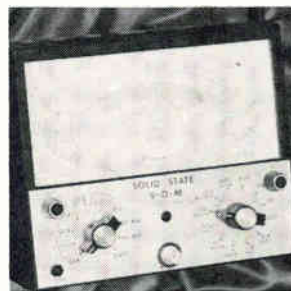

Portable, battery-operated volt-ohm-milliammeter model 801 features low power ohms for IC's, 5-mw sensitivity and 10-megohm input resistance. It provides a-c/d-c current measurements of 5 μ a to 1.5 amps and permits db measurements of -70 to 66 db. It uses a 25 μ a suspension movement meter with $7\frac{1}{2}$ in. scale length. Price is \$200. Triplett Corp., Bluffton, Ohio 45817 [366]



Bidirectional counter model MDBC Mini-Diget will count incoming positive pulses at a rate exceeding 15 Mhz and, with proper signal applied, add or subtract these pulses to arrive at a net accumulation. Provisions within the unit enable the user to preset to an arbitrary count of zero before initiating new count. Instrument Displays Inc., 18 Granite St., Haverhill, Mass. [367]

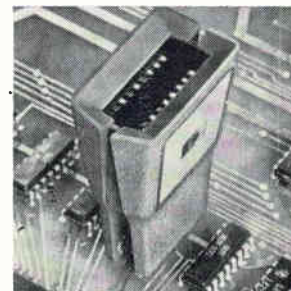

Logic clip model 10528A is a handy troubleshooting and design aid that clips onto TTL or DTL IC packages and instantly displays the logic states of all 14 or 16 pins. It has 16 light-emitting diodes, each of which follows voltage-level changes on one pin. A lighted diode indicates a high logic state (+5 v). Hewlett-Packard Co., 1501 Page Mill Rd., Palo Alto, Calif. 94304 [368]

Would the engineer who asked us to design a marking system to serialize on an electronic praying mantis, please call (603) 352-1130.

It's ready.

If for some strange reason you're not making electronic praying mantises, how about your transistors, IC's, SCR's, diodes, thyristors or whatever. We can handle those, too.

We've got the systems, typefaces, inks, supplies and services to mark whatever you make, and mark it right.

Our problem-solver booklet will tell you more about us.

Write for it now.

(before you go bugs)

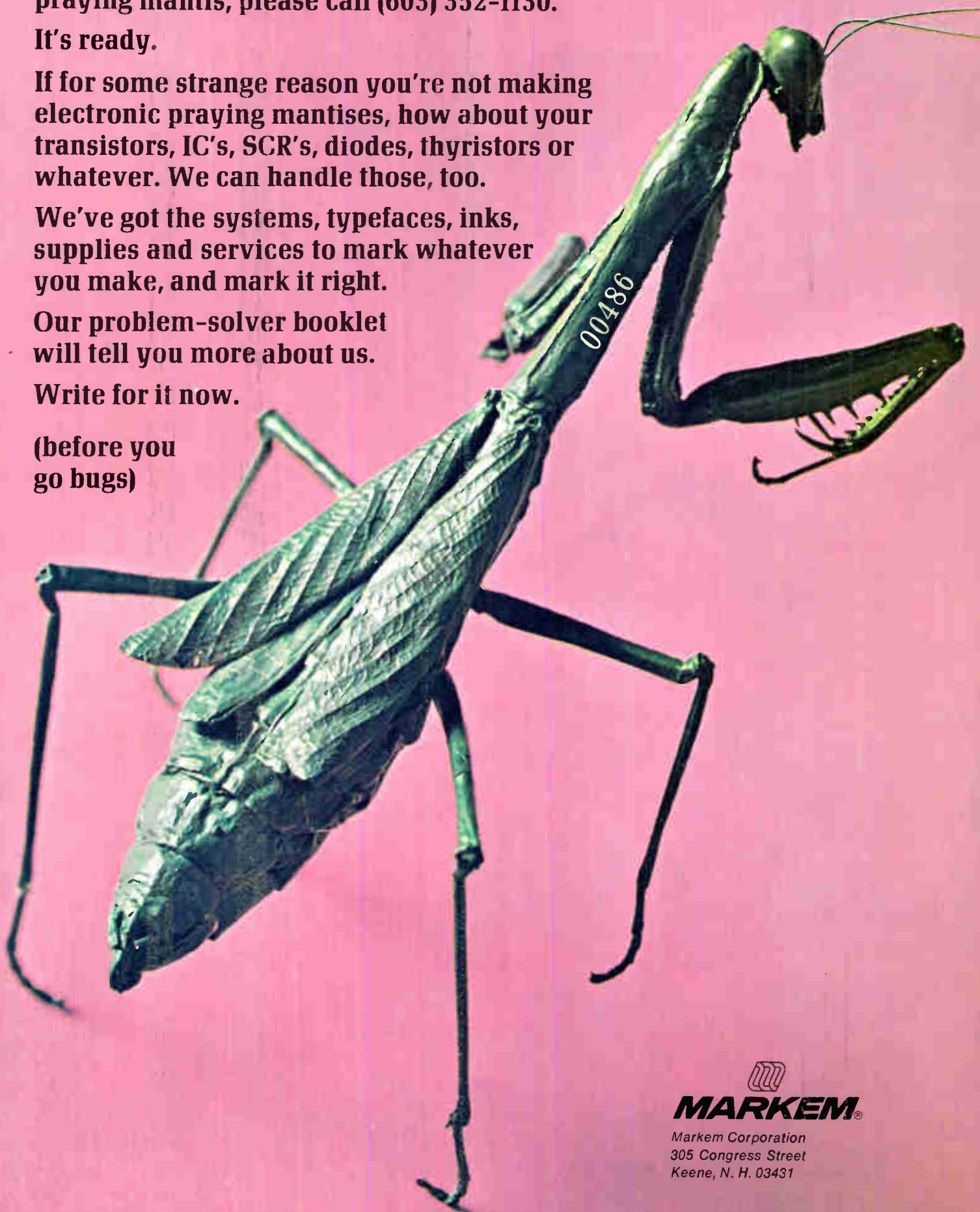

MARKEM®

Markem Corporation
305 Congress Street
Keene, N. H. 03431



NOW AVAILABLE
Westinghouse
di/dt
Gate Thyristors
These high di/dt devices reduce
circuit component costs.
Write for our new data sheet

**Off-the-shelf
Westinghouse thyristors
balanced for all
critical parameters.
Try 'em.**

Design Security

With thyristors that meet all critical design parameters—not just a couple—you get more design security. And Compression Bonded Encapsulation (a Westinghouse exclusive) to assure low thermal impedance. Our parameter optimization gives you another bonus: reduced equipment size . . . plus savings on

circuit components.

Vital statistics: 40 to 550 amps, up to 2000 volts; standard JEDEC and POW-R-DISC packs.

For complete data and prices, contact your local Westinghouse Distributor (see adjacent listing) or Westinghouse Semiconductor Division, Youngwood, Pa. 15697.

You can be sure... if it's Westinghouse





Westinghouse Industrial Semiconductor Distributors

Alabama

ACK Semiconductors, Inc.
Birmingham 205 322-0588
Electronic Wholesalers, Inc.
Huntsville 205 534-5722

Arizona

Hamilton Electro of Arizona
Phoenix 602 272-2601
Kierulff Electronics Corp.
Phoenix 602 273-7331

California

Newark Electronics
Inglewood 213 674-8440
Hamilton Electro Sales
Los Angeles 213 870-7171
K-Tronics
Los Angeles 213 685-5888
Elmar Electronics, Inc.
Mountain View

415 961-3611

Hamilton Electro Sales—North
Mountain View

415 961-7000

Hamilton Electro of San Diego
San Diego 714 279-2421

Colorado

Electronic Parts Co.
Denver 303 266-3755
Hamilton Denver
Denver 303 934-5508

Connecticut

Cramer Electronics, Inc.
North Haven 203 239-5641

Florida

Cramer Electronics, Inc.
Fort Lauderdale 305 566-7511
Electronic Wholesalers, Inc.
Orlando 305 841-1550

Georgia

Specialty Distributing
Atlanta 404-873-2521

Illinois

Semiconductor Specialists, Inc.
Chicago 312 279-1000
Pace/Avnet Electronics
Schiller Park 312 678-6310

Indiana

Fort Wayne Electronics Supply, Inc.
Fort Wayne 210 742-4346
Ra-Dis-Co.
Indianapolis 317 637-5571
Radio Distributing Co.
South Bend 210 287-2911

Maryland

Pyttronic Inc.
Baltimore 301 727-5100
Hamilton Electro Sales
Baltimore 301 796-5000
Cramer Electronics, Inc.
Rockville 301 424-2700

Massachusetts

Cramer Electronics, Inc.
Newton Ctr. 617 969-7700

Schweber Electronics
Waltham 617 891-8484

Michigan

Semiconductor Specialists, Inc.
Detroit 313 255-0300

Minnesota

Semiconductor Specialists, Inc.
Minneapolis 612 866-3434
Stark Electronic Supply
Minneapolis 612 332-1325

Missouri

Electronic Components for
Industry Co.
Kansas City 816 421-8400

Electronic Components for Industry Co.

St. Louis 314 647-5505
Hall-Mark Electronics Corp.
St. Louis 314 521-3800

New Jersey

General Radio Supply Co., Inc.
Camden 609 964-8560

Angus, Inc.

Moorestown 609 235-1900
Sterling Electronics, Inc.
Perth Amboy 201-HI 2-8000

New Mexico

Kierulff Electronics Corp.
Albuquerque 505 247-1055

New York

Stack Industrial Electronics
Binghamton 607 723-6326
Summit Distributors
Buffalo 716 884-3450
Cramer/Eastern
East Syracuse 315 437-6671
Schweber Electronics
Long Island 516 334-7474
Milgray Electronics, Inc.
New York 212 989-1600

Ohio

Sheridan Sales
Cincinnati 513 761-5432
Sheridan Sales
Cleveland 216 524-8120
Hughes-Peters, Inc.
Columbus 614 294-5351
Mentronics, Inc.
Mentor 216 946-3058

Oklahoma

Hall-Mark Electronics Corp.
Tulsa 918 835-8458

Pennsylvania

Cameradio Company
Pittsburgh 412 391-4000

South Carolina

Sawyer Electronics Corp.
Greenville 803 235-0438

Texas

Hall-Mark Electronics Corp.
Dallas 214 231-6111
Midland Specialty Co.
El Paso 912 533-9555
Hall-Mark Electronics Corp.
Houston 713 781-6100
Lenert Company
Houston 713 225-1465
The Altair Co.
Richardson 214 231-5166

Washington

Hamilton Electro Sales of the
Pacific Northwest
Seattle 206 624-5930
Kierulff Electronics Corp.
Seattle 206 725-1550

West Virginia

Charleston Electrical Supply
Company
Charleston 304 346-0321

Wisconsin

Taylor Electric Company
Milwaukee 414 964-4321

Canada

Canadian Westinghouse
Hamilton, Ontario 416 528-8811

European Headquarters

Westinghouse Electric
International, S.A.
London, S.W. 1

Whitehall 2704

Westinghouse Semiconductor Division
Youngwood, Pennsylvania 15697



Pick it. The LM 1490's reference can be a Weston cell, a zener-diode source, or an external signal.

voltage being measured, hooks into the reference, and adjusts itself to compensate for any drift. The whole process takes but a few milliseconds. Solartron offers a choice of reference—a saturated or unsaturated Weston cell, a zener-diode source, or an external signal.

Like most standards-lab dvm's, this meter digitizes a signal by sending it through a voltage-to-frequency converter and counting the pulses from the converter for a preset period, called the integration time.

The 1490's ranges operate from 20.0000 millivolts to 1000.00 volts. Accuracy is: ($\pm 0.001\%$ full scale $\pm 0.003\%$ of reading ± 1 microvolt).

How sensitive the meter is depends on the integration time, range, and amount of filtering chosen by the user. Set to its 20-mv scale and running at six readings per second (five readings for 50-hertz line power), the 1490 resolves 100 nanovolts. In its 1,000-volt scale and making 600 readings a second, the meter resolves 1 volt.

Solartron engineers say that ability to handle noise is another of the instrument's strong points. Series-mode rejection is 90 decibels and common-mode rejection is 160 db (both ratings for 50-hz power). The user can make the noise rejection even better by hitting the x10 button, increasing the integration time while holding the sensitivity constant; the x2 button, synchronizing the power-line signal with the clock signal that sets the integration time; or the filter button, adding 30 db of rejection to signals that have frequencies higher than 50 hz.

Solartron Electronic Group Ltd., Farnborough, Hampshire, England [369]

When HP decides to build an automatic capacitance bridge, look what happens:

4 Test Frequencies. The HP 4270A is the only automatic capacitance bridge giving you four test frequencies covering the 1 kHz to 1 MHz range.



Wide Range. Measures from .001 pF to 1.2000 pF in six automatically selected ranges, to handle most popular components and devices.

Direct Reading. No need for time-consuming calculations. Displays capacitance and loss (D or G) simultaneously. The measurements look you clearly in the face.

Low Ground Test. Another HP exclusive. For the first time, you can automatically measure capacitance to ground.

It does things no other capacitance bridge can do. And it does everything in the reliable fashion you expect from HP instrumentation.

In short, the HP 4270A is engineered specifically to meet all the requirements of circuit design, component evaluation, incoming inspection and

QA. Built-in programming and BCD output equip the instrument for systems applications as well. And it does all this for \$4825. Your local HP field engineer has all the details. Give him a call, or write to Hewlett-Packard, Palo Alto, California 94304; Europe: 1217 Meyrin-Geneva, Switzerland.

HEWLETT  PACKARD

18003

Power supply eliminates switching regulator

Low-voltage drop across series-pass element increases efficiency of power supply to better than 50% at 5-volt outputs

What happens when you decrease the voltage drop across the series pass transistor in a regulated power supply? The power dissipation is decreased, resulting in greater efficiency. And along with greater efficiency come better reliability and higher mean time between failures. These are the virtues Dynage Inc. claims for its new L-Series, d-c power supplies that achieve effi-

ciencies greater than 50%, compared to conventional series regulators with typical efficiency figures of 30% to 35% at 5-volt output levels.

Normally, there's about a 3-volt drop from the collector to the emitter of the series-pass transistor, accounting for 30 watts of loss at 10 amperes. The L-Series has a voltage drop of 1 volt across the

series element, or a 10-watt loss. In addition, no switching regulators, silicon-controlled rectifiers, and d-c to d-c converter techniques are used in the L-Series. All of these can add noise to the system.

Redesigned out. "We eliminated the regulators, SCR's, and d-c to d-c converters by redesigning the series pass section," says Peter Klein, marketing manager. Klein



Vhf/f-m solid state maritime receiver MR-201 consists of a 25-w unit in a rugged splash-proof case, a control panel, speaker panel and a handset. It uses only one crystal in a stabilized master oscillator, permitting immediate use of all 55 of the new maritime channels. It provides rapid channel selection through digital tuning. Collins Radio Co., Dallas 75207 [381]

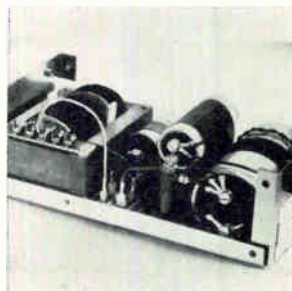

Partially regulated module power supply features adjustable taps to increase its flexibility. The taps provide 5 selectable outputs over a range of about $\pm 10\%$ using a flying-lead and clip arrangement. The PRM comes in 17 models. Model PRM12-5 (nominal 12 v, 5 amps) can be set up for voltages of 10.4, 11.2, 12.0, 12.8 or 13.6. Kepco Inc., 131-38 Sanford Ave., Flushing, N.Y. [382]

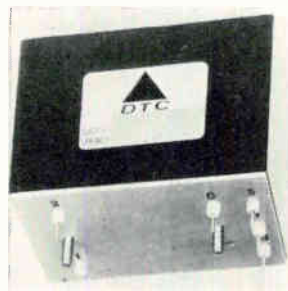

Power supply modules are available in 3.6-v, 5-v, and 15-v packages. They are housed in aluminum and epoxy cases only 2 x 2 x 3 in. Designed for military and aerospace as well as commercial-industrial use, the three modules meet a wide range of applications. The 1 to 24 price is \$59; the 100-plus price, \$49. Delta-Tronics Corp., 1710 E. Princess Dr., Tempe, Ariz. 85281 [383]

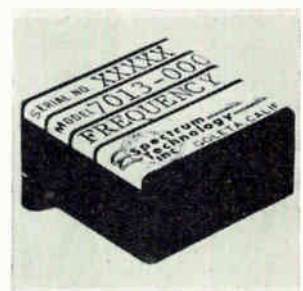

Subminiature, temperature compensated, crystal oscillator measures $\frac{1}{2}$ cu. in. in volume. Frequency range is 6 Mhz to 20 Mhz (any specified frequency). Calibration accuracy is ± 1 ppm at 25°C. Input voltage is any specified voltage between 12 v d-c and 20 v d-c; current, 6 ma to 30 ma depending on load. Regulation is $\pm 1\%$. Spectrum Technology Inc., Box 948, Goleta, Calif. [384]



Dual-output tracking power supply LXN-3-152 is designed to power operational amplifiers. It features tracking accuracy of 0.1% absolute voltage difference for all conditions of line, load and temperature. Regulation is 0.1%, line or load. Ripple is 1.5 mv rms, 5 mv peak-to-peak. Temperature range is 0 to 71°C. Lambda Electronics Corp., Broad Hollow Rd., Melville, N.Y. [385]

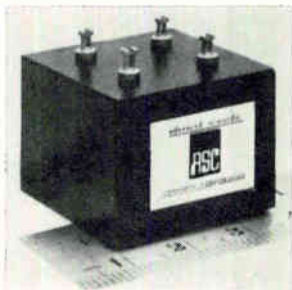

Power supply ASC-E21 incorporates electronic circuitry for powering up to 10 or more square inches of illuminated electroluminescent load. It is capable of operating over a wide d-c input voltage range. It will start at an input voltage level as low as 1.5 v d-c. It operates at a minimal input voltage of 9 v d-c. Daedalus Communicators, 1 Mitchell Place, New York 10017 [386]

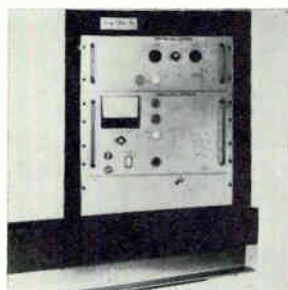

Laser system RG/1,000 produces 1,000 Mw of laser radiation with ruby or neodymium laser rods. Repetition rate is 1 pulse per minute. The system uses a Pockels cell Q-switch. Line widths less than 0.06 angstrom and beam divergence of less than 3 milliradians full angle can be achieved with ruby laser rods. Image Optics Inc., 1101 Colorado Ave., Santa Monica, Calif. 90404 [387]



FET-input differential operational amplifier model 40 features 10^{11} ohms input impedance, 50 pa/°C bias current and bias current drift, 50 uv/°C voltage drift, 5,000 common mode rejection, 200,000 open loop d-c gain, 100 khz full power response, and ± 10 v, 5 ma rated output. Unit price is \$12; availability, from stock. Analog Devices Inc., 221 Fifth St., Cambridge, Mass. [388]

Are you suffering from Intermittent opens of the IC

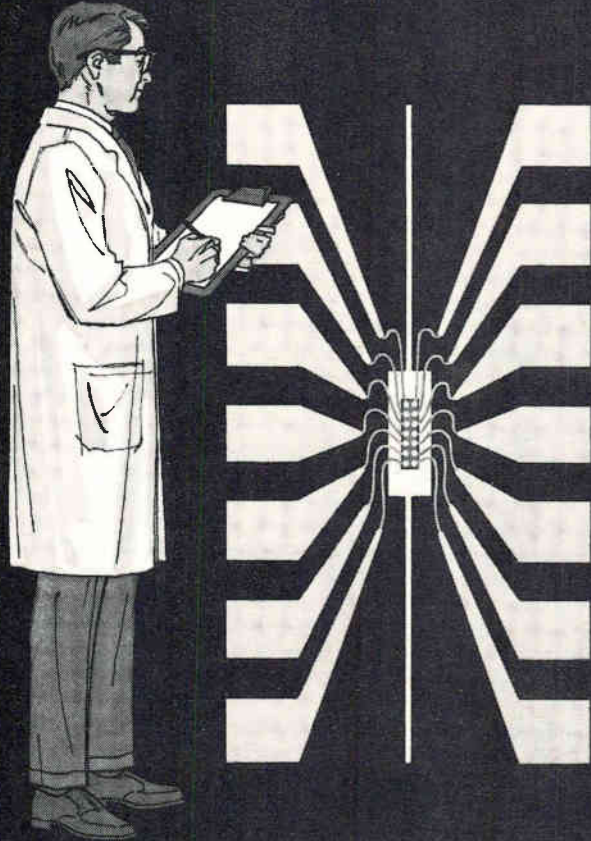

Cure it with Hysol MH15

New HYSOL MH15 semiconductor molding powders eliminate intermittent opens caused by bent or broken interconnecting lead wires in the molding process, by corrosion or thermal cycling of integrated circuitry at elevated temperatures. This molding powder is designed with a *better balance of properties* to meet more requirements than any other product we have seen. Its soft flow insures better moldability of dual in-line packages. HYSOL MH15 semiconductor molding powders increase yield and reduce costly material related IC failures. They're moisture resistant. Low flash, too!

For further information or technical assistance, call (716) 372-6310, or write HYSOL, Olean, New York 14760.

D HYSOL DIVISION
THE DEXTER CORPORATION

... includes built-in
overvoltage protection ...

said that the approach was simple, but would not reveal details.

Standard features in the L-Series, usually found only as an option in other units, are the adjustable built-in overvoltage protection and parallel operation. "The overvoltage protection is temperature compensated so the customer can be pretty sure that if the temperature goes up, the overvoltage set point won't," says Klein. The point is set to its nominal value, and if the customer wants a different setting, he can adjust it to fit his own requirements, Klein adds.

The parallel operation feature allows four power supplies to be connected in parallel with current shared between the supplies while remaining within $\pm 5\%$ of each other without degrading the specifications.

Clamping resistors are connected between the remote sensing terminals and the main power output terminals to prevent the output voltage from rising to a dangerous level when a sense lead is inadvertently opened. The clamping resistors have a negligible effect on the $\pm 0.3\%$ load regulation of the supply.

Other standard features of the L-Series include automatic overcurrent protection, thermal overload protection, and remote sensing. Remote programming capabilities also are featured.

Better mtbf. The mtbf figures for the L-Series are 30% to 60% greater than for the Dynage H-Series power supplies. The 75-amp unit runs for about 45,000 hours—a gain of about 15,000 hours on the older units.

The units come in five case sizes, all ready for mounting in a 3½-inch rack adapter. The units can be mounted on one of four sides in any mounting plane with other single and dual output power supplies.

The Dynage L-Series supplies have the highest watt-per-cubic-inch rating of any of the series regulators currently on the market. Full power rating is maintained at all input frequencies without derating.

Prices run from \$139 for the 5.5-

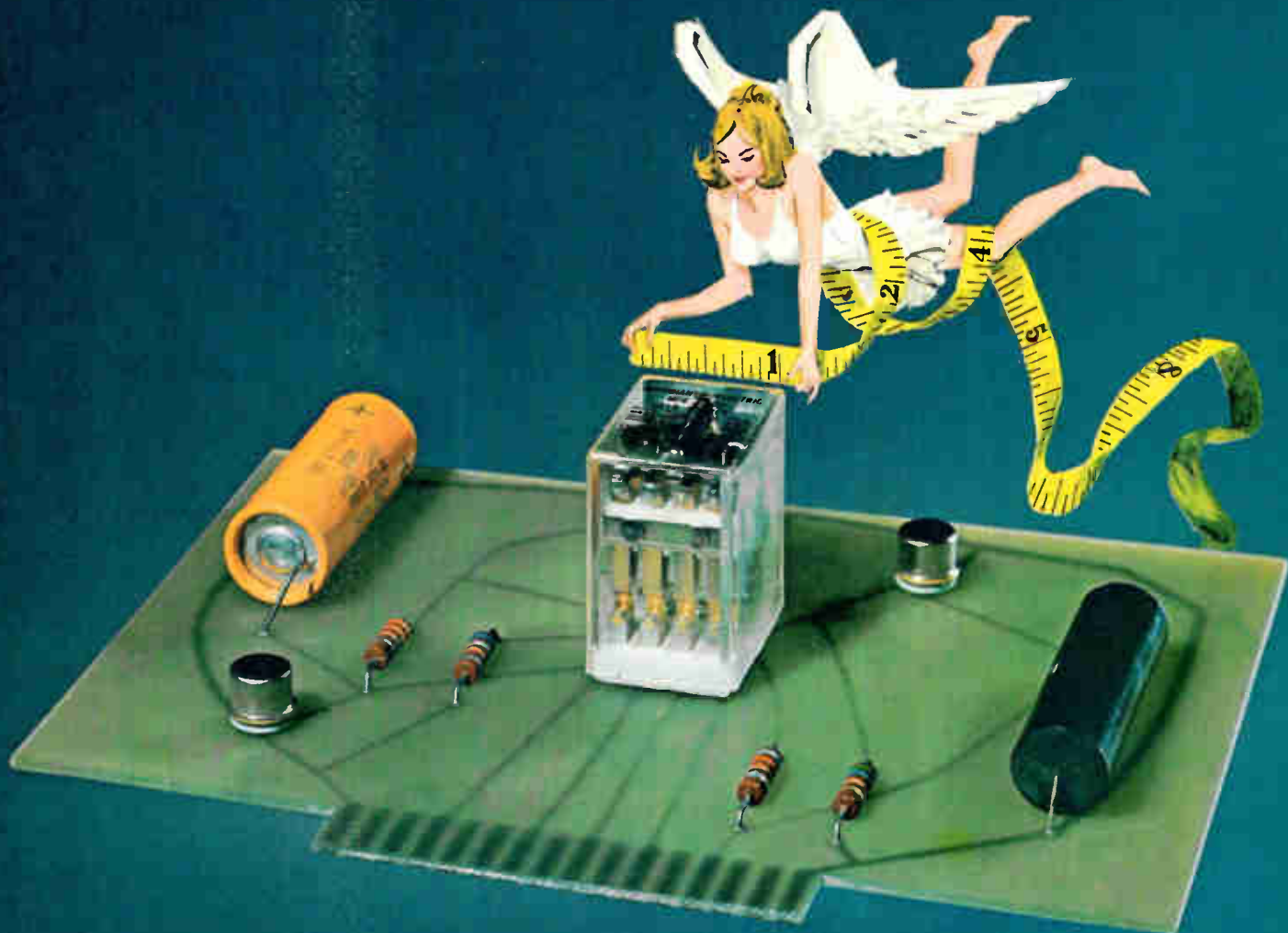

Trust your Guardian Angel

for the newest 4PDT—5amp miniature relay

Give us a cubic inch on your printed circuit board . . . and we'll fill it with a plug-in relay. The logical relay for logic systems, computers, business machines—any application requiring maximum endurance and reliability in minimum space. Our new 1310, 4PDT-5 amp miniature relay is just a little more than one cubic inch in size, with inductive load contact rating of $\frac{1}{8}$ hp @ 120V 60 Hz. But the small size doesn't limit its mechanical life of 100 million operations DC, 50 million AC. Minimum!



The miniature size doesn't limit its versatility, either. It's available with a choice of solder lug, quick connect .110, or printed circuit terminals—sockets for "plug-in" installation available with PC or solder lug. Other features like AC and DC versions, the Lexan dust enclosure that's standard, plus U/L and CSA recognition make this relay the answer to an engineer's prayers. (And all this time you didn't really believe you had a Guardian Angel!)



**GUARDIAN[®]
ELECTRIC**

MANUFACTURING COMPANY · 1550 West Carroll Avenue, Chicago, Illinois 60607



COMPLETE APPLICATION DATA is yours for the asking. Send for Bulletin B5-1.

Look what's happened to Collins SSB Mechanical Filters

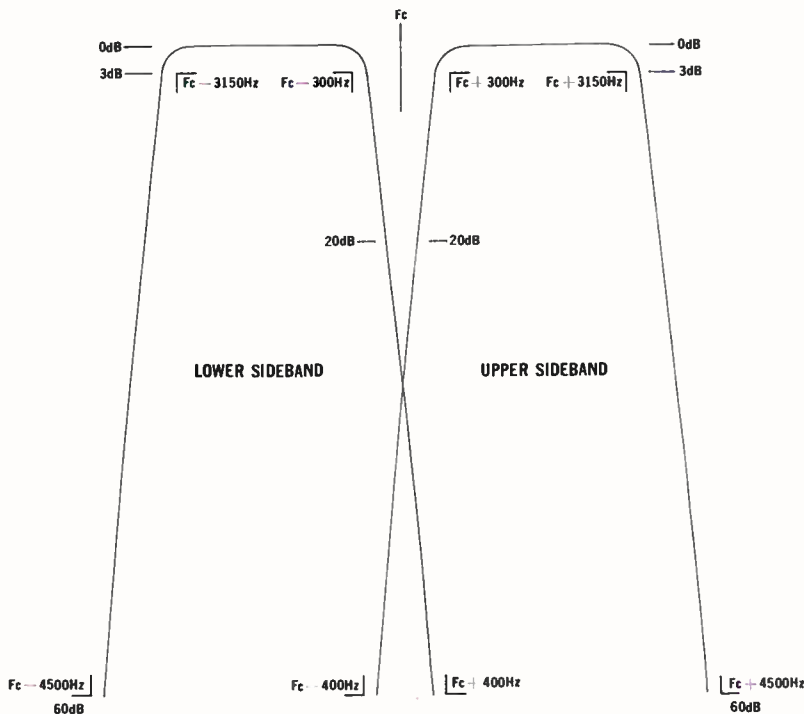

This diagram shows the "worst case limits" of Collins new single sideband 455 and 500 kHz mechanical filters. The worst-case-limit curves mean literally what they say—for any number of filters, exposed to any temperature within the specified operating temperature range, the performance of the worst filter in the group will be equal to or better than the limits shown.

Collins new F455Z-23C/24C and F500Z-22C/23C SSB filter pairs are highly selective, have low insertion loss and require no tuning. Envelope delay characteristics are smooth and flat enough for transmission of high speed data without equalization. Cost? Less than crystal filters.

Piezoelectric transduction and patented "double-bridging" techniques contribute to these ideal characteristics: carrier suppression better than 20 dB • audio response range from 300 to 3150 Hz • 60 to 3 dB bandwidth ratio 1.3 to 1 with transition as low as 400 Hz • insertion loss 3 dB • nominal passband ripple 1.5 dB • third order intermodulation distortion typically -62 dB with -20 dBm input • frequency shift of approximately 20 Hz over a temperature range of -20 to 65°C • hermetically-sealed package volume of three-fourths of a cubic inch.

These mechanical filters are examples of engineering and manufacturing excellence achieved at Collins through use of the C-System, an integrated, computer-controlled system for design and production.

For further information write Collins Radio Company, Dept. 600, Newport Beach, California 92663. Phone: (714) 833-0600.

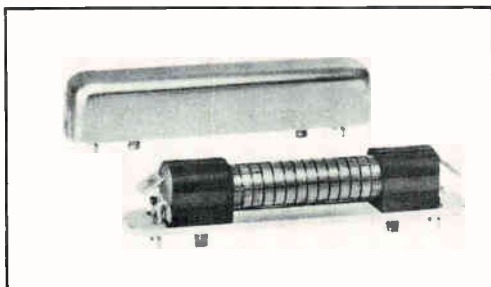

COMMUNICATION/COMPUTATION/CONTROL

amp supply to \$525 for the 75-amp unit. All units will be on a 72-hour delivery schedule by June 15.

Specifications

Nominal output voltages	5, 12, 15, and 24 volts
Output current ratings	1.4 amps to 75.0 amps
Combined line and load regulation	±0.5%
Load regulation	±0.3%
Line regulation	±0.2%
Ripple voltage	5 mv rms (max.) 15 mv p-p (max.)
Temperature coefficient	±0.05%/°C
Operating temperature range	-20°C to +71°C

Dynage Inc., 1331 Blue Hills Ave., Bloomfield, Conn. 06002 [389]

New subassemblies

Midispeed printer is minipriced

Size of electric typewriter, impact unit runs at 300 lpm and has a \$4,995 price tag

A small group of engineers, whose specialty was the design of impact line printers, formed their own company about a year and a half ago to produce a low-cost, medium-speed printer for the minicomputer market. They reasoned that they could build the printer that would cost less than comparable models from well-entrenched companies, yet still provide the user with a machine tailored to his needs, because theirs wouldn't need the costly mechanical parts essential to high-speed printers, which operate at about 1,000 lines a minute.

Syner-data unveiled its first model—Alpha—at the Spring Joint Computer Conference last week. The Alpha is a fully buffered, 300 line-per-minute, 80-column printer, not much larger than an electric typewriter. It uses standard carbon interleaved pin-fed paper, weighs less than 100 pounds, and contains the 64-character ASCII subset.

The unit will sell for \$4,995 in OEM quantities of 50, and \$6,660 for single units. In addition to the buffer, the price includes the inter-

You get all these design choices

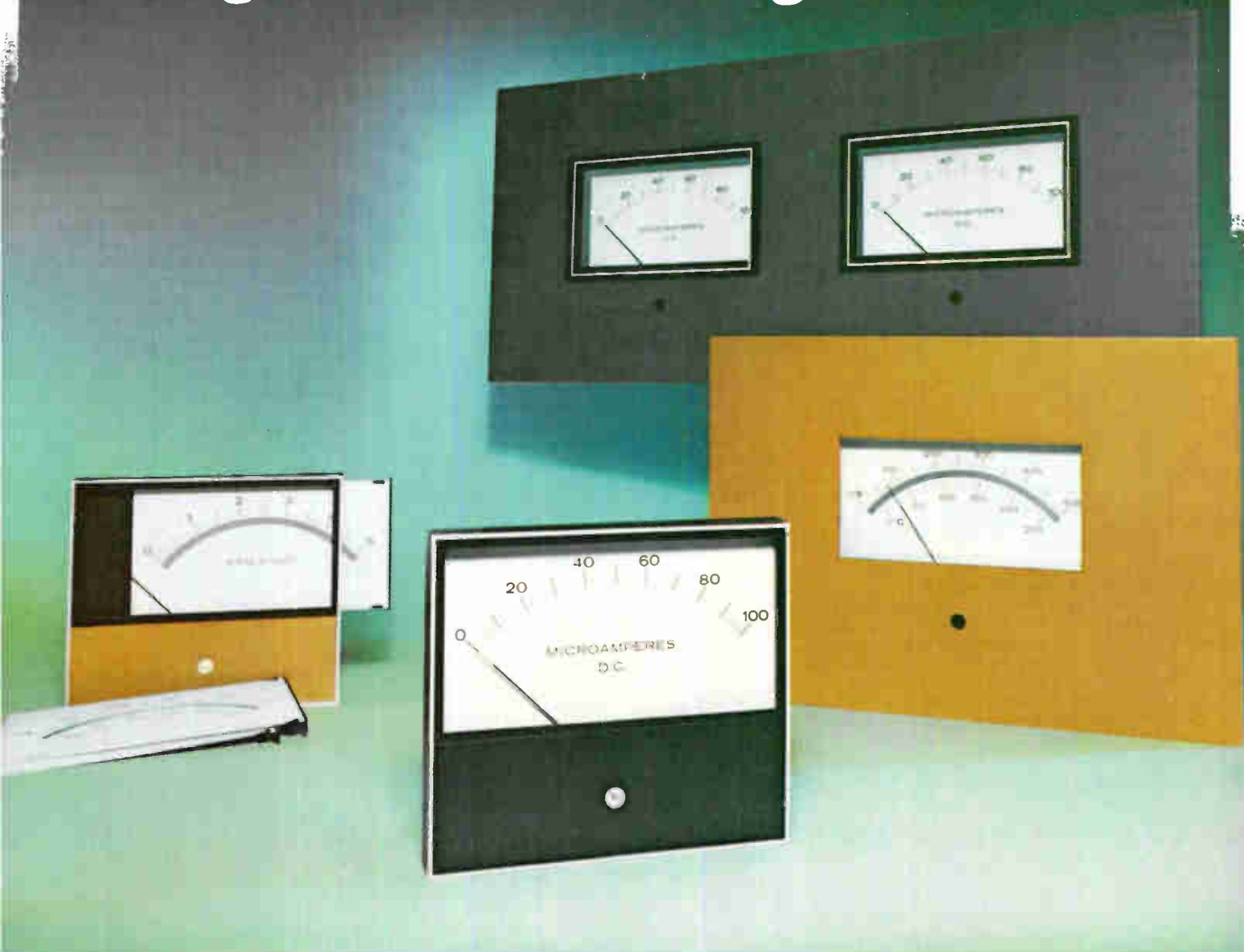

...with one new API meter

■ API Series 7000 panel meters, styled for the '70s, offer the greatest versatility ever built into a single meter design. You can front mount, bezel mount or lens mount. Change the slide-in scale in the field, without damage, to reduce inventory requirements. Enhance your panel design with "stick-on" front color plates. ■ Taut band and 1% tracking are standard in the most popular DC ranges. Phenolic cases incorporate glass windows that are scratch-proof, free of static electricity. Low OEM quantity prices. ■ *Ask for Bulletin 67.*

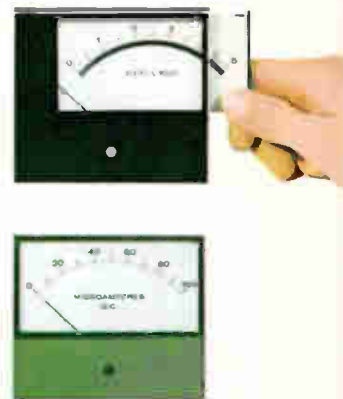

api INSTRUMENTS COMPANY | Chesterland, Ohio 44026 | (216) 729-1611

Circle 159 on reader service card

Need sophisticated components such as these?



This?

Most circuit designers do



Or this?

Integrated circuit packages are critical in use because about any standard.



And how about this two terminal device—

a small but critically important resistor?

After perusing the following details, more circuit designers and component-reliability engineers than ever before will realize that SAGE SILICOHM® miniature power resistors stand out above all others in providing:

- 1 smallest size vs wattage rating
- 2 fully welded construction using precision wire elements
- 3 Sage IMPERVOHM® silicone encapsulation, designed for 1000 volt body insulation and operating temperature extremes -65°C to 350°C
- 4 close tolerance, 1%, .5%, .25%, .1%, .05%
- 5 close TC, ±10 PPM/°C standard
- 6 copper leads standard; weldable nickel or Dumet when specified



- 7 premium high conductivity core materials available
- 8 non-inductive windings when specified
- 9 low values to .05Ω, specials even lower
- 10 millions of unit-hours reliability documentation under Polaris and Improved Minuteman programs

We welcome the opportunity to discuss your requirements.
Sage Electronics Corp., Box 3926, Rochester, N. Y. 14610
Tel: (716) 586-8010

Precision Power Resistors

SAGE

ELECTRONICS

SUBSIDIARY OF GULTON INDUSTRIES, INC.



... data-transfer rates to 400 khz in parallel ...

face electronics for most small computers currently on the market.

Syner-data uses punch-press parts which are more conducive to high-volume manufacturing techniques and help considerably in reducing the costs.

Hits drum. The Alpha still uses the conventional print-drum ap-

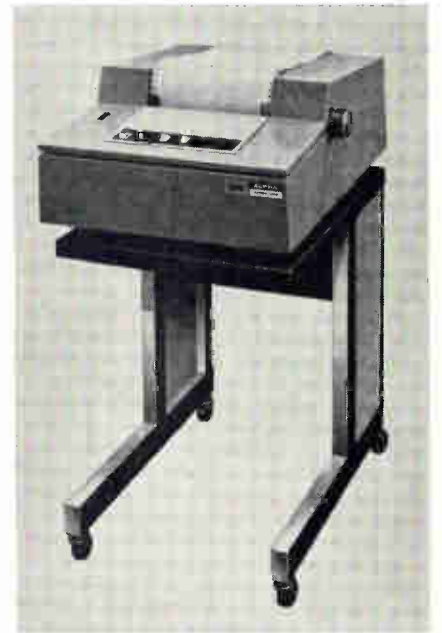

Wordsmith. Newly formed Syner-data showed off its first product—a fully buffered, 300-line-a-minute, 80-column printer—at the SJCC. Weighing less than 100 pounds, printer sells for \$4,995.

proach, but instead of a ribbon, it uses a Porelon ink roller. The roller is a cylinder saturated with ink that makes contact with the surface of the print drum.

The buffer handles data-transfer rates up to 400 kilohertz in parallel and 4,000 baud in serial. While the unit comes as a completely buffered printer with all interface electronics, the printer is also available to OEM customers without the buffer or any of the electronics except that for the drive mechanism.

Production quantities will be available in June.

Syner-data, Route 128, 133 Brimbal Avenue, Beverly, Mass 01915 [390]

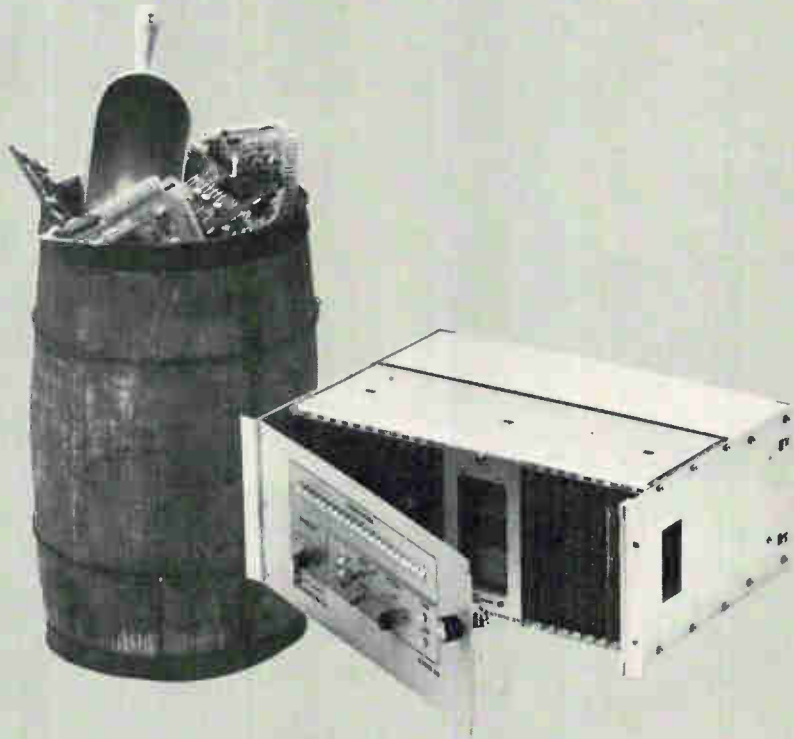

The Memory Store: Store/33

Now you can buy as much memory as you need: 4K x 6 up to 16K x 24. You have a choice of full cycle times: 650 or 850 nsec. You get plug-in stack construction and a power supply only if you want it. Store/33 offers $2\frac{1}{2}D$ cycle time at 3D prices. OEM quantities, for example, of the 8K x 16 version are under \$4700 without power. Part of the secret is that we make our own cores. And test them one hundred percent. Part is our long experience in running a memory store . . . an off-the-shelf memory store. Ask Bob Allen. 213/887-8000.

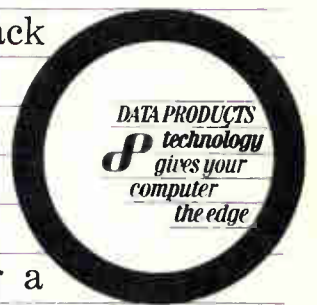

DATA PRODUCTS

6219 Oe Soto Avenue/Woodland Hills, California 91364

Los Angeles 213/887-8000 Minneapolis 612/927-8747 Dallas 214/231-2240 Acton, Mass. 617/263-3961 Bethesda, Md. 301/652-8120
Melbourne, Fla. 305/723-0720 Chicago 312/325-6630 Amsterdam, The Netherlands 020/156-297 London, England 01-579-2917

Circle 161 on reader service card

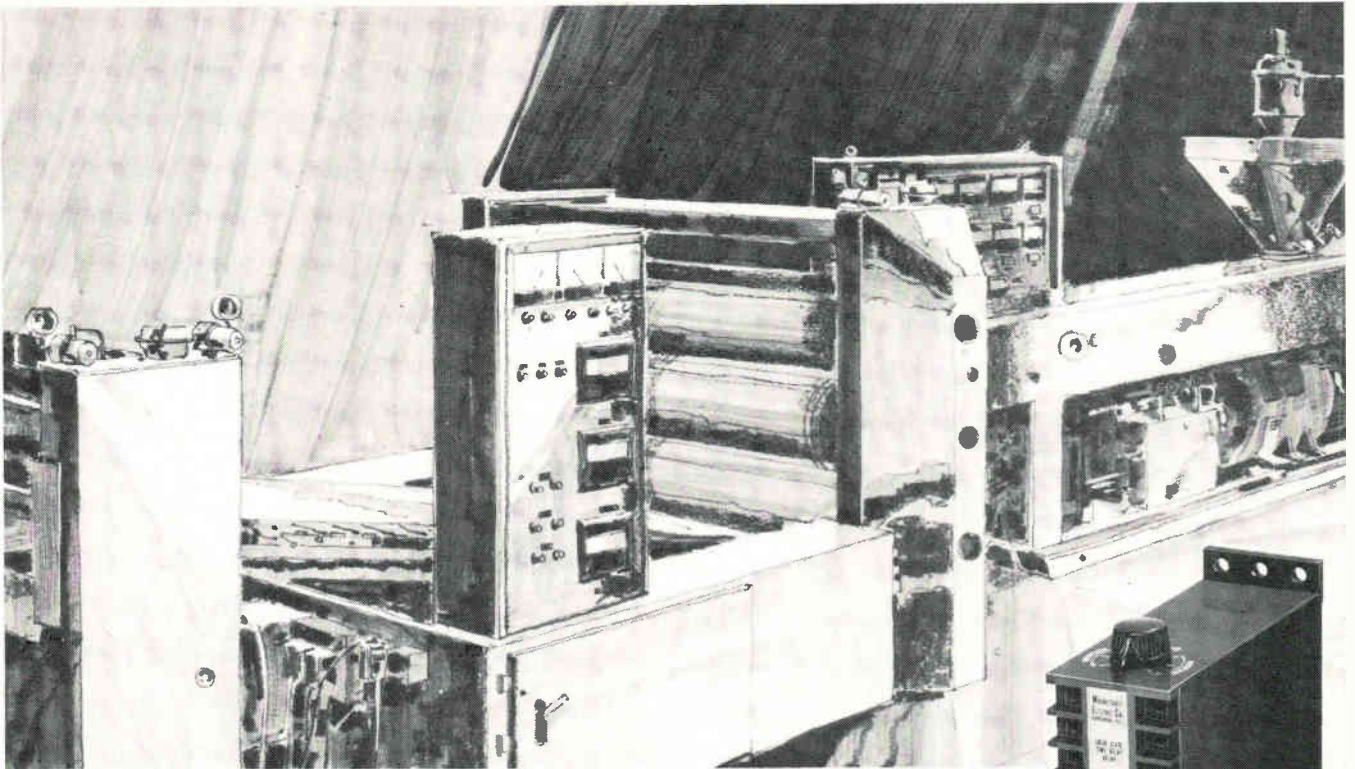

MAGNECRAFT THE CONTROLLER

**Heavy duty time delay and power relays
for rugged industrial applications**

The Solid State (hybrid) Class 211M time delay relay is designed for heavy duty service requiring accurate time delay control with $\pm 5\%$ repeatability. This time delay relay makes use of hybrid technology combining solid state circuitry for the timing function with an electromechanical relay for DPDT 10 ampere output switching. This highly reliable relay operates on AC or DC, has an adjustable delay for either operate time or release time. The surface mounted molded plastic enclosure incorporates screw terminals. In stock for immediate delivery, this new relay costs less than \$29.00 in single quantities.

The Electromechanical Class 112M time delay relay comes in a package similar to the 211M. However, it utilizes a highly reliable precision air dashpot for the timing function, and an electromechanical relay for the 10 amp DPDT output switch. The designer will quickly recognize the inherent quality and simplicity in the design. Also in stock for immediate delivery, this time delay relay costs less than \$29.00 in single quantities.

The Class 99 is ideal for heavy duty industrial power relay applications. Occupies less than $2\frac{1}{2}'' \times 2\frac{1}{2}'' \times 2\frac{1}{8}''$ of space. Yet, it's capable of switching 115 volts at up to 50 amps. Available with a "Magnetic-Blowout" for greater arc suppression and increased DC switching. Class 99 power relays can be supplied with contact combinations from SPST to DPDT at ratings up to 50 amps and in Underwriters Laboratories Listings. In stock for immediate delivery and priced as low as \$5.66 in single quantities.

For your source of 512 different stock relays, write for Magnecraft's Catalog No. 271.

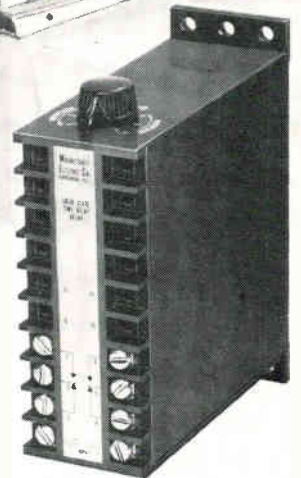

Class 211M
Class 112M
Time Delay
Relay

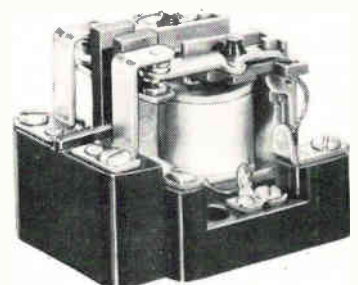

Class 99 Heavy
Duty Power Relay



Magnecraft® ELECTRIC CO.

5575 NORTH LYNCH AVENUE • CHICAGO, ILLINOIS 60630 • 312 282-5500 • TWX-910-221-5221

Digital filter is programmable

It synthesizes variety of filter functions without hardware changes; memory stores up to 200 12-bit words and can be controlled by computer

Filtering in digital communications has always been a one-for-one situation: one filter served to pass or reject one set of frequencies; for other values, you had to use other filters. Now Electronic Communications Inc. has developed a programmable digital filter that can synthesize, without any hardware changes, any filtering function that has a convolution integral. Further-

more, the filter is said to provide better amplitude-versus-frequency characteristics than conventional analog units while maintaining linear-vs-frequency characteristics, or constant envelope delay.

The filter, actually a special-purpose real-time digital computer, is the first developed for industry, says R. K. Keenan, manager of research and advanced development

at ECI. It's programmed through a tape reader and a solid state shift-register memory. Direct real-time computer control of the memory, another feature, provides time-varying adaptive filter capability. The unit also can do the same jobs as correlators and discrete fast Fourier transformers, and has numerous other capabilities.

One important application for

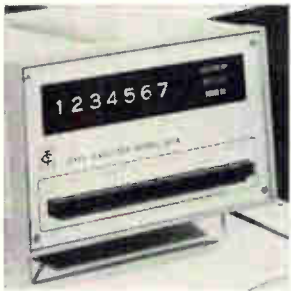

Compact data analyzer 301-A verifies operations of various devices and communications lines that make up data communications systems. It incorporates a regulated d-c power supply and all circuitry and connections to attach directly to data terminal, modem or system. Transmission speed is 50-300 baud. Technical Concepts Inc., Jefferson Rd., Rochester, N.Y. [401]



Acoustical data coupler 3300 is designed as a modular, self-contained unit for quick mounting directly on a model 33 Teletype with plug-in connections for error-free transmission between computers and remote terminals via telephone handsets. It can be installed in less than five minutes. Digital Techniques Corp., 4248 Delemere Court, Royal Oak, Mich. 40073 [402]

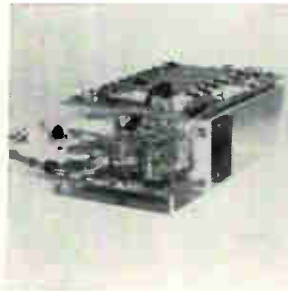

Data/telegraph response unit model 411 will generate four different responses of up to four characters each. A response is generated when one of four input circuits is triggered. The four codes can be ganged to produce two 8-character answers or one 16-character answer. Unit eliminates maintenance. Pulse Communications Inc., 5714 Columbia Pike, Falls Church, Va. [403]



Drum system PDP-10 consists of an interfacing controller and a 9-million-character drum memory with an average access speed of 17 msec. The entire system is packaged in a single unit requiring only 18 sq ft. It may be expanded to provide a mass storage media for PDP-10 users of up to 72 million characters. Bryant Computer Products, 850 Ladd Rd., Walled Lake, Mich. 98088 [404]



Data-Verter central magnetic tape terminal model 5237 is for gathering information sent over the telephone network from source recorders. It communicates with acoustical or unattended transmitters and records information on IBM compatible 9-channel magnetic tape in ASCII or EBCDIC code. Terminal's rental is under \$500 per month. Digitronics Corp., Albertson L.I., N.Y. [405]



Full-scale crt terminal called Envoy weighs 30 lbs and is packaged in a rugged carrying case. It displays up to 1,024 alphanumeric characters on a 5-in. diagonal crt. Compatible with teletypewriter data communication systems, it transmits and receives data over telephone lines at a rate of either 10 or 30 characters per sec. Applied Digital Data Systems Inc., Hauppauge, N.Y. [406]

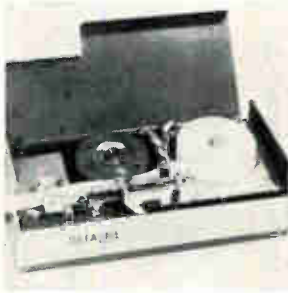

Desk-top strip printer model 3064-C is for the printed-copy data terminal market. It is less than 8 in. long and weighs 4 lbs. It can print 30 characters per second asynchronously. Still, a minimum of 100 million maintenance-free operations is assured. Prices, determined by quantity, range from \$555 down to \$391. Data-line Inc., S. Boro Line Rd., King of Prussia, Pa. 19406 [407]

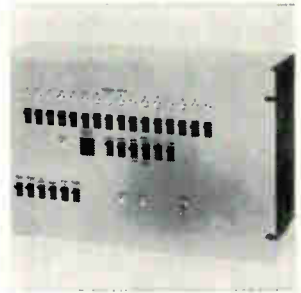

Programmable adaptable controller PAC-16 is a byte-oriented mini-computer with a repertoire of instructions for inputting, storing, manipulating and decision making. It is adaptable to system interfacing requirements with 35% of available logic space reserved for customer logic requirements. Price ranges from \$3,000 to \$3,850. Varisystems Corp., Newtown Rd., Plainview, N.Y. [408]

At Last . . .

The Right Digital Printer . . . At the Right Price

SCM now offers the
**Model M-120
Digital Printer**

featuring

- Serial Entry
- Numeric
- BCD Input
- 16 Columns

The SCM M-120 Printer is **American made** and sells for **\$190.** (less in quantity lots)

```
1 1 1 1 1 1 1 1 1 1 1 1 1 1 1 1
2 2 2 2 2 2 2 2 2 2 2 2 2 2 2 2
3 3 3 3 3 3 3 3 3 3 3 3 3 3 3 3
4 4 4 4 4 4 4 4 4 4 4 4 4 4 4 4
5 5 5 5 5 5 5 5 5 5 5 5 5 5 5 5
6 6 6 6 6 6 6 6 6 6 6 6 6 6 6 6
7 7 7 7 7 7 7 7 7 7 7 7 7 7 7 7
8 8 8 8 8 8 8 8 8 8 8 8 8 8 8 8
9 9 9 9 9 9 9 9 9 9 9 9 9 9 9 9
0 0 0 0 0 0 0 0 0 0 0 0 0 0 0 0
```

```
4 3 2 1 0 9 8 7 6 5 4 3 2 1
```



SMITH-CORONA MARCHANT
DIVISION OF SCM CORPORATION

Industrial Products

3210 Porter Drive

Palo Alto, California 94304

(415) 326-9500 TWX 910-373-1777

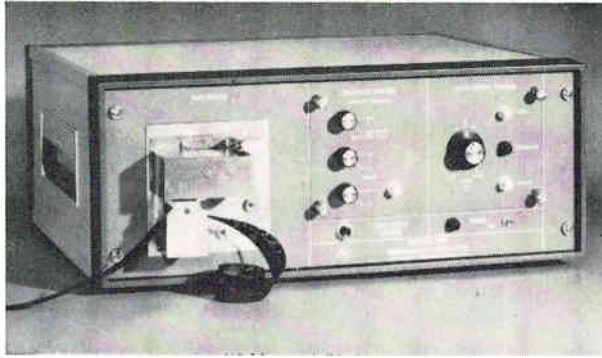

Synthesizer. A new filter is created by reprogramming the model 999, using paper tape.

the ECI unit is real-time experimental determination of the effects of various filters on system performance. The filter's maximum input frequency of 3.5 kilohertz can be extended to process r-f and i-f merely by using a mixer and local oscillator, provided the bandwidth of the processed signal does not exceed 3.5 khz.

Applications. Matched filtering in data processing systems, where data bit determination is a necessity, is another application for the filter, as is low-frequency modulation and demodulation. Comb filtering for spectral analysis of signals and line equalization, independent of the type of modem used, also can be done. The unit can be used in special-purpose voice processing—filters associated with vocoders can be realized by time-sharing between voice channels, says Keenan. Adaptive or time-varying signal filtering also is possible. It's a difficult task in analog filters because the time required for an analog filter to adapt is limited by the filter's bandwidth. But the ECI filter can adapt, or settle, in 100 microseconds, the inverse of its sampling rate of 10 khz.

With ECI's device, a bandpass filter can be constructed with bandwidth of 3 khz and exceptional frequency selectivity—attenuated by 55 decibels in 150 hertz—as well as a differential delay too small to be measured with conventional laboratory instruments. And if a filter with a different slope is required, say one equivalent to a 50-pole filter, all that need be done is cut a new paper tape using any general-purpose computer that uses Fortran.

This type of filter, when made using analog techniques, has 50 crystals and costs more than \$750. The change in the ECI filter is im-

plemented by running the tape through the filter.

Called the Model 999 programmable digital filter, the unit comes with a software package that does not require expert knowledge of digital filters, says ECI. For common filters, all that's needed are the filter's requirements. Special filters can be synthesized using special Fortran software supplied with the unit.

In operation, incoming analog signals are analog-to-digital converted; processed in a digitally implemented transversal filter; digital-to-analog converted, and smoothed to recover the processed analog signals.

The filter's memory is constructed using metal oxide semiconductor medium-scale-integration shift registers; its digital multiplier uses transistor-transistor logic. The total electronics package consists of more than 200 flatpacks. While an internal sampling rate of 10 khz is available, the user also can sample externally from 50 hz to 10 khz. The maximum temporal length of the shift registers is 20 milliseconds at the 10-khz sampling rate. The memory stores 200 12-bit words. Filter coefficients are entered into the memory in 90 seconds via the paper tape reader. However, if faster entry is desired, a computer can be hardwired to the Model 999 and all 200 words changed in 100 μ sec.

The unit measures 7 $\frac{1}{8}$ by 19 $\frac{1}{8}$ by 18 inches and will be priced under \$20,000. Options, such as a card reader and special-purpose software to customer specifications will be available; a plug-in providing correlator capability and a multiplexer for time-sharing are under development.

Electronic Communications Inc., Box 12248, 1501 72nd Street North, St. Petersburg, Fla. 33733 [409]

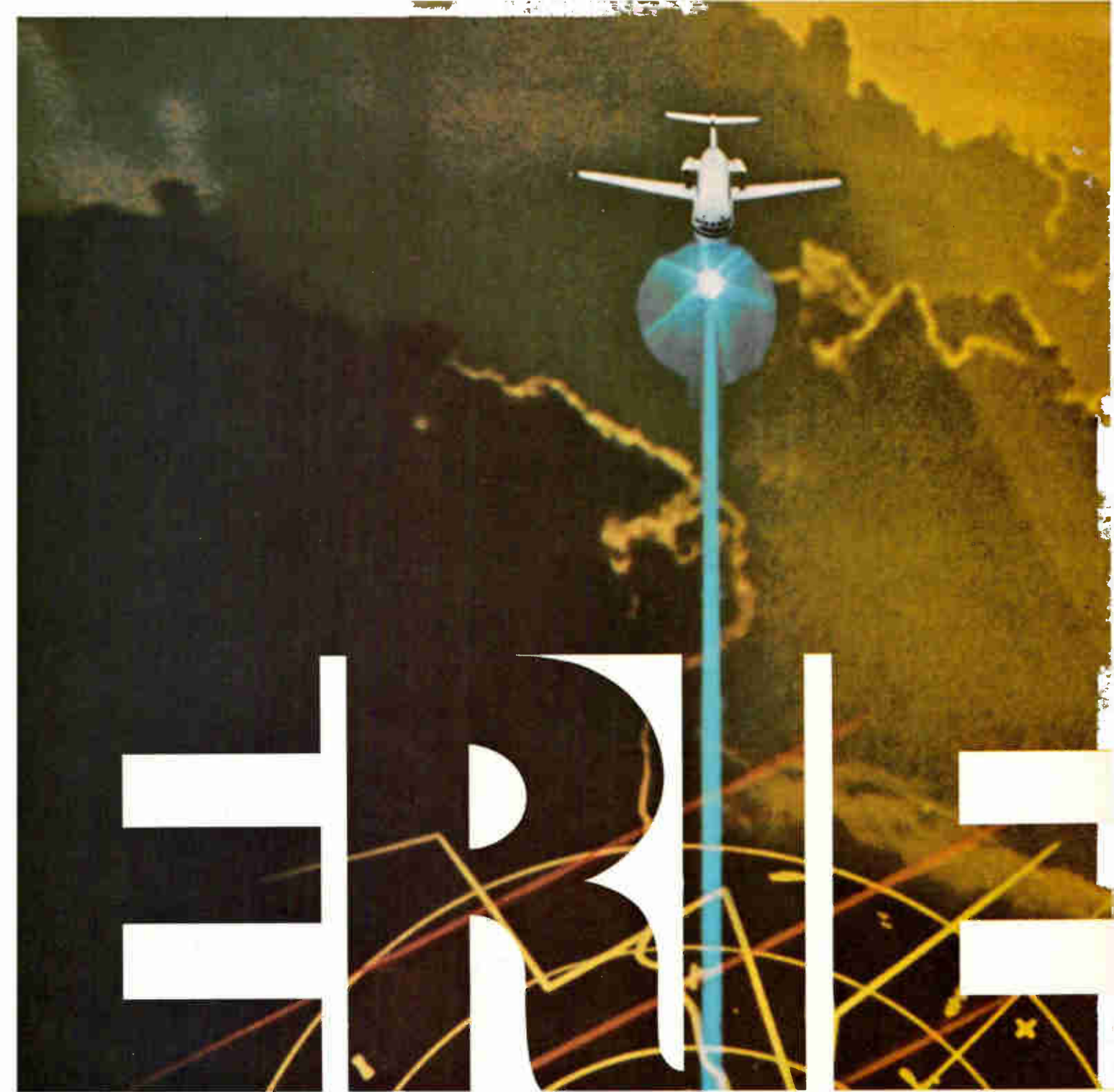

ERIE

When you want radar as pure and coherent as a laser beam...

Symbolic electronic signal undistorted by EMI —
photographed by Howard Sochurek

bring ERIE in early.

31,000 feet... heavy traffic... ugly weather over the Plains. This isn't the time for "noise" in the radar. But, no sweat! RCA's exciting new AVQ-30X Weather Radar is up front, sweeping the sky... protected from EMI by 39 special ERIE filters. No other airborne radar has ever approached the single or dual system reliability of the AVQ 30. From the start, RCA has called on the outstanding research and component capability of ERIE TECHNOLOGICAL to help in the development of this great new unit. Proof, once again, that it pays to bring ERIE in early.

ERIE TECHNOLOGICAL PRODUCTS, INC.

644 West 12th Street, Erie, Pennsylvania 16510
(814) 456-6597

Circle 165 on reader service card

Solid state is no mystery if you can read this

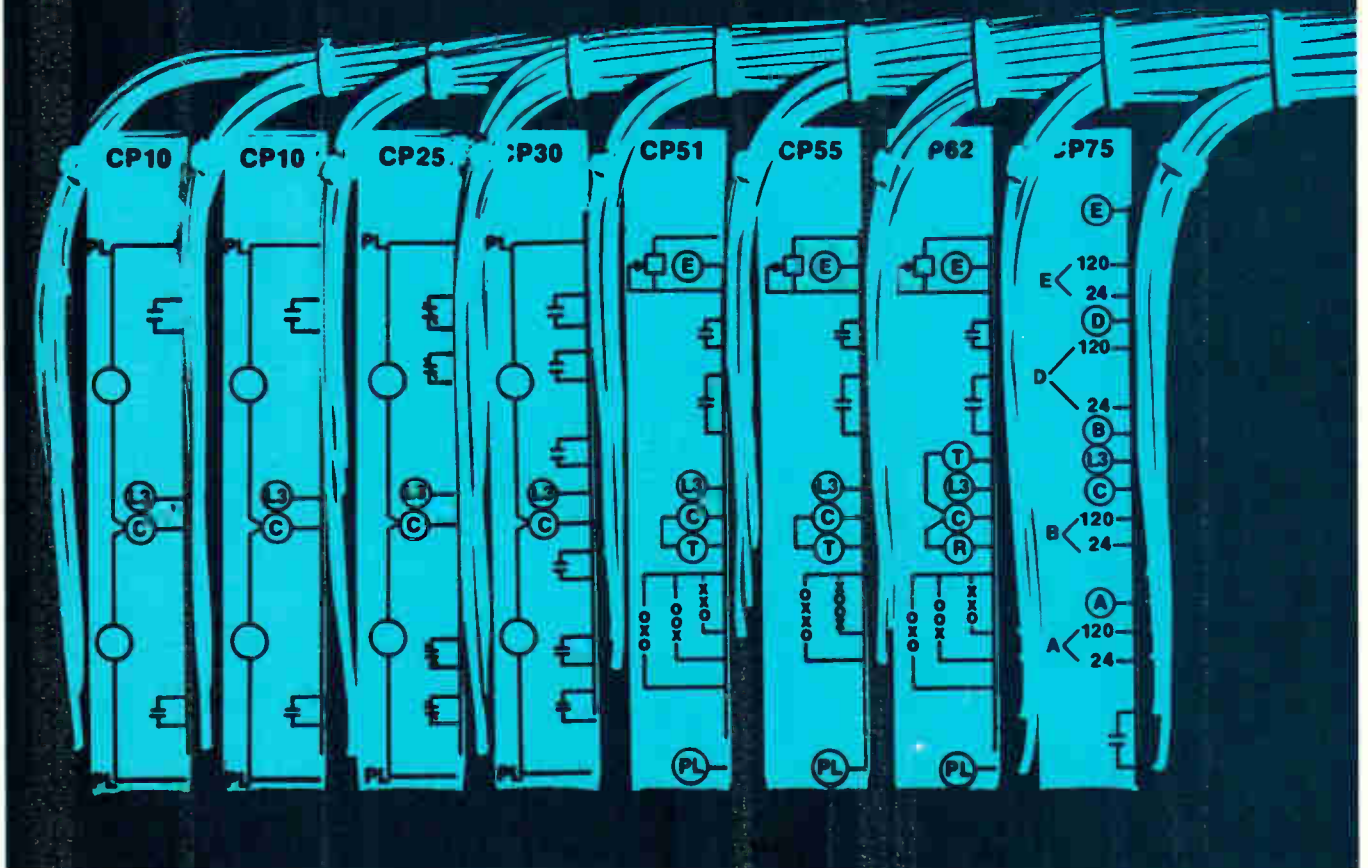

and this is Controlpac.®



If your systems and maintenance people get up-tight every time you talk solid state . . . relax. New Eagle Controlpac modules take the mystery out of it. Sure, all control functions are duplicated on printed boards, BUT, Controlpac utilizes electromechanical block diagrams and symbolism for easy understanding and installation. Trouble-shooting and periodic maintenance are done using the same "lamp-out" equipment and methods used for standard relay systems. So, what's so mysterious?

Get the simple facts about Controlpac, today. Write for Bulletin 35C. Eagle Signal Division, 736 Federal Street, Davenport, Iowa. 52803



Eagle Signal

a systems division of
GULF + WESTERN INDUSTRIES, INC.

See Eagle's new
Controlpac® plus
a dozen more
NEW industrial
controls

including:

- Metal detectors for accurate count • control • safety.
- 24 circuit solid state sequencing controls.
- Solid state 10 amp. load relays.
- High accuracy solid state timers.
- Modular cam timers.
- Relay clutch timers.
- Manual reset timers.
- Digital readout counters.
- Solid state plug-in counters.
- Add-subtract counters.
- Photo sensors.

AT THE
DESIGN
ENGINEERING
SHOW
Chicago
Amphitheatre
Booth 1470

GW Eagle Signal
a systems division of
GULF + WESTERN INDUSTRIES, INC.

Circle 167 on reader service card

Data handling

D-a converter is all integrated

Ladder-resistor network deposited directly on silicon chip; accuracy, eight-bit resolution holds over -55°C to $+125^{\circ}\text{C}$

Although digital-to-analog converters are available in monolithic integrated circuit form, they invariably require a separate ladder-resistor network, and they are not accurate for the full temperature range called for in military and space equipment.

But a new IC, offered by Radiation Inc., has neither of these shortcomings. Radiation's RI-1080 d-a converter is completely integrated—the ladder network consists of thin-film Nichrome resistors deposited directly on the silicon chip. And the circuit is accurate to $\pm\frac{1}{2}$ of the least significant bit (LSB) with eight-bit resolution over the -55°C to $+125^{\circ}\text{C}$ temperature range.

The circuit is fast, too. Its worst-case settling time is 1 microsecond to $\frac{1}{2}$ the LSB of the final value. This permits conversion rates in excess of 1×10^6 words per second, making it suitable for high-speed data correlation applications.

To get this kind of performance, the manufacturer uses dielectric isolation, instead of the usual p-n junction isolation, to separate the

components on the chip. Dielectric isolation reduces parasitic capacitance and also permits incorporation of both npn and pnp transistors on the same chip without degrading the performance of either.

The RI-1080 contains eight current switches, a bias network, a reference level network (which contains the npn's and pnp's for greater accuracy), and the RA and 2R integral thin-film resistor network. R in the last network is purposely low—5 kilohms—to keep the impedance change low as portions of the circuit switch from on to off.

Fast switch. Current-mode operation was selected for the circuit to give fast switching. In addition, the current mode makes the IC virtually immune to spurious switching spikes because the current through the switches is held at a fairly constant level, thus preventing the abrupt current surges that occur in voltage-mode switching devices.

The IC requires two power supplies, ± 5 and -15 volts, and an

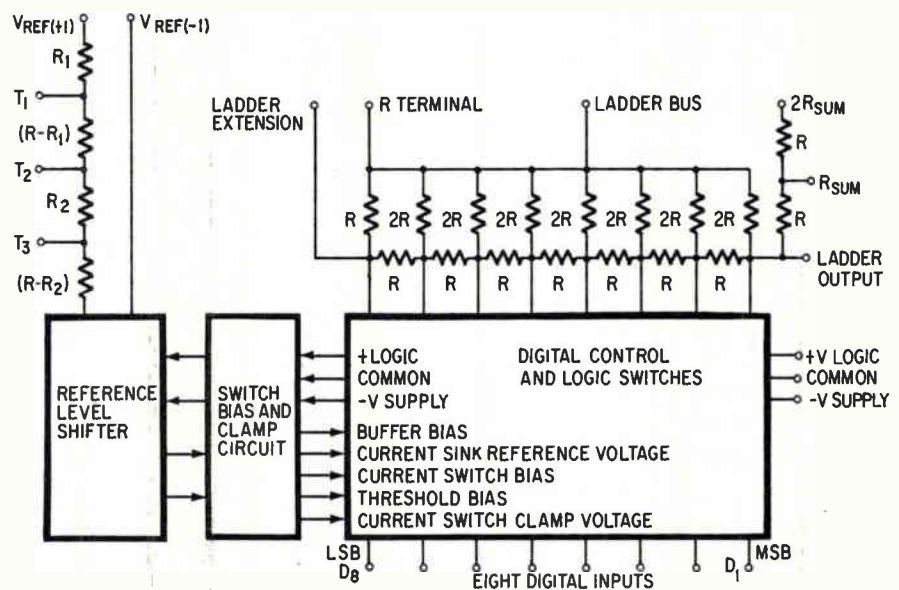

Mister d-a. Thin-film Nichrome ladder resistors are set for R-5k. Integrated logic switches operate in current mode for speed.



New 1970 CATALOG!

fully illustrating the complete line of

COAX • TWINAX • TRIAX and QUADRAX CONNECTORS • PATCH PANELS • PLUGS • JACKS • PATCH CORDS and ACCESSORIES

Also included in this colorful brochure is information detailing high and low frequency Coax switches and matrices for use in TV Broadcast, CATV, CCTV, ETV Communications, Telemetry, Telephone, Nuclear Instrumentation and Information Retrieval.



A unique technical discussion on "NOISE IN CABLE SYSTEMS" will be of great assistance in the design of all instrumentation, communication and data systems.

If YOU have a problem, ask the knowledgeable people at TROMPETER—they've been involved with the design of just about every patching and switching system made.

For YOUR catalog, or further information, contact

TROMPETER Electronics

8936 Comanche Ave. — Chatsworth, Calif. 91311 — (213) 882-1020 TWX 910 - 494-1210

Circle 207 on reader service card

HEW... more power to you!

Thank you Hewlett Packard for building so many top quality sweep and signal generators and frequency synthesizers.

You've created a market for our power amplifiers because many engineers need our product to extend the power output of your instruments. We've made sure that our broadband, untuned, 3 watt amplifier mates easily with most sweep generators, signal generators, and frequency synthesizers (no matter what brand). Our power amplifier also features an output meter plus low harmonic and intermodulation distortion. So thanks again Hew... and we're glad we could help you.

- 250 KHz-110 MHz frequency coverage
- 40 dB \pm 1 dB Gain
- 50 ohms input/output impedance
- Failsafe for any load mismatch and unconditionally stable.



MODEL 300L
\$535

The ENI Model 310L will provide 10 watts of power when identical specifications with higher output are required.

For additional specification and application information contact:

ENI ELECTRONIC NAVIGATION INDUSTRIES
1337 Main Street East Rochester, New York 14609 716/288-2420

external reference of 4 to 10 volts. It accepts eight digital inputs, either DTL or TTL. The analog output can be in one of three modes—single polarity with zero reference, single polarity with zero full scale, or dual polarity—depending on which of the integral input resistors the reference voltage is connected to. With V_{ref} connected to the 5-kilohm input resistor terminal and the ladder bus terminal, for example, the output will be in the bipolar mode, with the output ranging from V_{ref} for all inputs high to $(-V_{ref} + LSB)$ for all signals low.

The RI-1080 costs \$82.50 each in 100-to-999 quantities. It's available off the shelf in a 24-lead, $\frac{1}{4}$ -by- $\frac{3}{8}$ inch package.

Radiation Inc., Melbourne, Fla. [410]

Data handling

Minicomputer sells for \$2,500

Rack-mountable machine
can interface with
teletypewriter

Low price is always a strong selling point, and officials at Computer Development Inc. are hitting it hard in the company's first product, the cd 200 minicomputer. The basic machine will sell for about \$2,500, including the central processor and power supply in a rack-mountable enclosure that contains a serial interface for an ASR-33 or ASR-35 teletypewriter with a built-in hardware bootstrap routine. Another \$1,000 will add a 1,000-byte core memory with a 1.2-microsecond cycle time; and about \$2,000 will add 4,000 bytes. The basic memory is an eight-bit unit, but the company says all instructions operate in eight or 16 bits.

Richard Pasternak, vice president for engineering at the new firm in Santa Ana, Calif., considers the cd 200 his third-generation design. Pasternak designed the 520I when he was at Varian Data

Announcing the Brush 440

If it doesn't meet
your portable recording needs,
maybe you don't need a
portable recorder.

It's tough to imagine a general purpose portable that could do more.

The Brush 440 has four 40mm channels, two event markers and a push-button choice of eight chart speeds. We guarantee trace linearity of 99.5%. Or better. And our stringless, springless servo system enforces pen position clear across the channel.

The traces are something else: clear,

crisp, uniform. Pressurized ink-writing puts them *into* the paper not onto it. There's no smudge, no smear, no puddling. A disposable ink cartridge holds up to a year's supply and can be replaced in seconds with no mess, no fuss.

There's more. Such as a wide choice of preamps that offer measurement ranges from $1\ \mu\text{V}$ per division to 500 V

full scale. Frequency response that's flat within $\pm 2\%$ of full scale from d-c to 40 Hz. And typically handsome cabinetry and rugged construction.

Look it over. Check it out. Add it up. And you'll see why this brand new 45 pounder is the ideal way to monitor such dynamic variables as temperature, pressure, strain, vibration or what have you. Ask your Brush representative for a demonstration. Or



write for details. Brush Instruments Division, Gould Inc., 3631 Perkins Avenue, Cleveland, Ohio 44114 or Rue Van Boeckel #38, Brussels 14, Belgium.

GOULD BRUSH

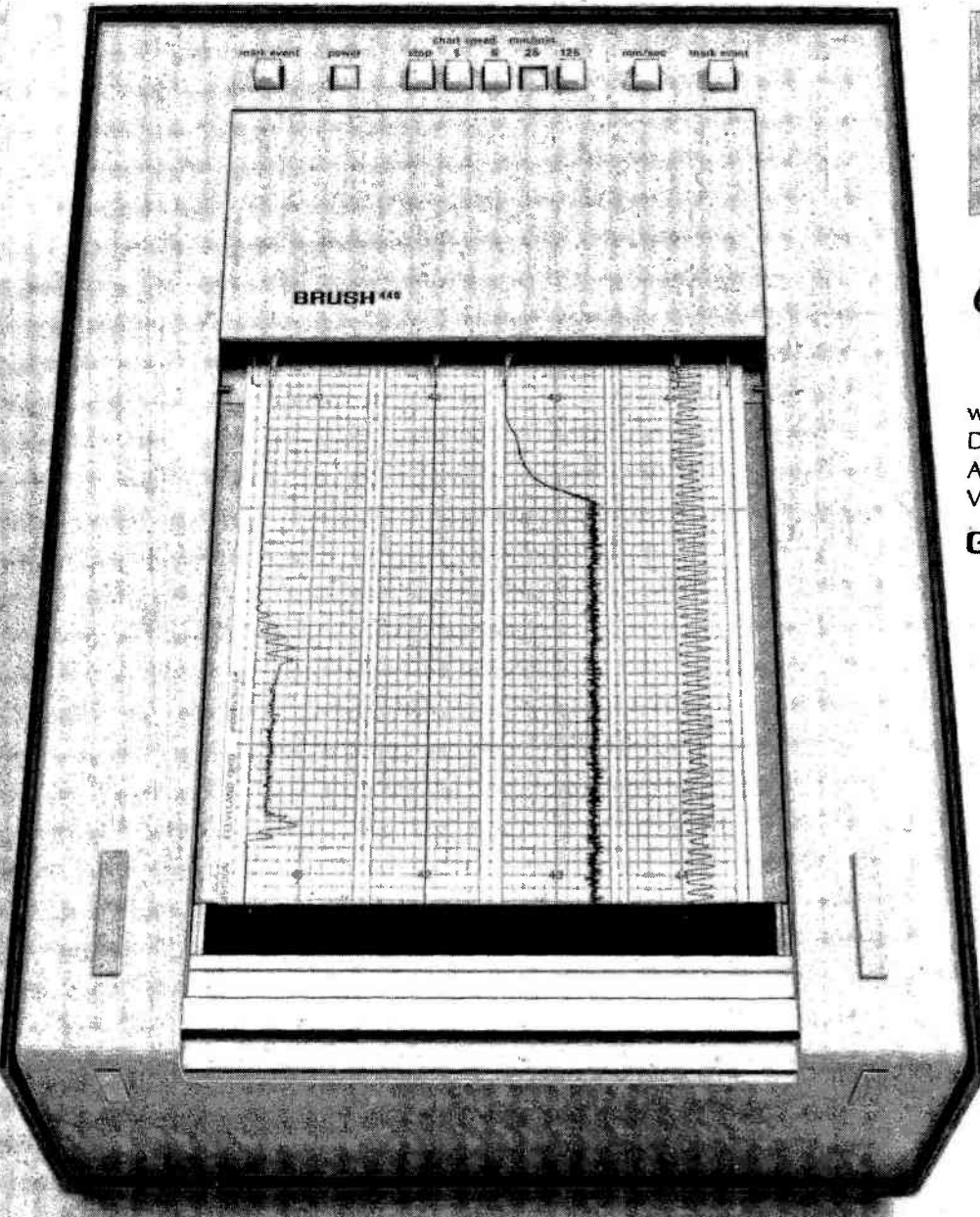

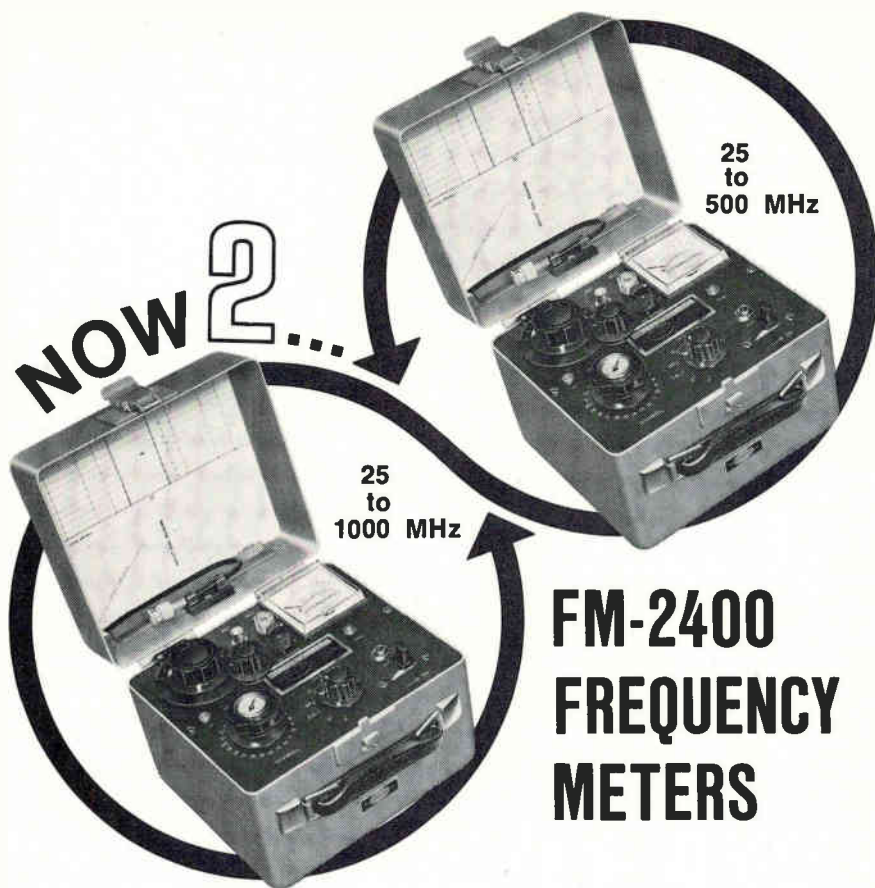

FM-2400CH (New)

- Tests Predetermined Frequencies 25 to 1000 MHz
- New Extended Range Covers 950 MHz Band
- Pin Diode Attenuator

FM-2400C

- Tests Predetermined Frequencies 25 to 500 MHz

The new FM-2400CH and the FM-2400C provide an accurate frequency standard for testing and adjustment of mobile transmitters and receivers at predetermined frequencies. The FM-2400CH with its extended range covers 25 to 1000 MHz. The Model FM-2400C covers 25 to 500 MHz. The frequencies can be those of the radio frequency channels of operation and/or of the intermediate frequencies of the receiver between 5 MHz and 40 MHz.

Frequency Stability: $\pm .0005\%$ from $+50^\circ$ to $+104^\circ\text{F}$

Frequency Stability: with built-in thermometer and temperature corrected charts. $\pm .00025\%$ from $+25^\circ$ to $+125^\circ$ (.000125% special 450 MHz crystals available)

Both the FM-2400CH and the FM-2400C are self contained in small portable cases. Complete solid state circuitry. Rechargeable batteries.

FM-2400CH (meter only)...\$595.00
 RF crystals (with temperature correction)..... 24.00 ea.
 RF crystals (less temperature correction)..... 18.00 ea.
 IF crystals.....catalog price

FM-2400C (meter only)....\$445.00
 RF crystals (with temperature correction)..... 24.00 ea.
 RF crystals (less temperature correction)..... 18.00 ea.
 IF crystals.....catalog price

Write for catalog



Deflation. Low cost of cd 200—\$2,500—is strong sales point.

Machines and did the logic design for the Micro Systems models 800 and 810 minicomputers. He figures the design is bound to be better the third time around.

Pasternak says he realizes that in most computers, the costs of the central processor, mechanical portions of the machine, and the memory are about equal. "We went to work on this relationship," Pasternak says, "and now the mechanical portion costs much less than the CPU, and the CPU and memory costs are about equal."

Price cuts in semiconductors are only a small part of the Computer Development economy story. The machine uses mainly transistor-transistor logic, and a good deal of this is at the USI complexity level—30 to 40 gates. One feature of the cd 200 that company officials believe is unique in such a low-priced machine is a universal bus instead of individual ports for the hardware connected to the CPU—the memory, input-output devices, front panel, and direct memory access.

"All of these complicate the mechanical design of the CPU," Pasternak explains, "so we decided to combine all of them in one bus. They all share the same set of wires. This allows us to construct an economical back-wiring plane that can receive connections from all four, including a number of memories."

Only three boards are required for the machine's CPU, leaving 12 plug-in connectors for optional devices—additional memory or I/O devices. Pasternak says the user likely will allocate this space so that one board slot might be filled

beetle of the industry:

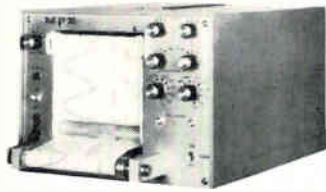

\$1175.

lightweight, low-priced MFE dual channel portable recorder!

Model M-22. The lightweight, portable, self-contained dual channel recorder from MFE that brings you high reliability and top performance at *bargain price*. Featuring two 50mm-wide analog channels. With Event Marker and Timer Marker, Internal 1-sec. Timer, Internal Calibration, Paper Take-up and 7-Step Signal Attenuator for maximum recording flexibility... *all standard equipment*. The 24-pound M-22 features 4 chart speeds: 1, 5, 25 and 50mm/sec. It employs MFE's reliable inkless heated stylus writing technique. It provides clear, precise, high resolution non-smudge, black traces on a no-fade, plastic-coated 200-foot chart. It's all in the Model M-22. Now at work in Industrial, Scientific, Medical and Educational applications.

OTHER HIGHLIGHTS Solid State • Noise less than .1mm • Sensitivity 10, 20, 50, 100, 200, 500, and 1000 mv/mm • Other MFE single, two, three, four and six channel recorders are available and conform to AHA Recommendations for Electrocardiography.

Contact MFE for full details, specifications and prices, now!

MFE MECHANICS FOR ELECTRONICS, INC.
340 Fordham Rd., Wilmington, Mass. 01887 (617) 658-5500 TWX 710-347-6938

Circle 208 on reader service card

BELL & HOWELL

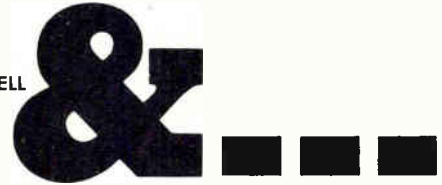

Circle 209 on reader service card



PASS ME THE AVO! SIL VOUS PLAIT • POR FAVOR

Worldwide, "Pass the AVO" means someone wants the most accurate, most reliable multimeter... anywhere. Twenty four ranges for AC and DC current, voltage and resistance. Full meter protection includes fuse, velocity actuated mechanical cutout and diode protection for meter movement.



This internationally famous AVO Model 8 has for over 50 years set the highest standard in multimeters. Over a million in use today!

Calibration, parts and service by factory trained personnel are available at our Plainview, N.Y. facility and in most countries throughout the world.

GENCOM DIVISION
varian/EMI

90 EXPRESS STREET PLAINVIEW N Y 11803
TELEPHONE (516) 433 5900

Write for your copy of Catalog 958 describing the AVO Model 8 and many other AVO instruments.

Circle 210 on reader service card

SPDT DPDT 3PDT 4PDT

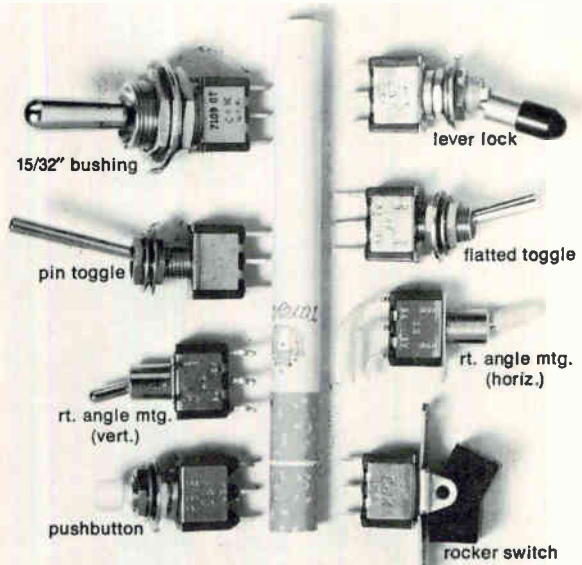

We'd rather switch than fight.

And have we ever switched! If you put any one of these 8 new subminiature switches on your "whatever", you'll have a better performing "whatever." All C&K switches are competitively-priced and Made-in-America. How's that for a switch? Ask for our new catalog.

C&K COMPONENTS, INC.

103 Morse Street, Watertown, Massachusetts 02172
Tel: (617) 926-0800

Circle 171 on reader service card

171

When 3 million lbs. rests on your tower base insulator, you've got to be good...



Lapp is.

Lapp is good . . . at designing and making tower base insulators. We've solved many tough insulator problems, electrical and mechanical, during the past 52 years.

Not just base insulators but, also guy insulators to 920,000 lbs. ultimate strength and antenna strain insulators up to 360,000 lbs. ultimate strength. Lapp designs and makes individual insulators, insulator assemblies and complete insulator systems to handle any antenna or tower insulation requirement.

You can count on Lapp for greater insulator knowledge, ingenuity, facility and quality. Let your insulating problems "rest" on us. Lapp Insulator Division, INTERPACE Corporation, LeRoy, N.Y. 14482

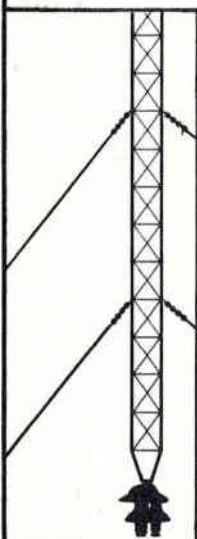

Lapp

INTERPACE
CORPORATION

with 4,000 words of memory, and typically three or four others devoted to I/O devices, leaving plenty of room for expansion.

Expansion is facilitated by both the universal-bus design, allowing additional memory or I/O devices to be plugged in on additional boards, and by the cd 200's asynchronous memory interface feature. The latter allows mixing of memory technologies to take advantage of speed where it's wanted, or to plug in new memories as they become available. For example, the machine has been run with a high-speed bipolar IC memory of up to 128 bytes with a 50-nanosecond cycle time, and a 1,024-byte MOS IC memory with a 1.5 microsecond speed. Thus core and semiconductor memories can be mixed, and there's also provision for variable-capacity read-only memories.

The memory organization is such that the first 61,439 bytes are allocated to memory and bytes 61,440 through 65,536 are for I/O controllers. "The only difference between memory and an I/O device, is the address," Pasternak notes. "This saved us money by allowing us to eliminate extra instructions to accommodate I/O." Further, all I/O devices can directly access the memory. This feature will be built into those devices "in which it makes sense," says Lambuth Cox, vice president for marketing. As examples, he lists tape controllers and disk and crt drives.

The cd 200 has 69 instructions and "several hundred modifications," says Pasternak. He feels the instructions are best suited for both I/O and list processing. Computer development will offer a Fortran assembler and simulator in its basic software package free.

Company officials believe 40% of the applications will be in communications—for concentration and preprocessing, for example. Another 30% of the machines are expected to be used as special controllers, such as buffer controllers for crt's, plotters and optical reading equipment, and another 30% in markets not yet cracked by mini-computers. The three CPU boards will be sold separately for \$1,600.

Deliveries will begin in August.

Computer Development Inc., 3001 Deimler St., Santa Ana, Calif. 92705 [411]

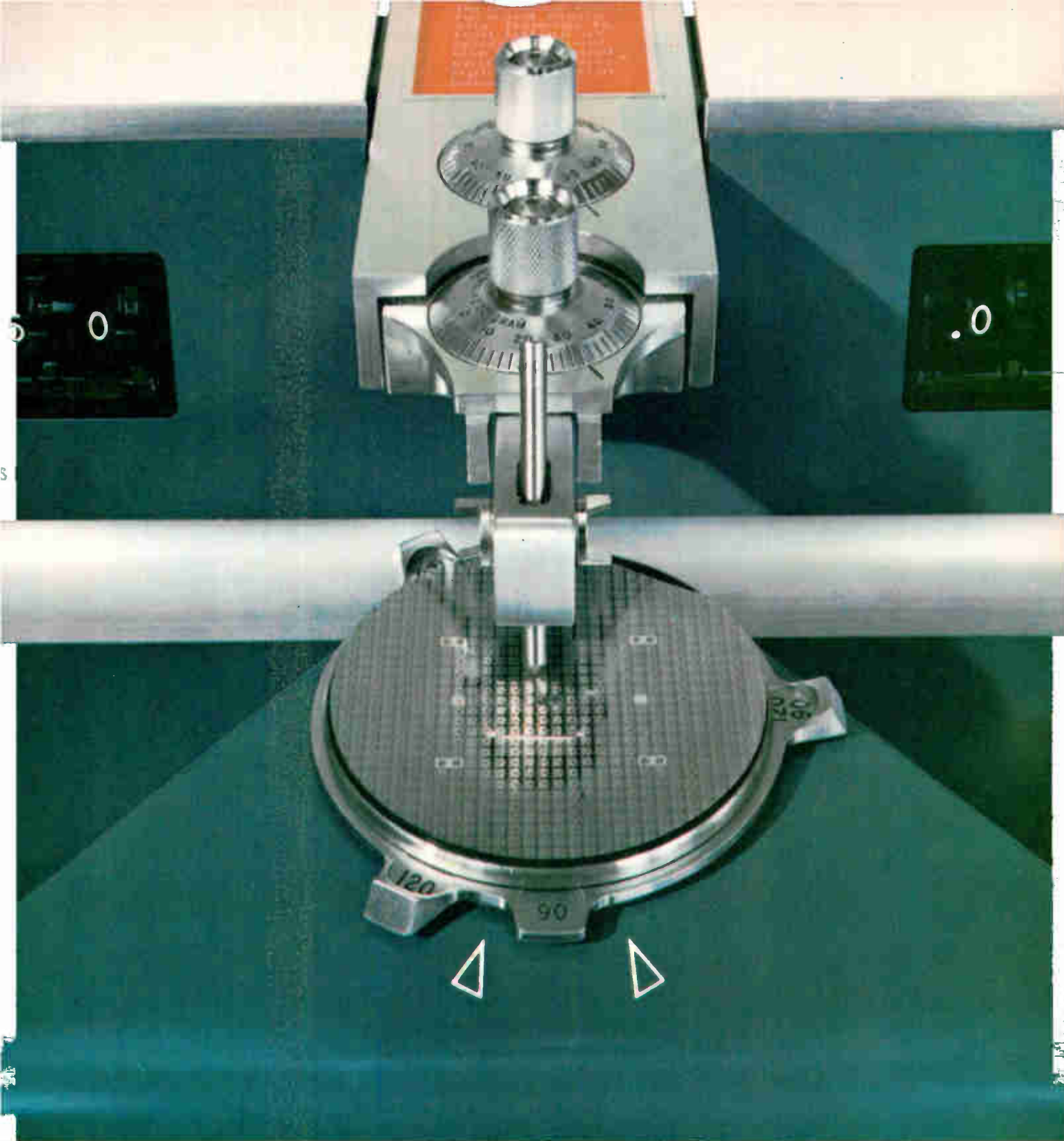

An economy of excellence

The Tempress four-pointed, Truncated Pyramid, Diamond Scribing Tool*, a unique Tempress development, will precisely scribe silicon wafers four to six times longer than conventional diamond scribing tools . . . an economy of excellence. Natural octahedron diamond crystals are hand selected for each tool. The diamond crystal is then ground across its natural edges to create a pyramid shape, the edges of which lie within the hardest planes of the diamond crystal. The peak of the pyramid is then

truncated to form four precision cutting points of maximum wear resistance. The efficiency and economy this tool has brought to semiconductor manufacturing reflects the Tempress Standard of Excellence, inherent in each miniature assembly tool and production machine produced by Tempress.

*Shown 2 1/2 times actual size.



TEMPRESS

Tempress Industries, Inc., 980 University Ave., Los Gatos, Calif. 95030

Circle 173 on reader service card

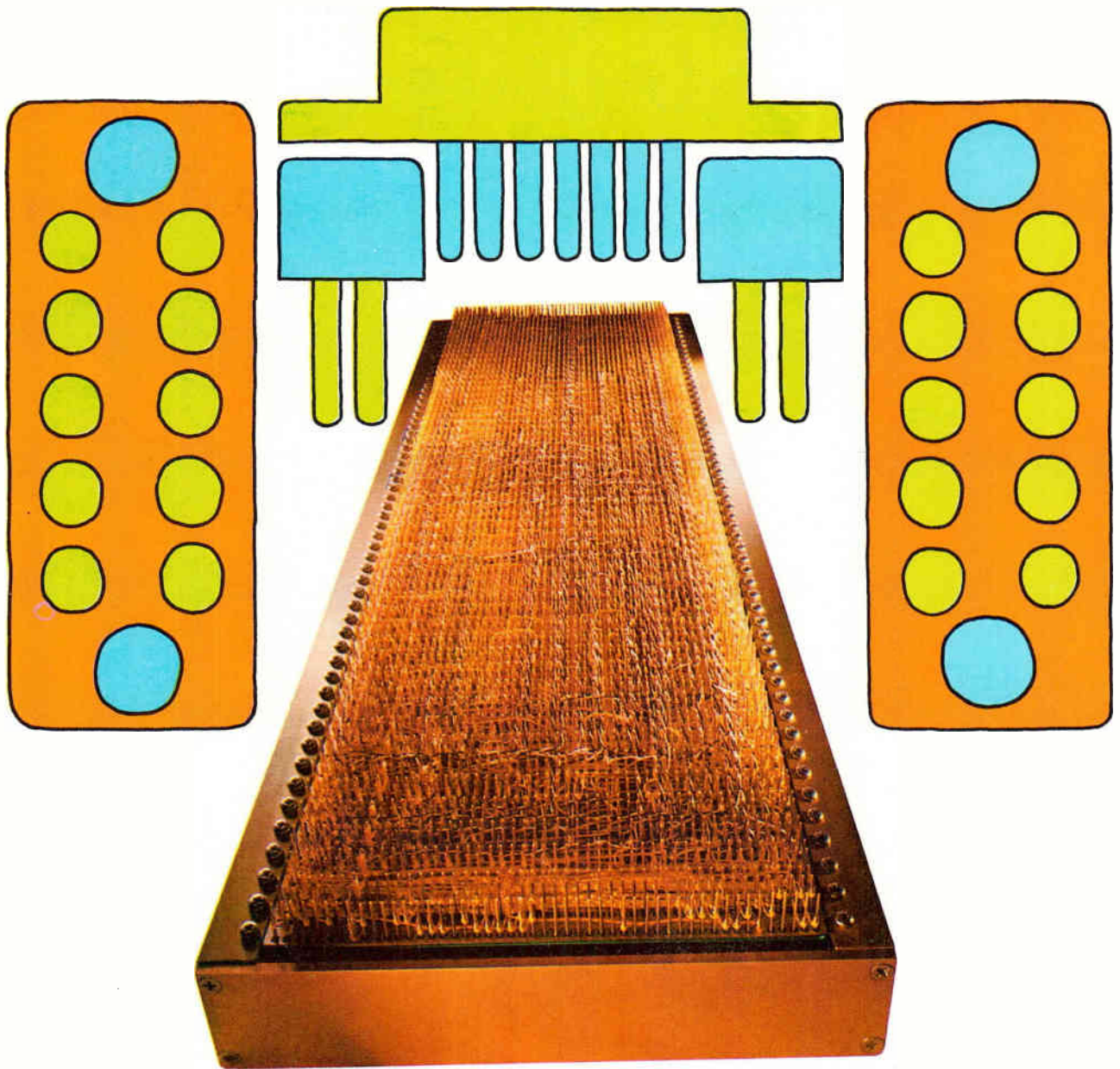

Winchester Electronics

— their obsession with precision is solving tomorrow's problems today.

Problems—like connectors requiring post true positioning to within a mere .020 of an inch—won't stump Winchester Electronics. They've been making AccurFrame® as close to perfection as modern wire terminating machines demand.

And this fact proves the point: Of the various types of wire terminating connectors, only the HW Series by Winchester Electronics, positioned in AccurFrame,

consistently meets the contact true position tolerances required by automatic wire terminating machines.

Now, if that doesn't say something for Winchester Electronics' AccurFrame, perhaps you have a connector requirement that does. Want to take us up on it? Write or call Winchester Electronics, Main Street and Hillside Avenue, Oakville, Conn. 06779.



**WINCHESTER
ELECTRONICS**

DIVISION OF LITTON INDUSTRIES



Interferometer goes right to work

Feedback loop keeps laser output constant, so there's no warmup period; instrument has range of 200 feet and resolution of 1 microinch

Like prizefighters and vacuum-tube radios, most laser interferometers need some warmup. The 5500A is an exception. Developed by engineers at the Hewlett-Packard Co.'s Santa Clara division, this interferometer is ready to work as soon as it's turned on. Since these distance-measuring devices find most of their work calibrating or controlling machine tools, zero-warmup time

means getting jobs through shops a bit faster.

Despite the fact that laser interferometers are relatively new to the machine shops, H-P will find some competition. For example, Cutler-Hammer's AIL division just came out with a new one, the \$15,400 Mark II [*Electronics*, April 13, p. 163]. However, project leader Gary Gordon says that his 5500A

has several features besides the quick turn-on time. Its range is 200 feet; it resolves 1 microinch, its accuracy is 0.5 parts per million; it automatically tunes its helium-neon laser; and its averaging circuits keep the readings steady, even when there's vibration.

The 5500A looks like most other laser interferometers; it has three parts—a laser assembly, a reflec-

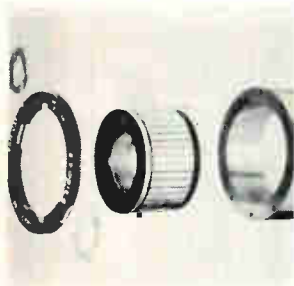

Direct-drive d-c torque motor D-3180 has been developed for positioning of control surfaces in light business aircraft. Peak torque is 480 oz in. and power input at peak torque is 260 watts. Friction torque is 10 oz in., and ripple torque is 7% average to peak. No-load speed is 73.5 radians per second. Litton Precision Products Inc., Marple at Broadway, Clifton Heights, Pa. [4211]



Resistance sensing power relay uses electrodes to detect the level of water, chemicals, or slurries in a storage tank. It can also operate as an ice bank control or condensation detector in protective control systems. Units come with either a 40 kilohm or 500 kilohm trip point. Output relay is rated at 8 amps. Mag-Con Engineering Co., 85 Richardson St. S.E., St. Paul, Minn. [4221]

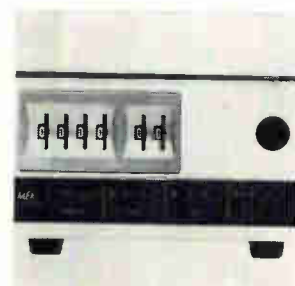

Solid state process counter series RCP uses IC techniques, permitting count rates up to 70 khz, with optional BCD display. The instruments are suited for all types of batching control operations, manual or automatic, and serve as ideal dividers for converting digital outputs from metering instrumentation to standard flow units. Machinery Electrification Inc., Northboro, Mass. [4231]



Solid state panel timer PT-100 has adjustable timing ranges from 100 msec to 1,600 sec. Accuracy is $\pm 2\%$ with repeatability to $\pm 1\%$ at constant temperature. Maximum time for reset is 50 msec. Operating ranges are from 12 v to 110 v, a-c or d-c, and four mounting options are available. Price (small lots) is under \$25. Chronologics Inc., 24 Martin St., Webster, N.Y. [4241]



Speed and draw indicators series 500 provide a digital readout of absolute speed or speed ratio (in %) between any two machines or machine sections as sensed by two hand photoelectric pulse gearmotors. Units are for use on any web process where speed between adjacent sections must be precisely monitored. Reliance Electric Co., 24701 Euclid Ave., Cleveland, Ohio 44117 [4251]



Electronic totalizing counter series 7123 Econo-Flex is suited for high-speed totalizing and linear measuring for industrial production. The counter operates at speeds to 10,000 counts per sec. It has five counting decades and features in-line illuminated digital display with long-life tubes and polarized window filter. Veeder-Root, 70 Sargeant St., Hartford, Conn. 06102 [4261]



Microminiature servo motor model 050/0011 features an ironless rotor designed to minimize ripple torque and optimize the torque-to-inertia ratio of the motor. It has a torque gradient of 0.75 oz in/amp and a torque-to-inertia ratio of 28,000 rad/sec². Friction torque is less than 0.004 oz in. Micro-Mo Electronics of New England, Box 227, Sudbury, Mass. 01776 [4271]



Battery-powered, thermocouple-to-current converter TA-01 offers integral cold junction compensation. The thermocouple amplifier amplifies a 5-mv full scale signal (120° C) into a 100 μ a output signal with an accuracy better than 1%. Load impedances up to 10 kilohms can be driven by the output circuit. Price is \$50. Integrated Controls Inc., Box 17296, San Diego, Calif. [4281]

Ultrasonic Cleaning... Basic Systems... Standard Consoles... Degreasers (with or without Ultrasonics) ... Automated cleaning systems...

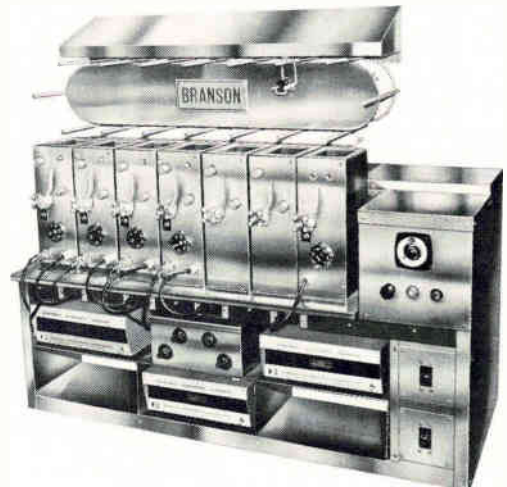
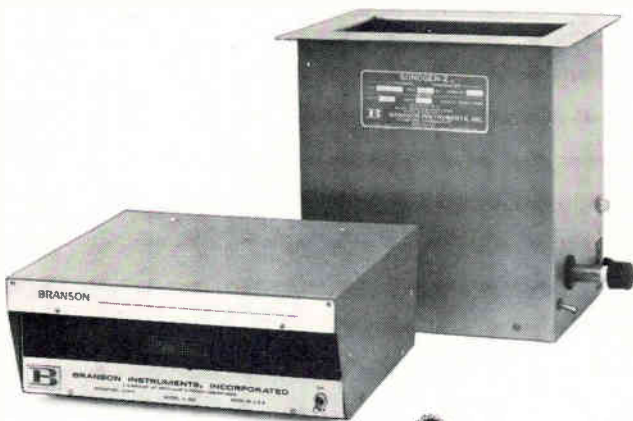

BRANSON
instruments company

For sound ideas in cleaning, testing and measuring.

BRANSON INSTRUMENT COMPANY • A Subsidiary of Smith, Kline & French • 76 PROGRESS DRIVE, STAMFORD, CONN. 06904

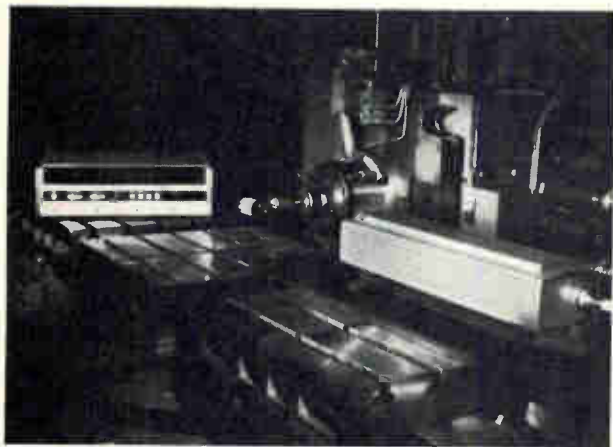

Three parts. The laser assembly, at right, sends a beam to the reflector, at center. The control box, left, calculates the laser-to-reflector distance from the Doppler shift of the reflected beam.

tor, and a control box. And in general, it works like most other Michelson-type interferometers. Either the assembly or the reflector is mounted on an object, such as a lathe's carriage. The assembly's splitter sends half of the laser beam to the reflector and the rest to an reference channel. Because of the Doppler effect, the frequency relationship between the reference and the reflected beam is a measure of the distance between the laser and the reflector. After calculating this distance, the control box displays the result.

The difference between the 5500A and other units is that the H-P laser puts out not one but two frequencies. In single-frequency units, a single photodetector combines the reference and reflected beams, and puts out a d-c signal. The H-P unit handles the reference and reflected beams separately, and generates an a-c signal that is used for calculating distance. A-c operation, says Gordon, is the key to the 5500A's resolution and range.

Split-up. H-P engineers get two frequencies out of their laser by putting it in an axial magnetic field that splits the spectral line, generating two optical frequencies, f_1 and f_2 , of opposite circular polarization. A splitter sends half of the beam along the reference channel to a photodiode whose output frequency is $(f_1 - f_2)$. The other half goes to a second splitter, which sends the f_1 portion out to the reflector and the f_2 portion along an internal path. The returning beam, whose frequency is $(f_1 + \Delta f)$, where Δf is the Doppler shift, recombines with f_2 in a second photodiode whose output frequency is $(f_1 + \Delta f - f_2)$.

After coming out of their respec-

tive photodiodes, the reference and the measurement signal each go to a frequency counter; the two counters drive a subtractor which keeps a running account of the frequency difference. Its output goes to the control box.

Feed rates. The 5500A can measure velocities up to 1 foot per second. Thus, the instrument can be used to measure feed rates.

Velocity measuring is one thing AIL's interferometer can't do. "We had it," says AIL product-line manager Joseph Engeman, "and we found there was no market for it."

Engeman hasn't seen H-P's unit, but after hearing specifications he concedes that its resolution, range, and warmup time are better than those of the Mark II. However he feels that the AIL unit is better in other areas. To demonstrate this he points to one feature that H-P chose not to be put on the 5500A. Temperature, pressure and humidity all affect the speed of light, and must be compensated for by any interferometer. With H-P's 5500A, the compensation is made by setting thumbwheel switches.

"The drawback here," says AIL's Engeman "is that the operator has to read his temperature, know his pressure, look up the humidity, and then look up on some chart some number which corresponds to these ratings. It's almost arbitrary as far as the operator is concerned; he doesn't know what it means. The way we do it, and the way Perkin-Elmer does it, is automatically; we have sensors (built into the interferometer). You don't have to go to a chart and look up a parts-per-million conversion."

Hewlett-Packard Co., 5301 Stevens Creek Blvd., Santa Clara, Calif. [429]

COMPARE CLOSE-UPS

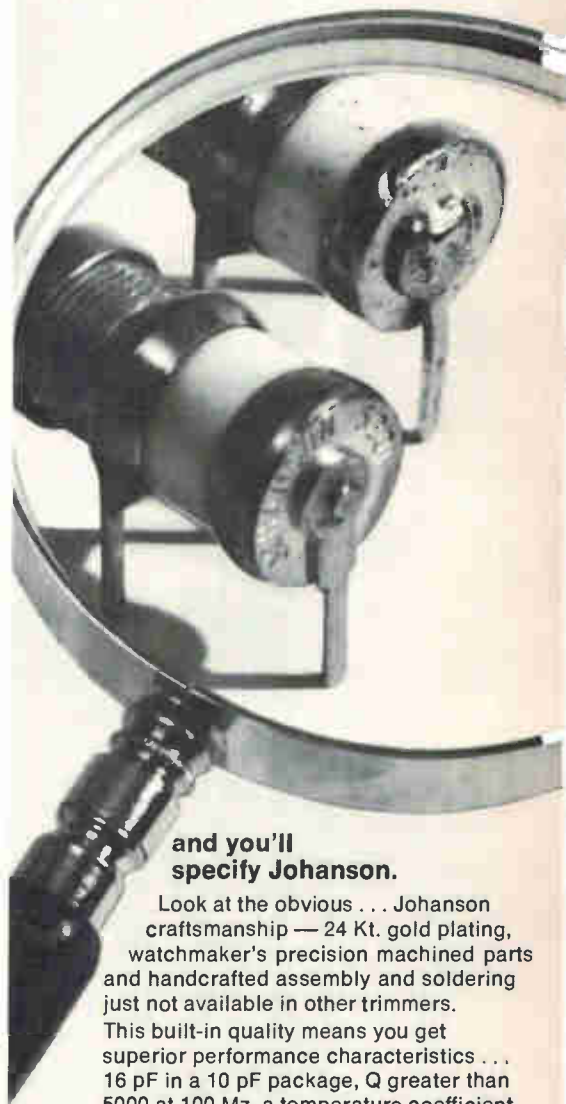

and you'll specify Johanson.

Look at the obvious . . . Johanson craftsmanship — 24 Kt. gold plating, watchmaker's precision machined parts and handcrafted assembly and soldering just not available in other trimmers.

This built-in quality means you get superior performance characteristics . . . 16 pF in a 10 pF package, Q greater than 5000 at 100 Mz, a temperature coefficient of 0 ± 15 PPM°/C, with tuning stability and long life.

Why settle for ordinary trimmers when the best is available — send today for our new catalog sheet on our 5200 series . . . and start comparing.



Johanson

MANUFACTURING CORPORATION

Rockaway Valley Road, Boonton, N.J. 07005
(201) 334-2676

Electronic Accuracy Through Mechanical Precision

**Five reasons why
more engineers have selected
Clairex photocells
over all others...**

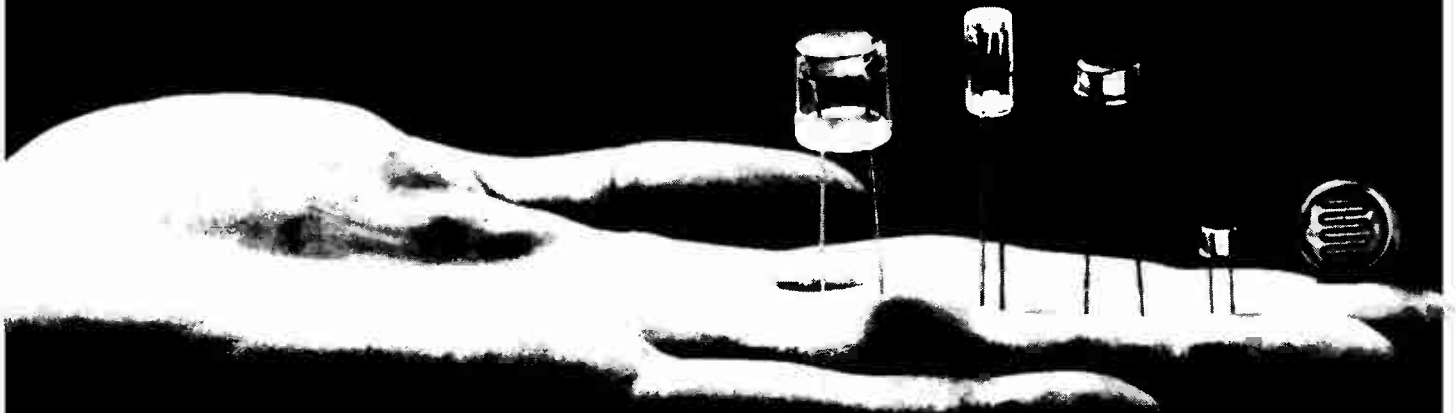

**These basic
Clairex packages cover
98% of all applications...
try one.**

Clairex has more experience supplying more high-quality photocells for more applications than anyone. Let us show you how we can perform in handling your problems. Call (914) 664-6602 or write Clairex,® 560 South Third Avenue, Mount Vernon, New York 10550.

CLAIREX ELECTRONICS

Read-only memory is field-programmable

Integrated-circuit ROM is supplied as complete package, and user programs it with electrical pulses—no special masks

When an equipment design requires only a few read-only-memory IC's with a single program, or when many ROM's with different programs are required (as when ROM's are used as logic circuits), expenses can soar. ROM manufacturers ordinarily impose a mask charge—\$1,000 or more—for each program required, on top of the price of the IC's. And time is a

factor too; a delay of about six weeks from date of order to date of delivery is usual—again because a special mask is required for each program.

An IC from Radiation Inc. promises better times. Called PROM (for programmable read-only memory), the IC requires no special masks. The customer programs with electrical pulses. He doesn't have to

wait for masks to be made—and doesn't have to pay for them. Although user-programmed ROM's were available previously, they had to be programmed by mechanical means such as scribing the metal interconnections on the chip or cutting them with a laser beam. The ROM therefore had to be furnished to the customer as an unpackaged chip. Radiation's PROM,

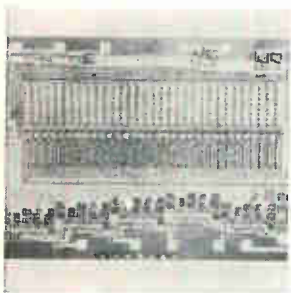

Monolithic TTL compatible IC memory SM320 consists of 256 bits of data storage arranged in a 32-word eight-bit matrix providing total memory capacity of 32 eight-bit words. It operates from a nominal supply of 5 v. Typical access time is in the 30 nsec range. The device is rated for operation from 0° to +75° C. Sylvania Electric Products Inc., Main St., Buffalo, N.Y. [436]

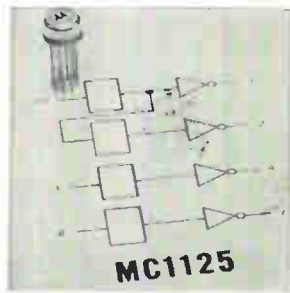

Flip-flop MC1125G is a monolithic device consisting of four toggle mode flip-flops with buffered Q outputs that use no standby power when driving capacitive-coupled loads. Typical power dissipation is 75 mw and operation is from d-c to 1 Mhz. Typical input capacitance is 2.5 pf and cross-talk figure is under 1%. Motorola Semiconductor Products Inc., Phoenix [437]



Integrated operational amplifiers TAA861 and TAA865 are d-c devices with a differential input and single-ended output. Output current is up to 70 ma. Input current can be set by adjusting the value of the externally connected d-c load. Applications are in control engineering, industrial electronics and a-f engineering. Siemens Corp., 186 Wood Ave. South, Iselin, N.J. [438]

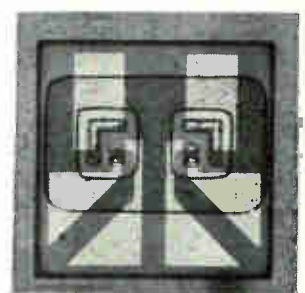

Silicon matched pair, transistor chips are for hybrid circuits and differential amplifier circuits. They are designated DI 4044/4878, 4100/4879, and 4045/4880. Characteristics include: dielectric isolation; monolithic construction; high d-c gain; low capacitance; and close parameter match, from 10 μ a to 1 ma. Dionics Inc., 65 Rushmore St., Westbury, N.Y. 11590 [439]



Solid state, red light-emitting diode 5082-4403 is functionally designed to displace miniature incandescent and glow lamps in indicator uses. The GaAs phosphide lamp is designed for self-mounting in panels or p-c boards. Typical useful life is 1 million hours. Unit is priced at 50 cents in large volume quantities. Hewlett-Packard Co., 1501 Page Mill Rd., Palo Alto, Calif. [440]



P-channel, insulated gate MOS FET 3N174 features low leakage and high input impedance, important in minimizing drift in operational amplifiers and in providing high accuracy in electrometer circuits. At 25° C maximum drain current is -5 na; maximum gate-terminal current, -2.5 pa; low threshold voltage, -2 to -6 v. Texas Instruments Inc., P.O. Box 5012, M/S306, Dallas [441]

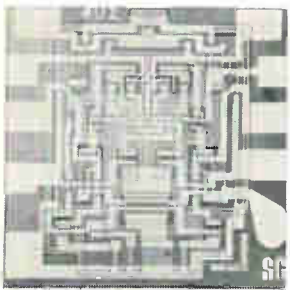

Variable gain, frequency response beyond 50 Mhz, and provision for gating and agc are features of linear IC amplifier SG 1402. At 10 v, typical gain is 25 db and power consumption is just 50 mw. Applications include use as a wide-band amplifier, balanced modulator or demodulator and as a phase switch. Silicon General Inc., 7382 Bolsa Ave., Westminster, Calif. 92683 [442]



H-v npn silicon power transistors now come as 700 v devices in production lots. Specifications include: saturation voltage less than 600 mv at 3 amps; sustaining V_{CEO} in excess of 500 v; and minimum h_{FE} at 3 amps of 15. Typical uses include vertical and horizontal deflection circuits for crt instrumentation. Solttron Devices Inc., Blue Heron Blvd., Riviera Beach, Fla. [443]

OKAY, THE HONEYMOON'S OVER. SEND IN THOSE ORDERS FOR LAMINATED PLASTIC SHEETS, RODS, AND TUBES; COPPER-CLAD; VULCANIZED FIBRE; MOLDED PARTS; AND FABRICATED NONMETALLIC PARTS. SEE HOW GREAT A MARRIAGE CAN BE.

When Synthane fabrication quality merged with Taylor materials capability, people found out. They kept us so busy filling orders we had very little time for dozing in the sun. Some honeymoon!

Now at last we're tanned, organized, and ready for new challenges. Our four plants are humming. But we can always handle more. So your order would be most welcome. We'll even work extra shifts to help you out.

After all, we got together to serve you better.



Synthane-Taylor Corporation, Valley Forge, Penna. 19481 • Plants: Valley Forge, Pa., Oaks, Pa., La Verne, Calif., Scarborough, Ont., Canada • An Alco Standard Co.



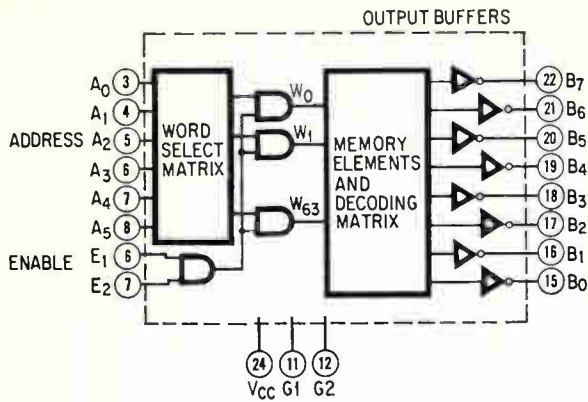

Set a bit. The memory is programmed in the field by applying a negative current ramp to each bit position that will be a logical 1.

however, is supplied completely packaged in a 24-pin hermetically sealed 1-by-3/8-inch flatpack.

The PROM contains a word-select matrix, and a 512-bit memory and decoding matrix with the memory matrix organized as 64-eight-bit words. Also included are open-collector output buffers that permit wired-OR operations. The transistors are bipolar and are dielectrically isolated.

As delivered by the manufacturer, all bits in the memory are set at logic 0. To program the memory—to change 0's to 1's, as desired—the user first connects the IC as shown in the diagram. To address a particular word in the memory for programming, the input switches are set to the binary equivalent of that word; a 0 is represented by -7.0 volts and a 1 is an open circuit. All the bits in this word now are available for programming.

Now, at the pin associated with the first bit (B₀, B₁, . . . B₇ to be changed from a 0 to 1, a negative-going current ramp is applied, with the output voltage of the current generator clamped at -7.0 volts. The easiest way to do this is to connect the negative terminal of a variable power supply to the proper output pin, then manually increase the voltage to approximately 7.0 volts.

On the chip the metalization connecting the transistor for that particular bit opens when the current ramp reaches a certain level. The open circuit occurs at a necked-down portion of the metalization as a result of the high current density through it.

While the ramp is being applied, current increases to 50 milliamperes. At the instant the break occurs, current drops to about 15 ma,

indicating that programming of the bit has been accomplished.

The procedure is repeated for each bit in the word.

More sophisticated electronics can be employed to make the programming process faster and more automatic. Radiation uses an automatic system to program ROM's for customers whose memory configurations are well established and are for standard patterns. Punched cards provide the program data.

The IC has an access time of 65 nanoseconds, a fanout of 20 ma, word-bit expandability, and parallel input, output, and chip-enable. It is compatible with DTL and TTL circuits. Total operating power is 400 milliwatts at 25°C. However, the enable feature permits power dissipation to be reduced to about 250 when the device isn't being addressed.

Price of the military version (-55°C to +125°C) is \$61.50 apiece in 100 to 999 quantities. The commercial version (0°C to +75°C) sells for \$47.

Radiation Inc., Microelectronics Division, Melbourne, Fla., 32901

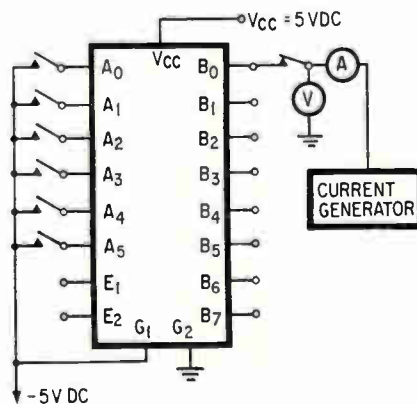

Speed rating. Word-select matrix, memory, decoding matrix, buffers are on chip. Words are 8-bit units.

Now available... In production quantities state-of-the-art TCXO's only from BULOVA

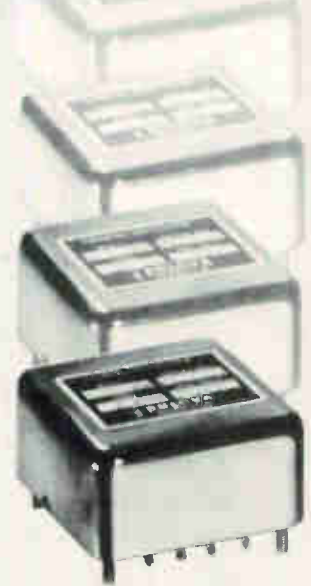

**frequency stability —
± 2pp10⁷ from - 40°C
to + 75°C to meet your
production schedules.**

SPECIFICATIONS:

Frequency Range: 3 to 5MHz

Frequency Stability

Temperature: ±2pp10⁷ maximum over the temperature range of -40°C to +75°C

Voltage: ±5pp10⁶ maximum for a supply variation of ±5%

Load: ±1pp10⁶ for a load variation of ±10%

Frequency Aging: ±1/10⁶ per week at 60°C

Output Voltage: 125 millivolts RMS into 50 ohms

Input Power: 12VDC ±5% at 50 milliwatts maximum

Size: 2" x 2" x 1"

Weight: 5.0 oz.

If you have a TCXO requirement or an oscillator problem that needs solving, call (212) 335-6000 or write

BULOVA
fcp **BULOVA**
FREQUENCY CONTROL PRODUCTS
Electronics Division of Bulova Watch Co., Inc.
61-20 Woodside Ave., Woodside, N.Y. 11377

It doesn't take a training director to run one.



A Fairchild SEVENTY-21 Super 8 Sound movie projector. The training device for untrained hands.

Take the average trainee that comes your way for instruction.

And instead of worrying about how you're going to make the time to process him properly and then train him, put a MOVIEPAK® cartridge into his hand. And show him how to slip it into the projector. Then, show him the on button. And the off button. And he's an expert. All ready to help train himself.

What goes into the MOVIEPAK you hand him?



(Popping up)

Until we built a truly portable projector, it was hard to get your on-the-job training films onto the job.

(Closed)



FAIRCHILD

Assembly line procedures. Orientation information. Films to increase typing speed. How to set up filing systems. Computer programming. Even existing 16 and 35 mm and videotaped programs converted to Super 8 Sound.

If you want to add or change soundtracks, there's a recording option available.

If you want to add more people to the audience, that's okay too. The screen is a rather large 9" x 12" and is visible in full room light.

And there's a surprising number of films for training available in MOVIEPAKS already.

Write or call for more information. And if you have the time, ask for one of our two second demonstrations.

Fairchild Industrial Products
75 Mall Drive, Commack, New York 11725
(516) 864-8500

New materials

Coating protects solder-free areas



Liquid elastomer solder resist and coating mask called Solder-Mask protects contacts, holes, and areas on p-c boards that must be kept solder-free when boards are machine soldered. It is quicker, safer, and less expensive than other masking methods. It is available in two types—regular and water soluble. The regular formula can be removed after soldering by peeling or rubbing. The water-soluble formula is removed by washing in hot (140°-150°F) water. Both types can be applied by brushing, applicator, or syringe needle. Solder Removal Co., P.O. Box 1678, Covina, Calif. 91722 [341]

Both effective emi shielding and gasket rigidity are featured in the Metalex gasket. It consists of a resilient, single-fin emi shielding strip mechanically joined to an aluminum extrusion. Available in many cross sections, the aluminum strip can be mounted directly by spot welding, screwing, riveting, or similar techniques. Since the emi strip is firmly locked into the jaw of the aluminum extrusion, it is impossible for the two to separate. The combined emi strip and gasket are available from a minimum cross section width of 1/2 in. and a minimum thickness of 3/8 in. Matex Corp., 970 New Durham Rd., Edison, N.J. 08817 [342]

Four new pourable elastomeric compounds are made from butyl rubber. The excellent impermeability of these materials to water makes them especially suitable as flexible encapsulants for electrical insulation, and as conformal coatings for electronic uses. Hardman Inc., Belleville, N.J. 07109 [343]

High-temperature grade 1303 polyester molding compound is a glass-reinforced premix type, electrical-grade material based on the company's grade 200 laminate-resin system and formulation. It is presently used primarily in coil forms and bobbins. The Glastic Corp., 4321 Glenridge Rd., Cleveland 44121 [344]

Short circuits.

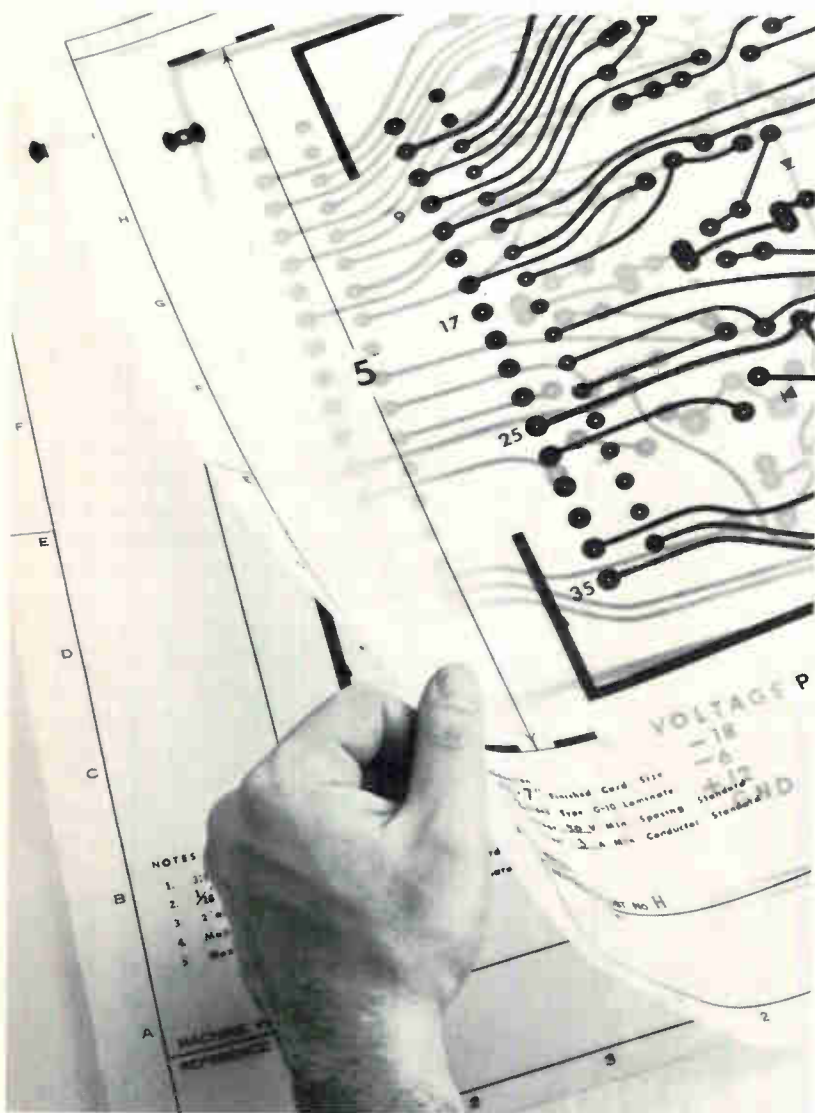

Now you can bypass slowdowns in printed circuit design.

Do your design problems include tape slippage and lack of dimensional stability on master layouts, numerous design changes, and other annoyances that hamper efficient printed circuit design?

If so, we believe that reproducing your taped master on KODAGRAPH ESTAR Base Film is the answer. For more information, contact your Kodak Technical Sales Representative, or write: Eastman Kodak Company, Business Systems Markets Division, Department DP742, Rochester, New York 14650.

DRAWING REPRODUCTION SYSTEMS BY KODAK

Kodak

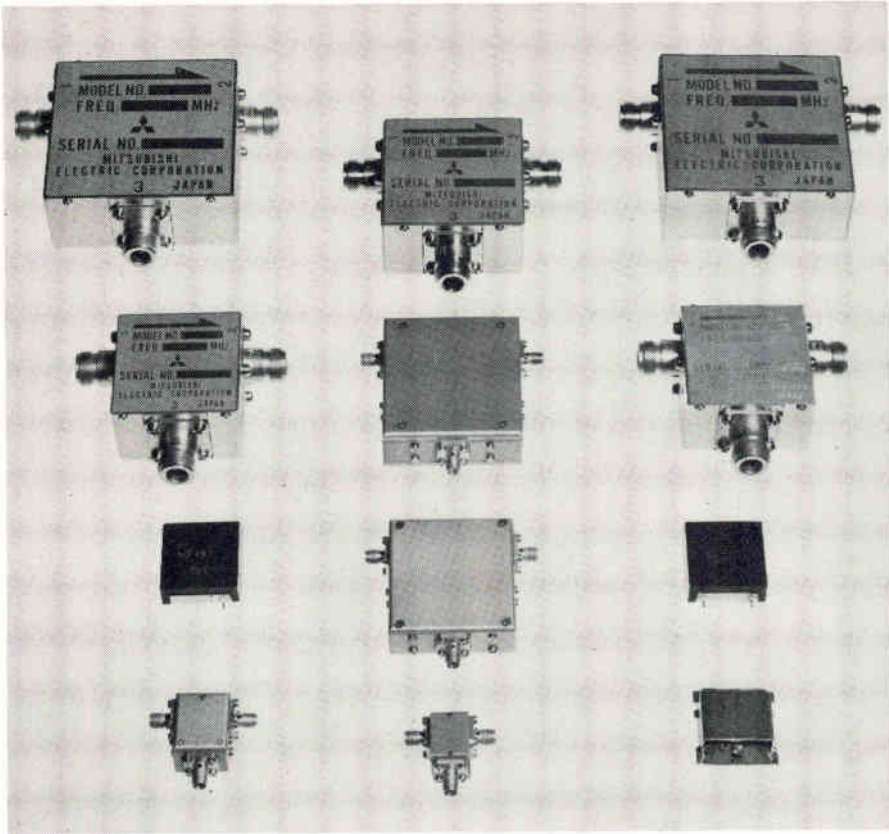

Thanks for Visiting the Mitsubishi Booth

We extend our sincere appreciation to all those IEEE Show visitors who took the time to stop by the Mitsubishi Electric booth. The enthusiastic interest shown in the displays was especially encouraging. We are glad to be able to report that our monolithic ICs and mini circulators—VHF, UHF, and SHF, as well as the 700 MHz type—were all favorably received.

Now that the show is over, we welcome any further inquiries from you about the new research developments and techniques.



Circle 184 on reader service card

FIGHT THEM ALL...

**Heart Attack
Stroke
High Blood Pressure
Rheumatic Fever**

GIVE ...SO MORE WILL LIVE HEART FUND



New Books

Gap-bridger

Linear Systems Analysis
Laurel J. Lewis, Donald K. Reynolds,
F. Robert Bergseth, and
Frank J. Alexandro Jr.
McGraw-Hill Book Co.
489 pp., \$16.50

Few engineers, once they complete their formal education, have either the inclination or the opportunity to utilize university resources to keep abreast of new developments and advance their skills. It is to the large and essentially unaided majority that this book, the introductory text in a new University of Washington series, is devoted. The purpose is to provide an opportunity for the practicing engineer to review mathematical ideas and procedures that need refreshing and to present material that until recently has not been included in the undergraduate education. The newer topics provide a foundation for further advanced study.

This book was written for a specific planned instructional program and is suitable as a text for formal courses. For the engineer who does not have the opportunity for group study, the text arrangement is appropriate for independent self-study.

In all of the chapters, theory is developed from a background of specific examples to suit practicing engineers who often like to see specific applications of the theories presented. The theory is not based on rigorous mathematics, but rather on the minimum amount needed to properly present the subject.

The problems included in each chapter are an important part of the overall design. The intention is that all of the problems be worked by the reader, since in many cases success and progress depend on understanding previous examples. Some problems are solved elsewhere in the book to enable the reader to confirm his understanding and evaluate his progress.

The two main ideas that progress through the book are merged at intervals through emphasis on common objectives. One path is concerned largely with ideas conveyed in mathematical form, often through algebraic relations—for ex-

DETECTIVE FOR HIRE

FACT (Flexible Automatic Circuit Tester), Hughes' random access test system can analyze the wiring integrity of any circuit. And FACT is for hire.

Through Hughes' lease/rental program, FACT's services can be contracted for a specific time period: short run production testing, peak loading, prototype assembly checkout—any schedule where time is short, but product reliability requirements are long.

Contact:

L. W. Risner
FACT Systems
Hughes Aircraft Company
P. O. Box 92904
Los Angeles, California 90009
(213) 670-9040



New Books

ample, the chapters on matrices, determinants, and linear transformations. The other path utilizes the concepts of frequency, resulting from observations of oscillations associated with the responses of physical systems. The chapters on the sinusoidal steady state and Fourier integrals develop these ideas. A chapter on block diagrams and signal flow graphs illustrates other forms of expression.

Because effective calculation and simulation are important aspects of analysis, a chapter on engineering synthesis is included.

Recently Published

Handbook of Radar Measurement, David Barton, Harold Ward, Prentice-Hall, 426 pp., \$18

Summarizes the theory, equations, tables, and graphical data needed to estimate the accuracy of radar measurement in range, Doppler, and angle. Covers the effects of noise, interference, multipath, scintillation, and system tolerances.

Theory of Optimal Control and Mathematical Programming, M. Canon, C. Cullum, and E. Polak, McGraw-Hill, 285 pp., \$18.50

Geared to the graduate-level student, this text presents a unified theory of constrained optimization in finite-dimensional spaces, considering the conditions of optimality and their utilization in algorithms.

Practically Speaking in Business, Industry and Government, R. Hays, Addison-Wesley, 198 pp., \$4.95

Designed for men and women in business, industry, and government who need to speak effectively in public. Covers some of the general aspects of public speaking, then proceeds into step-by-step suggestions for preparing, developing, and delivering a speech. Exercises, examples, and case histories are provided throughout the book.

Digital Simulation of Continuous Systems, Raohan Chu, McGraw-Hill, 423 pp., \$14.50

Covers digital simulation to systems through the application-oriented languages of Mimic, DSL/90, and the algorithmic language of Fortran IV. Describes logic and construction of Simic, a simplified version of the Mimic processor.

who's first
with a
Z-combo
cassette
head for
dictating and
telephone
answering?

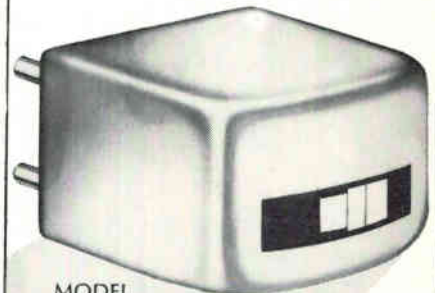

MODEL
ZW1R36K

.030" proximity of erase and
r/p gaps allows precision
editing. R/P inductance
200 mhy, 340 ohms
D.C.R., 0.7 RMS
voltage at
1 khz.

Nortronics is who!

- Extended tip version for card reader, drum and belt applications
- Dual channel units available
- Applicable as mini-digital tunnel-write head; request digital specs



**NORTRONICS
COMPANY, INC.**

8101 Tenth Avenue North
Minneapolis, Minnesota 55427
(612) 545-0401

put your stake in Florida.

We Have Competitive Advantages You Simply Can't Afford To Overlook

When your surveying team pounds the first stake into the good Florida earth you'll be off and running.

Florida has competitive advantages for you that are bound to find their way into your profit and loss statement.

Our recently passed laws governing revenue bond financing are going to smooth the pathway to new building and improvement.

We have a labor training and motivating program — without cost to you — that takes all the headaches out of recruitment.

The all-round advantages of Florida living make us the **most** attractive state for all kinds of skilled people.

When you start thinking about sites, think about Florida where you get the big competitive edge. Phone (904) 224-1215, or send the coupon.

Florida

FLORIDA DEPARTMENT OF COMMERCE
INDUSTRIAL DIVISION
107 WEST GAINES STREET
TALLAHASSEE FLORIDA 32304

HANDY COUPON FOR YOUR CONVENIENCE!

Florida Department of Commerce / 107 West Gaines St. / Tallahassee, Florida 32304 / Att.: Dept. "D-2"

I'm interested in a business or industrial future in Florida. Please send me more information.

Name

Title or Position

Company

Street

City State Zip

Technical Abstracts

Fast, dense MOS memory

A three-transistor-cell, 1024-bit, 500-nsec MOS RAM

W.M. Regitz, Computer Control Division, Honeywell Inc., Framingham, Mass.

J. Karp, Intel Corp., Mountain View, Calif.

A high-performance, low-cost, metal oxide semiconductor memory has been designed that stores 1,024 bits on one chip, as 512 words of two bits each, with all address decoding. It is a dynamic circuit with a cycle time of 500 nanoseconds for either reading or writing. It uses three transistors per cell and has 32 common refresh circuits—one for each column of 16 cells, whose data is refreshed in rotation. A similar approach to refreshing is used in the Four-Phase Systems array described recently [*Electronics*, Feb. 16, p. 109].

However, unlike the Four-Phase Systems design, this memory packs the cells a little more tightly together by using only one horizontal line common to all the cells in a row, instead of two. The tradeoff for this simplification is the use of a ternary or three-level signal on this horizontal line, with a low "off" level, a high level for writing or refreshing, and an intermediate level for reading.

At the beginning of a cycle, the capacitance of a vertical read bus that is common to 16 bits in a column of cells is precharged to the memory's supply voltage. Immediately after the precharging, one of 16 horizontal buses goes from ground to its intermediate level. This is sufficient to conditionally discharge the vertical read bus, if the cell at the intersection of the two buses contains a 1; but it is insufficient to charge the cell with any new data that may be arriving on the data bus, parallel to the read bus, because of the bias on the transistor connecting the data bus to the cell.

Following the conditional discharge, the read-bus capacitance contains the complement of the data in the cell. It is reinverted through a column-amplifier circuit and placed on the data bus, from which it can be read out, and from

which it refreshes the data in the cell. Refreshing occurs because, by this time, the horizontal bus has reached its high level, connecting the data bus to the cell. Following the refreshment of the cell, the horizontal bus returns to ground and a new cycle can begin.

During a write operation, new data on the digit bus is gated onto the data bus in place of the old data, which doesn't get past the column amplifier.

The circuit that generates the three levels on the horizontal bus, basically an analog circuit, tracks variations in operating temperature and in process parameters in such a way that its output, varying accordingly, is always within the margins required for the rest of the memory.

Presented at International Solid State Circuits Conference, Philadelphia, Feb. 18-20

Beam leadership

Rigid and nonrigid beam-lead substrates

F.J. Bachner, R.A. Cohen, and R.E. McMahon

MIT Lincoln Laboratory, Lexington, Mass.

It's no secret that to cash in on the increased chip density that large-scale integrated circuits offer, designers had to make more reliable the great number of assembly leads and interconnections on a single substrate.

Beam-lead technology was developed to relieve this problem. But, while reducing lead connections, beam leads can fall short in other important functions. Often they were unable to provide heat paths—a direct thermal route from the chip to the heat sink, which caused excessive chip heating and possible component failure. In addition, beam-lead techniques weren't flexible enough in circuit design to allow a given fabrication layout to accommodate a varying number of chips—from several to perhaps 100 or more. This would allow proper system partitioning to minimize off-substrate interconnections.

Beam-lead substrates, which allow assembly and interconnection of standard and beam-leaded mon-

packaged readouts

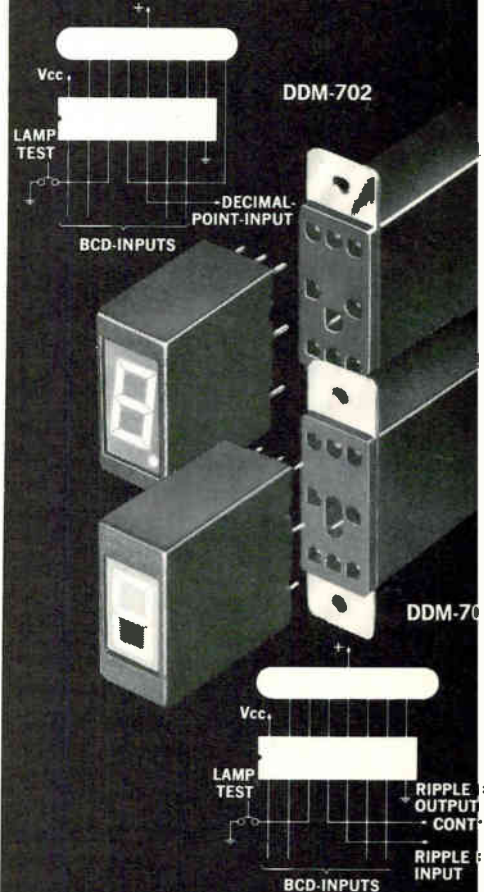

Now you can buy the complete readout and decoder/driver combination rather than assemble your own.

The ALCO "packaged readouts" include the 7-segment incandescent devices ready to plug into its own mating decoder/driver having a BCD input compatible with DTL and TTL circuitry.

Model DDM-702 has an ALCO MS-4100BC seven-segment readout and features an inverter-driver function necessary to energize the decimal point in the display device. Complete Package Price, \$19.95 (100 lot).

Model DDM-703 includes an ALCO MS-4000BC readout having a ripple blanking capability and intensity control input. Both models operate on 5V and have a lamp test provision. Complete Package, \$18.95 (100 lot).

It's more convenient to plan your designs the ALCO way. We provide a cost advantage whether application is for a prototype or in production. We also supply matching bezels and mounts to support up to 8 of the above modules.

Call us now at (617) 686-3887 and ask for one of our readout specialists.

ALCO

ELECTRONIC PRODUCTS, INC.

Lawrence, Massachusetts 01843

Face up to the flat one!

The inherent advantages of Zenith Flat-Face CRTs assure the brightest, clearest display of alpha-numeric and analog data. Parallax errors are minimized. Provides resolution as high as 2500 TV lines. Design variations include single and dual neck configurations. Optional rear projection ports and laminated implosion shields. For details, write or call (312) 674-8000.



ZENITH RADIO CORPORATION
THE RAULAND DIVISION
5614 W. JARVIS AVE. • CHICAGO, ILL. 60648 • 312-647-8000

Circle 212 on reader service card

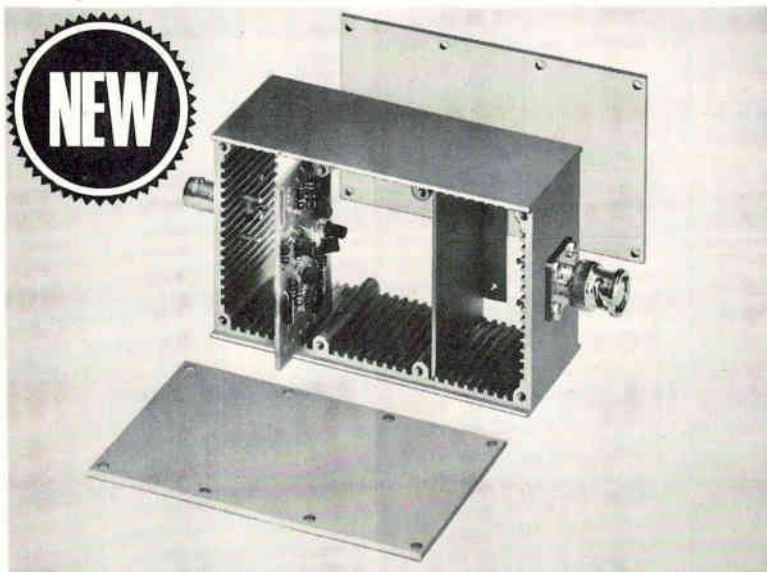

SHIELDED BOXES with CARD GUIDES

Rugged die-cast aluminum boxes, slotted to accept $\frac{1}{8}$ " circuit boards and shielding dividers. Excellent for packaging electronic circuitry. Boxes have removable top and bottom covers. Useable inside space: 4"x2"x1½". Several models with various connectors.

Write for 1969 Catalog



POMONA ELECTRONICS CO., INC.
1500 E. Ninth Street, Pomona, California 91766

Technical Abstracts

olithic chips, overcame these disadvantages. Two types of substrates can be used: rigid beam-lead units using glass, silicon or alumina, and nonrigid substrates made from a polyimide material such as Kapton.

Although several methods of rigid-substrate processing are available, the simplest employs ultrasonic drilling of the substrate to provide "windows" which are then backfilled with glass. This creates a smooth, continuous surface for the deposition of the lead metalization. Following metalization the glass is removed by etching in hydrofluoric acid.

Using this method, a six-stage register with alumina as the substrate material has been fabricated using gold metalization; circuit operation has encountered no difficulties due to the fabrication, thus proving the feasibility of the technique. In addition, larger rigid beam-lead substrates have been fabricated to accommodate a greater number of chips—a 36-hole substrate in which 30 holes are used for the chip location and heavy conductors are located in the area of the unused holes.

Nonrigid substrates can be made with Kapton, a polyimide film. The basic design is similar to the rigid beam-lead substrates except that the Kapton is either copper or nickel-clad on both sides and the interconnecting conductor pattern and beam-lead conductors are fabricated prior to etching of the windows. As with the rigid substrate method, gold or aluminum is deposited or plated on the conductor pattern and on both sides of the exposed beam leads.

Presented at International Solid State Circuits Conference, Philadelphia, Feb. 18-20.

How reliable, LSI?

The impact of reliability requirements on LSI technology
C.F. Schnable, R.S. Keen and M.M. Schlacter
Philco-Ford Corp.
Blue Bell, Pa.

The blessing of improved reliability promised by LSI is a bit mixed. Certainly there are reasons why large-scale integrated circuits should fail less often than simpler



One answer for the critical silicon shortage is 300 years old.

Algernon Sidney (1622-1683) said, "God helps those who help themselves." And production problems caused by the short supply of silicon can end with your own in-plant facility for crystal growing, zone purification or proprietary IC production.

Count on NCG for the industrial gases you'll need. We produce hydrogen and nitrogen for use in crystal growing. Our argon and helium provide inert atmospheres for zone purification as well as production of silicon, germanium or ICs.

NCG reliably supplies any quantity of these gases from a single cylinder to a neighboring air separation plant built and operated by our own personnel. Write to us for complete details.

NCG[®]

NATIONAL CYLINDER GAS
DIVISION OF CHEMETRON CORPORATION
840 North Michigan Avenue • Chicago, Illinois 60611

CHEMETRON

TRADEMARK

Technical Abstracts

IC's. Fewer bonds are needed; a smaller number of packages can do a given job; there's more redundancy; and in some cases hermetically-sealed LSI packages can replace a bundle of plastic-encapsulated circuits.

However, LSI is also subject to failure mechanisms that either don't exist or cause little trouble in less-complex IC's. These mechanisms pop up because LSI is characterized by multilevel metalization layers, smaller geometries, new processing techniques, higher power densities, less-complete functional testing, and lower-volume production.

Some mechanisms we already know about. Surface ion migration, microcracks in metalization at oxide steps, electromigration, shorts through oxide layers, and open wire bonds are understood. But we need new techniques to both life test LSI circuits and to study their other failure mechanisms.

One thing is clear. Bipolar devices are particularly sensitive to metalization-related increases in resistances, while surface-related failure mechanisms do most of the damage to MOS arrays. It appears that the principal failure modes in multilevel metalized bipolar arrays are open circuits at oxide steps, opens in metal lines as a result of electromigration, and shorts between metal layers at imperfections in the deposited dielectric.

In contrast to bipolar devices, metal oxide semiconductor circuits are fabricated on high-resistivity material and operate at higher voltages. This explains their susceptibility to surface-related failure mechanisms, which are caused by changes in the electrical properties of the silicon-silicon dioxide interface of the circuit.

A problem that plagues both MOS and bipolar devices is localized defects in silicon and thermally-grown silicon dioxide. Because the more complex an array is, the better the chance of a defect existing at an active area, yield falls off exponentially as circuit complexity goes up.

Presented at International Solid State Circuits Conference, Philadelphia, Feb. 18-20.

the most popular ALCOSWITCH

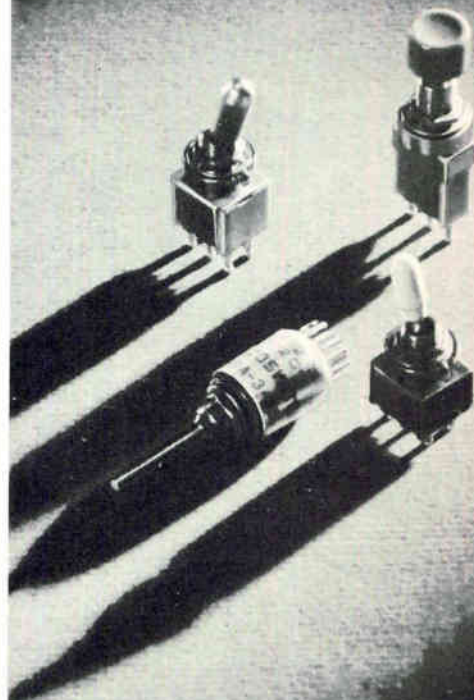

WE'RE
NOT
NO. 1, 2 OR 3

But we are popular in the miniature switch field.

You'll find our ALCOSWITCH[®] in test equipment, medical equipment, electronic controls, computers, and in thousands of installations where design engineers want the best without having to pay outrageous prices.

We're popular too, because ALCOSWITCH has one of the broadest lines available in miniatures — toggles, push buttons, rotaries, locking, slide, and rockers, along with a host of needed accessories.

ALCOSWITCH[®] is made for engineers — and you can fill your immediate requirements from our stocks or from one of our many ALCOSWITCH[®] stocking distributors in your area.

ALCO[®]

ELECTRONIC PRODUCTS, INC.

Lawrence Massachusetts 01843

Circle 189 on reader service card

Circle 213 on reader service card

Make your home safer and your family more secure with DeltAlert... the new burglar light/alarm

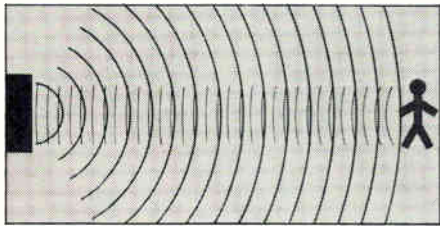

FACT: the rising tide in residential burglary threatens all of us today.

FACT: a home guarded with lights will reduce chance of robbery by 95%.

FACT: the simple-to-operate DeltAlert adds to overall home safety and protection.

Send for free illustrated brochure. See how you can easily protect your home and family economically with the brand new DeltAlert. The system monitors and blankets a 15 to 30 foot area, using sonar principles to "catch" any intruder entering the monitored area by turning on lights, activating alarms, or both. Easy to operate! Simply plug into a wall outlet, and plug lights into the back of the DeltAlert. No rewiring necessary. The unit comes in a handsome walnut finish, designed to complement any decor.



ONLY \$59.95
ppd.

Money Back Guarantee

Let your night watchman be DeltAlert.

Order Today,
or
Write for Free Brochure

DELTA PRODUCTS, INC.

P.O. BOX 1147 E / GRAND JUNCTION, COLO. 81501
(303) 242-9000

Please send free brochure DP 70-6

Enclosed is \$ _____

Ship ppd. Ship C.O.D.

Please send _____ DeltAlert(s)

Name _____

Address _____

City/State _____ Zip _____

DELTA PRODUCTS, INC.

P.O. BOX 1147 E / GRAND JUNCTION, COLO. 81501
(303) 242-9000

New Literature

Electromagnetic delay lines. ESC Electronics, a division of General Laboratory Associates, 534 Bergen Blvd., Palisades Park, N.J. 07650, has available a brochure describing its electromagnetic delay lines for critical air traffic control applications.

Circle 446 on reader service card

Analog multipliers. GPS Corp., 14 Burr St., Framingham, Mass. 01701, has published a booklet containing application notes on high speed analog multipliers. [447]

Analytical instruments. Varian, 611 Hansen Way, Palo Alto, Calif. 94303. A 12-page catalog describes a line of nuclear-magnetic resonance, electron-paramagnetic resonance, and mass spectrometers, as well as laboratory electromagnets, data-processing systems, and geophysical instruments. [448]

IC testers. Microdyne Instruments Inc., 203 Middlesex Turnpike, Burlington, Mass. 01803, offers a 12-page brochure explaining operation, testing procedures, specifications, and accessories for the models 716A and 824 bench-top IC testers. [449]

Antenna fabricating techniques. Polyflon Corp., 35 River St., New Rochelle, N.Y. 10800, has issued a bulletin that briefly describes fabricating techniques to produce antennas (di-poles, duplexers, conical spiral, spiral, and flat spiral). [450]

Ultraviolet filters. Spectrum Systems division, Barnes Engineering Co., 30 Commerce Rd., Stamford, Conn. 06904. Bulletin 400 describes the firm's standard ultraviolet filters with bandwidths ranging from 1% to 10%. [451]

MOS keyboard. Microswitch, a division of Honeywell Inc., 11 W. Spring St., Freeport, Ill. 61032, announces a product sheet describing MOS-encoded solid state keyboard 51SW5-2. [452]

X-Y recorders. Bolt Beranek and Newman Inc., 1762 McGaw Ave., Santa Ana, Calif. 92705, offers a data sheet describing a series of low-cost quality X-Y recorders. [453]

Portable terminal. Data Products Corp., 6219 DeSoto Ave., Woodland Hills, Calif. 1364. A six-page brochure describes the Porta Com, a portable computer-communications terminal that leases for \$95 a month and sells for \$2,450. [454]

Rack-and-panel connectors. Microdot Inc., 220 Pasadena Ave., South Pasadena, Calif. 91030, has issued a 12-page catalog describing its high-density rack-and-panel connectors. [455]

MICO

NEW MODEL 885 SEVEN RATIO WIDE-RANGE ENGRAVER

NO. 885

FOR LONG AND MULTI-LINE WORK

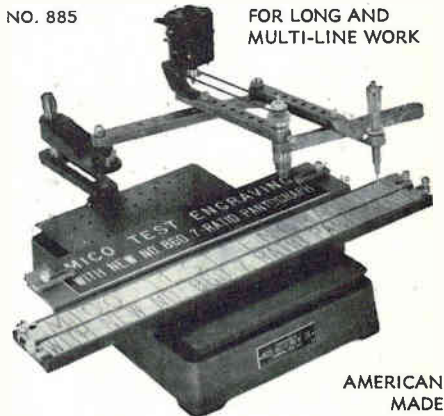

AMERICAN MADE

- A time-saver for large plate work
- Engravers letters 1/32" to 3" high using standard masters.
- Seven pantograph ratios—from 1:5:1 to 6:1.
- Choice of 3-ball-bearing spindle assemblies for 1/8", 3/16" or taper-shank cutters.
- HSS, COBALT and Solid Carbide Cutters.
- Single and multi-line copy carriers for holding, blanks 3/4" to 3 1/2" high.
- Accommodates Mico standard accessories.

Send for bulletins and prices

MICO INSTRUMENT CO.

77 Trowbridge St. Cambridge, Mass. 02138

Circle 227 on reader service card



ZIPPERTUBING® R.F.I. SHIELDING JACKETING

for quick application and protection of multi conductor cables!

SHN 3 for R.F.I. shielding and protection. Tinned copper braid, attached to inside overlap provides gasket type seal and solderable termination point.

SHX 4 — of special knitted compounded wire for highly flexible R.F.I. shielding.

CPE conductive polyethylene for electrostatic protection.

MS provides low frequency magnetic shielding.

For full information on specialized, high-performance jacketing, contact

THE **ZIPPERTUBING®** CO.

CORPORATE HEADQUARTERS
13000 S. BROADWAY
LOS ANGELES, CALIF. 90061
Los Angeles Phone: (213) 321-3901
New Jersey Phone: (201) 256-4980



BALTIMORE • BOSTON • CHICAGO • CLEVELAND • DALLAS
NEW YORK • ORLANDO • PHOENIX • SAN FRANCISCO • WEST GERMANY

Special introductory offer to new members of the ELECTRONICS AND CONTROL ENGINEERS' BOOK CLUB

	A042/500 NUMERICAL CALCULATIONS AND ALGORITHMS by Beckett & Hurt Pub. price, \$10.50 Club price, \$8.95		A494/754 ENGINEERING MANUAL, 2/e by R. H. Perry Pub. price, \$12.50 Club price, \$9.95
	A101/094 MICROELEC- TRONIC CIRCUITS AND APPLICATIONS by J. M. Carroll Pub. price, \$12.00 Club price, \$10.25		A523/401 CHARACTERIS- TICS AND OPERATION OF MOS FIELD- EFFECT DEVICES by P. Richman Pub. price, \$10.00 Club price, \$8.50
	A286/507 SOLID-STATE ELECTRONICS by R. G. Hibberd Pub. price, \$9.50 Club price, \$7.95		A037/604 DIGITAL LOGIC AND COMPUTER OPERATIONS by Baron & Piccirilli Pub. price, \$14.50 Club price, \$11.95
	A287/457 SUCCESSFUL ENGINEERING MANAGEMENT by T. G. Hicks Pub. price, \$8.95 Club price, \$7.25		A423/814 PULSE, DIGITAL AND SWITCHING WAVEFORMS by Millman & Taub Pub. price, \$18.00 Club price, \$15.30
	A347/506 ELECTRONIC DIGITAL TECHNIQUES by P. M. Kintner Pub. price, \$12.50 Club price, \$10.65		A565/031 AMPLIFIER HANDBOOK by R. F. Shea Pub. price, \$37.50 Club price, \$29.50
			A637/377 TRANSISTOR CIRCUIT DESIGN by Texas Instruments, Inc., Staff Pub. price, \$16.50 Club price, \$14.05
			A126/070 PRINTED CIRCUITS HANDBOOK by C. F. Cdombs, Jr. Pub. price, \$17.75 Club price, \$14.95
			A610/037 MODERN COMMUNICA- TION PRINCIPLES by Stein & Jones Pub. price, \$15.00 Club price, \$12.75
			A259/607 COMMUNICA- TION SYSTEM ENGINEERING HANDBOOK by D. H. Hamsher Pub. price, \$29.50 Club price, \$24.95

ANY ONE
of these great professional books
for only **\$1.00**
VALUES FROM \$8.95 to \$37.50

Special \$1.00 bonus book
comes to you with your
first club selection

SAVE TIME AND MONEY
BY JOINING TODAY

MAIL THE ATTACHED
POSTPAID CARD

IF CARD IS REMOVED
SEND COUPON BELOW

HERE is a professional club designed specifically to meet your day-to-day engineering needs by providing practical books in your field on a regular basis at below publisher prices.

How the Club operates: Basic to the Club's service is its publication, the *Electronics and Control Engineers' Book Club Bulletin*, which brings you news of books in your field. Sent to members without cost, it announces and describes in detail the Club's featured book of the month as well as alternate selections which are available at special members' prices.

When you want to examine the Club's feature of the month, you do nothing. The book will be mailed to you as a regular part of your Club service. If you prefer one of the alternate selections—or if you want no book at all for that month—you notify the Club by returning the convenient card enclosed with each *Bulletin*.

As a Club member, you agree only to the purchase of four books over a two-year period. Considering the many books published annually in your field, there will surely be at least four that you would want to own anyway. By joining the Club, you save both money and the trouble of searching for the best books.

ELECTRONICS AND CONTROL ENGINEERS' BOOK CLUB
330 West 42nd Street, 18th fl., New York, N. Y. 10036

Please enroll me as a member of the Electronics and Control Engineers' Book Club and send me the two books indicated below. I am to receive the bonus for just \$1.00, and my first selection at the special Club price shown. These books are to be shipped on approval, and I may return them both without cost or further obligation. If I decide to keep the books, I agree to purchase as few as four additional books during the next two years at special Club prices (approximately 15% below list).

Write Code No. of bonus book here

Write Code No. of first selection here

Name

Address

City

State Zip

E33138

Communications market in the 70's.

We have just initiated "A Study of Opportunities in the Communications Markets During the 1970's." This study will provide a limited number of clients with an in-depth analysis of the affect of changing technical, economic, and regulatory factors on the markets for communications systems, subsystems, products, and components. It will also forecast the size and structure of these markets.

For further information, please contact Mr. Samuel Weber, Manager, Electronics/Management Center, 330 West 42 Street, N.Y. 10036. Telephone: (212) 971-3485.

A joint undertaking of McGraw-Hill's Electronics/Management Center and Marcom Incorporated.

New Literature

Power supplies. Deltron Inc., Wissahickon Ave., North Wales, Pa. 19454, has available a 32-page power supply catalog and engineering manual. [456]

Test accessories. Pomona Electronics Co., 1500 E. Ninth St., Pomona, Calif. 91766, has published a 56-page general catalog of electronic test accessories. [457]

Digital strip printer. Clary Corp., 320 W. Clary Ave., San Gabriel, Calif. 91776, offers bulletin S-186, a brochure on a compact digital strip printer for commercial data systems. [458]

Static d-c drives. A.O. Smith Corp., 1146 E. 152nd St., Cleveland, Ohio 44110, has issued a brochure detailing features of pulsar static d-c drives. [459]

Multichannel oscilloscopes. Beckman Instruments Inc., 3900 N. River Rd., Schiller Park, Ill. 60176. The types EO-10 and EO-18 large-screen, multichannel precision oscilloscopes are featured in two-page bulletin 671. [460]

Thyristors. Transiron Electronic Corp., 168 Albion St., Wakefield, Mass. 01880, has available a designer's guide to industry-preferred thyristor types. [461]

Digital comparator. Computer Central, P.O. Box 5194, Detroit, Mich. 48235. A six-page brochure covers the model 711 linear range digital comparator, a digital summing junction with an analog output proportional to the digital difference. [462]

Mobile strip printer. Dataline Inc., 181 South Boro Line Rd., King of Prussia, Pa. 19406. An illustrated bulletin on the model 3064-M mobile strip printer shows the unit to be an economical digital impact printer for providing hard-copy readout in a broad spectrum of applications. [463]

D-c servo amplifiers. Inland Controls Inc., 250 Alpha Dr., Pittsburgh, Pa. 15238. Revised data sheets are available for three small d-c servo amplifiers that are designed to meet Mil-E-5400 including Mil-Std-704. [464]

Torque measurement. Waters Mfg. Inc., 533 Boston Post Rd., Weyland, Mass. 01778. A broad line of precision torque measuring instruments is described in an illustrated catalog. [465]

Solderless electrical terminals. AMP Inc., Harrisburg, Pa. 17105. A 20-page catalog contains complete descriptions, electrical and mechanical specifications, and dimensional data for the entire Diamond Grip product line of nearly 300 items. [466]

Magnetic pickup. Airpax Electronics, P.O. Box 8488, Fort Lauderdale, Fla. 33310. Two-page, illustrated data sheet



NORTON[®]
MAGNETIC HEADS
MULTITRACK
ERASE
RECORD
PLAY

Send now for complete technical literature.

NORTON
ASSOCIATES, INC.
 10 Di Tomas Court, Copiague, N.Y. 11726
 Phone: 516 598-1600

NEW! from GRC[®]

Molded NYLON SOCKET HEAD CAP SCREWS

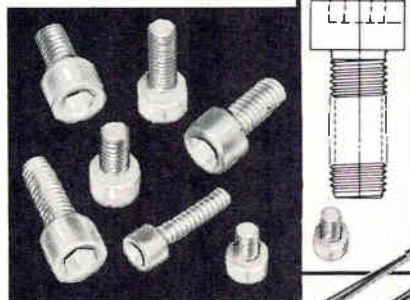

GRC's NEW HEX SOCKET CAP SCREWS are molded with GRC special methods and patented machines to deliver the famous GRC big difference—precise, uniform, flash-free, low-cost. Unusual properties make them suitable for wide range of applications: electrical insulating, vibration-proof, corrosion-resistant, with high strength-to-weight. And they are off-the-shelf—ready for shipment.

SAMPLES? SURE! Write today. We'll include catalog and data on other GRC plastic fasteners, screws, nuts, washers, rivets; many other types.

GRIES REPRODUCER CO.
 Division of Coats & Clark Inc.
 world's foremost producer of small die castings
 151 Beechwood Ave., New Rochelle, New York 10802
 • (914) 633-8600 Plants in: New Rochelle, N. Y. • Warren, R. I. • Toccoa, Ga.

THREAD SIZES:
 4, 6, 8, 10, 1/4"
LENGTHS: 1/8" to 1"



NEW PACKAGING STANDARD FOR RADIAL LEAD COMPONENTS

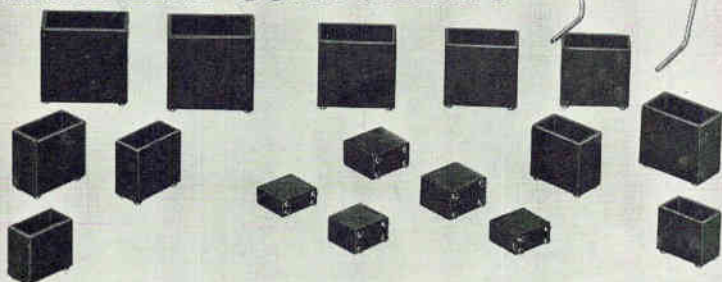

If you've been looking for packaging improvement in radial lead components, here is an answer to your problem....An expanded family of radial lead component encapsulation shells available from Robison Electronics. Produced from glass-filled Diallyl Phthalate, these shells range in size from .100 Wide x .250 Long x .250 Deep to 1.200 Wide x 2.400 Long x 1.350 Deep. All shells in this family incorporate two holes for lead ter-

mination and stand-off feet for PC mounting to allow solder fillet formation and flush cleaning of flux residues after leads are soldered. Precision molding assures consistency of size and appearance throughout the range of shells. Perfect for packaging resistors, capacitors, inductors, and other miniature components. Available from stock or within 2 weeks ARO. Contact factory for complete information.



ROBISON ELECTRONICS, INC.

2134 W. Rosecrans Ave., Gardena, Calif. 90249, ph. (213) 321-0080, 327-5661

Circle 216 on reader service card

Vector

Vector systems help you CUT BREADBOARDING TIME

SOLDERLESS
U-CLIP TERMINAL

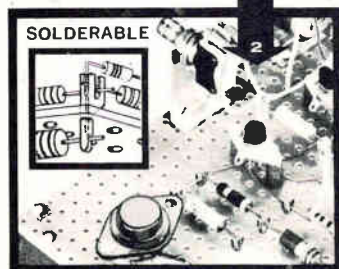
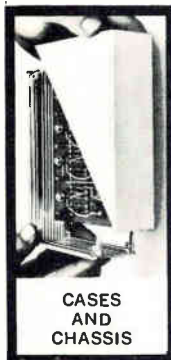
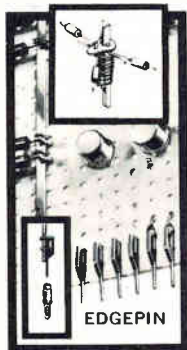

Choose the type that meets your needs.

1. Mount D.I.P.'s, Transistors, Round Can Integratreds, directly to board or in sockets. Patch cord hook-up available.
2. Solderable push-in terminals for .042", .062" or .093" holes.
3. Handsome new extruded aluminum rails that make into expandable circuit cases or chassis in virtually any size and shape. Hardware for mounting in plug-in racks or chassis.
4. Pre-punched Copper-Clad Cards for do-it-yourself etching. Also solderless spring terminals.

May we send you complete information including sample Vectorbord® and terminals? There is no obligation.

4 WAYS

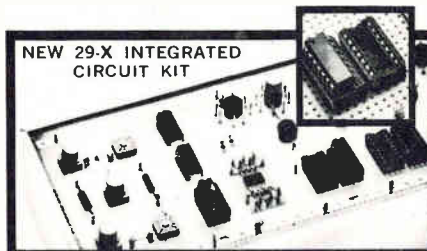

Vector ELECTRONIC COMPANY, INC.
12460 Gladstone Ave., Sylmar, Calif. 91342

194 Circle 194 on reader service card

New Literature

1-0001 describes a general-purpose type magnetic pickup for converting mechanical motion to an a-c voltage without physical contact or external power. [467]

Power supplies. Lambda Electronics Corp., Route 110, Melville, N.Y. 11746. Nine new lines of d-c power supplies are introduced in catalog supplement L-5. [468]

Meter catalog. Jewell Electrical Instruments Inc., Grenier Field, Manchester, N.H. 03105. A 50-page catalog contains engineering specifications and dimensions on each of the company's meter line, which includes elapsed-time indicators, taut-band panel meters and null indicators. [469]

Microwave devices. General Electric Co., 316 E. Ninth St., Owensboro, Ky. 42301. Revised 16-page technical brochure describes performance and typical applications of new generation microwave gridded vacuum tubes and microwave circuit modules. [470]

Semiconductors. Atlantic Semiconductor, 905 Mattison Ave., Asbury Park, N.J. 07712, has published a 20-page brochure on a line of silicon rectifiers and bridges. [471]

Radial lead resistors. Ohmite Mfg. Co., 3601 Howard St., Skokie, Ill. 60076. The labor, space, and cost saving benefits of PC-58 radial lead 3- and 5¼-watt wirewound resistors are described in catalog 120. [472]

Desk-top strip printer. Dataline Inc., 181 S. Boro Line Rd., King of Prussia, Pa. 19406. Bulletin 110 describes the model 3064-C desk-top strip printer, an economical digital impact printer for hard-copy readout. [473]

R-f generator. Lindberg Hevi-Duty Division, Sola Basic Industries, 2450 W. Hubbard St., Chicago, 60612. A bench-type r-f generator that has 20 msec response, even with ±20% change in power input, is described in bulletin 68100. [474]

H-v rectifier columns. International Rectifier, 233 Kansas St., El Segundo, Calif. 90245, has issued 24-page illustrated engineering bulletin B-107 on high-voltage rectifier columns. [475]

Impatt oscillators. Varian, Solid State Division, Salem Rd., Beverly, Mass. 01915, has available a four-page brochure describing its one-watt Impatt oscillators. [476]

Magnetic tape cleaner-evaluator. General Kinetics Inc., 11425 Isaac Newton Square South, Reston, Va. 22070, has published an eight-page illustrated booklet on the model CE-70 magnetic tape cleaner-evaluator. [477]

Electronics | May 11, 1970

the essential reference books from SAMS

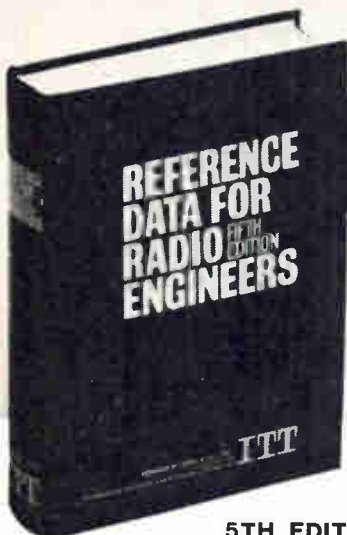

5TH EDITION
of the world-famous electronics data source
**REFERENCE DATA FOR
RADIO ENGINEERS**

OVER 350,000 COPIES SOLD IN PRIOR EDITIONS

Now contains 50% MORE DATA to include major information developed over the past 12 years (includes all-new data on micro-miniature electronics, space communications, navigation aids, reliability and life testing, international telecommunication recommendations, switching networks and traffic concepts, and quantum electronics). Provides, in addition, comprehensive data on all basic phases of electronics, including tables, formulas, standards, and circuit information. Prepared by an outstanding group of practicing engineers, professors, and industry and government experts, under the direction of the International Telephone and Telegraph Corporation staff. 45 data-packed chapters; 1196 pages; over 1350 illustrations; plus 41 page index. Order 20678, only \$20.00

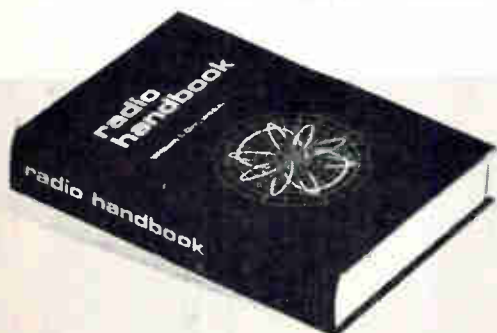

NEW 18TH EDITION OF THE FAMOUS E & E
RADIO HANDBOOK

by WILLIAM I. ORR, W6SAI. Completely updated edition of the famous communications handbook which is the electronics industry standard for engineers, technicians and advanced amateurs. Explains in authoritative detail how to design and build all types of radiocommunications equipment. Includes SSB design and equipment, RTTY circuits, latest semiconductor circuits and IC's, as well as special-purpose and computer circuitry. Provides the broadest coverage in the field on how to build and operate a comprehensive variety of high-performance equipment. Order 24020, only \$13.50

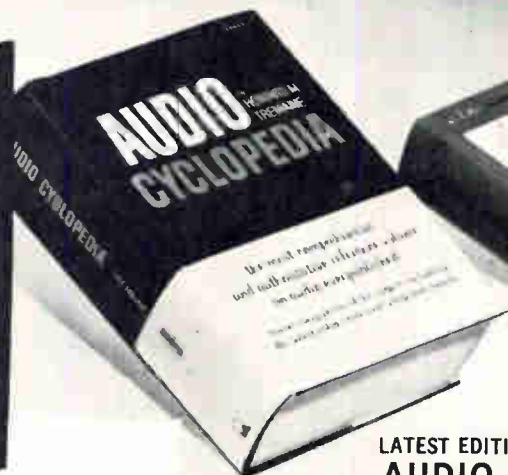

LATEST EDITION OF THE RENOWNED
AUDIO CYCLOPEDIA

by DR. HOWARD M. TREMAINE. This completely revised edition is the most comprehensive work on every phase of audio—virtually a complete reference library in a single volume. Includes the latest developments, right down to the newest solid-state and integrated circuits. Contains authoritative, concise explanations of thousands of topics in the fields of acoustics, recording, and reproduction. Covers basic principles, components and devices, film recording, studio techniques, motion picture equipment, audio installation techniques, audio measurements, etc. Over 1700 pages; 1600 illustrations. Truly the definitive reference work covering the entire audio art. Order 20675, only \$29.95

MODERN DICTIONARY OF ELECTRONICS (3rd Edition)

by RUDOLPH F. GRAF. This bestselling book now defines more than 16,500 terms directly associated with electronics. Includes special pronunciation guide. Also includes terminology often expressed in Greek alphabet symbols, abbreviated expressions for transistor parameters, and the most widely used electronic symbols and abbreviations. Covers terms used in the fields of microelectronics, space electronics, semiconductors, computers, data processing, etc. This famous work is the most complete and useful electronics dictionary available today. Over 400 illustrations. 608 pages. Order 20600, only \$9.95

**HANDBOOK OF ELECTRONIC
TABLES & FORMULAS (3rd Edition)**

A convenient one-volume source for all charts, tables, formulas, laws, symbols, and standards used in electronics. Includes valuable data for technicians, as well as useful circuit design data for engineers. With 8-page full-color chart showing latest FCC frequency spectrum assignments. Order 20648, only \$5.50

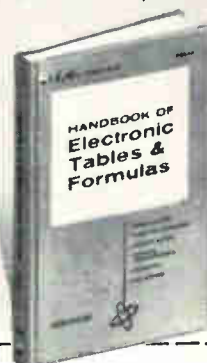

HOWARD W. SAMS & CO., INC., Dept. EL-5
4300 W. 62nd St., Indianapolis, Ind. 46268

Ship me the following books;

20678 20675 20600 20648 24020

\$ _____ enclosed.

Name _____

Address _____

City _____ State _____ Zip _____

PHILIPS

the strongest european group in integrated circuits is expanding their activity

Challenging opportunities Physicists

for development and design of new digital and linear monolithic IC's

Engineers

for solid state diffusion and production of integrated circuits

requirements:

at least B.S. degree in physics or electrical engineering
experience in integrated circuits or semiconductors readiness to work in
our facilities in Germany (VALVO GmbH, Hamburg)

please mail your resume to:

Dr. Schilling, PHILIPS Germany, 7 Monckebergstrasse, Hamburg 1, Germany

CIRCLE 966 ON READER SERVICE CARD

FIND YOUR DREAM JOB

Use this form to register with the **ELECTRONICS Manpower Register** a computerized talent-matching service designed to bring together job-seeking EE's with jobs-open employers.

EMR Computer Input Form		For Office Use Only	
Return this with a copy of your resume if you have one.		Registration Number	Initial of Last Name
Name	Date		
Address	City	State	Zip
Home Phone (include area code)	Have you registered with this system previously?		Yes <input type="checkbox"/> No <input type="checkbox"/>
Position Desired:			
Geographical Preference:			I will NOT relocate <input type="checkbox"/>
I will consider opportunities in the:		<input type="checkbox"/> Northeast <input type="checkbox"/> Mid Atlantic <input type="checkbox"/> Any location	I prefer: <input type="checkbox"/> Metropolitan area <input type="checkbox"/> Medium town <input type="checkbox"/> Rural area
<input type="checkbox"/> Midwest <input type="checkbox"/> South <input type="checkbox"/> Southwest <input type="checkbox"/> Calif. <input type="checkbox"/> Northwest			
Availability:	Date available (within four months)	Identity Release:	My identity may be released to: <input type="checkbox"/> All but present employer <input type="checkbox"/> Any employer
Education		Degree	Major field
		Year Earned	College or University
Present or Most Recent Position			
Employer	City/State		
From	Title	Duties & Accomplishments	
To			
Previous Position			
Employer	City/State		
From	Title	Duties & Accomplishments	
To			
General Information (Summarize your overall qualifications and experience in your field. List any pertinent information not included above.)			
Current Annual Base Salary	Total Years of Experience	U.S. Citizen <input type="checkbox"/> Yes <input type="checkbox"/> No	Level of Security Clearance
			Presently Employed <input type="checkbox"/> Yes <input type="checkbox"/> No

Resumes acceptable only from applicants residing within the UNITED STATES.

Mail (with a copy of your resume if you have one) to: **Electronics Manpower Register** 330 West 42nd St New York, N.Y. 10036

No fees or charges

ADDRESS BOX NO. REPLIES TO: Box No. Classified Adv. Dept. of this publication. Send to office nearest you.
NEW YORK, N. Y. 10036: P. O. Box 13
CHICAGO, Ill. 60611: 645 N. Michigan Ave.
SAN FRANCISCO, Cal. 94111: 255 California St.

EMPLOYMENT SERVICES

Fee Paid Employment Service for all technical fields since 1959. Over 1,000 U.S. client cos. Send resume. Atomic Personnel, Inc., 1518 Walnut St., Box L, Phila. Pa., 19102.

BUSINESS OPPORTUNITY

Capital Contacts—Before you try Public or Private Placements to Underwriters, Investment Banking Houses, write for free helpful information to Confidential Consultant 817—51st St. Brooklyn, N.Y.

Mr. Used Equipment Dealer:

When you advertise in the Searchlight Section . . . You have hired your most persuasive salesman:

He's efficient . . . He thrives on long hours . . . His territory is the entire nation . . . and overseas . . . He doesn't see buyers of used and new surplus equipment: They see him—regularly. They depend on him.

He is Searchlight—The section of this publication where wise dealers advertise and list their stocks for sale.

SEARCHLIGHT SECTION

Classified Advertising Dept.
 Post Office Box 12
 New York, N. Y. 10036

AUTOTRACK MOUNT



360 degree azimuth, 210 degree elevation sweep with better than 1 mil. accuracy. Missile velocity acceleration and slewing rates. Amplidyne and servo control. Will handle up to 20 ft. dish. Supplied complete with control chassis. In stock—immediate delivery. Used world over by NASA, USAF, MP-61-B. Type SCR-584. Ideal satellite tracking. Large spare parts inventory for back-up.

ANTI-AIRCRAFT GUN MOUNT

Will handle 6,000 lbs. rapid slew through 360° azimuth, 180° elevation. Mobile.

PULSE MODULATORS

250 KW HARD TUBE PULSER

Output 16 kv 16 amp. Duty cycle .002. Pulses can be coded. Uses 5D21, 715C or 4PR60A. Input 115 v 60 cy. AC \$1200 ea.

MIT MODEL 9 PULSER 1 MW—HARD TUBE

Output 25kv 40 amp., 30kv 40 amp. max. Duty cy. .002. .25 to 2 microsec. Also 5 to 5 microsec. and .1 to .5 microsec. Uses 6C21. Input 115v 60 cycle AC. Mfg. GE. Complete with driver and high voltage power supply. Ref: MIT Rad. Lab. Series, Vol. 5, p. 152.

2 MEGAWATT PULSER

Output 30 kv at 70 amp. Duty cycle .001. Rep. rates. 1 microsec. 600 pps. 1 or 2 msec. 300 pps. Uses 5948 hydrogen thyratron. Input 120/208 VAC 60 cycle. Mfr. GE. Complete with high voltage power supply.

18 MEGAWATT PULSER

Output 150KV at 120 amp. Rep. rate: 50-500 PPS. Pulse length: 5 msec. 15 KV 120 amp. into pulse transformer. Rise time 1.5 msec. Filament supply 5V 80 amp. incl. 17.5KV 1.5 amp DC power supply. Input: 220V 60 cy AC.

SCR 584 AUTOTRACK RADARS

Our 584s in like new condition ready to go, and in stock for immediate delivery. Ideal for telemetry research and development, missile tracking, satellite tracking. Fully Desd. MIT Rad. Lab. Series, Vol. 1, pps. 207-210, 228, 284-286. Comp. Inst. Bk available \$25.00 each.

HUNDREDS MORE IN STOCK
 LARGEST RADAR
 INVENTORY
 IN WORLD.
 WRITE
 FOR
 CATALOG
 ON YOUR
 LETTERHEAD

AUTOMATIC TRACKING SYSTEM

Sci. Atl. Mod. 3101-J70 Antenna Pedestal. AZ-EL 15 deg. per second rated speed. 23 inch dia. bearing. Complete w/control console & mag. amplifiers. Also in stock complete Glo-track receiving system for 200-400 MHz telemetry band including 12" square quad. Helix. All part of Atlas missile instrumentation system

AN/GSS-1 PASSIVE TRACKER

10 cm passive automatic tracking system with 6 foot parabola. Complete, mounted on van. Supplied by GE for Atlas instrumentation system.

MICROWAVE SYSTEMS

SPARE PARTS IN STOCK

Nike Ajax, Nike Hercules, M-33, MPS-19, TPS-ID, TPS-10D, FPS-6 SPS8, SCR-584, MPQ-18. From Largest Inventory in World

200-2400 mc. RF PKG

Continuous coverage, 30 Watts Cw nominal output. Uses 2C39A. Price \$575.

L BAND RF PKG

20 KW peak 990 to 1040 MC. Pulse width .7 to 1.2 micro sec. Rep. rate 180 to 420 pps. Input 115 vac incl. Receiver \$1200.

200-225 mc RADAR SYSTEM

1 Megawatt output, 200 nautical mile range for long range detection of medium and high altitude jet aircraft as well as general search. AN/TPS-28.

AN/GMD-1B RAWIN RADAR

L-Band Radiosonde Tracking System. Complete, new cond. in stock for immed. del. AN/GMD-2 computer mfg. Gen'l Mills also in stock.

500 KW L BAND RADAR

500 kw 1220-1359 msc. 160 nautical mile search range P.R.I. and A scopes. MITI, thyratron mod 5J26 magnetron. Complete system.

C BAND AUTOTRACK

1 Megawatt 10 ft. Parabola. Sperry.

AN/GPG-1 SKYSWEEP TRACKER

3 cm. auto. tracking radar system, Comp. pkg. w/indicator sys. Full target acquisition & auto. tracking. Input 115v 60 cy. new. In stock for immed. del. Entire sys. 6' x 3' x 10'. Ideal for infrared tracker, drone tracker, missile tracker, R & D

INDICATOR CONSOLES

AN/SPA-4A. PPI 10", range to 300 ml. VJ-1 PPI 12". Range to 200 ml. VL-1 RH1 12" to 200 mi. 60K ft.

Radio-Research Instrument Co.

45 W. 45th St., New York, N.Y. 10036 ■ 212-586-4691

CIRCLE 967 ON READER SERVICE CARD

LARGEST PUBLIC AUCTION SALE OF ITS KIND
 IN THE LAST 20 YEARS

\$1,500,000 INSTALLATION

of
 CRYSTAL DIVISION OF ELECTRA/MIDLAND CORPORATION
 MANUFACTURERS OF CRYSTALS,
 CRYSTAL FILTERS AND DISCRIMINATORS
 3151 Fiberglas Road Kansas City, Kansas

SALE DATES:

TUESDAY AND WEDNESDAY, MAY 26th AND 27th

OVER 3,000 ITEMS INCLUDING

OSCILLOSCOPES, OSCILLATORS, LEAK DETECTORS, PLATERS, SYNTHESIZERS, CENTRIFUGES, X-RAY MACHINES, SAWS, LAP-PERS, FREQUENCY METERS, WAVE ANALYZERS, FREQUENCY CONVERTERS, POWER SUPPLIES, IMPEDANCE METERS, SIGNAL GENERATORS, VOLTMETERS, AMMETERS, TEST CHAMBERS, TUNNEL FURNACES, LAB OVENS, TRANSFORMERS, BARIACS, RADIO RECEIVERS, SOLDERING EQUIPMENT

Stockroom Inventory Consisting of: Crystal Bases, Cans, Lap Carriers, Resistors, Capacitors, Wire, Saw Blades, etc.

Machine Shop Equipment, Factory Equipment, Office Equipment.

BE SURE TO WIRE, WRITE OR PHONE

FOR FREE DETAILED ILLUSTRATED AUCTION BROCHURE

INDUSTRIAL PLANTS CORPORATION

AMERICA'S FOREMOST AUCTIONEERS

316 S. LaSalle Street, Chicago, Ill. 60604 Area Code 312-922-7315

CIRCLE 968 ON READER SERVICE CARD



We took Honeywell's 2206 Visicorder to Pike's Peak!

Where do you need to take one? To prove that our incomparable 2206 Visicorder goes anywhere, we connected it to something just as incomparable... a pair of Hart Javelin skis instrumented with STATHAM transducers. And skied Pike's Peak.

Because our oscillograph records up to 12 channels simultaneously, as well as two event channels, we were able to record several parameters incurred while skiing (see actual record below). Which means that no matter how unusual your oscillograph needs, our 2206 Visicorder can meet them. Wherever they happen to be.



Use it on a test bench. Mounted in an automobile. Or boat. Wherever portability's important! It's light-tight (with integral take-up) and records at frequencies from 0 to 13kHz. On 150 watts. Which means you can use an ordinary vehicle electrical system or separate batteries as your power source.

And the 2206 Visicorder uses a mercury vapor lamp for true ultraviolet recording. So, you get high writing speeds — over 40,000 in/sec. Better trace density. And more permanent records, with no chemical processing necessary. Plus, an optional signal conditioning amplifier package that fastens right to the Visicorder!

You don't have to take the 2206 Visicorder to Pike's Peak to get peak performance. You pick the place. Pick up the 2206 Visicorder. And see for yourself.

For more information, call or write Lloyd Moyer, (303) 771-4700, MS 222, Honeywell, Test Instruments Division, P. O. Box 5227, Denver, Colorado 80217.



Honeywell
Honeywell engineers sell solutions

Electronics advertisers

May 11, 1970

ADC Products	55	Electronics & Control Engineers		Magnecraft Electric Co.	162
Midland Assoc., Inc.		Book Club	190A, 190B, 191	Mills, Fife and MacDonalds, Inc.	
Adret Electronic	14E	E/MC Electronics/Management Center	192	Mallory and Co., P.R., Mfg. Div.	82
Promotion Vente Publicite		Ries Cappiello Colwell, Inc.		Aitkin-Kynett Co.	
Alco Electronics Products, Inc.	130, 187, 189	Erie Technological Products Co., Inc.	165	Markem Corp.	151
Marketronics Advertising		Walker, Schmidt & Mackall, Inc.		Creamer, Trowbridge, Case and Basford, Inc.	
Allen-Bradley Co.	75	Fairchild Controls	134	Mechanics For Electronics, Inc.	171
Hoffman-York, Inc.		Van Der Boom, McCarron, Inc.	182	Scott Adv., Inc.	
American Lava Corp., Sub. of Minnesota Mining & Mfg. Co. Designers, Inc.	15	Fairchild Industrial Products		Mico Instrument Co.	190
American Optical Co., Space Defense Group	120	David Silver Adv., Inc.		Mitsubishi Electric Corp.	184
Fuller & Smith & Ross, Inc.		Fairchild Semiconductor, Inc.	18, 19	Hakuhodo, Inc.	
American Telephone & Telegraph Co., Yellow Pages	69	Chiat Day, Inc.		Morganite Resistors, Ltd.	33E
Cunningham & Walsh, Inc.		Farinon Electric	6	Scientific Advertising & Marketing, Ltd.	12E
AMP, Inc.	28, 29	Jack Herrick Adv., Inc.	15E	Multicore Solders, Ltd.	
Aitkin-Kynett Co., Inc.		Ferisol		Jefferies Harper & Partners, Ltd.	
Analog Devices, Inc.	39	Agence Domenach		National Electronics, Inc., Subsidiary Varian Associates	26
Adastra, Inc.		Florida Dept. of Commerce, Div. of Commercial Development	186	Connor-Sager Assoc., Inc.	
Andrew Corp.	62	William Cook Adv., Inc.		National Semiconductor Corp.	10, 11
Fensholt Adv., Inc.		Fluke Manufacturing Co., John Bonfield Associates	17	Hall Butler Blatherwick, Inc.	
A O I P	23E	Gencom Division—Varian/Emi	171	Norton Associates, Inc.	192
Dumesnil Publicite		A.D. Adams Adv., Inc.		J.J. Coppo Co.	
A.P.I. Instruments	159	General Electric Co.	24E	Nortronics Co., Inc., OEM Div.	185
George Z. Griswold Advertising		Robert S. Cragin, Inc.		Stral Adv. Co., Inc.	
Applied Materials	123	General Electric Co. (Analytical Measurement Business Section)	132	Oak Manufacturing Co., Div. of O/E/N	202
Hall Butler Blatherwick, Inc.		Robert S. Cragin, Inc.		Buchen Adv., Inc.	
A. R. Vetter Co.	148	General Instrument Corp., Semiconductor Products Div.	54	Owens-Illinois, Inc.	61
Augat, Inc.	83	Norman Allen Associates	13	Meldrum and Fewsmith, Inc.	
Horton Church & Goff, Inc.		General Magnetics		Pacific Measurements, Inc.	146
Beckman Instruments, Inc., Helipot Div.	86	McCarthy/Scelba/DeBiasi Adv. Agcy., Inc.	2nd Cover	Jack Herrick Adv., Inc.	
N. W. Ayer/Jorgensen/MacDonald, Inc.		General Radio Co.		Philco Ford, Microelectronics Div.	60
Bell & Howell—Electronics & Instruments Group	145, 171, 201	GRAD Associates		The Aitkin-Kynett Co., Inc.	
Coordinated Communications, Inc.		Gould Inc./Brush Instruments	169	Philips/Electrologica/Office Machine Div.	35E
Blue M Electric Co.	193	Carr Liggett Adv., Inc.		Media International	
South Suburban Advertising		Gould, Inc., Gaging & Control Div.	72	Philips Electronics Instruments	103
Brand-Rex	81	Carr Liggett Adv., Inc.		Marsteller, Inc.	
Creamer, Trowbridge, Case & Basford, Inc.		Grayhill, Inc.	145	Philips N.V. Pit/Tmi Div.	2E
Branson Instruments, Industrial Cleaning Div.	176	Carr Liggett Adv., Inc.		Marsteller, International S.A.	
Doremus and Company, Inc.		Gries Reproducer Co.	192	Polymotor S.A.	6E
Branson Sonic Power Div. of Smith Kline & French Laboratories	84	Harold Marshall Advertising		George Hynes & Partners, Ltd.	
Doremus & Company, Inc.		Guardian Electric Mfg. Co.	157	Pomona Electronics Co.	188
Buckbee-Mears Company	74	Kolb/Tookey and Associates, Inc.		Buxton Adv. Agcy.	
Midland Assoc., Inc.		Hamilton Watch Co.	124	RCA Electronic Components	4th Cover, 47, 145
Bulova Watch Company, Electronics Div.	181	Beaumont, Heller & Sperling, Inc.		Al Paul Lefton Co.	
Caroe Marketing, Inc.		Hansen Manufacturing Co.	200	RCL Electronics, Inc.	12
Bunker-Ramcor Corp., Amphenol Controls Div.	20, 21	Keller-Crescent Co.		Morvay Adv. Agcy.	
Marsteller, Inc.		Hewlett Packard International Div.	154	Redcor Corp.	148
Burr Brown Research Corp.	22E	Lennen & Newell, Inc.		Management Communication Consultants, Inc.	
N.A. Winter Adv. Agcy.		Hewlett Packard, Loveland Div.	56, 57	Reliance Controls, Ltd.	30E
Bussman Mfg. Div. of McGraw Edison Co.	137	Tallant/Yates Advertising		Bond Publicity Services, Ltd.	
Henderson Adv. Co.		Hewlett Packard, Microwave Div.	1	Robison Electronics	194
Captor Corp.	24	Lennen & Newell, Inc.		Rob's House of Marketing	
Weber, Geiger & Kalat, Inc.		Hewlett Packard, New Jersey Div.	79	Rohde & Schwarz	37E
Chemetron Corp.	189	McCarthy Scelba and DiBiasi Adv. Agcy., Inc.		RTC La Radiotechnique	20E, 21E
Buchen Adv., Inc.		Hewlett Packard, Rockaway Div.	25	Agence Giorgi	
Cinch Graphik Div. of United Carr Fastener Co.	70	Culver Adv., Inc.		Sage Electronics Corp.	160
Stral Adv. Co., Inc.		Hewlett Packard, Santa Clara Div.	2	Mathison Adv., Inc.	
C & K Components, Inc.	171	Lennen & Newell, Inc.		Schlumberger Ltd. EMD	3E
Van Cristo Associates		Honeywell Computer Control Div.	32	T.B. Browne, Ltd.	
Clairex Corp.	178	Creamer, Trowbridge, Case & Basford, Inc.		Schlumberger SIS	4E
Michel-Cather, Inc.		Honeywell Test Instruments Div.	198	T.B. Browne, Ltd.	
Collins Radio Co.	158	Campbell Mithun, Inc.		Schlumberger SOMV	7E
John G. Burnett Advertising		Howard W. Sams & Co., Inc.	195	T.B. Browne, Ltd.	
Colorado Video, Inc.	140	George Brodsky Adv., Inc.		Sierra Research Corp.	22
Wolff & Weir		Hughes Aircraft Co.	50, 51, 185	B.P. Myer Assoc., Inc.	
Computer Measurements Co., Div. of Newell Industries	73	Foot, Cone & Belding		Silec Electronique	8E, 9E
Jones, Maher, Roberts, Inc.		Hysol Corp.	156	Promotion Vente Publicite	
Cosmicar Optical Co., Ltd.	32E	Barber & Drullard, Inc.		Siliconix, Inc.	139
Matsushita, Inc.		Indiana General Corp., Electronics Div.	58	Robertson West, Inc.	
CRC	16E	The Griswold & Eshleman Co.		Singer Company, Ballantine Operation	119
SPI		Ing. C. Olivetti & C Spa.	19E	Technical, Industrial and Scientific Marketing, Inc.	
Data Products Corp.	161	Studio Giuliano Blei		Smith-Corona Marchant, Melabs Div.	164
Keene/Galloway Advertising		Intel Corp.	133	The Advertising Group	
Delco Radio Division, General Motors Corp.	30, 31	Bonfield Associates		Socapex	25E
Campbell-Ewald Co.		International Crystal Mfg. Co.	170	S.P.I.	
Delta Products, Inc.	190	Robert V. Freeland & Associates		Sodeco	38E
The William Loughran Co.		International Electronic Research Corp.	147	Dumensil Publicite	
Diglin, Inc.	85	Van Der Boom, McCarron, Inc.		Sogie	10E
Van Der Boom, McCarron, Inc.		Isostat	34E	Etudes et Creations Publicitaire	
Digital Equipment Corp.	121	Editions Gead		Solartron Electronics Group, Ltd.	5E
Kalb & Schneider, Inc.		ITT Europe	13E	T.B. Browne, Ltd.	
DuPont de Nemours & Co., Freon Div.	122	Brockie Haslam Chiney & Allon, Ltd.		Sorensen AG, CH-8045 Zurich	31E
N.W. Ayer & Son, Inc.		ITT Metrix	18E	Agentur Iff	
Eagle Signal Div. of Gulf & Western Co.	166, 167	Promotion Vente Publicite		Souriau & Cie.	26E
Geyer, Oswald, Inc.		ITT Semiconductor Div.	142	Ariane Publicite	
Eastman Kodak Co., Business Systems Markets Div.	183	Neals & Hickok, Inc.		Sperry Rand—Sperry Tube Division	17E
J. Walter Thompson Co.		Johanson Manufacturing Corp.	177	Neals & Hickok, Inc.	
Elco Corp.	27	Josephson, Cuffari & Co.		S.P. Elettronica	11E
Schaefer Adv., Inc.		Johnson Co., E.F.	76	Studio Sergio Rosata	
Electronic Navigation Industries	168	Martin Williams Advertising		Sprague Electric Co.	7
Hart Conway Co., Inc.		Lambda Electronics Corp.	3rd Cover	Harry P. Bridge Co.	
		Michel Cather, Inc.		Sylvania Electric Products Inc., Parts Div.	35 to 38
		Lapp Radio Specialty, Div. of Interpace Corp.	172	Doyle Dane Bernbach, Inc.	
		Wolf Assoc., Inc.		Synthane-Taylor Corp.	180
		LTT	28E, 29E	Gray & Rogers, Inc.	
		Publibel		Syntronic Instruments, Inc.	140
		Lundy Electronics and Systems, Inc.	202	Burton Browne Advertising	
		Snow & Depew Adv., Inc.		Systron-Donner Corp.	80
				Bonfield Assoc., Inc.	

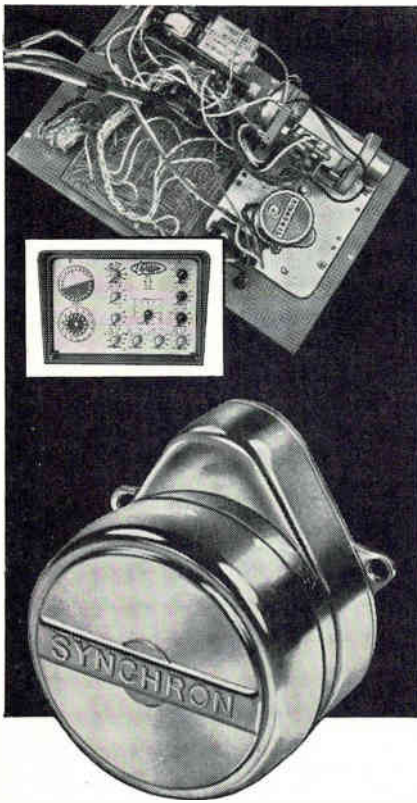

HOW SYNCHRON® MOTORS control this specialized TIME-DELAY RELAY

In this special design timer a Hansen SYNCHRON Motor drives the cam-type sequence timer for an electronic time-delay relay. When power is applied, SYNCHRON runs through the first three sequences; starts the time-delay relay, then stops. Relay performs a panel-adjustable delay period of 180-240 seconds, then returns power to the motor to complete the sequence. Special applications are easy to design, using SYNCHRON Motors. How about yours? Call or write Hansen, or your SYNCHRON representative, for brochure and all the facts.

SYNCHRON timing and control motors; 168 different speeds. Right, left or reversible rotations. 8, 20 or 30 oz.-in. torques; 220, 110 or 24 volts; 60, 50 or 25 cycles.

HANSEN

Manufacturing Co., Inc., Princeton, Ind. 47570

HANSEN REPRESENTATIVES: CAREY & ASSOCIATES, Houston and Dallas, Texas; R. S. HOPKINS CO., Sherman Oaks, Calif.; MELCHIOR ASSOCIATES, INC., San Carlos, Calif.; THE FROMM CO., Elmwood Park, Ill.; JOHN ORR ASSOCIATES, Grand Rapids, Mich.; H. C. JOHNSON AGENCY, INC., Rochester, N.Y.; WINSLOW ELECTRIC CO., Essex, Conn.; Villanova, Pa., and New York, N.Y.

EXPORT DEPARTMENT: 2200 Shames Drive, Westbury, N.Y. 11590

TEC, Inc.	202
Stevenson and Associates, Inc.	
■ Tektronix, Inc.	126
Dawson, Inc.	
Telecommunications Division of CANADIAN MARCONI Conti Adv. Agcy., Inc.	129
Teledyne Relays Co.	53
S. Michelson Advertising	
Tempress Industries, Inc.	173
Hal Lawrence, Inc.	
Texas Industrial Commission	201
The Pitluk Group Advertising	
Texas Instruments Incorporated, Components Group	23
Albert Frank-Guenther Law, Inc.	
■ Texscan Corp.	16
MacGill/Ross, Inc.	
Thomson-CSF Electron Tubes, Inc.	49
Mohr & Co., Inc.	
Triplett Electrical Instrument Corp.	131
Byer and Bowman Advertising	
Trompeter Electronics, Inc.	168
Stan Adams and Associates	
■ Trygon Electronics, Inc.	144
Technical, Industrial & Scientific Marketing, Inc.	
■ Tung-Sol Division, Wagner Electric Corp.	71
Winius-Brandon Co.	
■ United Transformer Co., Division of TRW, Inc.	149
Fuller & Smith & Ross, Inc.	
■ Unitrode Corp.	45
Silton Brothers, Inc.	
Universal Oil Products, Norplex Div.	8, 9
Campbell-Mithun, Inc.	
Utah Power and Light Co.	201
Gilham Adv., Inc.	
Vector Electronic Co., Inc.	194
Buck Advertising	
Vidar Corp., Instrumentation Div.	59
Bill Fisher Advertising	
Watkins-Johnson Co. (CEI)	14
William C. Estler Advertising	
Wavetek	141
Chapman Michetti Advertising	
Westinghouse Semiconductor Div.	152, 153
Ketchum, MacLeod and Grove, Inc.	
Weston Instruments, Inc., Archibald Div.	125
Arnold, Preston, Chapin, Lamb & Keen, Inc.	
Winchester Electronics, Div. of Litton Industries	174
Wilson, Haight & Welch, Inc.	
Xerox Data Systems	40
Doyle, Dane, Bernbach, Inc.	
Zenith Radio Corp.	188
Mills, Fife & MacDonald, Inc.	
Zippertubing Co.	190
Edward S. Kellogg Co.	

Classified & Employment Advertising

F.J. Eberle, Manager	
212-971-2557	
EMPLOYMENT OPPORTUNITIES	196
Philips	196
EQUIPMENT	
(Used or Surplus New)	
For Sale	
Industrial Plants Corp.	197
Radio Research Instrument Co.	197

- For more information on complete product line see advertisement in the latest Electronics Buyer's Guide
- Advertisers in Electronics International

Electronics Buyers' Guide

George F. Werner, Associate Publisher	[212] 971-2310
Regina Hera, Directory Manager	[212] 971-2544
Mary Tully, Production Manager	[212] 971-2046
Sales Offices:	
Boston, Ben Briggs	[617] CO2-1160
New York, Cliff Montgomery	[212] 971-3793
Jim Vick	[212] 971-2661
Chicago, Bob Denmead	[312] MO4-5800
Los Angeles, Kenneth Watts	[213] HU2-5450
Philadelphia, Joseph Bryan	[215] LO8-6161

Circulation Department

Isaaca Siegel, Manager [212] 971-6057

Research Department

David Strassler, Manager [212] 971-6058

Advertising Sales Staff

Dan McMillan	[212] 971-3468
Publisher	
Wallis Clarke	[212] 971-2187
Advertising Sales Service Manager	
Tomlinson Howland	[212] 971-6792
Promotion Manager	
Marilyn Crosson	[212] 971-6643
Promotion Assistant	
Warren H. Gardner	[212] 971-3139
Eastern Advertising Sales Manager	
Atlanta: Ga. 30309: Chariton H. Calhoun, III	1375 Peachtree St., N.E.
[404] 892-2868	
Boston, Mass. 02116: William S. Hodgkinson	
McGraw-Hill Building, Copley Square	[617] CO 2-1160
Cleveland, Ohio 44113: William J. Boyle, 55	Public Square, [216] SU 1-7000
New York, N.Y. 10036	
500 Fifth Avenue	
James R. Pierce	[212] 971-3615
John A. Garland	[212] 971-3617
Michael J. Stoller	[212] 971-3616
Philadelphia, Pa. 19103:	
Jeffrey M. Preston	
6 Penn Center Plaza,	[215] LO 8-6161
Pittsburgh, Pa. 15222: Jeffrey M. Preston,	
4 Gateway Center, [412] 391-1314	
Rochester, N.Y. 14534: William J. Boyle,	
9 Greylock Ridge, Pittsford, N.Y.	[716] 586-5040
Chicago, Ill. 60611: Ralph Hanning,	
Kenneth E. Nicklas, 645 North Michigan	Avenue, [312] MO 4-5800
Dallas, Texas 75201: Richard P. Poole, 1800	Republic National Bank Tower,
[214] RI 7-9721	
Houston, Texas 77002: Richard P. Poole	2270 Humble Bldg. [713] CA 4-8381
Detroit, Michigan 48226: Ralph Hanning,	
856 Penobscot Building	[313] 962-1793
Minneapolis, Minn. 55402: Kenneth E. Nicklas,	
1104 Northstar Center [612] 332-7425	
St. Louis, Mo. 63105: Kenneth E. Nicklas,	
The Clayton Tower, 7751 Carondelet Ave.	[314] PA 5-7285
James T. Hauptli [415] DO 2-4600	
Western Advertising Sales Manager	
Denver, Colo. 80202: David M. Watson,	
Richard W. Carpenter	
Tower Bldg., 1700 Broadway	[303] 266-3863
Los Angeles, Calif. 90017: Ian C. Hill,	
Bradley K. Jones, 1125 W. 6th St.,	[213] HU 2-5450
Portland, Ore. 97204: Don Farris,	
James T. Hauptli, 218 Mohawk Building,	
222 S.W. Morrison Street,	Phone [503] 223-5118
San Francisco, Calif. 94111: Don Farris,	
James T. Hauptli, 255 California Street,	[415] DO 2-4600
Pierre Braude Tel: 727 73 01: Paris	International Director
Paris: Denis Jacob	
17 Rue-Georges Bizet, 75 Paris 16, France	Tel 727 33 42, 727 33 60
United Kingdom and Scandinavia	
London: Oliver Ball, Tel: Hyde Park 1451	34 Dover Street, London W1
Milan: Robert Saidel, Roberto Laurer Jr.	1 via Baracchini Phone 86-90-656
Brussels: Denis Jacob	
27 Rue Ducale Tel: 136503	
Frankfurt/Main: Hans Haller	
Elsa-Brandstrom Str. 2	Phone 72 01 81
Geneva: Pierre Braude	
1 rue du Temple Phone: 31 95 60	
Tokyo: Noboru Matsumoto, McGraw-Hill	
Publications Overseas Corporation,	
Kasumigaseki Building 2-5, 3-chome,	
Kasumigaseki, Chiyoda-Ku, Tokyo, Japan	[581] 9811
Osaka: Akihiko Kamesaka, McGraw-Hill	
Publications Overseas Corporation, Kondo	
Bldg., 163, Umegae-cho Kita-ku [362] 8771	
Australasia: Warren E. Ball, IPO Box 5106,	
Tokyo, Japan	
Business Department	
Stephen R. Weiss, Manager	[212] 971-2044
Thomas M. Egan,	
Production Manager [212] 971-3140	
Maury D'Gongora,	
Assistant Production Manager [212] 971-2045	
Dorothy Carmesin, Contracts and Billings	[212] 971-2908
Frances Vallone, Reader Service Manager	[212] 971-2865

WANTED: ELECTRONICS MANUFACTURER

to help meet the needs
of a lucrative
Texas market

Excellent opportunity for growth-minded electronics manufacturer to locate in Texas and help meet the needs of the third fastest-growing state. Stable, productive labor. Incomparable tax advantages. Lowest living costs. For Texas Fact Book, write or call:

James H. Harwell, Executive Director
TEXAS INDUSTRIAL COMMISSION
Capitol Station Box JJ-E
Austin, Texas 78711
Telephone 512/475-4331

Circle 218 on reader service card

BELL & HOWELL

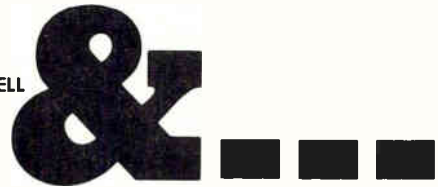

Circle 217 on reader service card

TURNOVER TURN YOU OFF?

Funny thing about Mountain West people. They like to work. So they do. Usually for the same company, even in the same plant, year after year. Ten national electronics firms in Utah report 1.7% to 4% labor turnover.

In this age of unrest, wandering and searching, there are some who would scorn this. But Mountain West people simply like living in Utah. And, most of them have been raised with a pioneer virtue of employer loyalty. And that's valuable anywhere.

So, in some ways, we may be a little "old fashioned." Or is the word *steadfast*? These people also are better educated than most of the country, with a median of 12.2 years of schooling (highest in the nation), compared with the national average of 10.6 years. More stable? Of course.

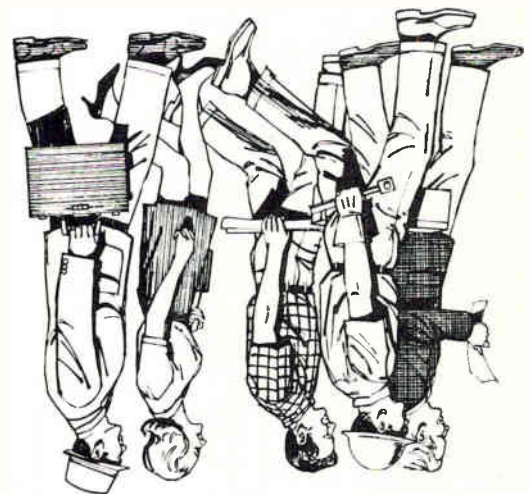

If you'd like to cash in on low turnover, write:

Ask for our new 28 page Brochure

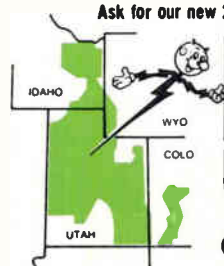

"A
Treasure Chest
in the
Growing West"

Wayne F. Mulcock
Director, Area Development
P.O. Box 899, Dept. E-3a
Utah Power & Light Co.
Salt Lake City, Utah 84110

Utah Power & Light Co.



OAK ECONO-LINE PUSHBUTTON^{T.M.}

JUST 25¢ A BUTTON*

*For most applications

We've got the button... throws from 1 PST to 8 PDT per button; sizes: .388" sq., .388" x .585" or .388" x .782"; legends engraved to your specifications; black or white buttons are standard, other colors on special order.

Push Rod Stroke... $\frac{3}{32}$ " plus $\frac{3}{64}$ " overtravel; push rod lengths optional at $\frac{1}{2}$ ", $\frac{5}{8}$ " standard length, $\frac{3}{4}$ ", $\frac{7}{8}$ " and 1".

Easy to wire... clips are Oak-pioneered double-wiping. For printed circuit boards or wire-soldering, PCB terminals are $\frac{3}{32}$ ", $\frac{1}{8}$ ", $\frac{3}{16}$ " standard length, $\frac{1}{32}$ " and $\frac{1}{4}$ " shoulder to tip. Choose terminals for wiring only or P.C. dual-purpose which have the wire hole in addition to the P.C. lug.

Compact Convenience... more buttons per area—24 on .394" centers, 16 on .591" centers, 12 on .788" centers. Any switching—momentary, push-push, interlock, or blockout or combinations. For full details, write today for Bulletin SP-346.



OAK MANUFACTURING CO.
A Division of OAK ELECTRO/NETICS CORP.
Crystal Lake, Illinois 60014
Phone: 815-459-5000 TWX: 910-634-3353
See us at NEW Show Booth No. 4218

L.E.D. INDICATORS

Solid State— Infinite Life!

Latest state-of-the-art made practical by TEC-LITE ... an easy-mounting line of subminiature indicators and switch-indicators, using the new L.E.D. (light emitting diodes).

The red-emitting L.E.D. light source gives infinite life and reliability, resistance to shock and vibration, avoids catastrophic failure. The lens is available in three colors (clear, amber or red) and designed to diffuse the light for greater angle viewing. Three models including one with switch, operate from a 5 VDC supply and rear mount in a $\frac{1}{4}$ " hole on $\frac{3}{8}$ " centers.

For full information on the SS Series — or our complete line of display/control products and systems — write: TEC, Incorporated, 6700 So. Washington Avenue, Eden Prairie, Minnesota 55343.



SSIL



SSB



SSIM

Actual Size



INCORPORATED

Circle 219 on reader service card

Eliminate

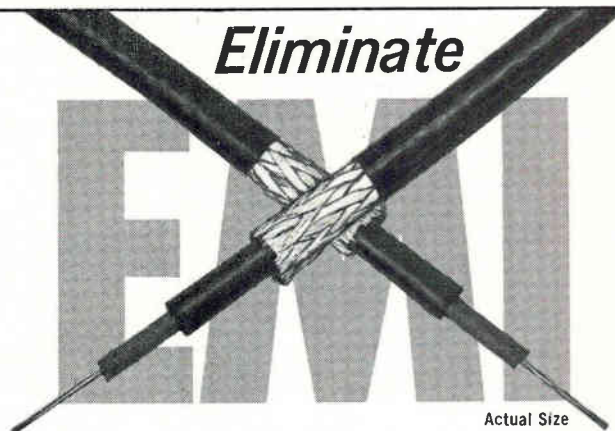

Actual Size

at drastically reduced cost!

LUNDY LossyLine Flexible Filter absorbs and dissipates unwanted or spurious electrical energy such as RFI/EMI, harmonics or other "noise." Inexpensive and easy to use. LossyLine requires no grounding, connectors or housing.

- 10 MHz to 100 GHz
- 10 to 100,000 Volts
- 100 dB attenuation
- -67° to +250°C
- 1 mA to 50 A
- 0.5" Minimum bend radius

SEND NOW FOR TECHNICAL LITERATURE



**LUNDY ELECTRONICS
& SYSTEMS, INC.**

Glen Head, New York 11545
516 OR 6-1440 • TWX 510-223-0605

Electronics reader service

Warning: The Post Office now requires your ZIP CODE on all mail. Please include your ZIP CODE number when filling out your reply card.

Use these handy post cards for more detailed information on: products advertised, new products, new literature.

Circle the number on the Reader Service post card that corresponds to the number at the bottom of the advertisement, new product item, or new literature in which you are interested.

Please print clearly. All written information must be legible to be efficiently processed.

If someone has beaten you to the post cards, you may obtain the needed information by writing directly to the manufacturer, or by sending your name and address, plus the Reader Service number, to Electronics Reader Service department.

All inquiries from outside the U.S. that cannot reach Electronics before the expiration dates noted on the Reader Service post card, must be mailed directly to the manufacturer. The manufacturer assumes all responsibilities for responding to inquiries. Electronics merely provides and clears requests for information from inquirer to manufacturer.

Correct amount of postage must be affixed for all mailings from outside the U.S.

To subscribe to or to renew Electronics

Fill in the "For Subscriptions" area on the card if you desire to subscribe to or renew your present subscription to Electronics. Send no money. Electronics will bill you at the address indicated on the Reader Service post card.

Multi-product advertisements

For information on specific items in multi-product advertisements which do not have a specific Reader Service number indicated write directly to manufacturer for information on precise product in which you are interested.

10 For employment inquiries fill in home address. May 11, 1970 Card Expires July 11, 1970 14

Name _____ title _____ For Subscriptions
 new renewal
 3 years \$16.00
 1 year \$8.00

Company* _____

Address _____

City _____ State _____ Zip Code _____

1	20	39	58	77	96	115	134	153	172	191	210	229	248	267	286	305	324	343	362	381	400	419	438	457	476	495	514	962
2	21	40	59	78	97	116	135	154	173	192	211	230	249	268	287	306	325	344	363	382	401	420	439	458	477	496	515	963
3	22	41	60	79	98	117	136	155	174	193	212	231	250	269	288	307	326	345	364	383	402	421	440	459	478	497	516	964
4	23	42	61	80	99	118	137	156	175	194	213	232	251	270	289	308	327	346	365	384	403	422	441	460	479	498	517	965
5	24	43	62	81	100	119	138	157	176	195	214	233	252	271	290	309	328	347	366	385	404	423	442	461	480	499	518	966
6	25	44	63	82	101	120	139	158	177	196	215	234	253	272	291	310	329	348	367	386	405	424	443	462	481	500	900	967
7	26	45	64	83	102	121	140	159	178	197	216	235	254	273	292	311	330	349	368	387	406	425	444	463	482	501	901	968
8	27	46	65	84	103	122	141	160	179	198	217	236	255	274	293	312	331	350	369	388	407	426	445	464	483	502	902	969
9	28	47	66	85	104	123	142	161	180	199	218	237	256	275	294	313	332	351	370	389	408	427	446	465	484	503	951	970
10	29	48	67	86	105	124	143	162	181	200	219	238	257	276	295	314	333	352	371	390	409	428	447	466	485	504	952	971
11	30	49	68	87	106	125	144	163	182	201	220	239	258	277	296	315	334	353	372	391	410	429	448	467	486	505	953	972
12	31	50	69	88	107	126	145	164	183	202	221	240	259	278	297	316	335	354	373	392	411	430	449	468	487	506	954	973
13	32	51	70	89	108	127	146	165	184	203	222	241	260	279	298	317	336	355	374	393	412	431	450	469	488	507	955	974
14	33	52	71	90	109	128	147	166	185	204	223	242	261	280	299	318	337	356	375	394	413	432	451	470	489	508	956	975
15	34	53	72	91	110	129	148	167	186	205	224	243	262	281	300	319	338	357	376	395	414	433	452	471	490	509	957	976
16	35	54	73	92	111	130	149	168	187	206	225	244	263	282	301	320	339	358	377	396	415	434	453	472	491	510	958	977
17	36	55	74	93	112	131	150	169	188	207	226	245	264	283	302	321	340	359	378	397	416	435	454	473	492	511	959	978
18	37	56	75	94	113	132	151	170	189	208	227	246	265	284	303	322	341	360	379	398	417	436	455	474	493	512	960	979
19	38	57	76	95	114	133	152	171	190	209	228	247	266	285	304	323	342	361	380	399	418	437	456	475	494	513	961	980

Business reply mail
 No postage stamp necessary if mailed in the United States

Postage will be paid by

**Electronics
 Reader service department
 Box 444
 Hightstown, N.J. 08520**

First class
 Permit no. 42
 Hightstown, N. J.

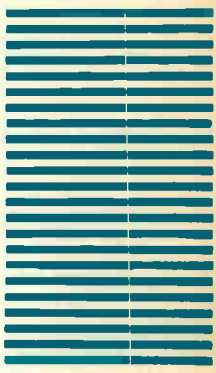

10 *For employment inquiries fill in home address. May 11, 1970 Card Expires July 11, 1970 14

Name _____ title _____ For Subscriptions
 new renewal
 3 years \$16.00
 1 year \$8.00

Company* _____

Address _____

City _____ State _____ Zip Code _____

1	20	39	58	77	96	115	134	153	172	191	210	229	248	267	286	305	324	343	362	381	400	419	438	457	476	495	514	962
2	21	40	59	78	97	116	135	154	173	192	211	230	249	268	287	306	325	344	363	382	401	420	439	458	477	496	515	963
3	22	41	60	79	98	117	136	155	174	193	212	231	250	269	288	307	326	345	364	383	402	421	440	459	478	497	516	964
4	23	42	61	80	99	118	137	156	175	194	213	232	251	270	289	308	327	346	365	384	403	422	441	460	479	498	517	965
5	24	43	62	81	100	119	138	157	176	195	214	233	252	271	290	309	328	347	366	385	404	423	442	461	480	499	518	966
6	25	44	63	82	101	120	139	158	177	196	215	234	253	272	291	310	329	348	367	386	405	424	443	462	481	500	900	967
7	26	45	64	83	102	121	140	159	178	197	216	235	254	273	292	311	330	349	368	387	406	425	444	463	482	501	901	968
8	27	46	65	84	103	122	141	160	179	198	217	236	255	274	293	312	331	350	369	388	407	426	445	464	483	502	902	969
9	28	47	66	85	104	123	142	161	180	199	218	237	256	275	294	313	332	351	370	389	408	427	446	465	484	503	951	970
10	29	48	67	86	105	124	143	162	181	200	219	238	257	276	295	314	333	352	371	390	409	428	447	466	485	504	952	971
11	30	49	68	87	106	125	144	163	182	201	220	239	258	277	296	315	334	353	372	391	410	429	448	467	486	505	953	972
12	31	50	69	88	107	126	145	164	183	202	221	240	259	278	297	316	335	354	373	392	411	430	449	468	487	506	954	973
13	32	51	70	89	108	127	146	165	184	203	222	241	260	279	298	317	336	355	374	393	412	431	450	469	488	507	955	974
14	33	52	71	90	109	128	147	166	185	204	223	242	261	280	299	318	337	356	375	394	413	432	451	470	489	508	956	975
15	34	53	72	91	110	129	148	167	186	205	224	243	262	281	300	319	338	357	376	395	414	433	452	471	490	509	957	976
16	35	54	73	92	111	130	149	168	187	206	225	244	263	282	301	320	339	358	377	396	415	434	453	472	491	510	958	977
17	36	55	74	93	112	131	150	169	188	207	226	245	264	283	302	321	340	359	378	397	416	435	454	473	492	511	959	978
18	37	56	75	94	113	132	151	170	189	208	227	246	265	284	303	322	341	360	379	398	417	436	455	474	493	512	960	979
19	38	57	76	95	114	133	152	171	190	209	228	247	266	285	304	323	342	361	380	399	418	437	456	475	494	513	961	980

Reprint service

All Electronics editorial matter available in reprint form:

For reprints of special reports and feature articles see list on right side of this page. Send your order to Electronics Reprint Department at the address indicated. To expedite mailing of your order for single reprints please send cash, check or money order with your order. Allow 3-4 weeks for delivery.

Bulk reprints of editorial matter can be ordered from current or past issues. The minimum quantity is 100 copies. Prices quoted on request: call 212-971-6643, or write to address below.

Warning: The Post Office now requires your ZIP CODE on all mail. Please include your ZIP CODE number when filling out your reply card.

3

Business reply mail

No postage stamp necessary if mailed in the United States

Postage will be paid by

First class
Permit no. 42
Hightstown, N. J.



Electronics
Reader service department
Box 444
Hightstown, N. J. 08520

10 Please Print Clearly

May 11, 1970 Card Expires July 11, 1970 14

Name _____ title _____ For Subscriptions
 Company _____ new renewal
 Address _____ 3 years \$16.00
 1 year \$8.00

1	20	39	58	77	96	115	134	153	172	191	210	229	248	267	286	305	324	343	362	381	400	419	438	457	476	495	514	533	552	571	590	609	628	647	666	685	704	723	742	761	780	799	818	837	856	875	894	913	932	951	970
2	21	40	59	78	97	116	135	154	173	192	211	230	249	268	287	306	325	344	363	382	401	420	439	458	477	496	515	534	553	572	591	610	629	648	667	686	705	724	743	762	781	800	819	838	857	876	895	914	933	952	971
3	22	41	60	79	98	117	136	155	174	193	212	231	250	269	288	307	326	345	364	383	402	421	440	459	478	497	516	535	554	573	592	611	630	649	668	687	706	725	744	763	782	801	820	839	858	877	896	915	934	953	972
4	23	42	61	80	99	118	137	156	175	194	213	232	251	270	289	308	327	346	365	384	403	422	441	460	479	498	517	536	555	574	593	612	631	650	669	688	707	726	745	764	783	802	821	840	859	878	897	916	935	954	973
5	24	43	62	81	100	119	138	157	176	195	214	233	252	271	290	309	328	347	366	385	404	423	442	461	480	499	518	537	556	575	594	613	632	651	670	689	708	727	746	765	784	803	822	841	860	879	898	917	936	955	974
6	25	44	63	82	101	120	139	158	177	196	215	234	253	272	291	310	329	348	367	386	405	424	443	462	481	500	519	538	557	576	595	614	633	652	671	690	709	728	747	766	785	804	823	842	861	880	899	918	937	956	975
7	26	45	64	83	102	121	140	159	178	197	216	235	254	273	292	311	330	349	368	387	406	425	444	463	482	501	520	539	558	577	596	615	634	653	672	691	710	729	748	767	786	805	824	843	862	881	900	919	938	957	976
8	27	46	65	84	103	122	141	160	179	198	217	236	255	274	293	312	331	350	369	388	407	426	445	464	483	502	521	540	559	578	597	616	635	654	673	692	711	730	749	768	787	806	825	844	863	882	901	920	939	958	977
9	28	47	66	85	104	123	142	161	180	199	218	237	256	275	294	313	332	351	370	389	408	427	446	465	484	503	522	541	560	579	598	617	636	655	674	693	712	731	750	769	788	807	826	845	864	883	902	921	940	959	978
10	29	48	67	86	105	124	143	162	181	200	219	238	257	276	295	314	333	352	371	390	409	428	447	466	485	504	523	542	561	580	599	618	637	656	675	694	713	732	751	770	789	808	827	846	865	884	903	922	941	960	979
11	30	49	68	87	106	125	144	163	182	201	220	239	258	277	296	315	334	353	372	391	410	429	448	467	486	505	524	543	562	581	600	619	638	657	676	695	714	733	752	771	790	809	828	847	866	885	904	923	942	961	980
12	31	50	69	88	107	126	145	164	183	202	221	240	259	278	297	316	335	354	373	392	411	430	449	468	487	506	525	544	563	582	601	620	639	658	677	696	715	734	753	772	791	810	829	848	867	886	905	924	943	962	981
13	32	51	70	89	108	127	146	165	184	203	222	241	260	279	298	317	336	355	374	393	412	431	450	469	488	507	526	545	564	583	602	621	640	659	678	697	716	735	754	773	792	811	830	849	868	887	906	925	944	963	982
14	33	52	71	90	109	128	147	166	185	204	223	242	261	280	299	318	337	356	375	394	413	432	451	470	489	508	527	546	565	584	603	622	641	660	679	698	717	736	755	774	793	812	831	850	869	888	907	926	945	964	983
15	34	53	72	91	110	129	148	167	186	205	224	243	262	281	300	319	338	357	376	395	414	433	452	471	490	509	528	547	566	585	604	623	642	661	680	699	718	737	756	775	794	813	832	851	870	889	908	927	946	965	984
16	35	54	73	92	111	130	149	168	187	206	225	244	263	282	301	320	339	358	377	396	415	434	453	472	491	510	529	548	567	586	605	624	643	662	681	700	719	738	757	776	795	814	833	852	871	890	909	928	947	966	985
17	36	55	74	93	112	131	150	169	188	207	226	245	264	283	302	321	340	359	378	397	416	435	454	473	492	511	530	549	568	587	606	625	644	663	682	701	720	739	758	777	796	815	834	853	872	891	910	929	948	967	986
18	37	56	75	94	113	132	151	170	189	208	227	246	265	284	303	322	341	360	379	398	417	436	455	474	493	512	531	550	569	588	607	626	645	664	683	702	721	740	759	778	797	816	835	854	873	892	911	930	949	968	987
19	38	57	76	95	114	133	152	171	190	209	228	247	266	285	304	323	342	361	380	399	418	437	456	475	494	513	532	551	570	589	608	627	646	665	684	703	722	741	760	779	798	817	836	855	874	893	912	931	950	969	988

1

Business reply mail

No postage stamp necessary if mailed in the United States

Postage will be paid by

First class
Permit no. 42
Hightstown, N. J.



Electronics
Reader service department
Box 444
Hightstown, N.J. 08520

To order reprints or for further information, please write to: Electronics Reprint Department, 330 West 42nd Street, New York, N.Y. 10036.

To expedite mailing of your order for single reprints please enclose payment with your order.

You may order any of the below listed reprints by key number. Discounts on quantities over 10.

- Key no. R-01 Computer-aided Design: Part I, The Man-machine Merger. 16 pages. \$1.25.
- Key no. R-04 Multilayer Circuit Boards: Sharpening An Imperfect Art. 7 pages. 50¢.
- Key no. R-06 Report on Japanese Technology: Sony. 20 pages. 50¢.
- Key no. R-010 Special Report on Large Scale Integration. 54 pages. \$1.50.
- Key no. R-011 Medical Electronics (1967). 8 part series, 44 pages. \$1.25.
- Key no. R-012 Special Report on Gallium Arsenide 17 parts. 32 pages. \$2.00
- Key no. R-016 Special Report on The Transistor: Two Decades of Progress. 48 pages. \$1.50.
- Key no. R-017 Special Report on Ferrites. 16 pages. \$1.00.
- Key no. R-021 Infrared Detector Characteristics. 23 x 11 inch fold-out chart. 50¢
- Key no. R-022 Active Filters: Part II, Varying the Approach. 8 pages \$1.00
- Key no. R-023 Special Report: Tomorrow's Communications. 32 pages \$1.75
- Key no. R-024 1969 Electronics Index to Technical Articles and Authors. Free
- Key no. R-025 Combined reprint of 1970 European and U.S. Markets Reports with two foldout charts. 62 pages \$1.75

SPECIAL REPRINT OFFER—75c
Key no. R-026 The Seventies: super but seething. A 56-page business outlook prepared by McGraw-Hill's Business Week.

- Key no. R-79 MOS Integrated Circuits. 12 pages. 50¢.
- Key no. R-78 The Overlay Transistor. 15 pages. 50¢.
- Key no. R-64 Field Effect Transistors. Parts I, II, and III. 64 pages. \$1.00.

New LXD-3-152

tracking dual output power supply designed to power operational amplifiers

+ and - (12 to 15 vdc) at 400 ma dc series-connected dual outputs
0.1% regulation, 1.5 mv rms ripple

only \$85.

Tracking accuracy

2% absolute voltage difference; 0.1% change for all conditions of line, load and temperature

All-silicon dc power supply using integrated circuits to provide regulation system

except for input and output capacitors, rectifiers and series regulation transistors

Convection cooled

no external heat sinking or forced air required

Increased reliability

through use of integrated circuits which replace discrete components from conventional designs

Regulation

0.1% line or load

Ripple and noise

1.5 mv rms; 5 mv p-to-p

Wide input voltage and frequency range

105-132 vac, 57-63 Hz

Wide temperature range

0°C to +71°C

Temperature coefficient

0.03%/°C

Remote sensing

Fixed current limiting

Complete serviceability

Overvoltage protection

requires only one OV accessory for both outputs

LC-OV-11 . . . \$20.00

No overshoot

on turn-on, turn-off or power failure

Outputs

positive, negative and common

Commercial contract plan

available for OEM and large-volume users. Contact local sales engineer for details.

Guaranteed for 5 years material and labor

LXD-3-152 3 $\frac{3}{16}$ " x 3 $\frac{3}{4}$ " x 5"

Model	ADJ. VOLT. RANGE VDC	MAX. MA DC AT AMBIENT OF: (1)				Price (2)
		40°C	50°C	60°C	71°C	
LXD-3-152	+ (12 to 15)	400	370	340	300	\$85
	- (12 to 15)	400	370	340	300	
CAN ALSO BE USED						
LXD-3-152	24-30	400	370	340	300	\$85

NOTES:

(1) For operation at other than 57-63 Hz, consult factory for ratings and specifications.

(2) All prices FOB Melville, N. Y. All prices and specifications subject to change without notice.

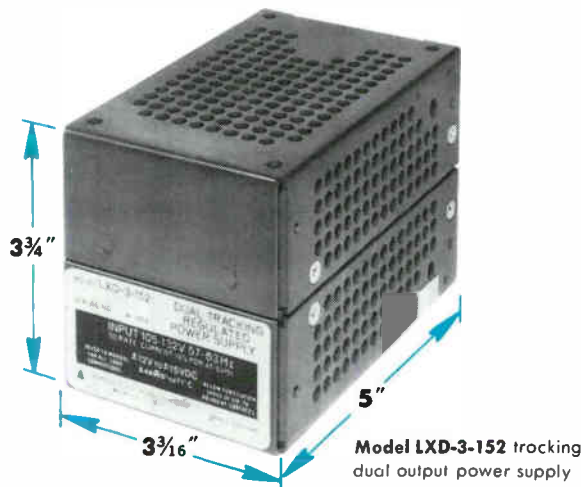

Lambda Electronics Corp., 515 Broad Hollow Road, Melville, L. I., New York 11746 • Tel. 516-694-4200.

Circle 901 on reader service card

Reading at a distance made easy...



with RCA Microwave Devices designed for telemetry

Build into your telemetry system all the advantages of size, weight, power, economy, and shock capability with products from a single source—RCA.

For more than two decades, RCA has manufactured devices in high volume for use from low L-band all the way to Ku-band.

Today RCA offers products for such diverse applications as: radiosondes, missile guidance, shell telemetry, joint inflight data systems, weather observations, pollution control, and experiments in bio-medical research, stress, environment, pressure, temperature, and mapping with the help of infrared.

In outline, these are some of the RCA devices available for your airborne and ground-based telemetry systems:

L- and S-band—Pencil Tubes and Cavities, Transistor Power Sources, Oscillators, Microwave In-



tegrated Circuits—for applications from 250 mW cw to 600 W peak.

S-band—High Power Transistor Amplifiers, Microwave Integrated Circuit Modules—in 5 W to 10 W systems.

C-, X-, and Ku-band—TEO's, Oscillators, Microwave Integrated Circuits—for use in the 100 mW range.

Wideband—Traveling-Wave Tubes for low and medium power applications up to 20 W.

For more information on RCA products available for your telemetry requirements, see your local RCA Representative. For technical data, write: RCA Electronic Components, Commercial Engineering, Section 76E-1/ZM7, Harrison, N.J. 07029. In Europe: RCA International Marketing S.A., 2-4 rue du Lièvre, 1227 Geneva, Switzerland.

RCA