

Reducing MOS threshold voltage 118

\$1.00 A McGraw-Hill Publication

Minimizing distortion in acoustic couplers 124

April 13, 1970

East Germany puts new emphasis on electronics 143

# Electronics®



**New technologies  
pave the way for  
millimeter waves  
in communications**

142 K55956 44R86 02-71  
R. KISSLER  
MAG. COMM.

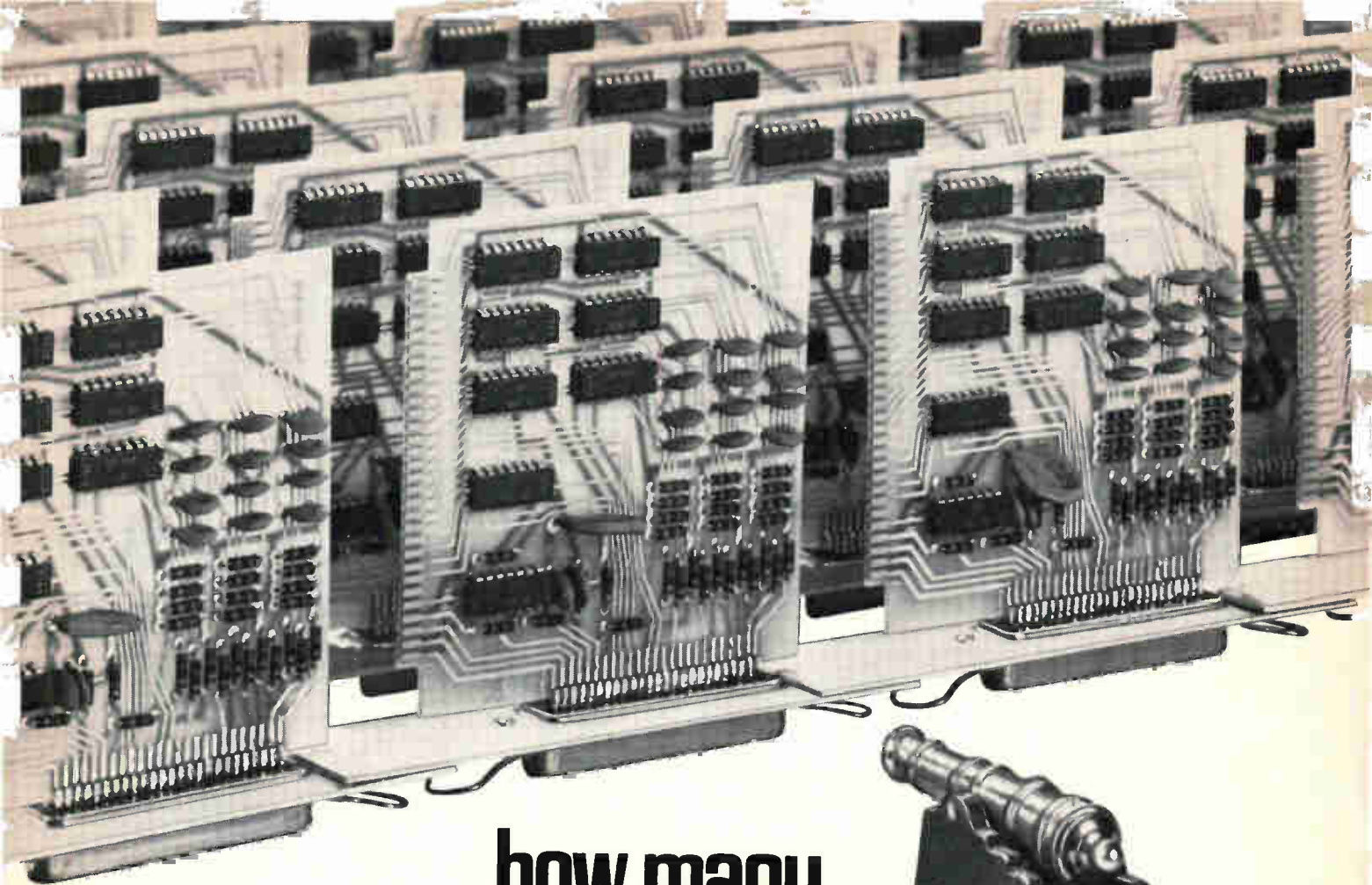

# how many will fall today?



Shoot down your defective printed circuit boards in the early rounds of the manufacturing process and win the battle of the ledger with GR's 1790 Logic Circuit Analyzer!

Put the 1790 into your battle plan and get the very best weapon available to check your logic circuits quickly and economically. The 1790 combines a capacity to handle almost any board configuration (up to 96 input pins and 144 outputs) with a simplified test language (technicians can learn it in only a few days) and computer speed (up to 4000 tests per second). The end product is a GO indication, or a scope-displayed or typewritten error message (or diagnostic instructions included in the test program) to give you the most powerful logic-circuit analyzer on the market. (A simpler GO/NO-GO test mode can also be used.)

Base price of the 1790 is \$32,500 (a strategic advantage for you), including installation and training. Additional computer memory and programmable logic levels are available as options. If you'd like more information for your strategy meetings, write General Radio Company, West Concord, Mass. 01781 or telephone (617) 369-4400. In Europe write Postfach 124, CH 8034 Zurich, Switzerland.

Price applies in U.S.A.

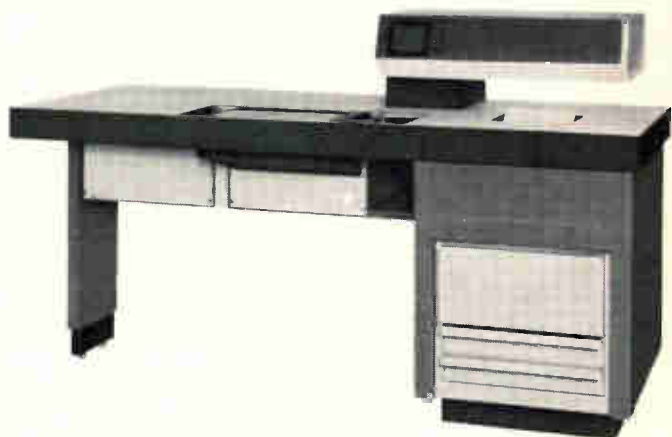

GENERAL RADIO



# It takes two minutes to check microwave designs our way.

## How long is it taking you?

If you're one or two generations behind in microwave measurement techniques, using fixed-frequency or magnitude-only swept-frequency methods, our only question is: "Why?"

Network analysis takes the drudgery out of microwave design. It's the third-generation advance that eliminates the tedium of point-by-point testing and provides more information than the traditional second-generation swept-frequency techniques.

In minutes, HP 8410S Network Analyzers measure all network parameters, 110 MHz to 12.4 GHz. By adding phase to magnitude measurements of transmission and reflection, they let you characterize active or passive components with a speed and accuracy never before possible. And measure attenuation, gain, impedance, admittance,

s-parameters — all in vector form.

Dynamic range of the 8410 is > 60 dB, with 0.1 dB resolution, and phase range is 360° with 0.1° resolution. Measurements are pushbutton-selected and answers are displayed on a CRT for your maximum

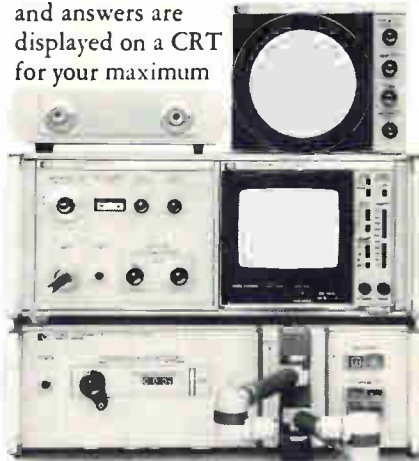

convenience. Just think how these advances can help you work with amplifiers, filters, transistors, antennas, cables and the like.

Why not see how practical network analysis can save you hours of work and give you a better designed product in the bargain? It's easy to check out. Just call your local HP field engineer and ask for more information on the technique and the instrumentation that will make it work for you. Or write Hewlett-Packard, Palo Alto, California 94304; Europe: 1217 Meyrin-Geneva, Switzerland.

HEWLETT  PACKARD

NETWORK ANALYZERS

04004

Circle 1 on reader service card

# Guess the price of HP's new counter



## Clues:

- it averages time intervals to 10 picoseconds
- it has a built-in 0.05% integrating DVM
- it's dc to 50 MHz, CW or burst
- its counter and DVM are easily programmable

Surprise: \$1550. That modest amount buys a Hewlett-Packard timer/counter that does things universal counters never did before. For example, it averages time intervals as short as 0.15 nanoseconds. So you can resolve to 10 picoseconds on repetitive signals.

That modest sum also buys a counter with a built-in integrating digital voltmeter. So it's the only counter that can measure internal trigger level settings or other inputs with DVM precision. Now you can measure 10 to 90% rise times, half power points and other voltage-dependent time intervals. That means unprecedented simplicity, for example, in propagation

delay measurements. The counter also features four integration times. As a DVM, it provides three voltage ranges, 60 dB noise rejection and 0.05% accuracy.

Even without these exclusive features, the 5326's are real bargains. They count to 50 MHz direct with seven-digit resolution (eight digits optional), measure period and multiple period average and scale input frequencies by any power of 10 up to  $10^8$ . They measure ratio and they totalize.

With programming and BCD output options, the 5326's fit easily into systems applications. Counter and DVM are DTL programmable through a common connector.

You can get all of these benefits in the 5326B for \$1550, or buy the same counter, less the DVM, in the 5326A for \$1195. Any way you look at the 5326 A or B—either is a great counter value. Your local field engineer has all the facts about HP's new IC counter line. Give him a call or write to Hewlett-Packard, Palo Alto, California 94304; Europe: 1217 Meyrin-Geneva, Switzerland.

**HEWLETT  PACKARD**  
ELECTRONIC COUNTERS

## Features

### Probing the News

- 137 **Manpower:** Layoffs reduce an already thin job market for EE's  
143 **Electronics abroad:** East German push in electronics pays off

### U.S. Reports

- 45 **Displays:** Photochromic glass for computer graphics  
46 **Companies:** Hittinger may put RCA in the ballgame  
46 **Avionics:** CAS is on the horizon —at long last  
47 **Communications:** Land-mobile relief may be coming; domestic communications satellite decision  
48 **Government:** ERC stays alive  
52 **Materials:** Hydrogen causes electronic failures  
52 **Solid state:** Schottky diode test results  
54 **Space electronics:** Materials sought for Skylab  
57 **Military electronics:** Radar gets phase data from returns  
59 **Advanced technology:** Mapping without pollution

### Electronics International

- 71 **Great Britain:** Operational computer with digital modules  
72 **France:** Microelectronics advances at Paris symposium  
73 **Japan:** Stereo multiplex tuner on a chip  
74 **The Netherlands:** Electronics on tap

### New Products

- 151 **In the spotlight**  
151 Recorder for automated tv nets  
155 **Data handling review**  
155 Modem tester uses many patterns  
161 Data terminal is fast printer  
163 **Industrial electronics review**  
163 Laser system calibrates tools  
165 Servo controls gas-flow rate  
166 **Components review**  
166 Active-filter line is semi-custom  
170 CdS photocells yield high output  
173 **Semiconductor review**  
173 Bipolar transistor reaches 15 Ghz  
176 **Instruments review**  
176 Microscopy refines IC testing  
182 **Subassemblies review**  
182 Hybrid couplers cover 30 Mhz-2 Ghz  
185 Step-repeat unit trims resistors  
186 **New materials**

## Articles

### Advanced technology 96

**Bell's money rides millimeter waves for future communications**  
High-performance Impatt and p-i-n diodes are the keys  
Laurence Altman,  
Electronics' staff

### Circuit design 106

**Designer's casebook**  
▪ Unijunction device eliminates contact bounce  
▪ Bridge circuit relies on common ground  
▪ Divider splits frequency into any ratio from 1 to 99

### Design theory 109

**CAD goes beyond first-generation programs to the capabilities of a second generation**  
Gatefold lifts features of available programs and those that will be offered soon

### Applied design 114

**Top performance from analog multipliers? Much depends on errors gauged in your circuit**  
Two input signals applied to device can be used to measure multiplying errors swiftly  
Tom Cate,  
Burr-Brown Research Corp.

### Memory technology 118

**Three ways to build low-threshold MOS**  
Easy interface with bipolars is the big advantage  
Warner Bridwell,  
American Microsystems Inc.

### Data handling 124

**Third harmonic cancels distortion in acoustic coupler**  
One method adjusts phase and amplitude of transmit signal's third harmonic to eliminate second-harmonic distortion  
Reuven Meidan,  
Applied Digital Data Systems

## Departments

- |                             |                             |
|-----------------------------|-----------------------------|
| 4 Editorial Comment         | 47 Index of activity        |
| 5 Readers Comment           | 69 International Newsletter |
| 9 Who's Who in this issue   | 83 Washington Newsletter    |
| 14 Who's Who in electronics | 189 New Books               |
| 22 Meetings                 | 191 Technical Abstracts     |
| 33 Electronics Newsletter   | 196 New Literature          |

# Electronics

Editor-in-Chief: Donald Christiansen

## Senior staff editors

Technical: Stephen E. Scrupski

News: Robert Henkel

International: Arthur Erikson

Art director: Gerald Ferguson

Assistant managing editors: H. Thomas

Maguire, Howard Wolff, William Buccì,

Richard Gundlach, Frederick Corey

Special projects editor: Roger Kenneth Field

Senior staff writer: John Johnsrud

Reader Communications manager: John D.

Drummond

## Department editors

Senior associate editor: Joseph Mittleman;

Advanced technology: Laurence Altman; Com-

munications: Leon M. Magill; Computers: Wal-

lace B. Riley, George Weiss; Design theory:

Joseph Mittleman; Instrumentation: Owen

Doyle; Military/Aerospace: Alfred Rosenblatt;

New Products: William P. O'Brien; Solid state:

George Watson, Stephen Wm. Fields.

Copy editors: Edward Flinn, William S. Weiss

Assistant art director: Charles Ciatto

Production editors: Susan Hurlburt, Arthur C.

Miller; Editorial research: Virginia Mundt; Edi-

torial secretaries: Claire Goodlin, Bernice

Pawlak, Barbara Razulis, Vickie Green, Terri

O'Neill.

## Field bureaus

Boston: James Brinton, manager; Gail Farrell;

Los Angeles: Lawrence Curran, manager; Ralph

Selph; New York: Peter Schuyten; San Fran-

cisco: Stephen Wm. Fields, Marilyn Howey;

Washington: Ray Connolly, manager; Robert

Westgate, Lois Vermillion; Frankfurt: John

Gosch; London: Michael Payne; Paris: Arthur

Erikson; Tokyo: Charles Cohen

Reprints: Virginia Mundt; Circulation: Isaaca

Siegel

Publisher: Dan McMillan

Assistant to the publisher: Wallace C. Carmichael

April 13, 1970

## Technology and a volunteer army

● Though it may be music to the ears of military electronics program managers in industry, a Presidential commission's endorsement of an all-volunteer army has hit some sour notes among senior military officers. Though the program notes appear inviting from an industry viewpoint, the finale, some general officers feel, could be disappointing—and even damaging. The recommendations of the Presidential Commission on an All-Volunteer Armed Force were delivered to the White House last month. The panel, headed by former Defense Secretary Thomas Gates, concurred, to no one's surprise, in President Nixon's campaign pledge to end conscription and upgrade military salaries and benefits to make voluntary service feasible.

Industry's military electronics program managers have been worried by rising Congressional and military criticism of overly complex and costly projects. Engineers have been wont to complain that their products perform only as well as the men who operate them. Likewise, many draftees frequently display more interest in counting the days to discharge than the number of blips on a radar screen. With an all-volunteer force, industry has led itself to believe it need not concentrate on idiot-proof designs.

User commands are inclined to agree that a professional force would increase operating efficiency and handling of their electronic systems. At least this is the view expressed in four private and separate conversations with four general officers—one Army, one Navy, and two Air Force. As one Air Force Systems Command leader puts it: "It seems that every good radar man, operator, and technician masters his job in the last two weeks before his discharge." And the erstwhile complaint of the carrier admirals is that their

best men rarely re-enlist, preferring to swallow the lures of private industry. These are long-standing opinions.

Less well known is the stronger view of these same general officers that the negative political potential of an all-professional force would override the gain that would be realized by more efficient use of technology.

"The United States has been well served by its military even if I do say so myself," begins one of the generals. "But the reasons for that, I believe, go beyond our concept of civilian control. It's not that simple. Civilian control has been possible because the cadre of professionals always has been relatively small and essentially apolitical. We've never had much of a political power base; we never had the opportunity. An all-pro Army might change all that. It won't affect me—I have two stars now and could retire tomorrow if need be—but it could affect the country, affect it seriously."

In the judgment of an admiral responsible for much of the Navy's technology, "We stand to lose in the service more than we might gain. By that I mean something apart from the politics involved. I mean we get a lot of bright, young people in the service that we might never see if the draft were ended. There's a lot of animosity to the military in this country now; it's not popular to be part of the 'complex.' But even before Vietnam, the military was something you joined only if you couldn't find anything better to do. That feeling still exists in a lot of places. I favor a different approach, something like a program of national service for everyone. There's no reason why there couldn't be a non-military option like the Peace Corps. But the military should try to broaden its base, not narrow it. That's the way to get more out of technology, in my opinion."

Published every other Monday by McGraw-Hill, Inc. Founder: James H. McGraw 1860-1948. Publication office 89 North Broadway, Albany, N. Y. 12202; second class postage paid at Albany, N. Y. and additional mailing offices.

Executive, editorial, circulation and advertising addresses: Electronics, McGraw-Hill Building, 330 W. 42nd Street, New York, N. Y. 10036. Telephone (212) 971-3333. Teletype TWX N. Y. 710-581-4235. Cable address: MCGRAW HILL N. Y.

Subscriptions solicited only from those professionally engaged in electronics technology. Subscription rates: qualified subscribers in the United States and possessions and Canada, \$8.00 one year, \$12.00 two years, \$16.00 three years; all other countries \$25.00 one year. Non-qualified subscribers in the U.S. and possessions and Canada, \$25.00 one year; all other countries \$50.00. Air freight service to Japan \$50.00 one year. Single copies: United States and possessions and Canada, \$1.00; all other countries, \$1.75.

Officers of McGraw-Hill Publications Company: Joseph M. Allen, President; John R. Emery, J. Elton Tuohig, Senior Vice Presidents; Gordon L. Jones Jr., Group Vice President; Vice Presidents: John R. Callahan, Editorial; John M. Holden, Marketing; David G. Jensen, Manufacturing; Jerome D. Luntz, Planning & Development; Robert F. Marshall, Administration; Robert M. Wilhelm, Finance; Director of Circulation: Ralph Blackburn.

Officers of the Corporation: Shelton Fisher, President and Chief Executive Officer; John J. Cooke, Senior Vice President and Secretary; Gordon W. McKinley, Vice President and Treasurer. Title © registered in U.S. Patent office. © Copyright 1970 by McGraw-Hill, Inc. All rights reserved. The contents of this publication may not be reproduced either in whole or in part without the consent of copyright owner.

Subscribers: The publisher, upon written request to our New York office from any subscriber, agrees to refund that part of the subscription price applying to copies not yet mailed. Please send change of address notices or complaints to Fulfillment Manager; subscription orders to Circulation Manager, Electronics at address below. Change of address notices should provide old as well as new address, including postal zip code number, if possible, attach address label from recent issue. Allow one month for change to become effective.

Postmaster: Please send form 3579 to Fulfillment Manager, Electronics, P.O. Box 430, Hightstown, New Jersey 08520.

## Readers Comment ▶



Though universal national service is popular in parts of Europe and works well in the Scandinavian nations, it's not clear whether or not the Gates Commission considered that option. What is clear is that the commission rejects "concern expressed about the growth of a separate 'military ethos' with an all-volunteer force."

It also is clear that President Nixon now has no intention of implementing the commission's recommended changeover in the fiscal year beginning July 1. He is moving with characteristic caution, listening to Defense Secretary Laird's reservations on the economics of the plan, and is unwilling to tilt a precariously balanced budget by tacking on the additional \$2.5 billion to fiscal 1971 defense spending that implementation would require. Indeed, there is a suspicion in the Capital that the President is listening to the private reservations of the military professionals and may let the Gates study languish in the National Archives with the reports of so many other previous commissions. The White House already has said it would be "premature" to attempt to translate the recommendations into legislation.

In any event, the all-volunteer armed force will never be a panacea for an electronics industry that feels its systems must now be designed by geniuses for use by idiots.

"Electronics engineers strike me as a pretty inbred bunch sometimes," observes one Air Force systems division chief. "And I can say that because I'm one of them. But their concern with this report should go beyond the end of their slide rules. There are a lot of answers for their systems problems, but the volunteer force isn't one of them. The best answers are the ones they'll find in the texts of first principles. Simplicity is one of them. Reliability is another." R.C. ●

### McGraw-Hill News Service

Director: Arthur L. Moore; Atlanta: Fran Ridgway; Chicago: Robert E. Lee; Cleveland: Arthur Zimmerman; Dallas: Marvin Reid; Detroit: James Wargo; Houston: Barbara LaRoux; Los Angeles: Michael Murphy; San Francisco: Margaret Drossel, Tyler Marshall; Seattle: Ray Bloomberg; Washington: Charles Gardner, James Canan, Herbert W. Cheshire, Seth Payne, Warren Burkett, William D. Hickman; Bonn: Robert F. Ingersoll; Brussels: James Smith; Hong Kong: Kate Mattock; London: John Shinn; Mexico City: Gerald Parkinson; Milan: Jack Star; Moscow: Jack Winkler; Paris: Robert E. Farrell, Stewart Toy; Tokyo: Marvin Petal

### Registered

To the Editor:

Your article on Picturephone [Jan. 19, p. 131] prompts us to reiterate that Picturephone is the registered service mark of the American Telephone and Telegraph Co. for see-while-you-talk, sometimes known as visual telephone services, in class 104 of the U.S. Official Trademark Classification. The registration number is 820,507.

Hugh S. Wertz

Legal and Patent division  
Western Electric  
New York

■ A&T is understandably desirous of protecting its trademark, which is being used more and more even outside the U.S. as a generic name. *Electronics* indicates trademarks by an initial capital: Picturephone.

### Watt's this

To the Editor:

It is bad enough to have to endure tv commercial claims of "20,000 volts of picture power," but to read in *Electronics* [March 16, p. 63] that a phonograph cartridge puts out "200 millivolts power" is more than I can take.

Alexander E. Martens

Analytical Systems division  
Bausch & Lomb Inc.  
Rochester, N.Y.

### Four!

To the Editor:

As I scanned through your March 30 issue, I felt that here were some genuine advances in the technology, well presented and very readable. Particularly enjoyable was the coverage of LSI packaging.

However, a minor error crept into the review of the ISSCC paper on page 152—"Super-squeeze-in." It states that there are three buffer memories on the chip, whereas there are actually four, one for each decade counter. I do not agree that the difficulty of identifying individual components is a tradeoff. I rate performance in electrical terms; if a device, circuit or system isn't easy to understand by visual inspection, life becomes harder for the competition and surely that's a benefit.

Incidentally, I believe these counters set a record for component density in a bipolar circuit. The counter section (minus the buffer memory and count-output stage) is only 3 by 30 mils, an area of 90 square mils, and contains 20 triple-collector pnp transistors, 20 npn transistors, and 20 resistors—a density of about 660,000 components per square inch.

Barrie Gilbert

Tektronix Inc.  
Beaverton, Ore.

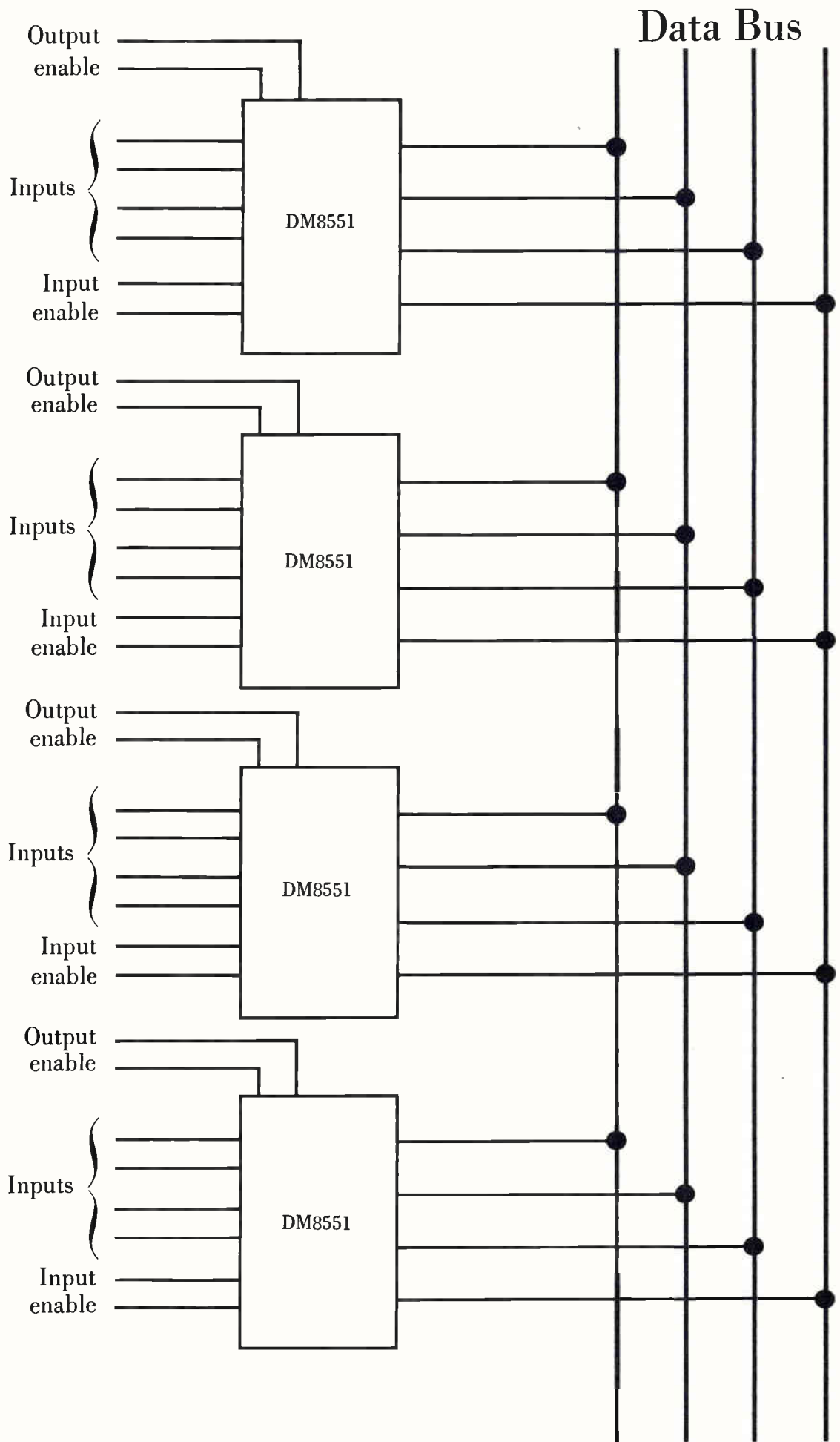



# Tri-state Bus-line

There's a third state in a TTL databus with our DM8551. Conventional low impedance logical 1, logical 0 and a high impedance state you can use as a logical "neutral." The 8551 gives you the high impedance characteristics of an open collector output with the high drive of TTL. It makes it possible to design mini-computers as bus-organized systems totally TTL. Direct coupling. Shorter lines. TTL all the way.

DM8551 — Bus-OR'd Quad D — operates synchronously from a common clock. This element has the further advantage of input data acceptance without controlling the clock. Specifically designed for use in bit serial and bit parallel applications. Controlling the third state makes it possible to connect the output of the 8551 directly to the output of other 8551s. You can impede the output of all devices except the one you select, logically.

Take it from National. The 8551 is a new concept in TTL and something else in a databus. TTL/MSI, logically from National Semiconductor. Write for App Notes and specs. 2900 Semiconductor Drive, Santa Clara, California 95051. (408) 732-5000. Telex: 346-353 Cables: NATSEMICON.

## National/TTL MSI

**NEW**

GENERAL  
MAGNETICS, INC.  
BLOOMFIELD, N. J.  
T/N 1000 172440  
S/N 363555

# Accurate Analog Computing with Magnetic Multipliers

**Product Accuracy**  
**1%**  
**Absolute**

Flat Pak magnetic modulators, analog multipliers, demodulators mount directly on IC cards.

- Flat Pak design only 0.1" thick.
- Zero Hysteresis.

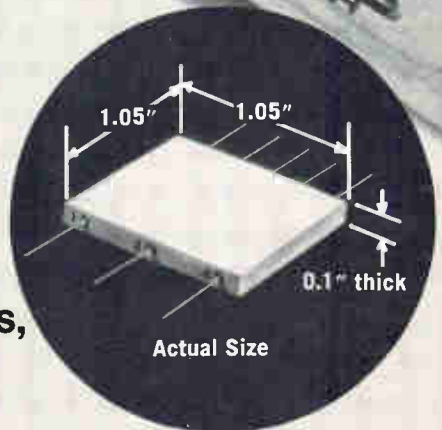

**Product accuracy 1% absolute or 2 MV whichever is greater over the temperature range of -55°C to +125°C**

- Hybrid assemblies mount directly on IC cards.
- Space saver design, typical dim. 0.1" thick x 1.0" x 0.75".
- Rugged design, extreme reliability. MTBF design goal 0.25 per million hours.
- Extremely low drift over -55° to +125°C range.
- Not affected by high intensity nuclear radiation.
- No external nulling or offset adjustments.
- No additional components or temperature compensation required.
- No external operational amplifiers required.
- ± 15 V DC power supply unless otherwise specified.
- Linearity: Better than 1% absolute or 2MV whichever is greater.
- Analog Multiplying Functions:

$$\begin{aligned} \pm DC \times \pm AC &= AC \\ \pm DC \times \pm DC &= \pm DC \\ AC \times AC &= AC \\ \pm DC \times AC &= \pm DC \\ AC \times AC &= \pm DC \end{aligned}$$

As an Analog Multiplier of a Bipolar DC signal times an AC signal, the output **product accuracy** is 1% of point, or 2 MV, whichever is greater over a dynamic range of 10,000:1 in each quadrant.

- Parameters over the temperature range of -55°C to +125°C :
- 1) Product accuracy 1% of point or 2 MV whichever is greater
  - 2) Zero Point Drift: ... Less than 2 MV of in phase component
  - 3) Gain Slope Stability: ..... Less than 2% change
  - 4) Dynamic range and output wave quality independent of temperature variations
  - 5) Distortion: ..... Less than 1%

Typical input/output parameters:  
 X Signal: ..... 0 to ±5V  
 Y Signal: ..... 0 to ±5V  
 Output: ..... 0 to 5V RMS across 5KΩ or greater

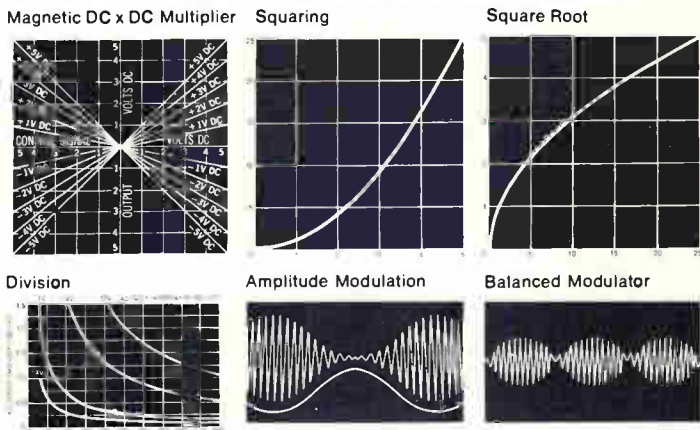

**MAGNETIC MULTIPLIERS**

Dynamic Product Range  
**80 db**

---

**Magnetic Modulators**

Dynamic Range:  
**60 db**

 There is No Substitute for Reliability  
**GENERAL MAGNETICS, INC.**  
 135 Bloomfield Avenue, Bloomfield, New Jersey 07003

# Who's Who in this issue



Meidan

**Israel** is the native land of Reuven Meidan, who wrote the article that starts on page 124, and communications has been his native discipline. An officer in the Israeli Army's Signal Corps from 1958 to 1963, Meidan later was named senior research engineer and project manager at the scientific department of the Israeli Ministry of Defense, where he specialized in communications and electro-optics. Last May, Meidan joined Applied Digital Data Systems, where he's manager of communications.



Bridwell

**A tour** through the semiconductor industry is still in progress for Warner Bridwell, who wrote the article starting on page 118. He worked at Motorola after college, then went to Fairchild, Signetics and Philco-Ford before returning to Motorola. He recently joined American Microsystems.



Altman

**Advanced technology** is the territory staked out by Laurence Altman, who wrote the article beginning on page 96. He has worked at the Advanced Optics Laboratory at Aberdeen Proving Grounds and was a senior physicist in the Nuclear Research department of Ford Instruments before joining *Electronics* last September.

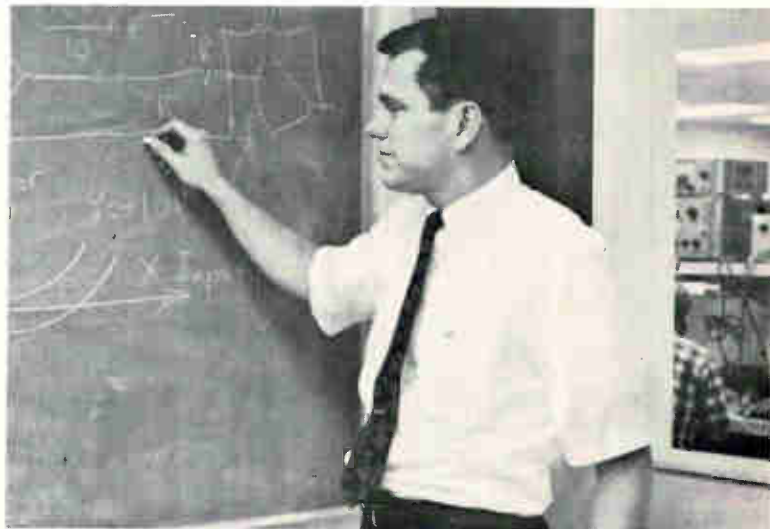

Cate

**Activity** has been a watchword for Tom Cate, who is the author of the article on obtaining top performance from analog multipliers that begins on page 114. A frequent contributor to publications in electronics, Cate is active in both the IEEE simulation council and the Instrumentation Society of America. Cate holds a BSEE from the University of Oklahoma and an MSEE from Wichita State University. He is a product engineer at Burr-Brown Research Corp., Tucson, Ariz.

# Who knows what lurks in the inner recesses of LSI?

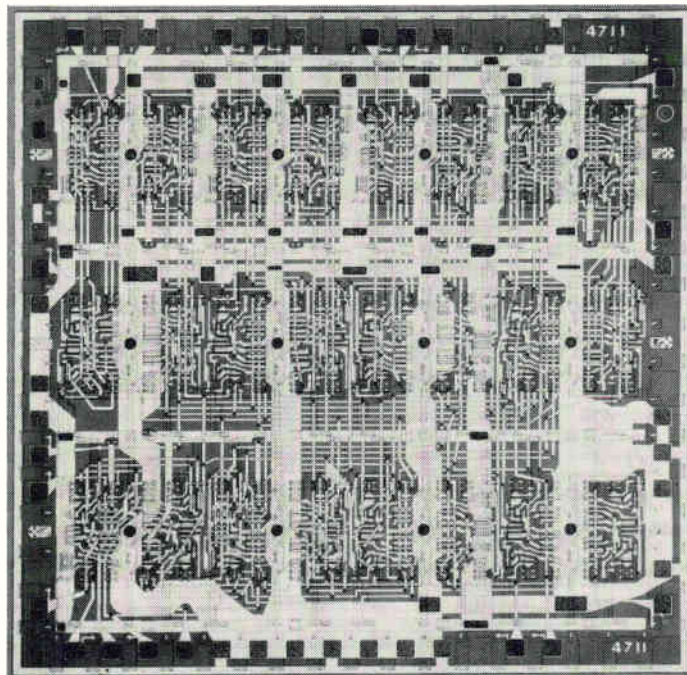

# FAIRCHILD

Sales/Service Offices:  
Sunnyvale, California (408) 735-5011 • El Segundo, California (213) 678-3166 • Oes Plains, Illinois (302) 299-1048 • Garland, Texas (214) 272-6687 • Ft. Lauderdale, Florida (305) 564-0546 • Cherry Hill, New Jersey (609) 667-0241 • Burlington, Massachusetts (617) 272-7060 • Isleworth, Middlesex, England Tel 560-0838 • 8 Munich 80, West Germany Tel 45-84-16 • Tokyo Electron Labs, Yokohama, Japan 226.045-471-8321

# The SENTRY knows.

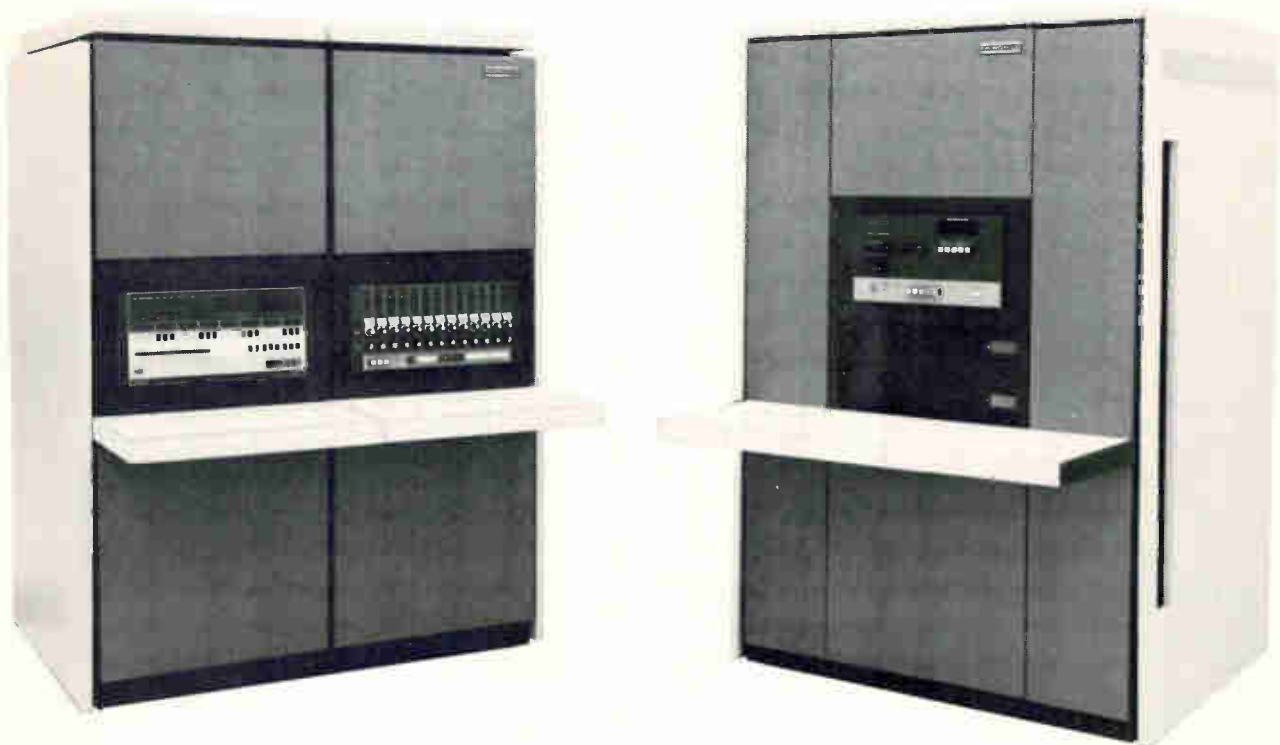

No one knows more about what's going on inside LSI than the SENTRY. And that's from a printed circuit to buried memory states with an internal feedback loop. The SENTRY 400 is the most comprehensive test system ever devised.

Using test programs that exceed 250,000 tests per second, the SENTRY 400 analyzes logic functions and DC parameters of 30, 60, 90, or 120-pin devices. Expandable to two 240-pin modules. You can debug prototypes under manual control at one station and

still maintain automatic production testing at others.

Ranging to 286,000 tests per second, the SENTRY 400 can run four simultaneous programs. The computer sets up the test conditions and holds the device up to a software model for pass/fail determination. Results from separate stations are multiplexed to the central computer and instrumentation unit.

The system controller is a specially designed computer, capable of processing extraneous data when not involved in

testing. The SENTRY 400 algorithmic problem oriented language finally provides a simple solution to the complex problem of LSI testing.

Standing behind the SENTRY 400 is the most extensive service network in circuit testing systems. Purchased systems include a one year warranty with contract maintenance available. Lease plans including maintenance are also available on both a long and short term basis.

Advancing technology in LSI demands new capabilities in testing. Meet the demand with the SENTRY 400.

# SYSTEMS

**FAIRCHILD**  
SYSTEMS TECHNOLOGY

Division of Fairchild Camera and Instrument Corporation, 974 E. Argus Avenue, Sunnyvale, California 94086 (408) 735-5011 TWX: 910-339-9217

The HP 1900 is the first pulse system to combine **state-of-the-art** performance with **plug-in** versatility.

The result? A single system that meets your most advanced testing requirements and still gives you the flexibility to meet the varying challenges of day-to-day changes.

With the 1900 pulse system, you can start with a 25 MHz plug-in that gives you up to one full amp output. Try this one when you are testing magnetic memory cores, MOS de-

VICES, or any other place where high current requirements have been tough to meet... up till now!

The same plug-in also provides a pulse with variable rise and fall times from 7 ns to 1 ms. An adjustable voltage output of up to 25 volts and the ability to amplify RZ or NRZ word formats. It all adds up to a plug-in designed to provide power to spare, plus the capability to handle a wide variety of testing requirements.

Or perhaps speed is what you need. Another plug-in gives you a **350 picosecond** fixed risetime pulse that you can control in width, offset, amplitude and polarity. Whether you're testing storage time in ultra-fast diodes or checking propagation delay you can be sure of getting the accuracy you require.

And when you need extremely short duration pulses at a rep rate of from 0 to 25 MHz, you'll appreciate the 400 picosecond falltime of this pulse. Just adjust for zero width and you are ready for impulse testing. This is the plug-in that will give you the ability to test the most advanced circuits available today... or tomorrow.

To give you complete control over the digital format of either of these plug-ins the 1900 system also provides a word generator. They combine to let you generate and shape the specific word that best fits your system.

**If pulses are your problem...  
meet HP's plug-in solution.**

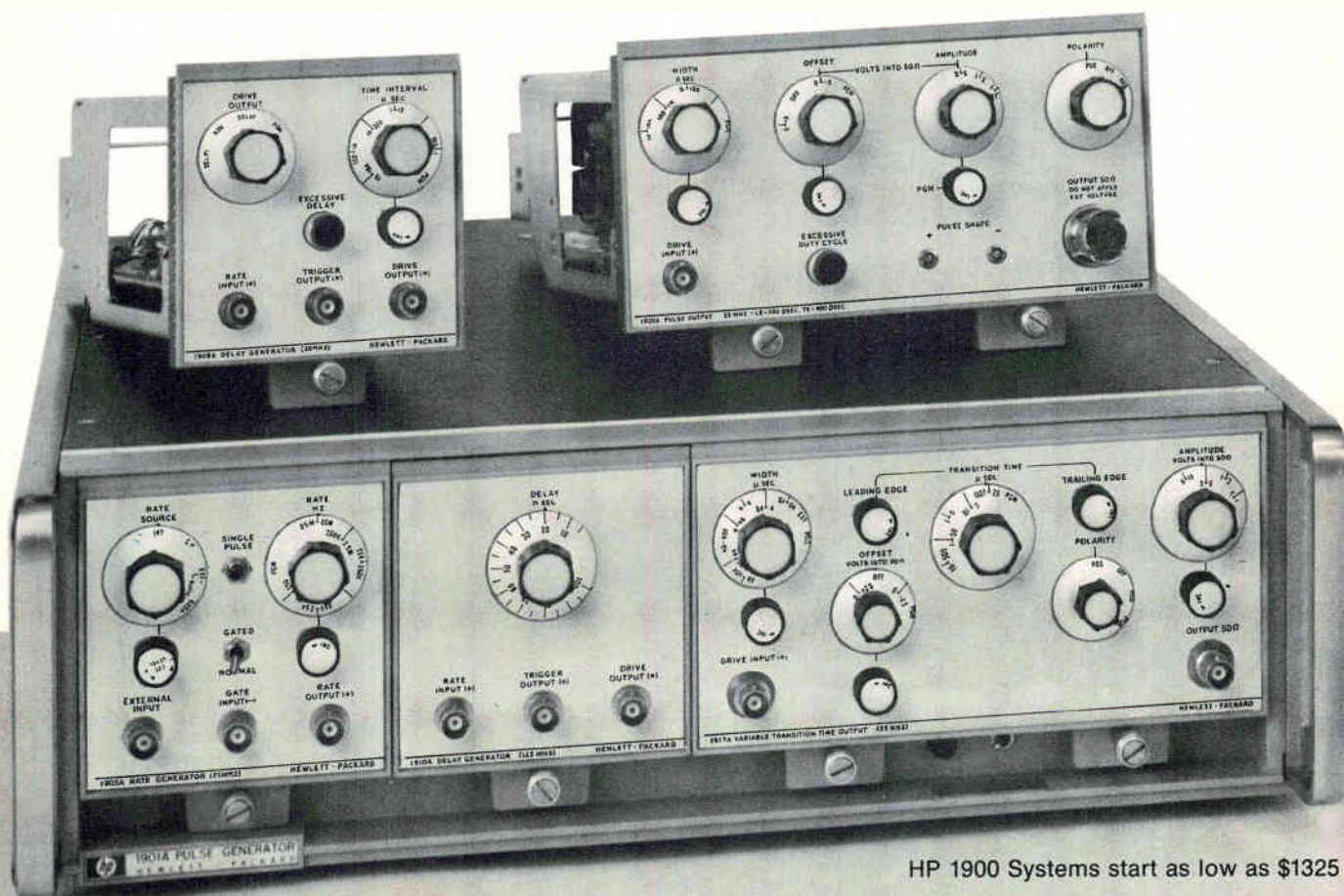

HP 1900 Systems start as low as \$1325

You can get 2- to 16-bit word lengths at a 0 to 50 MHz clock rate. A pseudo-random noise output and RZ and NRZ formats at the flick of a switch add to its capabilities. And, you are compatible with ECL, TTL, DTL, MOS, core memories or any other type of circuit you are testing.

To all of this performance add optional analog programming and you have the most advanced state-of-the-art pulse system available today!

**HEWLETT *hp* PACKARD**

SIGNAL SOURCES

But this is only the start of the HP 1900 pulse system's capability. You can select from two mainframes to meet your power requirements. Both are available with the inexpensive optional programming wiring that allows you to make the 1900 completely automatic.

The four additional plug-ins consist of a rate generator, two delay generators and a low-power variable transition time output (0.2 to 10V). Any number of plug-ins or additional mainframes can be added to your system. They can be stacked, mixed, cascaded or programmed to meet any configuration requirement... now or in the future.

Isn't it time you had the benefit of both state-of-the-art performance and plug-in versatility?

For more information on the pulse system that will enable you to keep up with the changing times, call your local HP Field Engineer. For data on all of HP's pulse generators, consult your 1969 HP catalog starting on page 342. Or, write to Hewlett-Packard, Palo Alto, California 94304. Europe: 1217 Meyrin-Geneva, Switzerland.

Price: Mainframes, \$450 and \$750. Plug-ins, from \$150 to \$1750.

080/3

Circle 13 on reader service card

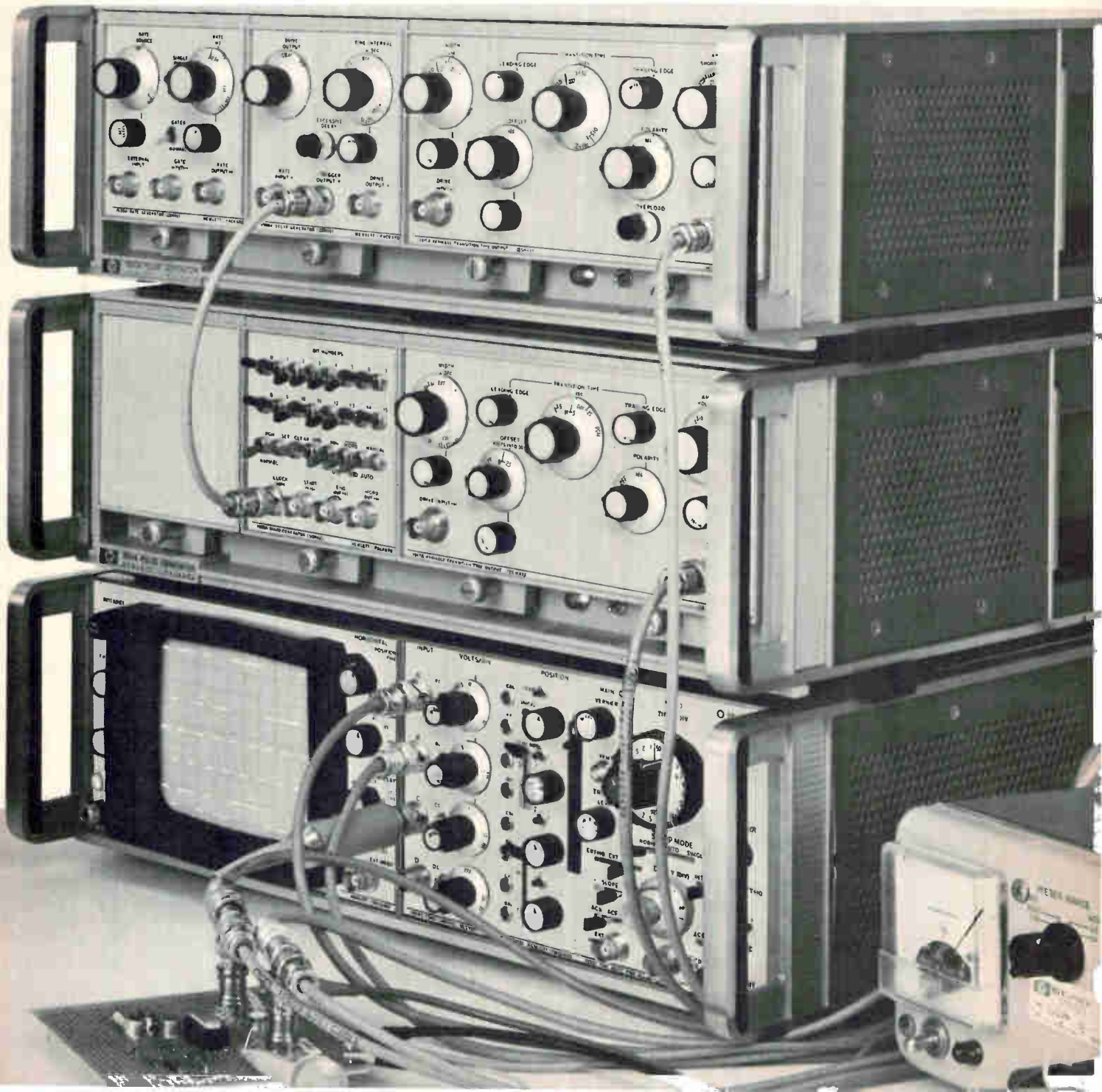

# HOT LINE

for "off-the-shelf"  
delivery of  
**RCL**  
**MINIATURE**  
**ROTARY**  
**SWITCHES**  
**249 TYPES!**

Same day  
shipment of  
up to 100 pieces  
of any catalog  
type ...

... 1 week delivery  
of up to  
1000 pieces!



**Call (201)**

**374-  
3311**

## RCL

**ELECTRONICS, INC.**

General Sales Office:  
700 South 21st Street  
Irvington, New Jersey 07111

## Who's Who in electronics



Spence

Unjamming America's land mobile communications, the most overcrowded segment of the spectrum, is a chore that can be likened to landing on the moon—extremely challenging. That's the assignment delegated to the Federal Communications Commission's deputy chief engineer, Raymond Spence Jr. The difference between Spence, a 40-year-old engineer, and the team that put men on the moon is that he will be remembered by far fewer people for his achievement.

But users of land mobile communications are nonetheless anxious to see the FCC set up its first National Spectrum Management Center on Congressional approval of fiscal 1971 funds [*Electronics*, Feb 16, p. 150]. The center, to be located in Chicago, will establish policy, guidelines, and first standards for several others planned by the FCC for congested metropolitan areas [see p. 47].

**Dipping a toe.** "This is the first major involvement in an implementation and development program," says Spence, who now heads FCC's new Spectrum Management Task Force. That body is responsible for working out organization and management of the centers. Until now, he says, the FCC has been "reviewing programs of others."

One task facing the national center is developing a systems concept for spectrum management, and transferring the concept suc-

cessfully to congested areas.

The national center's role within the commission still is being defined. Among the questions requiring answers, says Spence, are: "What will be the division of responsibility between the national and regional centers? Who will the regional centers report to?"

Perhaps the most delicate question is whether realization of the center will require realignment of the commission. Spence, understandably, is reluctant to speculate. The easiest and most palatable management scheme would be to expand the commission's Field Engineering Bureau, but there is also the possibility of "some entirely new organizational element," says Spence, declining to elaborate.

**Helpers.** Whatever the organizational structure, Spence is "very optimistic" about the center's success, but is "expecting it to be a rather large challenge." He expects that most user groups will cooperate in the center's work—since they will be the major beneficiaries—rather than buck it.

---

After a decade-long plummet, the Hoffman Electronics Corp. hopes it's on the comeback trail. The long-term chances of the effort rest on the shoulders of Wendell Sell, Hoffman's president.

The formidable challenge before



# There isn't another like it. A 1/4-inch, single-pole, six position, 28-vdc. Helipot switch for PC boards.

**Beckman**® INSTRUMENTS, INC.

**HELIPOT DIVISION**

Fullerton, California 92634

INTERNATIONAL SUBSIDIARIES: AMSTERDAM; CAPE TOWN;  
GENEVA; GLENROTHES, SCOTLAND; LONDON; MEXICO CITY;  
MUNICH; PARIS; STOCKHOLM; TOKYO, VIENNA



Model 374H \$3.00 (1-9 pieces)

Model 374 \$2.75 (1-9 pieces)

# Sweeping superiority

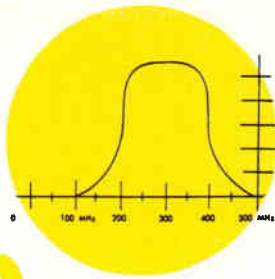

Bandpass presentation of a 200-400 MHz amplifier as tested with a VS-50, HM-50, and LN-40 log amp.



## THE UNIQUE VS-50 SOLID-STATE SWEEP GENERATOR 2-500 MHz

Master of hundreds of applications in the FM radio, VHF TV and TV IF, and most communication bands, the Texscan VS-50 can cover the 200-400 MHz range in a single sweep—and add 300 MHz of extra coverage. As the above frequency plot of a 200-400 MHz amplifier bandpass presentation shows, the oversweep permits out-of-band tune-ups and slope characteristics to be measured easily in a single test. Descriptive literature covering all technical details of this unique instrument—available only from Texscan—is yours for the asking, free on request.

### STATE-OF-THE-ART LEADERSHIP

**RF Output:** RF output is at least 1 vrms into a 50 ohm load.

**Sweep Width:** The sweep width is continuously variable from 500 KHz to 500 MHz at any center frequency, but the unit will not sweep above 500 MHz at rated output. The unit is also provided with a CW output mode for signal generator applications.

**Frequency Range:** The unit can be centered at any frequency between 2 MHz and 500 MHz and sweep anywhere with that range.



*Texscan*

CORPORATION

2446 NORTH SHADELAND AVENUE  
INDIANAPOLIS, INDIANA 46219

## Who's Who in electronics

Sell is indicated by the company's track record: net sales dropped to a low of \$23.8 million in 1968 from \$54.7 million in 1960. Along the way, Hoffman sold its semiconductor operation to Globe Union in 1967, and pulled out of the commercial television business in 1968, selling its controlling interest in Hoffman Products Corp. to Montgomery Ward. Things were better in 1969, when sales reached \$30.4 million. But most of it was military business, principally Tacan navigation units.

**On the double.** Sell's primary mandate will be to move the corporation strongly into new commercial markets while continuing to expand Hoffman's already healthy military business. He brings to the task a good mix of military and commercial experience. The West Point graduate—he reached the rank of brigadier general—was president of Teledyne Packard Bell and held executive positions at the Marquardt Corp., Boeing, and the Electronics division of the AMF Corp., formerly American Machine and Foundry.

According to Sell, a recent first-stage \$7 million contract award from the Navy for AN/ARN-84 microminiature tactical air navigation (Tacan) systems "has established us as the number one Tacan supplier in the world. As a result of this we are beginning to see the dam break in terms of new Tacan programs for other countries." The company also has a \$6 million research and development contract from the Army for the AN/ARC 98 high-frequency, single-sideband receiver, and has just completed in-house development of a solid state, coherent-pulse doppler radar altimeter that is expected to result in a multimillion-dollar military contract, says Sell.

**Health business.** "From my own point of view, developing systems aimed at reducing the cost of medical care for patients is a high-priority thing for us," he says. "This would include medical electronics, patient-record systems, patient-monitoring devices, and the whole problem of taking care of people, as well as nurse and medical technician training."

- Five full digits plus "1" for 20% overranging
- Basic unit measures 0 to 1100 volts dc in three ranges
- Auto ranging and polarity with active 3-pole switchable filter
- 25 millisecond sampling speed
- Full systems capability with timing signals and ready indicator
- Low cost options include ac voltage, millivolt-ohms, external reference (ratio) and fully isolated remote programming and data output.



## The first really new DVM in a decade

**Announcing the Fluke 8300A, a 0.005% digital voltmeter with full systems capability for \$1295**

There are a lot of good DVM's around. All but one share a common set of faults—overwhelming complexity and high cost. And as you might guess, the DVM that beats the others cold is the new Fluke 8300A.

Why?

Because Fluke uses a new A to D technique which reduces componentry by up to 500 percent. Obviously, when components are eliminated, good things happen. Power requirements go down, reliability goes up, circuitry is simplified, troubleshooting is speeded and reduced. Most important to the system

designer, lowered costs mean we can invest some of the savings in features you need in a DVM.

With all its features and accuracy, the Fluke 5-digit DVM sells for less than many 4-digit units. We price the options low, too. A fully loaded Fluke 8300A sells for \$2995. Comparable but not equal competitive instruments cost as much as \$5000.

And when the Fluke name goes on the front you know you're getting quality instrumentation... in keeping with the Fluke philosophy of bringing you standards lab performance in portable instrumentation.

Fluke, Box 7428, Seattle, Washington 98133. Phone: (206) 774-2211. TWX: 910-449-2850. In Europe, address Fluke Nederland (N.V.), P.O. Box 5053, Tilburg, Holland. Phone: (04250) 70130. Telex: 884-50237. In the U.K., address Fluke International Corp., Garnett Close, Watford, WD2 4TT. Phone: Watford, 27769. Telex: 934583.



# To put a priority encoder on a single chip,

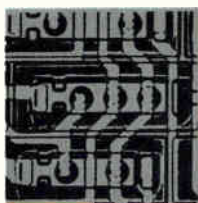

Fairchild introduces the first MSI 8-input priority encoder ever put in a single package. In fact, it's the first encoder of any kind ever put in a single package.

The new 9318 accepts data from eight active low inputs, selects the most significant input signal, and provides a binary representation of it on the three outputs. Input and output enables permit encoders to be cascaded without using additional components. This allows priority encoding of any number of input signals. Also, a group signal output is provided to show when any input is active.

In the tradition of Fairchild's MSI family, the 9318 is a highly versatile, highly reliable device. It can be used in code conversions, multi-channel D/A conversions, and decimal to BCD conversions. It will find application in priority interrupt systems, associative memories and keyboard encoders as well as a number of control applications.

The 9318 is TTL and DTL compatible and has a typical power dissipation of 200mW. It comes in DIP and Flatpak in both military and industrial temperature ranges.

To order the 9318, call your Fairchild distributor and ask for:

PART NUMBER	PACKAGE	TEMPERATURE RANGE	PRICE (1-24)	PRICE (25-99)	PRICE (100-999)
U7B931859X	DIP	0°C to + 75°C	\$15.35	\$11.80	\$10.25
U7B931851X	DIP	-55°C to +125°C	30.70	23.60	20.50
U4L931859X	Flat	0°C to + 75°C	16.90	13.00	11.30
U4L931851X	Flat	-55°C to +125°C	33.80	26.00	22.55

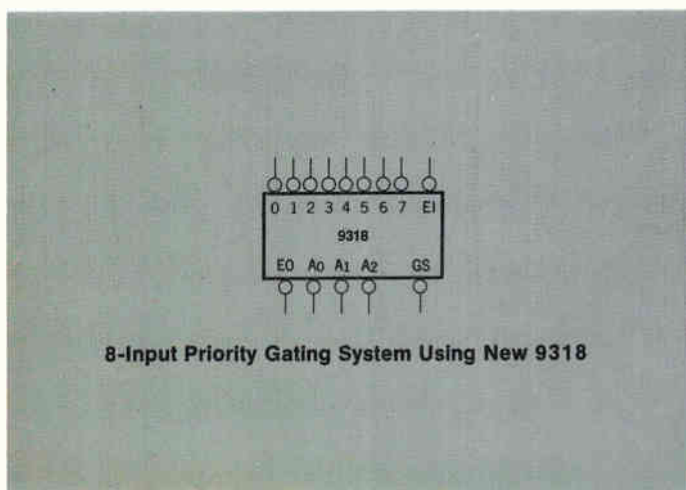
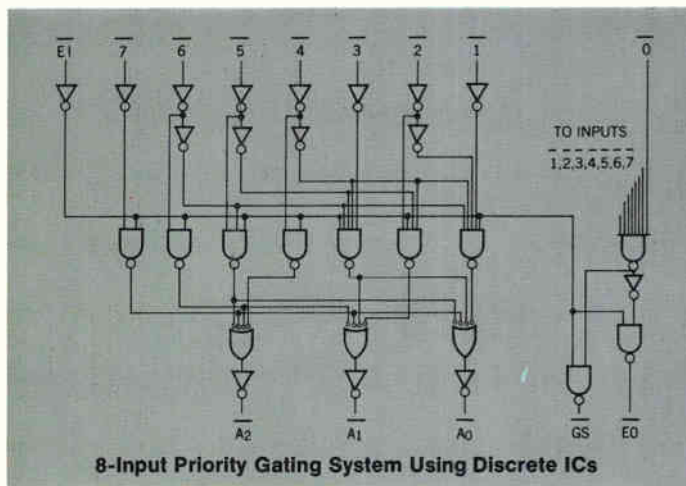

# you have to get serious about MSI family planning.

We put together a family plan by taking systems apart. All kinds of digital systems. Thousands of them.

First we looked for functional categories. We found them. Time after time, in a clear and recurrent pattern, seven basic categories popped up: Registers. Decoders and demultiplexers. Counters. Multiplexers. Encoders. Operators. Latches.

Inside each of the seven categories, we sifted by application. We wanted to design the minimum number of devices that could do the maximum number of things. That's why, for example, Fairchild MSI registers can be used in storage, in shifting, in counting and in conversion applications. And you'll find this sort of versatility throughout our entire MSI line.

Finally, we studied ancillary logic requirements and packed, wherever possible, our MSI devices with input and output decoding, buffering and complementing functions. That's why Fairchild MSI reduces—in many cases eliminates—the need for additional logic packages.

The Fairchild MSI family plan. A new approach to MSI that's as old as the industrial revolution. It started with functional simplicity, extended through multi-use component parts, and concluded with a sharp reduction in add-ons. Simplicity. Versatility. Compatibility. Available now. In military or industrial temperature ranges. In hermetic DIPs and Flatpaks. From any Fairchild Distributor.



**OPERATORS**  
9304 – Dual Full Adder/Parity Generator

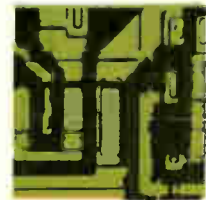

**LATCHES**  
9308 – Dual 4-Bit Latch  
9314 – Quad Latch



**REGISTERS**  
9300 – 4-Bit Shift Register  
9328 – Dual 8-Bit Shift Register

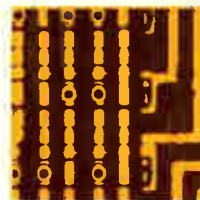

**MULTIPLEXERS**  
9309 – Dual 4-Input Digital Multiplexer  
9312 – 8-Input Digital Multiplexer

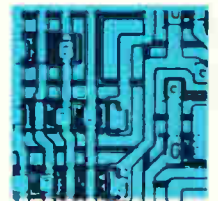

**DECODERS AND DEMULTIPLEXERS**  
9301 – One-Of-Ten Decoder  
9315 – One-Of-Ten Decoder/Driver  
9307 – Seven-Segment Decoder  
9311 – One-Of-16 Decoder  
9317 – Seven-Segment Decoder/Driver  
9327 – Seven-Segment Decoder/Driver



**COUNTERS**  
9306 – Decade Up/Down Counter  
9310 – Decade Counter  
9316 – Hexadecimal Counter



**ENCODERS**  
9318 – Priority 8-Input Encoder

**FAIRCHILD**  
SEMICONDUCTOR

# Make

## Matrix Rotary Switches

Designed for low-cost infrequently changed programming. Small, rugged, ideal for behind panel applications. Switch to switch wiring integral part of assembly to achieve maximum density. Printed circuit edge connectors make external wiring connections easy, fast and economical. Knobs position with positive detent action, eliminate contact bridging and clearly reveal numerical readout. Contact surfaces fully protected, self-wiping for high reliability. Designed to cover wide variety of digital memory, sequencing, X-Y coordinate and input-output switching applications.

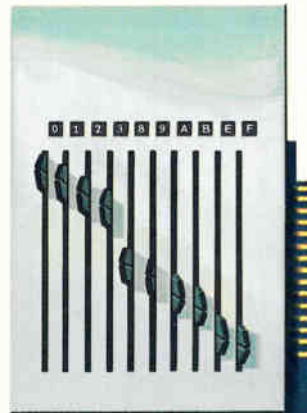

## Matrix Slide Switches

Here's reliable matrix switching for applications requiring manual data entry operations. Standard switch offers 5 slides, 10 positions, 5 x 6, 10 x 10 and 10 x 16—special sizes also available. Positive slide location assured by detented slide positions.

In-line visual readouts verify data entered. Unit is easily mounted. Ideally suited for data entry, test equipment programming, machine tool control and collection of fixed and variable transaction data.

## Input/Output Connectors

"M" Series connectors are available in wide variety of sizes and configurations. Standard miniature and subminiature pin and socket contacts are crimp snap-in and posted for machine wiring. All contacts terminated with AMP's automated tooling for lowest applied cost. Connectors also accommodate mix of standard and coaxial type connections.

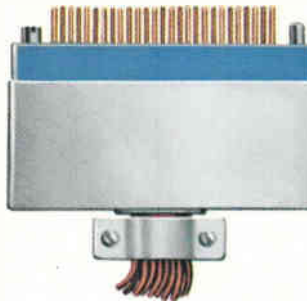

## Card Readers

The most complete line of Card Readers available anywhere. A wide variety of types and sizes—manual, solenoid and motor driven—to accept standard tab cards and plastic credit and badge type cards. Contact arrangements include either bussed rows or bussed columns with isolated outputs or bussed matrix types up to 12 rows and 22 columns. Self-wiping contacts. Lifetime bearings. Completely solderless wiring interface. Model 161 illustrated especially designed for use with badge cards.

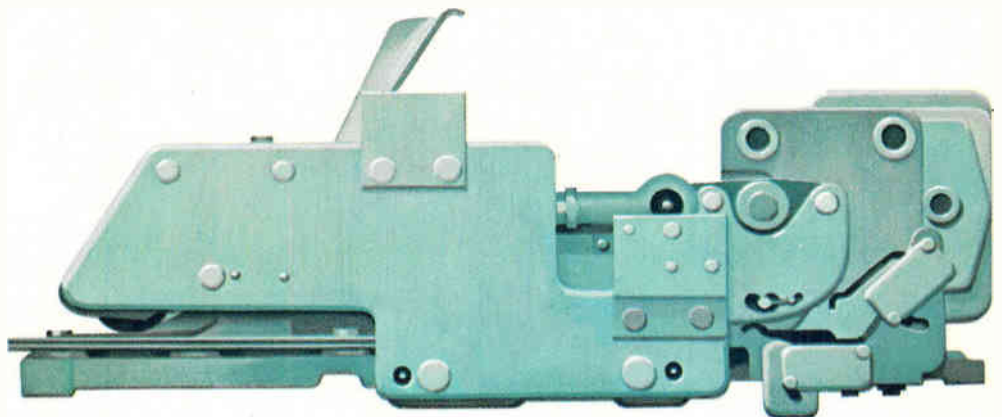

## Reader Imprinters

Designed for credit validation terminals and other terminals using input data from the credit card and imprinting on command. Imprints from embossed information on credit card and from any fixed data onto manifold forms. Cycles

are: read and imprint, or read and refrain from imprinting, as selected by external command to denote valid or invalid credit. Accepts plastic credit or badge type cards. Completely solderless wiring interface. Designed for long life and easy serviceability.

# or buy.

With AMP you can go either way:

**Choose from virtually all components necessary for any function you can name; or buy the complete terminal packaged to your specifications.** Components include slide switches, card readers, rotary matrix switches . . . everything from serial scanners and electronic logic to indicator lights and connectors of every type. Because of the flexibility of our com-

ponent designs we can build portions or complete terminals to be compatible with your system's interface requirements. Either way, when it comes to low-cost input terminals,

only AMP has a full-choice offering for the OEM.

For more on AMP's make or buy input terminal line write to  
**Industrial Division,  
AMP Incorporated, Harrisburg, Pa.  
17105.**



**AMP**  
INCORPORATED

# diversified components

\*Prices shown are single lot.  
Inquire about quantities.

## Proximity Switch Assembly

Encased magnet actuates a reed switch to within 1" ctrs. Rated 500  $\mu$ A, 60 VDC. RS-24-NO.



Circle 322

2.85\*

## Low-Current Readout

Compact 7-Segment readout features low-drive requirement. Plug-in mount. 2.5V @ 20 ma. per segment. With socket. MS-250A.



Circle 323

8.25\*

## 110V Neon Indicator

With built-in NE2H hi-intensity lamp & series resistor for 110V. Unique retainer allows front or rear panel mounting. 6" leads. Plastic housing, 1 1/2" long. BIM-B-3.



Circle 324

59¢\*

## Terminal Strip Kit

Low-loss ceramic strips. 2/56 threaded mounts. Can be resoldered thousands of times. Trial kit 2 each of 6 sizes. MEP Series.



6.00 kit

Circle 325

## Remote Control Relay

For safe, shock-free remote control circuit operations. Standard octal base plug-in; clear plastic cover. FRP-104.



Circle 326

5.45\*

## Machined Aluminum Knobs

Matched family of natural aluminum knobs featuring anodized satin finish. Has expensive appearance, but priced like plastics. K-Series. 1/2" dia. 45¢, 1" dia. 55¢ ea.



45¢\*



55¢\*

Circle 327

Immediate Deliveries on Above Items

# ALCO®

ELECTRONIC PRODUCTS, INC.  
Lawrence, Massachusetts 01843

## Meetings

### Broad and not too shallow

This year's Spring Joint Computer Conference will feature an unusually varied program appealing to a broad range of interests. Its semiannual predecessors have tended to be, like the Mississippi River, a mile wide and an inch deep, because they tried to provide something for everybody. On the contrary, this year's organizers have succeeded in putting together a program that, although broad, nevertheless includes several topics of current interest treated in sufficient depth to make the sessions well worth attending.

The conference this year will be held in Atlantic City from May 5 thru 7, late enough so that the weather shouldn't present a serious problem, as it has sometimes in the past.

**Breakthrough.** One of the most surprising topics in the conference program is "Humanities." Although individual papers on topics like textual analysis and computer-composed music have been presented in past conferences, a complete formal session on the humanistic aspects of computer technology is very unusual.

One session will be held on patents and copyrights, a topic of great current importance. Two of the panelists on this session will be Howard Popper and Michael Rackman; they wrote an article [*Electronics*, July 7, 1969, p. 96] presenting the case for patenting software. Their prediction in that article turned out to be pretty close to subsequent developments.

Larry Roberts, of the Advanced Research Projects Agency of the Defense Department, also heads a session in which various aspects of ARPA's currently developing computer network will be discussed. One of Roberts' associates will describe the network's general objectives. And representatives of various contractors and other organizations that are or will be connected into the network will discuss the hardware connection to the network, optimizing the network's cost to a user, network

topology, and protocol between dissimilar computers in the network [*Electronics*, Sept. 30, 1968, p. 131].

Common carriers will come in for their share of attention at SJCC. A panel will discuss various aspects of data transmission, the problems arising from its exploding use, and various solutions for these problems.

**Laws.** One session that doubtless will be extremely interesting and very worthwhile unfortunately carries with it a facetious connotation. Its title is "Lessons of the Sixties," and it's intended to show how the Seventies can profit from these lessons. But the preliminary program mentions Grosch's Law, Parkinson's Law, and Murphy's Law—all of which are rather gruesomely funny, and apply to situations that everyone has encountered.

For the uninitiated, Grosch's Law says, "A computer system's performance is proportional to the square of its cost." Parkinson's Law in computer terms states, "A data base, and its accompanying programs that are required to reside in random-access memory, tend to expand to occupy all available memory capacity." And Murphy's Law is, of course, "If anything can go wrong, it will."

For further information contact American Federation of Information Processing Societies, 210 Summit Ave., Montvale, N.J. 07645

## Telemetry that swings

Dynamic exhibits will be featured at the 1970 National Telemetry Conference to be held at the Los Angeles Hilton Hotel from April 27 through 30. These exhibits will display a variety of live and simulated projects, including instrumented-animal demonstrations, an outpatient telemetry system, actual management of the Pioneer spacecraft from the exhibit floor, and signals from the North Pacific Buoy Experiment.

(Continued on p. 24)



Get sine, square and triangle functions—and positive and negative going pulses, positive and negative going ramps—in the new HP 3310A. And there's more! You'll have these seven functions over a decade of decades—0.0005 Hz to 5 MHz.

All this capability is packed into a package only 7¾" wide, 4½" high, 8" deep! With the 3310A Function Generator performing many of the functions of the pulse generator, ramp

generator, bias box and amplifier on your bench—think about the clutter you eliminate... the instant access you'll have to all these signals.

With the dc offset capability of the 3310A, you can put any of the functions where you want them—easily and without biasing. And, with the choice of high or low level output, you can get clean low level signals without an external attenuator. You get a maximum of 15 V peak-to-peak into 50 Ω—and that's plenty of power to eliminate most needs for external amplification.

Add to this the external frequency control capability which allows you to sweep over a 50 to 1 range or tie the 3310A into a system—the price

of only \$575—solid-state reliability—and you know the HP 3310A is more than a function generator!

Order your HP 3310A today from your nearest HP Sales Office. For full specifications, write to Hewlett-Packard, Palo Alto, California 94304. Europe: 1217 Meyrin-Geneva, Switzerland.

**HEWLETT *hp* PACKARD**  
S I G N A L S O U R C E S

099/9

Circle 23 on reader service card

## This One Is More Than A Function Generator!

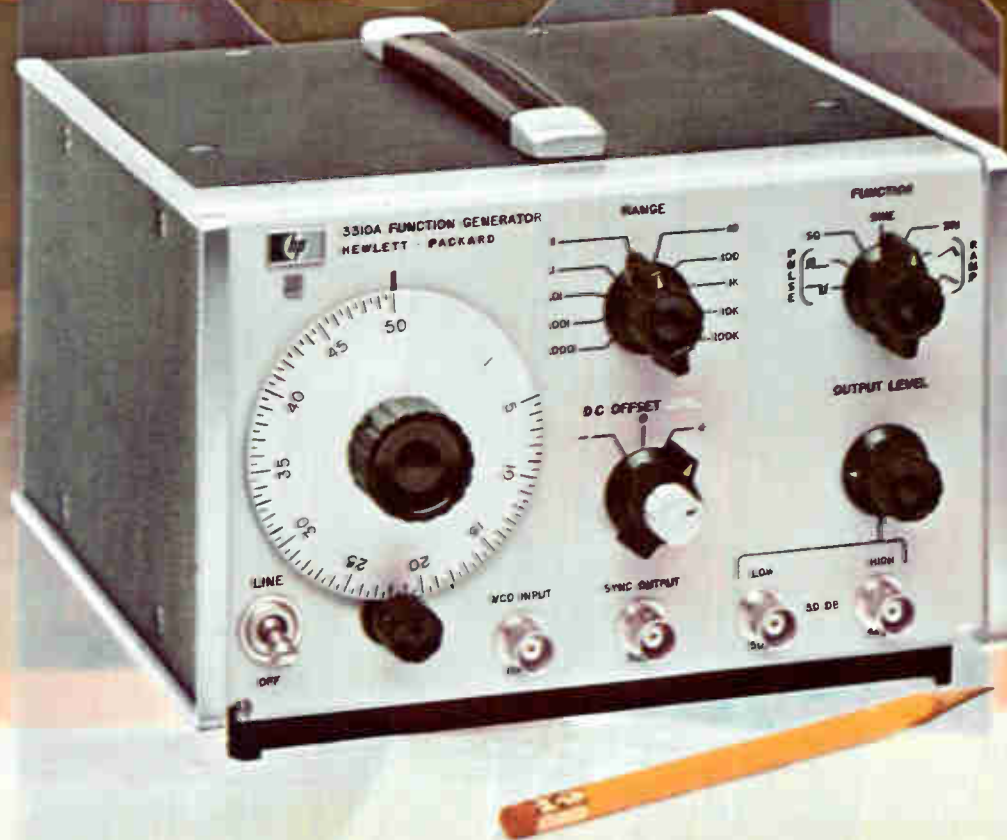

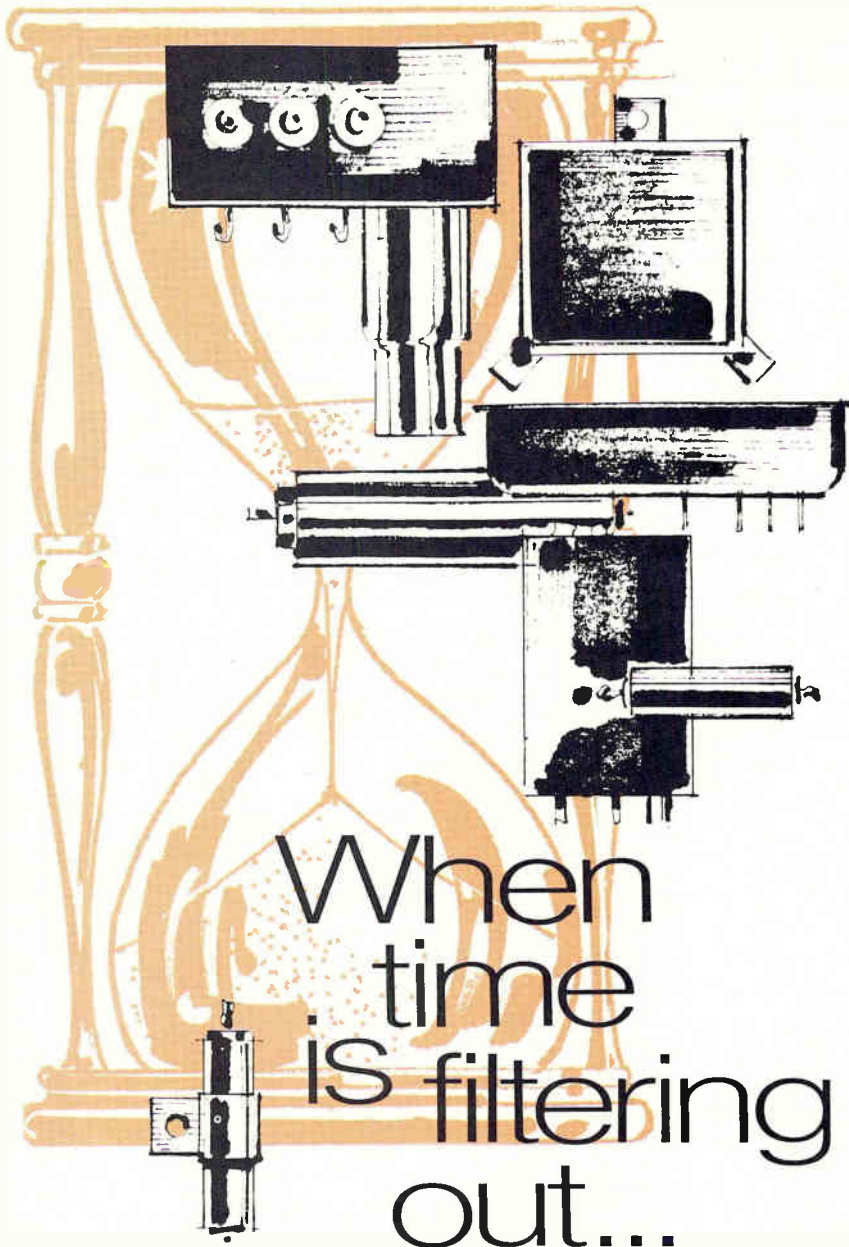

## Captor is quicker

Customers tell us our shipments of standard RFI/EMC filters are the fastest in the industry. Captor responds quickly on custom designs, too, with prompt attention given to problem-solving prototypes. One reason for Captor's time saving capability is a new environmentally controlled plant built expressly for the production of such electronic components as miniature EMC filters, communications and security filters, and custom designed filters and assemblies. One section handles large orders numbering into thousands of units; a separate section provides fast action on prototypes and short runs. Beat the clock . . . write for our capabilities brochure today!

  
**CAPTOR**  
 CORPORATION  
 Electronics Division

5040 Dixie Highway, Tipp City, Ohio 45371, Phone: (513) 667-8484

## Meetings

(Continued from p. 22)

The conference's technical program includes two educational seminars consisting of invited lectures and 12 technical sessions. Among the topics are biomedical telemetry, data-transmission techniques, on-line systems, transportation telemetry, and civil systems.

The invited lectures are to be presented on the first day of the conference in two parts—signal processing and telemetry for urban public systems. Signal processing includes geometry of coding, adaptive equalizer systems, and signal conditioning; while the telemetry section consists of lectures on urban police services, urban fire services, and health care delivery.

**Compact.** The session on data compression is particularly interesting since it examines formats as well as signal systems and methods. Among the papers scheduled are "An Associative Data Acquisition System" by M.D. Johnson and D.C. Gunderson of Honeywell, and "Simulation of Methods for the Redundancy Reduction of the Video Signal" by a group from the University of Milan.

The session on biomedical telemetry is divided into two parts. The first includes papers on temperature telemetry for determining the pyrogenic effects of drugs, remote spectral and discriminatory analysis of electroencephalograms, telemetry implantation in the pleural cavity, and acquisition techniques for physiological data via power lines. The second biomedical session includes topics such as physiological data-telemetry links, implantable biomedical systems, and a multichannel telemetry system for use in exercise physiology.

**Sea signals.** Computer-controlled telemetry and antenna positioning at sea is the lead-off paper in the on-line systems session. It also includes papers on graphical information-management systems, computer systems for the military, and a linguistic approach to telemetry decommutation.

Other papers of interest include the design of a computer-con-

(Continued on p. 26)



## Ball .002" dia., Iteration $\pm 5\%$

TEMPRESS HYDROGEN FLAME-OFF TORCHES FOR LEAD-BONDING MACHINES ARE STAINLESS STEEL, WITH SAPPHIRE ORIFICE INSERTS that maintain size and shape accuracy of the 2166°C hydrogen flame. The highly polished inner surface of the sapphire insert assures this by eliminating gas turbulence and a resultant distortion of the flame. The end result is essentially identical gold balls on every lead, from start to finish of a production run. 14X magnification of operation shows flame-off torch at left, with orifice partially visible. Gold wire, with perfectly formed ball, protrudes from Tempress tungsten

carbide capillary tube, ready for next bonding cycle. This extreme precision symbolizes the Tempress approach to every project . . . explains why it requires 11 months to train an operator for many Tempress production operations. Other Tempress products include automatic scribing machines, diamond scribes, diamond lapping points, and tungsten carbide probe contact needles.

*Lead-bonding, Model DTN-1, at Union Carbide Electronics.*



# TEMPRESS

Tempress Industries, Inc., 980 University Ave., Los Gatos, Calif. 95030

# THE AVAILABLES



## NL-950 Readout Tube available in quantities you need

- also for immediate delivery NL-940  
a direct replacement for the B-5750.
- made in U. S. A. (Geneva, Illinois)

For additional information and application assistance,  
write or call National Electronics, Inc.,  
a varian subsidiary, Geneva, Illinois 60134,  
Phone (312) 232-4300.

**NATIONAL ELECTRONICS, INC.**  
a varian subsidiary

## Meetings

(Continued from p. 24)

trolled, telemetry-data handling system and on-line stored-program decommutation techniques, both in the session on computer-controlled ground-station telemetry systems. A session made up of special topics lists papers dealing with noncoherent laser-modulation formats, effects of channel errors on pcm color image transmission, an experiment with vhf satellite and h-f single sideband communications for collection of data from the ocean, and the Pioneer project from 1965 to 1970.

For further information contact R.W. Sanders, Computer Transmission Corp., 1508 Cotner Ave., Los Angeles, Calif. 90025

## Calendar

**Semiconductor Packaging in the 1970's**, Polytechnic Institute of Brooklyn; Park Sheraton Hotel, New York, April 16-17.

**USNC/URSI-IEEE Spring Meeting**; Statler Hilton Hotel, Washington, April 16-19.

**American Power Conference, IEEE**; Sherman House, Chicago, April 21-23, 1970.

**International Magnetics Conference (Intermag), IEEE**; Statler Hilton Hotel, Washington, April 21-24, 1970.

**Southwestern IEEE Conference & Exhibition**; Memorial Auditorium, Dallas, April 22-24.

**Annual Frequency Control Symposium**, U.S. Army Electronics Command; Shelburne Hotel, Atlantic City, N.J., April 27-29, 1970.

**National Telemetry Conference, IEEE**; Statler Hilton Hotel, Los Angeles, April 27-30, 1970.

**National Relay Conference**, Oklahoma State University and the National Association of Relay Manufacturers; Oklahoma State University, Stillwater, April 28-29, 1970.

**Transducer Conference, IEEE**; National Bureau of Standards, Washington, May 4-6, 1970.

**Aerospace Power Conditioning Specialists Conference, IEEE**; Royal Pines Mo-

(Continued on p. 28)



When you want radar as pure and coherent as a laser beam...

Symbolic electronic signal undistorted by EMI —  
photographed by Howard Sochurek

## bring ERIE in early.

31,000 feet... heavy traffic... ugly weather over the Plains. This isn't the time for "noise" in the radar. But, no sweat! RCA's exciting new AVQ-30X Weather Radar is up front, sweeping the sky... protected from EMI by 39 special ERIE filters. No other airborne radar has ever approached the single or dual system reliability of the AVQ-30. From the start, RCA has called on the outstanding research and component capability of ERIE TECHNOLOGICAL to help in the development of this great new unit. Proof, once again, that it pays to bring ERIE in early.

### ERIE TECHNOLOGICAL PRODUCTS, INC.

644 West 12th Street, Erie, Pennsylvania 16512  
(814) 456-8562

Circle 27 on reader service card

# SENSITIVE MERCURY WETTED CONTACT RELAYS

Ultra-reliable, highest quality Sensitive Relays with mercury wetted contacts are ideal for critical applications, such as digital and analog computers, telecommunication systems, multiplex, industrial control equipment and power control devices. New type MWK (center off—SPST) is ideal for multiple channel switching.

## ELECTRICAL (Type AWCM):

**Contact Arrangements:**  
Form C and D

**Insulation Resistance:**  
1000 Megohms minimum

**Current Rating:**  
Up to 2 amps or 500 VDC

**Contact Resistance:**  
50 milliohms maximum

**Life:**  
1 billion operations

**Contact Bounce:**  
NONE

**Contact Rise Time:**  
10 nano seconds or less

**Operating Speed:**  
To 200 operations/second

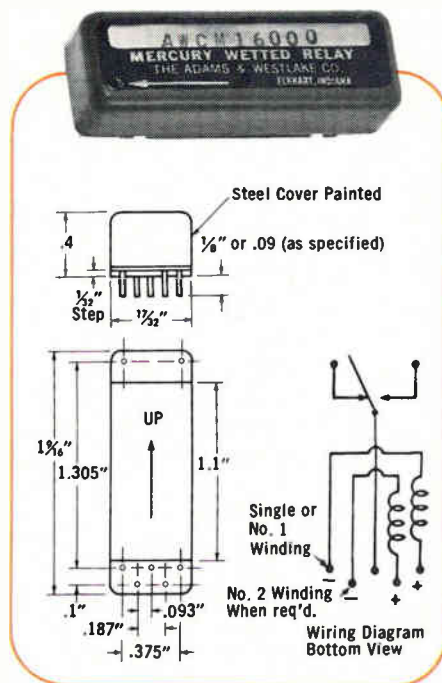

## PACKAGING (Type AWCM):

**Environmental Protection:** Hermetically sealed contacts, potted metal case

**Shielding:** Internal shielding available

**Shock and Vibration:** Withstands all normal handling/transportation effects

**Mounting:** Printed Circuit

Advanced manufacturing methods and stringent quality control procedures assure highest quality. Many types available directly from stock. Engineering and applications assistance available. Surprisingly short delivery schedules.

## MERCURY DISPLACEMENT RELAYS

Time delay and load relays meet the toughest, most demanding switching applications. Non-adjustable time delay relays offer contact forms A and B with delays up to 1/2 hour, current ratings to 15 amps. Load relays switch from 30 to 100 amps with contact forms A and B.

## DRY REED RELAYS

Miniature, intermediate, and standard sizes offer A and B contact forms with from 1 to 4 poles of switching. Typical life is  $20 \times 10^6$  operations (rated load) or  $500 \times 10^6$  operations (dry circuit).

USE READER-SERVICE NUMBER FOR COMPLETE INFORMATION



**THE ADAMS & WESTLAKE COMPANY**

Elkhart, Indiana 46514 • (219) 264-1141 • TWX (219) 522-3102 • TELEX 25-8458 • Cable ADLAKE

SUBSIDIARY OF  
**ALLIED PRODUCTS CORPORATION**

## Meetings

(Continued from p. 26)

tel, NASA, Greenbelt, Md., April 20-21. Industrial and Commercial Power Systems and Electric Space Heating & Air Conditioning Joint Technical Conference, IEEE; Jack Tar Hotel, San Francisco, May 4-7.

**Safety in Research and Development,** National Safety Council and the American Society of Safety Engineers; Cambridge, Mass., May 4-5.

**National Appliance Technical Conference,** IEEE; Leland Motor Hotel, Mansfield, Ohio, May 5-6, 1970.

**Spring Joint Computer Conference,** IEEE; Convention Hall, Atlantic City, N.J., May 5-7.

**Midwest Symposium on Circuit Theory,** IEEE and the University of Minnesota; University of Minnesota, Minneapolis, May 7-8.

**International Microwave Symposium,** IEEE; Newporter Inn, Newport Beach, Calif., May 11-14.

## Short courses

**Recent Advances in Separation Processes,** University of California at Los Angeles; Boelter Hall, May 4-15; \$420 fee.

**Active Filter Design,** George Washington University, Washington D.C., May 11-13; \$215 fee.

**Multivariate Analysis,** University of California at Los Angeles; Boelter Hall, May 14-16; \$245 fee.

**Research and Development,** University of Wisconsin, Department of Engineering, University Extension, May 14-15; \$70 fee

## Call for papers

**International Symposium on Circuit Theory,** IEEE; Sheraton-Biltmore Hotel, Atlanta, Dec. 14-16. June 1 is deadline for submission of abstracts to I.T. Frisch, Network Analysis Corp., Beechwood, Old Tappan Road, Glen Cove, N.Y. 11542.

**Conference on Vehicular Technology,** IEEE; Statler-Hilton Hotel, Washington, Dec. 2-4. June 15 is deadline for submission of papers to Dr. Peter Kelly, Kelly Scientific Corp., 3900 Wisconsin Ave. NW, Washington, D.C. 20016.

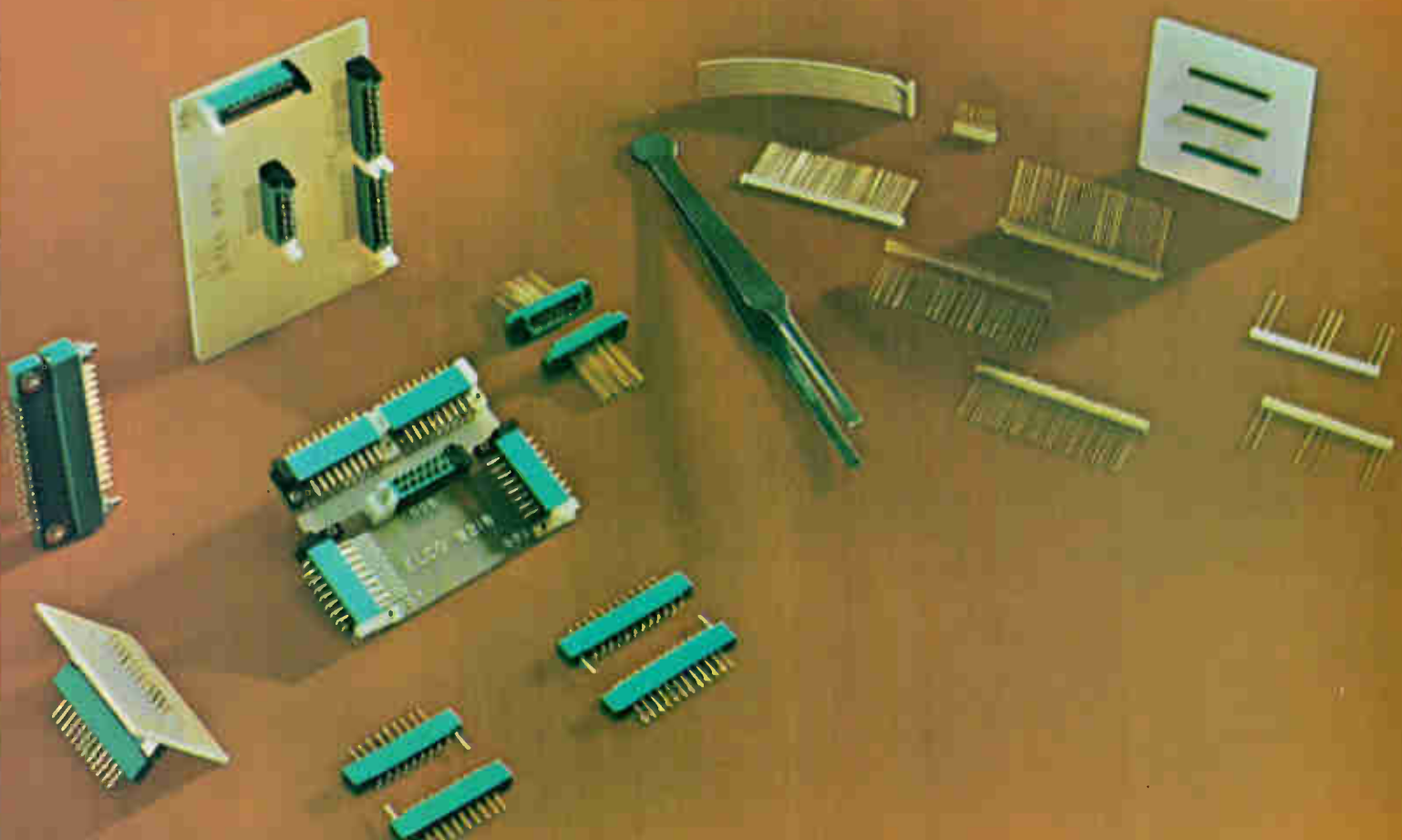

# Miniature, subminiature connectors, yes.

## Miniature, subminiature contacts, no.

Microelectronics can give you a pain in the tweezers. You have to be perfect. And you have to be perfect in places so small that a flea would have trouble scratching his back.

Actually, the electronics part isn't too hard, what with piezoelectric this's and thin-film that's to work with.

But, inevitably, there comes the day when all the this's and that's have to be put together. It's a problem. Mechanically. Electrically.

You don't want to put a big fat plug on a skinny little mini-circuit.

So you need miniature or subminiature connectors. Those we have. By the catalogfull.

But you sure don't need undernourished contacts. You need all the strength you can get, all the contact area you can get, all the hang-togetherness you can get.

Those we give you. Every miniature in our catalog is made with our patented Varicon™ contacts (you probably already know about them). Our newer sub-miniatures are made with Bi/Con™ contacts (which

is sketched at the left).

See the four mating surfaces?

Four mating surfaces, coined so that they're exceptionally hard and smooth.

Four mating surfaces, held together snugly by the spring-like action of the design. And by the innate characteristics of the phosphor-bronze.

Four mating surfaces, strengthened by a reinforcing web.

Four mating surfaces, on a contact that floats in its insulator to make sure that the four mating surfaces mate.

No comparably sized contact can match the Bi/Con's dimensional, electrical, and mechanical characteristics.

And no subminiature contact can match the Bi/Con's incredibly low price, either.

For more information, write, wire, call or TWX us for our Microelectronics catalog.

Elco Corporation, Willow Grove, Pa. 19090.  
(215) 659-7000. TWX 510-665-5573.

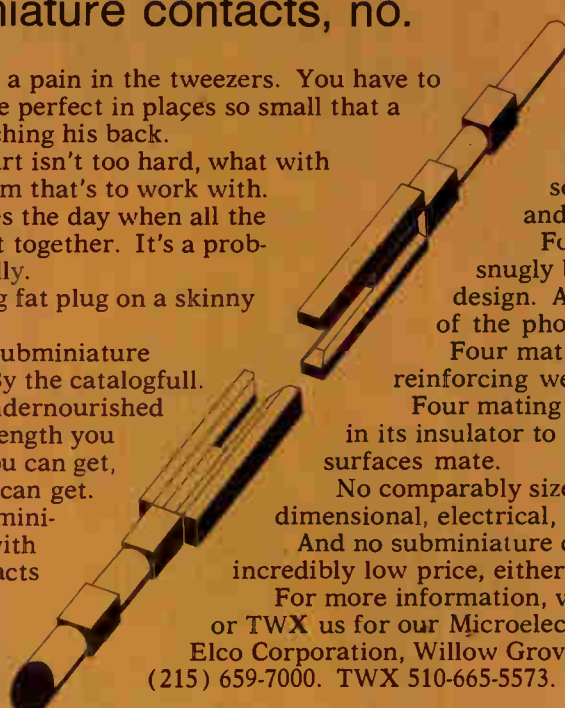

**ELCO** Varicon® miniatures  
Bi/Con® subminiatures

**They could  
be your  
power  
supplies  
coming  
down this  
production  
line**

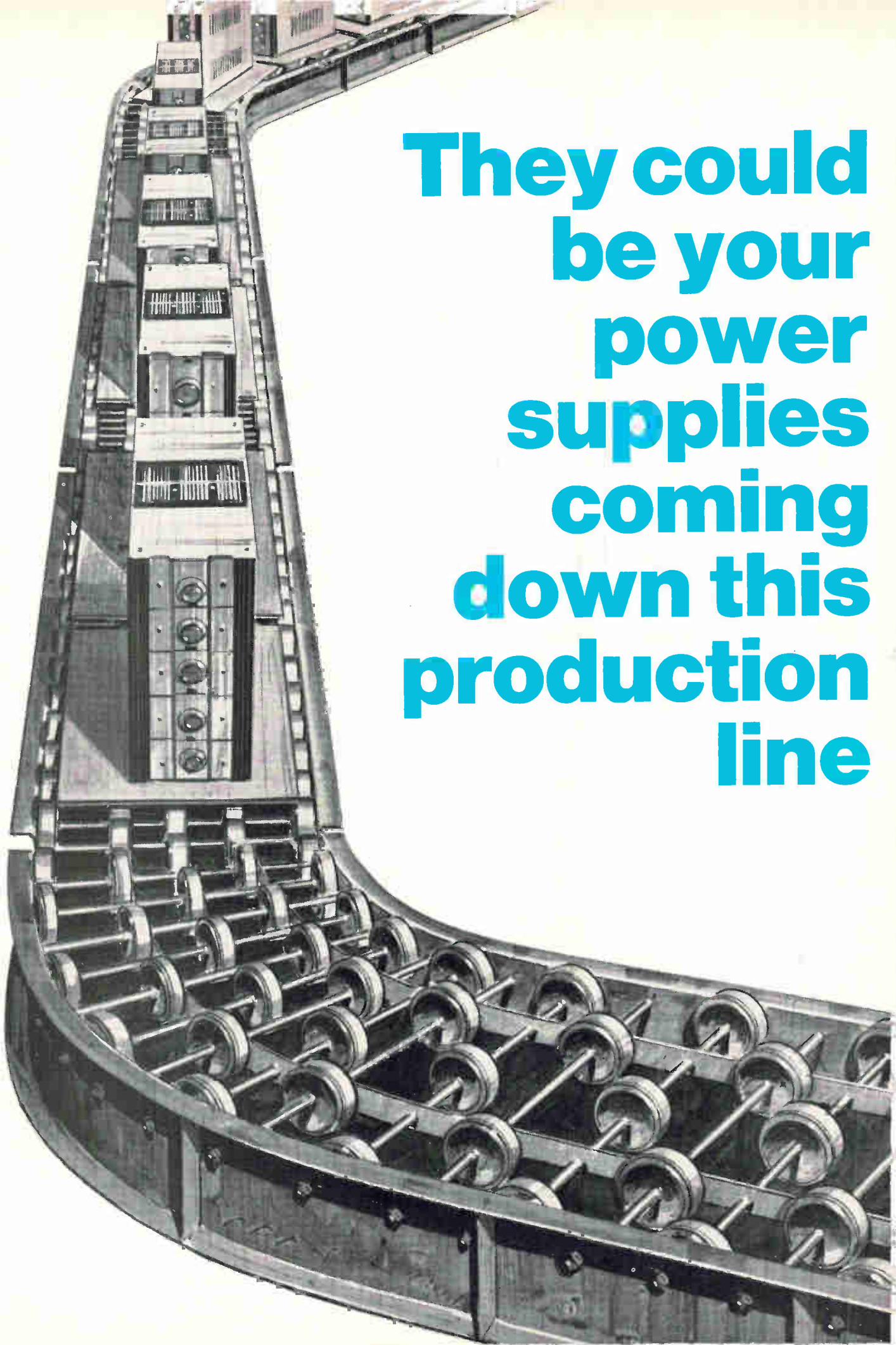



Consider Wagner as the primary source for your power supplies. Nowhere will you find greater capability, or more complete facilities to design and economically produce the power supplies you require, than at Wagner.

Right now, Wagner is a major producer of power supplies for the business machine industry. Production is computerized, with more than 275 bills of material totalling more than 6000 components stored in memory banks ready for production cycling. With the aid of roller-line assembly techniques, production has run as high as 25,000 units a month. And complex units at that.

Wagner capability encompasses a wide variety of products, electrical and electronic. Technologies encompass high voltage and high power, integrated circuitry and high density packaging. Wagner's experience has frequently contributed to design modifications that have reduced costs, improved the product; or both.

If this suggests things we might talk about, write or phone Mr. Richard Vieser, General Manager.

**TUNG-SOL DIVISION**

# **WAGNER ELECTRIC**

**CORPORATION**

630 W. Mt. Pleasant Avenue, Livingston, N.J. 07039  
TWX: 710-994-4865 Phone: (201) 992-1100 (212) 732-5326

Circle 31 on reader service card

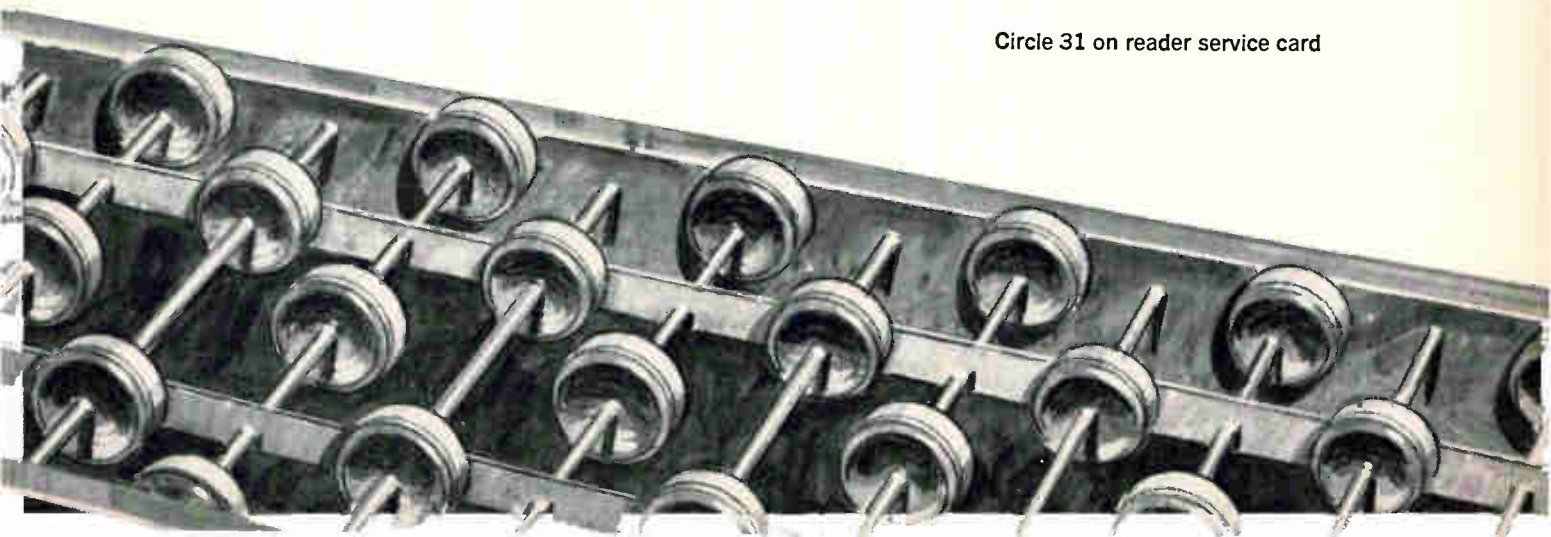

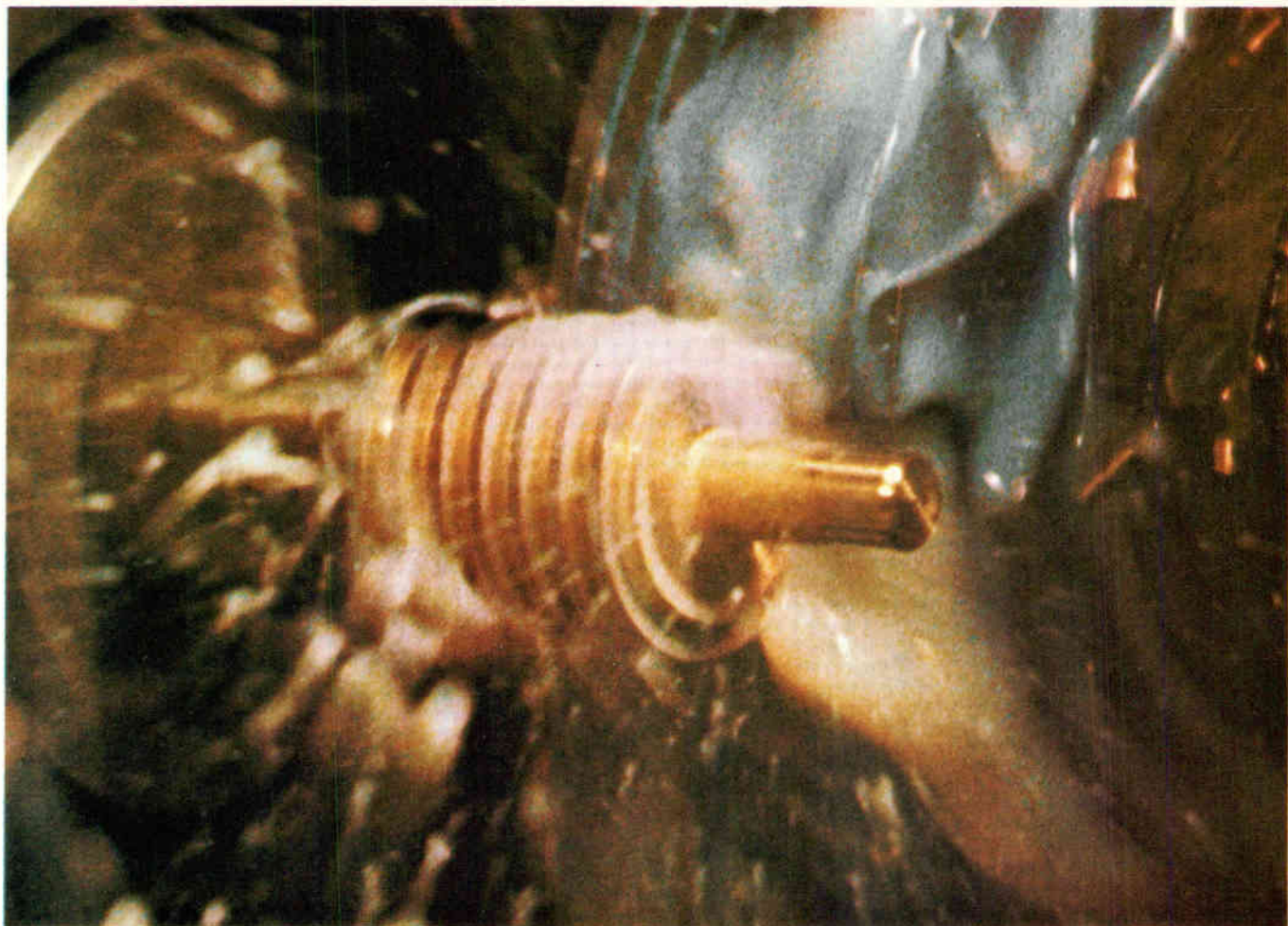

**TYPE: T**

Mtg. Area: 0.1 sq. in.  
 Q: > 2000 @ 150 MHz  
 pF: 1.3-5.4 to 1.9-15.7  
 TC: plus 30 ± 15 ppm/°C

**TYPE: U**

Mtg. Area: 0.2 sq. in.  
 Q: > 2000 @ 150 MHz  
 pF: 1.2-4.2 to 2.4-24.5  
 TC: plus 45 ± 15 ppm/°C

**TYPE: V**

Mtg. Area: 0.3 sq. in.  
 Q: > 2000 @ 150 MHz  
 pF: 1.4-13 to 2.2-34  
 TC: plus 50 ± 20 ppm/°C

## It takes brass to machine capacitors like these.

Johnson precision machines each rotor and stator for these compact capacitors from a single, solid brass extrusion. The benefits are outstanding mechanical stability and electrical uniformity. As a result, you get consistently high performance from every Johnson capacitor. You can rely on them for exceptionally high Q, low temperature coefficients and uniform minimum and maximum values. All at a cost probably lower than what you are now paying.

Return the coupon today for more complete information on the famous Johnson line of machined plate air variable capacitors. Or, perhaps you have a unique need. Our en-

gineers will be glad to work with you. Call (507) 835-2050.

E. F. JOHNSON COMPANY / 3004 Tenth Ave. S.W. / Waseca, Minn. 56093

- Please send new 1970 Capacitor Catalog (702-01)
- Specific interest: \_\_\_\_\_

NAME \_\_\_\_\_ TITLE \_\_\_\_\_

FIRM \_\_\_\_\_

ADDRESS \_\_\_\_\_

CITY \_\_\_\_\_ STATE \_\_\_\_\_ ZIP \_\_\_\_\_



**E. F. JOHNSON COMPANY**

---

# Electronics Newsletter

---

April 13, 1970

## Fairchild returns to innovative road

Now that C. Lester Hogan has just about completed the task of revamping Fairchild's Semiconductor division, and has gotten it back on a reasonable delivery schedule, the industry can once again look for new technologies to emerge from Mountain View. An example: the combination of silicon gate techniques with complementary MOS. The result is a circuit whose speed is compatible with that of transistor-transistor logic devices—10 megahertz—and can be driven by a 1.5-volt battery. One application is in electronic watches, but according to a Fairchild spokesman, "It will be well into 1971 before the first silicon gate C/MOS products appear."

Another new concept is the \$5 microwave source. Fairchild's Microwave and Optoelectronics division has developed a simple, small, and inexpensive microwave cavity that uses a Gunn oscillator for power.

## Sandia develops birefringent ceramic color filter

The Sandia Corp. has developed a material for ceramic filters whose birefringence can be electrically modified to produce light of any color. The new material, a lanthanum-modified lead-zirconate titanate ferroelectric ceramic, is called PLZT from the chemical symbols Pb, La, Zr, and Ti.

A wafer of PLZT appears transparent in ordinary light. But when an electric voltage is placed across it, the wafer rotates the plane of polarization of a beam of polarized white light passing through it by an amount that depends on the voltage and wavelength of incident light. Since white light contains all wavelengths, an analyzer can be rotated to obtain any color in the beam of light emerging from the wafer.

## CAD for filters asks little help

What is termed the most comprehensive computer-aided filter design software yet has just been made available by Applicon Inc. of Burlington, Mass. Called Match, it is a program that appears to leave little to the designer; Match asks only that the engineer supply a ballpark design which can be anything from an active filter to an esoteric microwave filter, plus a desired frequency response specified in terms of phase or amplitude. Match then optimizes the design itself; it is even capable of simulating the effect of aging or temperature changes on filter performance.

Match also has broad analytical capabilities: it calculates  $z$ ,  $y$ ,  $g$ ,  $h$ , and scattering parameters as well as  $a$ ,  $b$ ,  $c$ ,  $d$ , and group delay. The filter's characteristics can be shown afterward in either logarithmic or linear frequency response plots—or, for microwave filters, on normal or expanded Smith charts. The package is to be available through time-sharing service, and requires only a teletypewriter input-output station.

## Networks prepare for satellites

Network broadcasters will soon announce plans to terminate their contracts with the Bell System for more than \$65 million in annual program distribution charges. They plan to switch to satellites; the sales pitch of Joseph V. Charyk, president of Comsat, has particularly impressed them.

However, no final decision will be made by the networks until a

---

# Electronics Newsletter

---

study now under way is completed. The study, being done by Page Communications Engineers, is designed to help the networks decide whether to form their own consortium, hire Comsat, or join some other group—such as cable tv operators.

This action followed a Government recommendation that anyone be allowed to put up a domestic communications satellite [see p. 48].

## Solid state camera in Fairchild's lab

Developmental models of solid state cameras are being built at Fairchild Camera & Instrument in Syosset, N.Y., with light-sensing arrays of either silicon photodiodes or phototransistors. Information is read out through a scanning matrix, similar to the way a computer core memory is read, so that an electron gun and its vacuum are not needed.

Fairchild has built arrays of 100 by 100 sensors on a single silicon chip, but is more interested in developing linear arrays of up to 10,000 or more sensors. Such arrays could be used, for example, as the imaging sensor on an Earth Resources Technology Satellite [*Electronics*, May 12, 1969, p. 98].

Similar solid state image sensors are being worked on at RCA and Westinghouse [*Electronics*, Feb. 17, 1969, p. 54].

## NASA likely to leave APEX behind

Chances appear slim that TRW Systems' APEX gear will be used for the Apollo 13 moonshot. NASA originally purchased the APEX (for amplitude and phase extraction) system because ground simulation tests of color television transmission before Apollo 12 went up showed that voice and telemetry interfered with color signals—all three had to be sent simultaneously by the lunar module's sole transmitter [*Electronics*, Nov. 24, 1969, p. 39]. The word now is that NASA will probably stick with tunable low-pass filters to do the job on Apollo 13 that APEX would have done.

However, there is a good chance APEX will get a workout with Apollo 14, meaning follow-on business for TRW.

## Body's magnetism eyed as research aid

Scientists at MIT hope to learn if the human body's faint, fluctuating magnetic fields can be used in research and diagnosis of illnesses. Using a liquid-helium-cooled magnetic field detector called Squid (for superconducting quantum inference device), and a large chamber capable of shielding away all but about fifty-millionths of the earth's magnetic field, researcher David Cohen first will try to map the fields around the heart and brain; these can range only from a millionth to a billionth of a gauss.

The American Cancer Society is underwriting the brain research. It hopes to detect magnetic field changes due to displacement of healthy tissue by tumors.

## Mostek offers ion implantation

The Mostek Corp. has joined Hughes in offering a line of MOS LSI using ion implantation. Mostek, the Dallas firm formed by former Texas Instruments executives, makes its devices at the North Adams, Mass., plant of Sprague Electric. Mostek has been making p-channel devices since January that are directly compatible with transistor-transistor and diode-transistor logic.

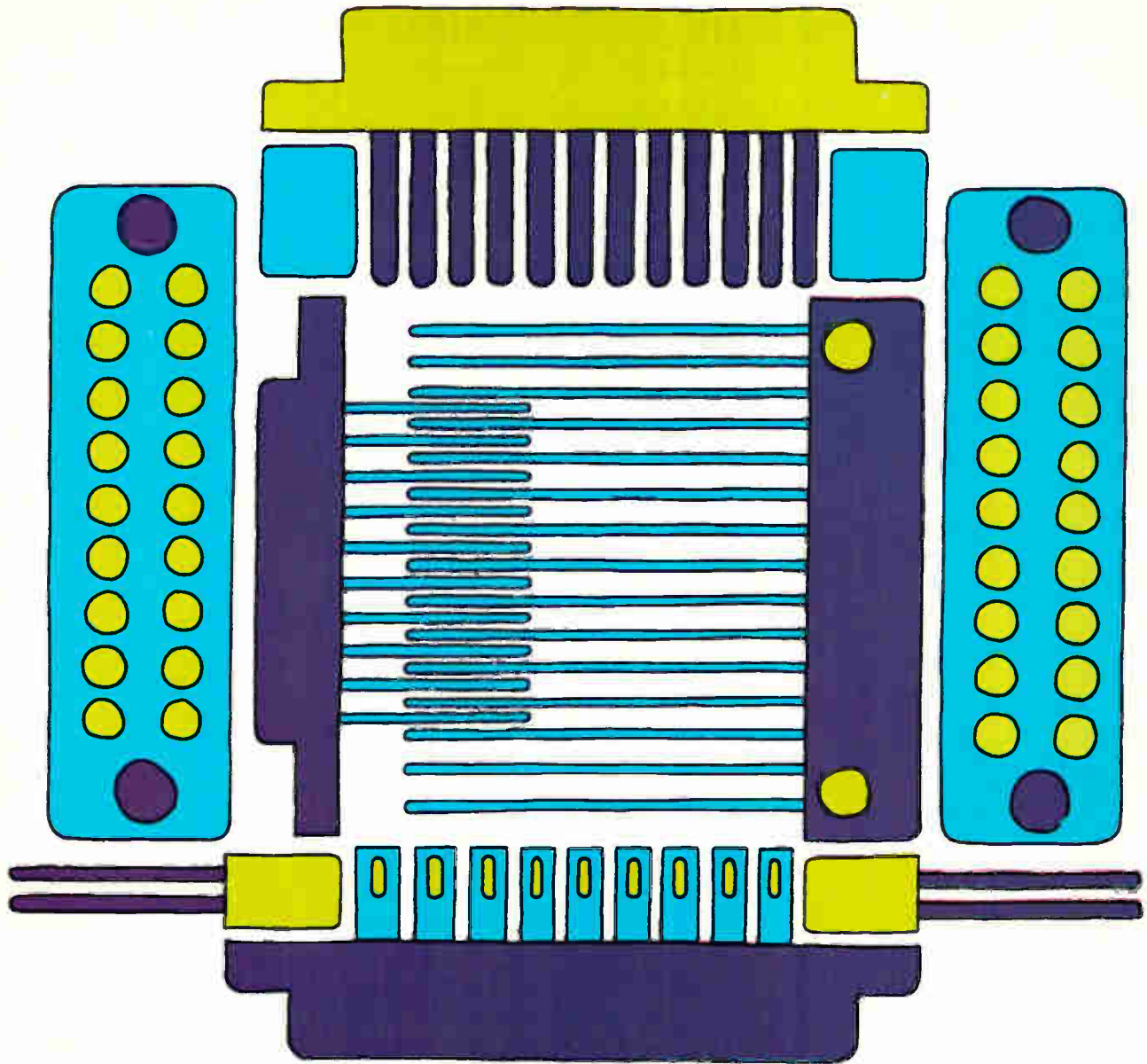

# Winchester Electronics

where in-stock printed circuit connectors are closing today's communications gap.

Typical of Winchester Electronics' capabilities in printed circuit connectors are our lines of card edge and board joiners pin and socket connector. And for even more exacting applications, our military approved HB/HBD series.

Available in single and double row terminations, these connectors not only meet

MIL-C-21097 requirements but exceed them in quality and reliability at an economical price.

So, before you go to the expense of ordering a special printed circuit connector, look into the in-stock selection at Winchester Electronics. Just write Winchester Electronics, Main Street and Hillside Ave., Oakville, Conn. 06779.



**WINCHESTER  
ELECTRONICS**

DIVISION OF LITTON INDUSTRIES





# Measure the others by Our New Digital Multimeter



Unique  
self-check calibration

- .1% basic accuracy
- AC, DC, Ohms
- 100  $\mu$ V resolution
- Auto-Polarity
- Optional Battery Pack

## \$375

**DIGI/EC**®

by UNITED SYSTEMS CORPORATION

918 Woodley Road • Dayton, Ohio 45403 • (513) 254-6251

Request new catalog D69B

Representatives throughout the World

Clean as a hound's tooth ain't clean enough...



If unaggressive cleaners are using more bark than bite on your product, you can be doggone sure of one thing. Product reliability needs

## Branson Ultrasonic Cleaning

Any product that can be placed in a tank can be cleaned or degreased consummately preparatory to plating, painting or finishing by Branson's ultrasonic cleaning systems. Every part of the part, every crevice and cranny is flushed clean by millions of imploding bubbles generated ultrasonically.

For mechanical or cosmetic cleaning to insure product reliability, Branson has a capacity from a quart to a vat full. Come clean. Are you hounded by doubt now? Branson Instruments Co. a subsidiary of Smith Kline & French Laboratories Progress Drive, Stamford, Connecticut 06904

Circle 37 on reader service card

Pin-sized microcircuit  
by Signetics Corp.  
cleaned *absolutely* by  
Branson ultrasonics.

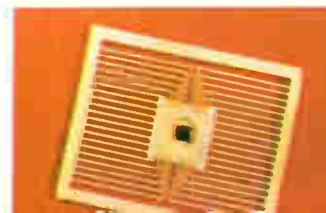

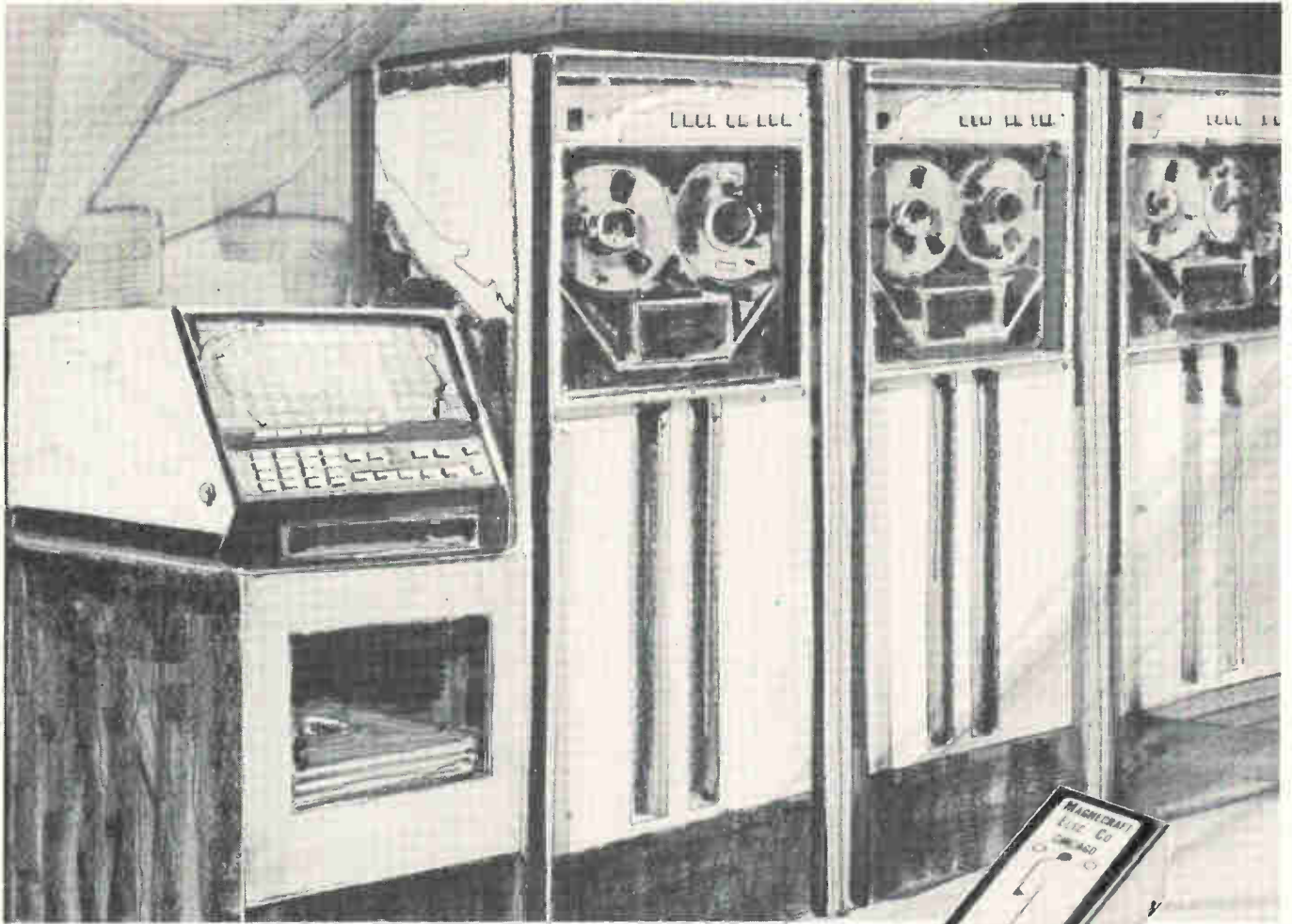

## **NEW! IC COMPATIBLE REED RELAYS**

***Let Magnecraft relays work, while  
your integrated circuits think...***

Our new IC compatible reed relays offer total isolation of the integrated circuit. These relays are capable of switching higher voltages, for example a neon lamp readout, while operating at the low input voltage of the IC, 2.5 volts or 5.0 volts.

Best of all, Magnecraft stocks the IC compatible reed relays for immediate delivery. They're priced right, too—as low as \$1.54 in 1000 quantities and even lower for larger quantities.

Contacts are rated 10 VA at 0.5 amp max. or 100 VDC max. resistive load with a configuration of SPST-NO (1 form A), and 3 VA at 0.25 amp or 28 VDC max. resistive load with a configuration of SPDT (1 form C). Two package designs for mounting are available: in-line axial leads; and low profile printed circuit type.

For all the facts on the new IC relays and Magnecraft's 512 other in-stock relays, send for our new Stock Catalog No. 271.

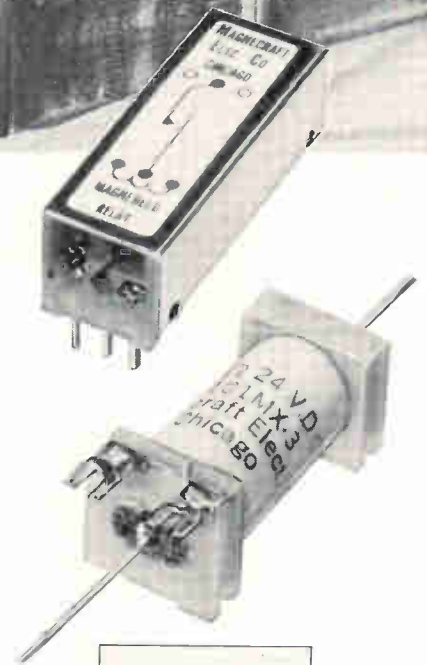

*Manufacturing Stock Relays for Custom Applications*

# **Magnecraft<sup>®</sup> ELECTRIC CO.**

5575 NORTH LYNCH AVENUE • CHICAGO, ILLINOIS 60630 • 312 282-5500



TI's quiet  
revolution in  
volume



## We deliver plastic DTL... more than 100,000 a day.

Get all the Series SN15830N DTL you need...now from TI...at lower costs in the economical, dual-in-line plastic package.

And you can't buy better reliability. We've accumulated 80,000,000 device hours of reliability test data during the four years TI has manufactured the DTL SN15830N series.

Compare the price, compare the

availability, compare the reliability—then give us a call and we'll put you on our delivery route today.

**TI delivers 33 DTL devices, including the tough ones:**

- ✓ all dual flip-flops
- ✓ all single flip-flops
- ✓ one-shot
- ✓ all power/buffer gates

Or if you'd like to do a little more comparing on this proven, broad-choice line in a proven package, get our slide-rule data sheet. Write Texas Instruments Incorporated, P.O. Box 5012, M.S. 308, Dallas, Texas 75222. That's where the quiet revolution is going on. Or call your authorized TI Distributor.



**TEXAS INSTRUMENTS**  
INCORPORATED

# NOW... A NEW AND EXPANDED MANUFACTURING SYSTEM FOR HIGH TECHNOLOGY INDUSTRIES

## ...by Hamilton Precision Metals

• COMPUTER • INSTRUMENT • TELECOMMUNICATION • BUSINESS MACHINE

The Precision Metals Division of Hamilton Watch Company is now geared to meet the requirements of computer, instruments, telecommunication and business machine manufacturers—as well as other high technology industries—with high-quality precision strip, foil and wire processing, precision Photoforming® and parts assembly.

Hamilton's metals technology includes precision rolling of ultrathin strip and foil and wire drawing in pure metals, commercial alloys and proprietary metals with highly specialized properties. This facility also includes heat-treating and annealing to provide the physical or magnetic properties required.

Photoformed parts are produced from the precision-rolled strip and foil in high volume, meeting the most rigid shape and dimensional specifications. Parts are manufactured by modern, high-production equipment in the most advanced chemical etching facility featuring "ultraclean" production conditions.

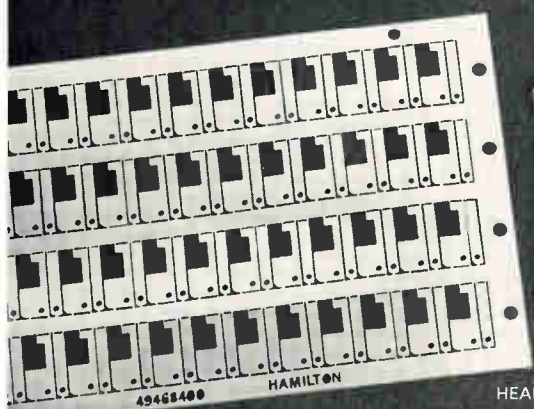
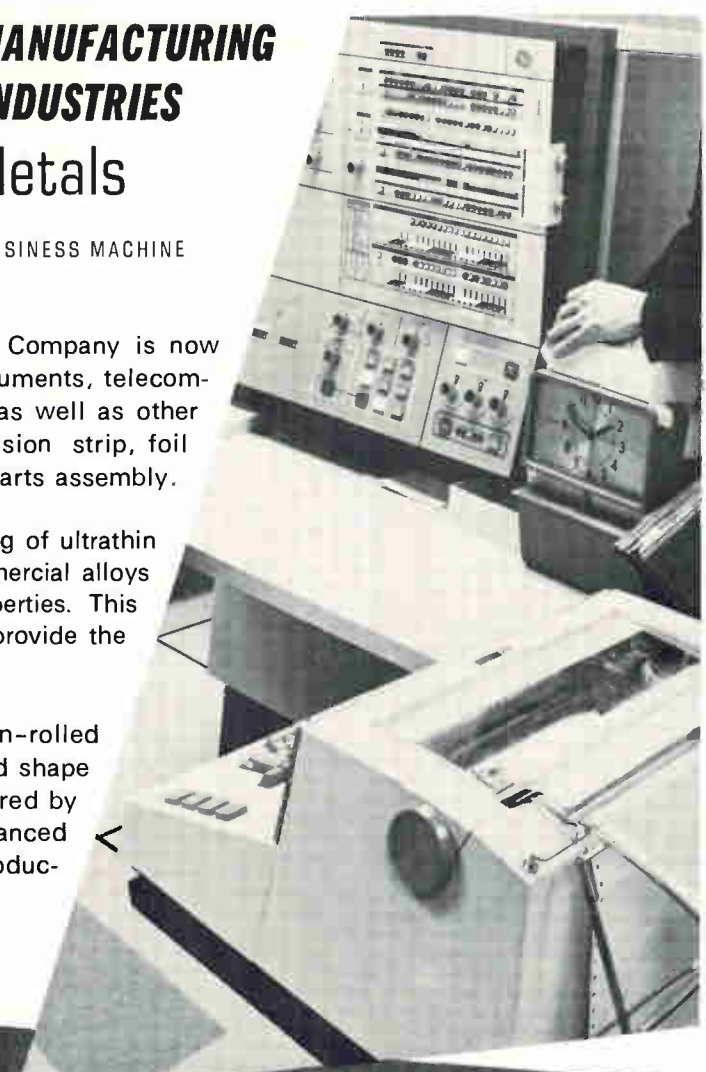

HEAD SPRINGS

TYPICAL COMPUTER PARTS

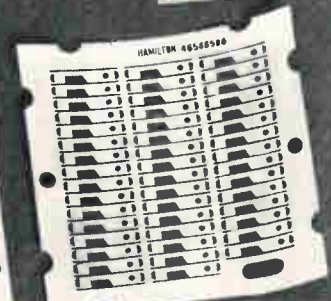

HEAD LAMINATIONS

COMPUTER CIRCUITS

TAPE CLEANER BLADES

SHIELDS

HEAD ALIGNMENT CLIPS

For useful printed data on precision-processed metals, Photoformed parts and assembled components write:

**PRECISION METALS DIVISION**  
**HAMILTON**  
 WATCH COMPANY • LANCASTER, PA. 17604 • PHONE (717) 394-7161

Next time you spec a solenoid, odds are 61,034 to 1 that Guardian can provide the one that will do the job. Because we've got that many standards . . . solenoids in every imaginable shape and size to meet virtually any electro-mechanical requirement. AC or DC. Hefty 50 pound pull or a fraction of an ounce. Intermittent or continuous duty. Pull

or push. Laminated, C-frame, box-frame or tubular. In 25 basic designs and 61 thousand variations. Not enough? Then we'll custom engineer a solenoid to fit your specialized application. (And you didn't know there was a Guardian Angel watching over engineers!) **NEW 44-PAGE GUARDIAN SOLENOID CATALOG** is yours for the asking. Write for Bulletin G-3.



**GUARDIAN® ELECTRIC**

MANUFACTURING COMPANY  
1550 West Carroll Avenue, Chicago, Illinois 60607

***Your Guardian Angel stacks the odds in your favor  
(61,034 to 1)***



# The hunt is on!

(Beware of the Grope.)

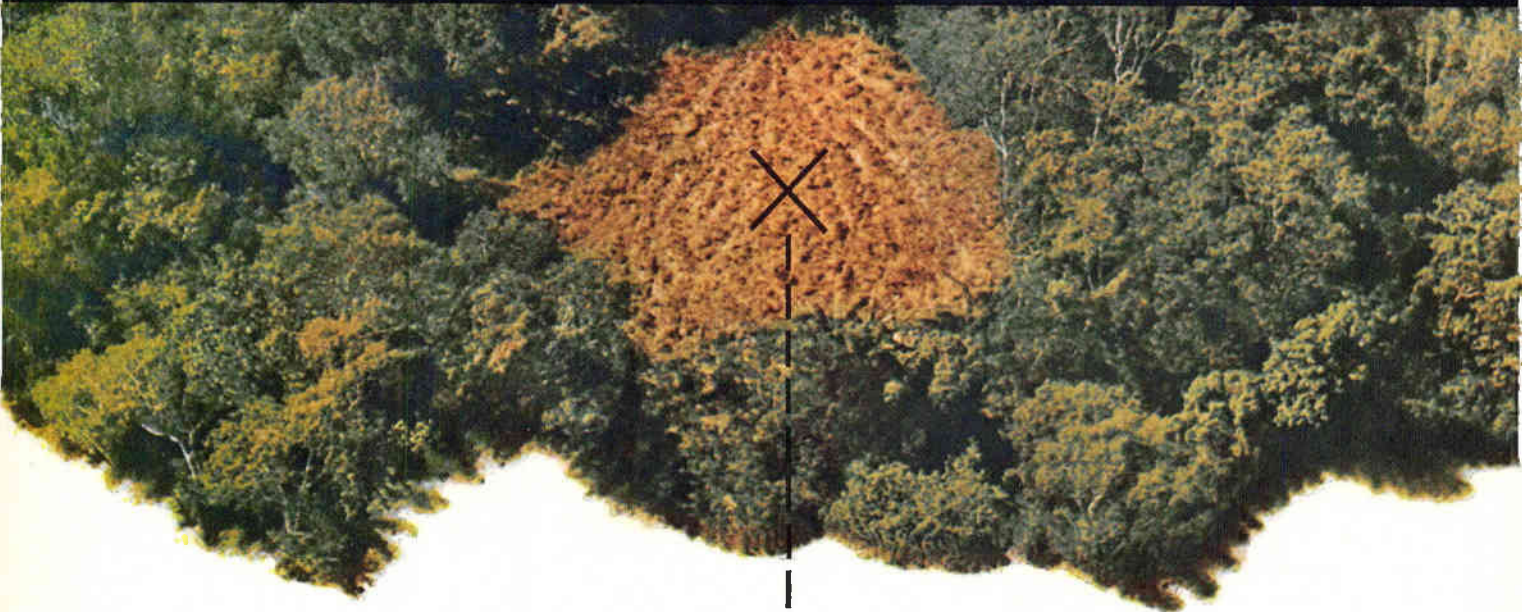

## How to head the hunt away from the Grope. Draw your prospect a map.



The Grope footprint goes in all directions, like you without the Yellow Pages.

That dratted Grope! He preys on people who don't know where to find what they're hunting for . . . turning their

search for you into a jungle hunt! So be prepared. Have your own special map in the Yellow Pages, so the only one that loses out is the Grope. It's easy, and it's the best selling map in town.

Here's your do-it-yourself speed lesson on the Yellow Pages Map Drawing course.

Call your local Yellow Pages representative today and place your Map with him!



## The Yellow Pages

Circle 42 on reader service card

**Emergency Service  
Day or Night**

**BARRY'S HEATING & PLUMBING**

Since **BHP** 1921

**COMMERCIAL,  
INSTITUTIONAL, RESIDENTIAL,  
INSTALLATION & REPAIRS**

Complete line of:

- Kitchens
- Laundries
- Sewage Systems
- Water Pumps
- Heating Systems
- Pipes and Drains

★ References

★ Ample Parking

★ Estimates

★ Delayed Payment Plans

phone **678-0743**

**77 Locust Lane. (Between Main and Central, one mile from RR. Station).**

Tell people what you will do for them. How you're different.

Be under the proper headings so people can find you fast. Maybe you should be under more than one heading. Think about that!

Use your logotype to gain recognition. Give facts about your qualifications.

Tell people about your special services . . . repairs, rentals.

List the products you carry.

Tell how easy it is to deal with you . . . credit, parking, hours, delivery.

Give telephone number and address, and if you're hard to locate, directions.

# Control Full-Wave Power To 6,000 W+ With Rugged, New MAC35 Triacs!

There's only one way to go for compact, economical, stepless control of 60 cycle AC for your demanding industrial/military designs — rugged, new MAC35/36 Triacs!

Rated at a full 25 amperes RMS, this "heavy muscle" series will easily handle 6,000 watts (240 V) and higher in light dimmers, power supplies, heating, A/C and motor controls, welding equipment and power switching systems, to name a few. And provide these important performance advantages:

- symmetrical gating and holding for AC applications
- low, 1.5 V (max) on-state voltage at 35 A
- uniform characteristics through all-diffused junctions
- 225 A peak one-cycle surge current protection
- 4 mA (max) peak blocking current @  $V_{DRM}$

Turn-on time is a scant 1.0  $\mu$ s, too, assuring efficient switching in all applications.

Even when cost is the prime consideration, the MAC35 series ensures optimum balance between price and continuous control performance — prices start as low as \$1.70, 100-up!

If you're now looking at Circuit Applications for the Triac, we have a new application note by the same name we'll send along with complete technical data on the MAC35/36. AN-466 discusses basic theory with control methods and circuit applications — a comprehensive guide to new and better ways to control power in today's thyristor circuits . . . with Triacs!

See your franchised Motorola distributor for stud or pressfit evaluation units now . . . or any of 155 other Motorola standard power thyristors!

Series	Package	$V_{DRM}$ Range V	$I_{T(RMS)}$ A	$I_{er}$ (typ) mA	$I_H$ (typ) mA
MAC35-1 to -7	Pressfit	25 to 500	25	20	10
MAC36-1 to -7	Stud				



*— where the priceless ingredient is care!*

**MOTOROLA**  
Power Thyristors

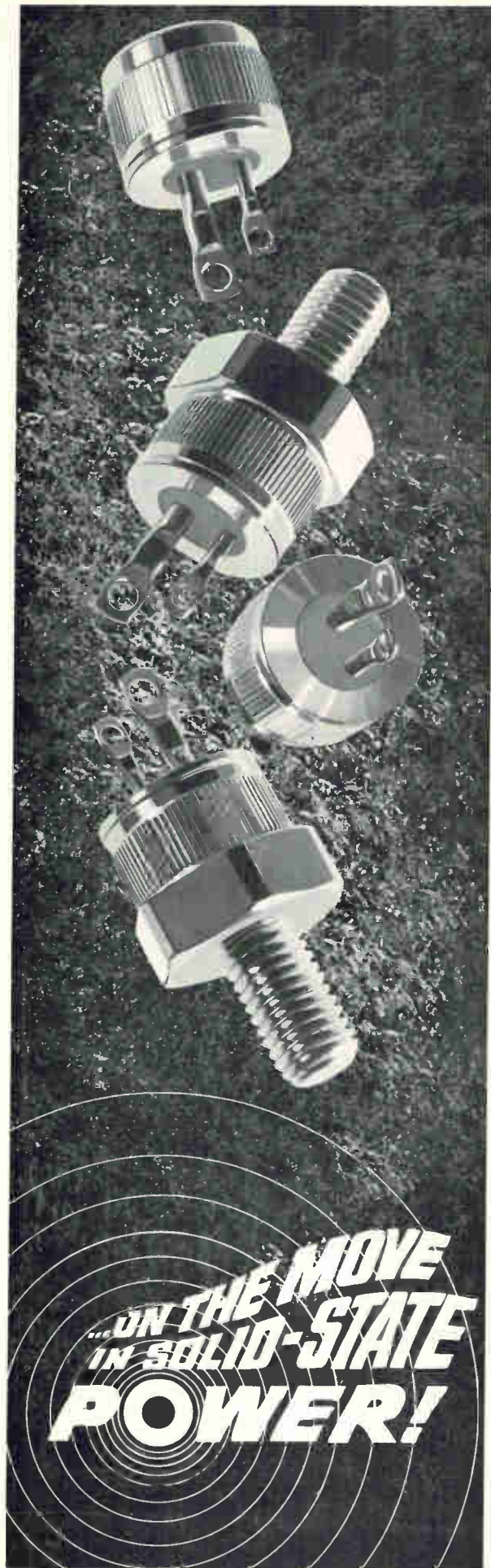

YT19 system cabinet, holds all the equipment shown (except teletypewriter) with room to spare.

CD51 controller-digitizer with programmable gain, controls 1024 channels, 10ns aperture time.

TE33 teletypewriter with paper tape reader and punch. (Includes controller.)

CF16 minicomputer with a 4K x 16-bit memory (expandable to 24K) and four different I/O modes. (Includes software.)

Optionally available: MR50 high-level multiplexer and associated channels (approximately \$2400 extra), if you want to mix high and low level signals. Also 10, 12 or 15-bit D to A converters for closed loop systems, and a variety of other off-the-shelf instruments and options to solve virtually any data acquisition problem.

PE20 peripheral controller for CD51/DM40 combination.

OP50 multiplexer switch card contains 8 switches with screw terminals. Each DM40 accommodates up to 16 such cards. Switch cards with other terminal types also available.

OP59 power supply for up to eight DM40s.

DM40 low-level differential multiplexer accepts up to 128 input signals (optionally expandable to 1024) in the range  $\pm 2.5\text{mV}$  to  $\pm 10\text{V}$  full scale, at a rate up to 20kHz, and with a CMR of 120db at DC.

All instruments and interfaces will be cabinet mounted and functionally tested together prior to delivery. If you're in a hurry, call (213) 679-4511, ext. 3668 or 3391.

**XDS**  
Xerox Data Systems  
El Segundo, California

**The last reason you should buy our data acquisition system is the price: \$21,600.**

# Photochromic glass displays its thing

Corning's computer graphics system eliminates local buffer storage and complex faceplate grid needed by most storage tubes

It's been a half-dozen years since researchers at Corning Glass Works developed a form of photochromic glass that could change color radically and rapidly when properly irradiated, and that was free of fatigue effects when cycled repeatedly through its color changes. Even then, it was the work of but a moment to think of dozens of possible applications. Today, one may buy photochromic eyeglasses that are like regular glasses indoors but become sunglasses when worn outdoors; some new office buildings have photochromic windows.

Now, one of the more sophisticated potential applications of photochromic glass—as a medium for short-term storage—has been realized. Corning has built its 904 computer graphics display system that uses a cathode-ray tube with a photochromic faceplate. This crt can display data traced out just once by a computer, and hold it for 15 minutes without fading or even

for days with the power off, without the complex and expensive faceplate grid in most storage tubes.

**Dark art.** The crt in Corning's new unit is simply a 5-inch tube with a phosphor that radiates ultraviolet light. Placed over it is a 2-by-3-inch faceplate made of photochromic optical fibers and backed by a dichroic film that transmits the ultraviolet light but reflects green or red light. The fiber-optic faceplate, when irradiated by the ultraviolet light from the phosphor, becomes darkened to visible light. It also reduces the dispersion of ultraviolet light, so that the radiation from a spot in the phosphor is funneled directly forward, affecting only one fiber in the plate.

To prevent ambient light from darkening the fibers randomly or bleaching the image too rapidly, the crt is enclosed in the machine. Its image is made visible by a probing beam of green light, whose

wavelength is too long to darken the photochromic glass and too short to bleach it appreciably. This probing beam passes through a beam splitter and through the photochromic faceplate to the dichroic film, which reflects it back to the splitter. On its second encounter the splitter reflects the beam, now carrying the image from the faceplate, to a 9-by-12-inch rear-projection screen on which the image is focused.

A lantern slide carrying reference axes, a map, or other background material can be inserted in the focusing optics of the probing beam to add this material to the projected display, thus relieving the computer of the task of generating it.

**Reflection.** A retractable mirror that can move into the path of the probing beam between the splitter and the projection screen reflects the light into an electrostatic printing unit for a hard copy of the display image.

Eventually, the image on the crt decays by itself. The reason is that the probing beam's effect on the photochromic glass, although minor, isn't zero; also, photochromic glass is subject to thermal bleaching except when it is cooled to cryogenic temperatures. But to destroy the image without waiting for its natural decay, a red light source moves in front of the faceplate, blocking the probing beam, and bleaching the image in a matter of seconds.

Up to 64 lines of 72 characters each can be displayed on the unit; it also can carry plots, diagrams, and the like. However, as with conventional storage tubes, the whole screen must be erased when any part of it is erased. Therefore, it cannot show a dynamic, or moving, display, as can some of the more

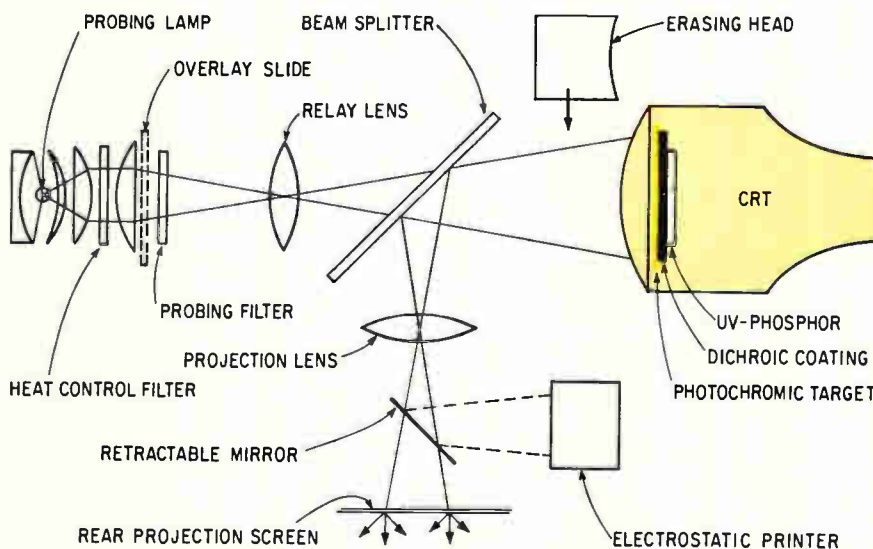

**Preserved in glass.** Conventional crt with ultraviolet phosphor and photochromic faceplate (color) retains information traced out just once. Probing optics project image from faceplate to screen.

## U.S. Reports

sophisticated conventional displays.

The display sells for \$19,650, between low-cost alphanumeric displays and complex dynamic systems.

### Companies

#### Solid (state) move

It's not often that the president of one electronics corporation accepts a vice presidency of another. But in the case of William C. Hittinger, who has resigned as president of General Instrument to become vice president and general manager of the newly formed Solid State division of RCA, the action is understandable.

For Hittinger, who will report directly to RCA chairman Robert W. Sarnoff, the move is a good one. For GI, it's another in a series of losses of key management personnel. And for RCA, hiring Hittinger away from GI and its chairman and chief executive, Moses Shapiro, is something of a coup.

Although the announcement of the formation of a Solid State division was not unexpected—RCA has been obviously moving in this direction for some time now—the news that Hittinger was going to head it took many in the industry by surprise, even though informed sources at RCA say that negotiations to this effect have been going on for more than six months. Hittinger has been at GI only since March 1968.

**Why so long?** What is even more surprising, however, is why RCA took so long to divorce its semiconductor operation from its electron tube work, where the two have been lumped together in the company's Electronics Component division. Few lists of major presences in the semiconductor industry would include RCA anywhere near the top. In fact, insiders say that power transistors are carrying the solid state profit load for the division. And part of the reason for this is that the division's top management, almost to a man, is composed of tube-oriented executives. Appointing Hittinger, and giving him



Hittinger. Might even find himself a company president again.

complete autonomy over semiconductor activities at RCA, is bound to change that situation. His experience at GI and in the Bell Telephone system before that is semiconductor-oriented and should enable him to move the somewhat paralyzed solid state operation at Somerville, N.J.

"And who knows," says one top RCA official, "if Hittinger can turn us around in the solid state field, he might even find himself once again a president, this time at RCA."

### Avionics

#### Payoff for CAS

What happens when a pilot receives conflicting commands from his on-board collision avoidance system (CAS) and a ground-based air traffic control station? The Federal Aviation Administration will try to come up with the answer this summer when it begins several months of simulated CAS-ATC interaction tests at its Atlantic City facility.

Watching closely will be the Air Transport Association, whose final report on 20 months of tests and evaluation of time-frequency CAS

says that the on-board system works. The ATA claims that the tests, using competing CAS prototypes from the McDonnell Douglas Corp., the Bendix Corp., and the Sierra-Wilcox team demonstrated that equipment built in compliance with ATA Air Navigation Traffic Control Report 117 "will prevent collisions in all types of operational situations."

**Timer.** The key component of all CAS hardware is an atomic clock for time-frequency synchronization. ATA says Hewlett-Packard has developed a relatively inexpensive production model that will drop clock unit costs to less than \$10,000 from the \$15,000 to \$17,000 price of the laboratory models used in the tests. Eventually, the ATA believes, the price will come down to about \$2,000.

But an RCA system called Secant-B, say insiders, could upset the whole applecart. Secant-B, for separation control of aircraft by non-synchronous techniques, is being kept under wraps. But it's known that RCA is projecting three versions, with the cheapest costing just \$500. The second would sell for \$10,000 to \$20,000, while the third would cost \$20,000 to \$30,000 and be aimed at airliners and military craft.

The electronics industry should realize a \$50-million-to-\$150-million world market for CAS hardware sales to the air carrier, business, and general aviation markets, according to the ATA. Costs per plane for CAS will range from \$50,000 to \$60,000 for duplicate systems on commercial aircraft to under \$8,000 for the less sophisticated requirements of business and general aviation. The latter market, however, is expected to develop slowly unless costs can be brought down further.

ATA communications manager Frank C. White believes enough production equipment could be ready "for significant implementation" by carriers in the first quarter of 1972. "We've got to go ahead with something that works and stop waiting for something else that might be better in the future," he declares. The modular nature of time-frequency CAS units will permit them to be modified at a latter



April 13, 1970

## Electronics Index of Activity

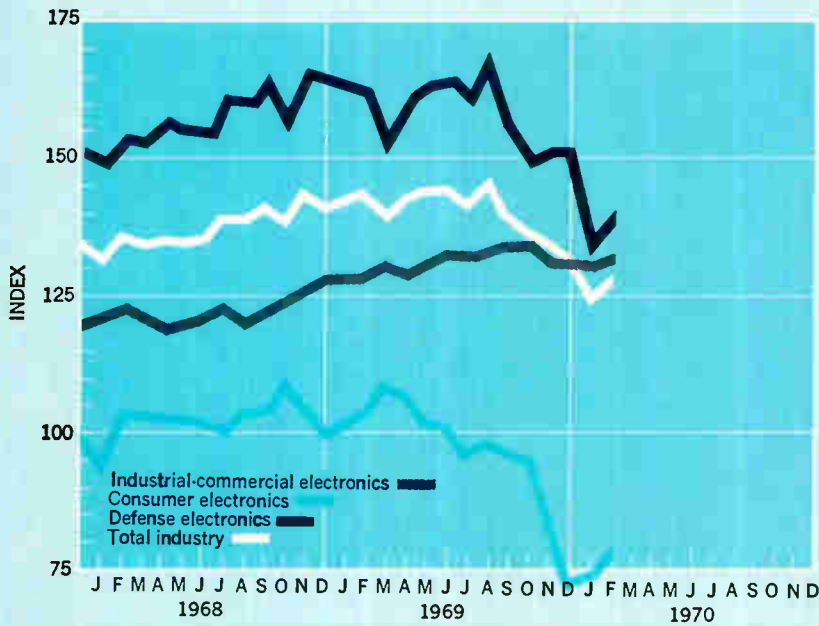

Segment of Industry	Feb. 1970	Jan. 1970*	Feb. 1969
Consumer Electronics	79.5	74.9	105.1
Defense electronics	141.2	136.8	166.5
Industrial-commercial electronics	133.1	131.8	129.1
Total industry	129.0	125.2	145.1

Electronics production in February climbed for the second month in a row after its four-month slide, reaching 129 index points. This was a 3.8-point increase over January's downward revised 125.2, but the index still was 16.1 points under the February 1969 figure.

All the components showed a monthly rise with consumer electronics in the lead. Its increase was 4.6 points to 79.5. The defense sector chalked up a 4.4-point gain to 141.2, while industrial-commercial managed a 1.3-point rise to 133.1.

Indexes chart pace of production volume for total industry and each segment. The base period, equal to 100, is the average of 1965 monthly output for each of the three parts of the industry. Index numbers are expressed as a percentage of the base period. Data is seasonally adjusted. \*Revised.

date for secondary applications such as navigation.

### Communications

#### Land-mobile action

The FCC, now that it has chosen Chicago as the site for its first Regional Spectrum Management Center, will send a data-gathering team to the Windy City as soon as Congress approves the National Spectrum Management Center [*Electronics*, Feb. 16, p. 150].

The first spectrum studies will aim at developing systems engineering and spectrum management procedures for the land-mobile services, later to be applied to other frequency users. If the land-mobile tests are successful—both in engineering and cost effectiveness—centers will be set up in nine or 10 other urban areas within three to

five years after completion of the Chicago test. Priority expansion areas will be New York City and Los Angeles.

**Vortex.** The national center will be in Washington. The capital was considered as the site of the first region but was rejected because "there's not much of a problem" in land-mobile congestion there, says Raymond Spence Jr., the FCC's deputy chief engineer in charge of working out details for the centers [see p. 14].

Initially, the center's work will be concerned with changing the administration of frequency allocation, equalizing channel loading, and increasing interservice and tri-service sharing. It will work on problems in the spectrum space now assigned to land mobile. But should the commission decide that certain parts of the uhf spectrum should be made available for land-mobile use, the center will be responsible for its allocation.

Relieving the land-mobile services from almost critical congestion has been a subject of much talk in Washington for a long time. Now that the FCC has decided to do something about it—pending expected favorable action by Congress on the fiscal 1971 budget—Spence says expectations are running high that the center will provide the services that have long been needed. Of course, he says, the program is "wrought with controversy," but he expects no major problems from user groups. Most of them, he says, are adopting an attitude of "wait-and-see what we [the FCC] propose," before they accept or condemn. "Anything will be okay as long as it can be done without great expense to them," he says.

**Changes possible.** Equipment makers will not be affected by the initial work of the center. But, says Spence, should new land-mobile systems concepts be adopted—such

## U.S. Reports

as in sharing—the result could be different standards for certifying types of equipment. For example, if the police, fire, and other public-safety services were to connect their communications systems together—as they have been encouraged to do, says Spence—they would need multichannel equipment in their mobile units.

The problem in this kind of change would be the expense of the equipment. But more important, the various services are now “very jealous of their frequencies,” says Spence. The national center could “very well act as a catalyst” toward this kind of interservice connection, he says, through procedure, recommendations, persuasion, or, possibly, regulation.

### A 90% decision

The FCC has gone almost all the way in concurring with a White House recommendation that anyone with the money and technology can put up a domestic communications satellite system [*Electronics*, Feb. 2, p. 128]. “They’ve gone 90% of the way,” in the view of one White House staffer, but the suggestion is that 90% is not enough.

What the FCC did not decide is the role that may be played by common carriers like American Telephone & Telegraph Co. in the domestic satellite game. Just prior to the FCC decision, White House special assistant Clay T. Whitehead made clear in informal remarks to the Electronic Industries Association that the Administration would look “unfavorably” upon joint ventures by such giant common carriers as AT&T and the Communications Satellite Corp. But Whitehead noted that joint ventures by satellite users, such as the three U.S. broadcast networks, would be “favored” by the Administration since they would not tend to restrict competition. The competitive aspect emphasized by Whitehead seemed to be directed at the report that AT&T and Comsat were discussing the prospect of a joint effort [*Electronics*, March 2, p. 77].

**No foreclosure.** In its decision, the FCC refused to foreclose what role carriers such as AT&T could play in space communications. Instead, the commission solicited further comments on whether it should follow the White House suggestion and hold hearings on an AT&T proposal; initially confine the carrier to leasing channels from other satellite systems, including Comsat’s; approve an AT&T system limited to public message service; or give AT&T a free hand in the marketplace with everyone else.

At the same time, the FCC is demonstrably reluctant to surrender its prerogatives by approving, as the White House study suggested, domestic satellite applications without hearings. The commission said it does plan technological evaluation of proposals. “I don’t think anyone really expected them to give up that function,” said one industry source. “It would have been too great a step.”

**Next step.** Because it decided to accept rulings for domestic systems while still seeking information before formulating a firm policy, the commission is braced for a flood of proposals. Among those planning to file are the three broadcast networks, which have engaged Page Communications Engineers to study a common broadcast satellite system; The Comsat Corp.; Western Union; the TelePrompTer Corp., a community antenna television company, in a joint effort with Hughes aircraft, which holds a minority interest in the CATV company; and, of course, AT&T.

Joseph Freitag, Applications manager for communication and navigation satellites at TRW, says the firm is avidly interested in building just the satellite, but doesn’t want to get into the long-lines carrier business.

One fallout from military communications systems sure to be applied to domestic satellites is the portable ground terminal. The concept is known to have distinct appeal to tv networks for on-site news broadcasts from remote areas. Several companies have built operating terminals for the military, including Sylvania, Philco-Ford, and

Collins Radio [*Electronics*, Nov. 10, 1969, p. 52].

The sole dissenter from the FCC decision was Commissioner Kenneth Cox, who said he favors development of multipurpose satellite systems, rather than the limited, special-purpose systems contemplated by a number of companies. Cox feels special-purpose systems will lead to “no expansion in the technology” and produce so many proposals that there will be “conflicting requests for orbital slots and frequencies.”

**Crowding.** That possibility was suggested in the FCC’s own notation that it presently sees only 16 orbital “parking spaces” for U.S. satellite use. In addition, the commission said that the presently available 4 to 6 gigahertz bands for domestic satellites raise “some doubt as to whether domestic satellite operations can be fully and economically accommodated.”

Beyond that, the commission also suggested that use of other frequencies be explored at the 1971 International Space Conference. The location of 4 to 6 Ghz ground stations near densely populated areas indicates “there may be a problem of sporadic interference from transmitting earth stations in the 6-Ghz band to terrestrial microwave systems in that band, and from terrestrial stations in the 4-Ghz band to receiving earth stations via anomalous propagation such as interfering signals from common volumes.”

## Government

### Reprieve

NASA will continue to support \$5 million to \$7 million in joint NASA-FAA aeronautical R&D in fiscal 1971 when the Department of Transportation takes over the electronics Research Center in Cambridge, Mass. NASA will drop many of its basic research programs now at ERC, allow about \$4 million in contracts to run out, and transfer its remaining programs to other centers [*Electronics*, Jan. 19, p. 39].

Frank J. Sullivan, director of

# The System Preserver



The largest semiconductor memory in the world will give your system forty times faster access, twice the capacity, and up to ten times the block transfer rate of high speed drums.

Storage can cost you less than a penny a bit for all usable storage . . . no record gaps.

You can achieve one and a half to five times faster throughput.

Its capacity for program storage and block transfer rate will enable you to utilize almost 100% of your processor's capability for the first time.

It will extend the life of your System/360 with no programming changes.

You will realize fourth generation performance.

The largest semiconductor memory in the world is called the SSU. (Semiconductor Storage Unit)

The System Preserver is a life saver if you're I/O bound.

ADVANCED MEMORY SYSTEMS, INC., 1276 HAMMERWOOD AVENUE, SUNNYVALE, CALIF. 94086. PHONE (408) 734-4330



# METALIZED POLYESTER CAPACITORS

ACTUAL SIZE



M2W  
SERIES

ANY SIZE, VALUE,  
VOLTAGE AND  
TOLERANCE

to your exact  
specifications...  
at stock prices

Unique, self-healing units that remain in circuit during voltage surges with little or no loss of electrical properties. Use the M2W's where size and weight are limiting factors and long life and dependability are required. The units utilize metalized Mylar\* Dielectric with film wrap and custom formulated epoxy resin end fill. Available in round and flat styles.

\*Du Pont Trademark for Polyester Film

Samples available on  
your letterhead request



CONDENSER CORPORATION

Dept. EL-4, 1065 W. Addison St.,  
Chicago, Ill. 60613 • 312-327-5440

## U.S. Reports

NASA's electronics and control division, says programs to be continued at the Transportation Department's new Systems and Technology Center will include those in pilot warning indicators, clear-air turbulence detection, collision avoidance, V/STOL integrated electronics, automatic landing systems, and other flight-control, navigation, and guidance systems including those involving satellites. Basic research to be dropped includes efforts in solid state physics, general materials investigation, and advanced design of microelectronic circuits. Most of the contracts in those areas are small—chiefly \$75,000 to \$100,000.

**Moves.** Space shuttle and station technology programs probably will be transferred to the Langley Research Center, the Ames Research Center, and the Houston and Marshall Space Flight Centers. In addition, avionics programs not kept at STC will be sent to Ames and Langley; other communications and component programs will be shifted to the Goddard Space Flight Center and the Jet Propulsion Laboratory.

Secretary of Transportation John A. Volpe says ERC director James C. Elms and a "vast majority" of ERC's employees will be kept at the new center, which will have a budget of about \$20 million for fiscal 1971, plus \$5 million to \$7 million in NASA support for R&D and \$2 million from the Department of Defense. Those figures compare with ERC's budget for research and program management (center salaries and overhead) of \$17.2 million in '69 and \$19.5 million this year, plus its R&D budget (contracts, materials, and equipment) of \$24.2 million and \$18.5 million, for the same years.

Most of the personnel will be retained from what now are the advanced technology and technical programs directorates; employees in the research directorate will be hardest hit. The number of men to be rehired hasn't been pinned down yet, but perhaps about 100 people will not be getting invitations. W. Crawford Dunlap, the present director of research, is said to have been quartering the country in search of jobs for his people with-

### Was it political?

Washington sources prefer to see the transfer of ERC from NASA to the Department of Transportation as a voter-mollifying move. Transportation Secretary John A. Volpe, they point out, is a former Massachusetts Governor who was trying to help his fellow Republican, Governor Francis W. Sargent, get re-elected.

While Bay State observers concede there may be some political side effects, they maintain that Sargent's reelection prospects probably won't be improved. Even at the height of last December's closure crisis, travelers had to direct taxi drivers to the ERC site in Cambridge—most simply never had heard of the installation, and many still haven't. Generally, most Bostonians appear careless of the center's fortunes and of Sargent's efforts in its behalf.

Even those who work at the center aren't going to be swayed much. "If Elms [ERC Director James C. Elms] were running, I'd vote for him," says one staffer who credits the director with saving the center, "but I really don't know what Sargent's efforts were worth in getting DOT in here."

out much success, and the job market in the Boston area is glutted.

**Use of cash.** Although the problem probably will be ironed out before May 15 when the Transportation Department hopes to have its operational plan ready for STC, NASA is concerned about whether its money will be spent for R&D support, or also will be used for salaries and center expenses.

Most of the funds for STC will come from the multimillion-dollar airport, airways, and mass transportation bills, whose passage is almost assured. The FAA's test and evaluation facilities in Oklahoma City and Atlantic City will not be affected by the acquisition of the Cambridge center.

Other planned R&D areas for STC will include sensors to measure and monitor transportation-caused pollution, highway traffic control and urban mass-transport-

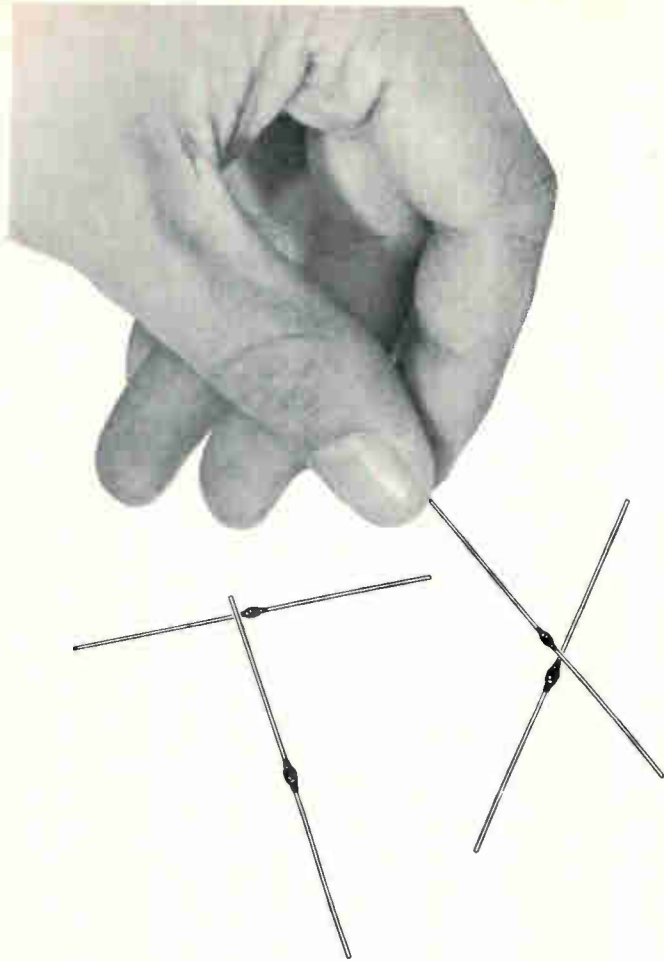

**That bread 'n' butter  
JAN 1N3611  
you've been using all along  
suddenly  
isn't so bread 'n' butter!**

**now available ...  
TX 1N3611  
100% process screened  
by Unitrode**

**the one and only voidless  
monolithic fused-in-glass  
controlled avalanche  
JAN TX 1N3611 Series  
2 amp rectifiers.**

**competitively priced**

**Unitrode also provides TX 100% process screening on JAN 1N4942 Series Fast-Recovery Rectifiers. Also available in stock for off the shelf delivery, JAN 1N4245 Rectifiers, and JAN 1N4956 Zener diodes.**

**Contact the factory, or your local Unitrode representative.**

WHAT'S INSIDE MAKES THE DIFFERENCE . . . THIS IS WHAT'S INSIDE EVERY UNITRODE DIODE

Hard glass fused to all silicon and pin surfaces creates a voidless monolithic structure. Perfect seal against all moisture and contaminants.

Temperature coefficient of glass and pins is matched to silicon. No degradation under severe thermal stress of high transients or repeated temperature shock — even from  $-195^{\circ}\text{C}$  to  $+300^{\circ}\text{C}$ .



Metallurgical bonds of pins to die faces at  $1000^{\circ}\text{C}$  allows extremely high surge capability, low thermal resistance. Virtually indestructible construction.

Controlled avalanche and permanently stable surface leakage characteristics. Hyperclean silicon surface fused only in hard glass. No oxides, silicones, or varnish are used.



Send for our Short-form Catalog C-146 and samples of the 1N3611. The catalog is just loaded with charts, graphs, curves, specs, and all kinds of goodies you'll enjoy.

For fast action, call Dave Greene COLLECT (617) 926-0404.

**UNITRODE**

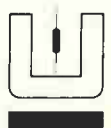

580 Pleasant St., Watertown, Mass. 02172 • (617) 926-0404

# KEPCO'S 2000V OP-AMP

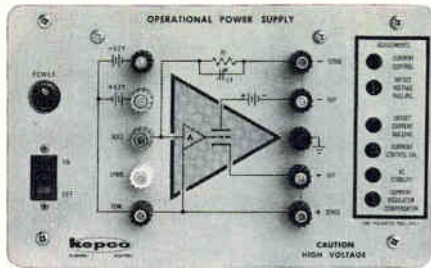

Model OPS 2000 — 0–2000V @ 0–10 mA

The scope photos show the effects of varying the feedback capacitance (adjustable from 100 pF to 1000 pF). The fastest response, of course, is with the 100 pF feedback capacitor, the other values are available to shape the response or to accommodate reactive loads. As the photos dramatically illustrate, the overall response can be varied at will to suit the task.

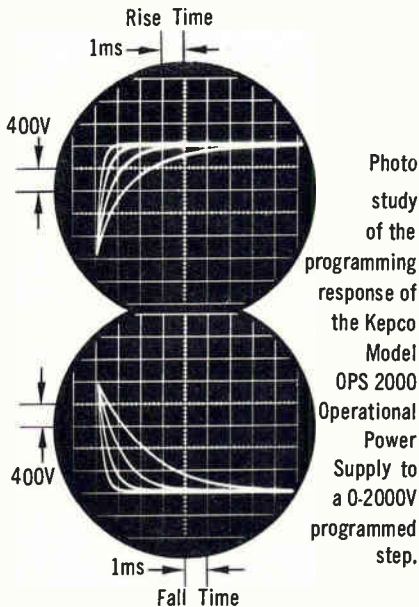

The fastest programming speed or slewing rate for this instrument, measured as the chord of the exponential to its first time constant, is about  $3.7V/\mu\text{sec}$  . . . the spec is  $1V/\mu\text{sec}$ .

Other OPS models cover 0–500V @ 0–40 mA and 0–1000V @ 0–20 mA with equally impressive specifications. Write to Dept. CC-14 we'll send you a nice spec. sheet.

**with KEPCO  
IT'S CONTROL!**

**KEPCO®**

131-38 SANFORD AVE. • FLUSHING, N.Y. 11352  
(212) 461-7000 • TWX # 710-582-2631

## U.S. Reports

tation systems analysis, auto-driver simulation systems in accident causes and prevention, and oceanographic data systems. However, ocean-data buoys will remain with the Coast Guard. DOT's new assistant Secretary for Research and Development, Robert H. Cannon Jr., 46, formerly director of Stanford University's Guidance and Control Laboratory, will supervise the center from Washington.

## Materials

### A case of gas

Hydrogen gas, an oft-overlooked by-product of the operation of storage batteries, has been fingered as the culprit in several electronic equipment failures. The most dramatic case was discovered about a year ago when 100% of the electronics in General Dynamics Convair's North Pacific Buoy failed, according to James Snodgrass of Scripps Institution of Oceanography. The reason: hydrogen from dry cells in the buoy reacted with palladium oxide used in thick-film circuits and formed water plus metallic palladium, which has much lower resistance. In another case, the Army Electronics Command reports that radio receivers blew up when an explosive mixture of air and hydrogen released by magnesium dry cells was accidentally sparked.

Although an explosion like the one the Army encountered hardly could escape notice, Snodgrass is concerned that most engineers are unaware of the chemistry problem posed by hydrogen, and that dry cells, as well as wet cells, produce the gas.

**Cures.** Several years ago, engineers at Autonetics discovered that hydrogen gas from wet-slug tantalum capacitors was contaminating thick-film resistors, particularly low-value units. Their solution was to retrofit with ruthenium- and iridium-based materials insensitive to the hydrogen. They also put hydrogen-absorbing getters in their equipment. Autonetics also found that electrolytic action of certain

metals could give off hydrogen, and so could certain transformer potting compounds.

Snodgrass suspects more "hydrogen-poisoning" cases would be uncovered if engineers knew what to look for. He cites the case of satellite communications receivers designed by Magnavox for the Navy. Over a period of time, there were failures in about a half-dozen receivers. However, engineers looking for the cause, and never having heard of the hydrogen problem, were concerned only with analyzing the active devices. And in getting at them, they destroyed the equipment's thick-film resistors—made with palladium oxide.

"Transistor failures could have been caused by the resistors going down," Snodgrass says, "but we'll never know." Silver-cadmium storage cells in the receivers, used as a backup in the event of a power failure, later were found to generate as much as 0.7 liter of hydrogen per hour. A new model of the receiver soon to be tested has no batteries.

Snodgrass also points out that sealing a battery is not enough. Polyurethane and silicone seal materials are porous to hydrogen gas. Not sealing equipment but providing some ventilation is a good idea, Snodgrass adds.

## Solid state

### Passing works

Integrated circuits are notoriously sensitive to any change in their finely tuned process sequence, so whenever a new device structure is introduced in an IC design, quality assurance men shudder. Even though the IC's may pass the tests at the end of a production line, the new structure may have defects that won't show up until much later.

Thus, one of the charges leveled at Schottky-diode IC's when they were introduced by the Intel Corp. [*Electronics*, July 21, 1969, p. 74] was that they incorporated a device structure that was unproven in IC's and therefore of questionable re-

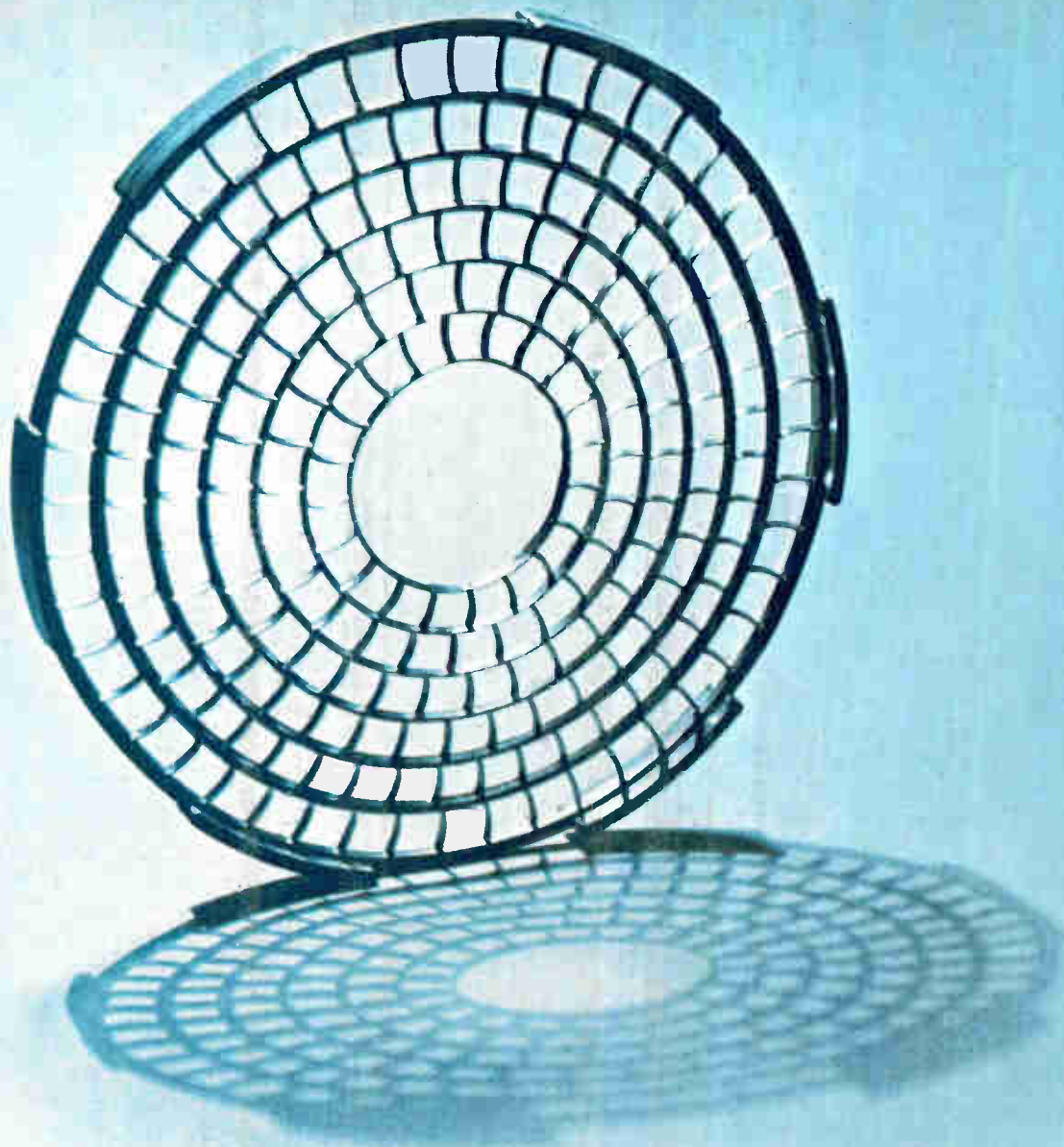

### Battery in the Round

Throughout the Bell System, lead-acid storage batteries provide standby supplies in case commercial power fails. Because these batteries are costly to maintain and replace, Bell Laboratories scientists undertook a thorough study and redesign. The new battery, cylindrical in form, should last for more than 30 years, rather than the present 15, with performance actually improving during most of that time.

Most of the changes are in the positive plates. As in conventional lead-acid batteries, these are lead lattices into which a lead-dioxide "paste" is pressed. But the new plates are round, slightly dished (not rectangular, as at present), and are stacked in a self-supporting structure. This stronger construction allows us to use pure lead which, though soft, is more resistant to destructive corrosion than the usual lead alloys.

But all battery plates do corrode to some extent and this causes the lattices to expand or "grow." In conventional designs, this growth pulls the lattice away from the lead dioxide, causing loss of electrical contact. In the new circular plates, the sizes of the concentric lattice hoops are calculated so that, as growth occurs, the space between hoops remains constant. Thus, contact with the lead dioxide is always maintained. Since, in addition, corrosion produces lead dioxide—the cell's active material—the storage capacity of the cell actually increases with time.

The paste, too, has been improved. In standard batteries, the paste is a mass of tiny rounded particles. These gradually fall away from the plate, reducing its capacity, and sink to the bottom of the cell where they cause short circuits. In the new

design, the particles are elongated, almost fibrous. They interlock with one another and stay in place.

The new battery case is transparent non-flammable PVC (polyvinyl chloride). To seal it, we paint a black PVC solution onto a "dovetail" between case and cover and heat the assembly with infrared. The resulting joint is extremely strong and completely acid-tight.

Last year, Bell Laboratories invited battery makers to consider producing the new design. Western Electric, manufacturing and supply unit of the Bell System, will then buy batteries from them. This will benefit the industry and greatly reduce the Bell System's \$30 million annual outlay for battery maintenance and replacement.

**From the Research  
and Development Unit  
of the Bell System—**



**Bell Labs**

## U.S. Reports

liability. Intel added the Schottky diodes, which consist essentially of an aluminum contact on the silicon IC substrate to speed up circuit response without resorting to gold doping. The company is using the Schottky technique to make fully decoded bipolar 64-bit memories with access time of only 60 nanoseconds.

As companies like Raytheon and Ferranti have gotten into the Schottky-IC act, potential users have become eager for reliability data.

Now, Intel has had time to do reliability studies. The verdict: after 45 million bit-hours of high-temperature life testing (corresponding to 160 million Schottky diode hours) with zero failures, Intel QA engineers R.T. Jenkins and D.J. Fitzgerald conclude that "the use of Al-Si Schottky barrier devices in LSI arrays poses no reliability problems." The engineers revealed their data in a paper at last week's Reliability Physics Symposium.

**Put to it.** Jenkins and Fitzgerald used IC's containing Schottky diodes and discrete Schottky diodes in their study. The devices were subjected to temperature-step stressing, forward-current-step stressing, high-temperature forward- and reverse-bias life testing, storage-life testing, and temperature cycling.

On the discretely, parameters ranging from the forward diode voltage to the equivalent noise current were measured during and after the tests. There were "no significant changes observed for any of the parameters."

The Schottky IC's tested were 64-bit memories designated i-3101. Some (182 units) were tested statically to determine the stability of the IC parameters; others (50 units) were tested dynamically to simulate actual operation. In the static 125°C life tests, half the 227 Schottky diodes were reversed, some zero-biased and the remainder forward-biased. In the 505,000 unit-hours Intel has accumulated so far, no changes in power-supply current or input-load current or increases in leakage current have been detected by the Teradyne

J-259 automatic tester used.

In the dynamic life test, again at 125°C, 12 words of 200 bits each were addressed in sequence. For each sequence, the stored information was read and compared; then the complement of the data was written into the memory and the procedure repeated. So far, no data errors have been observed in more than 3,800 hours of continuous operation at a data rate of 1 megahertz.

## Space electronics

### Material evidence

New experimental concepts are being solicited by three NASA scientists for use with Skylab 2 and subsequent space stations to be launched beginning in 1974 and beyond.

With selection of experiments completed for the first Skylab now scheduled for 1972 launching, NASA says it wants to hear from organizations interested in new, and possibly valuable, methods of materials research leading to new ways of manufacturing for space applications.

Ralph R. Nash, chief of materials science in NASA's Office of Space Science and Applications in Washington, heads the information-seeking trio. With him are J.M. Bredt of the headquarters manned missions staff and Robert E. Lake at Marshall Space Flight Center.

**Crystals.** So far, the chief electronics interest area seems to be the growth of larger and purer single crystals for semiconductors in the high-vacuum, low-temperature condition of space, as well as creation of ceramic and metallic materials with high melting points without the contamination of a container, and making controlled eutectic structures.

It's not a big program—the total effort will be only about \$600,000 in fiscal 1971. "The experiments won't keep anybody in business," say Bredt. But companies like General Electric and Westinghouse and schools like MIT and the Rens-

COMES WITH EVERY  
GE CAPACITOR

## Dependable Distributor Service

General Electric Distributors help you solve the tough ones with capacitors from local stock:

**EAST AND NORTHEAST**  
Cramer/Washington, Inc.  
692 Loftstrand Lane  
Rockville, Maryland 20850  
Tel: 301-424-2700

Gerber Electronics, Inc.  
852 Providence Highway  
Oedham, Mass. 02026  
Tel: 617-329-2400

Rome Electronics, Inc.  
108 Spring St.  
Rome, N. Y. 13440  
Tel: 315-337-5400

Schweber Electronics, Inc.  
Jericho Highway  
Westbury, N. Y. 11591  
Tel: 516-334-7474

5640 Fisher Lane  
Rockville, Maryland 20852  
Tel: 301-427-4977

213 Third Ave.  
Waltham, Mass. 02154  
Tel: 617-891-8484

Semiconductor Specialists, Inc.  
2011 Waverly St.  
Pittsburgh, Pa. 15218  
Tel: 412-351-3611

Standard Electronics, Inc.  
1501 Main St.  
Buffalo, N. Y. 14209  
Tel: 315-883-5006

**SOUTHEAST**  
Cramer/Florida Electronics  
4141 N.E. 6th Ave.  
Ft. Lauderdale, Fla. 33308  
Tel: 305-947-6517

Jackson Electronics Co.  
P.O. Box 19837  
Atlanta, Ga. 30318  
Tel: 404-355-2223

Schweber Electronics, Inc.  
2830 N. 28th Terrace  
Hollywood, Fla. 33020  
Tel: 305-927-0511

Southeastern Radio Supply Company  
414 Hillsboro St.  
Raleigh, N. C. 27603  
Tel: 919-828-2311

**MIDWEST**  
Electronics Marketing Corp.  
814 W. 3rd Ave.  
Columbus, Ohio 43212  
Tel: 614-299-4161

Hamilton Electro Sales  
920 S. Westwood  
Addison, Ill. 60101  
Tel: 312-543-8500

1400 W. 46th Ave.  
Denver, Colorado 80216  
Tel: 303-433-8551

Lew Bonn  
7275 Bush Lake Road  
Edina, Minn. 55435  
Semiconductor Specialists, Inc.  
P.O. Box 66125  
Chicago, Ill. 60666  
Tel: 313-255-0300

25127 W. Six Mile Road  
Redford, Mich. 48240  
Tel: 313-279-1000

**SOUTHWEST**  
Arco Electronics, Inc.  
P.O. Box 34772  
Oallas, Texas 75234  
Tel: 214-239-9123

Hamilton Electro Sales  
P.O. Box 10227  
Oallas, Texas 75207  
Tel: 214-638-0900

1216 W. Clay St.  
Houston, Texas 77019  
Tel: 713-526-4661

1741 N. 28th St.  
Phoenix, Arizona 85009  
Tel: 602-272-2601

**WEST & NORTHWEST**  
Elmar Electronics, Inc.  
2288 Charleston Rd.  
Mt. View, Calif. 94041  
Tel: 415-961-3611

Hamilton Electro Sales  
10912 W. Washington Blvd.  
Culver City, Calif. 90230  
Tel: 213-870-7171

2320 6th Ave.  
Seattle, Wash. 98121  
Tel: 206-442-2011

5567 Kearny Villa Rd.  
San Diego, Calif. 92123  
Tel: 714-279-2421

340 Middlefield Rd.  
Mt. View, Calif. 94041  
Tel: 415-961-7000

Kimball Electronics, Inc.  
350 Pierpont Ave.  
Salt Lake City, Utah 84101  
Tel: 801-328-2075

G. S. Marshall Co.  
9674 Telstar Ave.  
El Monte, Calif. 91731  
Tel: 213-686-1500

Electronic Capacitor & Battery Dept., Irmo, S. C.

**GENERAL ELECTRIC**

430-44





GE 50V .10 ± 10%

COMES WITH EVERY GE  
BLACK HAWK CAPACITOR

# Unique construction

Molded epoxy encapsulation. Precise dimensions. Mounting feet. Welded leads.

That's what makes the GE Black Hawk unique. What does this mean to your printed circuits? You get built-in "damage resistance" to vibration or shock with an epoxy case that also stands up to any soldering iron. You get the best utilization of circuit board space in grouping or single components with precise dimensions in case and lead location. Mounting feet elevate the body of the unit above the circuit board giving Black Hawk capacitors greater stability during dipping. Secure welding of the leads to the extended foils of the roll gives you a low dissipation factor and a firm electrical as well as an exceptionally strong mechanical connection.

The automatically insertable Black Hawk capacitors are available in

Voltage Ratings:	Capacitance Ratings:	Temperature Ratings:
50V, 200V,	.001 uf to 1.0uf (50V)	-55C to +85C (and +125C
400V, 600V	.001 uf to .68uf (600V)	with proper derating)

For further details, call your GE Electronic Distributor or GE ECSSO District Sales Manager, or write Section 43041, General Electric Co., 1 River Road, Schenectady, N. Y. 12305.

Electronic Capacitor & Battery Dept., Irmo, S. C.

GENERAL  ELECTRIC

# It took us years to develop the best stereo microscope.

## Now give us a few minutes to prove it.

Let us compare our StereoStar/zOOM to any stereoscopic microscope in your lab.

Our microscope offers high resolution, larger fields of view, greater working distance. We have as wide a magnification range as you're likely to need: a full 6 to 1 zoom range with magnifications from 3.5 X through 210 X. The zoom control knob is coupled—so that it's conveniently located on both sides, for either left or right-hand operation. And the entire head is easily rotatable through 360°.

135 years of optical excellence went into the AO StereoStar/zOOM. Let us compare it to any stereo microscope in your lab. After all, if it's worth your money, it's worth your time.

Call your AO Representative. Or write for our convincing 24-page brochure.



**AMERICAN OPTICAL  
CORPORATION**

SCIENTIFIC INSTRUMENT DIVISION - BUFFALO, N.Y. 14215



## U.S. Reports

selaer Polytechnic Institute are already involved.

### Military electronics

#### Phasing in

The Air Force raised the curtain on its hush-hush synthetic aperture dual-frequency radar this month—but only about six inches. Sadfrad, as it is known, is a side-looking radar with the unique ability to retrieve phase information from returns, not just amplitude.

Developed at the Air Force Cambridge Research Laboratories in Bedford, Mass., the program is classified for the most part—and its coordinator, Philip Blacksmith, also is a group security officer, so few details are available.

Dual-frequency side-looking radar systems aren't brand new, but the Sadfrad ability to retrieve phase data from targets is. Also apparently ahead of the art is the near-real-time, on-board processing of this data and its display on a color cathode-ray tube as a phase map.

Most side-looking radars today use radar returns to expose photographic film, which is then returned to the ground for processing. Some more sophisticated systems use a broadband telemetry link to the ground to speed reconnaissance, and others do some film processing in the air. But nothing seems to approach the security-shrouded sophistication of Sadfrad.

**Dual threat.** Sadfrad applies what is termed dual harmonic-phase signature technique. This appears to involve transmission of short pulses on two undefined frequencies, one in the low vhf region and the other in the uhf range, and digital processing of the returns.

While frequency hopping, chirp, frequency-agile radar, and other multifrequency schemes have been used for years to defeat countermeasures or improve resolution, little has been said about their ability—depending on frequency—to penetrate foliage or weather, or alternately, to accentuate targets that

# You've heard about hi rel. Solitron announces hi del.

And what is hi-del?

High delivery.

It's no news now when a company promises you high reliability zener diodes.

And it's not unprecedented for a company to produce a whole line of hi rel devices.

Including temperature compensated and glass passivated zeners.

With junctions of such precision geometry and purity of materials that their useful life is virtually infinite.

Solitron isn't the only company who can give you all that.

But we may be the only company who can give you all that *plus* fast delivery.

That's fast *delivery*. Not fast talk.

In 17 days. Less if we've got the units off the shelf.

And what we promise we deliver.

That's hi del. Call us up and we'll explain how it works.

Hi del is going to make life tougher on our competition.

Heck, it's going to make life tougher on *us*.

The only people who will have it easier will be you.

Which is as it should be.

**Solitron** DEVICES, INC.

256 Oak Tree Road, Tappan, N. Y. 10983  
Phone 914-359-5050  
TWX: 710-576-2654  
TELEX: 13-7346





# The Armadillo Connector proudly announces Son of Armadillo.



Some baby.

Our smaller, lighter substructure now comes bundled in real hard-shell protection.

Just like our D Series Connectors. We call them the Armadillo Connectors because we encase them in stainless steel for extra protection against abuse.

Now the little fellows, too, have extra strength to keep them providing the service they were built to provide.

Which is plenty. These W Series

connectors are more fully packed—10 contacts to the inch, without giving up contact size or spacing.

They align and polarize perfectly, with the Hughes PolarHex center jackscrew coupling system. Available in environmental, non-environmental and potting versions.

They come in arrangements to fit your needs, from 14 to 244 size 22 contacts. And they feature crimp snap-in contacts with the

famous Hughes retention mechanism.

You'll find they're more than a happening. They're a Blessed Event.

Write Hughes Aircraft Company,  Connecting Devices, 500 Superior Avenue, Newport Beach, California 92663. Phone (714) 548-0671. TWX 714-642-1353.



If it's happening in connectors, it probably started at Hughes.

## U.S. Reports

would be very faintly visible otherwise.

Returns from Sadfrad's transmissions are run through a digital-computer system and displayed on a further computerized bank of three crt's, one of which uses color.

**Looks like chart.** To the operator, the crt's color display would look like a chart of the ground unrolling continually from the top of the screen. The colors wouldn't bear much resemblance to the real thing, but would be normalized to indicate specific phase signatures. U.S. tanks would have different signatures—and colors—from those of the enemy, for example.

The black and white tubes would show the same area, but without color to aid target discrimination. All three could be stopped momentarily—with their data refreshed from the core of the General Electric display processor—and photographed for later use. Perhaps video tape could be used.

To help spot further detail, the displays from either of the two return frequencies can be combined on one screen.

Spokesmen at Cambridge say that Sadfrad is quasi-operational with flight tests in the offing. Sadfrad's application, like the phase-derivation technique, is classified. But it was originally said to have a tactical mission, perhaps for a southeast Asia operational requirement—and the use of low vhf as one of the frequencies suggests a foliage penetration attempt.

The emphasis on near-real-time speed and target discrimination suggest a reconnaissance system, with the ultrahigh resolution of side-looking systems, perhaps with a fire-control or anti-infiltration mission.

### Advanced technology

### Keep it clean

What can the nation's mapmakers do about controlling environmental pollution? A great deal, to hear them tell it. The U.S. Geological Survey's chief topographer, Robert Lyddan, contends that pollu-

tion of air and water, and environmental decay generally, can begin to be reversed by using satellite-compiled maps showing land usage, geology, hydrology, and related data.

Lyddan's views have some uncommon support. The Defense Intelligence Agency's Col. Lloyd L. Rall, whose principal interest in satellite mapping might be expected to run to ICBM targeting, believes infrared, radar, and thermal sensors have great potential for city planning, real estate assessing, and transportation layouts as well as crop analysis and flood control. "Using this potential," says Rall, "we could analyze and then preplan the disposition of waste and pollution at our facilities as well as police the pollution infringement of the vast Government land holdings."

**Data bank.** Both Lyddan and Rall agree that the first step in this direction should be the creation of a massive, computerized cartographic-data bank to store what Lyddan calls "countless items of information about the surface of the earth so that we can ask and receive a response to almost any conceivable question about the natural and man-made features on that surface." Lyddan sees the data bank as part of a National Cartographic Information Center.

**Urges first step.** Col. Rall, assistant chief of DIA's mapping and charting operation, urges that the American Congress on Surveying and Mapping make an independent beginning by creating "a National Computer Program Library, and for a light fee distribute its lists of holdings to its professional clients and users." As for automating such a storage and retrieval system, Rall says, "We fully recognize the gargantuan task that is involved; but, this we must do, and we must quit just talking about it."

As for automated-storage and retrieval of cartographic data, Rall believes early determination of standards is essential. "Definition of data elements, creation of computer-data codes and formats will provide a framework for a national cooperative effort," he says. "I stress cooperative effort because I

# How did Hughes get a reputation for innovation?

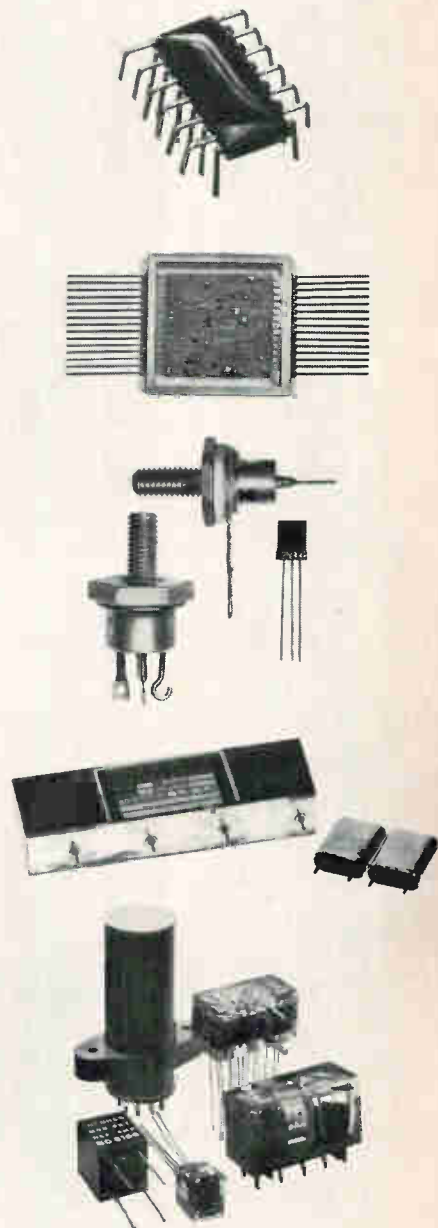

## That's how.

A reputation from technical know-how in developing better MOS devices (RS 283), bipolar and hybrid circuits (RS 284), discrete devices and monolithic circuits (RS 282), frequency control devices (RS 285), and special assemblies (RS 286).

**HUGHES**

HUGHES AIRCRAFT COMPANY  
INDUSTRIAL ELECTRONICS GROUP

Circle appropriate Reader Service (RS) number.

H<sub>(BEEP)</sub>P<sub>(BEEP)</sub>  
will really  
choke on  
our new 1018.

Yep.  
It's the only  
instrument yet  
that measures  
single or multiple  
microwave  
pulses.



Attach our new Model 1018 Log/Lin RF Peak Power Meter to any pulsed microwave system. Instantly you get a digital measurement of single or multiple microwave pulses as short as 350 nanoseconds. Independent



PACIFIC  
MEASUREMENTS

of pulse shape, PRF or pulse width. BCD output is system compatible. Write for a data sheet.

Pacific Measurements, Inc.,  
940 Industrial Avenue,  
Palo Alto, California 94303.  
We gotta be better.

## U.S. Reports

feel it is essential to getting the task under way."

**Replacing the shutter.** For the longer term, Rall sees electronics assuming more and more mapping functions now performed with cameras. Real-time systems, the DIA executive believes, "would not only eliminate unnecessary media such as film, but would also give an instant output indication of the processed data."

The Rall forecast is that "image-sensing array systems which can sense and process the input information on a real-time basis will start to appear toward the end of the decade." Adding memories or buffers to the package could be done where permanent or temporary storage of data is needed.

As lasers gain more ground as survey instruments, Rall suggests "optimum measurements might be done with the carbon-dioxide laser in the far infrared at 10.6 microns." If such a laser used a corner cube prism, instead of a transponder, it could "cut through haze and fog the way a microwave instrument can do it."

Rall sees electro-optic systems pointing precisely at targets while averaging atmospheric scintillation, with angles read automatically by shaft encoders and recorded for direct computer input. For less precise work, he envisions that industry will produce a new family of instruments which will have the principal user appeal—speed, and freedom from a host of critical adjustments.

## For the record

**Growing crowd.** IBM's System 3 has another competitor—the Friden System 10. It joins Hetra [*Electronics*, March 30, p. 33] in the battle for the small-computer market. The major new feature of the Friden machine is its hard-wired operating system. The logic maintains the partitioning of the ferrite-core memory into segments for up to 20 simultaneous users, protects the data in these segments from inadvertent alteration, and schedules the users in 33-microsecond time slots in rotation.

# IMMEDIATE DELIVERY

## PRODUCTION QUANTITIES!

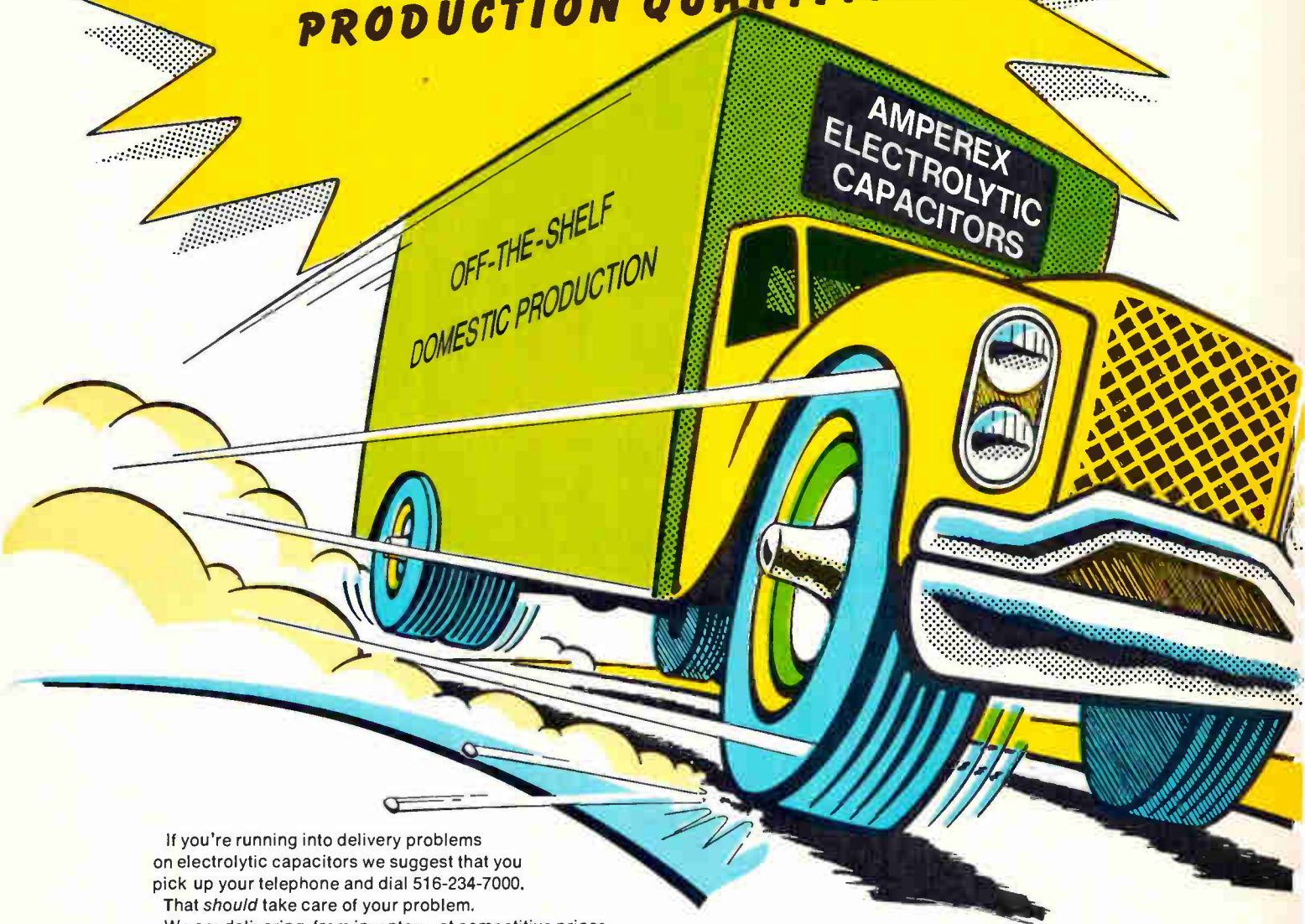

If you're running into delivery problems on electrolytic capacitors we suggest that you pick up your telephone and dial 516-234-7000.

That *should* take care of your problem.

We are delivering, from inventory, at competitive prices, production quantities of top quality axial-lead electrolytics in a wide range of capacitance and voltage ratings. Through the use of ultra-high-purity etched foil and applicable electrolyte... plus an exclusive double-cathode tab construction, we are producing the highest CV-product per can size available today. Sealed in aluminum cans and insulated with the famous 'Amperex blue' polycarbonate sleeves, Amperex dry electrolytics operate efficiently from  $-40^{\circ}\text{C}$  to  $+85^{\circ}\text{C}$ . No other line, domestic or imported, offers the Amperex combination of smaller size, higher performance, lower leakage and higher stability. Capacitance and voltage data for two of the most popularly used items are listed below.

For additional data on the entire Amperex line, write for condensed catalog: Component Division, Amperex Electronic Corporation, Hauppauge, New York 11787.

TYPE C425AR MINIATURE CAPACITORS		TYPE C425BR MINIATURE CAPACITORS	
CV PRODUCT: UP TO 640		CV PRODUCT: UP TO 2000	
CAPACITANCE	VOLTS	CAPACITANCE	VOLTS
8 $\mu\text{f}$ @	4V	400 $\mu\text{f}$ @	4V
125 $\mu\text{f}$ @	4V	320 $\mu\text{f}$ @	6.4V
100 $\mu\text{f}$ @	6.4V	200 $\mu\text{f}$ @	10V
64 $\mu\text{f}$ @	10V	125 $\mu\text{f}$ @	16V
2.5 $\mu\text{f}$ @	16V	80 $\mu\text{f}$ @	25V
16 $\mu\text{f}$ @	16V	50 $\mu\text{f}$ @	40V
40 $\mu\text{f}$ @	16V	32 $\mu\text{f}$ @	64V
1.6 $\mu\text{f}$ @	25V		
10 $\mu\text{f}$ @	25V		
25 $\mu\text{f}$ @	25V		
1 $\mu\text{f}$ @	40V		
6.4 $\mu\text{f}$ @	40V		
16 $\mu\text{f}$ @	40V		
4 $\mu\text{f}$ @	64V		
10 $\mu\text{f}$ @	64V		

# Amperex®

TOMORROW'S THINKING IN TODAY'S PRODUCTS  
A NORTH AMERICAN PHILIPS COMPANY



KBSR1 keyboard switch for logic encoding.

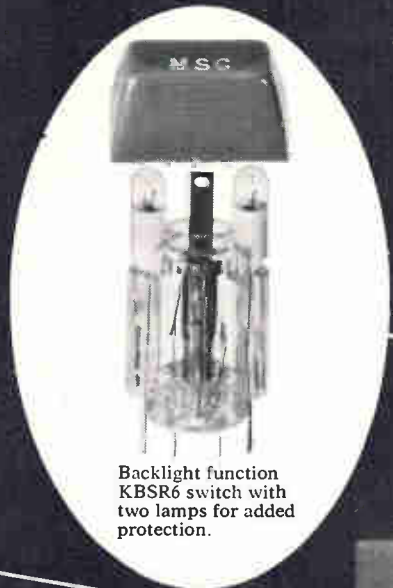

Backlight function KBSR6 switch with two lamps for added protection.



Two-level KBSR2 with double detent action for dual-circuit applications.

# RAYTHEON KEYBOARD SWITCHES:

## high-reliability, low-cost reed types— now available from stock.

Designed for switching at logic levels, these handsome Raytheon keyboard reed switches have a featherlight touch that is precise and reliable. Just a 2½-oz. touch activates the switch. Bounce is less than 250 microseconds. Operation is smooth and quiet in both directions.

**Wide range of special electrical configurations** are available on special order to meet keyboard needs for data entry devices, calculators, data retrieval systems, and many other applications. Unique backlit switches and function lights, with two 25,000-hour lamps and matching cap designs, are also available.

**Two configurations of key caps**—regular square caps, white with black characters, and a truncated design with 2-color molded characters—are available. Standard colors are grey or black with white characters, and white with black characters. All alphanumeric characters are available from stock. Caps with custom-engraving are available on special order.

**Long life expectancy\***. In terms of on-off operations, mean operation to failure is 800,000,000 operations. At a usage rate of one per minute, the indicated MTBF is 19,000,000 hours. At worst case usage rate of one per second, MTBF is 300,000 hours.



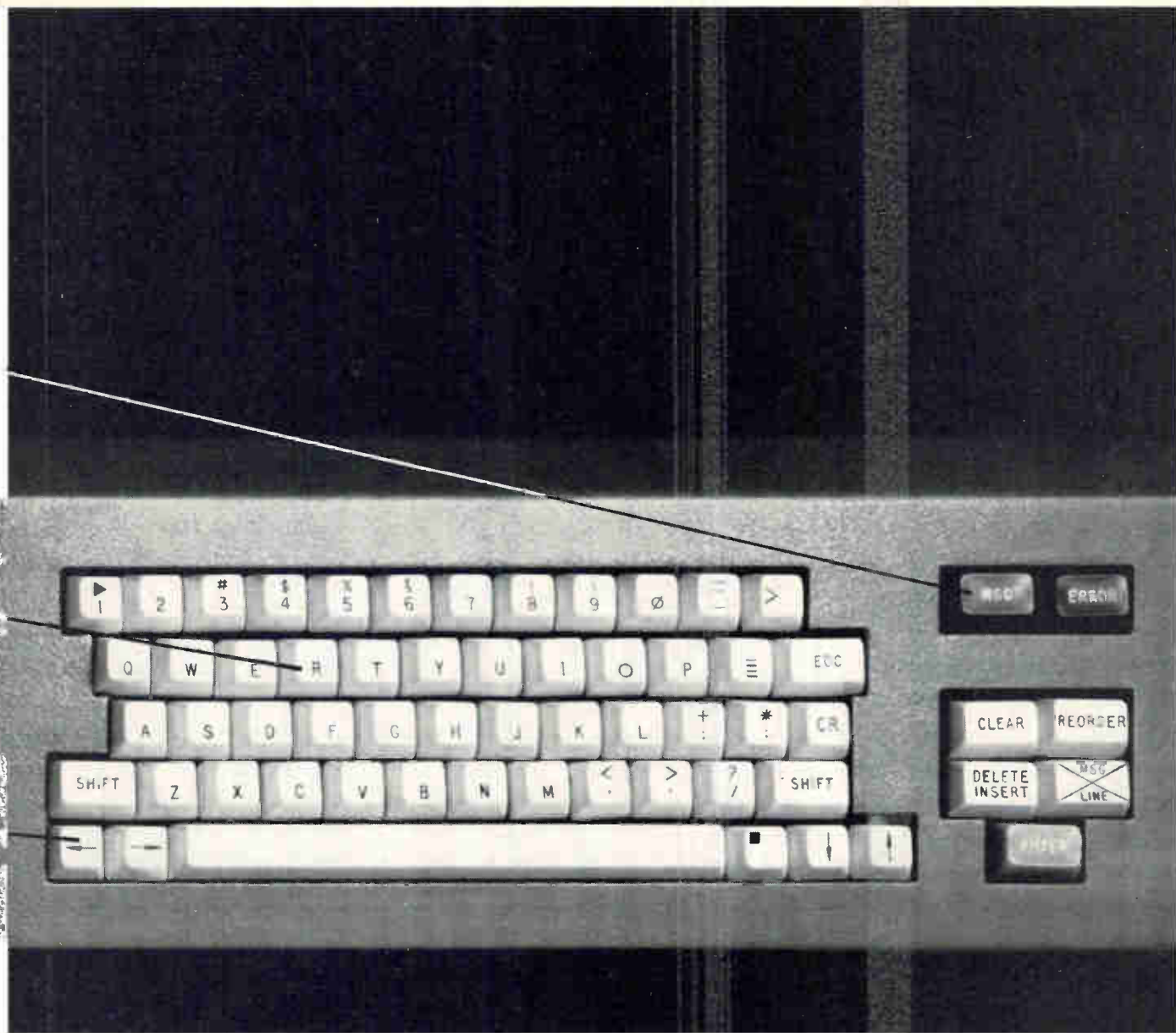

**Highest quality materials used throughout:** stain-resistant caps, polycarbonate see-through cases; stainless steel springs and beryllium copper contact supports. Reed contact material is rhodium-plated for low contact resistance and long life.

**Unique low-cost mounting.** Switches are designed to be plugged into printed circuit boards 1/16" to 1/8" thick. Contact pins snap in and firmly lock in place for flow solder, dip solder, or hand soldering. No wiring or mounting hard-

ware is required. This unique, low-cost mounting significantly reduces installation time and costs.

All switches are available with flat bases or slanted bases with 10° slope.

**Send reader service card for complete information.** For free sample, write on your letterhead—describing your application—to *Raytheon Company, Industrial Components Operation, 465 Centre Street, Quincy, Massachusetts 02169.* \*Established in government-qualified testing laboratory.

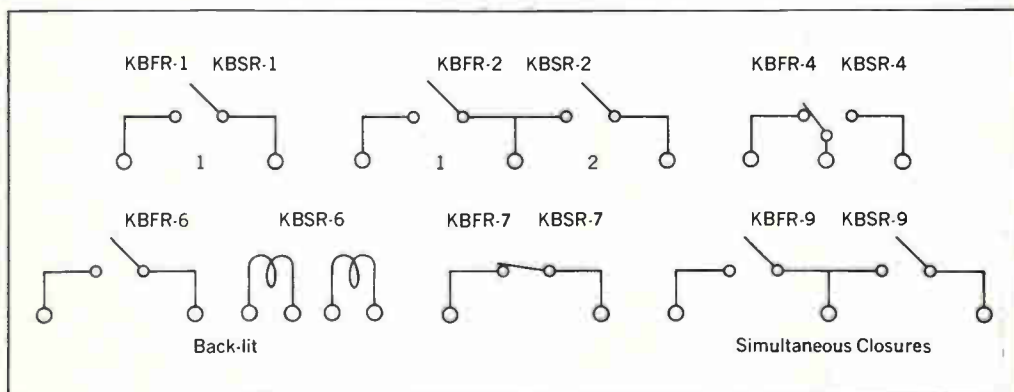



# 1400V, 5.0A Transistors. Delivering now, in quantity.

The Kokomoans' new DTS 802 and 804 NPN triple diffused silicon high energy transistors are here. You can order them from your Delco Radio distributors now in sample or production quantities. They were specially designed for high voltage inductive switching from rectified 3 phase 220 line, and magnetic deflection circuits in large screen color TV receivers.

They've been application-tested from production lots by

prospective users with stringent reliability requirements. They do the job. And their energy handling capability is verified by Delco Pulse Energy Testing.

The high energy reliability of Delco silicon power transistors has earned them a reputation for survival in the toughest switching jobs. It's a built-in advantage, vitally important where circuits are subject to transients or fault conditions.

Now you can simplify the design of high energy circuits with reduced size, weight, and component cost. Convert HV tube circuits to solid state reliability without the complexity associated with high current, low voltage devices. And fewer components mean higher reliability.

For prices and delivery or additional data on Delco's new DTS 802 and 804 contact us or your nearest Delco Radio distributor.

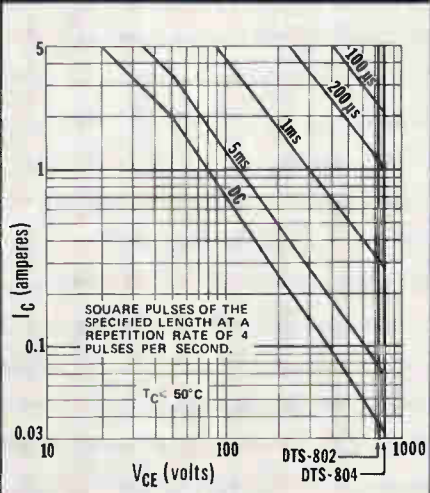

SAFE OPERATING CURVES

PARAMETER	DTS-802	DTS-804
Collector to emitter voltage ( $V_{CEX}$ )	1200V max.	1400V max.
Collector to emitter voltage ( $V_{CEO}$ )	1000V max.	1000V max.
Sustaining voltage ( $V_{CEO\ sus}$ )	750V min.	800V min.
Emitter to base voltage ( $V_{EBO}$ )	5V max.	5V max.
Collector current ( $I_C$ ) continuous	5A max.	5A max.
$h_{FE}$ , $I_C = 3.5A$ , $V_{CE} = 5V$	2.2 min.	2.2 min.
*P.E.T.; $I_C = 7A$ , $V_{CE} = 200V$ , $t_p = 300\ \mu\text{sec}$ , duty cycle $< 4\%$	420 mJ min.	420 mJ min.

**\*Pulse Energy Test**

Available in solid copper JEDEC TO-3 package.

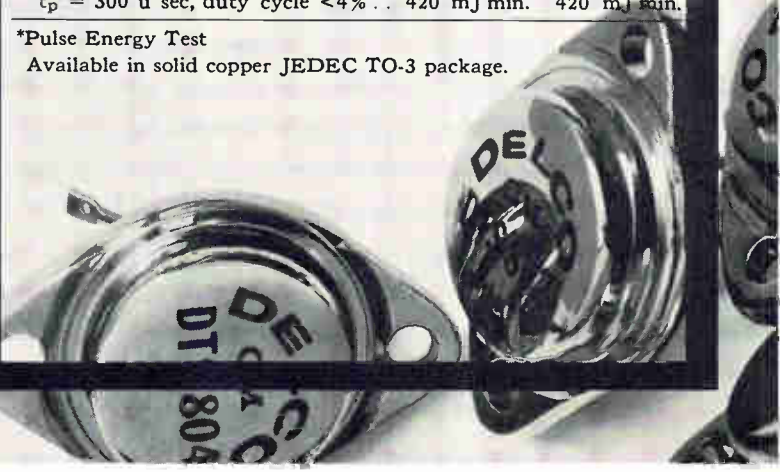

## From these Delco Semiconductor distributors.

- ALA., BIRMINGHAM • Forbes Distributing Co., Inc. (205)-251-4104
- ARIZ., PHOENIX • Sterling Electronics, Inc. (602)-258-4531  
• Hyer/Cramer Electronics, Inc. (602)-263-1112
- CAL., LOS ANGELES • Kierulff Electronics, Inc. (213)-685-5511  
• Radio Products Sales, Inc. (213)-748-1271
- CAL., PALO ALTO • Kierulff Electronics, Inc. (415)-968-6292
- CAL., SAN DIEGO • Milo of California, Inc. (714)-232-8951
- COLO., COLORADO SPRINGS • L. B. Walker Radio Co. (303)-636-1661
- COLO., DENVER • L. B. Walker Radio Co. (303)-935-2406  
• Hyer/Cramer Electronics, Inc. (303)-758-2100
- FLA., MIAMI • Mountain Electronics, Subsidiary of Avnet, Inc., (305)-634-4556
- FLA., WEST PALM BEACH • Mountain Electronics, Subsidiary of Avnet, Inc., (305)-833-5701
- ILL., ROSEMONT • F-J-R/Midwest, Inc. (312)-678-8560
- ILL., SKOKIE • Merquip Electronics, Inc. (312)-282-5400
- IND., INDIANAPOLIS • Graham Electronics Supply, Inc. (317)-634-8486
- MD., BALTIMORE • Radio Electric Service Co. (301)-823-0070
- MASS., NEWTON • The Greene Shaw Co., Inc. (617)-969-8900
- MICH., KALAMAZOO • Electronic Supply Corp. (616)-381-4624
- MICH., ROMULUS (Detroit) • Harvey Radio Co. (313)-729-5500
- MINN., MINNEAPOLIS • Stark Electronics Supply Co. (612)-332-1325
- MO., KANSAS CITY • Walters Radio Supply, Inc. (816)-531-7015
- MO., NO. KANSAS CITY • ECI Semiconductors, Inc. (816)-221-2400
- MO., ST. LOUIS • Electronic Components for Industry Co. (314)-647-5505
- N.J., CLIFTON • Eastern Radio Corporation (201)-471-6600
- N.M., ALBUQUERQUE • Hyer/Cramer Electronics, Inc. (505)-265-5767  
• Sterling Electronics, Inc. (505)-247-2486
- N.Y., BINGHAMTON • Federal Electronics, Inc. (607)-748-8211
- N.Y., NEW YORK • Harvey Radio Co., Inc. (212)-582-2590
- N.Y., WOODBURY, L.I. • Harvey Radio Company, Inc. (516)-921-8700
- OHIO, CINCINNATI • United Radio, Inc. (513)-761-4030
- OHIO, CLEVELAND • The W. M. Pattison Supply Co., Industrial Electronics Division (216)-441-3000
- OHIO, DAYTON • F-J-R/Ohio, Inc. (513)-278-9411
- OKLA., OKLAHOMA CITY • Radio, Inc. (405)-235-1551
- OKLA., TULSA • Radio, Inc. (918)-587-9123
- PENN., PHILADELPHIA • Almo Electronics, Division of Sterling Electronics (215)-676-6000
- PENN., PITTSBURGH • RPC Electronics (412)-782-3770
- S.C., COLUMBIA • Dixie Radio Supply Co., Inc. (803)-253-5333
- TEXAS, DALLAS • Adleta Electronics Company (214)-742-8257
- TEXAS, FORT WORTH • Adleta Electronics Co. (817)-336-7446
- TEXAS, HOUSTON • Harrison Equipment Co., Inc. (713)-224-9131
- UTAH, SALT LAKE CITY • Hyer/Cramer Electronics, Inc. (801)-487-3681
- VA., RICHMOND • Meridian Electronics, Inc., a Sterling Electronics Company (703)-353-6648
- WASH., SEATTLE • Kierulff Electronics, Inc. (206)-763-1550
- WASH., TACOMA • C & G Electronics Co. (206)-272-3181
- CANADA, ONT., SCARBOROUGH • Lake Engineering Co., Ltd. (416)-751-5980

Kokomoan's Regional Headquarters, Union, New Jersey • 07083, Box 1018 Chestnut Station, (201) 687-3770 ■ Santa Monica, Calif. • 90401, 726 Santa Monica Blvd., (213) 870-8807 ■ Chicago, Illinois • 60656, 5151 N. Harlem Avenue, (312) 775-5411 ■ Kokomo, Ind. 46901, 700 E. Firmin, (317) 459-2175 Home Office ■ Office includes field lab and resident engineer for application assistance.

THE KOKOMOANS ARE IN POWER  
**DELCO RADIO**  
DIVISION OF GENERAL MOTORS  
KOKOMO, INDIANA





**From CRT display  
to hardcopy printout.  
In seconds!**

A plotter takes 30 minutes. A dry-silver photographic process makes muddy copies.

But at Adage, Inc. the Gould 4800 Electrostatic Printer puts out clean hard copy in seconds. No wait.

No wonder the 4800 is now a catalogued item for Adage Inc.'s award-winning Graphics Terminal.

The Graphics Terminal is a CRT display computer system with infinite potential for interactive graphics applications in science and engineering. To name a few, cockpit design, mathematical equations and printed circuit cards.

Having the 4800 Electrostatic Printer on line the user can alter his design equation with a light pen and have clean hard copy of any stage within seconds.

Adage officials say their system is further enhanced by the economy of the 4800. It doubles as a printer by putting out both alphanumerics and graphics. It has fewer moving parts to maintain than conventional equipment. And Adage interfaced the

4800 in a matter of days . . . at surprisingly low cost.

**More 4800 facts:**

At 412,000 characters per minute, the Gould 4800 breaks the old printout bottleneck on your computer. It reproduces signals from any source of digital input or data transmission by telemetry, radio microwave and/or land line, quickly, quietly, accurately and economically.

4800 can probably recap the same benefits for your system as it does for Adage's Graphics Terminal. Write us to see. Don't wait. Graphics Division, Gould Inc., 3631 Perkins Avenue, Cleveland, Ohio 44114.

## GOULD CLEVITE

Gould 4800. The next generation of high-speed printers.



See the Gould 4800 at the S.J.C.C.  
Atlantic City—May 5, 6, 7. Booths 49008-49009

# STATION ANTENNA



A new 32 foot diameter design optimized for regional satellite communication systems. Shaped reflector concept achieves 70% efficiency in the receive band 3.7—4.2 GHz, verified by radio star tests. Optional transmit 5.9—6.4 GHz. Hour angle/declination mount for use with synchronous satellites. Precision manufacture of reflector modules insures simple field installation. This antenna is now in production and available. For full details, communicate with Andrew.

1-70

 **ANDREW**

---

# International Newsletter

---

April 13, 1970

## Liquid-crystal display heads for European market

Liquid-crystal display modules may hit the market in France before the end of the year. Prototypes of five-character display plaques turned up on the stand of Thomson-CSF at last week's Paris Components Show. Thomson, France's largest electronics company, expects it can sell the five-character plaques for about \$3.75 once they're in production.

The plaques measure about 2.75 inches long by 0.8 inch high. They operate on voltages between 10 volts and 30 volts and consume about 100 microwatts for each square centimeter of "illuminated" area. This works out to an average of 0.5  $\mu$ w for each element illuminated to make up a character. Each character area has 16 elements to handle the 26 letters and 10 digits; but on the average, only six elements need be energized for a character.

Thomson's liquid crystals are much like those of RCA. Britain's Marconi Co. is also working on liquid-crystal displays. Like Thomson and RCA, Marconi has developed liquids that turn from transparent to white opaque when a voltage is applied. But, rather than small alpha-numeric readouts, Marconi is aiming at overlays for radar displays in sizes from 4 inches square up to about 8 inches square. Marconi also has in the works a liquid-crystal blend that changes color from green to blue when charged.

## West German firms land \$75 million space contracts ...

As if any further evidence were needed that West Germany has become a major international technological competitor, two West German aerospace companies have just landed nearly \$75 million in space vehicle contracts. The larger of the two contracts, valued at about \$55 million goes to Messerschmidt-Boelkow-Blohm GmbH as prime contractor for designing and developing the German-American Helios sun probes.

The other contract, worth between \$17 million and \$19 million, goes to Dornier GmbH for an upper-atmosphere research satellite. Dornier's research satellite, called Aeros, is scheduled for a mid-1972 launch at NASA's Western Test Range in California, using a four-stage Scout carrier rocket. It will perform upper-atmosphere measurements over a period of at least six months. The satellite's initial apogee and perigee will be 620 and 1,460 miles. An electromagnetically active attitude control system, as well as a hydrazine power plant for orbital maneuvers, will be used for orientation of the spin-stabilized body.

## ... one is biggest ever in Germany's space program

Messerschmidt-Boelkow-Blohm's Helios is the largest German space probe contract awarded so far. It's also the largest bilateral space project in which the National Aeronautics and Space Administration has participated. The project calls for launching two identical German-built probes, one in 1974 and the other a year later. NASA will provide the carrier rockets; its scientists will devise some of the experiments for the probes' scientific payload. NASA requirements for some of its experiments are that the probes fly within about 19 million miles of the sun, the closest approach yet.

For MBB, success in space efforts apparently breeds success. The Helios contract award comes hard on the heels of the successful launching of Dial, which after Heos and Azur, is the third German satellite built under management of the Messerschmidt-Boelkow combine.

---

# International Newsletter

---

## **Philips' to push its own computers**

The sprawling Philips' Gloeilampenfabrieken, an international giant in electronics, is still a dwarf in computers. But, says Frits Philips, president of the Netherlands-based company, the new computer division is now growing sharply, chalking up \$30 million in annual sales. Philips' goal is \$300 million a year.

To reach that goal, the company is investing heavily in plants around Europe. First in line are subsidiary computer manufacturing plants in France and Belgium. Philips says his company is going to go it alone in computers, and will not enter into cooperative arrangements with other computer makers. The European market, he says, can easily accommodate four or five manufacturers.

And look for more Philips expansion in electronics, not less. Despite the company's recent interest in purchasing cable plants, Philips emphasized that the company was not heading toward the heavy electro-technical field.

## **Soviet laser used for telephone service**

The Russians have lifted the lid on an operational laser and telephone link that has been operating in Soviet Armenia for nine months. The helium-neon gas laser, used by astronomers at the Burakan Astrophysical Observatory for telephone communication with Yerevan, which is 15 miles away over very rough terrain, has proved the operational worth of such a link. Next step is to put in a carbon-dioxide laser to study communications characteristics at a different frequency.

Besides using the laser link for telephone calls, Soviet researchers are studying atmospheric effects, various modulation techniques, and error probability when transmitting binary data. The system uses a 40-milliwatt, continuous-wave HeNe gas laser. Each of the 24 two-way channels is 3.5 kilohertz wide; total system bandwidth is 100 megahertz.

## **French unveil a solid state photomultiplier**

France's Laboratoires de Marcoussis has put together what it bills as the first solid state photomultiplier. The laboratory, research arm of Compagnie Generale d'Electricite, France's top electrical equipment producer, has packaged in a kitchen-matchbox-sized module an avalanche photodiode, a stabilized power supply, and a preamplifier. An identical second photodiode—blacked out—closely temperature-tracks the detecting diode, keeping the amplification coefficient of the diode constant over a wide temperature range.

Marcoussis' first modules were designed for a military laser telemetry system and increased its range by kilometers, the company says. The module can pick up light flux lower than 1 nanowatt. It maintains an avalanche multiplication coefficient of 40 over a temperature range of  $-40^{\circ}\text{C}$  to  $+80^{\circ}\text{C}$  for 30-megahertz signals on a laser carrier of 1.06 micron wavelength. The military version sells for about \$2,200.

## **EIA plans to drop international unit**

To keep a hand in some international electronics activities, the Electronic Industries Association's Board of Governors may have to eliminate its International Department at its June budget meeting. The governors recently rejected a proposal to expand the international unit to divisional status [*Electronics*, March 30, p. 69]. EIA's seven semi-autonomous product divisions would have to conduct their own international operations on an individual basis, thus strengthening selected projects.



---

# International Newsletter

---

April 13, 1970

## Liquid-crystal display heads for European market

Liquid-crystal display modules may hit the market in France before the end of the year. Prototypes of five-character display plaques turned up on the stand of Thomson-CSF at last week's Paris Components Show. Thomson, France's largest electronics company, expects it can sell the five-character plaques for about \$3.75 once they're in production.

The plaques measure about 2.75 inches long by 0.8 inch high. They operate on voltages between 10 volts and 30 volts and consume about 100 microwatts for each square centimeter of "illuminated" area. This works out to an average of 0.5  $\mu$ w for each element illuminated to make up a character. Each character area has 16 elements to handle the 26 letters and 10 digits; but on the average, only six elements need be energized for a character.

Thomson's liquid crystals are much like those of RCA. Britain's Marconi Co. is also working on liquid-crystal displays. Like Thomson and RCA, Marconi has developed liquids that turn from transparent to white opaque when a voltage is applied. But, rather than small alpha-numeric readouts, Marconi is aiming at overlays for radar displays in sizes from 4 inches square up to about 8 inches square. Marconi also has in the works a liquid-crystal blend that changes color from green to blue when charged.

## West German firms land \$75 million space contracts . . .

As if any further evidence were needed that West Germany has become a major international technological competitor, two West German aerospace companies have just landed nearly \$75 million in space vehicle contracts. The larger of the two contracts, valued at about \$55 million goes to Messerschmidt-Boelkow-Blohm GmbH as prime contractor for designing and developing the German-American Helios sun probes.

The other contract, worth between \$17 million and \$19 million, goes to Dornier GmbH for an upper-atmosphere research satellite. Dornier's research satellite, called Aeros, is scheduled for a mid-1972 launch at NASA's Western Test Range in California, using a four-stage Scout carrier rocket. It will perform upper-atmosphere measurements over a period of at least six months. The satellite's initial apogee and perigee will be 620 and 1,460 miles. An electromagnetically active attitude control system, as well as a hydrazine power plant for orbital maneuvers, will be used for orientation of the spin-stabilized body.

## . . . one is biggest ever in Germany's space program

Messerschmidt-Boelkow-Blohm's Helios is the largest German space probe contract awarded so far. It's also the largest bilateral space project in which the National Aeronautics and Space Administration has participated. The project calls for launching two identical German-built probes, one in 1974 and the other a year later. NASA will provide the carrier rockets; its scientists will devise some of the experiments for the probes' scientific payload. NASA requirements for some of its experiments are that the probes fly within about 19 million miles of the sun, the closest approach yet.

For MBB, success in space efforts apparently breeds success. The Helios contract award comes hard on the heels of the successful launching of Dial, which after Heos and Azur, is the third German satellite built under management of the Messerschmidt-Boelkow combine.

---

# International Newsletter

---

## Philips' to push its own computers

The sprawling Philips' Gloeilampenfabrieken, an international giant in electronics, is still a dwarf in computers. But, says Frits Philips, president of the Netherlands-based company, the new computer division is now growing sharply, chalking up \$30 million in annual sales. Philips' goal is \$300 million a year.

To reach that goal, the company is investing heavily in plants around Europe. First in line are subsidiary computer manufacturing plants in France and Belgium. Philips says his company is going to go it alone in computers, and will not enter into cooperative arrangements with other computer makers. The European market, he says, can easily accommodate four or five manufacturers.

And look for more Philips expansion in electronics, not less. Despite the company's recent interest in purchasing cable plants, Philips emphasized that the company was not heading toward the heavy electro-technical field.

## Soviet laser used for telephone service

The Russians have lifted the lid on an operational laser and telephone link that has been operating in Soviet Armenia for nine months. The helium-neon gas laser, used by astronomers at the Burakan Astrophysical Observatory for telephone communication with Yerevan, which is 15 miles away over very rough terrain, has proved the operational worth of such a link. Next step is to put in a carbon-dioxide laser to study communications characteristics at a different frequency.

Besides using the laser link for telephone calls, Soviet researchers are studying atmospheric effects, various modulation techniques, and error probability when transmitting binary data. The system uses a 40-milliwatt, continuous-wave HeNe gas laser. Each of the 24 two-way channels is 3.5 kilohertz wide; total system bandwidth is 100 megahertz.

## French unveil a solid state photomultiplier

France's Laboratoires de Marcoussis has put together what it bills as the first solid state photomultiplier. The laboratory, research arm of Compagnie Generale d'Electricite, France's top electrical equipment producer, has packaged in a kitchen-matchbox-sized module an avalanche photodiode, a stabilized power supply, and a preamplifier. An identical second photodiode—blacked out—closely temperature-tracks the detecting diode, keeping the amplification coefficient of the diode constant over a wide temperature range.

Marcoussis' first modules were designed for a military laser telemetry system and increased its range by kilometers, the company says. The module can pick up light flux lower than 1 nanowatt. It maintains an avalanche multiplication coefficient of 40 over a temperature range of  $-40^{\circ}\text{C}$  to  $+80^{\circ}\text{C}$  for 30-megahertz signals on a laser carrier of 1.06 micron wavelength. The military version sells for about \$2,200.

## EIA plans to drop international unit

To keep a hand in some international electronics activities, the Electronic Industries Association's Board of Governors may have to eliminate its International Department at its June budget meeting. The governors recently rejected a proposal to expand the international unit to divisional status [*Electronics*, March 30, p. 69]. EIA's seven semi-autonomous product divisions would have to conduct their own international operations on an individual basis, thus strengthening selected projects.

# Operational computer does simulations now largely confined to analog units

New machine can simulate at 2 kilohertz without severe degradation; independent integrators and reduced number of hardware modules allow good accuracy with high stability and no long-term drift

As a simulator of practical problems, the digital differential analyzer has made no progress in displacing the conventional analog computer because it's too slow. An engineer who needs to simulate, say, vibrations up to 1,000 or 2,000 hertz, can't use the DDA, which can simulate in real time only up to about 10 hertz. The DDA is limited because it integrates in fixed increments with the incremental values determined by the highest rate of change during a cycle. That invariably means very small steps—sometimes one binary bit of a 16- or 24-bit word. Thus although the individual calculations are extremely simple, the total number of calculations required is very large.

Now a small, new British company, Ceta Electronics Ltd. of Bournemouth, largely staffed by ex-Plessey employees, has constructed a prototype of an entirely digital computer which it claims can simulate at 1 kilohertz with accuracy as good as any analog machine—and better than most—and at 2 khz without much degradation. It can't achieve the very fast simulation of some analog machines—around 10 khz—but will accommodate the vast majority of everyday simulations, claims Ceta.

**Pluses.** Ceta says that digital construction provides some important advantages over analog methods. First, its machine—the 1600 series—is inherently more stable, so that it doesn't need frequent recalibration. Second, it can repeat simulations over long periods without drift. Third, compared with analog machines of similar



Patchwork. Combining digital modules, Ceta Electronics operational computer achieves its speed by using prediction algorithms to vary increments.

performance, it has about half the number of hardware modules and hence a simpler patchboard which makes setup and program debugging easier. Fourth, all its integrators can work independently with respect to any variable, whereas in an analog machine all integrators must perform with respect to one variable, usually time. However, although time is the independent variable it can be scaled to represent some other quantity.

According to Ceta, independent integrators simplify many simulations. In particular they make it easy to generate fixed functions because analytic function generators are formed simply by connecting the integrators, instead of having to bring in extra diode function generators as in an analog computer.

Ceta admits to one disadvantage: at present it has available only complex multiplier modules. Thus,

carrying out simple multiplication involves a greater investment than with analog machines, for which cheaper multipliers for simple multiplication are available.

Like a conventional DDA, Ceta's computer consists of blocks of hardware logic interconnected through a patch-board. Each module in effect, is a small computer hardwired to perform either multiplication or integration—the main difference is that integrators have an additional register to accumulate results.

The standard shift-and-add algorithm in twos-complement arithmetic is used for multiplication. The inputs to a module are 24-bit binary whole numbers taken from other modules, or from the keyboard, at a 10-khz sample rate. However, the inputs are not incremented by small, fixed amounts repeated many times as in an ordinary DDA. Instead, sampled values

are adjusted to a prediction of what they will be in the sample 100 microseconds later. Hence, one step takes the place of dozens or even hundreds, which speeds up the process by two orders of magnitude, claims Ceta.

**Predict.** Clearly, everything depends on the validity of the prediction algorithms introduced before multiplication or integration. Bill Rae, who designed the computer, prefers to keep silent about proprietary information, but will say the stored values of the last two samples are used as a base. "I think there are only four principles on which we could base the algorithms" he says, "and if I say which one we use, it will tell our competitors which is best".

However, he claims that at the speeds for which the computer is designed—up to 2 khz, where the data is changing slowly relative to the sample rate—the errors of prediction are negligible and cause no noticeable degradation of performance. As speed goes up, though, the error rate rises. This factor imposes the speed limit on the machine.

The modules forming the multipliers and integrators are built in standard TTL series 74 IC logic using nearly all the complex functions presently available, but no custom design. The multiplier fits on two printed-circuit cards and the integrator on three. Peter Horne, Ceta's chief development engineer, says all the circuits in one module probably could be put on three or four custom-designed chips, and Ceta may go to custom design if demand for the computer justifies it. However, that wouldn't necessarily make the machine much smaller—the prototype is 20 by 20 by 12 inches—because displays and controls still would have to be fairly large.

The prototype has six integrators, six multipliers, two analog-to-digital inputs and two digital-to-analog outputs. It represents the smallest machine in the range, selling in England for about \$25,000. Ceta reckons the main demand will be for much bigger machines, and the company can make any size up to a maximum of 99 multipliers and

99 integrators. One version, which contains 36 integrators, 36 multipliers, and numerous other process modules—such as arbitrary function generators, summers, NAND/AND gates, and more input channels—is likely to cost around \$100,000 in England. The first public showing will be at Wescon in the fall.

## France

### Advancing microelectronics

For European electronics engineers April in Paris means the annual components show. But judging from its success last week, the Symposium on Advanced Microelectronics, organized by France's electronics trade union and held concurrently with the show, is becoming an attraction of equal stature.

Some 125 papers on research in integrated circuit design, semiconductor theory and production techniques were given by specialists from Europe and the U.S. Even the Russians sent a representative, who reported on advanced work in doping diamonds for use as semiconductors.

**Holography.** West German's Siemens reported success in harnessing holograms to the ticklish job of projecting masks onto semiconductor wafers. The problem with usual methods, noted Horst Kiemle of the company's Munich research laboratory, is that the masks are easily damaged by contact with the wafer surface. This usually requires replacement of high-priced masks after only a few uses.

Anxious to find a method that avoids mask-to-wafer contact, Siemens tried projecting a mask image through a high-resolution microscope lens. But the wide-angle field of vision required for most masks—about 50 millimeters in diameter—meant designing a special lens with too many individual elements for economical production.

Siemens next tried holograms, an idea first put forward in 1966. Projection through a hologram onto a wafer offers great potential because

it gives theoretically perfect resolution with unlimited field of vision.

But the main problem was what to use to capture the hologram image. Photographic emulsions were quickly ruled out because they thicken uncontrollably during development, and they diffuse blue light.

Researchers finally settled on the same kind of photoresist used to etch the semiconductor wafers, spread on ultraflat glass 25 mm thick. These holomasks assure exact superimposition of each successive image on a wafer, and they can be used over and over again.

One hitch remains: Siemens was forced to use Kodak Orthe resist, which it found to give rather low quality. But only the Kodak resist permits working with visible light, where lasers of adequate power exist. Other lasers could be used, but their efficiency is too low. Kiemle said he has reason to hope new lasers will be developed before long that will solve this problem.

The British also are well along on holographic mask projection. Workers at the Services Electronics Research Laboratory use one hologram to project six separate mask images [*Electronics*, Mar. 16, p. 64].

**Speedy.** Researchers from France's Thomson-CSF reported progress in their quest for a nanotransistor, a beast the French firm—along with some in the U.S.—is trying to tame for lightning-speed computers.

The giant 20-micron-wide lines that make up components in present-day integrated circuits permit parasitic signals, which hold down speed and frequency. Charging capacitance to distinguish between the high and low electrical levels that indicate the binary system's 0 and 1 creates heat, another hindrance to fast calculation.

Thomson-CSF wants to cut capacitance by reducing an IC's surface 1,000-fold. Using a special fine-beam ion bombardment machine developed in company laboratories, the firm has already produced IC's with a resolution as small as 0.2 micron permitting line width of 0.5 micron. This is a hair away from the industrial resolution record ap-

parently hold by IBM, with 0.1 micron. Researchers at Britain's Cambridge University have reached 600 angstroms, say company engineers. Thomson-CSF has solved the sticky problem of positioning multiple masks at the close tolerances needed for IC production by using laser interferometers.

The French company will do much better than its present line width in the future, says O. Cahen of Thomson-CSF. "But when we can do 0.2 micron industrially, we'll be home safe," he adds.

The company plans to test the electrical performance of a 2N9-18 type transistor that will be 100 times smaller than the standard unit. Thomson-CSF's ultimate goal, as it is for Westinghouse, Hughes, IBM and others, is to produce a computer on a chip. All these firms are experimenting with electron or ion beams. But first industrial applications of such circuit-squeezing nanoelectronics are several years away, Cahen says.

France's Société Alstom described a new patented method of using stochastic signals from a noise generator in analog-to-digital and digital-to-analog converter circuits.

The system permits elimination of resistance networks common to classic converters, as well as size reduction of analog sections, and simplification of logic circuitry. These feats permit the near-total integration of conversion circuits and open up possibilities of designing them in MSI.

Easily, the Paris symposium's

most exotic moment was the Russian's diamond-doping paper. Basic researchers from Moscow's Lebedev Physics Institute reported they have been able to force natural diamonds, normally insulators, to show hole conductivity—an achievement they suggest should lend itself to such applications as diamond charged-particle counters with an injecting electrode.

Such particle counters work at temperatures of 500°C and above, just the area where semiconductor diamonds display their greatest value, the Russians found. One problem, though: diamonds must be doped at high temperatures and pressures, creating formidable production problems.

The Russians produced n-type layers by doping diamonds with lithium, carbon, and phosphorous. Doping with aluminum and boron gave p-type layers.

## Japan

### Tuning in

Designing an integrated circuit to do without a tuned circuit is the next best thing to including a tuned circuit on the chip. Elimination of a tuned circuit is one of the novel features in a linear IC that is part of a new consumer line just introduced by Mitsubishi Electric Corp.

Such circuit simplification fits in with Mitsubishi's dual goals of offering IC's that cost less than the components they replace and mar-

kedly reducing the number of assembly operations in equipment using IC's. Simplified assembly and adjustment is important because of Japan's worsening labor shortage. [*Electronics*, Mar. 30, p. 4].

For these reasons Mitsubishi consumer IC's generally are special-purpose units that require only a limited number of external components. When their function is relatively simple, such as an a-m radio amplification, one IC provides all the active devices and many passive ones. When the set is more complex, such as a stereo or tv, one IC provides all the active devices and many of the passive ones to perform one entire function—such as stereo multiplex demodulation.

**Complex.** The stereo multiplex IC is the most complex consumer circuit made by Mitsubishi, and has about 60 transistors. The simplified circuit diagram shown omits three circuits which are similar to those used by others. They are the audio mute circuit, the stereo switch which disables the stereo function when receiving weak signals, and the stereo indicator lamp driver circuit.

Basically, the multiplex stereo f-m signal has four components. First there is an audio signal extending to 15 kilohertz, consisting of the sum of left and right channels, that is frequency-modulated onto the main carrier in the usual manner. Then there are both sidebands of the left-minus-right difference signal, amplitude-modulated onto a suppressed 38-khz subcarrier that is frequency-modu-

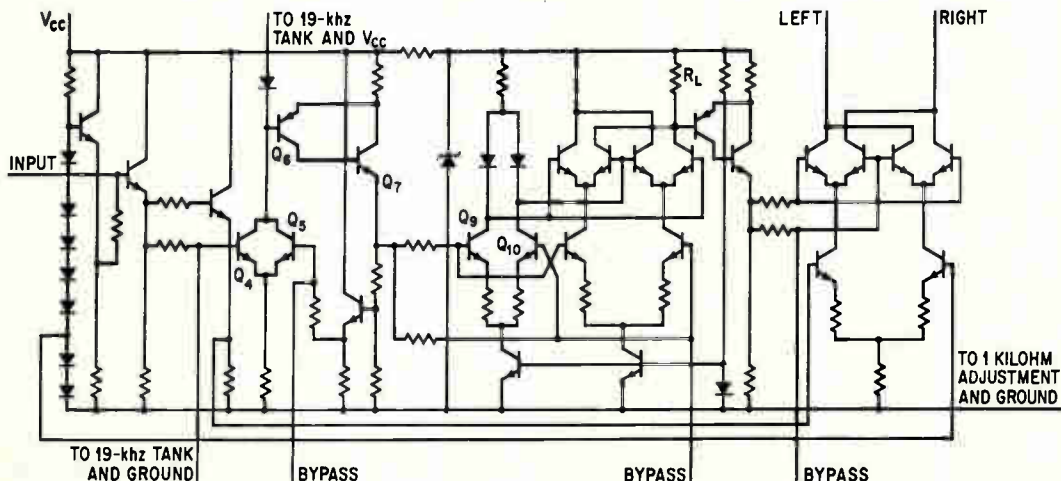

On a chip. Part of new line of consumer IC's from Mitsubishi, stereo multiplex IC has about 60 transistors. Only part of the total circuit is shown here. Main design feature is elimination of a 38-khz auxiliary tuned circuit.

lated onto the main carrier. A 19-khz pilot signal, frequency modulated onto the main carrier, is provided for generation of the reference carrier needed to detect the left-minus-right signal. There also may be a supplementary communications allocation signal, amplitude-modulated onto a 67-khz subcarrier that frequency-modulates the carrier.

The pilot signal circuit consists of input emitter-follower  $Q_2$  followed by a tuned amplifier which selects the 19-khz pilot signal and adjusts its phase. The d-c level then is shifted in the pnp-npn pair  $Q_6$  and  $Q_7$ .

This pilot signal then drives both a differential amplifier and a feedback loop that controls  $Q_5$  in parallel with  $Q_4$  for automatic gain control of the pilot signal. The differential amplifier primarily provides the level shift needed for proper operation of the multiplier circuit. Signal swings at the collectors of  $Q_9$  and  $Q_{10}$  are approximately equal to those at their bases because of the degeneration introduced in the circuit by the emitter resistors.

Since both polarity outputs are available, both inputs of the two upper differential amplifiers in the multiplier circuit are driven. In most differential amplifiers one side is connected to a-c ground.

Because signal swings are small, the multiplier always operates within the linear range of the transistors. Total current of both halves of the differential amplifier is constant over the linear range. Thus, if an input signal to the lower differential circuit causes current in one transistor in a pair to rise by a value  $X$ , the current in the other transistor in pair falls by the same amount. In the same manner the extra currents in transistors in the upper differential amplifiers can be represented as  $Y$ . Since the differential amplifiers are in series, the current in load resistor  $R_2$  is proportional to  $X$  times  $Y$ , which are both 19-khz sinusoidal waves. Their product is a sinusoidal function of 38 khz; the square of a sinusoidal wave is a double-frequency sinusoidal wave.

The desired 38-khz signal for

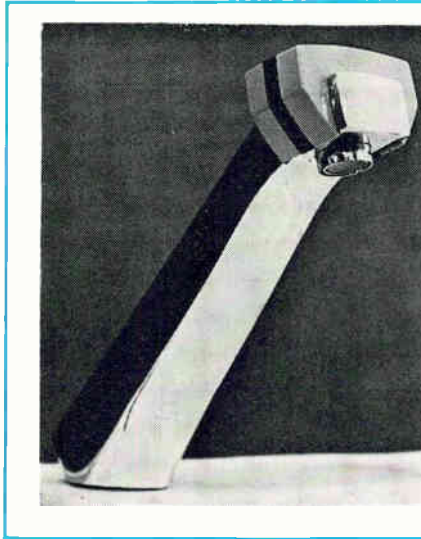

**An electronic faucet** developed in the Netherlands has no hot or cold water handles. Instead, sensors on the faucet react to movements of hands or other objects, such as artificial arms. The mixing tap supplies water if a hand is moved up or down within about 1 inch of the sensor. Repeating the motion cuts off the supply. Movement on the right side gives cold water, on the left side hot water, and on both sides warm water. The control box is mounted under the sink. The unit, which is aimed at hospitals, laboratories, and other clean-room applications, is made by Venlo Sanitaire of Venlo, Holland.

reinsertion in the left-minus-right signal thus is generated without need for a tuned circuit. Component and installation savings are realized, and the task of adjusting the 38-khz tank is eased. While two 19-khz tanks still must be adjusted, the necessity for switching to another frequency and performing more adjustments is eliminated.

The stacked differential amplifiers at the far right of the circuit act as product detector and matrix. The detector uses the 38-khz reference carrier, in either linear or switching mode depending on signal strength, to detect left-minus-right signal. It's then combined with the incoming composite signal to obtain the separate left and right signals. This product-detector matrix circuit has been used before—by Motorola—and it gave Mitsubishi engineers the hint they needed to start developing the multiplier circuit for doubling the pilot frequency.

**Power drive.** Another noteworthy new linear circuit announced by Mitsubishi is a monolithic audio power driver. This circuit is designed to both simplify assembly and to provide greater versatility than other hybrid integrated output circuits. Mitsubishi engineers say that the hybrid circuits are good for only one power output—they are wasteful when operated below rated power and obviously can't be used above their ratings. The Mitsubishi power driver, when combined with the usual outboard

components and two appropriate power transistors, can provide power output over a range extending to beyond 30 watts. This eliminates the need to stock a line of IC output amplifiers for differential power outputs.

Mitsubishi engineers say that this is the first consumer IC to be rated at 70 volts. The high rating was obtained with a standard structure, but with precise control of epitaxial layer resistivity and thickness, accurate base and emitter diffusion, and improved surface passivation.

A variation on the same idea is a dual preamplifier and driver for automobile stereo sets. The IC is coupled to four output transistors, two in each channel, by two driver transformers. It might seem contradictory to use transformers with integrated circuits, but set designers like this type of circuit because it is similar to the ones they've been working with.

Still another new Mitsubishi linear IC is a standard circuit—the sound i-f first developed by RCA—with little bit extra. The RCA circuit is easier to assemble than the discrete parts it replaces, but it costs more.

However, Mitsubishi engineers found that by including a driver stage on the same chip they could further reduce assembly operations and at the same time make a circuit they can sell for less than the cost of the components in the circuit it replaces.

# lev-er-wheel

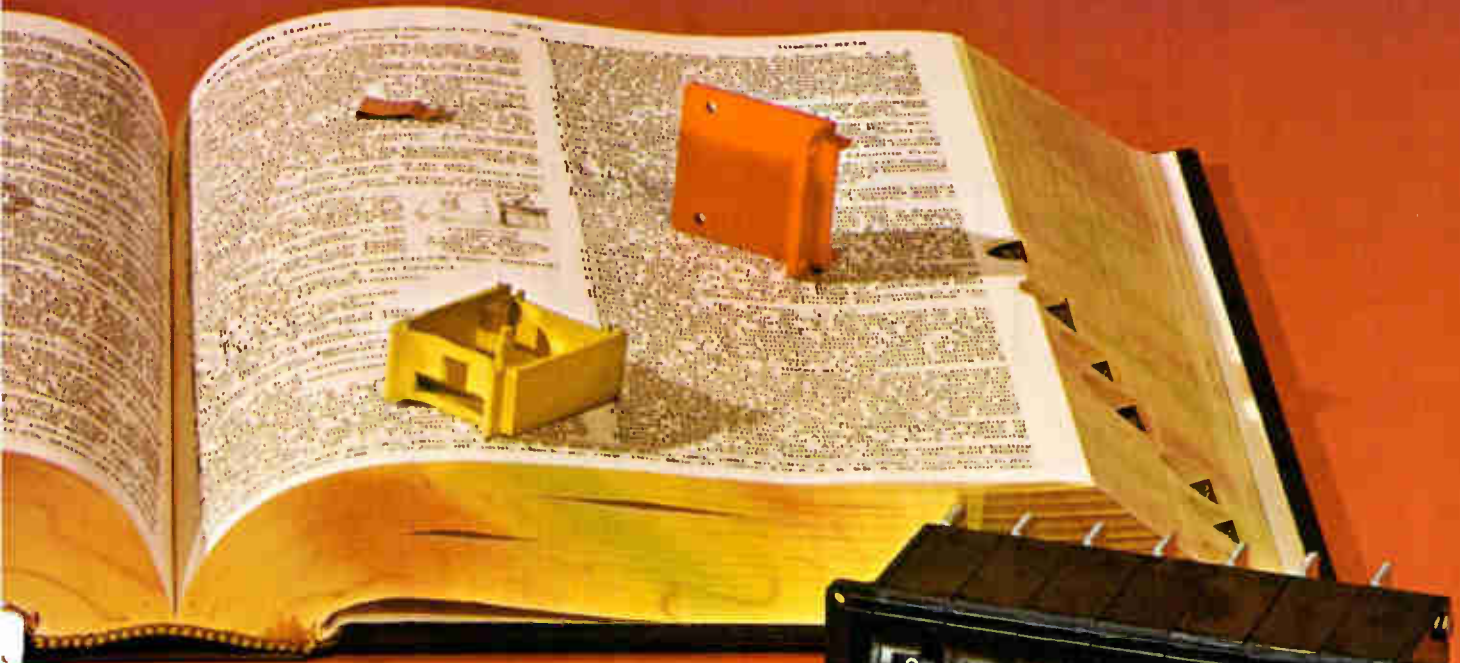

... so new  
you can't look it up  
in your Funk & Wagnalls

## LEVERWHEEL SWITCH ... a brand new concept ... Thumbwheel Lever-Action by CHERRY

**FASTER SETTING:** A single movement of the Leverwheel setting lever through its 60° arc is all that's necessary for a complete 10-Position cycle. (Compare *that* to plunking through the 360° rotation on conventional thumbwheel!)  
**Instant reset at no extra cost:** A simple sweep with the hand and all levers return to home position with every switch in the bank returned to "zero."

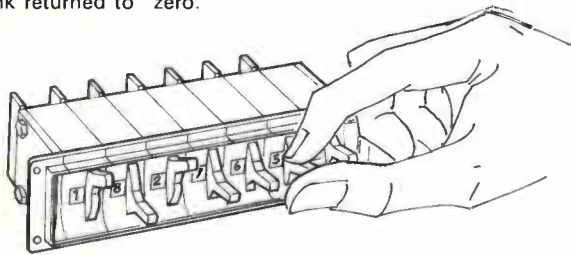

Cherry has new standard thumbwheel switches, too! Like the unique new Leverwheel, Cherry thumbwheel switches are available in miniature and subminiature sizes, totally-interchangeable with other leading thumbwheels.

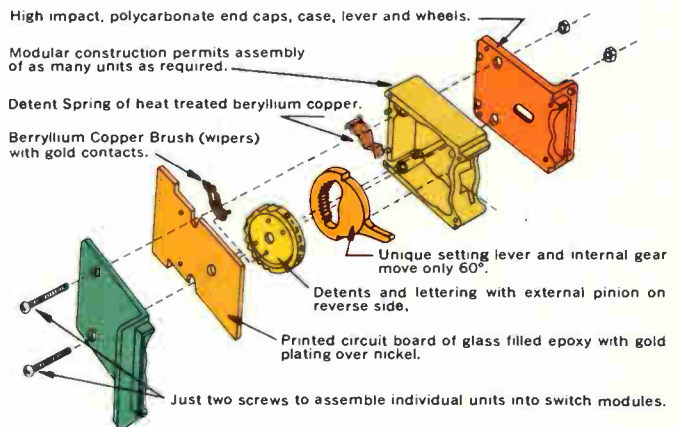

**SEND TODAY** for a copy of the new brochure describing Cherry Leverwheel and Thumbwheel Switches. For *immediate action* phone: 312/831-5024.

# CHERRY

CHERRY ELECTRICAL PRODUCTS CORPORATION • 1656 Old Deerfield Road, Highland Park, Illinois 60035

Circle 75 on reader service card

# ultrasonically assembled

at

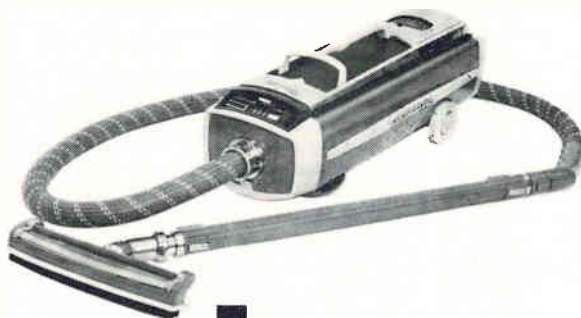

# Electrolux

Engineers at Electrolux chose ultrasonic assembly for this top-of-the-line Electrolux® cleaner. Why? To guarantee strong, clean assemblies at the lowest possible cost. Eight different parts are welded or staked ultrasonically on systems ranging from simple hand-loaded stands to rotary tables with up to twenty-four stations.

Are you still using glue, screws or staples? Find out how ultrasonics can give your thermoplastic parts top-of-the-line quality at lower cost. Write for bulletin S-889. Send unassembled parts or prints for a free evaluation.

Technical centers in major cities.

Overseas offices—Paris; Geneva; Frankfurt; Soest, N.V.; Tokyo

■ ■ ■ **BRANSON SONIC POWER COMPANY** 67 Eagle Road, Danbury, Conn. 06810



*It takes a while  
to achieve excellence*

*It takes forever  
to maintain it*

*Excellence is a complex thing, composed of many parts. It isn't achieved overnight . . . not by anything or anyone. We've devoted almost fifty years to developing the complete line of Markel insulating sleeveings, wire and cable . . . a total of some 3,500 different types and sizes. Each was painstakingly perfected to meet specific needs. It also took a lot of work to design the processes and equipment to manufacture these products in volume to sell at reasonable prices. In addition, we've built and trained an outstanding sales organization to make Markel products and know-how readily available to you. Over the years, Markel products and service have earned a solid reputation for excellence. But we know we have to keep on earning it . . . product by product . . . day by day . . . from now on.*

ONE SOURCE FOR EXCELLENCE  
in Insulating Tubings and Sleeveings  
High Temperature Wire and Cable



L. FRANK MARKEL & SONS, INC., NORRISTOWN, PA. 19404 • PHONE: 215/272-8960

Circle 77 on reader service card



**You'll get  
the direct print paper  
on the right faster.**

There's no need for "hurry" stamps on Astroprint oscillographic papers. Easy ordering and direct delivery are part of the package.

You also get a direct print, orthochromatic paper unsurpassed for

trace density, instant pop-up (less than 1 second), excellent image stability and sharp contrast. On mercury vapor, Xenon, and cathode ray light sources.

Astroprint DP 90 (for open magazine applications) and DP 80 (for closed magazines).

As a starter, test us for delivery and cost. Just call your local Xerox Product Specialist or write to Xerox Corporation, Dept. HL, Rochester, New York 14603.

The paper will prove itself.

**XEROX**

Xerox and Astroprint are registered trademarks of Xerox Corporation.

BRAND-REX PRESENTS  
**BUCK ROGERS**  
 IN THE 25th CENTURY

WILMA, DR. HUER AND I WERE JUST LEAVING NEPTUNE WHERE WE'D HELPED TIE IN A NEW NETWORK OF PERIPHERAL EQUIPMENT WITH THE MASSIVE NEPTUNIAN COMPUTER CONTROL CENTER.

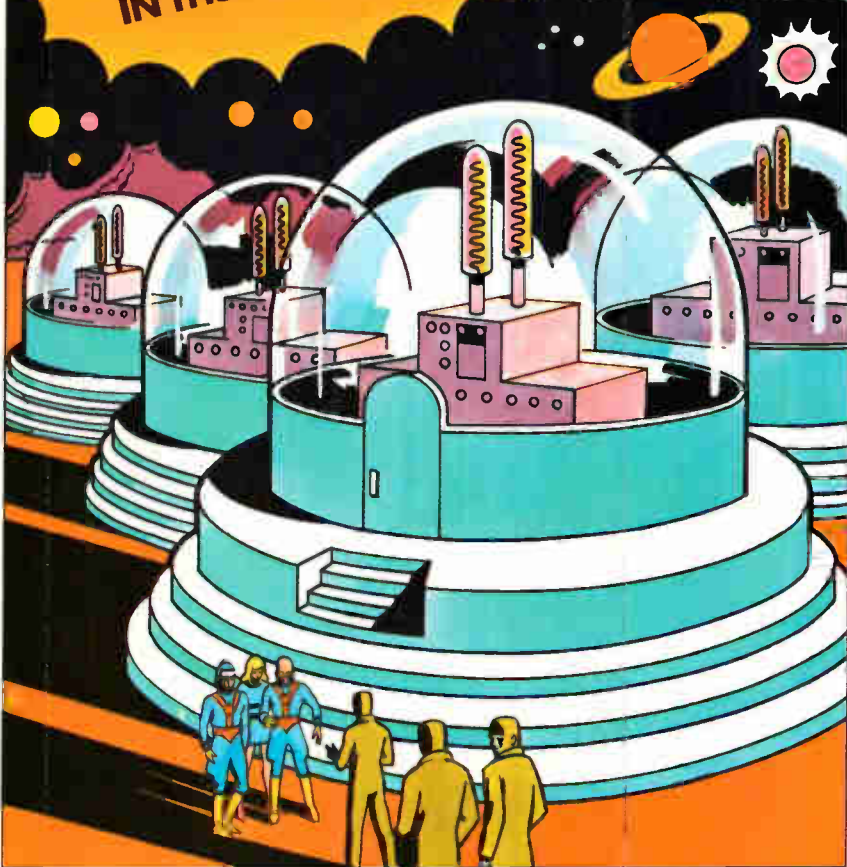

THANK YOU BUCK ROGERS, FOR PUTTING US WISE TO **BRAND-REX** WIRE AND CABLE. OUR COMPUTER SYSTEMS COULD NEVER HAVE FUNCTIONED WITHOUT THEM.

IF **BRAND-REX** IS ALREADY SUPPLYING THE 10 BIGGEST CENTRAL PROCESSING UNIT MANUFACTURERS IN THE UNIVERSE, IT STANDS TO REASON THEY'LL HAVE THE PRODUCTS COMPATIBLE WITH YOUR NEEDS. GOOD-BYE FOR NOW.



WE'RE OFF TO MERCURY TO DO ANOTHER CRITICAL HOOK-UP JOB WITH **BRAND-REX** WIRE AND CABLE.



SHORTLY AT THE PLANET MERCURY'S NEW COMPUTER CONTROL CENTER...

BUT DR. HUER, THIS MERCUREAN SYSTEM IS ENTIRELY DIFFERENT FROM THE ONE WE JUST WORKED ON FOR NEPTUNE.

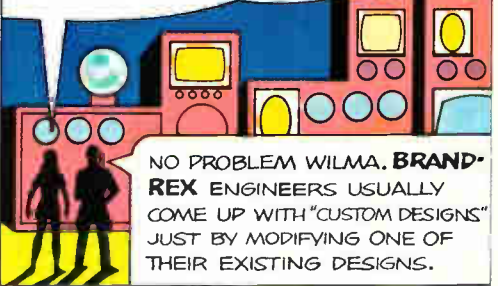

NO PROBLEM WILMA. **BRAND-REX** ENGINEERS USUALLY COME UP WITH "CUSTOM DESIGNS" JUST BY MODIFYING ONE OF THEIR EXISTING DESIGNS.

A FEW DAYS LATER—

THE WHOLE COMPUTER SYSTEM IS REALLY HUMMING NOW, BUCK.



THANKS ONCE AGAIN TO **BRAND-REX**. WILMA, THE PLANET MERCURY IS NOW WAY AHEAD OF ITS TIME WITH A PERIPHERAL SYSTEM THEY CAN LIVE WITH FOR MANY YEARS.

SAY EARTH-FOLKS: DID YOU KNOW THAT **BRAND-REX** ENGINEERS TURN OUT AS MANY AS 3,000 NEW CABLE DESIGNS IN A YEAR? NO WONDER THEY HAVE MORE UL APPROVALS ON COMPUTER WIRE AND CABLE THAN ANYONE ELSE. THEY'RE USED TO WORKING HAND-IN-GLOVE WITH THE BIGGEST NAMES IN THE INDUSTRY SO THEY JUST NATURALLY OFFER THE MOST COMPATIBLE DESIGNS FOR PERIPHERALS AVAILABLE. TAKE MY ADVICE AND WRITE FOR THE **BRAND-REX** CATALOG ON BUSINESS MACHINE WIRE AND CABLE TODAY.

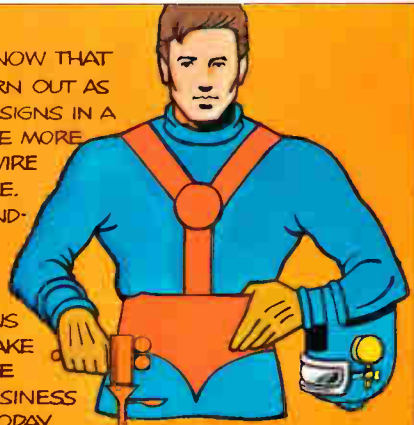

**BRAND-REX DIVISION** AMERICAN ENKA CORP.  
 WILLIMANTIC, CONN., 06226. PHONE 203 423-7771.

**BRAND-REX, WAY AHEAD IN WIRE AND CABLE**

# Just about everything you need for ordering wafers or dice

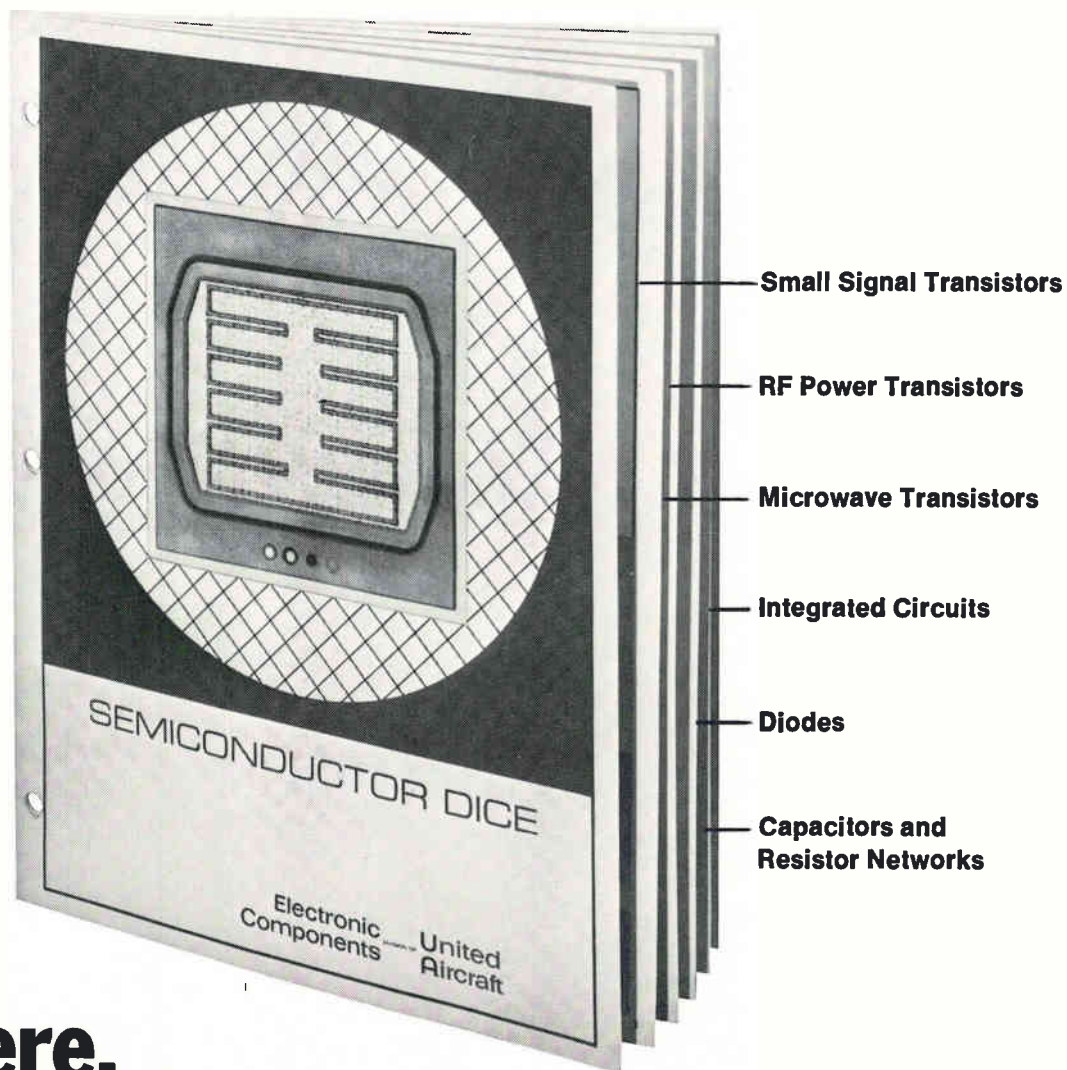

**is in here.**

In the new United Aircraft Semiconductor Dice catalog you will find complete information about All UA small signal transistors, RF and Microwave transistors, diodes, capacitors, and resistor networks. Complete specifications and geometries are given for all categories, and they are cross-referenced with regard to device types. Geometries of 5400/7400 Series integrated circuits are also given.

You can obtain a copy of the United Aircraft Semiconductor Dice catalog from any of our distributors or sales representatives, or by writing directly to Don Tabbut, Marketing Dept.

**Electronic Components** DIVISION OF **United Aircraft**

TREVOSE, PENNSYLVANIA Tel. 215-355-5000 TWX: 510-667-1717  
West Coast Office: 128 E. Katella Ave., Orange, Calif. (714) 639-4030

DESIGNERS AND PRODUCERS OF • RF AND MICROWAVE TRANSISTORS  
• CUSTOM HYBRID CIRCUITS • MONOLITHIC INTEGRATED CIRCUITS • SEMICONDUCTOR DICE



**BRINGING  
NEW IDEAS**

**TO LIGHT**

The new  
GE Lowmount\*:  
high-intensity lighting  
for 10 to 20 foot  
mountings.

Now put the economies and conveniences of high-intensity-discharge light sources to work 10- to 20-foot mounting heights.

The Lowmount delivers comfortable, cool and even illumination. How? With a new refractor design that spreads out lamp beam and heat, lowers brightness. Arc tube is completely hidden from any viewing angle. Sealed charcoal-filter optical assembly keeps airborne dirt and grit away from reflector and lamp. Unit accommodates 400-watt ballasts for mercury metal halide, and Lucalox® lamps and is rated at 40 Centigrade ambients.

It's ideal for textile, electronic, food processing and other industrial applications.

See your GE representative for the facts on the new Lowmount luminaire. Or write: Lighting Systems Department, Hendersonville, North Carolina 28739.

\*Trademark of General Electric Company 460-56

**GENERAL  ELECTRIC**

# BOURNS

*bridges the generation gap in...*

## PANEL CONTROLS

*...with* **CERMET**

Bourns introduces a new generation of Panel Controls with cermet resistance elements for top performance in high-grade commercial, industrial and RV4, RV5, RV6 type applications.

The hang-up of the hot molded carbon element control (that's the older generation) is it weakens, can't stand the heat.

Bourns found a way to cool it . . . with cermet!

What you get is stability, a better temperature coefficient, a higher power rating in a smaller package.

One 1/2" and two 3/4" diameter units constitute the basic model line which covers all RV4, RV5 and RV6 type applications. Their profiles are the thinnest in the industry. All models show excellent high frequency characteristics, extremely low noise and good setability.

**COST?** Less than a dollar for Model 3859 in production quantities. Then subtract the price of rejections, complaints and delays common with the older generation. Delivery is off the shelf.

Turn on with Bourns. Send for Data Packet on cermet Panel Controls or call your local Bourns sales office for a sample.

**Model 3862**, 1/2" dia., 1/4" standard or locking bushing with or without panel seal, 1 watt at 125°C. **Model 3852**, 3/4" dia., standard or locking bushing — 1/4" with or without panel seal for Mil Spec type uses, 3/8" for industry; 2 watts at 70°C. **Model 3859**, 3/4" dia., 3/8" tough plastic bushing; also snap-in version; 2 watts at 70°C.



# Washington Newsletter

April 13, 1970

## Law enforcement R&D money to triple in 2 years

Funds for the Institute of Law Enforcement and Criminal Justice over the next one or two years are expected to double or triple the \$19 million in fiscal 1971 money sought by the Justice Department for its principal R&D activity. The institute's budget request already is more than double the \$7.5 million fiscal 1970 spending level. Attorney General John Mitchell's forecast specifies that much of the money will go for such hardware as new communications, air and ground mobility systems, and night-vision-equipment performance data for police evaluation. But he's characteristically cautious in warning that "we not overfund this problem in its infancy. Overfunding would cause waste and make it more difficult to get money from the Congress later." Nevertheless, he suggests that Congress might want to earmark 10% of the parent Law Enforcement Assistance Administration's money for the institute. Current LEAA funding request: \$480 million.

## Rigid specs planned for police radios

Watch for a rigid set of design specifications for the police personal transceiver program later this month when LEAA puts out its request for proposals [*Electronics*, March 16, p. 45]. Walter Key, electronics and communications program manager, warns that specifications will be "so tough" that industry will have to call up its most advanced design capabilities.

The new radio will probably call for a hidden antenna and an exterior handle since antenna breakage is regarded by many police users as the most serious problem. Sophisticated touch control to eliminate false keying is expected to be another requirement. Voice activation of units has been suggested as a solution to false keying, though it is unlikely to be required immediately. Bidders' estimates place the transceiver proposal's value over an 18-month period as high as \$6 million, depending on the number of production units called for in the six months following a year of development work.

## Foster may get Army Secretary post

Rumbles that Secretary of the Army Stanley R. Resor soon will return to private life are getting stronger. At least two Pentagon generals say that Director of Defense Research and Engineering John S. Foster Jr. is scheduled to move into the Army post. Foster, a Johnson Administration holdover, is known to be distressed by the latest round of military R&D cutbacks, but some insiders wonder why he would surrender the DDR&E slot, with its rank of Assistant Secretary of Defense, for the Army post. Resor, an LBJ holdover who carries good Republican credentials, reportedly is scheduled to leave early this summer. The man behind the move is said to be Deputy Defense Secretary David Packard, who believes Foster is best equipped to shape up the Army after a variety of management goofs stemming from the service's rapid growth during the Vietnam War.

## Congress to leap on Laird's ad libs

More trouble with Congress awaits the Defense Department on two spending fronts—strategic aircraft and R&D.

In both cases, Defense Secretary Melvin Laird inadvertently provided Congress with ammunition when he departed from the text of

# Washington Newsletter

his remarks to the Electronic Industries Association's spring conference in the Capital.

Laird ad libbed the observation that the Soviet Union's price tag on foreign sales of its MIG-21 is \$950,000, while France sells its high-performance Mirage fighter for \$1.1 million. Defense spending opponents are set to match the prices with the estimated \$13 million to \$15 million unit costs of the Navy's F-14 and the Air Force's F-15, still on the drawing boards.

Equally serious, Laird aroused Senate Majority Leader Mike Mansfield (D., Mont.) when he said DOD is working with the electronics industry to repeal section 203 of the 1970 Appropriations Act which requires defense-sponsored R&D to be directly related to military needs. Mansfield calls the statement an affront to the Congress and claims it is the first public statement by a Defense Secretary that he was working with industry to thwart Congressional intent.

## Product safety unit urges Federal rules

Opponents of industry's self-regulation of safety standards will draw support from an unreleased, 54-page staff report made by the National Commission on Product Safety which concludes that "Federal legislation appears to be the critical need" for standards establishment and enforcement. The "fiddler calls the tune" in industry-sponsored organizations like the American National Standards Institute, asserts the staff report.

The NCPS study suggests the engineering community could play a larger role in improving standards. It notes that "engineers cannot evade political and economic issues any more than can public officials or businessmen: even their silence expresses a forceful opinion." Opposition to voluntary standards stems from the view that "standards emanating from industry via the consensus method are deficient in requirements and coverage," are usually set without public participation, and lack enforcement penalties.

## Holographic camera may go to moon

A small, lightweight holographic camera may be used on one of the later Apollo lunar missions. Hughes Research Laboratories and the University of Arizona have proposed the camera to NASA for high-resolution photography of lunar dust particles as small as 5 to 30 microns. Arizona's Thomas Gehrels, chief investigator for the holocamera project, says particle photographs taken on the lunar surface are desired since the particles themselves tend to stick to one another when picked up by an astronaut and thus lose much of their individual detail.

Robert P. Bryson of NASA's Apollo lunar exploration directorate, says he believes it is a "novel and sound approach" and he has recommended the study be approved.

## Software prices to rise if U.S. demands discount

The net effect of a proposed government plan to require bulk-rate discounts for single software computer packages could send software costs to non-government computer users soaring. That's what computer specialists are reading into plans of the General Services Administration which annually buys \$2 billion in computer services, outside of those for weapons systems. Should the GSA invoke the four-year-old law and apply bulk buying to software, industry is expected to pass along development costs to other customers.



# Sylvania introduces a new 40-lead, glass-ceramic, sandwich-type, unitized, hermetically sealable large scale integrated circuit package.

(whew.)

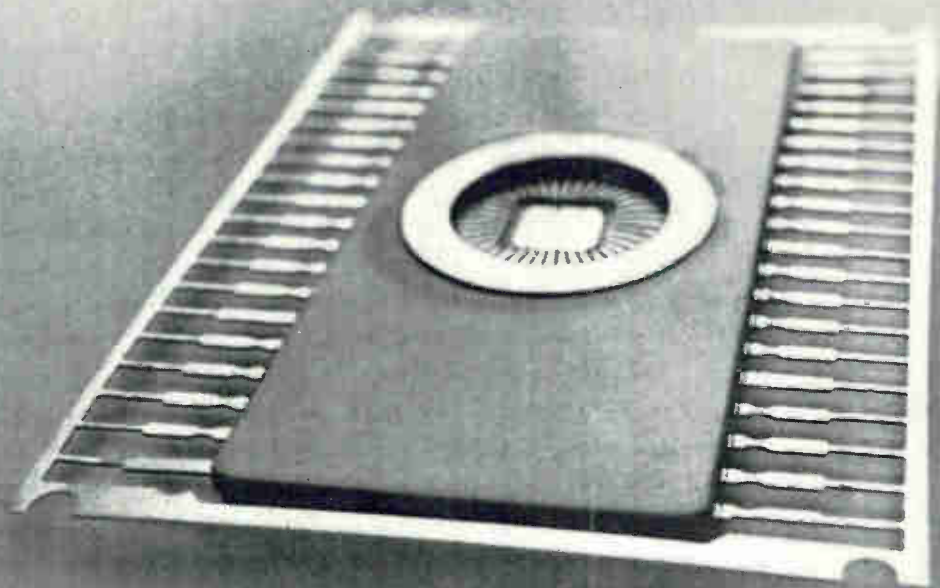

Here is the first glass-ceramic package in the IC major leagues. And that, friends, marks the beginning of the end of the LSI package shortage. Write to: Sylvania Precision Materials, Parts Division, Warren, Pa. 16365. Or telephone: 814-723-2000. Ask for Bill Williamson.

**SYLVANIA**  
GENERAL TELEPHONE & ELECTRONICS

# Our new automatic test equipment tells you where your electronic system went wrong, and how to fix it. In plain English.

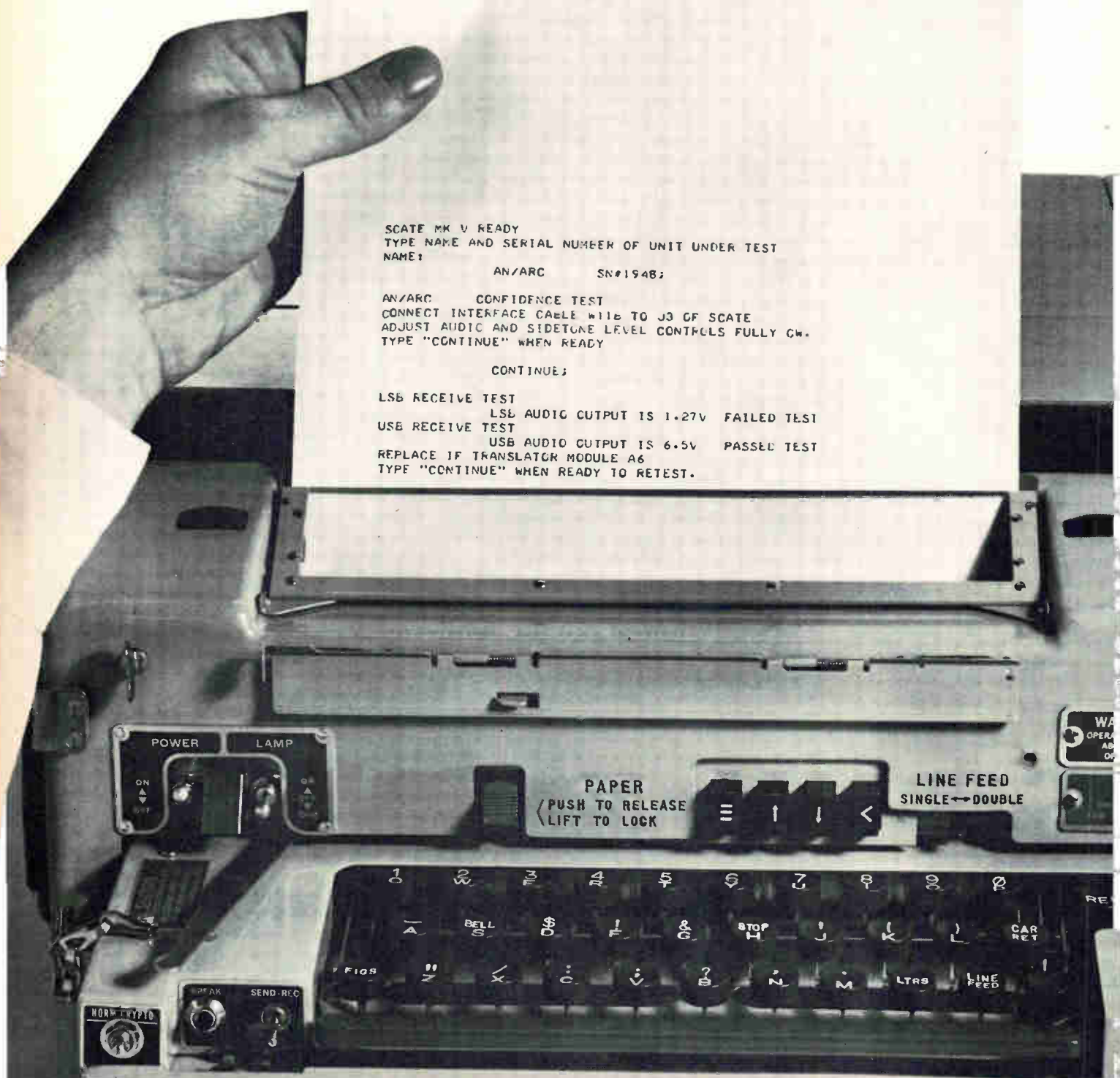
A black and white photograph of a teletype machine. A hand is pointing to a printed test report on a sheet of paper emerging from the machine. The report contains test results for a SCATE MK V unit. The machine has a keyboard with various function keys like 'BELL', 'STOP', 'LINE FEED', and 'LTRS'. There are also control panels for 'POWER', 'LAMP', 'PAPER', and 'LINE FEED'.

SCATE MK V READY  
TYPE NAME AND SERIAL NUMBER OF UNIT UNDER TEST  
NAME: AN/ARC SN#194B;

AN/ARC CONFIDENCE TEST  
CONNECT INTERFACE CABLE W11B TO J3 OF SCATE  
ADJUST AUDIO AND SIDETONE LEVEL CONTROLS FULLY CW.  
TYPE "CONTINUE" WHEN READY

CONTINUE;

LSB RECEIVE TEST  
LSB AUDIO OUTPUT IS 1.27V FAILED TEST

USB RECEIVE TEST  
USB AUDIO OUTPUT IS 6.5V PASSED TEST

REPLACE IF TRANSLATOR MODULE A6  
TYPE "CONTINUE" WHEN READY TO RETEST.

Each new generation of electronic systems used to bring along its own maintenance and support problems. Because each new type of electronic equipment needed new testing procedures, new training and some new test equipment.

For the Army, the problem is even greater. Because its field maintenance and support equipment has to be mobile. And it has to be relatively simple to operate.

**That's where our SCATE® MK V comes in.**

General Dynamics' Electronics division went to work on this problem: creating a computer-controlled automatic test system light enough to be mobile, simple enough to be operated without complex training, adaptable enough to be used for all the Army electronic systems into the mid-1980's.

The answer is SCATE MK V, a unique electronic diagnostic tool.

**SCATE MK V talks English.**

SCATE MK V talks your language. The man who operates it, in the field, needs no advanced training. If he can read or write English, he can be trained to use this equipment in a matter of weeks, not months.

Once an operator is trained, he does not have to know how the unit under test works. SCATE MK V already does. Its computer is programmed for that.

Because the program is in English and on line, the programming costs and time are reduced by as much as 50% compared

to other automatic test equipment.

**SCATE gets things down to size.**

SCATE MK V is about one-third of the size of any similar existing equipment. It can be mounted in a portable shelter on the back of a truck. Or it can be delivered to the field by helicopter.

The reason for the smaller size of SCATE MK V is that its computer is used more extensively in the measurement function as

well as the control function. This eliminates the need for special and redundant test equipment. **One answer for nine commodity areas.**

The Army has identified a requirement for computer-controlled automatic test equipment (CATE) in nine commodity areas: radio communications; wire and

carrier communications; army avionics; fire control equipment; engineering survey and map equipment; missile systems; combat surveillance; laser systems; and communications security.

SCATE MK V can be programmed to provide support in any of these materiel areas.

SCATE MK V is a good example of what we do best.

At General Dynamics we put technology to work solving problems from the bottom of the sea to outer space...and a good bit in between.

**GENERAL DYNAMICS**

Additional technical information is available on SCATE MK V on request. Write: General Dynamics, Dept. 850, 1 Rockefeller Plaza, New York, N.Y. 10020.



# We figure a brand in the computer should go lookin



Ten months ago we opened Computer-vision. We started with a bunch of brainy guys and some good experience.

But lots of new companies have brainy guys with

experience. So we went looking for something else: trouble.

We wanted to put our brainy guys to work on problems that nobody had ever solved before.

## **Thwack.**

You see, David was a fairly gutsy little shepherd. But he would have been a totally unknown fairly gutsy little shepherd if he hadn't decided to take a shot at Goliath.

So we went looking for problems. And we found them:

## **Nobody.**

Nobody had ever made an automatic integrated circuit mask-alignment machine. Nobody had ever made a creative computer graphic system. Nobody had ever perfected a low cost photoplotter.

## **Somebodies.**

Suddenly we were in the computer-controlled automation business. And we brought in more brainy guys to show we meant it: Ken Levy for the mask-aligner, Dave Friedman for the creative computer graphic system, Joe Sliwowski to perfect the photoplotter, and Mike Mendelsohn to tie in the whole operation with software.

Then we went to work.

## **That was eight months ago.**

Today we humbly announce our Autolign 2686™ automatic mask-aligner. Our INTERACT-

# A new company in the industry looking for trouble.

INTERACTgraphic1™ creative computer graphic system.  
And our Compucircuit 100™ photoplotter.

Ho-hum.

In fact, we don't just announce them: We're already shipping them.

## **Right now, real time.**

These were no small problems. People have refined computer systems in all kinds of ways. What they haven't done is improve the interaction between man and computer in creative problem solving. But we have with our four foot interactive surface, INTERACTgraphic1™.

And they haven't provided highly accurate, low cost tools to capitalize on the product of this interaction. But we have with our Compucircuit 100™

And they haven't used special purpose computers to solve the biggest problem in IC manufacture. But we have with our Autolign 2686™ automatic mask-aligner.

## **Tomorrow.**

Now we start looking for trouble again: It won't be hard to find. And half our new products are probably just sitting around waiting to be invented.

So pretty soon we'll be putting together more brainy guys to solve another problem.

## **Some day we may put you in bed with a computer.**

And we'll keep looking for new ways to make a man and a computer interact better.

Because lots of people have made computers more creative. We want computers to make lots of people more creative.

So please take a look at what we've done. SJCC Booths 13015-16. But why wait, write Computervision, Northwest Industrial Park, South Avenue, Burlington, MA 01803, (617) 272-7240.

## **✓ Computervision Corporation**

Look. If you've got the computer, we've got the vision.



The  
Computer  
Store.

# The Computer Store.

Welcome to the Bloomingdale's of the computer industry. If you're shopping around at the SJCC for something nice in the way of a mini, drop in at the BIT booth. No.46020. You can get a swell little model right off the rack. And take it home with you. And if you're anything like a lot of OEM's we've been talking to lately, it should be a perfect fit. Our mini is the BIT 483. A fast number. With less than one microsecond speed, nobody's ever said, "Sam, you made the cycle time too long." And it's built like a brick one, too.

It's fantastically reliable and ought to give you much less down time than some of those stripped-down models on the market. What's more, for all its power, the 483 is really quite a simple machine and easy to learn how to run. (If you're looking for that sort of thing, you may be interested to know it was one reason BIT recently decked

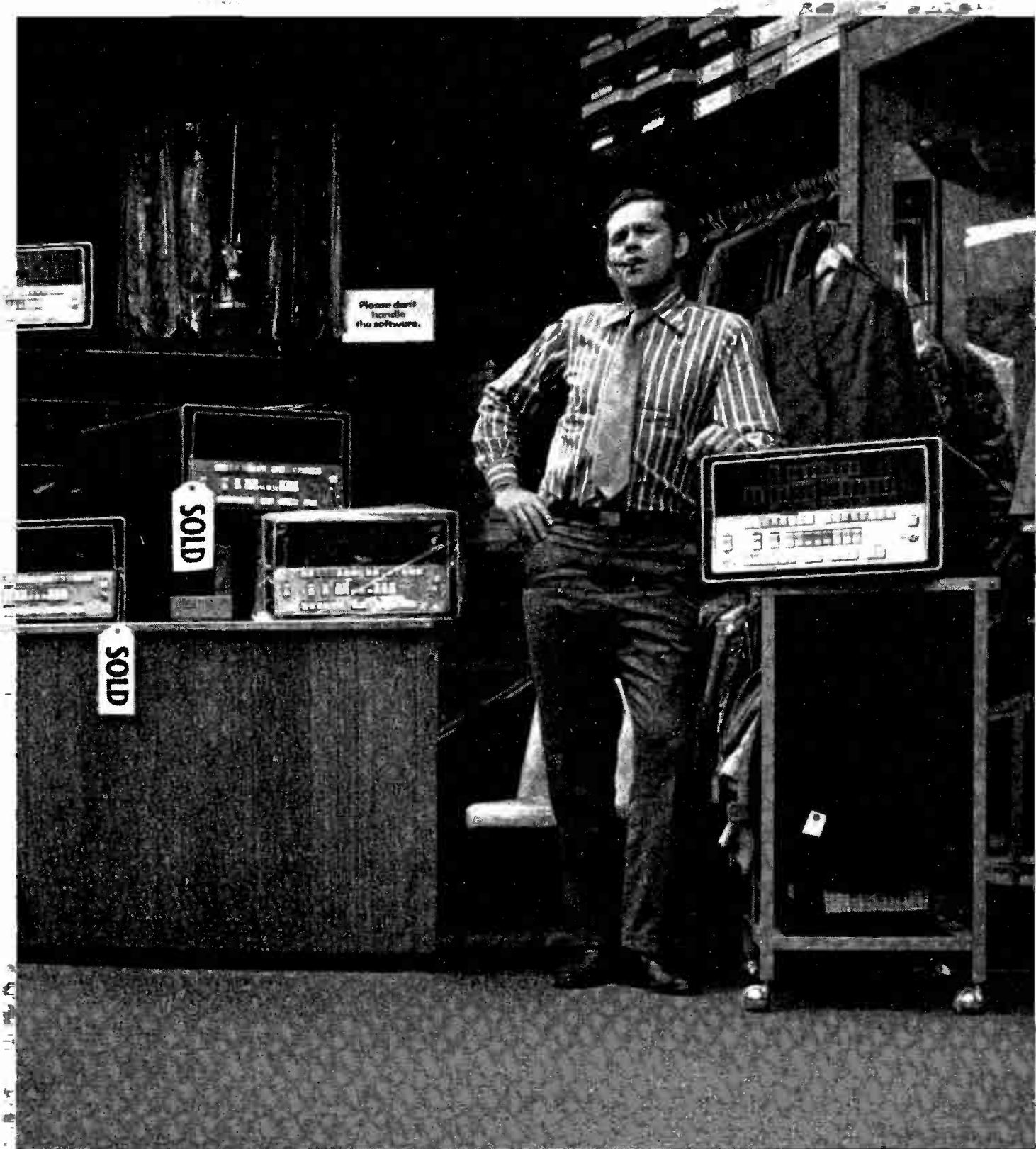

The BIT 483 is a general purpose digital computer to contend with: proven design performance and unparalleled problem solving capability; BYTE orientation; variable word length; cycle stealing data channel; expansion to 32K memory within the same box; binary and decimal arithmetic; priority interrupt; and a complete line of I/O options. These are what make the BIT 483 the price/performance champion of the minis. And as the company that's popping them off our production line like so many two-pants suits, we're here to say we stand behind our merchandise. We produce in volume and we service what we produce. Come into the Computer Store for a little shop talk, a little demo. And maybe you can walk out with a little computer under your arm.



BIT INCORPORATED  
5 Strathmore Road

Circle 91 on reader service card

**DELAY GENERATION  
SCRATCH PAD MEMORY  
REFRESH MEMORY  
INPUT-OUTPUT BUFFERING  
DATA ACCUMULATION  
AND OTHER APPLICATIONS**

GENERAL INSTRUMENT ADVANCED NITRIDE TECHNOLOGY PRODUCTS

**GIANTS<sup>TM</sup>**

**do it  
better**

**WITH DUAL 50-BIT  
AND DUAL 64-BIT  
STATIC SHIFT  
REGISTERS**

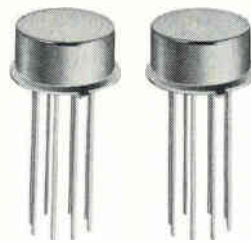



# Now... GIANT Dual Registers – with exclusive TTL, DTL and MOS compatibility – provide performance, reliability and cost advantages previously unattainable in serial storage applications.

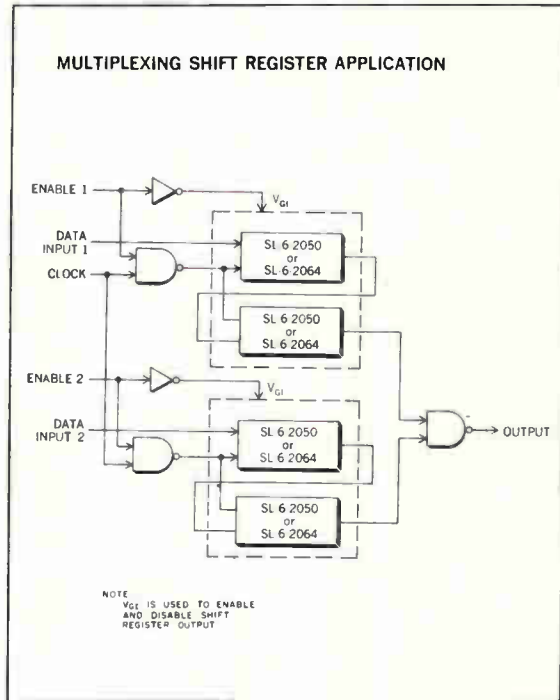
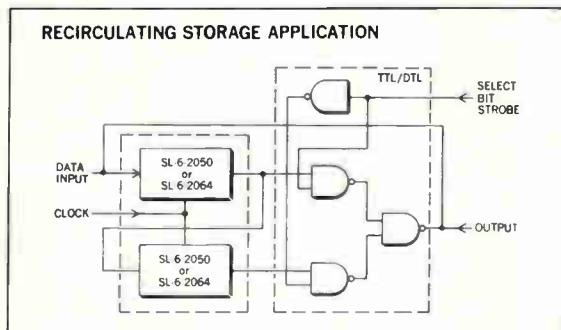
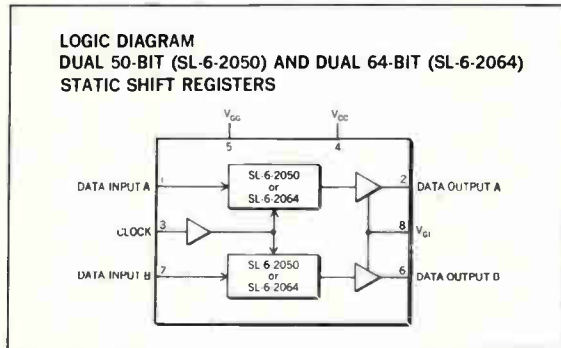

Among their various and marked advantages over bipolar and delay line serial storage systems, General Instrument's GIANT Dual 50-bit and Dual 64-bit DC shift registers operate with the lowest power dissipation available for static registers . . . a mere 7 milliamps typical.

The GIANT Dual 50-bit and Dual 64-bit shift registers operate over the full military temperature range of  $-55^{\circ}\text{C}$  to  $+125^{\circ}\text{C}$ .

The well known performance and reliability advantages inherent to all MTNS (Metal-Thick Oxide-Nitride-Silicon) devices are, of course, present in these GIANT shift registers. They are directly compatible with TTL, DTL and MOS and require no interface electronics.

A perusal of the comparison chart (above right) should make clear the fact that in serial storage applications insofar as performance, reliability and cost savings are concerned . . . "GIANTS do it better."

The GIANT Dual 50-bit (SL-6-2050) and the Dual 64-bit (SL-6-2064) DC shift registers are available from your au-

Parameters	Delay Line & Interface Electronics	GIANT Dual Shift Registers
Power Requirements	200 mA Typical @ $\pm 12\text{ V}$	7 mA Typical @ $+5\text{ V}, -12\text{ V}$
Size	6" x 1" x 1/2" Typical	.370" Dia x .260" H (TO-77)
Weight	1.5 lbs.	1 gram
Number of Parts	50-75	1
Operating Temperature	$25^{\circ}\text{C}$ $+20^{\circ}\text{C}, -10^{\circ}\text{C}$	$-55^{\circ}\text{C}$ to $+125^{\circ}\text{C}$

thorized General Instrument distributor. For full information write General Instrument Corporation, Dept. 56, 600 West John St., Hicksville, L.I., N.Y. 11802. (In Europe to General Instrument Europe S.P.A., Piazza Amendola 9, 20149 Milano, Italy; in the U.K., to General Instrument U.K., Ltd., Stonefield Way, Victoria Rd., South Ruislip, Middlesex, England.)

Price in quantities of 100 pcs.: SL-6-2050 @ \$13.00 ea.; SL-6-2064 @ \$16.75 ea.



GENERAL INSTRUMENT CORPORATION • 600 WEST JOHN STREET, HICKSVILLE, L. I., NEW YORK

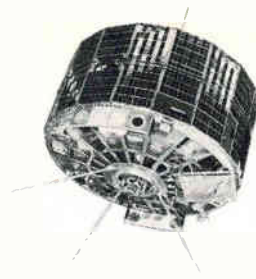

FROM  
**Weather "Bird"**  
TO  
**Tropo-scatter**  
**in one quick**  
**frequency change**

**MCL's 2-1/2-KW PLUG-IN CAVITY**

Giving a big assist to the Department of Commerce's Satellite tracking command is MCL's 2.5KW plug-in amplifier, an integral part of the up-link command transmitter. This high-powered cavity unit supplies the signal power so vital to the telemetry communications of the ESSA Satellite (Environmental Survey Satellite) or the Weather Bird.

Adaptability to a wide range of frequencies gives the MCL amplifier system almost limitless applications in other command communication channels.

Tropo-Scatter, for example, is used by oil companies as a communications' link in the Sahara desert. Other applications include testing equipment for checking out antennae, laboratory and field testing.

A conference call to MCL engineers just might put you on the right wave length regarding your application needs.

Call (312) 354-4350 or send for **MICROWAVE MARKETPLACE CATALOG**—Edition "A".

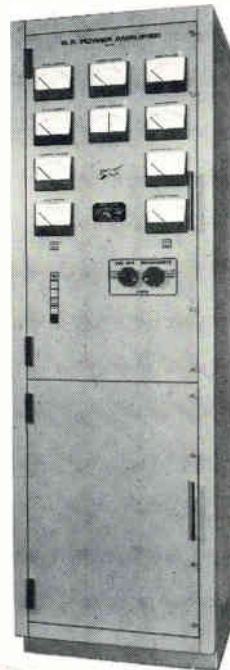

**MCL** **MICROWAVE CAVITY LABORATORIES**  
DIVISION OF KMS INDUSTRIES, INC.

10 North Beach Avenue, LaGrange, Illinois 60525

# Technical Articles

---

**Bell's money rides millimeter waves for communications**  
page 96

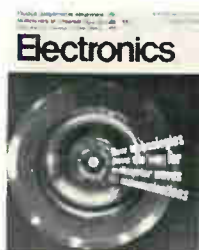

With communication lines expected to be severely taxed sometime in the near future, the Bell System is putting a strong effort behind an underground millimeter-wave system to provide the required increase in capacity. The system is still in the experimental stage, but the key elements stem from advances already made in the state of the art of high-frequency silicon Impatt diodes, p-i-n diodes, and cavity structures that allow wide-band tuning.

**CAD goes beyond first-generation programs**  
page 109

First-generation computer-aided design programs have been around since 1965. But many improvements have been incorporated into an upcoming second-generation of CAD programs. *Electronics* has prepared a foldout chart that summarizes the features and capabilities of both groups.

**Getting top performance from analog multipliers**  
page 114

With multipliers finding new uses beyond analog computers, a new problem arises: specifications that serve the computer may not do for such applications as signal processing and telemetry. The user can determine the multiplier specifications that best fit his needs by gauging the errors he encounters in his circuit.

**Three ways to build low-threshold MOS**  
page 118

Combining compactness, low cost and high speed in a circuit often calls for combining MOS and bipolar circuits. Establishing the interface between them becomes easier when both have the same low threshold voltages. There are three available methods for attaining low-threshold MOS, and each has its tradeoffs.

**Adding third harmonic cancels distortion in acoustic coupler**  
page 124

The nonlinear characteristics of a telephone handset's carbon microphone introduce second-harmonic distortion in acoustic data couplers, limiting telephone-line use to those with attenuation 21 db below the transmitted signal. But proper introduction of the third harmonic can eliminate the distortion, allowing use of lines with 31 db of attenuation.

---

## Coming

**R-f power transistors**

Although lagging behind the U.S., Europe and Japan are moving ahead strongly in r-f power-transistor technology. While trying to attain higher watt-megahertz values, overseas firms are emphasizing high efficiency and broader bandwidths.

# Bell's money is riding on millimeter waves for future communications

High-performance Impatt and p-i-n diodes, and wideband tuning are the keys, says **Laurence Altman** of Electronics' staff

● Capacity is the name of the game in the telephone industry. And with new and expanded services—telephone, Picturephone, data links—certain to strain capacity, Bell Laboratories is putting its technological muscle behind an underground millimeter-wave system. Bell's experimental work in the essential elements of the system has already furthered the state-of-the-art by producing silicon Impatt diodes that put out 100 milliwatts at frequencies in excess of 100 gigahertz, cavity structures that make possible tuning over approximately a 10% bandwidth in the 50-GHz range, and new high-speed switching diodes. In addition, the Laboratories have developed the theory and conducted extensive experiments to transmit millimeter waves through waveguides at every low loss.

Until recently, reliable solid-state electronic devices for the repeaters that periodically regenerate the millimeter waves signals during long distance transmission simply did not exist. Primarily, because reliability was lacking—and because anticipated “traffic jams” were far in the future—AT&T, Bell's parent, decided to put off millimeter wave system development work in the early 1960's, although research was actively pursued.

But the emergence of continuous-wave solid-state Impatt millimeter wave sources that could operate reliably in this frequency range with sufficient power—100 mw and above—at room temperature was the key

technical development that got Bell's millimeter-wave communication systems back on the planning board. In addition, the gallium arsenide Gunn diode operating in the limited-space-charge-accumulation (LSA) mode—also a Bell invention—showed great promise in the 50-to-100 GHz bandwidth.

Using these new devices, a 50.4 GHz solid-state experimental repeater—the regenerating link vital to a long-haul system—was built at Bell's research facility in Crawford Hill, N.J. Several methods of millimeter-wave generation were considered: an LSA diode operating directly at the millimeter-wave frequency; a 12.6-GHz Impatt driving a quadrupler to obtain the millimeter-wave power; and a 50.4 GHz Impatt oscillator, developed later.

Invented by John Copeland at Bell labs, the LSA diode was the first power source to be used successfully in the Crawford Hill repeater. It seemed the ideal millimeter wave source with its potential of covering the entire millimeter wave band with high efficiency and high power. In fact, successful operations in Bell's experimental repeater of a low power version made a considerable stir in communication circles.

Ironically, the LSA diode will not be used in Bell's initial repeaters. Material problems with the GaAs in LSA devices have not yet been solved, even in the laboratory. Because of this, Bell planners felt that the

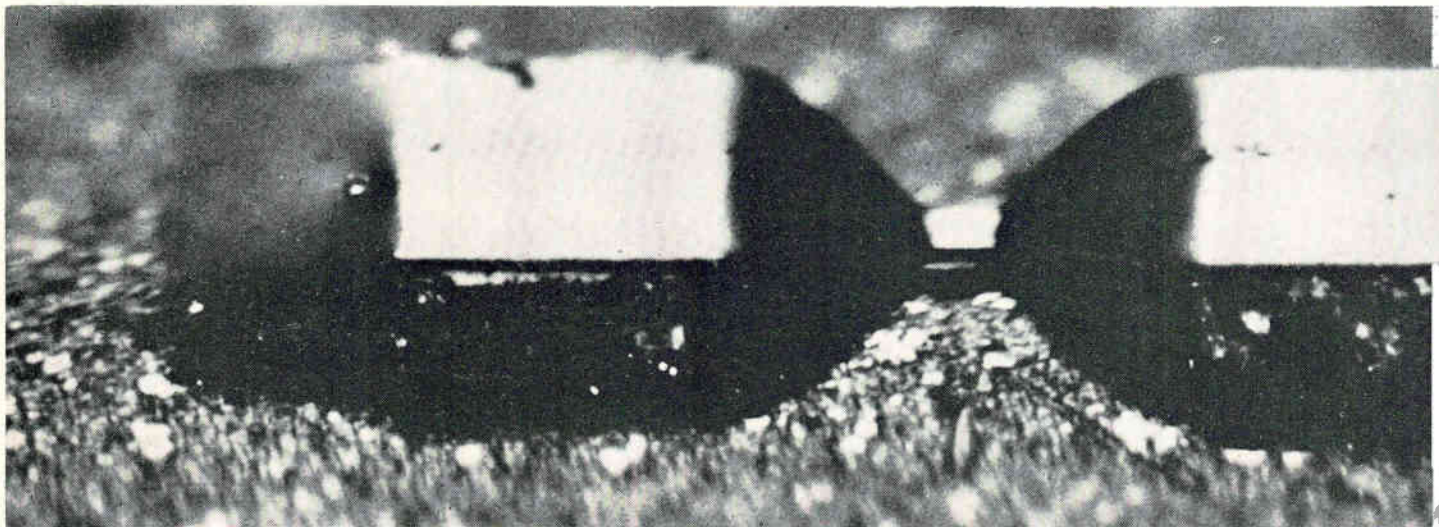

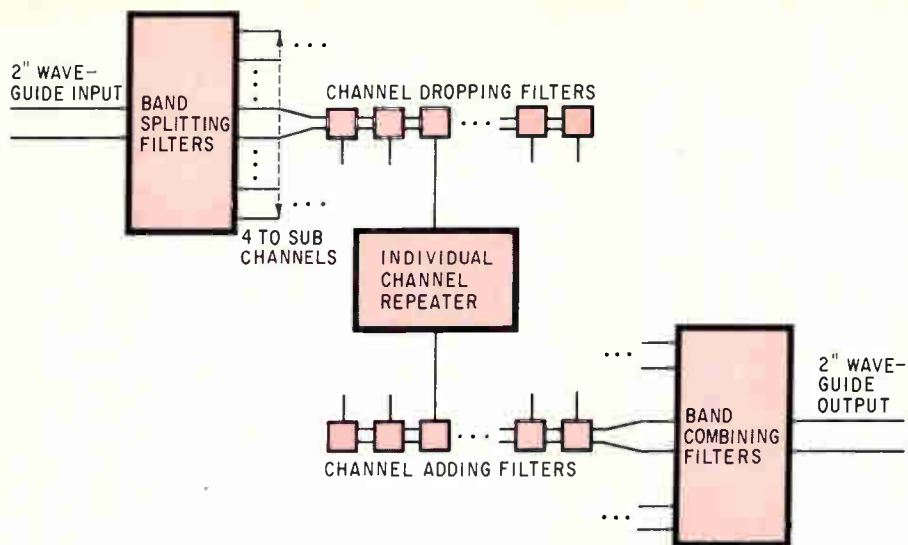

Again and again. In a typical repeater station, band-splitting filters will divide the 70 GHz band into sub-bands which are passed to individual channel repeaters by channel-dropping filters. After a new modulated millimeter-wave signal is reconstructed, channels are added, and the band is recombined and transmitted.

LSA device could not at this time offer the required reliability. In addition, the Impatt-harmonic generator, one of the modulating schemes used in the experimental repeater, has also become less attractive as powerful fundamental Impatt oscillators in the millimeter wave region have become available.

Consequently a silicon Impatt diode operating at millimeter-wave frequencies will be used in the first repeaters that are being built for system trials scheduled in 1974. Impatts can cover the system's frequency band (a 110-milliwatt Impatt operating at 110 GHz was announced by Bell at the Submillimeter Wave Symposium held earlier this month). And significantly, Impatts use silicon as the active semiconductor material instead of gallium arsenide, whose higher carrier mobility is required for LSA operation. Silicon technology is far better established than GaAs, which needs a substantially higher degree of purity than does silicon. These new silicon Impatts are required in both ends of the repeater as a local oscillator and as a power source.

Repeaters are signal-handling centers which regenerate the signals from point to point at discrete intervals on the long-distance route. In the proposed millimeter-wave system, incoming carrier signals, digitally coded with information—voice, data, Picturephone—will enter repeaters from the waveguide, where they will

be detected, amplified, regenerated, and transmitted to other repeater stations down the line. The waveguides form the transmission lines that connect one repeater to another. Each repeater station will be capable of handling a total of 120 channels (four of which are spares)—60 in each direction. Thus each repeater station—installed in manholes—will have 120 independent repeater circuits.

A repeater has four major functions: down-conversion and i-f amplification; detection, where the i-f digital signal is demodulated to baseband and a timing signal is derived; regeneration, where a new, undistorted, digital baseband signal is generated and modulated onto the carrier; and transmission, where the signal is routed into the waveguide.

Although the repeaters scheduled for the proposed system will be based on the earlier experimental version built at Crawford Hill, there are a few essential differences. Besides the use of Impatts instead of the LSA diodes, the current repeaters will modulate directly at millimeter-wave frequencies instead of up-converting. In the Crawford Hill model, it was necessary to modulate an i-f carrier with the baseband signal and then pass the signal through a varactor multiplier to get the modulated millimeter-wave signal. This method was used because, although solid-state millimeter wave sources were available for use as local oscillators, none

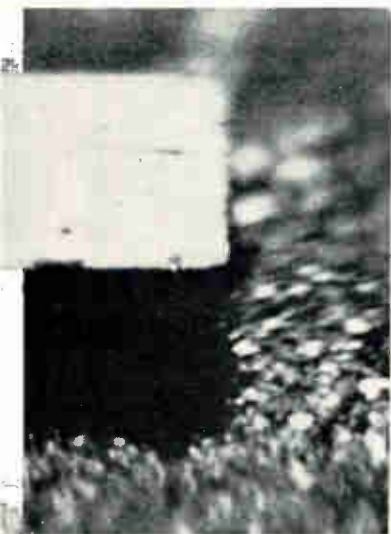

The Impatt's the thing. The silicon Impatt diode shown in the center of the photograph probably is the most important new component Bell Labs developed for its millimeter-wave communications system. Capable of 100 milliwatts of continuous power in the 40-110 gigahertz band, it will provide the source of millimeter-wave energy for the first systems Bell plans to build.

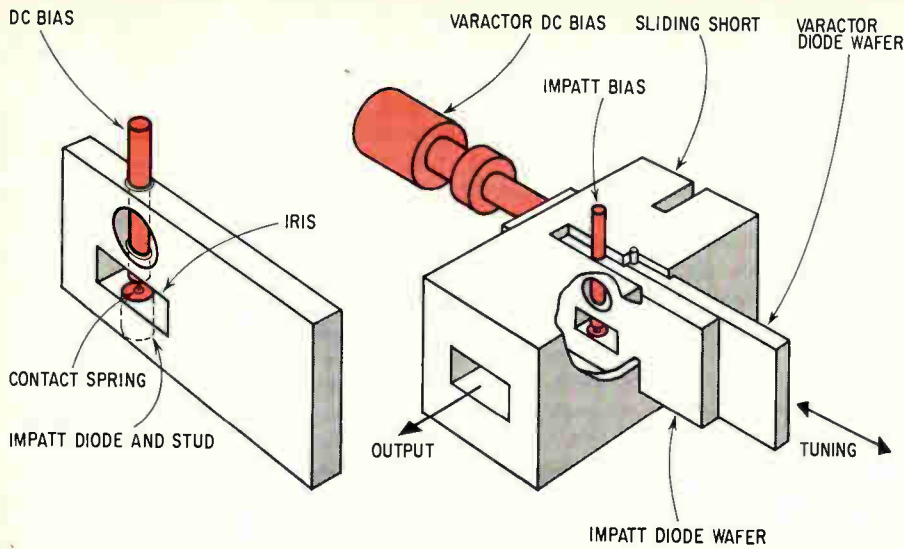

**Tune up.** For operation as a wideband (10%) millimeter-wave source, an Impatt diode can be set into a resonant-iris structure, left. The iris aperture's size, shape, and thickness determine the range of oscillation frequency. Tuning is accomplished in an oscillator mount, right, where the iris wafer with its Impatt is mounted along with a varactor diode. The relative coupling between the Impatt diode and the varactor diode (and thus, the tuning characteristics) can be adjusted by varying the relative position of the two diodes.

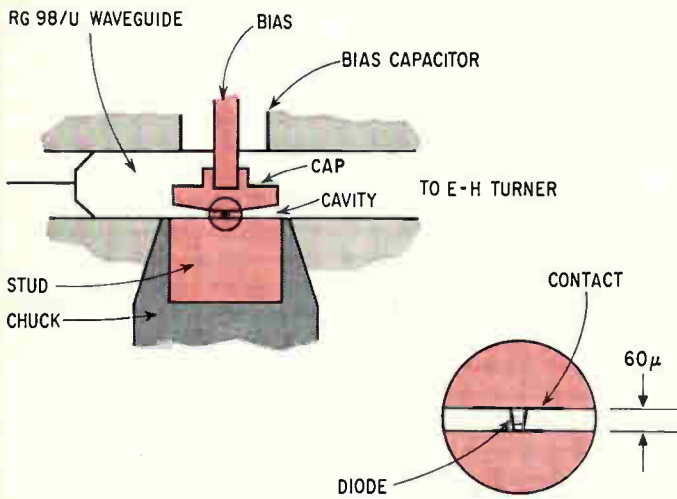

could deliver the required 100 mw of power. However, with the advent of the new Impatts, which can supply more than enough power, the up-converter—and with it, its 6-decibel loss factor—was eliminated. By modulating the Impatt diode at millimeter frequencies, Bell can obtain power at least an order of magnitude greater than with up-conversion.

**Bell is considering** several different methods of modulating millimeter Impatt oscillators. Among these are: frequency or pulse modulation of the diode directly, and a pulse modulation scheme (path-length modulation) external to the diode. The latter has the property of separating the oscillator and modulating functions, thus making it possible to optimize both functions independently.

For the frequency-modulation method to be most useful in a wideband millimeter wave system, the Impatt diode oscillator must be tunable over a wide range, with bandwidth effectively determining the amount of information that can be impressed onto a given oscillator output. Ordinarily, the Impatt diode oscillator circuit uses a radial-line resonant cavity, whose resonant frequency determines oscillation frequency. Since Bell needs a large quantity of Impatts operating at different frequencies in the millimeter band, and must be able to tune each during signal modulation, the ideal approach is with oscillators using one diode structure that could

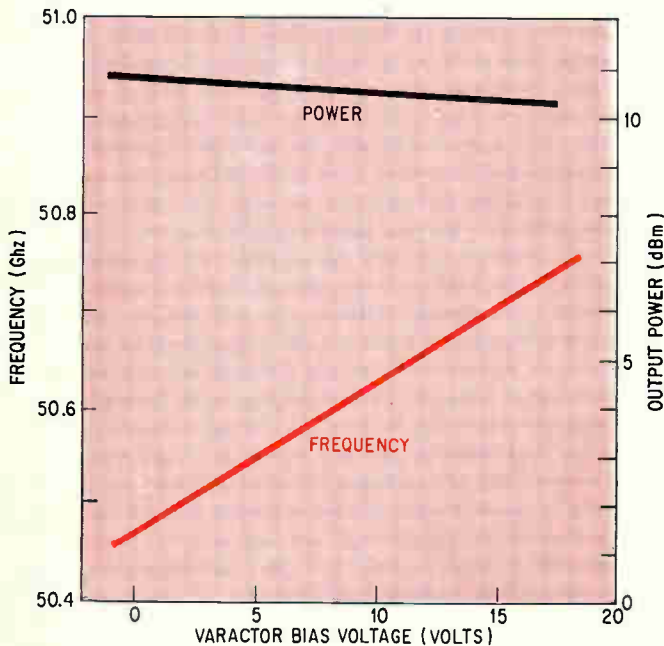

**Radial route.** Impatt diodes also can be mounted in a radial-line cavity. An older arrangement than the iris structure, coupling between the cavity and the waveguide is adjusted by a tuner and sliding short. Since the frequency is determined mainly by the size of the cavity, the sliding short provides only a 2% tuning band. When varactor tuned, the output frequency could be varied by 300 Mhz, but the output power drops, as shown in the graph.

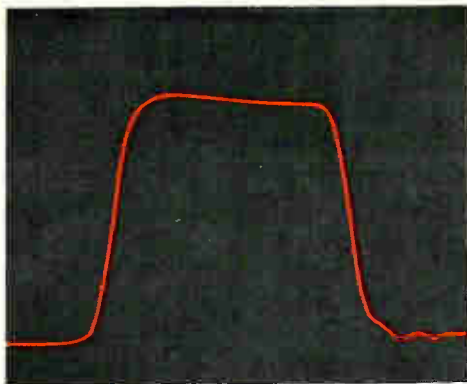

BASEBAND PULSE

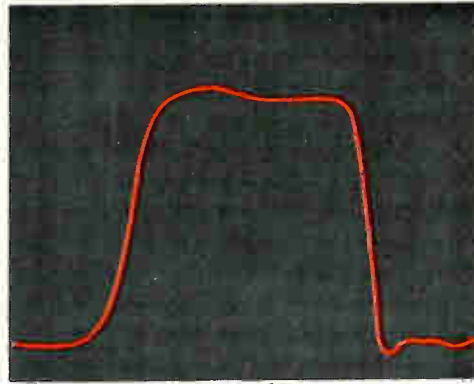

FM-PULSE

**True Grit.** Direct frequency modulation of the Impatt diode—variation of the oscillation frequency by varying the bias current—can be accomplished with almost no distortion of the original modulating baseband pulses. An input baseband pulse, left, before modulation, a detected f-m pulse, right, after modulation, show almost no increase in rise time or distortion.

be tuned with the same cavity structure.

But because the cavity inductance in shunt with the diode is much smaller than the equivalent diode inductance, the radial-line cavity configuration is difficult to tune either mechanically or electrically. Therefore even large changes in the cavity inductance have only a very small effect on the diode. In fact, the oscillation frequency could only be tuned a few hundred megahertz by varying the diode bias current; a tuning range of only 300 Mhz could be obtained, even with a varactor deviating the frequency, primarily due to the load of the external circuit coupled to the cavity.

To improve tunability, the Impatt diode's equivalent inductance must dominate that of the other circuit elements.

Bell did it with a recently developed resonant iris cavity that produces the desired wideband tunability. The iris, or millimeter wave opening, is made in a thin wafer which is mounted in an oscillator cavity assembly. Oscillation frequency range and the Q of the iris are determined by the thickness, size, and shape of the iris aperture. Different irises can be used in channels of different frequency ranges to achieve the band of frequencies used in the system. For Impatt diodes operating in the 50-60 Ghz range, the wafers can be 0.100-inch thick with a rectangular aperture 0.010-0.030 inch high and 0.100-0.148 inch wide.

With this structure the diode equivalent inductance dominates in the circuit. In recent test with a loaded Q of about 10, varying the bias current of the diode and thus varying the diode equivalent inductance, oscillation frequencies were tuned over 9 Ghz in the 50-60 Ghz range—almost 10%, and an order of magnitude greater than the radial-line cavity structure.

**Two approaches** using this cavity structure can achieve direct frequency-modulation of the Impatt. One method uses a varactor diode to tune the circuit; another achieves modulation by varying the bias current to change diode inductance. Both methods have trade-offs that must be considered. Although the circuit is much more complex with the varactor-tuned oscillator, the power output of the oscillator remains almost constant over the frequency band, resulting in negligible amplitude modulation. On the other hand, an oscillator tuned via its bias-current has simpler circuitry, but power output varies with bias current, causing a-m distortion. And removing the distortion requires further circuit processing.

The other Impatt modulating approach uses a path-length modulating circuit. This requires a diode switch with micron dimensions for operation at millimeter-wave frequencies. The diode must withstand the 100-mw c-w power levels of the Impatt, and perform at subnanosecond switching speeds. To attain this speed, Bell

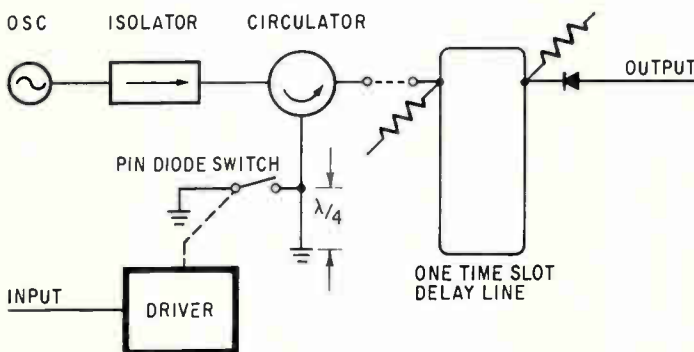

**Proper path.** Path-length modulation of an Implatt diode uses a p-i-n diode as a switch to change the phase of the millimeter wave. The input to the diode is the baseband signal; the output of the time slot delay line is a baseband-modulated signal.

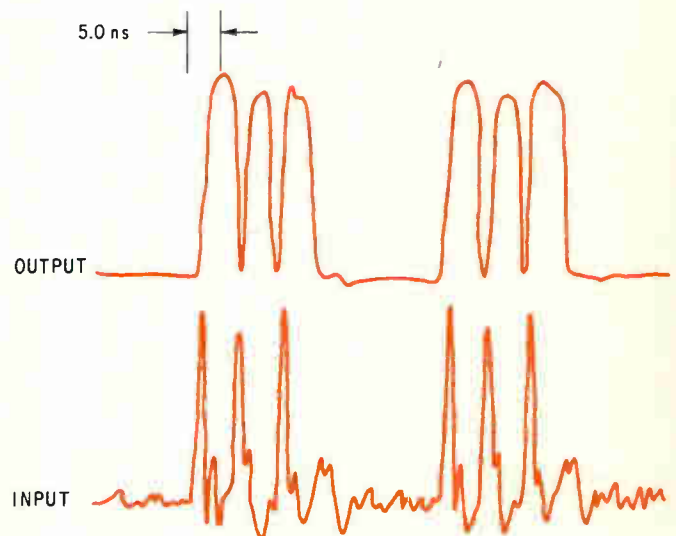

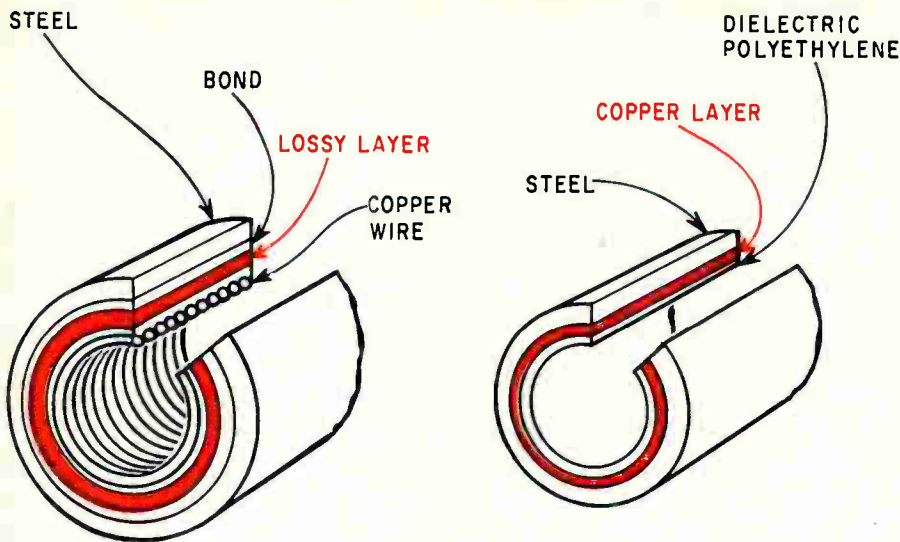

**Waveguide ways.** Although two types of waveguide section will be used in Bell's millimeter-wave system to eliminate unwanted modes, the dielectric-clad sections are cheaper to fabricate and will be used wherever possible. However, at bends and other points in the line where mode production is particularly severe, the helix waveguide will serve as a filter, removing all but the low-loss  $TE_{01}$  mode.

scientists developed a p-i-n diode switch with an intrinsic doping "i" region only 2 to 3 microns deep. The switching speed is approximately 0.7 nsec—0.5 nsec reverse-to-forward and 0.7 nsec forward-to-reverse when driven by 50 ohms. This falls well within system requirements for high-frequency oscillator modulation. Moreover, the diode loss at 50-60 Ghz is only about 0.7 in both states, and it can handle more than 100 mw of oscillator power.

**The switch's basic function** is to serve to change the phase of an Impatt oscillator signal, which is fed into the switch through one port of a circulator. The switch is driven by the baseband pulse train; it closes when a pulse is present, and opens when there is no pulse. When it's closed, the millimeter wave is reflected from the switch back to the circulator. When the switch is open, the wave passes through and is reflected at a ground point a quarter-wavelength past the switch, so that when the reflected wave again reaches the circulator, its phase is changed by  $180^\circ$ . The signals, either phase-changed or not, depending on the presence of a baseband pulse, pass out of the circulator to a time-slot delay line which yields a pulse output only when there is a phase change. This pulsed output, which is transmitted down the waveguide, therefore is a duplicate of the original baseband binary code at the millimeter-wave frequency.

Recent experiments by Bell Labs using p-i-n diodes to modulate an Impatt at millimeter-wave frequencies in high-speed switching circuits have appeared promising enough to warrant further development for system trials in 1974. Loss, speed, and power handling capability of this method makes it a strong competitor of direct frequency deviation.

Although improvements still are being made in the performance of the silicon Impatt diode sources, the structures developed by T. Misawa, a Bell scientist, over the past year or so will most likely serve as the Impatt model. Previously, avalanche diodes operating in the Impatt mode routinely have been pulsed yielding substantial output power in the 50-100 Ghz range—even to 300 Ghz and above. However, these pulsed diodes, which have conventional linearly-graded junction structures, require too high a current density for feasible c-w operation at about 100 mw. At this power level, linearly-graded junction devices dissipated enough heat to cause rapid degradation.

The answer was to develop fabrication methods that allow construction of abrupt junction structures, which have narrower avalanche regions than the linearly graded junctions. Because of this, much less current density is required for diodes operating at reasonable efficiency—say about 3%. Moreover, with shallower junction depths, which are required to make abrupt junctions, and

**Low loss.** In attenuation tests conducted on a two-mile underground waveguide course, total line attenuation including  $40^\circ$ - $90^\circ$  bends (graph, upper left) measured approximately 4 db per mile in the 50-60 Ghz range. Straight-length attenuation (lower left) was only about 2.5 db per mile, decreasing with increases in frequency. Since the bends in an actual system will be very slight, overall system attenuation is expected to be no more than 3 db per mile, allowing repeater spacing between 25-30 miles. The graph on the right shows attenuation for various bends, the sharper the bend the greater the loss.



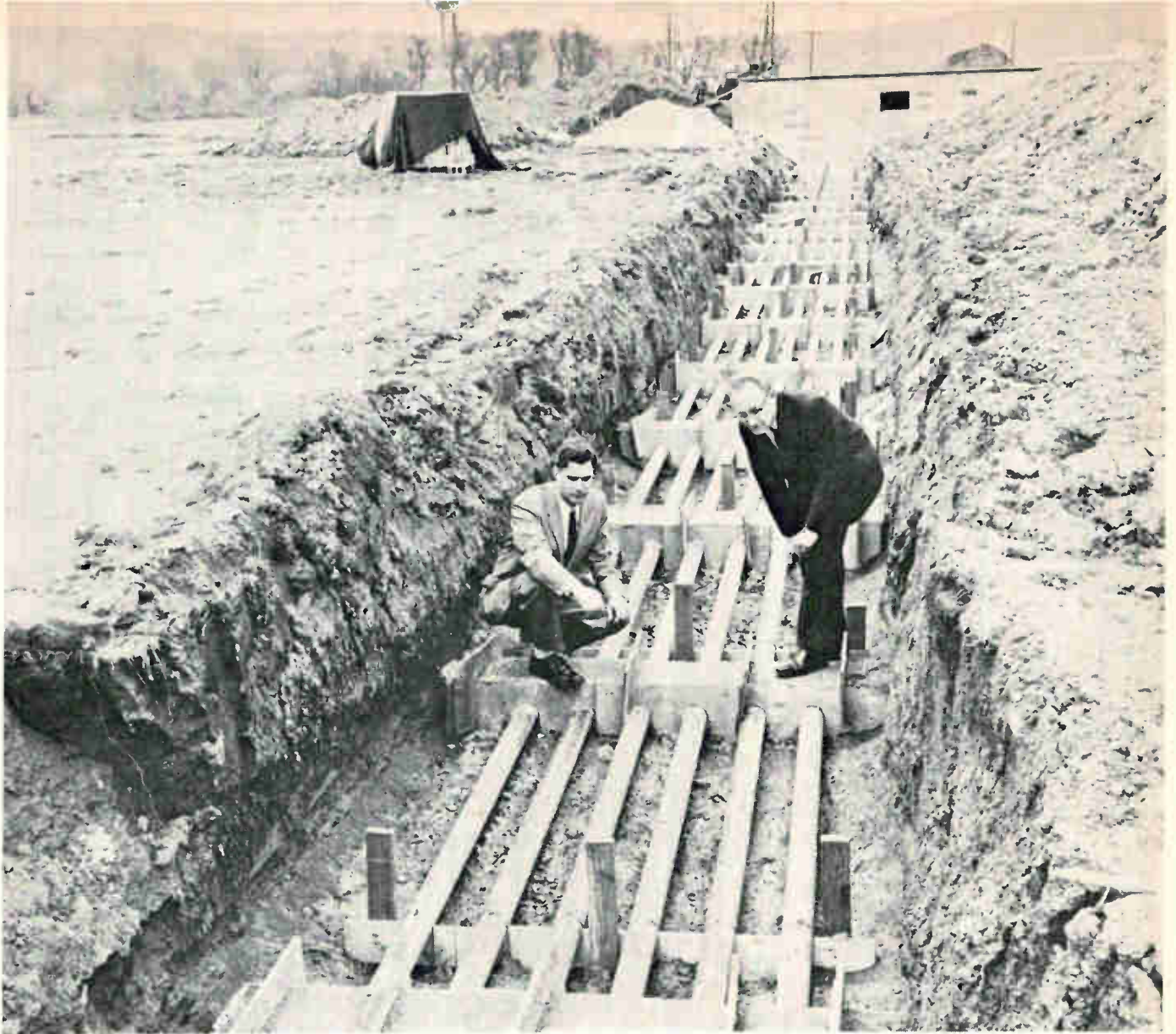

**Ditched.** A series of experimental waveguide sections was installed to test signal attenuation. Since the cost of trenching is very high, parallel guides could be installed in each ditch, and used when demand warrants.

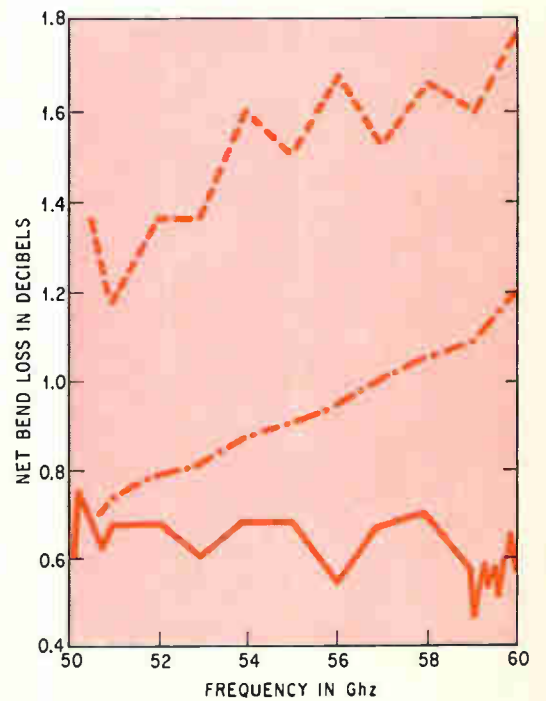
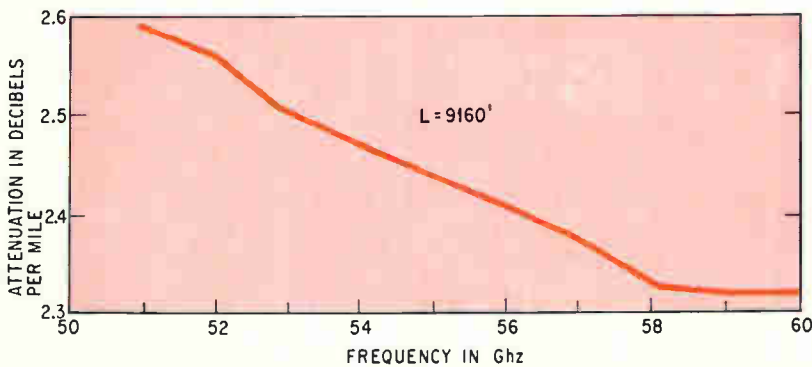
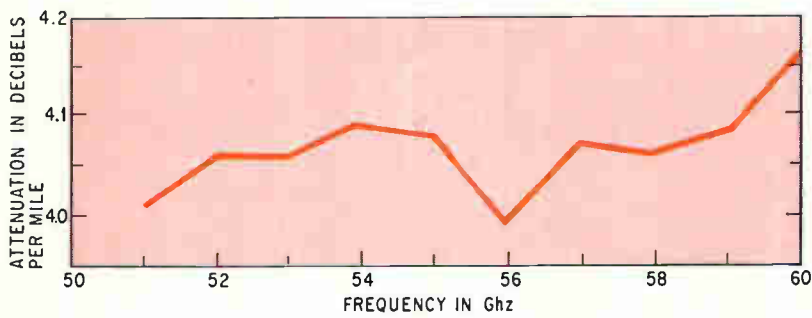

## Tracing a call

Bell's drive to operate a commercial millimeter wave system by the end of the decade assumes that Picturephone service—to be introduced commercially this year—will catch on in a big way. Since a single visual conversation will use the equivalent of 100 voice channels, the millimeter wave system, which will be designed to carry 240,000 voice channels simultaneously or combinations such as 1000 Picturephone signals, 100,000 voice channels, and  $2 \times 10^9$  bits per second of data, should fill the bill—at least temporarily.

There's always the possibility that traffic will grow to the point where even higher-capacity systems, such as laser communication networks, will be needed. But at present, development work on laser communications isn't nearly as advanced as that of millimeter wave technology.

Bell's planned digital national network that will culminate in the millimeter wave system will work as follows: a call leaving your home for a cross-country trip might be time-division multiplexed—along with 23 other calls—onto a T-1 pulse-code modulation system with a bit rate of 1.5 megabits. Four T-1 signals or their equivalent (96 voice channels or a single Picturephone signal at 6.3 megabits, for example) would be multiplexed into a T-2 line. Through successive stages signals finally would be multiplexed onto a single coaxial line carrying a 282-megabit signal. One hundred and twenty such lines or channels (four of them spares), will enter terminal equipment which will do the processing, such as modulating each of the signals onto a different millimeter carrier frequency. The modulated signals will then be frequency multiplexed and transmitted through buried waveguides. As in any transmission system they'll suffer attenuation and some distortion of the modulated pulse envelopes. However, at intervals of between 15 and 20 miles, signals will be separated by repeaters into individual modulated carriers. There, they will be demodulated and then regenerated so that fresh, non-distorted signals are transmitted over the next millimeter wave guide section to the following repeater.

Because of the pulse-code modulation, signal dis-

tortion won't accumulate with distance.

Unlike repeaters in analog systems, which are essentially amplifiers, the millimeter-wave system repeaters don't amplify both signal and noise. Instead, circuits determine whether or not a pulse is present in a time slot, and if a pulse is there, however distorted, a new, clean pulse is generated.

Finally, after going through many repeaters, the 70-gigahertz band is received at a distant terminal and eventually is separated into individual modulated carriers. At that point some channels may be demodulated back to baseband and routed over coaxial cable to other offices. Other channels may be substituted and then another millimeter wave link may be used to carry the 58 channel signal—with some different channels—to another toll office.

The first permanent commercial installation will most likely connect major cities—New York to Washington or New York to Philadelphia—wherever demand justifies increased capacity. Eventually the system will branch out to form major East-West and North-South grids—perhaps three in each direction. As in all of Bell's installations, economic factors, rather than just technological readiness, will decide actual use.

If all goes well, the equipment will be ready by the end of the decade. Although no firm timetable is set, a one-channel breadboard repeater should be ready by the end of year; from this a brassboard model will be constructed and made ready for the trials scheduled for 1974. A parallel effort is under way to develop for the trials a waveguide design suitable for long-distance transmission.

Building the low-loss, 2-inch, waveguide for production and getting it into the ground is perhaps the major remaining developmental task. These factors demand that the waveguide be free of imperfections and that its installation in the ground be as straight as possible—Bell has calculated that where possible only bends with large radius of curvature should be used to yield the required unwanted mode production and attenuation levels.

The straightness requirement will of course complicate the installation. Current figures on repeater gain and waveguide attenuation—in the 3-decibel per mile range—indicate that repeaters will be spaced at both ends of 15-20 miles of straight length pipe.

Bell is considering the use of special techniques such as laser programed trenchers and special airborne surveying equipment. And though Bell has neither the land-moving and grading equipment that highway departments have at their disposal, much of its installation work will be similar to a highway department. Much of the problem could be eliminated if Bell were allowed to use major state and Federal highway banks for some of the route, or railroad rights-of-way, thus eliminating a great deal of grading and surveying. But still the pipe must be buried below the frost line. And what Bell will do at large rivers, the Rocky Mountains and the Grand Canyon, and to pass through major urban areas is another question. Just getting land in many urban sections may be difficult enough.

Another installation problem will be determining the lay of the land, not just on the surface but down to a six-foot depth. Hidden rock formation and high ground water levels in the path of the waveguide could raise the cost of installation to prohibitive levels and therefore must be avoided wherever possible. Consequently, geological data is being gathered on many areas that could be selected as waveguide routes.

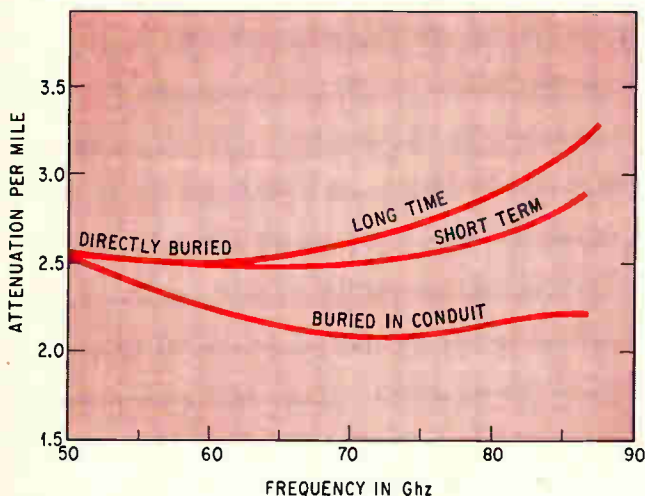

Buried alive. By burying the waveguide in a conduit, attenuation over the long term is reduced by 0.6 decibels and 0.3 db over the short term.

with upside-down (flip-chip) mounting, the current density can be continuously maintained without excessive heating.

Typical abrupt junctions with acceptor depths of 0.5 micron were made by diffusing boron into an n-type epitaxial layer with uniform doping. Epitaxial thicknesses of 1.5 to 2.0 microns and space-charge layer widths of about 0.5 and lower were achieved in the fabrication. With these devices Bell obtained output powers up to 150 mw in the 50- to 84-Ghz range.

The diodes unencapsulated were placed in a standard rectangular M-band waveguide. A metal rod was brought down through the waveguide to make a pressure contact to the diode. A small local cavity was formed around the diode by placing a shaped metal piece of the tip of this rod—thus forming a localized cavity directly around the diode inside the waveguide. The oscillation frequency then was determined principally by the size of the cavity, and coupling between the cavity and the waveguide could be optimized by a combination of a movable short in the back and a suitable tuner in the front.

To reach the upper end of the proposed bandwidth—the 110-Ghz range—similar Impatts with lower breakdown voltages have been operated at 106 Ghz at c-w output powers of 37 mw, about one-third the required power. However, very recently Bell Labs reported on

100-mw c-w operation of an Impatt, a development that ensures the entire system range of 40 to 110 Ghz.

**One of the essential** components of a millimeter wave system is the waveguide—the transmission line of the system. Although waveguide theory and some preliminary laboratory designs have been around for some time, performance outside the lab has been largely nonexistent. And since millimeter-waveguide transmission is a new technology, offering no previous models on which to base system designs, it was exceedingly difficult to project laboratory results into actual performance. Therefore, Bell's major waveguide effort now is to develop laboratory-built waveguides into rugged underground systems suitable for the long haul.

The job has been complicated by the delicate nature of handling millimeter transmission in waveguides. The usual rectangular waveguides employed for years in microwave transmission can not be adapted to millimeter wave frequencies because attenuation is too high at these frequencies. Long distance transmission requires circular guides which has a cross-section larger than a wavelength. But unlike rectangular guides, which can support only one mode of transmission at a time, these circular guides can support many, all but one of which are unwanted, and eventually these unwanted modes can show up as noise at the receiver.

Of all the multi-modes that can exist at millimeter wave frequencies in circular waveguides, only one family of modes—the circular electric ( $TE_{0n}$ ) pure modes have less attenuation as the frequency increases, the low-loss mode being the  $TE_{01}$  mode. Using this low-loss mode, the high frequencies—the higher the better—of millimeter waves can be used without the usual attenuation associated with waveguide transmission. And the higher the frequency of the carrier the wider the band width and the greater the information handling capacity of the system.

However, there is an important tradeoff. To realize the desirable attenuation properties of the circular electric mode, the diameter of the waveguide must be large compared to the wavelength. But for a given wavelength, as the waveguide diameter is increased, so is the production of unwanted modes. Therefore a compromise between wavelength and diameter must be made. In the frequency range of, say, 40-110 Ghz, a waveguide diameter of about 2 inches seems optimum in all respects; it still permits the low-loss transmission of the circular electric mode, while at the same time does not make multi-mode production so severe as to render the system impractical.

In addition, the 2-inch-diameter waveguide is small enough to allow economical production, helping to minimize material costs.

**The mode problem** is further compounded by the ease with which some spurious modes are produced during transmission and are reconverted back to the low-loss circular-electric mode. Even if a mode transducer could generate a signal consisting only of the circular-electric mode during transmission, any imperfection, bend or kink in the waveguide will produce other modes. Further complication results from the fact that these undesirable modes, traveling at a slightly different velocity than the low-loss circular-electric mode, can be reconverted back to the circular-electric mode when they encounter other waveguide imperfections or intentional bends

## Repeaters rule the route

Many of Bell Lab's major developments in solid state devices and circuitry will be incorporated in the repeater for its proposed millimeter-wave communications system.

In operation, the millimeter wave signal—a 40 to 110 gigahertz, frequency multiplexed, pulse-code modulated signal at a 282-megabits-per-second rate—enters the repeater circuit and encounters band-splitting filters which divide the 70-GHz band of the waveguide into sub-bands. Each of these sub-bands encounters a channel-dropping filter which separates individual channels for individual repeaters. Since Bell is planning a total of 120 channels—60 each way—there will be 120 identical repeaters, each operating at its own frequency. Together they make up a repeater station, which is installed in a manhole.

The signal from an individual channel first passes through a down-converter which translates the millimeter wave's frequency to the 1.3 GHz i-f frequency of the repeater. The down conversion is followed by a low-noise wideband transistor amplifier which provides 50 to 60 decibels of gain. The amplified signal then is used to lock in an oscillator, which serves as a limiter to remove amplitude modulation from the f-m signal, picked up during waveguide transmission.

The output of the phase-locked oscillator, further amplified by a second transistor amplifier with a gain of about 30 db, is injected into a phase detector which gives two output signals. One is a replica of the information-coded baseband signal of the sending repeater; the second is a timing signal for regeneration. Thus the detector provides both a timing signal, consisting of a sine wave at the bit frequency recovered from the transmitted signal, and a baseband information signal. The latter, with its 282 megabit/sec rate, then is applied to a regenerator along with the timing signal; the regenerator decides which of the bits was transmitted in each time slot. Thus the output of the regenerator is the digitally-coded baseband signal which is then used to modulate a millimeter wave oscillator directly or drive a p-i-n diode path-length modulator. This, together with an external oscillator, will again provide the modulated millimeter wave. This modulated signal then is combined with the signals in the other channels through a series of channel-adding filters and band-combining filters identical to those used at the input. The output then is passed through a  $TE_{01}$  mode transducer and launched down a 2-inch circular waveguide to another repeater manhole.

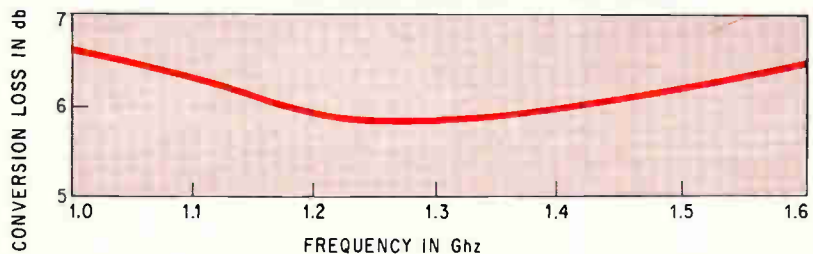
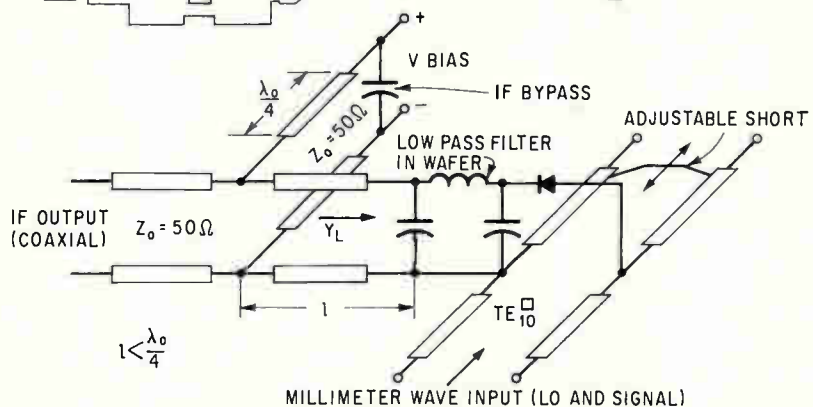
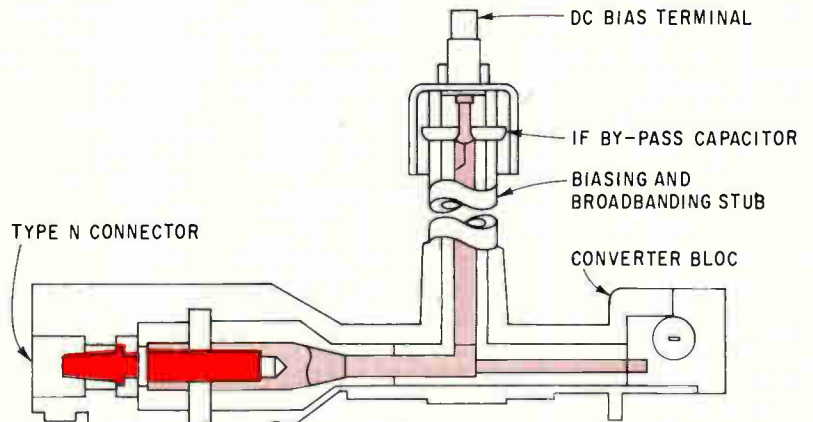
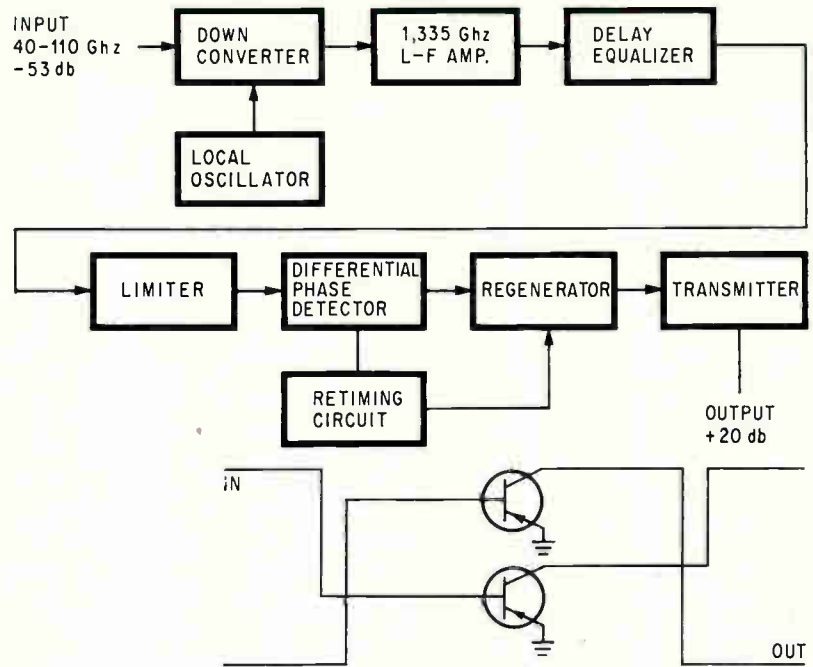

Hardware highlights. Shown are block diagram of the repeater, schematic of the i-f amplifier and the down-converter with its equivalent circuit. The amplifier has a noise figure of less than 4 db. Because of the good match between sections it can be cascaded to produce high gain—60 db. The conversion loss of the down-converter (graph) is approximately 6 db.

down the line. This causes spurious signals in the receiver and must be avoided. In fact, a great fraction of Bell's design effort is directed towards methods and components that will suppress these unwanted modes.

Modes that are most troublesome are those that are highly coupled with the circular-electric mode, the stronger the coupling the greater the ease of mode conversion and reconversion. Fortunately, all modes other than the  $TE_{0n}$  family require some current to flow in the longitudinal direction on the waveguide. In contrast, all the wall current in the  $TE_{0n}$  family flow only in the circumferential direction. Therefore, a circular guide, which is constructed from a stack of conducting disks insulated from each other would permit the  $TE_{01}$  mode to propagate properly but would inhibit the undesired modes. The behavior of this stack-disk type guide can be approximated by a helix wound waveguide. The helix consists of a closely wound insulated copper wire covered with a jacket of dielectric material surrounded by a coaxial metal shield for mechanical strength and general protection.

**Negotiating bends** and turning corners does require that some longitudinal wall currents exist, and even the helical type guide exhibits high loss in curves and bends. This problem can be solved by using dielectric-clad circular waveguides which consists of a metal tube first lined with a highly conductive copper lining followed by a dielectric lining about 7 mils thick. In unlined circular waveguides, the unwanted  $TM_{11}$  mode propagates at the same speed as the desired  $TE_{01}$  mode. In particular, in a bend the  $TE_{01}$  mode couples very strongly to the  $TM_{11}$  mode and would tend to produce severe losses because of the lossy propagation characteristics of the  $TM_{11}$  mode. The dielectric lining has very little effect on the  $TE_{01}$  mode but couples strongly to the  $TM_{11}$  mode, changing its velocity of propagation and thereby decouples the  $TM_{11}$  mode from the  $TE_{01}$  mode. In a practical system the dielectric lined guide is expected to be less expensive than the helix guide. It is planned, therefore, to construct the actual waveguide installation (both straight sections and bends) of a mix between the dielectric line and the helix guide, where the helix guide is used as a mode filter whenever the spurious modes have reached undesirable levels.

Besides unwanted mode production, attenuation is another important consideration. Given the repeater

gain, it will determine the length of a waveguide link before regeneration is required—the repeater spacing. Surface smoothness, bends, kinks, and other tube imperfections all affect attenuation. With current fabricating techniques, Bell figures that repeater stations can be placed from 15 to 20 miles apart; and to verify these expectations a two-mile helix waveguide course was built in the early 60's at Holmdel. The experimental course consists of a triangular loop of two parallel conduits buried below the frost line. The helix consists of #37 annealed insulated wire wound inside a steel pipe, and approximates the structure Bell hopes to use in its system. Constructed in 15-foot lengths, it is connected by precision-threaded couplings. The coupling is critical: seams increase both the attenuation and mode production.

**The course** consists of both of straight lengths and angle bends of various degrees—from  $42^\circ$  to  $90^\circ$ —formed by  $90^\circ$  mitered elbows back to back, with an adjustable rotary joint between them to give the specific angle. Since oxygen has several strong absorption lines in the millimeter-wave band, it was essential during the tests—as it will be in the actual system—to keep the waveguide filled under positive pressure with high-purity dry nitrogen. If a breakdown occurs, the guide must be flushed with nitrogen, pumped, and then refilled.

The results of Bell's experiment on this course have proven the feasibility of using the helix-wound waveguide for long-haul transmission—at least in the selected band of frequencies. Between 50–60 Ghz, over the two-mile loop, attenuation varied smoothly from 2.6 db per mile at 50 Ghz to 2.3 db per mile at 60 Ghz. This preliminary test indicates that with the expected repeater gain of approximately 80 db, repeater spacing from 15 to 20 miles should be attainable.

While the 15 ft of circular waveguide butted together to form the approximately 20 mile link are crucial, it would be to no avail unless they can be connected to the millimeter wave sources in the repeater station. To make this connection requires a very complex microwave splitting network. Starting with a 51 millimeter circular guide, the network splits the signal into 120 sub-bands to connect to the individual repeater. Since the source diode's resonant cavity in the repeater is rectangular, a mode transducer must be used that will change its propagating mode—the rectangular  $TE_{10}$ —to the system's circular electric mode.

This can be done with a composite waveguide structure consisting of several sections which generally have a tapered transition from rectangular to circular in cross-section, the dimensions of which depend upon the wavelength of the signal. Waveguide filter and wave splitting networks will be used that are tuned to the particular frequency sub-band of the repeater to which they are connected.

These networks can be quite lossy. In fact, losses in this small section of the waveguide can be as large as in the entire line between repeaters. Therefore, Bell is involved in extensive design and experimental work to make certain that network losses do not become so large that repeater spacing must be reduced, thereby greatly increasing the cost of the system across the country. Since repeater stations could cost \$1 or \$2 million, low-loss network are an essential economical factor in the system analysis. ●

# Designer's casebook

*Designer's casebook is a regular feature in Electronics. Readers are invited to submit novel circuit ideas and unusual solutions to design problems. Descriptions should be clear. We'll pay \$50 for each item published.*

## Unijunction device eliminates contact bounce

By Carl Brogado

Technetics, Inc., Boulder, Colo.

A simple way to eliminate the contact bounce from mechanical switches relies on a programmable unijunction transistor to generate a clean pulse. The unijunction transistor can be programmed from whatever supply voltage is desired, whereas other circuits containing integrated circuits are restricted to the IC's supply whose voltage must be filtered to prevent accidental triggering from transients in the system.

The unijunction's firing voltage is set for 3 volts by the voltage divider, comprising  $R_2$  and  $R_3$ . When the switch is depressed,  $C_1$  begins to charge toward the supply voltage through  $R_1$ . The voltage divider allows the voltage on  $C_1$  to reach the transistor's peak firing voltage, at which point the transistor discharges the capacitor, producing a positive pulse at  $R_4$ . The charging rate of the pulse is determined by the values of resistor  $R_1$  and capacitor  $C_1$ .

The value of  $R_1$  is chosen so that the charge current,  $I_n$ , is much greater than the valley current,  $I_v$ , for the transistor. Thus, the transistor will remain in the saturated region until the pushbutton switch is released.

This scheme has proven to be completely immune from any contact bounce produced by the switch.

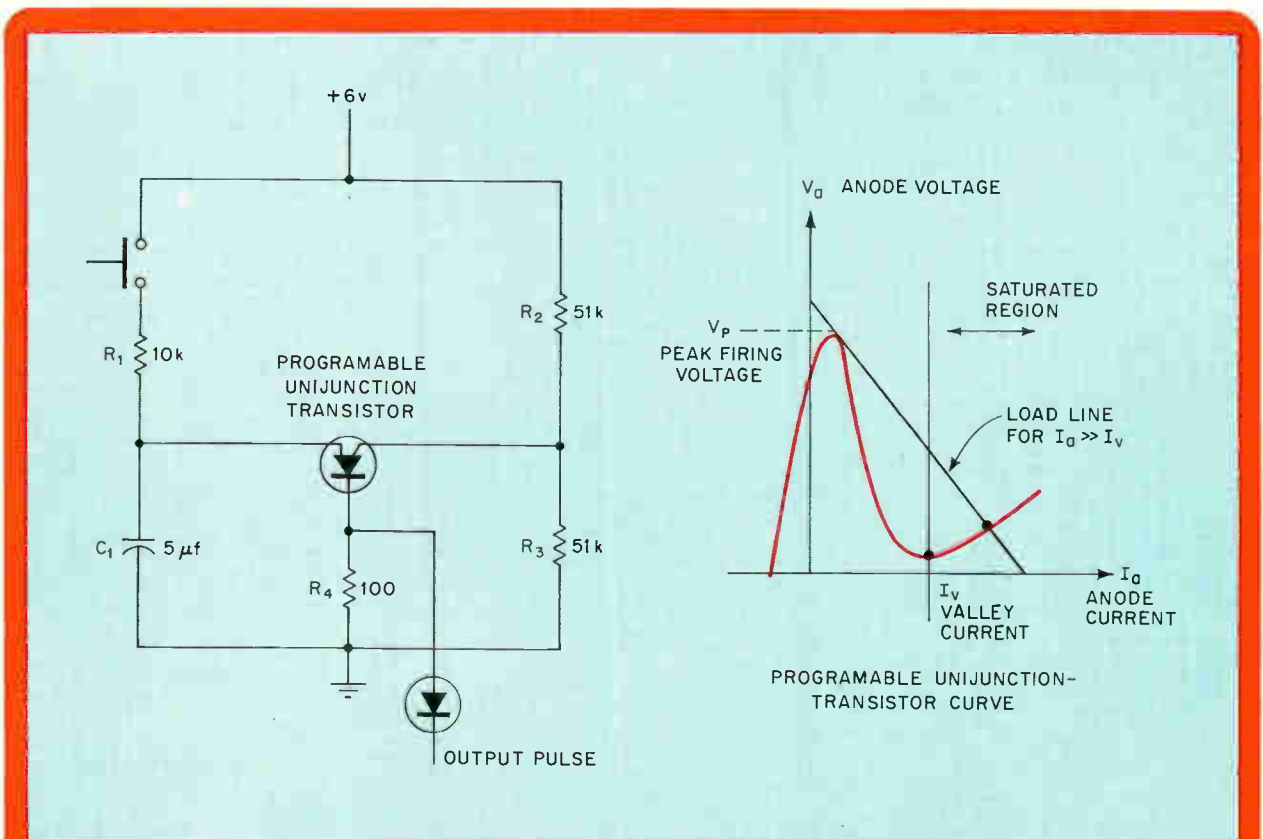

Clean and free. With a programmable unijunction transistor, clean pulses can be generated free of switch-contact bounce with whatever supply voltage is being used. When  $C_1$  charges to the transistor's peak firing voltage, the transistor discharges the capacitor and generates a pulse at  $R_4$ .

# Bridge circuit relies on common ground

By Gilbert Bank

Westinghouse Ocean Research Lab., San Diego, Calif.

A bridge circuit is frequently used at the output stage of an amplifier when large bipolar output voltage swings are generated. While maintaining the same drive level to the load, the bridge circuit halves the requirements on the  $V_{ce0}$  breakdown characteristics of the output transistors. Most bridge circuits require the load to float, but this circuit overcomes this disadvantage by using a common ground for both the input and output. However, it does require a floating power supply.

The input transistors,  $Q_1$  to  $Q_4$ , drive the bridge output transistors,  $Q_5$  to  $Q_8$ . Resistors,  $R_b$ , and diodes,  $D_1$  to  $D_4$ , bias the circuit into class AB operation, thus preventing crossover distortion.

The positive and negative inputs are  $E_2$  and  $E_1$ , respectively, and the output is taken at  $E_0$ . Either input may be grounded or driven. The circuit can be treated as a low-gain differential amplifier. If  $E_1$  is grounded and  $E_2$  is driven positively,  $Q_3$  and  $Q_2$  are forward-biased, and they in turn, drive  $Q_7$  and  $Q_6$  into conduction.

Due to the beta differences in the transistors, the voltage drops across  $Q_6$  and  $Q_7$  will not be equal. This results in an unequal power dissipation. The voltage differences are sensed by appropriate divider networks and are brought into the common-mode range of the amplifier at  $E_a$  and  $E_b$ . Amplifier,  $A_1$ , senses this difference and supplies a current through  $R_f$  into the resistors  $R_e$  in such a way as to correct any unbalances in the opposite legs of the bridge.

Although not shown here for simplicity sake, resistors should be inserted in the collector circuits

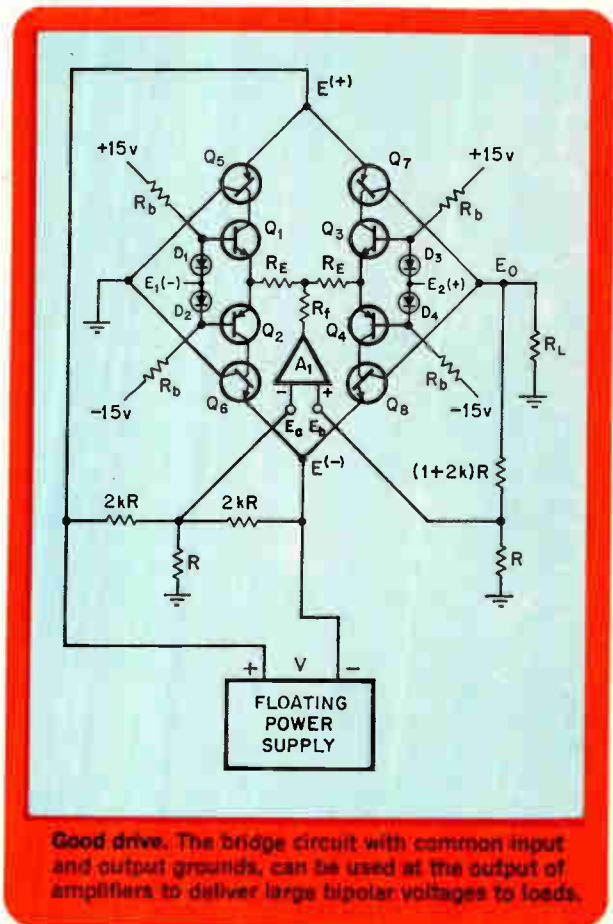

Good drive. The bridge circuit with common input and output grounds, can be used at the output of amplifiers to deliver large bipolar voltages to loads.

of transistors,  $Q_1$  to  $Q_4$ , and in the emitter circuits of transistors,  $Q_5$  to  $Q_8$ .

Because the bridge is automatically balanced, it is not necessary to use matched-transistor complements for  $Q_5$  and  $Q_6$ , and  $Q_7$  and  $Q_8$ . Good performance can be obtained using silicon npn transistors and germanium pnp transistors.

# Divider splits frequency into any ratio from 1 to 99

By Ken Erickson

Interstate Electronics Corp., Anaheim, Calif.

This programable pulse-frequency divider breaks down frequency into any submultiple with ratios from 1 to 99. Two thumbwheel switches provide

the programed division ratio to a decade-counter integrated circuit. Frequencies exceeding 10 megahertz can be divided by the circuit.

The counter easily expands to form several decade stages with proportionately larger division ratios.

A two-stage synchronous counter which generates the new frequency, is made from two decade counters of four bits each. As an example of how the division ratio is accomplished, assume a ratio of 3 is desired. Switch  $S_1$  is set at 3 and  $S_2$  at 0. This ratio is internally converted by the switches

to a 9's complement binary code which makes up the preset data for the decade counter. Thus the 9's complement of 03 is obtained by subtracting each digit from 9 to get 96. The binary-coded decimal equivalent of 96 is generated at the output terminals of the thumbwheel switches. Outputs from switch  $S_1$  appear on lines 4 and 2, while  $S_2$  outputs are on lines 1 and 8.

The decade counter starts at a count of 96. Gate 2's input from  $T_c$  is enabled, because the  $T_c$  output of the counter is a logic 1 when the counter is at its maximum count of 9 and also during a carry when more than one stage is used. However, the input to gate 2 from  $Q_3$  of the units part of the decade counter is inhibited— $Q_3$ 's output being a logic 1 only on the counts of 8 and 9. Therefore, no pulse is transmitted through gate 2 during the counts of 96 and 97. Each input pulse steps up the counter by one, but no pulse appears at gate 2's output until a count of 98 is reached; then a logic 1 appears both at the  $T_c$  output and the  $Q_3$  output of the counter. The one-shot multivibrator is triggered and delivers a pulse to the output via the pulse transformer,  $T_1$ , which serves to isolate grounds.

On the arrival of the next input pulse, a carry is generated at both  $T_c$  outputs of the counter enabling the counter's PE inputs and resetting the count to the original preset coded input. As

shown below, the decoded output is a logic 1 every third count giving a division ratio of three.

clock no.	count	decoded output logic level
1	96	0
2	97	0
3	98	1
4	96	0
5	97	0
6	98	1
7	96	0
8	97	0
9	98	1

A terminal count of 98 is decoded instead of 99 to allow for the one clock cycle required for the synchronous preset of the two decade counters.

Gate 1 inverts the input signal. The inverted signal feeds gate 2 for the purpose of implementing the special case of divide-by-one. For this particular division ratio, the counter's terminal count and the preset code are the same. This means that the outputs of the counters never change state.

The one-shot multivibrator provides the pulses needed to drive the pulse transformer. With the value of  $R_1$ , the pulse width is typically 45 nanoseconds. Transistor  $Q_2$  and resistor  $R_2$  are used to limit the current of  $Q_1$  in case of an inadvertent short-circuit across the transformer's secondary winding.

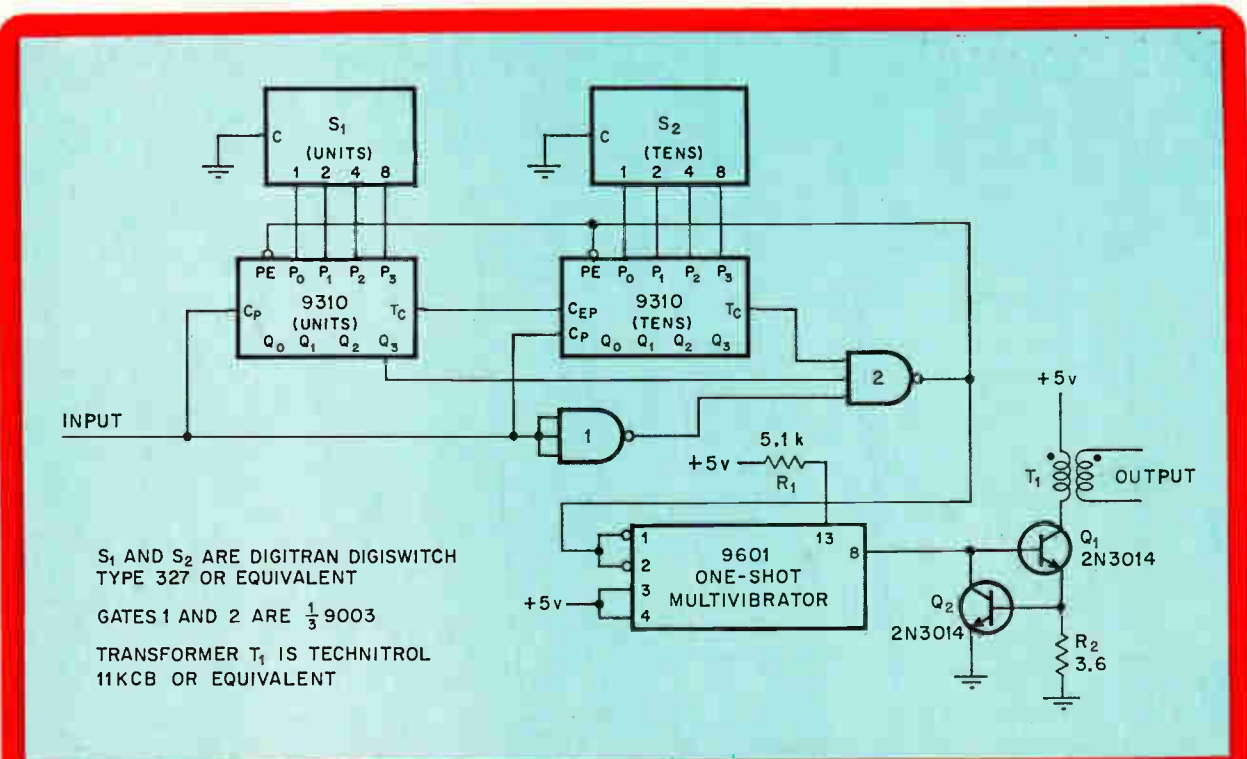

$S_1$  AND  $S_2$  ARE DIGITRAN DIGISWITCH TYPE 327 OR EQUIVALENT  
 GATES 1 AND 2 ARE  $\frac{1}{3}$  9003  
 TRANSFORMER  $T_1$  IS TECHNITROL 11KCB OR EQUIVALENT

**Choice of ratio.** Any desired division ratio of input clock pulses can be obtained by setting the switches,  $S_1$  and  $S_2$ , to the ratio. The preset data is supplied to the decade counter as a nine's complement code. The decade counter counts from the preset value to a count of 98, whereupon it returns to its preset value.



# COMPUTER-AIDED DESIGN GOES BEYOND

## First generation

	ECAP	NET-1	Predict	Sceptre	Calahan	Circus	Nasap
<b>General purpose</b>	Yes	Yes	Yes	Yes	No	No	Yes
<b>Special purpose</b>	No	No	No	No	Yes	Yes	No
<b>Application:</b>							
Circuit analysis	Yes	Yes	Yes	Yes	Yes	Yes	Yes
Circuit synthesis	Yes	Yes	Yes	Yes	Yes	Yes	Yes
Device design	Yes	Yes	Yes	Yes	Yes	Yes	Yes
<b>Input features:</b>							
Special coding required	Yes	Yes	Yes	Yes	No	Yes	Yes
Sequential node numbering	Yes	Yes	No	Yes	Yes	Yes	Yes
Random sequence of input	Limited	Yes	Yes	Yes	No	Yes	No
Voltage or current sources	Yes (with modification)	Yes (with modification)	Yes	Yes	Current sources only	Yes	Yes
Tabular input for signal sources	Yes	Yes	Yes	Yes	Yes	Yes	No
Analytic description of branch elements	Yes	No	Yes	Yes	No	Yes	No
Analytic descriptions of signal sources	No	No	Yes	Yes	Yes (available with modifications)	Yes	No
Automatic modification of input (repeated runs)	Yes	Yes	No	Yes	Yes	Yes	Yes
<b>Type of input:</b>							
Batch cards	Yes	Yes	Yes	Yes	Yes	Yes	Yes
Light pen	Yes	Yes	No	Yes	No	No	No
<b>Modeling capabilities:</b>							
Built-in models	No	Yes (transistors -diodes)	No	Yes	No	No	No
Allows small-signal models	Yes	No (inconvenient)	Yes	Yes	Yes	Yes	Yes
Allows large-signal models	No (inconvenient)	Yes (built in)	Yes	Yes	No	Yes	No
<b>Output options:</b>							
Transfer functions	No	No	No	No	Yes	No	Yes
Pole-zero locations	No	No	No	No	Yes	No	Yes
Symbolic expression for time response	No	No	No	No	Yes		Yes
Time response output	Selected variables	Node voltages and currents	Branch voltages and currents	Selected variables	Output node	Yes	Yes
Steady-state solution	Separate analysis	Yes	Separate analysis	Yes	No	Yes	Yes
<b>Programming features:</b>							
Program language	Fortran II and IV	Madcap and FAD	Fortran II and FAD	Fortran IV	Fortran II and IV	Fortran IV	Fortran IV
Recommended memory capacity	32,000	32,000	32,000	32,000	32,000	Overlaid in 175,000	48,000
<b>Network formulation:</b>							
Topological or matrix	Both	Matrix	Matrix	Matrix	Topological	Matrix	Topological
Primary integration routine	Implicit numerical relation	Predictor-corrector	Runge-Kutta	Runge-Kutta, predictor-corrector	Runge-Kutta, inverse Laplace		
<b>Which machine can it be used on</b>	Univac 1108, IBM 7094, CDC 3600	IBM 7094	IBM 7094	IBM 7094	IBM 7094, CDC 3600, CDC 6600	IBM 360, IBM 7094	Spectra 70, B-5500, IBM 7094, 360, Univac 1108, GE 635, 645, Sigma-10
<b>Unconventional features</b>	Plotting routine (transient)	None	Calcomp crt plots	Printer	Calcomp crt plots	Printer plotting, radiation responses	Symbolic transfer function

# AND FIRST-GENERATION PROGRAMS...

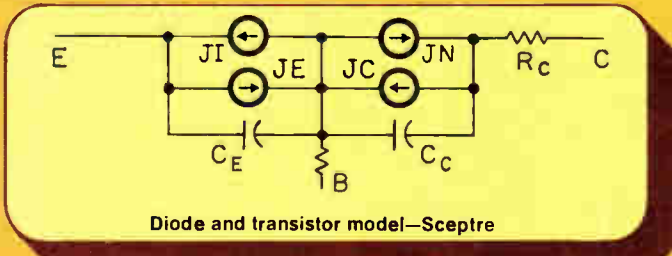
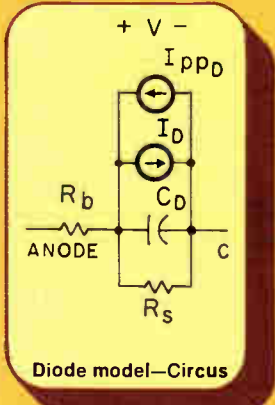
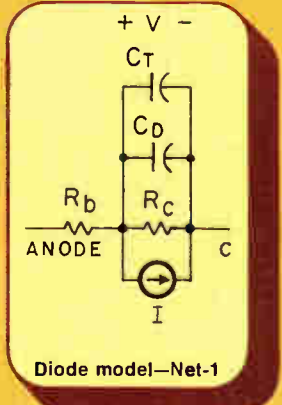
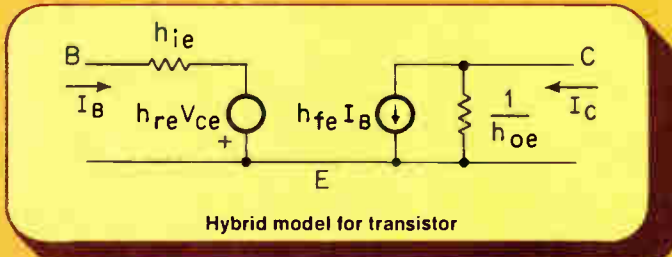
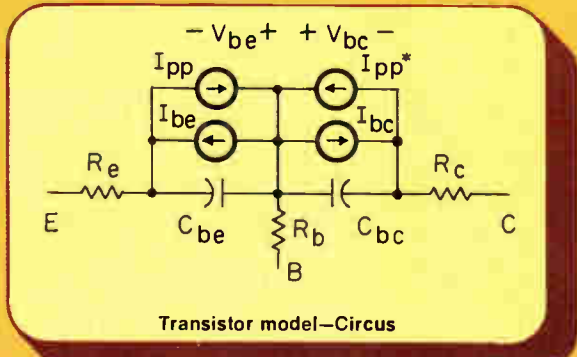
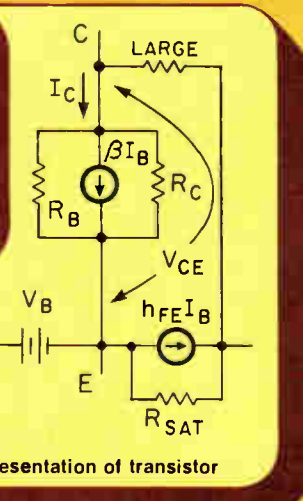
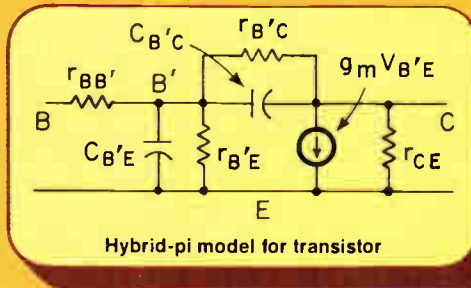
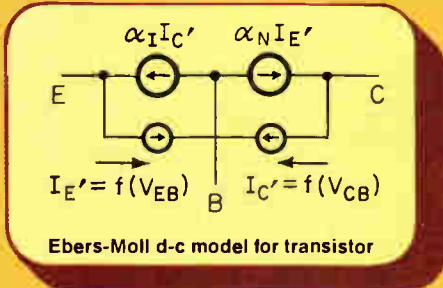

Today's circuit designers can choose from a host of available computer programs, of which almost all are general-purpose routines. But general-purpose routines are not always the best approach to specific design problems. These routines, first-generation computer-aided design programs, often have to be modified to meet special requirements. Unfortunately, modifications lead to extra steps, which often waste a great deal of the computer's storage—making the programs inefficient and even costly.

Changing all this are second-generation CAD programs, which are only now becoming available. These programs have been designed to overcome many weaknesses of the first-generation

ration routines. These weaknesses include the repetition of instructions for groups of elements that are repeated in a design, the inability to use algebraic expressions to describe desired functions, the inability to store waveshapes, and the lack of memory.

First-generation programs are based on circuit and numerical analysis techniques that date back to 1965. The newer programs, which will become available over the next three years, will use sparse matrixes. First-generation programs, on the other hand, employ dense matrixes.

This foldout chart shows what features are available in both first- and second-generation CAD programs.

# ... TO THE EXPANDED CAPABILITIES OF SECOND-GENERATION CAD PROGRAMS

Second generation	Lisa	Cornap	Pane	Sacsy	Trac	Ancir	PCAP	Rips	Cadic	DCCAP	Snap	A-c-CIP	D-c-CIP	Transistor Parameter
General purpose	No	No	No	No	No	Yes	No	Yes	Yes	Yes	Yes	Single-frequency a-c circuits	No	No
Special purpose	Yes	Yes	Yes	A-c, Y parameters	Yes	No	Yes	No	No	No	No	No	Yes	Yes
Application:														
Circuit analysis	Yes	Yes	Yes	Calculates Y parameters	Yes	Yes	Yes	Yes	No	Yes	Yes	Yes	Yes	Yes
Circuit synthesis	Yes	Yes	Yes	Yes	Yes	Yes	Yes	No	No	No	Yes	Yes	Yes	Yes
Device design	Yes	Yes	Yes	Yes	Yes	Yes	Yes	No	Yes	No	Yes	No	No	Yes
Input features:														
Special coding required	No	Yes	Yes	No	Yes	Yes	Yes	Yes	Yes	Yes	Yes	Yes	Yes	Yes
Sequential node numbering	Yes	Yes	Yes	Yes	Yes	No	Yes	No	Yes	Yes	Yes	Yes	Yes	Yes
Random sequence of input	Yes	Yes	Yes	A-c	Yes	No	Yes	No	Yes	No	Yes	Yes	Yes	Yes
Voltage or current sources	Yes	Yes	Yes	Yes	Yes	Both	Yes	Yes	Yes	Yes	Yes	Current	Current	Yes
Tabular input for signal sources	Yes	Yes	Yes	Yes	Yes	Yes	Transient	No	No	No	Yes	Yes	Yes	Yes
Analytic descriptions of branch elements	Yes	Yes	Yes	No	Yes	Yes	Yes	Yes	Yes	Yes	Yes	Yes	Yes	Yes
Analytic descriptions of signal sources	No	No	No	No	No	Yes	Yes	No	No	No	Yes	No	No	No
Automatic modification of input (repeated runs)	Yes	Yes	Yes	Parameter sensitivity for 1% component change	Yes	Yes	Yes	No	No	Voltage only	Yes	Yes	Yes	Yes
Type of input:														
Batch cards	Yes	Yes	Yes	Yes	Yes	Yes	Yes	Yes	Yes	Yes	Yes	Yes	Yes	Yes
Light pen	No	No	No	No	No	No	No	No	Yes	No	No	No	No	No
Modeling capabilities:														
Built-in models	No	No	No	No	Yes	Available	Yes	No	No	No	No	No	No	No
Allows small-signal models	Yes	Yes	Yes	Yes	Yes	Yes	Yes	Yes	Yes	No	Yes	Yes	Yes	Yes
Allows large-signal models	No	No	Yes	No	Yes	No	Yes	No	No	No	Yes	No	No	No
Output options:														
Transfer functions	Yes	No	No	Y parameters	No	Yes	No	No	No	No	No	No	No	No
Pole-zero locations	Yes	Yes	No	No	No	No	No	Yes	No	No	Yes	No	No	No
Symbolic expression for time response	No	No	No	No	No	No	No	No	No	No	No	No	No	No
Time response output	Yes	Yes	No	No	Yes	No	Yes	No	No	No	No	No	No	No
Steady-state solution	Yes	Yes	Yes	Y parameters	Yes	Yes	Yes	No	Yes	Nonlinear d-c	Yes, parameter sensitivity, worst-case variation	Yes	Yes	Yes
Programming features:														
Program language	Fortran IV	Fortran IV	Fortran IV	Fortran IV	Fortran, Assembler	Fortran IV	Fortran IV	Fortran II	Preddefined format	No	Fortran IV	Fortran IV	Fortran IV	Fortran IV
Recommended memory capacity	130,000	150,000	280,000		128,000	256,000	30,977	60,000	120,000	90,000	65,000	16,000	16,000	16,000
Network formulation:														
Topological or matrix	Matrix	Topological	Topological	Matrix	Matrix	Matrix	Matrix	Matrix		Matrix	Topological	Matrix	Matrix	Matrix
Which machine it can be used on	IBM 7094; IBM 360	IBM 360	IBM 360	IBM 360; IBM 50	IBM 7094; IBM 360; CDC 3600; Univac 1108; Burroughs 5000	IBM 360; IBM 67	IBM 360		IBM 360; IBM 40	IBM 360	Univac 1108 and GE 635	IBM 360; IBM 40; GE 635	GE 635	GE 635, SDS 940
Unconventional features	pole-zero, sensitivity, root locus		Worst case, statistical analyses	256,000 core, distributed RC devices for 12-node circuits	user-defined models, radiation effects	Crystal-controlled circuits to 0.1 ppm					Monte Carlo automatic response plots	Optimizes circuit parameters for Nasap-II	Automated d-c circuit design	
Maximum capacity	125 branches, 50 nodes		200 elements, 60 nodes		200 elements	more than 100 elements	200 branches, 50 nodes	30 nodes, 30 branches	100 elements	40 nodes, 100 branches	50 nodes, 200 elements	30 nodes, 50 elements	30 nodes, 50 elements	9-element parasitics

# COMPUTER-AIDED DESIGN GOES BEYOND FIRST-GENERATION PROGRAMS

## First generation

	ECAP	NET-1	Predict	Sceptre	Calahan	Circus	Nasap
<b>General purpose</b>	Yes	Yes	Yes	Yes	No	No	Yes
<b>Special purpose</b>	No	No	No	No	Yes	Yes	No
<b>Application:</b> Circuit analysis Circuit synthesis Device design	Yes Yes Yes	Yes Yes Yes	Yes Yes Yes	Yes Yes Yes	Yes Yes Yes	Yes Yes Yes	Yes Yes Yes
<b>Input features:</b> Special coding required Sequential node numbering Random sequence of input Voltage or current sources	Yes Yes Limited Yes (with modification)	Yes Yes Yes Yes (with modification)	Yes No Yes Yes	Yes Yes Yes Yes	No Yes No Current sources only	Yes Yes Yes Yes	Yes Yes No Yes
Tabular input for signal sources	Yes	Yes	Yes	Yes	Yes	Yes	No
Analytic description of branch elements	Yes	No	Yes	Yes	No	Yes	No
Analytic descriptions of signal sources	No	No	Yes	Yes	Yes (available with modifications)	Yes	No
Automatic modification of input (repeated runs)	Yes	Yes	No	Yes	Yes	Yes	Yes
<b>Type of Input:</b> Batch cards Light pen	Yes Yes	Yes Yes	Yes No	Yes Yes	Yes No	Yes No	Yes No
<b>Modeling capabilities:</b> Built-in models	No	Yes (transistors - diodes)	No	Yes	No	No	No
Allows small-signal models	Yes	No (inconvenient)	Yes	Yes	Yes	Yes	Yes
Allows large-signal models	No (inconvenient)	Yes (built in)	Yes	Yes	No	Yes	No
<b>Output options:</b> Transfer functions Pole-zero locations Symbolic expression for time response	No No No	No No No	No No No	No No No	Yes Yes Yes	No No Yes	Yes Yes Yes
Time response output	Selected variables	Node voltages and currents	Branch voltages and currents	Selected variables	Output node	Yes	Yes
Steady-state solution	Separate analysis	Yes	Separate analysis	Yes	No	Yes	Yes
<b>Programing features:</b> Program language	Fortran II and IV	Madcap and FAD	Fortran II and FAD	Fortran IV	Fortran II and IV	Fortran IV	Fortran IV
Recommended memory capacity	32,000	32,000	32,000	32,000	32,000	Overlaid in 175,000	48,000
<b>Network formulation:</b> Topological or matrix Primary integration routine	Both Implicit numerical relation	Matrix Predictor-corrector	Matrix Runge-Kutta	Matrix Runge-Kutta, predictor-corrector	Topological Runge-Kutta, inverse Laplace	Matrix	Topological
Which machine can it be used on	Univac 1108, IBM 7094, CDC 3600	IBM 7094	IBM 7094	IBM 7094	IBM 7094, CDC 3600, CDC 6600	IBM 360, IBM 7094	Spectra 70, B-5500, IBM 7094, 360, Univac 1108, GE 635, 645, Sigma-10
Unconventional features	Plotting routine (transient)	None	Calcomp crt plots	Printer	Calcomp crt plots	Printer plotting, radiation responses	Symbolic transfer function

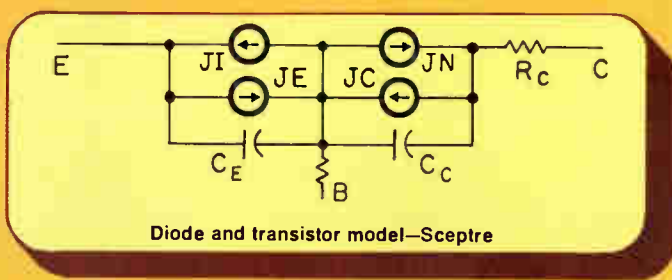
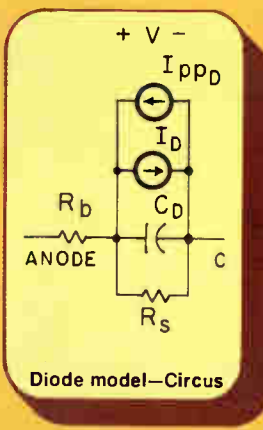
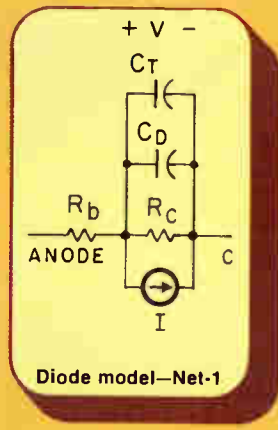
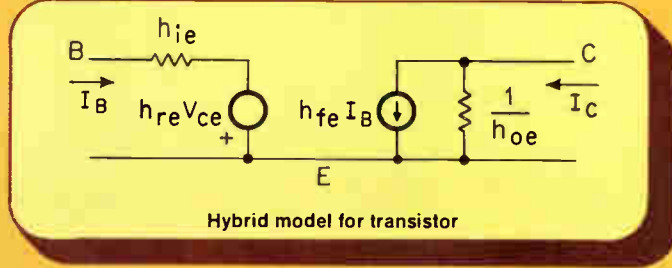
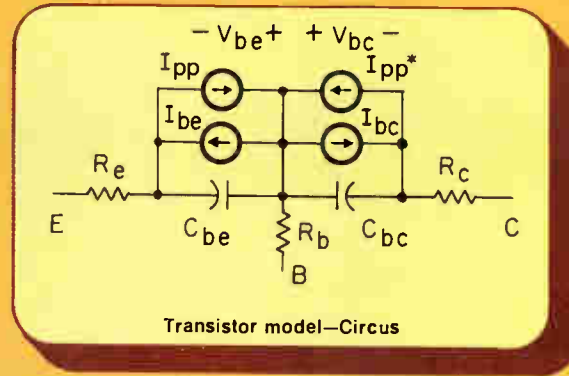
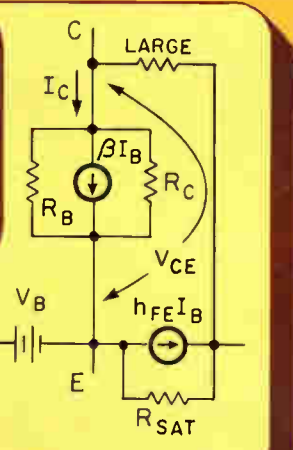
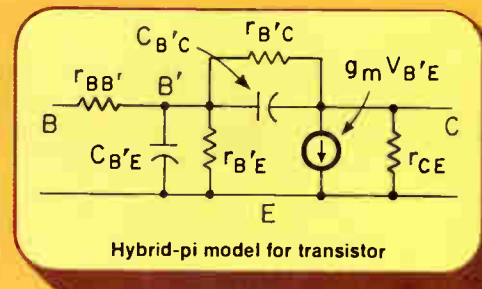
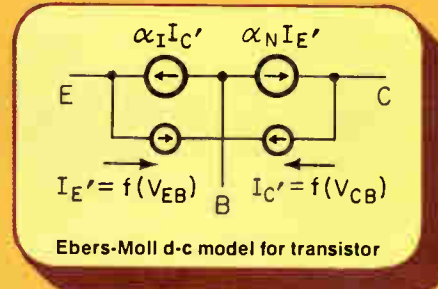

Today's circuit designers can choose from a host of available computer programs, of which almost all are general-purpose routines. But general-purpose routines are not always the best approach to specific design problems. These routines, first-generation computer-aided design programs, often have to be modified to meet special requirements. Unfortunately, modifications lead to extra steps, which often waste a great deal of the computer's storage—making the programs inefficient and even costly.

Changing all this are second-generation CAD programs, which are only now becoming available. These programs have been designed to overcome many weaknesses of the first-generation

ration routines. These weaknesses include the repetition of instructions for groups of elements that are repeated in a design, the inability to use algebraic expressions to describe desired functions, the inability to store waveshapes, and the lack of memory.

First-generation programs are based on circuit and numerical analysis techniques that date back to 1965. The newer programs, which will become available over the next three years, will use sparse matrixes. First-generation programs, on the other hand, employ dense matrixes.

This foldout chart shows what features are available in both first- and second-generation CAD programs.

# Samples - at continuously adjustable rate.

# Triggers - one knob control 3Mv to 2000MHz.

# Displays - no ambiguity - DC to 2000MHz @ 1Mv sensitivity.

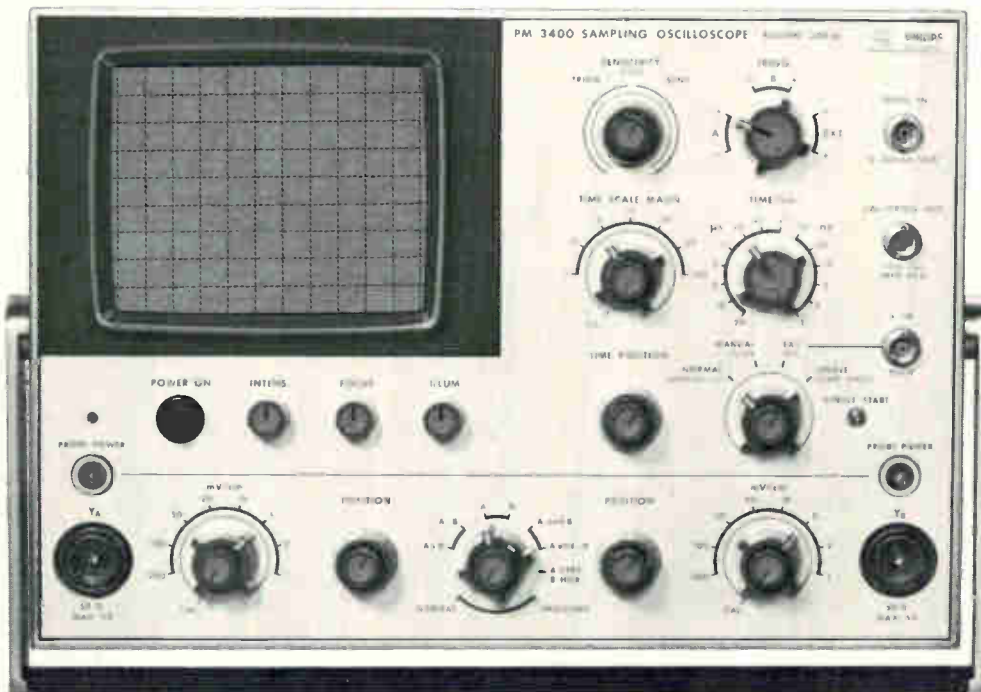

PM 3400  
Sampling Oscilloscope  
\$2,725

#### More of the Unbeatable Philips Scopes



PM 3231  
15MHz 10mV  
Dual Beam  
Delay Lines  
\$1,050



PM 3200  
10MHz  
2mV/div  
\$495

**Compact (9" x 13" x 19") excellent cost/performance ratio** (\$2,725 is all it takes), **unique circuitry** and design (we list the innovations below) make the new Philips PM 3400 sampling oscilloscope an unusually capable and versatile instrument . . . in fact it's, the only one of its class.

The innovations: Continuously adjustable sampling rate. Electronic signal smoothing plus long persistence phosphors give unambiguous display, undistinguishable from real time

scopes. Internal triggering, to catch leading edges, to 1.7 GHz and higher. DC to 1.7 GHz bandwidth, sensitivity variable between 1 mv and 200 mv/cm. Rise time, 200 ps, trigger sensitivity 3 mv. Electronically compensating amplifiers maintain a linear scope presentation over the 8 x 10 area of the CRT.

Write us today for technical data . . . see for yourself in full detail why we say that the PM 3400 rates a cost performance ratio of excellent.

**PHILIPS  
ELECTRONIC  
INSTRUMENTS**

750 S. FULTON AVE. - MT. VERNON, N.Y. 10550  
A DIVISION OF PEPI, INC.

# Top performance from analog multipliers?

# Much depends on errors gauged in your circuit

Two input signals applied to device can be used to measure multiplying errors swiftly and efficiently, asserts *Tom Cate* of Burr-Brown; an operational amplifier and a scope are what's needed to do the job

● Once restricted to use in analog computers, analog multipliers are finding new applications—particularly in signal processing and telemetry—as integrated circuitry lowers prices and improves performance in the devices. But the proliferation of both modular multipliers and applications creates a problem: multiplier specifications that are adequate for the computer may not serve the communications equipment designer or the servo producer. It's important that the user determine which multiplier specifications and test procedures will best fit his own needs.

Unlike amplifier error which is dependent on just one input, multiplier error is dependent upon two inputs. Thus, the error can be envisioned as a surface in the X-Y plane, where X is one input and Y is the other. For any d-c value of X and Y, there is a particular error. The multiplier scale factor is usually 1/10, and the output,  $E_o$ , is expressed by,

$$E_o = \underbrace{\frac{1}{10} XY}_{\text{Ideal Output}} + \underbrace{\epsilon}_{\text{Error}}$$

The total error  $\epsilon$  can be broken down into five components—an X-input offset error, a Y-input offset error, a gain or scale-factor error, an output offset error, and

input offset error and the nonlinearity. With  $X = 0$ .

$$\epsilon(0, Y) = \epsilon_x Y + f(0, Y)$$

The multiplier output will be

$$E_o = \epsilon_x Y + f(0, Y)$$

The X-channel input offset is adjusted to make  $\epsilon_x$  zero. The Y-channel is adjusted in a similar manner.

Gain error is best adjusted by making one input a d-c value of 10 volts and sweeping the other input through its full-scale range of  $-10$  v to  $+10$  v. If all the offset errors were previously adjusted out, then

$$E_o = \overbrace{X}^{\text{Ideal}} + \overbrace{KX + f(X, 10)}^{\text{Error}}$$

where  $Y = +10$  v for this case. The gain is then trimmed to make the error as small as possible. Since the nonlinearity  $f(X, Y)$  is different in each region of the  $X, Y$  plane, it's best to look at gain error for several different values of  $X$  and  $Y$ .

One quick way to test multiplier accuracy—maximum error divided by full-scale voltage—is to apply a known d-c voltage into one input and sweep the other with sine wave attenuated by the value set by the d-c input. the multiplier's full-scale range. Output should be a sine wave attenuated by the value set by the d-c input. If d-c input is the full-scale value of 10 volts, the sine wave is unattenuated; if d-c input is, say, 1 volt, the output sine wave is 10% of input value.

If 2.5 volts were applied to the X input and 10  $\sin \omega t$  volts were applied to the Y input, then  $E_o$  is:

$$\text{(Ideal) (Error)}$$

$$E_o = \frac{XY}{10} + \epsilon$$

$$E_o = \frac{(2.5)(10 \sin \omega t) + \epsilon}{10} = 2.5 \sin \omega t + \epsilon$$

To measure error,  $E$ , use an operational amplifier to subtract, in this case, one-quarter of the input sine wave from  $E_o$ .

A circuit based on this principle is shown below. A two-deck switch,  $S_1$ , selects a d-c input of 0,  $\pm 2.5$ ,  $\pm 5$ , or  $\pm 10$  volts, and the multiplier's gain. Sine-wave

a nonlinear component. Some multipliers, such as the Burr-Brown 4094/15C, have provisions for externally trimming these error components to zero, except for the nonlinear component. The expression for total error  $\epsilon$  as a function of the inputs  $X$  and  $Y$  is

$$\epsilon(X, Y) = \underbrace{\epsilon_o}_{\text{Output Offset}} + \underbrace{K \frac{XY}{10}}_{\text{Gain Error}} + \underbrace{\epsilon_x Y + \epsilon_y X}_{\text{Input Offset Error}} + \underbrace{f(X, Y)}_{\text{Nonlinear Component of Error}}$$

Inside the multiplier, the input offset error usually depends upon the input amplifier circuitry, output offset and gain error depend on the output amplifier, and the nonlinear function  $f(X, Y)$  depends upon the multiplication technique (variable-transconductance, or quarter-square.)

How can you sort out these errors? The first step is to set  $X$  and  $Y$  to zero so that

$$\epsilon(0, 0) = \epsilon_o + f(X, Y)$$

The nonlinear component is usually designated to be zero at  $X$  and  $Y$  equal to zero, so with  $X$  and  $Y$  of zero

$$E \sim \epsilon_o, \text{ the output offset}$$

After adjusting  $\epsilon_o$  to zero, the next step is to look at

Multiplier tester. D-c input voltages of 0,  $\pm 2.5$ ,  $\pm 5$ , or  $\pm 10$  volts can be fed into the circuit when the two-deck selector switch,  $S_1$ , is set in one of four positions, from top to bottom. Switch also sets the gain for the multiplier.

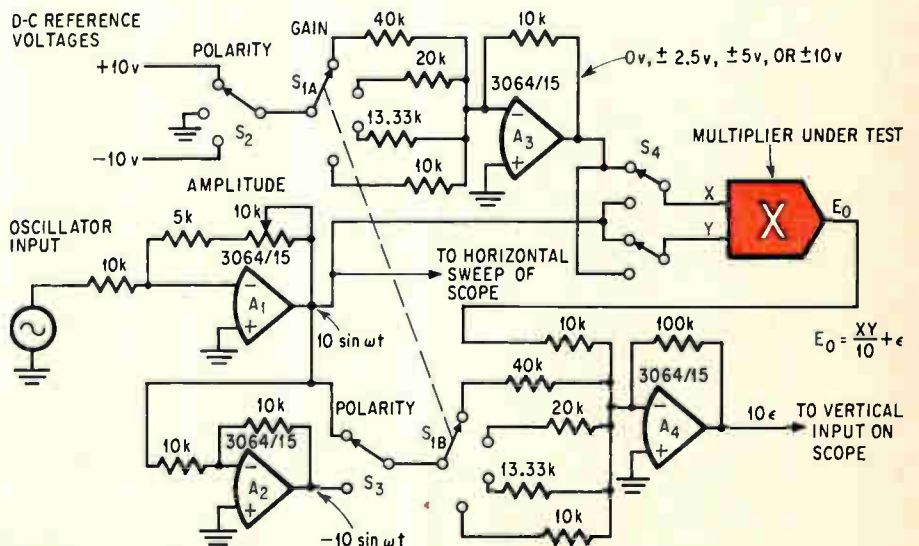

**Squaring.** Two equal inputs are fed into this squaring-mode tester and are integrated, yielding ramp functions. The ramps are then integrated and the resulting curves are subtracted from the ramps to determine the multiplier error.

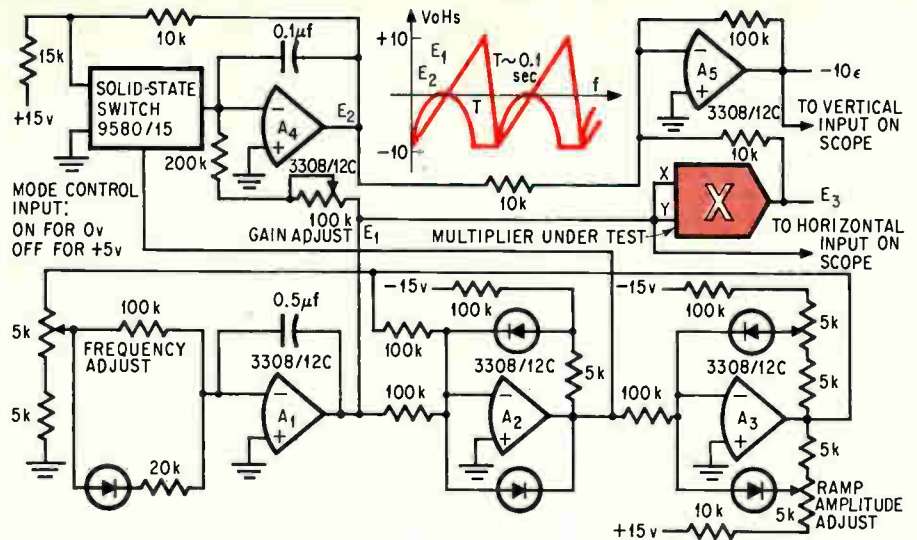

amplitude is not critical—it goes into both the multiplier and the summing amplifier, and  $A_4$  looks at the difference between multiplier output and the sine wave.

But the summing networks associated with amplifiers  $A_3$  and  $A_4$ , as well as the d-c reference voltages, must be accurate. Although peak error can be determined simply by measuring the peak output of  $A_4$ , much more valuable data can be obtained by sweeping the horizontal axis of a scope with the sine wave input and driving its vertical axis with 10 times the error voltage, or  $10 \epsilon$ . This operation determines the total error  $\epsilon$ . Relative magnitudes of output offset error, gain error, input offset errors, and nonlinearity can be determined by looking at all these error curves.

The same test setup can measure the multiplier's frequency response. All that's required is to increase the input oscillator frequency and watch the error display on the scope: error curve will be represented by a distorted Lissajous pattern. As frequency is increased, additional error occurs due to phase shift. Only 0.57 of phase shift introduces 1% of additional error. Since absolute error is the total of the d-c and phase-shift errors, the curve can display error due to phase shift at frequencies well below any full-power frequency response limitation.

When both inputs are the same, the device is capable of squaring. Here the X and Y inputs are fed the

same input signal; output should be  $X^2/10$ . Again, squaring accuracy can be measured on a point-to-point basis with a digital voltmeter, but a scope display is much more informative. Just integrate a ramp to obtain a time-squared waveform. The ramp also is squared in the multiplier under test, and subtracting the integrated ramp from the squared ramp yields the error.

A circuit for squaring-mode testing is at top of the next page; amplifiers  $A_1$ ,  $A_2$  and  $A_3$ , generate a ramp that sweeps from  $-10$  volts to  $+10$  volts. The range  $E_1$  is integrated by amplifier  $A_4$ . The op amps are low-cost, field effect transistor input units, and 9580/15 module is a solid-state switch with current amplification. When the 9580/15 is turned on,  $A_4$  resets to  $-10$  volts regardless of the input  $E_1$ . When the 9580/15 is gated off,  $A_4$  acts as an integrator with a gain of four. Representing the start of the ramp as  $t = 0$  and the end of the ramp as  $t = T$ , the integrator's input and output are:

$$E_1 = -10 + \frac{20}{T} t$$

$$E_2 = \frac{-4}{T} \int E_1 dt - 10$$

$$= -10 \frac{+40}{T} t - \frac{40}{T^2} t^2, 0 \leq t \leq T$$

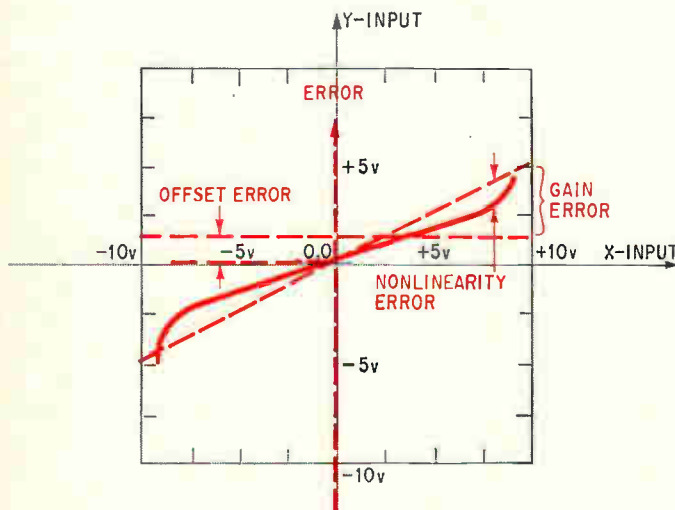

**Error plot.** The points used to produce this typical error display (left) with the multiplier tester above.



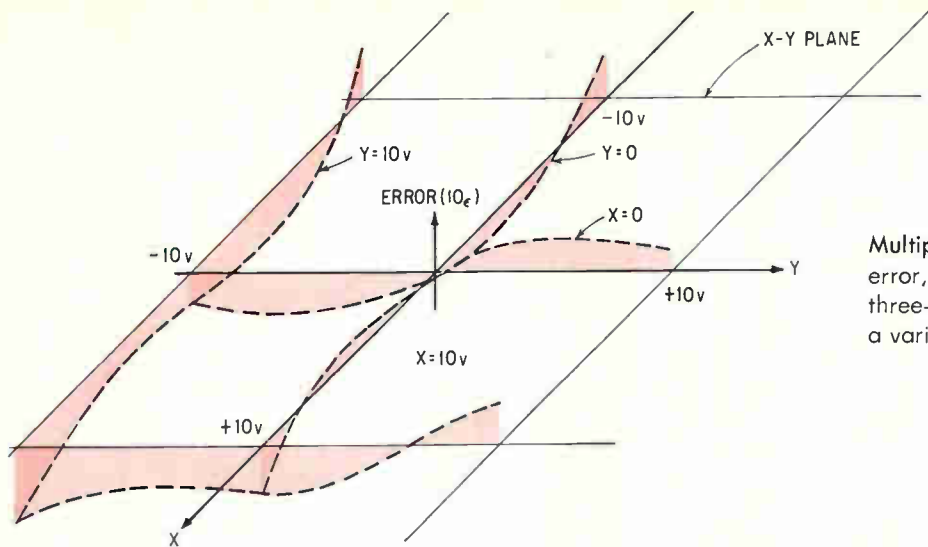

Multiplier error. Oscilloscope plots of error, lower left, are shown on a typical three-dimensional surface, top left, for a variable-transconductance multiplier.

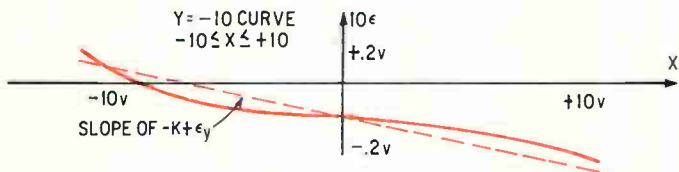
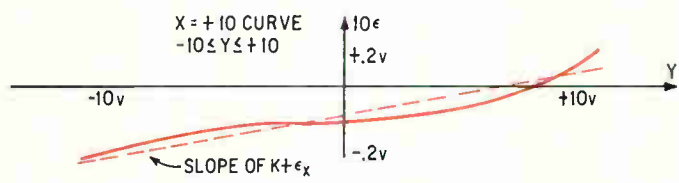
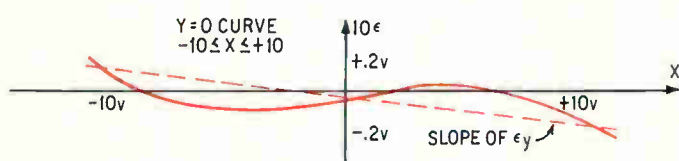
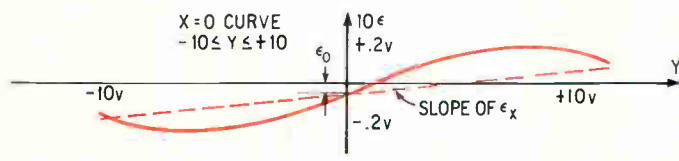

The same ramp  $E_1$  is squared in the multiplier under test; the multiplier output from  $t = 0$  to  $t = T$  is

$$E_3 = \frac{\text{Ideal } E_1^2}{10} + \text{Error } \epsilon$$

$$E_3 = \frac{1}{10} \left( -10 + \frac{20}{T} t \right)^2 + \epsilon$$

$$E_3 = 10 - \frac{40}{T} t + \frac{40}{T^2} t^2 + \epsilon, \quad 0 \leq t \leq T$$

If integrator output  $E_2$  is added to the multiplier output  $E_3$  during the time  $t = 0$  to  $t = T$ , the error term is isolated.

$$\begin{aligned} \text{Output of amplifier } A_5 &= -10 (E_2 + E_3) \\ &= -10\epsilon \end{aligned}$$

A scope display of squaring error as input swept from  $-10$  volts to  $+10$  volts may be achieved easily—just apply  $-10 \epsilon$  to a scope's vertical input and drive the horizontal sweep with ramp  $E_1$ .

Although this technique is fine for testing squaring accuracy of quarter-square or variable-transconductance-type multipliers, a problem may be encountered in testing time-averaging type multipliers—triangle-averaging or pulse-height, pulse-width types. The ramp input to the multiplier has high-frequency harmonics that may go beyond the frequency-response capability of a time-averaging-type multiplier. Since the error caused by the high-frequency harmonics may not settle out quickly enough, a very slow ramp must be used when testing time-averaging-type multipliers. With this circuit the integrator feedback capacitors should be increased by a factor of 10.

With these two circuits, dynamic tests of multiplier accuracy are easy to perform. The nature of errors is very obvious when error is displayed as a function of the input voltage, and the relative magnitudes of output offset gain error, input offsets, and nonlinearity are easy to observe. The multiplier can also double frequencies, perform control functions, modulate, demodulate, and solve many common arithmetic exercises. With its further development, the multiplier is sure to become a standard analog building block. ●

# Three ways to build low-threshold MOS

Easy interface with bipolars is the big advantage of low-threshold MOS; *Warner Bridwell\** of American Microsystems, Santa Clara, Calif., discusses three processes for building the devices and the tradeoffs encountered

● Low-threshold metal oxide semiconductor circuits are rapidly taking over larger and larger segments of the semiconductor market. And it's no wonder that their popularity is on the rise; the low threshold—2 volts, against 4 volts or more for the high-threshold circuits—gives these circuits three major advantages. First, it simplifies the task of establishing an interface between the MOS circuit and a bipolar circuit. Second, it substantially improves the MOS circuit's speed-power product. Finally, it facilitates generating bias and clock levels.

To appreciate the actual importance of these three advantages, the high-threshold circuit's shortcomings must be fully understood.

Because the low-transistor turns on with only 2 volts on its gate—in some designs it's even less—a simple interface between a driving bipolar circuit and a driven MOS circuit is possible. (The interface between a driving MOS circuit and a driven bipolar circuit doesn't involve the MOS threshold and is equally simple with both kinds of MOS circuits.) This simplicity is due to the fact that the MOS chip's input signal can have positive and negative levels quite close together—as close as 0 and 4 volts—and still have enough overdrive to nearly saturate the input MOS transistor. Normally, the substrate of either bipolar or MOS circuits is connected to system ground; the main supply voltage for diode-transistor logic and transistor-transistor logic circuit is

+5 volts; and the signal swing for p-channel MOS—the most common variety—is between ground and a negative voltage. Therefore, by biasing the MOS substrate to +5 volts, which is the bipolar supply voltage, the MOS input signal swing goes from 0 to -4 volts to +5 to +1 volts. This transition makes the MOS input easy to generate with bipolar circuits.

Although the 4-volt circuit would be relatively slow, easily attainable compromise designs, such as those outlined below, can speed up the MOS circuit without unduly complicating the bipolar circuit.

**With the low-threshold circuits**, the supply voltage can be as low as 5 volts for slow circuits that switch in a few microseconds, and 10 volts for more typical speeds of 1  $\mu$ sec or less. The lower voltages result in lower power dissipation and a speed-power product lower than that obtainable with high-threshold circuits. (In speed-power products, as in golf scores, little numbers are better than big numbers, because speed, in this context, actually is the switching time in seconds, rather than frequency in  $\text{sec}^{-1}$ , the usual dimension of speed.)

How can these supply voltages be reduced in this way? The diagram at right shows how. Here, transistor  $Q_2$  inverts the signal at its gate;  $Q_1$ , when conducting, forms a low-impedance path that serves as a load resistor for  $Q_2$ . Assume that the supply voltage  $V_{dd}$  is -13 volts and that both transistors, which are high-

\* Mr. Bridwell wrote this article while at Motorola Semiconductor

threshold devices, begin to conduct when their gate voltages become more negative than  $-4$  volts, relative to the transistor's source. Assume further that when  $Q_2$  is conducting, the voltage drop from its source to its drain is 1 volt, so that the circuit's output is  $-1$  volt.

Assuming that the circuit in the diagram is driving a similar circuit, this output voltage is insufficient to turn on that driven circuit. But when the circuit illustrated turns off, its output eventually goes to  $-13$  volts, the supply voltage, because the current in the circuit is zero and therefore no voltage drop appears across  $Q_1$ .

Therefore the total swing of the circuit's output from  $-1$  volt to  $-13$  volts is 12 volts. Theoretically the full 12-volt swing will never be realized because it lies along an exponential curve; therefore the circuit specifications must call for an output swing greater than 4 volts but less than 12 volts, occurring within a tolerable switching time. Suppose this swing is 9 volts. The first 3 volts of this swing is just enough to turn on the driven circuit; the other 6 volts would be overdrive, which speeds the driven circuit's turn-on and avoids the possibility of its jittering in the presence of noise. This 9-volt swing takes 1.39 time constants, 1.39 being the value that satisfies the equation:

$$(1 - 1/e)^x = 9/12$$

But if the two transistors in the diagram are replaced by low-threshold devices, with the same impedance and

the same output capacitance, then  $Q_2$  turns on with a signal of only 2 volts, not 4. With  $Q_2$  off, the 6-volt overdrive for the next stage is attained when the output voltage reaches 8 volts; for this level to be reached in 1.39 time constants, the total swing must be 9.33 volts, and the supply voltage must be 10.33 volts. This lower supply voltage for the low-threshold circuit reduces the circuit's power dissipation if the low-threshold and high-threshold impedances are equal.

If a larger overdrive were desired for any reason, it would either bring the dissipation of the low-threshold circuit closer to that of the high-threshold version, or it would slow down the circuit. The former would occur because of the increased supply voltage; the latter would stem from the larger multiple of the time constant.

Thus the turn-off time, during which an inverter's output increases to an acceptable level to turn on the following stage, is the primary speed limitation in MOS logic circuits. Where this speed is kept constant, the low-threshold circuit, dissipates much less power.

In addition to the interface and speed-power advantage, the low-threshold circuits require smaller bias and clock levels. These signals appear on the line  $V_{gg}$ , and turn on the transistor  $Q_1$  from time to time to keep the output capacitance charged and the output signal from disappearing. But if  $Q_1$  were kept on steadily to maintain the charge, the circuit's power dissipation would be rather high—particularly if  $Q_2$  also were on.

Even though  $Q_1$  has the same threshold level as  $Q_2$ , the bias and clock signals must be considerably larger than the threshold. In the high-threshold circuit, the output is at  $-13$  volts when  $Q_2$  has been off long enough to eliminate all transients. This 13-volt level is the reference point for the threshold of  $Q_1$ , because threshold voltages are always measured from gate to source. Therefore, the amplitude of the clock pulse  $V_{gg}$  must be at least  $-17$  volts relative to system ground. Add to this a tolerance of about 1 volt on the threshold, another 1-volt tolerance on the supply voltage, and about 3 volts from miscellaneous effects that arise from the particular shape and size of the transistor elements, their interconnections, and so on. These add up to about 22 or 23 volts. Finally, turning on the transistor to a state more than just barely past the threshold requires 3 or 4 volts of overdrive, for a total of about 27.

A similar analysis for the low-threshold circuit yields

Basic circuit. Output voltage of this simple MOS configuration swings between negative supply voltage  $V_{dd}$  and a volt or so below ground—the voltage drop across  $Q_2$ . Clock voltage  $V_{gg}$  depends on thresholds of  $Q_1$  and  $Q_2$  as well as on output voltage level.

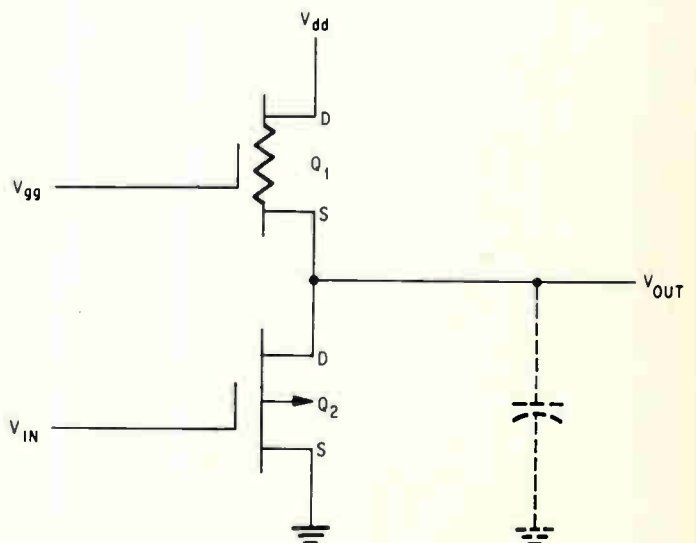

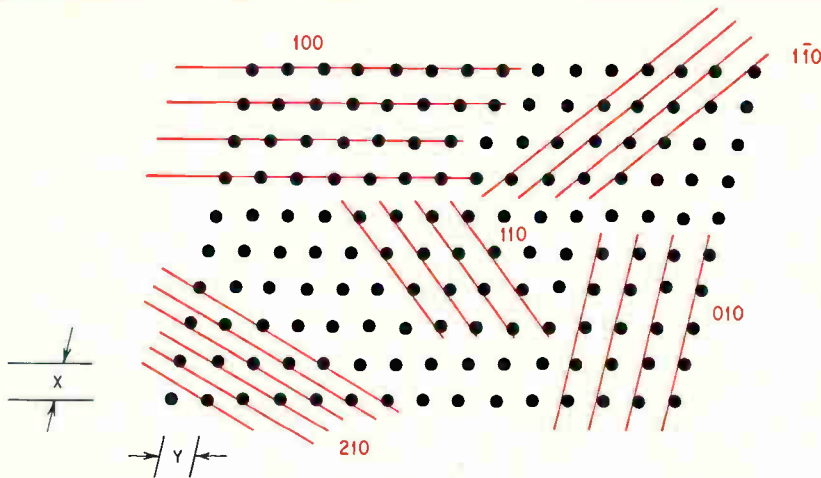

Indexes. Orientation of crystal planes relative to atoms in crystal lattice is specified by three-digit Miller indexes.

Z INTO THE PAGE

## Plane facts about crystals

A crystal consists of a repeating pattern of atoms similar to a wallpaper pattern, but in three dimensions instead of two. Likewise, a space lattice comprises a series of points; each point corresponds to one atom in the crystal lattice. These points may lie in parallel planes in a number of different ways.

Each orientation of the planes is designated by a set of Miller indexes, which is a group of three numbers corresponding to the three axes in space,  $x$ ,  $y$ , and  $z$ . (Although in mathematics these axes are usually considered perpendicular to one another, they need not be perpendicular; and in crystallography they usually are oblique.) The Miller indexes of a set of planes are the number of planes between successive lattice points in each of the three directions, counting the plane through the first point but not the one through the second. In the diagram above, all the planes are shown parallel to the  $z$  axis, and are viewed edgewise; since going in the  $z$ -direction crosses no planes, all the  $z$ -indexes are 0.

In the upper right-hand corner the bar over the middle 1 indicates that the planes are oppositely tilted to the others in the diagram, and therefore have the equivalent of negative slope; the bar represents a minus sign, even though no signed directions are attributed to the axes.

Crystals also have various axes of symmetry, which pass,

for example, through the centers of the two opposite faces, through two opposite corners, through the mid-points of opposite edges, and so on. These concepts of symmetry divide crystals into six kinds, called cubic, tetragonal, trigonal, orthocubic, monoclinic, and triclinic.

Crystals with cubic symmetry are the simplest forms. They come in three different formats: primitive, face-centered, and body-centered. In the primitive cubic crystal lattice, atoms are located only at the corners of the cube; the simplest planes are shown below.

In the face-centered cubic lattice there are additional lattice points—atoms in the center of each face of the cube. These extra points lie in the planes for which the Miller indexes are either all even or all odd. The (111) plane would be one of these; the (100) plane would not.

In the body-centered cubic lattice there is an extra atom, or lattice point, in the center of each cube. These central points lie on planes for which the sum of the Miller indexes is even. Neither the (111) nor the (100) planes, important in the low-threshold mos process, would include these central points because the sums of both of these sets of indexes is odd.

### Reference

Daniels and Alberty, "Physical Chemistry," John Wiley, 1955.

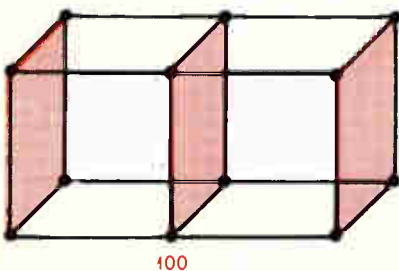

100

Cubic. Simplest cubic lattice contains these three basic crystal planes, among others.

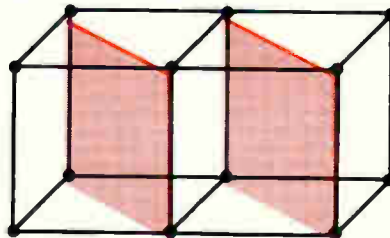

110

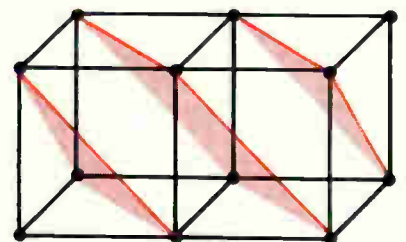

111

a clock signal of about 16 volts, which obviously requires a less complex generating circuit than does a 27-volt clock. In fact, several commercially available bipolar integrated circuits can provide 16-volt clock signals for low-threshold MOS circuits.

These considerations—interfacing with bipolar circuits, the speed-power product, and the clock-pulse generation—clearly show that low-threshold MOS transistors are handy things to have on tap.

**There are three ways to build** these low-threshold circuits—by properly orienting the crystal structure in the semiconductor layer, by using silicon nitride as the insulating material instead of silicon oxide, or by using doped silicon instead of metal in the top layer.

Originally the process was developed around the use of a silicon crystal cut along the (100) plane, rather than the (111) plane traditionally used for MOS transistors. [See "Plane facts about crystals," opposite.] The threshold is reduced because the silicon's surface state charge is less along the (100) plane than along the (111) plane. This surface-state charge is established, in part, by uncommitted bonds between atoms in the crystal; the (111) plane has more of them than the (100) plane. In a ball-and-stick model of the crystal cut along the (111) plane there would be more sticks attached at only one end, and therefore protruding from the plane, than if the model were cut along the (100) plane; these pro-

truding sticks would represent uncommitted bonds.

Nevertheless, the low threshold obtained with the (100) crystals also is present in parasitic transistors that invariably show up between adjacent MOS transistors on a single chip. These transistors and their effect on the circuit are shown on the next page. In some cases their delivered currents are part of the normal current in the device, and are taken into account in the design. But other parasitic transistors tend to pull the normal on and off levels of designed transistors closer together than they should be, reducing the difference between 0 and 1 logic levels and making the circuits more susceptible to noise.

These parasitic transistors operate because the clock voltage is considerably higher than the supply voltage, relative to system ground, so that it can establish a field effect channel in an undesirable area. The tendency of these undesired channels to form can be offset, but every compensation has its tradeoffs. For example, the insulating oxide layer can be made thicker in the places where parasitic transistors are likely to form; this increases the separation between the metal layer and the substrate, thus decreasing the electric field intensity in the substrate and retarding the tendency of spurious channels to form. But increasing oxide thickness transforms a gently rolling hill-and-dale topography into craggy mountains, and the metal layer tends to break on the precipitous "hillsides." Or the substrate material can be chosen with a different resistivity before any diffusions or depositions are made; this can alter the characteristics of any spurious channels that do form so that they make less trouble. But it also adversely affects the characteristics of the other transistors.

Another method of compensating for parasitic transistors is to diffuse a barrier of n+ material between the channel areas. These barriers have a higher threshold than the n material of the substrate so that spurious channels are less likely to form across them. In addition, by taking advantage of the processing step required to add the n+ material they offer the possibility of making npn bipolar transistors on the same chip with the MOS devices.

**A second way** to obtain a low threshold voltage is to use silicon nitride in place of silicon oxide as the insulating layer between the gate and the channel. Threshold voltage is inversely proportional to gate capacitance; nitride increases capacitance because its dielectric content is twice that of oxide. Furthermore, nitride can be used on silicon with a (111) cut; here, parasitic transistors are less of a problem because of the fewer uncommitted bonds in the (111) plane.

But silicon nitride has its disadvantages too. Among these is a tendency for the threshold to shift when the transistor is strongly biased.

This shifting is caused by the different crystal structure of silicon nitride and doped silicon, leaving some uncommitted bonds in the zone where the structures meet. This strong biasing occurs when large pulses arrive at the gate as either signal or noise. In many typical systems diodes are included in the input lines to absorb these pulses, reducing the likelihood of strong biasing. But where the biasing does occur, the nitride can be put down over a thin layer of oxide instead of directly on the silicon substrate. There are fewer uncommitted bonds between the nitride and the oxide,

## Everybody's doing it

As Warner Bridwell, author of the accompanying article, points out, Motorola is hard at work on various aspects of the low-threshold process. It's producing multiplexers and random-access memories on (100) silicon; and it's looking hard at both the silicon-gate and silicon-nitride processes, though neither of these at present is past the development stage.

Fairchild Semiconductor, on the other hand, is concentrating on the silicon-gate process, though still producing high-threshold circuits in volume for its old customers. Fairchild's spinoff and neighbor, Intel Corp., is another silicon-gate house, but doesn't produce any high-threshold devices because, as a new company, it has no established product line to maintain. Intel has announced a 256-bit random-access memory with full decoding, and a dual 100-bit shift register; larger memories are coming. At the International Solid-State Circuits Conference last February, Intel disclosed its design for a 1,024-bit random-access memory developed with Honeywell Inc.

Signetics Corp. expects to be in production with the (100) process by 1971; meanwhile it is looking at the silicon-gate process and another self-aligning technique.

One industry spokesman pointed out that high-threshold circuits do have some intrinsic advantages. For example, when low-threshold MOS circuits are incorporated in a system that contains TTL circuits, the TTL can drive the MOS directly, but because of its limited current output the MOS can't drive the TTL at the latter's full speed capability unless a sense amplifier is interposed. High-threshold MOS doesn't need the sense amplifier; the high-threshold circuit alone is cooler than the combined low-threshold circuit plus sense amplifier. When high threshold's easier production process and better yield are considered, low-threshold suddenly looks less attractive.

However, Bridwell points out that the input from TTL to MOS is still important—in effect, there is a tradeoff between the sense amplifier on the MOS-TTL side and the level shifter on the TTL-MOS side. Furthermore, the circuit density of MOS is high enough, he says, so that chips can become dissipation-limited with the high-threshold process—their size and complexity can be limited not by the number of components or the number of internal or external connections, but by the amount of power they handle. Very dense chips simply can bake themselves into oblivion. "This problem is much less serious," he notes, "with the low-threshold process."

SCHEMATIC

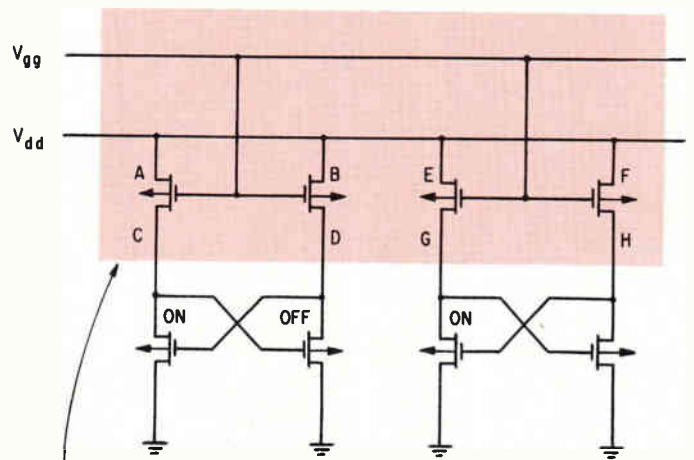

TINTED AREA SHOWN IN MASK LAYOUT

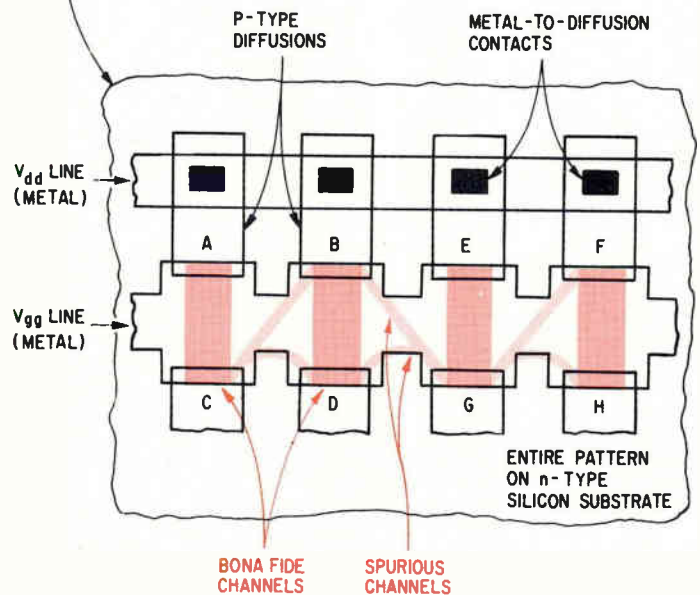

Parasitic. In the four transistors that serve as load impedance for these two static flip-flops, there are parasitic transistors between points as shown by the spurious channels (medium tint). When the flip-flop transistor connected to point C is conducting, point C is at or near ground, whereas points B and D both are at the supply voltage. Metal strip forming  $V_{GG}$  line is continuous across the entire area, forming structure essentially identical to bona fide transistor between A and C (dark tint).

and very few between the oxide and the silicon, thus overcoming the tendency of the threshold to shift. Unfortunately, this additional oxide layer introduces processing difficulties.

Sometimes this shifting threshold can turn out to be a blessing in disguise. For example, Litton Industries, Fairchild Semiconductor, and Hughes Aircraft all have made electrically alterable read-only memories that depend on the tendency of the threshold to shift [*Electronics*, April 14, 1969, p. 50; April 28, 1969, p. 39; Oct. 27, 1969, p. 65].

**A third way** to obtain a low threshold voltage is to fabricate the gate structure from heavily doped silicon instead of metal, again within the substrate material cut along the (111) plane. Silicon gates are made of p-type polycrystalline silicon, whose work function is less than that of the aluminum used in ordinary MOS circuits. The difference between the work functions of the gate and the semiconductor therefore is less, and this influences the threshold voltage both directly and through a reduced surface state charge.

In addition, silicon gates offer two advantages in fabrication; automatic gate alignment, and the possibility of mixing both bipolar and MOS circuits on the same substrate, without the  $n+$  barrier diffusion.

The gate alignment is possible because the same mask defines the area in which the gate insulation and

the silicon gate itself are deposited, in successive steps. With a metal gate different masks are required; possible alignment tolerances require the gate to overlap the source and drain slightly, boosting capacitance and circuit size and restricting speed.

And the bipolar MOS mix is possible because the silicon-gate layer protects everything beneath it from any further high-temperature processes to which the wafer is subjected. Making bipolar structures involves several such high-temperature steps, whereas the MOS process has only one—where the source and drain are diffused into the substrate. All subsequent steps in the MOS process occur at low temperature; but if a high-temperature process were attempted on a completed MOS structure with metal gates, it would contaminate the oxide and change the threshold.

Completing all the high-temperature steps before starting those at low temperature isn't feasible at present. It would involve repeated temperature cycling, which introduces serious control problems.

**As with the other** low-threshold processes, the silicon-gate process has its drawbacks. For example, the silicon deposition is an extra step; metal deposition is still required because external connections can't be made directly to the silicon. But a metal layer can be deposited that can join such external connections to the silicon.

On the other hand, even this dark cloud has its silver lining. With both the silicon layer and the metal layer available, an extra level of interconnection can be made directly on the chip, reducing the number of outside connections and the area of circuits. In one case, at Fairchild Semiconductor, the layout area of a shift register cell was reduced by half [*Electronics*, Sept. 29, 1969, p. 88].

But even with all these advantages of a low-threshold process, achieved by whatever means, high-threshold circuits are by no means obsolete. Customers of companies that have been producing MOS circuits from the beginning won't be in much of a hurry to alter the design of established products—notably shift registers—to incorporate the newer low-threshold circuits. In other configurations, parasitic transistors are less of a problem in high-threshold circuits. And on an economic level, the old-line producers have a substantial capital investment in the high-threshold equipment that they won't discard casually. ●

# Adding third harmonic cancels acoustic coupler's distortion

Method devised by Applied Digital Data Systems' adjusts phase and amplitude of the transmit signal's third harmonic to eliminate the coupler's unwanted second-harmonic distortion

● Like almost anything else, acoustically coupled data sets have been experiencing their share of difficulties with telephone lines. Second harmonics of the transmitted signals—a result of the nonlinear characteristics of the telephone handset's carbon microphone—interfere with received signals, causing data errors. This interference restricts operation to relatively high incoming signals, requiring low telephone line attenuation during transmission. Thus, it is especially unfeasible to send data during peak telephone hours when roundabout routing increases line length and signal attenuation. But now, a method of reducing second-harmonic distortion by injecting the third harmonic component of the fundamental frequency allows full duplex operation—simultaneous transmission and reception—on lines with as much as 31 decibels of signal attenuation and 41 db in half duplex—one way transmission. This is a 10-db improvement over other acoustic couplers which cannot operate over lines with more than 21-db attenuation, and permits transmission-signal levels as high as  $-9$  dbm, the maximum allowed by the Bell System. Most acoustic couplers operate in full duplex at levels 10 db below Bell's specified limit to avoid second-harmonic interference.

The acoustic coupler transmits asynchronously—via the telephone handset—at a rate up to 300 bauds, usually compatible with the Bell 103 data set, in the following

manner. The transmit frequency-shift-key channel of the acoustically coupled data set operates at 1,070 hertz—a binary "0" or space—and at 1,270 hertz—a binary "1" or mark; the second harmonics are at 2,140 hz and 2,540 hz. But the receive channel space and mark are 2,025 hz and 2,225 hz, respectively, placing the 2,140-hz second harmonic of the transmit-space signal directly between them.

Keying between space and mark spreads the energy over the frequency spectrum surrounding the two shifted frequencies. Because of this energy spread the receiver must be capable of detecting energy throughout the receiver band—1,975 to 2,275 hz. Filtering of the transmit-space second harmonic is impossible since it falls within this band. The result is a permanent frequency spread during transmission.

Data transmission via an acoustic coupler is especially critical since the received signal can be relatively weak due to line attenuation between the two transmission points. The Bell Systems states that the limit for full duplex operation of its 112A acoustic coupler is 21 db, achievable if the transmission rate is 150 bauds. But, since the worst possible attenuation in the Bell System is 49 db, any improvement in data transmission, namely the cancellation of second harmonics, would reduce the gap between lines met in practice and lines acceptable for data transmission by the acoustic coupler.

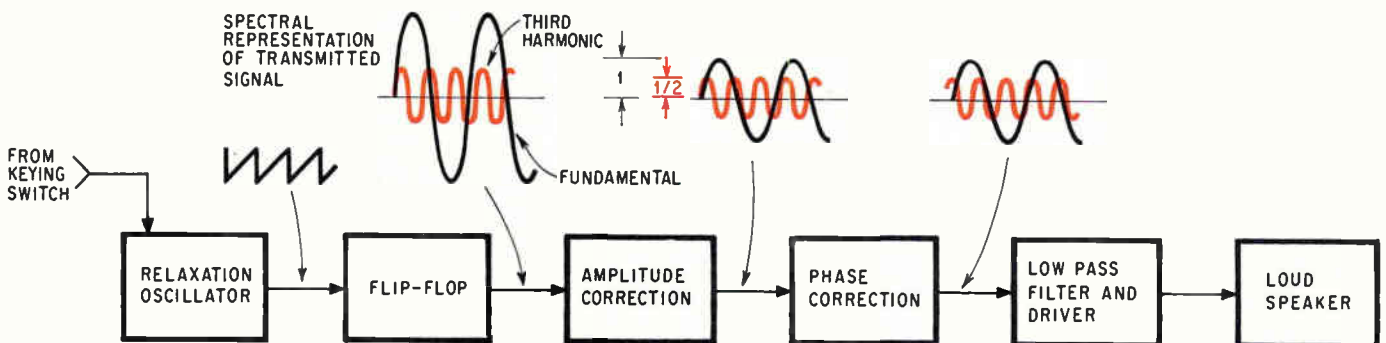

TRANSMITTER





**Data by phone.** The acoustic coupler is seen under test in the laboratory; a telephone is seated on top of the coupler while a keyboard is used to punch in the desired information.

The second-harmonic problem affects the acoustic coupler both in full- and half-duplex operation. The half-duplex, or transmit-only operation is restricted because the transmitter must lock onto the receiver's carrier to insure he is on the line. The transmitter can lock onto its own second harmonic and transmit without the computer listening at the other end of the line.

Obviously, it would be an all around benefit to get rid of the unwanted second-harmonic signal. This can be done by injecting a third-harmonic component along with the fundamental frequency. Fortunately, the third harmonic doesn't interfere with system operation, and therefore the procedure can be carried out in the acoustic coupler. When the added third has the correct phase and amplitude, it generates an intermodulation term between the third and the fundamental. This term cancels the second harmonic. And because this term is proportional to the nonlinearity of the carbon microphone, cancelation is independent of the degree of nonlinearity, and also of frequency. Hence, the method holds true for any telephone handset.

The fundamental frequency and third harmonic are generated in the transmitter section of a new acoustic coupler developed by Applied Digital Data Systems of Hauppauge, N.Y. Here, a relaxation oscillator operating at twice the fundamental-space frequency triggers a flip-flop which produces a square-wave signal at

exactly the desired fundamental frequency. Frequency-shift-keying to the transmit-mark frequency is accomplished by switching a resistor in and out of the relaxation oscillator, thereby changing the discharge time of the capacitor, and hence, the frequency. The output square wave of the flip-flop has no even harmonics, and is rich in odd harmonics.

However, the third harmonic is  $180^\circ$  out of phase from the fundamental and is only one-third as large in amplitude. To meet the cancelation conditions, it can be shown mathematically that the third harmonic must be in phase with the fundamental, and be half as large in amplitude. Hence, phase and amplitude correction—a two-stage operation—must be carried out.

The amplitude-correction stage uses a resistance-capacitance high-pass circuit that acts on both the fundamental and third harmonic so that its outputs are signals whose amplitude ratio is 1:0.5. The following stage, which consists of an operational amplifier and additional circuitry, shifts the phase of the third harmonic relative to the fundamental.

Once the fundamental and third harmonic are in phase, they go to a low-pass filter and driver, also utilizing op amps with an RC-feedback network. This network filters out the higher harmonics present in the square wave and boosts the output signal prior to the loudspeaker which couples the corrected signal to the

**Data in, data out.** The relaxation oscillator triggers the flip-flop to produce the desired square-wave signal which includes the third harmonic. The amplitude-correction stage yields a fundamental-to-third harmonic ratio of  $1:\frac{1}{2}$  while the phase-correction stage brings the two signals into phase. The result is the intermodulation term that cancels the unwanted second-harmonic distortion. The receiver accepts data from the phone lines and processes it prior to insertion into the interface.

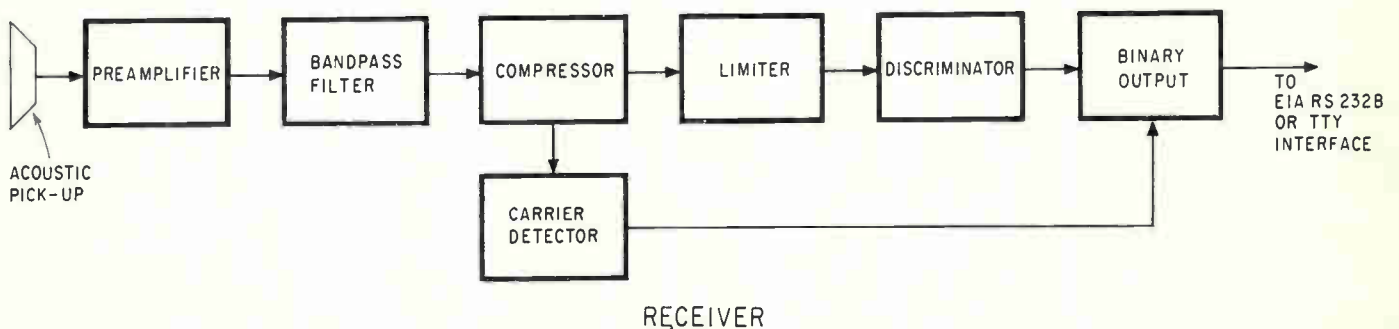

**Non filterable spread.** The cross-over area between the receive space and mark and the transmit second-harmonic spectrum cannot be filtered as a result of the keying rate of 300 bauds. Cancellation by third-harmonic injection is the method used to remove this interference.

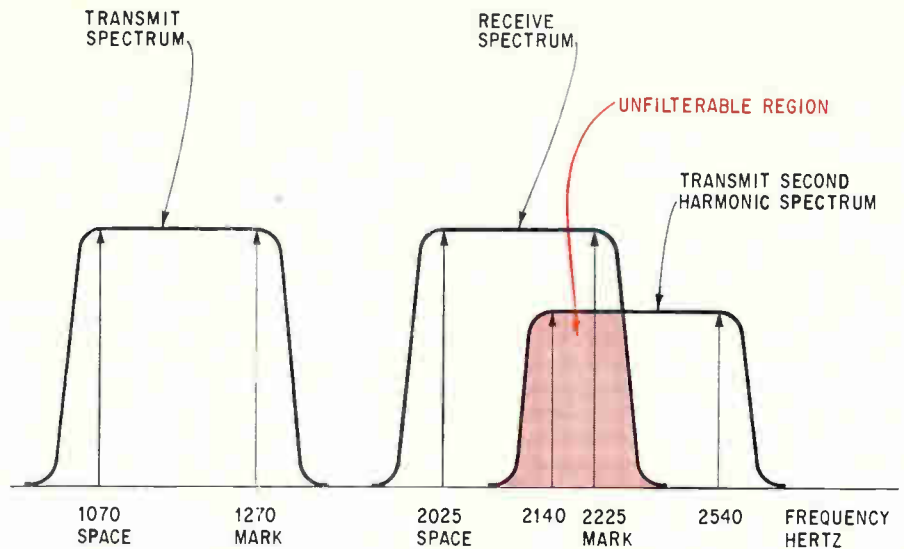

telephone-handset microphone for transmission.

In the receiver, data is acoustically coupled from the telephone handset's earphone. The signal is filtered to remove any remnants of the transmitted mark—2,540 hz—that might be present. A carrier detector feeds directly into the binary output stage and is used to clamp the binary output to the mark frequency to prevent noise from producing erroneous signals when the carrier is not present.

The mathematical analysis of the second-harmonic cancelation by third-harmonic injection can be shown in the following manner. The nonlinear response of the telephone handset's carbon microphone can be approximated by

$$y = ax + bx^2$$

where  $x$  is the mechanical input power and  $y$  is the electrical output;  $a$  and  $b$  are amplitude constants. The cubic term  $cx^3$  and other higher order terms as well are neglected because they do not contribute to the second harmonic and their amplitudes are small.

Assume that the mechanical input power is a sine function,  $x = \sin \omega t$ —the amplitude is normalized to 1 and the phase referred to zero. The electrical output power can then be written

$$y = a \sin \omega t + b \sin^2 \omega t$$

By trigonometric expansion, the second harmonic term,  $b \sin^2 \omega t$ , is

$$B = -\frac{b}{2} \cos 2\omega t$$

This is the interfering signal which must be canceled. Thus, if the third harmonic with amplitude  $K$  and phase  $\Phi$  is added to the fundamental, the resulting mechanical input power will be

$$x = \sin \omega t + K \sin (3\omega t + \Phi)$$

and the electrical output of the composite signal is

$$y = a[\sin \omega t + K \sin (3\omega t + \Phi)] + b[\sin \omega t + K \sin (3\omega t + \Phi)]^2$$

Using trigonometric expansion once again, the energy of the second harmonic is

$$B = -\frac{b}{2} \cos 2\omega t + K b \cos (2\omega t + \Phi)$$

The second term of the second-harmonic energy equation is the intermodulation component and will cancel the first term when

$$K = \frac{1}{2} \text{ and } \Phi = 0$$

These cancelation equations determine the amplitude and phase of the injected-third harmonic. Since the coefficient  $b$  does not affect the equation, the method is independent of the microphone used and is universal. Furthermore, the method is independent of frequency making it effective over any band of frequencies. ●

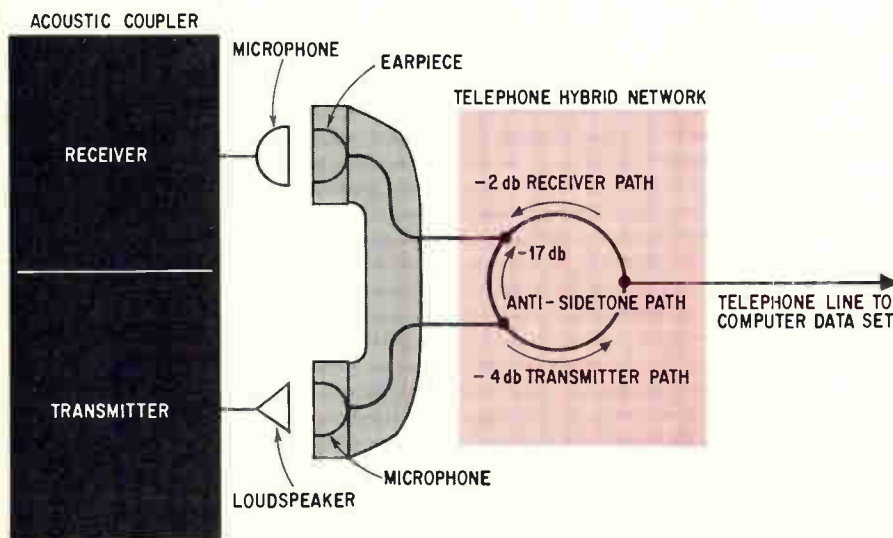

On the line. The transmitted signal is coupled to the earpiece via the antisidetone path whose attenuation is typically 17 db while the signal to the telephone line is attenuated by 4 db in the telephone's hybrid network; the incoming signal sees 2 db of attenuation.

# Signetics springs the lock.

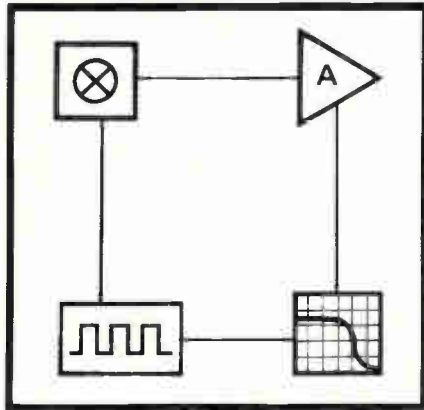

The Phase Locked Loop has hit the market. It's better known as the monolithic phase locked signal conditioner and demodulator. And it's available from Signetics.

This small wonder has all kinds of applications for designers of communication and data equipment. Like 1) FSK and FM demodulation (without tuned circuits), 2) signal locking, reconstitution and conditioning, 3) tone and marker detection, 4) AM synchronous detection, 5) frequency multiplication and division, 6) signal searching and tracking.

In short, the phase locked loop, a complete system on a chip, eliminates tuned circuits altogether. And it reduces the cost and size of designs while improving their stability and reliability.

There are two versions—the 560 and the 561 (the latter adds an AM synchronous detector to the 560). And both operate from less than 1Hz up to 30MHz.

The device has so many possibilities. It will be the universal building block that the op amp has become.

So get in on it now. Write for a complete description of performance, applications and spec sheets.

And lock it up.

## Signetics

Signetics Corporation 811 E. Arques Ave., Sunnyvale, Calif. 94086 / a subsidiary of Corning Glass Works  
Signetics International Corporation, Zug Switzerland (042) 21-25-44



## Hit the Nail Right on the Head in Florida.

### Our Competitive Advantages For Industry Are Tailored

**To Meet Your Needs** When you look toward Florida for a plant site, you are putting your efforts where they'll do the most good. We have a great deal for you in this booming, business-oriented state. We have a built-in competitive edge for you that just can't be ignored. This factor is being recognized by more and more firms with an eye on the future: A tremendous variety of sites, a recruitment and training program (free to you) which has your labor force ready for you when the doors open . . . new laws concerning revenue

# Florida

DEPARTMENT OF COMMERCE  
107 WEST GAINES STREET  
TALLAHASSEE, FLORIDA 32304

bond financing for construction and improvement.

There's a lot more to your competitive edge in Florida. Let us tell you about it in confidence. Phone (904) 224-1215, or send for coupon.

HANDY COUPON FOR YOUR CONVENIENCE!

Florida Department of Commerce / 107 West Gaines St.  
Tallahassee, Florida 32304 / Att.: Dept. "D-3"

*I'm interested in a business or industrial future in Florida.  
Please send me more information.*

Name .....

Title or Position .....

Company .....

Street .....

City ..... State ..... Zip .....

... or 4, 5, 6 or maybe over 100! If you're using a crystal ball to determine bit error rates of digital links, tape recorders, modems, or any digital transmission or storage device... investigate the unique advantages of LINK-BERC (Bit Error Rate Calculator). For the first time, a single 5 1/4 inch unit offers so many advantages.

0 to 10 Megabits/second.

Measure bit errors in periods ranging from 100 to 10 million bits... on a continuous basis.

Bit error rates of Modems, Magnetic Discs, PCM Bit Synchronizers, etc.

■ Measure bit error rates of digital simplex links... duplex links are not required.

■ Rapidly determine bit errors on magnetic tapes previously recorded on the same or other recorders.

■ Also measure clock slippages... advance or retard slippages are indicated and clock regeneration can be optimized.



These features and many others are explained in detail in a new Application / Design Bulletin. For your copy, contact: Data-Control Systems, Inc. Commerce Drive, Danbury, Conn. 06810. Telephone: (203) 743-9241... or our world-wide network of experienced field engineering representatives.



DATA-CONTROL SYSTEMS, INC.

# see bit-errors...two, maybe three..



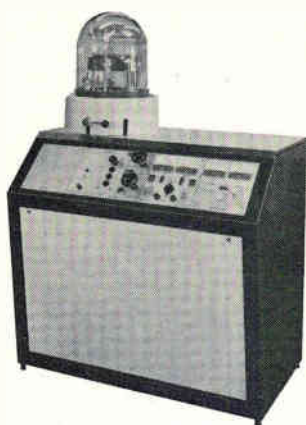

## E12E Vacuum Coater

This is the 12" coater that has established itself as the outstanding system for electron microscopy and provides both carbon and platinum carbon evaporation. It can, in fact, answer the requirement for any coating assignment, within the scope of a 12" bell jar system.



## E19E Vacuum Coater

The ultimate in versatility and efficiency, it provides the complete evaporation capability for precision coatings. Available with a comprehensive range of bell jar accessories, it may be equipped with Edwards monitor and/or controls to tailor operation exactly to any requirement.



## EC18 Vacuum Coater

The "Safe-locked" economy coater protects system integrity against operator error and features a schematic illuminated display that monitors system status. It may be equipped with Edwards patented Plasma-glo discharge cleaning equipment. This provides for an improved glow discharge cleaning technique to remove molecular contamination.

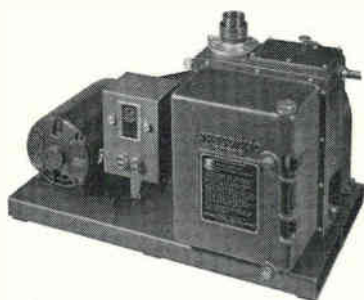

## Mechanical Pumps

The pumps with the 14 outstanding features: positive anti-suck-back, patented oil control valve for protecting system and maintaining vacuum, no contamination from condensable vapors, highest ultimate vacuum, and 10 more — your assurance of fastest, most economical vacuum, without vibration or noise.

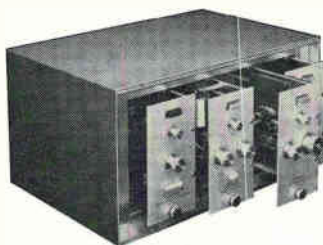

## Automated Film Deposition Control Systems

Completely automatic, semi-automatic or manual control is possible with these modular systems. They may be used in conjunction with Edwards rate and thickness monitors and are capable of controlling either resistance-heated or electron gun sources.

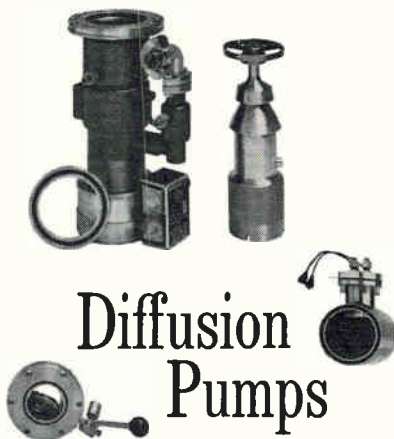

## Diffusion Pumps

Valves and Thermoelectric Baffles

Unique vacuum brazing with a high vacuum bake at 1000° C. achieves a degree of cleanliness not attainable by any other method of manufacture; eliminates internal crevices, and assures freedom from weld decay. All units are individually tested. Stainless steel bodies, aluminum alloy interior assemblies, sizes from 1" to 36".

EDWARDS HIGH VACUUM INTERNATIONAL LIMITED



High Vacuum, Inc.

GRAND ISLAND, NEW YORK 14072  
IN CANADA: OAKVILLE, ONTARIO

EDWARDS HIGH VACUUM LTD.  
Manor Royal  
Crawley, Sussex, England

EDWARDS ALTO VUOTO S.p.A.  
Via Pisacane ang. Via Dante  
Pero (MI), Italy

EDWARDS HOCHVAKUUM GMBH.  
Frankfurt/Main — Niederrad,  
Hahnstrasse 46, Germany

# We know what it can do.

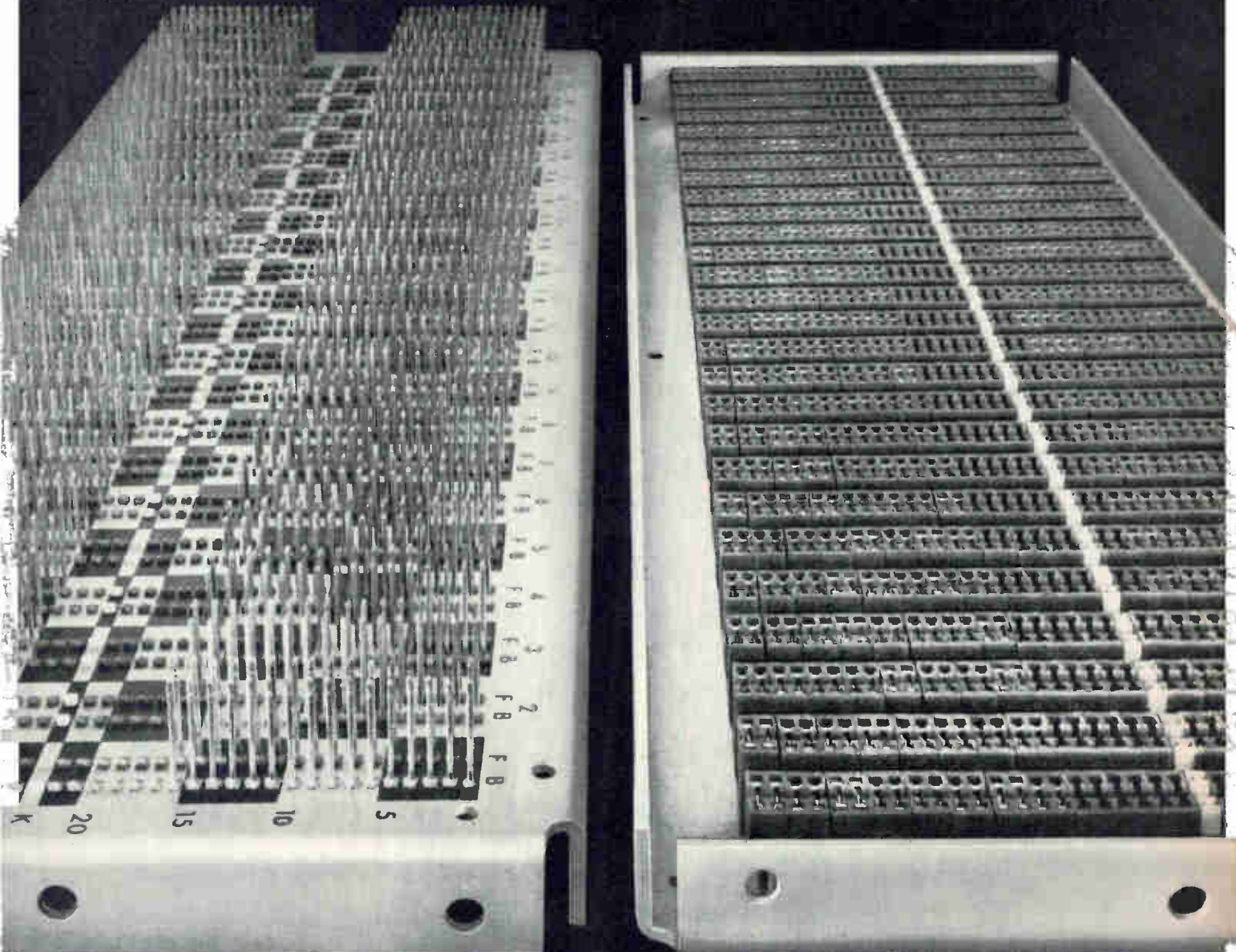

# You tell us where.

That's a solderless wrap modular plate connecting system you're looking at. Both sides of it.

When we design one, we know how good it is in terms of performance, reliability and component flexibility—but you can tell us where it can do you the most good. We'll design one to your requirements, if you tell us what your requirements are.

The system consists of edge-type modular connectors for solderless wrap termina-

tions. And can accommodate a .056" to .068" thick double sided printed circuit board. The basic components are combinations of 4 and 6 position contact modules. Polarization modules or keys. Card guides, bussing strips and grounding clips. All installed on an aluminum plate up to 24" x 24".

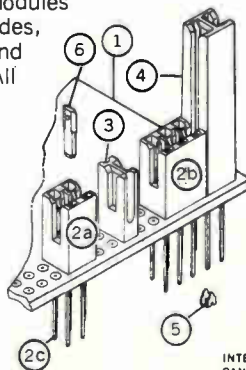

#### Basic Components for Modular Connecting Systems:

1. .080" thick aluminum plate up to 24" x 24"
2. contact module assemblies: combinations of (a) 4 and (b) 6 position modules with (c) .025" square posts for solderless wrap
3. polarization modules occupying

a contact space—for either catalog series

4. card guides with 1 to 4 optional ground posts—.025" square
5. grounding clips which can be placed in any post position
6. polarization key for between stations on the .125" x .125" grid only

Burndy will supply your system custom wire-wrapped to your individual specifications, or unwired for your own assembly line wiring. In either case you'll find the system ideal for uninterrupted back plane applications. It's not only practical for production quantities, its modular format is easily rearranged for breadboarding.

We'll be glad to sit down with you and work out a system. All you need is the need. Just pick the time and the place.

 **BURNDY**  
Electronic Products/Norwalk, Connecticut

INTERNATIONAL SALES HEADQUARTERS & MANUFACTURING FACILITIES:  
CANADA/ENGLAND/BELGIUM/MEXICO/BRAZIL/JAPAN/Sales Offices in Major Cities

# next time you think oscillator... don't!

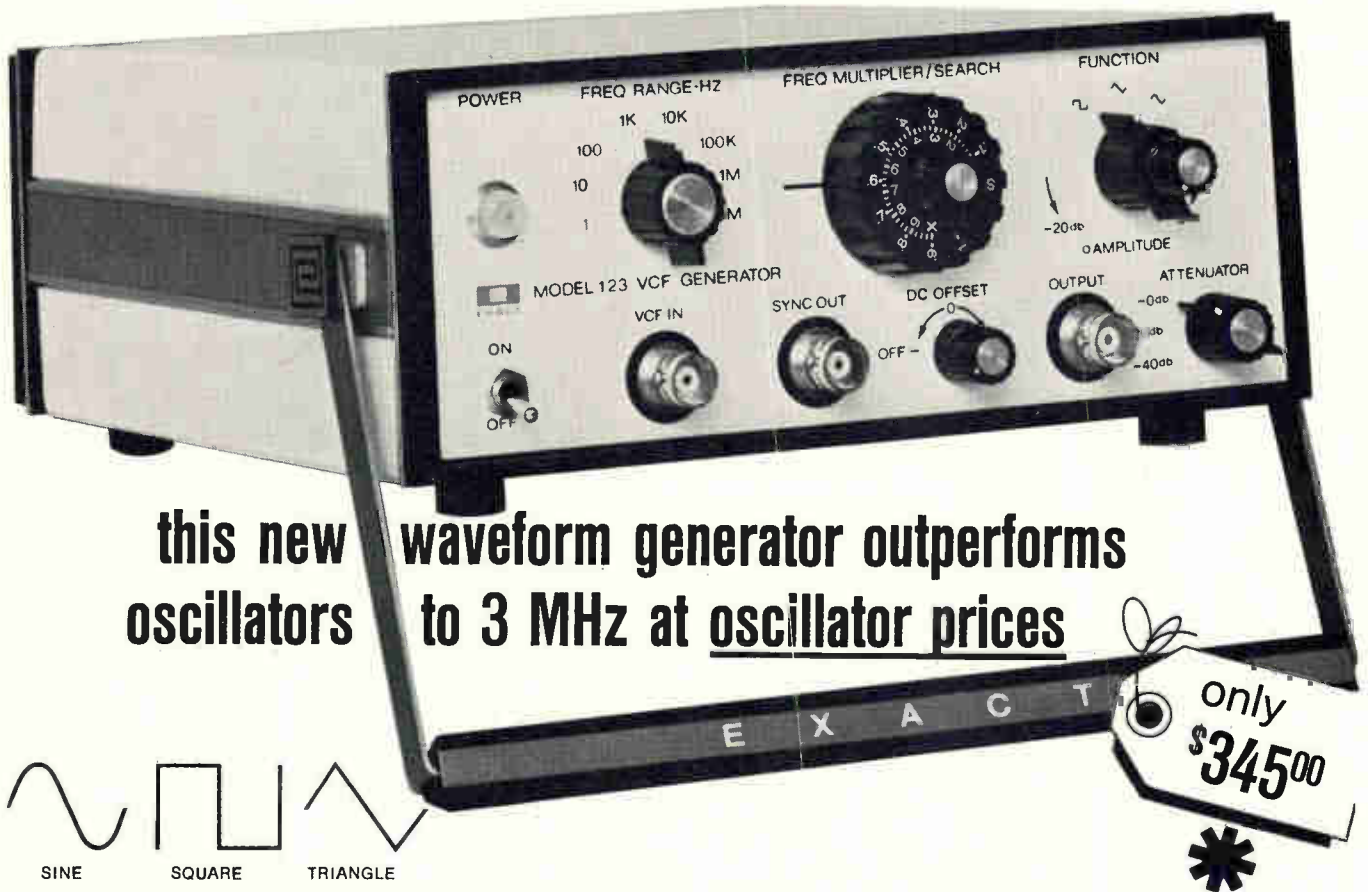

this new waveform generator outperforms  
oscillators to 3 MHz at oscillator prices

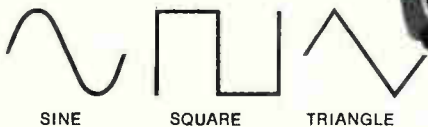

## THREE WAVEFORMS

**GREATER BANDWIDTH** — Dynamic frequency from 0.1 Hz to 3 MHz.

**EXTERNAL VCF** — Control voltage can be either DC programming or AC frequency modulation. 1000:1 range.

**OUTPUT POWER**—All waveforms at least 20 V P-P into open circuit, 10 V P-P into 50-ohm load.

**MINIATURE SIZE**—Only 2 $\frac{7}{8}$ " high, 7 $\frac{3}{8}$ " wide, 8 $\frac{1}{2}$ " deep. Just 4 pounds.

Exact's new Model 123 VCF Waveform Generator not only outperforms oscillators in its range, but surpasses the performance of any waveform generator in the same league. And at a price you'd expect to pay for an oscillator!



**EXACT**  
electronics, inc.

## WHAT YOU GET FOR ONLY \$345 IN THE MODEL 123:

- Kelvin-Varley Divider frequency control for greater accuracy.
- Variable  $\pm 5$  V DC offset.
- db Step Attenuator.
- Floating output provision.
- Search mode for manually sweeping 1000:1.
- Combination tilt-stand and handle.
- Easy maintenance—single P.C. board with calibration procedure printed inside top cover.

**\* Tight budget? Check Exact's new Model 120. Only \$295.**

Box 160 • Hillsboro, Oregon 97123 • Telephone (503) 648-6661



# Full performance at a price you can afford



You don't have to be a Scotsman to know that you pay more for top performance. So if we told you this new 3-digit DPM was made to sell for less than \$115 in OEM quantities, you'd figure its performance at something less than that delivered by our higher priced models.

But you'd be wrong. And here's why.

First of all, our initial objective was to develop an instrument for OEM measurement needs of the scientific and medical community. Obviously, price was an important factor. But so was performance. The happy solution

was to eliminate a few of the more exotic functions that these users normally don't require. For example, 100% overrange and standard BCD output (an option available on Model 1261).

Secondly, instead of compromising performance, we've actually *improved* it! Model 1261 is a basic 0-99.9 millivolt DC meter with 50% overrange capability, 100 microvolt resolution, long-term stability, 50 megohm input impedance, high rejection characteristics, and Weston's patented dual slope\* circuitry. It's packaged in the plug-in case that's common to all our

DPM's, giving you Weston front panel serviceability.

This latest addition to our DPM family brings .1% accuracy within range of practically everyone's budget. Make your own comparisons, spec for spec, with other digital compacts on the market. Write today for complete data and ranges available.

WESTON INSTRUMENTS DIVISION,  
Weston Instruments, Inc., Newark, N.J.  
07114, a Schlumberger company

**WESTON®**

Our  
new  
micropower  
op amp  
runs  
off  $\pm 1\text{v}$   
with  $20\ \mu\text{W}$   
power  
consumption.

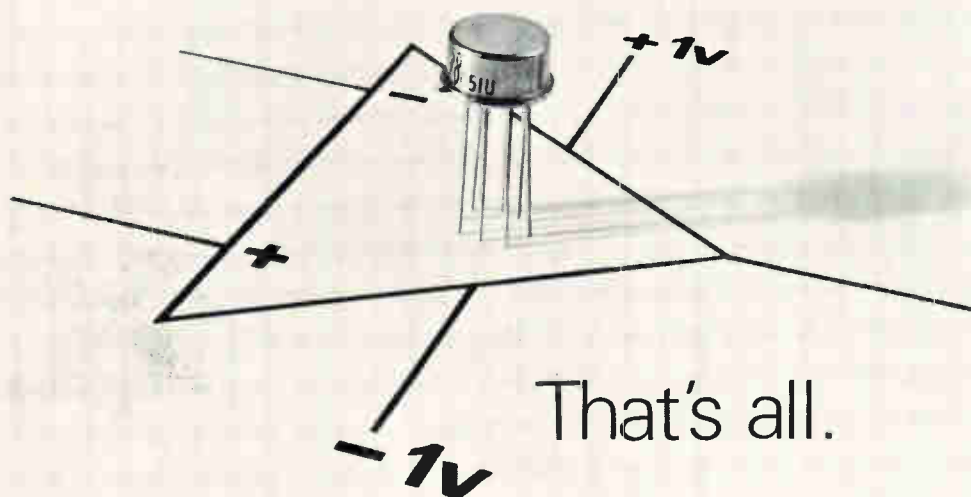

That's all.

Solitron's UC4250 micropower op amp uses so little power that its batteries will last as long as their shelf life. It needs so little voltage that only two single cells are needed. (Although it can handle up to  $\pm 18\text{v}$ .)

The other specifications aren't so bad either. 3 nanoamps input bias current with tempera-

ture drift of zero nanoamps per degree C. 100 db gain into a 10K load. And it's available now. From (who else?) Solitron.

Solitron Devices, Inc., P.O. Box 1416,  
San Diego, California 92112.  
Telephone 714/278-8780.  
TWX 910-335-1221.



FROM THE

# WAVE MAKERS:

## A NEW SERIES OF SOLID STATE PROGRAMMABLE OSCILLATORS



Krohn-Hite's Series 4100 Rack-Mounted Solid State Programmable Oscillators are the new generation of medium-priced, precision general purpose oscillators. They combine the convenience of automatic programmed frequency and amplitude selection with the outstanding performance characteristics of the popular Model 4100 Push-Button Oscillator. Covering the frequency range of 0.1 Hz to 1 MHz, Series 4100 Programmable Oscillators boast a frequency calibration accuracy as low as 0.1%.

Available in four models, Series 4100 Oscillators are designed for either standard manual operation or automatic programmed frequency or amplitude selection by any one of several commonly available means, such as computer output, punched cards, punched tape or computer mag tape. Programming format is the standard 1-2-4-8 binary coded decimal system. A unique feature of the Series 4100 Programmable Oscillators is the capability to produce both sine and square wave outputs with 1/2 watt of power into 50 ohms with remote or local frequency control. Best of all, Series 4100 provides a degree of frequency stability, low distortion, and amplitude stability that can't be matched by competitive units.

The following chart provides a brief rundown of the important operating parameters of the new generation Series 4100 Solid State Programmable Oscillators. And don't forget the model 4100A non-programmable oscillator is still available at \$550. They're all products of the recognized leader in variable filters who's out to make waves in oscillators, too. For complete technical information on any of these new Krohn-Hite Oscillators, write THE WAVEMAKERS: Krohn-Hite Corporation, 580 Massachusetts Avenue, Cambridge, Massachusetts 02139 U.S.A.

Tel: (617) 491-3211 TWX: 710-320-6583

SERIES 4100 SOLID STATE PROGRAMMABLE OSCILLATORS										
Frequency Range	Osc. Model	Freq. Acc. %	Max. Volts	Output Impedance	Dist.	Square Wave	Prog. Amplitude	Approx. Ship. Wt. lbs kgs	Price	
0.1 Hz to 1 MHz	4131R	0.1	10 RMS	50	0.02%	yes	no	30/15	\$1375	
0.1 Hz to 1 MHz	4141R	0.1	10 RMS	50	0.02%	yes	yes	30/15	\$1585	
1 Hz to 1 MHz	4130R	0.5	10 RMS	50	0.02%	yes	no	27/13	\$1075	
1 Hz to 1 MHz	4140R	0.5	10 RMS	50	0.02%	yes	yes	27/13	\$1285	

**KH** KROHN-HITE  
CORPORATION

OSCILLATORS / FILTERS / AC POWER SUPPLIES / AMPLIFIERS

# Is Your Computer Doing Things For You... Or To You?

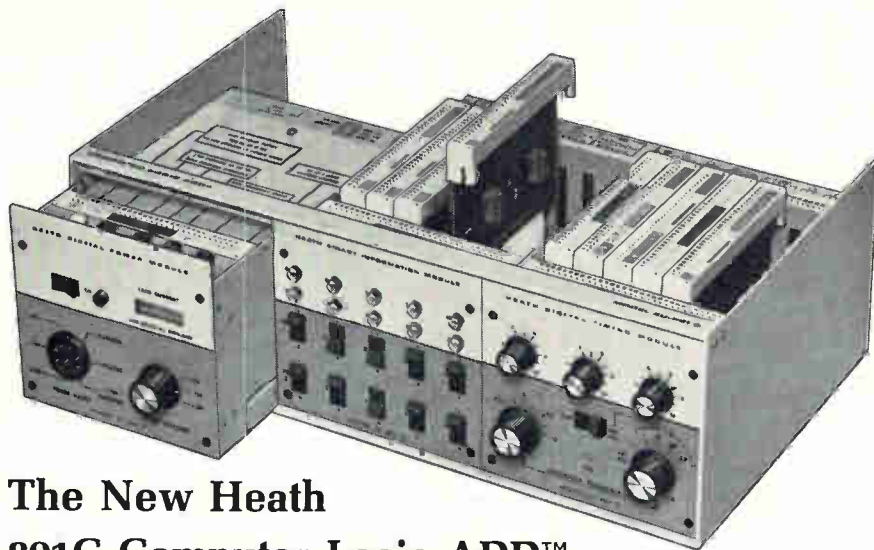
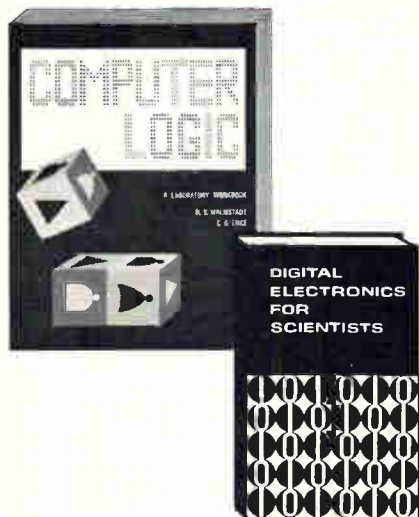

## The New Heath 801C Computer Logic ADD™ Broadens Your Understanding

### What Is Your General Purpose Computer Doing?

Is it doing things for you in your problem solving that make the job easier, faster, more accurate? Things like analyzing, processing, measuring... working as an integral, active part of your design process? Does your knowledge of how your computer works, and what it can do, enable you to significantly alter your view of the problem... to the point of finding a better solution? Or is your computer, by being something of an enigma, doing things to you... like wasting your valuable time... increasing costs... degrading the accuracy and repeatability of your results? Is your computer doing things for you... or to you? The New Heath 801C System Can Help You Find Out... by broadening your understanding of computer logic. The Computer Logic ADD is designed to give you the basic knowledge of computer logic you need to effectively use the computer as a functional part of your designing and problem solving methods. The 801C System consists of the new EU-801C Computer Logic Analog-Digital Designer (ADD), a pioneering new text, "Digital Electronics For Scientists", by Drs. Malmstadt & Enke, and a Workbook keyed to the text and written to lead the newcomer a step at a time through basic logic functions and methods of manipulating data.

The EU-801C Computer Logic ADD is a precision teaching and design device composed of three Modules... Digital Power, Binary Information and Timing. Plug-in circuit cards in the Modules contain discrete logic functions such as AND, OR, NOR, NAND, INVERT etc., and the solderless connectors on the top of each card allow the user to patch the cards together with ordinary hook-up wire to form logic subsystems and systems identical to those used in present computers. Standard logic symbology is used throughout the system so the cards can be connected according to common logic diagrams. The ADD is also completely open-ended... more complex circuit cards are available from Heath to provide design & self-teaching capability for computer interfacing, digital instrumentation and control functions.

The Workbook, written by Drs. Malmstadt & Enke, is applicable to anyone interested in learning basic computer logic concepts and functions. The Workbook contains descriptive summaries, textbook references and specific instructions for 50 experiments. The experiments systematically "open up" the computer so that its basic logic functions and data handling methods become clearly understood. The format, experiments and presentations are designed for self-teaching and self-checking of one's comprehension. Table Of Contents by chapter: (1) Gate Logic... the student becomes familiar with logic levels, truth tables, Nand/Nor gate logic, Boolean Algebra, and encoder, adder, subtracter, decoder, multiplexer, comparator, parity and relative magnitude detector circuits and functions. (2) Flip-Flops... one of the most basic logic functions, used in all types of registers, for buffer storage, counting, converting, scaling and many other computation and measurement applications. (3) Counters & Scalers... including BCD counting, decade counters, scalars, variable modulus counters and preset counters. (4) Shift Registers... this set of experiments illustrates all the basic shift register circuits and applications. (5) Counting Measurements... this chapter demonstrates the use of counters to measure frequency, period and time interval. (6) Binary Computation... including serial and parallel addition and subtraction, which are the basis for all types of computation in actual computers.

Text—"Digital Electronics For Scientists" is a complete, up-to-date reference and study text for modern digital logic techniques. Although only the non-electronic portions of this text are used with the 801C System, the complete text offers an invaluable source of information for those interested in probing further into the nature and uses of current digital techniques.

The New Heath 801C System... can be the key to making your small computer an active, functional part of your design process. Order your 801C System now... and discover that your computer can be doing things for you, instead of to you. EU-801C, complete system .....\$365.00\*

### FREE Heath Scientific Instrumentation Catalog



Describes these and other precision instruments for laboratory, engineering, education and R & D applications. Send for your FREE copy now... just write on your school or company letterhead.

HEATH  
a Schlumberger company

HEATH COMPANY, Dept. 580-04  
Benton Harbor, Michigan 49022

Please send FREE Heath Scientific Instrumentation Catalog

Name \_\_\_\_\_

Address \_\_\_\_\_

City \_\_\_\_\_ State \_\_\_\_\_ Zip \_\_\_\_\_

Prices and specifications subject to change without notice.  
\*Mail Order Prices; F.O.B. Factory

EK-284

# Layoffs reduce thin job market

Recruiting is down, furloughs are up, as defense and aerospace cutbacks continue and the economy remains soft; instrument houses offer some hope

By Peter Schuyten

Electronics staff

About the only good thing electronic engineers have to say about this year's employment picture is that it can't possibly get worse. According to college placement officials, company personnel directors, and industry surveys, 1970 may rank with 1964 as one of the worst years in recent history for EE employment. Many companies are laying off EE's, and others have completely eliminated college recruiting. And those still recruiting at engineering schools or placing ads are seeking either the narrow specialist or the outstanding June graduate.

Of course as always, bright spots exist in the employment market. Among them are certain specialties—microwave engineers and computer-peripheral designers, for example. In some cases entire industries such as instrument makers and semiconductor houses look strong.

Hardest hit are EE's employed in the defense-aerospace sector. At the Boeing Co. of Seattle, best estimates have it that nearly 1,000 EE's and associated engineering types will leave the company payroll in a relatively short period. Engineering employment at Boeing, which peaked at nearly 14,000 at the start of 1968, now stands at about 10,200 and is expected to go down another 1,000 before the end of the year. In February, for example, nearly 800 engineers of all types—Boeing won't list its engineering layoffs by categories—were laid off in a single week.

Some research and development groups have been entirely eliminated, but for the most part engi-

neering groups are given discharge quotas ranging from 10% to 50%. And Boeing's not the only one feeling the pinch. Much of the West Coast's aerospace and defense industry has fallen on hard times.

North American Rockwell's Autonetics division is still measuring the shakeout from a major reorganization closely followed by an across the board 10% cut in personnel. "While a high percentage of the 4,000 or so engineers and scientists at Autonetics at the start of the cutback last December were EE's, the ratio of EE's to other types of employees on a program-by-program basis will remain the same," says Cedric O'Donnell, the firm's vice president and general manager for research and engineering. Except for specified needs—mostly in environmental testing which requires engineers with higher degrees and specified equipment experience—the hiring picture is dim.

**Open transfer.** As for layoffs Autonetics handles this problem by a system of "open transfer." Personnel being cut are placed in this category for a minimum of two weeks stretching out to six weeks or more, depending on seniority

or job classification. During this period, the transferee may seek other positions within the company. With proper experience and seniority, the man can find a position and "bump" whomever is currently holding it. Supervisory personnel, by company policy, are required to accept the senior person qualified for the job. The person bumped is then on open transfer, and so the process continues until someone gets the final bump.

Continuing along the West Coast, Hughes Aircraft, reacting to dropping workloads, plans to let about 70 EE's go on a selective basis: two thirds from the Ground Systems group in Fullerton, Calif., and one third from Hughes' Culver City installation. However, many of these are being picked up by other divisions to fill normal attrition, according to Grant Chandler, Hughes' corporate director of industrial relations. Currently, Hughes is hiring a small number of microwave-circuit designers and experienced test engineers.

Like Boeing and many other aerospace firms, the Martin Co.'s Orlando, Fla., division doesn't break down its layoff figures into engineering specialties; however, overall employment has dropped from 8,200 last year to 6,200 this year. The entire spectrum of engineering specialties was affected by the layoffs, which have been caused both by contract losses and by the end of many in-house programs.

Martin, says a spokesman, uses a hybrid layoff system. Past performance is the prime consideration; specialty and seniority are secondary. The company has tried

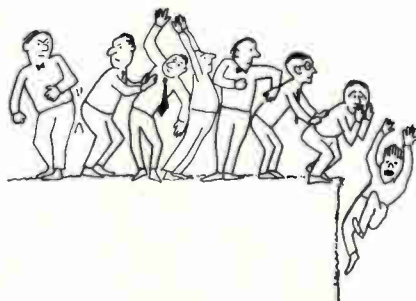

to relocate laid-off engineers within the parent company. However, the stretchout of the Viking program at Martin-Denver just about brought this placement procedure to a halt. Martin has also sought to place its surplus engineers in other companies in the area, but those firms, faced with their own employment problems, have not been too receptive. In fact, if the evidence of one company spokesman can be taken seriously, many engineers are now leaving engineering altogether rather than continue their nomadic existence. Most of these engineers prefer to work as insurance salesmen, stock brokers, and real estate men, or even open pizza parlors rather than leave Florida.

There will be no real bidding for new engineering talent during the rest of 1970, according to a company official. And the people currently on-board, especially trouble-

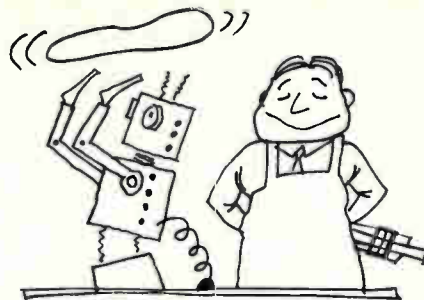

Electro-PIZZA  
30¢ a chip slice

shooter types, will continue to suffer since the need for them has dramatically decreased. The fact is that Martin-Orlando is reducing overhead to make funds available to penetrate new markets.

Continuing the list of companies hard hit by defense and space cut-backs is Lockheed-Georgia which is in the process of cutting back a work force which at one time numbered above 32,000. It is approaching the 30,000 mark now

through normal attrition, but projections have it falling as low as 25,000. There, engineers are being laid off on a selective basis, with one here and another there, rather than wiping out an entire department or section. Hardest hit are the contract, or job shop, engineers, most of whom have already been laid off, according to Hugh Gordon, personnel services division manager. Contract engineers numbered several hundred and include an unascertained number of EE's. Fewer than 25 members of the permanent engineering staff have been laid off, but the firm is still studying its workload to determine how many more of these permanent engineers will be let go.

There have been three separate layoffs in the past six months at Electronic Communications Inc. of St. Petersburg, Fla., involving engineering personnel. And company

### 'Three statistics'

Large-scale layoffs—like those occurring at the Boeing Co. in Seattle—are conceived of largely in terms of statistics and percentages. But the professional engineer who finds himself in an unemployment line sees it differently. Despair, disillusionment, and in some rare cases, resourcefulness characterize the engineers who find themselves out of work.

George Klein, put in 14 years at Boeing before being laid off. Recently he had worked on the hardening of Minuteman missile silos. Far from being despondent about his layoff, he "never even shed a tear." Instead, Klein, who enjoys working on color tv sets and hi-fi's as a hobby, opened an electronics repair service—Klein Electronics—on some property he owns in a good commercial location. Business has been good and now Klein Electronics may take on other ex-Boeingites as jobbers on a concession basis—working house calls, for example.

But Klein is more the exception than the rule. A more typical example of the laid-off Boeing engineer is Jim McGlothlin, an electrical engineer who has worked as a technical writer for the company for nearly four years. For many years McGlothlin, 38, had been a nondegree technical writer, work-

ing for a number of well-known East Coast firms. Seeking increased job security, he returned to school in 1964 to complete work on his BSEE. Nevertheless, two months ago he received his termination notice along with hundreds of other Boeing engineers.

**Broken promise.** "When Boeing recruited me, I was assured that the aerospace industry had stabilized and that prospects for continued employment here were very good. Now I'm disappointed not only with the company but with the aerospace field in general. We engineers are little better than

construction workers who go from one camp to another." Because of widespread unemployment in the Seattle area, McGlothlin is now faced with having to relocate. The house that he bought at the peak of a booming real-estate market, he hopes to rent for just enough to cover the cost of his mortgage payments.

Lester Hedeem has a different sort of problem. With Boeing for more than 23 years, Hedeem is a mechanical engineer who ended up as a senior engineer in an electronic systems group working on assembly and check-out of the Minuteman missile. When that nine-man group was trimmed to two, he was promised a job in another Boeing division, but then the company stopped all transfers. The result: Hedeem got his notice.

Now he's doing hourly work for a contractor and looking for a job as a mechanical engineer in the commercial field. He sees no chance of employment in the aerospace industry, recognizing that his electronics work was too specialized. The Seattle Professional Engineering Employees Association, which represents Boeing engineers, has walls of one room covered with job opportunities but none seem to apply to him. "I just seem to be a misfit," he concludes.



McGlothlin: Waiting game

vice president and general manager of the Aerospace division Paul G. Hansel, says that ECI is still clearly overstaffed for the present backlog of business. Contract delays, stretchouts, and cut-backs make the situation highly uncertain for the EE.

Hansel, like his colleagues at virtually every other defense or aerospace contractor is faced with a dilemma; large systems and hardware contracts require experienced engineers but company growth requires new engineers to grow within the company. However, ECI, like others, has decided that at this time it can't afford to bid for new engineering talent. Thus, the B average June graduate, in Hansel's opinion, won't find a job in the aerospace industry.

Consumer-oriented electronics firms are living in a paradox. Despite a horrible first quarter and a projected bad second quarter in sales, consumer companies—according to spokesmen at Zenith, Motorola, and Admiral—are holding the line on EE employment. Although all three companies say there are no EE's being laid off, the attrition factor has to be considered. Consumer companies, by their own admission, aren't replacing EE's as fast as they leave, nor are they actively recruiting on college campuses.

For their part college placement officials, like UCLA's Charles Sundberg, tell June graduates that employment is a matter of settling for a job; the day of the highly selective graduate is over. According to Sundberg, "The BSEE doesn't need to expect to go unemployed, but he is not going to enjoy the same demand for his services that existed a couple of years ago."

This year, the defense and aerospace contractors, traditionally the largest employers of June graduates, have generally been discounted as employers, says Dennis Ryan, associate director of placement at Pittsburgh's Carnegie-Mellon University. Furthermore, Ryan reports that overall recruiting visits to the campus are down 20% from last year—a condition that holds true around the country. Jean Ellis of Southern Methodist University's placement office has been receiving letters from recruiters that say, "Due to a reduc-

tion in our employment needs" or "Due to the fact that we have already been able to fill our projected needs for this year, we will not return to your campus for a spring visit." A placement official at one Midwestern engineering school also reports a decline in job offers over last year. And some students who get offers don't report them. The reason: embarrassment over not getting the high salaries offered last year's students.

**Draft factor.** The draft and draft deferrable jobs are an increasingly controversial area in college recruiting. At one end of the spectrum, students, such as those at Illinois Institute of Technology, actively seek companies that have Government contracts and can offer deferments, says IIT's director of placement William Smith. The same is largely true at the Massachusetts Institute of Technology, where, according to MIT's director of placement Robert K. Weatherall, the typical student is not concerned with sociological issues. "And the availability of draft deferments is still a strong motive for working in defense-oriented companies," Weatherall concludes.

Unlike MIT, engineering students at Tufts University tend to stay "away from companies they know are on Government contracts," reports career counselor William C. Wrenn. However, Wrenn says, "In the course of conversations, students say they don't want to do defense work, but this is as often as not because they feel the defense industry is economically unstable now." UCLA's Sundberg, on the other hand, sees no increase in the number of EE's staying away from defense-aerospace work—when they can get it.

Even harder hit than the BSEE engineers are those with master's and doctorate degrees. For those with higher degrees, the employment picture seems to be really tightening. Research-oriented staffs, reports UCLA's Sundberg, now seem to be remarkably static.

Perhaps the most fertile areas for both new and experienced engineers are the instrument houses and the semiconductor firms. A Fairchild official reports that the company is actively recruiting EE's because of the firm's expansion into new fields of technology. The

# COMPARE CLOSE-UPS

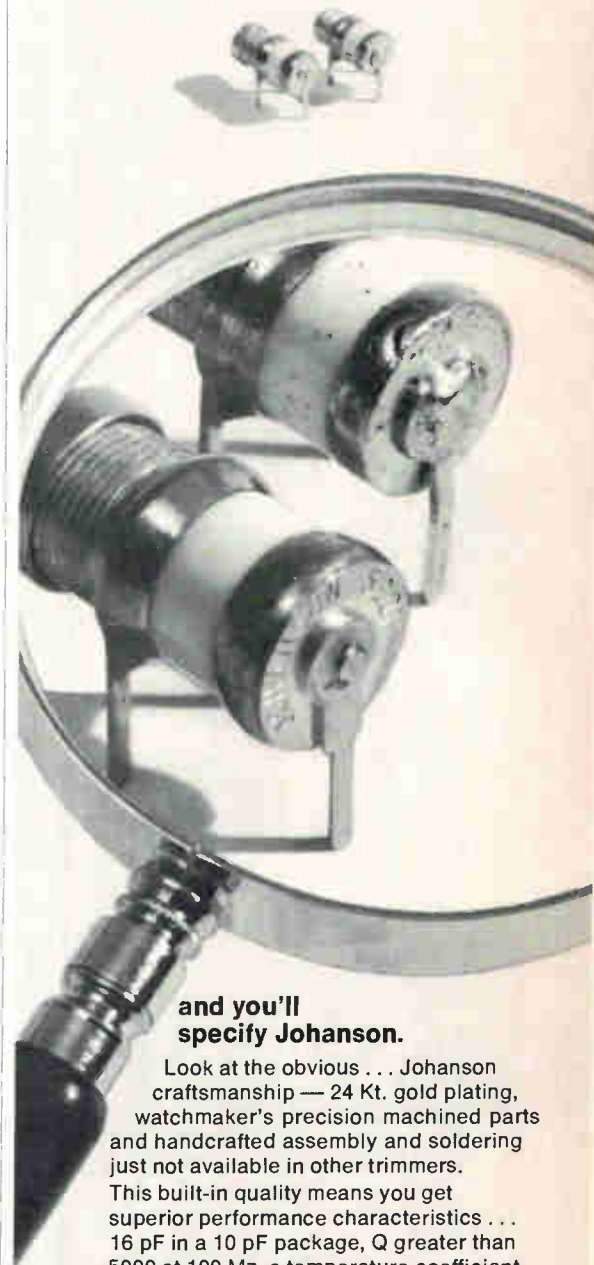

## and you'll specify Johanson.

Look at the obvious . . . Johanson craftsmanship — 24 Kt. gold plating, watchmaker's precision machined parts and handcrafted assembly and soldering just not available in other trimmers.

This built-in quality means you get superior performance characteristics . . . 16 pF in a 10 pF package, Q greater than 5000 at 100 Mz, a temperature coefficient of  $0 \pm 15$  PPM°/C, with tuning stability and long life.

Why settle for ordinary trimmers when the best is available — send today for our new catalog sheet on our 5200 series . . . and start comparing.



*Johanson*

**MANUFACTURING CORPORATION**

Rockaway Valley Road, Boonton, N.J. 07005  
(201) 334-2676

*Electronic Accuracy Through Mechanical Precision*

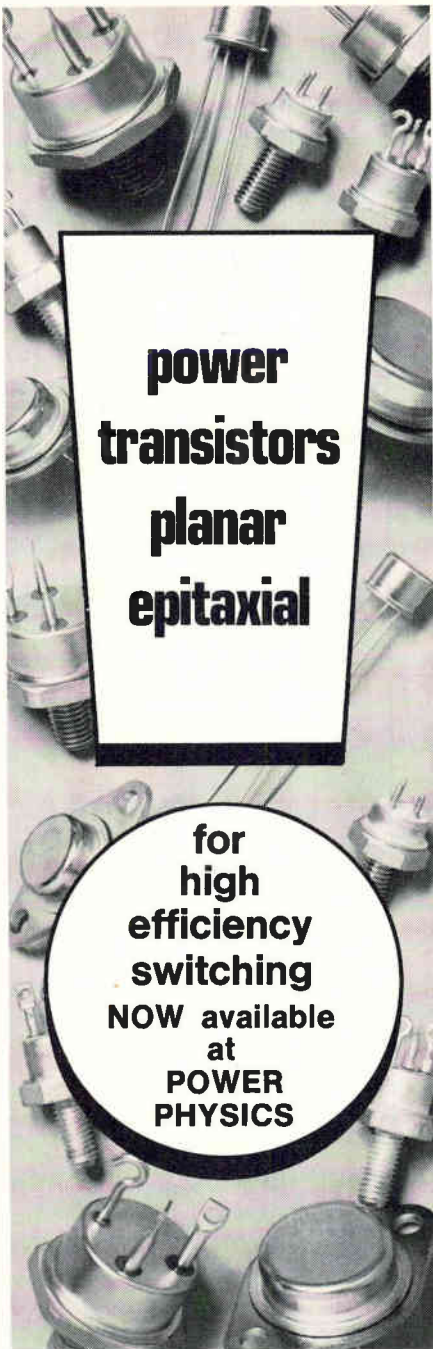

**power  
transistors  
planar  
epitaxial**

**for  
high  
efficiency  
switching  
NOW available  
at  
POWER  
PHYSICS**

POWER PHYSICS does it again . . . with a complete line of silicon NPN Planars for power switching Ft: 150-200 MHz; useful hFE from 3A to 50A Ic; VCEO up to 140V. Some of the more popular types include: 2N 2658, 2N 2812-14, 2N 2880, 2N 4000-3, 2N 4150, 2N 5539. A variety of packages include: TO-5, TO-59, TO-3, TO-61, TO-111, TO-63, TO-68, TO-66. Most are available from stock.

Write for the new **POWER PHYSICS** literature on Planar Epitaxial Silicon NPN Power Transistors.

**PP**  
**POWER PHYSICS**  
CORPORATION

Industrial Way West • P.O. Box 626  
Eatontown, New Jersey 07724  
Telephone (201) 542-1393

10

growth in its semiconductor business has created 75 new openings. And in Fairchild's Systems Technology division, a relatively new operation, there are currently between 25 and 50 openings. But again it's the specialist who's in greatest demand, the microwave and optoelectronics expert.

**Wants specialists.** Texas Instruments is another firm scouring the market for EE's. Like Fairchild, TI wants the specialist—in microwaves and computers. And one TI spokesman reports that the company actually has a dearth of engineering talent in the Dallas area and now recruits in other parts of the country to staff its R&D labs.

Perhaps the best sector of the industry for the EE to point himself toward is instrumentation. Despite a sluggish economy and defense and NASA cutbacks, instrument houses report they are still looking for engineers.

As the instrument houses get deeper into the systems business—as most of them are—engineers well versed in programing computers and interfacing them with other equipment are becoming the top draft choices. Non-linear Systems Inc., which employs about 30 engineers now, is looking for more, according to merchandising manager Michael Gualiano. The immediate need is for specialists in data acquisition, and metal oxide semiconductor, large-scale integration testing. The Systron-Donner Corp. also expects to increase the number of engineers it employs, reports J.E. Niebuhr, general manager of the firm's instrumentation group. And many of Hewlett-Packard's divisions are also looking for talent, especially its Automatic Measurement division.

Division marketing manager Robert Grimm reports that the most crucial need at this stage of development is for EE's who know how to interface instruments and computers. Grimm says that 15 EE's are needed "right away."

**Safe spot.** Ironically, while much of the softness in the employment market can be traced directly to cutbacks in Government spending, one of the safest places for an EE to work is the Government.

Although the Nixon Administration says the Defense Department plans to cutback some 93,900 jobs



through military base closings and consolidation of installations, few engineers in Government service will be affected, says an official of the Civil Service Commission.

At last count, two years ago, the Civil Service Commission figured the Government employs some 14,991 EE's. An updating survey is currently in progress but a CSC official says the incomplete data suggests that the figure hasn't changed much. The majority of Government engineers have a Civil Service rating of GS-13 which pays \$15,800 annually to start and rises to a top of \$20,555.

**Stable nature.** Taking the GS-13 rating as typical—although all in that rating are not EE's—the relatively stable nature of middle-income Federal jobs is borne out by military budget requests. The Army, for example, wants 14,427 GS-13's in its new budget. While the figure is down from the present level of 14,674, the increases at the next highest levels—GS-14 and GS-15—more than offset the drop. The Navy's figure of 10,194 GS-13's is down some 357 jobs, yet one senior Naval personnel specialist says, "We're not dropping any specialists in electronics; they're too valuable." The Air Force figure of 9,402 is relatively unchanged from the current level, as are those of the Defense Communications Agency—with 313—and the Defense Intelligence Agency—with 292.

In nondefense agencies, the pattern is much the same. The Federal Aviation Administration, for example, has budgeted increases in the GS-13 through GS-15 categories into which most engineers fall, with the GS-13 category—the largest—up more than 10% to nearly 9,600 jobs. Even the National Aeronautics and Space Administration, with its Electronics Research Center in Cambridge, Mass. set to close, is scheduled for a total of 30,550 jobs—only 800 less than in fiscal 1970.



# The industrial emergence of Iowa:

**122 of America's top 500 companies now operate 457 plants in Iowa.**

As World War II ended, the farm states of the Midwest found themselves in a difficult position. Technological and biological advances had made it possible for one farmer to farm more land than ever before. The result — fewer and fewer farm jobs. With the prospect of mass unemployment in the future, Iowa set out to industrialize herself.

Slowly at first, then more rapidly, Iowa's industrial capacity grew as her recruitment methods reached a high level of sophistication. In recent years Iowa trade missions have jetted abroad, seeking new markets for Iowa products. High level brainstorming sessions have produced some startling ideas. A new promotion theme — "Iowa . . . a place to grow" — has been developed. A contemporary new symbol depicting growth in all directions has been designed. Iowa's dynamic young governor has led groups of Iowa businessmen throughout the nation acquainting industrial prospects with Iowa's advantages. Today Iowa's soaring industrial output exceeds even her enormous agricultural contribution. Among the new industries selecting Iowa sites last year: General Mills, Inc. and Kitchens of Sara Lee are building plants in the state and Transamerica Investors Group is erecting a 20-story office building.

Iowa's biggest asset is her people. Iowa colleges and universities graduate more Ph.D.'s per capita than any other state. Her work force is intelligent, educated and endowed with typical Midwestern pride in work. Personnel Directors privately admit Iowa plants are generally more productive than sister plants in other states.

Iowa has made one of the most successful agricultural-to-industrial transitions in history . . . adding one while keeping another. In the 1970's, Iowa is truly a place to grow.

# If you think Iowa is just a cornfield . . . think again.

For a number of important reasons, Iowa's factories produce even more than her fields . . . reasons you should know. For information about the industrial emergence of Iowa, send this coupon.

(Confidential Reply Coupon)

Iowa Development Commission  
Dept. E-4, 250 Jewett Building  
Des Moines, Iowa 50309

NAME \_\_\_\_\_

FIRM \_\_\_\_\_

ADDRESS \_\_\_\_\_

CITY \_\_\_\_\_ STATE \_\_\_\_\_ ZIP \_\_\_\_\_

 **Iowa**  
a place to grow

Iowa Development Commission

**Do we have  
a versatile, thin-film deposition  
system for you!**

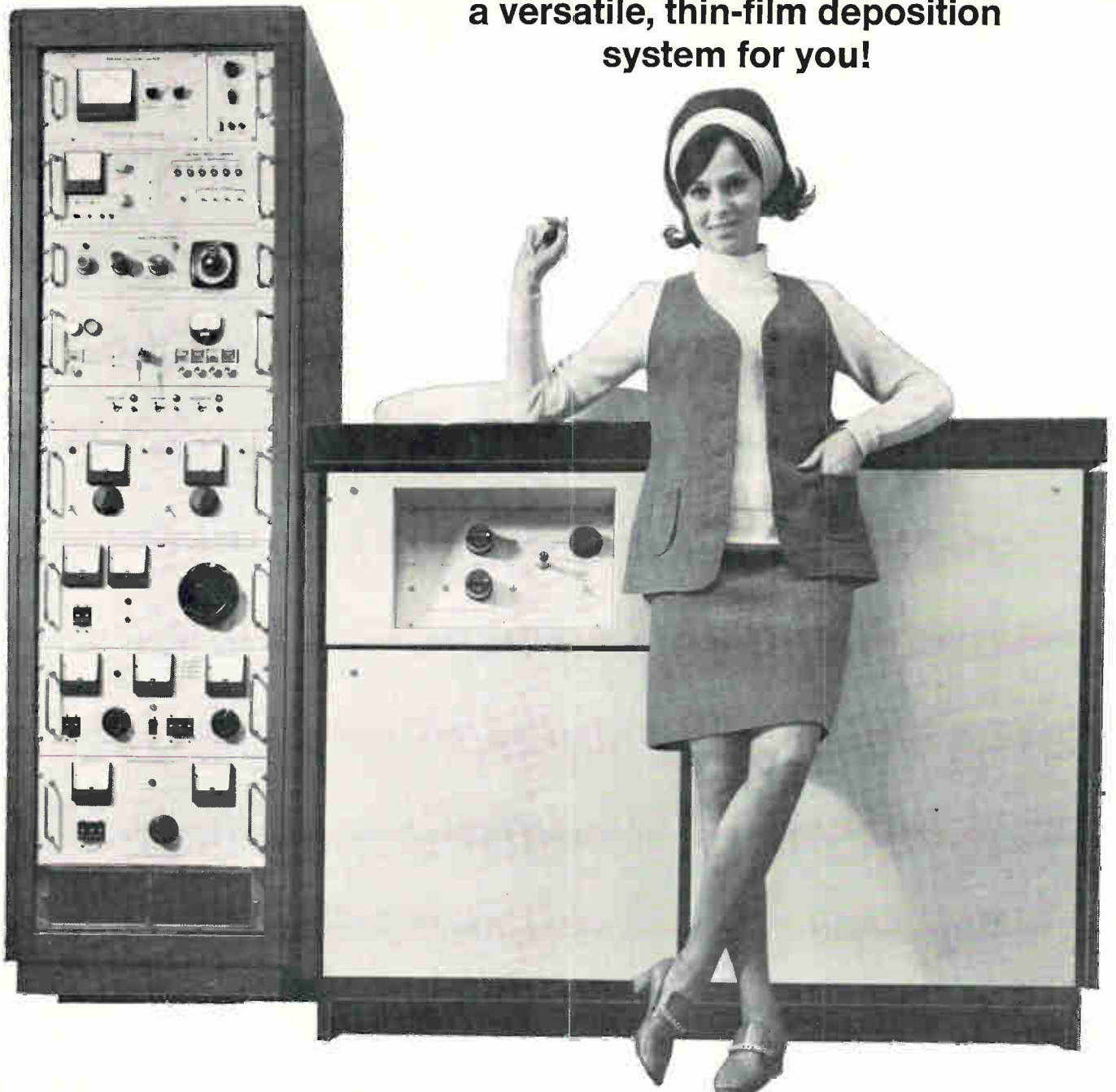

It's the new AST-601, an ideal unit for thin-film production operations like yours. Ideal because it teams high product throughput with reasonable cost.

What about sequence versatility? Four modular work stations let you handle a variety of operations including sputtering (DC/RF, diode or triode), sintering and evaporation. Substrate handling versatility, too? You bet, thanks to a rotational fixture which accommodates various size substrates, shuttering, substrate heating and shielding between work stations. And the AST-601 even offers automatic control of the vacuum cycle to prevent operator error.

Easy loading. Versatile. Economical. That's the new AST-601 for you. For more information, write: The Bendix Corporation, Scientific Instruments and Equipment Division, 1775 Mt. Read Blvd., Rochester, N.Y. 14603.

Scientific Instruments and Equipment Division is part of Bendix Aerospace-Electronics Company.



# East German electronics push pays off

Emphasis on automation to offset labor shortage yields sharp gains in growth and exports; instruments, computers, communications shine, but IC's lag

by John Gosch

Electronics staff

The country's chief of state listens intently as the young mathematician explains some details of a computer. Every now and then he lowers his head as if to ponder the facts. But seconds later, he turns to someone nearby and starts a lively conversation. They could be discussing the merits of data processing for the economy; or perhaps production figures for the year ahead.

The site of this episode: Hall 15, forum for East Germany's electronics industry at the sprawling Leipzig fair grounds. The people: Walter Ulbricht and members of East Berlin's Politburo visiting the fair last month.

The length of time Ulbricht and his companions spent in Hall 15 is an indication of what sector of industry is "in". For electronics is the area East Germany's state-run economy that's been getting by for the most government attention recently.

At the Leipzig fair, the electronics industry was doggedly determined to present itself at its best. Miniskirted hostesses wearing red caps circulated everywhere to provide service with a smile. Coffee and cognac were offered generously to those discussing technical details with industry experts inside the booths. And a smoothly functioning translation service was available for foreign visitors.

But more than mere ostentation underscores the status of electronics in East Germany these days. Official statistics and government proclamations provide a more accurate fix on the role the industry has been assigned in the country's



Top level. Under the eyes of visitors, Walter Ulbricht (right) hears of new developments at the Leipzig Fair's communications electronics area.

"scientific-technical revolution," an oft-repeated slogan at the fair. And then, too, after-hour shop talks in the Saxony city's restaurants provided a good sounding board for Western experts.

**Up and up.** It's performance that counts. And on the whole, the East German electronics industry has performed admirably so far. Starting from scratch less than two decades ago, the industry has enjoyed a spectacular rise, climbing by up to 15% annually in recent years. Government planners and industry officials are projecting a similar growth pattern well into the 1970's.

In 1968, the latest year for which official figures are available, output of the electrotechnical industry, including electronics, topped \$3.2 billion, a gain of better than 12% over the previous year. Electronics, which accounts for roughly one third of electrotechnical production, enjoyed a considerably higher growth rate. Output of components alone showed a 30% increase, jumping from \$131 million to \$170 million.

To be sure, estimates show that production last year missed the government's target by 1.6%. This may be due, Western observers say, to logistics and supply prob-

lems caused by a harsh and early winter. Still, the electrotechnical sector grew by 11.4%, outpacing production of any other industry branch.

And there's no letup in sight. In its Perspective Plan 1970, the Ministry for Electrotechnology and Electronics is shooting for an overall gain of 15.1%. And well-above-average growth is planned in certain electronic sectors. Output of data processing systems, for example, is to rise by 60%, while office-machines production is earmarked for a 41.4% hike. Similar increases are slated for other products: 38% for measuring and control equipment, 33% for specific optical-electronics apparatus, and 18% for automatic telephone switching centers.

Automation-conscious East German central planners are giving top priority to electronics. In fact, the push is coming from the highest levels of government. Walter Ulbricht himself stresses electronics and automation when he calls upon the industry to modernize the economy and raise productivity. Nowhere else in the Eastern Bloc, except perhaps the Soviet Union, is automation getting such attention. As one West German industry observer puts it, "In East Germany automation has almost become a state religion." This may well account for the fact that East Germany ranks among the top six industrial countries in Europe and has the highest standard of living among Communist bloc nations, including the Soviet Union.

**Hard labor.** Electronics is emphasized not only to raise productivity—a 9.4% productivity increase is this year's target—but also to offset a chronic shortage of labor. The problem began with the country's low birth rate during the post-war years and was aggravated by large-scale defections before the western borders were sealed. Some sources estimate that the manpower outflow to West Germany caused a \$30 billion loss to East Germany's economy.

Still another reason for stressing electronics is the seemingly insatiable market throughout the Eastern Bloc and in other parts of the world. Roughly half of last year's electrotechnical production was exported either directly or indirectly



At the console. The most powerful computer in East Germany's stable is the Robotron R300, here linked with a 200-baud data transmission terminal.

(as part of mechanical systems or installations). East Bloc countries accounted for about three-quarters of the exports, with the Soviet Union alone taking 40% of total exports.

To assess the East German electronics industry qualitatively it may be pointless to use current Western European standards across the board. Without the inflow of American technology that has helped push development in other European countries, East Germany has had to rely mainly on its own resources. And despite cooperative agreements between the powers of the Comecon bloc—the Communist equivalent of the Common Market—mutual assistance in some vital sectors, such as advanced semiconductor technology, leaves much to be desired. Says one West Germany company official, "Where certain national interests are concerned, every country is striking out on its own." Then, too, embargos and lack of access to Western electronics know-how through licensing deals have hurt.

Such handicaps notwithstanding, the East German electronics industry has performed amazingly well, and is generally ranked number two in the Communist Bloc; only the Soviet Union has greater output. In some pinpointed areas, East German products can even stand comparison with the West.

**Fair time.** The nine-day Leipzig fair in March provided a good vantage point into the state of East German electronics art. Western

fair-goers awarded high marks to East German instrumentation and measuring equipment. Of note were capacitance and inductance meters, measuring bridges, quartz-controlled frequency standards and d-c/a-c digital voltmeters with a resolution to 100 microvolts—all from VEB Funkwerk Erfurt.

In the data processing field, long a soft spot in the industry, East Germany apparently has overcome its initial computer production problems. The country's present mainstay computer is the Robotron R 300, a second-generation machine intended for commercial applications and roughly equivalent to a tape-based IBM 1401 in power and programability.

The R 300 is made at VEB Kombinat Robotron at Radeberg near Dresden, where computer design and production is concentrated. It is not exported because of the strong computer demand at home. So far, some 100 R 300's have been installed throughout the country. A follow-up version of this system is said to be in development.

Typical of East German efforts in the process control field is the new PR 2100 which can handle analog and digital inputs from 256 test points. The machine is designed for on-line open-loop or closed-loop control functions in such sectors as chemical processing, power generation and in metal-working. Radeberg engineers are working to adapt the system to other jobs as well.

Despite concentration on com-

mercial and industrial electronics, East German central planners haven't ignored the consumer area. There are now more than 4.3 million black-and-white television receivers in use among East Germany's 17 million people, and the industry already has turned to color. Broadcasts, albeit limited, started last October, making East Germany the second color country in Eastern Europe.

There are still some production hurdles to be overcome, especially with color tubes. But in receiver design East German engineers developed the "RFT Color 20" in just 10 months. Except for its power supply the Color 20 uses transistors throughout.

**Weak links.** But the Leipzig fair also bared some weak spots that continue to blemish East Germany's electronics industry. Missing at the stands were monolithic integrated circuits, for example. This came as a surprise to many Western fair-goers, especially since the industry seemed to have made a promising start several years ago. IC's are supposed to be made at the country's Frankfurt/Oder semiconductor plant, but they are, it is said, of such low quality that they can't be considered for general applications. Western observers think the lag in IC's is due to some very serious production problems, specifically to the lack of modern manu-

facturing equipment for uniform production runs. Presumably, East German IC's will turn up at next year's fair, or perhaps earlier. Most likely they will be TTL types that are suitable for industrial applications.

The deficiencies in some areas, however, are more than offset by excellence in others. In commercial communications, the East Germans are pace-setters in the Communist Bloc, taking big strides in both output and technology. Some 15 factories, backed by the efforts of the Institute for Communications Technology at East Berlin and of several technical universities doing research on a contract basis, have turned out well over \$500 million worth of communications gear last year. Some of the equipment is rated on a par with Western products.

One plausible reason for East Germany's communications expertise is its relatively long tradition of innovations in the area, enabling designers to fall back on previous technology as they push for more sophisticated equipment.

**Exports.** Attesting to East Germany's performance in communications is the sector's high export volume. Nearly half the output goes abroad. Rating highest on the list of foreign customers are, as expected, other Communist countries, with the Soviet Union by far the

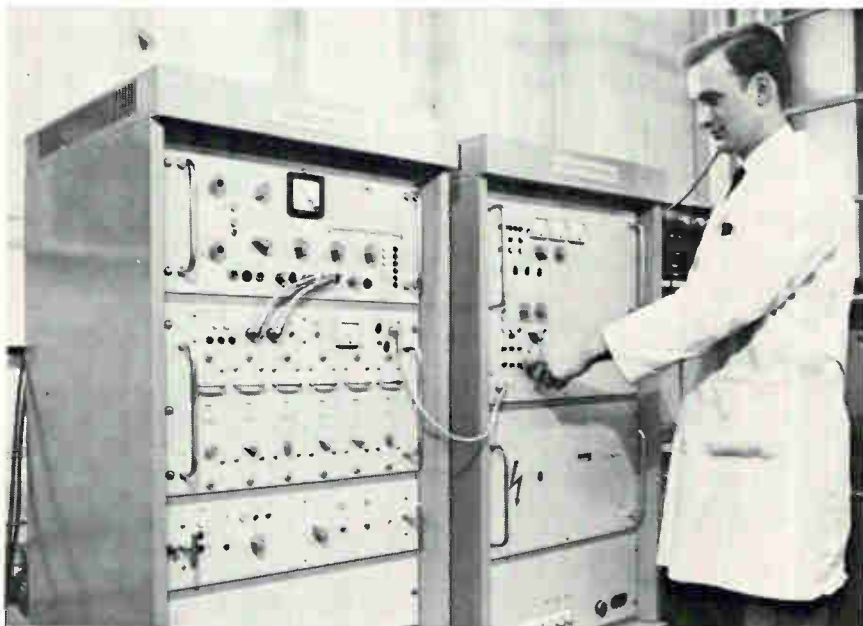

Sending the word. Communications equipment is the big electronics export item for East Germany. Here is a 1-kilowatt short-wave transmitter.

# Instant module time check

**CURTIS 620-PC  
ELAPSED TIME  
INDICATOR**



**SHOWN 1 1/2 TIMES  
ACTUAL SIZE**

Increasingly important in military equipment philosophy is the field or line replacement module.

With this Curtis Elapsed Time Indicator mounted on each functional replaceable module of your system you have an accurate record of operating hours for each individual module regardless of its installation history. Operating time record becomes part of module. Unit is extremely small, weighs little, uses little power, and is not expensive! For full details, ask for information on Model 620-PC. Meets requirements of MS 3311 (AS).

WRITE OR CALL

# Curtis

INSTRUMENTS, INC.

200 Kisco Avenue  
Mount Kisco, N.Y. 10549  
(914) 666-2971

# Solid state is no mystery if you can read this

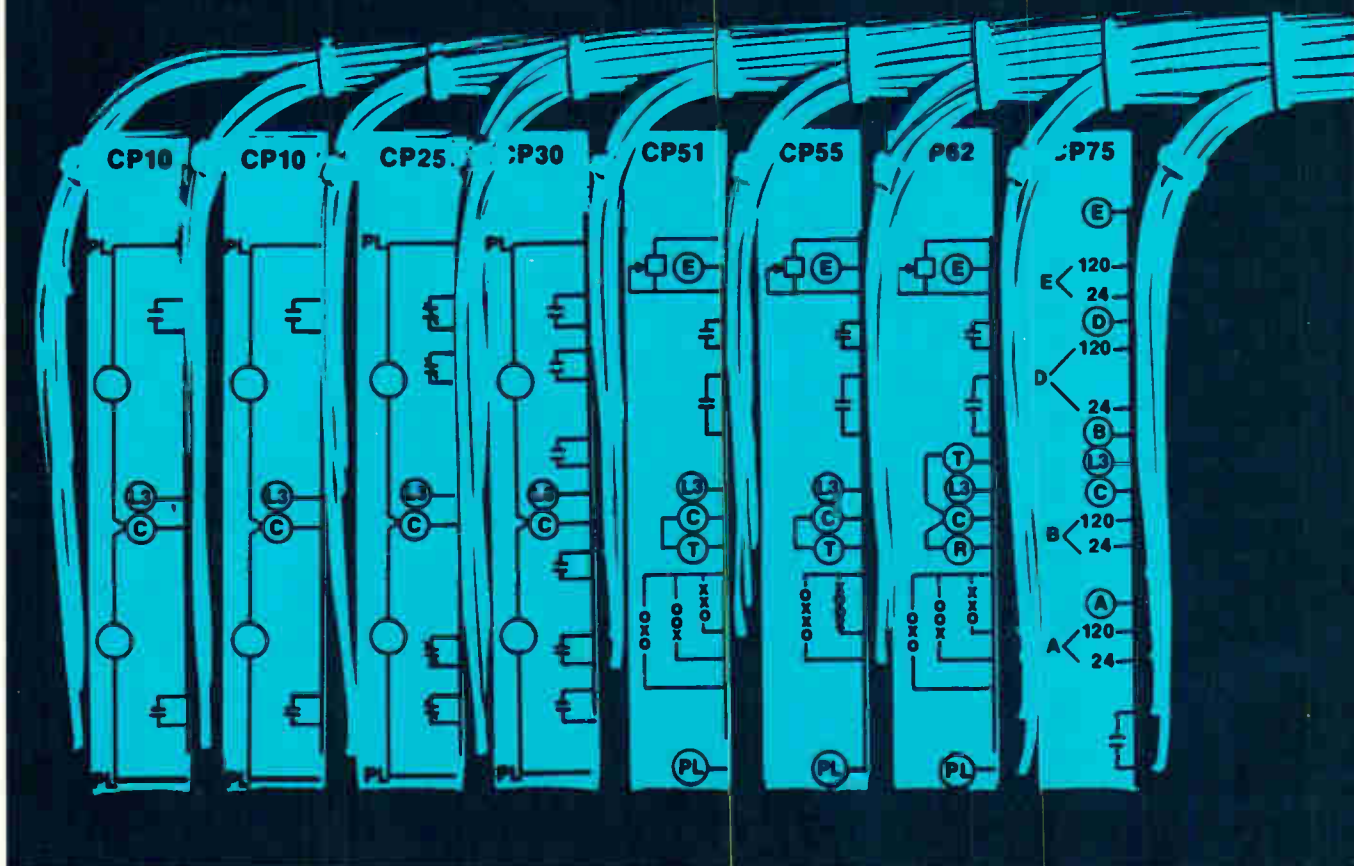

## and this is Controlpac.®



If your systems and maintenance people get up-tight every time you talk solid state . . . relax. New Eagle Controlpac modules take the mystery out of it. Sure, all control functions are duplicated on printed boards, BUT, Controlpac utilizes electromechanical block diagrams and symbolism for easy understanding and installation. Trouble-shooting and periodic maintenance are done using the same "lamp-out" equipment and methods used for standard relay systems. So, what's so mysterious?

Get the simple facts about Controlpac, today. Write for Bulletin 35C. Eagle Signal Division, 736 Federal Street, Davenport, Iowa. 52803



**Eagle Signal**

a systems division of  
GULF + WESTERN INDUSTRIES, INC.

# See Eagle's new Controlpac® plus a dozen more NEW industrial controls

including:

- Metal detectors for accurate count • control • safety.
- 24 circuit solid state sequencing controls.
- Solid state 10 amp. load relays.
- High accuracy solid state timers.
- Modular cam timers.
- Relay clutch timers.
- Manual reset timers.
- Digital readout counters.
- Solid state plug-in counters.
- Add-subtract counters.
- Photo sensors.

AT THE  
DESIGN  
ENGINEERING  
SHOW  
Chicago  
Amphitheatre  
Booth 1470

**GW Eagle Signal**  
a systems division of  
GULF + WESTERN INDUSTRIES, INC.

biggest. But developing countries in the Near East and in Africa are becoming increasingly important customers.

Elsewhere around the world East Germany is filling communications needs in areas where Western firms are no longer active because of political reasons. An example is the delivery of 25 teletype exchange systems to Cuba. Also installed in Cuba is an East German-built short-wave radio center for communications with Europe. In the Western African nation of Guinea, East German engineers have built a broadcasting center and a microwave radio relay link. And in Iraq they've set up a carrier frequency system for multichannel communications between Bagdad and Hilla.

Technically, too, East German communications has staked out a front-line position in certain areas. One is telephone switching engineering. One switching installation that uses electronics components abundantly is the ETS 700 developed at VEB Fernmeldewerk Arnstadt. The experimental system, already in use in East Berlin, is acquainting postal authorities with the technology and economics of running an electronic installation so that eventually a decision can be made on parameters for a standardized design.

**On the phone.** Like most similar systems in the West, the ETS 700 is really semielectronic. Reed relays are used for speech path switching. The system's control-current circuitry, however, contains

semiconductor components, of both the discrete and thin-film hybrid variety, in addition to reed relays. The register blocks of the ETS 700 are built almost exclusively around thin-film circuits, whereas the system's marker units use a combination of thin-film circuits, discrete semiconductors and electromechanical components. For reliability, silicon semiconductors are based on planar technology.

The basic thin-film building block of the ETS 700 is a triple-input, resistor-transistor logic device designed to perform NOR functions. The 0 and 1 signal levels are from 7.5 to 8.3 volts and from 0 to 0.5 volts, respectively. Signal delay relative to seven series-connected NOR circuits is 10 microseconds. To facilitate maintenance, most components are installed on plug-in printed-circuit boards.

The system's fully electronic register blocks, each laid out to handle 1,000 subscribers, functionally constitute a small process computer. They direct the system and handle all information required to establish a connection and to process a call. Information on connecting paths and their momentary status is read into a memory unit where it's temporarily stored for later processing. The memory contains ferrite-core storage blocks and drivers and read amplifiers, and handles words of five bits—four are information bits while the fifth is a parity bit for control.

Actually, electronic switching system engineering is nothing new

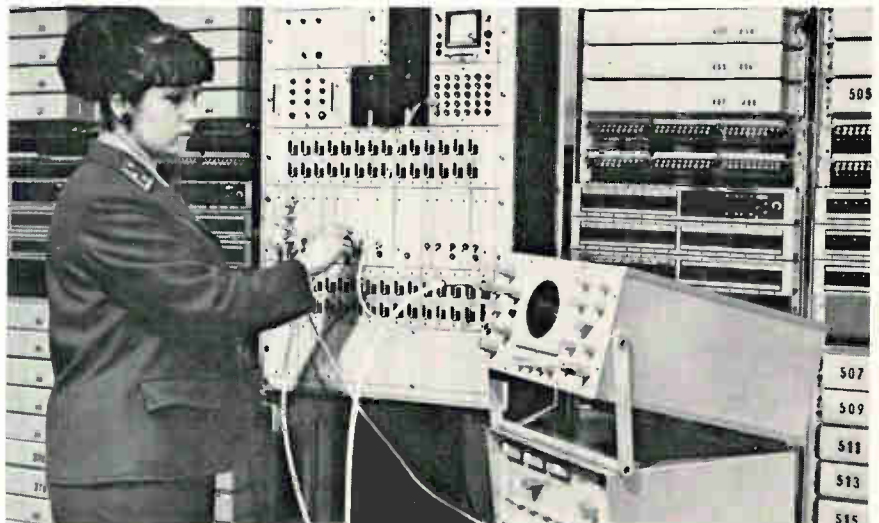

In code. Pulse code modulation gear PCM 30/32 is designed for time multiplex transmission on 30 telephone channels.

# BUGS ARE BIG BUSINESS

Every year a million dollars go down the drain because "bugs" are big business in components. Buggy coils and transformers can cause many costly breakdowns. It's enough to bug anyone! And it's about time bugs were stamped out. For years Delevan has been waging an intensive campaign to exterminate this threat. That's why Delevan uses X-Ray and fluoroscopic equipment to insure consistent quality and long life in its magnetic components. Long ago, Delevan adopted rigorous manufacturing controls in order to meet stringent military standards. A continuous audit of these controls is conducted by our Defense Supply Agency approved environmental laboratory. That's why Delevan is testing to the latest revision on Mil C 15305 rev. D—testing that includes 2,000 hr. life test, 15 g force vibration, 50 g force impact, 10 day moisture resistance, and temperature cycling. And that's how Delevan catches the bugs before they catch you. Send for a Catalog of Our "bugless" Products.

**Delevan**  
Division



AMERICAN  
PRECISION  
INDUSTRIES INC.

270 QUAKER RD. / EAST AURORA, N. Y. 14052  
TELEPHONE 716/852-3600 TELEEX 091-293  
OTHER DIVISIONS OF AMERICAN PRECISION INDUSTRIES INC.: BASCO • DUSTEX •  
MOELLER INSTRUMENT CO. • OXFORD CORP. • TRUCK EQUIPMENT CO.

in East Germany. The first encounter with this new techniques came several years ago when East German project engineers headed a multinational development effort that resulted in the East's first electronic exchange installation. That system, called EATZ, was turned over to East Berlin postal authorities in 1967 and was jointly developed by the Soviet Union, Hungary, Poland, Roumania, Bulgaria, and Czechoslovakia, with East Germany coordinating and managing the project.

**Pulsating.** Another area of communications which the industry is pushing is pulse-code modulation, which allows multiple use of existing cables in a nation where telephone usage is rising steadily. Now in production at VEB RFT Fernmeldewerk Leipzig is a pcm system called PCM 30/32, shown for the first time at this year's fair. Using time-division multiplex, the system allows transmission of 30 telephone channels on two conductor pairs in symmetrical cables. What's more, in conjunction with a data multiplexer one channel can be used for data transmission at rates up to 64 kilobits per second.

The PCM 30/32, designed primarily for short-haul phone traffic, consists of two terminals with repeaters for signal regeneration installed along the line. The distance between repeaters is roughly 1.25 miles depending on line attenuation, on the number of pcm channels used, and on the cable's cross-talk properties.

In the system, a sample of the speech signal is taken at an 8-kilohertz rate—every 125  $\mu$ sec. A pulse-amplitude modulated signal is produced; its momentary amplitude is evaluated, coded into a binary number, and then is transmitted in digital form.

Following the trend toward higher speech quality, the East Germans have settled on 256 quantizing steps in their PCM 30/32. For signal companding, the so-called 13-segment-line technique is used and is considered more advantageous than, for example, the smooth mu characteristic curve because digital techniques can be more readily implemented. The fully transistorized 30/32 system uses a digital line rate of 2.048 megabits per second.



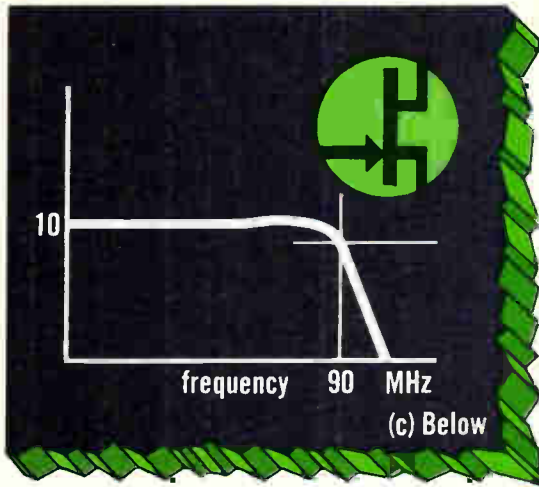

# FETS FOR VIDEO AMPS from SILICONIX.

If you've a wide band application (approaching 100 MHz), need high  $Z_{in}$  ( $10\text{ M}\Omega @ 1\text{ MHz}$ ) and want low  $C_{in}$  (down to 1 pF), think FETs. Here are three circuit ideas for starters:

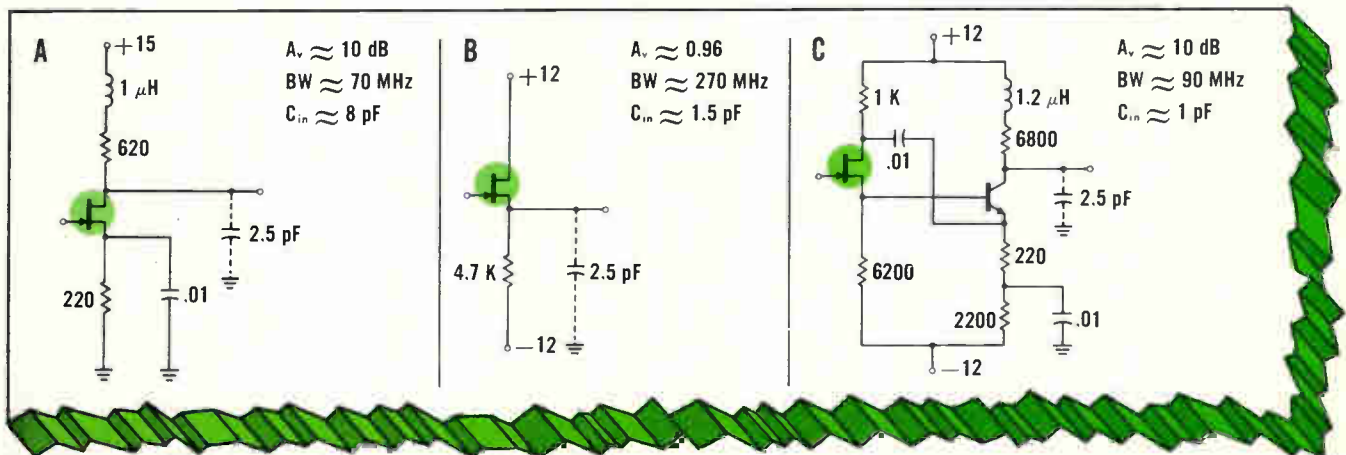

Siliconix assumes no responsibility for circuits shown, nor does it represent or warrant that they do not infringe any patents.

The Siliconix 2N5397 gives you the best  $g_{fs}/C_{in}$ . We do have FETs with even lower  $C_{in}$ . For details on these and other circuit approaches, write or call any of the numbers below.

- New York: Sy Levine (516) 796-4680
- New England: Al La Croix (617) 762-8114
- Ft. Worth/Dallas: Charlie Williams (214) 231-8151
- St. Louis: Jim Spicer (314) 291-3616
- Minneapolis: Ed Koelfgen (612) 920-4483
- Southern California: Dave Ferran (213) 420-1307
- Northern California: Chuck Brush (408) 246-8000



2201 Laurelwood Road • Santa Clara • California 95054  
 Telephone (408) 246-8000 Extension 201 • TWX: 910-338-0227  
 In Europe: Siliconix Limited, Saunders Way, Sketty, Swansea, Great Britain

# **SCIENCE/SCOPE**

14 soldiers hit the bullseye on their first TOW missile shot during a brief training course at Redstone Arsenal, Ala., recently. Only one man in the class of 15 needed a second shot to score a hit with the wire-guided anti-tank missile, which is automatically steered to the spot at which a gunner aims. The TOW system, a lightweight, portable, heavy-assault weapon for use by the infantry, can be fired from a ground tripod or a variety of vehicles and helicopters.

Two high-resolution scanning radiometers built by Santa Barbara Research Center, a Hughes subsidiary, are being used aboard the new ITOS I weather satellite to provide cloud cover maps on a global basis. As the satellite circles Earth on its 909-mile-high, near-polar orbit, the radiometers will also measure cloud altitudes. They produce high-quality daytime pictures and -- unlike TV cameras -- are equally effective at night.

The first AWG-9 Phoenix weapon control system, reconfigured for the new F-14A fighter, was delivered to the U.S. Navy recently by Hughes. Its weight has been pared from 2,000 lbs. to less than 1,400. It is the only air-to-air system with a track-while-scan radar mode that enables it to launch up to six Phoenix missiles and keep them on course while searching the skies for other possible targets. It also launches the F-14A's Sparrow and Sidewinder missiles and directs the firing of its 20mm. Vulcan cannon, giving the F-14A the world's best "dogfight" capability.

The world's most powerful ultraviolet laser was delivered to the U.S. Army Electronics Command recently by Hughes research laboratories. The continuous-wave laser uses doubly-ionized argon as the lasing material. It produced a maximum output of 2.3 watts during a one-year program of research, development, and fabrication. UV lasers are expected to find use in data recording and display, spectroscopy, and photochemical research.

Opportunities for microwave engineers at Hughes' Electron Dynamics Division in an active program to design and develop advanced microwave sources and amplifiers utilizing silicon and gallium arsenide IMPATT, TRAPATT, and Varactor diodes. Must have experience in microwave circuit design involving tunable cavities, filters, and related solid-state devices. Please write: Mr. R.E. Wolfe, Hughes EDD, P.O. Box 2999, Torrance, CA 90509. Hughes is an equal opportunity employer.

The management-control system which Hughes developed for the U.S. Air Force's new TV-guided Maverick missile was accepted without modification -- the first time the Air Force has validated a cost schedule planning and control system on the initial submission by a contractor. The 8-foot, 500-lb., air-to-ground missile successfully completed its first guided test flight recently.

New products introduced at the NEPCON show included: a new line of XY positioning tables designed for use with numerical controls or stepping motors; they are adaptable to laser drilling, trimming, cutting, welding, and soldering, artwork generation, and circuit board drilling....several new configurations of Hughes' numerically-controlled wiring machine, including a harness-laying head and dual work tables with a combination of heads.

*Creating a new world with electronics*



Circle 150 on reader service card

# Recorder built for automated tv nets

'Third-generation' unit has vacuum columns for smooth handling of tape; buffer circuit minimizes synchronization problem, prevents picture degradation

By Stephen Wm. Fields

*Electronics staff*

**Four years in the making**, the AVR-1—a new-generation video tape recorder from Ampex—made its debut last week at the National Association of Broadcasters show in Chicago. According to Donald Kleffman, marketing manager of the Video Products division, "The AVR-1 is completely new from the ground up. The tape transport uses vacuum columns which provide more constant tape tension and thus better interchangeability of tapes and faster starts. And in the electronics, all of the controls are d-c so that remote operation for automatic programing is now easily accomplished."

Ampex has a history of introducing significant products at NAB. In 1956 it introduced the first videotape recorder, the VR-1000. The second generation VTR, the VR-2000 was introduced at the 1964 NAB show. Lawrence Weiland, vice president and general manager of the Video Products division says that the new recorder "significantly advances the art of video-tape recording through higher picture quality in color or black and white, improved reliability and simplified maintenance, broader studio and production capabilities as a result of improved operating and editing features."

The price for the AVR-1 system starts at \$100,000. Delivery of the equipment is scheduled to begin in July of this year.

The improved picture quality is due to both mechanical and electrical innovations. Mechanically, the AVR-1 is the first broadcast unit to employ vacuum columns for

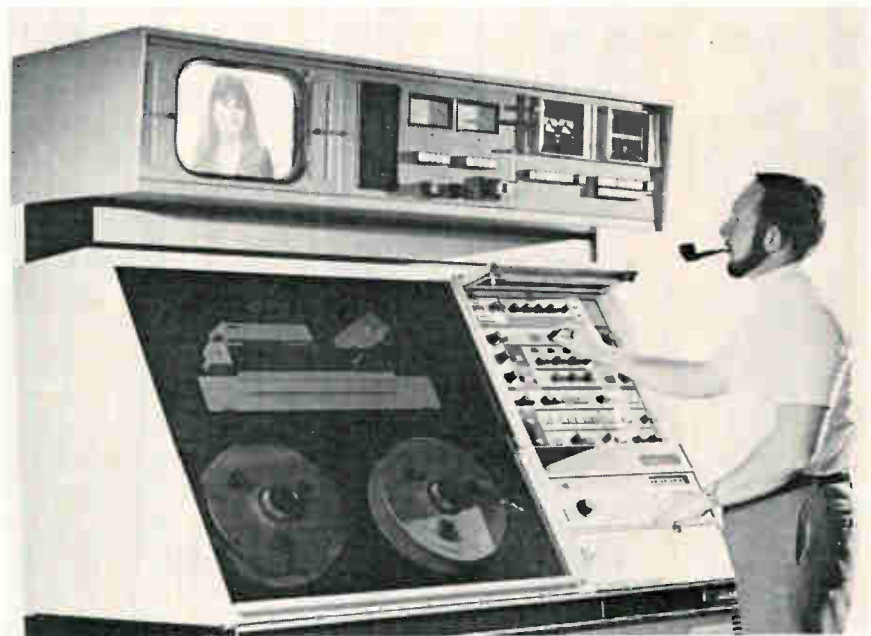

Looking ahead. Videotape recorder is designed to fit in with the next major development in broadcasting—computer control of stations.

smooth, rapid tape handling. A vacuum capstan driven by a printed-circuit motor also increases the transport's ability to maintain constant speed. Kleffman says that one problem with present recorders is tape tension, which must be constant for the tapes to be interchangeable. Sometimes, slow-to-respond motors and rollers, which control tension, allow the tape to stretch—a problem in terms of interchangeability. He says the AVR-1 employs vacuum columns that respond rapidly and virtually eliminate tape stretch. This problem occurs not only in recording and playback, but also in the fast forward and rewind modes. But again, because of the vacuum system, tape

tension is constant. The system works on a constant speed principle (400 inches per second) instead of constant torque.

**Strong points.** Electrically, the AVR-1 has two principal features: elimination of most synchronization problems and the adaptability to remote and computer control. One of the most common sync problems is caused by a change in program source material. During a national news program, for example, reports come in from various local stations, each with its own sync generator. When the program is put on tape (for rebroadcast to the West Coast at a later time, for example) the different segments are not in sync with each other. To the viewer, this

# Are you suffering from Intermittent opens of the IC

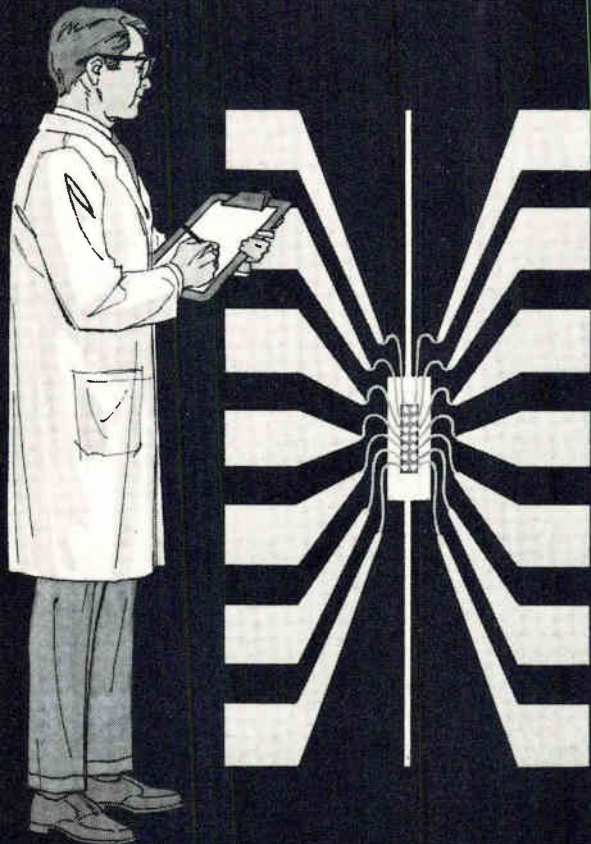

## Cure it with Hysol MH15

New HYSOL MH15 semiconductor molding powders eliminate intermittent opens caused by bent or broken interconnecting lead wires in the molding process, by corrosion or thermal cycling of integrated circuitry at elevated temperatures. This molding powder is designed with a *better balance of properties* to meet more requirements than any other product we have seen. Its soft flow insures better moldability of dual in-line packages. HYSOL MH15 semiconductor molding powders increase yield and reduce costly material related IC failures. They're moisture resistant. Low flash, too!

For further information or technical assistance, call (716) 372-6310, or write HYSOL, Olean, New York 14760.

**D**EXTER **HYSOL DIVISION**  
THE DEXTER CORPORATION

shows up as a rolling picture or a tearing of the picture, and generally the picture will be corrected within a few seconds unless the viewer's set is adjusted on the border line, in which case the picture will continue to roll even after the vtr sync has been corrected.

**Quick.** But besides being annoying to the viewer, an out-of-sync condition is a "severe disturbance to the transmitter," says Kleffman. The AVR-1 can record nonsynchronous picture-source material with minimum perceptible discontinuity in playback. The output is continuously synchronized and is automatically adjusted for maximum picture quality as soon as the playback button is pushed. "This also eliminates the run-up time problems common in present videotape recorders," says Kleffman.

The key to solving the sync problem is a new time-correction circuit that works in conjunction with the fast-responding transport. The circuit, or buffer as Kleffman calls it, is made up of seven switched delay lines with a voltage-controlled delay line at the end. It corrects an out-of-sync condition of up to 32 microseconds with no picture degradation. If the disturbance is greater than 32  $\mu$ sec, the tape is brought back into the proper frame by the vacuum handling system. In this case, the picture on the viewer's screen will fade to black and then come up again, and the total disturbance time will be less than 200 milliseconds.

**Like a camera.** The quick-acting transport also allows an instant picture from a vtr. This, according to Kleffman, pushes tape ahead of film in that there is no roll and cue delay. "The vtr is now a source of program material just like another camera," says Kleffman.

Another new feature is the new Mark 4 editor which permits single-frame editing and automatic color framing that matches the phase of incoming video signals to that of the recorded signals. Incoming video signals do not have to be synchronous to local reference sync generators.

In addition to the editor, programming on the AVR-1 is facilitated by a cue-tone control system and a tape-timer.

Ampex Video Products Div., Redwood City, Calif. 94063 [338]

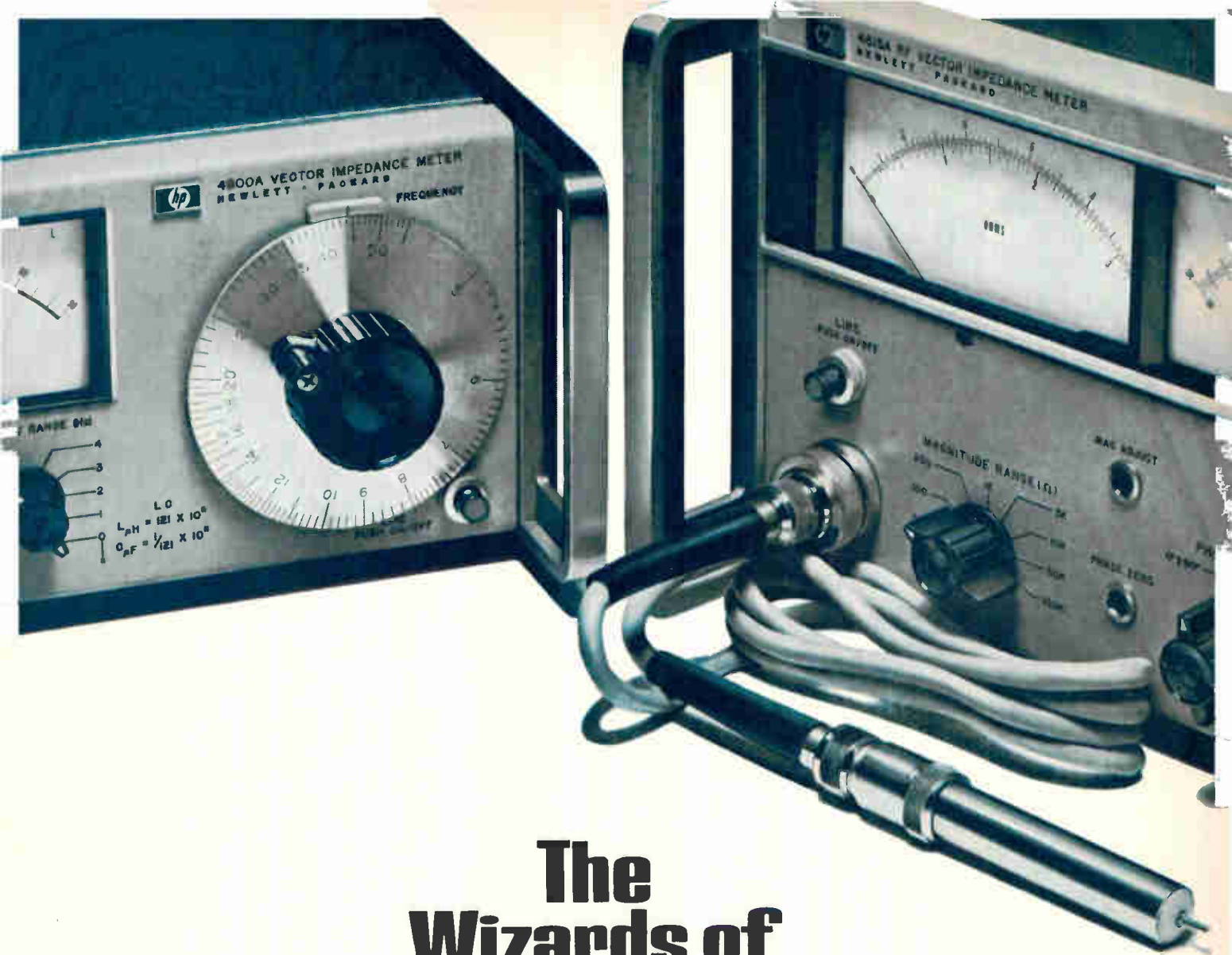

# The Wizards of $\theta Z$

**Like magic . . . vector impedance instruments read out complex impedance in an instant.**

With the HP impedance meters, measurements involving impedance magnitude,  $Z$ , and phase angle,  $\theta$ , no longer require tedious test procedures. These measurements are now as easy to make as voltage readings. No nulling . . . no balancing . . . no calculations to make. The wizardry of these HP instruments provides direct readout of  $Z$  (in ohms) and  $\theta$  (in degrees) over a continuous frequency range.

**HP 4800A Vector Impedance Meter** covers the 5 Hz to 500 kHz range. You set the frequency, select

the impedance range and read:  $Z$  from 1 ohm to 10 Megohms, and  $\theta$  from  $-90^\circ$  to  $+90^\circ$ . \$1650.

**HP 4815A RF Vector Impedance Meter** covers 500 kHz to 108 MHz. Measures, via a probe, active or passive circuits directly in their normal operating environment.  $Z$  from 1 ohm to 100 K ohms;  $\theta$  from  $0^\circ$  to  $360^\circ$ . \$2650.

Application Note 86 describes many applications of the 4800A and the 4815A Vector Impedance Meters including the measurement of  $Z$ ,  $R$ ,  $L$ , and  $C$ . For your copy and complete specifications, contact your local Hewlett-Packard field engineer or write: Hewlett-Packard, Green Pond Road, Rockaway, New Jersey 07866. In Europe: 1217 Meyrin-Geneva, Switzerland.



HEWLETT **hp** PACKARD

IMPEDANCE INSTRUMENTS

# Panel design ideas from Dialight

Many different push button cap and bezel options permit custom panel designing with standard switches and matching indicators. Designers and engineers are welcoming these low-profile, snap-in-mounting push button switches that are interchangeable with most 4-lamp and 2-lamp displays.



Units available in  $\frac{3}{4}$ " x 1" rectangular,  $\frac{3}{4}$ " square,  $\frac{5}{8}$ " round and  $\frac{5}{8}$ " square designs. Bezels with or without barriers in black, gray, dark gray or white. Legends are positive or negative—either visible or hidden when "off." Switches are momentary or alternate action and low level to 125V at 5A, resistive.

CIRCLE READER CARD NO. 250.



**Snap-in bezel simplifies mounting. Fingertip grip permits easy cap removal.** These switches and indicators are easily slipped into mounting cutout for a snug fit. No tools are needed. Fingertip grip makes push button cap installation or removal an easy job. Caps come in a full range of colors or with underlying color filters. Each cap has a metal insert that receives T-1 $\frac{3}{4}$  bulb with

midget flanged base. Mounting cutouts may be made for individual units or for groupings of two or more units in horizontal or vertical panel configurations so that many different arrangements are possible.

CIRCLE READER CARD NO. 250.



**Reliable readouts for high ambient lighting conditions—6V AC-DC, 10V AC-DC, 14-16V AC-DC, 24-28V AC-DC, 150-160V DC or 110-125V AC.**

You can read these readouts in a bright room from any viewing angle up to 30 feet away. Sharp seven segmented characters are formed by patented light-gathering cells (U.S. Pat. No. 3,210,876). They're designed for use with high-reliability neon or incandescent lamps to meet a variety of circuit voltage requirements. Separate BCD to 7-line translator driver. PC boards also available. Modules directly compatible with integrated circuit decoder drivers now universally available.

CIRCLE READER CARD NO. 251.

**Wide selection of Datalites® and subminiature indicators are among 1,500,000 visual indicators available to designers.** It's now easier than ever to select the units that meet your panel and circuit requirements from the many thousands of Datalites and subminiature indicator lights available from Dialight. Variety of lens shapes, colors and finishes. Many different positive or negative legends. Incandescent 1.35-120V; neon—high brightness at 110-125V AC and standard brightness at 105-125V AC-DC. For clearance holes from  $\frac{5}{32}$ " to  $1\frac{1}{32}$ ".

CIRCLE READER CARD NO. 252.

New 56-page Product Selector Guide provides data on 1,500,000 readouts, switches and indicator lights. Get your copy today.

CIRCLE READER CARD NO. 253.



## DIALIGHT DIALCO

# Modem tester offers variety of patterns

Troubleshooter probes asynchronous as well as synchronous units and provides five separate checks including 2,047-bit pseudo-random test

The rapid growth of computer time-sharing and digital communications created a need for troubleshooting gear for the owner and user of data modems. To fill this need, Sanders Associates' newly created subsidiary, Sanders Data Systems Inc., introduced the ESD-101 modem tester, a portable unit.

Sanders claims the ESD-101 is the only modem tester priced as low as

\$1,500 that tests both asynchronous and synchronous modems. Asynchronous modems, which need no clock, are simpler and less costly to build than the synchronous variety, and are finding their way into a growing number of low-cost data terminals. Sanders' tester supplies patterns of 75; 150; 300; 600; 1,200; 1,800; and 2,400 bits per second. The rate of synchro-

nous tests will vary with the modem clock: peak rate is 200 kilobits per second.

According to the designer of the ESD-101, John F. Leaver, it offers a wider variety of test transmissions than most other testers available. "While most instruments offer either a long or short bit pattern, the 101 offers five separate checks: it transmits marks, spaces, marks



Compatible, stand-alone, key-to-tape data station designated Libra 1 includes features for more efficiency and economy. It offers a read-after-write check, selective non-verification and a true English display in a modular unit that takes no more space than that presently occupied by a standard keypunch machine. International Data Sciences Inc., 100 Nashua St., Providence, R.I. [401]



Digital computer DC6024/3 features a full cycle time of 1  $\mu$ sec and a fixed word length of 24 bits. It is for applications requiring real-time control and complex calculations. Basic system includes five 24-bit general purpose registers; an 8,192 word memory; hardware; four levels of priority interrupt; and software. Datacraft Corp., Box 23550, Ft. Lauderdale, Fla. [402]



Magnetic tape controller model 119 is IBM-compatible. It contains a 9-track, 800 bpi, continuous read-write magnetic tape transport. It has a reel size of 10.5 in., a continuous tape velocity of 5 ips and a rewind speed of 96 ips. The unit measures 35 15/16 x 24 9/16 x 18 1/2 in. Price will be under \$10,000. Daedalus Computer Products Inc., Box 248, N. Syracuse, N.Y. [403]

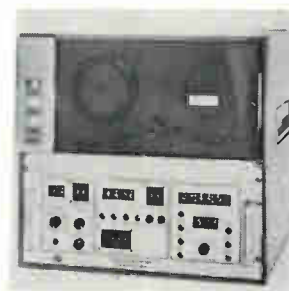

Data acquisition system type DDS1103 accepts bipolar analog voltages up to  $\pm 10$  volts. The data is converted into a 12-bit binary value and recorded in either a binary or BCD format on a synchronous IBM compatible tape. The system includes memory for data collection prior to recording onto tape. Price is \$11,250. Digital Data Systems, 18819 Bryant St., Northridge, Calif. [404]



Digital printer AN72 is designed to interface with a wide variety of equipment. For example, it can be fed with 4-line, 5-line, or 6-line BCD data. If a 4-line input is used, the printer can print all the decimal digits plus 6 additional signs and symbols. For standardization, input follows an ASCII format. Datadyne Corp., Valley Forge Center, King of Prussia, Pa. 19406 [405]



Tape transport called DigiDeck has two independent bit serial data recording channels which may be operated simultaneously or independently in various modes. It brings the speed and convenience of magnetic tape to small data systems requiring an accurate, low-cost method of storing and retrieving digital data. International Computer Products Inc., Box 34484, Dallas [406]



Line printer model 2410 is a 132-column unit designed for use with small/medium size computers and data communications terminals. The company's Mark IV print hammer provides printing speeds of 245 to 1110 lines a minute for all 64 characters. A drum speed of 1,760 rpm allows for a time sharing of electronics. Data Products Corp., 6219 DeSoto Ave., Woodland Hills, Calif. [407]



Time division multiplexer TDX-2 can multiplex up to 88 channels with one unit. It will speed intermix up to four rates: 300, 150, 134.49, and/or 110 bps. Status and data quality indicators provide rigorous diagnostic capability. The unit will transmit all combinations of 7 and 8 bit data characters. Rixon Electronics Inc., 2120 Industrial Parkway, Silver Spring, Md. [408]

If an amplifier  
is an amplifier,  
is there any good reason you  
should order an Alfred Amplifier  
in the 1 to 12.4 GHz range?



As Gertrude Stein put it, "A rose is a rose is a rose." Why choose one over the other? Simply put, some are better than others.

And that's the way it is with Alfred 1 and 10 watt microwave amplifiers. They may not be exciting, but they are better because they provide "total protection" for the TW Tube and exceptionally stable phase and gain performance.

*Alfred Series 5000 Amplifiers* are the lowest price 10 watt amplifiers on the market. They offer 30 dB gain and are designed to offer continuous performance under the most rigorous conditions.

*Alfred Series 560A Amplifiers* deliver 1 watt at 30 dB gain. They are available with 50 dB gain and amplitude modulation ranges.

**More information.** To arrange a demonstration or get full details, call your full service Alfred Sales Engineer or, if you wish, write The Singer Company, Instrumentation Division, Alfred Operation, 3176 Porter Drive, Palo Alto, California 94304. Phone 415-326-6496.

**SINGER**  
INSTRUMENTATION

and spaces, a seven-bit digital signal, and a 2,047-bit pseudo-random test pattern," he says.

The first two checks are useful for viewing the individual frequencies of a data signal, while the third and fourth checks will allow tones to be displayed on a scope—the seven-bit pattern in a more nearly random arrangement. The 2,047-bit pattern can be viewed with a delayed-sweep oscilloscope triggered by a signal from a sync jack on the back of the tester. Each signal can be repeated as often as desired and, in any case, errors are displayed on a counter.

**Spots patterns.** Adding a dual-trace scope can be revealing as there's an error-indication pulse available at another back-panel jack. Scanning the 2,047-bit pattern on one trace, with the other show-



Travel-size. Modem tester is small enough for field use.

ing only error pulses, spots exact error patterns in modems—as when a modem yields an error each time a binary 0 follows a series of 1's.

There's a "jitter jack" too, which gives a digital signal corresponding to the timing skew in the signal coming out of the modem under test. By routing this through an analog voltmeter and adjusting the modem's delay equalizer for the lowest reading, the difference in real pulse-arrival time from the time at which it should arrive can be minimized.

Probably the most used readout on the ESD-101 will be the numerical-display tubes which show accumulated errors; since it's possible to transmit a controlled number of test bits—switch-selected amounts from  $10^3$  to  $10^7$  bits—it's possible to push the start button, watch the errors count up, and convert directly to an error rate.

In some cases, long-duration



# Tools for the Project Engineer

## CompuREED™ RELAYS AND SCANNERS

The CR300 Series Relay is the newest development in low-level analog switching and includes 12 models available in one, two or three pole, form "A" switching configurations with dry or mercury-wetted reed switches operating at rates up to 200 channels/sec. The CR600 Series Scanner using the CR300 reeds provides low-speed, high accuracy sampling of analog signals in the  $\pm 5$  mV to  $\pm 1$  V f.s. range with programmable gain control. The reed switches provide as low as  $<0.1 \mu\text{V}$  thermal offset. CR300 series typically \$14, CR-600 Scanner typically \$35 / channel. Circle 220 on Reader Service Card



CompuREED™

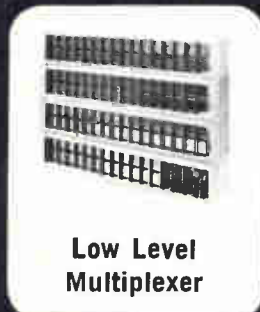

Low Level Multiplexer

## LOW-LEVEL MULTIPLEXERS

The significantly different LM700 Series Low-Level Mux features transformer isolation of each channel, allowing independent operation. Also featured is high common mode voltage capability of 120V RMS. Input range is  $\pm 5$  mV to  $\pm 1$  Volt and an accuracy of  $\pm 0.05\%$  RTO,  $\pm 5 \mu\text{V}$  Volts RTI,  $\pm \frac{1}{2}$  LSB. Channel rate is 10 KHz. Common mode rejection is 120 DB @ 60 Hz with 1K ohm unbalance in the input lines. Gain settings are programmable. Typical price is \$95 per channel. Circle 226 on Reader Service Card

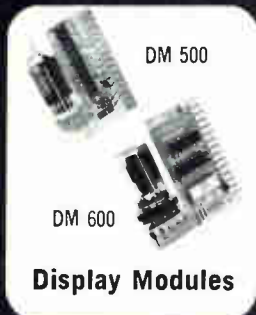

Display Modules

## DISPLAY MODULES

The DM500 and DM600 Series are self-contained, plug-in decimal display units. The DM500 Series use Amperex gas discharge type indicator tubes and the DM600 Series use the RCA NUMITRON 7-segment indicator tubes. Both series are available with decade counter, decoder/driver and quad latch storage register. All models plug into a standard 15-position (0.156" spacing) connector. The indicator tubes provide numerical read-out from 0 to 9 including decimal point. AN ATTRACTIVE BEZEL AND MOUNTING CHASSIS IS AVAILABLE. Single quantity prices start as low as \$75.90. Circle 222 on Reader Service Card

Circle 222 on Reader Service Card

## DC POWER SUPPLIES

The PM400, 500, 600 and 700 Series Regulated DC Power Supplies offer a total of 73 models with output voltages ranging from 3.6 to 180 VDC. The PM400, 500 and 600 Series have power outputs of less than 2 watts. The PM700 Series offer 5, 15 and 180 VDC supplies with up to 18.9 watts power. The PM800 Series Unregulated DC Power Supplies offer six models with output voltages from 5 to 45 VDC and output currents up to 440mA. Single quantity prices for the PM400, 500 and 600 Series start at \$25.95. The PM700 Series start at \$31.95 and the PM800 Series start at \$16.80. Circle 224 on Reader Service Card

Circle 224 on Reader Service Card

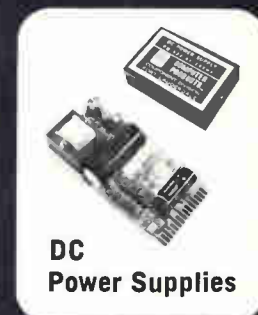

DC Power Supplies



CompuLogic™

## CompuLogic™

The CL800 Series comprises a complete family of plug-in logic circuit modules using monolithic DTL integrated circuits. The series consists of positive logic, NAND based circuits with each circuit card containing two hermetically sealed, 14-pin, dual in-line, ceramic packages. Each circuit module measures only 1.25" x 2.5" and mates with standard 30-pin, 15-position, card-edge connectors with 0.156" spacing. The basic series consists of 18 separate circuit module types containing both high and low-speed models. A typical price for CompuLogic™ is \$10.00. Circle 223 on Reader Service Card

Circle 223 on Reader Service Card

## DIGITAL PANEL METERS

The DP400 Series measures DC voltage accurately (.05%  $\pm \frac{1}{2}$  count for 2000 and 4000 count models. .02%  $\pm 1$  count for 10,000 count models) with up to 10,000 count resolution. It offers 11 voltage ranges (200mV, 400mV, 1V, 2V, 4V, 10V, 20V, 40V, 100V, 200V and 400V). Temp. coefficient is .005%/°F (2000 and 4000) and .003%/°F (10,000). Single quantity prices start as low as \$198.00. Guaranteed shipment within 15 to 30 days. Circle 225 on Reader Service Card

Circle 225 on Reader Service Card



Digital Panel Meter

## A-TO-D CONVERTERS

The AD300 Series offers 14 standard models providing binary or BCD output code with 8, 10 or 12 bit binary resolution or 12-bit BCD resolution. Bipolar inputs of +4V to -4V or +10V to -10V are standard input configurations. 10KC conversion rates are standard, 20KC available. Accuracy is  $\pm 0.025\%$ ,  $\pm \frac{1}{2}$  LSB. The AD 300 Series are mounted on three plug-in P.C. boards measuring 2.75" x 5.25" x 1.0". Single quantity price for 12-bit binary 10KC, only \$189.00. Circle 221 on Reader Service Card

Circle 221 on Reader Service Card



A/D Converter



D/A Converter

## D-TO-A CONVERTERS

The DA035 Series provides 8, 10 or 12-bit binary or 12-bit BCD resolution, with or without input data storage, on a P.C. card measuring 2.75" x 5.25". Inputs are TTL and DTL compatible. There are 40 models with six full-scale analog output ranges up to  $\pm 10$  volts and  $\pm 10$  mA available. F.S. settling time is less than 50 $\mu$  sec. Conversion rates up to 200 KHz. Accuracy on 12-bit models is  $\pm 0.05\%$ ,  $\pm \frac{1}{2}$  LSB. Single quantity prices start as low as \$69.00. Circle 227 on Reader Service Card

Circle 227 on Reader Service Card

Call or Write for Specifications, Prices and Delivery on our Entire Line.



**COMPUTER PRODUCTS™**  
FORT LAUDERDALE

Post Office Box 23849  
Ft. Lauderdale, Fla. 33307  
Telephone: (305) 933-5561

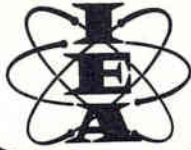

8th INTERNATIONAL  
**INSTRUMENTS  
ELECTRONICS  
AUTOMATION**  
EXHIBITION  
**Olympia London England**  
**11-16 May**  
**1970**

## THE WAY THE WORLD IS GOING

The ways of the world and its people are being dramatically changed by the accelerating progress of electronics.

The Eighth International Instruments, Electronics and Automation Exhibition – the world-known IEA – presents the whole international picture of what Britain's Minister of Technology describes as "the most important technology in the world today".

IEA '70, again expanded in area, is one of the world's greatest technological events. It not only

updates progress but hints broadly at an even more exciting future.

The 1970 exhibition will follow the show-after-show record-breaking trend, bringing exhibitors and visitors from all over the world. The last show attracted 120,000 people, 9,000 of them from 80 foreign countries.

IEA is really international. America, Canada, Japan, East Germany, Poland, France, Czechoslovakia are among the countries who help to present the up-to-the-minute technological picture.

## IEA SHOWS THE WAY THE WORLD IS GOING

An **IEA** Exhibition

**INDUSTRIAL EXHIBITIONS LIMITED**

9 Argyll Street London W1V 2HA England

## ... errors injected to pinpoint faults ...

tests are necessary. In such instances the display-tube readout will blur if the error count goes over 999; as Leaver says, "almost regardless of the duration—from an hour to overnight—if you have 1,000 or more errors you want to troubleshoot." He adds that counters on most other testers just start over from zero, and thus the count displayed may not be a true reflection of the test.

**Sync-lost light.** There's also a lamp which lights if the tester loses sync with the incoming bit train. But since lost sync may also be due to clock failure in synchronous modems, or to line conditions, the test should be repeated to spot the trouble. Leaver says that most other modem testers just cease to function if sync is lost. Sanders automatic re-syncing action makes operation easier, but this feature also makes the "sync lost" light necessary.

What happens if everything looks rosy, and no errors are counted on the display? The modem under test may be defective anyway or the test set itself could be faulty.

To forestall uncertainties, Leaver added an error-injection system that plants one error per kilobit in the test stream. Thus, the user checks his data set against a predetermined number of errors rather than against an arbitrary test pattern and knows that if the error count is either high or low, something is wrong.

The ESD-101 works with modems on- or off-line, in simplex, half-duplex, or full-duplex setups. With the shorting plugs supplied, it's possible to test two modems with a single ESD-101; its test patterns are transmitted from one to another and loop back again through both modems and finally into the ESD-101.

The tester weighs 7 pounds and measures 3 by 10 by 11 inches, making it suitable for portable applications such as field testing and servicing.

Sanders Data Systems Inc., a subsidiary of Sanders Associates, Daniel Webster Highway South, Nashua, N.H. 03060 [409]

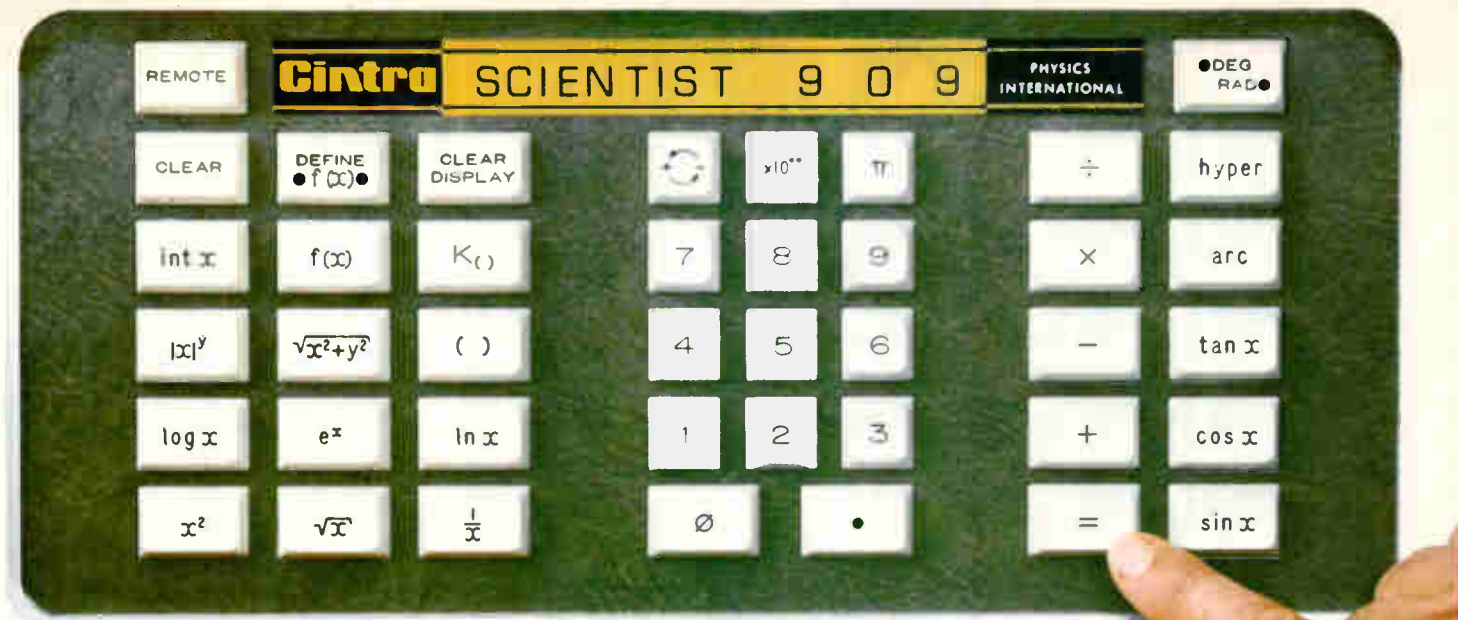

# Talk to me, Cintra Scientist.

## What should I ask you?

**Ask a lot.** Ask, for example, the solution to  $(A + B \times C)^{(D+E \times F)} =$ , where A, B, C, D, E and F can be data or any combination of keyboard functions such as  $\sin X$ ,  $\log X$ ,  $e^x$ , etc. Just key it in exactly as written and you'll have the answer by the time your finger is off the equals key. The Scientist's dynamic range is 200 decades with 10 significant figure accuracy.

**Try it yourself.** Take an everyday slide rule operation such as  $286.4 \times 10^{20} \div .004612 \times 10^{12} =$ . The answer is immediate! Your entered data can be in scientific notation, floating point or combinations of both. The Scientist will keep track of decimal points and exponents for you. All keys are hardwired, and note how logically they're arranged. Power? **Ultra-power** is more like it.

**Stored constants?** You get 26 with the basic model, up to 122 optional.

**No machine language** to learn! The Cintra Scientist talks your language. Press the keys and find out for yourself in just five minutes.

**Behind the keyboard?** Hermetically-sealed MOS/LSI and integrated circuitry assures reliable, trouble-free performance.

**Can you operate as a computer, too?** Certainly. With the Cintra Model 927 Programmer, up to 25,600 consecutive steps can be performed automatically in addition to loops, branches and subroutines. Further-

more, the modular design allows expansion into a mini-computer with peripherals such as the Cintra 941 Printer, plotters, and A to D converters for on-line/off-line applications.

Just \$3,780 puts the power of the Cintra Scientist at your fingertips. Now ask yourself a question. Shouldn't I find out more about the Cintra Scientist?

### Look at these unique keys

**$|x|^y$**  **Ultra-powerful.** Includes all 10-digit integer and non-integer values of x and y.

**$\times 10^{**}$**  An **order of magnitude** more versatile. Enter floating point and scientific notation data, or any combination interchangeably.

**=** **Equate the value.** Press the key and immediately see the result of a long complicated expression.

**( )** **In a bracket by itself,** this key allows any other key to operate on a group of terms.

**DEFINE  $f(x)$**  Use this **highly functional 84-keystroke** programmer for series expansions, transcendental equations, operational analysis, etc. Define f(X) as any function up to 84 consecutive steps; thereafter execute this defined function with one f(X) keystroke (254 steps opt.).

**$K()$**  **Constantly works for you.** Set constants equal to  $K_1$ ,  $K_2$ , etc. To reuse any constant in any equation, simply key  $K_0$  and the subscript thereafter. Stores up to 26 (122 optional) 12-digit constants including exponent and signs.

**$\sqrt{x^2+y^2}$**  **Statistically proven** most useful for least square sums, RMS, and vector magnitudes, etc.

**DEG RAD** View your data from a **better angle.** Keylight shows which trigonometric units you are using.

**REMOTE** This **far out** key lets you communicate with up to 99 instruments: printers, plotters, computers, A to D converters, etc.

Your answer is the Cintra Scientist—the 24-pound computer at your fingertips.

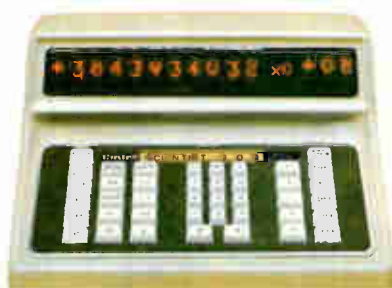

440 Logue Avenue  
Mountain View, California 94040  
(415) 969-9230  
Cintra Incorporated—a subsidiary  
of Physics International Co.

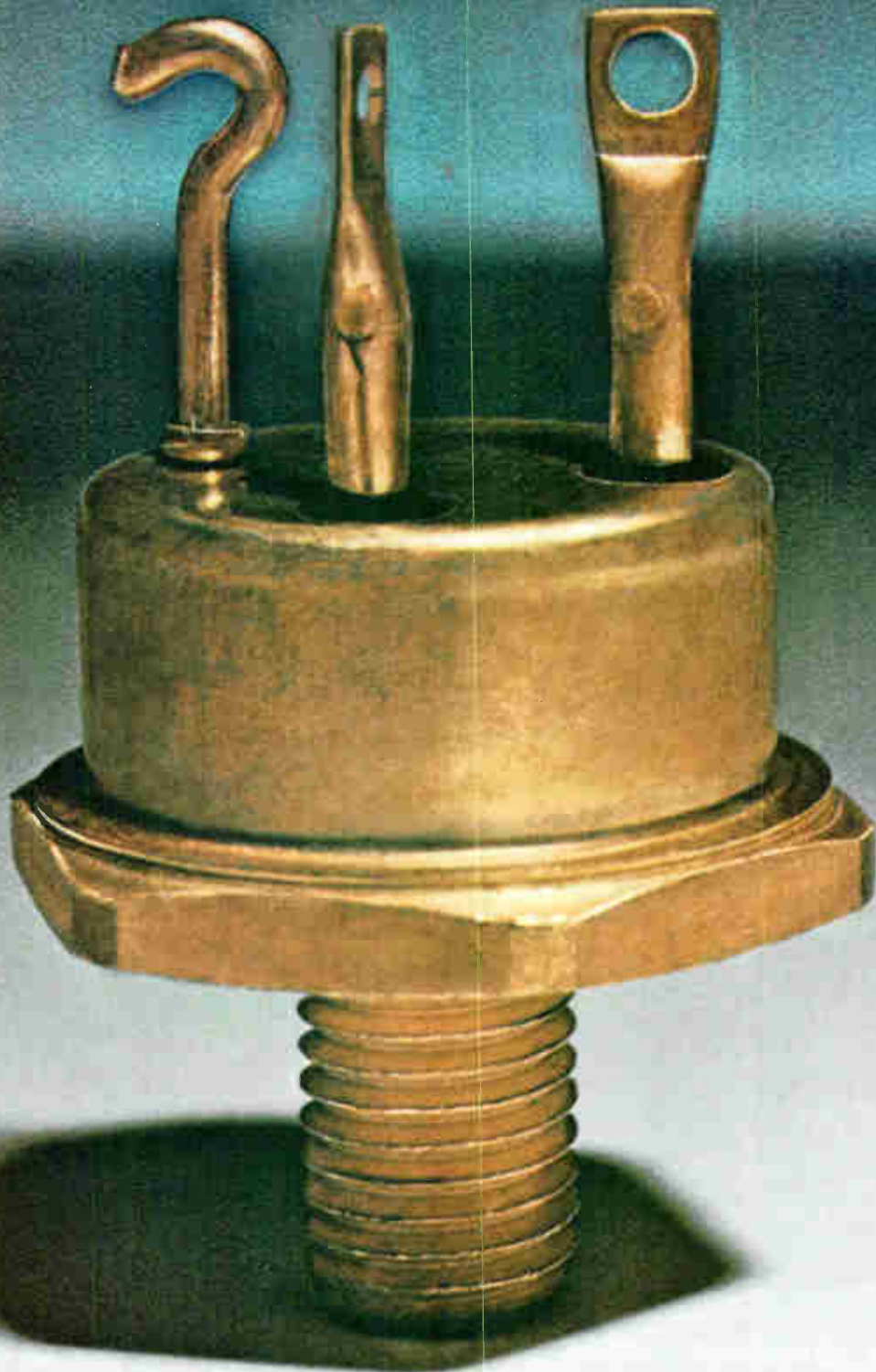

## Bargain driver.

**Westinghouse epi  
base power transistors  
save you a driver stage  
or cut driver  
transistor cost.**

How do we do it? Through an exceptional combination of frequency, power and gain capability. Our devices give you maximum turnoff time ( $t_s + t_f$ ) of 1.15 microseconds or less, with high gain, particularly at high currents—up to 75 amps. Hard solder construction minimizes possibility of thermal fatigue. Hermetically sealed in popu-

lar TO cases, these devices are manufactured by military processing to maximum reliability. Broad SOAs too.

Other hard facts: total switching time of .95 to 1.75 microseconds maximum, currents 2-75 amps, voltage 40-375 volts, power 35-260 watts. So drive a bargain: contact Westinghouse Semiconductor Div., Youngwood, Pa. 15697.

You can be sure...if it's Westinghouse





### Westinghouse Industrial Semiconductor Distributors

**Alabama**  
ACK Radio  
Birmingham 205 322-0588  
Electronic Wholesalers, Inc.  
Huntsville 205 539-5722

**Arizona**  
Hamilton Electro of Arizona  
Phoenix 602 272-2601  
Kierulff Electronics Corp.  
Phoenix 602 273-7331

**California**  
Newark Electronics  
Inglewood 213 674-8440  
Hamilton Electro Sales  
Los Angeles 213 870-7171  
K-Tronics  
Los Angeles 213 685-5888  
Elmar Electronics, Inc.  
Mountain View 415 961-3611  
Hamilton Electro Sales—North  
Mountain View 415 961-7000  
Hamilton Electro of San Diego  
San Diego 714 279-2421

**Colorado**  
Electronic Parts Co.  
Denver 303 266-3755  
Hamilton Denver  
Denver 303 934-5508

**Connecticut**  
Cramer Electronics, Inc.  
North Haven 203 239-5641

**Florida**  
Cramer Electronics, Inc.  
Fort Lauderdale 305 566-7511  
Electronic Wholesalers, Inc.  
Orlando 305 841-1550

**Georgia**  
Specialty Distributing  
Atlanta 404 873-2521

**Illinois**  
Semiconductor Specialists, Inc.  
Chicago 312 279-1000  
Avnet of Chicago  
Schiller Park 312 678-6310

**Indiana**  
Fort Wayne Electronics Supply, Inc.  
Fort Wayne 210 742-4346  
Ra-Dis-Co.  
Indianapolis 317 637-5571  
Radio Distributing Co.  
South Bend 210 287-2911

**Maryland**  
Pyttronic Inc.  
Baltimore 301 727-5100  
Hamilton Electro Sales  
Hanover 301 796-5000  
Cramer Electronics, Inc.  
Rockville 301 424-2700

**Massachusetts**  
Cramer Electronics, Inc.  
Newton Centre 617 969-7700  
Schweber Electronics  
Waltham 617 891-8484

**Michigan**  
Semiconductor Specialists, Inc.  
Detroit 313 255-0300

**Minnesota**  
Semiconductor Specialists, Inc.  
Minneapolis 612 866-3434  
Stark Electronic Supply  
Minneapolis 612 332-1325

**Missouri**  
Electronic Components for  
Industry Co.  
Kansas City 816 421-2400  
Electronic Components for  
Industry Co.  
St. Louis 314 647-5505

Hall-Mark Electronics Corp.  
St. Louis 314 521-3800

**New Jersey**  
General Radio Supply Co., Inc.  
Camden 609 964-8560  
Angus, Inc.  
Moorestown 609 235-1900  
Sterling Electronics, Inc.  
Perth Amboy 201-HI 2-8000

**New Mexico**  
Kierulff Electronics Corp.  
Albuquerque 505 247-1055

**New York**  
Stack Industrial Electronics  
Binghamton 607 723-6326  
Summit Distributors  
Buffalo 716 884-3450  
Cramer/Eastern  
East Syracuse 315 437-6671  
Schweber Electronics  
Long Island 516 334-7474  
Milgray Electronics, Inc.  
New York 212 989-1600

**Ohio**  
Sheridan Sales  
Cincinnati 513 761-5432  
Sheridan Sales  
Cleveland 216 524-8120  
Hughes-Peters, Inc.  
Columbus 614 294-5351  
Mentronics, Inc.  
Mentor 216 946-3058

**Oklahoma**  
Hall-Mark Electronics Corp.  
Tulsa 918 835-8458

**Pennsylvania**  
Cameradio Company  
Pittsburgh 412 391-4000

**South Carolina**  
Sawyer Electronics Corp.  
Greenville 803 235-0438

**Texas**  
Hall-Mark Electronics Corp.  
Dallas 214 231-6111  
Midland Specialty Co.  
El Paso 912 533-9555  
Hall-Mark Electronics Corp.  
Houston 713 781-6100  
Lenert Company  
Houston 713 225-1465  
The Altair Co.  
Richardson 214 231-5166

**Washington**  
Hamilton Electro Sales of the  
Pacific Northwest  
Seattle 206 624-5930  
Kierulff Electronics Corp.  
Seattle 206 725-1550

**West Virginia**  
Charleston Electrical Supply  
Company  
Charleston 304 346-0321

**Wisconsin**  
Taylor Electric Company  
Mequon 414 241-4321

**Canadian Westinghouse**  
Hamilton, Ontario 416 528-8811

**Westinghouse Electric International**  
London, S.W. 1 Whitehall 2704  
New York 212 692-3322

**Westinghouse Semiconductor Division**  
Youngwood, Pennsylvania 15697

## Data handling

# Data terminal is fast printer

User selects speed up to 60 characters per second; debut planned for SJCC

When a computer user wants to print out data at a reasonably rapid rate—say 50 characters per second—he usually has to go to a line printer. But many users, especially time-sharing customers, don't have the room or the money for this type of equipment. For these users, Memorex will introduce its model 1240 printer-terminal at the Spring Joint Computer Conference in Atlantic City, May 5-7.

The 1240 is about the size of the popular Teletype terminal, but instead of a speed of about 10 or 15 characters per second, it operates at user-selectable speeds of up to 60 cps. Other features are built-in full- or half-duplex modems, 120-character line, tractor feed for paper, and an interchangeable print cartridge for changing type fonts.

According to Chris Soter, sales manager at Memorex, "The 1240 bridges the gap between the terminal and the printer—it is both." He says that it expands the capabilities of a large segment of time-sharing users who are now restricted by 10- or 15-character per second terminals; and the increased printing speed is also useful in commercial data-processing applications in which high volumes of printed data are handled.

Soter says that the print mechanism, which consists of a moving belt containing the characters, uses about one fourth of the parts needed in similar printers. Thus the unit, although it has a significantly higher printing speed, also has increased reliability.

Delivery of the terminal is scheduled to begin in October, and prices start at \$4,200.

Memorex/Equipment Group, San Thomas at Central Expressway, Santa Clara, Calif. [410]



# EVEN SQUINTING WON'T HELP.

No use, fellas. You need a microscope to see the world's most densely packed LSI circuit.

That's what Electronic Arrays has done this time.

4692 transistors (4096 bits of memory) on a single 88 x 94 mil chip.

Since that kind of density is not available elsewhere, may we take this hallowed moment to proudly proclaim our EA 3300 (a 512 word, 8 bit/word ROM) the champion of the LSI world.

We didn't, however, design the EA 3300 this way just to show off.

EA 3300 has the most functional complexity of any product available today in a 24 pin package.

That reduces cost.

A smaller die further reduces costs by giving you higher yields and greater product performance and reliability.

Our entire line of Registers, ROM's, Read/Write RAM's and Logic circuits is made in *production quantities* with the same close-tolerance MOS technology as the EA 3300.

And all products are available *immediately* from 24 distributors nationwide, and 6 international distributors.

To see is to believe. Do both by addressing your purchase orders to your nearest EA distributor or to Electronic Arrays, Inc., 501 Ellis Street, Mountain View, California 94040. (415) 964-4321.



**electronic  
arrays, inc.**

**Proven MOS products delivered in volume.**

Forms for your specialized bit patterns are available from any of our representative offices or directly from the factory. The EA 3307, which is an EA 3300 already programmed to be an EBCDIC to ASCII and ASCII to EBCDIC code converter, is available from distributor and factory stock. Features include two output inhibit controls that give 1024 4/bit words; nine input addresses; all decoding on the chip; power requirements less than 100 milliwatts; synchronous 2-phase clock, 24 pin hermetic dual-in-line package.

Circle 162 on reader service card

# Laser system calibrates tools

Compact, portable interferometer for shop applications uses retroreflector fastened to machine by magnetic base

Amid the flood of predictions during the early 1960's about the laser's potential, maser-laser pioneer Charles H. Townes insisted that its most significant applications would be in metrology.

Townes probably had laboratory-type measurements in mind. But development of lasers as industrial measurement tools already has come a long way. This week at the

International Tool Exposition in Detroit, Cutler-Hammer's AIL Division will demonstrate its Mark II laser interferometer, a machine-shop tool that is portable, compact, modular, lightweight, and relatively inexpensive at \$15,400.

The interferometer consists of the sensor unit, which includes the helium-neon gas laser source and its power supply, beam-splitting

optics, and a diode detector; a corner cube retroreflector, and the control electronics.

The interferometer calibrates measuring instruments, tools, and other precision devices in machine shops. It can also be used as the sensor for open-loop or closed-loop numerical-control machining work, and for optical tooling, calibration of circular tables and tilt

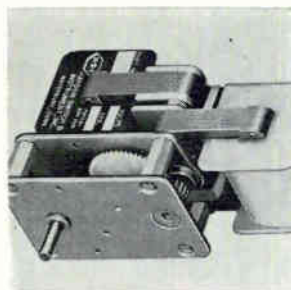

Reversible-step servo motor series 36300 has two p-m rotors in a tandem laminated magnetic structure with two center-tapped coils. Each half coil is treated as a separate coil, providing four discrete fields. Energizing the coil sections individually in sequence 1, 2, 3, 4 causes rotor to rotate in 90° steps for one full turn. Haydon Switch & Instrument Inc., Waterbury, Conn. [421]

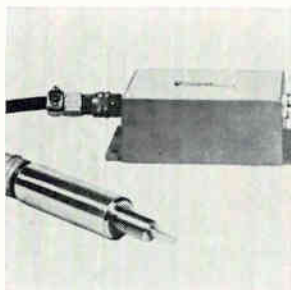

Displacement limiting and control systems CDDC-100 and CDDCP-100 are for industrial and OEM uses. They respond to position, displacement, thickness, gaging, and indexing throughout a range from  $\pm 0.005$  to  $\pm 3$  in. Units are self-amplifying and self-contained requiring no auxiliary electronics. Columbia Research Laboratories Inc., MacDade Blvd. & Bullens Lane, Woodlyn, Pa. [422]



Size 18 d-c tachometer CVO 9612 001, for industrial applications, features a high output of 100 v per 1,000 rpm and exhibits low-ripple voltage. Used for feedback-drive or velocity servo-drive functions, it serves as an integral part of a contour-control system. Ambient temperature range is  $-54^\circ$  to  $+100^\circ$  C. Singer-General Precision Inc., Kearfott Division, Little Falls, N.J. [423]



Slo-Syn synchronous/stepping motor type LS50 has a low shaft speed of 28.8 rpm at 60 hertz without step-down gearing. Used as an a-c motor it will start, stop, and reverse almost instantly. The motor will stop within 25 msec without external braking. It is rated for 120 v 0.2 amp. It features 40 oz-in. torque. Superior Electric Co., 382 Middle St., Bristol, Conn. 06010 [424]



Micro water detector is designed to detect water on surface of the walls, ceilings, standpipes, and areas where space is limited and access difficult. When water contacts the cartridge, it swells up, pressing against an internal water-proof switch which starts alarm. Unit can be connected into existing alarm systems. Price is \$21.95. Retawmatic Corp., 509 Fifth Ave., New York [425]



Single-turn, cermet precision pot model 139 features a high-power rating suited for industrial use in controls and instrumentation. It offers a resistance range of 500 ohms to 1 megohm, essentially infinite resolution, and a standard independent linearity of  $\pm 0.5\%$ . Power rating is 5 watts at  $40^\circ$  C. Spectrol Electronics Corp., 17070 E. Gale Ave., City of Industry, Calif. [426]



Constant torque a-c variable-speed drive system meets rigid Mil specs. With this system, the exact output speed of the motor shaft can be set and held to 0.05%. Heart of the unit is a digital frequency-control system. A sampling counter senses motor speed every 2.62 sec and compares this speed value to a precision standard. Welco Industries, 9027 Shell Road, Cincinnati [427]

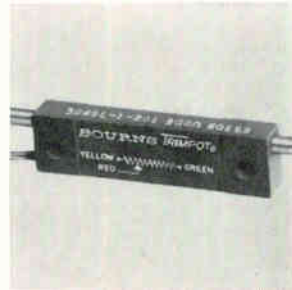

Cermet element, position pot 3049 has a  $\frac{1}{2}$ -in. nominal stroke with mechanical life of 20,000 cycles and  $\pm 2\%$  standard linearity. It is expected to find wide acceptance in industrial controls and lab-type applications. Resistance range is 100 ohms to 1 megohm. Power rating is 1 w at  $70^\circ$  C. Price (500 lots) is \$4.65 each. Bourns Inc., 1200 Columbia Ave., Riverside, Calif. [428]

... for faster setup in shop environment,  
laser warmup time reduced to 10 minutes ...

frames, and for multi-axis measurement to assure synchronous movement of machine parts.

Lightweight and rugged in construction, the interferometer can be carried to any shop location, and can be set up and made ready for precise measurements within minutes. The laser's normal warmup time of 45 minutes has been reduced in the AIL design to less than 10 minutes. The laser high-voltage power supply has been built into the sensor head, assuring that no voltage higher than 115 volts is carried in the cable. This permits the size of the cable to be reduced to one-half inch in diameter. In addition to permitting a slender and flexible cable, the design assures that the operator is not exposed to high voltages at any time.

In the basic system configuration, light from the laser strikes a partially reflecting diagonal mirror and is divided into two separate paths. The reflected beam is di-

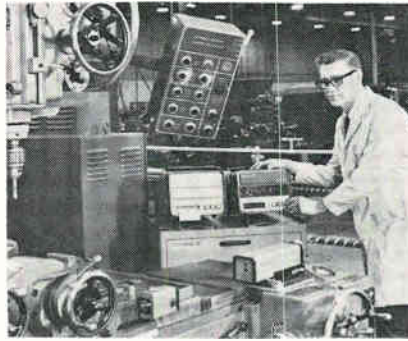

Precision. Laser is verifying the positioning accuracy of a jig borer.

rected downward through a reference reflector, and is returned to the beam splitter. The transmitted beam hits the moving target-prism in the retroreflector unit and is also returned to the beam-splitter where it is recombined with the reference light. There is no need to fasten the retroreflector to the machine being measured; a powerful magnetic base holds it firmly.

Because of the coherent characteristics of laser light, the intensity in the recombined beam is a function of the difference in path lengths between the two beams. Maximum intensity results from differences of an integral number of whole wavelengths. Minimum intensity is obtained for differences of an odd number of half-wavelengths. The alternation of high and low intensity is called a fringe pattern.

In a system configuration where two fringe patterns are generated, a relative phase shift of 90° between the patterns is caused, and electronic circuitry can detect the direction that the prism moves, then calculate the number of wavelengths over which it has traveled. High accuracy can be attained by correcting for changes in the laser wavelength due to air density variations.

The sensor head in the system measures 3 $\frac{3}{8}$  by 3 $\frac{3}{8}$  by 13 inches, and weighs 14 pounds. The electronics case measures 8 by 10 by 17 inches, and weighs 30 pounds.

AIL Division of Cutler-Hammer, Deer Park, Long Island, N.Y. 11729 [429]

**Print your blessings.**

**Count 'em. Code 'em. Time 'em.**  
**Add 'em. Cost 'em. Read 'em. Keep 'em.**



## Servo controls gas-flow rate

Deposition system regulator  
accepts program voltages  
from computer or monitor

**Chemical deposition** of dielectrics and thin films for integrated circuits demands precise control of gas flows by a servo valve system, so that manufacturing tolerances will not vary from circuit to circuit. The AMF 5100 servo valve system of Applied Materials Technology Inc. provides a flow regulation to within 0.2%, guaranteeing the necessary reproducibility in the preparation of epitaxial dielectrics and conducting films.

The control element for the gas flow is a micrometer-type valve that is regulated by a servo motor. The input signals to the servo motor are provided by an electronic unit which converts a program voltage from a digital computer or other

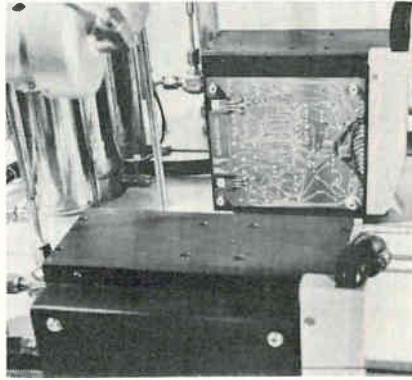

Controller. With cover off servo valve, circuitry is visible.

monitoring device to the appropriate d-c signals used by the servo motor to position the valve for cor-

rect opening.

When an enabling signal is applied the motor adjusts the valve to the desired flow rate. While the enabling signal is maintained, a flow sensor and feedback network compensate for process variations due to load changes, and also for pressure and temperature variations.

The model 5100 is a self-contained unit except for power supplies. The user need only provide the programmed-voltage source and the desired electronic sensor. The servo package is mounted on the side of the valve-mechanism housing, and connections to the package are made with a 22-pin edge connector.

The model 5100 accepts control signals in the range of 0 to 5 volts for easy accommodation to program sources such as paper tape readers and other computer peripheral equipment.

Applied Materials Technology Inc., 2999 San Ysidro Way, Santa Clara, Calif. 95051 [430]

It's hard to find an end to what our MULTI-PRINTER™ can do. And no other does so much, so accurately and reliably.

For the record, a Multi-Printer gives you visual and electrical readout of serial/parallel data input from an electrical or electronic source. At its heart is the decade, a 10 or 12-character magnetic printing device, complete with its own printed and electrical readout. And because our decades are made of quality glass fiber circuit boards and solid steel frames, you can depend on long-lasting and trouble-free performance. One Multi-Printer can take up to 30 decades to spell out information with whatever symbols or characters you choose.

It'll do your ticketing, billing, timing and production monitoring, or give you remote readouts of recording instruments. It prints on pressure-sensitive paper rolls or ticket card forms — without smudges or ink splashes, on as many as seven copies.

In short, there's no typical application for our Multi-Printer — just an uncommonly large number of time and money saving uses. And since it's so beautifully modular, we can build it with just the number of decades and symbol types you want.

For full details, write to Product Manager, IIT General Controls, 1838 Flower Street, Glendale, Calif. 91201. International Telephone and Telegraph Corporation.

You can really count on our Multi-Printer.

**IIT**  
COUNTERS

# Active-filter line is semi-custom

Partially assembled integrated-circuit catalog units are completed and adjusted to suit customer's application

**Exchanging** the slide rule for computer-aided design, and discrete components for integrated circuits, Analog Devices has developed a new catalog line of active filters. The company has been selling discrete-component custom-design active filters since June of 1968.

The new line includes low-pass, high-pass, bandpass, and band-reject filters with Butterworth,

Bessel, Chebychev, and Paynter transfer characteristics. And though the filters are specified tightly in the catalog, Analog Devices plans to retain some custom flexibility by stockpiling partially assembled filters, then adding frequency-compensating components and making final adjustments in response to customer requirements.

This way, it will be able to com-

bine some of the parts-cost leverage of volume production with the flexibility of custom design, and, according to C. Peter Zicko, analog products marketing manager, still be able to deliver within two weeks.

"The market for active filters today is much like that for op amps several years ago," says Zicko. "Enough companies have begun building their own active filters,

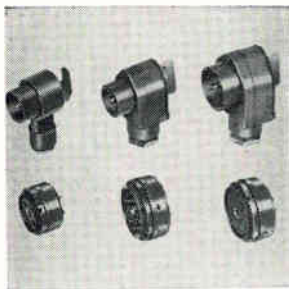

Waterproof power connectors series UW, conforming to MIL-C-12520, come with 4, 9, 14, 19, or 30 contacts, with current ratings ranging from 11 to 41 amps. They are designed for power and control circuit applications in mobile radar, radio, teletypewriter, and related communications equipment. Insulator material is glass-filled diallyl phthalate. Rico Corp., Willow Grove, Pa. [341]

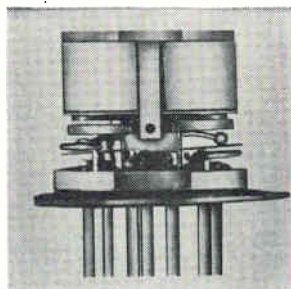

Four-pole magnetic latching relays types 424A and 424AD come in a TO-5 transistor can. Versions are available with nominal coil voltages ranging from 5 to 26.5 v d-c; d-c coil resistances are 61 to 2,000 ohms, respectively. They require 125 mw pull-in power, and have contact bounce of less than 3 nsec. Teledyne Relays, 3155 W. El Segundo Blvd., Hawthorne, Calif. 90250 [342]

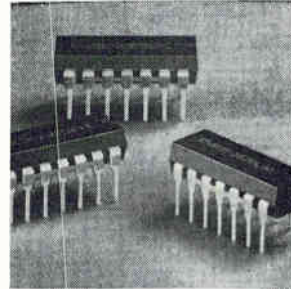

Three 14-pin dual-in-line reed relays—all compatible with DIP-IC devices—include: the GB812A (2 Form A); the GB811C (Form C); and the GB813C, a mercury-wetted Form C that is position-insensitive. They offer a solution to high-density p-c packaging problems. All can be automatically inserted. Grigsby-Barton Inc., 107 N. Hickory St., Arlington Heights, Ill. 60006 [343]

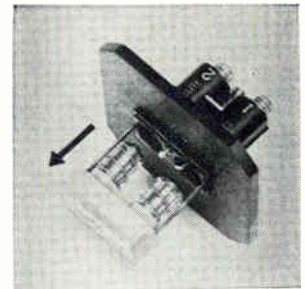

Two-lamp pilot light series 201 will display as many as 3 lines of wording in any one of 6 illuminated colors and mounts in 2 drilled holes instead of costly square panel cutouts. Applications are in aircraft, ground-support equipment and industrial control panels. Units may be operated at 6, 12 and 28 v d-c or 115 v a-c. Master Specialties Co., 1640 Monrovia, Costa Mesa, Calif. [344]

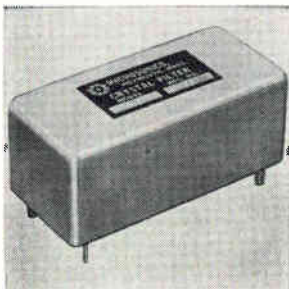

Single-sideband crystal filter model SB56A features a carrier frequency of 5 Mhz with 3 db high and low bandwidth of +3.5 khz and +300 hz respectively. Carrier rejection is 20 db minimum. Temperature range is -20° to -71° C and ripple is 2 db maximum. Filter dimensions are 2.38 x 1.03 x 1 in. Microsonics Division of Sangamo Electric Co., 60 Winter St., Weymouth, Mass. [345]

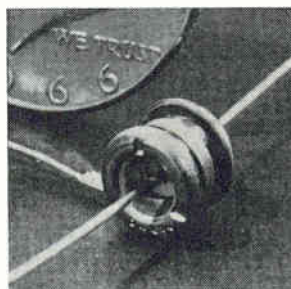

Triggerable spark gap KAT05-01 is for fast bipolar switching of high currents of up to 3,000 amps. It can transfer charges up to 5 amp/sec each discharge. Operating voltage range is 90-450 v. Unit is neither dv/dt nor di/dt sensitive and can withstand transients without damage. It is 0.36 in. diameter, 0.30 in. long. Siemens Corp., 186 Wood Ave. South, Isehn, N.J. [346]

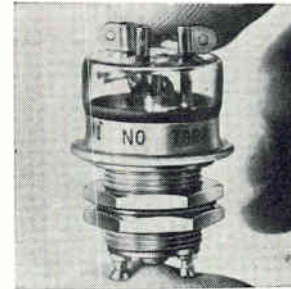

High-voltage, high-vacuum magnetic latching relay TCR/L has a spdt contact configuration and can switch 2,500 w with a 3 msec, 18 v d-c pulse. It can be operated at 5,000 v in air and 15,000 v in oil or gaseous dielectric media. Because of the short pulse used to operate the relay, coil temperature rise is negligible. Torr Laboratories Inc., 2228 Cotner Ave., Los Angeles [347]

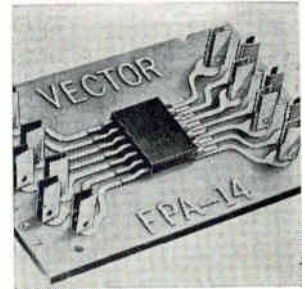

Flatpack adapters are for mounting 14-lead IC's on circuit boards. The adapter is a 3/16-in. epoxy paper wafer with a 2-oz. copper etched pattern which matches the 0.05-in. spaced lead pattern on flatpacks. Price for small quantities is 53 cents per wafer in packages of four. Units are available from the factory. Vector Electronic Co., 12460 Gladstone Ave., Sylmar, Calif. [348]



# Our MD 200 is the finest MOS/LSI tester available!

"We have the capability of conducting on-wafer tests, both digital functional and parameter, at speeds to 2MHz . . . prior to packaging. The MD200 is able to do this because the analysis is done at the probe head, not in a computer 30-50 feet away. With as many as 16 stations of 64 probe pins controlled by a single computer, we've had to automate everything . . . including mechanical functions such as probe down sensing, off-wafer detection and inking; making our MD200 the fastest fully-automated system available.

"To simplify programming, and significantly reduce test time, we've created TOIL (Test-Oriented, Interactive Language). Included in TOIL are all the necessary parameter and functional tests to evaluate both the logic and the circuits on the wafer. Most importantly, programming is reduced to a series of questions and answers.

Therefore, minimal training of personnel is required.

"Macrodata's MD200 has the capability of performing a detailed analysis of your complete MOS/LSI design and production cycle . . . based on factual test results. Additionally, we've included a complete complement of test aids . . . test generation programs, and yield evaluation mapping programs, to reduce total test and evaluation time.

"The MD200 is available now. We'll be delighted to demonstrate it for you. Or write for our 16 page brochure describing Macrodata's MD200 Diagnostic Test System in detail."

Dr. William C. W. Mow  
President  
Macrodata Company



Macrodata Company Test Systems Division  
20440 Corisco Street, Chatsworth, California 91311



# more than a power supply

You get more than a power supply when you specify this or any Hewlett Packard power supply. An international network of 220 sales/service offices are at your disposal . . . the most comprehensive service manuals detailing every aspect of the supply from theory and operation to troubleshooting . . . protection circuitry including an internal overvoltage "crowbar" to safeguard delicate loads, standard on this Low Voltage Rack (LVR) Series. OUTPUTS: 10V @ 20, 50, or 100A; 20V @ 10, 20, or 50A; 40V @ 3, 5, 10, 30, or 50A; 60V @ 3 or 15A. RIPPLE AND NOISE: typically 200 $\mu$ V rms, 10mV p-p. Remote Programming and lots more. Prices start at \$350.

## and you can customize it with these options...

- 10-Turn Output Voltage and Current Controls
- Chassis Slides
- 3-Digit Graduated Decadial for Voltage or Current
- 115V, 208V, or 230Vac Inputs
- 50Hz Input.



HEWLETT  PACKARD

POWER SUPPLIES

Over 100 power supplies are described in the 1970 HP Electronics Catalog. Write for your copy.

# hp DC POWER

From 10 $\mu$ V to 4000V

From 1 $\mu$ A to 2000A

From \$90 to \$3,500

From manual to computer controlled.

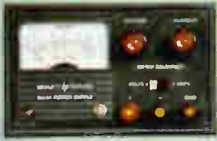

## LOW COST SUPPLIES

Compact laboratory power supplies can be stacked or rack mounted. Choose from 6 well-regulated models: 10V @ 1A; 25V

@ .4A; 50V @ .2A. Three Constant Voltage/Current limiting models — \$90. Three Constant Voltage/Constant Current models — \$115.

**Constant Voltage/Constant Current with Automatic Crossover, Remote Programming, Remote Sensing, Auto-Series or Parallel, Optional Internal Over-voltage "Crowbar"**



## MEDIUM POWER / TRANSISTOR REGULATED

Precisely regulated. Programming speeds as fast as 500 $\mu$ s. 20 models: 7.5V @ 3 or 5A; 10V @ 10A; 20V @ 1.5, 3, 5, or 10A; 30V @ 1A; 40V @ .75, 1.5, 3, or 5A; 60V @ 1 or 3A; 100V @ .75A; 160V @ .2A; 320V @ .1A. \$144 to \$395.



## MEDIUM POWER / SCR REGULATED

8 models: 20V @ 15 or 45A, 40V @ 10 or 25A; 60V @ 5 or 15A, 120V @ 2.5A; 600V @ 1.5A. \$360 to \$550.

## HIGH POWER/SCR REGULATED

12 Models: 4V @ 2000A; 8V @ 1000A; 18V @ 500A; 36V @ 300A; 64V @ 150A; 110V @ 100A; 220V @ 50A; 300V @ 35A; 600V @ 15A. \$1275 to \$3500.

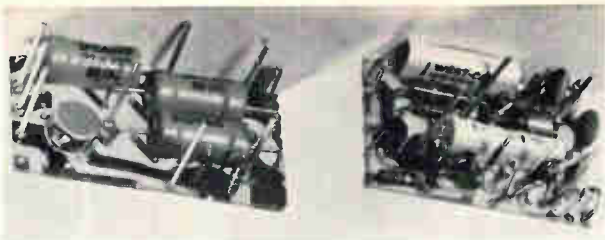

Streamlined. IC active filter, left, is designed to replace type that required many components.

so that applications and volume are about to increase very quickly."

If price is a sufficient incentive, this expansion should accelerate; Analog's prices start at \$22 (100-unit lots), and are designed to be low enough to tempt buyers away from in-house designs.

Also helping to broaden applications, especially into areas like medical instrumentation, oceanography, and geophysics is the range of cutoff or center frequencies covered by the line—from 20 kilohertz down to 0.001 hertz, also said to be an industry low for catalog items. "Formerly, anything with response below 0.1 hz was an extra-cost, custom device," says Zicko.

**Low noise.** Analog specifies the noise inherent in its active filters as well. Levels for the line are less than 50 microvolts rms from 0 to 20 khz.

Zicko says this is important because active filters are continually finding their way into new noise-reduction applications—in telemetry, for example, where the filter is used to eliminate unwanted high or low frequencies before the sampled signal is relayed to an analog-to-digital converter. "In almost all such applications, engineers carefully manage an error budget for their system," says Zicko, "and, unlike most companies, Analog is giving them a figure for the active filter."

Analog's computer-aided designers also have been able to combine good gain and drift stability with high input impedance through careful selection of the IC op amps and other components.

Impedance can be as high as 1 megohm for Butterworth filters operated in the 1-hz region; gain, nominally zero, can be trimmed to 0.02 decibel and is stable within the same limits even though input dynamic range may be 10,000 to 1; input offset drift is typically  $\pm 50 \mu$ V per  $^{\circ}$ C; input bias current is 10 picoamperes maximum.

Zicko notes that the high input impedance and low bias current are important in medical-monitoring applications where leakage current must be minimized.

Prices run up to \$62, depending on filter types and quantity. Custom units cost more. Nearly all types can be delivered within two weeks.

Analog Devices does not have a monolithic-IC facility. The company is using some off-the-shelf IC's made by National Semiconductor Corp., and Intersil is supplying other units that are manufactured to Analog's specifications.

Analog Devices Inc., 221 Fifth St., Cambridge, Mass. 02142 [349]

# Electronic Packagers of America!

Your  
"NEP/CON '70 EAST"  
is in  
New York  
June 16-18.

A reminder from the airline that  
goes all out to get you there.

**SOMEHOW, YOU FEEL  
MORE IMPORTANT ON TWA.**

New components

## CdS photocells yield high output

Eliminate need for  
preamplifier circuits  
in optical card reader

**Most photocells** generate output voltages too small to be detected by logic circuits without first being boosted by preamplifier circuits. In the case of card readers or other such devices that may contain 100 or more of these cells, the added circuitry can be both costly and complex. However, the light-sensor matrix CR 100S built by Panasonic uses an improved cadmium sulfide photocell that generates outputs 100 times greater than phototransistors and 50 times greater than other CdS cells, eliminating the need for the extra hardware.

The matrix consists of 100 CdS sandwich-type cells, each with a series-connected diode, arranged in a 10-row-by-10-column matrix. The matrix is most suitable for reading either punched cards or credit cards in a static condition. The matrix is also available in larger sizes of 12 by 20, and 12 by 80.

Light incident on a glass substrate decreases the resistance of the photoconductive layer of the cell, generating a current at the output terminals. The output current is a function of the bias voltage applied to the cell and the candle power of the incident light. These CdS cells generate large output currents at lower light levels than other photocells—only 10 to 30 foot-candles of light are needed instead of the 100 to 300 ft-c in silicon light sensors. The effect of the lower light level is to minimize internal heat problems.

The photocurrent of each cell is linearly proportional to the illumination and varies from about 0.03 milliamperes to more than 10 ma over a range of 0.1 ft-c to 100 ft-c at a 1.5-volt bias.

Matsushita Electric Corp., 200 Park Ave., New York 10017 [350]

# Under-drafting.

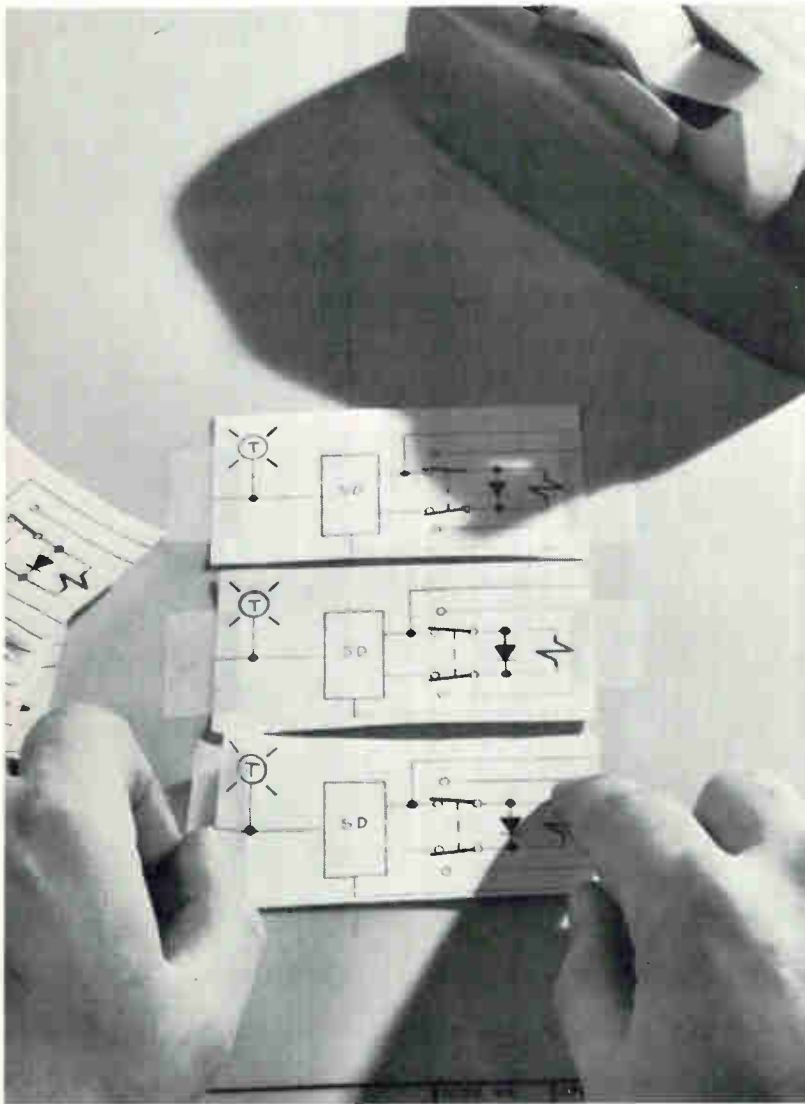

**Draw less.  
Let photography  
handle your repeat  
drafting chores.**

If you're retracing design elements that are repeated again and again in a drawing, you're overdrafting. Same thing applies if you're retracing a design that's part of another drawing.

Save time. Underdraft with KODAGRAPH Films and Papers for a welcome change. Let them do the repetitive work — photographically.

Talk it over with your local Kodak Technical Service Representative. Or write Eastman Kodak Company, Business Systems Markets Division, Department DP 728, Rochester, New York 14650.

**DRAWING REPRODUCTION  
SYSTEMS BY KODAK**

Kodak

# Announcing the Brush 440

**If it doesn't meet  
your portable recording needs,  
maybe you don't need a  
portable recorder.**

It's tough to imagine a general purpose portable that could do more.

The Brush 440 has four 40mm channels, two event markers and a push-button choice of eight chart speeds. We guarantee trace linearity of 99.5%. Or better. And our stringless, springless servo system enforces pen position clear across the channel.

The traces are something else: clear,

crisp, uniform. Pressurized ink-writing puts them *into* the paper not onto it. There's no smudge, no smear, no puddling. A disposable ink cartridge holds up to a year's supply and can be replaced in seconds with no mess, no fuss.

There's more. Such as a wide choice of preamps that offer measurement ranges from 1  $\mu$ V per division to 500 V

full scale. Frequency response that's flat within  $\pm 2\%$  of full scale from d-c to 40 Hz. And typically handsome cabinetry and rugged construction.

Look it over. Check it out. Add it up. And you'll see why this brand new 45 pounder is the ideal way to monitor such dynamic variables as temperature, pressure, strain, vibration or what have you. Ask your Brush representative for a demonstration. Or

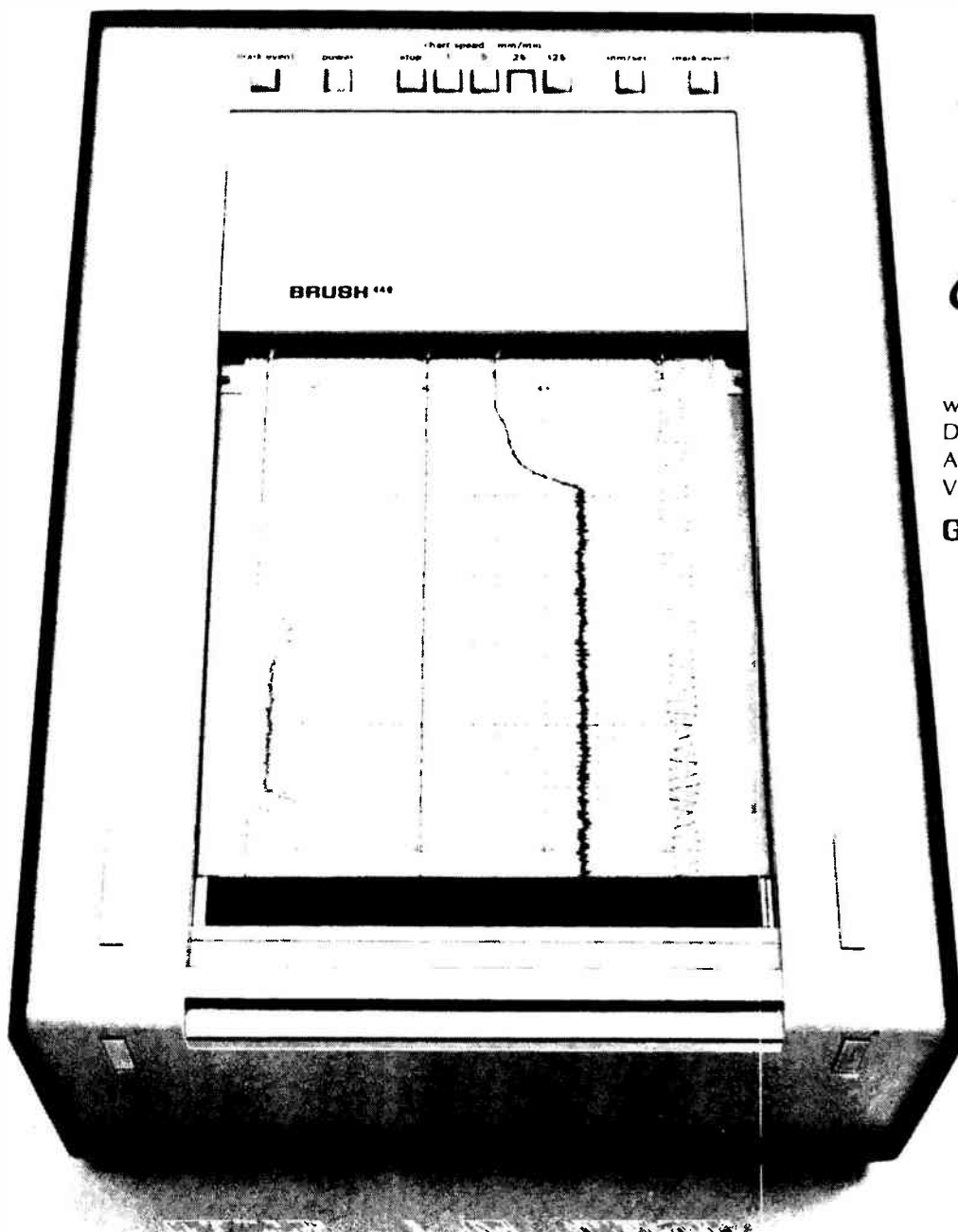

write for details. Brush Instruments Division, Gould Inc., 3631 Perkins Avenue, Cleveland, Ohio 44114 or Rue Van Boeckel #38, Brussels 14, Belgium.

**GOULD BRUSH**



# Bipolar transistor reaches 15 Ghz

Shallow-diffusion process also yields 50-mw output; unit designed for microwave sweepers and spectrum analyzers

An  $f_{max}$  of about 12 gigahertz has been representative of the state of the microwave transistor art. Texas Instruments, for example, has been building transistors in this frequency range, as has Fairchild Semiconductor, which has developed a gallium arsenide field-effect transistor with an  $f_{max}$  of 12 Ghz [*Electronics*, March 16, p. 44].

Now, however, Hewlett-Packard

has come up with a new silicon bipolar transistor that has maximum available power gain, MAG, of unity at 15 Ghz. (MAG is the maximum power gain of a transistor without external feedback and with its input and output simultaneously and conjugately matched.) At a collector-base voltage of 15 volts and collector current of 20 milliamperes, the transistor has a current gain

( $h_{FE}$ ) of 100. Power capability of the device is remarkably high; at 8 Ghz, it delivers 4.5 decibels of gain at 400 milliwatts bias with power output of 50 mw. According to George E. Bodway, manager of H-P's microelectronics operation, "Devices which formerly were state-of-the-art, those with  $f_{max}$  figures of 10 to 12 Ghz, gave much less than that, even in their useful

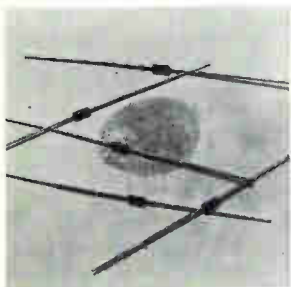

Zener diodes are available in the double plug, DO-35 package. Electrical characteristics feature zener voltages from 6.2 through 47 volts, and meet the 1N710 through 1N730, 1N754 through 1N759, and 1N957 through 1N977 specifications. Voltage tolerances are 20%, 10%, and 5% with 1% available on special request. American Power Devices Inc., Andover, Mass. [436]



GaAs light-emitting diode OP-100 is suited for mounting directly into p-c boards for light emitter arrays. Used as discrete devices in light emitter arrays, the LED's eliminate problems caused by less reliable tungsten filament sources, or the expense of fiber optic assemblies for achieving multichannel light distribution. Optron Inc., 1201 Tappan Circle, Carrollton, Texas. [437]



Silicon single phase bridges BRH/T300 and BRH/T600 are 3- and 6-amp bridges for high reliability industrial and military use. They feature a miniature thermally matched design (1 x 1 x 0.4 in.). Both series have 10 to 2,500 v types with respective single cycle surge current ratings of 50 and 125 amps peak. Rectifier Components Corp., 124 Albany Ave., Freeport, N.Y. [438]



Silicon power transistors models 2N5589, 2N5590 and 2N5591 have been optimized for operation at 13.6 v for f-m/vhf mobile communications equipment. The devices, featuring low inductance TO-71 and TO-72 stripline packages, provide 3, 10 and 25 watts, respectively. Price (1-99) ranges from \$7 to \$24 each. Electronic Components Division, United Aircraft, Trevose, Pa. 19047 [439]

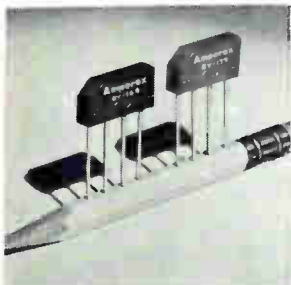

Plastic-encapsulated bridge rectifiers are comprised of four silicon double-diffused diodes. The BY 164, priced at 51 cents each in 1,000-lot orders, provides 1.2 amps output at 54 v into an R/L load. The BY179, priced at 56 cents, is specified at 1 amp output at 255 v into an R/L load. Units feature very low hum. Ampere Electronic Corp., Slatersville, R.I. 02876 [440]

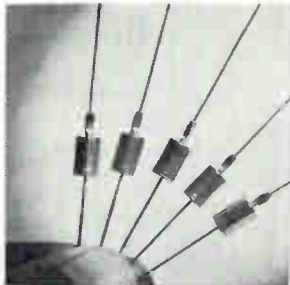

Transient voltage suppressors in the new TransZorb series can dissipate 1,500 w of peak power. They are available in voltages from 6.8 to 200 v (JEDEC types 1N5629 through 1N5665A). All dissipate 1,500 w of peak power for 1 msec with instantaneous clamping capability. Units come in the DO-13 package. General Semiconductor Industries Inc., 230 W. 5th St., Tempe, Ariz. [441]

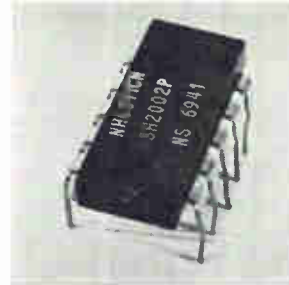

High voltage, high current hybrid drivers NH0011, NH0011C and NH0011CN use an IC driver and a h-v output transistor to provide output currents from 150 ma to 250 ma at up to 40 v. The design provides logic flexibility by using a 4-input NAND gate, a NOR input and a logic output for latching capability. National Semiconductor Corp., San Ysidro Way, Santa Clara, Calif. [442]



P-i-n diodes type 5082-3080 can attenuate or switch r-f signals that have frequencies as low as 1 Mhz, and do so without adding any more than 0.05% distortion. Devices are suited for use as current-controlled resistors in agc circuits of CATV amplifiers and in TR switches. Price (10,000-25,000) is 99 cents. Hewlett-Packard Co., 1501 Page Mill Rd., Palo Alto, Calif. [443]

# Small wonder: IT'S THE MOST ACCURATE and SIMPLEST WAY TO MEASURE PEAK POWER

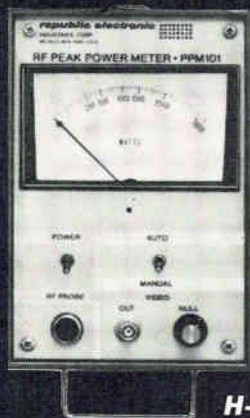

H-8", W-5 $\frac{5}{8}$ ", D-11 $\frac{1}{2}$ "

**FULLY AUTOMATIC...**  
NO CALIBRATION NECESSARY.  
**ACCURACY OF  $\pm 0.5$  db**  
TRACEABLE TO NATIONAL BUREAU  
OF STANDARDS.  
**FREQUENCY RANGE -**  
**950 to 1250 MHz**

*An Inquiry to our  
Marketing Department  
will give you full details*

(516) CH 9-1414

**republic electronic  
industries corporation**



 A Heath Techni Company

575 BROAD HOLLOW ROAD, MELVILLE, N.Y. 11746

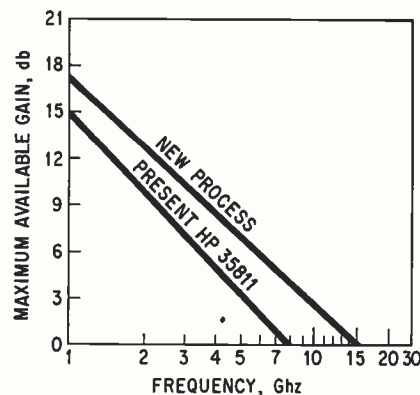

Improved. New transistor yields higher power for a given frequency.

range." Breakdown voltage,  $BV_{CEO}$  is 30 volts.

The company achieved this frequency and power performance by using shallow diffusion—the diffusion depth is one-fifth that of the typical high-frequency device. It wasn't necessary to go to extremely small collector and emitter geometry, the company found; the 0.1 mil geometry conventionally used for high-frequency transistors is adequate even though most predictions indicate that a 40% reduction in geometry would be necessary to obtain 15 Ghz.

The company won't reveal details of the fabrication process except to say that considerably fewer steps are required than for conventional fabrication. This, combined with the larger-than-expected geometry, means that H-P is getting excellent manufacturing yield and is therefore able to price the transistor reasonably. Instead of the usual \$100 to \$300 asked for introductory devices, the price will be under \$50 for packaged units and \$15 for bare chips in small quantities. These prices are similar to those for H-P's 8 Ghz 35811.

Devices with metalization similar to that in the new transistor have more than two million transistor-hours of operation in hybrid microcircuits in H-P's microwave sweepers and spectrum analyzers without failures of any kind, the manufacturer reports. This reliability is attributed to the use of composite metal layers for the contact, with gold as the top-most material. No aluminum is used, and this accounts for the absence of contact problems.

Hewlett-Packard Co., 1501 Page Mill Road, Palo Alto, Calif. 94304 [444]

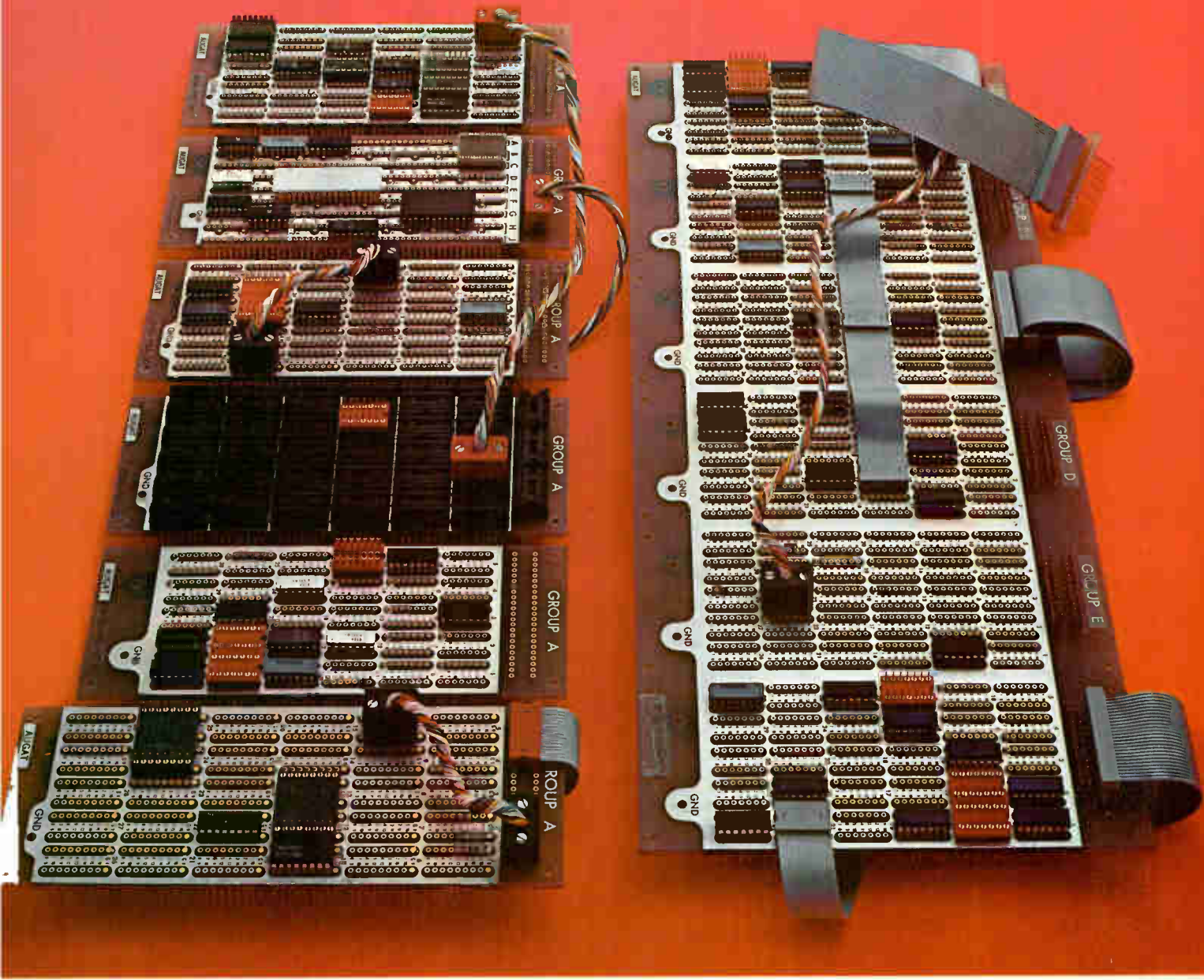

# 6x30=180

Now – specify 30 pattern panels, or any multiple up to 180 patterns – all standard catalog items.

Unique new I.C. packaging concept results in far greater flexibility, plus sizeable savings in space, time and money.

Modular panels are available in continuous rows of contacts for universal use, as well as 14 and 16-pin configuration.

Accessories include plugs with cable for interfacing and I.O. connections, and adaptors for mounting discrete components.

Close tolerances permit simplified mounting of single or multiple panels automatically wire wrapped on one plane – a service provided by Augat.

Let us show you the new approach to breadboarding, prototyping and production. Call us, (617) 222-2202, or write for new Catalog No. 266, Augat, Inc., 33 Perry Avenue, Attleboro, Massachusetts 02703.

**AUGAT** inc.

# Microscopy helps refine IC tests, processing

Surface-finish microscope measures contours of substrate or film

from 0.002 inch to 0.8 microinch; electron microscope uncovers faults in circuits

**Optical tools** are being called upon in the electronics industry, as elsewhere, to meet demands for higher precision and better product performance. One such tool is a surface-finish microscope developed by Nikon Inc., which combines the capabilities of three optical measuring methods to check the surfaces of semiconductor devices. Another, an electron microscope

system introduced by Philips, will be marketed for detailed inspection of integrated circuits, particularly in failure analysis programs.

In addition to non-destructive testing of ICs, the surface-finish microscope can be used for inspecting magnetic tapes, where surface finish is critical.

The Nikon system uses a replica technique for magtape inspection;

the procedure is simple enough for production-line quality control. The replicating material, called Press-O-Film, is positioned—reflective side down—on the surface. Moderate pressure is applied until the surface has been rubbed. When the replica has been removed, it is ready for microscopic evaluation.

The Nikon instrument combines the capabilities of a profile section

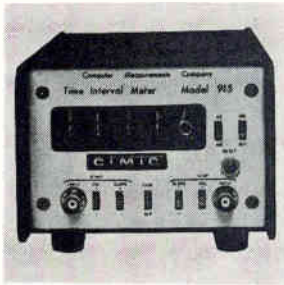

Time interval meter model 915 has a 1-Mhz temperature compensated crystal oscillator. It triggers on positive or negative going pulses, and can be operated in either a 1 $\mu$ sec or 1 msec mode, with a range from 0 to 99,999. Measurements start on A-input and stop on B-input. Price is \$555. Computer Measurements Division, Newell Industries, Bradley Ave., San Fernando, Calif. [361]



Automatic precision bridge type RLCB can be used for comprehensive resistance, capacitance and inductance component tests over the frequency range 50 hz to 20 khz. It is also suitable for all kinds of impedance measurements. Accuracy for R, L and C measurements is  $\pm 0.1\%$ ; dissipation and Q factor measurements,  $\pm 5\%$ . Rohde & Schwarz Sales Co. Inc., Box 148, Passaic, N.J. [362]

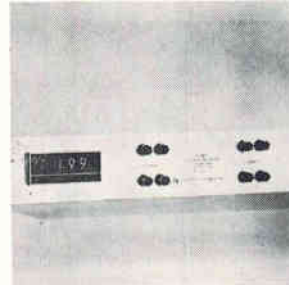

Digiwatt Halltplier wattmeter provides not only digital panel meter readout but two output signals as well. The output signals are 0 to 100 mv d-c analog signal and a BCD 1-2-4-8 output. Units are single-range, two-element, three-phase devices which provide highly accurate measurements of electrical power. Scientific Columbus, 1035 W. 3rd Ave., Columbus, Ohio. [363]



Digital oscillator series 2000, because of its versatility in control and setting, is suitable for in excess of 90% of all sine wave signal generation requirements in the range from 10 hz to 12 Mhz. Frequency selection is accomplished by digital front panel switches. Unit comes in a half rack package. J&J Instruments, 8141 Engineer Rd., San Diego, Calif. 92111. [364]

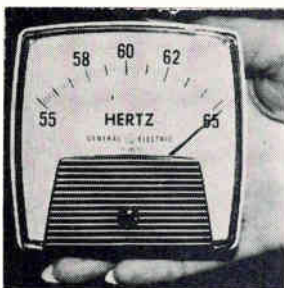

Frequency meter features a self-contained, integrally mounted transducer. Its design permits match and line-up on panels where other parameters such as a-c amperes, volts and elapsed time are being measured. Unit is available in 3 $\frac{1}{2}$  and 4 $\frac{1}{2}$  in. sizes and in the standard ranges of 45-55, 55-65 and 380-420 hz. Accuracy is  $\pm 3\%$ . General Electric Co., Schenectady, N.Y. [365]

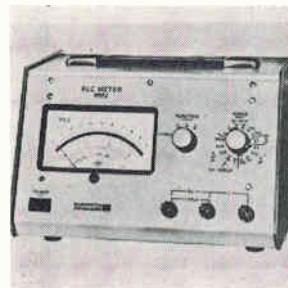

Direct reading RLC meter MM2 performs resistance measurements in 12 linear ranges from a virtual short circuit at 0.1 ohm to 1 megohm. Inductances are measured in 16 linear ranges from 3  $\mu$ h to 100 henrys full scale. Capacitance measurements also cover a dynamic span, in 16 ranges, from 3 pf to 100  $\mu$ f with linear readings throughout. The London Co., Sharon Dr., Cleveland [366]

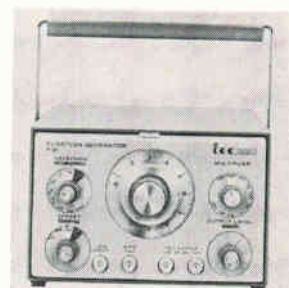

Compact, portable function generator model F51 operates over an 11-decade frequency spectrum of 0.0005 hz to 10 Mhz. It is designed to produce variable width pulse in addition to standard sine, square, triangle, plus and minus ramp, plus and minus fixed width pulse waveforms and sync. Price is \$595. Interstate Electronics Corp., P.O. Box 3117, Anaheim, Calif. 92803 [367]

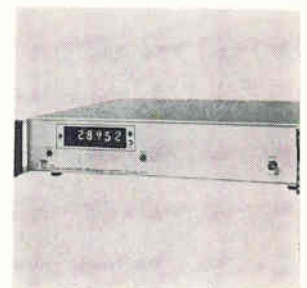

Computing frequency meter model 270 has no knobs and no adjustments, only a power switch and a reset button. To measure any frequency between 1 hz and 1 Mhz, one needs only to turn on the power, connect the input signal, read the frequency to 5 significant digits, and measurement takes only 1 second. Time Systems Corp., 265 Whisman Rd., Mountain View, Calif. [368]

**SPUTTERING  
TARGETS**

**GLAZED  
PARTS**

# Get higher yields across the board

**THICK  
FILM  
PASTES**

**O-I microelectronic materials make the difference.**

Higher yields. That's where the little things mean a lot.

Like with package sealants. If you could get 5 more good seals on every 100 packages you make, think of the money you'd save.

Like with thick film conductor pastes. Good paste can make a circuit. Bad paste can break it. Forever.

Like with substrate glazes, insulating films, glazed package parts, preform materials and sputtering targets.

We make them all. And more. They're all compatible, highly sophisticated products from the O-I family of work-together electronic materials.

To you, they mean higher yields. Across the board. We'd like to prove it to you. Write us a letter about your materials needs. We'll get back to you fast with literature. Samples, too, if you'd like.

You'll see. Our materials *do* make the difference.

**OWENS-ILLINOIS**  
ELECTRONIC MATERIALS  
Toledo, Ohio 43601



**PACKAGE  
SEALANTS**

**INSULATING  
FILMS**

**PREFORM  
MATERIALS**

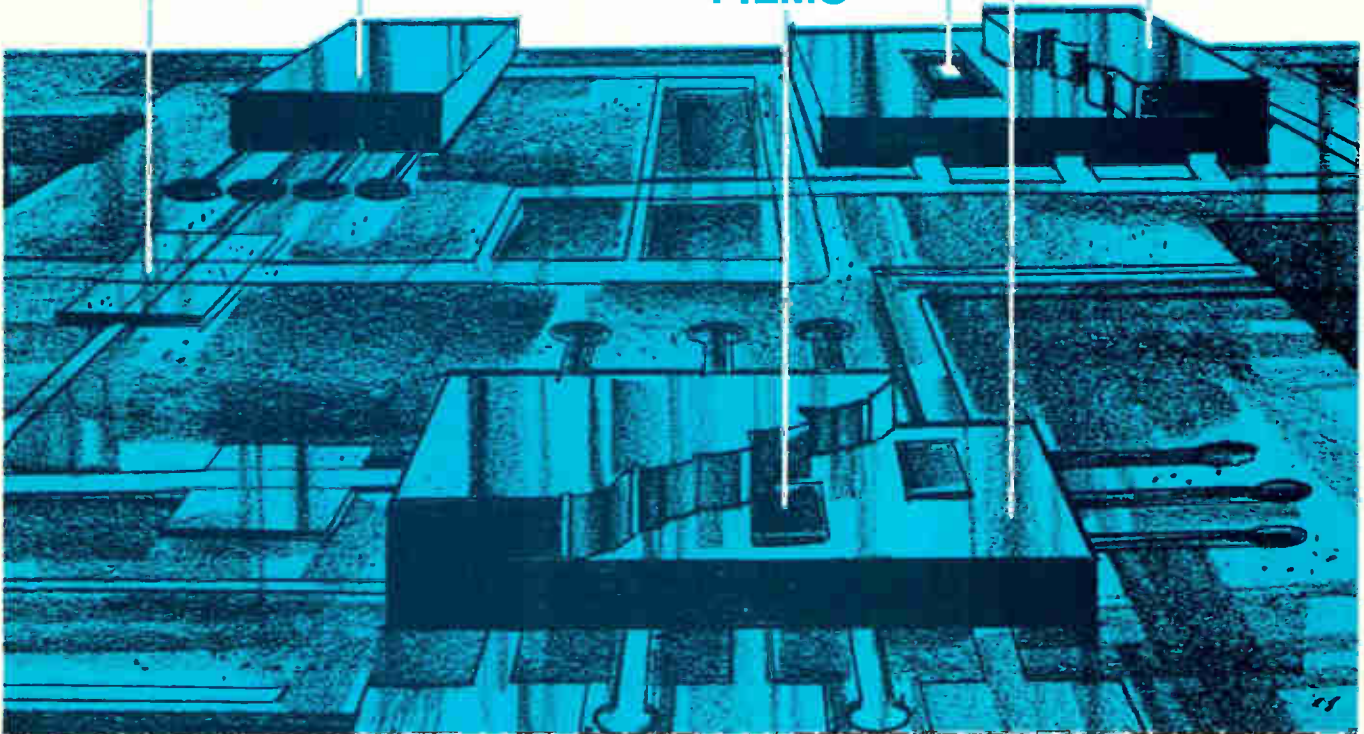

OWENS-ILLINOIS, INC.  
Customer Service Mgr.  
Electronic Materials  
Dept. T-4  
Box 1035  
Toledo, Ohio 43601

Please send me literature on:

- Package Sealants
- Substrate Glazes
- Sputtering Targets
- Have a technical representative call.
- Glazed Package Parts
- Thick Film Pastes
- Preform Materials

Name \_\_\_\_\_  
 Title \_\_\_\_\_  
 Company \_\_\_\_\_  
 Address \_\_\_\_\_  
 City \_\_\_\_\_ State \_\_\_\_\_ Zip \_\_\_\_\_

# READOUTS

## Super-compact! Lowest price!

Only from TEC! The industry's most compact digital read-out with I-C driver/decoder. At the lowest price: \$25.75 in 100-299 quantities, complete with Burroughs NIXIE® tube.

 TEC's TNR-70 Series replaces discrete components with this single monolithic silicon integrated circuit. Accepts 4-wire 1-2-4-8 BCD inputs and produces 10 mutually exclusive outputs. UL approved. Four logic function options: (1) I-C decoder/driver, (2) decoder/driver and buffer memory, (3) decoder/driver, buffer memory and decade counter, (4) decoder/driver and decade counter.

There are two basic models: TNR-70A with input logic levels of Logic "0" +1.5V to +4.0V, Logic "1" 0V to +0.4V. And TNR-70B with levels of Logic "0" 0V to +0.8V and Logic "1" +2V to 5.0V.

For full information, write: TEC, Incorporated, 6700 So. Washington Ave., Eden Prairie, Minn 55343 (612) 941-1100.

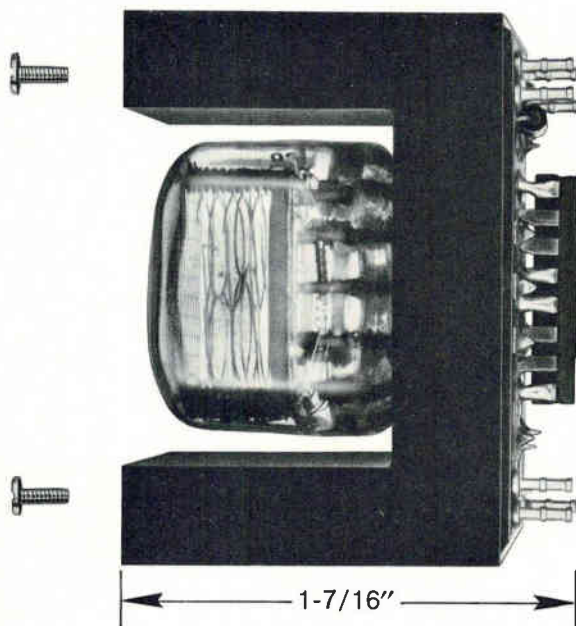

Compare TEC's 1-7/16" back panel projection with competitors' 2 1/2" minimum. Also compare TEC mounting (just 2 screws!) with others: 2 bolts, 2 standoffs, 2 lock washers, 2 nuts.

**TEC**<sup>®</sup>  
INCORPORATED



Surfacing. Microscope system measures smoothness with high precision.

microscope, a multiple-beam interference type, and a metallurgical microscope, and makes it possible to measure and photograph surface contours from 0.002 inch to 0.8 microinch. The basic system is priced at \$2,000. In thin-film deposition work and other IC processes, it is expected to replace the stylus-type instrument, which moves a diamond or sapphire tip over a device to record the surface pattern. The movement is electrically amplified, and either a current record or pen record gives a line profile of the surface. Only a narrow line section is surveyed, and the stylus leaves a scratch while recording only an average profile. "Through the optical techniques of light sectioning and interferometry," says Nikon's chief engineer, John Wilson, "you can get numbers for the height and slope of coatings and films deposited on substrates."

Another advantage of the optical technique, Wilson points out, is that it does not wear out, as does the best of the mechanical systems using diamond-tipped styluses. Also, unlike stylus equipment, the optical system indicates the presence of large holes, surface waviness, and other irregularities. The optical technique, Wilson says, is proving to be an important tool in the inspection of alumina substrates used in semiconductor processing.

Next in the line of optical tools



**All toroids look alike.**

**Our PULSE-RATED<sup>TM</sup> toroids really are alike.**

We developed the concept of *pulse rated* toroids to eliminate tedious selection problems. Now we've developed new materials. Fully proven. Component tested. So you get guaranteed performance over a temperature range of 0° to 60° C.

*Pulse-rated* toroids not only simplify your selection process, they practically eliminate scrap. So you get 100% yield in your pulse transformer production.

Specifications provided for every *pulse-rated* toroid include pulse in-

ductance, volt-microsecond product, and temperature behavior under pulse conditions.

Parylene-coated *pulse-rated* toroids in sizes and specifications to suit your design requirements are now available for off-the-shelf delivery. Want some? We welcome the opportunity to send you samples. And hot-off-the-press spec sheets. And to consult with you about your design problems. Write Indiana General, Electronic Products, Keasbey, N. J. 08832.

**indiana general** 

a division of Electronic Memories & Magnetics Corporation

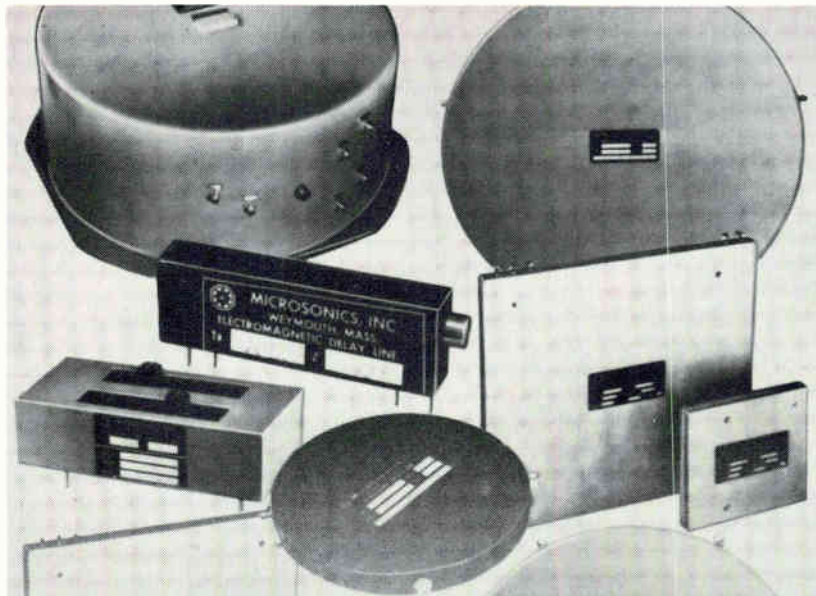

**LC & DC • DISPERSIVE • DIGITAL  
MAGNETOSTRICTIVE • QUARTZ  
GLASS • VARIABLE • TAPPED  
LC & DC • DISPERSIVE • DIGITAL  
MAGNETOSTRICTIVE • QUARTZ  
GLASS • VARIABLE • TAPPED  
LC & DC • DISPERSIVE • DIGITAL  
MAGNETOSTRICTIVE • QUARTZ  
GLASS • VARIABLE • TAPPED  
LC & DC • DISPERSIVE • DIGITAL  
MAGNETOSTRICTIVE • QUARTZ  
GLASS • VARIABLE • TAPPED  
LC & DC • DISPERSIVE • DIGITAL  
MAGNETOSTRICTIVE • QUARTZ  
GLASS • VARIABLE • TAPPED  
LC & DC • DISPERSIVE • DIGITAL**

**MICROSONICS**  
*for proven design, reliability &  
performance in*  
**DELAY LINES**  
*Serial Memories*



Write for Bulletins today  
**MICROSONICS**  
60 Winter Street, Weymouth, Mass. 02188  
Tel: 617 337-4200  
A division of the Sangamo Electric Company

**... electron microscope  
bares IC flaws ...**

to be marketed by Nikon in the U.S. is a photomask comparator, for quality control in the high-cost area of integrated-circuit manufacturing. This is designed to check the accuracy of step-and-repeat equipment for the production of masks and wafers. An IC mask can be superimposed on a standard reference type, or a wafer can be superimposed on a master mask. Each is made a different color and, when they are lined up, any deviation is clearly visible in the comparator.

When Philips unveiled its augmented electron microscope system, it pointed proudly to the instrument's first success: it helped unlock the secrets of sickle cell anemia.

What Philips has done, basically, is develop an attachment that makes a single electron microscope operate in both the transmission and scan modes. Developed by Philips' Poen Ong, the attachment converts the standard Philips EM 200 or EM 300 transmission instrument into a dual-mode type that can transmit or scan.

**Both ways.** As a tester, says marketing director Robert Deichert, the scanning mode could be used to examine chips to uncover tiny flaws, while in its transmission mode the microscope could be used for metallurgical work. It offers 150-angstrom resolution in the scanning mode, 20 Å as a transmission microscope.

But the big break is in cost. A scanning microscope, says Deichert, costs around \$100,000, and a separate transmission version would cost another \$70,000. But with the \$70,000 Philips EM 300 (the EM 200 is no longer made) plus the new \$22,000 attachment, a semiconductor maker or research lab would have the same system for just \$92,000.

What does the job in the new attachment, says Ong, are electromagnetic lenses. He adds: "I just changed their shape and increased the current."

Philips Electronic Instruments, 750 S. Fulton Av., Mt. Vernon, N.Y. [369]  
Nikon Inc., subsidiary of Ehrenreich Photo-Optical Industries Inc., Garden City, L.I., New York [370]





WE WANT OUR NAME ON THE TIP OF YOUR TONGUE!

**Scotchpar** 3M  
BRAND POLYESTER FILM COMPANY

Circle 213 on reader service card

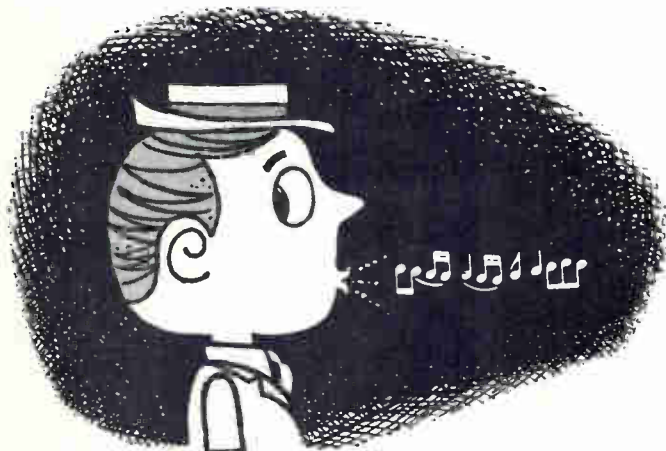

**YOU'RE WHISTLING IN THE DARK...**

if you think that heart disease and stroke hit only the other fellow's family.

**GIVE ... so more will live  
 HEART FUND**



*Contributed by the Publisher*

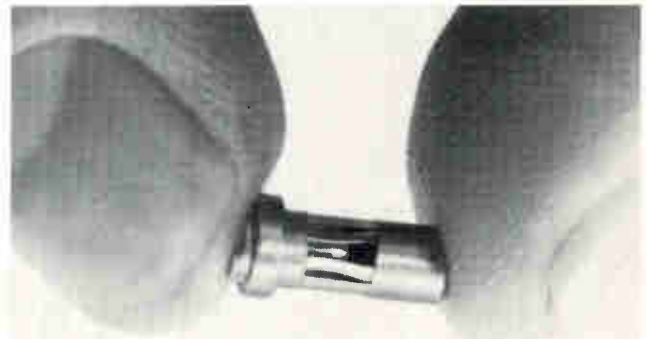

**it takes guts  
 to be a good connector**

The kind that can hold without appreciable change in contact resistance through 50,000 cycles and more. And that's the kind of guts you get with CAMBION cage jacks. Permanently swaged inside a precisely machined brass body, these beryllium copper cages come in jacks ranging from .016"-.080" in a wide variety of shapes and types for mounting components, patching, plugging. Complete range of mating pins also available. Our latest catalog has a complete selection - it's free for the asking.

The next time a salesman tries to sell you a connector, ask to see the insides - it isn't caged, it's not a CAMBION.

Cambridge Thermionic Corporation, 445 Concord Ave., Cambridge, Mass. 02138. Phone: (617) 491-5400. In Los Angeles, 8703 La Tijera Blvd. 90045. Phone: (213) 776-0472.

Standardize on

**CAMBION**

The Guaranteed Electronic Components

# Hybrid couplers cover 30 Mhz-2 Ghz

Soft dielectric film, solder tabs cut costs in fixed-price line; units can be soldered or spot-welded directly into stripline circuits

**Quadrature** hybrid couplers have been used for years to parallel power amplifiers, particularly solid state ones, so they'll produce higher output power in radar, communications, telemetry, and navigation gear.

Generally, the prices of the couplers have risen with their frequency, going as high as \$125 in the gigahertz region.

Merrimac Research and Development will introduce a line of hybrid couplers that sell, regardless of frequency, for \$40. The devices called the Filmbrid series, are supplied with solder tabs, rather than with expensive connectors or metal casings. Thus, they can be soldered or spot-welded directly into stripline and microstrip circuits.

Merrimac drives costs down still further by printing the coupler elements—capacitors, transformers, and conductors—on a relatively soft dielectric film called Duroid, rather than on more expensive alumina material. Line widths and separation can be controlled just as precisely as with alumina, according to the company. And each model in the line—a dozen types covering

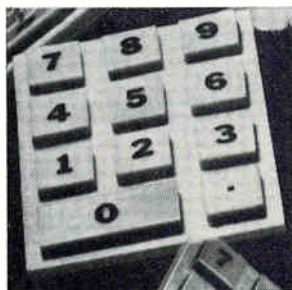

The Flex-Key system eliminates conventional mechanical parts resulting in a very thin digital switch that requires no space behind the panel. Heart of the system is a series of p-c modules placed in a keyboard arrangement. Simple construction consists of the elastomeric element, aperture film, and printed circuitry. Alco Electronic Products Inc., Box 1348, Lawrence, Mass. [381]

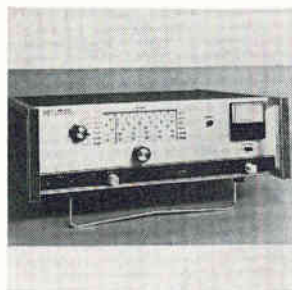

Tunable within six band-switched ranges, from 10 to 500 Mhz, amplifier RF-815 provides up to 8 w of r-f power into a 50-ohm load. It provides about 36 db of gain over its frequency range. The 3 db r-f bandwidth is 1.5 Mhz at the low end of the frequency range, increasing to 3 Mhz wide at 500 Mhz. RF Communications Inc., 1680 University Ave., Rochester, NY. 14610 [382]



Variable phase generator model 7920 provides two low-distortion, fixed voltage sine wave outputs. The phase angle between these two outputs may be varied from 0 to 360° by front panel controls (or optional remote BCD programming) which are calibrated directly in degrees, with an accuracy of ±0.05°. Base price is \$3,695. NH Research Inc., 1510 S. Lyon St., Santa Ana, Calif. [383]

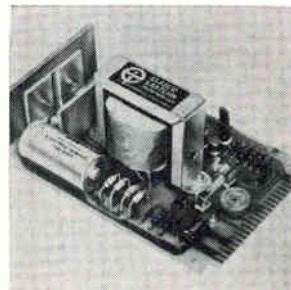

Plug-in power supply model LIC-3A is designed to power approximately 75 IC's and will deliver 5 v d-c at 3 amps. It operates from 105-125 v a-c, 60 to 400 hz. Line and load regulation is held to ±25 mv maximum with ripple and noise held to 10 mv rms max. After warm-up stability is ±5 mv. Price (1-9) is \$43 each. Elasco-Eastern Inc., 5 Northwood Rd., Bloomfield, Conn. [384]

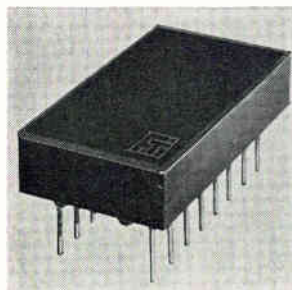

High-power BCD to 7-output decoder/driver FTD-1001 is a hybrid circuit packaged in a plastic-epoxy 16-in dual in-line configuration. Each output has a 30 v, 120 ma continuous drive capability. Surge currents of up to 400 ma are allowable. Maximum package power dissipation is 1 w. Price (1-99) is \$12.50. Fabri-Tek Micro-Systems Inc., S.W. 3rd St., Pompano Beach, Fla. [385]



Versatile magnetic tape drive is for specialized audio, instrumentation and communications applications. The drive system is capable of precise, variable speed from standstill to 120 ips with rapid start-stop characteristics. The unit has independent reel servos and constant tape tension in all modes. Magnetic Recording Systems Inc., 496 Grand Blvd., Westbury, N.Y. 11590 [386]

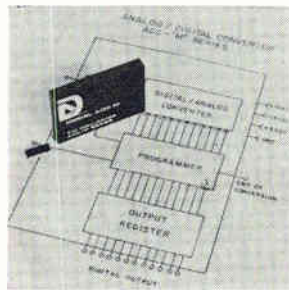

Solid state, high accuracy analog-to-digital converters series ADC-M are completely self-contained in plastic modules measuring 2 x 3 x 0.4 in. A modified successive approximation technique is employed, allowing for encoding speeds of 500 nsec/bit with resolutions up to 12 binary bits. Prices start at \$395 with two weeks delivery. Datal Corp., 943 Turnpike St., Canton, Mass. 02021 [387]



FET hybrid operational amplifier model 1408 offers discrete-amplifier performance in a small, low-profile package (0.6 x 0.6 x 0.2 in.). Features include a full power output response of 100 khz, a minimum unity-gain bandwidth of 2 Mhz, a guaranteed open-loop gain of 250,000, and a slow rate of 6 v/nsec. Philbrick/Nexus Research, Allied Dr. at Route 128, Dedham, Mass. [388]

# Now...CERMOLOX® Power for VHF-TV

New economy, long life, and convenience are possible now throughout the VHF-TV band. RCA devised techniques and up-graded CERMOLOX structures are being employed to advantage in RCA-8806 and RCA-8807—two new Beam Power Tubes designed for high performance up to 400 MHz.

8806 delivers 12.5 kW peak sync; 8807 offers 20 kW peak sync.

Neither tube requires screen or cathode tuning. You get stability. Both incorporate more cathode area than any equivalent tetrode on the market. You get lower operating cathode current density—and the longest life available today!

In RCA's continuing program to optimize UHF tubes for VHF-TV use, 8806 and 8807 employ precisely

aligned grid and screen wires. Low screen and grid current result. Because of the amplitude linearity of the tubes, you can use simple TV modulation schemes.

What about low sync compression and differential gain? No tube on the market can match RCA's performance. In VHF-TV service, phase linearity leading to low differential gain allows development of a new level of performance for broadcast transmitters.

Ask your local RCA Representative or your RCA Industrial Tube Distributor for more information on these tubes, including their use in SSB and FM. For technical data, write: RCA Electronic Components, Commercial Engineering, Harrison, N. J. 07029. In Europe: RCA International Marketing S. A., 2-4 rue du Lièvre, 1227 Geneva, Switzerland.

## RCA



\*Section D19T-1/ZR2

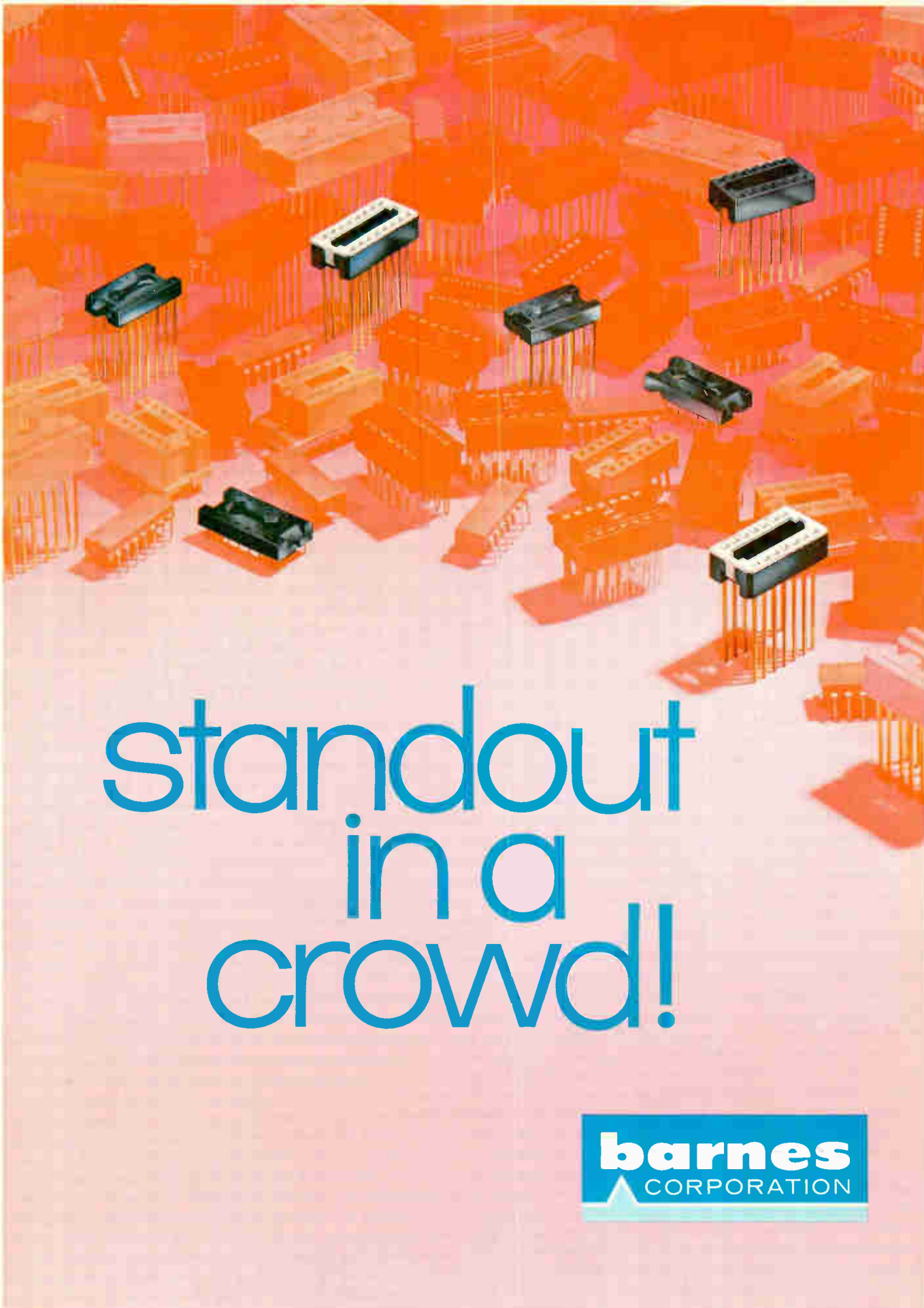

standout  
in a  
crowd!



30 megahertz to 2 gigahertz—comes in a shielded stripline configuration, with a ground plane on both sides of the circuit to minimize radio-frequency leakage.

Typical of the Filmbrid couplers is the model QRF-2-321G which, with a frequency range from 225 to 400 Mhz is in the middle of the line. Phase quadrature is  $90 \pm 2$ ; isolation, 25 db; coupling,  $-3$  db; amplitude balance,  $\pm 0.4$  db. The 50-ohm-impedance unit measures 1.1 by 1.25 by 0.15 inches and weighs 5 grams.

Merrimac Research and Development Inc., 41 Fairfield Place, West Caldwell, N.J. 07006 [389]

## New subassemblies

### Step-repeat unit trims resistors

Technique speeds process, involves less handling of ceramic substrates

Thick- and thin-film resistors often are printed en masse on so-called Snapstrates, pre-scribed ceramic substrates which can be snapped along the scribed lines into individual hybrids afterwards. However, Snapstrate users have found that most methods of resistor trimming are too time-consuming. If the hybrids are snapped before trimming, they are so small that it is difficult and tedious to align and trim them correctly, and they also are easy to lose. If the Snapstrate is trimmed while it is in one piece, handling can be reduced and the production rate can increase. But this, too, is time-consuming. Resistor trimmers can be positioned to trim only one resistor at a time.

Now the MPM Corp. has developed the model RT-SR6 which can trim all the resistors on one Snapstrate in a step-and-repeat movement. A thick- and thin-film resistor trimmer with an accuracy of 0.1% and a resistance reference from 10 ohms to 1 megohm is combined with a substrate holder which moves hybrids on the same Snap-

strate one after another under the cutting nozzle. Time spent trimming resistors is cut approximately in half with this method, according to Gunter Erdmann, MPM president.

The step-and-repeat assembly uses a metal plate which has reference holes to the right of the movable substrate holder. The Snapstrate can be aligned on the holder with an X-Y accuracy of 0.1% or better, and is held in place by a vacuum. An arm with a pin on the end extends from the substrate holder to the plate, and when the pin is placed in the hole on the upper left corner of the plate a corresponding hybrid on the Snapstrate is centered under the trimmer's cutting nozzle. The distance between holes equals the distance from the center of one IC to the center of the one next to it; if an IC is  $\frac{1}{4}$  inch square, for example, a plate with holes  $\frac{1}{4}$  inch apart is used. Snapstrates up to 3 inches square can be accommodated.

A fine X-axis adjustment of the step-and-repeat assembly and Y-



Step-by-step. Production-line tool can trim all resistors on a substrate. Step-and-repeat mechanism is at front.

axis nozzle movement allows cuts to be made to the right, left, front, or back of the circuit's center. When one IC is trimmed the reference arm is moved over one hole, and the next IC is in exactly the same relative position as the one before it.

A complete resistor trimmer with step-and-repeat capability costs \$5,300. The step-and-repeat assembly also is available separately with vacuum mini-probes [Electronics, Mar. 16, p. 157] for \$600. Delivery time is four to six weeks.

MPM Corp., 9 Harvey Street., Cambridge, Mass. 02140 [390]

# standouts!

Model 121-2002-144

Model 121-2001-164

Model 121-2002-144

Standouts across the board. Barnes production mounting DIP sockets are designed that way. Each with an extra special plus. Series 121-2001 features low profile (only .160" ht.), low price, allows greater packing density. Series 121-2002 is noted for highest reliability, longest life (10,000+ test insertion capability), at a low cost.

Write or call for complete technical information and samples.

#### Series 121-2001 contact specs.:

121-20011-144—14 lead, phos. broz., tab  
121-20011-164—16 lead, phos. broz., tab  
121-20012-144—14 lead, BeCu, tab  
121-20012-164—16 lead, BeCu, tab  
121-20013-144—14 lead, BeCu, wire wrappable  
121-20013-164—16 lead, BeCu, wire wrappable

#### Series 121-2002 contact specs.:

121-20021-144—14 lead solder type, black lid  
121-20022-144—14 lead wire wrap., black lid  
121-20023-144—14 lead solder type, white lid  
121-20024-144—14 lead wire wrap., white lid

121-2002 Series all have phosphor bronze contacts.

**barnes**  
CORPORATION

LANSDDWNE, PA. 19050 ■ 215/622-1525

**barnes** / THE WORLD'S MOST COMPLETE  
LINE OF SOCKETS,  
CARRIERS AND CONTACTORS FOR I.C.'S

# Set-Point Control $\pm 1\%$

## ...made easy with Sensitak® Models 11&12 Solid-State/Dry Reed Relays

- Overvoltage or Undervoltage
- Latch or On-Off types
- Isolated dry reed load contacts
- Operate on 1 Vdc and/or 1 mA
- $-20^{\circ}\text{C}$  to  $+70^{\circ}\text{C}$  ambient

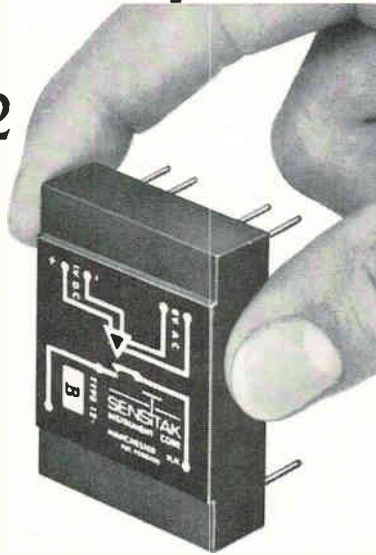

### OVER/UNDER VOLTAGE MONITOR (metering relay)

For precise monitoring of a nominal 48 volt dc line connect overvoltage Model 12A and undervoltage Model 12B relays and an 8 Vac Model 13 power supply with both inputs across the 46 to 50 Vdc line through appropriate series resistors. Load switch on 12A closes when the input is 49 volts or more, and opens when the input falls below 49 volts. Load switch of 12B opens when the input is 47V or more, and closes when the input falls below 47V.

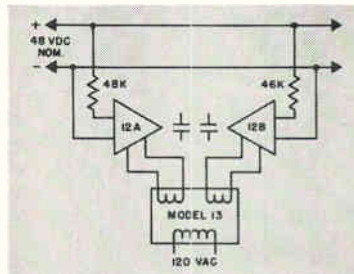

### PRECISE OVERLOAD RELAY

Precise overload protection is provided by connecting a Model 11A overvoltage latching relay to a Model 13 power supply through a N.C. pushbutton switch. The input voltage powers the load through an NPN transistor connected so it is normally conducting. Potentiometer R is adjusted so the relay contacts latch when the load current exceeds 1 ampere. This removes the saturating bias from the transistor, thereby removing power from the load. Reset by momentarily depressing switch S.

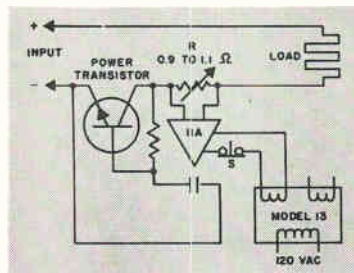

### PRECISE LOGIC VOLTAGE MONITOR (wide or narrow differential)

This logic circuit monitors input variations from 20 to 80 Vdc. The load switch of a Model 11A overvoltage latching relay closes at 50 Vdc and remains closed while the input varies over a wide range. The 22K series resistor causes the reed switch of overvoltage on-off relay Model 12A to close at 23 volts, thus supplying primary power to the 11A which remains in standby until latched by a 50 volt input signal. The load switch of the 11A remains closed until the input drops below the 23 volt set point of the 12A at which time the switch on the 12A opens, thus unlatching the 11A.

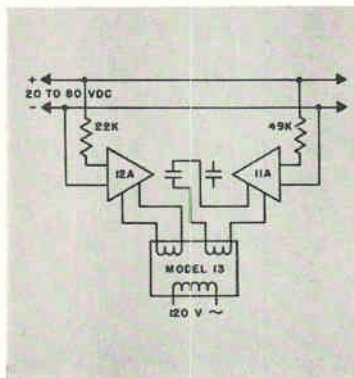

Get 4-page Bulletin B/10611. Write to:



**STRUTHERS-DUNN, INC.,  
SYSTEMS DIVISION**

1114 State St., Bettendorf, Iowa 52722

New materials

## Coatings provide conductive films



Palladium silver, ceramic conductive coatings 9600 and 9600C are for thick-film IC's. Intended for the printing of high quality, low-cost conductors, these coatings can be fired (at temperatures from  $700^{\circ}$  to  $1,000^{\circ}\text{C}$ ) to give dense films exhibiting excellent adhesion, good solder leach resistance, and high migration resistance. Adhesion to the substrate is in excess of 3,500 psi and conductivity is 0.03 to 0.05 ohm/square. Electro-Science Laboratories Inc., 1133 Arch St., Philadelphia 19107 [491]

Eccoshield ES is an electrically conductive lacquer based on fine silver with excellent coatability and adherence to almost any clean, hard surface. One coat of the material develops a surface resistivity substantially less than 1 ohm/square. Successive coats can reduce this to less than 0.1 ohm/square. Price is \$30 per lb., and a 6 oz. spray can sells for \$10. Emerson & Cuming Inc., Canton, Mass. 02021 [492]

Birox thick film resistor compositions, designated 1011 and 1013, have low sheet resistivities. Resistivity value of composition 1011 is 10 ohms/square; that of 1013 is 30 ohms/square. Temperature coefficient of resistance is less than 100 ppm in the temperature range of  $-55^{\circ}$  to  $+125^{\circ}\text{C}$ . Reproducibility of resistance values using the new materials is better than  $\pm 10\%$ . Price is \$100 per troy ounce in 100-oz quantities. DuPont Co., Wilmington, Del. 19898 [493]

Thermally conductive epoxy called Thermabond bonds equally well to porous and nonporous materials. It has been used to bond flatpacks to heat sinks, copper tubing to aluminum plates and hermetically sealed semiconductor cases to press-on convection heat sinks where vibration is a factor. Thermalloy Co., 8717 Diplomacy Row, Dallas 75247 [494]

# USE TRON RECTIFIER FUSES TO PROTECT



**VARIABLE SPEED DRIVES**  
... as used in machine tools and conveyor controls.

**INVERTERS**  
... wherever it is necessary to produce alternating current from direct current, such as non-interruptible power supplies.

**BATTERY CHARGERS**  
... used to charge batteries of industrial trucks, forklifts, etc.

**PLATING POWER SUPPLIES**  
... used to furnish direct current for electro-plating processes.

**POWER CONTROLS**  
... as used for heating, cooling and temperature control applications.

... or wherever a fast-acting fuse is needed in the protection or isolation of electronic or electrical components.

*TRON fuses offer you a complete line—1/2 to 1000 amps.—voltages up to 1500.*

They are designed for the protection of solid state devices such as semi-conductor rectifiers, thyristors, SCR's—wherever extremely fast opening and great limitation of let-through current is needed.

*For full information on TRON Rectifier Fuses and time-current characteristic charts, write for BUSS Bulletin TRFS.*

**BUSSMANN MFG. DIVISION,  
McGraw-Edison Co.,  
St. Louis, Mo. 63107**

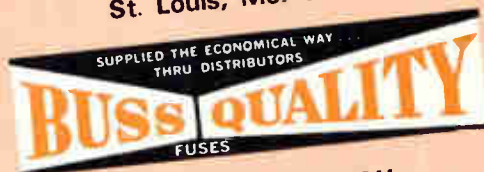

**FOR FUSES AND FUSEHOLDERS OF UNQUESTIONED HIGH QUALITY FOR EVERY PROTECTION NEED...**

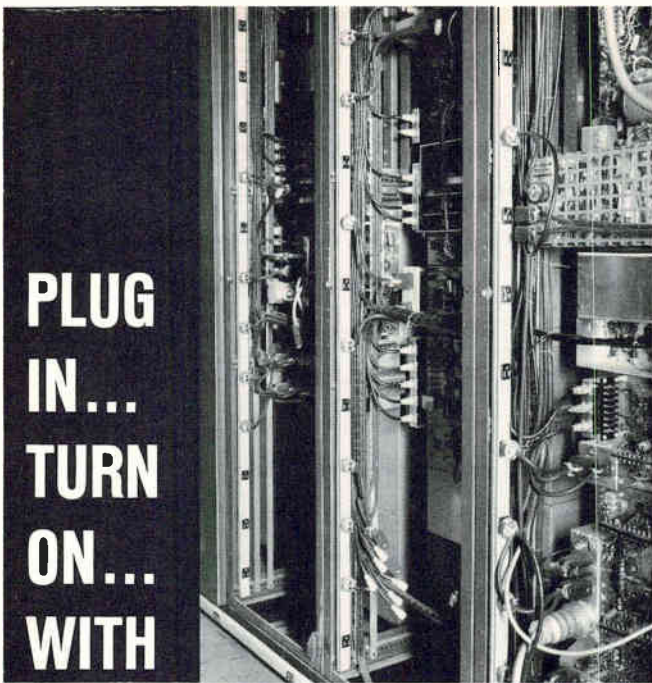

**PLUG  
IN...  
TURN  
ON...  
WITH**

**PLUGMOLD<sup>®</sup>  
MULTIOUTLET  
SYSTEMS BY**



Send for detailed information on Plugmold systems that provide electrical outlets wherever you need them in electronic equipment, racks and consoles.

**THE WIREMOLD COMPANY**  
Hartford, Connecticut 06110

Circle 214 on reader service card



CVI video sampling instruments allow your computer to "look" at practically anything. High accuracy bandwidth compression of conventional television signals opens new doors to data processing in research and industrial applications. Let us tell you about some of our unique video devices.

COLORADO VIDEO, INCORPORATED  
P.O. Box 928 • Boulder, Colo. 80302 • Phone (303) 444-3972

**cv****i**

Video Data Acquisition • Processing • Display • Transmission

188 Circle 188 on reader service card

**New materials**

Copper-clad laminate called Insulstruc X2FR-PG is for printed-circuit boards. Particularly useful for applications requiring superior toughness at low cost, the high-density material has izod impact strength of 7 foot pounds, solder dip resistance of 20 seconds (Mil-P-13949D), and other excellent mechanical and electrical characteristics typical of glass polyester. Cincinnati Development & Mfg. Co., 5614 Wooster Pike, Cincinnati, Ohio 45227 [495]

Microwave absorber materials feature high power and high temperature (over 500°C continuous duty) capabilities. They offer new design possibilities in the application of lossy dielectrics. Suggested applications include waveguide or coaxial r-f loads for military and industrial communications equipment, and for consumer products such as microwave ovens. Carborundum Co., P.O. Box 367, Niagara Falls, N.Y. 14302 [496]

Non-fibrous, self-extinguishing epoxy tubing is for use in electronic encapsulation and insulation. It is centrifugally cast and is available with or without fillers in sizes ranging from 0.137 in. o-d to 5 in. o-d. Resdel Corp., Rio Grande, N.J. 08242 [497]

High K 707 and 707L copper clad dielectric laminates in sizes from 4 x 4 in. to 24 x 36 in. and thicknesses from 0.015 in. are for use by the vhf, uhf and microwave industries as a material instrumental in reducing over-all package size. The materials are available with controlled dielectric constants from 3 to 25, thus offering a wide design latitude for all strip transmission-line applications. Custom Materials Inc., Alpha Industrial Park, Chelmsford, Mass. 01824 [498]

Single-component, 100% solids epoxy compound, designated Epo-Tek H41, is filled with pure gold powder for high electrical conductivity. It is designed for bonding of passive components in hybrid-circuit fabrication. Curing requires 15 minutes at 150°C, 45 minutes at 120°C, and two hours at 100°C. The cured film is suitable for intermittent operation in the 300°C to 350°C range. Epoxy Technology Inc., 65 Grove St., Watertown, Mass. 02172 [499]

Ferrite materials known as Ceramag 24H and 24K have initial permeability of 5,000 and 7,500, respectively. Both materials hold their permeability over a wide range of sizes. Stackpole Carbon Co., St. Marys, Pa. 15857 [500]

Flexible shielding insulation, known as Insulflex Crepe kraft-aluminum foil, features 50% controlled minimum elongation to enable it to conform snugly to edges and corners of irregular shapes. It is supplied in sheets or custom slit rolls to meet individual requirements. Dennison Mfg. Co., Framingham, Mass. 01701 [501]

Electronics | April 13, 1970



## New materials

Five **conductive** silver-resin systems are offered in kit form. Uses of these conductive systems range from circuit manufacturing where electrical connections are made to heat-sensitive solid state devices, to emi/rfi caulking seams in electronic enclosures. Designated as 72-00010, the kit contains eight, 1-ounce components which produce three, low-volume resistivity, two-component epoxy solders and two easy-to-use, one-part caulking/sealing systems. Technical Wire Products Inc., 129 Dermody St., Cranford, N.J. 07016 [502]

**Room-stable**, fast-curing epoxy pellets are formed from a new series of epoxy powders that cure rapidly at lower temperatures than were previously available. The pellets present a convenient method of applying a given amount of epoxy to a specific area. The one-component materials do not require mixing, and when heated above 200°F yield extremely durable cured epoxy resins. Amicon Corp., 25 Hartwell Ave., Lexington, Mass. 02173 [503]

**Polyester-coated** glass-cloth insulation called Polytemp shows 80,000 hours life at 180°C. It is available in a variety of finished thicknesses from 0.005 to 0.015 in. Natvar Corp., P.O. Box 67, Rahway, N.J. 07066 [504]

**Emi gasket material** consists of oriented wire in rubber for both rfi attenuation and moisture and environmental integrity of electronic enclosures. The gasket strips and sheets are available in width ranges of 3/32 in. to 9 in. and thicknesses of 3/32 in. to 3/4 in. and wire is either monel or aluminum embedded in either silicone or neoprene, in solid or sponge form. Spectrum Control Inc., Fairview, Pa. [507]

**Photopolymer dry-applied resist**, called Phodar, reduces p-c board etching to a simplified five-minute process. Phodar cuts preparation time because no special cleaning solutions are required and meticulous care to assure perfect adhesion between film and plate is unnecessary. There is no waiting time between lamination and exposure, and Phodar completely eliminates the post-baking cycle after development. The new film is manufactured in 1, 1.5 and 2.5 mil thicknesses, all with a tolerance of  $\pm 0.0001$  in. It is available in widths ranging from 3 to 12 in. Photopolymer Research Corp., 726 W. Glendale Ave., Milwaukee 53201 [505]

**Extruded flexible grommet and edging**, called the Nytrim line, is available in standard 25- and 50-ft. lengths. The user makes his own grommets to fit any-shaps opening by cutting to size from rolls. Both grommet and edging are extruded from nonconductive black or natural type 6/6 nylon. The smooth finish of the grommet strip protects wire or cable from chafing. Weckesser Company, 4444 West Irving Park, Chicago, Ill. 60641 [506]

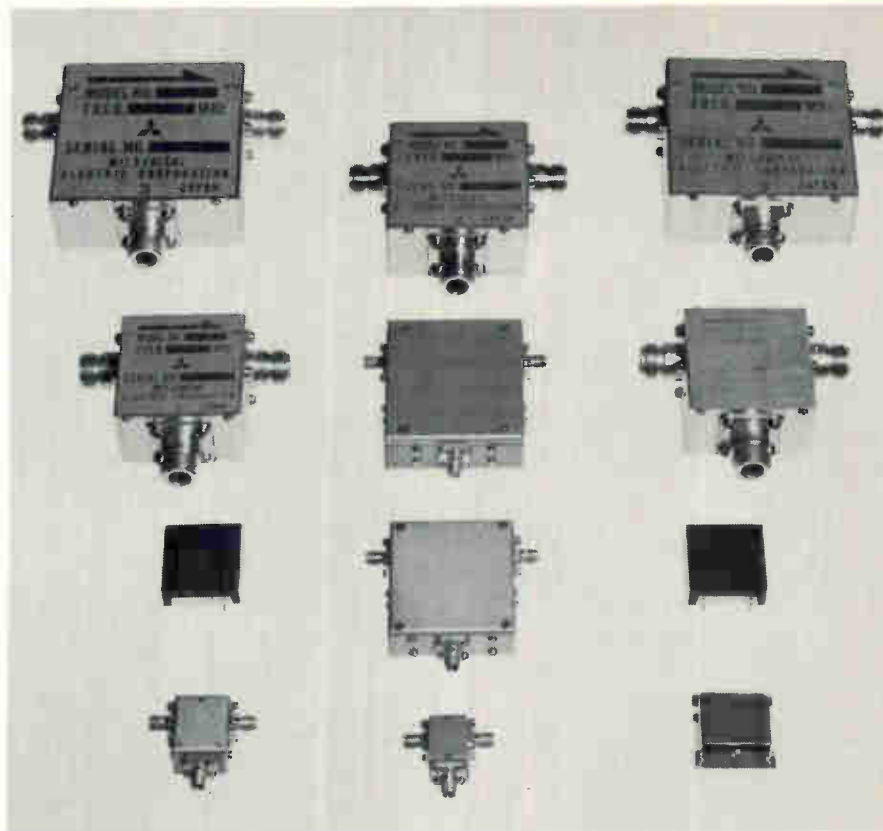

## Thanks for Visiting the Mitsubishi Booth

We extend our sincere appreciation to all those IEEE Show visitors who took the time to stop by the Mitsubishi Electric booth. The enthusiastic interest shown in the displays was especially encouraging. We are glad to be able to report that our monolithic ICs and mini circulators—VHF, UHF, and SHF, as well as the 700 MHz type—were all favorably received.

Now that the show is over, we welcome any further inquiries from you about the new research developments and techniques.



ADVANCED AND EVER ADVANCING

**MITSUBISHI ELECTRIC**

Tokyo, Japan

Circle 215 on reader service card

# FIGHT THEM ALL...

**Heart Attack  
Stroke  
High Blood Pressure  
Rheumatic Fever**



**GIVE ... SO MORE WILL LIVE HEART FUND**

# You're no better

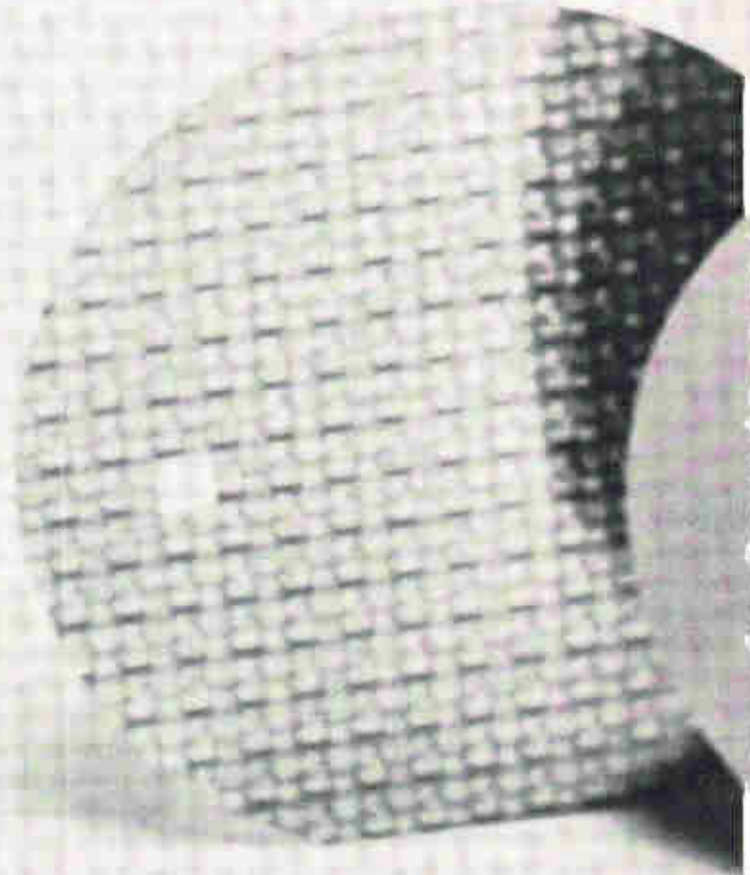

When the chips are down, no semiconductor device is better than the process equipment used to make it. If it isn't in the wafer, it isn't going to be. And that's where we can give you better control, tighter tolerances, endless repeatability and unsurpassed thin film uniformity and quality.

We manufacture the best epitaxial reactors and vapor phase deposition equipment in the industry. Bar none. Laboratory models that give you state-of-the-art processing to match your creative capabilities. Production

models that transfer state-of-the-art achievements into large volume production quantities.

With Applied Materials, you get true uniformity of film characteristics not only across the wafer and from wafer-to-wafer within a run, but most important—the same degree of uniformity in run after run after run. Thickness, resistivity, dielectric characteristics and surface quality are often uniform beyond current capabilities in delta measurement techniques.

Applied Materials' specifications weren't developed

# than your wafers.

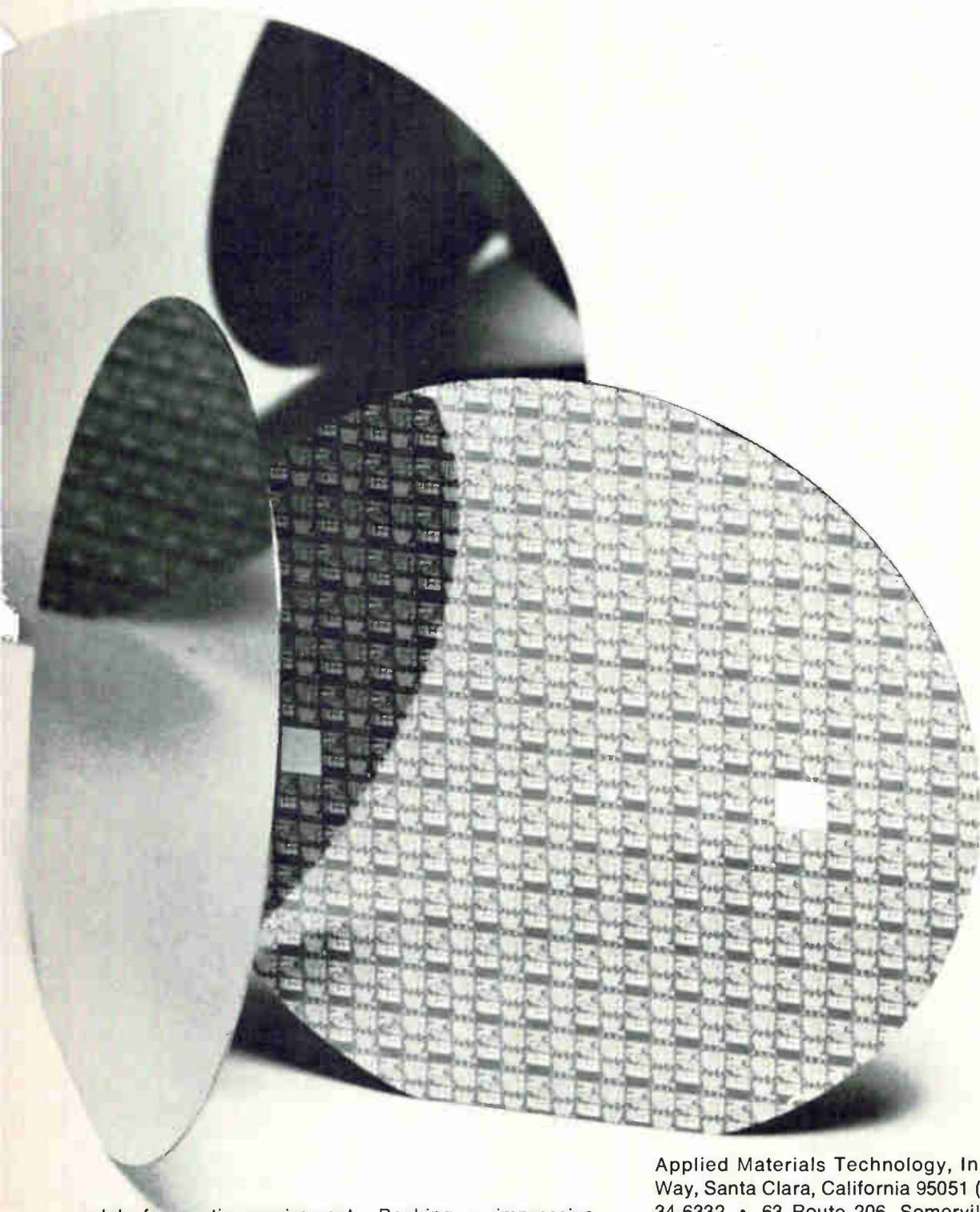

solely for exotic requirements. Backing up impressive technological accomplishments are the most rugged workhorses available for quantity production. Wafer to wafer. Run to run. You'll consistently produce better devices in thin film systems from Applied Materials Technology.

May we quote on your next purchase? Call collect for immediate requirements.

Applied Materials Technology, Inc., 2999 San Ysidro Way, Santa Clara, California 95051 (408) 738-0600 Telex: 34-6332 • 63 Route 206, Somerville, N.J. 08876, (201) 722-3300 Telex: 83-3439 • In Europe: Advanced Semi-

conductor Materials, Wokingham, U. K. Bilthoven, Netherlands; München, West Germany. In Japan: Kanematsu-Gosho, Tokyo.



**applied materials**

Circle 216 on reader service card



## This cleaning agent is boiling. At 118° F. It's Du Pont FREON® TF solvent.

FREON fluorocarbon solvents are ideal for low-temperature vapor degreasing. Cooling time is eliminated for post-cleaning processing and testing. There's no damage to heat-sensitive parts. And low heat passage to the work environment.

If your product has to be cleaned thoroughly, safely and economically, there are five more reasons why you should be using FREON solvents:

**1. Complete Wetting and Penetration.** High density com-

bined with low surface tension lifts soils and floats away trapped contaminants.

**2. Compatibility.** No damage to widely used materials of construction.

**3. Chemically Pure and Stable.** No need for acid acceptance and scratch tests. No inhibitors needed. Parts dry residue-free.

**4. Lower Overall Cleaning Costs.** FREON is recoverable for reuse indefinitely. Power requirements are low in vapor

degreasing. Fewer production rejects. Save labor by cleaning complete assembly instead of separate parts.

**5. Safe.** Nonflammable and non-explosive. Low in toxicity, though prolonged skin contact will remove natural oils and should be avoided.

If you have a cleaning problem or are looking for an improved cleaning system, write today to Du Pont Company, Room 8789-B, Wilmington, Delaware 19898.



**FREON**  
Cleaning Agents

## CLOSE SUPPORT RADAR



TOTAL ELECTRONIC  
SYSTEMS CAPABILITY.  
SPECIALISTS IN  
TIME/FREQUENCY,  
RADAR AND  
DATA SYSTEMS  
OFFERING RAPID  
GROWTH.

**SIERRA**

RESEARCH CORPORATION  
an equal opportunity employer

P.O. BOX 222, BUFFALO, N. Y. 14225

## New Books

### Getting switched on

Engineer's Relay Handbook  
National Association of Relay  
Manufacturers  
Hayden Book Co., New York  
355 pp., \$13.95

With the deluge of relays that hits the market each year, it's any wonder that an engineer or system designer is able to keep up with the current status of what's around. Manufacturers have been good at providing quantity but slow at offering technical information about their product—information that is greatly needed in today's relay market.

Now, such information is available in a hard covered text providing the designer and engineer with details on each relay's construction and behavior. Included in the book are operating principles, properties, performance characteristics, application requirements, specifications, and testing of relays. The book is not intended to help those directly involved with the manufacture of relays, but instead is aimed at engineers responsible for specifying the correct type of relays for a given application. Consequently, it deals primarily with performance factors, the specification of these factors, and application considerations.

This second edition is intended as a working handbook and not as an encyclopedia. It retains most of the information found in the first edition with added advancements in the art associated with relay applications, corrections, and changes to make the handbook as useful as possible. New sections on reed, mercury-wetted, electro-mechanical, and solid state relays increase the handbook's scope, making it a valuable reference for the engineer's library, as well as a source for application engineering information.

For specialized interests outside the scope of the book, the Association provides the reader with an extensive bibliography of available publications directly concerned with specific areas of application.

The National Association of Relay Manufacturers (NARM) was founded in May of 1947. It now is

## better switch



- **HIGHER RATINGS:**  
10 amps @ 125 VAC
- **LONGER LIFE:**  
250,000 operations
- **HIGHER IMPACT:**  
New metal case
- **MEETS IEC SPECS:**  
5A/250 VAC — 10A/115 VAC
- **LOWER PRICES (SPDT):**  
1.95 ea., 1.17 lots of 100
- **U/L OPTIONAL:**  
Write for details
- **SPDT AND DPDT TYPES:**  
With 1/4" or 15/32" bushings
- **IMMEDIATE DELIVERY**

A new series of miniature toggle switches with a cylindrical metal case where reliability is a prerequisite in the smallest size possible. All metal construction and high impact insulation allows use under all environmental conditions.

Alco-switch	Bush-ing	Type	One-24	500-999
MCT-110D	1/4	SPDT	1.95	.98
MCT-220N	15/32	DPDT	2.55	1.28
MCTG-110D	1/4	SPDT	1.95	.98
MCTG-220D	15/32	DPDT	2.55	1.28

Write for other quantity prices

# ALCO®

ELECTRONIC PRODUCTS, INC.

Lawrence, Massachusetts 01843

Circle 189 on reader service card



## MTLC SERIES

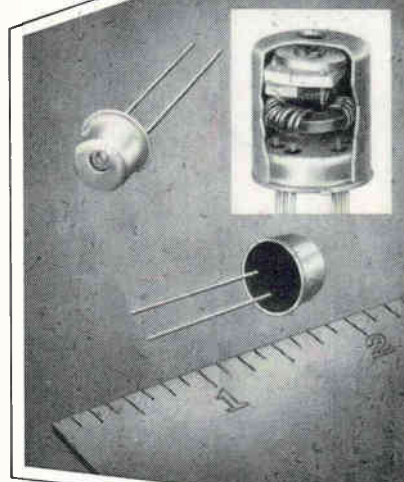

### MICRO-MINIATURE TUNED-CIRCUIT PACKAGE

JFD MTLC TUNERS enable circuit designers to shrink various LC circuits into TO-5 configurations completely compatible with today's miniaturized or hybrid circuitry. The tuning element is a microminiature variable ceramic capacitor measuring: .208 x .280 x .120 in. thick. These variable ceramic capacitors offer high capacitance plus a choice of wide  $\Delta$ Cs in extra small, ultra stable units. New improved construction makes MTLC more rugged than ever.

JFD builds these miniature circuits with high quality ferrite and iron inductor toroidal cores, providing maximum Q for any given frequency. Where necessary, special JFD Uniceram fixed capacitors are used with Modutrim microminiature ceramic variable capacitors to yield lower center frequencies or to satisfy special circuit requirements.

Standard tunable LC networks are available for a wide range of applications such as: RF tank, FM discriminator, impedance matching, frequency multiplier, IF amplifier and many others.

Write for catalog.



### JFD ELECTRONICS CORP. / COMPONENTS DIVISION

15th Avenue at 62nd Street  
Brooklyn, New York 11219  
Phone 212-331-1000

SUBSIDIARY OF RIKER-MAXSON CORPORATION

## New Books

composed of approximately 25 member companies set up as a clearing house for information about Government directives concerning the relay industry as well as for promoting the establishment of industry standards. The framework of this organization provides a forum for the exchange of ideas and a meeting ground for the solution of common problems of a technological nature.

To accomplish this goal, the group has built a comprehensive portfolio of technical publications providing a direct service to the NARM membership and to the electrical/electronics industry at large. As part of the program, the association offers this text to the industry in general and the relay user in particular.

### Recently Published

**Principles of Microwave Ferrite Engineering**, J. Helszajn, John Wiley & Sons, 258 pp., \$12.50

Presents the theory of microwave ferrite and garnet devices. Material covered includes the junction circulator, coupled wave theory, yig devices, microwave switching, and a variety of basic topics such as perturbation theory, non-linear theory, propagation in waveguides and mode equations.

**Linear Systems Analysis**, L. Lewis, D. Reynolds, F. Bergseth and F. Alexandro, McGraw-Hill, 479 pp., \$16.50

First in a series designed to acquaint practicing engineers with mathematical ideas and procedures. Emphasis is placed on general concepts applicable to all branches of engineering rather than to particular specialties. The theory is developed from a background of specific examples without undue preoccupation with mathematical rigor.

**Practically Speaking in Business, Industry and Government**, R. Hays, Addison-Wesley, 198 pp., \$4.95

Designed for men and women in business, industry, and government who need to speak effectively in public. Covers some of the general aspects of public speaking, then proceeds into step-by-step suggestions for preparing, developing, and delivering a speech. Exercises, examples, and case histories are provided throughout the book.

## LET GPS HELP YOU THINK FUNCTIONS

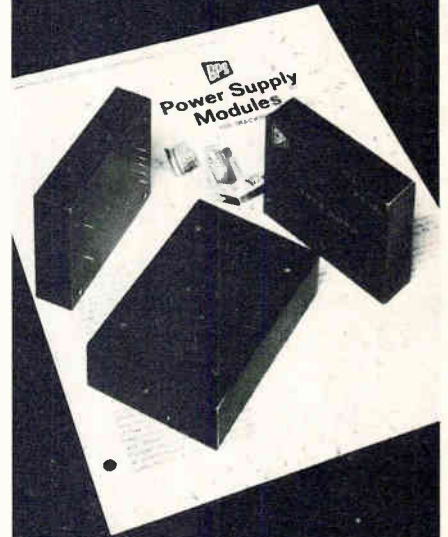

### LOW PROFILE Power Supply Modules

$\pm 15V$  TRACKING

- Available from stock.
- Low prices: \$33 and up in quantity.
- 8 Models with output currents from 50 mA to 200 mA.
- Line regulation to 0.005%.
- Load regulation to 0.02%.
- Noise: 1 mV peak-to-peak max.
- Encapsulated in compact 0.78" thick x 2 1/2" x 3 1/4"

Write for descriptive brochure and application notes to:

**GPS CORPORATION**  
14 Burr Street,  
Framingham, Mass. 01701  
(617) 875-0607



GPS — The Complete Source for  
Compatible Operational Elements.

## STABILITY & QUALITY

High quality capacitors unrivalled in the precision, dependability and compactness. Quality is recognized by ever wider use in measurement equipment, computers, and automatic controllers. "LEAF" the matter of capacitors to MATSUO ELECTRIC CO.



# MATSUO

## SOLID TANTALUM CAPACITORS FOR HYBRID ICs - "MICROCAP".

### Specifications:

Operating Temperature Range:  $-55^{\circ}\text{C}$  to  $+85^{\circ}\text{C}$   
 Standard Voltage Rating: 6.3, 10, 16, 20, 25, 35 VDC  
 Standard Capacitance Value: .001 to 22MFD (E6 series)  
 Standard Capacitance Tolerance:  $\pm 20\%$  (M)

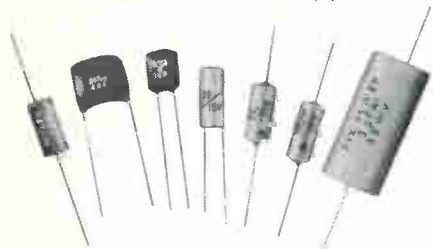

MATSUO'S other capacitors include:

**Metallized Polyester Film Capacitor:** Type FNX-H mylar wrapped.

**Solid Tantalum Capacitors:** Type TAX hermetically sealed in metallic case, Type TSX encased in metallic case and sealed with epoxy resin, Type TSL encased in metallic case and sealed with epoxy resin. **Polyester Film Capacitors:** Type MFL epoxy dipped, Type MFK epoxy dipped, non inductive, Type MXT encased in plastic tube, non inductive.

For further information, Please write to Manufacturers and Exporters

## MATSUO ELECTRIC CO., LTD.

Head Office: 3-5, 3-chome, Sennari-cho, Toyonaka-shi, Osaka, Japan  
 Cable: "NCGMATSUO" OSAKA Telex: 523-4164 OSA  
 Tokyo Office: 7, 3-chome, Nishi-Gotanda, Shinagawa-ku, Tokyo

Circle 228 on reader service card

## Technical Abstracts

### Damaging X rays

The silicon-diode array camera tube  
 G.E. Smith  
 Bell Telephone Laboratories Inc.  
 Murray Hill, N.J.

A recent development in the testing of silicon-diode array camera tubes developed for Picturephone was the discovery that X rays cause changes in target performance. These X rays are generated by the electron beam striking the decelerating mesh; among the changes caused is raster burn-in. The principal effect is a change in dark current with time.

A small portion of the target area—about one-tenth—was scanned with an electron beam for an extended period of time and the video measurements were compared with the dark current over the full raster area, before and after the aging. It was found that the dark current increased within the rastered area while a halo existed outside the rastered area, indicating an even larger increase in dark current.

The principal effect of the damage to the target was to increase the fast-state density at the silicon-dioxide interface. And, since the principal cause of dark current is generation-recombination at surface states, it is a likely explanation of the increase in observed dark current. The postulation that X rays were responsible for this increase was based on the existence of the halo since ion burn-in should only have occurred in the rastered area. On the other hand, the X rays produced at the decelerating mesh—about 0.1 inch away from the target—would have been expected to have an effect over an area extending 0.1 inch beyond the rastered area—the area of the observed halo. And, the calculated X-ray flux corresponded to dosages over the aging period which were comparable to those used in previous radiation-damage experiments. The mesh operated at 1,000 volts.

The instantaneous X-ray flux was measured by determining the distribution and number of electron-hole pairs created by the X rays on the target itself. The electron beam was blanked for several

# the impossible ALCOSWITCH

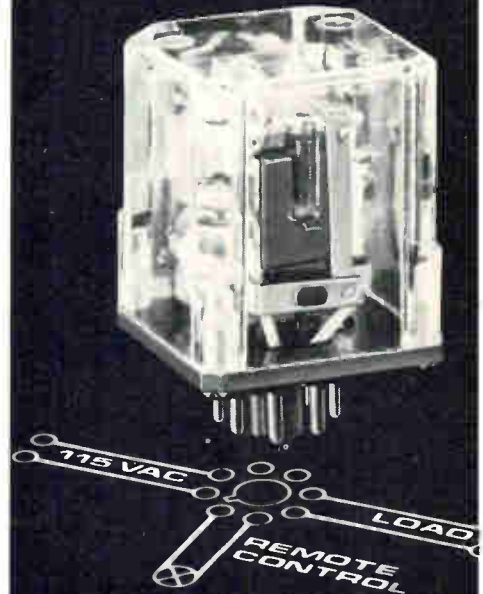

Since when does ALCOSWITCH make relays? Since we learned how to make the impossible switch. All we've done is to combine a step-down transformer and a relay in a single core, all miniature.

If your product operates on 115 VAC and has possibilities of remote operation chances are you could use the ALCOSWITCH-RELAY!

Refer to the figure below: by simply shorting the remote control leads "X" the flux path changes thereby closing the relay armature.



The only product in the world of this type that allows you to control up to 600 watts remotely, safely, and economically.

Whether you manufacture hi-fi amplifiers, electric fans, vacuum cleaner projectors, thermostat controls, consumer appliances or industrial equipment, you may have a need for this revolutionary switching product.

If you are seeking a marketing advantage for your products, we will be happy to assist you by suggesting one of our ALCOSWITCH-RELAYS.

# ALCO

ELECTRONIC PRODUCTS, INC.

Lawrence, Massachusetts 01843  
 Circle 191 on reader service card

# TRYGON the power supply leader...

introduces  
the **FIRST**  
Triple Output  
lab power supply



Model TL8-3

**\$199.**

The first 3 in 1 power supply made for general lab use and IC applications.

Outputs are 0 to +8 VDC at 3A;  
0 to +32 VDC at 1A and 0 to -32 VDC  
at 1A. That's less than \$70 an output.  
Quite a savings over buying separate  
supplies to do the job that this ONE  
can do and Better!

- Exclusive tilt handle accessory
- Overvoltage protection module accessory
- Precision Trygon Performance and Reliability

Write for details and get your copy of  
Trygon's new 1970 Power Supply  
Handbook

**TRYGON POWER SUPPLIES**

111 Pleasant Avenue, Roosevelt, New York 11575  
Tel: 516-378-2800 TWX: 510-225-3664  
Trygon GmbH 8 Munchen 60, Haidelweg 20, Germany  
Prices slightly higher in Europe.

## Technical Abstracts

frames so that the flux could be integrated, and the resulting stored charge in a single scan was displayed and measured. Dark current present during measurement was reduced by cooling the target. The result of the cooling was that fluxes corresponding to video signals were of the order of a few nanoamperes while those for an uncooled display were 10 times higher. The permanent increase of this dark current varied considerably; however, they were of the order of 0.1 to 1.0 na/hour with the mesh at 1,000 volts.

The most promising method of reducing the extent of this burn-in is to reduce the mesh voltage and to change the focusing method from electrostatic to magnetic to preserve resolution.

The extent of the burn-in correlated with the magnitude of the X-ray flux in a linear fashion. Another result of the experiments was that the X-ray flux increased with the fifth power of the mesh voltage in the 500 to 1,500 volt range.

Presented at the International Solid-State Circuit Conference, Philadelphia, Feb. 18-20.

### Electric eyes

MOS electronics for a reading aid for the blind

J.D. Plummer and J.D. Meindl  
Stanford University, Stanford, Calif.

Perhaps the most spectacular success in applying new circuit techniques to medical problems has been scored in providing reading aids for the blind. Using a bipolar phototransistor image array, a group working at Stanford University recently developed an optical-tactile reading aid which converts printed characters to unique and recognizable vibrations, thus allowing a blind person, through the sensitivity of his fingers, to "read" virtually all printed material.

Called the Optacon, this device proved so successful in trials with blind students that a new IC version of the early design, using metal oxide semiconductor technology in place of bipolar elements, was successfully undertaken. This new MOS design significantly reduces both size and cost—a com-

**FREE  
SAMPLES**



Printed Wiring Shapes and Patterns  
for Artwork Accuracy in Seconds

Yours — free for the asking — a trial sample packet of By-Buk time saving pressure sensitive printed wiring drafting aids. Discover the efficiency of this partner to faster, more accurate artwork production. By-Buk offers thousands of ideas in printed wiring shapes, patterns and tapes. Individually die cut on quick release backing paper. Easy to apply. Available in opaque black, transparent red and transparent blue.



See these cost savers for yourself. Send for your free samples, plus 20 page product line catalog.

**BY-BUK COMPANY**



4326 W. Pico Blvd.  
Los Angeles, Calif. 90019  
(213) 937-3511

Circle 229 on reader service card



**NORTON<sup>®</sup>  
MAGNETIC  
HEADS**

**MULTITRACK  
ERASE  
RECORD  
PLAY**

Send now for complete technical literature.

**NORTON**  
ASSOCIATES, INC.

10 Di Tomas Court, Copiague, N.Y. 11726  
Phone: 516 598-1600

Circle 230 on reader service card



# solid state...up to date

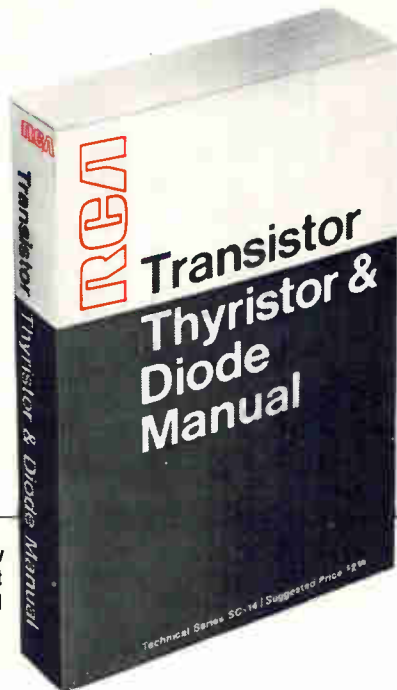

More than 100 new pages of latest information added

Suggested price \$2.50

CONTENTS	PAGE
<b>MATERIALS, JUNCTIONS, AND DEVICES</b> .....	3
Semiconductor Materials, P-N Junctions, Current Flow, Types of Devices	
<b>BIPOLAR TRANSISTORS</b> .....	11
Design and Fabrication, Basic Circuits, Characteristics, Biasing, Bias Stability, Coupling, High-Frequency Operation, Switching, Transient Effects	
<b>MOS FIELD-EFFECT TRANSISTORS</b> .....	33
Theory of Operation, Fabrication, Electrical Characteristics, General Circuit Configurations, Handling Considerations	
<b>THYRISTORS</b> .....	40
Silicon Controlled Rectifiers, Triacs, Diacs, Gate Characteristics, Switching Characteristics, Ratings, Critical Rate of Rise of On-State Current, Holding and Latching Currents, Critical Rate of Rise of Off-State Voltage, Transient Protection, Radio-Frequency Interference	
<b>SILICON RECTIFIERS</b> .....	59
Thermal Considerations, Characteristics, Ratings, Overload Protection, Series and Parallel Arrangements	
<b>OTHER SEMICONDUCTOR DIODES</b> .....	65
Tunnel Diodes, Varactor Diodes, Compensating Diodes, Photoconductive Diodes, Light-Emitting Diodes	
<b>LINEAR SYSTEM APPLICATIONS</b> .....	74
Detection, Amplification, Oscillation, Frequency Conversion, Automatic Frequency Control, Frequency Multiplication	
<b>TV DEFLECTION AND COLOR DEMODULATION</b> .....	128
Scanning Fundamentals, Sync, Vertical Deflection, Horizontal Deflection, Color Demodulation	
<b>POWER SWITCHING AND CONTROL</b> .....	144
Nonsinusoidal Oscillators, Switching Regulators, Converters and Inverters, Automobile Ignition System, Pulse Modulators, Light, Heat, and Motor Controls	
<b>COMPUTER CIRCUITS</b> .....	174
<b>DC POWER SUPPLIES</b> .....	183
Rectification, Filtering, Regulators	
<b>TESTING AND MOUNTING</b> .....	191
<b>SYMBOLS</b> .....	211
<b>SELECTION CHARTS</b> .....	217
<b>TECHNICAL DATA</b> .....	223
<b>OUTLINES</b> .....	564
<b>MOUNTING HARDWARE</b> .....	576
<b>CIRCUITS</b> .....	582
<b>INDEX</b> .....	653

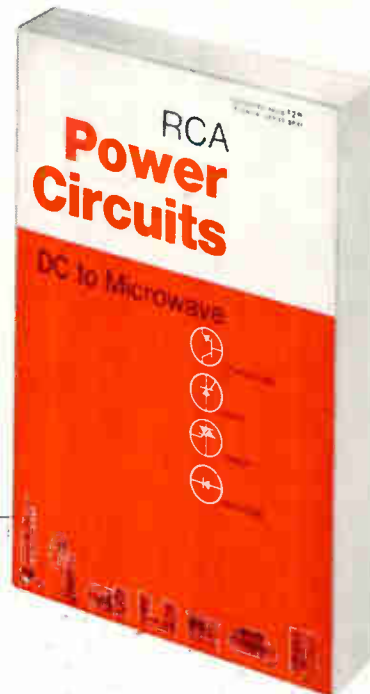

Newly expanded information for the circuit designer

Suggested price \$2.00

CONTENTS	PAGE
<b>SEMICONDUCTOR MATERIALS, JUNCTIONS, AND DEVICES</b> .....	3
Semiconductor Materials, Current Flow, N-P-N and P-N-P Structures, Types of Devices	
<b>SILICON RECTIFIERS</b> .....	10
Theory of Operation, Characteristics and Ratings, Series and Parallel Rectifier Arrangements, High-Voltage Rectifier Assemblies, Packaging	
<b>THYRISTORS</b> .....	29
Theory of Operation, Construction, Ratings and Characteristics, Series and Parallel Operation, Transient Protection	
<b>SILICON POWER TRANSISTORS</b> .....	65
Design and Fabrication, Basic Transistor Parameters, Maximum Ratings, Thermal Considerations, Second Breakdown, Safe-Area Ratings, Small-Signal Analysis, Large-Signal Analysis, Switching Service	
<b>RECTIFICATION</b> .....	149
<b>POWER CONVERSION</b> .....	162
<b>POWER REGULATION</b> .....	200
Linear Voltage Regulators, Switching Regulator, General Triggering Considerations, Phase-Control Analysis of SCR's, Motor Controls, Incandescent Lighting Controls	
<b>THYRISTOR AC LINE-VOLTAGE CONTROLS</b> .....	226
General Considerations, Motor Controls, Heater Controls, Incandescent Lighting Controls	
<b>HIGH-FREQUENCY POWER AMPLIFIERS</b> .....	262
Design of RF Power Amplifiers, Matching Networks, Marine Radio, Citizens-Band Transmitters, Mobile Radio, SSB Transmitters, Aircraft Radio, Community-Antenna TV, UHF Military Radio, Microwave Amplifiers and Oscillators, Frequency Multipliers	
<b>CONTROL AND LOW-FREQUENCY POWER AMPLIFIERS</b> .....	379
General Considerations, Audio-Frequency Power Amplifiers, Ultrasonic Power Sources, Servo Amplifiers	
<b>BIBLIOGRAPHY</b> .....	438
<b>INDEX</b> .....	440
<b>RCA TECHNICAL PUBLICATIONS</b> .....	444

New and indispensable

Order yours today from your RCA Distributor

or RCA Electronic Components,  
Commercial Engineering, Section D13-19SD,  
Harrison, N. J. 07029

# Simpson's Goof-Proof 260-5P



the  
VOM  
they  
can't  
burn  
out!

- **All Ranges Protected** except for 10 Amp, 1 kV, and 5 kV ranges. Even takes line voltage on the Rx1 range without damage!
- **Button Pops Out to Indicate Overload.** Lets operator know instantly that an overload is present. Does not require massive overloads to activate.
- **Cannot be re-set While Overload Is Present.** The 260-5P's protective circuits are truly defeat-proof.
- **New Shock-Proof Taut Band Movement** cannot develop error-causing friction from rough classroom treatment. Self-shielding, too.

**GOOF-PROOF 260-5P VOM**  
Complete with test leads and operator's manual . . . . . **\$97<sup>00</sup>**

**Simpson**  
INSTRUMENTS THAT STAY ACCURATE

GET "OFF THE SHELF" DELIVERY  
FROM YOUR LOCAL  
ELECTRONIC DISTRIBUTOR.



**SIMPSON ELECTRIC COMPANY**  
5200 W. Kinzie Street, Chicago, Illinois 60644 • Phone (312) 379-1121  
EXPORT DEPT.: 400 W. Madison Street, Chicago, Illinois 60606. Cable Simelco  
IN CANADA: Bach-Simpson Ltd., London, Ontario  
IN INDIA: Ruttonsha-Simpson Private Ltd.  
International House, Bombay-Agra Road, Vikhroli, Bombay

## Technical Abstracts

mon processing program can be used to fabricate the entire device. Further, the MOS circuitry reduces the number of leads between elements and external interconnections, thereby increasing reliability and reducing power requirements.

Like the bipolar design, the new device is composed of three circuits—a self-scanned image sensor, a control or multiplexing logic circuit, and a self-scanned drive circuit which energizes vibration-producing piezoelectric elements. In simple terms, a 24 x 6 (six-channel) array of MOS phototransistors senses an image of a printed character which, through the MOS multiplexing system, is translated into a tactile image produced by a corresponding array of vibrators.

Each photosensor in the array consists of a photodiode and an MOS switch. A charge integrator-comparator combination serves as the detector for the system and makes a light/dark decision for each photosensor element. To cancel the effects of column switching noise, this detecting process has a three-step interrogation sequence—reset, sample, readout—and this, together with the charge integrator, results in considerable improvement in signal-to-noise ratio.

After detection by the photodiode array, the signals from the six channels corresponding to a unique character are passed to the control circuit, where they are multiplexed onto a single information channel. This single output then is fed to the drive circuit of the piezoelectric stimulator, where it is reconstructed into six channels to activate the appropriate tactile stimulators in the "reader" array.

A laboratory model of the MOS Optacon has a unit photodiode size of 150 microns by 300 microns; about 73% of this area is active photosensing area. Typical frame rates in the reading aid are about 200 hertz, allowing an interrogation time of 35 microseconds for each element in the image sensor. This means that scan rates are fast enough to allow the use of dynamic, rather than static, MOS shift registers.

Presented at the International Solid-State Circuit Conference, Philadelphia, Feb. 18-20.



# Manfred Watson has a big problem.

He dreamed up a new  
contraption, but the thingamajigs,  
whatchacallits and gizmos to build  
it are nowhere to be found.

Poor Manfred. He's an engineer. His 'head  
is full of new ideas for exciting new products.  
The ideas come easy. But finding  
somebody who makes the parts to build  
his brainstorm is "Manny's" biggest hang-up.

Relax, Mr. Watson. The answer is as close  
as your nearest mailbox. The Northern Plains  
Industrial Catalog. It's a complete, indexed,  
cross-referenced file of valuable information  
like, who makes it, where, and how to  
order. Chances are good we can give you a line  
on the gizmos you're looking for. So clip  
the coupon and return. We'll send you  
information absolutely free, complete  
and confidential.

Mr. W. A. Spitzenberger, Director  
Area Development Department  
Northern Natural Gas Company  
2223 Dodge Street  
Omaha, Nebraska 68102



Dear Bill:

I'm looking for a source of: \_\_\_\_\_

Name \_\_\_\_\_

Title \_\_\_\_\_

Company \_\_\_\_\_

City \_\_\_\_\_ State \_\_\_\_\_ Zip \_\_\_\_\_

## WHY GAMBLE!

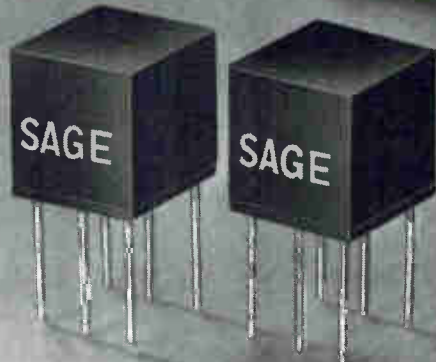

When your design calls for high reliability miniature transformers look to

## THE NEW SAGE MICROCUBE LINE

When Sage makes it, you can count on advanced design, highest quality and complete dependability. These new Microcube Miniature Transformers, featuring highly efficient laminated cores and sealed construction, are no exception. Specify Sage when you require . . .

- A MINIATURE BROADBAND AUDIO TRANSFORMER that utilizes minimum space and standard grid spacing. Sage can supply them with power ratings of up to 50 milliwatts at 1KHz; frequency response of  $\pm 2$  DB from 400 Hz to 250 KHz; 5% maximum distortion; primary impedance "Standard" to 25K ohms, "Special" to 100K ohms.
- A PLUG-IN PULSE TRANSFORMER with very fast rise times. Sage manufactures a microcube transformer with rise times to 50 nanoseconds; ET constants to 5000 volt microseconds; high pulse impedance with low droop.
- ONE SIZE PACKAGE STANDARDIZATION. Sage can provide miniature inductors in the microcube configuration featuring inductances to 50 henries, highest Q and excellent stability.

Give us the opportunity to discuss your requirements. SAGE ELECTRONICS CORP., Box 3926, Rochester, N.Y. 14610; Tel: (716) 586-8010

*A Leader in Micromagnetics*

**SAGE**  
**ELECTRONICS**  
SUBSIDIARY OF GULTON INDUSTRIES, INC.

## New Literature

**P-c enclosure guide.** Elco Corp., Willow Grove, Pa. 19090. A revised 16-page guide describes and illustrates a complete line of economical aluminum p-c card enclosures.

Circle 446 on reader service card.

**Fluoroplastic.** Pennwalt Corp., 3 Penn Center, Philadelphia 19102. Performance and property features of Kynar polyvinylidene fluoride for computer wiring are detailed in a brochure. [447]

**Vacuum system.** Varian, Vacuum Division, 611 Hansen Way, Palo Alto, Calif. 94022, offers a brochure on its VI-460, a fast-cycle vacuum system suited for production coating work. [448]

**Tape transport.** Potter Instrument Co., East Bethpage Rd., Plainview, N.Y. 11803, has released a data sheet describing the SC1081 automatic-loading magnetic-tape transport. [449]

**Active filters.** Varadyne Inc., 2330 Michigan Ave., Santa Monica, Calif. 90404, has assembled a data package consisting of data sheets, application notes, design notes, and general information on the design and selection of active filters. [450]

**Automatic counters.** Dana Laboratories Inc., 2401 Campus Dr., Irvine, Calif. 92664, has assembled an eight-page brochure covering eight automatic-counter models in the 8100 series. [451]

**Video switcher system.** Ampex Corp., 401 Broadway, Redwood City, Calif. 94063. Data sheet V264 describes solid state video-switcher system VS600, which is used in television production and control facilities for broadcasting and program recording. [452]

**Binary ladder networks.** Beckman Instruments Inc., 2500 Harbor Blvd., Fullerton, Calif. 92634. A two-page catalog sheet describes the thick-film series 812 binary ladder networks, which are compatible with the Fairchild 3750 d/a and 3751 a/d converter IC's. [453]

**R-f voltmeter.** High Frequency Engineering Co., 2626 Frontage Rd., Mountain View, Calif. 94040, has released a specification sheet listing the model 500 r-f voltmeter, a high-accuracy self-contained instrument for handling the frequency range 20 khz to 500 Mhz over a potential range from 200 mv to 15 v. [454]

**Pressure-sensitive foil.** Tapecon Inc., P.O. Box 4741, Rochester, N.Y. 14612, offers data sheet PSF-719 discussing its capability to change almost any metal foil—including steel, copper, aluminum, nickel, stainless steel, lead, and

# 80 MHz WIDEBAND RF POWER AMPLIFIER



## MODEL RF-805

- 10 Watts Output into 50Ω
- 0.1 Volts In — 22.5 Volts Out
- .05 MHz to 80 MHz Broadband
- Low Distortion
- Solid State
- Flat 47 db Gain

The RF-805 is a solid state amplifier, broadband from .05 to 80 megahertz, which produces ten watts with -30 db harmonic and intermodulation distortion. Lower distortion is available at lower output levels. Gain is 47 db minimum, constant within 1 db, so that full output is developed with less than 0.1 volt at the 50 ohm input. Accurate output metering and overload protection is provided.

The RF-805 will raise the power of most manual and swept tuned signal generators and thus extend the usefulness and versatility of available signal generators. Receiver testing, wattmeter calibration, antenna testing, RFI testing, attenuator measurements, and filter and component testing will be aided with the use of this equipment.



**R F COMMUNICATIONS, INC.**  
1680 University Avenue • Rochester, N. Y. 14610

Circle 231 on reader service card

# Technology Consultants, Inc. has the **TALENT** for helping your company profit!

Profitable growth to a position of industry leadership is often the result of ideas developed to maximum usefulness. But finding the skilled resources or time to move ideas into the money market could be a problem. TCI can help.

TCI provides a team of electronic specialists from a vast talent pool to extend your technical capability. They can help you solve critical technical problems when in-house resources may be limited. Or, guide your existing capabilities into new directions for growth. They assume overall job responsibility. And they relieve the financial burden of carrying a full-time technical staff on your payroll.

A TCI team of experts... with appropriate analytical and technical talent... and with direct support of all Electronics/Management Center resources is ready to help you by participating in:

- Systems design & analysis
- Search for new products
- Research & development
- Technical proposals
- Seminars for up-dating technical staffs
- Product feasibility studies
- Literature searches

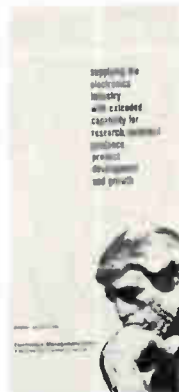

Ask for our brochure or call direct and arrange for a preliminary meeting now.



## Technology Consultants, Inc.

An Exclusive Technical Affiliate of

# E/MC

Electronics/Management Center  
330 West 42nd Street  
New York, N.Y. 10036  
(212) 971-3485

# FREE! CLAMP Design Manual

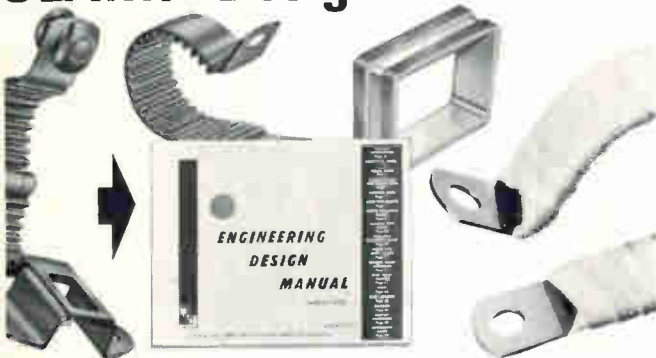

## 72 pages of engineering data!

The most complete work of its kind, this manual features 72 pages of prints, illustrations, tables, specifications and installation tips for any clamp situation. Whether of aluminum, titanium or stainless steel, from 1/8" to 6" diameter, for hot or cold temperature insulation... for any situation, you'll find the best way to "clamp down" clearly shown in this booklet. ■ Over 41,000 clamp designs at your fingertips, ready for shipments now, at big off-the-shelf savings. Also shows blocks, brackets, line supports and related items. BEFORE YOU DESIGN OR BUY, CHECK WITH TA FIRST! Write or phone today for a quotation. ■ Send for your free clamp manual today!

**TA MFG CORP**



A DAYCO COMPANY

4607 Alger Street, Los Angeles, California 90039 ■ Phone 213-245-3748/  
TWX 910-497-2065 L. A./WUX CAT L. A., Calif.

Circle 232 on reader service card

Circle 197 on reader service card

197



## Pfizer Research advances the science of sound and image recording.

The phenomenon of magnetism, which occurs naturally in some minerals, was known to the Greeks six centuries before Christ. Yet it remains perhaps the least understood of all forces.

For example, how *can* a thin coating of special iron oxides—on any of many base materials—reproduce with high fidelity almost the entire range of sound and visual communications?

Pfizer probably knows as much about this mystery as anyone, since we've pioneered in magnetic recording for over 20 years. Not in making tapes, drums, and discs except for test purposes . . . but rather in the iron oxides they require. Oxides possessing exceptional performance characteristics.

Pfizer has learned a lot about the subject, and is continuing to learn more, from our extensive research, development, and pilot plant manufacturing. If you make any of the products concerned, for consumer sales or industrial use, our advanced knowledge may help you.

Your technical inquiries will receive immediate attention.

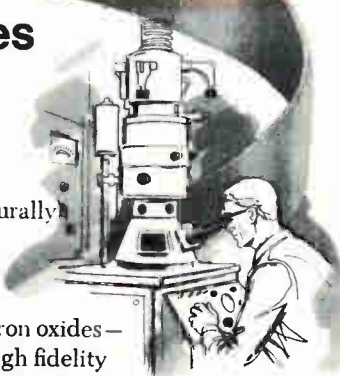

### Photo Caption:

GOETHITE— $\text{Fe}_2\text{O}_3 \cdot \text{H}_2\text{O}$ , hydrated ferric oxide. Named after poet J. W. von Goethe. Specimen from Gömör, Hungary and reproduced in scale of 4.3:1 reduction. High purity grades of synthetic Goethite are among the major sources of Pfizer's wide range of oxides for magnetic recording purposes.

**Pfizer**

**MINERALS  
PIGMENTS  
& METALS  
DIVISION**

Dept., 9E3 235 East 42nd Street  
New York, New York 10017

## New Literature

special alloys—into pressure-sensitive foil. [455]

**Motor-damping generator.** Weston-Transicoil, Division of Weston Instruments Inc., Worcester, Pa. 19490, has available a data sheet containing specifications on a 60-cycle, size 15 motor-damping generator. [456]

**Chart paper.** Beckman Instruments Inc., 3900 River Road, Schiller Park, Ill. 60176. An eight-page catalog, bulletin 663, lists comprehensive cost and specification data on available precision chart paper for Dynograph recorders. [457]

**Economy transistors.** Texas Instruments, P.O. Box 5012, M/S 308, Dallas 75222, has issued 12-page brochure CB-111 on its Silect line of low-cost transistors. [458]

**Microwave and r-f components.** Bendix, Microwave Devices Division, Hurricane Rd., Franklin, Ind. 46131, has issued a four-page brochure describing and illustrating popular numbers from its complete catalog of microwave and r-f components. [459]

**Precision screens.** Aremco Products Inc., P.O. Box 145, Briarcliff Manor, N.Y. 10510. A two-page brochure describes the 119 series ACCU-Screen precision screens for thick-film metalizing. [460]

**Varactor diodes.** KSC Semiconductor Corp., KSC Way (Katrina Road), Chelmsford, Mass. 01824. Complete electrical characteristics and absolute maximum ratings for 52 types of silicon epitaxial varactor diodes are listed in three data sheets. [461]

**Digital printers.** Datadyne Corp., Valley Forge Center, King of Prussia, Pa. 19406. Four-page engineering specifications sheet 3070 gives detailed specifications, illustrations, and prices for 10- and 20-line per second alphanumeric printers. [462]

**Analog-to-digital converters.** Computer Products, 1400 N.W. 70th St., Ft. Lauderdale, Fla. 33307. A four-page bulletin covers the complete AD30Q series (14 separate models) analog-to-digital converters, which have prices starting at \$169. [463]

**Uhf power amplifier.** RCA Defense Electronic Products, Front and Cooper St., Camden, N.J. 08102, has released a catalog sheet illustrating and describing the AN/GRA-110, a solid state, linear-power amplifier built to military specifications. [464]

**Emi shielding materials.** Radcon Corp., 246 Columbus Ave., Roselle, N.J. 07203. A four-page brochure covers materials that can be used to shield electronic equipment from stray elec-

# SANKEN Packs 50 Watts into A Hybrid Audio Amplifier!



SI-1020A (25W)



SI-1050A (50W)

SI-1000 Series Hybrid Power Amplifiers are designed and manufactured for a high power Hi-Fi stereophonic system. With the simple addition of power supply and a coupling capacitor to a speaker one has an IC audio amplifier of the highest quality.

#### OUTSTANDING FEATURES:

- \*Single-ended push-pull circuit
- \*Provided with temperature compensating element
- \*Can withstand a 5-second short-circuit in the output terminals due to special single-diffused power transistors
- \*Harmonic distortion of less than 0.5% at full power level

	SI-1020A	SI-1050A
Power supply voltage	48V	62V
Max. continuous output power (distortion < 0.5%)	25W	50W
Voltage gain	30dB typ.	
Frequency range (output 1W)	20Hz ~ 100kHz	
Input impedance	70k typ.	
Output impedance	0.2Ω typ.	
S/N ratio	90dB typ.	
Idling current	30mA typ.	



Write for further information to:  
**SANKEN ELECTRIC CO., LTD.**

1-22-8 Nishi-Ikebukuro, Toshima-ku, Tokyo  
Cable: SANKELE TOKYO Phone: 986-6151  
Telex: 0272-2323 SANKELE TOK

Circle 233 on reader service card

## FOR EXCELLENCE IN PUSH BUTTON SWITCHES SPECIFY GRAYHILL

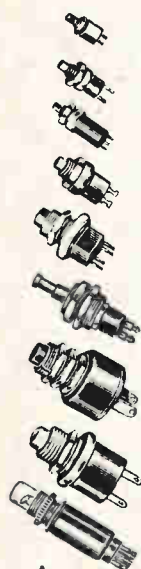

### A WIDE SELECTION TO CHOOSE FROM...

- Ratings To 10 Amp.
- SPST, SPDT, DPST, DPDT
- Diameters From 1/4" To 7/8"
- Behind Panel Dimension As Small As .32"
- Momentary - Push-Pull - Lighted - Alternate Action (Push-On, Push-Off)
- Wiping, Snap Action And Butt Contacts
- Solder Lug, "Faston" Or Printed Circuit Terminals
- Life Expectancy Up To 1,000,000 Operations

For your  
Grayhill Engineering  
Catalog offering complete  
technical data—contact



523 Hillgrove Avenue  
LaGrange, Illinois 60525  
Area Code 312, Phone 354-1040

... the Difference Between Excellent and Adequate

Circle 234 on reader service card

## WANTED: ELECTRONICS MANUFACTURER

to help meet the needs  
of a lucrative  
Texas market

Excellent opportunity for growth-minded electronics manufacturer to locate in Texas and help meet the needs of the third fastest-growing state. Stable, productive labor. Incomparable tax advantages. Lowest living costs. For Texas Fact Book, write or call:

James H. Harwell, Executive Director  
**TEXAS INDUSTRIAL COMMISSION**

Capitol Station Box JJ-E  
Austin, Texas 78711  
Telephone 512/475-4331

Circle 199 on reader service card

199

# There Is a Difference In Quartz Crystals

 Space age communication equipment demands a crystal that meets all standards of technical advancement. Crystals that were acceptable some years ago do not meet present day specifications. As a general rule, your crystal must be selected from the best quartz . . . (no throw off cuts). Tight tolerances demand selected angles of cut. The x-ray is important in making this selection. The crystal should be preaged with stress cycling. It should be checked for frequency change vs temperature change. It must be checked for optimum spurious response. It should be calibrated to frequency with the correct oscillator. International Crystals are manufactured to meet today's high accuracy requirements. That's why we guarantee all International crystals against defective materials and workmanship for an unlimited time when used in equipment for which they were specifically made.

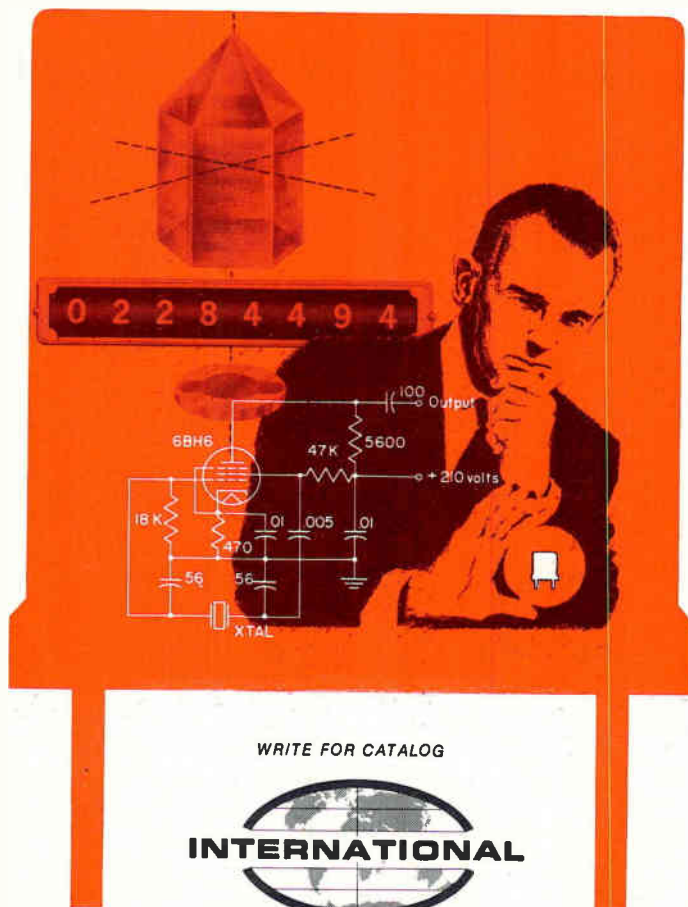

WRITE FOR CATALOG

**INTERNATIONAL**

**CRYSTAL MFG. CO., INC.**  
10 NO. LEE • OKLA. CITY, OKLA. 73102

## New Literature

**Magnetic or radio-frequency fields.** [465]

**Videotape recorder.** Ampex Corp., 2201 Estes Ave., Elk Grove Village, Ill. 60007. Brochure V69-24 describes features of the VR-5100E 1-inch videotape recorder with capstan-servo-controlled electronic editing and independent audio recording. [466]

**Video amplifiers.** Silicon General Inc., 7382 Bolsa Ave., Westminster, Calif. 92683. Technical bulletin 1401 describes a series of video amplifiers usable from d-c to 200 Mhz. [467]

**Air movers.** IMC Magnetics Corp., 570 Main St., Westbury, N.Y. 11591, has available catalog ND4r describing its complete line of cooling fans and blowers. [468]

**Random access memory.** Potter Instrument Co., East Bethpage Rd., Plainview, N.Y. 11803, has released data sheet PD1-105A on the DD4311 random access memory. [469]

**Diode guide.** Fairchild Semiconductor, Box 1058, Mountain View, Calif. 94040, offers a cross reference and selection guide for its extensive line of zener diodes and temperature compensated reference diodes. [470]

**Connectors.** Dale Electronics Inc., P.O. Box 609 Columbus, Neb. 68601, has published a 48-page catalog listing its full line of connectors. [471]

**Wafer scriber.** Lindberg Hevi-Duty, Division of Sola Basic Industries, 2450 W. Hubbard St., Chicago 60612. An automatic three-inch wafer scriber is discussed in two-page bulletin 84999. [472]

**Digital multimeters.** Dana Laboratories Inc., 2401 Campus Dr., Irvine, Calif. 92664, has available data sheet 1023 describing the series 5200 digital multimeters. [473]

**Neon glow lamps.** Signalite Inc., 1933 Heck Ave., Neptune, N.J. 07753. A 12-page, illustrated brochure contains a technical discussion on the design of neon glow lamps, their operational characteristics and their applications. [474]

**Cable assembly.** Sealectro Corp., 225 Hoyt St., Mamaroneck, N.Y. 10543. An advanced ConheX custom cable assembly from the company's fully tested, made-to-order line is described and illustrated in product bulletin CX13A. [475]

**Sample and hold circuit.** Data Technology Corp., 1050 E. Meadow Circle, Palo Alto, Calif. 94303. A sample and hold circuit that offers a rare combination of high speed and high accuracy is described in a four-page brochure. [476]



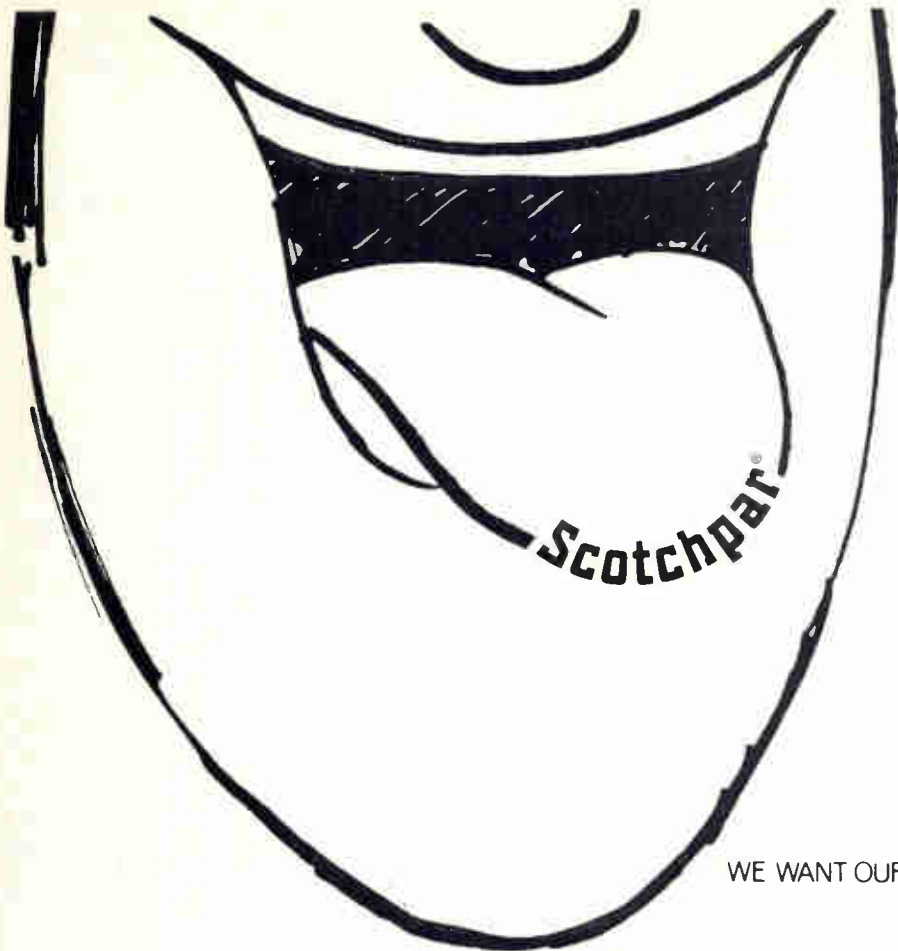

WE WANT OUR NAME ON THE TIP OF YOUR TONGUE!

**Scotchpar® 3M**  
BRAND POLYESTER FILM COMPANY

Circle 235 on reader service card

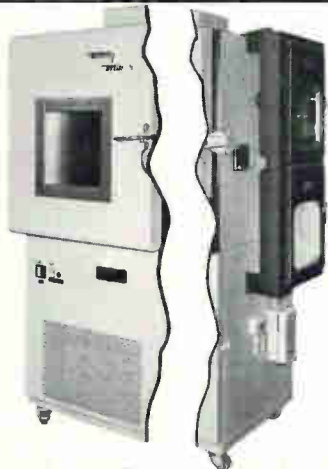

## THE SCHIZOPHRENIC.

I'm a temperature test chamber. No, I'm a temperature-humidity test chamber. No, I'm both, in one compact unit. My Dr. Jekyll side has a dry bulb temperature testing range of  $-100^{\circ}\text{F}$  to  $+350^{\circ}\text{F}$ . My Mr. Hyde personality combines temperature testing with a humidity range of 20% to 95%. I'm a five cubic foot automated test chamber with  $2^{\circ}$  control tolerances, but I have bigger brothers up to 64 cu. ft. (with other features) who can also help you. For full information write my keepers, Tenney Engineering, Inc.

**Tenney**  
ENGINEERING, INC.

1090 Springfield Rd., Union, New Jersey 07083 • (201) 686-7870  
 Western Division: 15721 Texaco St., Paramount, Calif. 90723



## PULSE GENERATOR

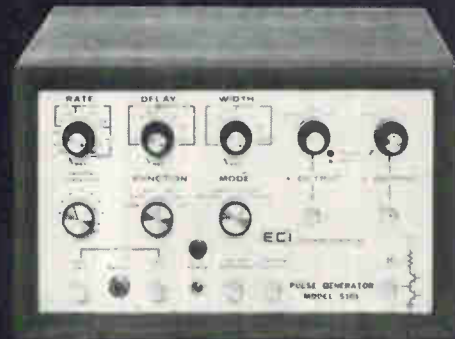

## 1 Hz to 50 MHz - \$525.

One pulse generator, the new ECI model 5101, produces pulse rates from 1 Hz to 50 MHz and includes features only found in much more expensive equipment. For example: Single or double pulse output, special integrated circuit output, 10 ns to 1 second pulse width, 10 ns to 1 second pulse delay with short circuit proof, current output having 3 ns rise (and fall) time.

Send for complete specifications, or call us collect and ask for an in-plant demonstration.



**ELECTRONIC  
 COUNTERS, INC.**  
 235 Jackson Street  
 Englewood, N. J. 07631  
 (201) 567-5300

# YOKE SPECIALISTS

## FOR INFORMATION DISPLAYS

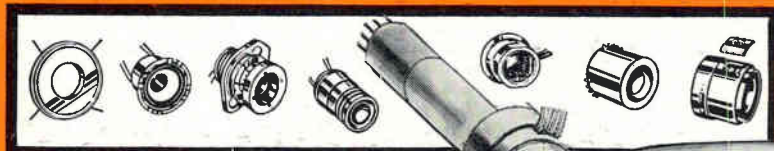

Syntronic's devotion to precision and attention to detail assure skillfully engineered deflection yokes in prototype or full production quantities. A complete line of value engineered yokes offer cost saving solutions to your CRT projects. Consult scientifically oriented Syntronic Yoke Specialists for the right yoke for your display.

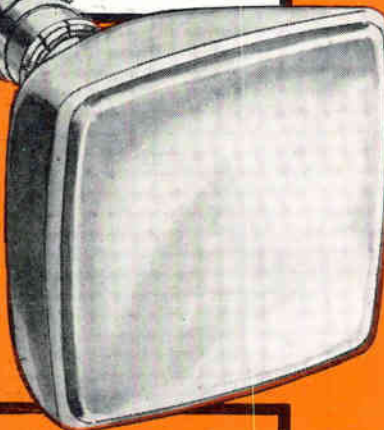

***syntronic*** INSTRUMENTS, INC.  
100 Industrial Road, Addison, Ill.  
Phone: Area 312, 543-6444

Circle 237 on reader service card

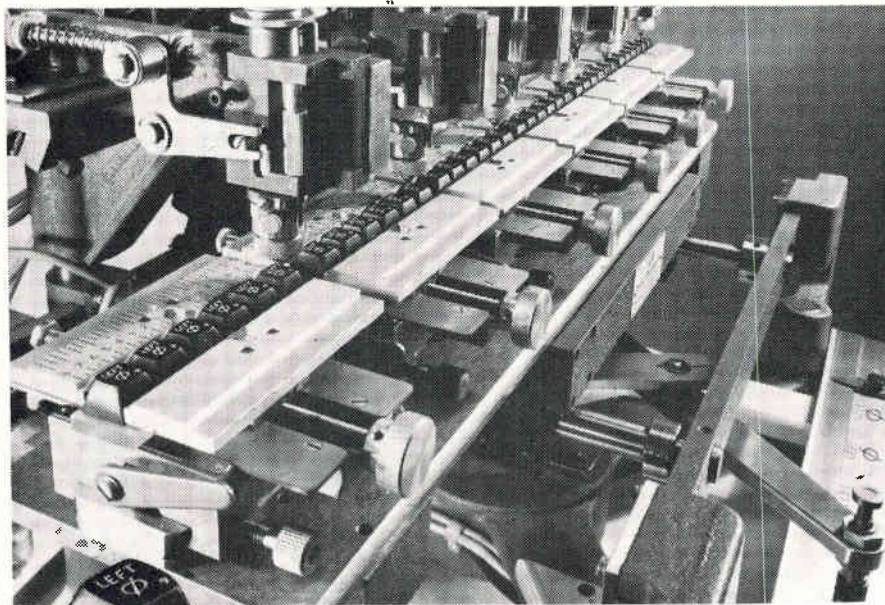

### 6 will get you 36

Now, new 6-spindle New Hermes engraves up to 36 machine keys with one set-up.

Any unskilled worker simply guides the pantographic tracer on this pneumatically-operated engraving

machine. Each spindle has an automatic depth-regulator, guaranteeing uniform depth and width of engraving over the complete contour of the key.

Write for detailed brochure No. 197.

*new hermes engraving machine corp.*

20 Cooper Square, New York, N. Y. 10003

Chicago, Atlanta, Los Angeles, Dallas, Montreal, Toronto, Mexico City

SEE US AT BOOTH 1146 IN CHICAGO



## New Literature

**Core-loss curves.** Magnetics, Components Division, Butler, Pa. 16001, offers a four-page folder that illustrates high-frequency core-loss curves for nickel-iron strip-wound cores. [477]

**Precision switches.** Cherry Electrical Products Corp., 1650 Old Deerfield Rd., Highland Park, Ill. 60035, has issued a 44-page catalog containing design information on several types of precision switches. [478]

**Pyrolytic graphite.** Union Carbide Corp., Carbon Products Division, 270 Park Ave., New York 10017. Technical information on grade HPG pyrolytic graphite for electronic applications is given in bulletin 442-21211. [479]

**Test equipment.** Tucker Electronics Co., P.O. Box 1050, Garland, Texas 75040. Forty-four page catalog 18 describes over 2,000 different test instruments or microwave components for sale or rent. [480]

**Hybrid IC capabilities.** J.W. Microelectronics Corp., 4901 Stenton Ave., Philadelphia 19144, has prepared a brochure outlining its capabilities in circuit design, materials engineering, prototype fabrication, manufacturing, and packaging of custom hybrid IC's. [481]

**Precision d-c measurements.** Hewlett-Packard Co., 195 Page Mill Rd., Palo Alto, Calif. 94304. Application Note 70 describes fundamental techniques of precise d-c measurements using four basic instruments. [482]

**Oscillographic recorders.** Beckman Instruments Inc., 3900 River Rd., Schiller Park, Ill. 60176. Bulletin 664, complete with tables, charts and photographs, offers the reader an informative analysis of the characteristics of direct-writing oscillographs. [483]

**Byte generator.** Adar Associates Inc., 85 Bolton St., Cambridge, Mass. 02140, has issued a technical data sheet describing the model EC-22 byte generator. [484]

**Control knobs.** Raytheon Co., Quincy, Mass. 02169, has available a catalog covering the Regency series of low cost control knobs designed for industrial and instrumentation markets. [485]

**Binary-decimal converters.** Microwave/Systems, 1 Adler Drive, East Syracuse, N.Y. 13057, has released a specification sheet on converters that will accept data from binary information sources, such as computers, and convert it to decimal form. [486]

**Memory systems.** Tetra Corp., 7309 Washington Ave. S., Minneapolis 55435, has released two new product data sheets covering its Alpha 10.2 and 12.2 memory systems. [487]

ADDRESS BOX NO. REPLIES TO: Box No.  
Classified Adv. Dept. of this publication.  
Send to office nearest you.  
NEW YORK, N. Y. 10036: P. O. Box 13  
CHICAGO, Ill. 60611: 646 N. Michigan Ave.  
SAN FRANCISCO, Cal. 94111: 866 California St.

POSITION VACANT

**Electrical-Electronic Engineers. Salaries \$10-\$25,000.** We specialize in developing nationwide job search programs to fit your particular position objective and location flexibility. Project, Design, R&D, and management openings in all fields. Fees Company Paid. 85 affiliate offices to serve you. Send resume in confidence with present and desired salary, reason for desiring change and location flexibility to Leonard Personnel, 310 Empire Bldg., Pittsburgh, Pa. 15222.

EMPLOYMENT SERVICES

**Resume Guide — Authentic writing instructions, clear, examples: \$2.** Executive Resumes. Box 246EL, Montclair, N.J. 07042.

**Fee Paid Employment Service for all technical fields since 1959.** Over 1,000 U.S. client cos. Send resume. Atomic Personnel, Inc., 1518 Walnut St., Box L, Phila. Pa., 19102.

BUSINESS OPPORTUNITY

**To Merge Your Company with the right partner on the right terms, at no cost to you, call us.** We work with many NYSE and AMEX corporations who seek "good match" acquisitions. Write or phone in confidence (your company will not be identified to anyone without your permission). Corporate Profiles, Inc. Box 3265, Stamford, Conn. 06905.

RESUMES

**The Resume Game: An Insider's Guide.** How to write & use yours successfully. Samples. \$4. Plymouth Pubs, Box 318A, Plymouth Mtg., Pa. 19462.

AUTOTRACK MOUNT



360 degree azimuth, 210 degree elevation sweep with better than 1 mil. accuracy. Missile velocity acceleration and slewing rates. Amplidrive and servo control. Will handle up to 20 ft. dish. Supplied complete with control chassis. In stock—immediate delivery. Used world over by NASA, USAF, MP-61-B. Type SCR-584. Ideal satellite tracking. Large spare parts inventory for back-up.

ANTI-AIRCRAFT GUN MOUNT

Will handle 6,000 lbs. rapid slew through 360° azimuth, 180° elevation. Mobile.

PULSE MODULATORS

250 KW HARD TUBE PULSER

Output 16 kv 16 amp. Duty cycle .002. Pulses can be coded. Uses 5D21, 715C or 4PR60A. Input 115 v 60 cy. AC \$1200 ea.

MIT MODEL 9 PULSER 1 MW—HARD TUBE

Output 25kv 40 amp., 30kv 40 amp. max. Duty cy. .002. .25 to 2 microsec. Also 5 to 5 microsec. and .1 to .5 microsec. Uses 6C21. Input 115v 60 cycle AC. Mfg. GE. Complete with driver and high voltage power supply. Ref: MIT Rad. Lab. Series, Vol. 5, p. 152.

2 MEGAWATT PULSER

Output 30 kv at 70 amp. Duty cycle .001. Rep. rates. 1 microsec. 600 pps. 1 or 2 msec. 300 pps. Uses 5948 hydrogen thyatron. Input 120/208 VAC 60 cycle. Mfr. GE. Complete with high voltage power supply.

18 MEGAWATT PULSER

Output 150KV at 120 amps. Rep. rate: 50-500 PPS. Pulse length: 5 msec. 15 KV 120 amp. into pulse transformer. Rise time 1.5 msec. Filament supply 5V 80 amp. incl. 17.5KV 1.5 amp DC power supply. Input: 220V 60 cy AC.

SCR 584 AUTOTRACK RADARS

Our 584s in like new condition ready to go, and in stock for immediate delivery. Ideal for telemetry research and development, missile tracking, satellite tracking. Fully Desc. MIT Rad. Lab. Series, Vol. 1, pps. 207-210, 228, 284-286. Comp. Inst. Bk available \$25.00 each.

HUNDREDS MORE IN STOCK  
LARGEST RADAR  
INVENTORY  
IN WORLD.  
WRITE  
FOR  
CATALOG  
ON YOUR  
LETTERHEAD

AUTOMATIC TRACKING SYSTEM

Scl. Atl. Mod. 3101-J70 Antenna Pedestal. AZ-EL 15 deg. per second rated speed. 23 inch dia. bearing. Complete w/control console & mag. amplifiers. Also in stock complete Glo-track receiving system for 200-400 MHz telemetry band including 12' square quad. Helix. All part of Atlas missile instrumentation system.

AN/GSS-1 PASSIVE TRACKER

10 cm passive automatic tracking system with 6 foot parabola. Complete, mounted on van. Supplied by GE for Atlas instrumentation system.

MICROWAVE SYSTEMS

SPARE PARTS IN STOCK

Nike Ajax, Nike Hercules, M-33, MPS-19, TPS-ID, TPS-10D, PPS-6 SPSS, SCR-584, MPQ-19. From Largest Inventory in World

200-2400 mc. RF PKG

Continuous coverage, 30 Watts Cw nominal output. Uses 2C39A. Price \$575.

L BAND RF PKG

20 KW peak 990 to 1040 MC. Pulse width .7 to 1.2 micro sec. Rep. rate 180 to 420 pps. Input 115 vac incl. Receiver \$1200.

200-225 mc RADAR SYSTEM

1 Megawatt output, 200 nautical mile range for long range detection of medium and high altitude jet aircraft as well as general search. AN/TPS-28.

AN/GMD-1B RAWIN RADAR

L-Band Radiosonde Tracking System. Complete, new cond. in stock for immed. del. AN/GMD-2 computer mfg. Gen'l Mills also in stock.

500 KW L BAND RADAR

500 kw 1220-1359 msc. 100 nautical mile search range P.R.T. and A scopes. MIT. thyatron mod 5320 magnetron. Complete system.

C BAND AUTOTRACK

1 Megawatt 10 ft. Parabola. Sperry.

AN/GPG-1 SKYSWEEP TRACKER

3 cm. auto. tracking radar system. Comp. pkg. w/indicator sys. Full target acquisition & auto. tracking. Input 115v 60 cy. new. In stock for immed. del. Entire sys. 6' x 3' x 10". Ideal for infrared tracker, drone tracker, missile tracker, R & D

INDICATOR CONSOLES

AN/SPA-4A, PPI 10", range to 300 mi. VJ-1 PPI 12", Range to 200 mi. VL-1 RH1 12" to 200 mi. 60K ft.

Radio-Research Instrument Co.

45 W. 45th St., New York, N.Y. 10036 ■ 212-586-4691

CIRCLE 966 ON READER SERVICE CARD

Resumes acceptable only from applicants residing within the UNITED STATES.

EMR Computer Input Form

Return this with a copy of your resume if you have one.

For Office Use Only

Registration Number Initial of Last Name

Name Date

Address City State Zip

Home Phone (include area code) Have you registered with this system previously? Yes  No

Position Desired:

Geographical Preference: I will NOT relocate   
I will consider opportunities in the:  Northeast  Mid Atlantic  Midwest  South  Southwest  Calif.  Northwest  Any location I prefer:  Metropolitan area  Medium town  Rural area

Availability: Date available (within four months) Identity Release: My identity may be released to:  All but present employer  Any employer (check one)

Education Degrees Major field Year Earned College or University

Present or Most Recent Position Employer City/State

From Title Duties & Accomplishments

To

Previous Position Employer City/State

From Title Duties & Accomplishments

To

General information (Summarize your overall qualifications and experience in your field. List any pertinent information not included above.)

Current Annual Base Salary Total Years of Experience U.S. Citizen  Yes  No Level of Security Clearance: Presently Employed  Yes  No

Mail (with a copy of your resume if you have one) to: Electronics Manpower Register 330 West 42nd St New York, N.Y. 10036

No fees or charges

**Bench or System — the HP 3450A gives you maximum performance in a minimum space.**

A quick look at the unfolding dodecahedron shows each of the 12 functions the Incredible Dodecameter performs. What it doesn't show is just how well this 5-digit multifunction meter performs each function.

For instance, you not only get true rms capability—you also get value-plus features like true 4-terminal ac ratio testing and 4-terminal ohms measurements.

And, accurate, fast measurements in each of these twelve categories is

only the start. You can add digital output and directly control external equipment like a printer. Or, add remote control and get full programmability for system use.

No matter what the application, you get more for your money with the HP 3450A.

This Incredible Dodecameter lets you start with the basic dc meter and add the capability that best fits your requirements. If your needs change, any of the options (except the rear

input terminals) can be easily installed in the field.

For more information on this outstanding 12 in 1 bargain, just call your local HP field engineer. Or, write Hewlett-Packard, Palo Alto, California 94304. Europe: 1217 Meyrin-Geneva, Switzerland.

Price Basic HP 3450A, \$3150; AC Option 001, \$1250; Ohms Option 002, \$400; Limit Test Option 003, \$350; Digital Output Option 004, \$175; Remote Control Option 005, \$225; Rear Input Terminal Option 006, \$50.

090/8

# The Incredible Dodecameter— A 12-in-1 way to better measurements!

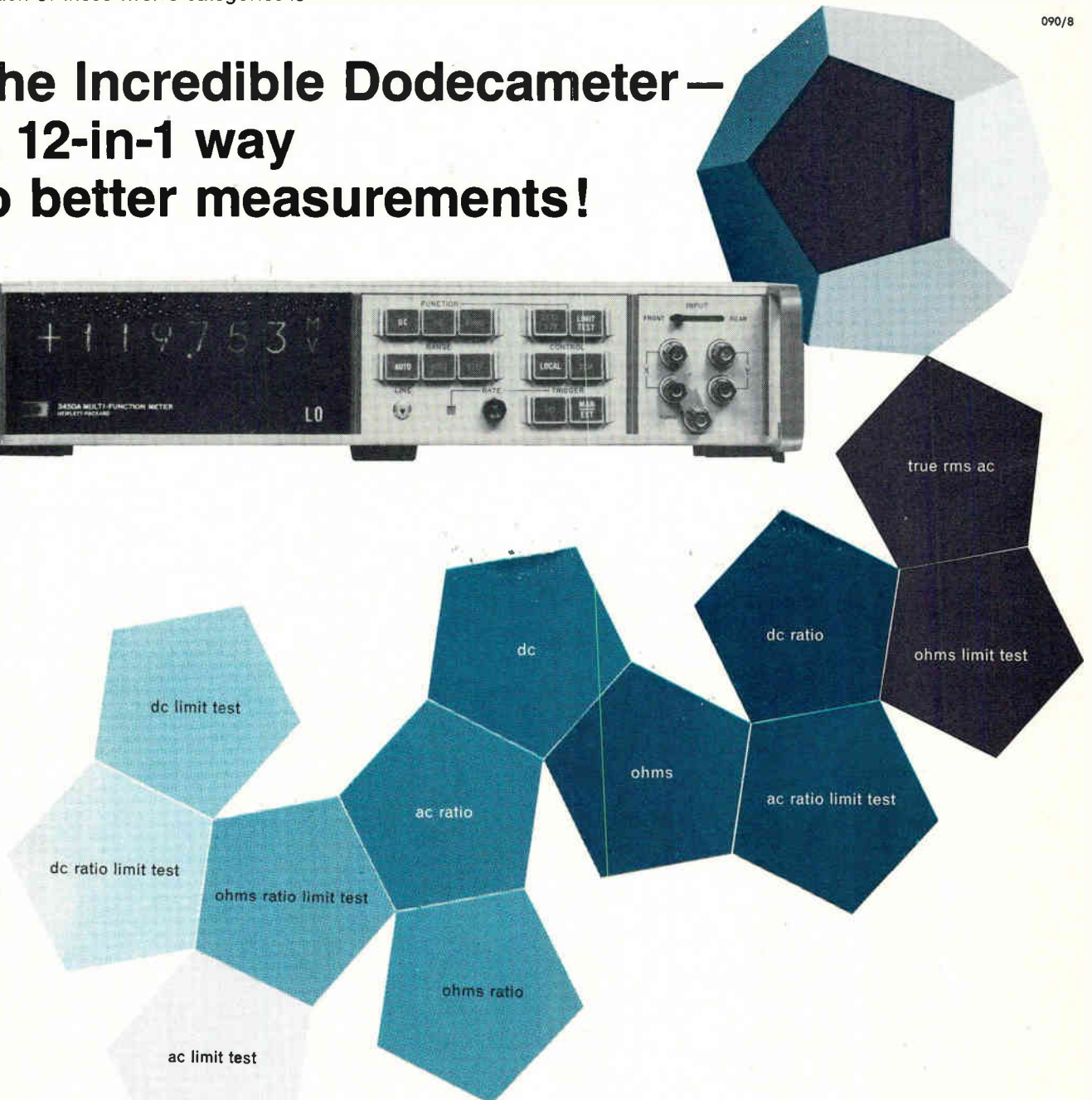
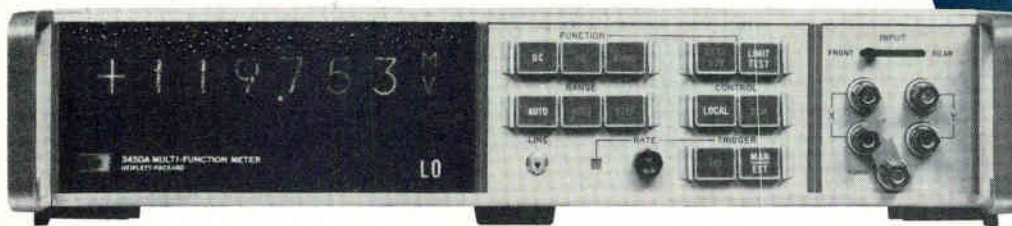

**HEWLETT  PACKARD**  
**DIGITAL VOLTMETERS**

# Electronics advertisers

April 13, 1970

Adams & Westlake Co. Jai Herbert Advertising Advanced Memory Systems Fleig and LeBoeuf Adv., Inc. Aico Electronics Products, Inc. Marketronics Advertising American Optical Corp., Scientific Instrument Div. Fuller & Smith & Ross, Inc. American Telephone & Telegraph Co., Yellow Pages Cunningham & Walsh, Inc. AMP, Inc. Aitkin-Kynett Co., Inc. AMP Europe Allardyce Palmer, Ltd. Amperex Electronics Corp., Div. of North American Philips Co. Sam Groden, Inc. Andrew Corp. Fensholt Adv., Inc. Applied Materials Hall Butler Blatherwick, Inc. Ates Componenti Elettronici, S.P.A. Publicitas Augat, Inc. Horton Church & Goff, Inc.	28 49 22, 189, 191 56 42 20, 21 19E, 20E 61 68 188B, 188C 21E 175	E/MC Electronics/Management Center Ries Cappiello Colwell, Inc. Erie Technological Products Co., Inc. Walker, Schmidt & Mackall, Inc. Exact Electronics Hugh Dwight Adv., Inc.	197 27 132	La Radlotechnique Agence Giorgi LTT Publibel	16E, 17E 24E, 25E
Macrodatta, Inc. Alden Adv. of California, Inc. Magnecraft Electric Co. Mills, Fife and MacDonals, Inc. Markel and Sons, L. Frank George Moll Adv., Inc. Matsuo Electric Co., Ltd. Daiko Advertising, Inc. Memory Systems, Inc. Microsonics, Inc. S. Gunnar Myrbeck and Co. Microwave Cavity Laboratories Don Z Advertising Minnesota Mining and Mfg. Co., Scotchpar Div. Young and Rubicam, Inc. Mitsubishi Electric Corp. Hakuhodo, Inc. Motorola Communications and Electronics, Inc. Brand Adv., Inc. Motorola Semiconductor Products, Inc. Lane & Wampler Adv., Inc. Multicore Solders, Ltd. Jefferies Harper & Partners, Ltd.	167 38 77 191 206 180 94 181, 201 188A 207 43 8E	General Dynamics Corp. Young and Rubicam, Inc. General Electric Co., Capacitor and Battery Department Robert S. Cragin, Inc. General Electric Co., Lighting Systems Department Doe-Anderson Adv. Agcy., Inc. General Instrument Microelectronics Michael Lawler & Borradaile Ltd. General Instrument Corp. Semiconductor Products Div. Norman Allen Associates General Magnetics McCarthy/Scelba/DeBiasi Adv. Agcy., Inc. General Radio Co. Horton, Church and Goff, Inc. Gould, Inc./Brush Instruments Carr Liggett Adv., Inc. Gould, Inc./Graphics Carr Liggett Advertising GPS Corp. Goldman and Daniels, Inc. Grayhill, Inc. Carr Liggett Adv., Inc. Guardian Electric Mfg. Co. Kolb/Tookey and Assoc., Inc.	86, 87 54, 55 81 15E 92, 93 8 2nd Cover 172 66, 67 190 199 41	Hamilton Watch Co. Beaumont, Heller & Sperling, Inc. Heath Co., Sub. of Schlumber Ltd. Advance Advertising Services Hewlett Packard, Colorado Springs Div. Tallant/Yates Adv., Inc. Hewlett Packard, Loveland Div. Tallant/Yates Advertising Hewlett Packard, Microwave Div. Lennen & Newell, Inc. Hewlett Packard, New Jersey Div. McCarthy Scelba and DiBiasi Adv. Agcy., Inc. Hewlett Packard, Rockaway Div. Culver Adv., Inc. Hewlett Packard, Santa Clara Div. Lennen & Newell, Inc. Hughes Aircraft Co. Foote, Cone & Belding Hysol Corp. Barber & Drullard, Inc.	40 136 12, 13 23, 204 1 168, 169 153 2 58, 59, 150 152
Barnes Corp. Industrial Public Relations, Inc. Beckman Instruments, Inc., Helipot Div. N.W. Ayer/Jorgensen/MacDonald, Inc. Bell Telephone Laboratories N. W. Ayer & Sons, Inc. Bendix Corp., Scientific Instruments & Equipment Div. MacManus, John & Adams, Inc. BIT Incorporated Hill, Holliday, Connors, Cosmopolos, Inc. Bourns, Inc., Trimpot Div. The Lester Co. Brand-Rex Creamer, Trowbridge, Case & Basford, Inc. Branson Instruments (Industrial Cleaning Division) Doremus and Company, Inc. Branson Sonic Power Div. of Smith Kline & French Laboratories Doremus & Company, Inc. Burdny Corp. The Gravenson Group, Inc. Burr Brown Research Corp. N. A. Winter Adv. Agcy. Bussmann Mfg. Div. of McGraw Edison Co. Henderson Adv. Co. By-Buk Co. J. R. Bloome Co.	184, 185 15 53 142 90, 91 82 79 37 76 131 22E 187 192	I.E.R. PEMA Indiana General Corp., Electronics Div. The Griswold & Eshleman Co. Industrial Exhibitions Walkley Hodgson, Ltd. International Crystal Mfg. Co. Robert V. Freeland & Associates Iowa Development Commission Cresswell, Munsell, Schubert & Zirbet, Inc. Isostat Editions Gead ITT Europe Brockie Haslam Chiney & Allon, Ltd. ITT General Controls MacManus, John & Adams, Inc.	29E 179 158 200 141 28E 31E 164, 165	JFD Electronics Corp., Components Div. Delphi Adv., Inc. Johanson Manufacturing Corp. Josephson, Cuffari & Company Johnson Company, E.F. Martin Williams Advertising	190 139 32
Cambridge Thermionic Corp. Chirurg & Cairns, Inc. Coptor Corp. Weber, Geiger & Kalat, Inc. Cherry Electrical Products Corp. Kolb/Tookey and Associates, Inc. Clntra Bonfield Associates Colorado Video, Inc. Wolff & Weir Computer Products, Inc. Art After Six Computervision Hill, Holliday, Connors, Cosmopolos, Inc. Contelec Mario Willi CRC SPI Curtis Instruments, Inc. Knudsen-Moore, Inc.	181 24 75 159 188 157 88, 89 30E 10E 145	Keeco, Inc. Weiss Advertising Krohn-Hite Corp. Ingalls Associates, Inc.	52 135	Keoco, Inc. Weiss Advertising Krohn-Hite Corp. Ingalls Associates, Inc.	52 135
Data Control Systems Technical, Industrial & Scientific Marketing, Inc. Delco Radio Division General Motors Corp. Campbell-Ewald Co. Delevan Electronics Corp. Stahlk. Fallier & Klenk, Inc. Dlalight Corp. Michel Cather, Inc. DuPont de Nemours & Co., Freon Div. N. W. Ayer & Son, Inc.	129 64, 65 148 154 188D	Lambda Electronics Corp. Michel Cather, Inc.	3rd Cover, 211, 212	RCA Electronics Components Al Paul Lefton Co. Raytheon Co., Components Div. Fuller & Smith & Ross, Inc. RCL Electronics, Inc. Morvay Adv. Agcy. Reliance Controls, Ltd. Bond Publicity Services, Ltd. Republic Electronic Industries Corp. Sharick Associates, Inc. R F Communications, Inc. Beachner Adv. Agcy. Rogan Brothers Christopher Adv., Inc. Rohde & Schwarz	4th Cover, 183, 193 62, 63 14 26E 174 197 207 33E
Eagle Signal Div. of Gulf & Western Co. Gever, Oswald, Inc. Eastman Kodak Co., Business Svstems Markets Div. J. Walter Thompson Co. Edwards High Vacuum, Inc. B. P. Myer Assoc., Inc. Elco Corp. Schaefer Adv., Inc. Electronic Arrays, Inc. Hal Lawrence, Inc. Electronic Counters, Inc. Tek-Mark, Inc.	146, 147 171 130 29 162 201	Sage Electronics Corp. Mathison Adv., Inc. Sanken Electric Co., Ltd. Seikosha Adv., Inc. Schlumberger Ltd. EMD T.B. Brown, Ltd. Schlumber SIS T.B. Brown, Ltd. Sierra Research Corp. B.P. Myer Assoc., Inc. Signetics Corp., Sub. Corning Glass Works Cunningham & Walsh, Inc. Silec Electronique Promotion Vente Publicite Silliconix, Inc. Robertson West, Inc. Simpson Electric Co. Amerad Advertising Service, Inc. Singer Company, The Instrumentation Div., Alfred Operation Bonfield Associates Sogle Etudes et Creations Publicitaire	196 199 3E 4E 189 127 12E, 13E 149 194 156 6E	National Electronics, Inc., Subsidiary Varian Associates Connor-Sager Associates, Inc. National Semiconductor Corp. Hall Butler Blatherwick, Inc. New Hermes Engraving Machine Corp. Lester Harrison Adv., Inc. Northern Natural Gas Co. Bozell and Jacobs, Inc. Norton Assoc., Inc. J.J. Coppo Co. Oak Mfg. Co., A Division of O/E/N Buchen Adv., Inc. Owens-Illinois, Inc. Meldrum and Fewsmith, Inc. Pacific Measurements, Inc. Jack Herrick Adv., Inc. Pechiney St. Gobain PEMA Pfizer & Company Chas. MPM Div. Newmark, Posner & Mitchell, Inc. Philips Electronics Instruments Marsteller, Inc. Philips N.V. Pit/Tmi Div. Marsteller International S.A. Polymotor S.A. Power Physics M.S.D. Adv. Agcy., Inc. PRD Electronics Caroe Marketing, Inc.	26 6, 7 202 195 192 207 177 60 11E 198 113 2E 34E 140 27E

# EAROM

an  
**Idiot Proof  
 Plated  
 Wire  
 Electrically  
 Alterable  
 Read  
 Only  
 Memory**

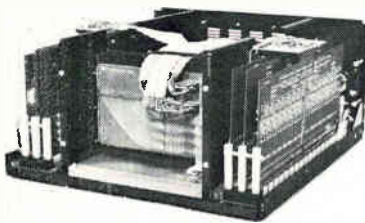

200ns NDRO cycle  
 1µs write cycle  
 non volatile  
 highly modular  
 60 day delivery

## Memory Systems, Inc.

3341 W. El Segundo Boulevard  
 Hawthorne, Calif. (213) 772-4220

□ Solartron Electronics Group Ltd. T.B. Browne, Ltd. Solitron Devices, Inc. Barnes-Champ/Advertising Solitron Devices, Inc. Christopher James Adv., Inc.	5E 134 57
□ Sorlaui & Cie. Ariane Publicite S.P. Ellettronica Studio Sergio Rosata Standard Condenser Corp. (Rtron) R.N. Johnson Advertising Struthers Dunn, Inc. Harry P. Bridge Co.	9E 7E 50 186
■ Sylvania Electric Products, Inc. Parts Div. Doyle Dane Bernbach, Inc.	85 202
■ Syntron Instruments, Inc. Burton Browne Advertising	
TA Manufacturing Corp. Bear Adv., Inc. Tec, Inc. Stevenson and Assoc., Inc. Tempress Industries, Inc. Hal Lawrence, Inc. Tenney Engineering Inc. Keyes Martin & Co. Texas Industrial Commission The Pitluk Group Advertising Texas Instruments Incorporated, Components Group Albert Frank-Guenther Law, Inc.	197 178 25 201 199 39
■ Texscan Corp. MacGill/Ross, Inc. Trans World Airlines Wells, Rich, Greene, Inc.	16 170
■ Trygon Electronics, Inc. Technical, Industrial & Scientific Marketing, Inc.	192
■ Tung-Sol Div., Wagner Electric Corp. Winius-Brandon Co.	30, 31
United Aircraft Electronic Components Cunningham & Walsh, Inc. United Systems Corp. Advertising & Merchandising, Inc.	80 36 51
■ Unitrode Corp. Silton Brothers, Inc. University Computing Co. Management Communication Consultants, Inc.	208
Westinghouse Semiconductor Div. Ketchum, MacLeod and Grove, Inc. Weston Instruments, Inc., Newark Div. Arndt, Preston, Chapin, Lamb & Keen, Inc. Winchester Electronics, Div. Litton Industries Wilson, Haight & Welch, Inc. Wiremold Company, The Charles Brunelle Co.	160, 161 133 133 35 188
Xerox Corp. Hutchins Adv. Co., Inc. Xerox Data Systems Doyle, Dane, Bernbach, Inc.	78 44

### Classified & Employment Advertising

F.J. Eberle, Manager  
 212-971-2557

EMPLOYMENT OPPORTUNITIES ..... 203

EQUIPMENT  
 (Used or Surplus New)

For Sale

Radio Research Instrument Co..... 203

- For more information on complete product line see advertisement in the latest Electronics Buyer's Guide
- Advertisers In Electronics International

### Electronics Buyers' Guide

George F. Werner, Associate Publisher  
 [212] 971-2310

Regina Hera, Directory Manager  
 [212] 971-2544

Mary Tully, Production Manager  
 [212] 971-2046

Sales Offices:

Boston, Ben Briggs [617] CO2-1160  
 New York, Cliff Montgomery [212] 971-3793  
 Jim Vick [212] 971-2661

Chicago, Bob Denmead [312] MO4-5800  
 Los Angeles, Kenneth Watts [213] HU2-5450  
 Philadelphia, Joseph Bryan [215] LO8-6161

Philadelphia, Joseph Bryan [215] LO8-6161

Philadelphia, Joseph Bryan [215] LO8-6161

Philadelphia, Joseph Bryan [215] LO8-6161

Philadelphia, Joseph Bryan [215] LO8-6161

Philadelphia, Joseph Bryan [215] LO8-6161

## Advertising Sales Staff

Dan McMillan III [212] 971-3468 Associate Publisher Wallis Clarke [212] 971-2187 Advertising Sales Service Manager Tomlinson Howland [212] 971-6792 Promotion Manager Marylin Crosson [212] 971-6643 Promotion Assistant Warren H. Gardner [212] 971-3139 Eastern Advertising Sales Manager	
Atlanta: Ga. 30309: Charlton H. Calhoun, III 1375 Peachtree St., N.E. [404] 892-2868	
Boston, Mass. 02116: William S. Hodgkinson McGraw-Hill Building, Copley Square [617] CO 2-1160	
Cleveland, Ohio 44113: William J. Boyle, 55 Public Square, [216] SU 1-7000	
New York, N.Y. 10036 500 Fifth Avenue James R. Pierce [212] 971-3615 John A. Garland [212] 971-3617 Michael J. Stoller [212] 971-3616	
Philadelphia, Pa. 19103: Jeffrey M. Preston 6 Penn Center Plaza, [215] LO 8-6161	
Pittsburgh, Pa. 15222: Jeffrey M. Preston, 4 Gateway Center, [412] 391-1314 Rochester, N.Y. 14534: William J. Boyle, 9 Greylock Ridge, Pittsford, N.Y. [716] 586-5040	
Chicago, Ill. 60611: Ralph Hanning, Kenneth E. Nicklas, 645 North Michigan Avenue, [312] MO 4-5800	
Dallas, Texas 75201: Richard P. Poole, 1800 Republic National Bank Tower, [214] RI 7-9721	
Houston, Texas 77002: Richard P. Poole 2270 Humble Bldg. [713] CA 4-8381	
Detroit, Michigan 48226: Ralph Hanning, 856 Penobscot Building [313] 962-1793	
Minneapolis, Minn. 55402: Kenneth E. Nicklas 1104 Northstar Center [612] 332-7425	
St. Louis, Mo. 63105: Kenneth E. Nicklas, The Clayton Tower, 7751 Carondelet Ave. [314] PA 5-7285	
James T. Hauptli [415] DO 2-4600 Western Advertising Sales Manager	
Denver, Colo. 80202: David M. Watson, Richard W. Carpenter Tower Bldg., 1700 Broadway [303] 266-3863	
Los Angeles, Calif. 90017: Ian C. Hill, Bradley K. Jones, 1125 W. 6th St., [213] HU 2-5450	
Portland, Ore. 97204: Don Farris, James T. Hauptli, 218 Mohawk Building, 222 S.W. Morrison Street, Phone [503] 223-5118	
San Francisco, Calif. 94111: Don Farris, James T. Hauptli, 255 California Street, [415] DO 2-4600	
Pierre Braude Tel: 727 73 01: Paris International Director	
Paris: Denis Jacob 17 Rue-Georges Bizet, 75 Paris 16, France Tel 727 33 42, 727 33 60	
United Kingdom and Scandinavia London: Oliver Ball, Tel: Hyde Park 1451 34 Dover Street, London W1	
Milan: Robert Saidel, Roberto Laureri Jr. 1 via Baracchini Phone 86-90-656	
Brussels: Denis Jacob 27 Rue Ducale Tel: 136503	
Frankfurt/Main: Hans Haller Elsa-Brandstroem Str. 2 Phone 72 01 81	
Geneva: Pierre Braude 1 rue du Temple Phone: 31 95 60	
Tokyo: Noboru Matsumoto, McGraw-Hill Publications Overseas Corporation, Kasumigaseki Building 2-5, 3-chome, Kasumigaseki, Chiyoda-Ku, Tokyo, Japan [581] 9811	
Osaka: Akihiko Kamesaka, McGraw-Hill Publications Overseas Corporation, Kondo Bldg., 163, Umegae-cho Kita-ku [362] 8771	
Australasia: Warren E. Ball, IPO Box 5106, Tokyo, Japan	
Business Department Stephen R. Welss, Manager [212] 971-2044 Thomas M. Egan, Production Manager [212] 971-3140 Maury D'Gongora, Assistant Production Manager [212] 971-2045 Dorothy Carmesin, Contracts and Billings [212] 971-2908 Frances Vallone, Reader Service Manager [212] 971-2865	

## Motorola temperature compensated crystal oscillators



**Come in small packages  
Do a big job**

Where low power, small size and instant warm-up are required, choose a Motorola TCXO. They're ideal for a wide variety of industrial applications.

**Small Size.** They come in packages as small as 1.5 cubic inch.

**Wide Frequency Range.** From 400 KHz to 40 MHz.

**Stability.**  $\pm 1$  ppm from 0° to + 55°C.

**Low Aging.** Less than  $1 \times 10^{-6}$  per year.

And if you need a non-standard TCXO, just let us know. Variations in input voltage, frequency, output level and wave shape are available on special order.

For complete information, send for your free copy of Bulletin TIC-3213 today. Write Component Products, Dept. 40F, Motorola Communications & Electronics, Inc., 4501 W. Augusta Blvd., Chicago, Illinois 60651; or call (312) 772-6500.



Circle 238 on reader service card

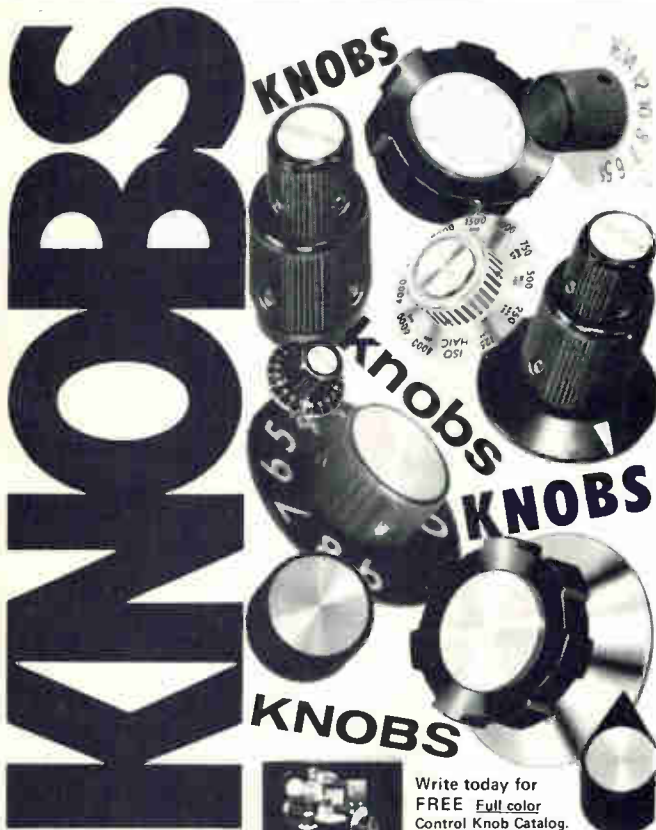

Outline your requirements for quotation and FREE knob sample



Write today for  
FREE Full color  
Control Knob Catalog.

**Rogan**  
BROTHERS, INC.

8031 N. Monticello Ave.  
Skokie, Illinois 60076  
312/675-1234

Circle 239 on reader service card

## Oak Versatility



**Now! One new exclusive switch replaces seven**  
You can easily eliminate tedious design engineering problems—just use versatile Multidex® switches. They're available in thousands of variations...are smaller than the switches they replace...yet provide more contacts (up to 36) at no additional cost. Crisp Detenting... the patented Unidex™ detent offers uniform "feel" for long life in choices from 10° to 36° throw. Meets MIL-S-3786, SR32 requirements.

Superb Insulation... molded diallyl phthalate meets MIL-M-14 requirements and guarantees electrical continuity between mounting and housing. Glass-alkyd insulation available on request. Special contacts and clips... Oak-pioneered, double-wiping, self-cleaning contacts assure trouble-free operation. Special AF clips with large windows speed wiring.

What's more, Multidex switches meet commercial and military environmental requirements. Special options available on request. For full details, write today for Bulletin SP-324.



**OAK MANUFACTURING CO.**  
A Division of OAK ELECTRO/NETICS EDAP  
Crystal Lake, Illinois 60014  
PHONE: 815-459-5000 TWX: 910-634-3353

See us at NEW Show Booth No. 4218

Circle 207 on reader service card

207

# How much is this flight costing you?



## UCC's Computer Utility lets your engineers work...not wait.

When your computer facility bogs down from overload, give your engineers a work plan, not a flight plan. Just plug into the UCC Computer Utility Network — through your own terminal, a UCC COPE, or other compatible system.

Put the pencil to what an engi-

neer's down time costs you while he's waiting to get to the computer, and the economics of the Utility stand out clearly.

Our nationwide network of UCC 1108's quickly puts an end to the

**the total service Computer Utility company**

ever-growing queue in computing.

Let your engineers work, not wait. Simply write or call your nearest UCC Computer Utility Center today.



**UNIVERSITY COMPUTING COMPANY**

1949 North Stemmons Freeway, Dallas, Texas 75207

Computer Utility Centers in: Boston, Chicago, Dallas, Denver, East Brunswick, N.J., Houston, Kansas City, Los Angeles, New Orleans, New York, Palo Alto and Tulsa.

Circle 208 on reader service card



# Only Lambda's power supplies are listed in Underwriters' Laboratories Recognized Component Index

## LM series: up to 150 volts, up to 33 amps

### All silicon semiconductors

#### Convection cooled

no external heat sinking required

#### Regulation

line .05% + 4mv  
load .03% + 3mv, no load to full load

#### Ripple and noise

1mv rms; 3mv p-to-p

### Wide input voltage and frequency range

105-132 vac, 45-65 Hz, 40°C rating not applicable  
for 50 Hz operation

### Wide operating temperature range

-20°C to + 71°C

### Temperature coefficient

.03%/°C

### Multi-current-rated

### Complete serviceability

all components replaceable

### Remote sensing

### No voltage spikes or overshoot

on turn-on, turn-off or power failure

### Remote programming

200 ohms/v nominal

### Completely protected

automatic current limiting and self-resetting thermostats

### Overvoltage protection

available as accessory up to 70vdc

### Finish

grey, FED. STD. 595 No. 26081

### Mounting

three surfaces for A, B, C, CC and D packages,  
One surface for E and EE packages.

### High performance option

All models available with these specifications  
at \$15.00 surcharge:

line regulation .01% + 1 mv  
load regulation .02% + 2 mv  
ripple and noise 0.5mv rms; 1.5 mv p-to-p with 60 Hz input  
temp. coeff. 01%/°C

### AC input option

add suffix "-V" to model number for 205-265 vdc operation,  
(40°C rating not applicable), and in U.S. and Canada  
add \$10.00 or 10% extra to the price, whichever is greater.

### Fungus proofing option

add suffix "-R" to model number and \$10.00 to price  
to obtain MIL-V-173 varnish on all fungi nutrient  
components.

### Lambda is its own distributor

## Lambda offers you 7 package sizes in these modular power supplies



**A module**

up to 120 volts • up to 2.0 amps



**B module**

up to 150 volts • up to 3.8 amps



**C module**

up to 150 volts • up to 5.3 amps



**CC module**

up to 150 volts • up to 11.0 amps



**D module**

up to 150 volts • up to 13.1 amps



**E module**

up to 150 volts • up to 22.0 amps



**EE module**

up to 150 volts • up to 33 amps

# LM series fixed-voltage models

## Package B 3 1/16" x 4 1/16" x 6 1/2"

Model	ADJ. VOLT. RANGE VDC	MAX AMPS AT AMBIENT OF: <sup>1</sup>				Price <sup>2</sup>
		40°C	50°C	60°C	71°C	
LM-B-3	3 ±5%	3.8	3.3	2.6	1.6	\$119
LM-B-3-P-6	3.6±5%	3.8	3.3	2.6	1.6	119
LM-B-4	4 ±5%	3.8	3.3	2.6	1.6	119
LM-B-4-P-5	4.5±5%	3.7	3.2	2.5	1.5	119
LM-B-5	5 ±5%	3.7	3.2	2.5	1.5	119
LM-B-6	6 ±5%	3.2	2.9	2.4	1.4	119
LM-B-8	8 ±5%	3.2	2.9	2.4	1.4	119
LM-B-10	10 ±5%	2.7	2.5	2.2	1.4	119
LM-B-12	12 ±5%	2.5	2.3	2.1	1.3	119
LM-B-15	15 ±5%	2.2	2.0	1.8	1.3	119
LM-B-18	18 ±5%	2.0	1.8	1.7	1.3	119
LM-B-20	20 ±5%	1.8	1.6	1.5	1.2	119
LM-B-24	24 ±5%	1.4	1.3	1.2	1.1	119
LM-B-28	28 ±5%	1.3	1.2	1.1	1.0	119
LM-B-36	36 ±5%	1.1	1.0	0.90	0.85	119
LM-B-48	48 ±5%	0.9	0.85	0.80	0.75	119
LM-B-100	100 ±5%	0.37	0.34	0.30	0.28	139
LM-B-120	120 ±5%	0.30	0.28	0.25	0.23	139
LM-B-150	150 ±5%	0.25	0.23	0.20	0.19	139

## Package D 4 1/16" x 7 1/2" x 9 3/8"

Model	ADJ. VOLT. RANGE VDC	MAX AMPS AT AMBIENT OF: <sup>1</sup>				Price <sup>2</sup>
		40°C	50°C	60°C	71°C	
LM-D-3	3 ±5%	13.1	11.3	9.2	6.2	\$209
LM-D-3-P-6	3.6±5%	13.1	11.3	9.2	6.2	209
LM-D-4	4 ±5%	13.1	11.3	9.2	6.2	209
LM-D-4-P-5	4.5±5%	13.1	11.3	9.2	6.2	209
LM-D-5	5 ±5%	12.6	10.8	9.2	6.1	209
LM-D-6	6 ±5%	12.4	10.6	8.9	6.0	209
LM-D-8	8 ±5%	12.2	10.3	8.8	5.9	209
LM-D-10	10 ±5%	10.8	9.7	8.5	5.7	209
LM-D-12	12 ±5%	10.0	9.2	8.3	5.7	209
LM-D-15	15 ±5%	9.0	8.4	7.9	5.3	219
LM-D-18	18 ±5%	7.9	7.4	6.9	5.0	219
LM-D-20	20 ±5%	7.4	6.9	6.5	4.9	219
LM-D-24	24 ±5%	6.7	6.3	5.8	4.8	219
LM-D-28	28 ±5%	6.0	5.6	5.2	4.7	219
LM-D-36	36 ±5%	5.4	5.0	4.7	4.3	239
LM-D-48	48 ±5%	4.1	3.9	3.6	3.1	239
LM-D-100	100 ±5%	1.7	1.5	1.3	1.1	239
LM-D-120	120 ±5%	1.5	1.3	1.1	1.0	239
LM-D-150	150 ±5%	1.1	1.0	0.90	0.80	239

## Package C 3 1/16" x 4 1/16" x 9 3/8"

Model	ADJ. VOLT. RANGE VDC	MAX AMPS AT AMBIENT OF: <sup>1</sup>				Price <sup>2</sup>
		40°C	50°C	60°C	71°C	
LM-C-3	3 ±5%	5.3	4.6	3.7	2.5	\$139
LM-C-3-P-6	3.6±5%	5.2	4.5	3.6	2.5	139
LM-C-4	4 ±5%	5.2	4.5	3.6	2.5	139
LM-C-4-P-5	4.5±5%	5.1	4.4	3.5	2.4	139
LM-C-5	5 ±5%	5.1	4.3	3.4	2.4	139
LM-C-6	6 ±5%	4.8	4.1	3.3	2.4	139
LM-C-8	8 ±5%	4.6	3.9	3.2	2.1	139
LM-C-10	10 ±5%	4.2	3.6	3.0	2.0	139
LM-C-12	12 ±5%	4.0	3.5	2.9	1.9	139
LM-C-15	15 ±5%	3.5	3.2	2.8	1.9	139
LM-C-18	18 ±5%	3.2	3.0	2.7	1.9	139
LM-C-20	20 ±5%	3.1	2.9	2.6	1.8	139
LM-C-24	24 ±5%	2.5	2.4	2.2	1.5	139
LM-C-28	28 ±5%	2.3	2.1	2.0	1.4	139
LM-C-36	36 ±5%	2.0	1.8	1.7	1.3	159
LM-C-48	48 ±5%	1.6	1.4	1.3	1.0	159
LM-C-100	100 ±5%	0.55	0.51	0.47	0.42	159
LM-C-120	120 ±5%	0.49	0.45	0.42	0.38	159
LM-C-150	150 ±5%	0.39	0.36	0.33	0.30	159

## Package E 4 1/16" x 7 1/2" x 11 3/4"

Model	ADJ. VOLT. RANGE VDC	MAX AMPS AT AMBIENT OF: <sup>1</sup>				Price <sup>2</sup>
		40°C	50°C	60°C	71°C	
LM-E-3	3 ±5%	22.0	20.0	16.5	10.0	\$269
LM-E-3-P-6	3.6±5%	21.0	19.0	16.5	10.0	269
LM-E-4	4 ±5%	21.0	19.0	16.5	10.0	269
LM-E-4-P-5	4.5±5%	20.0	18.0	16.4	10.0	269
LM-E-5	5 ±5%	20.0	18.0	16.4	10.0	269
LM-E-6	6 ±5%	19.0	17.3	15.6	10.0	269
LM-E-8	8 ±5%	18.0	16.4	14.7	10.0	269
LM-E-10	10 ±5%	16.0	14.5	13.0	9.5	269
LM-E-12	12 ±5%	15.0	13.6	12.3	9.5	269
LM-E-15	15 ±5%	14.0	12.7	11.5	8.6	269
LM-E-18	18 ±5%	13.0	11.8	10.6	8.6	269
LM-E-20	20 ±5%	12.0	10.9	9.8	8.5	269
LM-E-24	24 ±5%	11.0	10.0	9.0	7.6	269
LM-E-28	28 ±5%	10.0	9.0	8.0	7.1	269
LM-E-36	36 ±5%	8.0	7.3	6.5	5.7	269
LM-E-48	48 ±5%	6.0	5.4	4.9	4.3	299
LM-E-100	100 ±5%	2.0	1.7	1.6	1.5	299
LM-E-120	120 ±5%	1.7	1.5	1.4	1.2	299
LM-E-150	150 ±5%	1.4	1.3	1.2	1.0	299

## Package CC 4 1/16" x 4 1/16" x 9 3/8"

Model	ADJ. VOLT. RANGE VDC	MAX AMPS AT AMBIENT OF: <sup>1</sup>				Price <sup>2</sup>
		40°C	50°C	60°C	71°C	
LM-CC-3	3 ±5%	11.0	9.4	8.2	5.5	\$179
LM-CC-3-P-6	3.6±5%	11.0	9.4	8.2	5.5	179
LM-CC-4	4 ±5%	11.0	9.4	8.2	5.5	179
LM-CC-4-P-5	4.5±5%	10.5	9.0	8.0	5.5	179
LM-CC-5	5 ±5%	10.5	9.0	8.0	5.5	179
LM-CC-6	6 ±5%	9.0	8.4	7.7	5.5	179
LM-CC-8	8 ±5%	8.5	7.9	7.2	5.5	179
LM-CC-10	10 ±5%	7.5	7.0	6.3	5.0	179
LM-CC-12	12 ±5%	7.3	6.8	5.9	4.7	179
LM-CC-15	15 ±5%	6.0	5.6	5.1	4.3	179
LM-CC-18	18 ±5%	5.5	5.1	4.7	4.1	179
LM-CC-20	20 ±5%	5.0	4.6	4.2	3.6	179
LM-CC-24	24 ±5%	4.0	3.7	3.4	3.0	179
LM-CC-28	28 ±5%	3.5	3.4	3.1	2.8	179
LM-CC-36	36 ±5%	3.0	2.9	2.7	2.4	199
LM-CC-48	48 ±5%	2.5	2.4	2.2	1.9	199
LM-CC-100	100 ±5%	1.0	0.96	0.90	0.80	199
LM-CC-120	120 ±5%	0.9	0.86	0.80	0.70	199
LM-CC-150	150 ±5%	0.7	0.67	0.62	0.55	199

## Package EE 4 1/16" x 7 1/2" x 16 1/2"

Model	ADJ. VOLT. RANGE VDC	MAX AMPS AT AMBIENT OF: <sup>1</sup>				Price <sup>2</sup>
		40°C	50°C	60°C	71°C	
LM-EE-3	3 ±5%	33.0	29.0	25.0	20.5	\$320
LM-EE-3-P-6	3.6±5%	32.0	26.0	22.0	18.3	320
LM-EE-4	4 ±5%	32.0	26.0	22.0	18.3	320
LM-EE-4-P-5	4.5±5%	31.0	24.6	20.8	17.3	320
LM-EE-5	5 ±5%	31.0	24.6	20.8	17.3	320
LM-EE-6	6 ±5%	30.0	24.6	20.8	17.3	320
LM-EE-8	8 ±5%	28.0	23.5	19.7	16.5	320
LM-EE-10	10 ±5%	24.0	20.4	16.8	13.8	320
LM-EE-12	12 ±5%	21.0	19.0	16.1	13.2	320
LM-EE-15	15 ±5%	19.0	18.0	15.5	12.7	320
LM-EE-18	18 ±5%	16.5	14.8	12.4	10.1	320
LM-EE-20	20 ±5%	15.2	13.7	11.8	9.7	320
LM-EE-24	24 ±5%	14.0	12.5	10.8	9.0	320
LM-EE-28	28 ±5%	13.0	11.5	9.8	8.2	320
LM-EE-36	36 ±5%	10.4	9.8	8.6	7.1	320
LM-EE-48	48 ±5%	7.7	7.1	6.5	5.4	320
LM-EE-100	100 ±5%	3.3	3.0	2.5	2.1	350
LM-EE-120	120 ±5%	3.0	2.7	2.2	1.9	350
LM-EE-150	150 ±5%	2.2	2.0	1.75	1.50	350

# LM series wide-range models

## Package A 3 3/8" x 3 3/4" x 6 1/2"

Model	ADJ. VOLT. RANGE VDC	MAX AMPS AT AMBIENT OF: <sup>1</sup>				Price <sup>2</sup>
		40°C	50°C	60°C	71°C	
LM-201	0-7	0.85	0.75	0.70	0.55	\$79
LM-202	0-7	1.7	1.5	1.4	1.1	89
LM-252	0-7	2.0	1.8	1.4	1.1	99
LM-203	0-15	0.45	0.40	0.38	0.28	79
LM-204	0-15	0.90	0.80	0.75	0.55	89
LM-258	0-15	1.2	1.1	1.0	0.80	99
LM-261	0-24	0.70	0.65	0.60	0.45	89
LM-262	0-24	0.80	0.75	0.70	0.60	99
LM-206	0-32	0.50	0.45	0.40	0.30	89
LM-264	0-32	0.66	0.60	0.50	0.32	99
LM-266	0-60	0.35	0.31	0.28	0.25	109
LM-267	0-120	0.10	0.09	0.08	0.07	109
LM-268	0-120	0.15	0.14	0.12	0.11	119

## Package B 3 3/8" x 4 1/8" x 6 1/2"

Model	ADJ. VOLT. RANGE VDC	MAX AMPS AT AMBIENT OF: <sup>1</sup>				Price <sup>2</sup>
		40°C	50°C	60°C	71°C	
LM-B-0-7	0-7	2.8	2.6	2.3	1.5	\$109
LM-B-0-14	0-14	1.6	1.5	1.3	1.2	109
LM-B-0-32	0-32	0.8	0.7	0.6	0.5	109
LM-B-0-60	0-60	0.45	0.4	0.35	0.3	109
LM-217	8.5-14	2.1	1.9	1.7	1.3	119
LM-218	13-23	1.5	1.3	1.2	1.0	119
LM-219	22-32	1.2	1.1	1.0	0.8	119
LM-220	30-60	0.70	0.65	0.60	0.45	129

## Package C 3 3/8" x 4 1/8" x 9 3/8"

Model	ADJ. VOLT. RANGE VDC	MAX AMPS AT AMBIENT OF: <sup>1</sup>				Price <sup>2</sup>
		40°C	50°C	60°C	71°C	
LM-225	0-7	4.0	3.6	3.0	2.4	\$139
LM-C-0-14	0-14	2.2	2.0	1.8	1.5	139
LM-C-0-32	0-32	1.1	1.0	0.90	0.80	139
LM-C-0-60	0-60	0.60	0.55	0.50	0.45	139
LM-226	8.5-14	3.3	3.0	2.5	2.0	139
LM-227	13-23	2.3	2.1	1.7	1.4	139
LM-228	22-32	2.0	1.8	1.5	1.2	139
LM-229	30-60	1.1	1.0	0.80	0.60	149



Write, wire or cable for new 72-page catalog

## Package D 4 1/8" x 7 1/2" x 9 3/8"

Model	ADJ. VOLT. RANGE VDC	MAX AMPS AT AMBIENT OF: <sup>1</sup>				Price <sup>2</sup>
		40°C	50°C	60°C	71°C	
LM-234	0-7	8.3	7.3	6.5	5.5	\$199
LM-D-0-14	0-14	4.9	4.2	3.4	2.7	199
LM-D-0-32	0-32	2.5	2.1	1.7	1.3	180
LM-D-0-60	0-60	1.3	1.1	0.95	0.75	239
LM-235	8.5-14	7.7	6.8	6.0	4.8	199
LM-236	13-23	5.8	5.1	4.5	3.6	209
LM-237	22-32	5.0	4.4	3.9	3.1	219
LM-238	30-60	2.6	2.3	2.0	1.6	239

## Package E 4 1/8" x 7 1/2" x 11 3/4"

Model	ADJ. VOLT. RANGE VDC	MAX AMPS AT AMBIENT OF: <sup>1</sup>				Price <sup>2</sup>
		40°C	50°C	60°C	71°C	
LM-E-0-7	0-7	12.0	10.5	8.5	6.8	\$249
LM-E-0-14	0-14	7.4	6.4	5.2	4.1	249
LM-E-0-32	0-32	3.7	3.2	2.6	2.1	249
LM-E-0-60	0-60	2.1	1.7	1.4	1.1	249

## Package EE 4 1/8" x 7 1/2" x 16 1/2"

Model	ADJ. VOLT. RANGE VDC	MAX AMPS AT AMBIENT OF: <sup>1</sup>				Price
		40°	50°	60°	71°	
LM-EE-0-7	0-7	16	13.5	11.2	9.2	\$320
LM-EE-0-14	0-14	10.2	8.6	7.3	6.1	320
LM-EE-0-32	0-32	5.2	4.4	3.8	3.2	320
LM-EE-0-60	0-60	2.7	2.45	2.15	1.85	320

### NOTES:

<sup>1</sup> CURRENT RATING IS FROM ZERO TO I MAX. CURRENT RATING APPLIES OVER ENTIRE OUTPUT VOLTAGE RANGE. CURRENT RATING APPLIES FOR INPUT VOLTAGE 105-132 VAC 55-65 HZ. FOR OPERATION AT 45-55 HZ DELETE 40°C RATING. FOR OPERATION AT 360-440 HZ CONSULT FACTORY FOR RATINGS AND SPECIFICATIONS.

<sup>2</sup> PRICES F.O.B. FACTORY, MELVILLE, N. Y. ALL SPECIFICATIONS AND PRICES SUBJECT TO CHANGE WITHOUT NOTICE.

## Overvoltage Protectors

Model	Adj. Volt Range	Price
LM-OV-1	3-8V	\$30
LM-OV-2	6-20V	30
LM-OV-3	18-70V	30
LM-OV-7 (for EE pkg.)	3-8V	75
LM-OV-8 (for EE pkg.)	6-20V	75
LM-OV-9 (for EE pkg.)	18-70V	75

**Lambda has over 10,000 power supply units on-the-shelf for 1-day delivery. Every one is fully guaranteed for 5 years... material and labor.**

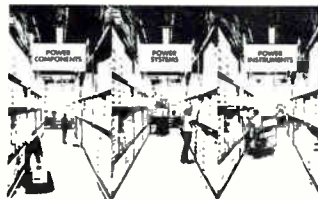

**LAMBDA**  
ELECTRONICS CORP.  
A *Veeco* Company

Have symmetry reflected  
H9V6 2Y1W1E7L7E7J6C7E9



## in your high-voltage designs with complementary pairs from RCA

Here's news for designers who have been waiting for high-voltage complements. RCA announces the TA7410, a new high-voltage silicon power transistor which extends the capability of RCA's whole new generation of p-n-p/n-p-n devices.

Featuring high-breakdown voltages and fast-switching, the TA7410 will be one of the most important transistors in a wide range of commercial, industrial, and military circuits...especially those using complementary pairs.

With new advantages from complementary high-voltage pairs you can:

- Obtain low output impedance at both + and - terminals with symmetrical series regulators
- Eliminate the destructive effects of leakage inductance in push-pull inverters
- Design line-operated, complementary linear amplifiers
- Create new complementary high-voltage switching inverters.

TA7410 is a p-n-p complement of the well-accepted 2N3585. Its companion type, TA7719, is a complement to 2N3584. TA7410 features a  $V_{CEO}$  of -300 V while TA7719 has a  $V_{CEO}$  of -250 V. Both are realistically specified for minimum betas of 20 at 1 A, and feature rise and fall times of 0.6  $\mu$ s maximum.

Let TA7410 and TA7719 complement your designs with their compact hermetically-sealed TO-66 packages. They represent the newest in a series of high-voltage complementary pairs that started with the 2N3440/2N5415—the industry's first such units (in hermetic TO-5 packages).

For more information, consult your local RCA Representative or your RCA Distributor. For technical data, write: RCA Electronic Components, Commercial Engineering, Section IN4-1/UT9, Harrison, N.J. 07029. In Europe: RCA International Marketing S.A., 2-4 rue du Lièvre, 1227 Geneva, Switzerland.

# RCA