

Fluidics complements electronics 88
Multiplexers as universal logic circuits 100
Five ways to design active filters 106

\$1.00 A McGraw-Hill Publication

October 27, 1969

Electronics®



Air
traffic
control:
pattern
for
survival

14Z KSS956 44R86 02-71
R. KISSLER
BASIC COMM ELEC

From near the banks of Loch Walden we bring you a GRrrrand new product, the 1192 - a wee bonnie counter that'll make your pocketbook smile. But don't let its size or price fool you; it's a real performer. For instance, it measures frequency (from dc to 32 MHz), period (single and multiple), time interval, frequency ratio, and, of course, it counts. Units of measurement and decimal point are automatically displayed. As little as 10 mV will trigger its input (up to 25 MHz), and you can control trigger threshold and attenuation. You get better than average stability with its internal crystal oscillator.

The 1192 can be ordered with 5, 6, or 7 digits, with or without BCD output, and for bench or rack use. A new companion scaler, the 1157-B, extends the upper frequency limit to 500 MHz. This unit mounts side by side with the 1192 in a common cabinet to form the 1192-Z.

Prices* for the 1192 range from \$575 for the 5-digit bench model without data output

to \$845 for a 7-digit rack model with data output. Add the scaler for another \$850. That gives you a 500-MHz counter for as low as \$1425. How's that for a bonnie bargain? If you order two or more, the unit cost is even less with GR's quantity-discount plan. Discounts range from 3% for 2-4 units to 20% for 100 units.

For free literature (postpaid) or an all-expense-paid demonstration, write or call General Radio Company, West Concord, Massachusetts 01781; telephone 617 369-4400. In Europe (except Scotland), write Postfach 124, CH 8034 Zurich 34, Switzerland. In Scotland, write General Radio Company (U.K.) Limited, Bourne End, Buckinghamshire, England, for special attention.

*Prices apply only in the USA.

GENERAL RADIO



Wee Bonnie Counter

X 1 0 0

fA pA nA nV μ V

AT 1 Hz BANDWIDTH

+ 0 10 20 30 dB



Our singularly accurate transistor noise analyzer tells you the whole story

The singular advantage of Hewlett-Packard's new 4470A is its inherent ability to read out transistor noise voltage (e_n), noise current (i_n) and noise figure (NF), accurate to better than ± 1 dB. And when you tie these factors into one neat package, you end up with the most complete noise performance story ever told. Unless you want accuracy an order of magnitude greater by calculating your measurements with e_n and i_n .

The 4470A was designed for accuracy and convenience in laboratory, for incoming device inspection and for QC testing applications on FET and bipolar transistors. Yet the analyzer is simple enough to be used by production personnel.

Measurements are made at 4 Hz bandwidths, for precise checks at 11 spot frequencies between 10 Hz and 1 MHz. Noise figure is read directly

in dB, using conveniently applied external or internal source resistances.

Since transistor gain varies between devices, an automatic gain control normalizes overall system gain to a fixed value independent of the transistor being used. And the 4470A is completely flexible for biasing transistors under test. The price is just \$4450.

Find out more about the simplicity of measuring transistor noise from your HP field engineer, or write to Hewlett-Packard, Palo Alto, Calif. 94304; Europe: 1217 Meyrin-Geneva, Switzerland.

HEWLETT  PACKARD



Quite simply, the most versatile preset counter ever.

It's the new 5330B Preset Counter from Hewlett-Packard. It can do about twice as much work as the second best preset counters. Yet it's priced about the same.

This 10 MHz counter can:

Normalize counted data to units such as gpm, psi and rpm.

Issue control signals when preset count or count rates are reached.

Introduce a selected offset in the reading. Be programmed remotely by automatic systems.

Totalize, find ratios and time intervals.

The 5330B gate times can be selected by a 5-decade front-panel "N" switch to any number of time units between 1 and 100,000. With a choice of 1 μ s, 10 μ s,

0.1 ms and 1 ms time units ("M"). So you can get normalizing factors from 1 to 10⁸.

This flexibility, together with the two limit control switches (L1 and L2), lets you virtually automate many processes such as batching. The limit switches generate output signals when the preset count is reached. These signals become the commands for your computer-run system.

The optional zero offset can be set at any number between 0 and 99,999. This lets your count start from a specific number and return to that number automatically.

All four of these functions can be remotely preset. It's also the first preset counter to offer an anti-noise option. This rejects high frequency noise that might mask low-frequency data.

You can also use this preset counter as a frequency divider. As a delay generator. Or as a precise, digitally selectable pulse generator.

If the 5330B is too versatile for you, the 5330A should be just right. It does slightly less (without limits, but zero offset option available), and costs slightly less.

The 5330A is \$1200. The 5330B is \$1550. To find out just how much they can do for you, call your local HP field engineer. Or write to Hewlett-Packard, Palo Alto, California 94304; Europe: 1217 Meyrin-Geneva, Switzerland.

HEWLETT  PACKARD

ELECTRONIC COUNTERS

News Features

Probing the News

- 127 **Aviation:** Air traffic control for the 1980's
134 **Government:** FCC's controversial commissioner

U.S. Reports

- 53 **Communications:** L-band tests periled by spinning ATS-5
54 **Air traffic control:** Contract slippage in NAS
55 **Communications:** Cheaper, smaller signal selector
55 **Displays:** Navy seeks war room picture
56 **Computers:** 18-bit model smaller than 8-bit machines
59 **Components:** Replacing high-power rectifier tubes
60 **Memories:** Modular answer to all questions
65 **Integrated electronics:** Printing active devices
65 **Manufacturing:** Varying interface charges; plastic bags change resistance tolerances

Electronics International

- 201 **Japan:** Gunn diodes generate pulses
202 **Japan:** Image dissector tracks wear on overhead railway wires
203 **Great Britain:** In As-In P for microwave semiconductor
204 **Great Britain:** checking buses the practical way

New Products

- 145 **In the spotlight**
145 Supply for IC's delivers 5 watts
149 Meter has 0.1% accuracy
152 Traffic monitor for time-sharing
157 **Components review**
157 Hybrid power amp puts out 100 w
161 **Instruments review**
161 Phase-angle meter for field tests
163 Pot promises 0.01 ppm accuracy
164 Dvm nudged into market
167 **Subassemblies review**
167 Cassettes made self-reversing
171 **Data handling review**
171 Industrial FFT computer bows
174 Analyzer checks computer operation
179 **Semiconductor review**
179 MOS IC adder handles 4 bits

Title R registered U.S. Patent Office; © copyright 1969 by McGraw-Hill Inc. All rights reserved, including the right to reproduce the contents of this publication in whole or in part.

Technical Articles

- Computers** 88 **Boosting reliability of disk memories**
Sound electronic design isn't enough by itself; good mechanical design can make the big difference
Roland Boisvert and S.A. Lambert, Digital Information Storage Corp.
- Circuit design** 96 **Designer's casebook**
▪ Sighting irregularities in small shafts
▪ Monitor guards three ways against power failures
▪ Zener in preregulator limits series transistor dissipation
- Digital design** 100 **Multiplexer doubles as logic circuitry**
James L. Anderson, Fairchild Semiconductor
- Design theory** 106 **Active filters: part 13**
Narrowing the choice
Michael Hills, University of Essex
- German IC's** 113 **Growing silicon on spinel adds up to high isolation, fast switching in IC's**
Heinrich Schlotterer, Siemens AG
- 116 **When does it pay to customize IC's?**
Uwe Bertram, Hans Hoffman and Hans-Wilhelm Neuhaus, Philips Zentrallaboratorium GmbH

Departments

- | | | | |
|----|--------------------------|--------------------------|------------------------|
| 4 | Readers Comment | 41 | Electronics Newsletter |
| 8 | Who's Who in this issue | 77 | Washington Newsletter |
| 14 | Who's Who in electronics | 182 | New Books |
| 30 | Meetings | 186 | Technical Abstracts |
| 39 | Editorial Comment | 191 | New Literature |
| | 199 | International Newsletter | |

Electronics

Editor-in-Chief: Donald Christiansen

Senior staff editors

Technical: Stephen E. Scrupski
News: Robert Henkel
International: Arthur Erikson

Art director: Gerald Ferguson

Senior associate editors: Joseph Mittelman, Harry R. Karp
Assistant managing editors: H. Thomas Maguire, Howard Wolff,
William Bucci, Richard Gundlach, Frederick Corey
Special projects editor: Roger Kenneth Field; Senior staff writer: John Johnsrud

Department editors

Advanced technology: Laurence Altman
Communications: Leon M. Magill
Computers: Wallace B. Riley, George Weiss
Design theory: Joseph Mittelman
Industrial electronics: Harry R. Karp
Instrumentation: Owen Doyle
Military/Aerospace: Alfred Rosenblatt
New products: William P. O'Brien
Solid state: George Watson, Stephen Wm. Fields

Field bureaus

Boston: James Brinton, manager; Gail Farrell
Los Angeles: Lawrence Curran, manager; Ralph Selph
New York: Peter Schuyten
San Francisco: Stephen Wm. Fields
Washington: Ray Connolly, manager; Robert Westgate, Lois Vermillion
Bonn: John Gosch
London: Michael Payne
Paris: Arthur Erikson
Tokyo: Charles Cohen

Copy editors: Edward Flinn, William S. Weiss

Assistant art director: Charles Ciatto
Production editors: Susan Hurlburt, Arthur C. Miller

Editorial research: Virginia Mundt

Editorial secretaries: Lorraine Longo, Claire Goodlin, Barbara Razulis, Vickie Green,
Bernice Pawlak, Patricia Bispham

McGraw-Hill News Service

Director: Arthur L. Moore; Atlanta: Fran Ridgway; Chicago: Robert E. Lee
Cleveland: Arthur Zimmerman; Dallas: Marvin Reid
Detroit: James Wargo; Houston: Barbara LaRouax
Los Angeles: Michael Murphy; San Francisco: Margaret Drossel, Tyler Marshall
Seattle: Ray Bloomberg; Washington: Charles Gardner, James Canan,
Herbert W. Cheshire, Seth Payne, Warren Burkett, William D. Hickman

McGraw-Hill World News Service

Bonn: Robert Dorang; Brussels: James Smith; Hong Kong: Kate Mattock
London: John Shinn; Mexico City: Gerald Parkinson; Milan: Jack Star
Moscow: Jack Winkler; Paris: Robert E. Farrell, Stewart Toy
Tokyo: Marvin Petal

Reprints: Gail Niles

Circulation: Isaaca Siegel

Reader communications manager: John Drummond

Publisher: Gordon Jones

Associate Publisher: Dan McMillan

Assistant to the publisher: Wallace C. Carmichael

Electronics: October 27, 1969, Vol. 42, No. 22

Published every other Monday by McGraw-Hill, Inc. Founder: James H. McGraw 1860-1948.
Publication office 99 North Broadway, Albany, N. Y. 12202; second class postage paid at Albany, N. Y.
and additional mailing offices.

Executive, editorial, circulation and advertising addresses: Electronics, McGraw-Hill Building,
330 W. 42nd Street, New York, N. Y. 10036. Telephone (212) 971-3333. Teletype TWX, N.Y., 710-581-4235.
Cable address: MCGRAW-HILL N.Y.

Subscriptions solicited only from those professionally engaged in electronics technology. Subscription rates:
qualified subscribers in the United States and possessions and Canada, \$8.00 one year, \$12.00 two years,
\$16.00 three years; all other countries \$25.00 one year. Non-qualified subscribers in the U.S. and
possessions and Canada, \$25.00 one year; all other countries \$50.00. Air freight service to Japan \$50.00
one year. Single copies: United States and possessions and Canada, \$1.00; all other countries, \$1.75.

Officers of McGraw-Hill Publications Company: Joseph Allen, President; John R. Emery, J. Elton Tuohig,
Senior Vice Presidents; Gordon L. Jones, Jr., Group Vice President; Vice Presidents: John R. Callahan, Editorial;
Paul F. Cowie, Circulation; John M. Holden, Marketing; David G. Jensen, Manufacturing;
Jerome D. Luntz, Planning & Development; Robert F. Marshall, Administration; Robert M. Wilhelmy, Finance.

Officers of the Corporation: Shelton Fisher, President and Chief Executive Officer; John L. McGraw, Chairman;
Robert E. Slaughter, Executive Vice President; Daniel F. Crowley, Donald C. McGraw, Jr., Bayard E. Sawyer,
Senior Vice Presidents; John J. Cooke, Vice President & Secretary; Gordon W. McKlincy, Vice President &
Treasurer.

Title registered in U.S. Patent Office; © Copyright 1969 by McGraw-Hill, Inc. All rights reserved. The contents
of this publication may not be reproduced either in whole or in part without the consent of copyright owner.

Subscribers: The publisher, upon written request to our New York office from any subscriber,
agrees to refund that part of the subscription price applying to copies not yet mailed.
Please send change of address notices or complaints to Fulfillment Manager; subscription
orders to Circulation Manager, Electronics at address below. Change of address notices
should provide old as well as new address, including postal zip code number. If possible,
attach address label from recent issue. Allow one month for change to become effective.

Postmaster: Please send form 3579 to Fulfillment Manager, Electronics,
P.O. Box 430, Hightstown, New Jersey 08520

Readers Comment

Schottky transistor

To the Editor:

Your article, "Schottky diodes make the IC scene [July 21, p. 74], shows a lateral Schottky-barrier collector (pnp) transistor. Yet, no reference is made to the paper, "The Schottky-Barrier Collector Transistor," given at the October 1966 International Electron Devices Meeting or to a paper of the same title published in "Solid State Electronics," Pergamon Press, June 1968. These are, as far as I know, the only papers published for this type of transistor.

G.A. May

University of British Columbia
Vancouver, Canada

▪ Authors R.N. Noyce, R.E. Bohn, and H.T. Chua apologize to reader May for not referencing his paper in their article. Their investigations did include one Schottky-barrier collector transistor in the form most easily included in npn transistor circuits. Other forms were not investigated because of incompatibility with the other processing. The goal of their work was to develop low-cost, high-yield processing for complex circuits.

Slightly better

To the Editor:

Regarding Lee L. Boysel's article on a fast, parallel adder [March 18, 1968, p. 119], he could have avoided using a separate carry circuit for each stage in the group by changing the propagation function to $P = \overline{A}B + A\overline{B}$, the exclusive OR of A and B rather than the inclusive OR. With this function, the carry-propagation signals for a stage are never both 1 at the same time. Thus, a carry signal can propagate only in the forward direction.

The diagram shows one way to realize the carry circuitry, using the exclusive-OR function and forming the complement of each carry. Alternatively, the transistors enclosed in the gray areas can be replaced by the circuit shown in

...looking for a specific interference filter?

Sprague makes many types to meet varied needs.

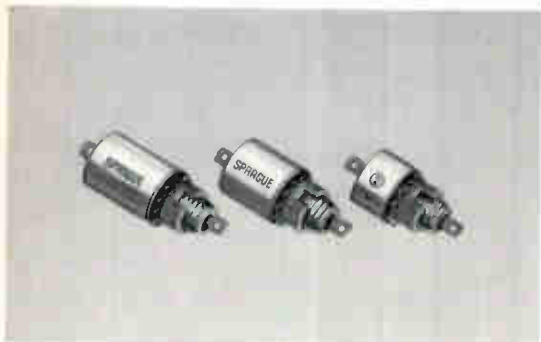

SUBMINIATURE EMI FILTERS FOR D-C APPLICATIONS

50 or 100 VDC @ 125 C
L and Pi circuits, 0.1 to 2.0 A
Feed-thru capacitors, 7.0 A

ASK FOR ENGINEERING BULLETIN 8130A

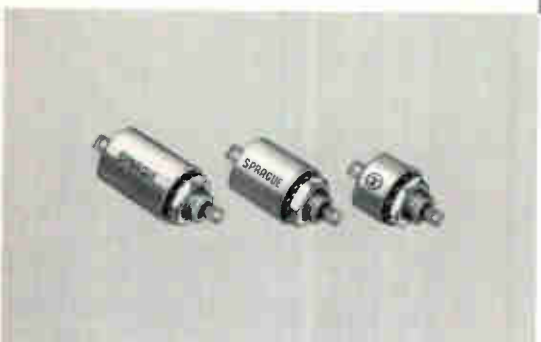

SUBMINIATURE EMI FILTERS FOR A-C APPLICATIONS

125 VAC, 0-400 Hz, 125 C
L and Pi circuits, 0.1 to 1.5 A
Feed-thru capacitors, 5.0 A

ASK FOR ENGINEERING BULLETIN 8131



GENERAL-PURPOSE EMI FILTERS

60 popular designs in various
circuit configurations
Current ratings, .005 to 50 A
Voltage ratings, 50 VDC to 250 VAC

ASK FOR ENGINEERING BULLETIN 8100B



HEAVY-DUTY POWER LINE FILTERS

250 VAC, 60 Hz
30, 50, 100, and 200 A
100 db from 14 KHz through
10 GHz at full load

ASK FOR ENGINEERING BULLETIN 8410

For engineering bulletins as noted above, write: Filter Division,
Sprague Electric Co., P.O. Box 39, Annapolis Junction, Md. 20701.

THE BROAD-LINE PRODUCER OF ELECTRONIC PARTS



'Sprague' and '®' are registered trademarks of the Sprague Electric Co.

THE BROCKER

Here's our newest, most attractive addition to the family: the JC rocker-handle circuit breaker. It's much too nice to hide on the back panel of your equipment: put it out front, and save yourself the price of an on-off switch.

Along with the front panel sales appeal you get the advantages of hydraulic-magnetic protection: precise ratings from 0.020 to 30 amp, job-matched time delays, optional special-function internal circuits, and a five-year warranty that's rather attractive in its own right. Write for Bulletin 3380.

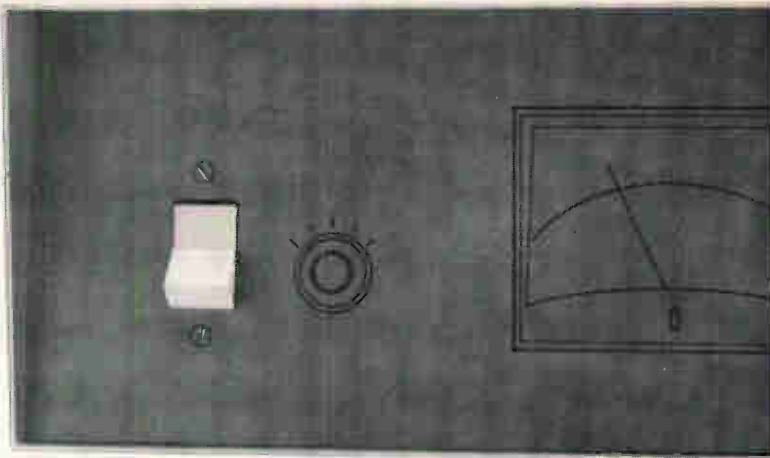

The 'old' original . . .



The breaker that started it all, our Series JA is fast becoming the first choice of OEM's. Available in multi-pole models with different specifications for each pole. Write for Bulletin 3350.



. . .and a snappy newcomer.

An especially convenient mounting design lets you snap the JB breaker right into the panel cutout, prewired or not. Secure enough to meet Mil-Std-202 for shock and vibration resistance.

The JB can be ordered with mounting-boss color caps that add sparkle and readability to multibreaker panels. Write for Bulletin 3360.



Readers Comment

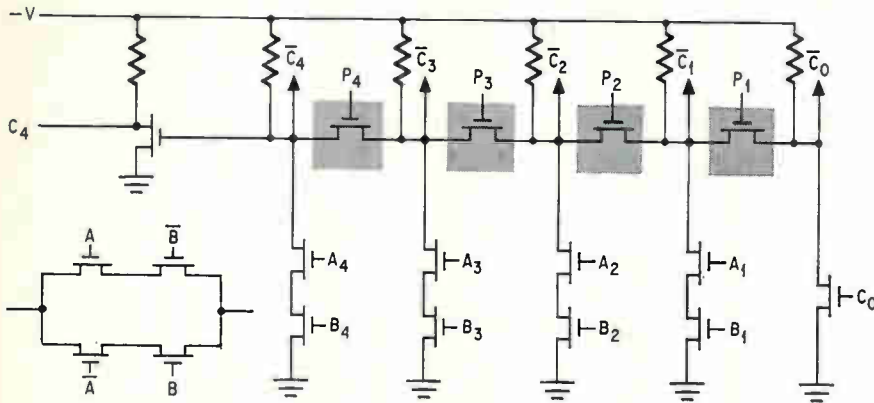

the inset. In that case, the propagation signal P would not be available separately, but it would open the channel after only a one-gate delay, instead of the two-gate delay required when P is formed first.

Likewise, the propagation function for the borrow in subtraction should be $P_s = \overline{AB} + AB$, the complement of the exclusive OR function.

Ronald C. DeVries
University of New Mexico
Albuquerque

■ Author Boysel says reader DeVries overlooks one important point. If all four pull-up resistors are supplying current at the same time, the transistor C_0 , serving as a current sink, would have to be very large and thus take up a lot of room on the chip. Furthermore, C_0 's extra capacitance slows the circuit's operation. For d-c operation, the approach taken saves space and speeds up operation, even though on paper it looks more complicated. On the other hand, in four-phase circuits, DeVries' ap-

proach is unquestionably better. In fact, Boysel, who is now with Four-Phase Systems Inc., is now working with this approach.

Vested interest

To the Editor:

Your story on AGA [Oct. 13, p. 210] stated that the company has "acquired control" of Consolidated Airborne Systems Inc. Actually, AGA's interest in Consolidated is limited to 200,000 shares—about one-third of the outstanding shares—purchased last month.

However, at the time of acquiring its stock interest in Consolidated, AGA entered into a shareholders' agreement with John I. Nestel, chairman of Consolidated. Under this agreement, Mr. Nestel is given the right to nominate 70% of Consolidated's board for a 10-year period, thus eliminating any thought that AGA seeks to obtain control of Consolidated.

William A. Washburn
AGA Corp.
Secaucus, N.J.



inseparable.

At Farinon you deal with microwave specialists because microwave is Farinon's only business. Farinon solid-state microwave is designed, built and sold by people concerned with providing the best possible point-to-point communications systems. By design, Farinon's multiplex systems provide the most versatile and efficient means for channelizing rf basebands.



Hundreds of Farinon solid-state microwave systems are operated by telephone companies, utilities, pipelines and others throughout the world. They operate in all frequency bands to 7 GHz, providing as many as 960 channels in some bands.

Give us a call when you want the specialized knowledge of microwave experts. We'll answer.

Farinon

Farinon Electric, 935 Washington St., San Carlos, Cal. 94070

SUBSCRIPTION SERVICE

Please include an Electronics Magazine address label to insure prompt service whenever you write us about your subscription.

Mail to: Fulfillment Manager
Electronics
P.O. Box 430
Hightstown, N.J. 08520

To subscribe mail this form with your payment and check new subscription renew my present subscription

Subscription rates: qualified subscribers in the U.S.: 1 year \$8; two years, \$12; three years, \$16. Non-qualified: 1 year \$25. Subscription rates for foreign countries available on request.

CHANGE OF ADDRESS

ATTACH LABEL HERE

If you are moving, please let us know five weeks before changing your address. Place magazine address label here, print your new address below.

name

address

city

state

zip code

Who's Who in this issue

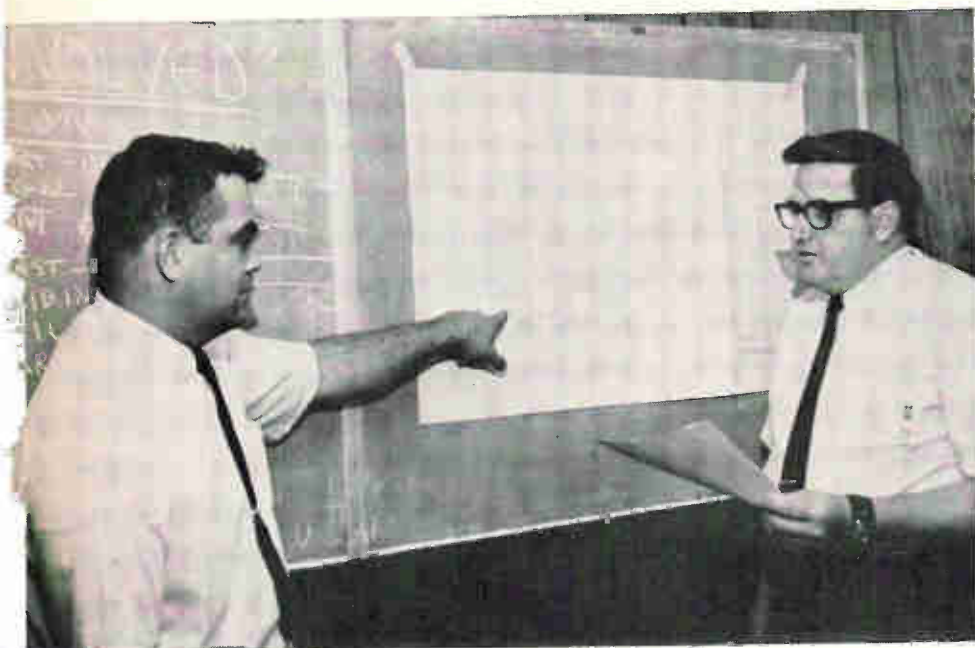

Lambert

Boisvert

Founding fathers of the Digital Information Storage Corp., Roland Boisvert and Stephen A. Lambert, authors of the article starting on page 88, came from the Digital Equipment Corp., where Boisvert was magnetic tape systems manager and Lambert was a special project engineer for disk memories. Boisvert is a graduate of the University of New Hampshire; Lambert attended Wentworth Institute.



Bertram

Neuhaus

Hoffman

Unconventional may be the word that best describes the techniques used by this trio of German engineers who authored the article starting on page 116, another in *Electronics'* series on German IC's. Their article describes an unconventional, but nevertheless significant, approach to designing customized digital IC's to meet specific, high-volume applications. Hans Hoffman is group leader for digital electronics at Philips Zentrallaboratorium GmbH in Hamburg—a subsidiary of the giant Dutch electronics company, Philips Gloeilampenfabrieken. Uwe Bertram and Hans-Wilhelm Neuhaus are members of Hoffman's staff.



Schlötterer

A new technique for achieving high isolation and fast switching time in MOS IC's by growing silicon crystals on a spinel substrate is described by Heinrich Schlötterer, in the article beginning on page 113. Schlötterer has been with Siemens AG in Munich since 1965. Schlötterer is no newcomer to this subject. Before, he worked on electron-optical methods for studying crystal growth and thin-film structures.



Anderson

"Join the Navy and see a future in electronics" could be the motto of James L. Anderson, author of the article starting on page 100. A Fairchild employee for the past three years, Anderson was introduced to electronics while serving in the Navy. Anderson, an assistant engineer at Fairchild, has worked on applications for bipolar MSI circuitry and now is concerned with LSI MOS mosaic arrays. He majored in history at San Fernando Valley State College.

Michael Hills, author of the article starting on page 106, is a lecturer on telecommunication systems at Britain's University of Essex. Hills, whose article compares five different designs for active filters, first became interested in this subject while working on his doctoral dissertation. His topic was based on a technique for the design of several bandpass filters to be used in telephone tone-dialing systems. Since that time he has been awarded a grant to develop a telecommunications programming language.

NEW FLAT PAK DESIGN ONLY 0.1" THICK

Radiation Hardened Magnetic Flat Pak Modulators, Analog Multipliers, Demodulators mount directly on IC Cards

ACTUAL SIZES

- Hybrid assemblies mount directly on IC cards.
- Space saver design . . . typical dimensions 0.1" thick x 0.5" x 0.75".
- Rugged design, extreme reliability. MTBF design goal 0.25 per million hours.
- Extremely low drift over -55° to $+125^{\circ}\text{C}$ range.
- Not affected by high intensity nuclear radiation.
- Capable of operating on carrier frequencies as high as five Mhz.
- One or more isolated or floating input signals may be used for modulating, multiplying, dividing, squaring or extracting a root.
- No external nulling or offset adjustments.
- No additional components or compensation required.
- No external operational amplifiers required.
- Standard $\pm 15\text{ V DC}$ power supplier unless otherwise specified.

TYPICAL FUNCTION PERFORMED
BY THESE COMPACT MODULES

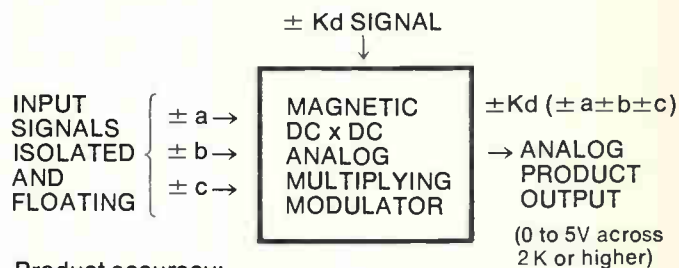

Product accuracy:
1% over temperature range -55°C to $+125^{\circ}\text{C}$.

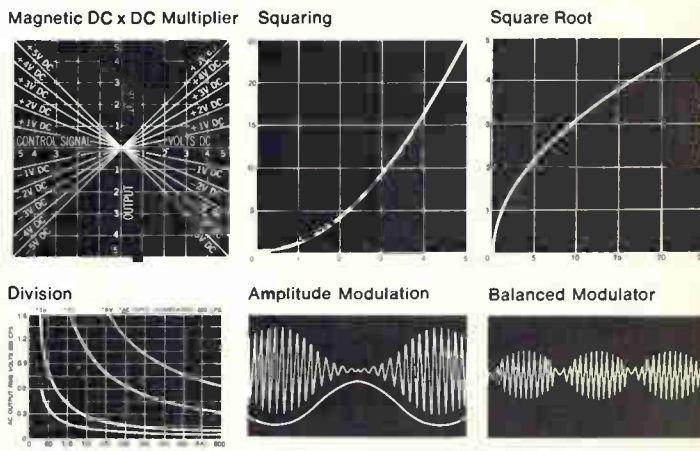

MAGNETIC MULTIPLIERS

Dynamic Product Range

80 db

Magnetic Modulators

Dynamic Range:

60 db



There is No Substitute for Reliability
GENERAL MAGNETICS, INC.
135 Bloomfield Avenue,
Bloomfield, New Jersey 07003

Circle 9 on reader service card

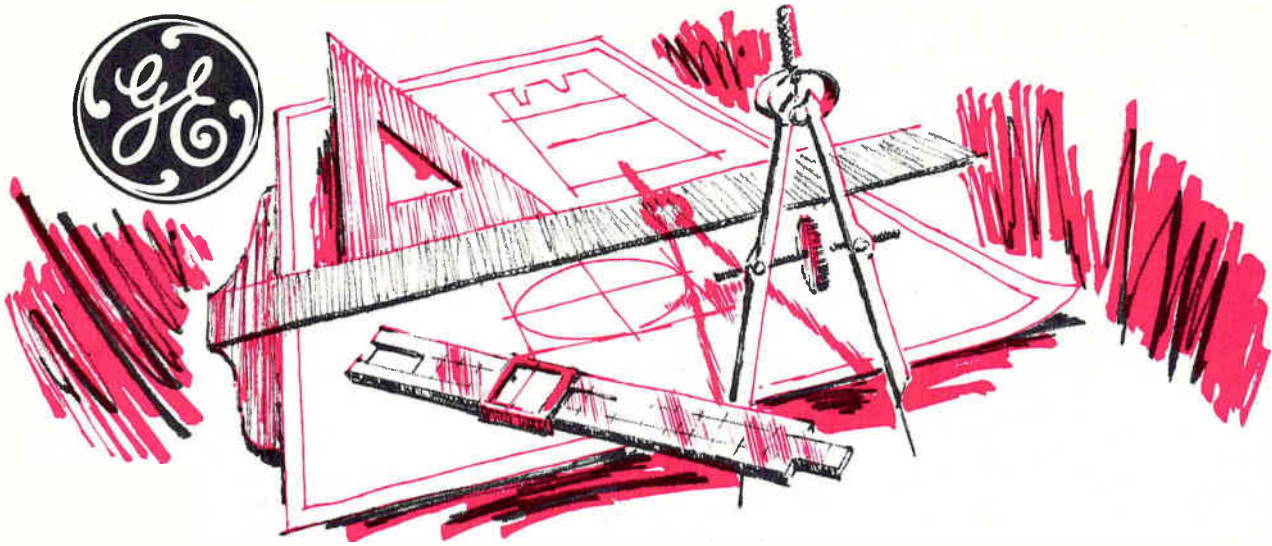

New 25 amp triac offers several exceptional performance features

GE has extended its broad thyristor line with the addition of a new 25 ampere triac. SC60 (stud-mounted) and SC61 (press-fit) offer several exceptional features:

Current rating 25A RMS
Voltage 200V, 400V, rating 500V
Surge current 250A Peak
Commutating 5V/μ sec.
dv/dt MIN.
Static 200V/μ sec.
dv/dt TYP.

The SC60/61 triac can handle up to 6KW at 240 volts and is compatible with PA424 and PA436 IC's for control of heaters, lamps and motors.

SC60/61 is well suited to high volume use in residential and industrial space heating, large lamp-dimming controls, temperature control in copying machines and many other applications. For details, circle 503.



Pin-sized Lodex® magnet

Now get proved Lodex® permanent magnets in sizes smaller than a pin

When designs call for tiny (even less than 1 millimeter) permanent magnets, GE has the answer. GE can produce powerful micro-miniature magnets at low cost—and in complex configurations, too.

The magnets are made of proved Lodex material. This exclusive GE product makes it possible to produce magnets in tiny, intricate shapes meeting extremely tight physical and magnetic tolerances.

Close piece-to-piece physical and magnetic uniformity often eliminates the need for final testing of the end product. These magnets are the perfect answer for such precise applications as reed switches.

For details, circle 504.

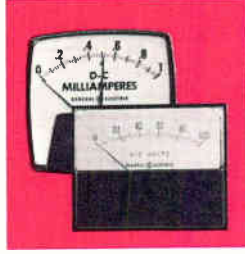

General Electric meter relays give you reliability at lower cost

Reliable performance at lower cost makes GE your best meter relay choice.

Functions include energizing alarms; close differential relaying; and controlling temperature, power, speed and frequency.

Proved GE design is better three ways:

- **New contactless control action.** Solid-state, light sensitive switch means simple, reliable control.
- **"Piggyback" control module.** Plug-in design saves installation time.
- **Choice of styles.** Easy-reading BIG LOOK® or low-profile HORIZON LINE® meter relays.

Applications range from critical monitoring in hospital intensive-care units to deep-well drilling control.

For details, circle 505.



100-CFM unit

Get reliable cooling for computer cabinets with proved GE fan assemblies

GE cooling fan assemblies offer years of continuous duty without maintenance. Available in two sizes, these blower fans feature all-angle operation and efficient air flow.

Small 90 and 100 CFM fans have KSB33-frame Unitized® motors and fit an opening 4¾" square. Near perfect bearing bores, accurate shaft-bearing alignment and metered oil bearings virtually eliminate bearing wear for long motor life.

GE's 500 CFM fan mounts on a 9.7" diameter bolt circle through holes in its aluminum venturi. Its KSP11-frame unit-bearing shaded-pole motor provides quiet, long-life operation.

For more information, circle 506.



New GE transistor is the ideal epoxy replacement for "hermetic" devices

General Electric's GET transistor series is a new answer to design problems. GET is the newest addition to GE's proved family of epoxy-encapsulated transistors dating back to 1962 . . . over 7 years of epoxy experience.

GET is the ideal epoxy replacement for "hermetic" devices . . . no expensive redesign needed. The new D32 package conforms to TO-18 mounting patterns and is available in these silicon planar, passivated models:

GE Model	Type	JEDEC No.
GET706, 708, 914	NPN	2N706, 708, 914
GET2221, 2222	NPN	2N2221, 2222
GET3638, 3638A	PNP	2N3638, 3638A
GET2369, 3013, 3014, 3646	NPN	2N2369, 3013, 3014, 3646
GET929, 930	NPN	2N929, 930

GE's quality epoxy forms a true chemical bond with metal to provide increased resistance to moisture and vibration damage. Low profile package means smaller circuits and lower cost.

For more information on GET and GE's "specials" capability, circle 508.



Check this new GE transmitter design

GE's C2003C transmitter is a Microwave Circuit Module containing a master oscillator and power amplifier using planar ceramic triodes.

It is one of many GE MCM's that help reduce design cycles, provide retrofit and lead to improved system performance.

C2003C benefits: meets performance and military requirements of the transmitter portion of IFF transponder

- permits two transmitters to function in space formerly used by one
- light weight
- significantly smaller
- simplified heat sinking
- excellent frequency stability with wide variations in antenna VSWR. For details, circle 507.

11 more

electronic components tailored for designers

General Electric components are engineered for reliability and cost effectiveness. No other single manufacturer offers such a wide selection of quality electronic components as General Electric. Specify GE in your designs.



GE fused quartz and fused silica add design flexibility to many applications

Highest purity GE Fused Quartz is being applied in crystal pulling, zone refining, semiconductor diffusion and research labware. And many new electronic applications are constantly being developed.

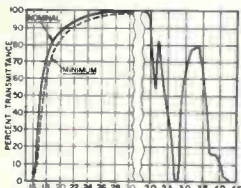

Transmittance Curve—151 Fused Silica for 1cm thickness*

GE type 151 Fused Silica, for critical optical jobs, is a schlieren grade material offering highest ultra-violet transmission.

Type 151 is one of five optical grades available. It is ideal for use in laser optics, absorption cells, spectrophotometer optical elements and schlieren photography.

For technical data and application assistance, circle 509.

*Excluding surface reflection losses



Tough, dependable indicating lights come in four sizes for varied application

GE has a broad assortment of low cost, high quality indicating lights (CR103, type H) that come with four mounting hole diameters for varied applications — 5/16", 15/32", 11/16" and 1". They all feature Lexan® (polycarbonate resin) lenses which diffuse light, eliminate "hot spots" and are virtually unbreakable.

Lens shapes include crown, spherical, torpedo and cylindrical. Lamps and lenses for most models install from the front without removing the assembly or opening the panel.

And a low-cost miniature indicating light (the CR103 HE) has been added to the line for applications where space is at a premium and minimum cost is essential.

The CR103 H line is perfect for applications such as panel indicators, lab equipment, appliances, meters, gauges, timers, and illuminated pointers and indicators for dials.

Get full-line details, circle 510 on the reader service card.



Innovative design gives GE Klystrons greater bandwidth, gain and efficiency

An experienced team of GE specialists uses innovative techniques to produce high-power Klystrons with greater bandwidth, gain and efficiency.

The Klystron above is just one example of GE's high-power pulsed microwave amplifier used in applications such as radar and particle accelerators.

GE Klystron designs can be developed in tunable and broadband types for all frequencies from UHF to X-band. They feature metal-ceramic construction, integral ion pumps and modular design for long life, low operating costs, and economical repair.

Put GE's team to work on your special Klystron application.

For details, circle 511.



New GE integrated voltage regulator smoothes ripple and protects IC's

GE's new integrated voltage regulator (IVR) is a monolithic IC that helps your power supply deliver constant, ripple-free voltage for solid-state circuit components. The device operates as a shunt regulator over a range of 10 to 40 volts at up to 400mW avg. power.

Total Avg. Power 400mW
Voltage 10-40V
Peak Current (10 sec pulse width, 1% duty cycle) 1A
Operating Temp. Range -15C to +125C
Temp. Coefficient of rated voltage .03%/°C typ.

Housed in the standard epoxy TO-98 package, GE's IVR is a low-cost means to stabilizing voltage for solid-state circuits. Applications are found in auto radios, TV ripple filters and as a reference amplifier for high-power regulation. The IVR can also be used where other voltage regulation methods have been too costly for high-volume use.

For details, circle 512.



Get over 1/2 farad at 5 volts with GE computer-grade capacitors

GE 86F500 high-capacitance computer-grade capacitors provide up to 540,000 μ f at five volts (34,000 μ f at 100 volts) in a single case.

These units are excellent when large blocks of capacitance are required, as in power supply filters.

86F500 units are rated for continuous duty at 65C or at 85C with proper voltage derating. GE's computer-grade capacitors provide highest capacitance per case size, high ripple current capability, low ESR and long life.

Units are available in nine case sizes — diameters 1 3/8" to 3" with lengths up to 8 5/8" — for operation up to 100 VDC.

For details, circle 513.

LOOK TO GENERAL ELECTRIC—your best source for more in electronic components.

ELECTRONIC COMPONENTS SALES OPERATION

GENERAL  ELECTRIC

285-53

If you've been discounting the Fairchild

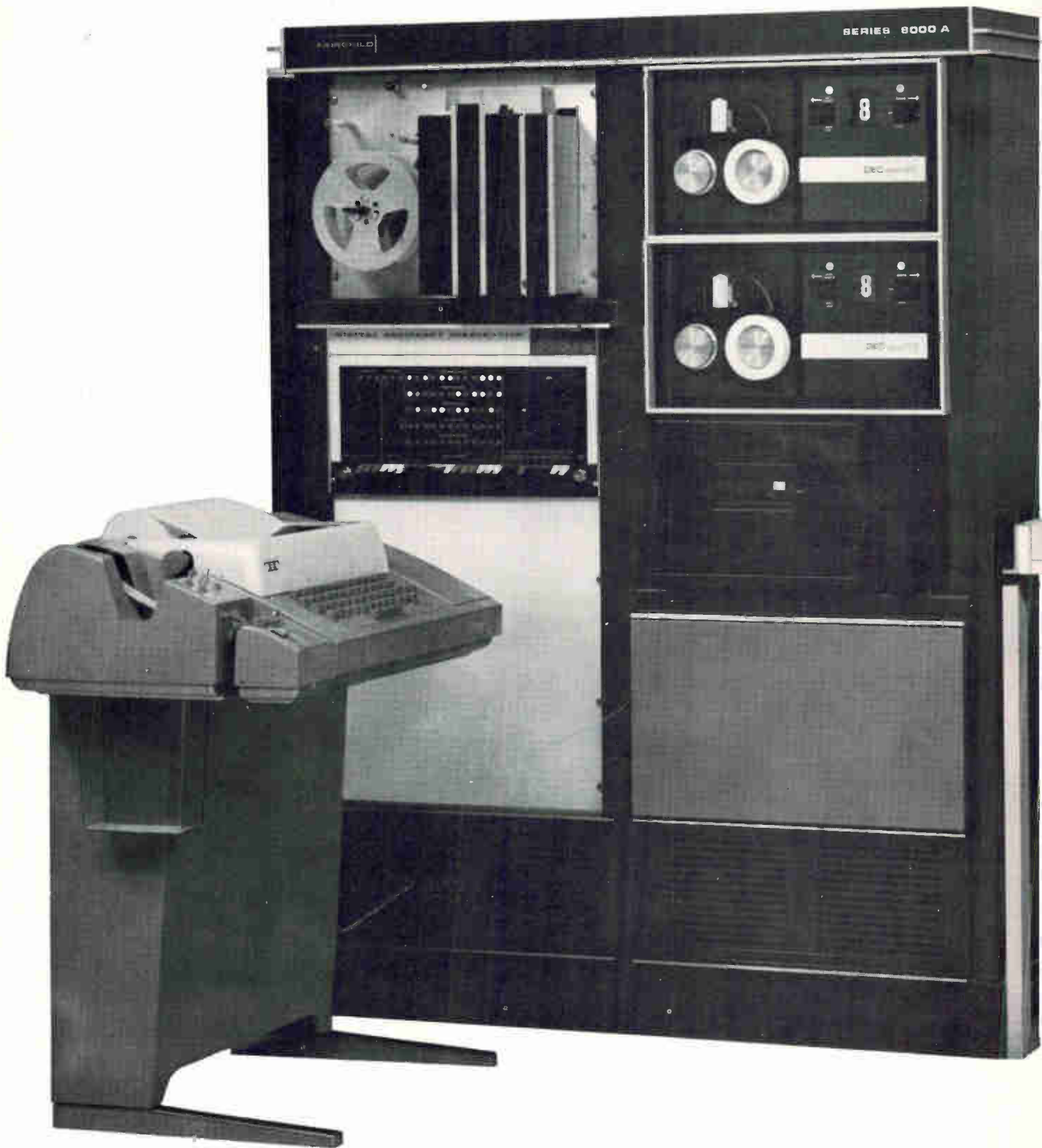

8000A function tester, cheer up...we have, too.

We've just cut the price of our 8000A Function Test System by 30%. And it's yours for the asking (and \$70,000) because we're delivering from stock.

In a month or less, you can be running functional tests on your complex digital circuits for as little as a nickel apiece. On PC cards, modules or hybrids. On ICs, MSI, LSI or even system sub-assemblies. Test up to 288 pins total, 72 simultaneously. If your circuit does something logical, the 8000A tells you if it's doing it right.

You don't have to slow down your testing by comparing your circuits against a standard that might or might not be right. You don't have to throw together

another thousand dollar black box every time you change your circuit. And you don't need high-priced help to run the 8000A — an unskilled operator can test your most sophisticated circuits. So if the price doesn't get you, the performance should.

Call Norm Baumann now for our detailed specs and find out how the 8000A gets more parts out the door faster. And makes sure a lot fewer come back.

FAIRCHILD SYSTEMS TECHNOLOGY

A Division of Fairchild Camera and Instrument Corp.

FAIRCHILD 974 East Arques Ave., Sunnyvale,
California 94086, (408) 735-5011

FAIRCHILD SYSTEMS TECHNOLOGY





Model 80 IC Tester

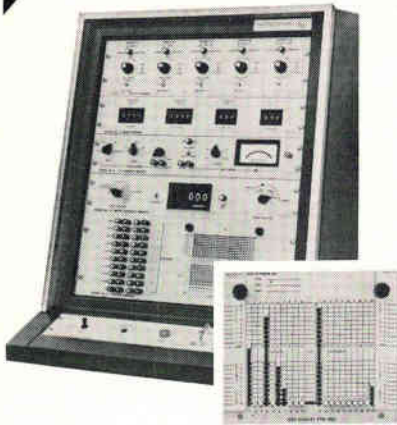

Versatile new low cost unit tests all digital and linear IC's

The new low cost Model 80 IC tester from Test Equipment Corporation can test all digital and linear IC's.

All signal sources and measurement devices for the Model 80 are programmed through a matrix, thus adding extreme flexibility to the type of tests performed. A unique program card (inset photo above) can provide even simpler, more rapid setup of the matrix, if desired.

An adapter converts the Model 80 to a high speed automatic GO/NO-GO programmable test system capable of complete functional logic testing of any digital IC with up to 16 leads.

The Model 80 performs all static tests on digital IC's and most dynamic tests required for linear circuits. Dynamic tests on linear IC's include open loop gain, input and output impedance, gain bandwidth, maximum output voltage swing, and others.

Low cost makes the Model 80 an excellent choice for incoming inspection, engineering evaluation or production testing. Its modular construction offers additional versatility to allow selection of specific capabilities as required.

Write today for pricing and technical information.

Test Equipment

CORPORATION
P.O. BOX 20215, DALLAS, TEXAS 75220 • 214/357-6271

Who's Who in electronics



Tatum of Fairchild

Problem: pride before production. **Solution:** John G. Tatum, Fairchild's new silicon power products manager, production man who puts business before pride.

Lester Hogan, president of Fairchild Camera & Instrument, said recently that one of Fairchild's biggest woes was "getting things from Palo Alto [R&D] to Mountain View [production] before they get to Sunnyvale [Signetics]." Though this was meant as a joke—Jim Riley, Signetics' president, was sitting next to Hogan at the time—Fairchild did have problems in getting ideas into production. San Francisco Bay Area electronics folklore has it that in the old days—1960 to 1965—the production staff refused to consider manufacturing anything that came out of advanced research—they thought the only semiconductor devices worth making came from production itself. Now Tatum will try to rewrite that folklore.

Enter Tatum. Tatum was with ITT Semiconductor in West Palm Beach, Fla., and moved to Fairchild just as ITT was phasing out its r-f transistor operation.

Tatum started in the r-f semiconductor business at the old Shockley Labs in 1963. Next came Cleveite, which sold its r-f power line to ITT. The new owner moved the operation from the Bay Area to Florida.

Regarding his prospects at Fairchild, Tatum says: "There has been a lot of development work and so I have a broad base to work with,

and we expect to have a lot of new products." One of the biggest coming markets for r-f power devices is in mobile communications systems, both commercial and military, says Tatum. "TI tried to build 12-volt devices but they lost key people and had to drop the project. ITT also had the same problem, but I think we can make it at Fairchild."

Behind the man. "Another ITT problem was that they did not have the technical backup that Fairchild has." Tatum says that he will be working closely with the microwave R&D people as well as r-f power R&D. Some of the problems Tatum plans to concentrate on are increasing the safe operating area, improving diffusion techniques, and getting finer line resolution. "We're working with large chips," says Tatum, "and we have to hold to 0.1-mil lines over the whole surface, so we have to work with the integrated circuit people as well as the power and microwave groups."

Looking at the big picture is a way of life for Sidney L. Hasin. As president of North American Rockwell's new information systems company (Narisco), he'll have an opportunity to bring that philosophy to bear on major financial, industrial, and government management problems. Narisco, formerly part of the corporation's Autonetics division, entered the growing information-management systems market this month and became free to chart an independent course, reporting only to the NR general office.

Narisco's 46-year-old president, while no newcomer to the business, is one of a new breed of managers who believe implicitly that the systems technology that made possible the Apollo and Minuteman programs can be put to work on many of the problems facing industry, finance, and government.

Broad. His philosophy is straightforward: Take a large overview of the customer's problems. "The first step is to evaluate a contract from

The new Fluke 893A will retire lots of good old Fluke voltmeters.

They won't be the only ones to go!

All kinds of differential voltmeters are likely to find quick retirement when you check out the new solid state Fluke Model 893A AC/DC Differential Voltmeter. Here's a low cost differential voltmeter with infinite resistance at null to 1100 volts, dc accuracy of 0.01%, ac accuracy of 0.05%, and integral battery pack operation.

Available in both half and full rack models, price is \$995 for either. Battery operation can be added at any time for only \$100. Grounded recorder output is available for \$50 more.

Ranges are 1, 10, 100, and 1000 volts ac and dc with 10% overranging. Resolution is 1 ppm of range. Reference regulation is the best available. Reference stability is 15 ppm/hr.

Using the instrument in the battery mode assures portability and complete isolation from the effects of power line interference. In the ac mode, the useful frequency range is 5 Hz to 100 KHz with a 1 mv accuracy. In the TVM mode, input resistance is 100 megohms, so you get the same advantages of low source loading as with older vacuum tube differentials.

Other user features include large, in-line readout with 360° rotation of voltage dials, virtual immunity to damage by accidental overload, and automatic decimal switching with range.

Ready to make the change?

We'd like to help. Your friendly Fluke sales engineer (listed in EEM and EBG) has all the facts as well as demo equipment. Call him or contact us directly if it's more convenient.



Fluke, Box 7428, Seattle, Washington 98133. Phone: (206) 774-2211.
TWX: 910-449-2850.

In Europe, address Fluke Nederland (N.V.), P.O. Box 5053, Tilburg, Holland.
Telex: 884-50237. In the U.K., address Fluke International Corp., Garnett Close,
Watford, WD2 4TT, England. Phone: Watford 27769. Telex: 934583.



Sweeping superiority

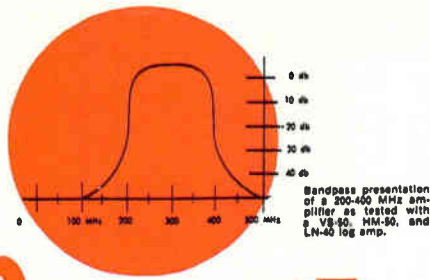

THE UNIQUE VS-50 SOLID-STATE SWEEP GENERATOR 2-500 MHz

Master of hundreds of applications in the FM radio, VHF TV and TV IF, and most communication bands, the Texscan VS-50 can cover the 200-400 MHz range in a single sweep—and add 300 MHz of extra coverage. As the above frequency plot of a 200-400 MHz amplifier bandpass presentation shows, the oversweep permits out-of-band tune-ups and slope characteristics to be measured easily in a single test. Descriptive literature covering all technical details of this unique instrument—available only from Texscan—is yours for the asking, free on request.

STATE-OF-THE-ART LEADERSHIP

RF Output: RF output is at least 1 vrms into a 50 ohm load.

Sweep Width: The sweep width is continuously variable from 500 KHz to 500 MHz at any center frequency, but the unit will not sweep above 500 MHz at rated output. The unit is also provided with a CW output mode for signal generator applications.

Frequency Range: The unit can be centered at any frequency between 2 MHz and 500 MHz and sweep anywhere with that range.



Texscan

CORPORATION

2446 NORTH SHADELAND AVENUE
INDIANAPOLIS, INDIANA 46219

Who's Who in electronics



Hasin of Narisco

a total problem standpoint," says Hasin. "Always look at the forest before looking at the trees. Then, get into the programs needed."

A transplanted New Yorker, who received his BSEE from New York University in 1944, Hasin in later years joined the trek of engineering talent to the West Coast. He landed his MSEE from the University of Southern California this year. Following management positions at Ramo Wooldridge, Litton Industries, Hughes Aircraft, and Bendix Aviation, he became manager of information-processing systems for North American Rockwell's Space division in 1963. Following a stint as assistant director of the Information Systems division and director of technology from 1964 through 1966, he was appointed director of the division, and later was made vice president of information systems for the Autonetics division.

Some of his coworkers are, in fact, a little in awe of Hasin's computer-like memory. Says one associate: "He has the ability to instantly retrieve anything he ever heard about a particular problem."

Crystal ball. The computer analogy fits when Hasin leans forward at his desk and, eyes flashing, rapidly describes his plans for Narisco.

"I expect the company to do at least \$12 million in business in fiscal 1970, based on a \$9 million backlog from 1969, and \$3 million in new contracts. There is no reason why Narisco shouldn't be a \$50 million-a-year operation within five years."

SEMICONDUCTOR NEWSBRIEFS

PUBLISHED BY MOTOROLA SEMICONDUCTOR PRODUCTS INC.

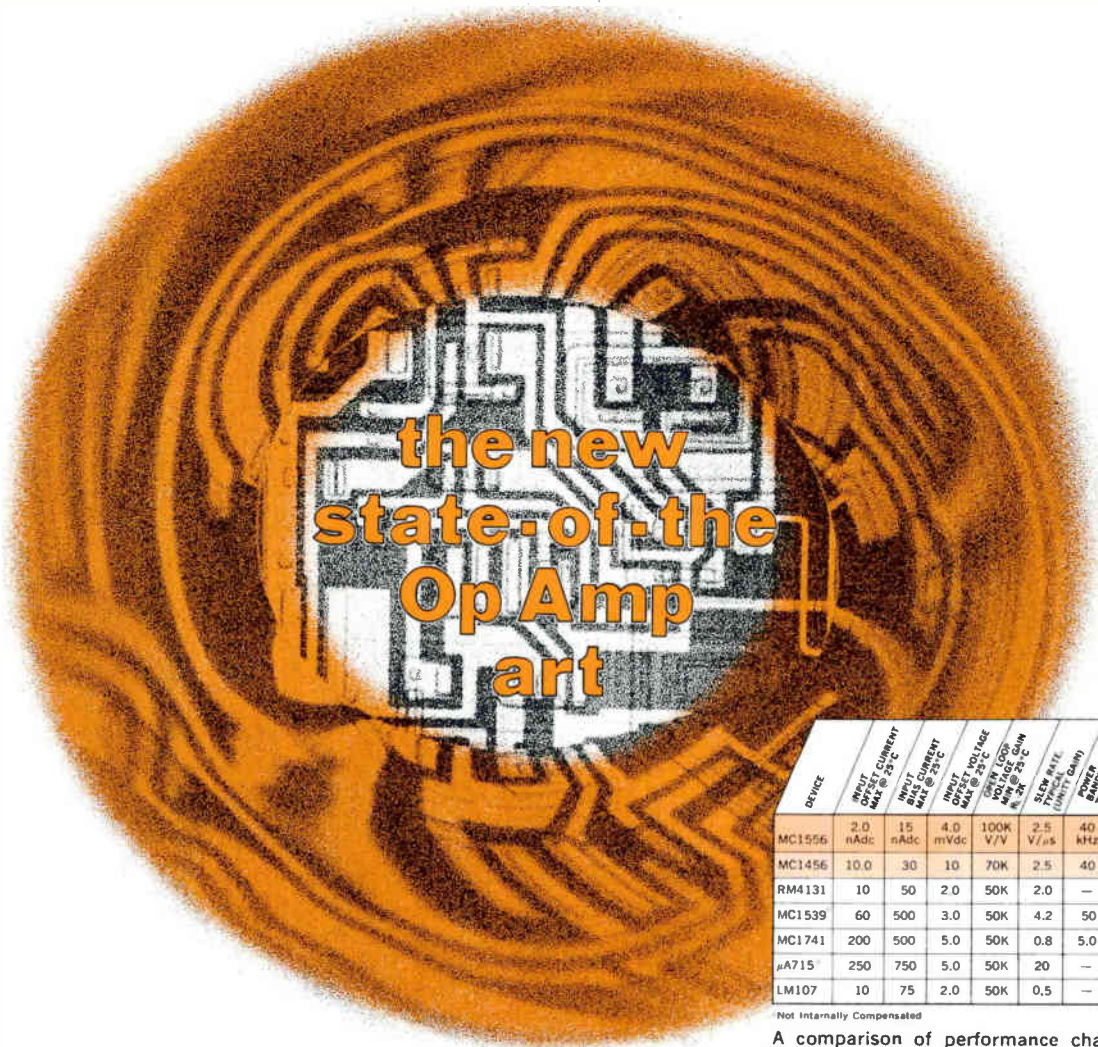

the new
state-of-the
Op Amp
art

DEVICE	INPUT BIAS CURRENT MAX @ 25°C	INPUT BIAS CURRENT MAX @ 75°C	INPUT OFFSET MAX @ 25°C	INPUT VOLTAGE LIMIT (V _{CC}) MAX @ 25°C	SLURP RATE (V/μs)	POWER SWITCHING LIMIT (kHz)	POWER CONSUMPTION MAX @ 25°C	PRICE 100/UP
MC1556	2.0 nAdc	15 nAdc	4.0 mVdc	100K V/V	2.5 V/μs	40 kHz	45 mW	\$28.00
MC1456	10.0	30	10	70K	2.5	40	90	\$15.00
RM4131	10	50	2.0	50K	2.0	—	57	\$20.00
MC1539	60	500	3.0	50K	4.2	50	150	\$ 7.50
MC1741	200	500	5.0	50K	0.8	5.0	85	\$15.00
μA715	250	750	5.0	50K	2.0	—	210	\$48.00
LM107	10	75	2.0	50K	0.5	—	90	\$33.00

Not Internally Compensated

A comparison of performance characteristics clearly indicates the superiority of the MC1556 over other popular monolithic Op Amps.

... makes others obsolete!

Most high-performance op amps today are of monolithic construction — to save space and to increase reliability. A few are internally-compensated — to reduce the need for external componentry and their associated higher cost.

Only one offers all three benefits . . .

(1) high performance; (2) monolithic construction; and, (3) internal compensation! That's the **MC1556**, an operational amplifier that promises to become the new linear IC standard of the industry!

The MC1556 and its reduced temperature-range counterpart, the MC1456,

For details circle Reader Service No. 281

are designed for use as summing amplifiers, integrators, or amplifiers with operating characteristics as a function of the external feedback components.

Both of these new linear circuits are available from distributor stock in the 8-pin TO-99 "G" suffix package.



Balanced Modulator/Demodulator IC Ups Carrier-Suppressed Performance

Closely-matched transistors, on a single monolithic chip, give Motorola's new **MC1596G** the ability to provide a high signal-to-carrier ratio and low-distortion, in a variety of modulator/demodulator designs. As its output is the

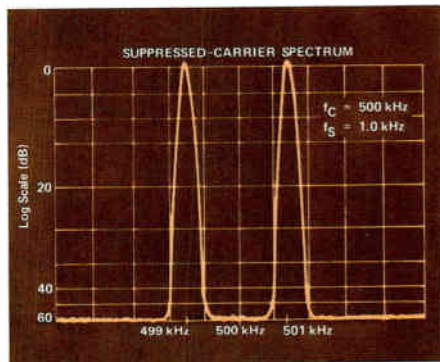

The MC1596G provides high, balanced, signal strength vs. carrier performance.

product of both an input voltage (signal) and a switching function (carrier), the MC1596G can serve to improve the performance, yet lower the cost of functions such as: synchronous AM-FM and phase or single side-band detection, frequency

doubling, mixing and, of course, suppressed-carrier and amplitude modulation.

When used as a balanced modulator, this linear IC provides a high suppressed-carrier figure of typically 60 dB at 0.5 MHz and 40 dB at 10 MHz; and, a high common-mode rejection ratio of 85 dB (typ.). In addition, it has adjustable gain and signal-handling capabilities and balanced inputs and outputs — and can operate over a wide bandwidth (trans-admittance: carrier-300 MHz; input signal — 80 MHz). It operates over the full -55 to +125°C temperature range.

And even though the MC1596G gives you all these superior performance characteristics, in a single, hermetically sealed, long-leaded version of the TO-100 case, you can reduce your modulator-circuit costs by up to a factor of three. For example, designs of this nature using discrete devices require expensive, closely-matched balancing transformers and a diode bridge. Even in quantity, a single transformer may cost as much as the total 100-up price of the MC1596G — only \$4.80!

For details circle Reader Service No. 282

IF Wideband Amplifier Has A Wide AGC Range, High Gain

Now Motorola offers the designer of precision RF/IF circuits a wideband amplifier that has both a broad AGC range (60 dB min. from dc to 60 MHz) and a minimum power gain of 40 dB at 60 MHz . . . the **MC1590G**! Packaged in the TO-99 hermetic 8-lead metal-can (-55 to +125°C), and inexpensive — only \$3.95 in 100-up quantities — it will be warmly welcomed by builders of high-performance military and commercial communications equipment, radar and video instruments. It also makes an excellent audio amplifier with AGC.

The power gain and AGC range of the MC1590G is equal to, or better than two well engineered discrete-component stages. And, the AGC has little effect on IF response as the input and output impedances remain practically constant. As the MC1590G can replace a complete discrete device assembly consisting of several capacitors, a slew of resistors and two or more IF transistors, a substantial savings in componentry and mounting costs can be realized. In addition, the wide-range gain control of the

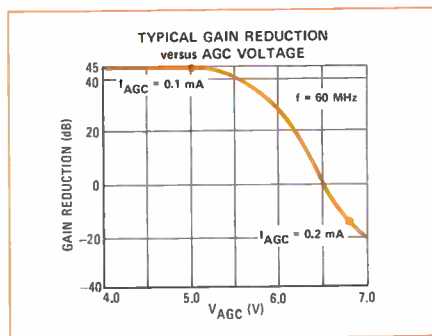

MC1590G appreciably lessens "detuning" effects.

Here are some other parameters that help make the MC1590G an outstanding value for high-performance HF and VHF designs:

- High Power Gain (typ):
 - 50 dB at 10 MHz
 - 45 dB at 60 MHz
 - 35 dB at 100 MHz
- Single-power-supply operation:
 - 6.0 to 15 Volts
- Low Reverse Transfer Admittance:
 - > 10 μmhos (typ) @ 60 MHz

For details circle Reader Service No. 283

Five More IC Complex-Functions Join Motorola's Burgeoning MTTL Line!

The **MC4012** 4-Bit Shift Register leads-off five new MTTL complex-function introductions. Consisting of four D-type flip-flops (operated in the synchronous mode), the MC4012 can be operated in either the serial or parallel-mode by application of a proper signal on the mode control. It will simplify the design of parallel-to-serial and serial-to-parallel converters, divide-by-N counters, number converters and adder/subtractor systems.

And, when your problem is the logical addition of two binary numbers, Motorola's new **MC15482/17482** provide an optimum answer! These units perform the addition of two 2-bit binary numbers and the look-ahead "carry" is provided internally between the two-bits. They can be interconnected to form longer words. Although functionally the same, the **MC25482/27482** have the exclusive OR of the two sets of input bits brought out. This reduces package-count when using these adders in look-ahead "carry" applications. Both types can be plugged directly into designs presently served by older T²L adders.

The new **MC5493/7493** 4-bit binary counters provide true high-speed counting versatility. For example, by using only one external gate it is possible to count to 7, 9, 10, 11, 12, 14, or 15. Hook-up two of them, add two gates and you can divide by any number up to 256.

And, for reliable Nixie Driver designs consider Motorola's new **MC7441AP**. It delivers up to 55 Volts with a maximum 200 μA leakage current. Output clamp-diodes are included to prevent oscillation. The MC7441A combines with the MC7475 quad-latch and MC7490 decade counter to form a complete read-out system.

These new Motorola complex-function MTTL integrated circuits are all available for your immediate evaluation from your local distributor's warehouse stock.

Type	Function	Price (100-up)
MC4012L	4-Bit Shift Register	\$11.50
MC15482/17482L	2-Bit Full Adder	16.00/9.00
MC25482/27482L	2-Bit Full Adder	16.00/9.00
MC5493/7493L	4-Bit Binary Counter	21.25/13.15
MC7441 AP	BCD-TO-Decimal Decoder And High-Level Driver	7.00

L suffix denotes TO-116 ceramic dual in-line case
P suffix denotes TO-116 Plastic dual in-line case

For details circle Reader Service No. 284



New Homogeneous-Bond Annular Silicon Power Transistors Shrug-Off High Temperature Excursions

Combining Annular, epitaxial, passivated die structures . . . with a unique homogeneous high-temperature "hard-

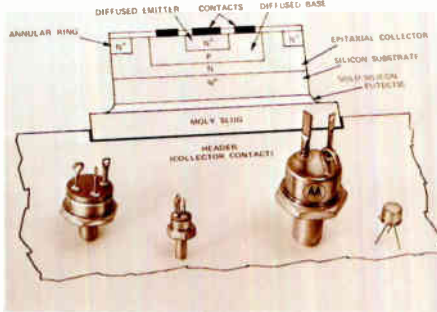

solder" die-to-header bonding method, Motorola advanced silicon power technology now adds a whole new dimension of reliability for power switching/amplifier circuits! Designers of industrial and military equipment which must operate

at top efficiency and be fail-proof — even when subjected to stringent overload and temperature-excursion conditions — can now specify silicon power transistors with assurance of long-term reliability.

For instance, the units' closely matched expansion coefficients preclude the development of "hot-spots" and/or junction rupturing due to high internal heating and thermal fatigue. (Extensive stress-testing has proven their ability to withstand 5,000 temperature cyclings, as performed on intermittent life tests, without any apparent damage or degradation!) And, Annular die structures virtually eliminate high-leakage problems so common to ordinary diffused-junction devices.

The first of these ultra-rugged power transistors are available in an assortment of hermetic "stud" and lead-mount metal cases, with I_C 's from 5 to 60A.

Type No.	Package	Polarity	I_C (cont.)	V_{CE0} (sus)	$V_{CE(sat)}^* @ I_C$	$h_{FE} @ I_C/V_{CE}$	$I_{CBO}^* @ V_{CB}$
MJ7200 MJ7201	TO-114	NPN	60 A	80 V 100 V	1.0 V @ 20 A	20-100 @ 20 A/5 V	100 μ A @ 100 V 100 μ A @ 120 V
MJ7000	TO-63	NPN	30 A	100 V	1.0 V @ 10 A	20-100 @ 10 A/4 V	5.0 μ A @ 100 V
MJ500 MJ501	TO-59 (col. to case)	PNP compl. to 2N5477/80	7.0 A	60 V 80 V	1.2 V @ 7.0 A	25-180 @ 2 A/2 V	10 μ A @ rated V_{CB}
MJ6700 MJ6701	TO-59 (isolated -col.)	PNP compl. to 2N5346/49		60 V 80 V			
MJ8100 MJ8101	TO-39	PNP compl. to 2N5336/39	5.0 A	60 V 80 V	0.7 V @ 2.0 A		

*Maximum

For details circle Reader Service No. 285

Premium NPN 20A And 30A Amplifiers And Switches For Peanut Prices

Specify the 2N3771/72 and you'll get power amplifiers that can handle V_{CE0} 's of 40V and $I_C = 30A$ (2N3771) and 60V and $I_C = 20A$ (2N3772); dissipate up to 150W at $T_C = 25^\circ C$; and, deliver minimum betas (h_{FE}) of 15 at 15A and 10A, respectively. Or, when you require the same power handling capability plus nanosecond switching speeds and saturation voltages below one-volt, plug-in the MJ3771/72. Whichever you need, you'll get peak-performance from all, all at the same low prices (\$2.50 each in 100-up quantities)!

In addition, you'll be getting high f_T values (especially with the MJ series) and exceptionally good safe operating areas. Check over the highlights in the

accompanying table and order units for evaluation from your distributor right now. He has ample local stock, backed by extensive factory inventory and production capacity.

Both series are packaged in low-silhouette TO-3 cases and operate over a -65 to $+200^\circ C$ temperature range.

Highlights	MJ3771/72	2N3771/72
Major Usage $\dagger I_C$ (cont) *typ	Pwr. Switching ($t_r=350ns^*$ @ 10A)	Pwr. Amplifier (up to 20/30A \dagger)
Low $V_{CE(sat)} @ I_C$ (max)	1V @ 15A(71) 1V @ 10A(72)	2V @ 15A(71) 1.4V @ 10A(72)
High $f_T @ I_C/V_{CE}/f$ (min)	2 MHz @ 1A/ 10V/1.0 MHz	0.2 MHz @ 1A/ 4V/50 kHz
V_{CE0} & I_C (cont)	40V & 30A(71); 60V & 20A(72)	
Low Prices (100-up)	\$2.50	

For details circle Reader Service No. 286

Rugged 60K Beta, 10-Amp, 40-Watt Darlington's Debut

Now there are rugged power Darlington amplifiers/switches around with nearly "out of sight" beta values . . . the MJ3801-02 series . . . and they run cool, calm and collected even under extremely high temperature conditions! At 6 Amps and 4 Volts, for example, the MJ3801 furnishes an ultra-high 10,000-60,000 gain range, while at 10 Amps it has an h_{FE} of over 1,000.

And, their Annular, passivated, two-

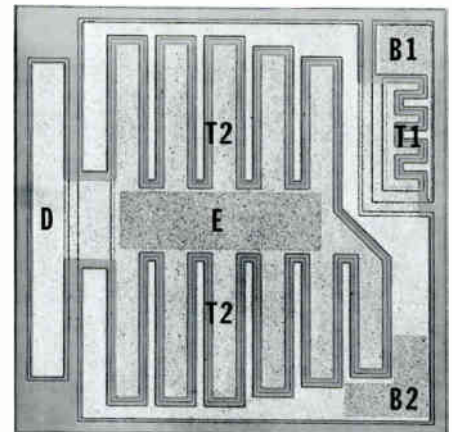

The 110-mil square die for the MJ3801-02 contains two power transistors in a Darlington configuration and a large diode.

transistor-plus-diode power chips (see illustration) are high-temperature "hard-solder" bonded into high-dissipation, TO-66, three-leaded cases. The result: micro-amp leakages, nanosecond switching and highly efficient, reliable performance, even when subjected to fatiguing high junction temperatures to $200^\circ C$!

Check the highlight specs in the accompanying table. They will show you how these new power Darlington's can up the performance of even your most stringent series-pass regulator, ultra-high-gain amplifier, motor-control and inverter application requirements. And, get the whole story by perusing the data sheet for these reliable power Darlington amplifier transistors.

Highlights	MJ3801	MJ3802
High $h_{FE} @ I_C = 6 A$	10 K to 60 K	1.0 K to 20 K
Low Leakage Current (I_{CBO})	10 μ A (max) @ 80 V	
High I_C	10 A (cont); 15 A (peak)	
Low $V_{CE2(sat)} @ I_C/I_{B1}$	1.5 V (max) @ 6 A/15 mA	
High BV_{CE0}	80 V (min)	
Fast Rise-Time	200 ns (max) @ 6 A	
Prices (100-up):	\$11.95	\$7.95

For a copy circle Reader Service No. 287



250-350V Thermopad Transistors Make H-V Design Costs Tumble

Imagine being able to get 250/300/350-Volt silicon power transistors for your line-operated audio and servo amplifier, low-current, high-voltage converter and AC line-relay designs . . . at quantity prices well below the one-dollar mark! Well, now with Motorola's new NPN **2N5655-57** Thermopad plastic packaged silicon power series you can do this and more!

Not only are they able to handle sustaining voltages up to 350 V (at inductive I_C 's of 100 mA), but they also provide high gain figures. For example, they have an h_{FE} of 30-250 at 50 mA. In addition, they display a maximum $V_{CE(sat)}$ of just 1.0 V at 100 mA; a minimum $f_T = 10$ MHz at 100 mA/10 V/10 MHz; and, an output capacitance of 25 pF at 10 V/100 kHz.

Their exclusive Annular triple-diffused die structures also provide exceptionally low-leakage currents (e.g. — maximum I_{CEX} values are only 100 μ A at rated V_{CE}) and excellent safe operating areas. Continuous I_C is a high 500 mA with a peak of 1.0 Amp. They operate up to junction temperatures of +150°C and dissipate 20 Watts at $T_C = 25^\circ$ C.

All three types are immediately available. 100-up prices: 2N5655 (250 V) — 75¢; 2N5656 (300 V) — 90¢; and, 2N5657 (350 V) — \$1.10. Call your Motorola distributor for evaluation units TODAY!

For details circle Reader Service No. 289

The PNP MJE-2955 complements its NPN counterpart to form low-cost, transformerless power-outputs as shown in the diagram.

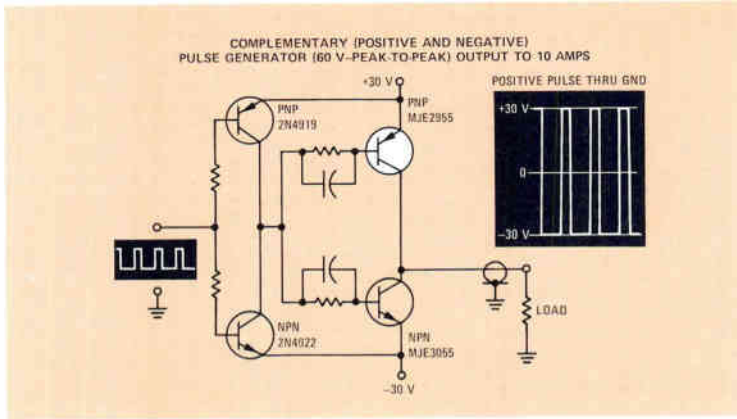

Popular Plastic 90-Watt NPN Now Has A PNP Power-Mate!

The MJE3055, a Thermopad plastic-packaged, low-cost version of the popular NPN 2N3055 silicon power transistor (introduced in NEWSBRIEFS Vol. 2 No. 4), now has a PNP "alter ego" . . . the **MJE2955!** All its electrical and mechanical specifications are the same as its NPN counterpart, making the pair a perfect match for complementary power-output designs.

And, their low prices qualify them for a broad range of consumer/industrial applications, where economical transformerless design simplicity is keynoted. Or, they can be used separately to optimize either PNP or NPN polarity circuits.

The 60-Volt PNP MJE2955 dissipates a full 90 Watts at $T_C = 25^\circ$ C, due to

its unique 0.030" direct chip-to-heat-sink Thermopad case design (operating temp. range: -55 to $+150^\circ$ C). Its beta is spec'd at two points, affording a complete picture of its high-gain-holdup capability over a wide current range.

And, as with its NPN mate, the MJE-2955 offers both high frequency response and fast switching times. It should prove a boon to designers of servo and low-frequency amplifiers as well as series and shunt regulators and power supplies, requiring both economy and top performance.

PNP Type	h_{FE} @ I_C	$V_{CE(sat)}$ @ I_C (max)	f_T (min)	Price (100-up)
MJE2955	20-70 @ 4 A 5 min @ 10 A	1.1 V @ 4.0 A	2 MHz @ 500 mA	\$1.95

For details circle Reader Service No. 288

Five Fresh FETs Fit Frugal Fast-Switching Functions!

One of Motorola's five new Unibloc plastic, N-Channel JFETs should prove to be both an economical and high-performance solution for whatever low-power chopper or high-speed switching design requirement you may have. Labeled the 2N5638-40 series and the 2N5653/54, they all have exceptionally low resistance and capacitance values, thus assuring fast switching characteristics. For example, the rise time of the 2N5638 is just 5.0 ns max. @ I_D (on) = 12 mA. They all have breakdown voltages of 30 Volts at $I_G = 10 \mu$ A and gate-currents (I_{GF}) of 10 mAdc. In addition, the units exhibit low leakage currents, as demonstrated by a maximum specified I_{GSS} value of 1.0 nA at 15 Volts.

And, as they are packaged in economical, yet rugged, TO-92 Unibloc transfer-molded cases, their prices are as much as one-half lower than their previously available metal-can counterparts.

Immediate prototyping needs are readily available from your local distributor and Motorola's extensive production capability can match even your most stringent large-quantity scheduling requirements.

Characteristics	2N5638	2N5639	2N5640	2N5653	2N5654
Low $r_{ds(on)}$ (max) @ $f = 1.0$ kHz	30 Ω	60 Ω	100 Ω	50 Ω	100 Ω
Low C_{iss} @ 12 V $f = 1.0$ MHz	10 pF (max)				
Low C_{rss} @ 12 V $f = 1.0$ MHz	4.0 pF (max)			3.5 pF (max)	
Fast Rise Time (max) (t_r) @ 10 V/50 Ω	5.0 ns @ 12 mA	8.0 ns @ 6 mA	10 ns @ 3 mA	5.0 ns @ 5 mA	8.0 ns @ 5 mA
Prices (1,000-up)	95¢	80¢	70¢	72¢	64¢

For details circle Reader Service No. 290



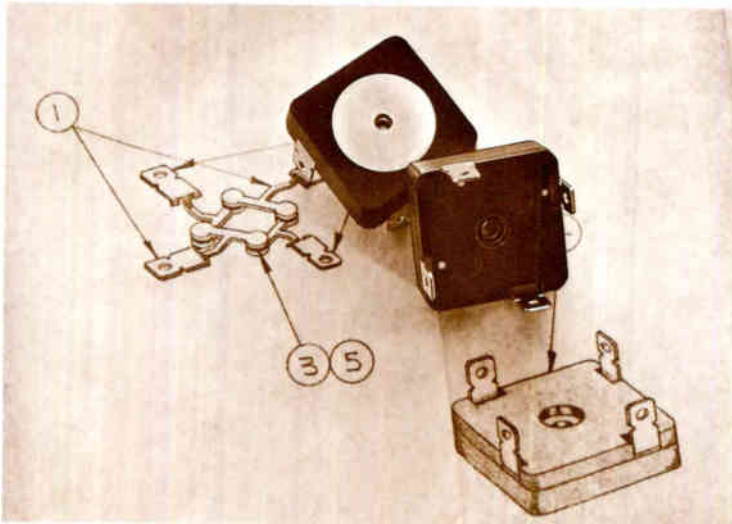

Four passivated silicon dice are combined in two compact, transfer molded packages (with or without metal insert) to form new high-surge Motorola MIDA bridges.

MIDA Bridges Now Have 12-27A Ratings

Motorola, the first to build economical MIDA (Miniature-Integrated-Diode-Assemblies) rectifier bridges, now offers the browniest power handling versions ever — the MDA980 series, with a dc output current rating of 12 Amps and the MDA990 series which handles 27 Amp loads (both at $T_c = 55^\circ\text{C}$). And, thanks to their unique structures — incorporating passivated, diffused - junction silicon dice, which have been carefully interconnected by integral heat-sinks and encapsulated in voidless, transfer-molded, compact packages — they provide above-and-beyond performance, even under the toughest environmental conditions.

For example, the MDA990 series has a built-in, electrically-insulated, aluminum disc heat-sink for high heat dissipation when metal-chassis mounted. Its top output current rating (27 Amps) is a

full two-Amps higher than similar, yet larger and more cumbersome encapsulated bridges. And, both series can easily take non-repetitive, one-half cycle surges up to 300 Amps (over 30% higher than other bridges in the same power class)!

All this, yet these “high current in a small package” single-phase, full-wave bridges carry cost/ampere prices comparable to discrete rectifiers having similar power output ratings. And, whether your job calls for reverse voltages below 50 Volts or up to 600 Volts, these bridges afford rectification efficiencies of up to 70%, or more, over a repetition recovery rate to 15 kHz.

A Designers Data Sheet, containing comprehensive curves as well as complete data, so fully describes these new MIDA bridges that the engineer gets all the information he needs from a single source — at a glance!

Series	I_o @ $T_c = 55^\circ\text{C}$	V_{RM} Range	I_{FM} (surge)	V_F (max)	I_R (max)	Prices (100-up)
MDA980	12 A	50 V to	300 A for	1.0 V @	0.5 mA @	\$2.40 to \$5.20
MDA990	27 A	600 V	$\frac{1}{2}$ cycle	$\frac{1}{2} I_o$	rated V_{RM}	3.00 to 5.90

For a copy circle Reader Service No. 291

New Ultra-Fast Plastic PNP Switches Offer Low Prices — Volume Availability!

Manufacturers of instrumentation equipment and plated-wire memories can now realize a substantial savings, in costs and delivery time, by specifying Motorola's new Unibloc (TO-92) plastic packaged MPS-L07/08 PNP high-speed silicon switching transistors. Their ultra-fast, efficient, parameters amply qualify them for applications such as digit-drivers

and complementary flip-flop designs.

For example, they have a typical combined t_{on} and t_{off} time of only 50 ns and maximum storage times of just 15 ns (MPS-L07) and 20 ns (MPS-L08), both at $I_c = 10$ mA. In addition, their exceptionally low saturation voltages — 0.07 V typ. at 10 mA — and high f_T 's (500 MHz and 700 MHz min., at 10 mA), ensure

For details circle Reader Service No. 293

High-Speed Switches Added To Micro-T Menage

The introduction of a new Micro-T packaged high-speed dual switching diode — the MMD7001 — along with a fast NPN saturated switching transistor (MMT3014), now expands Motorola's ability to serve designers of high-density and miniaturized circuitry.

The MMD7001 is particularly well suited for fast switching applications requiring high breakdown voltages (45 V min. @ 10 μA) and low capacitance values — just 3.5 pF, typ. Add to this a reverse-recovery time of only 3.2 ns (typ) @ $I_F/I_R = 10$ mA — along with a maximum forward voltage drop (at $I_F = 500$ mA) of 1.15 V — and you have a letter-perfect answer for high density switching designs requiring a comparatively high current handling capability.

As with the dual-diode, Motorola's new MMT3014 is speedy and efficient.

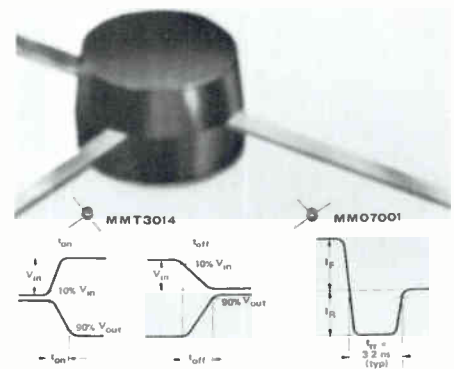

Both the Micro-T MMD7001 and MMT3014 have nanosecond switching speeds.

It has a combined t_{on}/t_{off} of less than 41 ns and a collector saturation voltage below 0.22 V, both at $I_c = 30$ mA. Capacitance is also low ($C_{jt} = 8$ pF and $C_{ub} = 5$ pF, max.). Its minimum f_T is a high 350 MHz @ 30 mA/10 V/100 MHz. It sells for \$1.52 (100-up).

For details circle Reader Service No. 292



PRODUCT BRIEFS

TWO NEW LOW-NOISE RF SILICON TRANSISTOR SERIES

— Fulfill Both Critical And Economy Requirements Up To 1.0 GHz

Two new sets of NPN silicon RF, low-noise, high-gain amplifier transistors for military and industrial applications, have joined Motorola's broad line of small-signal devices to serve high-frequency design requirements. Both the premium 2N5031/32 versions and the lower priced MM8006/07 are well suited for video wideband and general-purpose amplifiers ranging from 50 MHz to 1.0 GHz.

They are all packaged in the TO-72 four-lead metal can and have breakdown voltages of 10V (min.) @ 1 mA and $V_{CE(sat)}$ of just 0.35V @ 80 mA.

Type No.	G_{pe} (typ) @ f	NF @ f	f_r (min)	r_{in} , C_c (typ)	C_{cb} (max)	Prices (100-up)
2N5031/32	17 dB @ 450 MHz	2.5 dB/3 dB* @ 450 MHz	1.0 GHz @ $I_c = 5$ mA	5 ps @ 10 mA/6 V/ 31.8 MHz	1.5 pF @ 6 V/0.1 MHz	\$14.00/8.00
MM8006/07	25/20 dB @ 200 MHz	2.2 dB/2.7 dB† @ 200 MHz				\$ 4.00/2.60

*Maximum †Typical

For details circle Reader Service No. 294

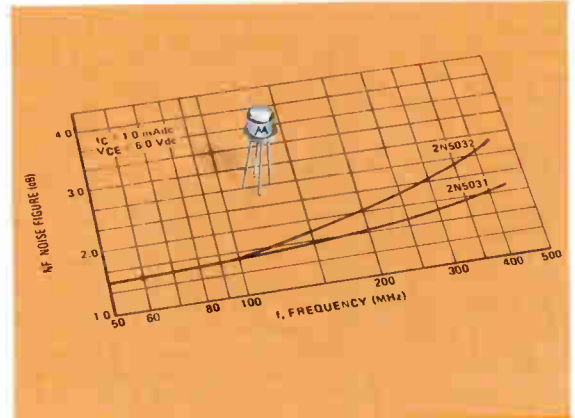

12.5-VOLT AND 28-VOLT RF POWER TRANSISTORS

— Operate From 470 MHz To 1.0 GHz At Efficiencies To 60%!

Three new NPN BET silicon UHF high-current transistors — the 2N5644/45/46 — have now joined Motorola's broadening EIA registered, ceramic strip-line packaged, RF power family. These devices are primarily designed for 12.5V supplies in industrial/consumer FM equipment operating up to 520 MHz. They have an excellent broadband capability thanks to their low lead-inductance strip-line packaging. And, their balanced-emitter construction provides protection against destructive secondary breakdown.

In addition, four new microwave types (for use with 28V supplies) have been added to the RF power line. The MM4429 and MM4430 are multiple-emitter devices which are packaged in ceramic stripline cases, while the 2N4428 (also multiple-emitter) is packaged in the TO-39 case. Their prime usage is in military and industrial UHF and L-band (1-2 GHz) microwave power amplifiers and transmitters. The MM8009, on the other hand, is ideal for frequency-multiplier or oscillator applications to 1.68 GHz.

For details circle Reader Service No. 295

Type	P_{out}	G_{pe} (min)	@ f	V_{cc}	Efficiency η	Price (100-up)
2N5644	1.0 W	7.0 dB	470 MHz	12.5 V	60% (min)	\$ 8.30
2N5645	4.0 W	6.0 dB				11.90
2N5646	12 W	4.7 dB				22.50

Type	P_{out}	G_{pe} (min)	@ f	V_{cc}	Efficiency η	Price (100-up)
MM4429	1.0 W	5.2 dB	1.0 GHz	28 V	45% (typ)	9.00
MM4430	2.5 W	5.0 dB				19.00
2N4428	0.75 W	10 dB	500 MHz	28 V	35% (min)	5.50

Type	P_{out}	@ f	f_r	V_{cc}	Efficiency η	Price (100-up)
MM8009	0.9 W (min)	1 GHz	1.0 GHz @ 50 mA	28 V	35% (min)	\$ 7.50
	0.3 W (osc) (typ)					

Packages: All in ceramic opposed-stripline cases (case 145A) except for the 2N4428 and MM8009 which are in TO-39 cases.

2-GHz OSCILLATOR MICROWAVE TRANSISTORS

— Eliminates Need for Costly Frequency-Multiplier Chains

Motorola's new MM8008/10/11 NPN silicon microwave transistors, designed primarily for military and industrial oscillator, frequency-multiplier, and UHF amplifier applications, represents a major high-performance vs. low-cost breakthrough. *Crystal and tuned-oscillators can now be economically developed which operate at frequencies previously possible only with expensive multiplier chains!* The result . . . not only a reduction in costs but also the simplification of circuitry, lower noise-levels and improved harmonic spacing.

Effective in the S-Band (2 to 4 GHz) and L-Band (1 to 2 GHz) microwave frequency spectrums, these devices are ideal for use in radar antenna systems, navigational instruments, telemetry, proximity fuzes and as varactor drivers.



Type No.	$P_{out(osc)}$		f_r (typ) @ I_c	C_{cb} (typ) @ V_{ce}	$V_{CE(sat)}$ (max)	Prices (100-up)
	Min @ 2.0 GHz	Typ @ 1.68 GHz				
MM8008	300 mW	550 mW	1.1 GHz @ 50 mA	1.3 pF @ 30 V	0.3 V @ $I_c = 100$ mA	\$17.50
MM8010	200 mW	450 mW				12.00
MM8011	100 mW	300 mW				7.10

Case Type — TO-107

For details circle Reader Service No. 296

NEW MRD500/510 SILICON PIN PHOTO DIODES

— Respond In Less Than 1.0 ns, And Are Sensitive To Low Radiation Levels

They turn-on in less than 1.0 ns (typ) and can be activated by low-intensity radiation sources. *They're the new Motorola MRD500/510 PIN photo diodes!* High radiation-sensitivity, fast turn-on-time and high signal-to-dark-current response make them ideal for use in such functions as: laser detection, light demodulation, light-emitting-diode coupling and shaft/position encoding.

Their Annular, passivated structures assure long-term stability. The MRD500 has a convex lens (for high sensitivity), while the MRD510's is flat, for use with external lens-systems.

Photo Diode Type	Response Time @ V_R/R_L (typ)	Radiation Sensitivity — $\mu A/mW/cm^2$ (typ) Note(1) @ $\lambda = 0.8 \mu m$	Dark Current @ $V_R/R_L/T_A$ (max)	Breakdown Voltage (min)	Capacitance @ V_R/f (max)	Prices (100-up)
MRD500	1.0 ns @ 20V/50 ohms	1.8	2.0 nA @ 20V/1.0 meg/25°C	100V @ $I_R = 10 \mu A$	4.0pF @ 20V/1.0MHz	\$7.25
MRD510		0.42				\$6.60

Note (1): Radiation Flex Density $H = 5.0$ mW/cm² — tungsten source (color temp. = 2870K)

For details circle Reader Service No. 297

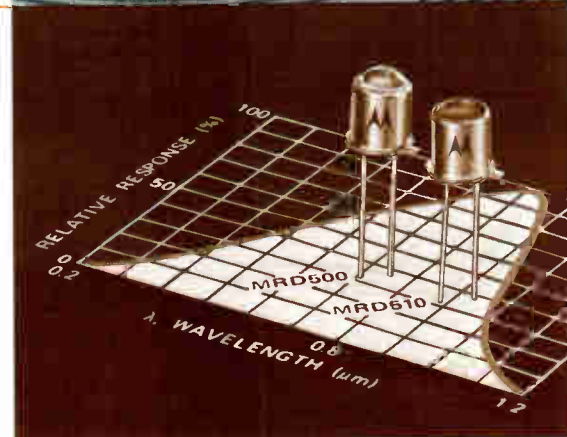



**METALS THAT TALK, SING
AND LISTEN...A SPECIAL
CAPABILITY OF CARPENTER!**

The reassuring sound of a family voice . . . the perfect fidelity of a favorite recording . . . theatres of color that bring lavish entertainment into millions of homes. These are the exciting developments in the field of audio/visual communications that all of us can enjoy. And essential to the flawless performance required of these products . . . specialty metals that make them talk, sing and listen. Carpenter produces a full range of electronic alloys used throughout industry, including Magnetic Core Irons, Glass Sealing Alloys, High Permeability Alloys, Electrical Resistance Alloys, Magnetostrictive and High Saturation Alloys, Controlled Expansion Alloys, and others. Why don't you entertain the thought of applying Carpenter electronic alloys to your product? See your Carpenter representative. Steel Division, Carpenter Technology Corporation, Reading, Pa. 19603.

*European Office: Emmastraat 39,
Amsterdam-Z, The Netherlands*

CARTECH CARPENTER
TECHNOLOGY

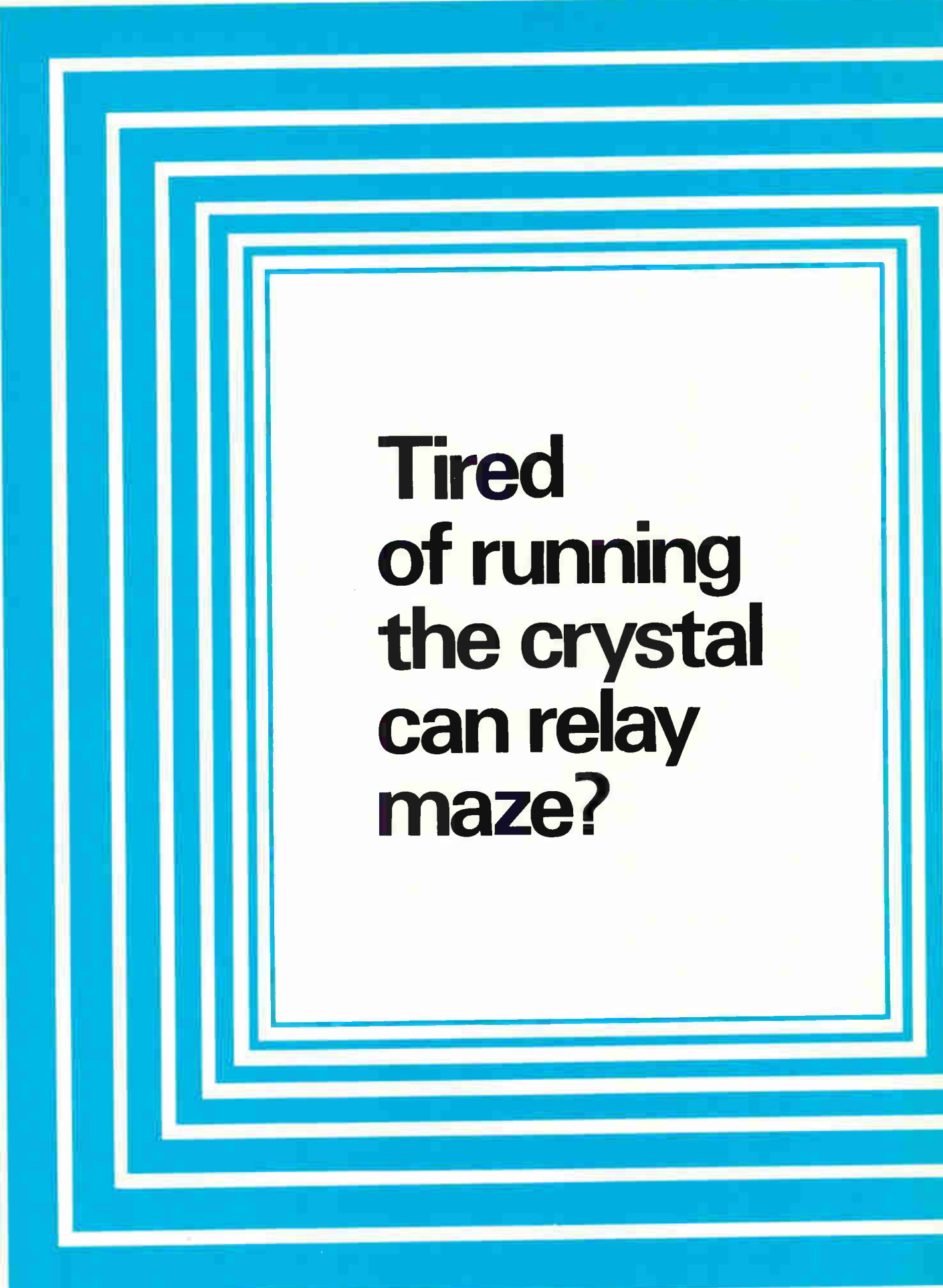









**Tired
of running
the crystal
can relay
maze?**





You don't have to any more!

■ Because we've got them all. Everything from power crystal cans to TO-5 relays, from military types to industrial/commercial devices. All built to the same exacting Clare quality. And, as you'd expect from Clare, the world's greatest selection of operating characteristics and mounting styles.

Military Relays. Every Clare military relay is designed to meet the requirements of MIL-R-5757. All feature hermetically sealed cases to eliminate contamination under the most severe conditions. Withstand temperatures from -65°C to $+125^{\circ}\text{C}$; shock to 100 G; vibration to 30 G.

 <p>Type TF. TO-5 transistor size; low-level to 1 amp.</p>	 <p>Type TF. Sensitive. To 40 mw sensitivity; low-level to 1 amp.</p>	 <p>Type MF. One-sixth size; low-level to 0.5 amp.</p>	 <p>Type HF & HFW. Low profile; low-level to 2 amp.</p>
 <p>Type F & FW. Full size; low-level to 3 amp.</p>	 <p>Type SF. 40 mw sensitivity; low-level to 2 amp.</p>	 <p>Type LF & LFW. Magnetic latching; low-level to 2 amp.</p>	 <p>Type PF. 10 amp. power.</p>

Industrial/Commercial Relays. A combination of economy and rugged construction to meet industrial/commercial requirements. Industrial/commercial versions are rated for 30 G shock and 10 G vibration.

 <p>Type TFC. TO-5 transistor size; low-level to 1 amp.</p>	 <p>Type MFC. One-sixth size; low-level to 0.5 amp.</p>	 <p>Type HFC. Rugged "metal" cover; low-level to 2 amp.</p>
 <p>Type FC. Full size; low-level to 2 amp.</p>		

For information, circle Reader Service number, call your Clare Sales Engineer or your local Clare Distributor. Or write for data on the types you need. C. P. Clare & Co., Chicago, Ill. 60645... and worldwide.

LOOK FOR



CLARE ON THE RELAY

a GENERAL INSTRUMENT company

NOW...THE SECOND SOURCE THAT'S **FIRST** IN QUALITY



1/20th the size of the conventional hermetically sealed unit with the same rating . . . yet it's the **largest** of the complete line of new KEMET® Micron Series microminiature solid tantalum capacitors

JUST TAKE A LOOK AT OUR QUICK COMPARISON WITH BRAND "X"

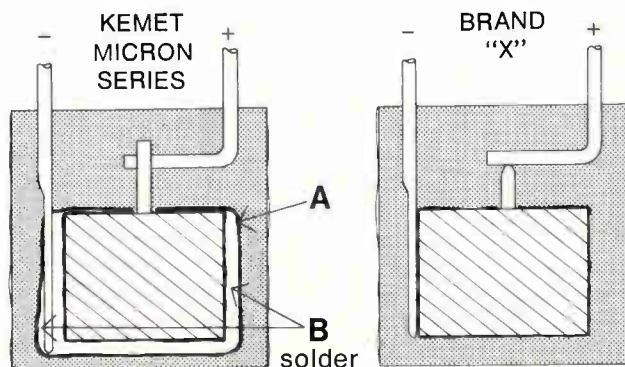

Construction Features	KEMET	BRAND "X"
A. Silicone barrier coat over anode prior to encapsulation to provide superior moisture resistance.	YES	NO
B. Negative lead solder bond to obtain superior mechanical bond for high shock and vibration, to assure better temperature cycling capability, to prevent open circuits, and to provide better electrical characteristics due to superior electrical contact.	YES	NO

Available with capacitance-voltage ranges from .001 to 220 μ F, 2 to 50 volts.

Call your Regional Sales Office today for complete information.

NEW ENGLAND: 300 First Avenue, Needham Heights, Mass. 02194 Tel.: (617) 444-5400 TWX: 710-325-1329 ●
MID-ATLANTIC: Tarrytown Technical Center, Electronics Division, Tarrytown, New York 10591 Tel.: (914) 592-9300 ●
CENTRAL: 120 So. Riverside Plaza, Chicago, Ill. 60606 Tel.: (312) 822-7022 TWX: 312-222-0491 ●
 11901 Madison Avenue, Cleveland, Ohio 44101 Tel.: (216) 221-0600 TWX: 810-421-8494 ●
WESTERN: 13601 E. Whittier Blvd., Whittier, Calif. 90605 Tel.: (213) 698-8077 TWX: 910-586-1342 ●
 2680 Bayshore Frontage Road, Mountain View, Calif. 94040 Tel.: (415) 969-9390 TWX: 910-379-6444

T 370

Radial Leads

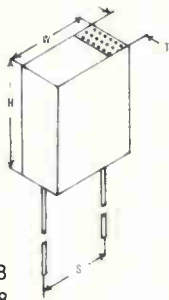

Lead Length:
Pos. 1-5/8 ± 1/8
Neg. 1-3/8 ± 1/8

T 372

Polar Rectangular 3-35 VDC

Axial Leads

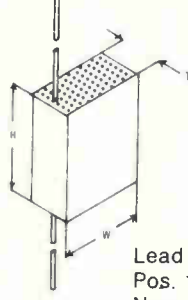

Lead Length:
Pos. 1-5/8 ± 1/8
Neg. 1-3/8 ± 1/8

Capacitor Outline Drawings

Case Dimensions—Inches

Case Size	H Case Height Max.	W Case Width Max.	T Thickness Max.	S Lead Spacing	Capacitance μ F
A	.125	.070	.040	.050	.001-1.5
B	.165	.120	.070	.100	.0047-10
C	.225	.185	.075	.150	.68-22
D	.290	.220	.110	.180	2.2-47
E	.310	.230	.130	.200	6.8-68
F	.475	.375	.150	.300	10-220

T 374

Radial Leads

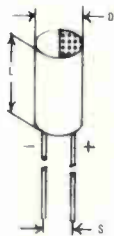

Lead Length:
Pos. 1-5/8 ± 1/8
Neg. 1-3/8 ± 1/8

T 376

Polar Cylindrical 2-50 VDC

Axial Leads

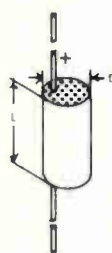

Lead Length:
Pos. 1-5/8 ± 1/8
Neg. 1-5/8 ± 1/8

Capacitor Outline Drawings

Case Dimensions—Inches

Case Size	L Case Length Max.	D Case Diameter Max.	S Lead Spacing	Capacitance μ F
A	.125	.070	.050	.001-2.2
B	.160	.070	.050	.001-.68
C	.200	.080	.050	.33-10
D	.225	.100	.070	.68-22
E	.250	.150	.120	1.5-47

T 371

Non-Polar, Radial Lead 2-50 VDC

A, B, C, E & G Case

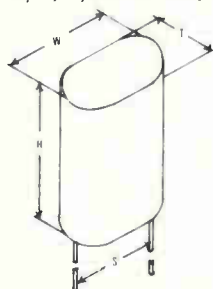

D, F, H & J Case

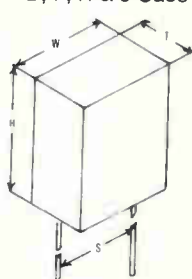

Case Dimensions—Inches

Case Size	H Case Height Max.	W Case Width Max.	T Thickness Max.	S Lead Spacing	Capacitance μ F
A	.135	.120	.070	.100	.001-1.0
B	.160	.120	.070	.100	.001-2.2
C	.200	.140	.080	.100	.15-4.7
D	.180	.125	.125	.100	1-4.7
E	.235	.190	.105	.125	.33-10

Case Dimensions—Inches

Case Size	H Case Height Max.	W Case Width Max.	T Thickness Max.	S Lead Spacing	Capacitance μ F
F	.240	.140	.180	.100	.47-10
G	.270	.290	.155	.200	1.5-22
H	.315	.180	.220	.150	3.3-22
J	.335	.230	.230	.200	6.8-33

Lead Length: All Cases 1-5/8 ± 1/8"

T 373

Non-Polar, Axial Lead 2-50 VDC

A, B, C, E & G Case

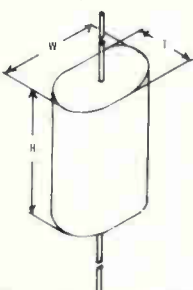

D, F, H & J Case

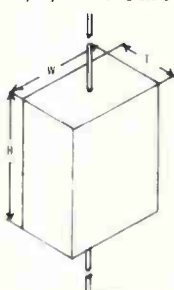

Case Dimensions—Inches

Case Size	H Case Height Max.	W Case Width Max.	T Thickness Max.	Capacitance μ F
A	.175	.120	.070	.001-1.0
B	.210	.120	.070	.001-2.2
C	.240	.140	.080	.15-4.7
D	.220	.125	.125	1-4.7
E	.275	.190	.105	.33-10

Case Dimensions—Inches

Case Size	H Case Height Max.	W Case Width Max.	T Thickness Max.	Capacitance μ F
F	.280	.140	.180	.47-10
G	.310	.290	.155	1.5-22
H	.370	.180	.220	3.3-22
J	.390	.230	.230	6.8-33

Lead Length: All Cases 1-5/8 ± 1/8"

**ELECTRONICS DIVISION
COMPONENTS DEPARTMENT**

P.O. Box 5928, Greenville, South Carolina 29606. Tel.: (803) 963-7421 TWX: 810-287-2536



THE DISCOVERY COMPANY

Union Carbide's Electronics Division is a total supplier to the Electronics Community through its Semiconductor Department, Components Department, Crystal Products Department, KORAD® Department, and Instrument Department.

MULTIPLEXERS



TOTAL ELECTRONIC
SYSTEMS CAPABILITY.
SPECIALISTS IN
TIME/FREQUENCY,
RADAR AND
DATA SYSTEMS
OFFERING RAPID
GROWTH.



P.O. BOX 222, BUFFALO, N. Y. 14225

Meetings

FJCC: Las Vegas is a natural

The decision makers at the American Federation of Information Processing Societies, which sponsors the Fall Joint Computer Conference, presumably picked Las Vegas and its Convention Center for this year's meeting (Nov. 18-20) to avoid a mad crush like the one that occurred last fall at San Francisco's Civic Auditorium, or last spring at Boston's War Memorial Auditorium. The Convention Center's size may well be adequate—but perhaps another crush will be averted because a third of the delegates will be out trying their luck against the one-armed bandits while another third are trying to catch a glimpse of Howard Hughes.

For the remaining third, the meeting itself promises to be quite interesting, although, as always, perhaps a bit too broad to satisfy any individual's particular needs. For example, R.A. Henle, I.T. Ho, G.A. Maley, and R. Waxman from IBM have prepared a discussion on applying the regularity of memory structures to logic circuits, thereby making the latter more amenable to large-scale integration. An entire session is devoted to computer privacy and security, and another to the field of medical data processing.

Representatives from four firms

of ostensibly widely divergent interests are authors of a paper on a sophisticated new display system; the firms are Shell Development Corp., Shell Oil Co.'s R&D subsidiary; Bolt Beranek & Newman Inc., a prominent computer-systems and applied physics organization; Sanders Associates, which recently made a splash in the compact memory field; and the Evans & Sutherland Computer Corp., an incorporation of two of the most sophisticated names in display technology. Four other papers discuss various way of attaining reliability through computer architecture.

A session entitled "What happened to LSI promises?" is reminiscent of two similarly titled sessions at last year's FJCC, one on hardware and the other on software. Lutz Micheel, from Wright-Patterson Air Force Base, will discuss a threshold-logic gate that can switch in 1 nanosecond and from which a multiplier could be built that would multiply two 16-bit numbers in 80 nsec. And Bell Telephone Laboratories will blow some of its magnetic bubbles in public—one of the first, or perhaps the first, public discussion of these devices.

For more information write AFIPS,
210 Summit Ave., Montvale, N.J. 07645

Calendar

Nuclear Science Symposium, IEEE;
Sheraton Palace Hotel, San Francisco;
Oct. 29-31.

International Electron Devices Meeting,
IEEE; Sheraton Park Hotel, Washington;
Oct. 29-31.

Northeast Electronics Research &
Engineering Meeting (NEREM), IEEE;
Sheraton Boston Hotel, War Memorial
Auditorium, Boston; Nov. 5-7.

University Conference on Ceramic
Science, Dept. of Metallurgical and
Materials Engineering, University of
Florida; Nov. 10-14.

Symposium on Adaptive Processes,

IEEE; Pennsylvania State University,
State College; Nov. 17-19.

Fall Joint Computer Conference, IEEE;
Convention Hall, Las Vegas; Nov. 18-20.

Commerce Laser Colloquium, Electronic
Industries Association and the U.S.
Commerce Department; Paris, France;
Nov. 18-20.

Conference on Magnetism and Magnetic
Materials, IEEE, American Institute of
Physics; Benjamin Franklin Hotel,
Philadelphia; Nov. 18-21.

Conference on Image Storage and

(Continued on p. 32)

Small wonder:



**Our new "4th generation"
12.5 MHz universal counter/timer**
Wonderful versatility.
Wonderful small package.
Wonderful small price.

With the new Model 100A you can measure average frequency, frequency ratio, single period or time interval, or count total events. It has a crystal-controlled clock, Monsanto integrated circuit construction, and built-in compatibility with a rapidly growing assemblage of accessory modules.

With its \$575 price tag, FOB West Caldwell, New Jersey, you can have big-league counter/timer performance at costs never before possible. Small wonder we are selling and delivering Model 100A's just as fast as we can build them. Accessory modules are also comparably modestly priced.

For a demonstration of our "Small Wonder," the Model 100A universal counter/timer, or for full technical details call your local Monsanto Field Engineer, or contact us directly at: Monsanto Company, Electronic Instruments, West Caldwell, New Jersey 07006, (201) 228-3800.

Monsanto

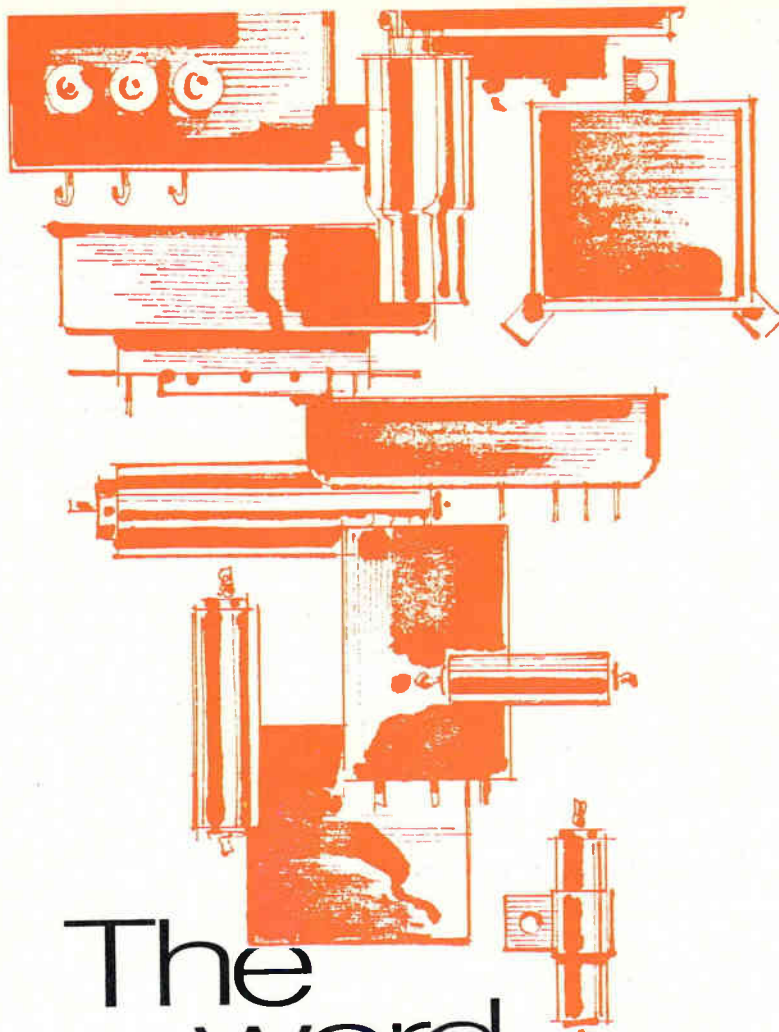

The
word
is filtering
down...

Captor is capable

Captor is the bright new face in electronic components, particularly filters. Deeply experienced. Imaginative. Capable of producing miniature EMC filters, communications and security filters, custom design filters/assemblies, and other electronic components. Capable too of fast delivery, competitive prices, testing, research. Capable of handling any size RFI/EMC filter order. Has the good word about Captor reached you yet? Write for our capabilities brochure today!

 **CAPTOR**
CORPORATION
Electronics Division

5040 Dixie Highway, Tipp City, Ohio 45371, Phone: (513) 667-8484

Meetings

(Continued from p. 30)

Transmission for Libraries, U.S. Dept. of Commerce; National Bureau of Standards, Gaithersburg, Md., Dec. 1-3.

Annual Conference, IEEE Group on Vehicular Technology; Columbus, Ohio, Dec. 4-5.

Conference on Applications of Simulation, Association for Computing Machinery, IEEE; International Hotel, Los Angeles, Dec. 8-10.

Fall USNC/URSI Meeting, IEEE; The University of Texas at Austin, Dec. 8-10.

Symposium on Circuit Theory, IEEE; San Francisco, Dec. 8-10.

National Electronics Conference, Conrad Hilton Hotel, Chicago, Dec. 8-10.

International IEEE G-AP Symposium, The University of Texas at Austin, Dec. 9-11.

Symposium on Application of Magnetism in Bioengineering, IEEE, Israel Society for Biomedical Engineering; Rehovot, Israel, Dec. 9-11.

Asilomar Conference on Circuits and Systems, Naval Postgraduate School, The University of Santa Clara, Stanford University, and IEEE; Asilomar Hotel and Conference Grounds, Pacific Grove, Calif., Dec. 10-12.

Winter Power Meeting, IEEE; Statler Hilton Hotel, New York; Jan. 25-30, 1970.

Annual Symposium on Reliability, Group on Reliability of the IEEE, American Society for Quality Control, American Society for Nondestructive Testing, and the Institute of Environmental Sciences; Ambassador Hotel, Los Angeles; Jan. 27-29, 1970.

International Solid State Circuits Conference, IEEE, University of Pennsylvania; Sheraton Hotel and University of Pennsylvania, Philadelphia, Feb. 18-20, 1970.

Short courses

System Effectiveness—From the Support Point of View, University of California at Los Angeles, Dec. 1-5. \$275 fee.

Characterizations and Models of SCR Circuits, University of Wisconsin,

(Continued on p. 34)



All components shown actual size



Only the new Allen-Bradley Type S cermet trimming resistors have all these features

Type S

shown twice actual size

for side adjustment



for top adjustment



The Allen-Bradley Type S is a one turn cermet trimmer in which you will find incorporated a wider range of features than in any other trimmer now on the market. Here are a few of the more important features.

- COMPACT—body is $\frac{3}{8}$ " dia.
- BUILT FOR EITHER TOP OR SIDE ADJUSTMENT
- 50 OHMS THRU 1 MEGOHM
- THE SEALED UNIT is immersion-proof
- TEMPERATURE COEFFICIENT less than 250 ppm/°C over all resistance values and complete temperature range
- UNIQUE ROTOR DESIGN provides exceptional stability of setting under shock and vibration
- SMOOTH CONTROL, approaches infinite resolution
- PIN TYPE TERMINALS for use on printed circuit boards with a 1/10" pattern
- VIRTUALLY NO BACKLASH

- WIDE TEMPERATURE RANGE from -65°C to +150°C
- RATED $\frac{1}{2}$ watt @ 85°C
- EXCEPTIONAL STABILITY under high temperature or high humidity
- MEETS OR EXCEEDS ALL APPLICABLE MIL SPECS
- COMPETITIVELY PRICED!

Need to know more about the Type S trimmer? Call your authorized A-B industrial electronics distributor. He'll give you immediate delivery at factory prices. Or write for detailed specifications to the Marketing Department, Electronics Division, Allen-Bradley Co., 1201 S. Second Street, Milwaukee, Wis. 53204. In Canada: Allen-Bradley Canada Limited. Export Office: 1293 Broad Street, Bloomfield, N. J., U.S.A. 07003.

©Allen-Bradley Company 1969



ALLEN-BRADLEY
QUALITY ELECTRONIC COMPONENTS

EC69-53A

Circle 33 on reader service card

THE
Next
 GENERATION
SCR



**DISC PACKAGED
 REGENERATIVE GATE
 SCR's**

Operation to 20 KHz with low switching losses
 ⊕ di/dt capability to 800 A/μsec. ⊕ low power
 gate drive ⊕ dv/dt capability to 500 V/μsec.
 ⊕ 175 and 370 amperes RMS ⊕ turn-off time
 capability to 10 μsec. ⊕ also available
 in stud type package to 470 amperes RMS.

For additional information and application assistance,
 write or call National Electronics, Inc.,
 a varian subsidiary, Geneva, Ill. 60134,
 phone (312) 232-4300.

NATIONAL ELECTRONICS, INC.
 a varian subsidiary

*1969 COMPETITION WINNER
 Cited by Industrial Research Inc.
 as one of the 100 most
 significant technical products of the year.*



A NATIONAL® exclusive,
 Patent Pending.

Meetings

(Continued from p. 32)

Madison, Dec. 9-10. \$70 fee.

Computer Control, University of
 Wisconsin, Madison, Dec. 11-12.
 \$70 fee.

Electronic Components, University of
 Wisconsin, Madison, Feb. 19-20.
 \$70 fee.

Call for papers

Electronic Components Conference,
 Electronic Industries Association and
 IEEE; Statler-Hilton Hotel,
 Washington, May 13-15, 1970. **Nov.
 15** is deadline for submission of
 abstracts to Darnell P. Burks
 Sprague Electric Co., Marshall St.,
 North Adams, Mass. 01247.

Computer Group Conference, IEEE;
 Washington, D.C., June 16-18, 1970.
Nov. 15 is deadline for submission of
 papers to T.C. Foote, IEEE Computer
 Group Conference 1970, P.O. Box 1727,
 Rockville, Md. 20850.

**National Aerospace Electronics
 Conference (NAECON)** IEEE and
 American Institute of Aeronautics
 and Astronautics; Sheraton-Dayton
 Hotel, Dayton, Ohio, May 18-20, 1970.
Dec. 1 is deadline for submission of
 abstracts to Mrs. Rita Gustin, 5455
 Flotron Ave., Dayton, Ohio 45424.

Southwestern IEEE Conference,
 Memorial Auditorium, Dallas, April
 22-24, 1970. **Dec. 1** is deadline for
 submission of abstracts and summaries
 to Prof. Andrew P. Sage, Information
 and Control Sciences Center, SMU
 Institute of Technology, Dallas,
 Texas 75222.

**Symposium on Management and
 Economics in the Electronic Industry**,
 IEE; University of Edinburgh, Scotland,
 March 17-20, 1970. Synopses should
 be sent immediately to Conference
 Department, IEE, Savoy Place,
 London WC2.

Conference on Gas Discharges, IEE;
 London, England, Sept. 15-18, 1970.
Dec. 1 is deadline for submission of
 synopses to Conference Department,
 IEE, Savoy Place, London, L.C. 2.

Frequency Control Symposium, U.S.
 Army Electronics Command; Shelburne
 Hotel, Atlantic City, N.J., April 27-29,
 1970. **Dec. 15** is deadline for
 submission of summaries to Director,
 Electronics Components Laboratory,
 Army Electronics Command, Fort
 Monmouth, N.J. 07703.

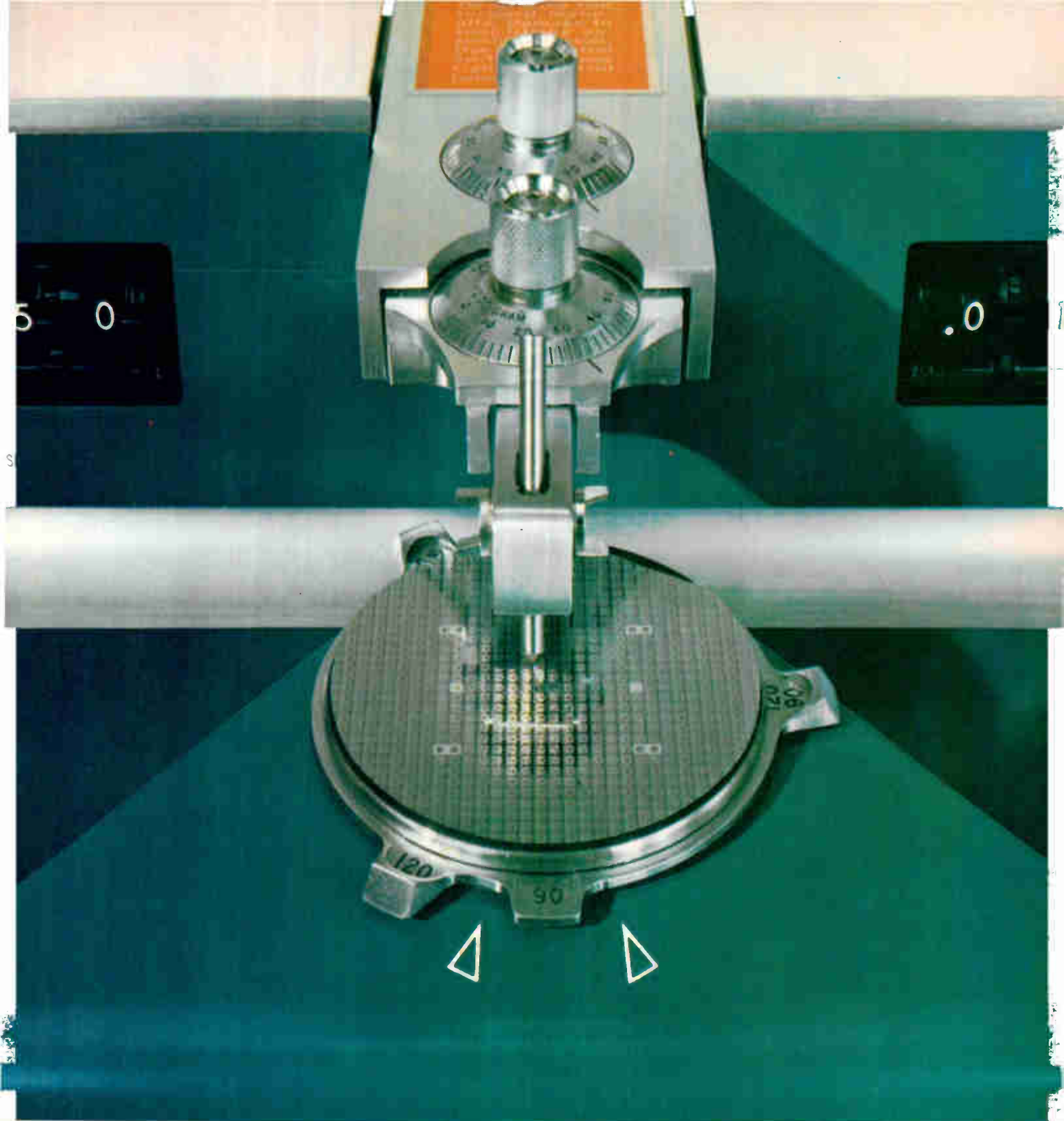

An economy of excellence

The Tempress four-pointed, Truncated Pyramid, Diamond Scribing Tool*, a unique Tempress development, will precisely scribe silicon wafers four to six times longer than conventional diamond scribing tools . . . an economy of excellence. Natural octahedron diamond crystals are hand selected for each tool. The diamond crystal is then ground across its natural edges to create a pyramid shape, the edges of which lie within the hardest planes of the diamond crystal. The peak of the pyramid is then

truncated to form four precision cutting points of maximum wear resistance. The efficiency and economy this tool has brought to semiconductor manufacturing reflects the Tempress Standard of Excellence, inherent in each miniature assembly tool and production machine produced by Tempress.

*Shown 2 1/2 times actual size.



TEMPRESS

Tempress Industries, Inc., 980 University Ave., Los Gatos, Calif. 95030

Circle 35 on reader service card

microtopics

New MOS 4-bit adder

Here's another unique MOS device from Philco-Ford . . . the pL4AO1C binary-BCD 4-bit adder . . . which can reduce package count and improve speed of your logic system. It can perform 4-bit parallel addition as fast as 2 microseconds. Compared to other MOS adders on the market, it has twice the "add" capability and considerably faster speed.

The pL4AO1C operates in either the 8-4-2-1 binary or binary coded decimal number system. In either system, addition of two 4-bit numbers and carry input yields a 4-bit sum output and carry output. It is supplied in a 24-lead flat pack.

CIRCLE 326 ON READER SERVICE CARD

New phase-locked avalanche oscillator source

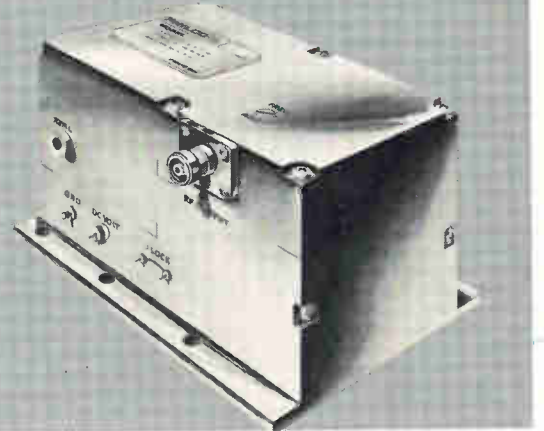

For the first time anywhere, we've applied the stability of phase-lock control to an avalanche oscillator power source. Frequency stability equals that of conventional multiplier chain sources. Power output is an order of magnitude greater than conventional phase-locked transistor oscillators—up to 250 milliwatts in Ku band.

Its unique phase-lock loop provides

broad phase-modulation capability. Spurious output is minimized because the oscillator operates at its fundamental frequency, without need for multiplication.

This unique new power source is smaller and costs less than a multiplier chain source. It's available from C through Ku band, and operates from -25° to $+72^{\circ}\text{C}$.

CIRCLE 327 ON READER SERVICE CARD

Digital Crosspoint Quad Switch... another MSI bipolar array

Now you can do the equivalent of telephone-style crossbar switching in solid state, by means of Philco-Ford DCQ—Digital Crosspoint Quad—bipolar array. The DCQ is a 2×2 array of crosspoints which can be configured to produce a switching matrix of whatever complexity you require. It is now being used in communications switching networks, and is applicable to switching of input-output lines connecting peripheral equipment to computers, or for any switching application where the information to be switched is in digital form. Each crosspoint is bi-directional, and includes selection and hold logic.

The chip contains the equivalent in complexity of 20 NAND gates. Double layer metallization is used

for interconnections. The DCQ utilizes T²L logic and will interface directly with Series 74 circuits. Power dissipation is a low 36 milliwatts. Selection and hold mode is accomplished typically within 60 nanoseconds. Information can be transferred through the data lines at rates up to 2 MHz.

The master chip can perform other functions beside crosspoint switching, simply by customizing the multilayer interconnection pattern. Think of it as an array of four basic cells, each consisting of two AOI gates and one NAND gate . . . which you can receive from us hooked up in just about any configuration you want. Tell us your application, we'll be glad to examine feasibility.

CIRCLE 328 ON READER SERVICE CARD

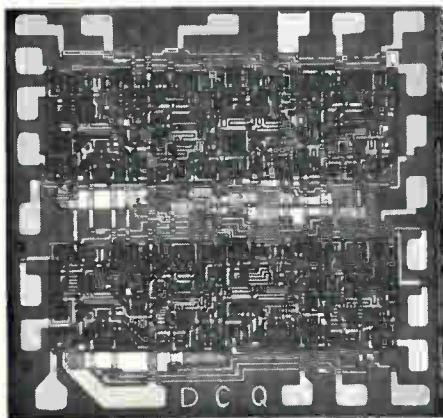

Something new in Series 74 T²L... glassivated chips in cerdip packages



Why consider another source for Series 74 T²L? Here are three good reasons from Philco-Ford.

RELIABILITY

As a final production step, we put an added layer of glass over the completed chip. This glassivation process protects the circuit against damage, and gives an extra measure of reliability.

HERMETIC DUAL-IN-LINE PACKAGES

All Philco-Ford Series 74 circuits are manufactured in hermetically sealed ceramic dual-in-line packages...

AND at prices comparable to plastic. Your assurance of quality is the experience we have gained in manufacturing many millions of cerdip DTL and T²L circuits.

CLAMP DIODES

All Philco-Ford Series 74 circuits have been designed with clamp diode inputs to reduce ringing and improve system noise immunity.

All popular Series 74 circuits are now available from our Lansdale facility, one of the country's largest IC manufacturing plants.

CIRCLE 329 ON READER SERVICE CARD

16-channel MOS multiplexer for time-division systems

The pL4S16C is a different kind of switch that can add new versatility of multiplexing functions in your telemetry, data sampling or communication system. Offset voltage is zero. Leakage current is less than 10 nanoamps. And it is voltage-driven... needs no complicated drive net-

work. You can clock it externally, or allow it to free-run on its 100 KHz internal clock.

As a 16-channel multiplexer, the pL4S16C gives you a choice of random access switching, or sequential sampling of all 16 channels, or of

simultaneous sampling of two banks of 8 channels... just by changing external wiring. Stack them up, and you can get switching in sequential or random access modes, in multiples of 16 channels. Or, if you like, you can use it to switch 2 to 16 channels.

CIRCLE 330 ON READER SERVICE CARD

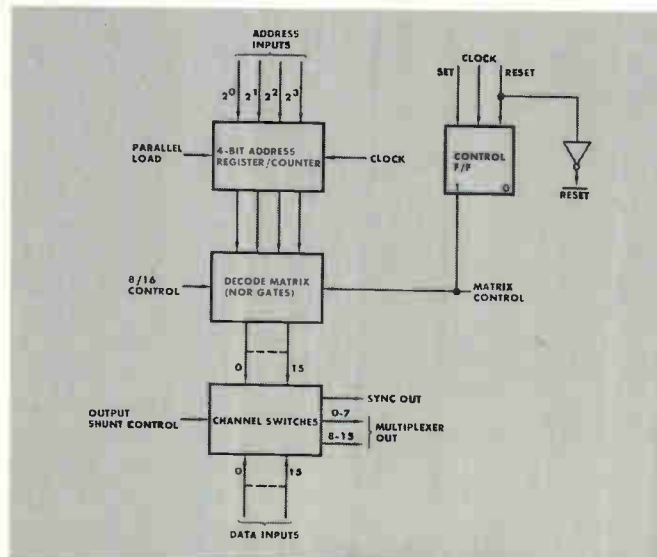

Typical Specifications

Offset voltage:	0 volts
Signal voltage swing:	10 volts max.
Channel leakage:	10 nA
"ON" resistance:	1000 ohms
Power dissipation:	150 mW max.
Input capacitance:	5 pF
Max. clock (sequential mode):	100 KHz
Package:	34-lead flat pack



Ultramation: a computer that rushes in where others fear to tread.

On ships plowing through icy water. In vans bouncing along jungle roads. In aircraft soaring five miles high. On production lines working next to heavy, vibrating machinery – places you wouldn't dare send an ordinary computer, you can send the ruggedized Honeywell DDP-516.

That's Ultramation: the ultimate in computer reliability from Honeywell.

Inside it's a powerful, flexible, general-purpose computer—our DDP-516. But ruggedized. We protected every logic module against vibration and shock. Tied the tilt-out drawers at four integral

points—making it virtually non-resonant (below 500 Hz). Gave it EMI suppression by enclosing the system in a welded steel cabinet and shielding the input/output, air intake/exhaust, and control panel.

Result: certification from Avco's independent testing laboratory that the computer meets applicable military and shipboard specifications – the first such certification ever given to a standard production computer.

Get all the facts on the fearless 516. Write Honeywell, Computer Control Division, Framingham, Massachusetts 01701.

The Other Computer Company:
Honeywell

Editorial Comment

Redefining computer goals

Should industry back off from stressing greater computing capability (bigger and faster computers) and concentrate, instead, on smarter computer systems? Such systems would converge on wanted solutions rapidly rather than merely pour out reams of data, most of which is useless. Some computer theorists, and even some pragmatists, believe priorities are misplaced insofar as hardware versus software is concerned.

At a seminar on "computers, communications, and the public interest," which was cosponsored recently by Johns Hopkins University and Brookings Institution and held in Washington, Herbert Simon, a professor of computer science at Carnegie-Mellon University, emphasized certain factors that bear upon the relative importance of faster processing and input-output techniques.

First and foremost on his list is what Simon calls "information overload." Simon contends that in the drive to develop greater data-processing capability, user attention somehow has been given short shrift. Unless information is processed in such a way that it can be absorbed by the user during the precise attention span that the user has allocated for it, it is of scant value. Simply, the information explosion consists of a proliferation of vast amounts of partly processed information, solutions to certain specific problems, and a great deal of arbitrary and/or obsolete data. Given the proliferation of computers and computer systems, the implication is that society will encounter a situation analogous to the development of a highway network that speeds traffic toward a city like New York, which cannot accommodate the result. A parallel would be the rapid accumulation of facts and figures in a management-information system. Such an accumulation could be so outsized and unwieldy that it could not be further reduced for the use of the chief executive, for whom it's intended.

What is really needed, then, is a system that is a good filter. It must analyze, digest, and screen information, not merely juggle data, print it, or

duplicate previously processed data.

Computer systems that acquire the human failing of being "information savers" frighten not only Simon, but others as well. Simon and those who agree with him suggest more work be done on programs that do not rely on the storage of vast amounts of data. Rather, they contend, programs are needed that can regenerate or recreate solutions either "from nature" or from a logical set of programmed problem-solving instructions. In the ideal situation, they observe, recreation of information in this manner could be cheaper than retrieval of stored information.

In light of these thoughts, what about the company that is facing the question of whether to buy another computer? Simon believes computer systems must deliver more pointed answers or the decision to acquire more computing power may be the wrong one; such a decision may only "worsen the disease" of information overload.

If this suggestion seems to cast a note of gloom over the optimistic outlook for the computer industry, consider these other factors. First, the goal of faster convergence of computer systems upon wanted solutions does not necessarily conflict with the objectives of computer technologists who are developing faster, more efficient hardware. Furthermore, the design of hardware and software has long since progressed to where neither can be considered independently. New partitioning techniques and logic-process schemes are aimed toward programing that will lead not only to greater efficiency in filtering, but to faster convergence to useful solutions as well. List processing is coming into use. There are also several new and sophisticated display systems which show complicated systems graphically so that man can easily understand them. Finally, it should be noted that even Simon is not favoring a moratorium on the production of computers. "We must build and use [computers] before we know *how* to use them," he suggests. ■

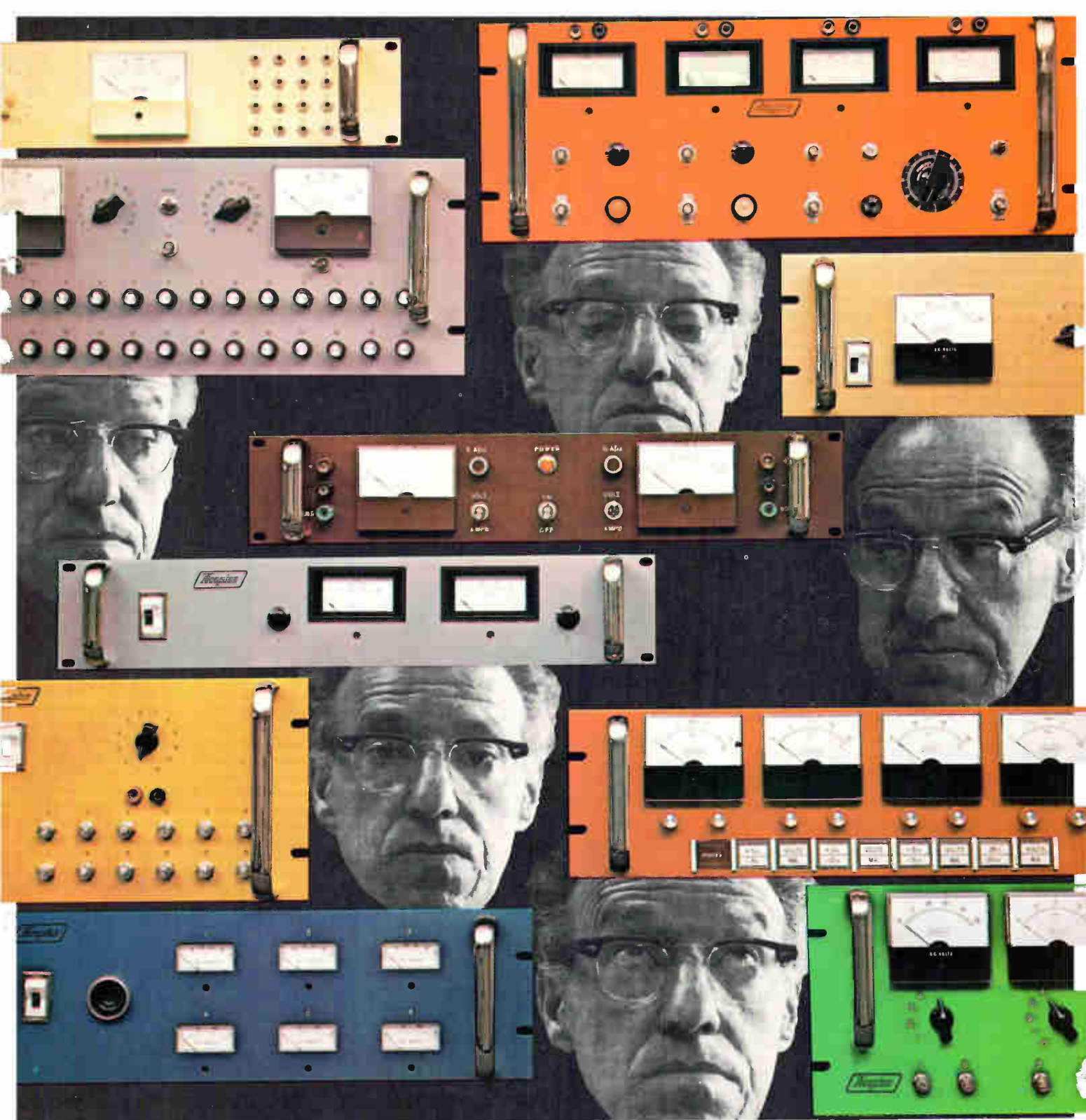

**Looking for a special power supply system?
Acopian will ship it in just 9 days!**

When you're looking for a multiple-output power supply system, and you need it in a hurry, look no further. Acopian will design it, build it, test it, and ship it...fully wired...*in just 9 days!*

Call 'hot line' 215-258-5441. Simply tell us the DC voltages and currents you need. We'll discuss—on the phone—the power modules, the panel size, accessories such as meters, terminations, test jacks, rotary

switches or any other feature you feel is important. Then—on the phone—we'll give you a firm price—and get the order going for guaranteed 9-day shipment.

Others make promises. Acopian makes power supplies. Power modules in 3 days, and now power systems in 9 days. For immediate service, call 215-258-5441. For literature, write Acopian Corporation, Easton, Pa. 18042.

Circle 40 on reader service card



Electronics Newsletter

October 27, 1969

**Honeywell to need
million digital IC's
a week by 1973**

Honeywell's Electronic Data Processing division is leaking word to suppliers that, based on market forecasts for its H-3200 computer, production demands could reach 1 million digital IC's per week by 1972 or 1973. That's 52 million digital IC's a year—more than were produced in the U.S. in all of 1966 and almost as many as were produced in 1967, according to EIA figures. The Honeywell IC's would be TTL, many of which would be custom designs, and at least some would be arrays with medium-scale integration.

If Honeywell's growing use of IC's is typical, the semiconductor industry had better expand at more than a linear rate. Industry predictions for 1972 pegged IC production between 200 million and 300 million units, low in light of the requirements of a single user.

**Coming from TI:
discretionary-wired
shift registers...**

Texas Instruments isn't wasting time. Just last summer it introduced its first commercial discretionary-wired product, an LSI digital differential analyzer [*Electronics*, Aug. 18, p. 145]. Now, the company is planning to introduce the industry's first line of discretionary-wired shift registers.

Making their bow next month will be three dynamic bipolar devices—a dual 253-bit unit, a dual-349 device, and a dual-501 unit. They will sell initially for about 40 cents per bit in medium quantities, but TI officials see the price dropping to less than 20 cents per bit in the next two years. Unlike the DDA introduced first, which has three layers of metalization, these products have only two metal layers, one of which is discretionary routed.

**... and 16 more
TTL devices**

TI is also continuing to fill out its nondiscretionary wired transistor-transistor logic line. Sixteen more products will be unveiled by year's end, four of which employ two layers of metalization. These devices—a synchronous decade counter, a synchronous binary counter, a six-bit binary rate multiplier, and a 64-bit read-write memory—have been furnished on a custom basis.

Jack Carsten, TTL marketing manager, says Fairchild has also sold some custom devices using two layers of metal, but the new TI products will be available in production quantities. And, he says, the two-layer devices will be medium- and large-scale integrated TTL. Carsten expects the extra cost of a second metal layer to be offset by higher yield because the dice can be made smaller. TI won't use two layers of metal for "much less than 50 gates," Carsten says.

**High-power r-f:
new light for end
of plasma blackout**

It may be possible to transmit signals through the reentry plasma—which blacks out communications with manned space vehicles—by pumping extra radio energy into the plasma itself. The high-power r-f boosts the energy of the plasma's free electrons so they'll combine with other plasma particles—which then are too massive to soak up other transmissions.

Working at the Air Force's Cambridge Research Laboratories in Bedford, Mass., the scientists already have tried "overfeeding" a plasma with a 20-watt beam of 7 megahertz r-f, and call their results to date excellent.

Electronics Newsletter

The next step: a tryout on a Trailblazer rocket to be fired from Wallops Island, Va.

Meanwhile, researchers contemplate seeding a reentry vehicle's ablative outer coating with chemicals like sulphur hexafluoride for more efficient electron absorption—the chemical equivalent of a larger appetite and smaller stomach.

Believe it or not! IBM, Government on same side

An unlikely, if unintentional, alliance for protection of computer software seems to have come about between IBM and the Government. Unlike their divergent positions on antitrust, **IBM and the Government are suddenly promoting markedly similar views on the still unresolved issue of software protection—views that are different from those held by both just a year ago.**

Patent Commissioner William E. Schuyler Jr., is rescinding his predecessor's software protection guidelines and the Patent Office is exploring new protection approaches that would stimulate software investment and encourage information exchange between competitors and users. IBM, opposed to software patenting a year ago, now wants protection for all software—patentable or not—to protect corporate investments. It wants a new type of protection, specifically tailored for computer programing.

Automation eyed as answer to rise in offshore tariffs

With the Federal Tariff Commission considering an increase in the import tax on "offshore-assembled" devices, semiconductor firms with operations in Hong Kong, Korea, and Singapore face the loss of the price advantage afforded by 20-cents-an-hour labor. **Some IC makers feel that automation of their domestic operation would take up the price slack.** One manufacturer is already preparing to switch to automated beam-lead bonding, should the Government raise the import tax.

TI, Motorola, and Fairchild reportedly are ready to make the change-over despite the high cost of automated equipment. It's estimated that automating a medium-sized plant could cost between \$5 million and \$10 million. And for a large operation, the cost for machinery can run as high as \$50 million.

However, at least one major manufacturer has adopted a wait-and-see attitude, declaring that automation just can't make up for the loss of cheap labor.

Addenda

Despite the market dominance of its own 54/74 transistor-transistor logic, TI hasn't given up on Sylvania's version, SUHL. **The firm has been selling both SUHL 1 and SUHL 2 for some time, and soon will show data sheets on a full line of gates and flip-flops.** However, the SUHL effort is divorced from the Houston-based 54/74 TTL work. The devices are produced in metal flat-packs and plastic dual in-line packages in the same department in Dallas that makes diode-transistor logic devices and linear integrated circuits. . . . The Imlac Corp. of Waltham, Mass., will introduce at the Fall Joint Computer Conference a 16-bit computer, with a 4K memory—an integral display system capable of both alphanumeric and graphics. Buyers of Imlac's PDS-1 will get a 1,040-character crt display capability and minicomputer processing in a single package for a price to original equipment manufacturers of \$6,500—**several thousand dollars less than the cost of most displays alone.**

DISPLAY DEVICES

Low-cost display tube operates on low signal voltage.

New "Flurotron" fluorescent indicator tube is compatible with voltage levels available in computers.

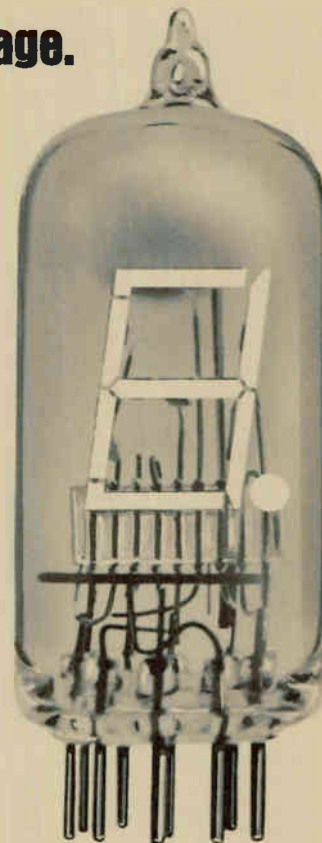
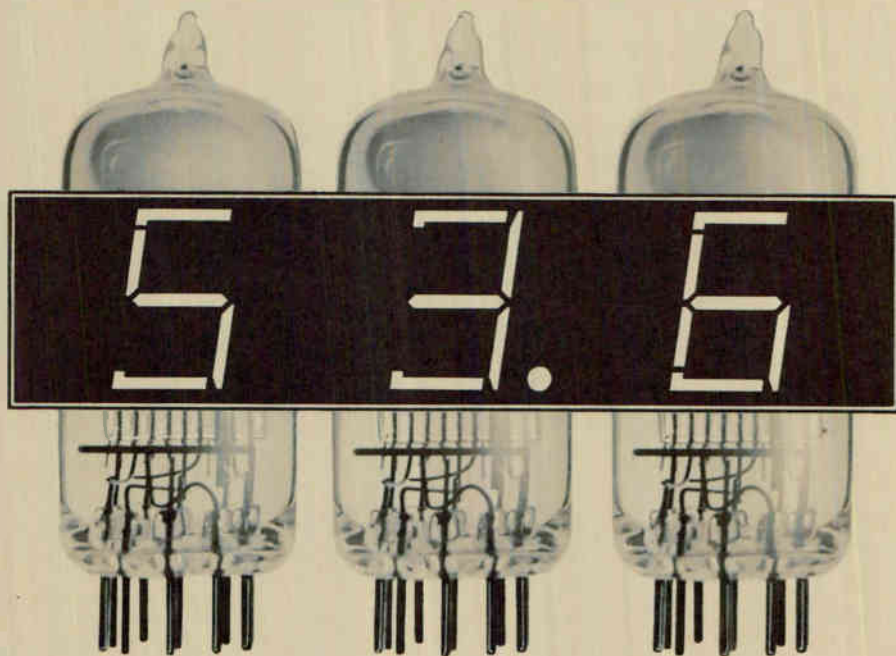

Our new "Flurotron" indicator tube combines the advantages of low cost with low signal and power operation. That alone should make it the device to consider for your next project requiring a numeric readout.

Priced at about $\frac{1}{3}$ the cost of comparable readout tubes, the "Flurotron" is an ideal display device for computer readouts, digital voltmeters, frequency counters and desk calculators. It operates from a 25 Volt signal as compared to 80 to 90 Volts required by other display tubes.

The "Flurotron" works on a simple principle and is not much more complicated than an ordinary incandescent bulb. It consists of directly heated cathode and eight anodes coated with fluorescent phosphor. When a voltage is applied to any of the anodes, they glow green. The anodes are arranged in a "figure-8" configuration (7 segments) so that any number from 0 through 9 can be formed by lighting the appropriate anodes.

Each "Flurotron tube" also includes a decimal point that may be used optionally. All connections to the "Flurotron" are made through a 10-pin base. The tube comes in a T-6 $\frac{1}{2}$ envelope and is designed for extra ruggedness. Light output is on the order of 200 foot-lamberts.

Because all fluorescent segments are located on a single plane near the tube wall, there are no parallax problems. The display can be viewed easily from a wide variety of angles. The in-line display also means that you don't have to look through a maze of unlighted characters in order to see the readout.

The "Flurotron" is a low current device. At 25 Volts, current requirements are only 0.5 mA per anode segment. The specially designed filament operates on only 1.4 Volts at low power drain. Low phosphor persistence provides a high-speed readout capability. With all of these advantages, doesn't it make sense to solve your next display problem with "Flurotron"? **CIRCLE NUMBER 300**

This issue in capsule.

Integrated Circuits

You can mix and match with our functional arrays.

EL Displays

New decoder-driver cuts EL display cost.

Circuit Assemblies

Variety adds spice to circuit board production.

Television

Here's a bright new 17" tube for your line of color sets.

Microwaves

Precision microwave resistors are current controlled.

CRTs

Our CRT designers solve engine tester problems.

Manager's Corner

How to make a good thing better.

INTEGRATED CIRCUITS

You can mix and match with our functional arrays.

No matter which TTL logic system you are designing with, Sylvania arrays will be compatible.

Our functional arrays are versatile. They'll work with any TTL logic system and most kinds of DTL logic, too. They have been specifically designed to have input/output characteristics that interface with all of these logic forms. As you can see from the table, our functional arrays match up with SUHL I, SUHL II, 7400N and 5400/7400 logic families.

The reason for this compatibility is a built-in commonality. All of our functional arrays use a 5-volt supply with TTL logic throughout. All have input/output buffering and all have the high noise immunity common to TTL circuitry. Sylvania functional arrays also have other advantages. They come in military and industrial temperature ranges.

But the really big advantage is the number of different functions available. These include fast adders, storage registers, scratch pad memories, binary and decade dividers and counters. The list shown is the most complete line of functional arrays available in the industry. All units are designed to give you the maximum in functional density at the lowest possible cost. All are available in 14-lead flat packs or dual in-line plug-in ceramic packages.

If you are designing with arrays or thinking of using arrays in your next project, you'll find our functional arrays applications booklet a handy design guide. Just circle the reader service number listed below to get your copy.

CIRCLE NUMBER 301

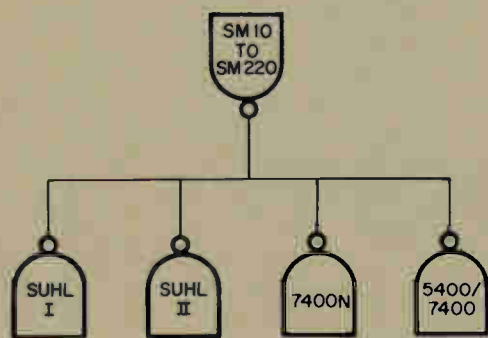

Sylvania arrays interface effectively with four major forms of TTL logic.

Compatibility of Parameters for Different TTL Families

Arrays	Logic	V _{cc}	Input		Output	
			V _{IL}	V _{IH}	V _{OL}	V _{OH}
SUHL I	TTL	5	—	—	—	—
SUHL II	TTL	5	0.9	1.4	0.5	2.8
Sylvania 7400N	TTL	5	0.9	1.6	0.4	2.7
Sylvania 5400/7400	TTL	5	0.8	2.0	0.4	2.4
Sylvania 5400/7400	TTL	5	0.8	2.0	0.4	2.4

Functional arrays, typical characteristics (+25°C, +5.0 Volts)

Function	Type No.	t _{pd} (nsec)	Avg. Power (mw)	Noise Immunity (Volts)—	Fanout
Full Adder	SM10 Series	Sum 22 Carry 10	90	1.0 1.0	These arrays are available in fanouts up to 15 and are completely compatible with SUHL I, SUHL II, and other TTL integrated circuits.
Dependent Carry Fast Adder	SM20 Series	Sum 22 Carry 10	125	1.0 1.0	
Independent Carry Fast Adder	SM30 Series	Sum 22 Carry 10	125	1.0 1.0	
Carry Decoder	SM40 Series	2	25	1.0 1.p	
4-Bit Storage Register	SM60 Series	20	30/bit	1.0 1.0	
Bus Transfer Output 4-Bit Storage Register	SM70 Series	20	30/bit	1.0 1.0	
Cascade Pullup Output 16-Bit Scratch Pad Memory	SM80 Series	25	250	1.0 1.0	
Decade Frequency Divider	SM90/92 Series	35MHz	125	1.0 1.0	
	SM91/93 Series	30MHz	85	1.0 1.0	
4-Bit Shift Register	SM110 Series	25MHz	120	1.0 1.0	
Parity Generator/Checker	SM120 Series	22	125	1.0 1.0	
Comparator	SM130 Series	17	120	1.0 1.p	
Programmable Binary Divider	SM140 Series	25MHz	150	1.0 1.0	
Programmable Decade Divider	SM150 Series	25MHz	150	1.0 1.0	
Binary Counter	SM160 Series	25MHz	135	1.0 1.0	
Decade Counter	SM170 Series	25MHz	135	1.0 1.0	
Binary Up/Down Counter	SM180 Series	25MHz	205	1.0 1.0	
Decade Up/Down Counter	SM190 Series	25MHz	205	1.0 1.0	
BCD to 7-Segment Translator	SM200 Series	85	280	1.0 1.0	
Dual 4-Bit Multiplexer	SM210 Series	10-20	130	1.0 1.p	
Demultiplexer	SM220 Series	9-14	225	1.0 1.0	

EL DISPLAYS

New decoder-driver cuts EL display cost.

Compact unit plugs directly into back of electroluminescent display panel.

We've made a major reduction in both the size and cost of decoder-drivers for electroluminescent displays. Our new SME-160 and SME-161 decoder drivers have the lamp socket as a part of the printed circuit card. As a result, these units plug directly into the back of the EL panel. A separate lamp socket is eliminated thus reducing the cost of the entire assembly.

The decoder-driver socket has been specifically designed to mate with the 1" size numeric digit and takes up only $\frac{1}{16}$ " of mounting depth behind the panel. Width of the driver module has been held to the width of the display digit, so that it is possible to mount individual modules side by side in multi-digit displays.

If you want to use these decoder-drivers with $\frac{1}{2}$ " digit sizes, we have a special adapter panel available to interface between the display panels and the decoder which is limited to two digits. For digit sizes larger than 1", adapter panels can be made with no restrictions on the number that can be mounted side by side. Use of the adapter panel increases mounting depth to approximately $\frac{3}{4}$ " behind the panel.

Electrically, the SME-160 and SME-161 decoder-drivers are identical to the larger and more expensive SM-158 and SM-159 modules. All special functions such as leading-edge zero suppression, lamp intensity modulation and lamp test input are standard features of these modules.

These modules are just one more reason for considering electroluminescent displays for all types of readouts. Among the many advantages of EL is the fact that catastrophic failures just don't happen. Power consumption is minimal. It takes as little as 1 mA at 250 Volts to drive a $\frac{1}{2}$ " EL numeric. Because of the low power levels, EL devices are cool running. There are no heat dissipation problems. In addition, the spectral output of an EL display closely matches the response curve of the human eye.

CIRCLE NUMBER 302

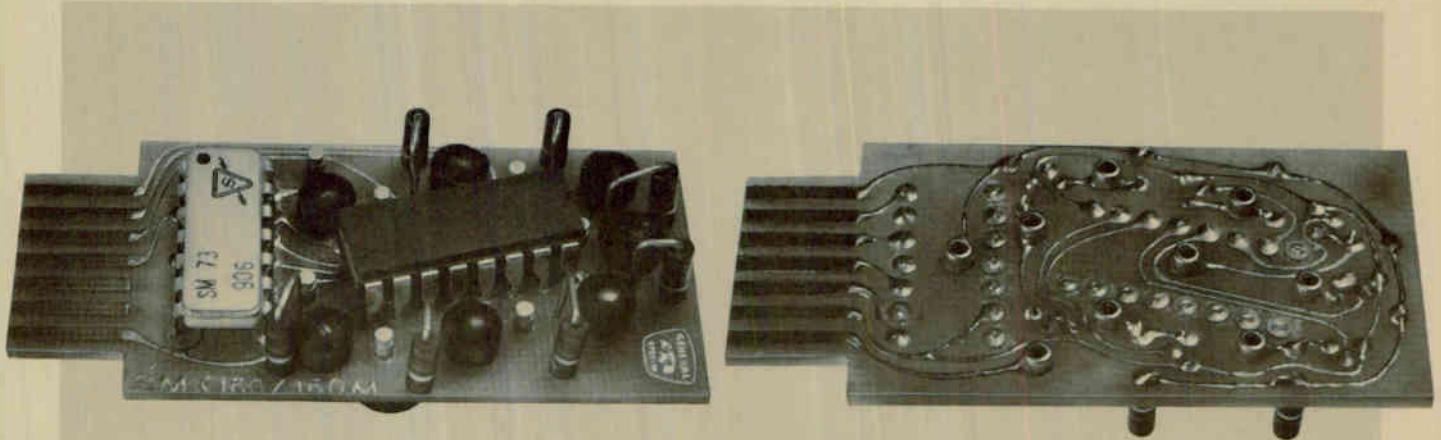

Decoder-driver mounts on the rear of 1" EL display.

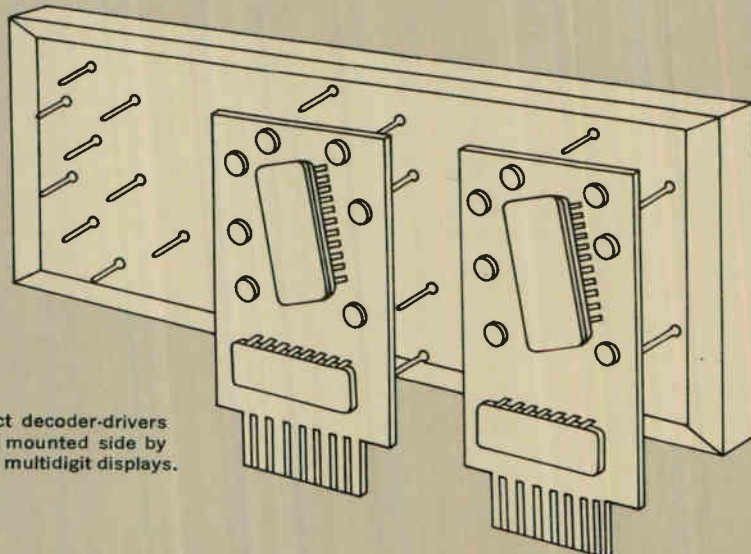

Compact decoder-drivers can be mounted side by side on multidigit displays.

CIRCUIT ASSEMBLIES

Variety adds spice to circuit board production.

Our circuit assembly facility is capable of taking on jobs with a wide variety of requirements.

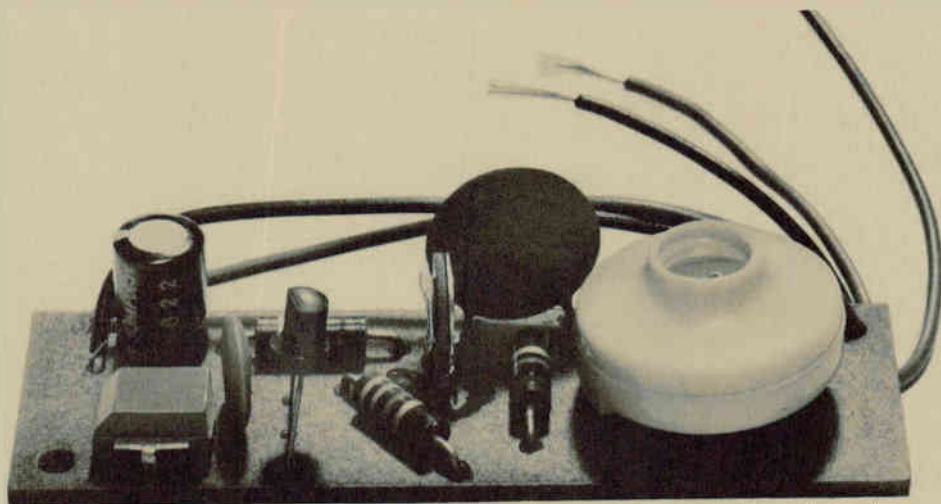

Simple circuit assembly for children's toy was turned out in large quantities at low cost.

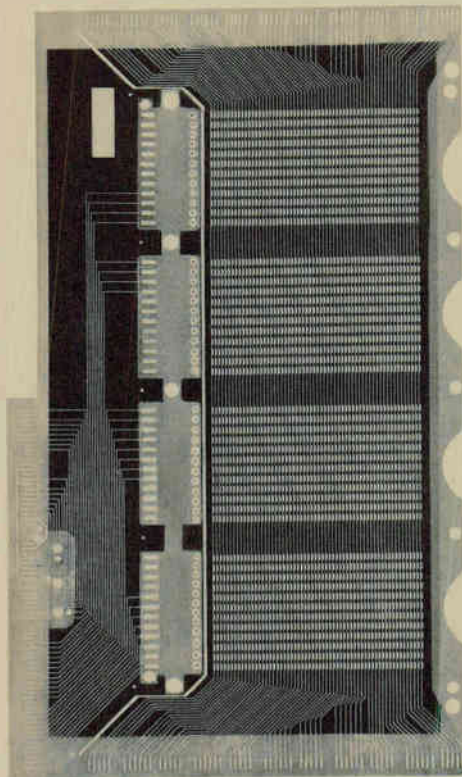

Large-size computer board holds 0.0005" tolerances over 20" span.

Not all printed-circuit board and circuit assembly production have the same standards of quality and reliability. Some jobs are high volume, some are low. But they all have one thing in common. They have to meet the customer's requirements. We at Sylvania have a high degree of flexibility built into our operation. As a result, we can handle work requiring ultra-high reliability for space missions or low-cost circuits for children's toys.

Here are four case histories that illustrate our flexibility and show how we can meet the varying requirements of our customers:

High reliability, high production—In our NAFI program, we have turned out over 20,000 printed-circuit assemblies in 82 different types. These modules are part of the Navy's Standard Hardware Program and have been used in the Fire Control and Guidance System for the Poseidon missile system. Of course, high reliability was a must. Specs called for a 30,000-hour operating life with a 10-year shelf life. In this project, we were supplied with input/output requirements. Our engineers were responsible for component selection, circuit layout, packaging

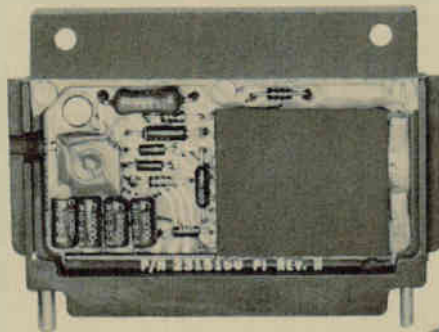

We've produced 20,000 of these NAFI modules in 82 different types.

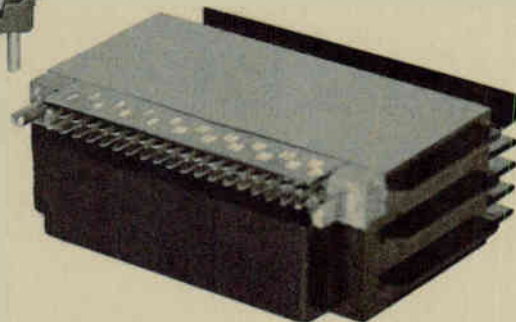

density to meet thermal and reliability requirements. **Ultra-high reliability, low volume**—Only 50 circuit boards were shipped to the customer in our lunar module circuit board production. But, very tight tolerances on these single and double sided boards made this a special project. Tolerances on these very high packing density boards were held to 0.0020" to 0.0025". Each board was inspected under 30 power magnification to make sure it measured up to specs.

Similar tight specs were required on a subassembly we made for Minuteman missile launch complex. These subassemblies are used in a checkout system and for a multi-aperture ferrite core driver.

High volume, commercial application—Typical of our capabilities for commercial applications is a circuit board made for a large computer manufacturer. This large-size board required holding dimensional tolerances of 0.0005" over a 20" span. Our fast-turnaround capability enabled us to get into production at a rate of 1200 boards a day only four weeks after start-up. **High volume, low cost**—A toy manufacturer needed a simple audio-activated control for a children's toy. He needed them at low cost and in large volume. We were able to come up with the assembly that would do the job for him. And we were able to produce them at the rate he needed—up to 2400 assemblies per day

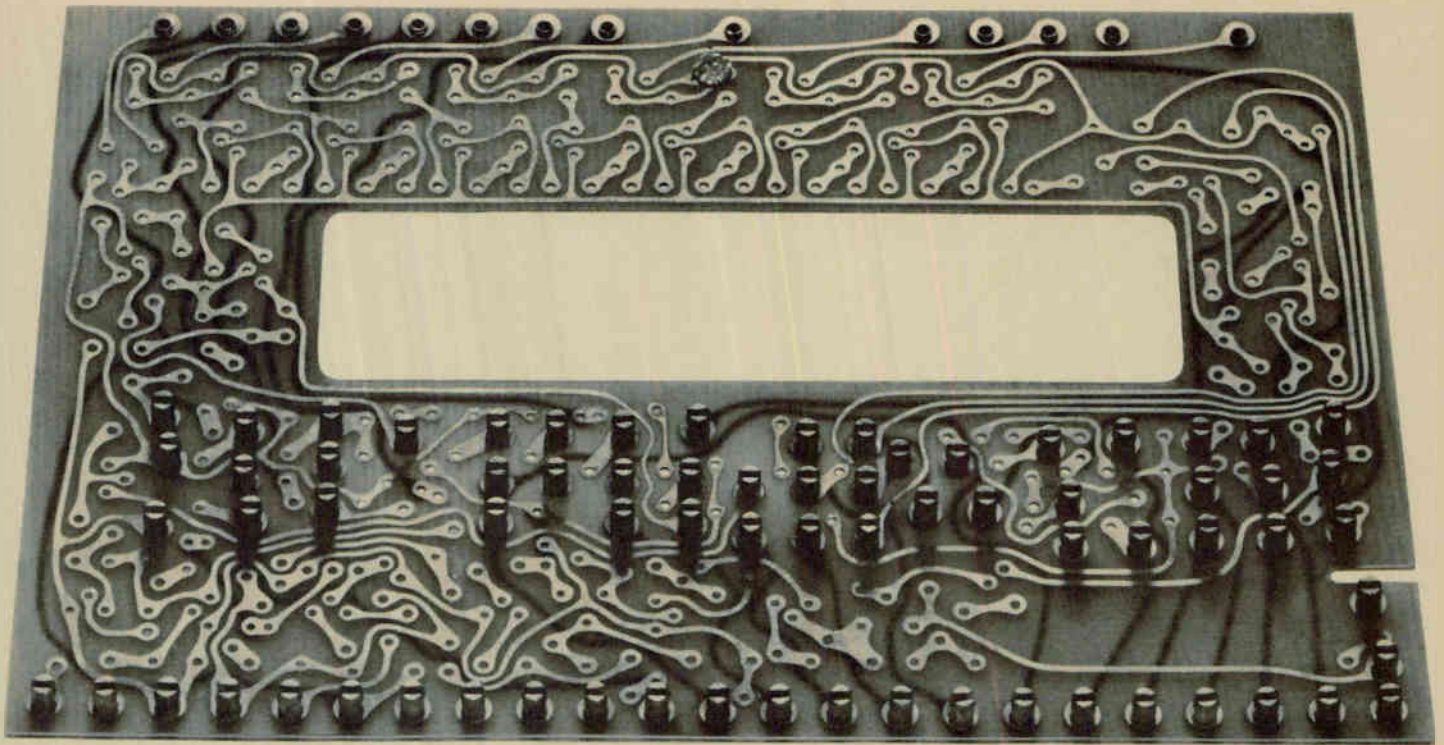

Circuit boards for lunar module required extremely tight specs in a small production run.

with 100-percent testing for the desired audio sensitivity.

As you can see, we can work with a wide variety of circuit and assembly board requirements, both military and commercial. And we'll work with you from any stage of the

game—from the drawing board, breadboard or from your own artwork. Our fast turnaround capability will enable us to meet your most demanding specs, whether they involve time, volume or tight tolerances. **CIRCLE NUMBER 303**

TELEVISION

Coming: a bright new 17" tube for your line of color sets.

New addition to color bright 85[®] line gives you a complete choice of sizes from 15" to 26" in 90° color tubes.

All of the well-known advantages of Sylvania's *color bright 85*[®] color picture tube line will be available in a 17" size. The new tubes, types ST-4773A and ST-4774A, are identical except that the ST-4774A comes with integral mounting brackets.

Both tubes utilize the Sylvania developed Europium activated yttrium vanadate phosphor that gives brighter reds. Brighter blues are obtained from an improved phosphor and brighter greens are attained by altering the chemical composition in conjunction with a change in particle size and distribution on the screen.

The brightness of the overall tube is further improved by Sylvania's patented process of depositing the phosphors in a dry state. This unique process optimizes the physical and chemical parameters that influence brightness and uniformity of coating.

As with all *color bright 85* tubes, an aluminized faceplate is used for enhanced brightness. A 48-percent neutral gray filter glass face panel is used to improve picture contrast.

These 17" color tubes also incorporate a low focus electron gun that provides circuit savings by eliminating the



Type ST-4774A color tube comes with integral mounting lugs.

need for an intermediate high-voltage supply. Generally, the depth of focus is very broad and the three electron guns can be focused sharply at a particular compromise focus voltage.

Each tube provides a 145-square-inch-usable viewing area and has kimcode implosion protection. This system eliminates the need for an integral protective glass cap of a separate safety-glass window. Another benefit is reduced weight. This tube type will be available in production quantities in 1970. **CIRCLE NUMBER 304**

MICROWAVES

Precision microwave resistors are current controlled.

Series resistance of PIN diodes is tested and specified over their operating range.

Now we've added an entirely new family to our PIN diode line. By specifying the series resistance of these diodes over their operating range, we can tell you exactly the resistance you will get at any current level. The result—a precision current-controlled microwave resistor.

These resistors are useful from 10MHz to X-band depending on the mounting structure. We classify them into the six categories shown in the charts to assure close tracking of series resistance from unit to unit.

This family of PIN diodes is fabricated by diffusing P-type impurities into one side of a wafer that has an epitaxially grown high-resistivity layer. This intrinsic layer provides the PIN diode with its unique properties at microwave frequencies. At low frequencies, these devices exhibit rectification properties as a PN junction does; however, at higher frequencies charge storage in the intrinsic region prohibits rectification.

The current-controlled microwave resistor has many uses in the RF and microwave regions. It can be used as a device for building precision attenuators, modulators, leveling circuits, AGC circuits, and many other circuits where a low frequency of DC controlled microwave resistor is needed.

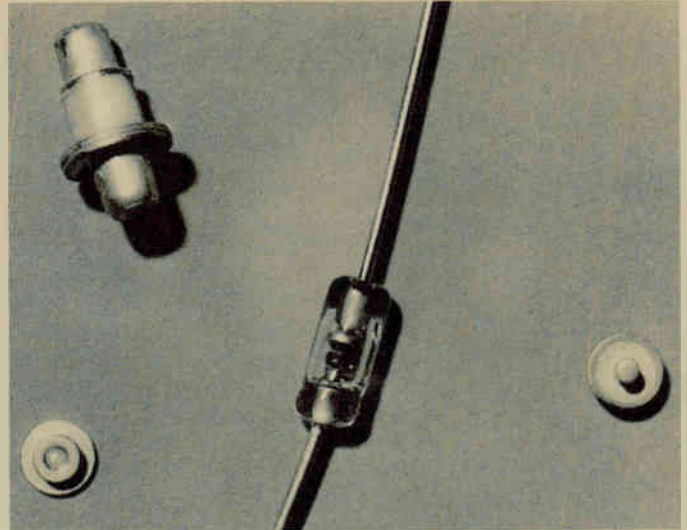

Current-controlled resistor family is available in a variety of package configurations.

Absolute maximum ratings:

Total Power Dissipation	P_T	See Note 1
Peak Power Handling Capability	P_P	to 10 Kw
Reverse Working Voltage	V_R	At breakdown voltage
Storage Temperature	T_{stg}	175°C
Operating Temperature	T_{opr}	150°C
Switching Time	T_s	4 nanoseconds typical

$$\text{Note 1: } P_T = \frac{150^\circ\text{C} - T_A}{R_{\theta D} + R_{\theta M}}$$

P_T = Total Power Dissipation

T_A = Ambient Temperature

$R_{\theta D}$ — Thermal Resistance of Diode

$R_{\theta M}$ — Thermal Resistance of Mount

CIRCLE NUMBER 305

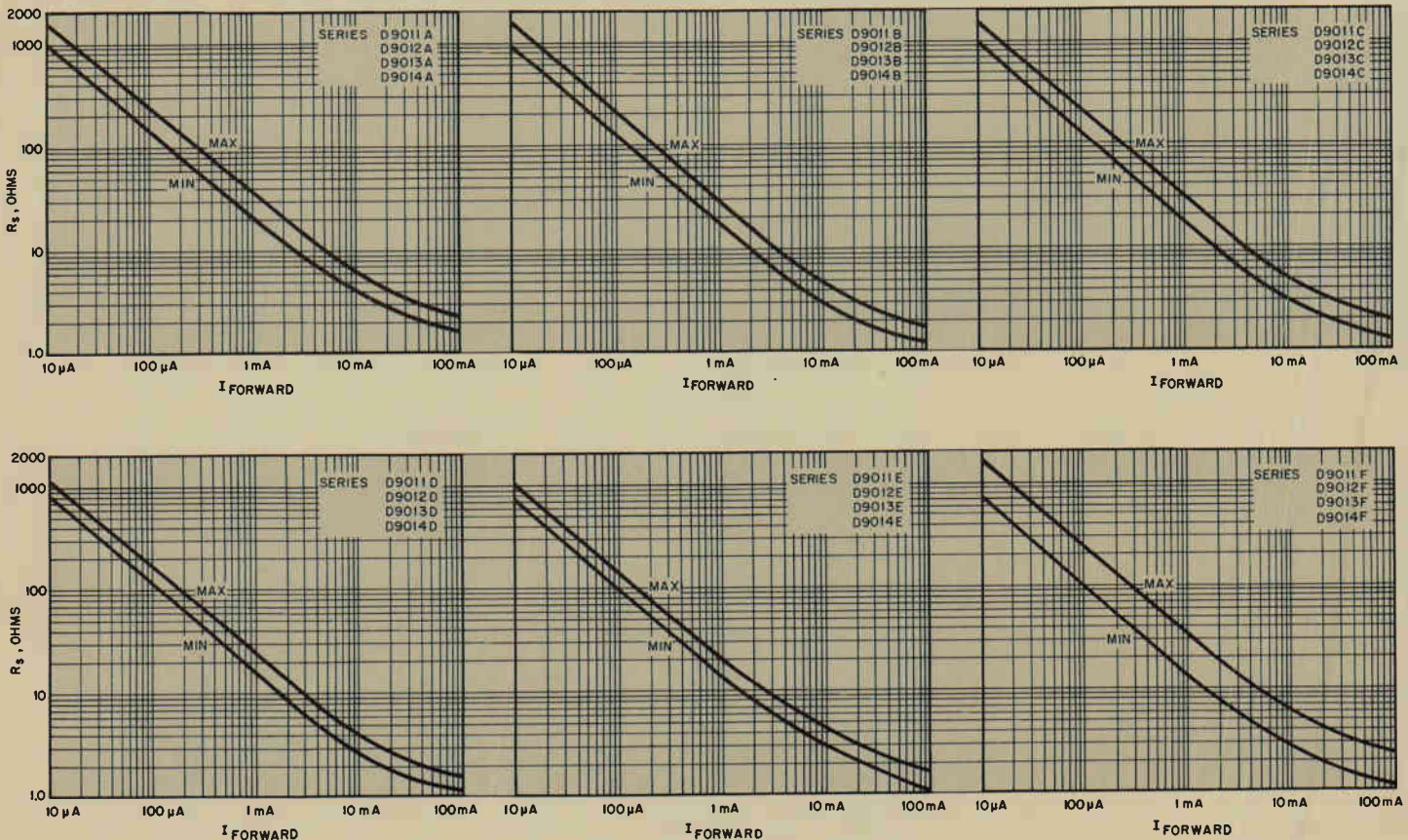

CRTs

Our CRT designers solve engine tester problem.

Unique scope requirement met by modified conventional TV tube.

When Sun Electric Corporation was developing its new 1120 electronic engine tester, everything was progressing smoothly except the scope for ignition-system testing. The scope is used to show primary and secondary ignition patterns in three different display positions (for easier diagnosis), and can also be used to test coils both on and off the engine.

The advanced design for the 1120 called for a CRT that was bigger in viewing area, yet smaller in overall size than previous tubes. The problem was that such a tube didn't exist. Sylvania's CRT engineers came up with a modified version of a conventional television picture tube that filled the bill perfectly. The result—a perfectly satisfactory display at a cost far less than that of a custom design. It is a 12" black-and-white tube modified for 6.3-Volt, 450-mA heater operation.

The tube has a rectangular gray filter glass faceplate with a viewing area of 74 square inches. The short neck—only 3.75 inches—made it possible to fit the tube into the cabinet of the engine tester. It also features a bonded frame integral implosion-protection system that eliminates the need for an extra safety-glass faceplate.

As used in the automotive tester, the Sun scope provides test facilities for analyzing all types of ignition systems. Sun uses a specially treated reticule faceplate to minimize annoying and distracting light reflections. The tester can be used on both conventional and transistorized ignition systems. The brilliant pattern retains constant width regardless of engine speed and the patterns can be displayed independently or superimposed just by flicking a switch.

This application of Sylvania CRT's is just another example of how our extensive background in industrial, military and commercial cathode-ray tube design can be put to work for you. If you've got a CRT problem, talk to us. We've got the men that have the answers.



Sun ignition scope uses conventional television picture tube specially modified by Sylvania.



CIRCLE NUMBER 306

SEE OUR SPECIFICATIONS IN
VSMF
MICROFILM CATALOG
FILE

Use Sylvania's "Hot Line" inquiry service, especially if you require full particulars on any item in a hurry. It's easy and it's free. Circle the reader service number(s) you're most interested in; then fill in your name, title, company and address. We'll do the rest and see you get further information by return mail.

BUSINESS REPLY MAIL
No Postage Stamp Necessary if Mailed in the United States

FIRST CLASS
Permit No. 2833
Buffalo, N. Y.

POSTAGE WILL BE PAID BY

Sylvania Electric Products Inc.
Sylvania Electronic Components
1100 Main Street
Buffalo, New York 14209

Dept. D 8 8

MANAGER'S CORNER

How to make a good thing better.

With all the talk about LSI, beamlead devices, computer-aided design, and other such glamorous happenings, the so-called typical engineer has relegated the receiving tube to a respected, but nonetheless lowly, slot in his thinking.

That's certainly not the case at Sylvania's receiving tube operation. Here our engineers are faced daily with the task of monitoring and constantly improving the performance and reliability of the "old workhorse" of the electronics business. And that's a full-time job, largely due to the demands of color television for better performing components at lower cost.

Particularly noteworthy from performance and reliability standpoints were sharply increased tube requirements for critical socket areas, such as horizontal deflection, vertical deflection, damper and horizontal regulation. The performance objectives of these sophisticated circuits were such that they uncovered problem areas in tube engineering not previously encountered. The problems of arcing, heat dissipation, thermal stress, heater failure and slumping emission, became increasingly magnified.

As a result, our engineers had to go back to their electronics, chemistry and metallurgy textbooks and came up with some basic state-of-the-art advances. For example—

- (a) Cathode coatings with powdered nickel additive and reduced sodium content to improve emission, coating adherence to the cathode sleeve, and reduction of arcing.
- (b) Reduction of heater wire crystallization and long life failures by the use of rhenium tungsten heater wire.
- (c) Precise control of cathode materials by the use of powdered metals.
- (d) Improvement of heat dissipation and transfer within

the tube by new and "sandwich-type" plate materials.

Sylvania also took a fresh look at mechanization and automation of manufacturing techniques and how they could be applied to tube production. Our Equipment Development organization for many years has provided Sylvania manufacturing plants with the highest caliber, most modern production machinery in the industry. Reduction or elimination of variables typical of manual methods has been accomplished by auto-grid machines, auto-mount assembly, auto-welding, auto-heater winding, auto-testing, etc. Uniformity of parts and sub-assemblies used in the finished tube has been amazingly well controlled, and uniformity and reliability of the finished product are natural results.

In a highly sensitive device, such as an electronic tube, cleanliness is synonymous with quality. Sylvania has sharply increased the use of controlled atmospheres (filtered air, temperature and humidity controls) in its manufacturing areas to reduce another group of variables adversely affecting product uniformity and reliability.

Sylvania's adherence to rigid quality control principles is well recognized. Its tube making organizations are essentially quality-oriented, with broad-based quality departments defining and monitoring all materials and processes from the raw material stage to the finished product. These are highly technical groups, well disciplined and with authority to take immediate action when the product quality deteriorates.

Sylvania's receiving tube organization gladly accepts the challenge of providing and maintaining the highest quality and reliability to the users of its products.

William J. Bowes

W. B. Bowes
Operations Manager, Receiving Tubes

This information in Sylvania Ideas is furnished without assuming any obligations.

SYLVANIA

GENERAL TELEPHONE & ELECTRONICS

NEW CAPABILITIES IN: ELECTRONIC TUBES • SEMICONDUCTORS • MICROWAVE DEVICES • SPECIAL COMPONENTS • DISPLAY DEVICES

D8

NAME _____
PLEASE PRINT

TITLE _____

COMPANY _____

ADDRESS _____

CITY _____ STATE _____ ZIP _____

Circle Numbers Corresponding to Product Item

300	301	302	303	304
305	306			

Please have a Sales Engineer call



HOT LINE INQUIRY SERVICE

Need information in a hurry? Clip the card and mail it. Be sure to fill in all information requested. We'll rush you full particulars on any item indicated.

You can also get information using the publication's card elsewhere in this issue. Use of the card shown here will simplify handling and save time.

The proven way to capture data output: call on "The Perf."

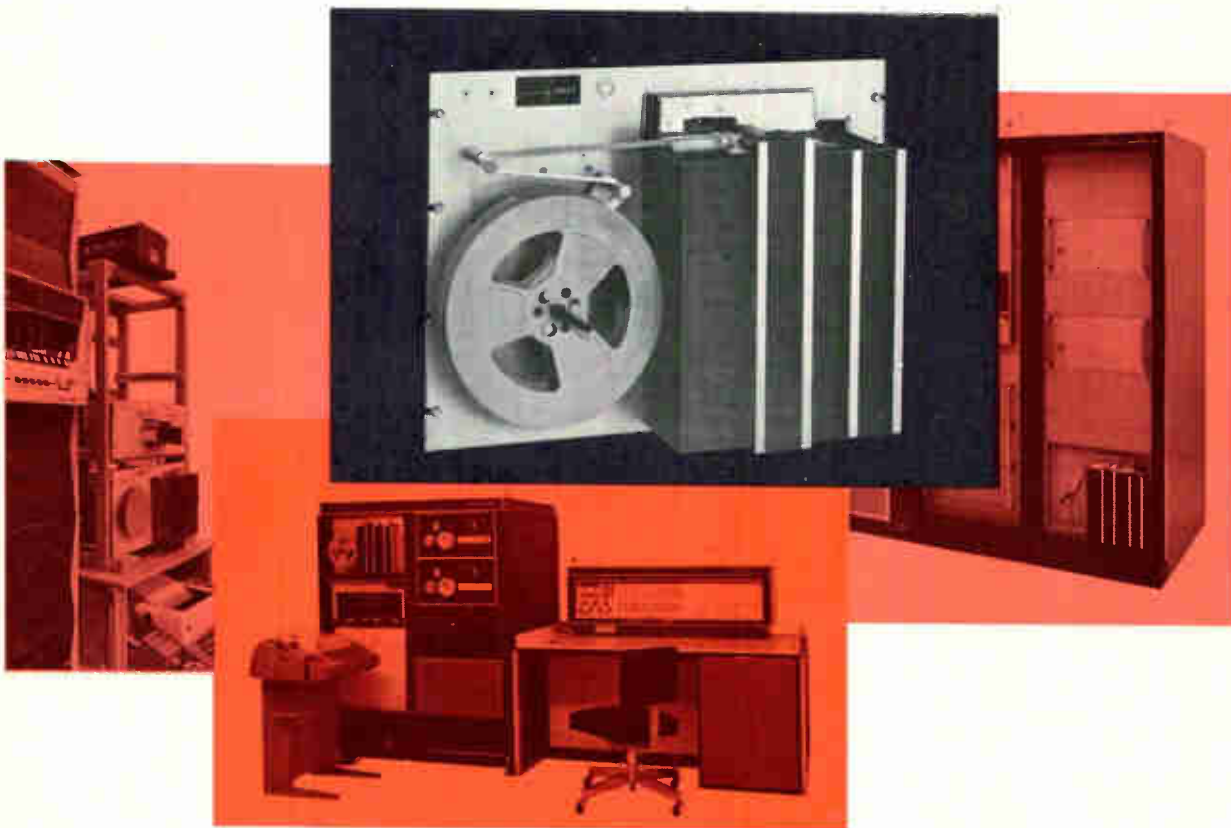

Our customers aren't much on model numbers (are any of us?). They call it "the Tally," or just as frequently, "The Perf."

Technically, it's the Tally P-120 perforator which features asynchronous operation up to a speed of 120 char./sec. You'll find it in use almost everywhere. For instance here, we're showing "The Perf" in use with two of the most popular scientific computers and one of the best known solid state component checkout systems. You'll also find the P-120 being used by a lot of other computer and data system equipment makers.

Why? Specifically because the Tally "performance quotient"... a dividend of features, specifications, price, and above all reliability... is the best in the industry. We package the P-120 in a rack size panel with integral tape handling including both supply and *take-up*. We build it from the most reliable components available based on knowledge acquired from twenty years experience. And we build it with built-in error checking capability.

If service is needed, our growing force of field engineers is as near as your telephone. Prompt, experienced service is yours on a nationwide basis.

For more information on the versatile P-120, as well as other Tally perforators, please address Tally Corporation, 8301 South 180th St., Kent, Wash. 98031. Phone (206) 251-5500. In the U.K. and Europe, address 6a George St., Croyden, Surrey, England.

→ **TALLY**



NOW
FROM STEWART-WARNER
28 HIGH-SPEED ECL II
MILITARY CIRCUITS
COMPLETELY INTERCHANGEABLE
WITH
MOTOROLA MECL II

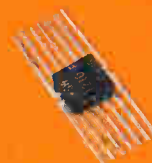

FAST...RELIABLE...INEXPENSIVE...AVAILABLE !

Fast—Stewart-Warner ECL II military circuits have typical times of only 4 nanoseconds.

Reliable—These ECL II's offer the designer the same reliability and design freedom he has with the slower logics, and they will be tested to the tough Class A level of the new MIL-STD-883.

Inexpensive—Stewart-Warner ECL II's are priced competitively with TTL's.

Available—These 28 high-speed ECL II military circuits are available now from your local Stewart-Warner Microcircuits Distributor in both ceramic flat-pack and dual in-line packages.

For more information, send for our ECL data sheets. And, for off-the-shelf delivery, call your local Stewart-Warner Microcircuits Distributor.

STEWART-WARNER 
COMPANIES SYMBOL OF EXCELLENCE

STEWART-WARNER MICROCIRCUITS, INC.
730 EAST EVELYN AVENUE, SUNNYVALE, CALIFORNIA 94086
PHONE 408/245-9200 TWX 910-339-9210

L-band satellite plan hits a tailspin

Failure of ATS-5 stalls NASA-FAA-Air Force tests of precision navigation-communications program and jeopardizes its future

Two and a half months after its launch, Applications Technology Satellite 5 spins in orbit about the earth, and that's the catch; ATS-5 never was intended to rotate. Like ATS-1 and ATS-4, it was to have used gravity gradient stabilization booms to keep it in an earth-oriented attitude.

If there had been no spin, an array of 12 cavity-backed spiral antennas would have radiated and received L-band signals (at 1.55 and 1.64 gigahertz) to be used by NASA, the FAA, and the Air Force for experiments in satellite communications and navigation for ships and aircraft. Ironically, installation of this L-band transponder system—and the time it took to decide to install it—delayed the launch of ATS-5 almost a year. It originally was to have gone up in September 1968.

Dash it all. The FAA and NASA were just about to agree on a coordinated set of L-band experiments when the satellite failed. Though

the agencies would have shared some aircraft, equipment, and data, no final agreement was made and all L-band work, including that of the Air Force's 621B Navsat program, seems stalled by the ATS-5's gyrations.

NASA and the FAA had similar goals. Both agencies wanted to test tone-ranging schemes for fixing the positions of planes in flight. TRW Systems is said to have an approach theoretically capable of spotting a plane with an error of ± 100 feet, and NASA would have begun testing it.

Both FAA and NASA were concerned about multipath, signal fades, and propagation delay, problem areas with potentially severe effect on the accuracy of a Navsat system, especially over the Atlantic Ocean with its widely variable sea states.

The Air Force's Space and Missile Systems Organization (Samso) could have used data on ionospheric effects on satellite trans-

missions. One knowledgeable source says the requirements for 621B fix accuracy are so exacting that a 10-foot change in aircraft-to-satellite path length could be intolerable. If the experiments showed excessive refraction of radio beams, the Air Force probably would be forced to hike the power of satellite transmitters or change frequencies—and this would rise the price of the already costly 621B.

Noising around. Both NASA and the FAA wanted information on aircraft radio noise; r-f noise from cities, the ground, the sky, and precipitation static; and interference from on-board equipment. This would have yielded a base line for satellite and aircraft transmitter power.

The FAA particularly wanted to test digital data transmission and to do intelligibility tests of voice communications relayed through the satellite. There's now a question in airline circles as to whether vhf or L-band will be most cost-effec-

What went wrong

ATS-5 carries a heat-transfer pipe to help cool its sunward and heat its spaceward sides. It's now thought at NASA that someone miscalculated the forces caused by fluid movement in the heat pipe. As a result, when the satellite went into orbit it also went into a flat spin on an axis 90° to the correct one.

At that point NASA officials began to worry about ejection of the kick-stage engine; they feared the released engine could damage the spacecraft. They knew that even if ejection was clean, the axis of rotation of the ATS would change, and that there was only a 50-50 chance that the new direction of rotation would be the right one. The engine departed cleanly, but NASA caught the wrong end of the odds; ATS-5 began to rotate around

the right axis, but in the wrong direction.

Weights which would have spun outward at the ends of long wires to slow the satellite's spin instead became more tightly wound, and the gravity gradient booms were deemed too fragile to extend.

NASA now plans to get all the data it can from ATS-5, then take braver action. For now, millimeter-wave propagation and other experiments are working well, and these will be completed. Then NASA plans to mesh out the gravity gradient booms slowly. Although ultra-fragile, it's hoped that if they are pushed out slowly enough, they might stop the spin and stabilize the satellite. But nobody is betting on it; the heavy ATS-5 is spinning at 76 rpm, making for a lot of momentum.

U.S. Reports

tive in the 1970's, and results here would have helped the FAA and the airlines to set guidelines for avionics already being planned and purchased for such aircraft as the Boeing 747 and the SST.

Though the L-band situation looks grim, the agencies involved are working to find alternatives to ATS-5. Meanwhile, the Boeing Co., under contract to equip a KC-135 and a DC-6 for high- and low-altitude tests, respectively, has been told by the FAA to cool it for about three months. The first segment of this three-phase program already has cost the FAA \$500,000 in study money and the stretch-out should add about \$90,000, according to Boeing. And assuming the FAA finds a way out, the last two phases of the contract—the actual fitting out of the planes—still will remain.

Another basket. NASA, which might have shared some of the planes' time with the FAA, seems to have been hurt least by the ATS-5 failure. Perhaps because almost everything NASA designs has a little redundancy in it, NASA's L-band test program provided for a backup should the satellite fail.

TRW Systems is under a \$500,000 contract to NASA's Electronics Research Center to deliver L-band test gear in March—and in the package is equipment that could be carried in a high-flying plane to simulate signals from a satellite.

Leo M. Keane, head of ERC's satellite programs office, says NASA is talking with Samsco about the loan of either a U-2 or modified B-57 to carry TRW's transponder gear to 80,000 to 100,000 feet. Presumably the planes, to be equipped by Boeing and TRW, could operate with a fake ATS-5 almost as well as with the real thing.

But Samsco might not be too eager to deal with NASA on this. Most of its interest is in ionospheric effects, and not even a U-2 flies that high.

The FAA also is cautious about simulations, less for technical reasons than for psychological ones. The FAA must make a pitch to international air carriers within the next few years for a worldwide agreement on a Navsat system, and they feel data taken from an aircraft

wouldn't have the credibility of that from a satellite.

Eureka. So it's not surprising that the FAA is casually mentioning that it seems to have located an unallocated Thor-Delta launch vehicle; or that NASA has quietly asked Philco-Ford's WDL, Hughes, TRW, and Boeing to submit rough outlines of the lead time, cost, and capabilities of a small satellite carrying L-band gear alone.

Meanwhile, NASA headquarters has asked its scientists to determine exactly how much valuable data can be gained from ATS-5, and how much more could be gotten from a smaller satellite. Insiders say that the various centers involved will be making their pitches during the fall, hoping for a backup satellite decision around the turn of the year.

Both agencies realize that Congress is not feeling philanthropic, and an FAA spokesman quotes a \$10 million price tag for a new small satellite. It's not known whether this quote covers an FAA-only program, or a joint NASA-FAA development, or even if it includes launch costs. But even if new items appear in the fiscal 1971 budget, launch is more than a year away.

Getting late. Meanwhile, a clock ticks loudly in the background. A TRW-NASA study predicts up to five years' lead time for a useful Navsat system. Even if started now (and the government won't start without the needed experimental data), it's thought that a 1975-1977 estimated operational date is optimistic. And by then the North Atlantic air routes will be crowded with a mix of SST's, jumbo jets, and aging first-generation commercial jets.

Air traffic control

At the crossroads

The Federal Aviation Administration will look at a back-up source if Raytheon fails to resolve by December the design problems with its planned view display consoles for the en-route portion of the advanced National Airspace System (NAS). That's the word of Gustav



Test. AIL's direct altitude identity readout.

E. Lundquist, a retired Air Force general who's director of the NAS program office.

"Raytheon must make its schedule," says Lundquist, adding that the company will get no more money until the equipment becomes acceptable for production.

The FAA's award of \$44.8 million to Raytheon's Equipment division of Wayland, Mass., in January 1967 has slipped 15 months; \$15 million in additional funding has been approved, the agency says. The award, largest equipment contract by the FAA at the time of the authorization, covers one-third of the material in the advanced NAS. It's the final link to provide air traffic controllers with an automatic display of aircraft positions in three dimensions using alphanumeric identification and altitude of each target on a scope.

The problems. Lundquist says Raytheon's problems are in display brightness and line width. Richard F. Frakes, NAS en-route systems division chief, notes quality of display appearance is poor—brightness varies within characters as well as around them, line widths are too wide and nonuniform, and focusing is not uniform. For example, "if alphanumerics are not crisp, the letter S and the figure 5 are easily confused," Frakes points out.

Asked about reports that Raytheon's computer data channels were unable to handle a fast data stream, Frakes replies, "Writing

speed was never a problem." He explains that Raytheon's equipment initially was designed to handle only 60 consoles in a center. A year ago, however, FAA's traffic forecast for five high-density centers—New York, Washington, Chicago, Cleveland, and Fort Worth—indicated that up to 90 consoles per center and more sophisticated hardware to drive them would be necessary. Thus, Raytheon's total system—data channels and consoles—will go into 15 centers with lower activity.

At the five high-density centers, the FAA has turned to IBM's Federal Systems division in Gaithersburg, Md., for 9020E display channel processors, which will be able to drive up to 90 consoles—presumably Raytheon's—per center. The FAA decision led to a \$38.4 million award to IBM at mid-month.

In the IBM package are 9020E systems for control centers in New York and Cleveland in 1971, another for Washington a year later, plus 9020D central computer complexes, which perform the basic computing function, for 1971. New York, Cleveland, Chicago, and Fort Worth will get 9020E's.

At the same time, IBM got another \$7.8 million for two smaller 9020A computers for the Minneapolis and Miami centers, the same as ordered earlier from IBM for the first stage of the NAS automation effort.

The changes. An FAA official spokesman declined to call Raytheon's added \$15 million funding a cost overrun. Instead, he attributed the need for extra money to contract changes covering such things as altitude filtering, select beacons, and weather substations, plus permission to expand the cabinetry housing the hardware.

At the time of the first Raytheon award, it was explained, there was limited space in the en-route ATC centers. This strictly proscribed Raytheon's equipment size. Subsequently, FAA decided to expand its centers, permitting larger cabinetry.

As for the 22 pieces of computer update equipment in the Raytheon contract, the FAA says it will take early delivery for installation at 20 centers, its Atlantic City test site, and the Tennessee FAA Academy.

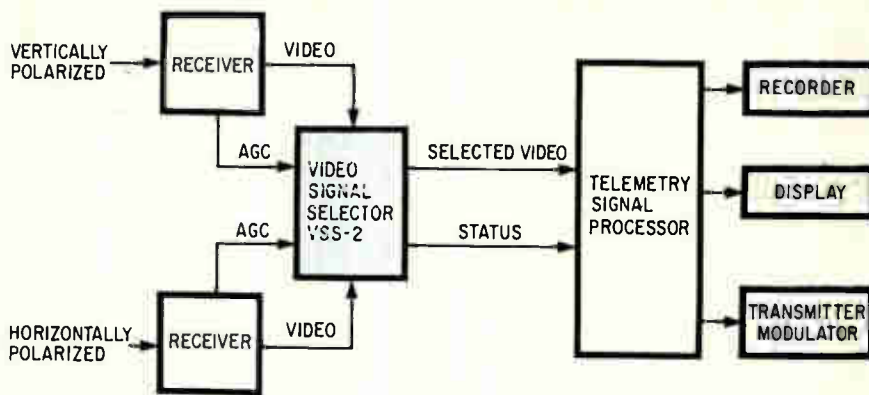

Pick 'em. Dynalex's VSS-2 compares AGC voltage from the receivers. The video signal with the higher voltage is switched to telemetry signal processor in 500 nanoseconds, averting loss of data frames. DEI 1074 receivers were used in Navy evaluation tests.

Communications

Switch in time

When the Navy wants to switch rapidly between two airborne ultra-high frequency telemetry receivers to avoid video signal fading, the job is done by a device that fills a 19-inch rack. Now a two-channel video signal selector that does the same task—in a plug-in module that's just 1.5 inches square and 0.5 inch high—is being evaluated by the Navy. Developed by Dynalex Inc., the VSS-2 selector features a 500-nanosecond switching time.

An accepted means of avoiding the loss of telemetry data has been to use two receivers, one with a horizontally polarized antenna system, and a second with a vertically polarized unit assuring a strong signal on at least one of the two antennas. Rapid switching between the two receivers is vital because a 2-microsecond data gap can cause loss of a complete data frame.

Comparison. The selector picks the strongest video signal for relay to the telemetry signal processor by comparing the magnitude of two automatic gain control inputs from the two receivers, using a differential window comparator to look at the telemetry bit stream. Two externally mounted trim pots adjust the comparator network's window limits, or hysteresis, from ± 5 millivolts to ± 550 mv, and vary the offset within a range of ± 1 volt. Adjustment of the window limit

controls comparison sensitivity, and the threshold adjustment allows the insertion of offset to compensate for bias within the AGC of either receiver. The AGC inputs can be 0 to -10 volts d-c, with 50 ohms input impedance.

The video signal inputs, ± 5 volts d-c to 450 kilohertz, are brought to two MOS FET switches, and the signal from the receiver found by the comparator to have the highest AGC voltage is switched to a high-speed, integrated circuit op amp. Output for the selected video channel is ± 5 volts d-c to a minimum 1,000-ohm load. Accuracy is $\pm 0.05\%$ from 0°C to 70°C . A 0 volt and $+5$ volts d-c output indicates to the telemetry signal processor which video signal has been selected. External power requirements for the selector are ± 15 volts d-c at 30 milliamps.

Hold. When a video channel is chosen, the selector will not switch again until the AGC voltage for that channel drops below the comparator's window limit. This prevents excessive cycling between channels that otherwise would result from nearly identical AGC voltage levels.

Displays

On the big board

Not to be left out of the act, the Navy, like the other services, wants a large-screen display system for its war rooms. But the Navy hasn't

U.S. Reports

yet decided which of four types eventually might meet its minimum requirements—a 16-by-16-foot, computer-driven, real-time arrangement that can position up to 100 forces in color on a background map.

The four possibilities: multiscribing or multispotting projectors, electroluminescent panels, or light port matrix systems. The first two are available now and appear to cost only about half as much as the others, which exist only in small feasibility models—large working versions are at least several years and much costly research and development in the future.

Thus, the Navy's dilemma is whether to settle for the simple, cheaper system now or sit still for the far more sophisticated and expensive layouts.

Banking. The multispotting system employs a bank of projectors, each of which uses a symbol wheel displaying one force, such as a plane, carrier, destroyer, or submarine, and its identification number. The wheel can be changed instantly to display other forces. The force type, identity (friend or foe) and course is indicated by the

symbol's color, shape, and position. Its characteristics, including mission, weapons, and fuel capacity, are identified by its number, and the viewer's attention can be attracted to a particular force by blinking the symbol. A separate reference projector shines a background map on the screen.

Hugh Caligiuri, Naval War College Major Improvement Plan project officer, has been experimenting with a prototype multispotting projector built in 1965 by Dumont for the Army Electronics Command at Fort Monmouth, N.J. He feels it can be expanded easily from its present 48 projectors.

The multiscribing system is similar to the multispotter in that it, too, utilizes a bank of projectors, but it differs in employing slides. Up to 10 forces can be inscribed on each slide with a diamond or metal stylus, but updating is slow—about a minute—and the individual symbols cannot be blinked. Models of the system made by LTV, Northrop Corp., and Kollsman Instruments are being evaluated aboard ships, at the Pentagon and the White House, and by NASA.

Apollo maps. One of the most advanced multiscribing units—a rear projection system developed by Philco-Ford—is used by NASA at its Manned Spacecraft Mission Control Center in Houston. A slide showing a lunar map in one color and primary and secondary landing sites in another color is projected on a 10-by-20-foot screen. Six other projectors, driven manually or by a computer, display predicted lunar orbit trajectories, and blips representing the command/service and lunar modules in other colors. The color differentiation enables flight controllers to distinguish points of importance faster than if a single-color display were used to locate the modules.

As with all such rear-screen systems, high heat (about 400°F), extreme magnification (240 times), and ultraviolet radiation (a 2,500-watt xenon lamp is used) are major problems.

The electroluminescent (EL) panel and light port matrix displays, on the other hand, consist of a number of addressable light elements, similar to, but more sophisticated than, the animated advertising signs seen, for instance, around New York City's Times Square. Both displays can be tape-driven—a rather slow method—or can be operated in real-time by a digital computer. The display proposed by the Navy would have 2,048 EL elements, or 1,024 light port elements to a side.

-Computers

Bit by bit

A new company hopes to use an 18-bit computer that's smaller than most eight-bit machines as a springboard into end-user applications in industrial control and data acquisition, automatic testing, data communications, typesetting, medicine, traffic control, navigation, and other areas. The machine, called the CLS-18, would sell to original equipment manufacturers for \$7,500, well below the price of most 12- and 16-bit models; it's the brainchild of Computer Logic

Follow the girl

Will the Navy brass follow the advice of a civilian only two years out of college—and a mere girl, at that?

Wendy Billett, 23, is considered by her superiors one of the brightest electronics engineers at the Naval Electronic Systems Command's technology branch at the Washington Navy Yard. One of her first projects at Navelex was to develop a new system of cost-effectiveness analysis, which, if used correctly by the Navy, might get it out of hot water with Congress and the public. To show her bosses that her analysis is a workable and useful engineering tool, Miss Billett used it to evaluate the four war room display systems being considered by the Navy. Her recommendations: the Navy's best bet, rated 100%, would be the multispotting projector. The multiscribing projector scored 91%, while electroluminescent panels are a

poor third with 40% and the light ports trail badly at 19%.

She explains her study this way: "The model forces the definition of minimum requirements and ideas between which cost-effectiveness analysis is meaningful. It outlines trade-offs and provides two evaluation parameters: system value and cost effectiveness."

She determined the cost-effectiveness index for each display by dividing its performance effectiveness by its 10-year life cycle cost. Performance effectiveness includes system capability, performance quality, response time, reliability, maintainability, flexibility, expandability and human engineering.

Miss Billett joined Navelex on graduation from Ursinus College in Collegeville, Pa., because she liked the idea of working with computers—in the first 18 months she attended five computer schools. Her home town is Yardley, Pa.

ON ONE CHIP:

A PLATED-WIRE, HARDENED SENSE AMP

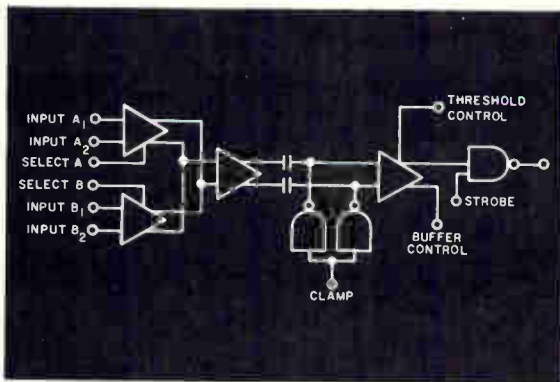

- The first application of linear and digital technology in one monolithic sub-system.
- The RA-2540R system in a single chip performs the functions of two hardened differential amplifiers and a hardened voltage comparator
- 1 mV signal sensitivity in high noise environment
- 10 ns access time
- Internal D.C. restoration
- Selectable dual channel
- Hardened
 - Photo current compensation
 - Dielectric isolation
 - Thin film resistors
 - Advanced device design

You always get: Off-the-shelf delivery, full plated-wire temperature range and compliance with MIL-STD-883 . . . when you pick the BEST IC for the job from Radiation's fast expanding linear-hardened line.



Lexington, Massachusetts (617) 862-1055
Norwalk, Connecticut (203) 853-3641
Washington, D.C. (202) 337-4914
Dallas, Texas (214) 231-9031
Long Beach, California (213) 426-7687
Palo Alto, California (415) 321-2280
Albuquerque, New Mexico (505) 268-3549
P.O. Box 37, Melbourne, Florida 32901 (305) 727-5430

RADIATION
INCORPORATED
SUBSIDIARY OF HARRIS INTERTYPE CORPORATION
MICROELECTRONICS DIVISION

U.S. Reports

Systems Inc. of Billerica, Mass.

The first CLS-18 is due to be assembled and powered up by mid-November; by the end of the year it should be operational. But the CLS-18 may be a stalking horse for an as yet unnamed computer.

The CLS-18 will use a versatile multiaccumulator architecture reminiscent of much larger machines. Twelve major registers are planned, and six of these will be accessible by the programmer. Also, four so-called general registers are individually addressable and mutually interactive with the 4K-by-18 core memory.

First claimed. All four of these registers handle 18-bit words, and perform group arithmetic, shifting, logical operation, comparison, and checking. This ability to reach all four general registers from memory and access each individually prompts company president Charles H. Wheelock to term the

CLS-18 "the first minicomputer with fully usable multiaccumulator architecture."

Wheelock also considers the machine's 18-bit word length and the consequently powerful instruction set unique in minicomputers. The nearest competition seems to come from a few bulky 18-bit minicomputers costing \$20,000 or more.

Another feature rarely found in minicomputers is the CLS-18's push-down list. Reacting to interrupts, the list saves and, afterward, restores machine conditions; during an interrupt, it locates storage areas for interim calculations, freeing registers to accept data from peripherals or other sources.

The CLS-18's input-output structure includes microprogramed data transfer instructions which allow the programmer to work easily with the general registers and up to 64 peripheral devices.

To aid I-O control and interrupt

operations, an optional microprogramed computer will be available to control the machine's direct memory access channel, dividing its use among peripherals with up to 144 levels of priority interrupt.

In other minicomputers, most such operations are handled through software, but the push-down list, I-O processor, and microprogramed data-transfer scheme should make for an efficient, easy to program, interrupt system with response well below 3 microseconds.

Over the horizon. Though the machine to come afterward will inherit most of these characteristics, it is to be only about 1.75 inches high compared with the CLS-18's seven inches.

Vice president Bruce K. Smith claims that in industrial control, each inch on a 19-inch rack costs about \$1,000, thus such a computer could mean a system cost reduction of \$3,000 to \$8,000, depending on the computer replaced.

But to squeeze a computer down to the thickness of a club sandwich is, says Smith, going to mean careful application of thin film, multi-IC hybrid techniques.

It's already apparent to Smith that heat sinking will be one of his major design problems, but careful partitioning, and the division of functions into two or more hybrids, should handle the problem, he feels. And the CLS-18 already is being partitioned with hybrids in mind to ease transfer of its architecture from one format to the other.

Already slated for hybridization are the CLS-18's arithmetic and multiplex units, and the memory control logic soon may follow.

Smith figures that he can lay down up to 20 medium-scale IC chips per square inch without pushing the hybrid art; thus he expects about two square inches of hybrid substrate to hold all necessary memory control logic in the future machine.

Panel problem. The contemplated design is too thin for a muffin fan, and Smith expects that heat sinking and partitioning will solve the thermal problems. But he does admit that the control panel



Making the scene. With New York City's police "war room" already operating—direct phone links to precincts, tv at likely trouble spots, and a small computer—Sylvania is field testing this computerized dispatch system with other police departments. It's aimed at getting police to where they're needed quickly. The Sylvania approach is called automated command control and dispatch. When a crime or accident is reported, a clerk types the location on the computer console, keying in a priority code indicating the seriousness of the situation. In seconds, the computer displays a letter symbol at that location on the dispatch monitor, a cathode-ray tube. Simultaneously, patrol units assigned to the area are indicated on the crt; a color code indicates the availability of the units. The dispatcher then selects a unit, assigns it by radio to where it's needed, and feeds this information to the computer, which displays the assigned unit on the monitor.

IT'S A WINNER!

VERSAWATT



VERSAWATT is RCA's plastic unit on a solid-copper base which displays brute power dissipation capability—up to 50 watts in the transistor line; power handling capability up to 10 kW in thyristors. It is rugged. It has "volumetric" efficiency. It has compactness—a space-saving advantage over larger, equivalent types—that makes VERSAWATT an ideal package for PC board applications where hermetic types previously were employed.



RCA VERSAWATT Transistor Family

TYPE	V_{CER} (sus)**	I_{FE}
2N5293+	75 V	30-120 @ $I_C = 0.5$ A, $V_{CE} = 4$ V
2N5294+		
2N5295+	50 V	30-120 @ $I_C = 1$ A, $V_{CE} = 4$ V
2N5296+		
2N5297+	70 V	20-80 @ $I_C = 1.5$ A, $V_{CE} = 4$ V
2N5298+		
2N5490*	50 V	20-100 @ $I_C = 2.0$ A, $V_{CE} = 4$ V
2N5491*		
2N5492*	65 V	20-100 @ $I_C = 2.5$ A, $V_{CE} = 4$ V
2N5493*		
2N5494*	50 V	20-100 @ $I_C = 3$ A, $V_{CE} = 4$ V
2N5495*		
2N5496*	80 V	20-100 @ $I_C = 3.5$ A, $V_{CE} = 4$ V
2N5497*		

+ $\theta_{J-C} = 3.5^\circ\text{C/W max.}$ * $\theta_{J-C} = 2.5^\circ\text{C/W max.}$ ** $R_{BE} = 100$ ohms

RCA VERSAWATT Triac Family

	V_{DROM}	I_{GT}	
		I, + III - modes	I, - III + modes
40668	200 V	25 mA max.	60 mA max.
40669	400 V	25 mA max.	60 mA max.

$\theta_{J-C} = 2.2^\circ\text{C/W max.}$

VERSAWATT means versatility in mounting possibilities. RCA offers three basic configurations (you can devise your own option to fit your needs). These configurations are for PC boards and direct plug-in for TO-66 sockets.

VERSAWATT is a plastic package offering different chips for outstanding electrical performance—in transistors, from milliamperes to several amperes. In thyristors, 120- and 240-volt line operation VERSAWATT 8-ampere triacs have low thermal resistance—better than many hermetic types. They offer a high 100 A peak surge current capability.

VERSAWATT has proven reliability, backed by data from more than three years of field testing in commercial and industrial applications. An added plus: VERSAWATT transistor units employ Hometaxial-base construction, the industry's best answer yet for freedom from second breakdown.

Check the charts for units packaged as VERSAWATT transistors and thyristors. There are more to come. Right now, see your local RCA Representative or your RCA Distributor for more information. For technical data on specific types, write: RCA Electronic Components, Commercial Engineering, Section IN10-2, Harrison, N.J. 07029.

U.S. Reports

might take some engineering time. "After all, there's a limit to the size of a knob or indicator—one can't miniaturize eyes or fingers," he says. And there's not much room on a 1.75-by-19-inch panel.

So far the answer to this one is a remote control panel, connected by an umbilical and placed near the machine's teletypewriter console. The CLS-18's basic architecture already treats the control panel as a peripheral device, making necessary only a modest change to usual control practice as the panel would access the mainframe through the I-O controller.

Components

Navy plugs in

High-power rectifier tubes have been just one more headache for military radar operators. The tubes require at least 15 minutes of warmup; have a high noise-to-signal ratio, generating lots of "hash;" require costly air-conditioning systems; and have an average life span of three months—six with luck.

The Air Force licked the problem with the Unitrode Corp.'s controlled reverse avalanche silicon diode modules as replacements. The two modules have voltage ratings of 2,000 through 5,000, and 5,000 through 10,000 volts, respectively. They can be stacked and attached to a tubelike base to achieve plug-in replacements with ratings up to 500 kilovolts. The Federal Aviation Administration has adopted the concept for its radars—the modules not only are cheaper, but they operate without cooling, last for the life of the equipment, and produce virtually no noise.

Flank speed. But it is the Naval Electronic Systems Command which has moved to widen the module market, expanding applications to sonars and transmitters, and specifying them as replacements for 105 different rectifier tube types. With this new spec in hand, the Defense Electronics Supply Center in Dayton, Ohio, is scheduled to make a major purchase of the modules later this

year, expected to top \$1 million.

A number of manufacturers are scrambling to get aboard DESC's qualified product list before the purchase. In addition to those already in the market—Unitrode, Semtech Corp., and Solitron Devices—expected competitors will be General Electric, Hughes, IRC, RCA, Varo, and Westinghouse. Of the Westinghouse effort, one government official notes, "They're eating crow as they do it. They didn't believe there would be any market."

What is the market? If the solid state rectifier replacements last the life of the system, and new systems go solid state from the start, what happens when all existing hardware is retrofitted? Senior NESC engineer William Rhodes says, "The potential in the commercial broadcast transmitter market is even bigger than the military requirement."

Money talks. The Naval Electronics System Command chief, Rear Adm. Joseph E. Rice, nonetheless is excited about the savings the modules developed for the Air Force could bring the Navy. "We are the first to use this technique for applications right across the board," he points out. Potential economies are high in submarines, as they cannot use mercury-gas-filled tubes for safety reasons and have had to employ more expensive rectifiers filled with argon and other exotic gases. Now Adm. Rice says he has issued a specification to all segments of the Naval Material Command requiring use of the solid state modules in all applications as replacements for high-power rectifier tubes.

Savings on Navy's AN/FRT-39 and 40 transmitters, according to Adm. Rice, work out to \$481,000 a year in terms of tubes eliminated. Overall, he says, the Navy figures it will save \$2 million a year by not having to replace an estimated 300,000 tubes.

Representative of the 105 tube types the modules will replace is the 6895. "It's in the upper-middle-class category," says engineer Rhodes, with a peak inverse voltage rating of 20,000 volts. On the Navy's last order, the tubes cost

about \$109 each. Its modular equivalent would cost "roughly \$50," according to Rhodes.

Since an operational tube never achieves its peak voltage rating, a replacement for the 6895 would not necessarily mean stacking four 5,000-volt modules together. More likely, says Rhodes, three modules with a combined 15,000-volt rating could be used to replace a 6895 tube running at 12 or 12.5 kilovolts.

Memories

Remember the mainframe

Two enterprising engineers have formed a company that they hope will supply computer mainframe makers with modular memories for just about any function they need—and several they haven't gotten around to needing yet. The two,

Alterations

The Electronic Data Processing division of Honeywell—Joseph F. Kruy's alma mater, so to speak—uses alterable read-only memories in some of its large-scale computers. But these can be made only by servicemen who make the changes during regular maintenance calls; the electrical alterations are a good deal quicker and easier than the only alternative, mechanically replacing the memory. This is to prevent an inexperienced operator from possibly disabling the entire computer. Kruy's idea is to make the read-only memory alterable by the supervisory program while the system is running, so that it might, for example, look like an IBM System 360 for a few milliseconds while communicating with one satellite, and like a Univac 1108 for a few more while tied to another satellite.

Joseph F. Kruy and Richard J. Egan, are president and vice president, respectively, of Cambridge Memories Inc. in Newton, Mass.

Educated in Hungary, Kruy founded CMI after more than 10

TRW High Powered Switching Rectifiers

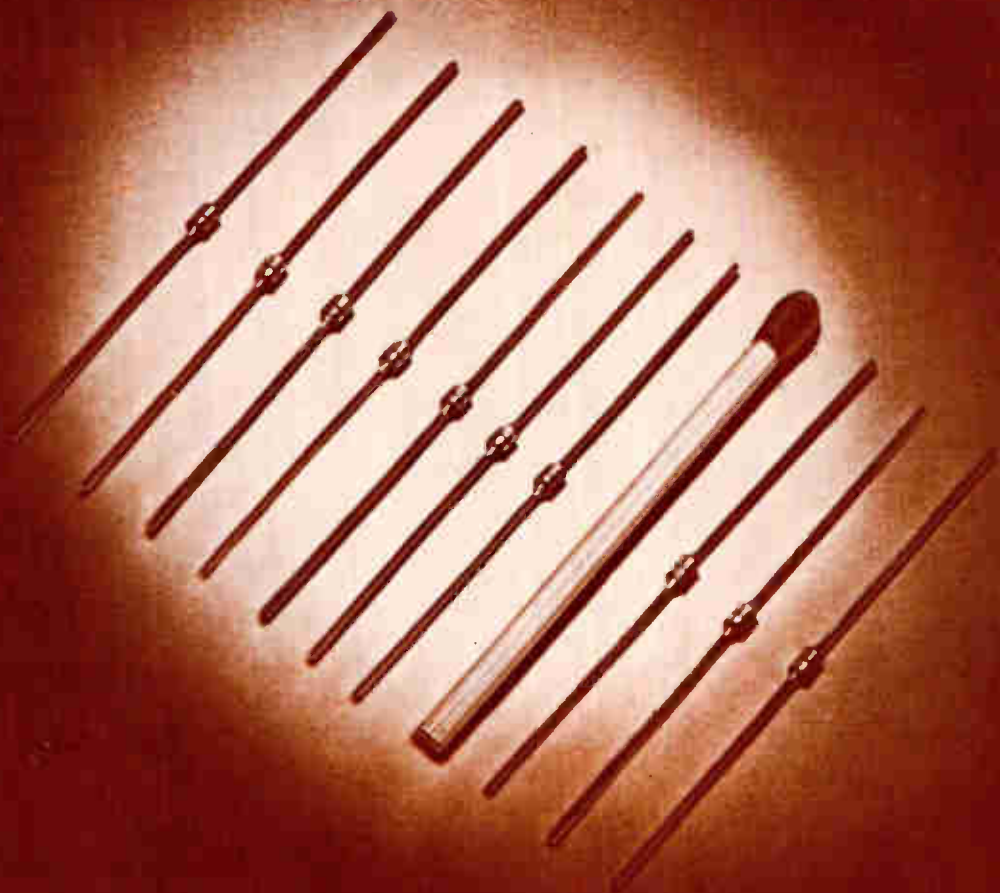

...unmatched speed and reliability

TRW double slug rectifiers are the fastest available in their current and reverse voltage range. At 2 amps and 100 volts, for instance, they'll switch in 20 nanoseconds. That is three times as fast as anything else you can buy...ideal for high speed inverters and switching regulators.

They are extremely reliable, too. The die is passivated with oxide before encapsulation, and

the alkali-free glass is fused to the passivation for void-free reliability.

TRW now offers a complete family of low leakage zeners and rectifiers up to 10 watts as well as general purpose diodes to 600 volts in the same package. For complete information contact any TRW distributor or TRW Semiconductors, Inc., 14520 Aviation Blvd., Lawndale, Calif. 90260.

Phone (213) 679-4561. TWX 910-325-6206. TRW Semiconductors, Inc. is a subsidiary of TRW Inc.



DIALCO DATALITES[®]

mount as close
as 1/2 inch center
to center

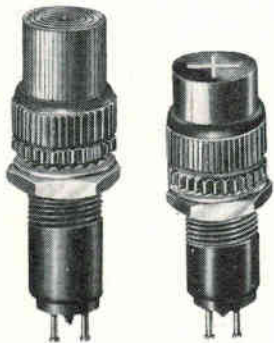

SHOWN ACTUAL SIZE

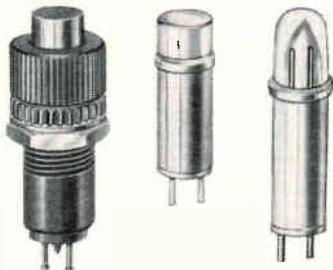

Designed to meet
or exceed requirements of
MIL-L-3661B.

Replaceable plug-in
cartridges: Incandescent for
1.35-120V; neon—high-brightness
operation 110-125V AC, and
standard brightness operation
105-125V AC-DC.

Wide range of lens
shapes, colors and finishes.

Broad selection of
positive or negative legends.

Available off-the-shelf
for prompt delivery.

Send for free catalog



SAMPLES ON REQUEST—AT ONCE
NO CHARGE

Dialight Corporation, 60 Stewart Ave.,
Brooklyn, N. Y. 11237. (212) 497-7600



U.S. Reports

years at Honeywell's Electronic Data Processing division, where he directed work in advanced memories, circuits, and logic (including LSI), plus optical character recognition, displays, and optical mass memories. With Egan, formerly memory products marketing manager at Lockheed's Data Products division, Kruey plans to carve out sales in a market which has yet to materialize—advanced computers.

Versatile. The company's marketing approach already is clear. "We want to take the load off mainframe designers by supplying modular, expandable memories, which need as little special design attention as possible and which are reliable," says Kruey. Thus CMI's first two products were an expandable (from 4K) 18-bit core main memory system mounted on 12-by-12-inch plug-in boards, and a sequential-access MOS memory subsystem that stores data in forms from 50 one-bit words to 200 words at eight bits each. The MOS unit is on a 5.75-inch-square plug-in board, and is aimed at the peripheral equipment field and buffer applications.

To be shown at the Fall Joint Computer Conference will be a 1K-by-nine-bit core memory module with 850-nanosecond cycle time, and a shift register using domain tip propagation logic, a magnetic logic format developed at the Laboratory for Electronics, and purchased by CMI [*Electronics*, March 20, 1967, p. 48].

All four products use a maximum of two supply voltages ("Power supply cost can be high relative to memory cost," says Kruey); need minimal power conditioning, and use little standby power. This isn't just to attract customers, Kruey maintains—it's also designed to make CMI a force in the 1970's—during which, says Kruey, "memory in its varied forms may become the most important feature of computer architecture."

Design. Kruey feels EDP hardware and logic design are becoming less and less important as techniques like LSI force use of ever-larger building blocks. But larger blocks alone could remove flexibility from computer design—and perhaps operation. Trying to offset this by ap-

plying memory techniques, Kruey looks ahead to a "fluid architecture" wherein a multiprocessor would adapt its mode of operation to suit tasks and programs at hand through use of control computers, microprogramming, and alterable read-only memories.

An alterable ROM sounds like a contradiction, but says Kruey, "an alterable ROM could combine great speed with the real-time alterability of core to allow a fluid microprogramming system in which various computers could be emulated, and differences in software or machine language largely offset."

Kruey says that "fluid architecture" originated at the Standard Computer Corp. in Los Angeles. A spokesman for Standard calls the concept "a multimemory, multi-language, computer-within-a-computer" approach that eliminates fixed relationship between functional blocks, making it both problem and program adaptable.

Later load. Thus, CMI is developing an alterable core ROM with 100-nanosecond estimated read time, and a write time of less than 1 microsecond. Kruey notes that in addition to a software alterable form, it could be sold without write electronics, or in turnkey format, where its program would be loaded at CMI's (or the user's) plant with a plug-in peripheral loader.

Envisioning the advanced computer as a central processor surrounded by other processors using alterable ROM-stored instruction sets, Kruey also is preparing to supply anticipated massive memory needs for the central or control computer—the central processor would have to supply lengthy, detailed sets of instructions for each satellite.

CMI's entry in the mass-memory field will use etched permalloy technology—developed under Air Force sponsorship by LFE and sold to CMI along with domain tip propagation logic [*Electronics*, July 11, 1966, p. 135].

Egan says that CMI expects to achieve storage costs of 0.25 cent per bit, and estimates that standard core memory techniques will be hard-pressed to move much below a penny. "We'll shoot for the so-

Better solutions come from Weatherford

Try these for starters: System Interface Circuits. TTL. Light Sensors.

TI's 10 sense amplifiers simplify system circuit interfacing. Interfacing between high speed, ferrite memory cores and TTL logic systems no longer presents a "no-man's land" of problems because of TI's choice of sense amplifiers. All device types feature dual pre-amps (4K memory cores per input) with individual channel strobing and TTL compatible outputs. The SN7520N/21N pre-amps drive a single cascade-gate output, while the SN7522N/23N output is an open-collector gate. The SN7526N/27N feature the industry's first data register output for narrow strobe windows. The SN7524N/25N and SN7528N/29N have individual channels, each input having its own gate output. The pre-amp outputs in the SN7528N/29N are also available for use as test points. We can furnish an application report and data sheet on TI's 10 or circle 271 on the Service Card.

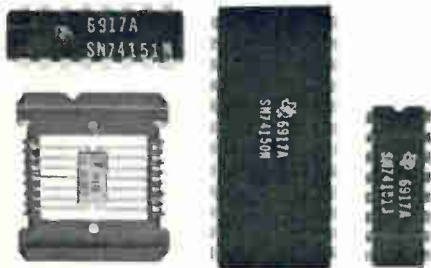
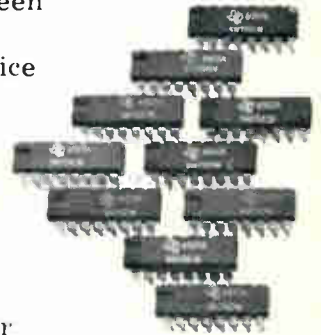

TI's 3 new MSI data selectors cool multiplexing costs. You can put the cost of multiplexing "on ice" with TI's new data selectors — each of which selects one of 16 (or eight) data sources determined by the binary address inputs. Each contains both inverter-drivers and AND-OR-INVERT gates in a single package. Result: reduced design time, inventory and circuit costs. The SN54150/SN74150 are 16-bit data selectors in 24-pin plastic packages. SN54151/SN74151 are 8-bit circuits in either the 16-pin plastic or ceramic dual-in-line packages. The SN54152/SN74152 are 8-bit selectors available in flat packs. For data sheet on this trio of data selectors, get in touch with us. Or circle 272 on the Service Card.

TI's 16 new light sensors lighten your selection burden. TI's tiny LS600 silicon planar light sensor has sired a big, new family of 16 devices, TIL601-TIL616. Now you can pick and choose what you need quickly and precisely from standard and coaxial packages, round or flat lens and four light-sensitivity ranges (0.5-3 mA, 2-5 mA, 4-8 mA, 7 mA). All are readily available and are designed for use in high-density matrix in-line readout equipment. Pick the round lens for optical arrays requiring minimum cross talk; choose the flat lens when you need a wider viewing angle. We can supply data sheets or circle 273 on the Service Card.



For better solutions, call your authorized TI distributor



R. V. WEATHERFORD CO.

DISTRIBUTORS OF ELECTRONIC COMPONENTS AND EQUIPMENT

ANAHEIM, CALIFORNIA
1550 Babbitt Street
714-532-6741
714-547-7521

GLENDALE, CALIFORNIA
6921 San Fernando Road
813-849-3451

PALO ALTO, CALIFORNIA
3240 Hillview Drive
Stanford Industrial Park
415-321-5373

PHOENIX, ARIZONA
1917 North 25th Drive
Carson Industrial Center
602-272-7144



POMONA, CALIFORNIA
1095 East 3rd Street
714-623-1261
213-966-8461

SALES OFFICES: San Diego, California, 714-278-7400 • Seattle, Washington, 206-762-4200 • Dallas, Texas, 214-231-6051

Announcing the "Freon" Solvent Drying System.

Dries water-wet parts spot-free at 118°F...in 3 easy steps.

1. Lower the parts into the drying sump containing FREON® T-DA 35 solvent boiling at 118° F. Low-temperature boiling eliminates water spotting caused by the evaporation of water. (This system, using the high density of FREON, works by the displacement of water, rather than its evaporation.) No spotting of parts means fewer rejects. And the low-temperature operation also helps to protect delicate parts. The system is compatible with most plastics, elastomers and metals.

2. Remove the parts and allow the excess solvent to drain back into the drying sump. (The solvent is re-usable—no need to discard the solvent because it is saturated with water.) After draining, lower the parts into the first rinse sump containing FREON TF.

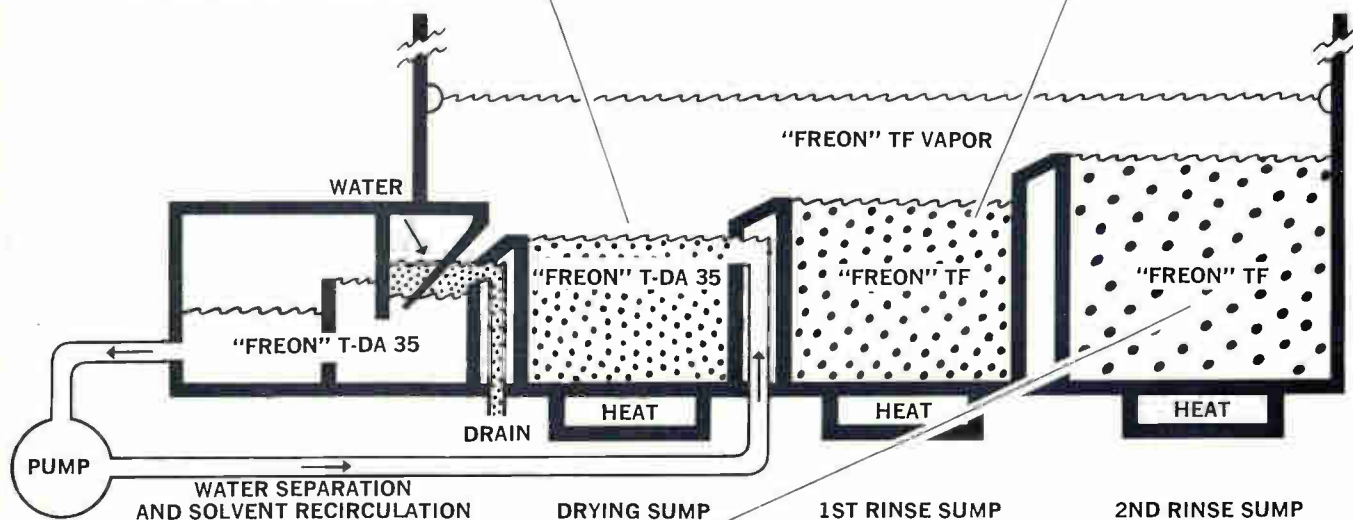

3. Remove the parts from the first rinse sump. Allow to drain and then place in the second rinse sump. Remove the parts and hold them in the vapor zone above the sump. When the dripping stops, remove the parts from the drying system. Parts will be completely dry, spot-free and immediately ready for further processing.

The whole, remarkably simple operation takes only a few short minutes. Furthermore, it is completely safe. FREON solvents are nonflammable, nonexplosive, nonirritating and low in toxicity. **For further information on the efficient, economical FREON Solvent Drying System, write: DuPont Company, Room 7304-T Wilmington, Delaware 19898.**

FREON SOLVENT
Drying System

DU PONT Freon®
solvents

U.S. Reports

called bulk core market with this—the 17-to-20-megabit random access memory area,” says Egan; “we really don’t expect much competition here from monolithic memory techniques, even though in two years the market should exceed \$150 million.”

Making it. Egan’s bullishness derives from the batch-assembly technique used to make etched permalloy memory planes. “Today 80% of the cost of a core memory is in wire, cores, and stringing—right where etched permalloy can save us the most: magnetics.”

If yields are high enough, etched permalloy even might sell against disk stores. “This would be stiff competition,” says Kruey, “but even though our cost per bit would be perhaps 10 times higher, we might outsell disks where fast random access, zero latency time, and high (nonmechanical) reliability and redundancy are needed.”

Integrated electronics

Print it!

Though thick-film hybrid technology is enjoying handsome growth, it still labors under the burden of a separate manufacturing step for inserting active devices. But George D. Lane, president of Electro Materials Corp. of America, Mamaroneck, N.Y., flatly predicts that within five years it will be practical to print some active devices of modest performance on a substrate, using manufacturing operations and resistor pastes like those for printing passive elements.

Resistor pastes, which are silk-screen-printed onto a substrate and then sintered at a high temperature, are combinations of noble metals and glass frit. Therefore, they behave as semiconductor materials. Under certain conditions, Lane discovered, resistors made of these materials conduct better in one direction than in the other. The result, says Lane, is a diode.

The diode doesn’t have a single fabricated junction. Instead, many junctions are formed randomly by

the intimate contact of the different granules distributed in the paste, the net result being a preferential direction to form one equivalent junction.

In the lab. It’s not practical to make diodes this way yet, says Lane, but he has printed experimental diodes, using conventional thick-film processes that have about a 10-to-1 ratio of reverse resistance to forward resistance. Lane is confident that this ratio can be improved upon, and his company, which makes resistor and conductor pastes, is continuing to investigate the conductance phenomenon.

Meanwhile, a printed thermistor has been added to the list of passive elements that can be designed into hybrid thick-film circuits. A thermistor is a nonlinear resistor that has a large negative temperature coefficient of resistance and exhibits an exponential change in resistance versus temperature.

Conventionally, when a circuit needs a thermistor—say for temperature compensation—it is added as a discrete element. Now, says Lane, the new thermistor paste made by his company can be printed and fired like resistor pastes. Thermistor material resistivities range from 300 ohms per square per mil of thickness to 10 megohms per square per mil. Temperature coefficient of resistance depends on the material, and is about -0.5% per degree centigrade.

Manufacturing

Controlled charge

Depending on the function of the device, interface charge can be a boon or a bane in metal-nitride-oxide semiconductors. In a digital integrated circuit made by the MNOS process, for example, the charge is highly undesirable because it makes the threshold voltage unstable. In an MNOS memory, on the other hand, interface charge is the mechanism by which data is stored.

A semiconductor manufacturer obviously would find knowledge of

113

MAJOR CHARACTERISTICS

BASIC UNIT, model CR 41

- RANGE: 10 nsec to 999 nsec.
- 10 nanosecond RESOLUTION
- START and STOP independent channels.

PLUG IN, model CR 42

- RANGE: 1 nsec to 99 msec
- 1 nanosecond RESOLUTION
- START and STOP independent channels.

● 3-DIGIT DISPLAY

● BCD OUTPUT, 8-4-2-1 code, positive true

● CRYSTAL AGING RATE: 1 part in 10^8 /day

● Provision for use of EXTERNAL TIME BASE

LABORATOIRES de MARCOUSSIS - Route de NOZAY - 91-MARCOUSSIS - FRANCE

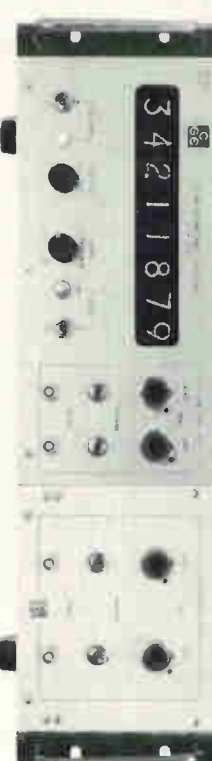

NANOSECOND

TIME INTERVAL METER

(1000 MHz DIRECT COUNT)

MODEL CR 42

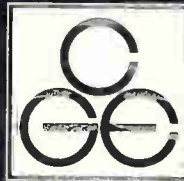

**LABORATOIRES
DE MARCOUSSIS**

Centre de Recherches de la CGE
Route de NOZAY - 91-MARCOUSSIS
FRANCE

tél : 920.82.50 - télex : 26.877 LAB-MARCO

TRYGON pow errr supplies...

the *NEW* Super Trypack System / OEM Modules!



TPSA Series

3.2 to 30 VDC, up to 1.25 amps. Integral OV on IC output ratings. From \$56.

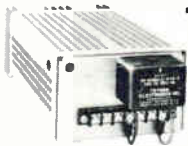

TPSC Series

3.2 to 30 VDC, up to 5 amps. Integral OV on IC output ratings. From \$80.

Super Trypack units offer the system designer two modular sizes to choose from with complete flexibility for systems integration or rack adapter usage with Trygon Liberator units of even higher ratings.

Dual output modules, covering 11.5 to 15.5 VDC, and up to 1.8 amps, are also available in this series.

- Overvoltage Protection
- Precision Performance
- Complete System Reliability
- Unattended Continuous Operation
- Compatible with Liberator Systems Group in Rack Adapter Combinations for up to 161 VDC and 70 amps operation.

TRYGON MEANS POWER!

Write now for complete data and pricing of these new power modules.



111 Pleasant Avenue, Roosevelt, New York 11575
Tel: 516-378-2800 TWX: 510-225-3664
Trygon GmbH 8 Munchen 60, Haidelweg 20, Germany
Write for Trygon Systems Power Supply Catalog.
Prices slightly higher in Europe.

U.S. Reports

the factors that affect this charge and a means of varying it a great help. At Fairchild Semiconductor's R&D Laboratories, two scientists—Valentine Rodriguez and Dov Frohman-Bentchkowsky—have shown that the charge can be controlled by varying the composition of the silicon nitride layer. Rodriguez and Frohman-Bentchkowsky have established relationships among interface charge, electronic conductance, and deposition conditions. They've also studied charge and discharge times as a function of voltage and temperature.

Charged. Silicon nitride, of course, has attracted attention as a substitute for silicon dioxide insulating layer in IC's and discrete devices; Si_3N_4 resists contamination much more effectively than SiO_2 , and reduces threshold voltage [*Electronics*, March 31, p. 117]. The problem is that an uncontrollable charge is trapped at the interface of the nitride and the silicon substrate when a voltage is applied to a metal-nitride-semiconductor transistor.

The solution was to thermally grow SiO_2 on the silicon before depositing the nitride—in other words, using an MNOS structure. This circumvents the unstable metal-nitride interface charge, but unfortunately—or fortunately, depending on what the device is expected to do—another charge comes into play at the interface of the oxide and the nitride.

This interface charge is a result of the difference in electronic conductance between SiO_2 and Si_3N_4 (it would, in fact, occur with any two insulating materials). When a voltage is applied to the MNOS structure, a minute current flows through the insulating layers—on the order of 10^{-11} or 10^{-12} amperes. Since SiO_2 tends to have a much higher conductance than Si_3N_4 , it draws more current, and this excess current is stored as charge at the interface.

Inching along. Through an etching experiment, Rodriguez and Frohman-Bentchkowsky showed that the stored charge is located at the nitride-oxide interface. They made an MNOS structure with aluminum as the metal and silicon as

the semiconductor; nitride and oxide each were 1,000 angstroms thick. The Fairchild researchers applied a voltage to the structure to create the stored charge. Then they etched into the insulating layers in steps of 200 Å, and measured the charge at each etch increment. Only when they got within 200 Å of the nitride-oxide interface was a significant charge observed.

The next step was to determine how the relative conductances of the two layers could be varied to either enhance or diminish the storage of charge. The oxide layer in an MNOS structure is thermally grown from the silicon substrate; since the silicon is of a fixed composition, the conductance of the oxide can't be varied. But the nitride can be deposited by the decomposition of a mixture of silicon tetrachloride and ammonia, and the proportions of the mixture—which can be easily varied—can have a strong effect on the conductance of the resulting nitride.

The nitride conductance can be varied over “several orders of magnitude” according to Rodriguez, with a similar effect on the interface charge.

As for plans to exploit conductance control commercially, there's still much work to be done. “We haven't explored all the possibilities,” Rodriguez says. “Long-term behavior remains a big question.” How long will a charged or discharged interface retain its state? “Days, months, or years,” Rodriguez replies.

It's in the bag

What happens when a manufacturer tests its resistors 100% and knows they're all good before they're shipped, then the customer tests them 100% and finds they're not all good?

Angstrom Precision Inc., the manufacturer, and Standard Elektrik-Lorenz of West Germany, the customer, found themselves in this position when 2.4% of a shipment of 5,000 resistors unaccountably flunked their incoming inspection. The units were 1/20 watt metal film resistors with a $\pm 0.1\%$

Technology sale.

Order Ray IV or Ray V now for prompt delivery.

Those brainy guys in our lab have really shifted into high gear when it comes to dreaming up semiconductor advancements. Here's a couple of new technologies they've established feasibility for, but haven't turned into chips yet. If one looks good to you, give us a call and we'll discuss a delivery date on a custom product or two.

Ray IV: Radiation Hardened Circuits. Just the ticket for digital and linear circuits, or discrete components. Ray IV isolates circuit elements with polycrystalline dielectrics. It bolsters hardening through new component geometries and diffusion profiles. It features thin film resistors. Beam lead techniques. And consistently uses low-Z metals wherever possible in chip and package.

Ray V: Micropower Digital Logic. Especially great for TTL. Ray V is lavished with state-of-the-art touches such as Schottky barrier Baker clamps, washed emitters, platinum silicide contacts and high density gold interconnects. It recognizes high impedance resistors for the long snaky rascals they are, and it cannily substitutes small-geometry transistors in current-regulating circuits. And thereby promises power dissipations as low as $50 \mu\text{W}$ per gate, and propagation delays down to 30 ns.

So look 'em over. Even if these aren't your cup of tea, they illustrate once again the abiding shrewdness of doing business with the company that gets the ideas. And delivers the goods. Raytheon Semiconductor, Mountain View, California. (415) 968-9211.

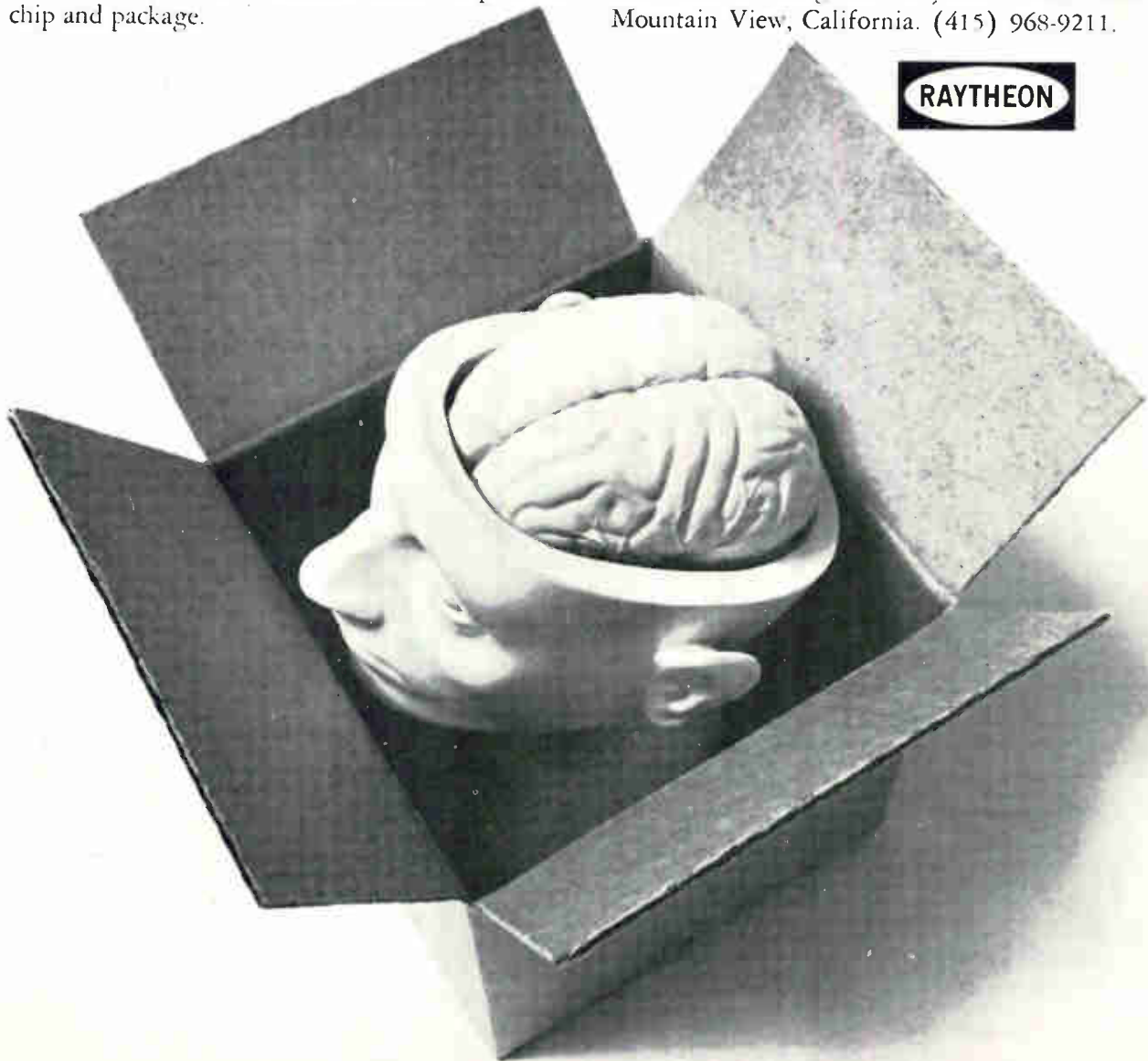
The Raytheon logo consists of the word "RAYTHEON" in a bold, sans-serif font, enclosed within a black oval border.

High Current Silicon Rectifier Stacks...

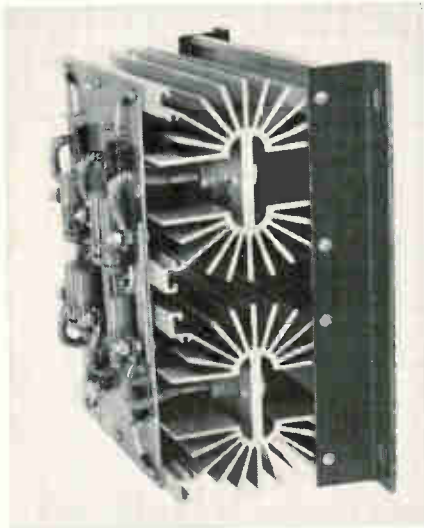

Typical Tung-Sol high current silicon rectifier stack assembly.

Outstanding efficiencies in size, weight and power

Exclusive finned-aluminum radiator design, combined with low-thermal-impedance silicon rectifiers, provides Tung-Sol rectifier stacks with efficiencies unmatched in the high current range. Bolt grooves and interlock channels, integral to the radiator extrusions, ease assembly and permit mounting in any plane.

These standard, high-efficiency stacks are available in single phase center tap, single phase bridge, three phase bridge, and six phase star assemblies. All are fully described in Catalog T-483. Write for your free copy today. Tung-Sol Division, Wagner Electric Corporation, 630 W. Mt. Pleasant Avenue, Livingston, N. J. 07039. TWX: 710-994-4865. Phone: (201) 992-1100.

TUNG-SOL®
HELPS YOU DO MORE
...WITH LESS

©Reg. T.M. Wagner Electric Corporation

U.S. Reports

resistance tolerance.

Angstrohm shipped the resistors to TRW Systems, which transshipped them to Standard. Three months later, Standard reported that 119 resistors were out of tolerance, and rejected the shipment.

Cultivated fields. TRW and Angstrohm then attempted to duplicate the conditions the resistors were subjected to from the time they left the manufacturer until they arrived at Standard. The culprit: plastic bags in which TRW shipped the resistors. The combination of vibration and low humidity on the plane that carried the resistors to Germany created high-voltage electrostatic fields on the bags, and these fields caused a permanent change in resistance values.

The TRW-Angstrohm failure analysis showed that there was no detrimental effect on temperature coefficient or long-term stability, but the change in resistance was serious enough to eliminate plastic bags unless they're antistatic or foil-lined. What's more, the resistance change isn't limited to units of Angstrohm manufacture, that company found; thin-film metal resistors produced by Nepeco and IRC showed the same tendency when subjected to high electrostatic fields in Angstrohm's failure analysis.

For the record

Lab deal. EDP Technology, a Washington, D.C., software firm, will buy Cornell Aeronautical Laboratory for \$25 million—if. The big if is the lifting of a temporary injunction obtained by the State of New York barring Cornell University from selling the Ithaca, N.Y., facility. Cornell and EDP have asked for an early trial on the issue. Another problem could be staffing the lab. While its full complement is 1,500, including 630 scientists and engineers, the announced intention of the university to sell it hasn't discouraged anyone from leaving. The question is just how many stayed. The prospective purchaser specializes in developing systems for education, business, health, and community planning.

The INNOVATORS

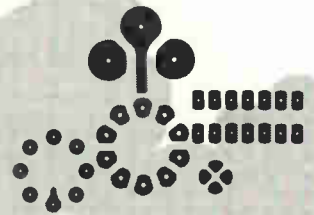

FIRST

Bishop introduced the multi-pad configuration! More accurate, less work.

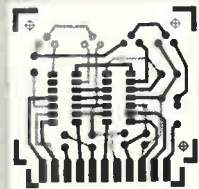

NEXT

Bishop introduced absolute registration for two-sided printed wiring boards with the only photographically compatible Red and Blue System.



NOW

Bishop offers you the largest selection of pressure-sensitive electronic component drafting aids in the industry. Over 15,000 to choose from! Precise, uniform, easily applied. All in our new comprehensive 68-page printed-circuit design guide and catalog. Send for yours now! We'll send you free samples, too.



Bishop Graphics, Inc.

7300 Radford Avenue, North Hollywood, California 91605 (213) 982-2000
©1969 BISHOP GRAPHICS, INC.

THIS PROGRAM WAS SUPPLIED TO YOU VIA THE

APOLLO LUNAR CAMERA by

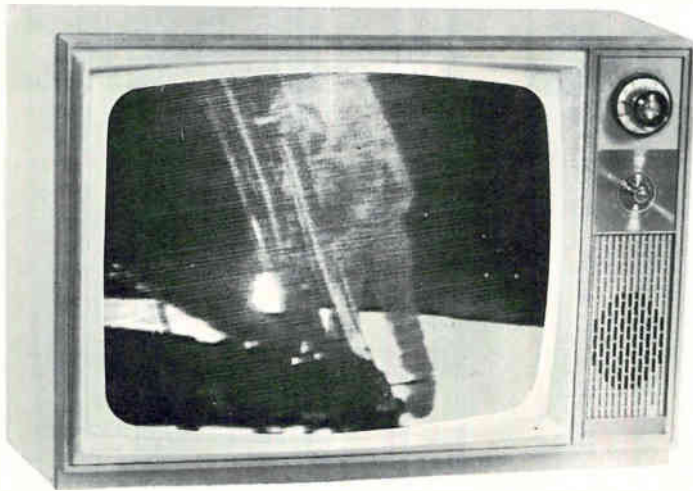

POWERCUBE[®] MODULES...

In a power supply that weighed less on earth than any conventional supply would weigh on the moon!

The power supply for the Apollo 11 portable lunar camera consisted of six standard Powercube modules — a Preregulator, a DC-AC Inverter, AC-DC Converters, and Multi-output Converters with a total earth weight of 4.8 ounces. Such a system is capable of delivering nine separate regulated voltages ranging from 5 to 400 Vdc from a single 28 Vdc input.

Although you may not have a need for a power supply on the Moon, Powercube can solve your size and weight, high power converter problems on Earth. Each standard off-the-shelf module, weighing 0.8 ounce with a 0.5 cubic inch volume, is capable of delivering 0 to 3500 volts at 30 watts.

Powercube's patented construction technique assures reliability in a product line that includes, in addition to the modules that powered the lunar camera, DC-DC Regulators, DC-DC Pulse Regulators, DC-AC Inverters, AC-DC Regulated Converters, and AC-DC Complementary Converters. All Powercube modules are identical in appearance and can be easily soldered or welded together to form subminiature power supplies.

Send for your 24 page designer's aid catalog.

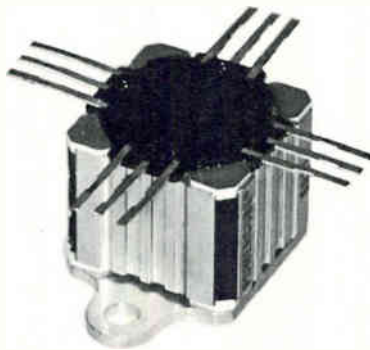

ACTUAL SIZE



POWERCUBE CORPORATION

214 CALVARY STREET, WALTHAM, MASS. 02154 (617) 891-1830

SUBSIDIARY OF UNITRODE CORPORATION

"RELIABLE HIGH POWER CIRCUITS AT A FRACTION THE SIZE"

You've relied on components Here are 15 reasons

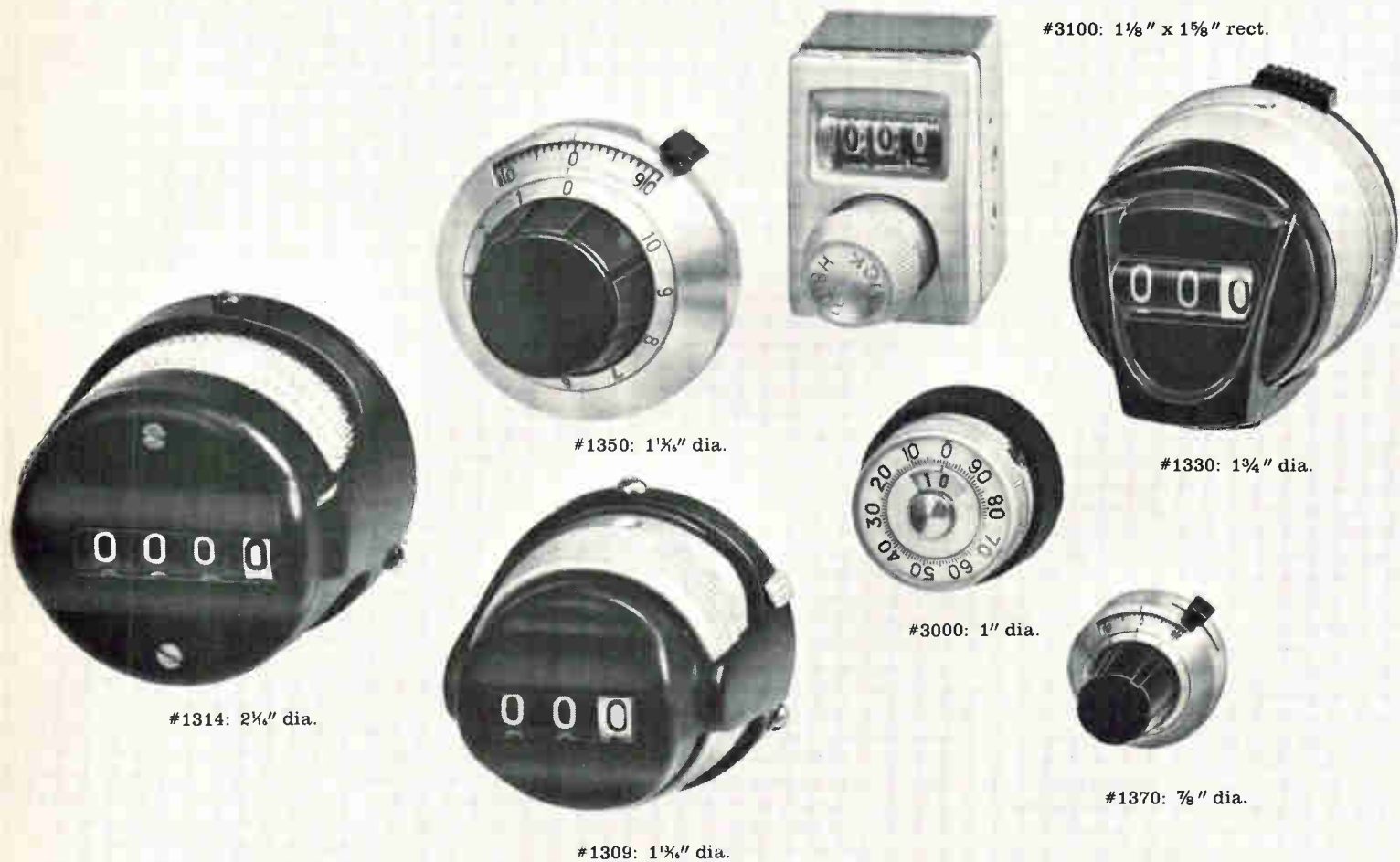

Amphenol for years. to continue.

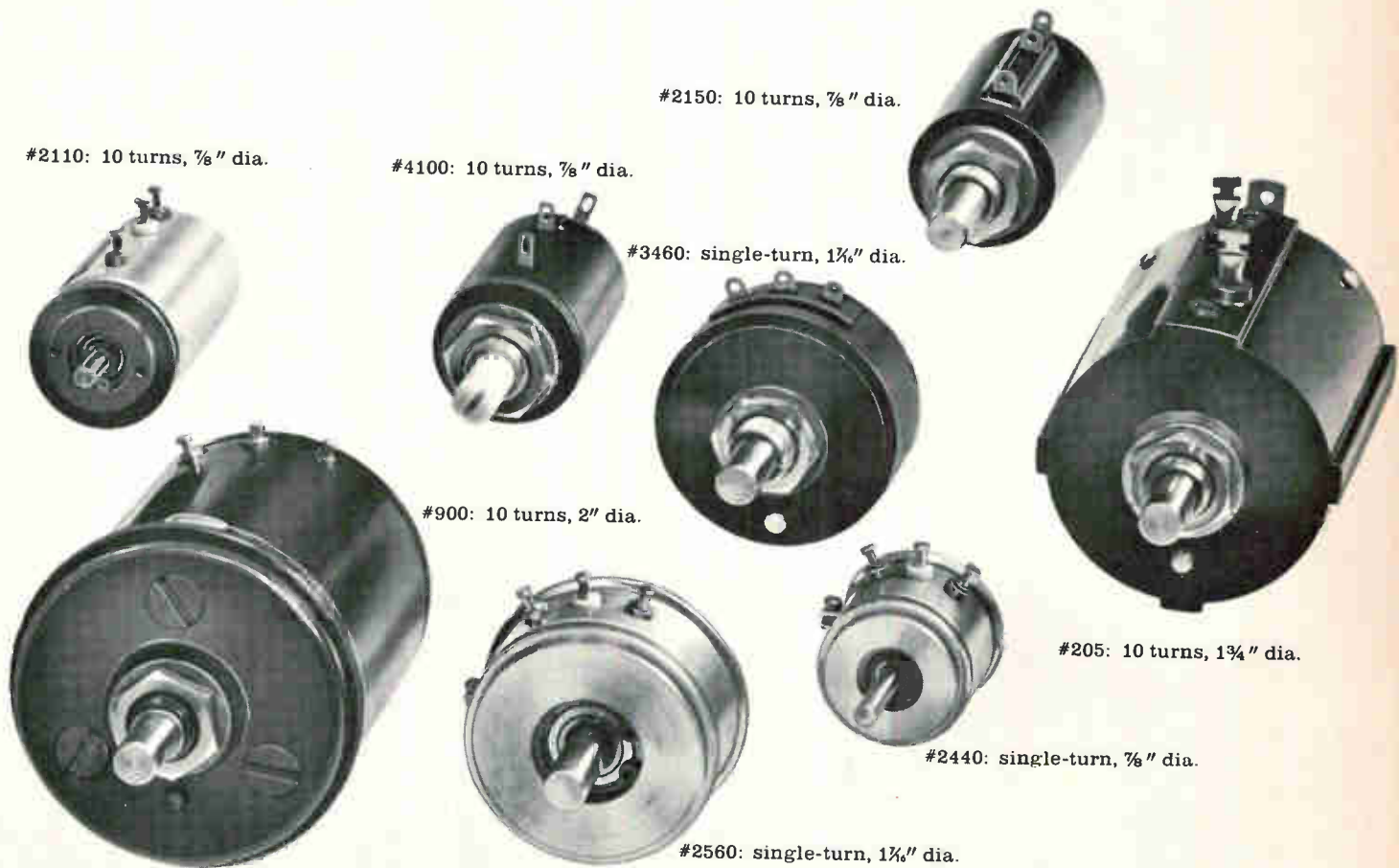

These pots and dials have the same built-in reliability and quality you've always received from Amphenol.

The widest range of resistances, optional linearities and sizes highlight our single-turn and multi-turn precision wirewound pot line. Our

concentric scale and digital counting dials offer optional gear ratios and come in multiple color combinations.

If you need more reasons, write for our new full-line catalog. For off-the-shelf delivery, contact your Amphenol distributor. Amphenol Controls Division, Janesville, Wisconsin



AMPHENOL

THE BUNKER-RAMO CORPORATION

Circle 71 on reader service card

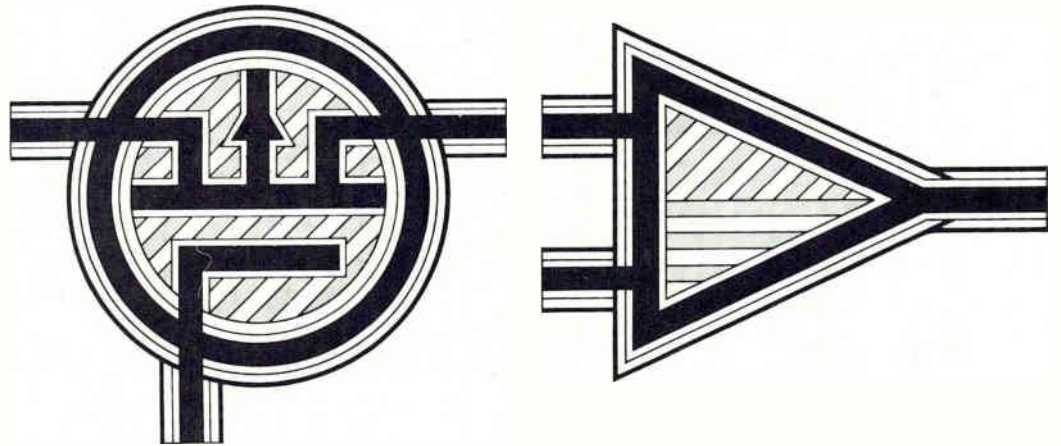

Applications Power *

more data
transmission
applications for
**ANALOG
SWITCHES
& OP AMPS**

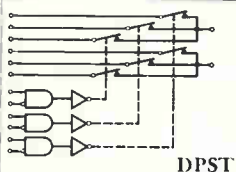
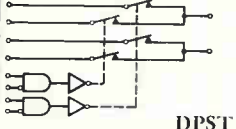
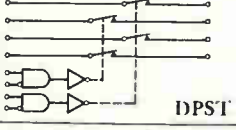

* Applications Power . . . A broad product line, an extensive network of stocking distributors and an experienced applications team waiting to serve you.

Here are two more examples that illustrate the versatility of Siliconix driver/FET switch packages in data transmission systems.

Functional Description	Channels	Type	Max. $r_{DS(on)}$ (ohms)	Switch Type
 DPST	3	DG120 121	600 600	PMOS PMOS
 DPST	2	DG122 132	600 600	PMOS PMOS
 DPST	2	DG126 129 140	80 30 10	N N N
 SPECIAL FUNCTION	1	SI3001	600	PMOS

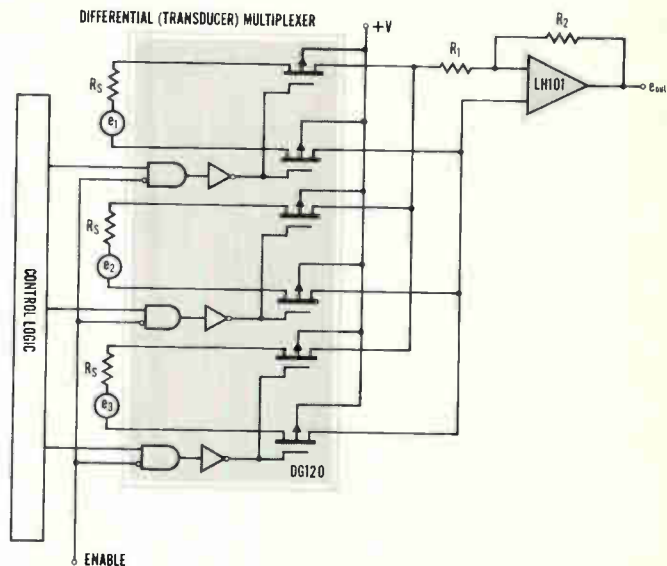

This three channel version of a transducer-multiplexer uses a single DG120 along with an LH101.

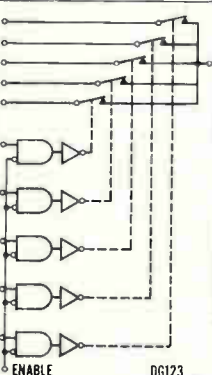
Functional Description	Channels	Type	Max. $r_{DS(on)}$ (ohms)	Switch Type
 DG123	2	DG110	600	PMOS
		111	600	PMOS
		112	600	PMOS
		133	30	N
		134	80	N
		141	10	N
		147	600	PMOS
		148	40	PMOS
4	DG116	600	PMOS	
	118	600	PMOS	
5	DG123	600	PMOS	
	125	600	PMOS	

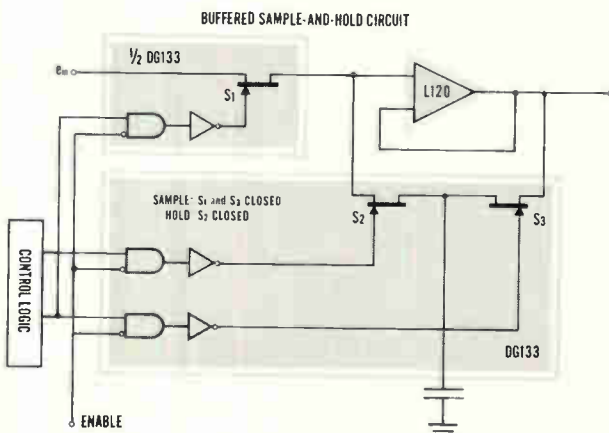

Low input leakage of the L120 OP AMP makes it ideally suited for sample-and-hold circuits. Two channels of this circuit require three DG133s and one L120. An alternative approach would require two DG129s and one L120 for two channels.

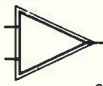
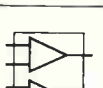
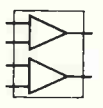
SILICONIX OP AMPS	Max. input offset voltage -55 to +125°C	Max. input current	Min. open loop gain	Output voltage swing	Slew rate	
 LM 101  LH 101 (Internally compensated)	6 mV	200 nA	50K	±12V	0.25V/μsec.	<ul style="list-style-type: none"> • Operation from ±5 to ±20V power supplies • Low current drain • Continuous short circuit protection • Same pin configuration as 709 amplifier
 L 120						200 mV

Working on data transmission? Write today for complete information on all Siliconix FET switch combinations and OP AMPS.

For instant applications assistance, call the number below.

Our new address . . .
Siliconix incorporated
 2201 Laurelwood Road • Santa Clara, Calif. 95054
 Phone (408) 246-8000 Ext. 201 • TWX: 910-338-0227



With a little

The new Bit 483 mini computer is not lucky. It's a machine with about as much daring as a hammer.

We designed quiet, dull reliability into the soul of our new 483.

And then we started stamping out that soul like cookies. If anything was a gamble, that was.

But then, a guy named Ford kind of took the initial risks on mass-production.

He showed that mass-producing something like the 483 would allow us to deliver the 483 yesterday. And that producing in volume would allow us to discount the price.

Putting your money on the 483 means putting your money on a general purpose



Bit of luck.

digital computer with proven design performance and unparalleled problem solving capability. BYTE orientation. Variable word length. Cycle stealing data channel. 350 nanosecond memory access time. Binary and decimal arithmetic. Priority interrupt. And a complete line of I/O options.

That makes the 483 the cost/performance leader in the mini computer field. And we're making it the best serviced computer in any field.

Frankly, the kind of people who take a chance on the 483 are the kind of devil-may-care people who take a chance on t.v. sets, the horseless carriage and peanut butter in the jar.



BIT, INCORPORATED
5 Strathmore Road
Natick, Mass. 01760

Visit us at FJCC booth 6304-6 and at NEREM booth 1D-83

Circle 75 on reader service card

IT'S SUPERFLEXIBLE

a
new kind
of
HELIAX®

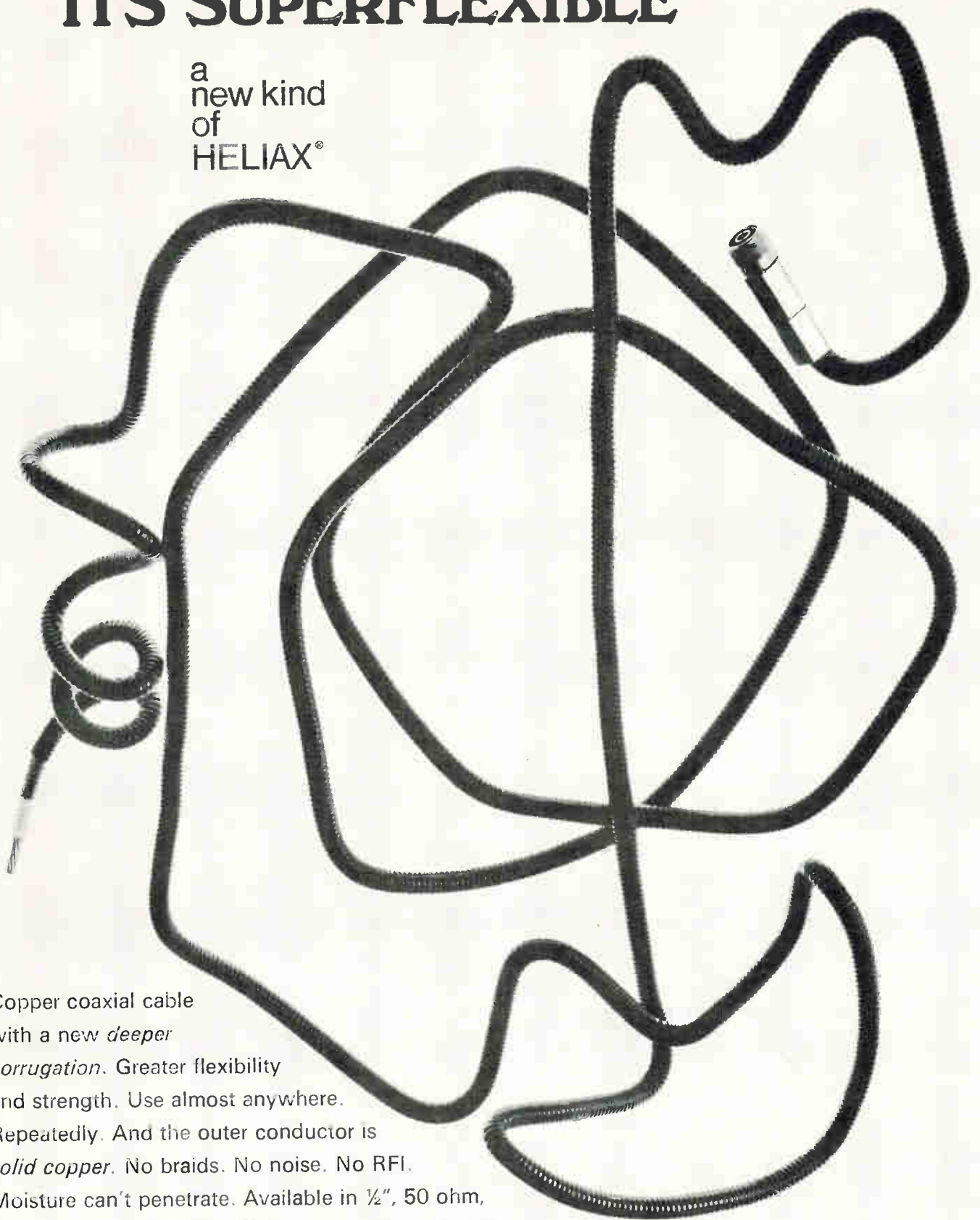

Copper coaxial cable with a new *deeper corrugation*. Greater flexibility and strength. Use almost anywhere. Repeatedly. And the outer conductor is *solid copper*. No braids. No noise. No RFI. Moisture can't penetrate. Available in 1/2", 50 ohm, foam dielectric, Type FSJ4-50. Connectors, Type N or GR-874. Like a sample? Communicate with Andrew.

12-68



ANDREW

CONTACT THE NEAREST ANDREW OFFICE OR ANDREW CORPORATION, 10500 W. 153rd STREET, ORLAND PARK, ILLINOIS 60462

Circle 76 on reader service card

Washington Newsletter

October 27, 1969

Response pours in on wafer LSI for Navy's AADC

More than 40 companies already are interested in developing modules to package LSI in full wafer configurations for the Advanced Avionic Digital Computer (AADC). The Naval Air Systems Command expects to choose "several" development contractors from the response to its request-for-proposals that's coming out in November.

Navy program managers insist there is no preferred approach for packaging LSI at this point, despite their acknowledged interest in a Hughes Aircraft LSI interconnect method called pad relocation [*Electronics*, Oct. 13, p. 44] that the Navy feels has potential for "great cost savings" in large production runs of wafers.

AADC is backed by \$1 million in fiscal 1970 money that has been obtained in a year when most new military starts are dying of economic starvation. Despite the hooker that any potential contractor must agree to permit the Navy to distribute any or all of its technological inputs to other companies on a "need-to-know" basis [*Electronics*, Sept. 29, p. 73], the list of companies interested in the Naval airborne computer project reads like a "who's who" of the electronics industry.

Army tightens purse strings for new technology

Count on a tough effort to get the Army Materiel Command to spend money on developing or building state-of-the-art equipment, or gear that hasn't been proven operationally. Congress has been "disenchanted with our progress," admits Gen. Ferdinand Chesarek, AMC commander, who indicates the command is playing it cool on new technology after the problems it encountered with such programs as the Cheyenne helicopter.

New equipment will have to be proven elsewhere, even by commercial users, before the Army will consider gear based on new technology, Chesarek indicates, citing such examples as Precision Instrument's laser mass memory and IBM's 360/195 giant processor. The Army's problem, he says, is to devise appropriate uses for such systems as the laser memory, which stores a trillion bits in 26.5 square feet at relatively low cost. As for the 360/195, the AMC commander says the Army has "major problems to resolve" before it can use such a system.

Go-ahead likely for Comsat on domestic satellite . . .

The Nixon Administration, under increasing pressure to get started on a domestic communications satellite system for television relay, is likely to flash the green light on an experimental pilot system soon—perhaps in November. Presidential advisers shortly are expected to echo a September recommendation of the President's Task Force on Telecommunications: give Comsat the responsibility to build and operate a pilot domestic system. If the Administration goes along, then the final step is approval by the FCC.

There was nothing new in the proposal made by CBS this month that the tv networks set up their own satellite relay system. ABC made much the same pitch four years ago, and GE earlier this year made a detailed domestic satellite proposal. Comsat, which presented its domestic satellite plan to the FCC in 1966, wants to discuss its latest plan with the three tv networks. Only difference between the two is that Comsat would retail its satellite services directly to users, eliminating common carriers, notably AT&T.

Washington Newsletter

... as first contract for ground stations is readied ...

While the Administration tries to decide who should build the pilot domestic communications satellite system, Comsat—Nixon's likely choice—is going ahead with what will be the first hardware contract. Comsat shortly will announce the winner of the award for three transportable ground terminals, which will be prototypes for small stations in the domestic system.

Eight companies bid on the contract, which will be worth around \$1 million. Though Comsat denies it, sources say it has narrowed the field to four finalists: Collins, Hughes, Motorola, and Raytheon. Those cut were Page, Nippon Electric, Radiation Systems, and Sanders. The last stage of the bidding was described as a Chinese auction in which the company that takes the biggest loss will get the award. So far, with a possible 200 to 300 ground stations at stake, none of the four finalists is shirking. One finalist already is getting quotes from subcontractors for gear to equip up to 30 stations, anticipating an award for that many by early November.

The transportable terminals will use cooled parametric amplifier front ends to meet bandwidth and noise figure requirements.

... and Alaska puts heat on Nixon to get ball rolling

Some of the strongest pressure exerted on the White House to get going on the pilot domestic communications satellite program is coming from Alaska. In fact, Alaskan leaders assert there's a "very real possibility" that the 50th state will turn to Canada's domestic satellite system when it becomes operational in 1972.

Sen. Mike Gravel (D., Alaska), says the problem is Comsat, which he calls "unmanageable in its present form with industrial competitors on its board." He's pushing his bill (S. 2928), now before the House Commerce Committee, which would amend the Communications Satellite Act to permit ground-station ownership by states or entities designated by them.

Color-tv fire probe doesn't worry EIA

The electronics industry apparently isn't too concerned over the latest Government probe into tv-set safety. "Anything that plugs in the wall will cause a fire sometime," says Jack Wayman, EIA vice president, in dismissing the National Commission on Product Safety's investigation into reports that some color-tv sets have caught fire spontaneously. Wayman calls the ratio of sets reportedly catching fire "infinitesimal"—only hundreds out of the 85 million tv sets across the country.

Mike Lemov, attorney for the commission, won't identify the manufacturers of the color tv sets reportedly causing all the trouble, maintaining it might create an "unfair competitive advantage" to other makers.

The commission, meanwhile, has sent inquiries to some 15 set makers asking if they had reports of fires on their sets.

Addendum

Cutler-Hammer's AIL division is now promoting its AN/TPX-42 ground-based processing and display system to the FAA. However, sources at the agency, which is having its troubles with Raytheon's display consoles for the National Airspace System (See p. 54), say the AIL system can't be considered as a replacement for Raytheon's hardware since the latter is designed for a capacity of three to four times that of the TPX-42. The AIL system's 128-target capability limits it to low-density terminals in civilian applications.

2760 watts and 7" panel height?

Yes! With the Sorensen DCR Series

\$900⁰⁰

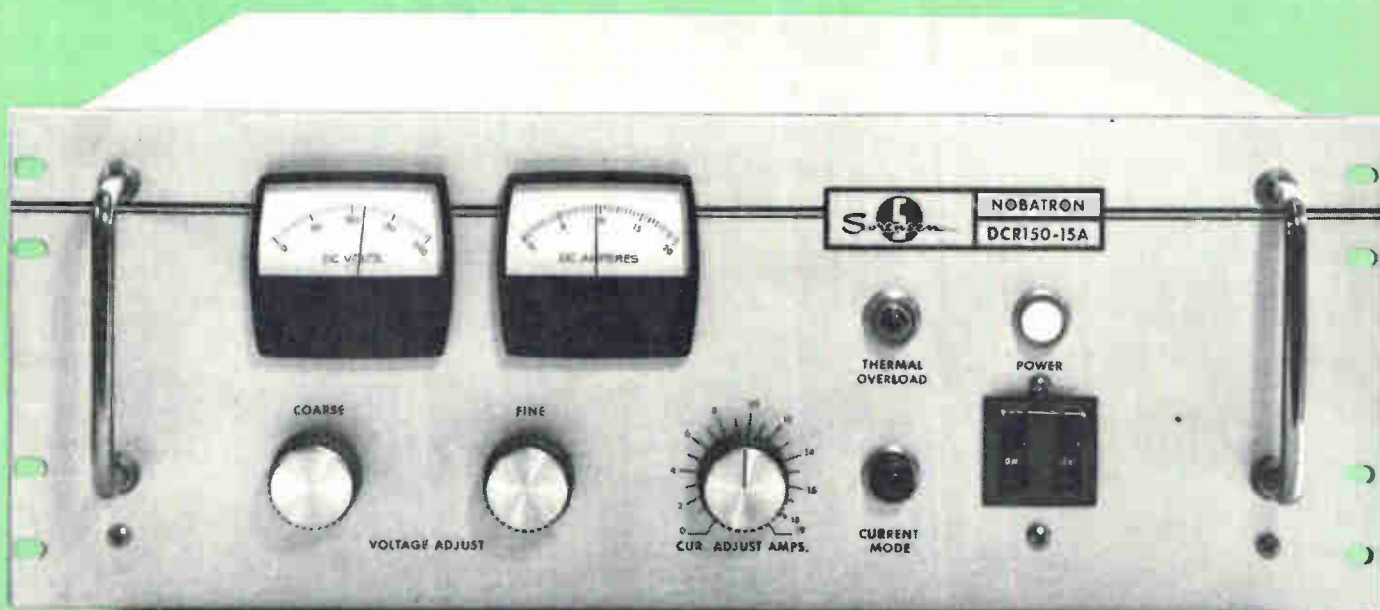

The multi-temperature rated DCR Series (115% I_o @ 30°C/100% I_o @ 55°C/65% I_o @ 71°C) contains eleven models which are available from stock in the 7" high package utilized by model DCR 150-15A. They cover the voltage ranges of 0-20, 40, 60, 80, 150 and 300Vdc at currents to 144A.

Features include: ■ $\pm 0.075\%$ voltage regulation and current regulation with automatic crossover ■ optional overvoltage protection ■ compliance with MIL-I-26600 and MIL-I-6181D ■ 25,000 hour MTBF.

The versatile and proven performance

of these models make them ideal for industrial or scientific applications such as: life testing or production aging of semiconductor devices, forming electrolytic capacitors, controlled charging and discharging of batteries, precision electroplating and controlling magnetic devices.

For more information contact your local Sorensen representative or; Raytheon Company, Sorensen Operation, Richards Avenue, Norwalk, Connecticut 06856.

Tel: 203-838-6571;

TWX: 710-468-2940;

TELEX: 96-5953

RAYTHEON



Circle 200 on Inquiry Card

We'll go to any length to get into your memory

National's capable of going a long way (or short) to get the right MOS shift registers into your memory. The applications are unlimited.

For starters, you get a variety of bit lengths from our standard line, available immediately. Your National distributor's got them on the shelf and waiting.

If you can't find the register length your application requires, give us a call. We'll program your register length into our standard process. We've been making MOS so long, our memory's capable of anything.

How's that register?

DYNAMIC

Dual-25	MM400	-55°C to +125°C
	MM401	-55°C to +125°C (Internal 20K pull-up resistor)
	MM500	-25°C to +70°C
	MM501	-25°C to +70°C (Internal 20K pull-up resistor)
Dual-50	MM402	-55°C to +125°C
	MM403	-55°C to +125°C (Internal 20K pull-up resistor)
	MM502	-25°C to +70°C
	MM503	-25°C to +70°C (Internal 20K pull-up resistor)
Dual-100	MM406	-55°C to +125°C
	MM407	-55°C to +125°C (Internal 20K pull-up resistor)
	MM506	-25°C to +70°C
	MM507	-25°C to +70°C (Internal 20K pull-up resistor)
Dual-64	MM410	-55°C to +125°C
Accumulator	MM510	-25°C to +70°C
Triple-60+4	MM415	-55°C to +125°C
Accumulator	MM515	-25°C to +70°C

STATIC

Dual-16	MM404	-55°C to +125°C
	MM504	-25°C to +70°C
Dual-32	MM405	-55°C to +125°C
	MM505	-25°C to +70°C
8-bit	MM408	-55°C to +125°C
Serial to Parallel	MM508	-25°C to +70°C
8-bit	MM409	-55°C to +125°C
Parallel to Serial	MM509	-25°C to +70°C
Dual-32	MM419	-55°C to +125°C
Split clock	MM519	-25°C to +70°C

Write or call National Semiconductor, 2975 San Ysidro Way, Santa Clara, California 95051.

(408) 245-4320. TWX: 910-339-9240 Cables: NATSEMICON

National/MOS

MODEL 605: THE LOW-COST MULTIPLIER
 1% ACCURACY
 NO TRIM POTS

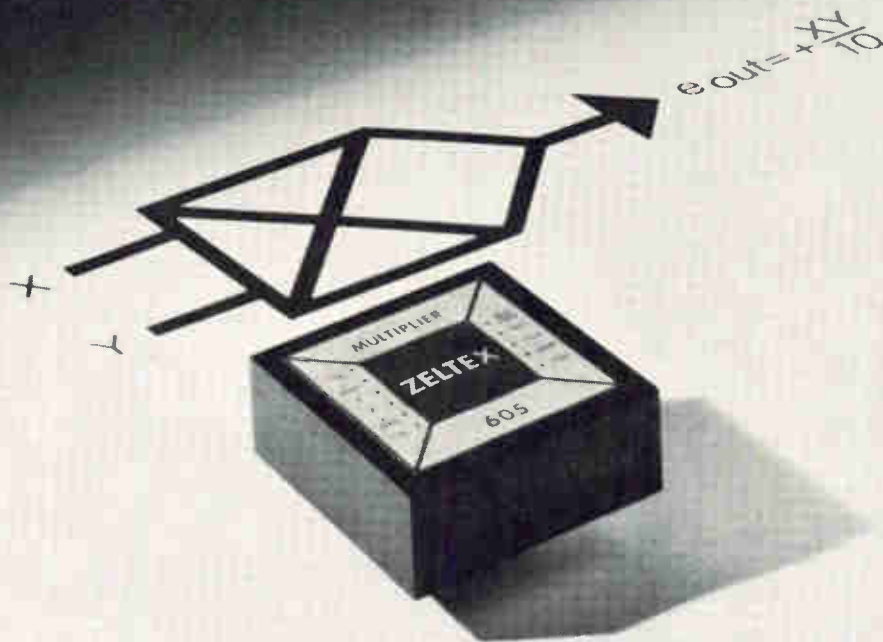

Compare specifications and you'll see that the Zeltek 605 beats every other low-cost multiplier on the market. It provides full-power output to 100 kHz, and small-signal frequency response is 500 kHz.

Yet the price, in quantity, is only \$39!

To get your copy of Bulletin 1056C containing complete specifications and Applications Bulletin 1063A, circle the reader service number below, or write or phone

Other key specifications include:

- Output 10 V @ 4 mA
- Noise 2 mV rms
- Slew Rate 6 V/ μ s
- Size 1.5 x 1.5 x 0.62 inches

ZELTEX, INC.

A Subsidiary of REDCOR CORPORATION
 1000 Chalamar Road, Concord, Calif. 94520
 (415) 686-6660

Space-saving trimmers

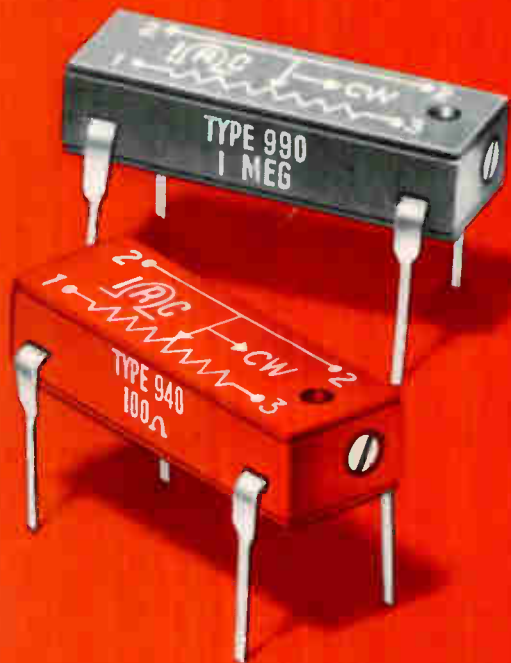

DIP construction matches IC size. Cuts assembly costs.



5/16-in. doubles performance of 1/4-in. trimmer—cuts cost almost in half.

These new IRC precision trimmers in dual-in-line packages simplify PC board layout. Only .200-in. high, their pin spacing is the same as the TO-116 size integrated circuit. It is fully compatible with high-speed automatic inserting equipment.

Pin spacing of these IRC 5/16-in. square trimmers matches the 1/4-in. square unit. Only .031-in. larger on each side, they can cut your cost almost in half and give you three times the power rating of the 1/4-in. and 40% better resolution.

Both DIP and 5/16-in. are available with precision wirewound and infinite resolution Metal Glaze elements. All units are fully sealed and impervious to common industrial solvents because of a silicone rubber shaft seal and epoxy bonding at all seams.

These units, like all IRC Metal Glaze trimmers, have a maximum guaranteed TC of $\pm 150\text{ppm}/^\circ\text{C}$ over the entire resistance range, with typical TC being $\pm 100\text{ppm}/^\circ\text{C}$, and at no added cost. For complete technical information and prices, contact your IRC Industrial Distributor or write IRC St. Petersburg Division of TRW INC., 2801 72nd St., North, St. Petersburg, Florida 33733.



DIVISION OF TRW INC.

The
Choice
is **TTL.**

Now, an MSI dual quad latch that won't break the bank...

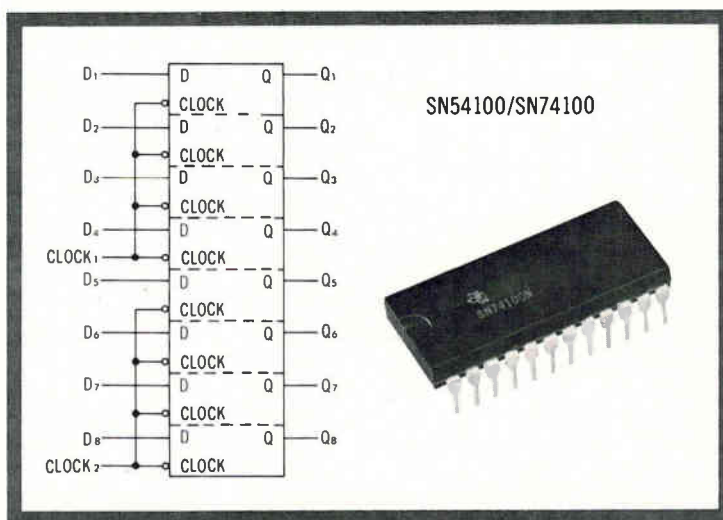

\$7.42 from TI—your first source for TTL.

If the cost of temporarily storing 8 bits is more than you really like to pay, then TI's new MSI dual quad latches (SN54100/SN74100) will please you.

For example, the SN74100N, in 100-999 quantities, is a cost-conscious \$7.42.

These new MSI functions combine two independent quadruple latches in a single, 24-pin dual-in-line plastic package. Typical power dissipation is 40 mW per latch. And the SN54100/SN74100 are fully compatible with TI's other TTL

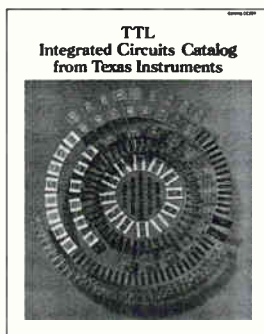

and DTL integrated circuits.

As attractive as the price is, you'll want more details before you buy. Our new 424-page TTL catalog contains a data sheet on these dual quad latches as well as sheets on all TI Series 54/74 circuits. Circle 255 on the Reader Service Card, or write Texas Instruments Incorporated, P. O. Box 5012, M.S. 308, Dallas, Texas 75222. Or call your authorized TI Distributor.



TEXAS INSTRUMENTS
INCORPORATED

TRW Polycarbonates

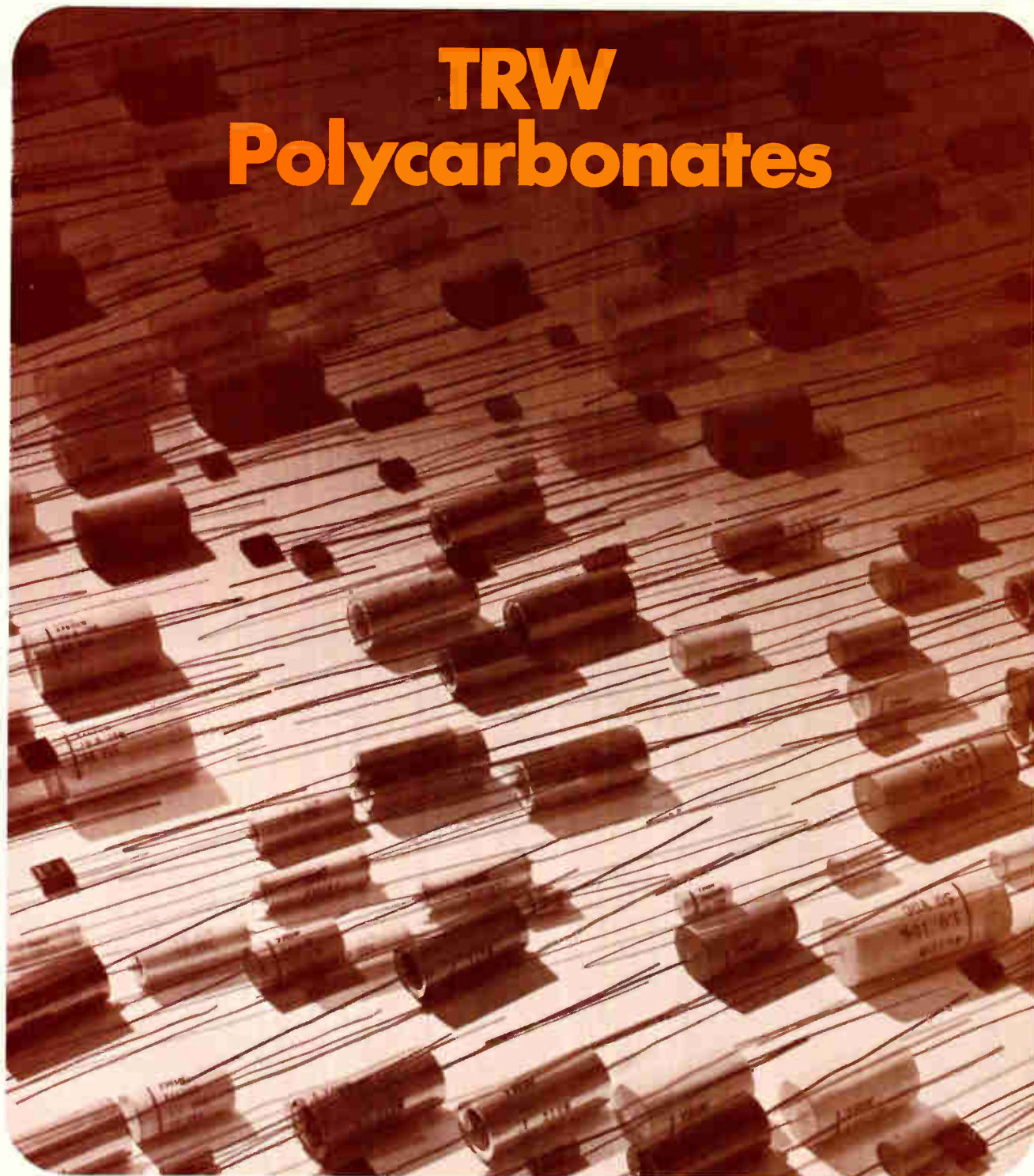

...small answers to big problems

Need capacitors with premium electrical and TC properties...and in the smallest possible package? Polycarbonate capacitors are your answer. And no one knows more about polycarbonates than TRW.

As the pioneer in polycarbonate capacitor development, TRW has the know-how to get that "extra

ounce of performance" out of this remarkable material. We can meet your design requirements with either metallized or foil wound polycarbonates in a wide range of capacitances, voltage ratings, shapes, and sizes. Standard types will solve most design problems...if not, let's talk about your special requirements.

For full information, contact TRW Capacitor Division, Box 1000, Ogallala, Nebraska. Phone: (308) 284-3611. TWX: 910-620-0321.

TRW®

$\pm 50 \text{ ppm}/^{\circ}\text{C}$ in all Helipot Cermet Trimmers

This significant advance in Helipot's cermet technology is now available at only a dime/unit more . . . 100 ohms thru 2 megohms. In addition, you get essentially infinite resolution, environmental stability, reliability, no catastrophic failures — all superior to wirewound trimmers. We'll also deliver off-the-shelf, locally stocked trimmers with a standard tempco of $\pm 100 \text{ ppm}/^{\circ}\text{C}$ in the 100 ohm thru 2 megohm range.

Beckman

INSTRUMENTS, INC.

HELIPOT DIVISION

FULLERTON, CALIFORNIA • 92634

INTERNATIONAL SUBSIDIARIES: AMSTERDAM; CAPE TOWN; GENEVA; GLENROTHES, SCOTLAND; LONDON; MEXICO CITY; MUNICH; PARIS; STOCKHOLM; TOKYO; VIENNA

Technical Articles

**Boosting reliability
of disk memories**
page 88

Unless there is a good mechanical design, even the best of electronic designs can't guarantee a relatively high level of reliability. A good example of how much mechanical design counts is a new disk memory. Maximum reliability as well as maximum performance stems in large part from a rather unusual mechanical design. Air bearings are used instead of the usual ball bearings, fluidics control the mechanical motion, and a sealed enclosure stores the disks.

**Multiplexers double
as logic circuits**
page 100

It's now possible to perform any kind of combinational logic function—including NAND, AND, NOR, exclusive OR, and compare—with a single universal logic circuit, a digital multiplexer that's fabricated on a single chip. The designer thus reaps the benefits of medium-scale integrated circuitry—small size, high speed, easier layout design, and better reliability. And he avoids the expense of custom design every time he wants circuits to perform different combinational logic functions. All that's required is the application of standard logic design principles involving truth tables and Karnaugh maps.

**Active filters: part 13
Narrowing the choice**
page 106

Because several circuits, such as gyrators and negative-impedance convertors, are available for active filter design, it's difficult to judge at first glance which is best for a particular application. Five circuit techniques are examined—a single operational amplifier, negative-impedance converter, integrator and lag, triple op amp, and the gyrator.

**Air traffic control:
Girding for the 1980's**
page 127



Technological evolution, rather than revolution, is the recommendation for development of a national air traffic control system for the 1980's and early 1990's. The Department of Transportation's Air Traffic Control Advisory Committee urges upgrading the National Airspace System with increased computer capacity; scanning beam microwave instrument landing systems for landing and terminal navigation; the use of dual-lane runways and intermittent positive control; a ground-based collision-avoidance system, and with both improved accuracy vhf omnirange and higher-capacity distance-measuring equipment. A post-1995 system would employ communications and navigation satellites in a highly automated network.

Coming

**Microsound: Tomorrow's
signal processing**

An emerging technology that uses surface acoustic waves has the potential of replacing practically all the signal-processing circuits found in today's radar, navigation, and communications systems. An article by J. H. Collins and P. J. Hagon of Autonetics will point out the techniques that are involved and the devices that are emerging.

Boosting reliability of disk memories

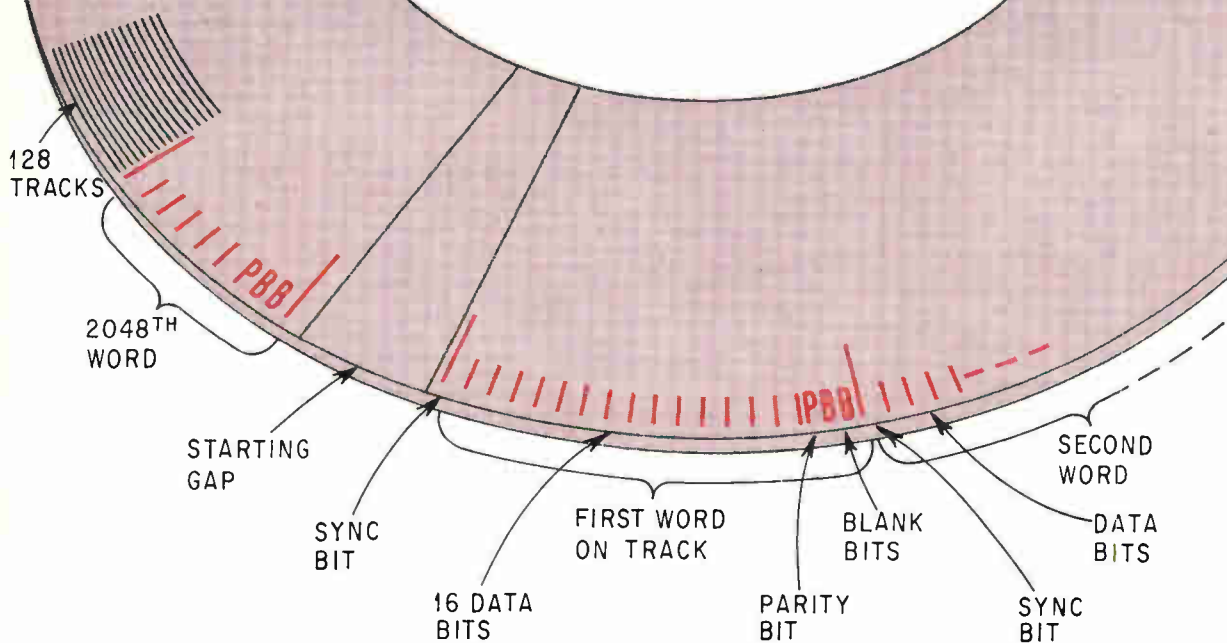

One in twenty. A synchronizing bit signals the beginning of every 16-bit word, of which 2,048 are recorded in each track; a parity bit and two blank bits follow the data. A gap 1/60th of a revolution in length separates the last word in a track from the first; but the 128 gaps don't actually line up in a pie-shaped sector as depicted in this diagram. Rather, because each track has its own read-write head, and because the heads are arranged in eight groups of 16 around the supporting casting, the gaps are also distributed around the disk.

Sound electronic design isn't enough by itself; good mechanical design can make the big difference, according to *Roland Boisvert* and *S. A. Lambert* of Digital Information Storage Corp.

● Mechanical design often has been ignored in electronic design, only to turn out to be the keystone without which otherwise technically sound and reliable equipment collapses. But if mechanical considerations in an electronic product are given very high priority, and are considered along with the design of the electronics, as in a new digital disk recorder with removable disks, the goal of high total reliability can be achieved:

▶ Timing reliability is high because read-write timing is controlled by synchronization bits interspersed among the data bits—and with only one sync bit in every 20 bit positions on the disk, against one in four or even one in two in some systems.

▶ Mechanical reliability is high because all major bearing surfaces run on air bearings rather than ball bearings, while the drive's mechanisms are controlled by fluidic logic instead of relays and solenoid valves.

▶ Data reliability is high because the disks are stored in sealed cartridges. From these they are loaded into the drive without being exposed to the dirt in room air.

Significantly, a major byproduct of the quest for mechanical reliability in the new recorder—Digital Information Storage Corp.'s DDR-1—is the first combination of effectively infinite storage capacity with fast access time. Removable disks provide the capacity, limited only by shelf space available for disk storage. Fast access results from having a read-write head for every track. These two

features, a giant bonus when combined in one machine, are made possible by the air bearing's intrinsic self-centering property, which permits the disk to be accurately positioned relative to the heads, even as it spins at up to 3,600 revolutions per minute.

To permit a large quantity of data to be stored on each disk, some single-disk systems are arranged with storage surfaces on both sides of the disk. If the unit is removable, the two-sided arrangement requires read-write heads to be retracted during loading and unloading. But a head-retracting mechanism with one head per track would be so cumbersome as to be uneconomic, so these systems also require the heads to move from track to track preceding most reading and writing operations.

On the other hand, recording data on only one surface of the disk requires very small spacing between tracks. This can be close enough to cause crosstalk between tracks, and other problems, on disks using iron oxide coating; but when the magnetic recording medium is the nickel-chromium material that has become increasingly popular, these problems aren't serious. Nickel-chromium also permits tight packing of bits within a track. But close track-spacing means that the heads must be very accurately positioned over the tracks.

Accurate positioning, up to now, has precluded a removable disk. Enter the head-per-track approach—which has the added advantage of sharply reducing access

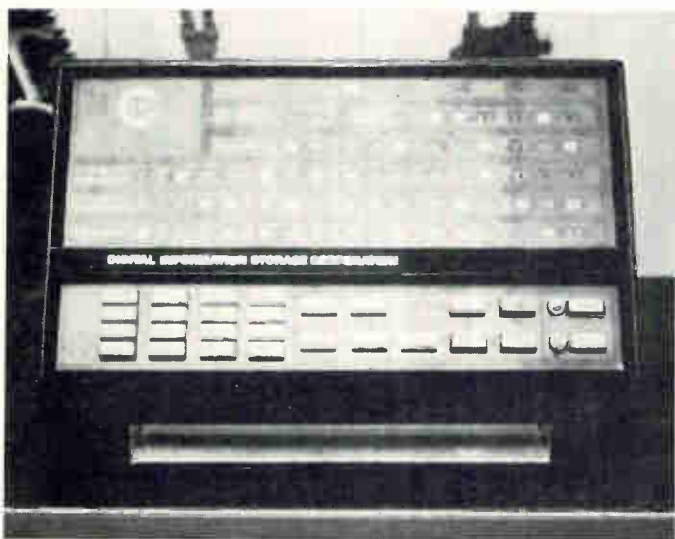

Simple. This view of the DDR-1's front panel also shows the slot through which disks are loaded into the machine from their storage cartridge, which is called a DISClosure. Here the machine appears on a table top, requiring the air compressors to be placed under the table or nearby. A stand is available that conceals the compressors in its base.

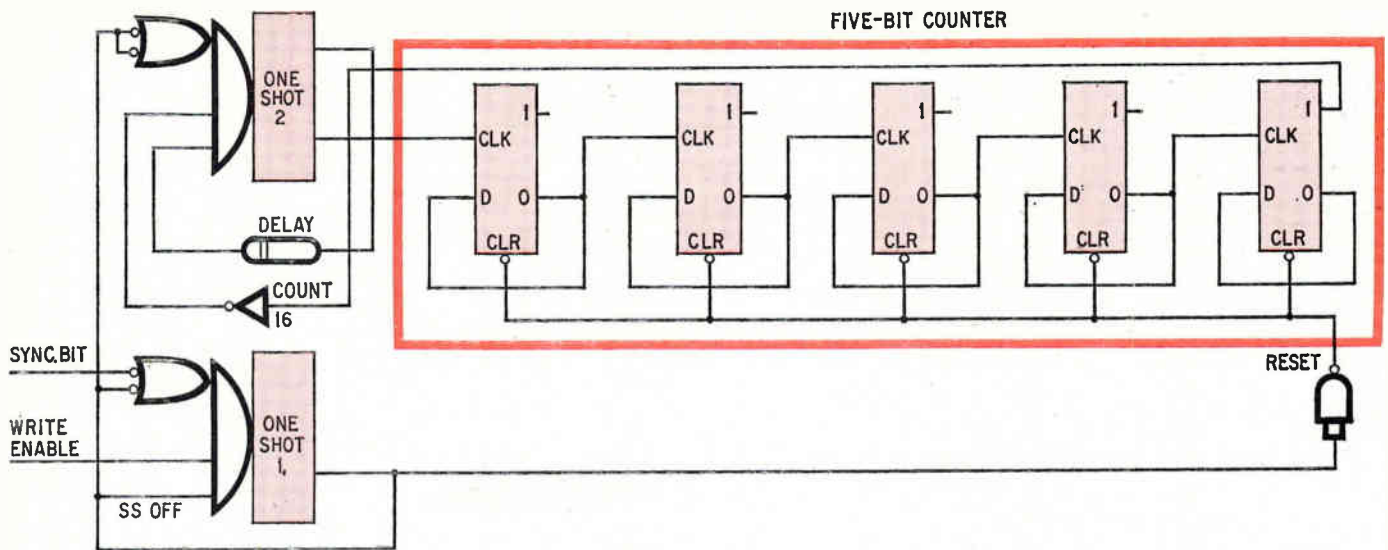

time. Thus a command from the computer to read or write data in a particular location on a particular track is delayed only by the time required for the location to come around under the head—at most one revolution of the disk—avoiding the additional delay for the track-seeking motion, which can be up to 10 times the rotational lag.

On many older fixed-disk storage units, synchronizing pulses are obtained from one of several timing tracks when writing or reading data in other tracks. But at high recording densities, the tolerances in these timing tracks become very critical. For example, the disk shows gyroscopic behavior under even slight external shock, causing a slight precession of the disk; or, under certain circumstances, it can set up a standing wave in the disk. Both the data and timing heads are mounted on flexible supports to ride out such disturbances, but they may ride in opposite directions and upset the phase relationship between the timing and data pulses.

These considerations—and a great many more—have forced designers of removable-disk systems to incorporate timing into the data tracks. These sync pulses necessarily somewhat dilute the density of the recorded data—sometimes to a very great extent, as when every other pulse is a sync pulse. But since in the DDR-1 only every 20th pulse is a sync pulse, dilution of the data density is almost negligible. It works because of a highly reliable method of clocking the data following every sync pulse,

and because of the machine's mechanical design details.

The reliability factor in the air bearing enters the picture here. For one thing, it tends to cushion external shocks, so that they are reduced in severity, if indeed they reach the disk at all. For another, because the air bearing is self-centering, it automatically compensates for any changes in the rotating mass comprising the disk, the supporting hub, the shaft, and the motor rotor as a result of external shocks or just ordinary wear and tear. Electronic engineers may not always realize the complexities involved when something spins in the presence of external forces. For example, the axis of rotation presumably passes through the center of mass—but not when the mass is unbalanced or when it is precessing gyroscopically.

Another detail is mounting of the read-write heads. In some systems, for example, they ride out transient disturbances in the disk because they sit on short horizontal arms that rotate a few degrees in a vertical plane around a support. The sideways component introduced by this rotation is only a tiny fraction of the vertical motion. But at high densities even that tiny fraction may be all or a large part of the distance between two bits, disrupting the timing of both read and write operations.

The DDR-1's heads are mounted on spring brackets secured against lateral motion at each end; the heads are free to move up and down as necessary, but can't move

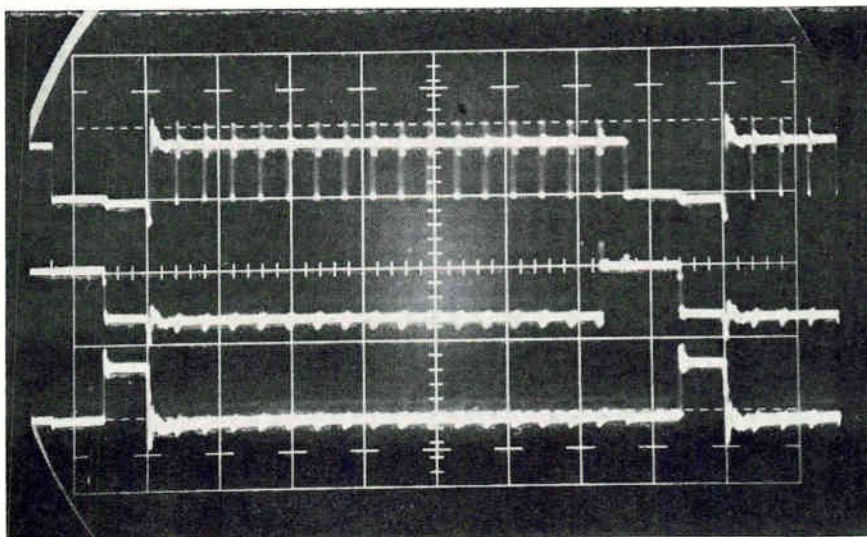

Word timing. These three signals generate all internal timing in the DDR-1. The top trace goes positive when the sync bit is read, and goes negative 17 times at 800-nsec intervals while reading or writing one word. The middle trace, rising 100 nsec after the 16th negative pulse, signals parity time; the bottom trace is the start signal for the next word.

Timing generator. Two single-shots and a five-stage counter control the DDR-1's timing. The circuits, made to military specifications, are affected only negligibly by long-term drift.

Bits, words, tracks

Bits per word	16 plus parity and sync
Words per track	2,048
Data tracks	128
Words per disk	262,144 Expandable to 1,048,576 via three slave units
Average access time	16.67 msec (8.33 msec available)
Bit frequency	1.25 Mhz (2.5 Mhz available)

at all in a lateral direction.

When the DDR-1 receives a read or write command from the computer, it first selects the proper head for the desired track. Then it waits for the desired word to arrive under the head. A continuously running counter keeps track of the word that is coming up next, and when the counter matches the requested address, data transfer begins to or from the computer.

At this point, the DDR-1 sends an interrupt signal to the computer to request data for writing, or to indicate that the data is forthcoming on a read command. All disk storage units do this. But the DDR-1 also sends an early warning signal $16N + 5$ microseconds before the desired word is located; N is the number of words between the two interrupts. This number is wired into the machine; usually it's 4, but it depends on the user's requirements.

This early warning permits the computer program to finish an operation before attending to the disk; to start a routine to hold the computer's status while the disk operation is in progress; or perhaps to avoid starting a new task that it will have to discontinue shortly.

Each word stored on a DDR-1 disk begins with a sync bit, as shown on page 88, followed by 16 data bits, one parity bit, and two binary 0's that serve as a marker between words, for a total word length of 20 bits. There are 2,048 of these words in a single track, plus a gap of about 550 microseconds to indicate the starting point.

At the start of a read or write operation with an address less than the wired-in value of N , the early warning signal occurs at the beginning of this gap.

Coding is NRZI, a non-return-to-zero function, with change on ones; this is a common technique in which the disk coating always is magnetically saturated, and in which a 1 is represented on the disk by a flux reversal from saturation in one direction to saturation in the other. Successive 1's are thus depicted by flux reversals in opposite directions, whereas a 0 is represented by the absence of a reversal. As seen by the sense amplifier, therefore, the absence of a pulse shows a 0, and successive 1's, whether separated by 0's or not, are represented by pulses of opposite polarity generated by the alternating flux reversals. Parity is even—the parity bit insures that the number of bits in each word, including the sync bit, is even.

Timing depends on two single-shots and a five-stage binary counter, as shown at the top of page 90. One of the single-shots, when off, holds the counter in its reset state. At the end of the 550- μ sec gap, the Enable line turns on, and the following sync pulse turns on the first single-shot, releasing the reset. It stays on for about 15 microseconds, long enough for the entire word to be written, then shuts off. But while on, it opens a gate to the second single-shot, which drives itself through a delay line and the same gate, and therefore oscillates at

Spaced out. The read-write heads are assembled into a single head pad; 16 pads are mounted as eight pairs spaced around a supporting casting. This arrangement minimizes the lead length from the heads to the sense amplifiers, which are on the nearest circuit board eight inches away.

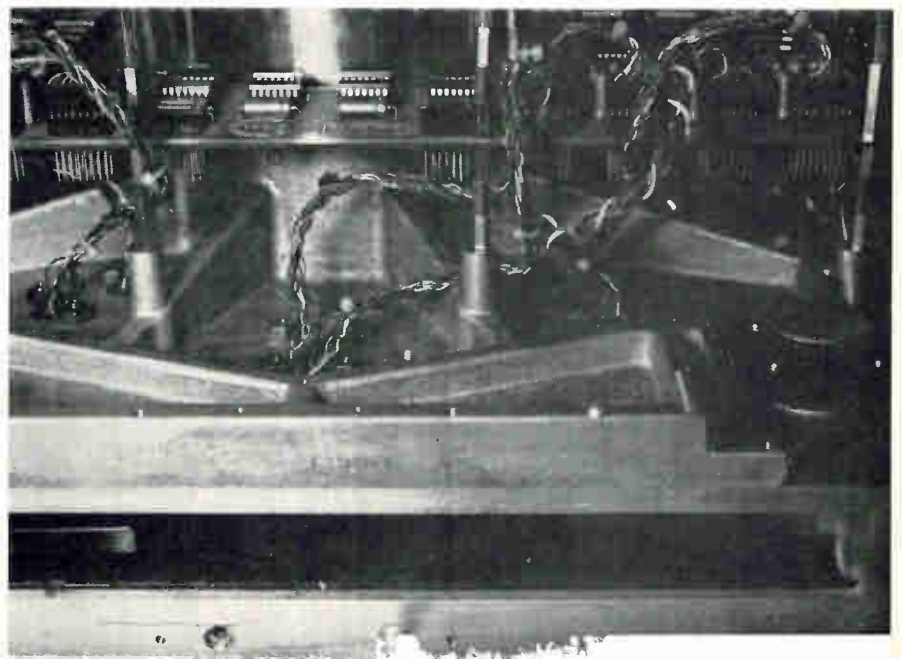

... the whole disk-loading procedure is carried out by pneumatic and fluidic equipment; there isn't a single ball bearing anywhere in the business end of the machine.

Diode decoupling

A reasonably straightforward circuit, but one believed to be unique, shown below, decouples the sense amplifier from the write circuits. It begins with a write trigger (not shown in the diagram) which changes state whenever a 1 is to be written; the trigger's change turns on one of the two write transistors Q_1 and Q_2 and turns off the other, reversing the current through the winding in the head. This current originates at the +30-volt supply, and passes through switches in the selection matrix; it divides into two nearly equal parts to pass through matched resistors connected to the two ends of the head winding, whose resistance is much lower than that of the resistors. One of the currents passes through the head winding; they recombine and go to whichever of the two write transistors is conducting. When these transistors change state and reverse the current through the winding, the matched resistors damp the inevitable inductive kick, an improvement over a common design that has a center-tapped winding and no return path for inductive currents. Revers-

ing the current in the winding reverses the saturation in the disk's surface according to the NRZI encoding.

Because the write transistors are connected to +15 volts, the diodes between their collectors and the sense amplifier are reverse-biased, so that the amplifier is decoupled from the write circuits.

When reading, both write transistors are turned off because the Write Enable line is off; the +30 volts in the matrix selection thus forward-biases the diodes and admits read signals in the millivolt range, riding on the large d-c bias, directly to the sense amplifier, which is floating at +25 volts. A capacitor at the amplifier's output blocks direct current, but passes data to the logic circuits.

This read-write circuit design carries with it a bonus: it can switch from write to read, or vice versa, in 350 nanoseconds. This permits the DDR-1 to read a word immediately before or after writing in the adjacent location on the same track. There is no waiting for a full disk revolution, as in most disk storage units.

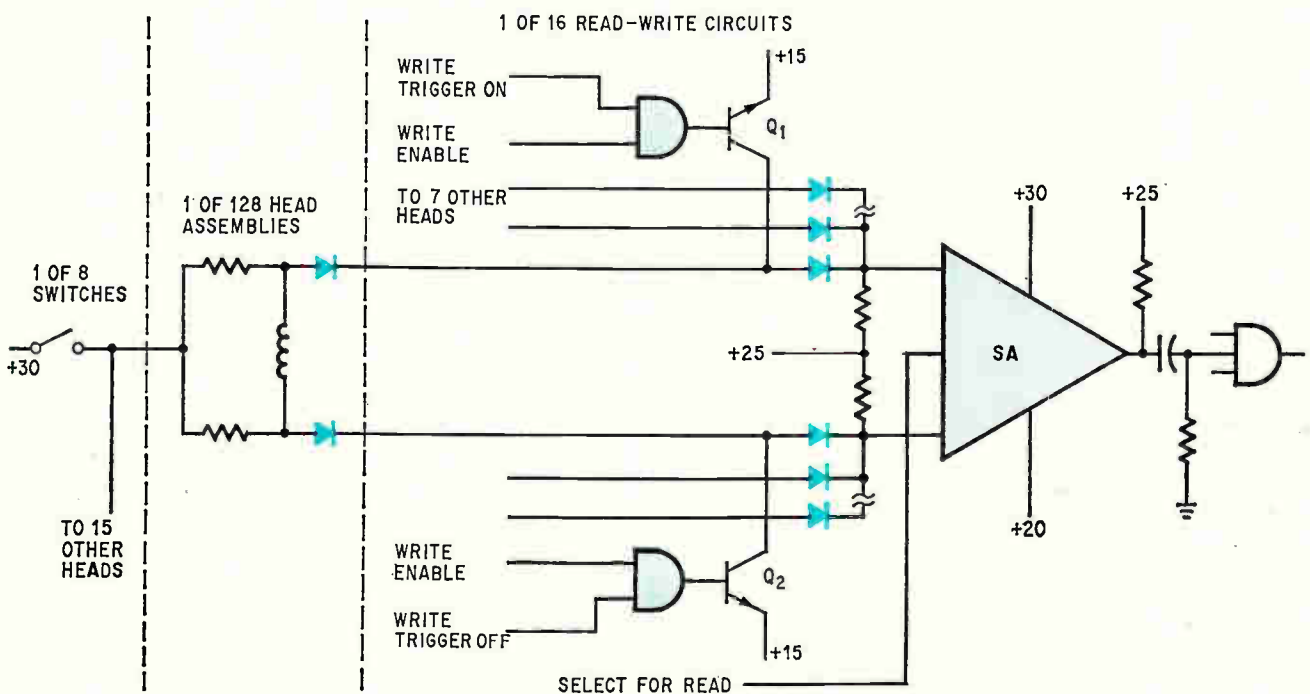

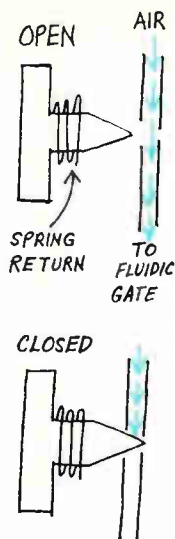

Gadgets. Fluidic manual switches (left) are made from standard electric pushbuttons with electrical parts removed and tubing connections added. Fluidic proximity detectors (right) control the logic as mechanical motions are initiated or completed.

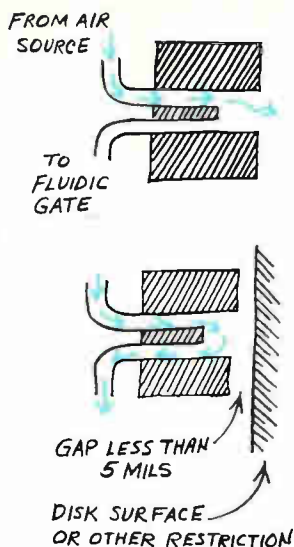

1.25 megahertz. Its oscillations drive the binary counter, an array of five flip-flops—each a standard off-the-shelf product. The flip-flops actually are six three-input NAND gates on a chip, interconnected to act like a flip-flop; when the 0 output is connected to the data input, the circuit acts like a binary flip-flop, changing state with every positive shift of the clock input. This same 0 output is connected to the clock input of the following stage to produce the binary counting action.

The binary unit counts up to 16, then shuts off the oscillator. At that moment the second single-shot is on; when it turns off, it steps the counter again. The 17 pulses from the single-shot synchronize the writing of the 16 data pulses and the parity bit. Immediately after the 17th pulse, the first single-shot turns off, signaling the end of the word. The next sync pulse starts the process again, whether data is being transferred or not.

To interchange disks, the DDR-1 takes advantage of mechanical design ideas unique to disk storage units. First, disks not in use are kept in sealed cartridges. When a disk is to be loaded, the operator places one edge of the cartridge in a slot at the front of the machine. The mechanism opens the cartridge seal and a similar one on the machine, reaches into the cartridge, hooks onto the hole in the center of the disk, and pulls it into position underneath the motor shaft. At this point the operator must remove the cartridge, which recloses both

seals; then the motor shaft picks up the disk, accelerates it to the proper speed, and brings it up under the read-write heads. When the disk is unloaded, the sequence is reversed: the mechanism pushes the edge of the disk to get it into the cartridge, and reseals both the cartridge and the machine before the operator can remove the cartridge.

What's extraordinary is that the whole procedure is carried out by pneumatic and fluidic equipment; there isn't a single ball bearing anywhere in the business end of the machine.

Ball bearings have serious drawbacks in a disk storage unit. The disk must be capable of axial and rotational motion; ordinary ball bearings support only rotation, while specialized adaptations would require multiple bearings. Also, ball bearing wear subjects a rotating disk to undesirable motions, or even to development of a harmonically curved surface resulting from vibrations that are even multiples of its angular frequency of rotation as at left below. Lubrication doesn't always avert the problems, and the lubricant could pollute the magnetic recording surface.

These difficulties were averted with air bearings. Because air's fluid nature tends to equalize the pressure in any given mass of air, and because any off-center motion of the shaft tends to vary this pressure, the air bearing is intrinsically self-centering. And it's so friction-free that

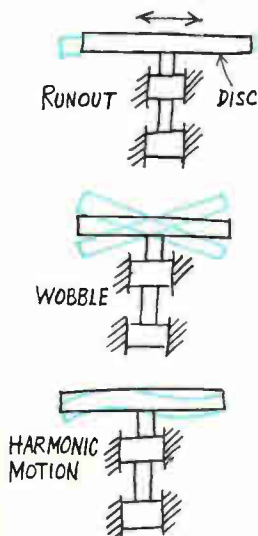

Anti-wobble. The undesirable motions that can occur with ball bearings (left) are avoided in the DDR-1 with air bearings, shown at right. The shaft spins in a rotational bearing, and the hub and piston bear upward against thrust bearings, all films of air under pressure.

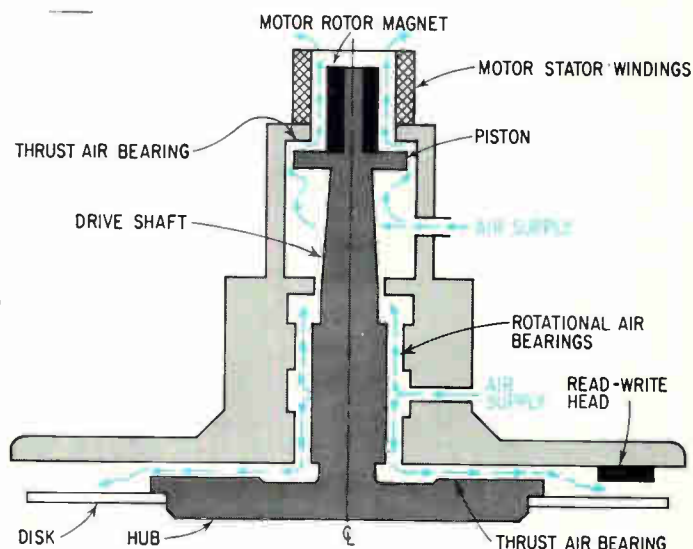

Fluidic logic

Air or any other compressible or incompressible fluid passing through pipes, jets and interaction chambers can be made to perform logic functions just as well as electronic circuits. In some way fluidic devices surpass their electronic counterparts—for example, in their resistance to nuclear radiation or their continued operation over wide temperature ranges. The principal limitation is speed; switching functions occur at speeds ordinarily measured in milliseconds, and at best in hundreds of microseconds. But in controlling relatively gross mechanical operations, as in the DDR-1, speed isn't critical and fluidics fill the bill.

Operation of fluidic logic devices is based on the tendency of a jet of fluid flowing parallel to the wall of a passage to adhere to that wall. A jet emerging from input duct A in the diagram, once it has attached itself to the wall of the left-hand outlet, as illustrated, stays there; nearly all the fluid volume exits through duct B. But a relatively small control jet at duct C can detach the main jet from its wall and force it against the opposite wall, where it remains after the control jet turns off. Now the major portion of the fluid exits through duct D. Another control jet appearing at E can switch the main jet back to its original position. This configuration behaves exactly the same as an electronic flip-flop; it has two stable states and remains in either state indefinitely unless it is switched to the other by a relatively small control signal.

A somewhat similar configuration implements the familiar NOR function in fluidics. Here the basic element, instead of being Y-shaped like the flip-flop, has one output leg in a straight line with the input and the other at a somewhat sharper angle than the flip-flop outputs. A laminar stream of fluid, flowing into the interaction chamber, continues straight through and attaches itself to the wall of the output leg in the absence of any control inputs at the side of the interaction chamber. Fluid emerging from this output represents the 1 state of the circuit. But a small control signal entering the interaction chamber through any one or more of the control input ducts can break this wall attachment and divert the jet to the other leg. Because of the relatively sharp turn from the input to the new output, the flow becomes turbulent and the jet doesn't attach to the wall—when the control signal turns off, the jet returns to the straight-through path. Thus the circuit is an implementation of the NOR logic function. Its operation as part of a larger logic array assumes that the 0 output, in which the flow is initially turbulent,

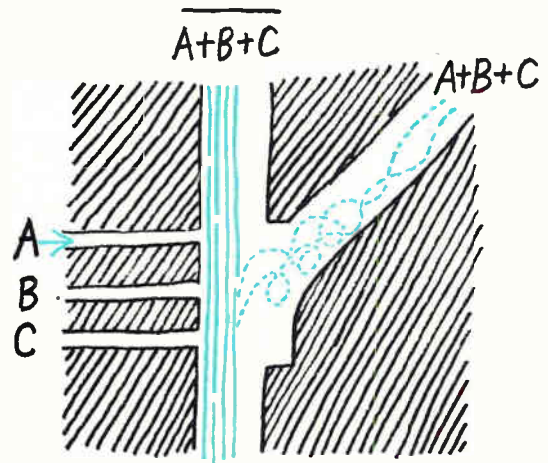
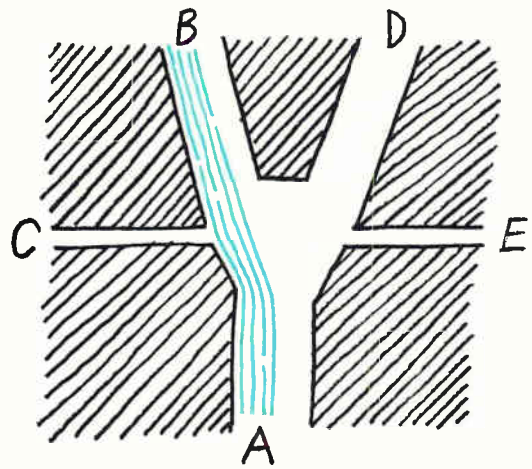

long and straight before feeding any other logic block, so that the flow again becomes laminar.

One of the benefits of fluidics is the ease with which fluidic large-scale integrated circuits can be put together. Almost all of the fluidic controls in the DDR-1 are built on a single lump of plastic about the size of an ordinary brick; "worm holes" in the brick are the passageways and chambers in which the fluidic logic functions are implemented. The fluidic brick isn't really as solid as it looks—it's made up of several layers of plastic, some with convoluted grooves and some with holes for connecting grooves in different layers.

Brick. In this assembly the two white layers contain arrays of fluidic NOR blocks; the other layers contain holes and channels that interconnect the blocks, when the "fan" shown here is closed and riveted together. This photo is of a dummy block; the assembly made for the DDR-1, by Pitney-Bowes Corp., contains four white layers.

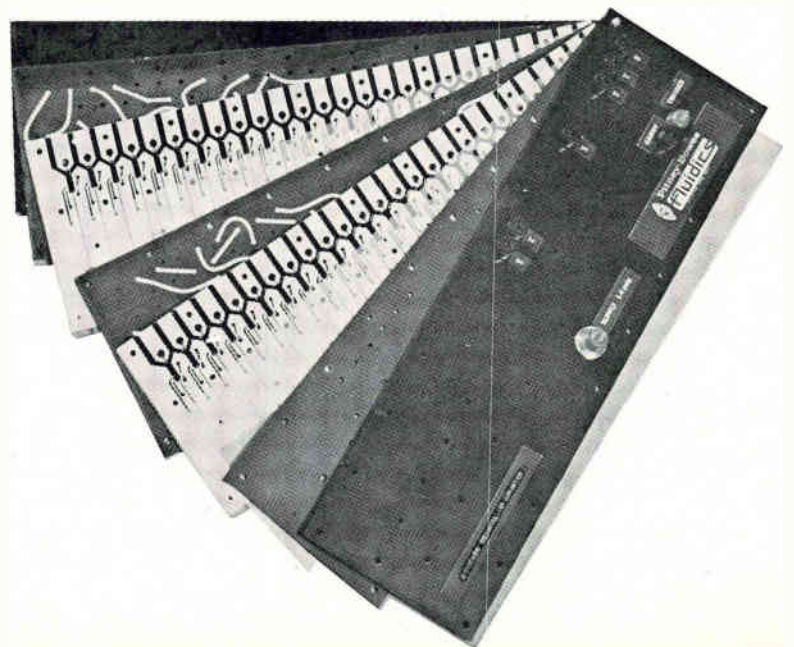

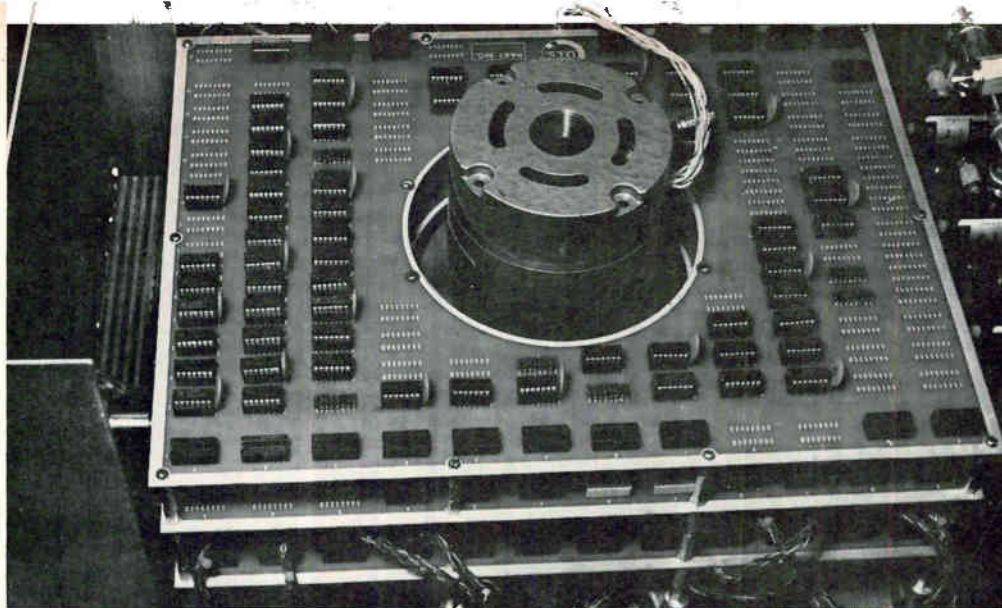

Three layers. All electronic components are mounted on three 12-by-16-inch printed-circuit boards. Two boards carry the electronics common to all machines; the top board is tailor-made for a particular computer. Large center holes permit all three boards to fit over the housing for the floating piston and shaft.

it requires only a fraction of the torque a conventional bearing demands from the hysteresis-synchronous motor. And the air bearing, unlike the ball bearing, inherently permits axial motion.

Three air bearings are used: a rotational bearing surrounding the shaft that connects the drive motor to the hub supporting the disk; a thrust bearing above a floating piston that raises the shaft, hub, and disk into position for reading and writing, and another thrust bearing above the hub itself.

The floating piston, shaft, and hub [see p. 93] are cast as a unit; the motor rotor, which is a permanent magnet, is press-fitted onto the top of the shaft and becomes permanently a rigid part of the casting. After the disk has been mechanically latched onto the hub, air pressure on the piston raises it, together with the disk and the rotor. When the rotor enters the rotating magnetic field of the motor stator, the shaft begins to turn; by the time the shaft has reached its uppermost position, it is almost at its maximum speed.

At this point the piston is almost in contact with the bottom of the motor shell and the hub carrying the disk is almost in contact with the bottom of the shaft housing. In both places, a thrust air bearing is established—at the top by the air that pushes the piston up, at the bottom by air escaping from the shaft's air bearing. The differential pressure between each of these two thrust sur-

faces and the supply pressure controls the disk position with respect to the read-write heads with an accuracy of a few parts in 100 million, or a few hundredths of 1% of the nominal spacing between the disk surface and the read-write heads.

Since air already was available for the DDR-1's bearings, it was logical to use air in fluidic devices for controlling the recorder's mechanical motions.

In fluidics, as in electronics, a NOR gate is one of the simplest logic elements; from an array of NOR gates, logic functions of any desired complexity can be constructed [see "Fluidic logic," p. 94]. These NOR gates, combined with a very simple proximity detector control, for example, removal of a disk from its cartridge provided the cartridge is in place and another disk isn't already in the machine.

Most of the air flows from the fluidic logic vents into the space around the electronic circuitry in the recorder, keeping the components cool. Then it recycles through a duct at the back of the cabinet to the blower at the bottom. A small part of the fluidic logic air, and all of the air from the bearings, pressurizes the interior of the compartment containing the disk loading mechanism and the read-write heads. As a result, when the seals on the compartment and on the disk cartridge open for loading or unloading, air flows out, keeping the interior of the compartment free of contamination. ●

Designer's casebook

Designer's casebook is a regular feature in Electronics. Readers are invited to submit novel circuit ideas and unusual solutions to design problems. Descriptions should be short. We'll pay \$50 for each item published.

Sighting irregularities in small shafts

By George S. Lehsten

Col-Nic Industries, Naperville, Ill.

A wobbling high-speed shaft may need new bearings, but it's not easy to measure the wobbles if they're only fractions of an inch off center. Now, a simple setup consisting of a neon lamp excited by an audio oscillator, a sighting tube, and a photocell can display shaft irregularities on an oscilloscope. It's then easy to determine where undesirable movements occur along the shaft.

The sighting tube, which is slightly larger than the shaft's diameter, is directly aligned with the neon lamp's electrodes so that light from the lamp just passes over the shaft's surface through the tube. If the shaft is smaller than the spacing be-

tween the lamp's electrodes, the neon lamp can be rotated to compensate. For larger shafts two neon bulbs can be combined using one electrode from each bulb and inserting a diode in each line so the photocell only sees one electrode at a time.

An audio oscillator's frequency is synchronized with the speed of the shaft and excites the neon lamp's electrodes. The resultant light pulses travel down the sighting tube to a photocell. The photocell converts the light energy to electrical pulses which are displayed on the oscilloscope.

If the shaft's rotation is uneven, less light reaches the photocell and the pulses on the scope are alternately shorter than they would be had the shaft been perfect.

The amount of shaft movement is measured by comparing the variation of the shorter pulses with a reference full scale pulse measured without any shaft. Also, the position of the irregular shaft areas can be determined by adding paint to the area and observing the effect in the pulse heights on the scope.

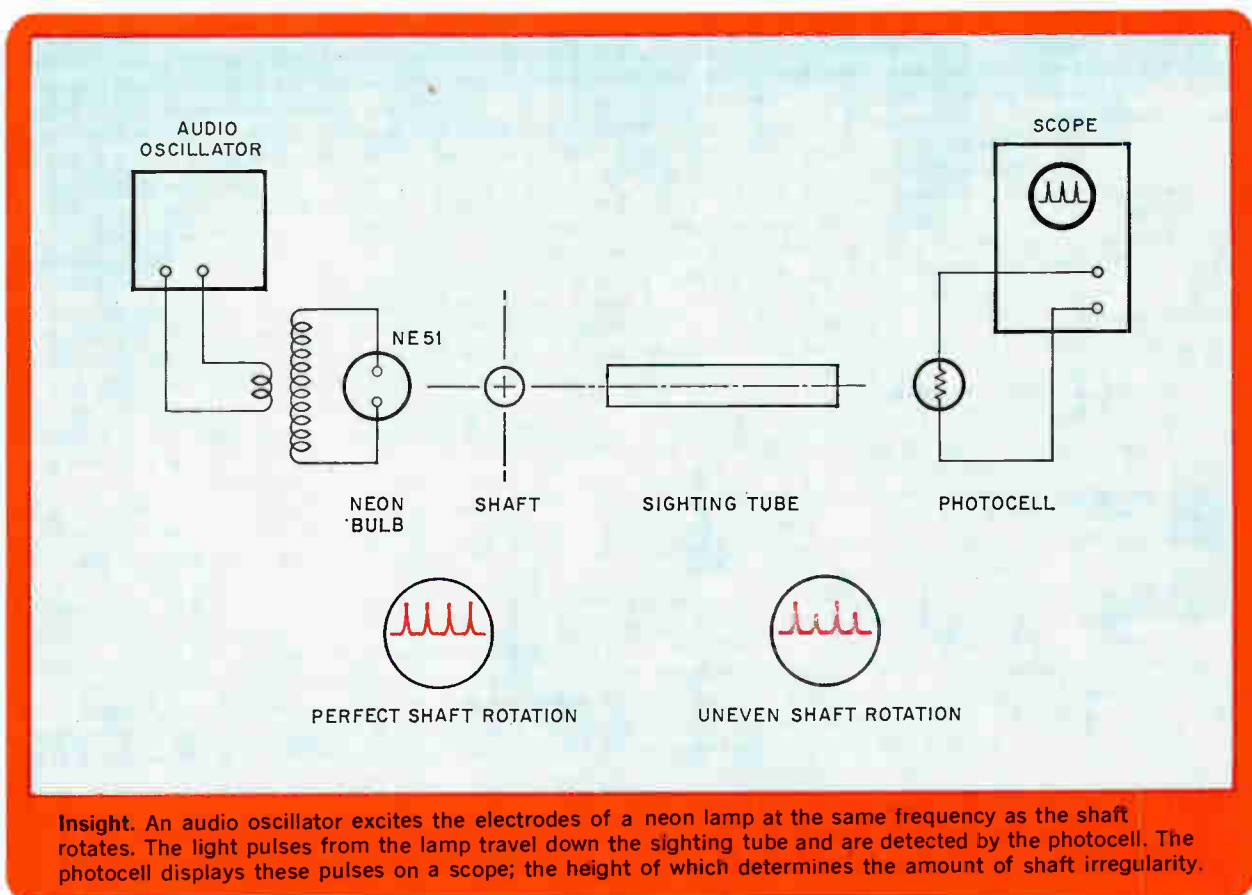

Insight. An audio oscillator excites the electrodes of a neon lamp at the same frequency as the shaft rotates. The light pulses from the lamp travel down the sighting tube and are detected by the photocell. The photocell displays these pulses on a scope; the height of which determines the amount of shaft irregularity.

Monitor guards three ways against power failures

By Darold K. Smith

General Dynamics Corp., San Diego, Calif.

Equipment operating from three-phase power sources can be damaged if there is a loss of one phase, or if the line voltage rises above or falls below safe operating levels. Protection against these power failures can be insured by a circuit that monitors and compares the sum of the three-phase line voltages with a regulated supply voltage and removes power from the equipment in the event of a power loss or an overvoltage.

The regulated supply shown above consists of three rectifier diodes, a two-section RC filter and a zener diode. The unregulated supply below, in addition to the diodes and filter, contains a 1.2-kilohm load resistor and a four-layer diode.

At normal line voltages the unregulated supply's

output voltage is slightly larger than the regulated output which applies a negative voltage to the transistor's base. The transistor conducts and operates the relay which in this application closes the main three-phase power supply contactor.

Now suppose that the input line voltage increases above a certain desired maximum voltage. The four-layer diode at the output of the unregulated supply breaks down when a voltage greater than its breakover voltage is applied across it; this breakdown effectively clamps the transistor's base to ground turning it off. The control relay opens which in turn opens the main power supply contactor. To reactivate the relay, the power at the input must first be removed.

If the line voltage falls below normal, a net positive voltage is applied to the transistor's base because the 1.2-kilohm resistor at the unregulated supply's output lowers its voltage more than the positive supply's output. The transistor, therefore, cuts off and opens the relay. Also, if one of the three phases is lost, the effect is similar to the case for the low line voltage.

The over and undervoltage trip points can be adjusted by potentiometers R_1 and R_2 . Increasing

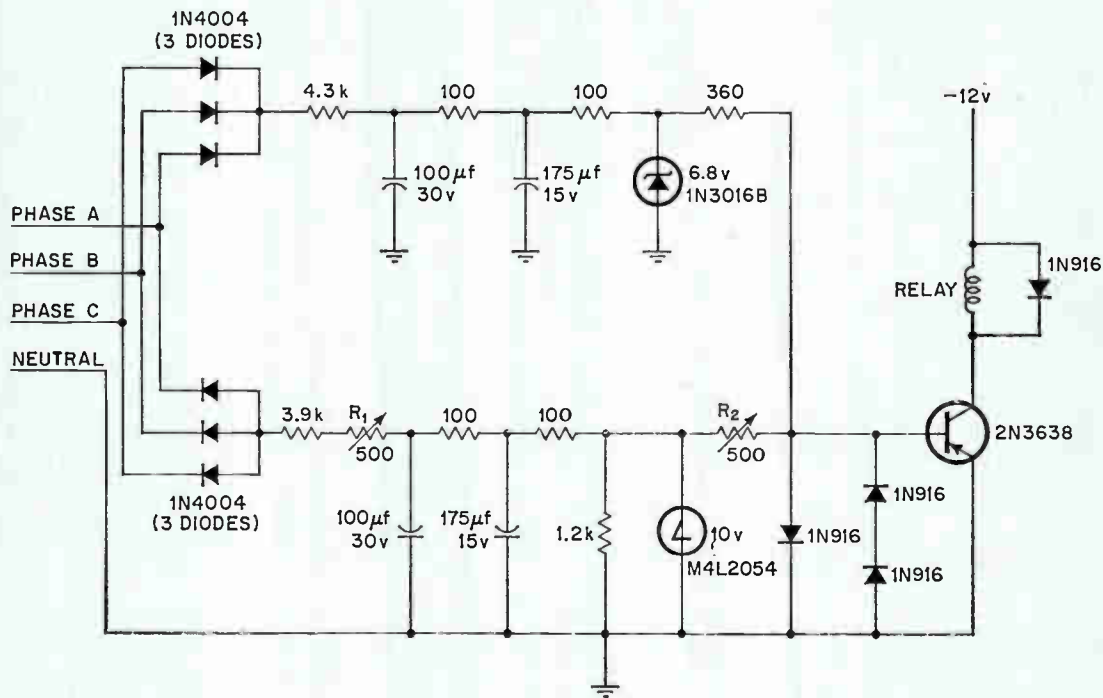

Protection. The positive output of the regulated supply (above) is summed with the negative voltage from the unregulated supply (below) at the transistor's base junction. Overvoltages or phase loss apply a net positive voltage to the transistor's base to open the control relay.

R_1 's resistance, raises both the over and undervoltage trip points while decreasing R_1 lowers both trip points. Increasing R_2 lowers the overvoltage trip point, but increases the undervoltage trip point and vice versa.

To allow for momentary voltage drops in the power lines without activating the contactor control

circuitry, the capacitor values shown in this circuit add a 0.2-second delay to the input signal.

The circuit can be used for single phase operation by removing two of the diodes at each input. The 3.9- and 4.3-kilohm input resistors, however, should be replaced with 1.5- and 2-kilohm resistors, respectively.

Zener in preregulator limits series transistor dissipation

By Peter Pohl

Institute of Nuclear Sciences, New Zealand

The series pass transistors in regulated power supplies are the source of much unwanted heat. The silicon-controlled rectifier preregulator when added to the power supply decreases the heat dissipation

of the pass transistor and thus a large heat sink isn't necessary for the transistor. In addition, the preregulator is easy to hook up since it doesn't need the external triggering or added voltage lines other circuits have.

As long as the voltage across the pass transistor is less than the zener breakdown voltage, the silicon-controlled rectifier conducts and the capacitor charges. If the power supply voltage exceeds the zener breakdown voltage, the SCR cuts off. The average power dissipation of the pass transistor is thus the product of the current drawn and the zener voltage.

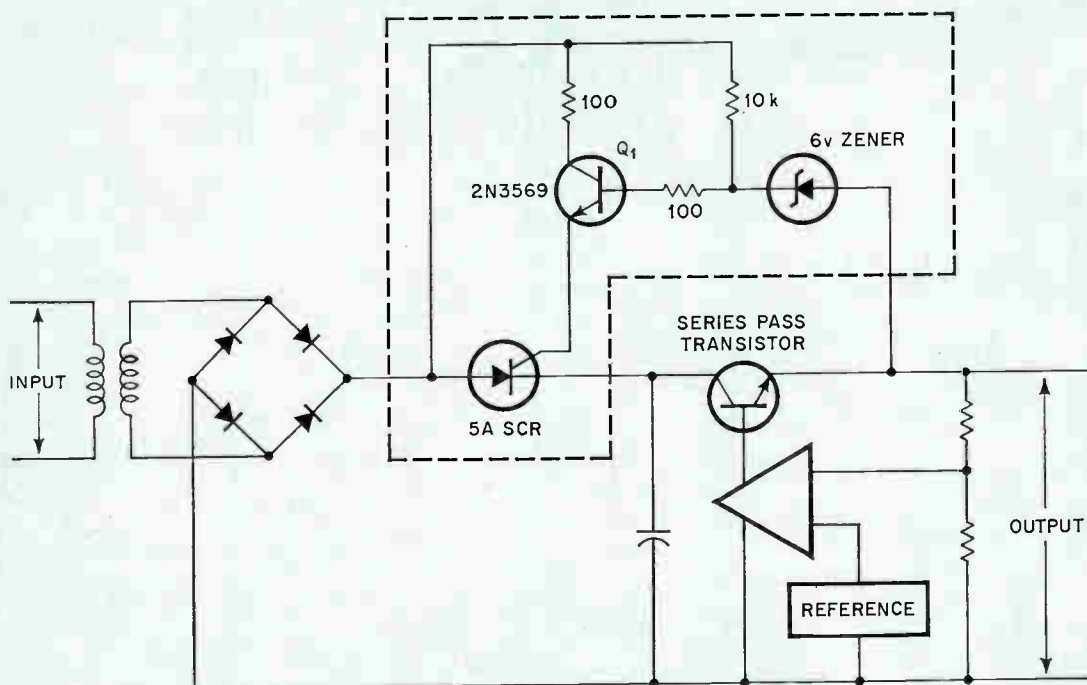

Easy hookup. The SCR preregulator shown boxed easily can be connected to conventional power supplies and reduces the heat dissipation in the series pass transistor. The average heat dissipation generated across the series transistor is the product of the current and the zener voltage.

Got masks, need parts?
Send masks. Get parts. Two weeks.

NORTEC 
ELECTRONICS CORPORATION

3697 TAHOE WAY, SANTA CLARA
CALIFORNIA 95051 (408) 732-2204

INSTANT
INSTANT

High or low V_{gst} same low price, same

Multiplexers double as logic circuits

Capable of performing combinational-logic functions for any number of variables, digital multiplexers can replace interconnected packages and thus lower costs

By James L. Anderson

Fairchild Semiconductor, Mountain View, Calif.

Combining many logic functions in a single package is always attractive to a designer of combinational logic. However, most of the time this means custom-design which leads to expense and difficulty in making design changes once the masks are made. But now, a digital multiplexer offers complexity—many gates on a single chip—along with the ability to perform just about all the logic functions of the single packages. Moreover, the unit is an off-the-shelf item.

Depending on how logic-level inputs are applied externally, the multiplexer can perform any kind of combinational logic function, including NAND, AND, NOR, exclusive OR, and compare. It is actually so versatile that it takes on the aspect of a universal logic circuit.¹

And, compared with the interconnected packages, the multiplexer, because it is contained on a single chip, offers higher speed, better reliability, easier design, and simplified printed-circuit board layout. These improvements are the reason why medium scale integration is used to place complete functional logic circuits such as shift registers, counters, and decoders on single chips. It is also easier to stock one type of multiplexer rather than several types of gates.

Combinational logic functions have been performed using two types of Fairchild Semiconductor multiplexers—the dual, four-input 9309 and the

eight-input 9312, as shown schematically below. While these units are fabricated with transistor-transistor micrologic, the principles for implementing the functions are the same for any type of device technology, whether diode transistor logic or whatever. These principles can be understood by first reviewing how multiplexers operate.

Essentially, they are electronic switches sequentially connecting input-data lines to a single output. In a standard multiplexing application, digital signals are fed to the multiplexer's input terminals (I_0, I_1, I_2, \dots), and binary control signals are fed to the select terminals (S_0, S_1, \dots). For example, to connect I_0 to the output on a dual, four-input unit, a 0 is applied to both select lines, and each combination of select-line signals corresponds to one of the four inputs.

On the dual, four-input unit, the two select lines are common to both halves of the multiplexer so that it behaves like a two-pole, four position switch. On the eight-input multiplexer, three select lines control the eight input lines, and the device resembles a single-pole, eight-position switch.

Applied as a universal logic circuit, the four-input multiplexer can handle as many as three variables—two are applied to the select terminals, and the fourth variable or its complement goes to each of the input lines.

Any of the possible functions of three variables

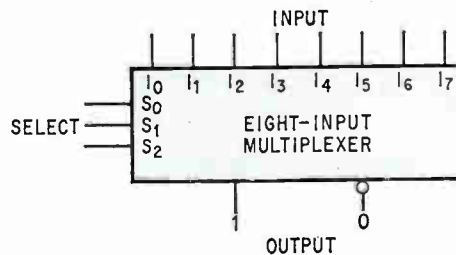
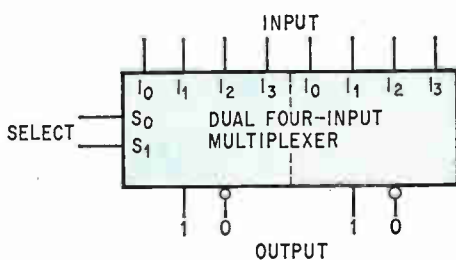

Anything goes. Dual, four-input multiplexer, left, and eight-input unit, right, are used as universal logic circuits. Binary signals on the select lines determine which input line is tied to the output.

FUNCTION

$$F = XY\bar{Z} + \bar{X}YZ + X\bar{Y}Z + \bar{X}\bar{Y}\bar{Z}$$

TRUTH TABLE

X	Y	Z	F
0	0	0	1
0	0	1	0
0	1	0	0
0	1	1	1
1	0	0	0
1	0	1	1
1	1	0	1
1	1	1	0

KARNAUGH MAPS

	X	\bar{X}	
Y	1	0	\bar{Z}
	0	1	Z
\bar{Y}	1	0	Z
	0	1	\bar{Z}

	X	\bar{X}	
Y	1	0	\bar{Z}
	0	1	Z
\bar{Y}	1	0	Z
	0	1	\bar{Z}

LOGIC CIRCUIT

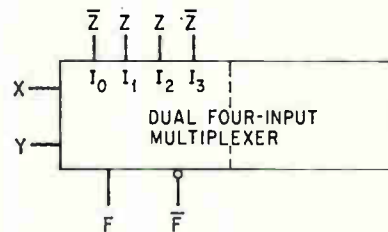

Try it with three. Even-parity function of three variables is implemented with one-half of a dual four-input multiplexer, right. A truth table is written first, then a three-variable Karnaugh map is made. Each of the four multiplexer inputs is allotted a map area. The signals applied to the input lines are found by inspecting the 1's and 0's contained in the cells of the areas.

—there are 256—can be generated with one-half of the dual, four-input multiplexer. And any of the possible functions of four variables—which amount to a prodigious 65,536—can be handled by just one, eight-input unit.

The best way to illustrate how a given function is implemented with the multiplexers is by working out examples. Suppose a logic function must produce an output every time any two of three variables, X, Y, and Z, are 1. Expressed in Boolean form, this function, F, is

$$F = XYZ + \bar{X}YZ + X\bar{Y}Z + \bar{X}\bar{Y}\bar{Z}$$

This is an even-parity function, commonly used in digital circuitry to check whether an error has crept into the combination of ones and zeros making up a digital word. It does this by counting the number of 1's in a word. An even number would, for example, mean the word code is correct.

From the Boolean expression, a truth table is

$$F = XY\bar{Z} + \bar{X}YZ + X\bar{Y}Z + \bar{X}\bar{Y}\bar{Z}$$

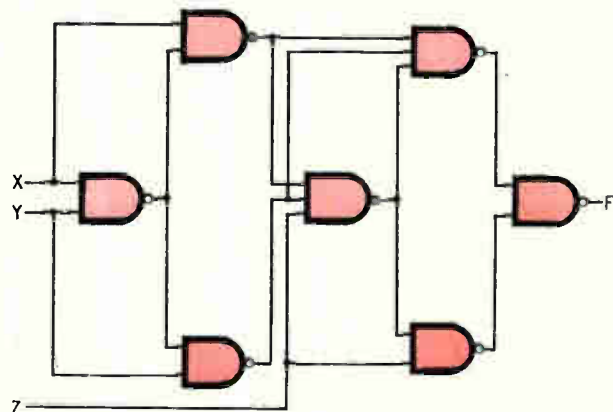

The old way. Implemented with discrete NAND gates, the even-parity function requires five, two-input and two, three-input gates packages.

FUNCTION

$$F = Q_0 \bar{Q}_2 Q_3 + Q_0 \bar{Q}_1 Q_3 + \bar{Q}_1 Q_2 \bar{Q}_3 + \bar{Q}_0 Q_1 \bar{Q}_3 + \bar{Q}_0 Q_1 \bar{Q}_2$$

TRUTH TABLE

Q ₀	Q ₁	Q ₂	Q ₃	F
0	0	0	0	0
0	0	0	1	0
0	0	1	0	1
0	0	1	1	0
0	1	0	0	1
0	1	0	1	1
0	1	1	0	1
0	1	1	1	0
1	0	0	0	0
1	0	0	1	1
1	0	1	0	1
1	0	1	1	1
1	1	0	0	0
1	1	0	1	1
1	1	1	0	0
1	1	1	1	0

Four of a kind. The procedure for implementing a function of four variables is the same as for three, although an eight-input, instead of a four-input, multiplexer is used. A truth table, left, is made and then the Karnaugh maps, below. Values of Q₃ to be applied to the input lines of the multiplexer, I₀ to I₇, are found from the areas in the maps allotted to each line.

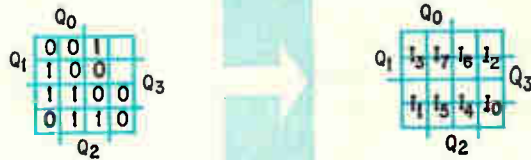

KARNAUGH MAPS

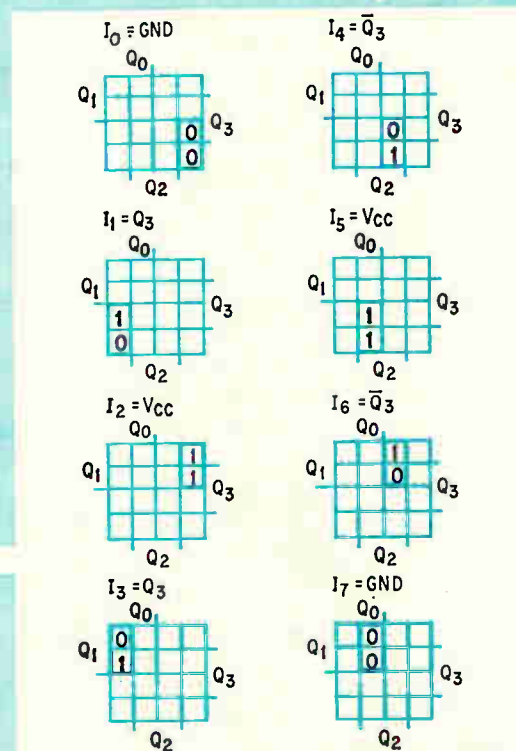

LOGIC CIRCUIT

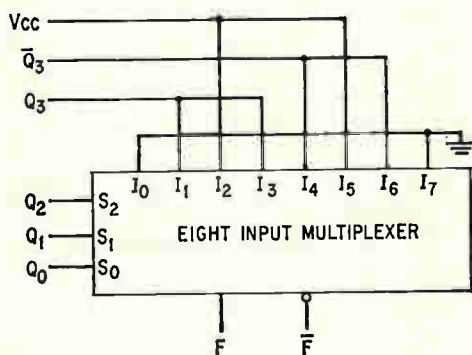

first drawn up for the function, shown on page 101. This table shows all of the eight possible combinations of ones and zeros the three variables may have. And it also shows the output, F, that results from each combination as determined from the Boolean expression.

Next, a Karnaugh map containing eight squares, or cells, is made for the function. This can be made by working from the function itself or, which may be easier, by working from the truth table. Either the truth table or the map can be used to determine how to connect the three variables to the

multiplexer. Generally, it's easier to use the map when the function contains more than three variables. In either case, first choose two of the three variables—let's say X and Y—to feed the two select terminals. The remaining variable, Z, or its complement, \bar{Z} , will be connected to the input terminals, I₀, I₁, I₂, and I₃.

Indicates connections

The truth table shows that when X and Y are 0, the output, F, is the complement of Z, and F is 1 when Z is 0, and 0 when Z is 1. This means that \bar{Z}

TRUE COMBINATIONS

ABC	INPUT	DEF
000	I ₀	000
001		000
011		000
100		000
110		000
000	I ₁	100
001		100
011		100
101		100
111		100
000	I ₂	010
001		010
011		010
111		010
000	I ₃	110
001		110
011		110
100		110
001	I ₄	001
010		001
011		001
100		001
000	I ₅	101
100		101
001		101
101		101
011		101
001	I ₆	011
101		011
110		011
111		011
100	I ₇	111
001		111
011		111
111		111

Six pack. A function of six variables must be divided into two parts, ABC and DEF, resulting in two levels of logic implementation. The table of true combinations, left, lists the conditions when an output must occur. The table is divided into the eight possible binary combinations of D, E, and F. Input signals to the first level logic are found using Karnaugh maps for variables A, B, and C, below. The output from each first-level multiplexer feeds an input line of the second-level multiplexer implementing the D, E, and F combinations.

KARNAUGH MAPS FOR FIRST LEVEL

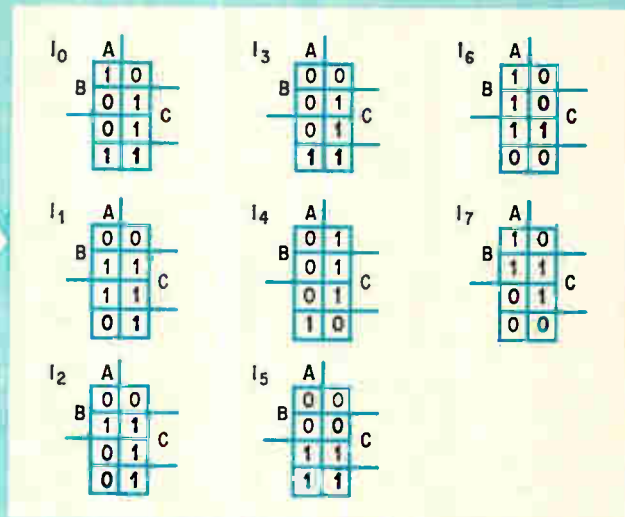

LOGIC CIRCUITRY

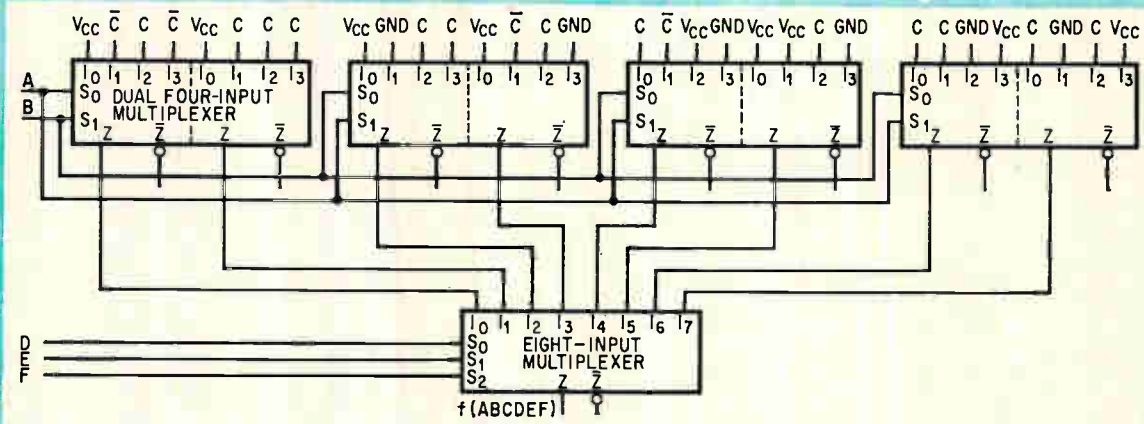

must be connected to I₀. When X is 0 and Y is 1—select code 01—the multiplexer's internal gating is such that input I₁ is connected to the output. In this instance the truth table indicates that the output, F, will be 1 only when Z is 1. Hence, the variable Z itself must be connected to the input I₁. If this procedure is followed for the remaining two possible combinations of X and Y, it's found that Z should be connected to I₂ for input select code 10, and \bar{Z} to I₃ for input select code 11.

If the Karnaugh map is used to figure out what to connect to the input terminals, an intermediate

step is needed. The map's eight cells must first be divided into four, two-cell areas—each containing a cell for Z and one for its complement \bar{Z} . Each area is allotted to one of the four, input terminals, as shown at the top of page 101.

Each area will contain any of the four possible combinations of 1's and 0's—00, 10, 01, or 11. But the way the binary digits are located determines the signal that must be obtained at the multiplexer output and, hence, the signal to be applied to the corresponding input terminal.

Thus, if an area has two 1's, the output must

TRUE COMBINATIONS

f(CDB)	INPUT	f(EFA)
000		000
100		000
010	I_0	000
101		000
110		000
111		000
<hr/>		
000		100
100		100
010	I_1	100
101		100
110		100
111		100
<hr/>		
100		010
010		010
110	I_2	010
001		010
101		010
111		010
<hr/>		
100		110
110	I_3	110
111		110
<hr/>		
000		001
110		001
001	I_4	001
111		001
<hr/>		
010		101
101	I_5	101
<hr/>		
000		011
010		011
110	I_6	011
<hr/>		
100		111
001		111
101	I_7	111
011		111
111		111

Different packaging. Logic implementation can be simplified if the variables are grouped more carefully, as is done for the same six-variable function, $f(ABCDEF)$, shown on the preceding page. One dual, four-input multiplexer is eliminated if the variables are grouped by CDB and EFA. This is because second-level terms I_0 and I_1 turn out to be identical, and I_7 is the complement of I_6 .

KARNAUGH MAPS FOR FIRST LEVEL

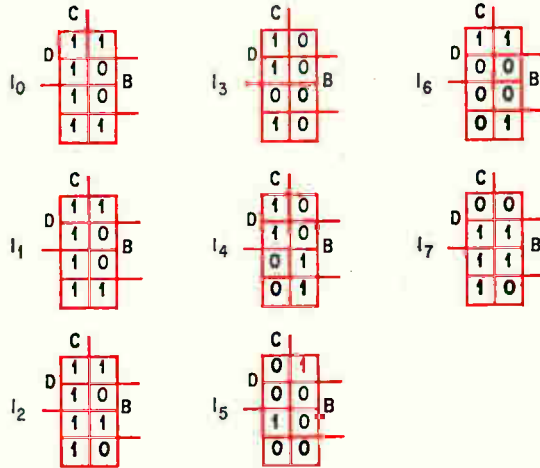

LOGIC CIRCUITRY

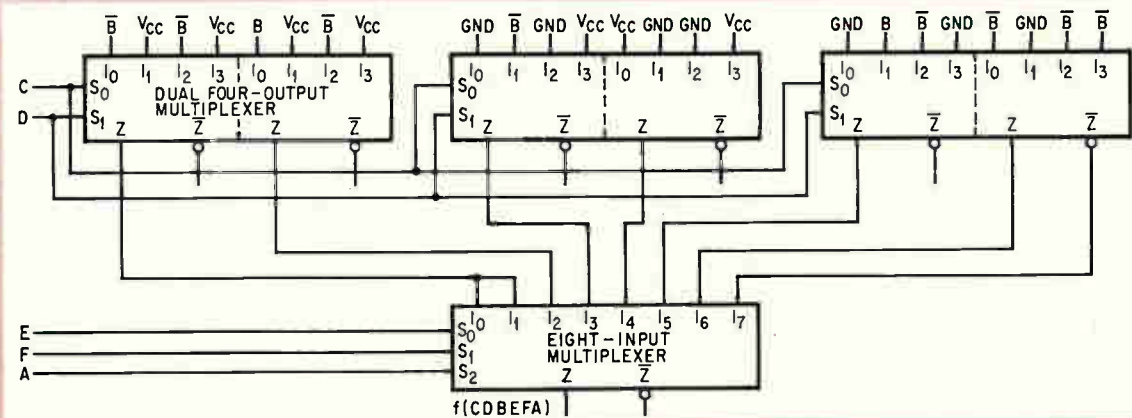

always be 1. It is sufficient to apply a constant voltage, V_{cc} , equal to the voltage value of 1, to the corresponding input.

On the other hand, if an area has two 0's, the output will always be 0, and the constant voltage level for 0, or ground, must be applied to the corresponding input.

A combination of 1 and 0 in an area indicates that the output signal will change. But how it will change depends on whether the 1 is in the Z or in the complementary portion, \bar{Z} , of the Karnaugh map. If the 1 lies within the four cells assigned to

Z on the map, then the output will vary with Z, and Z itself must be applied to the corresponding input terminal. If the 1 lies within the four cells assigned to \bar{Z} , then \bar{Z} must be applied to the corresponding input.

Steps to take

It turns out that for this example only the values of Z and \bar{Z} must be supplied to the input terminals, as shown in the schematic of one-half of the dual, four-input multiplexer on page 101. It's possible to summarize the procedure to be followed

in determining the connections to be made to the multiplexer in a series of steps:

- Draw a truth table for the three variables. Determine the values of the third variable— Z , and \bar{Z} , or the constant condition of 0 or 1—that are to be applied to the input lines.

- Construct a Karnaugh map.

- Allot areas of the map to inputs I_0, I_1, I_2 , and I_3 .

- With two of the variables applied to the select lines of the multiplexer, determine the values of the third variable— $Z, \bar{Z}, 0$ or 1 —that are to be applied to the input lines from the location of 1's and 0's in the allotted areas.

To get some idea of the advantages of using the universal logic circuit, compare its simplicity with what is required to implement a three-variable function using the minimum possible number of discrete standard NAND gates, shown on page 101. The logic was designed with the following typical constraints: maximum inputs per gate is three, and any gate may drive three other gates.

Five, two-input and two, three-input gates, available in a minimum of two packages, are needed. By contrast, only half of the dual four-input multiplexer is needed to generate the same function. Moreover, the universal logic circuit not only carries out the function faster (25 nanoseconds compared with 43 nsec), but also requires less power, fewer connections, and provides true and complementary outputs. And in addition, the remaining portion of the multiplexer is available to generate another logic function.

The approach to implementing a universal logic circuit for three variables can be extended to four variables with the eight-input multiplexer. Again, the best way to proceed is by working out an example.

Suppose the truth table for the function to be implemented is as shown on page 102. The function simplifies to

$$F = Q_0\bar{Q}_2Q_3 + Q_0\bar{Q}_1Q_3 + \bar{Q}_1Q_2\bar{Q}_3 + \bar{Q}_0Q_1\bar{Q}_3 + Q_0Q_1Q_2$$

As before, a Karnaugh map is made. Then, an area on the map is allotted to each of the eight input terminals of the multiplexer. The required input connections are found as before by examining the cells in the map and seeing whether they contain the combinations 00, 01, 10, or 11. Thus, referring to the figure the input connections are

$$\begin{array}{ll} I_0 = \text{ground} & I_4 = \bar{Q}_3 \\ I_1 = Q_3 & I_5 = V_{CC} \\ I_2 = V_{CC} & I_6 = \bar{Q}_3 \\ I_3 = Q_3 & I_7 = \text{ground} \end{array}$$

When five or more variables must be handled, more than one level of universal logic circuits are needed. That is, one set of logic circuits feeds another. For example, a general six-variable universal logic implementation requires eight four-input universal elements—contained in four pack-

ages—in the first level and a single eight-input multiplexer circuit in the second.

When a particular function of six variables $f(ABCDEF)$ must be generated, it is first divided into two parts— ABC and DEF . This simplifies the functional implementation. Instead of a six variable problem it is now two three-variable problems, and is solved as follows:

- Factor out each combination of D, E , and F and obtain the function of the other three variables, $f(ABC)$, associated with each combination.

- Collect all terms of $f(ABC)$ corresponding to each unique input combination of D, E , and F .

- Implement each function of ABC as a function of three variables as described earlier. This yields first level outputs.

- Feed the first level outputs into an eight-input universal logic circuit that is controlled by the combinations of D, E , and F , which are applied to the select lines.

The steps involved in implementing a six-variable function are shown on page 103. Instead of expressing it in Boolean form, the function is presented in a table of its true combinations. (This table shows only the combinations of variables that cause an output; it does not show all the possible combinations that a complete truth table does.)

Make the map

From the information in this table, Karnaugh maps are made for the three variables A, B , and C . This is done by first dividing the table into the eight possible 1 and 0 combinations of D, E , and F . The variables A, B , and C feed each of these combinations. So the next step is to make a three-variable map for A, B , and C . As before, A and B are arbitrarily applied to the select terminals, $C, \bar{C}, 0$, or 1 to the input terminals of the multiplexer.

Four dual four-input multiplexers make up the first logic level. The output of each feeds an input terminal, I_0, I_1, \dots, I_7 , of the second-level universal logic circuit consisting of a single, eight-input multiplexer.

It's possible to simplify the implementation by carefully selecting the variables to be included in the first-level functions. In general, select variables for first-level functions that are either identical or the inversion of one another; they reduce to the fewest variables.

Thus, the function $f(ABCDEF)$ can be implemented by transforming it into a first-level function $f(CDB)$ and a second level combination, E, F and A . This partition makes use of the helpful facts that $f(CDB)$ is identical for second-level terms I_0 and I_1 , and that the second-level term I_7 is the complement of I_6 . The result, shown opposite, is that fewer packages can implement the function. ■

References

1. S.S. Yau and C.K. Tang, "Universal Logic Circuits and Their Modular Realization," Proceedings of the 1968 Spring Joint Computer Conference, p. 297.
2. C. Maley and J. Earle, "The Logic Design of Transistor Digital Computers," Prentice-Hall, 1963, pp. 300-317.

Active filters: part 13

Narrowing the choice

Selecting one of the many active filter designs available can be puzzling; five common ones are compared to help choose the best for a specific task

By Michael Hills

University of Essex, England

Choice, not chance is the goal of the designer seeking the right active filter circuit for his specific application. Since the engineer must know how to design, for example, circuits using only one operational amplifier, or how to maintain component sensitivity levels with two op amps, the problem of selection becomes more intricate. Adding to the difficulty is the necessity of minimizing the number of components.

Five circuit choices—single-operational amplifier, negative-impedance converters, integrator and lag method, triple op amp, and the gyrator—are examined here. The techniques are compared on the basis of sensitivity to active and passive parameter variations, number and complexity of active elements, and their component values.

In nearly all, component sensitivity—the effect of a 1% change in an element's value on the filter's response—is a major problem. The filter's response is proportional to the component's sensitivity and to the network's Q. A 1% change in a component's value will cause at least a 10% change in a pole location in a network whose Q = 10. This is especially critical in a multipole filter produced by cascading several second-order circuits. For example, if a four-pole network is built with only one active device, the sensitivity will be proportional to the product of the Q's of each conjugate pole. The transfer function of a typical second-order filter can be expressed by

$$H(s) = \frac{V_{out}}{V_{in}} = \frac{K}{1 + dTs + T^2s^2} \quad (1)$$

where d is the damping factor, and $\omega_c = 1/T$ is the cutoff frequency. The steeper the response curve, Q large, the smaller d must be. The circuit Q is related to d by $Q = 1/d$.

Since any active filter is a combination of an active device with an RC network, it's useful to review the principals of RC theory. The simplest RC circuit that produces a second-order transfer function is a two-section network. In terms of its component values, the transfer function of the low-pass circuit shown at bottom of facing page is written as

$$\frac{V_{out}}{V_{in}} = \frac{1}{1 + (C_1R_1 + C_2R_2 + C_2R_1)s + C_1R_1C_2R_2s^2} \quad (2)$$

Setting $C_1R_1 = T_1$ and $C_2R_2 = T_2$ simplifies the form of equation 2 to

$$\frac{V_{out}}{V_{in}} = \frac{1}{1 + (T_1 + T_2 + \lambda T_1)s + T_1T_2s^2} \quad (3)$$

where $\lambda = C_2/C_1$.

For a normalized cutoff frequency of unity, let $T_1T_2 = 1$. Equating like coefficients of the middle terms in equations 1 and 3 yields

$$d = T_1 + T_2 + \lambda T_1 \\ = (1 + \lambda)T_1 + 1/T_1$$

Since $T_1T_2 = 1$, the minimum value of d occurs when $T_1 = 1/\sqrt{1 + \lambda}$ and is $d_{min} = 2\sqrt{1 + \lambda}$. Since λ is a positive number, the minimum value, d_{min} , would occur when $\lambda = 0$. The value would be $d_{min} = 2$.

Because it's not physically possible for λ to be zero, the range of the filter response curve is limited. Consequently, the best that can be achieved is a value of $d = 2$, obtained at the expense of $\lambda = 0$; this would require very large ratios of capacitor and resistor values.

Multipole filters require two or more RC circuits

separated by a unity-gain voltage amplifier for isolation. The transfer function in this case is given by

$$\frac{V_{out}}{V_{in}} = \frac{1}{1 + (T_1 + T_2)s + T_1T_2s^2} \quad (4)$$

For $T_1T_2 = 1$ then, $d = T_1 + 1/T_1$, so $d_{min} = 2$ for $T_1 = T_2 = 1$. In this case the two capacitors may have any values, provided $C_1R_1 = C_2R_2 = 1$.

To produce more complex characteristics without inductors, the active filter techniques depend on feedback circuits. The transfer function of a feedback circuit as shown at top left of page 110, is

$$H(s) = \frac{V_{out}}{V_{in}} = \frac{AB}{1 - \beta A} \quad (5)$$

where $V_1/V_{in} = B$ is the voltage transfer function of some passive RC circuit at the input, $\beta = V_2/V_{out}$ is the feedback ratio, and A is the gain of the active element.

For instance, a low-pass Sallen and Key¹ circuit shown on page 109 can be considered in this form.

Since the output impedance of the amplifier ideally is zero, C_1 is grounded with respect to the input circuit. The input resistor, R_1 , is grounded via the input voltage source. Hence the circuit shown in the table may be considered to be equivalent to that at the top right of page 110.

The input RC circuit introduces a frequency dependent loss, B , where

$$B = \frac{V_1}{V_{in}} = \frac{1}{1 + (T_1 + T_2 + \lambda T_1)s + T_1T_2s^2} \quad (6)$$

The voltage-feedback ratio, β , is given by

$$\beta = \frac{V_2}{V_{out}} = \frac{sT_1}{1 + (T_1 + T_2 + \lambda T_1)s + T_1T_2s^2} \quad (7)$$

The effective gain of the amplifier portion with feedback is

$$A' = \frac{A}{1 - \beta A}$$

Thus the effect of frequency-selective feedback is to tailor the gain of the stage to achieve the desired filter function. For low d values, βA must be close to unity. Since small changes in component values result in large changes in the filter's response, the value of βA must be set tightly.

The overall filter characteristic of the circuit is now expressed by

$$H(s) = \frac{AB}{1 - \beta A} = \frac{h}{1 + ds + s^2} = \frac{N(s)}{D(s)} \quad (8)$$

so, putting

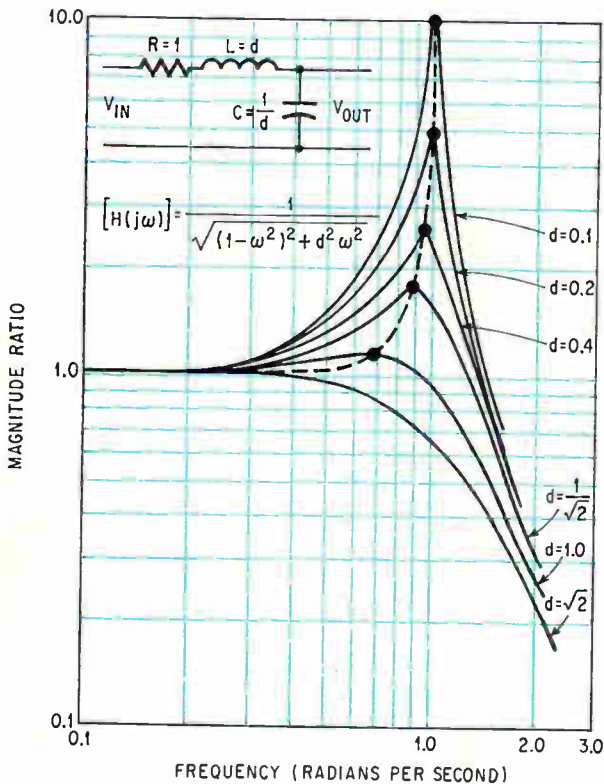

Frequency response. Voltage transfer function for a simple RLC passive network is plotted for six damping factors. As d is made smaller the typical second-order response peaks sharply.

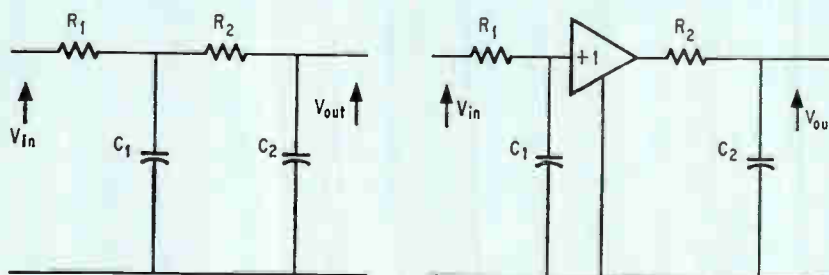

Low-pass filter. Simple RC network at left generates a second-order frequency response but requires a large resistor and capacitor ratio to achieve a minimum sensitivity. By adding a unity-gain voltage amplifier the ratio problem is circumvented.

$$B = 1/D(s) \quad \text{and} \quad \beta = sT_1/D(s) \quad (9)$$

then

$$\frac{A}{D(s) - AsT_1} = \frac{h}{1 + ds + s^2} \quad (10)$$

Because the numerator does not effect the pole locations, variations of A in the numerator of equation 10 will not effect the overall response as much as in the denominator. Therefore, the designer must find a technique for partitioning the denominator on the left-hand side of equation 10 to find the smallest d value. This can be achieved with the Horowitz² technique of negative-impedance converter synthesis.

For the second-order case, Horowitz shows that the optimum partitioning is given by, $1 + ds + s^2 = D(s) - b_0s = (1 + s)^2 - b_0s$; $b_0 = (2 - d)$.

Hence, the optimum Sallen and Key circuit is obtained for $D(s) = (s + 1)^2$. For the RC circuit under consideration, this may be achieved only for $T_1 = T_2 = 1$ and $\lambda = 0$; $A = (2 - d) = h$.

The minimum d value requires an infinite capacitor and resistor ratio. For a value of d other than minimum, tables are handy. Such a guide appears on page 109.

To observe the effect of a varying component parameter the designer should write the transfer function for the optimum circuit in terms of the circuit elements. Thus

$$\frac{V_{out}}{V_{in}} = \frac{1}{1 + (T_1 + T_2 - AT_1)s + T_1T_2s^2}$$

Hence

$$d = \frac{T_1 + T_2 + AT_1}{\sqrt{T_1T_2}} (1 - A) \sqrt{\frac{T_1}{T_2}} + \sqrt{\frac{T_2}{T_1}} \quad (11)$$

Since A is the gain, it is an important factor in producing an accurate filter response. Any deviation in component value will have lesser influence because they are ratios. If $A > 1 + T_2/T_1$, then an unstable system will be produced.

Economy is goal

If the filter is constructed with integrated circuits, or in thin-film form, a large, open-loop gain amplifier can be obtained economically—but it will be difficult to obtain accurate R and C values. The component values may, however, be chosen to minimize the effect of passive component variations, but at the expense of the filter's sensitivity to the variations of the active components. The circuit with the least passive component variation occurs for a unity-gain amplifier, and the corresponding sensitivities are given in the table.

One active-filter scheme that relies on a positive feedback amplifier is the negative-impedance converter. Any impedance placed across the input terminals will appear as the negative of that impedance when observed at the output. The circuit is shown at bottom, page 110, where A is the gain of an ideal voltage amplifier. If the input voltage to the amplifier is E_1 , the output is AE_1 , so the current I_1 must be $(E_1 - AE_1)Z$. The input impedance thus is $E_1/I_1 = Z/(1-A)$; hence, for $A > 1$, a negative impedance will occur. For $A = 2$ the input impedance is $-Z$.

The ideal negative-impedance converter in the table is redrawn at bottom right, page 110; this circuit exhibits the required transfer characteristics between terminals 1-2 and 3-4.

The transfer function of this circuit is expressed by

$$\frac{V_{out}}{V_{in}} = \frac{(A-1)}{1 + S[T_1 + T_2 + (1-A)C_2R_1]s + s^2T_1T_2} \quad (12)$$

$$\begin{aligned} \text{Hence } d &= \frac{T_1 + T_2 + (1-A)C_2R_1}{\sqrt{T_1T_2}} \\ &= [1 + \lambda(1-A)] \sqrt{\frac{T_1}{T_2}} + \sqrt{\frac{T_2}{T_1}} \end{aligned}$$

In this case, the value of d depends on the product AC_2R_1 as well as the individual time-constants. Thus this circuit, which is completely equivalent to the conventional NIC in terms of input-output behavior, is as sensitive to component variations as the Sallen and Key circuit, and is not as easy to construct. Since the output voltage of the NIC circuit goes across a capacitor, it is always necessary to use an isolating amplifier for proper impedance matching.

Alternative partitioning technique

The partitioning of equation 8 into that of 9 may also be done with an inverting amplifier as follows:

$$\text{Let } A = \frac{-1}{s(s+d)}, \quad B = 1, \quad \beta = 1 \quad (13)$$

then

$$\frac{AB}{1 - \beta A} = \frac{-1}{1 + ds + s^2}$$

This leads to a class of active filters which have an integrator and a lag in the forward path, and 100% negative feedback, since β is chosen as unity.

The transfer function of the integrator with a finite-gain amplifier of A is

$$V_2 = \frac{-1}{T_1[(1 + 1/A)s + 2/AT_1]} \quad (14)$$

and the RC circuit is

$$\frac{V_2}{V_0} = \frac{1}{1 + T_2s}$$

Comparing the techniques

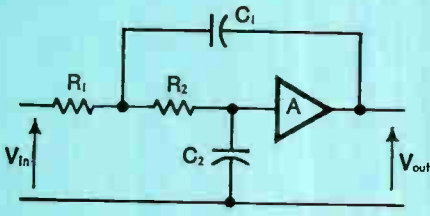
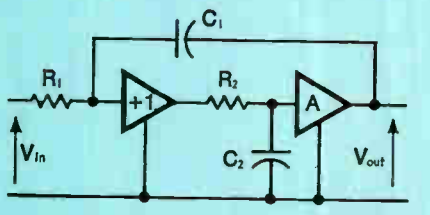
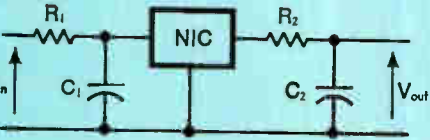
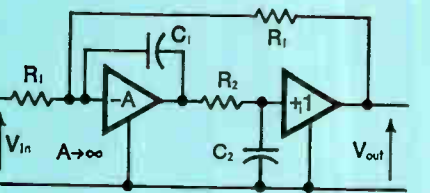
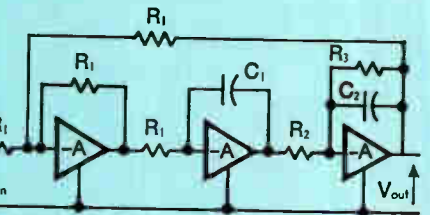
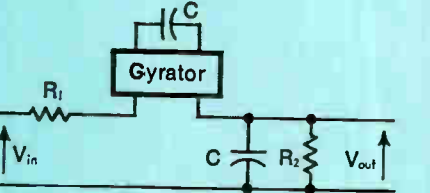
Technique	Design procedure	Sensitivities					Remarks
		S_R	S_C	S_A	S_f	S_β	
1. Sallen and Key (single amplifier) 	a) For minimum active sensitivity $\lambda = C_2/C_1$, as small as possible. $T_1 = 1/\sqrt{1+\lambda}$, $A = 2(1+\lambda) - d/\sqrt{1+\lambda}$ b) For minimum passive sensitivity $\lambda = 1/4 d^2$, $A = 1$, $T_1 = 2/d$ c) For minimum passive sensitivity but $\lambda_{min} > 1/4 d^2$ $A = 1 + \lambda - 1/4 d$, $T_1 = 2/d$	-1	-1	-2	4	1	Low output impedance, $R_2/R_1 = 1 + 1/\lambda$ Low output impedance, $R_2/R_1 = 1$ but very small λ needed Low output impedance, $R_2/R_1 = 1$
2. Sallen and Key (double amplifier) 	a) For minimum active sensitivity $A = 2 - d$, $T_1 = 1$ b) For minimum passive sensitivity $A = 1 - 1/4 d^2$, $T_1 = 2/d$	-1	-1	-2	6	1	Low output impedance, $R_2/R_1 = C_1/C_2$ arbitrary value Low output impedance, the positive gain is now less than unity, so this requires potentiometer after the +1 amplifier
3. Negative-Impedance converter 	Minimum active sensitivity (Horowitz decomposition) $K = 1$, $\lambda = 2 - d$, $T_1 = 1$	-1	+1	-2			Output across capacitor, so isolating amplifier necessary. S_A refers here to converter ratio error.
4. Integrator and lag 	$T_1 = d$	$1/2 d$	$1/2 d$		$2/d$		Low output impedance, $R_2/R_1 = 1/4 d^2 C_1/C_2$ so large ratios needed. Sensitivities similar to 1(b) and 2(b).
5. Integrator loop 	$T_1 = 1$, $R_3/R_2 = d$	d	0		2		S_R refers to coefficient of $(R_3 - R_2)$. Low output impedance, bandstop and bandpass outputs available simultaneously. Active and passive sensitivities simultaneously low.
6. Gyator 	$R_2 = (d/2 - d)R_1$, $1/C = \sqrt{1/2 d} R_2$, $L = R_1/\sqrt{1/2 d}$					$\delta d = 1/2 d (R_1 - R_2)$	Best performance since first-order behavior is governed only by R_1 and R_2 . May be used in cascaded circuits but greatest circuit complexity.

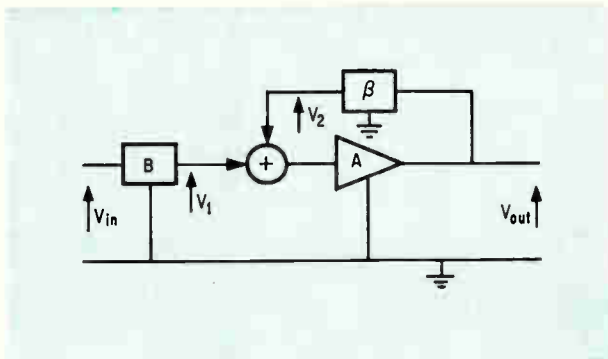

General network. Feedback circuit represents a typical model for an active filter. Network B is coupled to an operational amplifier of gain A that contains a feedback loop of gain β .

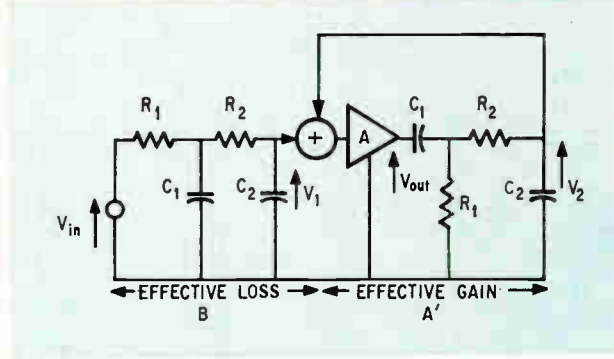

Partitioning. The Sallen and Key active filter can be divided into two basic parts—effective loss and gain. The input network introduces a frequency-dependent loss, and the feedback proportions the gain.

For large A, the $1 + 1/A$ term in equation 14 may be taken as unity; hence the overall transfer function becomes

$$\frac{V_{out}}{V_{in}} = \frac{-1}{1 + (T_1 + 2T/A_2)s + T_1T^2s^2} \quad (15)$$

Hence for this system

$$d = \frac{T_1 + 2T_2/A}{\sqrt{T_1 T_2}}$$

Since d is an algebraic sum it is not possible to make its value too small, unless a large A is selected. For large A and $T_1T_2 = 1$ the designer may assume $d = T_1$ for a first approximation. The actual d will be

$$d' = d + \frac{2}{Ad} \quad (16)$$

Because A is a large value the circuit cannot become unstable since the pole positions remain in the left-hand side of the s-plane. Thus this circuit seems less sensitive to component changes in the active and passive parameters, but when these

sensitivities were computed it was found⁵ that they were virtually the same as for the unity-gain Sallen and Key circuit, but that the latter circuit uses one less resistor.

Integrator-loop filters

Another active filter replaces the passive RC lag-circuit by its active equivalent; this effectively removes the need for a large ratio of component values. Another sign-inverting amplifier is necessary, as shown in the table. The transfer function of the circuit is

$$\frac{V_{out}}{V_{in}} = \frac{1}{1 + [(R_3/R_2 + 1/A) T_1 + AT_2] s + s^2 T_1 T_2} \quad (17)$$

Hence for a normalized cutoff frequency $T_1 = T_2 = 1$ and $R_3/R_2 = d$, and A, large, then

$$d' = d + 2/A \quad (18)$$

and the error term is reduced by a factor of $1/d$ from the two-amplifier version. This circuit has

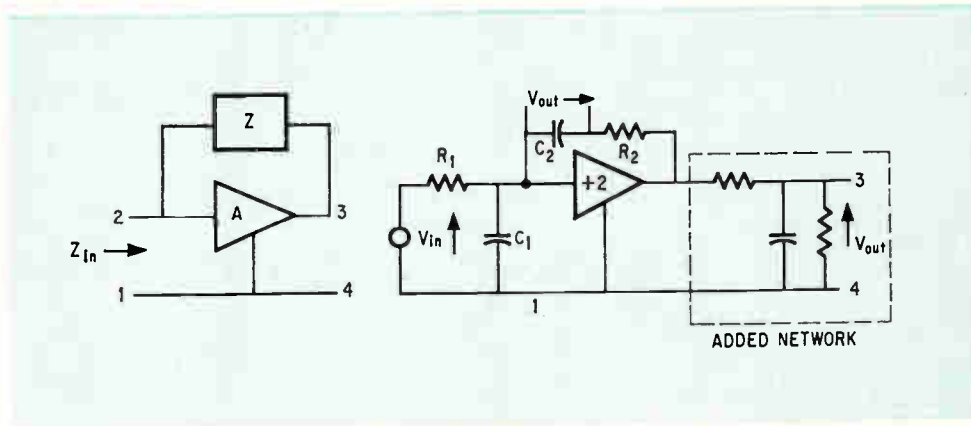

NIC. Ideal feedback amplifier, left, is used in the negative-impedance converter, right, to produce a desired transfer function.

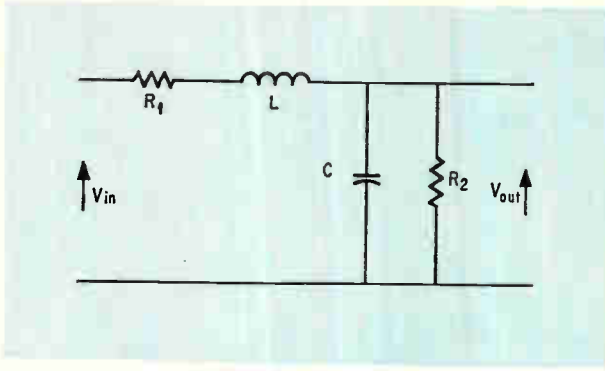

Low pass. RLC filter is insensitive to 1% changes in L. However, the main drawback to an active filter equivalent is that it requires many components.

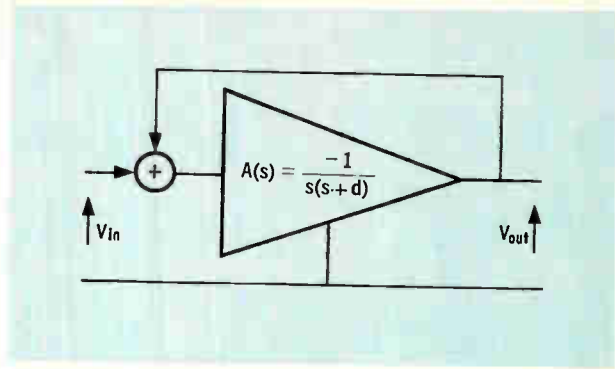

Special class. By using an operational amplifier whose gain is $-1/s(s+d)$, the designer obtains a circuit that has an integrator and a lag in the forward path.

low passive and active sensitivities simultaneously. It's possible to fabricate a two-amplifier version, but since additional RC's are needed more component-sensitivity results.⁷

The gyrator

The conventional application for a gyrator is to employ a capacitor across one port to produce the terminal properties of an inductor across the other port.^{8,9} The engineer starts designing an active filter with a gyrator by drawing the passive RLC circuit that gives him the desired response. He then replaces the inductors by gyrator-capacitor combinations. Any change in the parameters of the gyrator produces a change in the equivalent inductor value. Thus, the circuit's sensitivity may be examined by finding the component change of the original passive circuit to an inductance value change.

One such RLC network example is the low-pass filter shown directly above. For this second-order circuit the voltage transfer function is given by

$$\frac{V_{out}}{V_{in}} = \frac{R_2}{R_1 + R_2} \frac{1}{1 + \left[\frac{L + CR_1R_2}{R_1 + R_2} \right] s + LC \left[\frac{R_2}{R_1 + R_2} \right] s^2} \quad (19)$$

where $LC \left[\frac{R_2}{R_1 + R_2} \right] = T^2$

and

$$d = \frac{1}{\sqrt{R_1 + R_2}} \left[\sqrt{\frac{L}{CR_2}} + \sqrt{\frac{CR_1}{C}} \right] \quad (20)$$

Now if L changes by a small amount, δL , then T is only slightly affected and the change in d is expressed by

$$d = \frac{1}{\sqrt{R_1 + R_2}} \left(\sqrt{\frac{L}{CR_2}} - \sqrt{\frac{CR_1}{L}} \right) \quad (21)$$

This term may be made zero by a suitable choice of component values. Use the table to help select these values for a known d value.

The gyrator filter has the best sensitivity behavior of all those considered here, but it's only slightly better than the integrator loop for the second-order case. The advantages of this filter are even greater for higher-order networks because inductors are directly replaced by gyrators and not by cascading second-order RC sections. The main drawback is that it requires the largest number of passive components in simulating the gyrators, especially if the inductors in the equivalent LCR filter are ungrounded, as is usual for low-pass filters.

Sensitivity values given in the table are coded as follows: S_R for resistors, S_C for capacitors, S_A for the Sallen and Key amplifier, S_f for the integrator-lag amplifier, and S_b for the feedback network. The values that are given in each case are based on the design procedure. ■

References

1. R.P. Sallen and E.L. Key, "A Practical Method of Designing RC Active Filters," I.E.E. Trans. CT-2, March 1955, pp. 74-85.
2. I.M. Horowitz, "Optimization of Negative Impedance Conversion Methods of Active RC Synthesis," I.R.E. Trans. CT-6, September 1959, p. 296.
3. P.J. McVey, "Sensitivity in Some Simple RC Active Networks," Proc. I.E.E. 112, 7, July 1965, pp. 1263-9.
4. W. Saraga, "Sensitivity of Second-Order Sallen-Key Active RC Filters," Electronics Letters 3.
5. M.T. Hills, "Active Filter Design," Research Memorandum RM68/6, Department of Electrical Engineering Science, University of Essex, England.
6. S.S. Hakim, "RC Active Filters Using an Amplifier as the Active Element," Proc. I.E.E. 112 5, May 1965, pp. 901-12.
7. D. Wolff, "Active RC Filters with Differential Integrators," Electronics Letters 4 20, April 10, 1968, p. 428.
8. D.F. Sheenan and H.J. Orchard, "High-Quality Transistorized Gyrator," Electronics Letters, 2, 1966, p. 274.
9. A.S. Morse and L.P. Huelsman, "A Gyrator Realization Using Operational Amplifiers," I.E.E.E. Trans. CT-11, 1964, pp. 277-8.
10. H.J. Orchard, "Inductorless filters," Electronics Letters, 2, 1966, p. 224.
11. D.F. Sheenan, "Gyrator Floating Circuit," Electronics Letters, 3, 1, June 1967, p. 39.

Here's One Place Where Your Dollar Is Worth A Dollar

Two new HP oscillators are teaching the old standard new tricks in performance and value. Both the new HP 204C and HP 209A Oscillators have exceptional spectral purity ($<0.1\%$ -60dB). Both have FET's in the bridge for improved stability—balanced output—sync in/out. All this adds up to greatly improved performance. And, you get this extra value at only a modest increase in price over the old standard.

Both oscillators offer improvements that assure you of a consistent signal—test after test—time after time... whether you are testing on a production line, researching in a design lab, or instructing future engineers.

Portable, line or battery powered. The 204C is a clean, inexpensive oscillator with a frequency range of 5 Hz to 1.2 MHz. Power output is 2.5 Vrms into 600 Ω , 5 Vrms into open circuit. Choose interchangeable power packs—line, rechargeable or mercury battery. Price HP 204C, \$250 to \$285.

High power output, sine or square wave. The 209A generates simultaneous sine and square wave outputs over a frequency range of 4 Hz to 2 MHz. Amplitudes are independently adjustable. Power output for sine wave is double that of 204C—5 Vrms into 600 Ω , 10 Vrms into open circuit. Square wave output is 20 V peak-to-peak. Price HP 209A, \$320.

Get full value for your signal-source dollar. Consult your HP Instrumentation Catalog for full specifications and order your oscillator by calling your nearest HP telephone order desk. For additional data, write Hewlett-Packard, Palo Alto, California 94304. Europe: 1217 Meyrin-Geneva, Switzerland.

099/2

HEWLETT  PACKARD
S I G N A L S O U R C E S

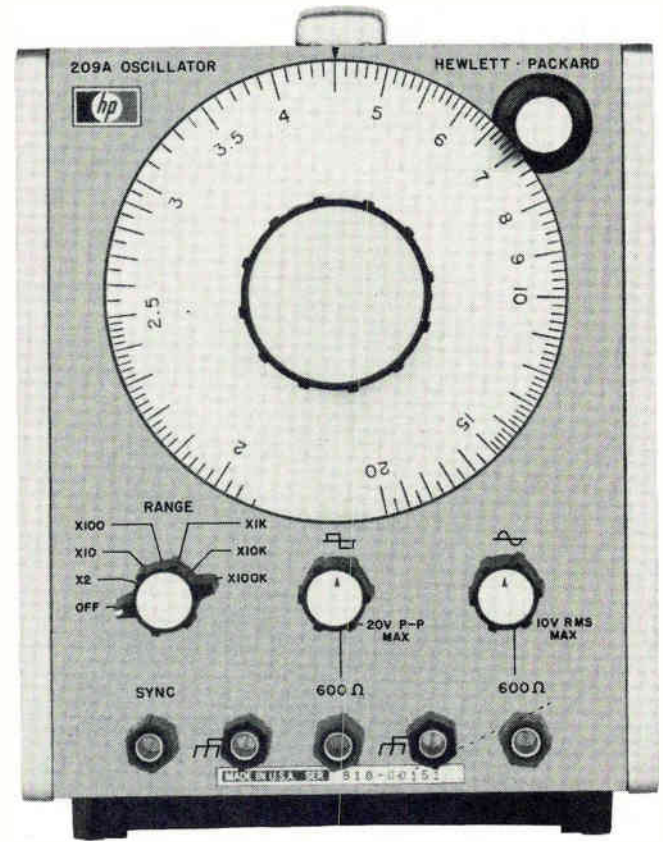
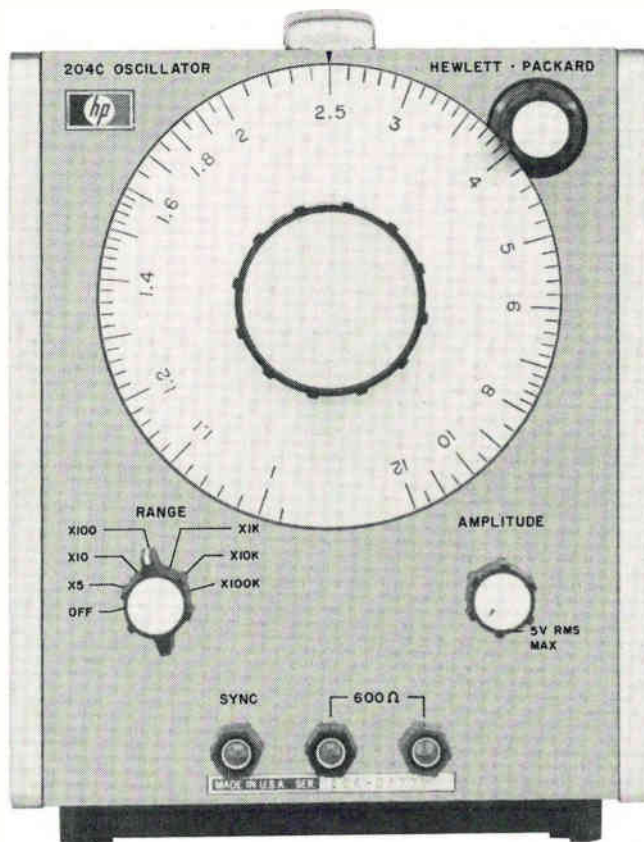

Growing silicon on spinel adds up to high isolation, fast switching in IC's

Spinel, a silicon-compatible crystal structure, has a distinct edge over both bulk silicon and sapphire as a substrate material in MOS devices for high-performance applications

By Heinrich Schlötterer

Siemens AG, Munich

True isolation—that is, electrical isolation—is well-nigh impossible in a conventional monolithic integrated circuit. Because of the silicon substrate's conductivity, there is always some interaction of the circuit elements on the chip, causing parasitic capacitive and resistive coupling.

In applications where high frequency response, fast switching, or low leakage current is essential, air-isolation IC's—using a highly insulating substrate—can do the trick. And spinel is one of the most promising materials for the substrate.

These IC's can be made by depositing a thin film of single-crystal silicon on the substrate, etching the film to make islands of silicon, and then using conventional photolithographic techniques to diffuse an active or passive component in each island.

The silicon-on-spinel technique requires careful sawing and cutting of the spinel, and it's more expensive than usual IC fabrication processes. But, in critical applications, its advantages are well worth the expense. In fact, Siemens AG is experimenting with the technique to make metal oxide semiconductor IC's—including complementary MOS—with one-third the switching time of the conventional bulk devices. Moreover, these newer devices have negligible leakage current. In discrete silicon-on-spinel transistors, switching times of less than 1 nanosecond have been realized.

Spinel is the generic name for a family of crystalline materials in which oxygen ions form a close-packed cubic lattice structure with tetrahedral and octahedral interstices, as on next page. The interstices can hold metallic atoms. The general formula for spinel is AB_2O_4 , where A is the metal in the tetrahedral interstices and B is the metal in the octahedral ones.

Silicon-on-spinel IC's are only one of many possible film-on-insulator devices. Other semiconductors, such as germanium, gallium arsenide, and cadmium sulphide, could be used as thin-film material. Siemens started with silicon as the thin-film semiconductor material because it's so well understood and easy to use. The other materials, however, are promising and could open the way to new thin-film devices and IC's. To qualify as insulating substrate, a substance should have the same crystal symmetry as the thin film, and should be resistant to high process temperatures—during deposition of silicon films the substrate is exposed to reactive gases at 1,200°C. Quartz, calcium fluorite, beryllium oxide, and silicon carbide have been tried as substrates for silicon at some companies, but only spinel and sapphire have so far been used successfully.

Siemens favors spinel over sapphire because it offers significant advantages—among which, its crystal structure is more compatible with that of silicon, and it causes less unwanted doping of the silicon. Siemens uses the magnesium-aluminum spinel: magnesium is the A metal; aluminum is the B metal.

Significant symmetry

The crystal-lattice diagram on next page shows the big advantage of spinel as a substrate material. Both spinel and silicon have cubic symmetry; thus, regardless of the crystal orientation of the spinel substrate, an epitaxial, single-crystal film of silicon can be grown on it. Sapphire, on the other hand, has rhombohedral symmetry, and since silicon can be grown only on certain lattice planes, surface preparation of sapphire is considerably more critical

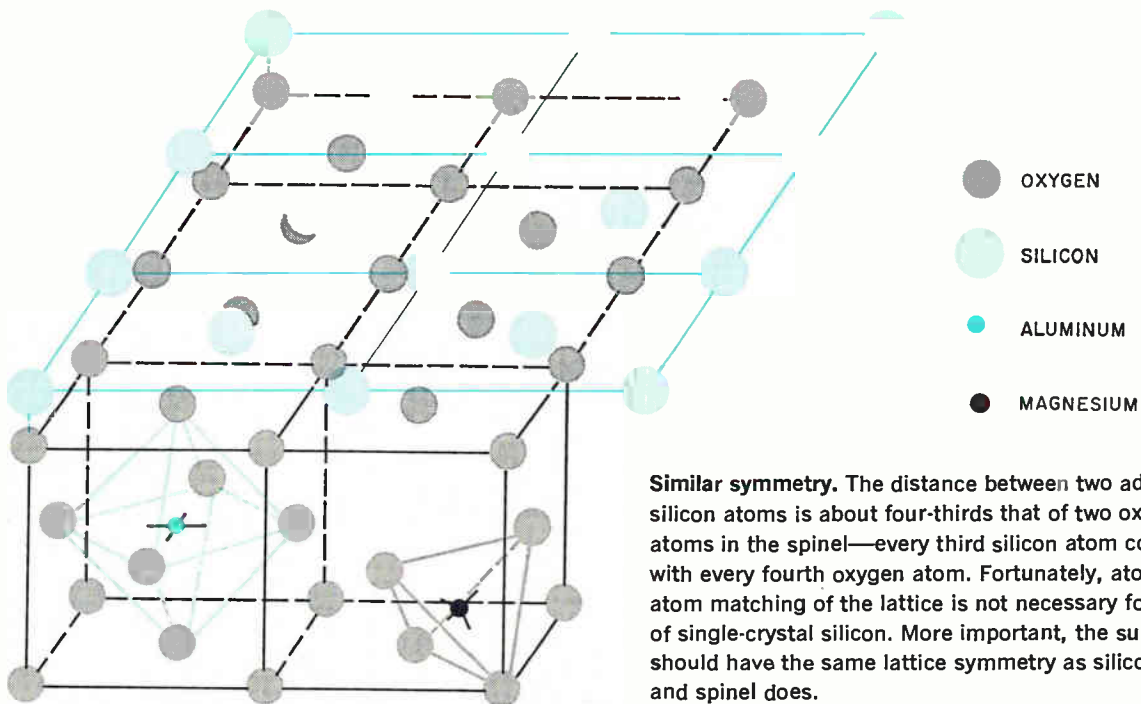

Similar symmetry. The distance between two adjacent silicon atoms is about four-thirds that of two oxygen atoms in the spinel—every third silicon atom coincides with every fourth oxygen atom. Fortunately, atom-for-atom matching of the lattice is not necessary for growth of single-crystal silicon. More important, the substrate should have the same lattice symmetry as silicon—and spinel does.

and complicated.

Spinel's symmetry advantage is important, since single-crystal films of silicon are essential in any film-on-insulator device. Polycrystalline films are easier to deposit. But the boundaries between adjacent crystals seriously impede the flow of charge carriers through the polycrystalline film—carrier mobility is reduced to unacceptable levels. The mobility of an n-type single-crystal thin film of silicon in the 1-0-0 orientation can be as high as 600 centimeters²/volt-second, whereas in polycrystalline films, mobility is only 10 cm²/volt-sec.

Another problem with polycrystalline devices is stability: parameters tend to vary with time and temperature more than in single-crystal devices.

Although they're vastly superior to polycrystalline silicon, single-crystal silicon thin films don't do so well against bulk materials. Heteroepitaxial growth (growth on a substrate composed of a different material) causes crystal defects in the single-crystal silicon film. Also, the silicon film shows much greater expansion with temperature than the substrate. Since the film is deposited at high temperature, it is strained under high compressive stress at room temperature. But the thermal mismatch is much smaller with spinel than with sapphire.

The combination of crystal defects and the piezoelectric effect of the compressive stress keeps the mobility of single-crystal, thin-film silicon lower than the maximum attainable in bulk silicon (about 1,500 cm²/volt-sec). Fortunately, this doesn't seriously affect the characteristics of silicon-on-spinel MOS devices. Transconductance and channel mobility are just a bit lower than in bulk devices, while the big improvement in switching speed and parasitic capacitance in the thin film devices more

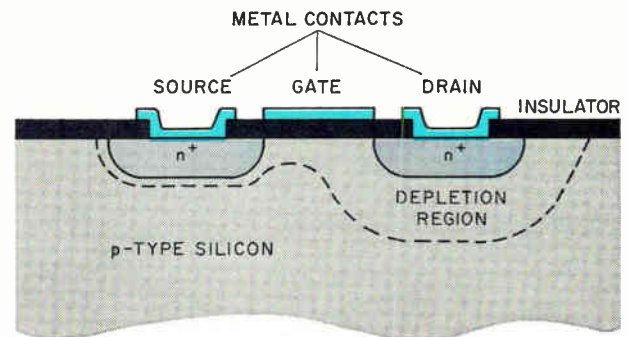

BULK SILICON

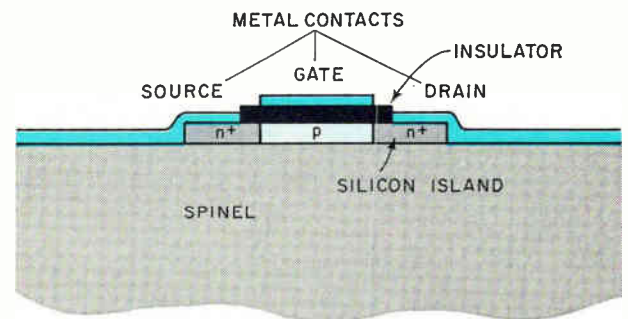

SILICON ON SPINEL

Capacitance curbs. Because spinel confines the depletion region to the channel between source and drain, the silicon-on-spinel MOS transistor has much less capacitance than the bulk version.

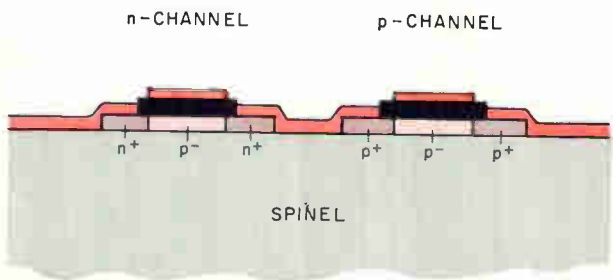
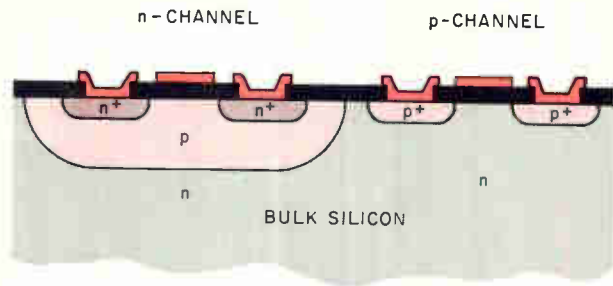

Complements of MOS. Formation of p-channel and n-channel transistors on the same substrate requires elaborate and critical processes in bulk-silicon IC's; in one such process, a p region must be diffused deep into the silicon to provide isolation. But in silicon-on-spinel IC's the islands provide their own isolation. In the p-channel silicon-on-spinel transistor, the thinness and high resistivity of the p region give it a high ohmic value, but when a voltage is applied it becomes highly conductive.

than compensates.

A potential hazard in silicon thin-film growth is called autodoping—aluminum from the substrate passes into the silicon film, where it acts as an acceptor. Fortunately, autodoping from spinel almost always is negligible, and under similar growth conditions, spinel's autodoping level is about 10 times lower than sapphire's.

Silicon isles

The silicon film must be divided into islands to achieve isolated devices. This is done by photolithographic masking and etching, as shown above right. A special etchant, which attacks silicon much faster than the photoresist or silicon dioxide, is used. The silicon islands then can be made into circuit elements by conventional masking, oxidation, and diffusion techniques.

Siemens has concentrated on MOS devices rather than bipolar units. MOS transistors made of thin-film silicon switch much faster—by a factor of three or more—than those made of bulk silicon, because drain-source capacitance is proportionally lower in the thin-film version. In the bulk MOS transistor,

PRODUCTION OF ISOLATED SILICON ISLANDS

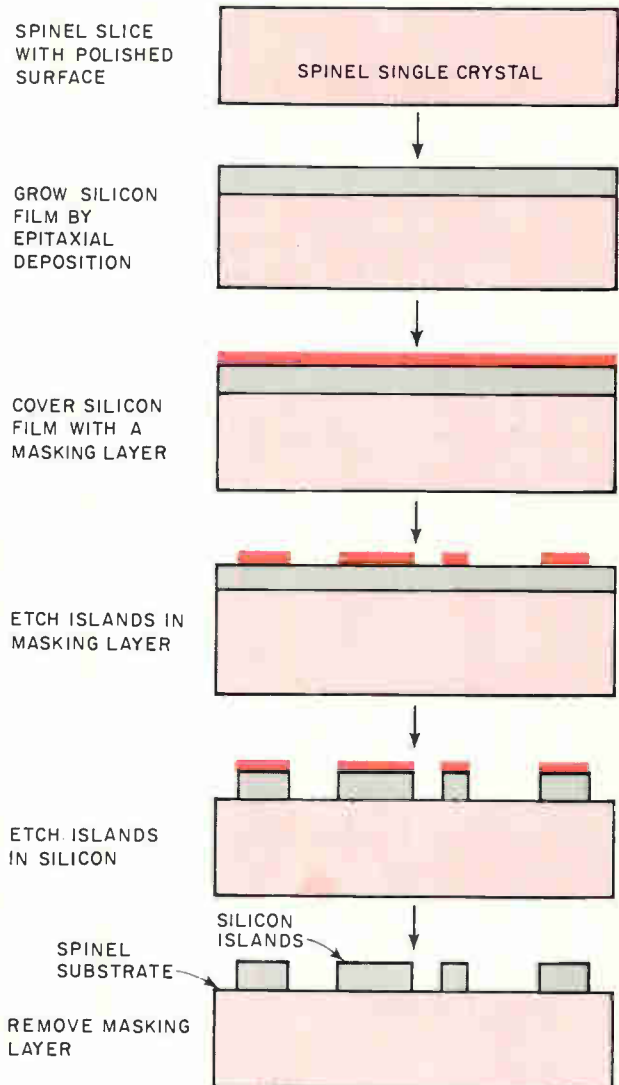

Isolation. Circuit elements in a silicon film on a spinel substrate are isolated from each other by etching into islands. Then, transistors, diodes, resistors, and capacitors are formed in the islands by conventional methods.

when a voltage is applied to the drain and gate, the space-charge region deeply penetrates the bulk material, as shown at bottom of opposite page. In the thin-film MOS transistor, however, the active region is confined to the channel between drain and source by the spinel substrate, drastically reducing parasitic capacitance.

The only path

Furthermore, leakage currents are very low in silicon-on-spinel devices because the only path between components other than intentional connections is through the spinel, which has extremely high resistance.

In active memories, complementary p-channel

and n-channel devices in the same chip have the advantage of low quiescent power dissipation and high speed. But making complementary MOS transistors in bulk material poses processing problems. It requires diffusion of p regions of medium, uniform resistivity deep into the bulk silicon, and complex processes are needed to do this with reproducibility. Alternatively, the medium-resistance p region can be formed by epitaxially filling grooves in an n substrate with p silicon—but growth conditions are critical under this technique.

With silicon-on-spinel, these process problems simply don't arise. Complementary transistors can be made by using high-resistivity p-type silicon as the film. After the islands are etched, conventional photolithographic and diffusion techniques can be used to make the n-channel and p-channel transistors, as shown on preceding page, top left. And because space-consuming isolation junctions aren't needed, more complementary MOS transistors can be packed in a given area of silicon on spinel.

It's easier to deposit conduction lines with the

silicon-on-spinel technique, too. With bulk silicon, an insulating layer must be placed between the lines and the semiconductor substrate. Inevitably, this leads to parasitic lead capacitance, the magnitude of which depends on the substrate resistivity and the thickness and dielectric constant of the insulating layer.

With spinel, on the other hand, the conducting lines can touch the substrate directly, and parasitic lead capacitance is negligible. Moreover, the thin silicon film, instead of the conventional aluminum, can be used for the lines. It's only necessary to etch the silicon in the required interconnection pattern, then to highly dope the lines to give them low resistance.

Crossovers of conducting lines also are much simpler to fabricate with silicon-on-spinel. The first interconnection plane is the low-resistivity silicon film in direct contact with the spinel. An insulating silicon-dioxide layer is grown on the silicon, and a metal is deposited directly on the oxide to form the crossover. ■

German IC's

When does it pay to customize IC's?

High-volume office-machine applications justify mix-and-match approach in MSI units; chip area, power dissipation—and costs—are reduced

By Uwe Bertram, Hans Hoffmann, and Hans-Wilhelm Neuhaus

Philips Zentrallaboratorium GmbH, Hamburg

Off-the-shelf integrated circuits aren't necessarily the most economical answer in high-volume office-machine applications. In the long run, designers who invest a little extra time and money to customize their IC's ultimately can realize a net saving through reduction of both chip area and power dissipation.

Philips Zentrallaboratorium GmbH has designed several medium-scale integrated circuits for office equipment under the specialty policy. These IC's primarily employ diode-transistor logic, which is ideal for office machines—it's inexpensive, and although not the fastest logic form, speed is fully equal to the application.

But the cells used in the MSI circuits aren't exclu-

sively DTL: internally almost anything goes—transistor-transistor, emitter-transistor, or direct-coupled transistor logic—as long as the input and output levels are DTL-compatible. The result: a reduction in the number of transistors, diodes, and isolation islands, and in the total value of resistors. In a 1-bit arithmetic unit, for example, these reductions effected a 30% shrinkage in chip area; in a one-out-of-10 decoder, the area reduction was even greater. At the MSI level of complexity, many of these gates don't fan out to the external pins of the package. Therefore, only external gates must be compatible with the other circuits in the system and, in this case, operate at the 6-volt supply used for the Philips DTL series.

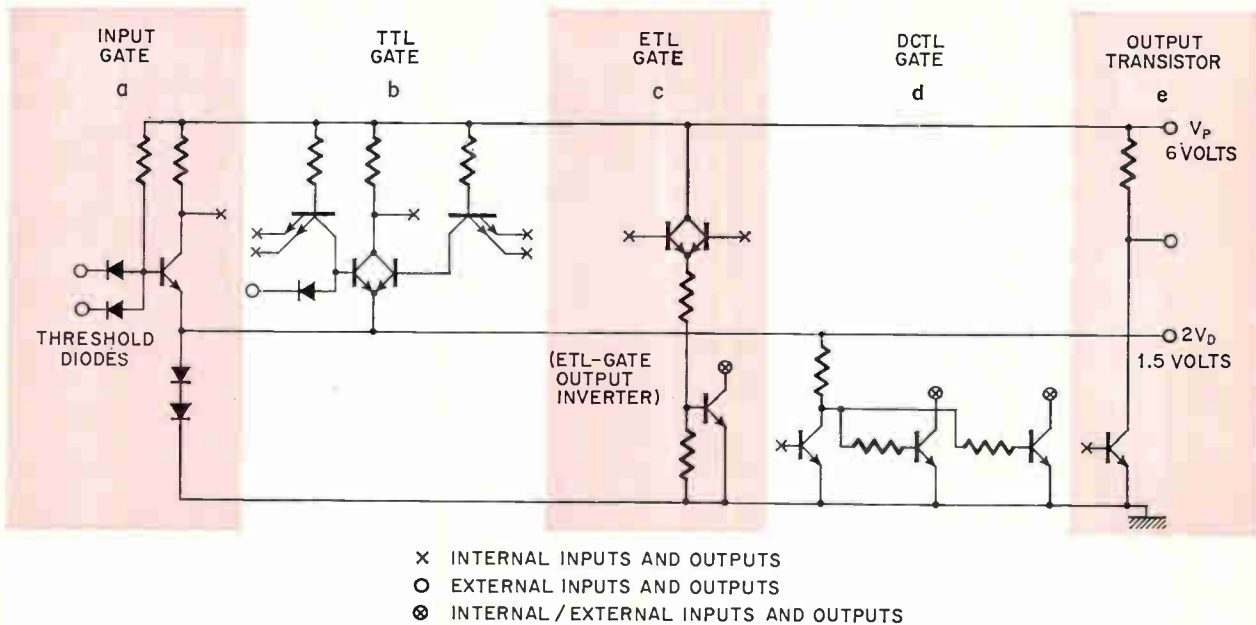

Basic cells. Specialized design approach permits use of various logic-gate configurations inside the chip, even though external voltage and current levels conform to DTL standards. All cells, however, are made by the standard DTL process.

Designing internal gates for lower operating voltage will cut power dissipation, and the level of integration for a given power consumption can therefore be increased. By adding an additional internally generated voltage level, a fraction of the current into the device can be used twice.

The basic gates at the top of this page were designed for Philips MSI circuits for office machines. The input gate (a) has two common threshold voltage diodes connected to the emitters of the inverter transistors. For a circuit with many inputs, this arrangement reduces the number of shifting diodes and base resistors.

Multiple-emitters

For the internal TTL gates (b), the supply voltage (8 volts maximum) is lowered by two diode drops, but still permits use of multi-emitter transistors. Internal gates can be coupled directly, without using shifting diodes, since a lower signal-to-noise ratio is tolerable inside the chip. To allow an additional internal input, a collector-base diode is provided at the collector of the multi-emitter transistor of internal gates.

For the inverter transistors in both the input gate and the TTL gate, the voltage corresponding to a logic zero is $2V_D + V_{CE(sat)}$, the sum of the two diode voltage drops and the collector-emitter saturation voltage. Since this is not the standard DTL logic zero, the ETL gate (c) is provided for controlling output inverters. In fact, in the Philips circuits ETL cells—which have a power-speed product comparable to that of DTL—are used to perform as many logic functions as possible, particularly since all the OR transistors can be placed in a common isolation region (the resistor diffusion) to save

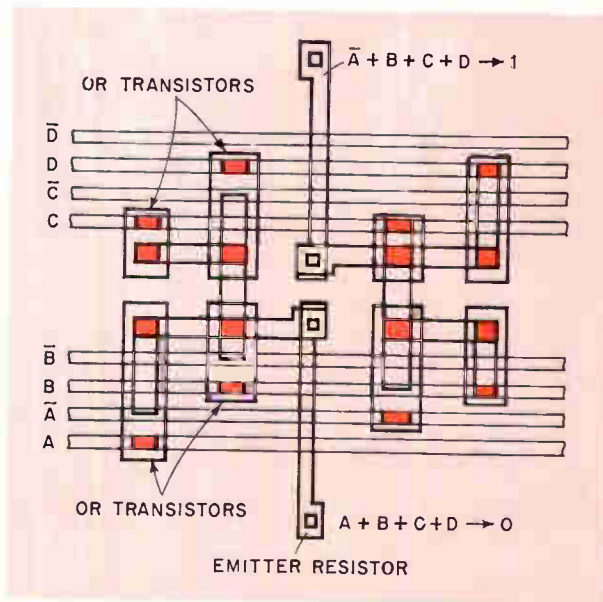

Middle of the road. ECL circuitry for decoding can be located at regular intervals under the information lines, considerably easing circuit layout.

space on the surface of the chip.

The output level of the ETL cell is the same as the standard DTL output, but its current is too low for adequate DTL fan-out. A high fan-out can be achieved by adding a direct-coupled inverter.

This gate design (a,b) insures that a certain minimum current flows through the two threshold diodes. Only a fraction of this current is needed to maintain the threshold; the remainder can drive gates in the voltage level between ground and $2V_D$, which is approximately 1.5 volts. The DCTL cell (d)

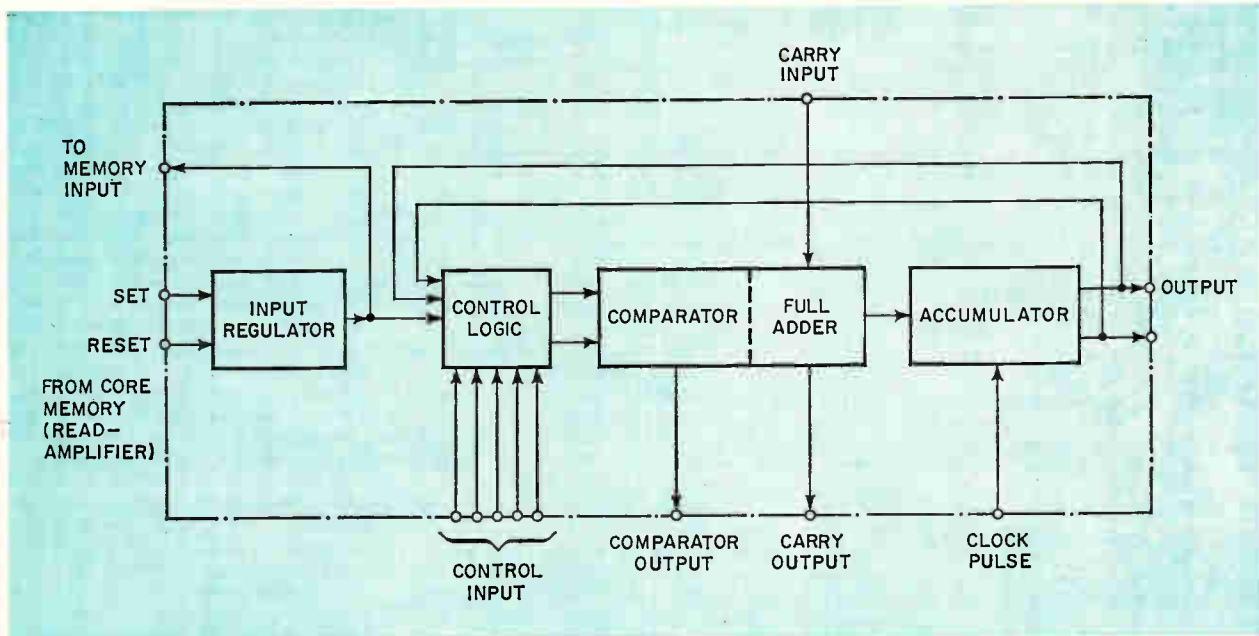

Partitioning. By dividing the circuit functions so that each bit is completely processed on a single chip, four identical circuits, instead of several different ones, can be used to make a four-bit arithmetic unit.

is well suited to this supply voltage.

The collector resistor of the inverter transistor of the ETL gate can be used in either of two ways. It can be connected to the $2V_D$ threshold voltage and thus control the DCTL gates in the lower voltage level, or it can be connected to the supply voltage V_P . The DCTL gates can switch the output transistor (e).

The disadvantage of the introduction of an additional voltage level, $2V_D$, for internal use, is that circuit layout becomes more complicated; more crossovers are needed.

In designing with the new internal supply voltage it's also important to make sure that the minimum current from the upper voltage level always remains higher than the maximum current required to operate the gates in the lower level. But since the relative currents are determined by resistor ratios, not by absolute resistor values, this isn't as difficult as it might seem.

Using these basic cells, Philips has built—with a standard DTL process—a one-out-of-10 decoder and a one-bit arithmetic unit.

The decoder converts the binary-coded-decimal code into the decimal code. It's intended for decimal-oriented machines—a printer, for example—and for directly controlling the drive transistors for ferrite-core memories. For the latter, the first three input terminals are used for coding and the fourth is employed for the read or write pulse.

One big problem in designing a decoder is laying out a crossbar system to distribute the eight information lines to the 40 inputs of the decoder gates. Fortunately, the ETL cells provide a simple solution in the Philips decoder because the transistors can use the same isolation region. The eight infor-

mation lines, divided into two groups of four lines each, shown on preceding page, control 10 ETL gates, each with four emitter-follower transistors in parallel to perform the OR function.

The special merit of this arrangement is its regularity. All the ETL-OR circuitry is located under the information lines, which are tapped by connecting to emitters directly underneath. The OR-functions are performed in the space between the two groups of information lines, and the OR signals are passed under the information lines to the inverters via the emitter resistors.

The only limitation on the size of the OR transistors is the process technology, so they can be made very small indeed. The collectors are connected to the upper supply voltage by the buried layer. The inverter of the ETL gate uses the current from the four-input double inverters to yield a large fan-out. The regularity of the cross-bar system allows an easy adaptation to any desired code.

The arithmetic unit even more clearly illustrates the advantages of the Philips tailored-design approach. For this application, in which the machine processes four bits in parallel, if the arithmetic unit were partitioned into the usual subfunctions—full adder, register, and accumulator—several distinct circuits would have to be designed, each of which could only be used once in each office machine. But by designing the MSI circuit to completely process a single bit, as shown above, the same circuit can be used four times in each machine.

This circuit has many input and internal gates, and only few outputs, so the cells shown on page 117 can be utilized to particular advantage. The accumulator flip-flop is built up from the DCTL basic cell. ■

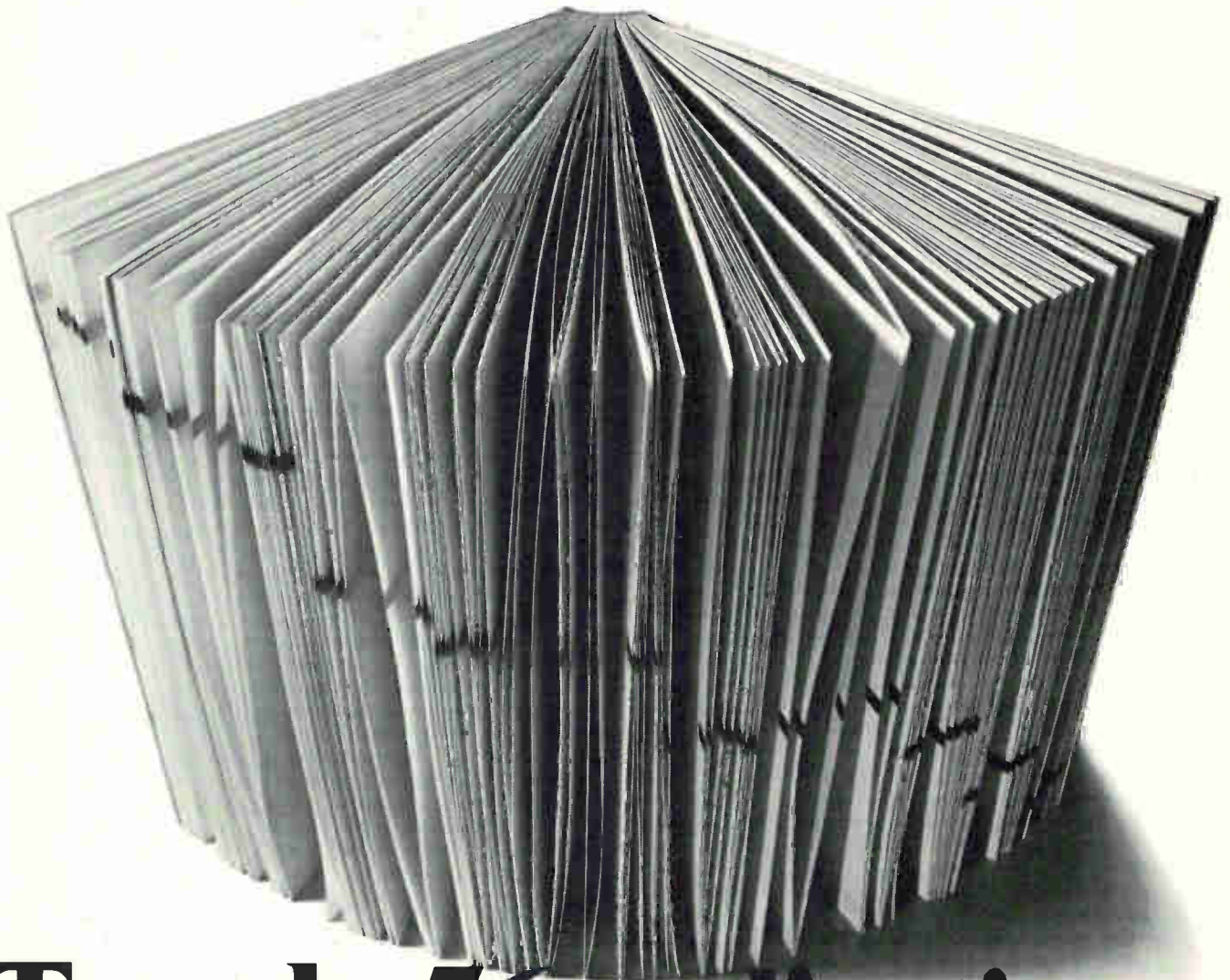

To make 56 applications, make one application.

Dear Signetics:

I herewith apply for my free copy of the brand new, second edition of your Applications Memos book. The one you've beefed up to a whopping 416 pages. And eight expanded sections. And a total of 56 applications.

I figure it can really help me come up with some great integrated circuit designs. (And when it comes to being helpful, your Applications Department wrote the book!)

Mail to: Mr. Stan Goodrich, Signetics Corporation, 811 E. Arques Ave., Sunnyvale, California 94086.

Name _____

Company _____

Address _____

City _____

State _____

Zip _____

Signetics 

Signetics Corporation A subsidiary of Corning Glass Works

**Now we're in the memory business.
And here's a bipolar scratch pad**



to help you remember.

Anyone with half an eye can see the bright future of the semiconductor memory business. And for months Raytheon's been deploying to nab a lion's slice of that action. We herded up all the processing niceties of our high-rel military components. All the 10th-mil-tolerance magic of our Ray III TTL. All our way-out beam-lead technologies. And now we're in the business.

Leading off with our spanking new 64 bit bipolar RAM. We guarantee a 45 nanosecond read time, but it usually coughs up a word in under 35 ns. And the entire chip, including on-chip address decoding, write and sense circuitry, perks along on only 350 mW. Cost per 100-000 is \$51.50 (—55° to +125°C version) and \$38.00 (0° to +70°C). Available now, off distributors shelves, in a 16-lead DIP. Flatpacks coming up.

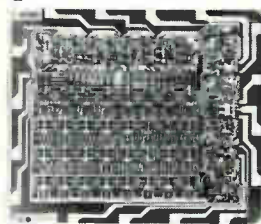

What else? Before the end of the year, look for beam-lead 256-bit and 512-bit multi-chip arrays in 24 pin DIP packages.

And by next June, a monolithic beam-lead 256-bit bipolar scratch pad in a 16-pin DIP. With super-quick access times, thanks to far tighter tolerances and new cell designs. Plus Schottky barrier diodes, washed emitters and like that.

Then in 1970 we'll be unveiling a line of IC read-only memories. And after that it's just a little time until we're mainly in the mainframe memory business.

All of which proves you better keep us in mind when you're in the memory market. The company that gets the ideas and delivers the goods. Raytheon Semiconductor, Mountain View, California. (415) 968-9211.



Circle 121 on reader service card

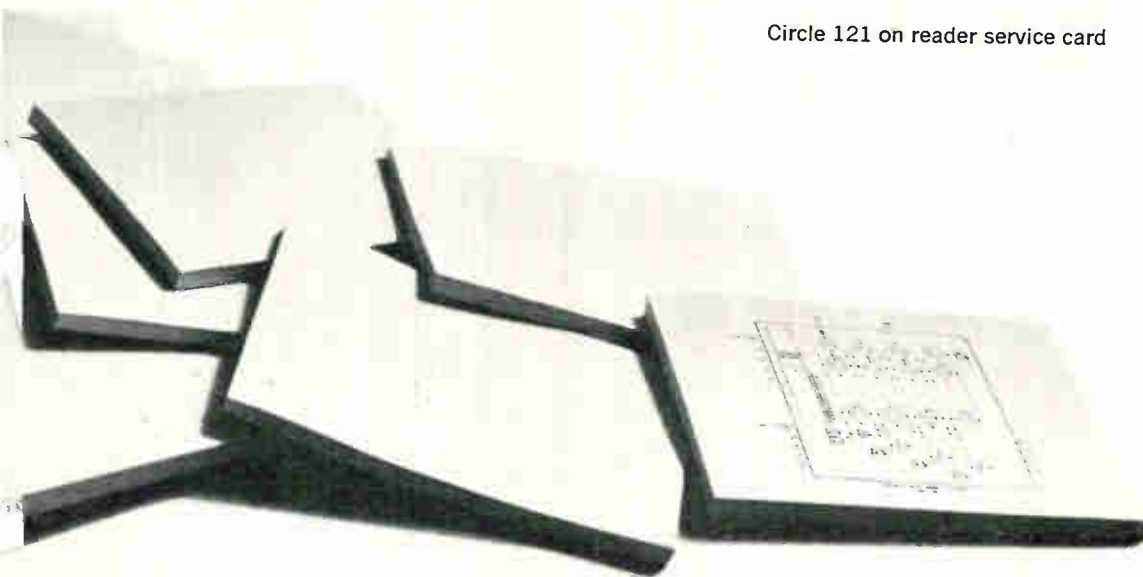

FIRST 256-BIT DECODED IC MEMORY

This fast random-access memory is world's first silicon gate MOS.

Model 1101.

- Fully decoded
- 1.5 μ sec max. cycle time
- DTL and TTL compatible
- OR-Tie capability
- Low power dissipation (50 μ W/bit on standby, 2 mW/bit during access)

Guaranteed cycle times

Test	Speed	Conditions
Read cycle	1.1 μ sec typ. 1.5 μ sec max.	5v input pulse. 10 nsec rise and fall. 1.5v reference level.
Write cycle	0.3 μ sec min.	Load is 1 TTL gate.

Guaranteed DC characteristics

(At $T_A = 25^\circ\text{C}$, $V_{CC} + 5\text{v}$, $V_{DD} = -7\text{v}$, $V_D = -10\text{v}$)

Test	Limit	Conditions
Input load current	500 nA max.	$V_{in} = 0\text{v}$
Power dissipation	700 mW max.	
Input "low" voltage	-10v to +0.5v	
Input "high" voltage	+3v to +5.3v	
Output sink current	3 mA min.	$V_{out} = 0.45\text{v}$
Output "low" voltage	+0.45v max.	$I_{OL} = 1.5\text{mA}$
Output "high" voltage	+3.5v to +5.0v	$I_{OH} = +10\mu\text{A}$

Prices, Model 1101

1 to 9: \$150	100 to 249: \$ 65
10 to 24: \$110	250 to 499: \$ 55
25 to 99: \$ 80	

Available at over 40 locations

For delivery, call your Intel distributor, Cramer Electronics or Hamilton Electro Sales.

If more convenient, write or phone us directly. Call collect (415) 961-8080.

Intel Corporation is at 365 Middlefield Rd., Mountain View, Calif. 94040. Telex INTEL 34-8366.

Intel regional office in Costa Mesa, Calif., phone (714) 545-8541.

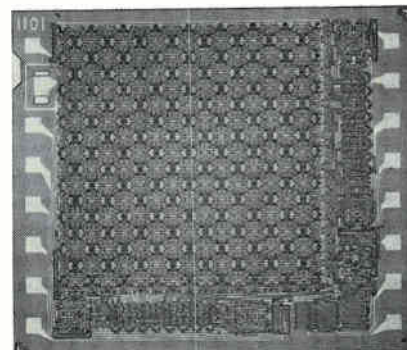

intel

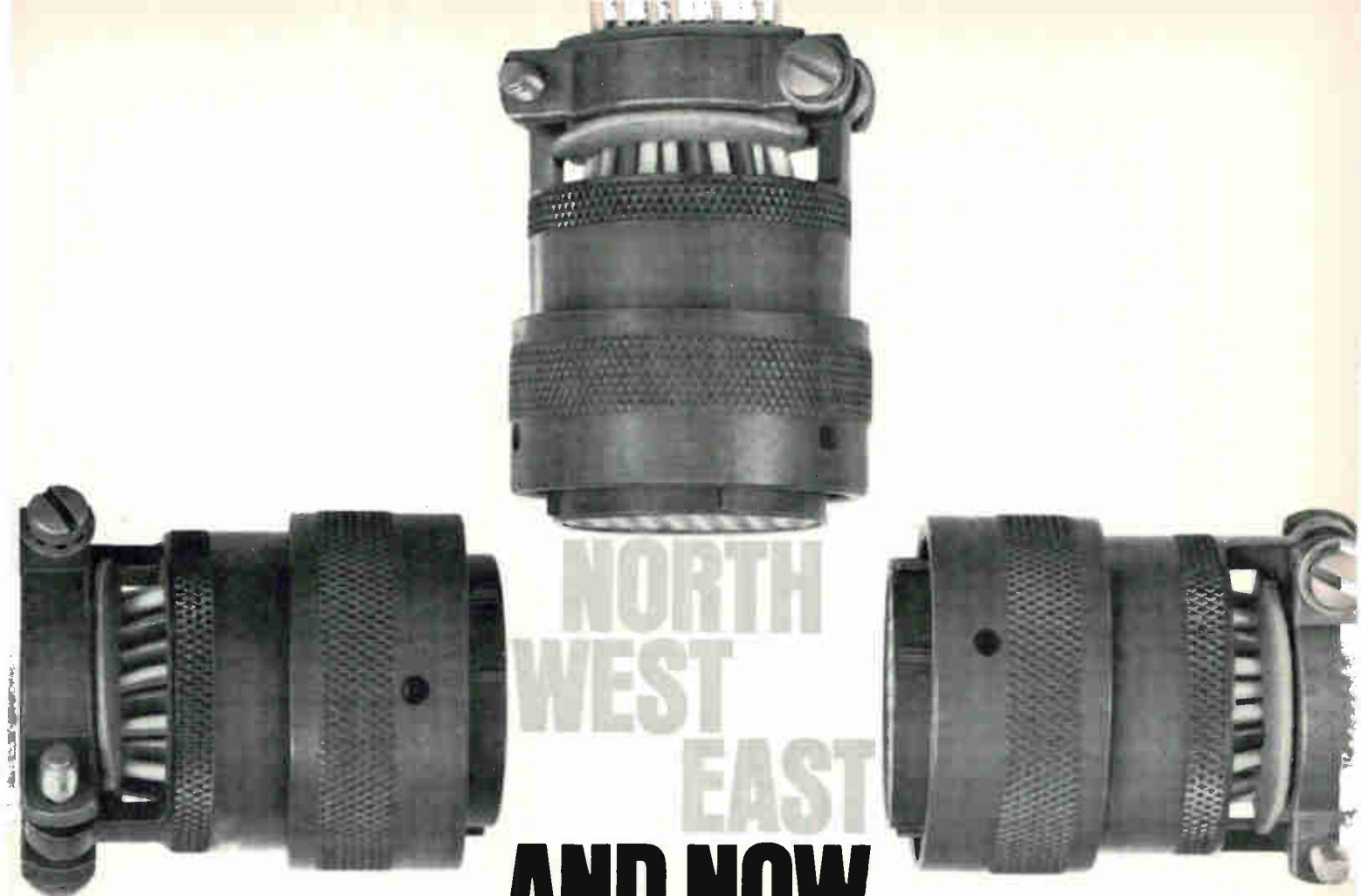

NORTH
WEST
EAST

AND NOW SOUTH

**NEW QIK-FACILITY
IN THE SOUTH**
assures record delivery wherever you need
Bantam™ miniature round connectors.

With the opening of our latest Qik-Facility in Garland, Texas, electronic and avionic firms in that state as well as Kansas, Oklahoma, Tennessee, Georgia, Alabama and Florida can now benefit from Burndy "clean room" assembly and rapid delivery of Mil C-26482, smooth crimp and solder in all configurations, and the new line of Trim Trio Bantam.

At all our locations, highest military and industry standards are constantly maintained in a temperature-controlled and humidity-controlled atmosphere, with specialist staffs of engineers available to help determine your requirements and assist your installers.

Burndy also offers unique installation tooling, capable of producing 2,000 crimps per hour. With no big investment! Your nearest Burndy sales office has direct contact with one of these Qik-Facilities: North, Chicago, Ill.; West, El Segundo, Calif.; East, Norwalk, Conn.; South, Garland, Texas.

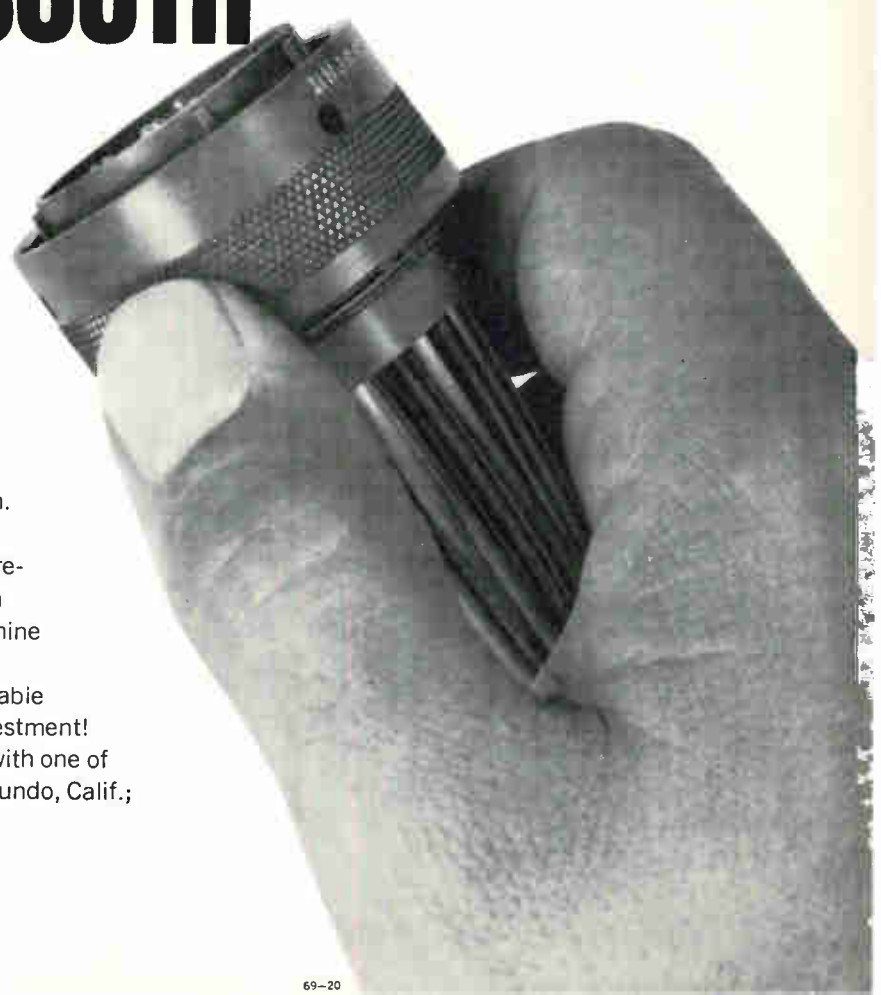

 **BURNDY**
Norwalk, Connecticut

When it comes to systems that give you total surface finish plus geometric measurements all recorded on paper, the choice is pretty limited.

The Surfalyzer 360 Gaging Station.

The Surfalyzer 360 gives you more information than any other system on the market. For example the part shown here is being checked for roundness, concentricity, axes alignment, perpendicularity, parallelism, and surface finish.

You also can get complete surface mapping, including profile, flatness, waviness, roughness, and average roughness. And the stylus force can be as light as 50 mg., so you can use the Surfalyzer 360 on soft material without fear of damage.

The Surfalyzer 360 measures ID's and OD's from 0.050" to 45". Spindle accuracy is 0.000,001" axially and radially. Basic system linearity is 1%, with extremely high frequency response. All the facts can be recorded with non-smudging ink on either a linear or polar recorder.

Besides microinch roundness measurement capabilities, the Surfalyzer 360 has a linear drive with



a 12" stroke and 1 microinch accuracy. In addition there's a linear recorder, a scanner for complete surface mapping of an area, switching provisions for using two probes and adjustable height stands. The entire station is vibration isolated with its own surface plate.

Want to know more about the most complete surface finish and geometric measurement system on

the market? Write or call for the full Surfalyzer 360 story. Clevite Corporation, Gaging and Control Division, 4601 N. Arden Drive, El Monte, California 91731. Tel: (213) 442-7755.

CLEVITE

The non-catalog connector.

If you can't buy it. We'll make it. Any kind of printed circuit connector.

Tell us how many positions, how many contacts. And what kind of shape it ought to be in.

We'll take it from there, and turn out a connector for you, at a price that's probably the lowest in the business.

The biggest reason is our contacts—because they're the biggest single factor in the price of connectors.

We put more gold at the contact area than any plater does. But we weld it there instead of plating it. So we use less gold overall.

As a result, our contacts are the best you can buy. (Maybe that's why many of our competi-

tors use them.)

We also do our own wire drawing, coining, forming, bending, and solder plating. We design our own tooling and mold our own plastic bodies. And we assemble and test the whole connector ourselves.

If you're looking for ordinary connectors look in ordinary catalogs.

But if you want something a little special, now you know where you can go.

Sylvania Metals & Chemicals, Parts Division,
Warren, Pennsylvania 16365.

SYLVANIA
GENERAL TELEPHONE & ELECTRONICS

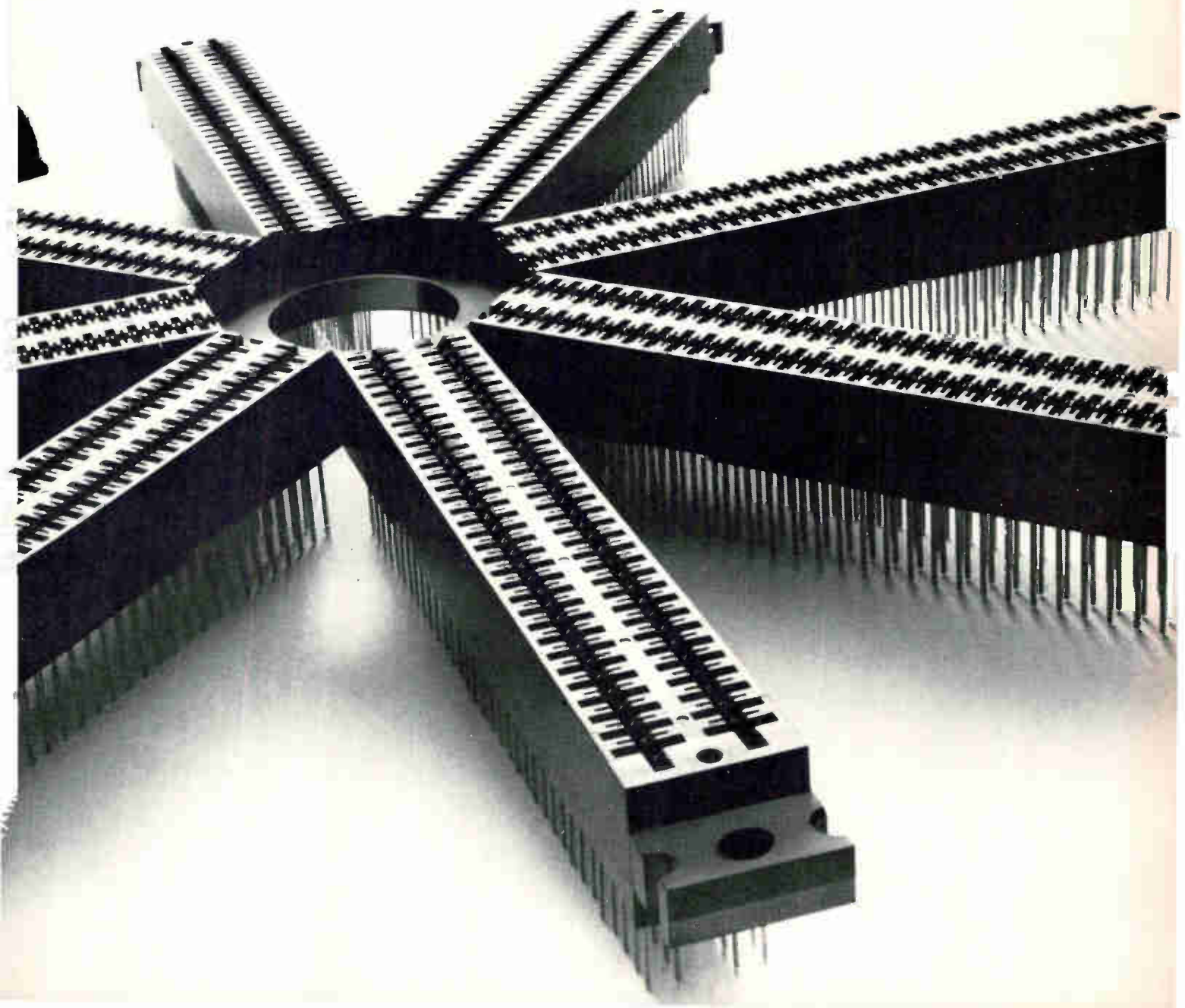

predictable

pulse performance

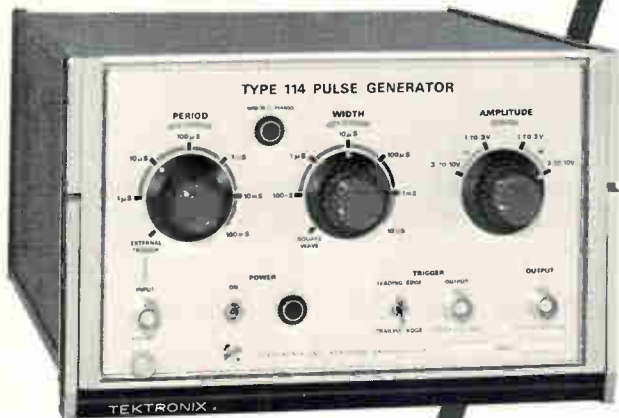

from
Tektronix®

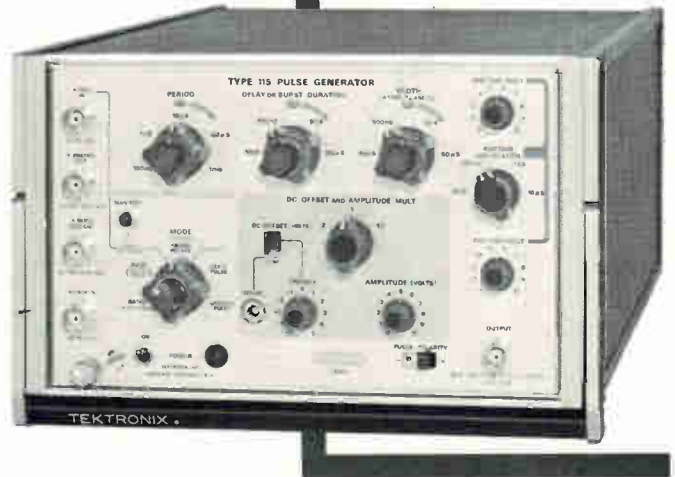

TYPE 114 PULSE GENERATOR

- 10-Hz to 1-MHz Repetition Rate
- 10-ns Risetime and Faltime
- Pulses or Symmetrical Squarewaves
- ± 10 V into 50 Ω , Short-Proof Output

Pulses or Squarewaves—You may have either using this solid-state generator! The compact Type 114 provides pulses with 10-ns risetimes and falltimes, periods variable from 1 μ s to 100 ms and widths variable from 100 ns to 10 ms. Pulse amplitudes are adjustable from ± 1 V to ± 10 V into 50 Ω . Aberrations are $\leq 5\%$ at ± 10 V into 50 Ω . Symmetrical squarewaves are instantly available by setting the Width control to the squarewave position. Squarewave period and amplitude ranges are the same as for pulses. External trigger input permits synchronizing the Type 114 output with other events up to 2-MHz repetition rate. An optional rack adapter provides for mounting one or two Type 114 or Type 115 Pulse Generators in only 5 1/4 inches of panel height. Consult your Tektronix Catalog for detailed description of the Type 114 and the optional rack adapter.

Type 114 Pulse Generator \$340

NEW! TYPE 115 PULSE GENERATOR

- 100-Hz to 10-MHz Repetition Rate
- Variable Risetime and Faltime, 10 ns to 100 μ s
- Variable DC Offset, ± 5 V
- ± 10 V into 50 Ω , Short-Proof Output

This multi-purpose, solid-state generator produces exceptionally clean pulses with aberrations less than 3% P-P at ± 10 V into 50 Ω . Pulse risetime, falltime, width, delay, period, amplitude and baseline offset are separately variable, permitting precise waveform simulation. Five operating modes offer a variety of outputs—undelayed pulses, delayed pulses, paired pulses, burst of pulses and gated pulses. Risetimes and falltimes are continuously variable from 10 ns to 100 μ s and periods are variable from 100 ns to 10 ms. Pulse widths are variable from 50 ns to 500 μ s with duty factors to 75% (50-ns minimum pulse separation). A continuously variable DC offset feature permits positioning pulse baseline through a range of +5 volts to -5 volts. Triggering is selectable, internally or externally. A detailed description of the Type 115 Pulse Generator is found in your Tektronix Catalog.

Type 115 Pulse Generator \$865

U.S. Sales Prices FOB Beaverton, Oregon

To evaluate either of these pulse generators in your application, call your Tektronix Field Engineer, or write Tektronix, Inc., P.O. Box 500, Beaverton, Oregon 97005



Tektronix, Inc.

committed to progress in waveform measurement

Air traffic control for the 1980's: Survival to cost billions of dollars

ATC group sees wider computer role, scanning beam microwave ILS as essential components in upgrading the National Airspace System

By Ray Connolly

Associate editor

If today's air traffic control is in a state of crisis, what will be the picture 10 years from now when air traffic is expected to be doubled? The Federal Aviation Administration, which is having trouble just improving the present National Airspace system (see p. 54), needs to begin work now on developing the next-generation system to meet the 1980-and-beyond requirements.

This call for top national priority is sounded in a report to the Department of Transportation from the Air Traffic Control Advisory Committee. Contents of the report are being disclosed publicly at the IEEE Electronic and Aerospace Systems Convention and Exposition (Eascon) in Washington this week.

The study spells out requirements for, among other things, the hardware that needs to be developed and built for the proposed system—work that would require billions of dollars to be spent with the electronics industry.

Should the Administration fail to assign a high national priority for upgrading the National Airspace System, there will "10 midair collisions a year" involving commercial air carriers and general aviation aircraft by 1980, predicts Lawrence A. Goldmuntz, executive secretary of the ATC Advisory Committee.

The chairman of the ATC Advisory Committee, Ben Alexander, who is chairman of General Research Corp., extrapolated the data on 1968 near midair collisions, and came up with the same kind of

grim prediction. Alexander's committee predicts collisions between air carriers and general aviation craft at nine in 1980, rising to a phenomenal 41 by 1995, if work doesn't get under way on the new system soon.

Though by 1980 U.S. aviation activity is expected to be at least double the 1968 rate, and to double again by 1995, the projected collision rate will rise much more rapidly. Moreover, says Alexander, "The demand for ATC service is estimated to almost treble by 1980 and to treble again by 1995."

The committee "strongly and unanimously recommended a program starting immediately to selectively upgrade the National Airspace System beyond 1995.

Components of an upgraded NAS system would include: scanning beam microwave instrument landing systems for landing and terminal navigation; major additional computer capacity; a discrete addressed ATC radar beacon system, including an air-ground data link of varying sophistication depending on the aircraft; provisions for intermittent positive control (IPC) where justified by traffic congestion to reduce the midair collision threat; and improved accuracy for vhf omnirange (VOR) and higher-capacity distance measuring equipment (DME). Further, airports would be designed and instrumented for higher capacity by increasing use of parallel runways, and halving separation between them and approaching aircraft as well. Achieving the latter, however,



A near miss—this time!

depends on successful development of scanning beam microwave ILS, precise monitoring and data-linked commands.

Future caveats. For 1995 and beyond, the committee warned that "some caution is in order" even though its space and computer studies were encouraging. Reliability, they contend, is the key to both techniques since "they must perform virtually without outages." Further, it is not yet known if the fully automatic controller can work its way out of emergency situations safely, while a satellite system

(continued on p. 129)

ATTENUATE & MODULATE, 250 MHz- 12.4 GHz for \$550!

Model E-150 shown 1/2 size



For less than half the cost elsewhere, the Alfred Model E-150 PIN Modulator provides electronically controllable attenuation in one unit over a broad frequency range with wide dynamic range and low SWR at all attenuation levels.

The E-150 replaces four single band units for maximum economy and flexibility. To provide control and power signals for one or two PIN modulator units, Alfred offers the Model E-150P PIN Controller. Using the E-150P, attenuation and modulation can be varied continuously. The PIN Controller provides both local and remote operation. Price of the E-150 is \$550; the E-150P, \$175.

For more information, call your Alfred sales engineer or write Alfred Electronics, 3176 Porter Drive, Palo Alto, California 94304. Phone: 415-326-6496. TWX: 910-373-1765.

ALFRED ELECTRONICS

Collision avoidance: Cockpit or on the ground?

The concept of intermittent positive control (IPC) using a ground-based computer for aircraft collision avoidance appears at first glance to be one of the most controversial recommendations of the ATC Advisory Committee. U.S. air carriers, working through the Air Transport Association, are in the midst of flight testing independent airborne systems that use competing hardware developed by McDonnell Douglas, Bendix, and the team of Sierra Research and Wilcox Electric.

But the Lambda Corp. of Rosslyn, Va., which studied IPC feasibility under a six-month, \$20,000 FAA contract, doesn't see the concept as competitive with the cockpit systems now being tested. Instead, Lambda's Ken Willis sees IPC as a more sophisticated, parallel system for the 1980's and beyond, when an upgraded National Airspace System (NAS) and air terminal system could become operational. Further, says Willis, IPC would only be used as a backup to a primary air traffic control system.

A cockpit system, which will prevent collisions of comparably equipped aircraft, is expected to be available to airlines next year.

Under the IPC concept, aircraft would be equipped with a simple ground-to-air data link and display in addition to an ATC radar beacon transponder. The suggestion that an IPC data link and display could be integrated with a beacon transponder is already generating concern within the aviation community as to costs associated with redesign and installation.

Limiting commands. Lambda's concept, aimed at preventing pilots from being overwhelmed by commands from an IPC system as well as limiting memory requirements for a ground-based computer, calls for dividing the airspace and putting this information in a computer memory in numbered cells. The dimensions of these cells would correspond with the distance an aircraft could cover in 40 seconds at a speed of 300 knots. As one of its six-to-eight functions, says Willis, a ground computer such as the Univac 1320, which probably will be used in the air terminal system, would reserve one or more words for each cell in memory—a

technique Lambda calls implicit geometric filtering.

An aircraft's identity would be stored in the cell through which it is passing. In the event an attempt was made to place another aircraft in an occupied cell, a warning would be flashed immediately to the pilot. [See diagram describing cell approach on p. 129]. The computer would issue positive commands via the data link directly to the pilot display without intervention of a human controller. Lambda asserts that if the commands were followed—whether delivered by a computer in a terminal area, or one at an en route control point—safe separation distances could be maintained between aircraft.

By attaching data recorders to IPC computers, says Willis, flight patterns and computer commands could be stored for the record and used to determine responsibility for near-misses or midair collisions. With such a record, pilots refusing to follow computer commands could be "ticketed" for air-traffic violations, he suggests.

Though the IPC and the cockpit collision-avoidance systems are similar in that equipped aircraft do not have to be under positive air traffic control to avoid collisions, IPC would not operate on transoceanic flights or over countries where the ground-based system was not installed. The Air Transport Association's airborne package, however, would operate anywhere in the world where similarly equipped aircraft would be flying.

Lambda calculates that IPC could function effectively even in "worst case" projections and include aircraft flying random patterns with no procedural separation and without benefit of see-and-be-seen evasive maneuvers.

Long way off. Nevertheless, Willis emphasizes only initial design work has been completed on the computer algorithm and that considerable effort remains to develop an efficient thoroughly debugged software package. Lambda believes IPC could be implemented by 1975 if appropriate data links and displays are also operable.

Willis says IPC could be used to warn general-aviation aircraft to keep clear of terminal control areas.

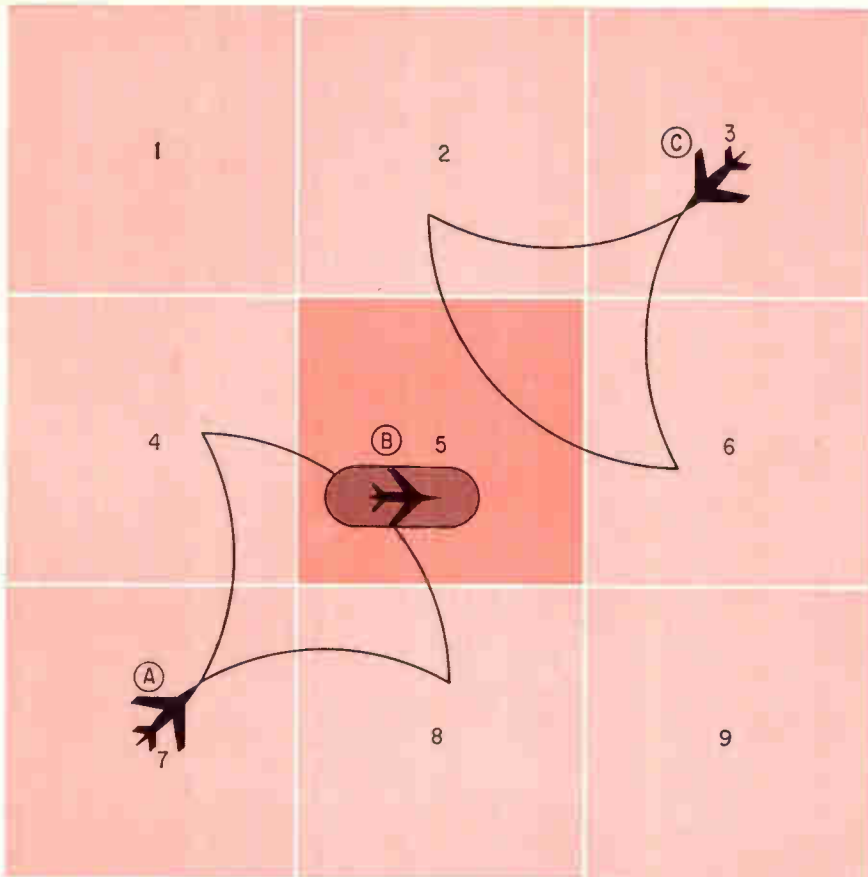

WORD	CONTENT
1	0
2	C
3	C
4	A
5	A+B+C
6	C
7	A
8	A
9	0

(continued from p. 127)

must be immune from catastrophic failure "due to hostile human acts."

The recommendation to DOT secretary John Volpe: a research program to run parallel with the NAS upgrading to clarify issues in designing and scheduling an ATC system for the year 2000.

The most significant unresolved question is whether or not the Nixon Administration is willing to initiate a spending program estimated to run upwards of \$4 billion to \$5 billion to achieve all the NAS upgrading, including some \$250 million in R&D—a figure far greater than FAA has ever been able to get from Congress in the past. Other political considerations that could slow down implementation of the report's technology are the continuing in-house dispute between

Collision avoidance. In Lambda's plan, airspace is divided into cells; one word for each cell is stored in a ground-based computer. When two or more aircraft are loaded into one word, as in word 5 at left, the computer flashes a warning to the pilots. Cones in front of aircraft A and C, both flying under visual-flight clearance, indicate where the aircraft could be in the next 40 seconds. Aircraft B is flying under instrument-flight clearance. Each cell represents distance covered in 40 seconds by aircraft travelling at 300-knots.

DOT and its subsidiary, FAA, over program responsibility. A number of sources point out that the Advisory Committee report was authorized by DOT—not FAA. Further, there is the distinct possibility that some segments of the aviation community—general aviation as well as air carrier interests—will feel some of the recommendations run counter to their own interests—for example, the recommended ground-based collision avoidance system that seems to conflict with the Air Transport Association's cockpit system now in test (see panel).

In apparent FAA criticism, the report says current ATC problems are "exacerbated by impatience

KEEN CRYSTAL DETECTORS

10 MHz to 12.4 GHz
 ± 0.5 db Response
 SWR less than 1.5



With flat frequency response and low SWR, Alfred broadband crystal detectors, Models 1001, 1002, and 1003 provide top performance in your leveling, power measurement, broadband RF detection and reflectometer requirements.

Brief Specifications.

Frequency Range: 10 MHz-12.4 GHz

Frequency Response: ± 0.5 db full range

SWR: Less than 1.5 full range
 Sensitivity (no load); Power input required to produce 0.1 v rectified output—no greater than 0.4 mw

Square Law Response: Within ± 0.5 db, low level to 1 mw input when properly terminated.
 Maximum Input Power: 100 mw
 Connectors: Input, Model 1001 Type N, Model 1002 OSM, and Model 1003 APC-7 output BNC.
 Price: \$115 with BNC, \$160 with OSM Connector, and \$175 with APC-7 Connector.

For more information, call your Alfred sales engineer or write Alfred Electronics, 3176 Porter Drive, Palo Alto, California 94304. Phone: 415-326-6496. TWX: 910-373-1765.

ALFRED ELECTRONICS

Instant module time check

CURTIS 620-PC
ELAPSED TIME
INDICATOR



SHOWN 1½ TIMES
ACTUAL SIZE

Increasingly important in military equipment philosophy is field or line replacement module.

With this Curtis Elapsed Time Indicator mounted on each functional replaceable module of your system you have an accurate record of operating hours for each individual module regardless of its installation history. Operating time record becomes part of module. Unit is extremely small, weighs little, uses little power, and is not expensive! For full details, ask for information on Model 620-PC. Meets requirements of MS 3311 (AS).

WRITE OR CALL

Curtis

INSTRUMENTS, INC.

200 Kisco Avenue
Mount Kisco, N.Y. 10549
(914) 666-2971

How upgraded ATC system would work

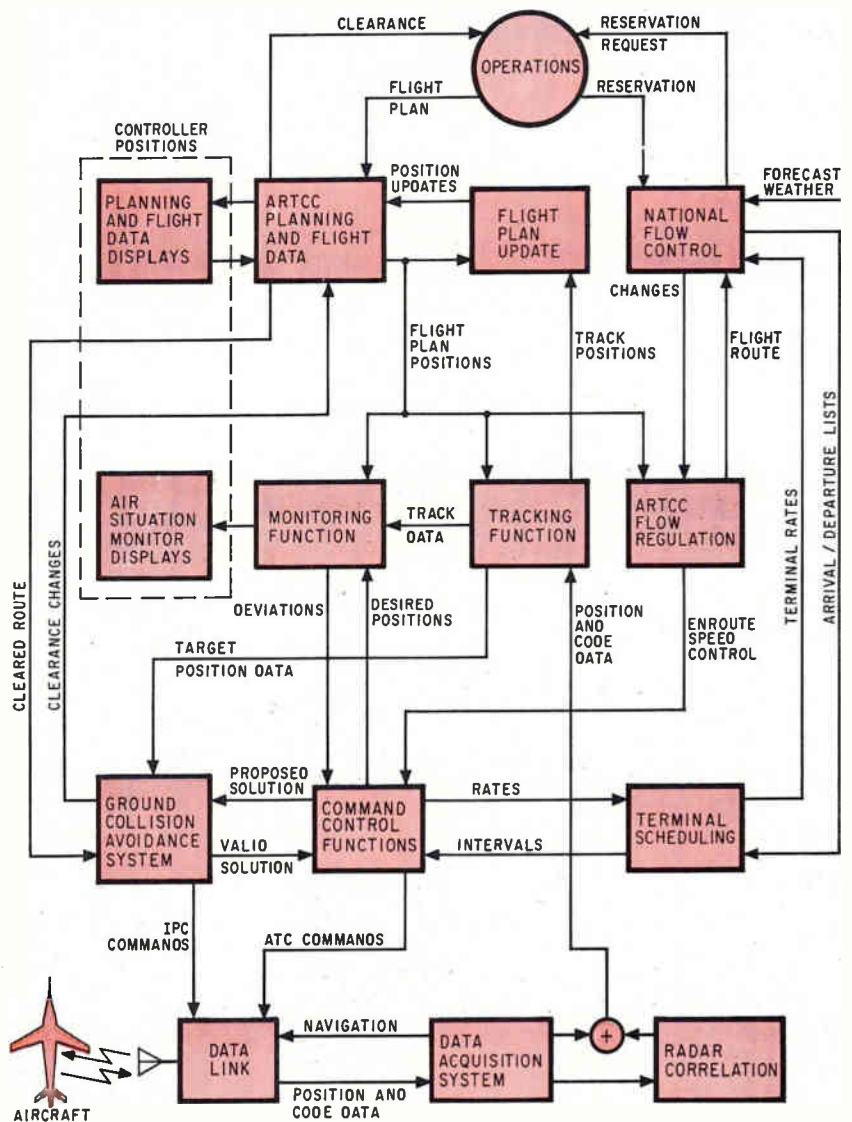

with the slow pace with which modern technology is being applied to air traffic control.”

Nevertheless, the committee decision to upgrade the National Airspace System was based on the less expensive economics of evolution using “well-established technology” and “thoroughly tested operational concepts” to minimize the risk of failure. This approach was chosen over “revolutionary” systems—“revolutionary” in that they advocate changing the system fundamentally and completely,” explains the chairman. He advocates “giving control back to the flight deck” so that aircraft could carry most ATC hardware on board, or implementing integrated navigation, communication and data acquisition functions through such techniques.

In directing its first require-

ments for upgrading the NAS to a 1980's system, the committee relies heavily on automation. Using a projected Los Angeles basin traffic pattern 10 times that of 1969, and determining major system functions—flow regulation, flight data processing and updating, flight progress monitoring, terminal sequencing and spacing, separation assurance and data acquisition system processing—the study projects an EDP system capable of handling up to 42,660,000 instructions-per-second in an en-route system. Memory capacity requirements run to a comparably staggering scale, calling for as much as 1,486,400 words of fast storage in an en-route, system backed up by another 1,332,000 words of memory.

Though the third-generation ATC system computers also must provide for automatic recovery from a

variety of system failures—and do it as an integral part of the computer operational program—government and EDP industry officials agree that the state of computer art will be able to meet these requirements.

What will be the state of the 1975 computer art for use in a 1980 system? The study shows 10 technology requirements, including a reliability factor for basic electronic components that is one order of magnitude greater than that experienced now. The speed of these components will have to be near 2 nanoseconds to obtain add times of 50 nanoseconds—a figure that equates to a maximum through-put of 20 million instructions per second.

In the technology cost race, substantial reductions are contemplated. Loaded logic, for example, is forecast at 60 cents to a dollar per logic node—including packaging, cooling, power, wiring and cabinetry. Main memory with a 150-to-500 nanosecond cycle time is projected to cost about 5 cents a bit regardless of whether film, wire or logic technology is used.

Second-level random access backing memory of film, wire or MOS logic would have a cycle time in the 2-to-5-microsecond range and cost a 1/10th-of-a-cent a bit. Designers forecast data banks of 10^7 to 10^8 using this approach, while ultrathin film memory for non-destructive readout is seen most cost-effective in 10^8 to 10^{10} bit packages.

Beacon. The ATC radar beacon system—primary source of position, identity and altitude in the National Airspace System—“already is approaching overload” in some of the busiest terminals, according to Mitre Corp.’s Robert C. Renick, who worked for the committee with his boss, Mitre president Robert Everett.

To produce a next-generation beacon replacement, the committee chose an evolutionary Rho-Theta design concept on which present beacons are based. Rho-Theta systems measure aircraft range and angle. Of the four in-depth studies of data acquisition, this approach beat three kinds of trilateration using a constellation of satellites, one-way ranging (time-frequency), and two-way ranging, both of the

latter using ground stations.

Five general principles—including one usage limitation—should be followed for advanced beacon design, according to Renick. They include the obvious requirements that all planes have automatic altitude encoders in their beacons; data acquisition, accuracy and reliability will be adequate for an automated ground system, and beacons will be used in en-route and terminal situations for primary data acquisition, while an upgraded Vortac—vhf omnirange tactical air navigation—will be the primary navigation system. Additionally, upgrading of ground interrogator hardware will have to be effected so that aircraft with contemporary beacons still will be usable. At the same time, FAA will have to implement controls to prevent unrestrained use of interrogators that might overload the system.

Two phases. Renick believes an upgraded beacon system could be gradually introduced in as little as two years in two phases. In the first, improve interrogators operating only in two standard modes—range and azimuth, and range, azimuth and altitude—would be added to, or used as replacements for, some existing units. By separating these interrogators from the radar, better coverage and reception will ensure, according to the Mitre manager. With altitude reports from all aircraft, this third-dimension data can be delivered to the central computer which, in turn, can deliver beacon overlays registered in the coordinates of any radar. Thus, system overload can be controlled by turning off unneeded separate interrogators at each radar.

Phase II will permit discrete addressing of aircraft equipped with new transponders. New interrogators will transmit and receive data link information, interleaved in time and space with the standard modes. In the two respective modes interrogated aircraft respond with selected coded information on range and on range and altitude, respectively.

Though this new hardware will permit more accurate aircraft positioning in high-density airspace, it also suggests either larger outlays for general aviation aircraft if they expect to continue to use high-



HEAT-SHRINK MYLAR* TUBING

Having an extremely high dielectric strength, HS “Mylar” may be specified in very thin wall thicknesses to reduce space requirements. It is shrinkable as much as 50% to provide an immovable, tight fit. *TM-DuPont Co.

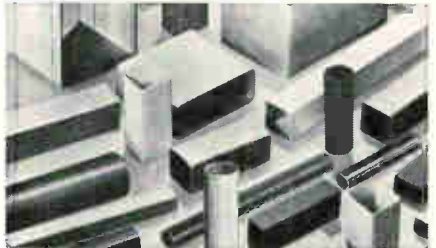

DIELECTRIC KRAFT TUBING

Meets general dielectric requirements for a variety of applications including; coil and transformer forms, capacitor covers, light shields, spacers, etc. Can be produced in almost any wall thickness and tubing dimension.



RESINITE PHENOLIC TUBING

This phenolic impregnated kraft tubing is mechanically stable, non-corrosive and reasonably priced. Resinite tubing may be punched, slit, cut and have lugs applied for a large number of applications such as coil forms, spacers and shafts.

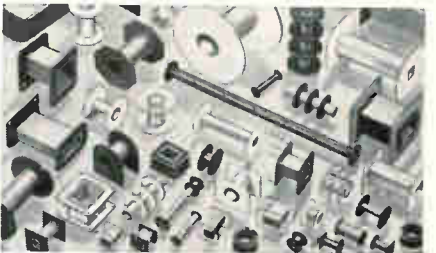

FABRICATED BOBBINS

A wide range of materials and the largest inventory of tooling in the industry allows you to have your choice of high quality bobbins at reasonable prices. Precision’s patented “Plastilokt”® process assures positive affixing of flanges.

Precision
Paper Tube Company

1033 So. Noel Avenue, Wheeling, Ill. 60090
Phone: (312) 537-4250, Chicago: 631-1445

Until our new Unipulser II came along,



single decade counters were pretty much alike.

Compare it with any competitor on these eight points:

- 1. Size.** Unipulser II is more compact than any comparable electric counting decade.
- 2. Durability.** Mechanical and electrical transfer lives are longer than those of comparable decades. That's because Neyoro g wiper contacts provide the highest quality electrical contacts available.
- 3. Power.** Three voltages are standard, not just one. 12, 24 and 48 VDC.
- 4. Readability.** Large figures, wide-angle viewing.
- 5. Unitized metal diecast frame.** This makes Unipulser II self-supporting from the front and simplifies installation. Push button preset model has the same frame dimensions.
- 6. Input.** Counts from transistorized circuits, photocell impulses or standard contact closures. Speeds up to 40 cps; count is retained even if power fails.
- 7. Modular.** Each Unipulser II has its own drive input circuit, transfer and reset circuit and an eleven-line output for control or electrical readout. This lets you combine Unipulser II's in series for sequential counting or parallel entry. Control circuitry also lets you use them as recycling or single cycle predetermined counters—or as counters with remote display. Or even as readout devices for *other* counters or recording units.
- 8. Price.** Here's the best part. Our prices begin at \$18 and go down just as fast as anyone else's on quantity buys. Push button reset model begins at \$19. All in all, you won't find another decade that does so much for so little. For full information and specifications, write for Unipulser II catalog. 622 N. Cass Street, Milwaukee, Wisconsin, 53202.

The modular Unipulser II has hundreds of uses, from metering to data processing to all types of production control.



DURANT
DIGITAL INSTRUMENTS
A CUTLER-HAMMER COMPANY

density terminals, or installation of intermittent positive control (IPC) collision avoidance receivers to prevent garbling of beacon replies in high-traffic areas.

The hangup. Implementing the advanced beacon system, however, will require "prior agreement of all common system users—civil and military," concedes the Mitre official. "This agreement may, in practice, be unattainable for various political or operational reasons, and therefore a different approach may be more attractive in the end." One possible source of complaint is the general aviation community, whose beacon system costs would be higher since an entirely new system—rather than just an IPC decoder and display—would be required.

Renick suggests designing a new interrogator system around a new frequency in the 1600 Mhz band which would continue to transmit standard interrogations and receive standard replies, but would, he says, "transmit all roll-call interrogations and messages in the 1600 Mhz band." Both ATC and IPC replies could be received on a second frequency in this band, providing a garble-free channel for both. Renick also believes it's feasible to build a circular phased array interrogator operable at both 1030 and 1600 Mhz, although it's unlikely that existing rotating interrogators can be modified to transmit and receive data at 1600 Mhz. It's a disadvantage, he says, that has to be considered carefully in the early stages of system implementation.

By tightening specifications for both interrogators and transponder beacons in conjunction with adoption of a discrete address operation mode, says Renick, range and azimuth accuracies of 100 feet and 0.12° can be achieved. Current system accuracies are 370 feet and 0.25° to 0.4° with a center-marker, 4° beam. However, he says, "under the garbled situation that pertains to the terminal environment, FAA does not presently use center marking for separation service."

Microwave Scanning

A possible alternative to these tighter specifications is use of microwave scanning ILS for measuring such accuracies.

Mechanically-rotated airport sur-

veillance radar (ASR) also represents a limitation on tracking accuracy in view of their 4-second rotation rate. Though this can be halved by back-to-back units, Renich calls 360-degree electronic scan systems a necessary goal.

Electronically-steered arrays eliminate the problem of mechanically rotating a large aperture antenna, which is required for the better angular accuracy and resolution of narrow beams—a 2° beam at 1030 megahertz requires an aperture of about 30 feet. They also can form multiple simultaneous transmit and simultaneous receive beams as well as use all interrogation levels efficiently.

Microwave ILS. For landing aids, the report draws on military microwave scanning beam technology in which the study sees features needed at high-density terminals—particularly if capacity is to be increased by use of dual-lane runways and closer spacing of aircraft. Existing ILS, says FAA's David Sheftel, is constrained by its single-course line character and overflight interference. Another problem: obstructions, such as hangars and other structures in the area. Microwave scanning ILS could overcome these handicaps, says Sheftel, but also appears applicable to short takeoff and landing airports due to its comparatively small size and ability to operate in relatively congested areas.

Such a system should be designed, he says, "for compatibility with carrier takeoff or landing facilities"—a reference to systems such as Cutler-Hammer's Airborne Instruments Laboratory AN/SPN-41, now in use by the Navy and also being sold as the tactical instrument landing system to the Royal Swedish Air Force [*Electronics*, July 21, pp. 46-47].

"Frequency spectrum considerations," says Scheftel, "dictate that this type of aid must fall within either the Ku band or C band in order to obtain sufficient bandwidth for channeling."

The FAA official cites a "growing consensus" that scanning beam technology is the primary contender for just about all future military and civil applications. Certainly the approach receives a major boost from the ATC Advisory Committee report.

"And now, class, in these few remaining minutes, I'd like to devote some time to the lanthanides. More commonly known as the rare earths. These include elements 57 through 71—lanthanum through lutetium—plus yttrium and thorium. Briefly, then, the rare earths are . . ."

Come clean. You don't remember any of it, do you? What little was said about the rare earths in your chemistry class was way back when. Lost among all the other "extraneous" bits and pieces of knowledge that bombarded you.

Past history. Who needs to know about the rare earths *now*? You do. You—if you're in electronics.

Because what you're looking for is something with unique ferro-, ferri-, and paramagnetic properties—right?

**Were you asleep
when your college chemistry prof
talked about the lanthanides?**



Know it or not, what you're looking for may be one of the rare earths. Others have looked at them and found what they wanted. Witness the use of the rare earths as superconductors and semiconductors. As lighting and CRT phosphors. As capacitors. As who-knows-what being worked on right now behind closed doors.

We'd like to convince you to agree (no matter how grudgingly) that you *do* need to know more about the rare earths. And we'd like to propose a method for doing so.

Find a willing and knowledgeable *chemist*. One of your co-workers, perhaps, in another department. Diplomatically discover what he already knows about the rare earths as electronic raw materials.

And, of course, you or your friend the chemist are free at any time to call us for information. What we have to tell you about the rare earths is certainly never boring.

9-214

RARE EARTH DIVISION

AMERICAN
POTASH & CHEMICAL
CORPORATION

A SUBSIDIARY OF KERR-MCGEE CORPORATION

258 Ann Street; West Chicago, Illinois 60185; Telephone: (312) 231-0760

Nicholas Johnson, a man with a mission

Controversial FCC commissioner takes on all comers, particularly Ma Bell, in his zeal to put 'public good and public interest' ahead of everything else

By Roger Kenneth Field

Associate editor

Once a slumbering agency, the Federal Communications Commission has become in recent months the high court for the electronics industry. The agency has handed down several landmark decisions that are having tremendous impact on the way electronic technologies are applied, on the way communications products are sold, and on the way the telephone system is viewed.

Much of the pressure for change at the FCC has come from within the commission itself—from Nicholas Johnson, the controversial commissioner who is often described as a maverick. Johnson thinks in terms of "the public good, the public interest." Simply put, he places pub-

lic interest before industry interest. The result is that he has made some powerful enemies of broadcasters and telephone-company executives. And with good reason.

Johnson's primary thrust is aimed at the broadcasting and telephone industries. Johnson authored the now-famous Carterfone decision opening up the \$55 billion telephone system to "foreign attachments," although AT&T had fought just such a decision for decades. Johnson was instrumental in the decision allowing Microwave Communications Inc. to set up a microwave link from St. Louis to Chicago and lease channels to all comers—in direct competition with AT&T. And Johnson has been in-

strumental in effecting price reductions in off-hour long-distance calls—a course of action that could have enormous consequence for executives and designers involved with communications and computers.

How Johnson feels about these and other issues could well give a hint of the future for those industries affected by decisions of the FCC. In the following exclusive interview, the commissioner speaks out and reveals his feelings and opinions.

Where is the telephone system falling down in its service to society and in its preparation for the future? What would you do to change this situation if you could control the telephone system completely?

JOHNSON: My principal concern with the telephone company [AT&T] is what I view to be the failure of the company to recognize its social, economic, and political role in our society. I think that it is impossible even to "profit-maximize," let alone serve the public interest, if one operates the telephone company the way some librarians used to operate their libraries. You may recall the story of two librarians meeting at a convention. One asked the other, "How are things going?" She replied, "Everything is marvelous. All the books are in but two—and they are coming in next Tuesday."

In what way is the telephone company like that librarian?

JOHNSON: Much of what the telephone company does is designed to prevent people from communicating, rather than encourage it.



"I have often found the public statements of [AT&T chairman] Romnes and other high officials of AT&T quite imaginative, public spirited and encouraging. It is the actions of the company that distress me"—Nicholas Johnson (above)

Like what?

JOHNSON: The telephone company has failed to adequately anticipate and prepare for the present and future demand for communications service for computers. The telephone company has failed to anticipate and provide the services now being offered by cable-television companies. It has failed to conceptualize itself as in the "communications" rather than the "telephone" business. Look at all the terminal equipment potentially available that could be used: facsimile transmission, computer-access devices, closed-circuit tv, teaching machines, and so forth. The telephone company has failed to anticipate communications demands, generally, in ways that are now coming back to haunt it, such as the recent breakdown in Wall Street and elsewhere.

I would point out that each of these failures has produced a lower rate of return for the company, less profits, less dividends for shareholders, and has had a very retarding impact on the economic growth of our country and upon the ability of this company to serve the public in ways that are demanded of it. I am speaking of failures that have been just as costly for shareholders as subscribers—maybe more so.

But my principal interest is the public interest. The telephone is a device that could help to unite far-flung families and friends, yet our system of billing for long-distance calls tends to impede that. There is a political significance as well. It presently costs more to call Washington from Hawaii or Alaska than it costs to call Washington from London. This has a measurable impact on what we describe politically as the "United" States.

There are numerous other examples I could point to of practices of the telephone company that not only disserve the public interest, but also tend to rob the shareholders. I have twice attempted, in two different on-the-record proceedings, to get the company to address the consequences of our providing them a rate of return substantially in excess of what they're now earning—perhaps no limit on rate of return at all. Would you believe that they [telephone executives] were so enamored of the 19th Century public-utility principles they have

Tune him out, say the broadcasters

Commissioner Johnson may be a thorn in the side of telephone executives, but he is even more of a thorn to broadcasters. So much so, in fact, that a group of Southern broadcasting associations has petitioned President Nixon to oust Johnson from office now—four years before his seven-year term expires.

The rancor of broadcasters centers on a statement the commissioner made on a nationally televised panel show. Johnson, who has always favored allocation of free broadcasting time for candidates for public office said, "For the industry to hold up elected officials and make them pay to get time from public property (the airwaves) is kind of like a criminal stealing a woman's wedding ring after he's raped her."

To be sure, criticism of the broadcast industry by FCC commissioners is nothing new. FCC chairman Newton Minow is best remembered for characterizing television programming as "a vast wasteland." His predecessor, James Fly, likened radio to "a dead mackerel in the moonlight—it both shines and stinks." But Johnson goes beyond colorful quotes: he questions the automatic renewal of broadcast licenses, insisting instead on reevaluation each time a license comes up for renewal. And on this point, quite understandably, broadcasters are extremely sensitive.

Does the commissioner's position warrant Presidential removal? Here, in Johnson's own words, he describes what rights he believes broadcasters should and shouldn't have, and precisely why he feels that granting licenses "in perpetuity" would violate the original intention of those congressional acts that defined the purpose of commercial broadcasting:

"I think it's very unlikely that any local broadcaster who has been in the business a long time, doing an outstanding job of public service and of quality programming, is going to be deprived of his public trust—at least not by anyone I know of who has sat upon this commission, does so now, or is likely to in the future. But in this industry, as in any other, there is a small percentage of broadcasters more interested in ever-increasing profits than in their local responsibilities and public trust. Whether that percentage is 1/100 of 1% or 15% is a matter for some debate. But I think the leaders of any industry would recognize that some of their competitors are more responsible—better citizens in the business community—than others. Some of the grossest failings of broadcasters have involved double billing and misrepresentations to advertisers; the FCC has not been much more strict in penalizing those broadcasters than it has been with the broadcasters who are diserving the public.

"But the important point here is that Congress in 1927 and 1934 recognized expressly the threat to democracy of the potential for control of the mass media in America. Congress anticipated stations would be owned locally, operated by people whose only business was the broadcasting business, and who recognized their responsibility to their local community.

"It expressly provided that no one could own a broadcasting license . . . in the very first section of the portion of the Communications Act that deals with commercial broadcasting. It provided that broadcasters are to be public trustees of public property, that they have no rights, save during the term of their three-year license. They have no more right to a renewal of that license than a highway contractor has to a second contract after he is finished building the first stretch of highway. They must, like an elected public official, 'run on their record.' That's a quotation from the U.S. Court of Appeals.

"One of the leading spokesmen for the Communications Act said that if ever broadcasting property should fall into the hands of a few and the mass media should be so dominated, then 'woe be to him who disagrees with them.'

"We have seen this political power come into effect today where the broadcasting industry can obtain virtually any single piece of legislation that it wants from Congress. Any elected official in this country who is running from a district that is preponderantly covered by one or a few vhf television stations simply must look to the owners of those stations as his principal constituents. I think this is dangerous. Increasingly, we are seeing stations owned not by local citizens, but by national industrial conglomerate corporations with no ties to the local community. And some of these conglomerates are running stations on a formal basis, profit-maximizing and putting out the same programming in all the communities that they cover."

20W zeners in DO-4

... part of a total range
which offers 170 different
voltage/power ratings.



The compact DO-4 encapsulation used for the Mullard type BZY93 zener diode is the smallest available anywhere for a 20W device. It has also resulted in an extremely low cost-per-watt figure on a device with $\pm 5\%$ tolerance.

Other features of the BZY93 include drift-free operation and a very high standard of reliability—even at extreme rating limits. This latter characteristic results from the Mullard conservative rating policy which specifies life performance at maximum rated power.

400mW to 75W, 3.3 to 75V—The Mullard zener range offers 170 different voltage/power ratings. Advantages include sharp knee characteristics, low dynamic resistance and low leakage current.

Pocket Chart—The new laminated plastic chart illustrated gives rapid selection information on Mullard zeners... products which are the result of extensive

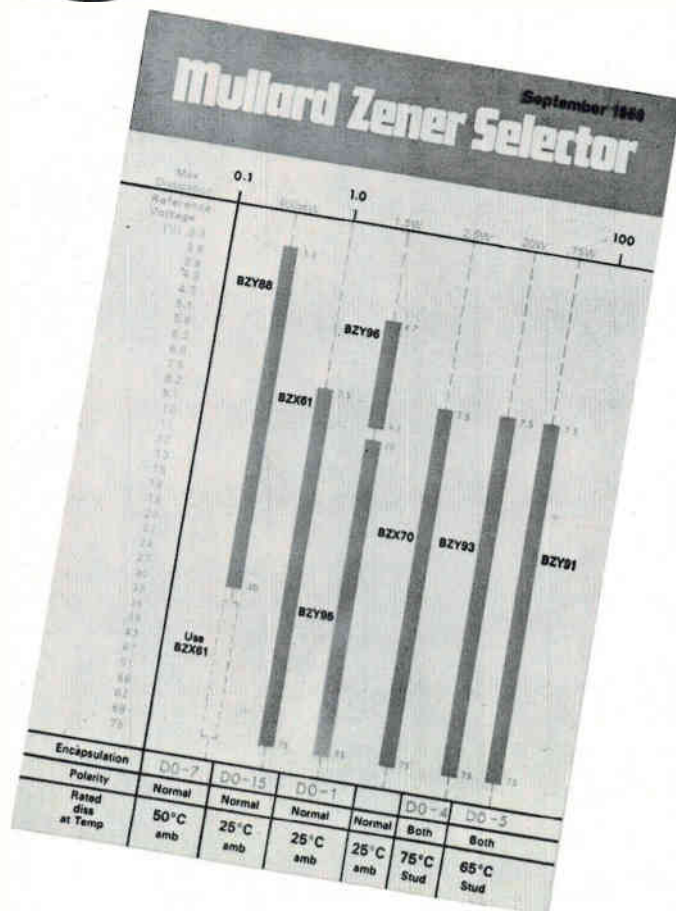

research and development programmes in the Mullard laboratories in England. Mullard employ 1000 qualified scientists and engineers and have six major plants, with over 3 million square feet of floor space.

Write today for information on Mullard zeners, and for the name of your local representative.

Mullard Limited, Mullard House, Torrington Place, London W.C.1. England.

U.S.A. enquiries to Mullard Inc., 100 Finn Court, Farmingdale, Long Island, New York 11735, U.S.A. Telephone: (516) 694-8989. Telex: 961455

Mullard

MOL56

grown to love that they were unwilling even to address the question? I was stunned.

The company's debt-equity ratio, which the company itself finally acknowledged had been undesirably weighted on the equity side, has held down shareholders' dividends at the same time it raised subscribers' rates. That's pretty hard to do, but Bell did it.

The company is considering trying to rectify its failure to exercise options under liberalized depreciation provisions. It has delayed introducing the new technology of electronic switching. It failed to provide a national emergency number for the people of this country—long after the "inferior" telephone companies of most of the civilized nations of the world provided the service as a matter of course. It expressed excessive reticence to develop a coin-operated telephone that would enable people to place calls to the operator without first depositing a dime. One could go on endlessly multiplying the examples of ways in which this company has failed to recognize the social, economic, and political role that it plays, to its own detriment and that of the country at large.

The Carterfone case and the MCI case seem to outline two areas that FCC has specifically opened up for competition with AT&T. One is the question of terminals, the other is the question of transmission of the information itself. Are you planning to open up competition on all fronts for AT&T—telephone communication, Picturephone, video transmission for tv networks?

JOHNSON: The FCC is in the business of deciding cases one at a time as they arise. And I would not want to prejudge any cases that might come along in the future. But as a general proposition, I would prefer to stand with the assumption that a fully functioning free private enterprise competitive system, with informed consumers, will best serve the public interest—and will do so better than Government regulation. It would only be in those instances in which the marketplace, for one reason or another, does not work as effectively or efficiently as it should that I would want to substitute regulation.

But certainly there is no justifi-

cation in my mind for providing an essential service in our society through a Government-regulated monopoly if that service could be provided with higher quality and lower cost through a competitive system. So I think it is fair to say that—while my principal commitment is, as it must be, to serving the public interest in these matters—I will be continuing, as I have in the past, to look for areas in which the FCC can legitimately work itself out of a job and turn more of these matters over to the marketplace.

What do you think of AT&T chairman H.I. Romnes' announcement that in the future there will be a one-minute connection with a target-charge of 35 cents coast to coast? This is primarily intended for the computer people, but it is merely a token gesture in answering the data problem?

JOHNSON: I have often found the public statements of Mr. Romnes and other high officials of AT&T quite imaginative, public spirited and encouraging; it is the actions of the company that distress me. Two years ago when considering AT&T rates, I pointed out to them the gross underutilization of their \$35 billion plant. The company has simply never understood—or, if it has understood, has failed to apply—the most elementary principles of peak-load pricing.

The telephone system is virtually unused from 10 p.m. until 8 a.m. I suggested that the company's shareholders would be richer and the public better served if the company would provide very significant reductions in after-midnight rates. Its response was to cut the rate from \$1 to 75 cents after midnight. This was not quite the order of magnitude that I had in mind. There are very few people who would stay up until midnight in order to save a quarter.

The one-minute rate is another example of Bell's offering too little too late. In most of the civilized nations of the world, it has long been possible to call anywhere in the country on a message-unit basis—as the distance increases the time decreases. But it is possible to call the longest distance possible for some period of time for a message unit charge that may be 5 cents or

Find it fast! in the **FREE NEW 1970 Newark industrial electronic catalog**

A \$9,000,000 INDUSTRIAL ELECTRONIC INVENTORY
720 PAGES • OVER 70,000 ITEMS; 500 MAJOR LINES
INCLUDING THE COMPLETE LINE OF



PRECISION POTS



Wirewound, single and multi-turn, linear and non-linear, diameters from 1/2" to 3".



TRIMMER POTS

Wirewound and non-wirewound, to 1 Megohm. Single, 15, 25, 42 turn, square, round, rectangular and TO-9 case size.



TURNS—COUNTING DIALS

Digital or concentric readout.

Immediate delivery from stock—factory OEM prices
—fast efficient service from 11 Newark warehouses.
One source for the products you need, in the quantities you need.



For your free catalog write to:

Main Office & Warehouse

NEWARK ELECTRONICS CORPORATION

500 North Pulaski Chicago, Illinois 60624
(312) 638-4411

AUTHORIZED P & B WAREHOUSES IN

- Minneapolis, Minn. (612) 331-6350
- Cincinnati, Ohio (513) 421-5282
- Denver, Colorado (303) 757-3351
- New York City (212) 255-4600
- Dallas, Texas (214) BR 2-3571
- Detroit, Michigan (313) 548-0250
- Los Angeles Area (213) OR 8-0441
- Grand Rapids, Michigan (616) 452-1411
- New Orleans, Louisiana (504) 834-9470
- Houston, Texas (713) 782-4800



less! Compare that with our "low, low telephone rates."

Has anyone proposed that calls be priced on a continuous curve?

JOHNSON: Well, even better, some reports I have seen indicate that as much as 50% of the cost to the telephone company of a long-distance call is the cost of billing you for that call, and otherwise running a system which is dependent upon a time-distance formula and individually billed calls.

Might it be cheaper if the company simply charges you for the connection and forgets about the time? Or distance?

JOHNSON: As a general proposition, it would seem to me that the telephone company would want to offer as much service as possible on an incremental cost-free basis. That is to say, it seems to me that both the company's profits and the public interest would be served if people chose whether to use the communication system on the basis of their communications needs versus other demands upon their time, rather than in terms of cost. Note that this is what we do with most of the so-called "local" services.

When you make a local call you do not reflect upon the price that you must pay for this service. It is incremental cost-free; that is, once you pay your monthly telephone bill there is then no additional cost for your use of the telephone. You use the phone, or not, based solely upon to whom you want to talk, when, and for how long. If a system would be devised for a nationwide telephone service of this character—a system that would provide adequate revenue to the telephone company—it might be a clearly more satisfactory way of providing service.

The telephone company's principal objection to this, to the extent that I can fathom it, is that such a plan would produce an increase in the use of the telephone—an argument which the company often raises to oppose proposed improvements in service.

As you interconnect more and more phones, thoroughly, with more and more long-distance lines and more and more lines between phones, the system approaches what in

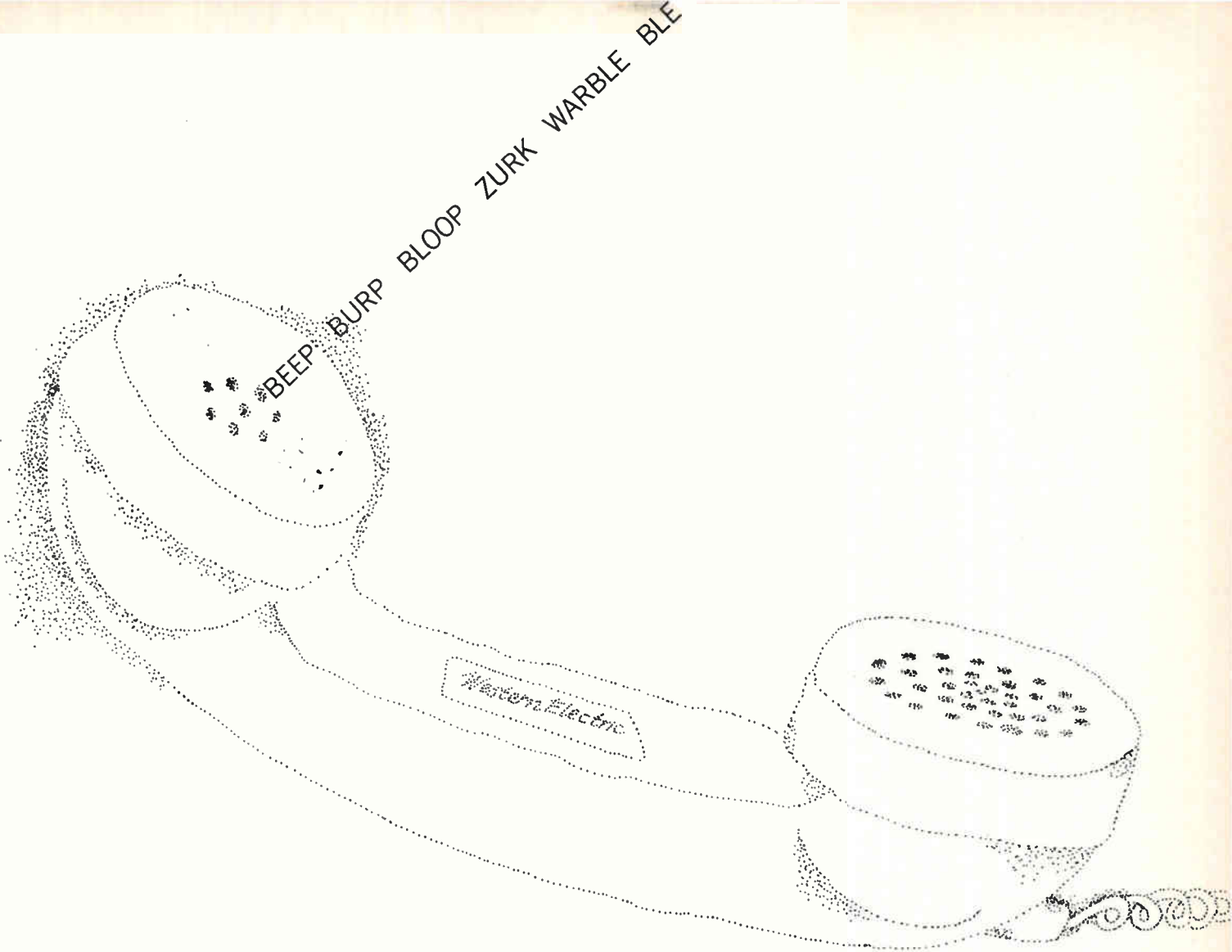

MONOTHERM® UNDERSTANDS

If you want the output of a computer fed directly into another business machine 3,000 miles away, Western Electric's Data-Phone® Data Communications Set can make the connection. Over ordinary telephone lines.

Data bits from the computer are converted to tones by a Data-Phone data set. At the receiving end a similar set changes the tones back into the signals required by the business machine.

The key component in many Data-Phone data sets is a Western Electric 3A2 Data Unit. And at the heart of the Data Unit is a Riegel

Monotherm® flexible laminate of copper and Type H-Kapton® used for the printed circuits.

Why Monotherm? Because it's an extremely flexible laminate which folds like a book to compact size, thus saving valuable space. Because it eliminates the need for a color-coded wiring maze. Because it possesses high dimensional stability. Because it can be automatically (and repeatedly) soldered. Because its uniquely high heat resistance makes it easily repairable in the field.

If automated mass production, high reliability, low cost, im-

proved serviceability and small size are design requirements of your circuits, why not make a connection with Monotherm? The coupon will do it.

Synthane - Taylor Corporation
Valley Forge, Pennsylvania 19481

Please send me Kapton®/copper data sheets and the Conductor and Dielectric Guide for Riegel Monotherm.

Name _____

Company _____

Street _____ City _____

State _____ Zip _____



synthane·taylor

EXCLUSIVE U.S. DISTRIBUTOR OF RIEGEL MONOTHERM IN SHEETS AND ROLLS

Monotherm®—registered trademark of Riegel Paper Corporation for its laminations of conductive and dielectric materials.
Kapton®—registered DuPont trademark for its polyimide film. Data-Phone®—registered trademark of Western Electric Co.

Circle 139 on reader service card

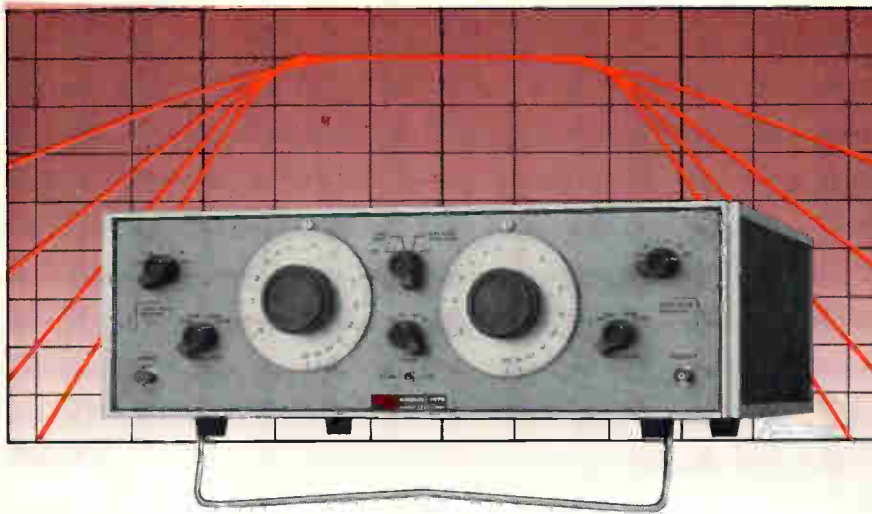

New multifunction filter with selectable attenuation slopes covers 0.02 Hz to 20 KHz

MODEL 3750 — All solid-state. Functions include low-pass, high-pass, band-pass, and band-reject. Attenuation slopes may be set at 6, 12, 18 or 24 db-per-octave, with maximum attenuation greater than 80 db. Gain switch may be set at 0 or 20 db. Designed for line or battery operation with batteries internal and rechargeable. Bench model: 5 $\frac{1}{4}$ " high x 16 $\frac{5}{8}$ " wide x 13 $\frac{1}{16}$ " deep. Rack model: 5 $\frac{1}{4}$ " high x 19" wide x 13 $\frac{1}{16}$ " deep.

Price, without batteries, \$850

MODEL 3700 — A new, all solid-state variable band-pass filter covering the 0.2 Hz to 20 KHz range. Attenuation slopes: 24 db-per-octave, extending to greater than 80 db. Selectable band-pass gain: 0 or 20 db. Line or battery operation with batteries internal and rechargeable. Bench model: 3 $\frac{1}{2}$ " high x 8 $\frac{5}{8}$ " wide x 13 $\frac{1}{16}$ " deep. Rack model: 3 $\frac{1}{2}$ " high x 19" wide x 13 $\frac{1}{16}$ " deep.

Price, without batteries, \$550

SEE THEM AT NEREM, Boston, November 5, 6, 7.
Booth #1D22-23.

OVERSEAS SALES OFFICES: BELGIUM, C. N. Rood s. a. DENMARK, SC Metric A/S; FRANCE, Antares; GERMANY, Nucletron Vertriebs-GMBH; HOLLAND, C. N. Rood n. v.; ITALY, Dott. Ing. Mario Vianello; SWEDEN, Teleinstrument; ISRAEL, R.D.T. Elect. Eng. Ltd.; JAPAN, Shoshin Shoji Kaisha, Ltd.; AUSTRALIA, Sample Electronics (Vic.) Pty., Ltd.; G. B., B & K Inst. Ltd.

**KH KROHN-HITE
CORPORATION**

580 Massachusetts Ave., Cambridge, Mass. 02139, U.S.A.
Phone: (617) 491-3211 TWX: 710-320-6583

Oscillators / Filters / AC Power Sources / DC Power Supplies / Amplifiers

physics is a real network. If that is the case, would it not be better to have either a blanket charge for any call independent of distance, or no charge at all, simply billing people for the use of the phone?

JOHNSON: It has often been argued that the so-called long-distance service has been grossly overpriced and used as a subsidy, in effect, for local service—a political decision to serve the needs of the state regulatory commissions, which are loathe to raise their local rates. The result may also be salutary in terms of national economic and social goals—or it may not be. Maybe we should want to encourage the installation of home telephones by soaking the rich for "long-distance" calls. Maybe it would be better to encourage greater national use of the system. My point is only that the issue has never been addressed in these terms. Your observation about the relationship between distance and cost of telephone service is interesting.

It seems to me that the irrationality of the present pricing system is best illustrated when one thinks in terms of satellite communications. If a satellite is positioned 22,000 miles from the earth's surface, then by definition all calls travel 44,000 miles—22,000 up and 22,000 back down. It makes no difference to the satellite whether the ground stations on the earth are separated by 1,000 miles or 10,000 miles. With such a system it becomes very difficult to rationalize why distance is a relevant factor in calculating price.

Is there anything manufacturers of communications equipment—the modems, terminals, receivers and transmitters—can do in the design of new equipment to cooperate with and help the FCC?

JOHNSON: There are a number of things. The answer depends upon which particular product line you are talking about. We have some difficulty with the tv receivers—X radiation and electronic radiation are now problems. We passed legislation regarding the uhf tuner: the all-channel bill. We need, from time to time, to improve mobile radio receivers and transmitters to permit them to operate on narrower bands.

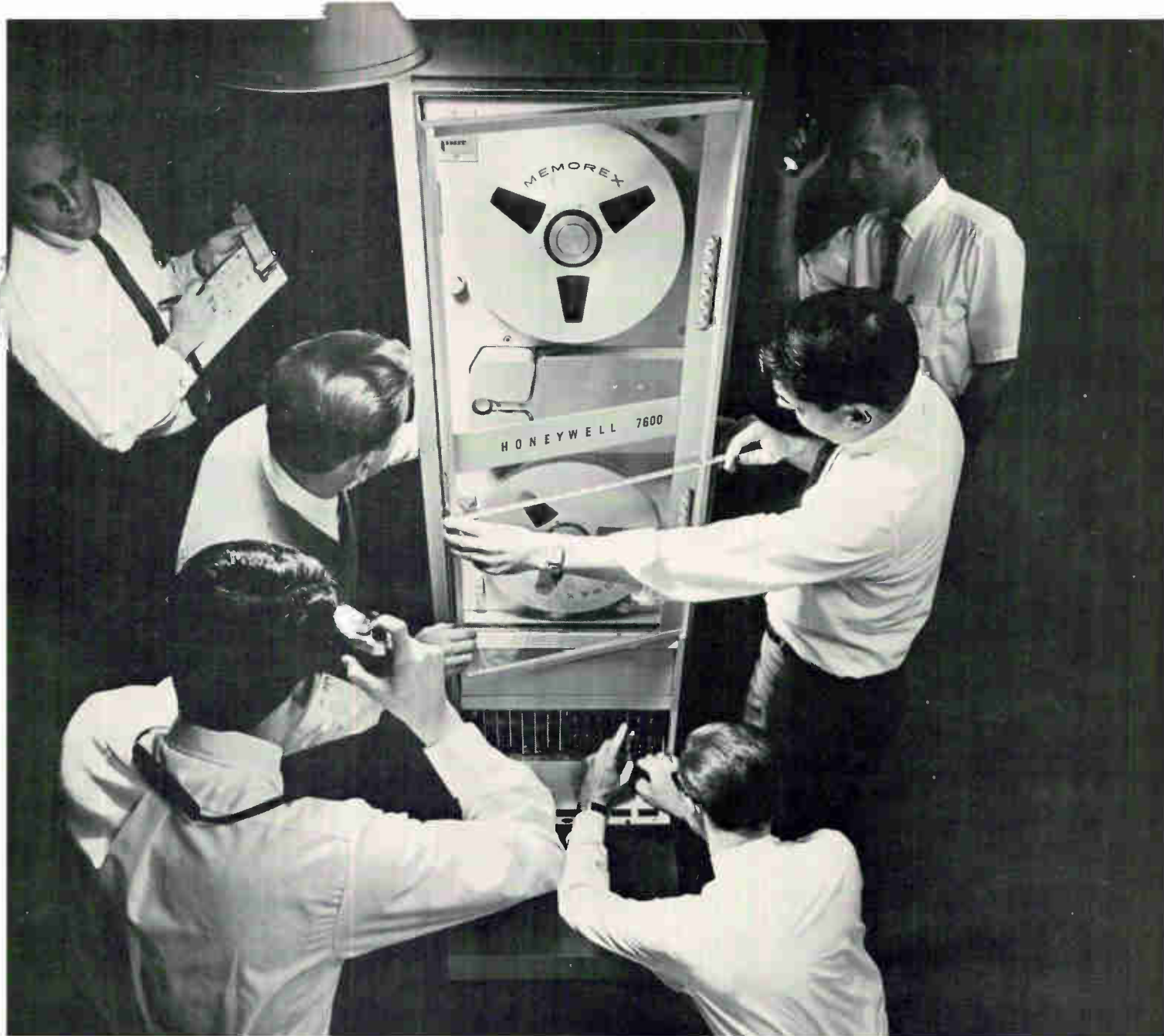

No matter how they measure it, the Honeywell 7600 checks out as the best value in the tape field!

From the way people are trying to copy it, you'd think our 7600 is the hottest tape system around. It is!

Compare the specs on our 7600 with those of some recent competitive machines and you'll notice something very interesting. A small revolution is taking place in the magnetic tape system industry. We started a trend. And now, others are following!

The Honeywell 7600 Series bears copying. Its modular design lets you specify the system you need now, and permits future expansion without costly modifications as your requirements grow. Easily maintained plug-in electronics give you a wide selection of bandwidths, and mechanical options include a choice of 10½" or 15" transport.

With its low flutter, skew, and time base error and high S/N ratios, the 7600's signal fidelity can't be matched by comparably priced units. And, due to its mechanical simplicity (no belts, pulleys, gears, or pinchrollers) and inherent reliability, our com-

petitors are going to have a rough time building a machine that will operate as economically as the 7600. It's priced lower than you'd expect, too, giving you more performance for your money than any other tape system!

The great 7600 Series is another example of how Honeywell's broad line, backed by local sales and service, can provide the *precise* solution to your instrumentation problems. For a demonstration, call your local Honeywell Sales Engineer. For technical literature, write: Honeywell Inc., Test Instruments Division, P.O. Box 5227, 4800 E. Dry Creek Rd., Denver, Colorado 80217.

Honeywell

Honeywell engineers sell solutions

Circle 141 on reader service card

LSI/MSM

MSI/LSI circuit seminar
for equipment
and systems designers.

Presented by
Electronics Management Center.
An information service of McGraw-Hill
California-December 1-3, 1969
Airport Marina Hotel
8601 Lincoln Blvd.
Los Angeles, Calif.

Program

1. Evolution of large scale integration (LSI)
2. MOS device structure and characterization
3. Basic MOS circuit techniques
4. Topological design and layout
5. Advanced circuit techniques
6. LSI artwork generation
7. Logic implementation with LSI
8. Design examples
9. MOS/Bipolar interface techniques
10. Low threshold technology
11. Cost consideration for LSI
12. Computer aided design
13. MOS structures and fabrication techniques
14. Process constants and minimum design rules
15. Yield factors and process control
16. Facilities and equipment requirements for LSI
17. Applications and product types most suited to LSI
18. Currently available MSI/LSI products
19. Advanced technology trends
20. Technological controversies

Purpose

The MSI/LSI seminar is designed to acquaint systems designers with the capabilities and limitations of the LSI technology. It will provide for more effective product planning through knowledgeable appraisal and proper use of LSI for specific applications. Attendees will receive instruction in MOS device models and characterization, and in MOS circuit forms and their performance comparisons. They will also learn topological rules that permit multiple sourcing of LSI arrays, procedures for the design of a standard cell library, how to make an LSI composite plan drawing, and how to determine transient response and propagation delay. LSI cost factors will be discussed, and systems designers will be instructed in the preparation of specifications for LSI.

Faculty

Presentations, discussions, and work sessions are under the direction of the staff of Integrated Systems Technology, Inc. of Santa Clara, California. Each member of the staff has wide experience in the areas of circuit design, systems application and semiconductor research and development. *Donald E. Farina*—President, Integrated Systems Technology, Inc. One of the contributors to the design of the first micrologic integrated circuit families. Served as head of the R&D department in digital circuits for Fairchild Semiconductor, responsible for both digital circuit and bipolar device structure development.

For the microelectronics division of Philco-Ford Corporation Mr. Farina served as Director of R&D and was responsible for device and research devoted to MOS large scale integration. He received his BSEE at New York University in 1953.

Ronald Pasqualini—Vice President, Engineering. Widely experienced in R&D on MOS memory systems for Philco-Ford Corporation. Performed initial logic design, circuit analysis, and composite layout of a monolithic read-only memory. Was responsible for the interface between R&D processing and R&D design.

Systems design experience in integrated circuits includes shared responsibility on an Air Force large scale array navigation computer, and Ranger spacecraft. Also designed a monolithic 2-MHz binary/BCD converter employing 4-phase circuit techniques.

Mr. Pasqualini holds a BS in Aeronautics from M.I.T., 1962, and an MSEE from U.S.C., 1966.

Richard Craig—Vice President, Technologies. Mr. Craig has devoted the major portion of his career to the semiconductor. With three major semiconductor manufacturers his experience includes such early developments as planar and epitaxial processes and structures. More recent experience includes responsibility for

the development of advanced MOS LSI techniques, including multilayer and minimum size structures, oxide and interface charge control, and MOS circuit innovation and evaluation.

Mr. Craig received his BA in Physics from Fresno State College in 1958.

Richard Aladine Carberry—Senior Design Engineer. Presently involved in the logic and circuit design of complex MOS devices, and the design of digital equipment utilizing bipolar and MOS IC's. As a project engineer for Philco-Ford Corporation he was involved in the design of MOS memory and arithmetic chips for a guidance computer, as well as a sequencer and other control circuitry utilizing bipolar IC's. For Lockheed Missiles and Space Company he designed analog circuits for a guidance system, switches, modulators and demodulators, active and passive filters, and various operational amplifier circuits. Mr. Carberry holds BSEE and MSEE degrees from the University of California at Berkeley.

Fee

The registration fee for all sessions, a complete set of notes, and luncheons —\$385.

Registration

Register now for the Los Angeles program. Use the registration form below. Make checks payable to Electronics/Management Center. You must register in advance. We will be happy to bill you or your company, but only paid-up registrants will be permitted to attend the seminar. Hotel reservations should be made directly with the hotel. A number of rooms is being held for seminar attendees. When you make your reservations, identify yourself as an attendee of the MSI/LSI seminar.

MSI/LSI

MSI/LSI circuit seminar for equipment and systems designers.

Samuel Weber, Mgr.
Electronics/Management Center
330 West 42nd Street, N.Y., N.Y. 10036

Please register me in your
three day seminar at \$385

Check enclosed

Bill me

Bill company

PO # _____

Name _____ Title _____

Address _____

Company _____

City _____ State _____ Zip _____

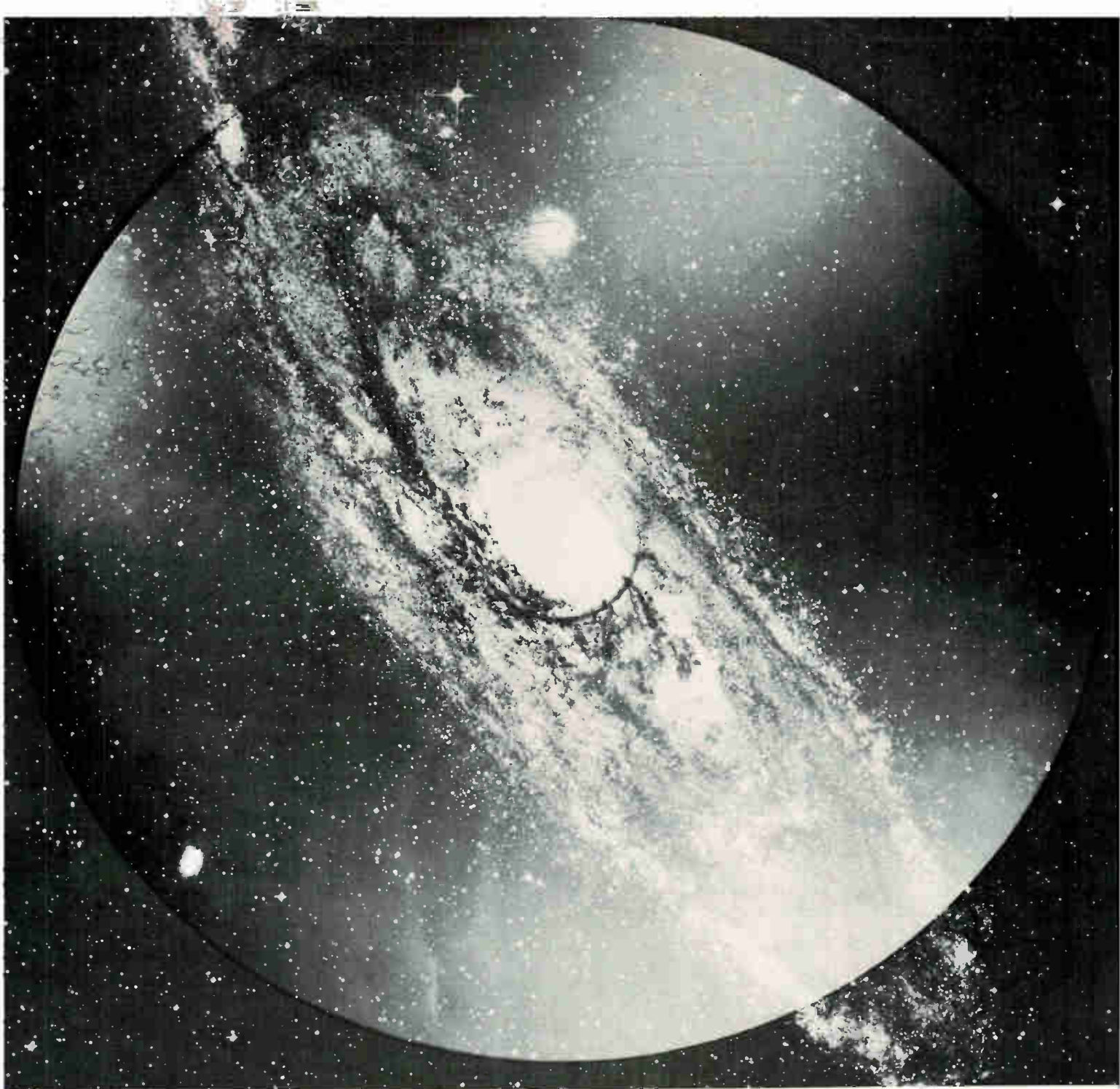

Data Instrumentation Recorders that know no bounds

In the field of instrumentation recording, no manufacturer offers the versatility, quality, or deliverability of DMI. As the pioneer in plated magnetic disc recording, this capability is unquestioned. Our recorders are methodically produced, meticulously tested, and universally accepted by some of the more sophisticated users of instrumentation recorder analysis equipment.

No wonder—considering our constant concern with progress and excellence. The new IDR-200, for example, already stands alone in the field of instrumentation recording. It is utterly versatile . . . available in single or dual channel models . . . both reproducing simultaneously if you wish. It stores 25 seconds of 2 MHz data on a 14" plated magnetic disc.

And it is operationally practical as well as functional. Meant to capture and store data for wideband transient analysis, signal analysis, spectrum analysis, data reduction,

correlation studies, telemetry, and one-shot phenomena. The possibilities know no bounds.

For those with less demanding situations, we offer the IDR-100—a durable performer in wide-band instrumentation disc recording of the more compact variety. While it is a bench-top device, its specifications are comparable to the finest instrumentation tape recorders.

If the Data Instrumentation Disc Recorder is not a familiar device to you, or you wish to learn more about the usage of this medium and its many applications, write or call for a data package.

The Disc People



1400 Terra Bella Avenue, Mountain View,
California 94040, Telephone (415) 961-9440

Tiny supply for IC's delivers 5 watts

1.6-cubic-inch regulated source permits half-inch spacing between p-c boards;
four-stage unit can work from either a-c input or battery

Everything seems to be getting smaller in electronics—except power supplies. This results in a contrast between inch-long dual in-line IC packages and so-called miniature power supplies, which usually are bigger than a pack of king-sized cigarettes and several times as heavy.

But the newly founded Datacube Corp., has a regulated power supply that requires neither large inductors and transformers nor large filter capacitors. It has an overall efficiency of more than 60%, making for easy heat dissipation—and less heat to dissipate.

The company claims its new DUP 5-1 is the smallest power supply available in terms of watts per cubic inch. The DUP 5-1 measures 2 by 2 by 0.4 inches, making a volume of 1.6 cubic inches. Its nearest competitor (which puts out 2.5 watts to the DUP 5-1's 5 watts) measures 2.5 by 3.5 by 1.25 inches for a 10.9 cubic-inch volume.

Not only does it take less board area, but its thinness allows printed circuit boards to be packed together on standard half-inch spacings—thicker supplies may waste up to 3 p-c board sockets, even though the IC's they power are less than a half-inch high.

More blocks, less box. How did Datacube put a 5-watt power supply into such a small volume? According to Stanley M. Karandanis, vice president, the key lies in designing each of the unit's four stages to dissipate the least possible energy and to optimize them for the best combinations of voltage, current, and component size.

Stage one is a rectifier bridge. Instead of a bulky transformer reducing voltage to about the desired level at the input, Karandanis designed the DUP 5-1 to accept a-c



Powermite. Source for integrated circuits takes up less than 2 cubic inches. It is thin enough to permit half-inch spacing of printed-circuit boards, yet puts out 5 watts to power any of the families of digital logic.

power and rectify it directly. "We wanted a minimum of 60-hertz iron," he says. The voltage coming from the rectifier peaks at about 180 volts, and since the higher the voltage the more energy a given-sized capacitor can hold, a very small capacitor helps smooth and store the rectified energy.

Stage two is a chopper. Fed by the rectifier, it varies the width of its output pulses to get the most energy out of the storage capacitor, and yields an output of about 45 volts intermittent d-c. A diode-choke-filter capacitor network removes a-c components from the chopper's output and feeds a d-c

Modular 5-volt power supplies for digital IC's

Company	Model No.	Output Power	Volume in cu. inch	Output per cu. inch	Price
Analog Devices	903	2.5 w	10.9	230 mw	\$49
Arnold Magnetics	PCA-5/500	2.5 w	5.6	440 mw	\$84
Computer Products	PM429	1.25 w	6	200 mw	\$36
Datacube	DUP 5-1000	5 w	1.6	3 w	\$49
Semicon. Circuits	P1.5.500	2.5 w	7.6	325 mw	\$50

Dual Transistors



17 tight trackers

Tight thermal tracking. Low drift. High stability. All essential in circuits which process matched signals. They're yours when you design with TI dual and matched-pair transistors.

Use them for high and low current applications in your operational and differential amplifier designs...as flip-flops, emitter-followers, gates and counters in your switching and logic circuits...and for audio, compound and pulse amplifiers.

From its line of 73 standards and hundreds of specials, TI has selected 17 dual and matched-pair transistors that meet the majority of multi-channel circuit needs.

*†Matched-Pairs
**Trademark of Texas Instruments



They're part of TI's line of preferred semiconductors, selected after months of computer demand analysis to save you time and money in specifying discrete devices.

To obtain data and specifications on preferred dual and matched-

TI Preferred Dual and Matched-Pair Transistors

Type	Polarity	Package	Type	Polarity	Package
TIS92*	NPN	TO-18 SILECT**	2N2920	NPN	TO-77
TIS92M*	NPN	TO-18 SILECT**	2N2977	NPN	TO-71
TIS93†	PNP	TO-18 SILECT**	2N2979	NPN	TO-71
TIS93M†	PNP	TO-18 SILECT**	2N3350	PNP	TO-77
2N2060	NPN	TO-77	2N3680	NPN	TO-77
2N2223	NPN	TO-77	2N3838	NPN/PNP	FLAT PACK
2N2639	NPN	TO-77	2N4854	NPN/PNP	TO-77
2N2642	NPN	TO-77	2N5045	N-CH.FET	TO-71
2N2643	NPN	TO-77			

pair transistors, write for TI's *Preferred Semiconductors and Components Catalog*: Texas Instruments Incorporated, PO Box 5012, MS 308, Dallas, Texas 75222. Or just circle reader service



TEXAS INSTRUMENTS
INCORPORATED

to-d-c converter, stage three.

Operating at a switching frequency of about 20 kilohertz, the converter acts as a line isolator and supplies overload protection. Two transistors drive the primary of a small transformer in the converter and are very tightly specified. If, for example, the chopper were to fail, the two transistors would overload, burn out and act as a safety switch, preventing damage to any IC's powered by the supply.

Following the converter are a synchronous rectifier and a regulator. But little regulation is needed, as each stage of the DUP 5-1 has been designed to supply a tightly regulated signal to the next.

The DUP 5-1 delivers 5 volts d-c at one amp, working off input frequencies from 47 to 420 hz at 105 to 125 volts. The supply even will work from a battery. By doing away with the usual input transformer, Datacube thus has made a-c power input optional for the designer.

Accuracy of the DUP 5-1's output voltage is ± 0.5 volt; with external trim it can be adjusted $\pm 2\%$. Line and load regulation both are 0.05% with ripple and noise one millivolt RMS or less.

More to come. With the DUP 5-1 or other units in the line it will be possible to power any of the various logic families—diode-transistor, resistor-transistor, transistor-transistor, high-noise-immunity logic, and emitter-coupled—as well as metal oxide semiconductor and large-scale integrated circuits, and almost all analog circuits now on the market.

There also are plans for DUP-series supplies for specialized circuits like sense amplifiers which take +5 or -15 volts, as well as a combined unit offering -5 volts for TTL together with ± 15 volts for analog circuits. This one is aimed especially at makers of analog-to-digital and digital-to-analog converters. There will be a supply offering +5 volts and an unregulated 180-volt output for numerical-readout tube decoder-driver applications.

The DUP 5-1 costs \$42 in lots of 50 to 99. Delivery time is four to six weeks.

The Datacube Corp., 49 Pollard St., Billerica, Mass. 01862 [338]

High Powered Pulses

(up to ± 20 volts at 1 amp.)

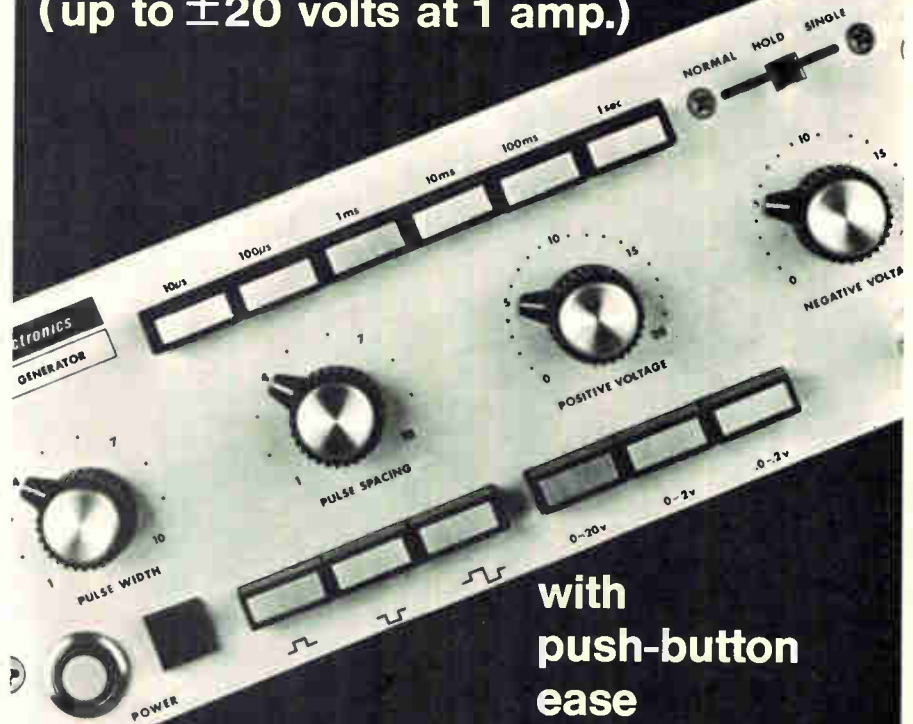

with
push-button
ease

Designed for testing

- Relay logics
- R. C. networks
- Motor and relay controls
- General pulse application

Pulse generator Model 541 has all the versatility one would expect from Applied Electronics: 0.5 Hz to 50,000 Hz rep rate, 10 μ sec. to 10 sec. pulse width and pulse spacing control, $\frac{1}{2}\%$ overshoot on square wave at ± 20 volts with full short circuit and overload protection. Half rack size. \$310 f.o.b. Burlingame, California.

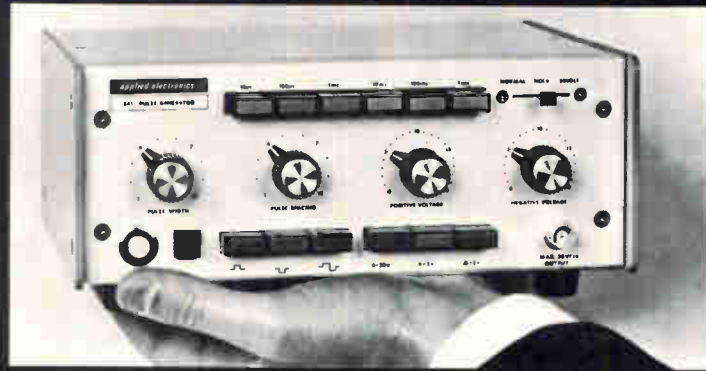

Send purchase order or literature request to:



applied electronics

877 Cowan Road • Burlingame, California 94010 / Telephone (415) 697-2701

Off-the-Shelf Recorder Order Guide

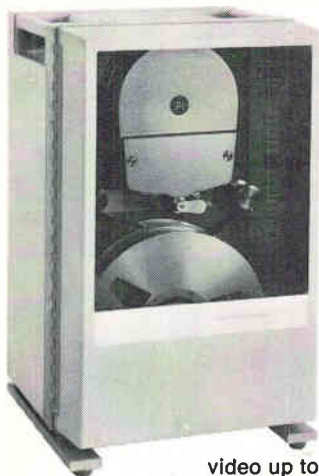

PI-7100 Video/Instrumentation
Captures video, radar, RF, multiplex, telemetry . . . any broadband data up to 1.5 MHz, or video up to 3.5 MHz. Operates for 90 minutes on a 10½" reel of tape using helical scan transport. Includes VariScan™ and StopScan™ playback.

PI-1387 High Environment Digital
Write only, IBM compatible; 200 BPI, 7 track formats. Inexpensive, compact, lightweight (less than 17# without tape). Operates in virtually any environment. Uses single 12 VDC power source.



PI-5100 Long Term Monitor
IRIG formats. Two models—1" tape (weighs 60#); ½" tape (weighs 35#). Uses 12 VDC source; low power consumption.

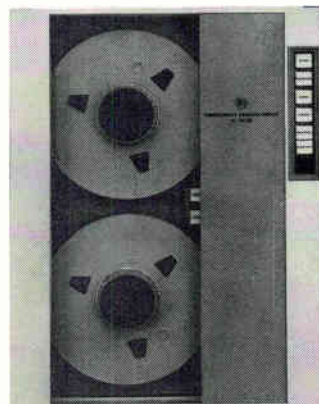

PI-1200 Digital
Read/Write, IBM compatible; 7 or 9 track formats. Three modes: high speed, slow, and incremental.



PI-6200 Portable Instrumentation
Lab quality. Pushbutton operation. Low-cost ¼" tape. Up to 8 channels with three switchable FM or Direct record/reproduce speeds—0.375, 3.75, 37.5 ips—provide time contraction or expansion in 1:10:100 ratio. Optional loop adaptor and remote control. Operates on any power: 105 to 125 or 210 to 250 VAC; 48 to 400 Hz + and -12 VDC.

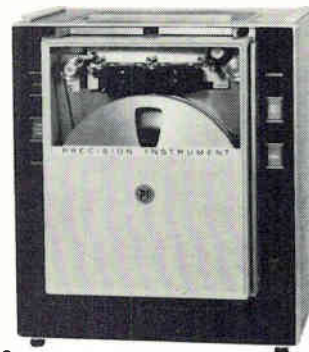

PI-2100 IRIG Portable
Records/reproduces up to 14 tracks of FM or Direct data. Snap-on reel or loop magazines, vibration isolation mounts, and many more accessories available "off-the-shelf" to increase versatility.

And that's not all...

We can supply virtually any kind of special recorder, or modified standard models to meet your unique requirements. We also make the first practical, on-line trillion bit mass memory, Unicon 690®, a totally new laser recording system.

What's more, because we make all kinds of tape recorders, we can recommend the one that's best

for you — objectively, professionally. And, we'll provide all the engineering, documentation, training, and service support you need. Just send the coupon to 3170(A) Porter

Drive, Palo Alto, Calif. 94304. Or call (415) 321-5615. Worldwide sales and service representatives.



PRECISION INSTRUMENT

TO: **PRECISION INSTRUMENT COMPANY**
3170 (A) Porter Drive, Palo Alto, California 94304.

I want to know more about:

6200 7100 5100 1200 1387 2100
 Unicon 690 Other _____

My application is _____

Name _____ Title _____

Company _____

Address _____

City _____ State _____ Zip _____

Call me immediately at _____

Circle 148 on reader service card

Meter has 0.1% accuracy

\$380 price puts 3½-digit multimeter in gap between analog and 0.01% digital instruments



Small drop. When measuring current, the 1240 has a voltage drop across it no greater than 0.2 volt. The meter's frequency range is 40 hertz to 20 kilohertz.

To hear him tell it, Tom Kelly's best customer is going to be Tom Kelly. Weston Instruments' 1240, a 3½-digit multimeter, is "just what the boys in my group have needed for a long time," he says. Kelly heads the team of Weston engineers who designed the 1240, which will make its debut at Nerem (Boston, November 5-7) along with the 1241, a digital volt-ohmmeter.

The 1240 features low price, accuracy and versatility. Selling for \$380, the instrument's accuracy is $\pm 0.1\%$ of the reading $\pm 0.5\%$ of full scale when measuring d-c voltage. And in addition to five d-c voltage ranges, from 0.2 volt up to 1,000 volts, the 1240 measures a-c voltage in five ranges, from 200 millivolts to 500 volts and d-c and a-c current, each in five ranges from 200 microamps to 2 amps. It also reads resistance in six ranges, from 200 ohms to 20 megohms.

Assuming the user's viewpoint,

Kelly says: "The \$200 multimeters, like the Simpson 260, don't have enough accuracy for us, and we just can't afford to hand everybody in the lab a \$1,000 or \$2,000 instrument (whose accuracy is 0.01% or better). The 1240 fills this gap and meets the needs of most engineering laboratories." And Jack Stegenga, Weston's new product manager, predicts that the 1240 also will be popular for field testing—it accepts a special battery pack—and in production-line work—it can be panel-mounted.

When measuring d-c voltage, the 1240 has an input impedance of 100 and 1,000 megohms, respectively, for its 0.2-volt and 2-volt ranges. For the higher ranges, the impedance is 10 megohms. For a-c voltage applications, the impedance is 1 megohm and 50 picofarads. And accuracy is 0.5% reading ± 1 digit for input frequencies between 40 hertz and 10 kilohertz. From 10 to 20 kHz, the accuracy is

Small Space, Large Range



The Hewlett-Packard 3200B VHF Oscillator, in small space, offers continuous coverage of frequencies from 10 to 500 MHz. The 3200B provides $\pm 0.002\%$ frequency stability over a 5-minute period, a high RF output level and an output attenuator. It is ideal as a general purpose source of CW signals and will also accept external pulse or amplitude modulation. The 3200B may be used with an accessory doubler probe to extend the frequency coverage to 1000 MHz. Size: 7½" wide, 6½" high and 13½" deep. Price: \$525. For more complete information, contact your local Hewlett-Packard field engineer or write: Hewlett-Packard, Rockaway Division, Green Pond Road, Rockaway, New Jersey 07866. In Europe: 1217 Meyrin-Geneva, Switzerland.

HEWLETT **hp** PACKARD

SIGNAL SOURCES

1083A

Meet the Members of The Board...

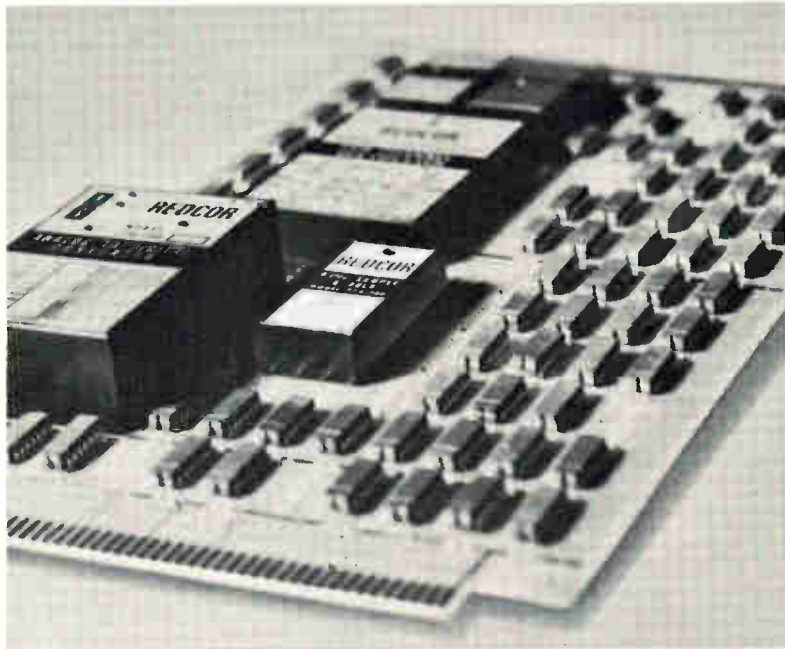

...Dual In-Line Conference

For the successful management of analog circuit design, the designer's board members must have background characteristics based upon dynamic response specifications and a proven performance with known sources and loads. The designer's board members must also have the ability to "fit in" with the others whether they be dual in-lines, discrete or flat-pack components. Our packaging configuration allows the designer this freedom.

The guaranteed performance of REDCOR's closed loop module concept frees the system designer from the concern, risk and expense normally experienced with other analog modules.

To support those special circuit and system design requirements, REDCOR can supply not only the modules, but the boards, chassis, and power supplies.

Analog-to-Digital Converters
Digital-to-Analog Converters
Multiplexers
Sample and Hold Amplifiers
TRICON Fast Settling Amplifiers

BUF-FET Ultra Fast Settling
Amplifiers
Dynamic Bridge Amplifiers
REDIREF Voltage Reference
Supplies
Comparators

REDCOR's board members come prepared to meet any situation. For a complete catalog listing specified performance, write or call:

R
C **REDCOR**
CORPORATION

Complete Systems Capability / 7800 Deering Avenue, P.O. Box 1031,
Canoga Park, California 91304—(213) 348-5892

... dual-slope converter is the basic circuit ...

1% ± 1 digit.

Low drain. The 1240, when working as an ammeter, doesn't drain much from a circuit—the voltage drop across it is just 0.2 volt. Accuracy for d-c current readings is between 0.2% ± 1 digit and 0.5% ± 1 digit, depending on the range. For a-c readings, the accuracy is 1% ± 1 digit or better for input frequencies between 40 hz and 10 khz.

Accuracy for all but the highest resistance range is 0.5% ± 1 digit; for the 20-megohm scale it's 2%. "This means you can measure both precision resistors with 0.1-ohm resolution and those high-megohm carbon resistors," says engineer Kelly.

At 60 hz, the 1240 has a common-mode rejection ratio of 80 decibels and a normal-mode rejection ratio of 35 db. It makes five readings per second and operates on either 115 volts, 60 hz or 230 volts, 50 hz.

The 1240's basic circuit is a dual-slope converter, identical to the one used in the 1292, Weston's digital panel meter. "We have a tried and proven design," points out product manager Stegenga. Connected to the dual-slope circuit is an average-responding converter which measures a-c.

Although Weston runs against plenty of competition in the dpm market, Stegenga doesn't expect the 1240 to face many challengers. "Oh, a few companies will jump in," he says. "Anybody can build a dpm, but it takes experience to put together the circuits needed for a 26-range meter."

At Nerem, Weston also will introduce a less complex version of the 1240. Called the 1241, this meter measures only d-c voltage and resistance, and will sell for \$325. While the 1240 may have a market all to itself, the 1241 is going against an entrenched foe. "Fairchild came along and made this market (for a digital volt-ohmmeter) with its 7050," says Stegenga, "and now we want a piece of it."

Delivery time of both the 1240 and 1241 will range from stock to six weeks.

Weston Instruments Division, 614 Frelinghuysen Ave., Newark, N.J. [339]

did you know?



General Electric **volt-pac**[®] variable transformers help you vary voltage dependably...year after year,* after year, after year, after year, after year, after year, after year, after year...

Send in this coupon for free bulletin giving complete details on Volt-Pac transformer features, ratings and application data; or see your GE sales representative today.

* Laboratory tested for over one million failure-free operations.

GENERAL  **ELECTRIC**

Circle 151 on reader service card

.....
• Section 413-34
• General Electric Company
• Schenectady, New York 12305
• Please send me free bulletin GEA-8110 on Volt-Pac Variable Transformers.
• NAME _____
• COMPANY _____
• TITLE _____
• ADDRESS _____
• CITY _____ STATE _____ ZIP _____

Who put 500 KHz-1 MHz in a tiny TO-5 COLDWELD CRYSTAL PACKAGE?

(who else but BULOVA!)



Who else could offer such a broad range of low frequency output from a series of masterfully miniaturized packages?

Now Bulova produces a coldweld-enclosed crystal built to an even tighter spec — in a smaller container — at a lower price!

In the TO-5 can, for example, with the frequency range of 500 KHz to 1 MHz, you get a tolerance of $\pm .025\%$ from -40°C to $+70^{\circ}\text{C}$, (or to specification), and aging is 1 PPM per month after stabilization. All this with a coldweld seal to eliminate the problems from contamination and frequency shift caused by solder flux and heat.

What's more, Bulova supplies an entire line of high precision crystals in a selection of packages. Virtually the entire frequency spectrum is available, from 2 KHz to 140 MHz for oscillator and filter applications, in every type of package: glass sealed, solder-seal, metal holders, and, of course, coldweld.

For more data, call 212-335-6000, see EEM Section 2300, or write —



BULOVA
FREQUENCY
CONTROL PRODUCTS

Electronics Division of Bulova Watch Co., Inc.
61-20 Woodside Ave., Woodside, N.Y. 11377
(212) 335-6000

Go Bulova, and leave the designing to us!

Data handling

Time-sharing traffic cop

Minicomputer can do concentration, pre-processing; will handle communications for 96-terminal system

Suppose you have to process data coming into a central point from up to 96 terminals—including teletypewriter, and low- and medium-speed asynchronous modems and binary devices—and being transmitted at up to six different baud-rate combinations simultaneously. You can program a general-purpose computer to do the job, but you might be tying up an expensive machine for this data-communications task.

To avoid the need for costly tie-ups of this kind, data-processing system designers are developing special machines to handle communications [*Electronics*, March 31, p. 154].

At the Fall Joint Computer Conference, Nov. 18-20 in Las Vegas, Micro Systems Inc. will introduce its entry, the Micro 812.

William Roberts, MSI's vice president for research and engineering, says a typical application of the microprogramed Micro 812 might be in a time-sharing system in which data from a number of lines is to be concentrated down to one phone line. "But we're not selling a concentrator," Roberts stresses. "We're selling a computer that can do concentration." MSI is aiming the machine at original equipment manufacturers for use as an interface unit to do data concentration, or as a pre-processor for larger computers "to free the larger computer from data communications worries," as Roberts puts it.

Not many machines like the Micro 812 are available, says Roberts. Interdata is the only other firm that he knows of offering a microprogramed minicomputer specifically for data communications applications, and that machine can't handle as many input devices as MSI's can.

Stored program. A microprogramed computer's control unit

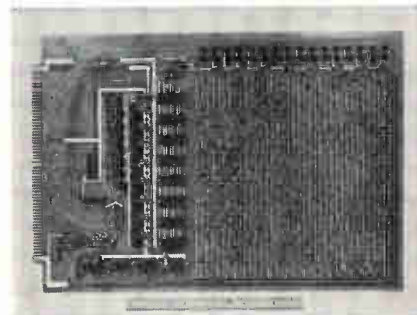

Microprogramed. Memory card, bottom photo, carries diodes that perform microprogramming in the 812. Diodes take up right half of card.

holds a stored program, while a fixed control machine is hard-wired. The program in the control unit can be quickly changed from one application to another, and tailors the computer for a given job without changing the hardware implementation. In the Micro 812, MSI officials say, 16 powerful microcommands are available to optimize the machine for the data-communications job, with microcommand word lengths of 16 bits. In effect, microprogramming in the machine simplifies most input/output interface requirements because the data from the teletypewriters or modems is timed and buffered internally without additional hardware or software.

In the Micro 812, the microprogram is contained in a discrete diode read-only memory with a 220-nanosecond cycle time. The basic

FREE TEST...

(How can you solve
your filtering problem
if you don't know
you have a problem?)



FREE PROOF

that Cox can solve a contamination problem
you may not know you have,
boost your filtrate throughput up to ten times,
and guarantee filtrate purity within absolute limits!

Do you insist on "absolute" filtration, without knowing if your filtering system delivers it, day in, day out?

More importantly, do you *know* the proper degree of filtration your process actually needs, or is it based on an educated guess?

At no obligation, Cox will be glad to analyze both the efficiency and the effectiveness of your present filtering system. We'll be glad to evaluate the true degree of filtering which your process requires. We'll show how you can achieve the ideal balance between particle retention and filtrate throughput, while increasing throughput volume many times. If your present system turns out to be correct for your process requirements, we'll tell you so and go away.

But chances are we can show you ways to improve your present process, ranging from suggesting

minor improvements up to proposing a totally new set of specifications and the mechanical changes necessary to maintain those specs on a continuing basis.

DO IT NOW: send us a representative sample of your process filtrate, together with a note telling us your filtering specifications and the nature of your process and product. We'll return to you an analysis report within 24 hours after receiving your test sample. There's no obligation.



COX INSTRUMENT
DIVISION OF LYNCH CORPORATION

15300 Fullerton Avenue • Detroit, Michigan 48227

ASK

A Micro

COMPET

Now ask a Micro Compet. At last you can. Our extensive development of ELSI (Extra Large Scale Integration) specifically for use in electronic calculators (Electronics 11/11/'68) has paid off. The result you can see. Micro Compet QT-8D.

It's hand-sized and weighs just 3 lbs. Silently performs $+ - \times \div$ and mixed calculations up to 8 digits. Answer response is fast and clear on a new green read out.

We think Micro Compet is a design breakthrough. It's compact, stable and easy to use. It should be good. We made the first solid-state electronic calculators and today make more than anybody else.

Ask to see Micro Compet QT-8D soon.



A single 1/8" square ELSI does the work of 1875 electronic components. With 4 ELSIs Micro Compet ensures maximum performance in ultra-miniature dimensions.

**Magnified ELSI
by 50 times**



**Model
QT-8D**

SHARP

HAYAKAWA ELECTRIC CO., LTD. Osaka, Japan

U.S. Subsidiary: SHARP ELECTRONICS CORP. 178 Commerce Road Carlstadt, New Jersey

... first unit handles inventory system ...

machine, which includes a 4,096-word by 9-bit core memory for the user's program, sells for \$10,000. Each group of 24 input lines dictates a need for an additional interface board in the computer. Besides handling the 96 low-speed teletypewriters (up to 360 bauds), the machine can be arranged to accommodate a maximum of 32 medium-speed input lines (less than 9,600 bauds). Each interface board will permit the computer to handle 24 additional teletypewriters or 16 additional modems.

Reserve. Roberts says a small computer without microprogramming would have half its I/O capability consumed in handling 16 teletypewriters; by contrast, the Micro 812 can accommodate its maximum 96 lines and mixed baud (bits per second) rates—110 bauds, 134.5 bauds, and 150 bauds, for example—using only 70% of its I/O capability.

In performing the I/O function of the teletypewriters, the microprogrammed read-only memory samples the inputs, reconstructs the characters it "sees" on a given input line, and, in a time-sharing system, may store a line of data—a printed line—before sending it to the central processor. Besides the microprogrammed processor and core memory, the basic machine includes a systems control panel, power supply, power-fail-automatic restart, memory parity, a real-time clock, six communications rate clocks, and provisions for additional communications interface boards. The unit is 8¾ by 17¾ by 23 inches.

The first Micro 812 machine went this month to Rydacom, a subsidiary of Ryder Systems Inc. of Miami, Fla., for use in an on-line warehouse inventory control system. MSI's Roberts expects the Micro 812 to account for some 30% of his firm's business next year; since introducing the Micro 800 and Micro 810 early this year, MSI has booked \$3 million worth of business from those two machines.

Typical delivery time for the Micro 812 will be 60 days.

Micro Systems Inc., 644 East Young St., Santa Ana, Calif. 92705 [340]

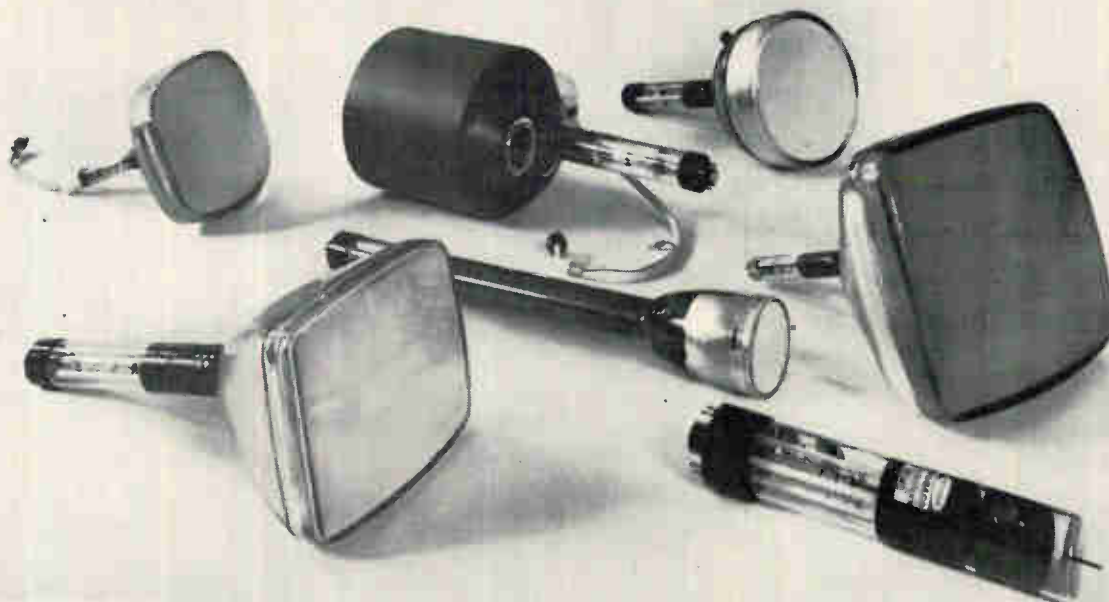

These men specialize in developing CRTs for your toughest applications.

Together, they have a wide range of capabilities for cathode-ray tube design, application, and manufacture. In fact, they've developed CRTs for radar and avionics displays • air-traffic control and ground-support equipment • computer terminal CRT displays • large-screen and simulation display systems • flying spot scanners and photo recorders —among others.

They daily produce a large number of Dataray* CRTs in a wide

range of standard and special types, in screen sizes from 2" to 24", and in all available phosphors. They also supply combination electrostatic and magnetic deflection types for writing alphanumeric while raster or random scanning.

For complete information on Dataray CRTs, call or write: *Raytheon Company, Industrial Components Operation, 465 Centre Street, Quincy, Massachusetts 02169. Tel: 617 479-5300.*

Tubes shown: CK1387P- for airborne cockpit display; CK1437P- with rear window for combined photo-recording and operator display; CK1355P- airborne display tube with anti-corona high-voltage connector; CK1439P- for computer CRT displays; QV367 test CRT for phosphor investigation; CK1447P- narrow-neck, high deflection sensitivity CRT for computer displays; CK1414F- Symbolray™ monoscope for alphanumeric generation.

*Registered trademark of Raytheon Company



Circle 155 on reader service card

Why pay \$595 when you can have this 15-MHz counter for only \$395?

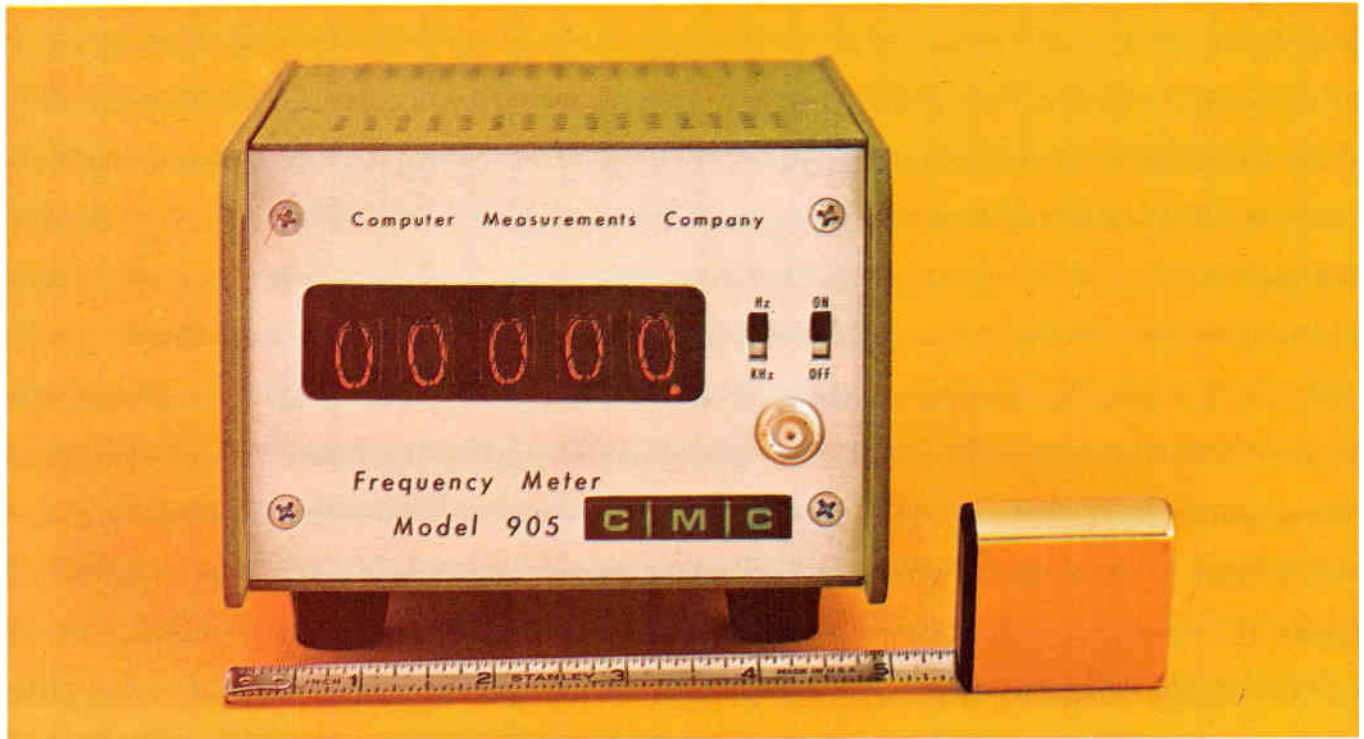

WHAT!

For less than \$80 per digit?

The CMC Model 905 is by far your biggest buy in a little counter. You get 15-MHz IC performance, 5-digit readout, a 1-MHz crystal oscillator, an automatic trigger level, simplified controls, and a convenient tilt-up stand—all in a tiny package only 5-inches wide and 3½-inches high.

This mighty little counter weighs only 3½ pounds, and yet it's a reliable workhorse for production line or laboratory. Its IC design results in increased reliability, improved heat dissipation, and reduced power requirements of only 8 watts typically.

Now, the low-cost high quality Model 905 brings an integrated-circuit frequency meter within the budget of every user, both large and small. If you need an instrument for making accurate frequency measurements up to 15 MHz, the Model 905 will give you maximum counter-for-your-dollar. So if it's frequency you are measuring, why pay

double the 905 price for functions you don't intend to use?

CMC sales representatives in all major cities are ready now to bring a Model 905 directly to you for a personal test demonstration. Test one. (You'll be glad you did.) Buy several. (They're very small.)

For the full specs, just circle the reader service card; and for a demonstration, contact your local CMC representative.

COMPUTER MEASUREMENTS



A DIVISION OF NEWELL INDUSTRIES

12970 Bradley/San Fernando, Calif. 91342/(213) 367-2161/TWX 910-496-1487

Hybrid power amp puts out 100 watts

First of a new line uses 'heat-spreading' technique; unit aimed at servo and aircraft intercom applications

Dissipating heat from hybrid power amplifiers can be a difficult problem. And usually, the solution makes the hybrid device prohibitively expensive for all but the most demanding military and industrial applications.

But RCA's Electronic Components division believes it has an inexpensive answer to the heat problem. In fact, so convinced are

division officials that they've given the go-ahead for a whole line of hybrid power amplifiers, the first of which is now ready for the marketplace.

Called the TA 7625, this first device measures 2½ by 3 by 1¾ inches and develops 100 watts output with 40 watts dissipation. According to Warren Totten, the division's marketing manager for

circuit modules, it can be used in servo applications to power such things as tape drives, in intercom and entertainment systems aboard aircraft, or as a power operational amplifier. The last application is possible, says Totten, because "you can adjust the gain externally."

Containing two output power transistors, eight diodes, nine transistors, 23 thick-film resistors, and



Miniature multipin connectors feature a 7/16-28 threaded coupling. With 5 key mechanical polarization one shell size of ½ in. max. o-d is available in 3, 5, 7, and 9 power contacts and in combinations of coax and power types. All are rated at 1 amp. Insulating materials are fused glass or molded thermosetting compound. Ted Mfg. Corp., Shawnee Mission, Kan. [341]



Split-screen storage tube permits stored information to be displayed on part of the screen while data is continuously read out on the remaining part. It is ideal for use where it is advantageous to visually compare known and unknown data. The tube is useful in commercial and industrial as well as medical instrumentation. Westinghouse Electric Corp., Pittsburgh, Pa. [342]



Alumina insulated bushing assembly AB1 provides electrical isolation for variable air dielectric trimmer capacitors mounted on conductive chassis or other surfaces. It has a resistance rating of 10⁶ megohms, and can be used with any standard air trimmer with a 15/64 in.-64 threaded bushing. Price in lots of 100 is \$2 each. Voltronics Corp., West St., Hanover, N.J. [343]

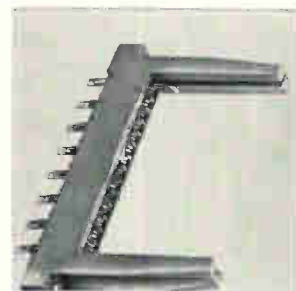

Card-edge connector 6030, available with 15 single-readout or 30 dual-readout contacts, offers a choice of terminations that includes solder (wire hole or p-c tab), taper tab, and low-cost wire wrap post. Current rating is 5 amps, with a contact resistance of 6 milliohms. Insulation resistance exceeds 25,000 megohms. Elco Corp., 155 Commerce Dr., Fort Washington, Pa. [344]

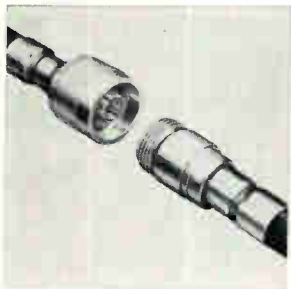

Fully crimpable N series coaxial connector is designed to exceed performance requirements of MIL-C-39012. The contact is first crimped onto the cable center conductor and then the braid is securely crimped. This 50-ohm coaxial connector performs to 11 Ghz with a typical swept frequency of 1.15 vswr. Cable retention force exceeds 125 lbs. AMP Inc., Harrisburg, Pa. [345]

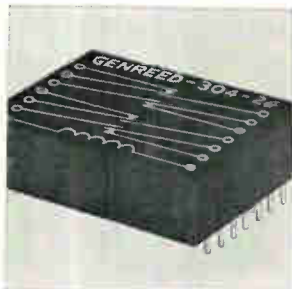

Multicircuit reed relays series 300 contain various combinations of spst and spdt miniature magnetic reed capsules in a molded housing. Electrical connections to capsules and operating coils are made by contact pins on standard 0.100-inch grid spacing for p-c boards. Standard coil operating voltages are 6, 12, and 24 v. General Reed Co., 19 Walnut Ave., Clark, N.J. 07066 [346]



Center-tap 3/8-inch trimmer potentiometer model 75SCT features resistance values from 100 ohms to 20 kilohms and stand-offs for easy board washing. Its diallyl phthalate case is impervious to all normal cleaning solvents. An "O" ring seals the adjustment shaft to protect internal parts against severe environments. Techno-Components, 7803 Leona Ave., Van Nuys, Calif. [347]

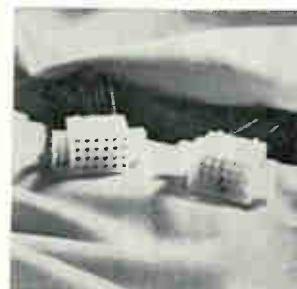

Miniature connector 1625-24 is a 24-circuit device having a nylon body with integrally molded mounting ears on both plug and receptacle. It accepts crimp-type terminals available in tin-plated brass, phosphorous bronze, and gold or silver-plated brass. The connector has applications in business machines and computers. Molex Products Co., Katrine Ave., Downers Grove, Ill. [348]

Control/alarm shortcut.

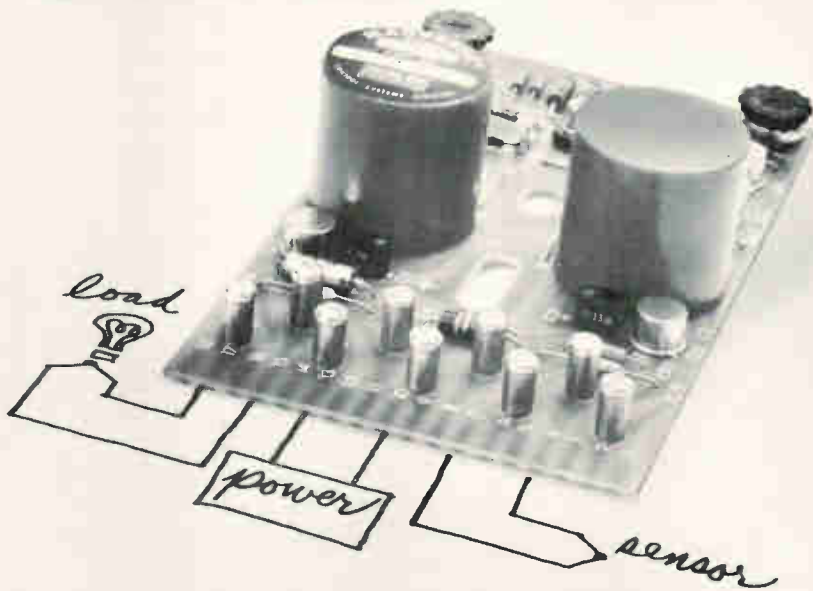

MAGSENSE

control/alarm for temperature, pressure, speed, flow

Here's the fast, low-cost way to solve control/alarm problems. Hook up sensor, load and power source to a MAGSENSE® module and adjust the setpoint (or dual setpoints). That's it. No time and money wasted designing and debugging a circuit. And you've got proven-in-service performance and reliability.

Capabilities. MAGSENSE modules offer 100-billion power gain, accept inputs as low as 10 microvolts or 1 microamp directly *without* preamplification. Completely isolated inputs are *unaffected* by common mode voltages as high as 110vac, 60 Hz or overloads as large as 1000-times full scale. And they operate from a *single* 28v or 12v power source.

Flexibility. Standard models offer a wide range of options including single, dual and remote setpoints, adjustable hysteresis, choice of output action, transducer excitation voltage, and cold junction and copper compensation on thermocouple models. And, in the off-chance a standard model won't fit your precise application, we can custom-build one quickly, inexpensively.

Take the short cut. Write or call for your free copy of the MAGSENSE Application Manual. It has all the specifications and prices. And all the shortcuts.



CONTROL DATA
CORPORATION

Magnetic Products Operation, Dept. 305
Control Data Corporation
775 Colorado Avenue So.
Minneapolis, Minnesota 55416
Phone 612/544-8851

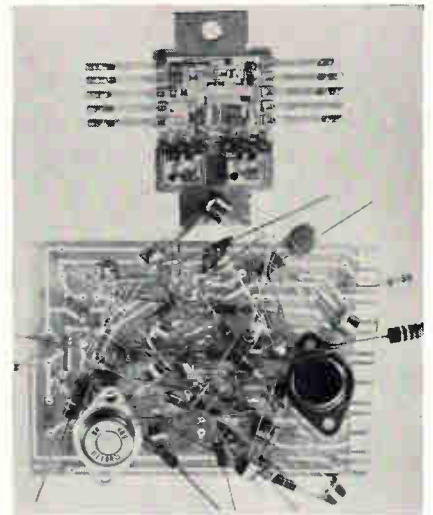

New and old. Hybrid module does job of discretes shown at bottom.

seven ceramic chip capacitors, the device's 3-decibel response is from 20 hertz to 55 kilohertz at 60 watts power level. But Dale Baugher, engineering applications leader, points out that what makes the device work is the way heat is dissipated.

Both output transistors, which are equivalent to RCA's 2N3055 chips, are mounted on copper blocks, or heat spreaders, as Baugher calls them. Because these heat spreaders are about six times the size of transistor chips, the heat generated by the chips can spread over this larger area at about a 45° angle, thus reducing its intensity per unit area. With the heat spread out this way, it is also possible to use relatively inexpensive alumina to electrically isolate the output transistors, instead of higher-priced beryllia.

Although the customer still has to heat-sink the entire device, "we've at least made it possible for him to do this with ease because the heat is so evenly spread out," says Baugher.

Main customers. Priced at \$80, the seven-amp peak linear amplifier, as Totten prefers to call the device, is still too expensive to be used in consumer electronics products. "Our primary emphasis will be for military and industrial applications. But within three years we expect to be able to get the price down to between \$10 and \$20, where it would be attractive for audio circuits," says Totten.

RCA Electronic Components, Somerville, N.J. 08876 [349]

Class Mates

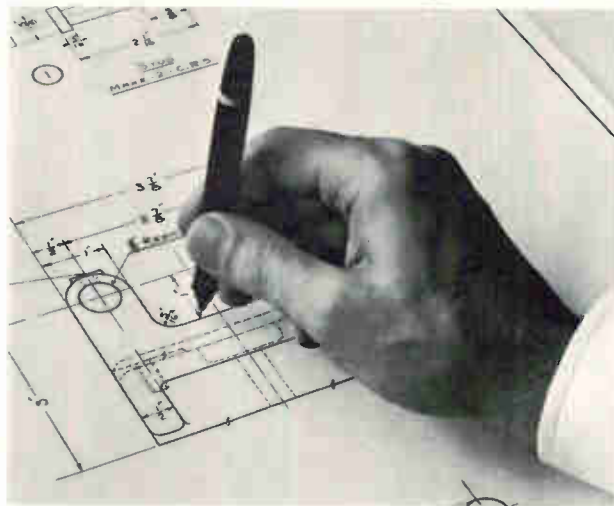

With KODAGRAPH ESTAR Base Films and jewel-tipped pens, you save time and find drafting easier and more efficient.

Use a jewel-tipped pen on KODAGRAPH ESTAR Base Films and you'll discover how easy drafting has become these days. And why so many firms have discarded the familiar pencils and steel-tipped pens in favor of this breakthrough combination.

It's the combination that saves you creative drafting time. Lots of it.

KODAGRAPH ESTAR Base Films make things easy in the drafting room. Photographic line erasure is a

breeze. You get top dimensional stability, sharp blacks. You can reclaim tired drawings in short order, make beautiful second originals, end retracing.

Though Kodak doesn't make jewel-tipped pens, we cite them as a smart investment. They outlast pencils and even standard pens a hundred times over. The longer wear and increased production pay for their initial cost very quickly.

Try these classmates. Contact your Kodak Technical Sales Representative for many other shortcuts possible with KODAGRAPH ESTAR Base Films. Or write us: Eastman Kodak Company, Business Systems Markets Division, Rochester, New York 14650.

Kodak

DRAWING REPRODUCTION SYSTEMS BY KODAK



*Who ever heard
of a computer
that*

TALKS CONTROL?

The GRI 909 computer is the closest thing to it. We call the technique Direct Function Processing.

"If meter output is less than zero, go to alarm."

"Turn on tape reader."

"Send complemented output of analog-to-digital converter to controller."

These instructions are representative of GRI's unique functional approach to assembly language. When you have defined the functional operations of your system, you have very nearly written the control program for the GRI 909.

Direct Function Processing adds many new dimensions to computerized system control. To find out more, write for our new brochure describing the GRI 909 computer.



GRI Computer Corp.

76 Rowe Street,
Newton, Mass. 02166
(617) 969-7346

gn-909
You have never seen a computer
like this before. See it at the FJCC.



Voltmeter tells all—for \$650

Instrument for testing field radars, avionics gear measures total voltage, fundamental voltage, phase

Taking measurements at a radar site on a cold, rainy day is bad enough; if you have to do some calculating while out there, your normally pleasant disposition might be totally shattered. To help make field testing and calibrating of radars, avionic equipment, and air traffic control gear a quick affair, engineers at North Atlantic Industries Inc. designed the 210 phase-angle

voltmeter. Besides measuring a signal's total voltage, the 210 knocks the distortion out of a signal, and then measures the voltage of the signal's fundamental, the voltage of the fundamental's in-phase and quadrature components, and the fundamental's phase angle.

The 210 has 11 ranges, from three millivolts full scale to 300 volts. When measuring the total

voltage only, the 210's frequency range is 20 hertz to 40 kilohertz. When making the phase-dependent measurements, the instrument works with signals whose frequencies are within 5% of 400 hz.

If the user wants simply to measure voltage, he connects the unknown signal to the 210, turns the function switch to TOTAL, sets the range, and reads the voltage off



Precision multimeter model 61 features 50,000 ohms per volt sensitivity, protection of the 17 μ a movement against overloads of up to 100,000% in either direction, accurate response to frequencies up to 100 khz. Ranges starting at 250 mv d-c and 25 μ a d-c can measure as low as 5 mv and 0.5 μ a. Scientific Educational Products Corp., 30 E. 42nd St., N.Y. 10017 [361]



Projection surface analyzer called Surfaspac detects macroscopic imperfections and projects them for display on an eight-inch screen. It is especially suited for examination of polished and epitaxial silicon wafer surfaces. Price is in the \$2,850 range, with delivery 6 to 8 weeks ARO. Applied Materials Technology Inc., 2999 San Ysidro Way, Santa Clara, Calif. 95051 [362]



In-circuit and out-of-circuit tests are possible without removing transistors or without change in basic procedure with the model 162 transistor/FET tester. Measuring 9 x 7 $\frac{1}{4}$ x 4 in., the d-c operated unit weighs 6 lbs. It is battery operated for complete portability. It is priced at \$99.95. Dynascan Corp., B&K Division, 1801 W. Bells Plaine Ave., Chicago, 60613 [363]



Capacitance bridge R-127 can provide immediate mutual capacitance measurements at frequencies to 1 Whz. This capability is made possible by balanced input terminals. Accuracy is $\pm 0.1\%$. Primary use of the R-127 is measurement of 3-terminal networks, and small ungrounded or single ended capacitances. Siemens America Inc., 350 Fifth Ave., N.Y. [364]

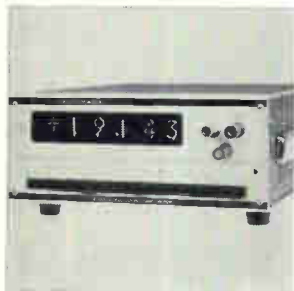

Volt/ohm/amp meter model 1820 is a 0.01% unit with 4 digits of display. It features 100% over-range, auto polarity and push-button operation. It provides 5 voltage and resistance ranges from 0.01 mv to 1,000 v and 0.1 ohm to 19.999 megohms, with d-c amps from 0.001 μ a to 1,000 ma in 6 ranges. Eldorado Electrodata Corp., 601 Chalomar Rd., Concord, Calif. [365]



Manual balance digital indicator MDX-11 is used with bonded strain gage force and pressure transducers with 2 mv/v or 3 mv/v output signals. Full scale output is 100,000 counts with a 30% overrange capability. A course control knob of 12 additional steps of 10,000 counts each is included. Accuracy is 0.05%. Transducers Inc., E. Rivera Rd., Santa Fe Springs, Calif. [366]



High frequency, dual channel oscilloscope 1050 offers a triggering device that eliminates trace flicker. Another advantage is maintenance of signal synchronization regardless of the vertical positioning of either trace. Unit also features sensitivity to 1 mv/cm from d-c to 25 Mhz in both channels with X10 gain. Dumont Oscilloscope Laboratories Inc., W. Caldwell, N.J. [367]



Triggered sweep, 5-in. oscilloscope/vectorscope TO-50 offers features normally found only in lab-quality test instruments at a price of \$329.50. Features include 10-Mhz bandwidth; d-c amplifiers to eliminate pattern bounce, permit viewing a-c and d-c simultaneously; and calibrated vertical attenuator and horizontal time base. Lectrotech Inc., 4529 N. Kedzie Ave., Chicago [368]

Have a load to position?

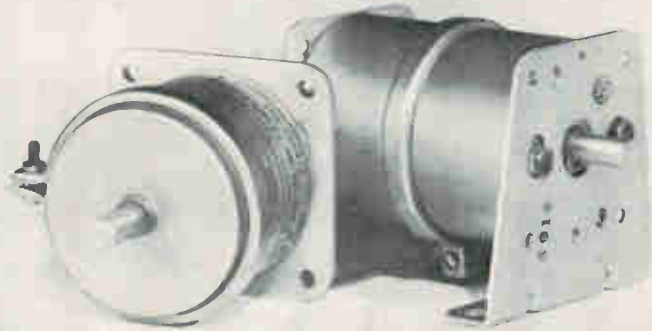

Five things you'll like about these new Ledex Stepping Motors

High torque-to-size ratio. Breakaway torque of up to 160 ounce-inches...drive a constant friction load of up to 64 ounce-inches. An exclusive new tooth clutch, with positive grip-action drive makes this high torque output possible.

Unidirectional and bidirectional models available. Choice of 18 (20°) and 12 (30°) step models for remote load driving. Bidirectional models let you position loads CW or CCW.

Minimum Life of 3 Million Steps (in both directions on bidirectional models). From design through production, they're built-to-perform. All working parts fully enclosed.

Uniform Stepping Accuracy ($\pm 1^\circ$). Entirely non-accumulative. Then consider other Ledex Series 50 stepping motor features like the ability to add rotary switches and position remotely or manually in either direction, response to simple square wave input (no expensive logic circuitry required) and their ability to meet military environmental requirements. Practical pricing too (under \$15 unidirectional; under \$21 bidirectional in 500 lots).

Twenty stock models available to help you get a quick start on your prototype.

Write for this new catalog. Or, tell us about your application and we'll recommend a solution.



Specialists in remote positioning



LEDEX DIVISION, LEDEX INC.

123 Webster Street, Dayton, Ohio 45402 • phone (513) 224-9891

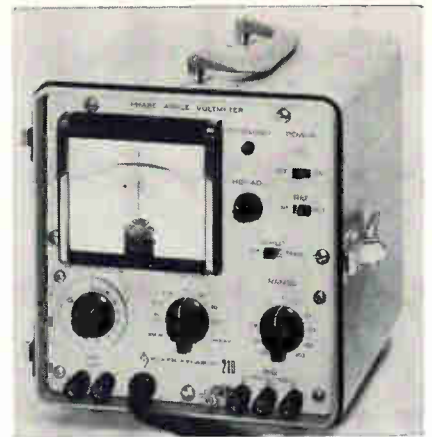

Field service. Phase-angle voltmeter is designed for on-site testing.

the 210's zero-in-the-center scale. Inside the instrument is an amplifier followed by a rectifier and additional measuring circuitry.

To measure the fundamental, the user just switches to FUND; this puts in front of the amplifier a bandpass filter, centered at 400 hz. The scale shows the fundamental.

Next the user connects a 400-hz reference signal to the 210 and switches to the 0° setting. The reference turns the rectifier into a phase-sensitive demodulator which passes only that part of the input's fundamental that's in phase.

Turning the REFERENCE ϕ dial shifts the reference. The dial is scaled in degrees, and by peaking the meter with this dial, the user can determine the phase angle to within 3°.

Switching to the 90° position shifts the reference 90°, making the voltage measured by the instrument the quadrature component. The function switch has also 180° and 270° settings in case the input lags behind the reference.

The 210's accuracy for voltage measurements is 2%, and the instrument resolves 100 microvolts.

Running off a 115- or 230-volt line, the meter draws 40 watts. The power line frequency can be any value between 45 and 440 hz.

There are three models of the 210. The 210B, which routes the reference through an isolation transformer, costs \$575. The 210C, which has transformers in both channels, costs \$650. The 210/10, a low-accuracy model, costs \$490.

North Atlantic Industries Inc., Terminal Dr., Plainview, N.Y. 11803 [370]

New instruments

Pot promises 0.01 ppm accuracy

Unit compares two voltages by switching from one to the other; price is \$6,550

When it comes to getting accuracies better than one part per million, engineers at Julie Research Laboratories Inc. suggest ordering a double—that is, a double-voltage potentiometer.

As the Julie people tell it, there are three ways to make high-accuracy comparisons. One is to use a single potentiometer. First the engineer connects one of the voltages to the potentiometer and adjusts it until he zeroes a null meter, also attached to the pot. Then he disconnects the first voltage, connects the second, and nulls again. Because the voltages aren't being measured simultaneously, drifts cause significant error.

A second approach is to use two potentiometers and two null meters. Drift problems are gone, but the cost is obviously doubled, and errors creep in because no two systems are identical.

The third and best approach, according to Julie, is to use a double-voltage potentiometer, such as the DVP-108J that the company is introducing. A single potentiometer, it can be switched from one voltage to another. This results in very-high accuracy. At worst, the accuracy is 0.1 ppm. But when the voltages being compared are close in value, the accuracy can be 0.01 ppm.

Aside from the technique itself, high stability resistors also account for the pot's accuracy. The instrument generates no more than 1 picovolt of thermal electromotive force, and the oil-immersed standard resistors in some circuits have a ratio stability of 0.2 ppm per year.

By itself, the 108 is priced at \$6,550. But with Julie's ND-107 null detector/preamplifier, the instrument's price is boosted to \$7,100.

Julie Research Laboratories Inc., 211 W. 61 St., New York, N.Y. 10023 [371]

**NOW AVAILABLE
FOR IMMEDIATE DELIVERY:**

FAST SWITCHING

2 AMP and 5 AMP TRANSISTORS

from  Solitron

Solitron has expanded its line of ultra-fast switching transistors with the introduction of 2 AMP and 5 AMP devices. These new units are the fastest switching transistors in the industry now available for "off the shelf" immediate delivery. Features include planar construction and rise time less than 10 nanoseconds.



TO-5



TO-60

2 AMP SERIES

Type Number TO-5	Type Number TO-60	BV _{CBO}	BV _{CEO}	t _{ON} max.	t _{OFF} max.
SDT6101	SDT6104	65	30	50 ns	50 ns
SDT6102	SDT6105	65	40	50 ns	50 ns
SDT6103	SDT6106	65	50	50 ns	50 ns

5 AMP SERIES

Type Number TO-5	Type Number TO-60	BV _{CBO}	BV _{CEO}	t _{ON} max.	t _{OFF} max.
SDT6110	SDT6113	65	30	65 ns	65 ns
SDT6111	SDT6114	65	40	65 ns	65 ns
SDT6112	SDT6115	65	50	65 ns	65 ns

Dial 1-800-327-3243 for a "No Charge" telephone call and further information

Solitron DEVICES, INC.

1177 BLUE HERON BLVD. / RIVIERA BEACH, FLA. / (305) 848-4311 / TWX: (510) 952-6676

NOW! from RMC

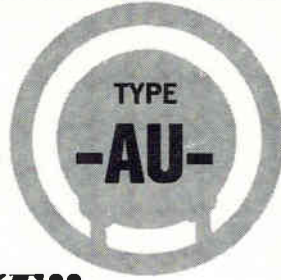

“ACROSS-THE-LINE” U.L. LISTED DISCAPS

EIA Class				
Class II	330 470 680	820 .001 .0015 .0022 .0027	.0033 .0039 .0047 .005	.0068 .0082 .01
Class I				
NPO	3.9 - 20	21 - 31	32 - 47	
N750	15 - 35	36 - 61	62 - 82	
N1500	15 - 67	68 - 119	120 - 180	

THICKNESS: .225 Max.

RMC now offers a complete line of ceramic disc capacitors fully approved by Underwriters Laboratories for the NEW “Across-The-Line” capacitor requirements. This approval is required of all capacitors utilized directly or indirectly across the power supply line.

This application is significantly different from the “Antenna Coupling and Line By pass” capacitor requirements of Underwriters Laboratories Subject 492, and the original RMC -U- capacitor type continues to be approved for those applications.

SPECIFICATIONS

CAPACITANCE: Within specified tolerance:
Class I @ 1MC and 25°C
Class II @ 1KC and 25°C

CAPACITANCE TOLERANCES AVAILABLE:
Class I ±5%, ±10% or ±20%
Class II ±20%, +80-20%

WORKING VOLTAGE: 150 VRMS @ 60 cycles (210 volts peak AC plus DC)

POWER FACTOR:
Class I .1% max. at 1 MC
.2% max. less than 30 pf
Class II 1.5% max. at 1KC

INSULATION RESISTANCE: Greater than 7500 Megohms @ 500 VDC

TEMPERATURE COEFFICIENT:
Class I NPO N750 N1500
Class II Z5U; Z5F 1500 pfd. And Less.

FLASH TEST:
Per U.L. Sub. 492

LIFE TEST:
Per U.L. Sub. 492

INSULATION RESISTANCE AFTER HUMIDITY:
Greater than 1000 Megohms @ 500 VDC

BODY INSULATION: Durez phenolic—vacuum wax impregnated. Standard coating on leads 3/16" max. measured from tangent

LEAD STYLES AVAILABLE: Long lead—#20 AWG tinned copper



RADIO MATERIALS COMPANY
A DIVISION OF P. R. MALLORY & CO., INC.
GENERAL OFFICE: 4242 W. Bryn Mawr Ave., Chicago, Ill. 60646
Two RMC Plants Devoted Exclusively to Ceramic Capacitors
FACTORIES AT CHICAGO, ILL. AND ATTICA, IND.

New instruments

Dvm nudged into market

Dana's 5½-digit unit, with multimeter plug-ins, competes with Fluke entry

The lowest-priced 5½-digit volt-meter with full multimeter capability—that's how Dana Laboratories describes its models 5230/550 (full rack width and 3½ inches high) and 5270/550 (half-rack width and 7 inches high). They sell for \$1,395 as basic dvm's.

Dana says the nearest competitor is the model 8300A from the John Fluke Manufacturing Co., which sells for \$1,295 without any options. But a Dana spokesman points out that its machines incorporate a millivolt-measuring capability in the basic price while the Fluke instrument offers this as an option. And a potential buyer looking for full multimeter capability finds a price tag of \$2,095 for the Fluke instrument vs. \$1,995 for Dana's.

Temptation. Bart Weitz, product marketing manager in the measurements division, says the instruments have been in development for some time, but their introduction wasn't hurried because no moderately priced 5½-digit machine existed to tempt possible buyers of higher-priced Dana units away from them. Then along came Fluke, so in comes Dana.

The models 5230 and 5270 offer basic autoranging d-c volts measurement from 1 volt to 1,000 volts plus 20% over-ranging

The two options that give the Dana units the full multimeter performance—a-c and ohms measurement—cost \$450 and \$150, respectively. The a-c option provides measurements at 1, 10, 100 and 1,000 volts rms in a range from 50 hertz to 100 kilohertz.

Additional options are an analog output to drive a strip chart recorder, \$50; d-c to d-c ratio, \$100; and binary coded decimal output, \$250. Delivery time is 45 days.

Dana Laboratories Inc., 2401 Campus Drive, Irvine, Calif. 92664 [372]

**A major
breakthrough!**

**Buckbee-Mears
research has
found a way to
produce small
holes in thick
metal!**

*Our secret is to
lamine metal*



Until now, no one has been able to produce holes in thick metal at anything smaller than a one-to-one ratio. We put our world leading technology in photomechanical reproduction to work and came up with a way to laminate sheets of etched metal in perfect register. We can produce sharply cornered holes of any design in metal much thicker than the width of the hole.

The trick was to eliminate the radii in the corners caused by the laminating process. Our scientists succeeded so well that Buckbee-Mears can accurately register 10,000 holes per square inch over an 11" by 11" area. We can even register up to 40,000 holes per square inch if you need it!

Tolerance on registry is $\pm .0005"$. Tolerance on hole size

is $\pm .0002"$. We are able to laminate up to 1,000 layers of .005" thick material in accurate collimation.

There are countless applications for small holes in thick metals. A few examples might be core nests, fluid amplifiers and collimator screens. Buckbee-Mears can produce masters and the actual laminated metal parts. Either or both.

If you need small holes at better than a one-to-one ratio in any type of metal, any thickness, talk to Buckbee-Mears. We've got a capability to solve your problem.

Solving people's problems is the way we became the world's leader in photomechanical production. Call or write Bill Amundson, our industrial sales manager, and tell him what you need. His number is 612-227-6371.

PRECISION METAL AND GLASS ETCHING • ELECTRO FORMING • AUTOMATED DESIGN
bmc
SAINT PAUL, MINNESOTA 55101

BUCKBEE-MEARS COMPANY

Have coils gone about as far as they can go?



Chances are, you're using some pretty darned good coils right now. So you may have decided that you'll never be able to find any better ones. Nonsense. If you aren't using our brand at the moment, the solution is simple. Switch. You'll get a noticeably higher degree of reliability. (After all, we've been the leader in R. F. chokes ever since the days we helped establish the military specifications for inductors.) We also deliver a greater depth of technical assistance. And our prices? Very competitive. Or perhaps you're already using our coils. If so, the future is still promising. Because we'll be continuing to improve our present models and develop new ones. For a sample order of our pace-setting coils, write AIRCO SPEER ELECTRONIC COMPONENTS, St. Marys, Pennsylvania 15857. Then see where they go from here.

Ask the passive innovators at **AIRCO Speer**

Speer resistors Resistor and conductor paste Jeffers JC precision resistors Jeffers JXP precision resistors and networks Jeffers inductors Jeffers capacitors PEC variable resistors and trimmer potentiometers.

Kit provides self-reversing for cassettes

Package for equipment makers uses small 2-channel record/play head to minimize hum pickup; erase heads are made of ferrite material

In the consumer area, sales of audio tape recorders run second only to color tv. And the rivalry between 8-track stereo and cassette systems grows sharper as equipment makers introduce such improvements as faster forward-and-rewind capabilities for 8-track tape players and automatic reversing for cassettes.

To provide self-reversing for cassettes, Michigan Magnetics has de-

veloped a two-channel record/play head that is set in the middle of two erase heads and tape guides, all mounted on a nest assembly. The company says it selected this design instead of a four-channel head because the two-channel equipment will require fewer adjustments on the part of the listener and will reduce interaction between channels.

Donald P. Humphry, the marketing manager, says "Our record/play head also is 20% to 30% smaller than any cassette head we've seen. This makes the head much less susceptible to hum pickup, a major problem with units designed for the hi-fi market."

For the original equipment manufacturer, the packaged assembly offers the advantage that, since it



Line-operated, regulated, h-v power supplies series ARA-106 have an output from 4 kv to 18 kv. Ripple is less than 0.1%. They are designed for use with crt's, image pickup, display and phototubes, and as a general-purpose high voltage source. Operating temperature is -20° to 75° C. Advanced High Voltage Co., 8635 Yolanda Ave., Northridge, Calif. [381]

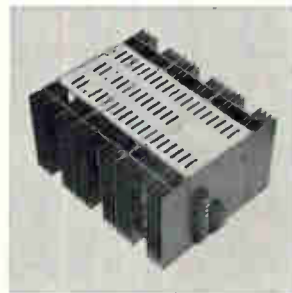

Inverter series P24 converts 22-26 v d-c to 115, 220 or 440 v a-c, 60 hz at 240 v-a. Inputs and outputs are isolated. Regulation is within $\pm 0.2\%$ for input variations of 22 to 26 v d-c, and is within 1% limits for load changes of $\frac{1}{2}$ to full load. Output voltage is adjustable $\pm 10\%$ from nominal. Abbott Transistor Labs Inc., 5200 W. Jefferson Blvd., Los Angeles [382]



Sine wave tuning fork oscillator model 16B05's output is a short-circuit protected sine wave featuring a maximum harmonic wave form distortion of only 5%. Frequency may be specified from 360 hz to 15 khz. Input voltage is 22 to 32 v d-c with current dependent upon frequency (25 to 35 ma). Price is \$148 in 100 quantity. Barden Co., 2217 Purdue Ave., Los Angeles [383]



Memory systems Alpha 10.2 and 12.2 feature modular construction. Basic modules come in sizes of 10,024 to 40,960 bits. Cycle times are 1.50 μ sec for the 10.2, which has a maximum size of 1024 x 10, and 1.75 μ sec for the 12.2, with module capacities to 4,096 x 10. Units occupy 65 and 130 cu in. respectively. Tetra Corp., 7273 Washington Ave., S., Minneapolis 99435 [384]



Wideband r-f amplifier model 400-20 is constructed using hybrid thick film techniques assuring high reliability and small size. It has a 1-db bandwidth from 500 khz to 400 Mhz. Gain is 20 db, ± 1 db. Noise figure is a maximum of 4 db and vswr (input and output) is 2:1 max. Price is \$275. Sierra Systems Inc., 2255 Old Middlefield Way, Mountain View, Calif. [385]



Encapsulated power supplies are designed to power operational amplifiers and function modules. Four units are available to supply ± 15 v d-c: PS-121, 50 ma; PS-122, 75 ma; PS-123, 100 ma; PS-124, 200 ma. Single units are priced at \$38, \$51, \$79, and \$198 respectively, with quantity discounts offered. GPS Instrument Co., 14 Burr St., Framingham, Mass. [386]

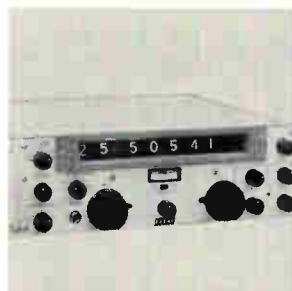

H-f receiver model RA6218 features an electronic counter with a 7-digit display, locked to a built-in high stability crystal frequency source, enabling the operator to read the receiver tuned frequency to within 10 hz. Frequency range is 1 to 30 Mhz. The unit measures $5\frac{1}{4}$ x 19 x $17\frac{1}{2}$ in. Racial Communications Inc., 8440 Second Ave., Silver Spring, Md. [387]



D-c/d-c positive or negative point-of-load regulators CX-95 come in 14 models with outputs from 3 to 24 d-c at 4 amps and inputs from 7 to 35 v d-c, depending on model. Input ripple reduction is better than 200:1. Built-in short-circuit protection is also featured. Price is \$45 each, with quantity discounts available. Technipower Inc., Benrus Center, Ridgefield, Conn. [388]

Making Testers?



It's just one way to use Elgin's Integrid® Cards and power supplies to solve a design problem.

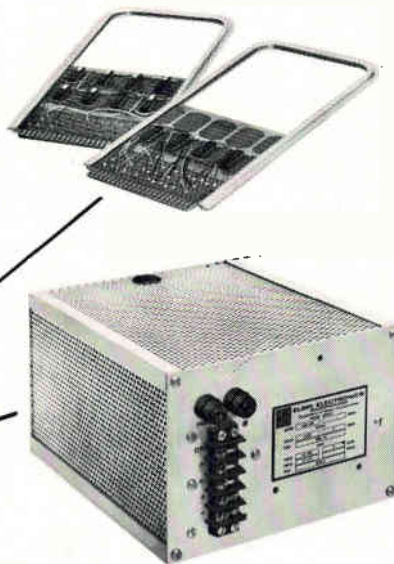
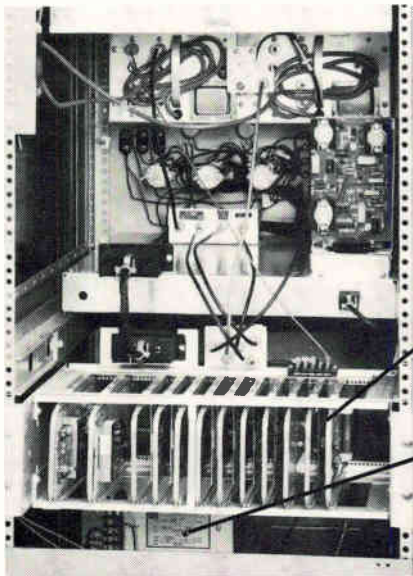

The custom test equipment pictured above demonstrates another use for these Elgin off-the-shelf products when you are faced with a job requiring reliable, low cost components.

Elgin's 5V power supplies in each tester feature exclusive over-voltage and over-current protection. They are available in three basic sizes with output currents of 4, 8 or 16 amps, at low cost with **GUARANTEED PROMPT DELIVERY**—on the way to you within 48 hours after receiving your order.

Inside each tester are 12 circuits assembled on our Integrid Card elements (dual-in-line's above). Integrid Cards are available in multiple patterns, permitting modular use of precisely the type and number of boards required.

The PC Assemblies being checked in the test equipment were made by us, including the printed circuit boards manufactured at our new PC board plant. Circle the reader Service Card for our new Integrid Card and Power Supplies folders.

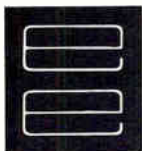

ELGIN ELECTRONICS
INCORPORATED

Subsidiary of Basic Incorporated
P. O. Box 1318 • Erie, Pa. 16512

comes prealigned in height, zenith and azimuth, it can be mounted on the cassette deck without further alignment.

A major difficulty in designing a reversible cassette system has been the need to maintain compatibility with the basic cassette design, to preserve the existing package configuration and tape format. The reversing features should not alter head dimensions or package openings, for example.

To keep the erase heads small enough to satisfy this design constraint and also protect against overheating at erase frequencies of 70 to 90 khz, the heads are made of a ferrite instead of a conventional mu-metal. The company says the ferrite can accommodate sufficient current to allow an erase level of 60 db without using a pressure pad, because of the efficiency of the magnetic circuit used in the erase heads. According to Michigan Magnetics, mu-metal heads would have to be driven so hard—to match this level of erasure—that overheating would result.

The company points to another feature of two-channel heads over four-channel types: there is no need for internal switching circuits in the tape recorder when shifting from forward to reverse drive. With four-channel heads, circuitry would be required to select the proper pair for each direction. Also, each time the tape switches direction, the user would have to readjust his amplifier to balance channels, since a new pair of tracks would be introduced.

The automatic head-reversing mechanism, in the form of assemblies called K-sets, will be sold to OEM's at \$11 to \$13 each, depending on quantity of the order.

Specifications

Record/playback head	
Impedance 1 khz	550 ohms
Record level	-12 db
Audio current	.025 ma
Bias current	.30 ma
Bias frequency	70 khz
Playback level	
at 1 khz	.20 mv
10 khz	-10db
Cross talk	35 db @ 1 khz
Tape speed	1 1/2 ips
Erase head assembly	
Impedance @ 70 khz	120 ohms
Erase frequency	70 khz
Erase current	110 ma
Erasure 400 hz	60 db
Tape speed	1 1/2 ips

Michigan Magnetics, Vermontville,
Mich. 49096 [389]

CROWBAR...?

The One Inside is FREE

Not so many years ago, the prudent transmitter engineer discharged a high voltage capacitor bank by dropping a shorting "crowbar" across its terminals. Today's "crowbar" is a protective overvoltage circuit found on DC power supplies — usually at extra cost. Now HP includes a crowbar as standard on its recently updated series of low-voltage rack supplies . . . at no change in price.

Long established as preferred system supplies for component aging, production testing, and special applications, these supplies have now been redesigned and expanded to meet the stringent demands of today's power supply user. Advantages include low ripple (peak-to-peak as well as rms), well-regulated constant voltage/constant current DC with outputs to 60 volts and 100 amps.

Where loads are critical and expensive, the extra pro-

tection — say, against inadvertent knob-twiddling — from a crowbar is invaluable. On all internal crowbars in this series, the trip voltage margin is set by screw-driver at the front-panel.

Pertinent specifications are: triggering margins are settable at 1V plus 7% of operating level; voltage ripple and noise is 200 μ V rms/10mV peak-to-peak (DC to 20 MHz); current ripple is 5 mA rms or less depending on output rating; voltage regulation is 0.01%; resolution, 0.25% or better; remote programming, RFI conformance to MIL-I-6181D.

Prices start from \$350. For complete specifications and prices, contact your local HP Sales Office or write: Hewlett-Packard, New Jersey Division, 100 Locust Avenue, Berkeley Heights, New Jersey 07922 or call (201) 464-1234 . . . In Europe, 1217 Meyrin, Geneva.

HEWLETT  **PACKARD**
POWER SUPPLIES

Additional data sheets available upon request

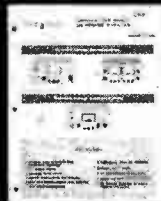

LAB SERIES
smaller package,
lower power,
optional crowbar



CROWBARS
A Technical
Discussion



**1969 Power
Supply Catalog**
— includes total
HP power supply line.

3 new RF power transistors — 7w, 20w, 40w @ 175 MHz

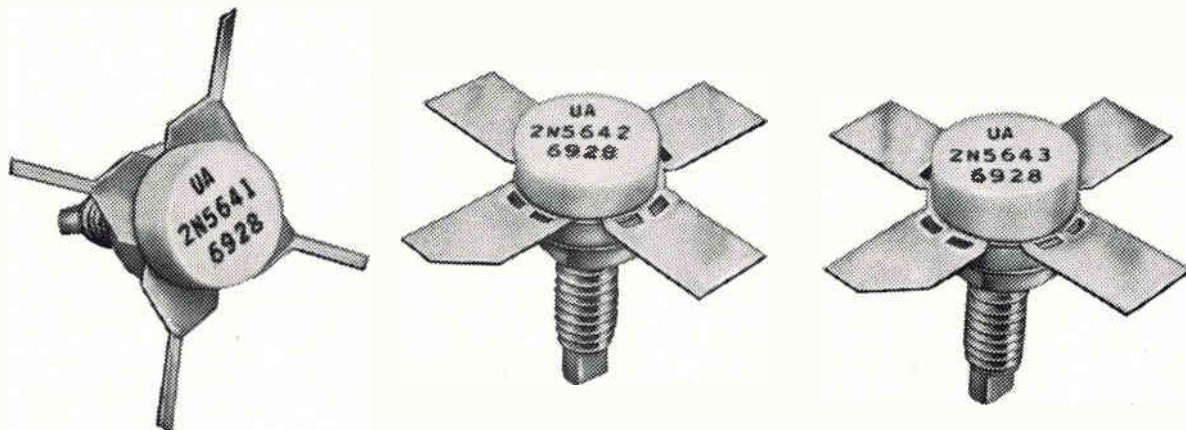

APPLICATION	DEVICE	FREQUENCY (MHz)	Power Out (Watts)	Power Gain (Min. dB)	Efficiency Min. (%)	f_t (Typ.) (MHz)	T_j	V_{cc}	Case
Class AB, B&C VHF Amplifiers	2N5641	175	7.0	8	60	400	200	28	CT-01
			5.0 Typ.					13.6	CT-01
	2N5642	175	20.0	8	60	400	200	28	CT-02
			10.0 Typ.					13.6	CT-02
	2N5643	175	40.0	7.5	60	400	200	28	CT-02
			20.0 Typ.					13.6	CT-02

■ Large signal specifications

■ Low inductance ceramic stripline packages

■ Tantalum nitride emitter ballasting resistors

These units are the latest members of a growing family of RF power transistors from United Aircraft. They qualify for AM-FM mobile or portable military and industrial applications. With an applied voltage of 28V, they provide output powers of 7W, 20W and 40W. At 13.6V, typical outputs are 5W, 10W and 20W.

S-Parameter data available. United Aircraft has installed a Hewlett-Packard Model 8542A Automatic Network Analyzer. It gives circuit designers valuable

assistance during preliminary design. This enables ECD to recommend a semiconductor that is truly compatible with the circuit requirement.

Also available: 2N4429, 2N4430 and 2N4431 RF power transistors in stripline and hermetic packages. Our latest RF catalog lists data on these and other devices in our line including: 2N3553, 2N3632, 2N3866, 2N5090, 2N3375, 2N3733, 2N4440, 2N5016, 2N4428 and 2N4012.

For RF power transistors for all VHF, UHF and microwave applications, write or call:

Electronic Components **United Aircraft**
DIVISION OF

TREVOSE, PENNSYLVANIA Tel. 215-355-5000 TWX: 510-667-1717

West Coast Office: 128 E. Katella Ave., Orange, Calif. (714) 639-4030

DESIGNERS AND PRODUCERS OF • RF AND MICROWAVE TRANSISTORS
 • CUSTOM HYBRID CIRCUITS • MONOLITHIC INTEGRATED CIRCUITS • SEMICONDUCTOR DICE

Industrial FFT computer bows

Hard-wired processor performs signal analysis on 1,000 data points in 28 milliseconds with resolution of 0.1%; interfaces with machine

When Time/Data introduced its T/D 100 about two years ago, it provided scientists with a means of using a Fourier transform algorithm to analyze signals in real time. With the introduction of the T/D 90 at the Fall Joint Computer Conference in Las Vegas, Nov. 18-20, high-speed time-series analysis will move out of the lab and go on the production line.

According to Ed Sloane, Time/Data's vice president and chief mathematician, the difference between the 100 and the 90, besides speed, is that the 100 was designed to interface with humans and the 90 will interface with machines. (The 100 can do a 1,000 point transform in 300 milliseconds and the 90 can do it in 28 msec.)

The basic 90 consists of a wired-

program digital processing unit with a set of six algorithms: Rapid Fourier Transform, inverse Fourier transform, auto spectrum, spectral averaging, linear hanning and quadratic hanning (smoothing operations in power spectrum analysis). Also included in the basic unit is a system clock, strobe manual control unit, and a system junction unit. Options include the



D-c coupled f-m record/playback subsystem SDM-119 is for accurate data acquisition. Utilizing a vco with center frequencies of 13.5 and 6.75 khz that exhibits a $\pm 0.5\%$ stability and linearity of $\pm 0.25\%$, the subsystem's playback section is accurate to $\pm 0.5\%$ with a $\pm 0.25\%$ linearity. International Components Corp., Asbury Ave. & Bowne Rd., Asbury Park, N.J. 07712 [421]



Incremental digital magnetic tape recorders are offered. Model 305 is a parallel entry recorder/reproducer system for 8-bit ASCII format sources. Model 315 is for 5-bit BCD numeric code. Model 325 is for recording scientific and research data with parallel entry in BCD format (5 digits of 4 bits each). Mobark Instruments Corp., Terra Bella Ave., Mtn. View, Calif. [422]



Data storage system series 1000 is for use with small to medium size computers. Two models are offered: the 1012 drive with a combination of removable and nonremovable disk, total capacity 22 million bits; and the 1011 drive with a single 11 million bit removable cartridge. System can be installed for under \$15,000. Iomec Inc., 345 Matthew St., Santa Clara, Calif. [423]



Plug-in random access core memory system FI-23 has capacities of 80 or 160 words with up to 17 bits per word. With a 2 μ sec access time, this 8 μ sec full cycle system incorporates the newest DTL semiconductors for logic, sense, timing and interface circuits. Power required is +5 v at 3 amps max. -5 v at 0.6 amp max. Ferroxcube Corp., Englewood, Colo. [424]



Data concentrator ADS-660 can multiplex up to 45 or more remote terminals over a single telephone line. A key feature is its ability to intermix up to 3 baud rates simultaneously. Channel capacity is determined by the baud rate speeds of the terminal devices used and the transmission line of the telephone line modems. American Data Systems, Chatsworth, Calif. [425]



Portable communications terminal Edityper is designed to operate in a conversational mode. Designed for the computer time-share market, the terminal will transmit and receive the EBCDIC, or correspondence, code. The terminal will operate with a Bell series 103A or F data set, or an equivalent acoustic coupler. Epsco Inc., Providence Highway, Westwood, Mass. 02090 [426]



An IBM-compatible magnetic tape system with controller, interface, and software for the PDP-8 computer, is available. Computer access is by a 3-cycle data break facility with a transfer rate of 10 K, 12-bit words/sec at a tape speed of 24 ips. A single 2400-ft tape reel will store in excess of 100 million bits. Computer Equipment Corp., 3707 Rawlins, Dallas 75219 [427]

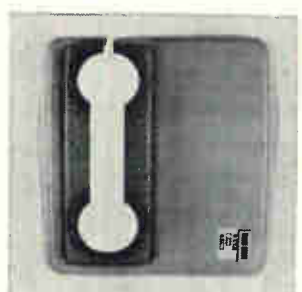

Acoustical data sets 2000 are for error-free coupling of remote terminals with computers via conventional telephone handsets. They include a linear frequency discriminator plus agc, multiple tuned receiver circuits, stable transmitters, oscillator and low second-order harmonic distortion transmitter output. DTC Corp., Leafdale Blvd., Royal Oak, Mich 48073 [428]

"The Dirty Fighter"

(Our New Ultra-Pure Cleaning System.)



Boy, does it fight dirty. With cascading rinses of ultra-pure hot water pouring over just about any miniaturized component you can name, impurities just don't have a chance. Not even the tiniest ones, down to 0.45 micron, escape the dirty fighter. Available with or without a laminar flow hood, and in two models with flow rates to 50 gph. The dirty fighter is clean-cut, however; steel cabinetry, recessed controls, sliding access doors, and a plastic-coated working surface.

Sure, our cleaning system fights dirty. You wouldn't want it any other way. Write or call for more information. Barnstead Company, 225 Rivermoor Street, Boston, Massachusetts, 02132, (617) 327-1600.

 **BARNSTEAD**
SYBRON CORPORATION

PC-91 digital coupler and controller which interfaces the 90 with a general-purpose digital computer; the PC-93 analog-to-digital converter; and the PC-92 display coupler which provides dual-channel linear and logarithmic d-a conversion, and controls for plotting.

Flexible. The T/D 90 can be used as either a peripheral or a free-standing device. The system is designed for high-speed time-series analysis under computer control, and will work with almost any general-purpose digital computer. By itself, the 90 performs Fourier transforms and auto-spectral density analysis in real time. The advantage of this system, according to Sloane, is that the digital computer can be used for "bookkeep-



Bookish. The T/D 90 is constructed with easy maintenance in mind; racks fold out and circuit boards open up like pages in a book.

ing functions" only, and the 90 will do the math. He says that mathematics can be done much faster than in a general-purpose computer.

Applications for the T/D 90 include vibration testing, speech analysis, radar signal processing, marine seismology, and analysis of medical data. Each requires a special applications console. For example, the vibration-test system would have to control the test table as well as analyze the data. And a panic button would have to be included to prevent destructive testing—in vibration testing, you cannot simply pull the plug to shut the

If you have more brains than money...

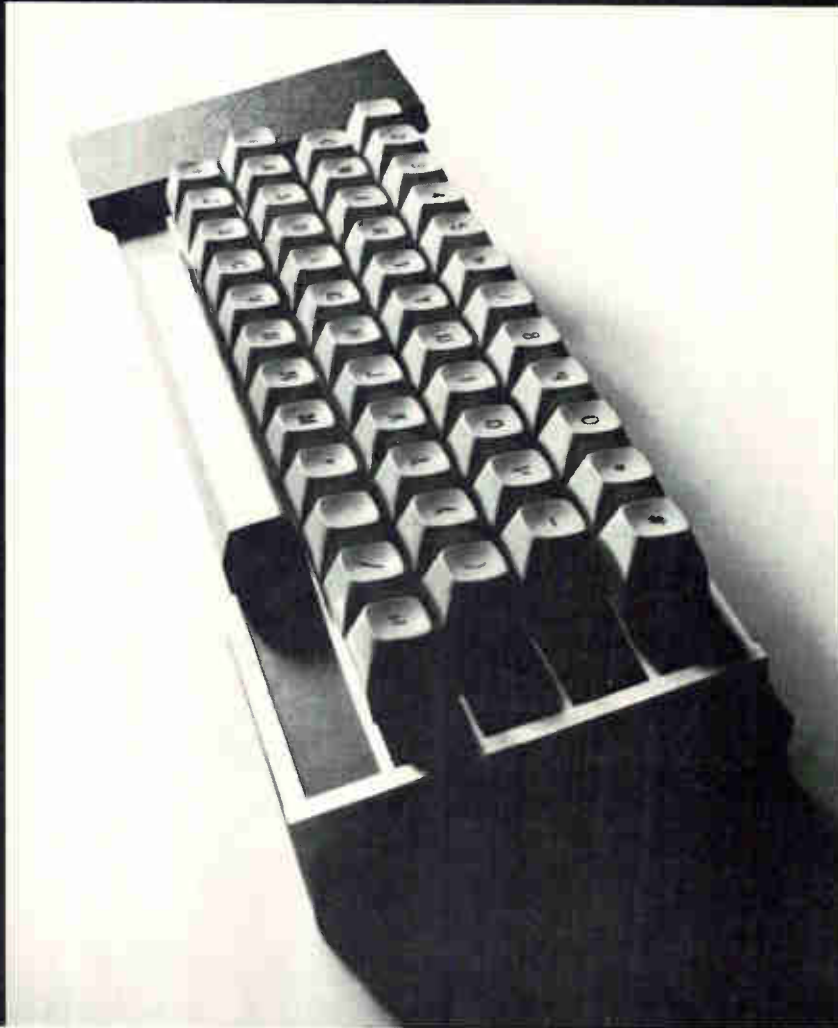

If you could eliminate the semi-conductors from a computer, and still get the same performance, could you see some dollars saved? Could you see higher reliability?

That's the approach we have taken with our input keyboard. We made it self encoding without electronics. We eliminated built-in solid-state circuits. We kept it simple.

And we saved you money. The Synergistics Self Encoding Keyboard is only \$68 in quantity orders.

That's with a 65-key layout. With fewer keys it's less, with more it's more. But the point is you can specify your own layout, from 12-key Touch Tone to over 100 keys – even mix keyboard sizes and shapes – without extra charge. Change keys yourself, too.

Most important, the Synergistics keyboard is here now, manufactured in quantity. Or, if you would like to check out everything we claim, order one for evaluation. And if you want to call us, ask for George Rice.

Yes, I am interested in the Synergistics Self Encoding keyboard. Please send me:

- Additional technical information.
- Instructions for ordering one keyboard for evaluation, made to my layout specifications. Prices to be included.

Name _____
Title _____
Company _____
Address _____
Zip _____

Synergistics, Inc.

10 Tech Circle, E. Natick, Mass. 01760 (617) 655-1340

FJCC: in the Sahara, Booth 27006,
NEREM: Booth 1J69

NOW...

Hamilton precision metals has added facilities...and is in the Photoformed® Parts business...



BIG!

Hamilton has added a new plant—just to produce precision, Photoformed® parts!

This new facility is equipped with the most modern photo-etching machinery on the market. The new equipment will produce precision parts in large quantities to the highest standard of dimensional accuracy.

Now, you can get from the Precision Metals Division, finished parts to the same degree of precision as world wide metal users have come to expect in Hamilton's strip and foil.

Hamilton offers the Total Capabilities of a completely integrated facility controlling every step from melt to finished strip or foil—and now to finished parts. This means that you get the same adherence to metallurgical standards and dimensional accuracy that has become the hallmark of Hamilton.

For the complete story on the capabilities of Precision Metals Division and what it can do for you, write for your copy of the new Photoforming brochure. It's yours for the asking—write today!

PRECISION METALS DIVISION
HAMILTON
WATCH COMPANY • LANCASTER, PA. 17604
• PHONE (717) 394-7161

system down, because transients are generated when power is cut off.

The T/D 90 basic processor will sell for \$38,000, and delivery will begin after the first of the year.

Time/Data Corp., 490 San Antonio Rd., Palo Alto, Calif. 94306 [429]

Data handling

Peeping Tom for computers

Analyzer monitors functions without disrupting operation

Ever wonder how to monitor the computer while it's cranking out data? It could be done by a low-cost, solid state computer analyzer made by Computer and Programming Analysis, Inc. of Cherry Hill, N.J. The unit is capable of monitoring up to 18 different computer functions simultaneously.

The CPA series 7700 analyzer allows the engineer to peek into his computer without interfering with operation. The analyzer, consisting of a control module, counter module, and probes, can monitor central processing units, CPU wait time, pure wait time, overlap time, channel loading, and numerous other functions. The unit will interface with computers of all sizes and is acceptable for use with leased units.

Although not designed to "snoop" on operators, the machine can help evaluate efficiency.

The control module is the heart of the 7700, supplying all power and master control functions as well as monitoring elapsed time. The counter module is the basic building block and contains the logic and controls to drive the read-out counters.

Units can be had with up to 18 six-digit electromechanical counters or as many as three electronic counters. The probes are high-impedance differential amplifier units having a one-to-one relationship with the readouts. Normal lengths

Hung up on things analog?

Unscramble with Philbrick/Nexus amplifiers.

Like we did in this inexpensive instrumentation amplifier with our new, easy-to-use monolithic IC amplifiers.

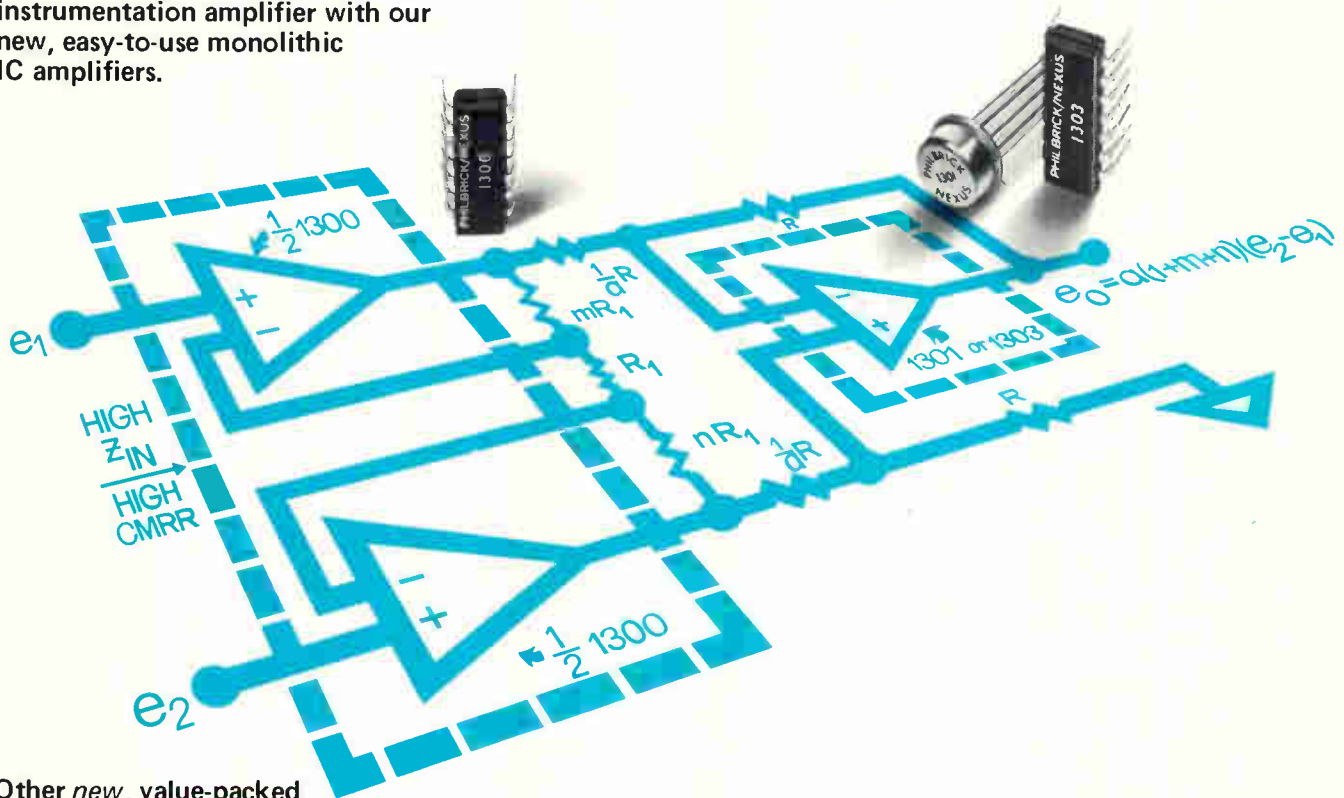

Other new, value-packed Op Amps from Philbrick/Nexus

Hybrid & Monolithic

1405 — This differential FET input, high speed, hybrid op amp comes in a dual-in-line size package with no external stabilization required. Salient specifications include 1 MHz full output frequency, $A_o = 500K$, slew rate of $50V/\mu\text{sec}$ and output current of ± 20 ma.

1300 — Dual amplifier monolithic chip in a dual-in-line size package. Two general purpose amplifiers in one package for the price of one. \$5.20 in hundred quantity.

1301/1303 — Single general purpose amplifiers in a dual-in-line size package (1303) and a TO-99 package (1301) compatible with $\mu A709$ size configurations. These amplifiers are very stable, free from latch-up, and output protected.

T82AH — Differential wideband IC amplifier in a 10-pin, TO-5 case with 70 MHz GBW, $20\mu V/^\circ C$ max. ($-55^\circ C$ to $+125^\circ C$), ± 10 ma output current, \$10.00 per hundred quantity. Has excellent performance in high speed comparator applications.

Discrete

1021 — A high CMRR economy differential FET input or better known as the "100-cubed" amplifier. CMRR of 100 dB (min.), full output frequency of 100 kHz (min.) and A_o of 100 dB (min.) with a hundred quantity price of \$27.00 make this a "value-cubed" amplifier! Other salient specifications are $\pm 10V$ common voltage range, ± 20 ma output current and -30 pa (max.) bias current.

1022 — This differential FET input, high voltage amplifier picks up where the 20V amplifiers leave off. Specifications include power supply range of $\pm 40V$ to $\pm 150V$; output voltage of $\pm 30V$ to $\pm 140V$; common mode voltage of $\pm 25V$ to $\pm 135V$; full output frequency of 50 kHz (min.) and output current of ± 20 ma. Priced at \$78.00 in hundred quantity.

1018/1020 — The lowest drift, differential, non-chopper stabilized amplifiers available! $E_{os} TC$ (max.) of $1.5/0.5/0.25/5/1.5/0.5/0.25 \mu V/^\circ C$ ($-25^\circ C$ to $+85^\circ C$) and $1.5/0.5 \mu V/^\circ C$ ($+10^\circ C$

to $+60^\circ C$) with hundred quantity prices starting at \$56.00 (101803) and \$33.00 (1020). These units are perfect replacements for chopper stabilized units in many cases with the added advantage of differential inputs.

1017 — An inexpensive, general purpose, high output current (± 125 ma from $-25^\circ C$ to $+85^\circ C$) amplifier in the standard small "Q" package. More power to you at \$29.50 in hundred quantity.

Write, today, for your free copy of the NEW 1969/70 Philbrick/Nexus Catalog.



For further information on any of these new Philbrick/Nexus products, contact your local Philbrick/Nexus field representative or Philbrick/Nexus Research, 22 Allied Drive at Route 128, Dedham, Massachusetts 02026. Telephone: (617) 329-1600.

No. 1 should do more . . . you expect us to.



PHILBRICK/NEXUS RESEARCH

A TELEDYNE COMPANY

We gladly leave the callawumpus to the competition.

We'll stick to our thing: good, efficient display terminals that are priced and programmed for today. No over-engineering. No idle parts sitting—and costing—till user requirements catch up.

Let the big companies fuss over their future fancies. The far-out, far-off stuff.

We have a complete line, combat-ready for immediate action.

And, our units start at under \$1500.

For further details, call (617) 272-6660 collect.

Or see us at the following:

NEREM '69, November 5-7,
Booth 1A73.
War Memorial Auditorium.

FALL JOINT COMPUTER CONFERENCE,
November 18-20,
Booth 21010,
Sahara Hotel.



Infoton

INFOTON INCORPORATED
SECOND AVENUE, BURLINGTON, MASSACHUSETTS 01803
Incorporating Information Research Associates, Inc.

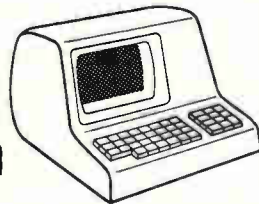

Circle 176 on reader service card

Want to be unique in our memory?

It's easy. Enter the Electronics Manpower Register.

We'll feed your professional background into the talent memory of our nationwide computerized recruitment service.

Our computer will match your unique profile against every opening being programmed into it by a long list of electronics

companies. You'll automatically be qualified for every logical career opportunity. But we'll only release your availability to those companies you approve.

To enter, send us your resume.

Electronics Manpower Register
Electronics
330 West 42nd Street
New York, N.Y. 10036

... analysis is tailored to user's system ...

are 12 feet; longer extensions are available.

The CPA series 7700 is available in six models—models 7706, 7712, and 7718 offer a counter module with six, 12, and 18 electromechanical counters respectively, a control module, and a set of probes. Models 7706E, 7712E, and 7718E have one, two, and three electronic counters respectively. Prices run to \$4,960 for the 7706, \$5,420 for the 7706E, \$7,690 for the 7712, \$8,880 for the 7712E. The 7718E costs \$10,860 and the 7718E is \$12,240.

Conversion. CPA offers conversion of electromechanical counters to electronic ones at \$950 per counter. Size and power limitations allow only two electronic counters



Modular. Computer analyzer can monitor up to 18 system functions.

per set of six counters in each counter module.

The models 7706 and 7706E are 10 inches high, 10 inches deep, and 19 inches wide; the 7712 and 7718 series are 20 inches high and as deep and wide as the 7706 series. The first production run began this month, with a production capability of 100 units per month. Delivery time is 45 days after receipt of order.

CPA will develop an applications procedure specifically tailored for each user's requirements at no additional cost.

Technical assistance at the user's facility is available at extra cost. A six-month warranty covers materials and workmanship.

Computer and Programming Analysis Inc., 1103 Kings Highway North, Cherry Hill, N.J. 08034 [430]

Circle 177 on reader service card →

Micro-Program Control

The micro-program control applies to one or several areas within a computer where READ-Only memory is used. Another area is program storage. The role of the micro-program control unit is to coordinate the internal elements of the computer so that some or one in logical sequence and at the proper time. This function can also be accomplished with the use of conventional diode gates. To minimize system costs, such gates are designed to perform a maximum number of functions. However, since each gate is fixed as a multiple logic and highly making changes to the control logic is tedious, long, and highly error-prone.

To overcome these shortcomings, READ-Only memories have been employed for micro-program control. In this application, the inputs to the READ-Only memory are the state of key elements within the computer, e.g., Instruction Register, Micro-program Counter, Overflow Flip-flop, etc. The READ-Only memory outputs go to controlling elements such as shift controls, transfers, registers, etc. Whenever a change in machine structure or an instruction word is needed, the modification is quickly implemented by modifying the appropriate word in the READ-Only memory. Since each micro-instruction for memory word is independent of every other micro-instruction, changing one instruction does not affect any other instruction.

There are additional advantages to using READ-Only memories in micro-program applications which are:

- Allow rapid changes in machine structure
 - Permit the offering of a family of compatible computer systems with the major variable between computers being the micro-program in the READ-Only memory
 - Provide a method for directly increasing system speed by increasing READ-Only memory speed
 - Significantly reduce system costs
- One study¹ comparing READ-Only memories with conventional logic found that READ-Only memories cut the number of circuit boards in a system by 25%, the number of components by 40%, and the number of components by 40%. This is in terms of a micro-program overall reduction. READ-Only memories can cut hardware costs by 36%.

Program Storage

This is the second area within a computer where READ-Only memories are used. Many programs, once written and debugged, are never significantly changed. For these programs, the high reliability, MTBF of 10,000 hours, low cost (1¢ to 10¢ per bit), fast speed (100-500 nanoseconds) and access time and non-destructive read out of READ-Only memory systems make them an ideal storage medium.

The READ-Only memory is used as a modular structure at the computer storage as shown lower left. The program is initially written and debugged using the erasable core memory. After debugging, the program is placed in the READ-Only memory for permanent storage.

Some of the types of program that have been stored in READ-Only memories include:

- assemblers
- bootstrap routines
- stored tables
- utility programs
- machine tool programs
- compilers
- debug routines
- emulators

¹Ward & J. Dufresne, "The Mountaintop: The Use of Read-Only Memory in Computer Design," IBM Computer Group News, March, 1967, p. 6.

Character Generation

Micro-program control applies to one or several areas within a computer where READ-Only memory is used. Another area is program storage. The role of the micro-program control unit is to coordinate the internal elements of the computer so that some or one in logical sequence and at the proper time. This function can also be accomplished with the use of conventional diode gates. To minimize system costs, such gates are designed to perform a maximum number of functions. However, since each gate is fixed as a multiple logic and highly making changes to the control logic is tedious, long, and highly error-prone.

To overcome these shortcomings, READ-Only memories have been employed for micro-program control. In this application, the inputs to the READ-Only memory are the state of key elements within the computer, e.g., Instruction Register, Micro-program Counter, Overflow Flip-flop, etc. The READ-Only memory outputs go to controlling elements such as shift controls, transfers, registers, etc. Whenever a change in machine structure or an instruction word is needed, the modification is quickly implemented by modifying the appropriate word in the READ-Only memory. Since each micro-instruction for memory word is independent of every other micro-instruction, changing one instruction does not affect any other instruction.

There are additional advantages to using READ-Only memories in micro-program applications which are:

- Allow rapid changes in machine structure
- Permit the offering of a family of compatible computer systems with the major variable between computers being the micro-program in the READ-Only memory
- Provide a method for directly increasing system speed by increasing READ-Only memory speed
- Significantly reduce system costs

One study¹ comparing READ-Only memories with conventional logic found that READ-Only memories cut the number of circuit boards in a system by 25%, the number of components by 40%, and the number of components by 40%. This is in terms of a micro-program overall reduction. READ-Only memories can cut hardware costs by 36%.

This is the second area within a computer where READ-Only memories are used. Many programs, once written and debugged, are never significantly changed. For these programs, the high reliability, MTBF of 10,000 hours, low cost (1¢ to 10¢ per bit), fast speed (100-500 nanoseconds) and access time and non-destructive read out of READ-Only memory systems make them an ideal storage medium.

The READ-Only memory is used as a modular structure at the computer storage as shown lower left. The program is initially written and debugged using the erasable core memory. After debugging, the program is placed in the READ-Only memory for permanent storage.

Some of the types of program that have been stored in READ-Only memories include:

- assemblers
- bootstrap routines
- stored tables
- utility programs
- machine tool programs
- compilers
- debug routines
- emulators

¹Ward & J. Dufresne, "The Mountaintop: The Use of Read-Only Memory in Computer Design," IBM Computer Group News, March, 1967, p. 6.

Displays

Relating Main Memory Storage Systems
Special Purpose Digital Systems

Communications Systems
Telemetry Systems
Analysis Systems
Signal Monitoring Systems
Machine Tool Controllers

Application Summary

For Product Computers

READ-Only Memory Applications:
bootstrap programs,
program storage,
micro-program control,
code converters,
stored tables,
calculator

high-speed multiplication and
programmable logic arrays
character generators,
keyboard to code converters,
code character generators,
micro-program control

punched paper tape code
trigonometric tables,
code converters,
keyboard to code converter
and/or waveform generator
status tables,
storage of operating

"READ-Only memories can cut hardware costs by 36%."

The above statement comes from the Engineering Guide to READ-only Memory Systems; a basic, working text written to get you into the technology with a minimum of fuss and bother. So you'll know when to use READ-only memory. And how.

It has everything an engineer needs. From the theories behind the technology to block diagrams of specific applications like program storage, microprogram control, character generation. With lots of nice little touches in between. Sequence photos showing how you can modify the memory contents. And a huge, fold-out work sheet with all the facts you need when designing a system. Timing diagrams, interface specifications, mechanical dimensions. The works.

Spend a quiet afternoon with the Engineering Guide to READ-only Memory Systems. It's free.

Write Paul Rosenbaum, Memory Technology Inc., 83 Boston Post Road, Sudbury, Mass. 01776, (617) 443-9911.

Memory Technology Incorporated

Booth No. 4405 at FJCC

THE 5000 PERM TOROID

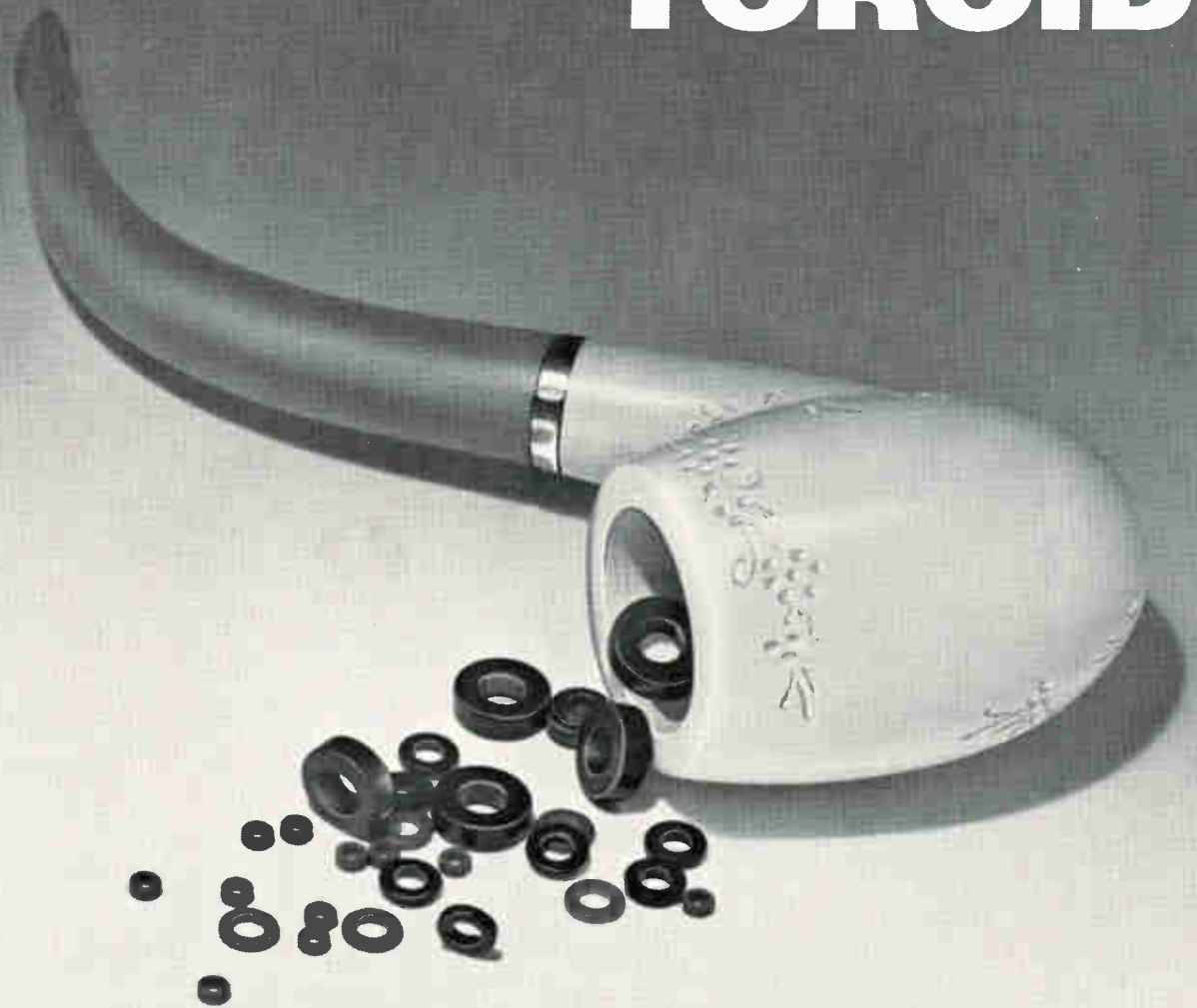

NO LONGER A PIPE DREAM

That's right. 5000 initial permeability. And we mean it!

Perhaps your designs for pulse transformers have gone up in smoke for want of a powerful enough material. Well, now you've got it. And then some. Stackpole Ceramag® 24H ferrite material.

Ceramag® 24H is a precision engineered product. Exact processing, density checks, rigid kiln controls and precise

sintering. You get more out of it simply because we put more into it.

Here are a few more conservative characteristics. Maximum permeability, 6900. Typical. Saturation flux density, 4100 gauss and residual magnetism of 850 gauss. If curie point is significant to your operation, how about one of 175° C. Then there's temperature coefficient. Ceramag® 24H goes + 0.700% / ° C at -25°

C to 25° C and -0.450% / ° C at 25° C to 75° C. And all of this with a disaccommodation factor of 1.4×10^{-6} .

Ceramag® 24H is ready. Are you? Drop us a line and we'll send you some even more interesting facts about this fantastic new material. And the charts to prove it. Stackpole Carbon Company, Electronic Components Division, St. Marys, Pa. 15857. Ph: 814-834-1521



STACKPOLE

Electronic Components Division

ALSO A LEADER IN THE MANUFACTURE OF QUALITY FIXED COMPOSITION RESISTORS

Circle 178 on reader service card

MOS IC adder handles 4 bits

Flexible unit for calculators processes binary or BCD; can be electronically stacked to provide high accuracy

An adder that can handle four bits and either of two numerical codes is a pretty valuable integrated circuit. While most adders have a two-bit capacity and are limited to a single code, Philco-Ford's new metal oxide semiconductor IC can process four bits simultaneously and can use either the 8-4-2-1 binary code or the binary-coded-decimal code.

On top of increased capacity, the IC offers flexibility. If the designer has BCD available in his equipment, he can use it as the input to the adder; or, if 8-4-2-1 binary is more convenient, he can employ that code. Or the same IC can be used for both codes in the same equipment—by switching the control function, the MOS IC can be made to process binary in one cycle and

BCD in the very next. Even for a manufacturer of two different kinds of equipment—binary-oriented or BCD-oriented—the adder offers simplified logistics, since the same unit can be used.

The code flexibility of the IC doesn't make it particularly complicated. "In fact," says MOS marketing manager Bob Simon, "I haven't yet figured out why other

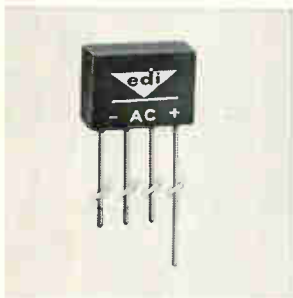

Miniature silicon rectifier bridges have piv ratings of 1,000, 1,500 and 2,000 v. Applications include voltage regulators, spark ignition systems, microwave tube and laser supplies, pocket scopes and electrostatic supplies. Dimensions are 0.625 x 0.468 x 0.25 in. A transfer molded case insures void free encapsulation. Electronic Devices Inc., 21 Gray Oaks Ave., Yonkers, N.Y. [436]

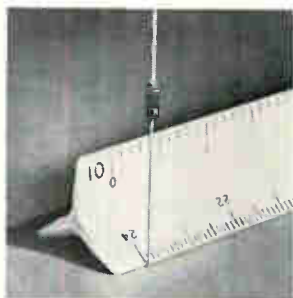

Temperature compensated zener reference units series 1N821-1N829 and 1N935-1N939 in DO-7 case provide stability and low noise. Applications include d-c voltage standards, d-c decade voltage reference sources, d-c voltmeters, X-Y strip recorders, and other applications requiring close temperature regulation. International Rectifier, 233 Kansas St., El Segundo, Calif. [437]

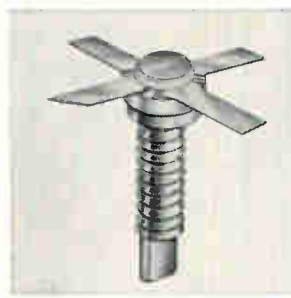

Microwave transistors operate at 2 Ghz. Source voltage is 28 v. Type 2N5766, 1 w output, can withstand infinite vswr at any phase angle. Types 2N5767 and 2N5768, 2.5 and 5 w output respectively, can withstand 3:1 vswr at any phase angle. Units are for advanced designs in radio relay, and phased array radar. TRW Semiconductors Inc., Aviation Blvd., Lawndale, Calif. [438]



Silicon power rectifiers come in stud mounted DO-5 packages. A double diffused, passivated junction technique assures stable electrical characteristics. Both standard and bulk avalanche types in voltage ratings from 50 to 1,000 piv are available. The F3, F4 and F5 series offer max. forward current of 31, 37 and 50 amps, respectively. Edal Industries Inc., East Haven, Conn. [439]

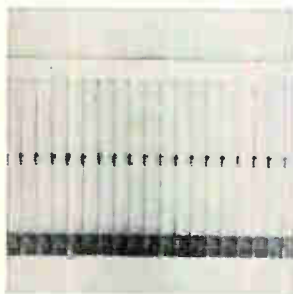

Silicon stabistors come in single (AP103), double (AP203) or triple (AP303) types. Chips are available in a 400 mw whiskerless package. Stabistors are used where controlled forward voltages are necessary such as voltage regulator circuits, sensing, and computer circuitry. Forward voltages are from 0.86 to 2.6 v at 100 ma. American Power Devices Inc., Andover, Mass. [440]

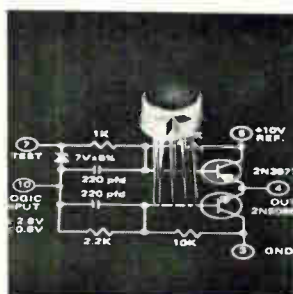

Hybrid IC ladder switches CDA4 are for direct-from-logic operation in digital-to-analog conversion. The CDA4 is meant for use with a +10-v reference. When used in conjunction with a 10K/20K ladder network, the switch provides 12-bit accuracy. Settling times under 1 μsec allow high speed operation. Price (1-99) is \$38 each. Crystalonics, 147 Sherman St., Cambridge, Mass. [441]

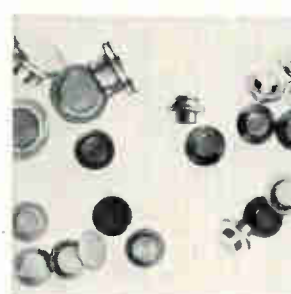

Space-qualified microwave tunnel diodes feature a ruggedization process for extreme reliability. The amplifier tunnel diode line comes in a choice of Ge, GaAs, and GaSb and in standard models to cutoff frequencies of 50 Ghz. Extremely low 1/f noise characteristics is a feature of the detector/mixer tunnel diode line. Aertech Industries, Stewart Dr., Sunnyvale, Calif. [442]

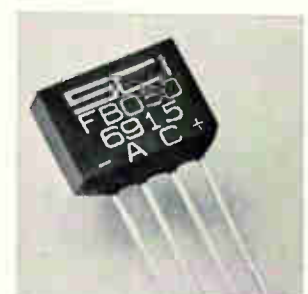

Full-wave bridge rectifiers FB are fabricated with double diffused silicon rectifier cells. Unit is encased in plastic with an in-line configuration easily adaptable to p-c board mounting. Units are rated for a maximum output current of 2 amps and peak in-verses voltages of up to 1,000 v per element. Scientific Components Inc., 350 Hurst St., Linden, N.J. [443]

What happened when doctors and engineers got together:



Doctors told engineers how they were using electronics and revealed their most urgent needs. Engineers described and demonstrated their newest equipment for diagnosis, treatment, and prevention. And hinted at things to come.

Their complete dialogue, with illustrations, makes pretty informative reading on a vital and growing market.

Here are some of the things it contains:

Computers: How they're joining the medical team. What computers are doing in diagnosis. In communications. The small computer as a paramedical aid.

Instrumentation: What's needed. What's available. Patient management. Protection. Standards and safety.

Electronics in the Hospital: The surgeon, the hospital, the instruments. What the administrator wants. Prescription for large-scale health care. The surgery department.

Electronics/Management Center
330 West 42nd Street, New York, N.Y. 10036

Enclosed is \$12 for a copy of the Proceedings of the First National Conference on Electronics in Medicine.

Send the Proceedings and bill me later. P.O. # _____

Name _____

Company _____

Address _____

City _____ State _____ Zip _____

people haven't done it."

The IC can be stacked to provide high accuracy. For example, it may be necessary to add two 16-bit numbers. In this case, four adders can be combined, since carry input and carry output terminals—at compatible voltage and current levels—are provided on each circuit.

The IC's adding speed depends on the operation mode. With the 8-4-2-1 binary code, the add cycle time is typically 1.8 microseconds (4 μ sec maximum). For the BCD code, the cycle time is somewhat

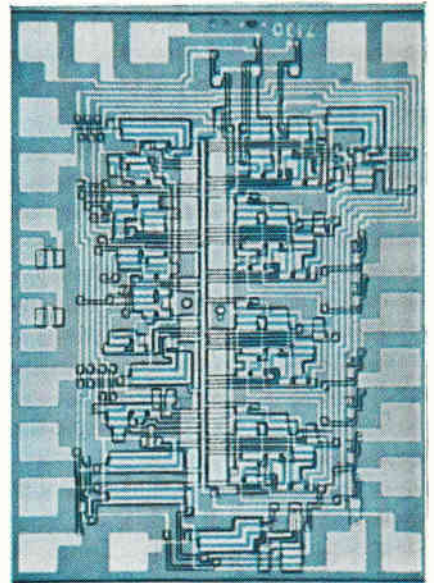

A choice. IC adder can be used, even in same equipment, for either binary or binary-coded decimal code.

longer, 2.1 μ sec usually. When the IC's are stacked, the limitation on speed is the carry propagation delay, according to Simon. With the 16-bit adder, for example, the cycle time would be four times the cycle time for each IC, or 7.6 μ sec.

Inputs and outputs are at typical MOS levels. At the input, a logic 0 is -3 volts and a logic 1 is -9 volts. The output levels are -2 volts for a 0 and -10 volts for a 1. Input leakage current is 100 nanoamperes at 28 volts and 25°C. Input capacitance is rather low; only 4.5 picofarads at 25°C and zero bias.

The circuit is available from distributor and manufacturer's stock. Unit price is \$12.90 in quantities of 100 to 999.

Philco-Ford Corp., Microelectronics Division, Union Meeting Rd., Bluebell, Pa. [444]

SWITCH 1800 WATTS WITH GRAYHILL

POWER TAP SWITCH

(Rated 15 Amps.—
125 VAC Resistive)



TYPICAL SPECIFICATIONS

- UL Listed
- 30° Angle Of Throw
- 2 To 11 Positions
- Solder Lug Or "Faston" Terminals
- Non-shorting Contacts
- Voltage Breakdown 2500 VAC
- Available With Special Shafts, Bushings And Other Modifications
- Life Expectancy Over 50,000 Cycles Of Operation At Rated Load

For your Grayhill Engineering Catalog offering complete technical data—contact



523 Hillgrove Avenue
LaGrange, Illinois 60525
Area Code 312, Phone 354-1040

... the Difference Between Excellent and Adequate

Circle 213 on reader service card



New Connectors increase packaging density

CAMBION Miniature Connectors... the easy, reliable way to incorporate many components into your circuit designs... patch in other circuit boards... hook up ICs... provide convenient pluggable/patchable compatibility for hard-wired components... engineer greater current carrying capacity with low contact resistance... insure a new level of reliability in circuit interconnection systems. CAMBION produces more mini-connectors than anyone else in the world. Jacks, plugs, sockets, patch-strips for PC and conventional applications; cage jacks, "C" and "D" spring jacks, taper pins and receptacles; combination plug-jacks, patch cords and other miniature connectors. More than 1000 varieties, including color-coded and insulated types. For full details on the best connector for your needs, call Cambridge Thermionic Corporation, 469 Concord Avenue, Cambridge, Massachusetts 02138. Phone: (617) 491-5400. In Los Angeles, 8703 La Tijera Boulevard 90045. Phone: (213) 776-0472.

Standardize on

CAMBION

The Guaranteed Electronic Components

Circle 214 on reader service card

RHG OFFERS

FM receivers for S band telemetry

Wideband, tunable 2.2 to 2.3 GHz, all solid state FM receivers are available off-the-shelf. Information bandwidths up to 12 MHz produce low distortion demodulation of high speed video data.

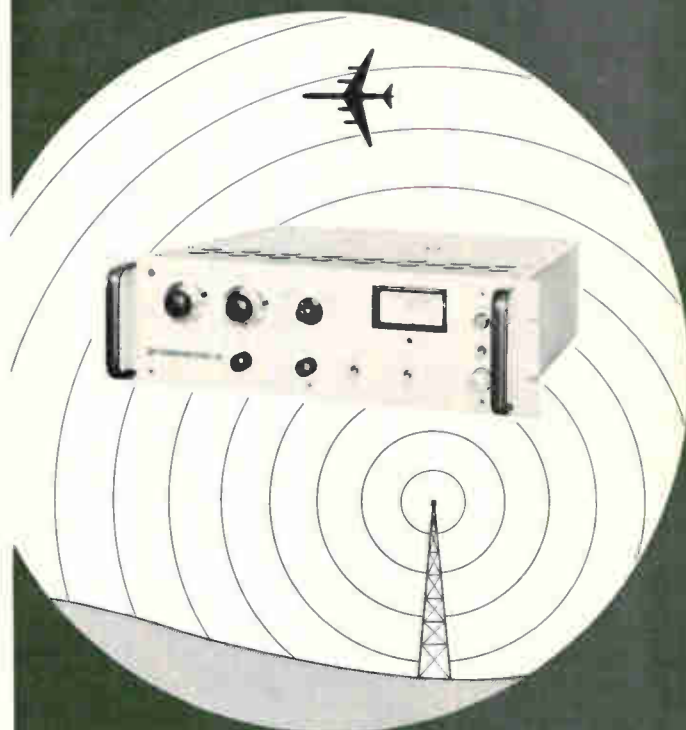

- TUNABLE 2200 to 2300 MHz
- BASEBANDS to 12 MHz
- LOW INTERMODULATION
- LOW NOISE FRONT END

RHG FM receivers include such features as a built-in ferrite isolator, balanced hybrid mixer, and AFC controlled solid state oscillator. They are MIL grade, RFI protected, and may be obtained for ground or airborne use. RHG lists a full line, from 1 to 18 GHz, in Catalog 69A or see EEM section 3400.

RHG

**RHG ELECTRONICS
LABORATORY · INC**

94 MILBAR BOULEVARD ■ FARMINGDALE
LONG ISLAND ■ NEW YORK 11735 ■ (516) 694-3100

Microwave Receivers, Transmitters and Components

Circle 181 on reader service card

REMOTE CONTROL SWITCHING WITH AUDIO SIGNALS



A single pair of wires, or a leased telephone line, can carry the audio signals for a complete control system.



For inaccessible areas or mobile installations, a radio transmitter and receiver system can carry the signals.

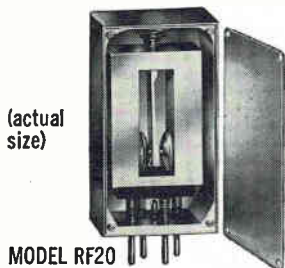

(actual size)

MODEL RF20
contactless resonant reed encoder/decoder
.395 x .620 x 1.100

An audio tone can be generated by an electronic oscillator or resonant reed encoder circuit, then transmitted by wire or radio. The tone activates a resonant reed relay to perform a control function.

Bramco reeds permit over 100 selective control frequencies within the 67 to 3000 Hz. spectrum. This is assured by: (1) the narrow response band-width of about 1% for decoders and (2) the high accuracy of Bramco reed encoders (1/10 of 1% of design frequency).

A big advantage of reeds in control switching is that they are ideally suited for simultaneous and sequential coded tone systems. The actual number of control functions possible in such a system is virtually unlimited. For example, over 3300 individual control functions are possible with only 16 frequencies coded sequentially in groups of three.

Compared to other types of tone filters, resonant reeds are small and inexpensive. They give more control functions per spectrum, per size, per dollar.

If you work with controls that select, command, regulate, or indicate, you should know how it can be done with audio signals. We custom design and stock a broad line of encoder/decoder components and modules. Bramco also custom designs LC filters from 0 to 200 KHz.

For literature write Bramco Controls Division, Ledex Inc., College and South Streets, Piqua, Ohio, or call 513-773-8271.



BRAMCO CONTROLS DIVISION
LEDEX INC.

College and South Streets, Piqua, Ohio 45356

New Books

Abstract magnetics

Digital Magnetic Logic
David R. Bennion, Hewitt D. Crane,
and David Nitzan
McGraw-Hill Book Co., 367 pp., \$15

Engineers sometimes become rather impatient with mathematicians who become so enamored of their abstract equations that their readers, if not they themselves, lose sight of whatever the abstractions are that the equations represent. The authors of this book may not have had that problem, but their readers are likely to encounter it. Indeed, the authors would have been well advised to have first described the elementary ideas with clarity, and then follow them with mathematically precise equations.

Instead, the authors plunge directly into a review of induced electromotive and magnetomotive forces, using Maxwell's equations. These equations are justly famous for their conciseness and precision. But one is jarred somewhat when the equations appear in the very first paragraph of a treatise on a subject unfamiliar to him.

In the third chapter, the authors discuss magnetic shift registers in somewhat less mathematical terms. And this discussion is immediately clearer than the one that preceded it. The following chapter describes magnetic shift registers that, unlike those in Chapter 3, don't require diodes and capacitors to isolate the stages to prevent shifting in the wrong direction.

Next comes two chapters on magnetic networks, which have loops and nodes analogous to those in electrical networks and are made of multiple aperture or multileg structures. These are reduced to generalized networks that are treated in detail. Here the authors feel obliged to throw in a few more equations, but to the reader's advantage—the equations are used as abstractions of material described in detail previously. And herein is a world of difference from the approach taken at the book's outset.

There is a chapter on formal derivation of transfer schemes, which, despite the subject matter, isn't heavily mathematical. Most

Au! Ag! Pt! Pd!

... And other precious metal alloys for microelectronic design!

PARTIAL LIST OF AVAILABLE ALLOYS & SOLDER PREFORMS

88% Gold 12% Germanium (Eutectic Alloy)
Strip and solder preforms in all sizes

80% Gold 20% Tin (Eutectic Alloy)
Strip, wire and solder preforms in all sizes

Gold with .1 to 1.2% Antimony
Wire, strip and solder preforms all sizes

Gold—.05% Min. Phosphorous
Wire, strip and solder preforms all sizes

95% Gold 5% Nickel
Wire, strip and solder preforms all sizes

Gold and up to .5% Arsenic
Strip and solder preforms all sizes

Silver with .1 to 1.2% Antimony
Wire, strip and solder preforms all sizes

Silver—.1% Min. Phosphorous
Wire, strip and solder preforms all sizes

95% Silver 5% Nickel
Wire, strip and solder preforms all sizes

Silver and up to .5% Arsenic
Strip and solder preforms all sizes

Special alloys produced on request at minimum charge.

Precious Metals in 99.9% Pure, 99.99% Pure, and 99.999% Pure.

The most modern production techniques, the latest refining methods and the best equipped research laboratories make Williams your one best source for all precious metals and their alloys.

Available in ultra-high purity sputtering discs, preforms, foil ribbon, tape, wire, sheet and other forms.

Write for our complete Precious Metals Catalog and Specification Sheets.



WILLIAMS PRECIOUS METALS
2980 MAIN ST. BUFFALO, NEW YORK 14214
Division of Williams Gold Refining Co., Inc.

New Books

of the discussion up to this point has assumed binary signals in the form of high-low or something-nothing flux or current pulses. But there is another chapter on bipolar, or positive-negative, binary signals and the designs that can be based on them—thin films, for example.

This is followed by a chapter on general logic designs, mostly combinational logic, with a short discussion of sequential or synchronous logic. This is more or less the denouement of all previous chapters—witness, in fact, the title of the book.

The book's final two chapters are more appendixes than anything else, summarizing the elementary physics of magnetism and magnetic flux-switching models. Both are chock full of equations, but these are probably less out of place here than elsewhere in the book.

Calling on computers

Computerized Approximation and Synthesis of Linear Networks

Jiri Vlach

John Wiley & Sons Inc., 477 pp., \$14.95

Since most circuits contain nonlinear elements, a designer must have a technique for predicting element behavior accurately if he wants his circuit to perform as he desires. There are techniques available, and they fall into a class of mathematics called approximation theory. These techniques require a linear model that comes close to describing a nonlinear element's behavior. Then he applies known or desired inputs and determines, through analysis, what the responses will be. The designer can apply the approximation theory to any type of element, be it electrical or mechanical.

This book concentrates on two main areas—approximation theory, and synthesis. However, because network synthesis is so widely understood, it is treated here only to the extent necessary for approximation purposes and for the design of ladder networks.

Modern network design requires many tedious computations. Therefore, a computer is an almost in-

Reed Relays that deliver more of what you need most...

VERSATILITY ■ RELIABILITY ■ ECONOMY



Standard and Miniature Reed Relays



Special Design Reed Relays

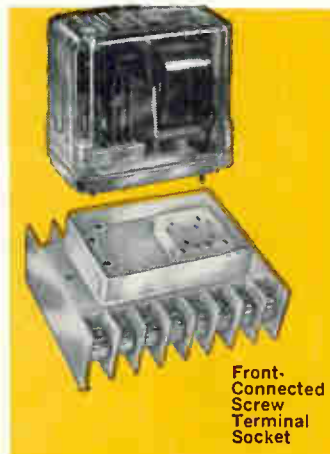

Front-Connected Screw Terminal Socket

Automatic Controls' Reed Relays — standard, miniature, or your special designs — offer individually supported reed switches, magnetic foil wrapped coils, non-magnetic terminals, and rhodium plated contacts, providing peak performance and reliability. Standardized contact configurations assure off-the-shelf delivery and maximum economy. For more of what you need most — specify Automatic Controls' Reed Relays everytime!

NEW from Automatic Controls... Front-Connected Screw Terminal Socket.

Accommodates the Automatic Controls' "family" of general purpose plug-in relays and time delay relays.

FREE LITERATURE!

Write for illustrated brochures and technical information:

- #800 Industrial Relays
 - #700 Pressure Switches
 - #940 Reed Relays
 - #720 Military Relays
 - #830 Ice Detection Systems
 - #874 Contactors
 - #859 Program Timers
- Specify above by numbers

Automatic Controls

Division



COOK ELECTRIC

200 East Daniels Rd., Palatine, Ill. 60067

New Books

dispensable tool. And because of this, the author not only explains the theory behind approximation techniques, but includes computer programs that can be applied. Thus the reader, for all practical purposes, has the answers to most of his problems at his fingertips. The programs are written in Fortran and described in special sections.

Knowledge of general network analysis and Laplace transform methods are assumed, as are the basic mathematics, but this information is included in the book to aid novices in the subject matter.

The first three chapters contain a review of the Laplace transform, analysis of networks, and behavior of networks with ideal characteristics. Basic are the conditions the designer must impose on different network functions to achieve desired results; any mathematical function that is the basis for subsequent network synthesis must contain all restrictive conditions imposed on it by the network to be designed. These conditions are presented in Chapter 4, laying the groundwork for the application of the approximation theory.

Different network characteristics, particularly for linear networks, are defined in Chapter 5, and programs evaluating them are also given. The following chapters introduce several transformations that make it possible to transform network characteristics into another frequency band, thus paving the way for further approximation.

Approximation of different characteristics is treated in Chapters 8 through 12; programs for solving pertinent problems are also included. The final two chapters, 13 and 14, discuss synthesis techniques and the synthesis of passive and active filters.

This book can be read in several ways. Readers interested primarily in information about the synthesis of networks should read Chapters 1 to 4, 8, and 14; those interested in approximation problems can start with Chapter 7 and return later to the preceding chapters. The book can also be used as a reference when a particular approximation problem is to be solved.



The things we do to stay in front!

Because we're No. 1 in control knobs . . .

and because we're Rogan

Our reputation means a lot to us. So much in fact that the knobs we make are quality knobs . . . knobs that are "out in front" with "real design appeal" —yet priced right to fit your budget. Write today for free New color catalog or see us in Sweets or Thomas Micro catalogs.

Rogan
BROTHERS, INC.
8031 N. MONTICELLO AVE.
SKOKIE, ILLINOIS 60076
PHONE: (312) 675-1234

Circle 216 on reader service card

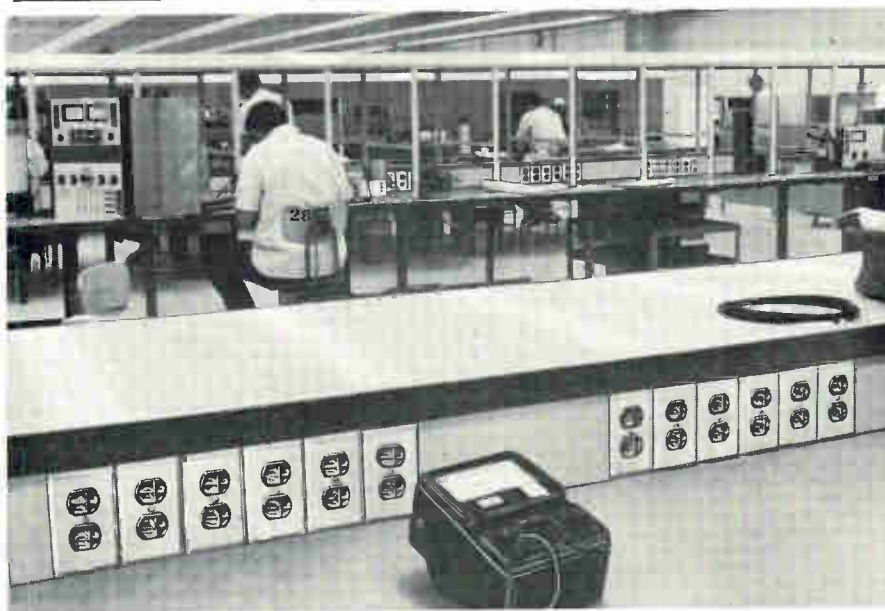

Electrical convenience for electronic equipment

Whether you make, use or test electronic equipment, the power you need can be delivered neatly in a Wiremold® surface wiring system. All necessary electrical

services and devices are housed in a single raceway, properly sized for present and future needs. Send for literature on the entire line of Wiremold systems.



THE WIREMOLD COMPANY / HARTFORD, CONNECTICUT 06110

ECONOMICAL Thin Film!

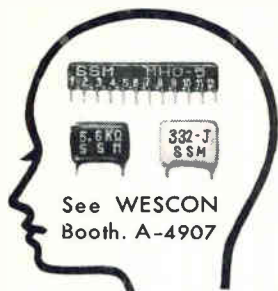

See WESCON
Booth. A-4907

What's needed for memory system is everlasting high accuracy. SSM's components are the very ones satisfying superior reliability.

- Plate-ohm: evaporated metal film resistor
- Pla-module: thin film modulated C-R circuit
- Pla-con: organic thin film capacitor by plasma reaction

SUSUMU INDUSTRIAL CO., LTD.

Minami Bldg 1-12 Ebisuminami
Shibuya-ku, Tokyo, Japan
TEL: Tokyo (03) 712-5990
TELEX: No. 246-6270

Circle 217 on reader service card



NORTON[®] MAGNETIC HEADS

MULTITRACK ERASE RECORD PLAY

Send now for complete technical literature.

NORTON

ASSOCIATES, INC.

10 Di Tomas Court, Copiague, N.Y. 11726
Phone: 516 598-1600

Circle 218 on reader service card

Technical Abstracts

Post-gadget era

Linear IC's in tv, and a-m and f-m receivers

Sumner B. Marshall
Sprague Electric Co.
Worcester, Mass.

Although the first integrated circuits appearing in consumer electronics were aimed primarily for advertising leverage, newer IC's have been developed that offer performance far better than their discrete counterparts. Today's IC's are found in the tv sound i-f with discriminator, amplitude modulated and frequency modulated i-f amplifier, color demodulator, and video processing circuitry.

One of the newest circuits is a sound-channel hybrid IC consisting of a 60-decibel, three-stage limiting amplifier and analog multiplier used as a quadrature discriminator, and an audio preamplifier. In an a-m and f-m receiver, two of these circuits are cascaded to function as an i-f amplifier. Ceramic or hybrid lumped filters are placed between the IC's to provide an interface between the limiter and the discriminator.

The first IC, functioning as an f-m i-f amplifier, provides a gain of 60 db at 10.7 megahertz; in the a-m mode, the circuit acts as a product detector. The second IC has the same gain at the same frequency, but its multiplier functions as a quadrature f-m discriminator. The product detector, which has a higher sensitivity than a ratio detector, is available without adding to the cost. Using these IC's instead of their discrete counterparts simplifies both the alignment and fabrication of sets.

The monolithic analog multiplier, used alone, has found a natural application as a synchronous color demodulator of the National Television System Committee 3.58-Mhz chroma subcarrier. The device's accuracy and stability are greater than those of vacuum-tube demodulators.

A high-voltage monolithic circuit has been developed using a planar process with epitaxial thickness and doping level adjusted for voltage breakdowns of 150 to 200 volts. The circuit uses three transistors

Circle 185 on reader service card →

brite glo[®] ALCOLITE

Alco's new Brite Glo[®] miniature lamp series is achieved through painstaking workmanship that assures the best pilot assembly on the market.

The new T-1 3/8 MNE neon series has an exclusive ring electrode construction that glows on the entire surface with direct current. Available as individual lamps or as miniature panel assemblies.

All our miniature incandescent pilot assemblies contain the most popular and long-life MIL-grade T-1 5 volt lamps. Choice of domed or cylindrical assemblies, in a variety of colors.

Our standard neon series are all equipped with NE2 lamps and are available in many lens styles and colors, with or without built-in series resistors.

For design-service assistance and price quotations, call (Area 617) 686-3887.

SEND FOR COMPLETE
ALCOLITE
CATALOG



ALCO

ELECTRONIC PRODUCTS, INC.

Lawrence, Massachusetts 01843

Up-date your film resistor library.

With our new literature on Mallory film resistors. A complete line. Made by the company with total capability in film resistors. Write, today.

Mallory Controls Company, a division of P. R. Mallory & Co. Inc., Box 327, Frankfort, Ind. 46401.

GENERAL SPECIFICATIONS

MALLORY TYPE	MILITARY TYPE	TEMPERATURE RATING	POWER RATING (WATTS)	RESISTANCE RANGE (OHMS)
Precision Resistors				
MAC 55	RN55	70°C & 125°C	1/4 & 1/10	10Ω-100K
MAC 60	RN60	70°C & 125°C	1/4 & 1/10	10Ω-499K
MAC 65	RN65	70°C & 125°C	1/2 & 1/4	10Ω-1 meg
Semiprecision Resistors				
MAL 07	RL-07	70°C	1/4	10Ω-100K
MAL 20	RL-20	70°C	1/2	10Ω-470K
MAL 32	RL-32	70°C	1	10Ω-1 meg
Power Resistors				
2MOL		70°C	2	30Ω-125K
3MOL		70°C	3	40Ω-125K
4MOL		70°C	4	85Ω-125K
5MOL		70°C	5	95Ω-125K
7MOL		70°C	7	125Ω-125K

MALLORY

Circle 219 on reader service card

MICO NEW MODEL 885 SEVEN RATIO WIDE-RANGE ENGRAVER

NO. 885

FOR LONG AND
MULTI-LINE WORK

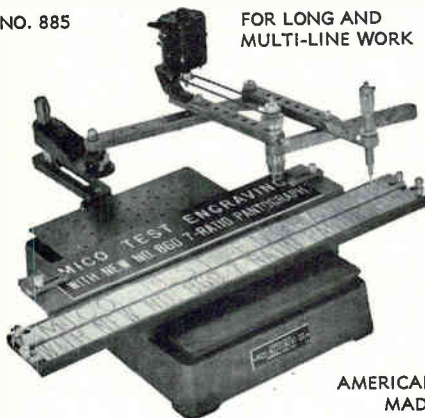

AMERICAN
MADE

- A time-saver for large plate work
- Engraves 3" x 19" area in one set-up.
- Seven pantograph ratios—from 1:5:1 to 6:1.
- Choice of 3-ball-bearing spindle assemblies for 1/8", 3/16" or taper-shank cutters.
- HSS, COBALT and Solid Carbide Cutters.
- Single and multi-line copy carriers for holding blanks 3/4" to 3 1/2" high.
- Accommodates Mico standard accessories.

Send for bulletins and prices

MICO INSTRUMENT CO.

77 Trowbridge St. Cambridge, Mass. 02138

Want to be unique in our memory?

It's easy. Enter the Electronics Manpower Register.

We'll feed your professional background into the talent memory of our nationwide computerized recruitment service.

Our computer will match your unique profile against every opening being programmed into it by a long list of electronics companies. You'll automatically be qualified for every logical career opportunity. But we'll only release your availability to those companies you approve.

To enter, send us your resume.

Electronics Manpower Register
Electronics
330 West 42nd Street
New York, N.Y. 10036

Technical Abstracts

interconnected to prevent the collector-to-emitter voltage of each device from exceeding half the collector-supply voltage, thereby extending the swing capability of the amplifier to the limit of voltage breakdown. This circuit provides the direct drive of a 17-inch, black-and-white cathode-ray tube.

Presented at Wescon, San Francisco, Aug. 19-22.

Hot spot

Reflow soldering with radiant heating
David Schoenthaler
Western Electric Co.
Princeton, N.J.

The cost and quality advantages of printed circuit boards, flexible cables, and thin film circuits can be improved by reliable mass joining methods for connecting different components and devices. Reflow soldering has proven successful in such applications as it joins without forming solder bridges between adjacent connections. The technique depends on photofabrication methods to precisely deposit small amounts of solder.

Radiant heat melts the solder which flows forming a reliable connection. Some of the advantages of radiant heating are that it allows excellent control of the soldering temperature, that it permits heating of otherwise inaccessible joint areas on transparent substrates, and that it eliminates the soldering peaks left after withdrawing a soldering iron from the molten solder.

Effectiveness of radiant-heating reflow soldering depends on the spectral characteristics of the source of radiant energy, on the energy absorption characteristics of the material to be joined, and on the efficiency with which the energy is focused on the material.

Compact, high power, incandescent lamps provide the radiant energy and are small enough for their filaments to serve as a point source for the precise optical reflectors that collect and concentrate the energy.

The emissive power of the filament increases as the fourth power of temperature. Consistent with life considerations, the lamp should be

STABILITY & QUALITY



MATSUO

SOLID TANTALUM CAPACITORS FOR HYBRID ICs - "MICROCAP"

Capacitance exceeding 10,000 picofarads obtained despite miniature size. "MICROCAP" features excellent heat resistance, solderability and mechanical strength comparable to conventional discrete components, for easy use in hybrid integrated circuits.

Specifications:

Operating Temperature Range: -55°C to $+85^{\circ}\text{C}$
 Standard Voltage Rating: 6.3, 10, 16, 20, 25, 35 VDC
 Standard Capacitance Value: .001 to 22MFD (E6 series)
 Standard Capacitance Tolerance: $\pm 20\%$ (M)

MATSUO'S other capacitors include:

Metallized Polyester Film Capacitor:

Type FNX-H mylar wrapped.

Solid Tantalum Capacitors:

Type TAX hermetically sealed in metallic case, Type TSX encased in metallic case and sealed with epoxy resin, Type TSL encased in metallic case and sealed with epoxy resin. **Polyester Film Capacitors:**

Type MFL epoxy dipped,

Type MFK epoxy dipped, non

inductive, Type MXT encased in plastic tube, non inductive.

For further information, please write to:

MATSUO ELECTRIC CO., LTD.

Head Office: 3-5, 3-chome, Sennari-cho, Toyonaka-shi, Osaka, Japan
 Cable: "NCCMATSUO" OSAKA Telex: 523-4164 OSA
 Tokyo Office: 7, 3-chome, Nishi-Gotanda, Shinagawa-ku, Tokyo

Technical Abstracts

run at its highest temperature. As a rule, the lamp with the lowest usable power rating will provide the most efficient filament temperature. The filament temperature determines its spectral characteristics of emission, typically from 0.76 to 4 microns.

To insure an efficient transfer of radiant heat to the material—that is energy absorption rather than reflection—the incident radiation flux should have a high percentage of short-wavelength energy. In general, it's best to heat metallic surfaces with energy less than 2 microns in wavelength. For copper and tantalum, the heat absorption increases sharply for wavelengths less than 1 micron.

When an application requires localized heating, an optical condenser system provides the higher intensity energy. The condenser gathers radiant energy over a wide area and discharges it through a small area to increase the radiant flux (watts per square centimeter).

Production soldering equipment relies on a flow of air or gas for convection cooling to protect insulation and other material from the higher soldering temperature. In fact, it's possible—in a three-second heating cycle—to make excellent solder fillets when joining Mylar-insulated wire, with minimum thermal distortion of the Mylar surface.

Presented at the International Electronic Circuit Packaging Symposium, San Francisco, Aug. 20 and 21.

Ferrites grow

Advances in planar ferrite devices L. R. Whicker, J. E. Degenford, D.C. Buck, and F.H. Harris Westinghouse Defense and Space Center, Baltimore, Md.

Recent radar applications have spurred the development of low cost, reproducible microstrip devices. A wide variety of ferrite phase shifters and circulators, built by Westinghouse, promise good electrical performance for batch-processed devices.

To build these phase shifters, a ferrite film is grown by a chemical vapor disposition process. This film

small wonders



A SERIES
SPDT

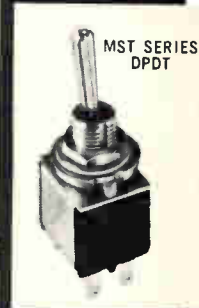

MST SERIES
DPDT



E SERIES
3 PDT



MUSTANG
4 PDT

Ever wonder who leads the way in miniature toggle switches? Since 1919 ALCO SWITCH has pioneered and introduced hundreds of ideas and the newest switch types that have set the standard for miniatures. Over half-dozen switch families are now available to choose from. Here are a few examples.

MST SERIES — Is the original and most-copied miniature toggle switch in the world. Rated 5 amps @ 115 VAC.

A SERIES — ALCO's newest series incorporates the most-wanted features that make this your "best buy" in miniature toggle switches. Rated 6 amps @ 125 VAC.

E SERIES — The "top of the line" miniature with the waterproof feature that makes it excel over all others. Rated 6 amps @ 125 VAC.

MUSTANG — The miniature switch with the standard switch appearance having 15/32" bushing. Rated 6 amps @ 125 VAC.

ALCO continues to provide you quality features without paying a premium such as solid silver contacts, use of better grade materials, combined mass production techniques and latest switch technology.

ALCO

ELECTRONIC PRODUCTS, INC.

Lawrence, Massachusetts 01843
 Circle 187 on reader service card

SUPERSOCKETS!

**NEW BARNES
HIGH-RELIABILITY PRODUCTION
MOUNTING DIP SOCKETS
... NONE BETTER**

Maximum reliability, longest life, highest quality, low cost too—all in one socket! New Barnes 121-2002 Series Production Mounting DIP Sockets. 10,000-plus insertion capability also increases usefulness for aging and burn-in applications. Interchangeable phosphor/bronze double wiping action type contacts/terminals replace easily—even while sockets are wired on P.C. boards! Accepts standard 14-lead DIP devices, features chamfered lead entrances and removable lids in black & white for easy color coding. Get the SUPERSOCKETS from Barnes. Send for more data.





Lansdowne, Pa. 19050 • 215/MA 2-1525

barnes / THE WORLD'S MOST COMPLETE LINE OF SOCKETS, CARRIERS AND CONTACTORS FOR I.C.'S

Circle 221 on reader service card



Specify AUSTRON LORAN-C to CALIBRATE FREQUENCY/SET TIME

Loran-C from Austron is your best solution to calibrating precision frequency standards and setting local clocks. Austron's Model 2000 Loran-C Tracking Receiver calibrates rubidium standards in two hours, eliminates expensive portable clock trips.

Whenever time and frequency are important, consider the benefits of Loran-C systems from Austron. Write for detailed data sheets and application note.

Visit our NEREM Booth 1F13 for a demonstration.



10214 NORTH INTERREGIONAL HIGHWAY, AUSTIN, TEXAS 78753 TELEPHONE (512) 454-2581

—bulk ferrite, Magnesium manganese TT-390—is deposited on the surface of platinum or other noble metals, which in turn have been deposited at appropriate spots on a supporting substrate material such as forsterite. Then, ground contacts and appropriate metal paths are evaporated directly onto the metal surface.

Over a range of approximately 360° at 10 gigahertz, the film phase shifter's performance closely resembled that of the bulk TT-390. However, its insertion loss is approximately twice that of devices using bulk material.

This loss is attributed to two factors: rough ferrite surface finish and the increase of dielectric loss tangent with increasing film thickness. The former is caused by grain growth of the deposit while the latter is due to oxygen diffusing into the surface during deposition. Subsequent treatment, however, helps reduce the grain growth and thereby diminishes the loss tangent.

Puck-type circulators have been formed by placing a Mg-Mn puck or "button" in a ceramic substrate such as alumina. Typical performance data shows that over a frequency range of from 2 to 12 GHz, these devices yield bandwidths greater than 20%, isolation greater than 20 decibels, insertion loss less than 0.5 db, and vswr of approximately 1.2—values comparable to present generation circulators.

Presented at Microelectronics Symposium, St. Louis, Sept. 10-11.

Space-age design

Integrated parametric amplifier module with self-contained solid state pump source

C.M. Allen, H.C. Okean, E.W. Sard, and H. Weingart
Airborne Instruments Laboratory,
Cutler-Hammer Inc.
Deer Park, N.Y.

Problems of size, cost, and complexity precluded the use of ultra-low-noise amplifiers in space-borne applications. However, now these barriers have been overcome with the design of a small, completely integrated, solid state S-band parametric amplifier that has its own

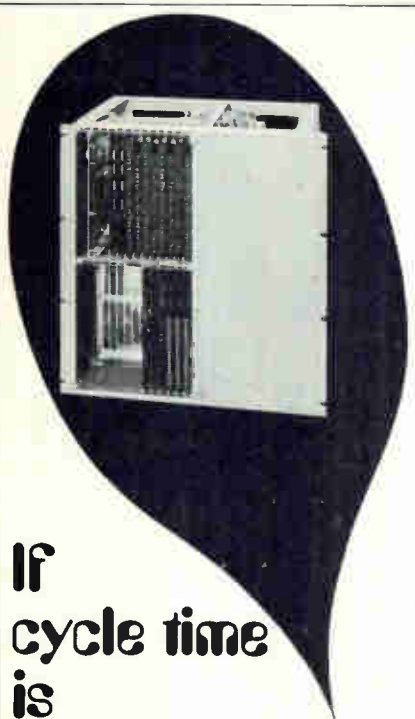

If cycle time is the name of your computer game, read the good news:

Toko Woven Plated-Wire Memory System HS-500 is now available.

Toko's woven plated-wire memory planes and stacks are already well known for their low-cost, high-performance characteristics. Now to be marketed for the first time is Toko's complete memory system, with a capacity of 4096 words by 16 bits expandable to 8192 words and 20 bits. Cycle time is a remarkable 500 ns. Other characteristics are 2D organization, destructive read-out operation, and TTL logic level interface. Cost of the system is remarkably low, and fast delivery can be guaranteed.

Besides this standard woven plated-wire memory system, Toko can undertake the manufacture of custom-made systems according to your specifications. Complete technical details from our New York office.

TOKO, INC.

Head Office: 1-17, 2-chome, Higashi-Yukigaya, Ohta-ku, Tokyo, Japan

TOKO N.Y., INC.
350 Fifth Avenue, New York, New York 10001

Technical Abstracts

pump source.

The unit, which employs thin-film microstrip technology, consists of a circulator-coupled, non-degenerate, shunt varactor diode parametric amplifier that operates at 2.25 gigahertz with a bandwidth of 100 megahertz, and a Gunn-effect oscillator pump source operating at 14 Ghz. Passband noise temperature range is 145° to 190°K.

The amplifier and pump stages are completely integrated in an aluminum housing, whose volume is less than 10 cubic inches; the unit weighs less than 0.6 pound. The only external connections are subminiature coaxial r-f input and output connectors, and a two-wire d-c bias connector requiring 8 volts at 0.5 ampere from an external supply.

The amplifier stage is fabricated on a glazed alumina substrate which has been metalized by vacuum deposition of copper-nichrome, and then photoetched, producing the required conductor pattern. The three-port circulator uses a 1-inch yig disk embedded in a hole in the substrate. A bias magnet provides a field of 600 gauss and is set in the housing base plate below the disk. Quarter-wave transformers adjust the impedance at the input and output ports of the circulator to 50 ohms; the varactor circuit is directly coupled to the third port. The circulator has a maximum insertion loss of 0.4 decibel at 2.25 Ghz and a 30-db isolation bandwidth of 120 Mhz. The idler circuit is formed by two parallel quarterwave open-circuited stubs connected directly across the varactor pill.

The waveguide pump source consists of an iris-coupled Gunn-diode oscillator cavity, a miniature waveguide isolator, and a waveguide-to-microstrip transducer. The pump source produces c-w power of 50-100 milliwatts between 13.8 and 14.2 Ghz. The isolator provides a minimum of 25 db of isolation with an insertion loss of 0.3 db and a voltage standing wave ratio of 1.25:1 over the band.

Presented at the Microelectronics Symposium, St. Louis, Sept. 10-11.

designer's keyboard

SB-033 — INTERLOCK
SB-034 — MOMENTARY

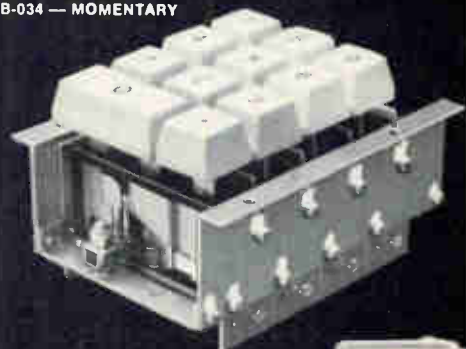

28.50 User Net

The ALCO modular idea is a simple concept for the design engineer to create his own custom push button layouts from "stock" switch modules and assemblies.

The basic modules allow use of up to twelve (shown at right) switches per section. A designer may stack any number of these switch sections in a group by themselves or in conjunction with the ALCO mating 12-segment keyboard assemblies (shown above).

Highly efficient, single pole "normally open" reed switches are used throughout, thus assuring reliability and extremely long life expectancy.

For design-service assistance and price quotations, call (Area 617) 686-3887.

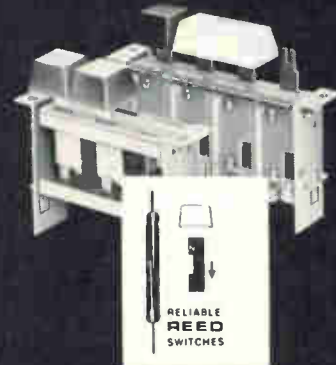

Available as Momentary and Interlock

ALCO

ELECTRONIC PRODUCTS, INC.

Lawrence, Massachusetts 01843

Circle 189 on reader service card

evening classes won't fit your schedule?

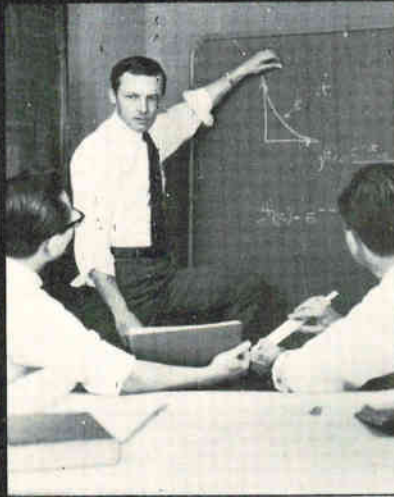

here's a practical way to keep up with new developments

Are irregular hours, travel and family obligations keeping you from attending classes—even though you worry about becoming technically obsolescent? Check into the Special Programs in Electronics for Engineers developed by CREI, the Home Study Division of the McGraw-Hill Book Company.

These are not simply courses, but comprehensive programs in advanced electronics offering major electives in such fields as :

Communications Engineering, Aeronautical and Navigational, Television Engineering, Automatic Control Engineering, Missile and Spacecraft Guidance, Radar and Sonar Engineering, Nuclear Instrumentation and Control, Computers.

Industry-recognized CREI Programs make it possible for you to catch up on new developments in electronics through study in your own home, at your own pace,

your own schedule. Free book gives complete information and details of technical material covered. For your copy, mail coupon below or write : CREI, Home Study Division, McGraw-Hill Book Company, Dept. 1844H, 3224 Sixteenth St., N.W., Washington, D.C. 20010.

Founded 1927



Accredited Member of the National Home Study Council



CREI. Home Study Division, McGraw-Hill Book Company
Dept 1844H, 3224 Sixteenth St., N.W.
Washington, D.C. 20010

Send me free brochure describing CREI Programs in Electronics for Engineers.

NAME _____ AGE _____

ADDRESS _____

CITY _____ STATE _____ ZIP CODE _____

COMPANY _____

TITLE _____

New Literature

Semiconductor applications. Westinghouse Electric Corp., P.O. Box 868, Pittsburgh 15230. The first three booklets in a continuing series of application notes provide useful information on the application of semiconductor products to a variety of problems. Circle 446 on reader service card.

Ultrasonic cleaning system. Branson Instruments Co., 76 Progress Dr., Stamford, Conn. 06904. An ultrasonic cleaning system designed to remove organic or inorganic soils is described in four-page bulletin S-901. [447]

Ceramic capacitors. Union Carbide Corp., P.O. Box 5928, Greenville, S.C. 29606, has available a complete product line catalog for the Kemet line of monolithic ceramic capacitors. [448]

Printed circuit dies. Lenkeit Industries Inc., 258 Broadhollow Rd., Farmingdale, N.Y. 11735, has issued a brochure entitled "Printed Circuit Dies: How to Tool Them Right." [449]

High performance motors. IMC's Eastern Division, 570 Main St., New York 11591. An illustrated 88-page catalog describes a full line of induction, synchronous, and torque motors. [450]

Coaxial cable. Uniform Tubes Inc., Collegeville, Pa. 19426. An eight-page bulletin 202D describes the types of Micro-Coax miniature, solid-jacketed coaxial cable available with total shielding to eliminate radiation leakage and obtain lowest possible attenuation. [451]

Power servo actuators. Weston-Transcoil, Worcester, Pa. 19490, has available a folder describing a line of power servo actuators for guidance and control systems. [452]

Information and data processing. Beckman Instruments Inc., 2500 Harbor Blvd., Fullerton, Calif. 92634, has released a 12-page bulletin entitled "Information and Data Processing Systems." [453]

Cycle timers. Cramer Division, Conrac Corp., Mill Rock Rd., Old Saybrook, Conn. 06475. An eight-page catalog illustrates and describes eight series of cycle timers ranging from simple single poke units to multicircuit programers. [454]

Numerical control system. CTC Computer Corp., 1018 Palo Alto Office Center, Palo Alto, Calif. 94301. A pocket-sized brochure describes the consulting and programming service for the numerical control system available through the company's Software Systems division. [455]

Dynamic shift register. Union Carbide Corp., 8888 Balboa Ave., San Diego,

locally... off the shelf

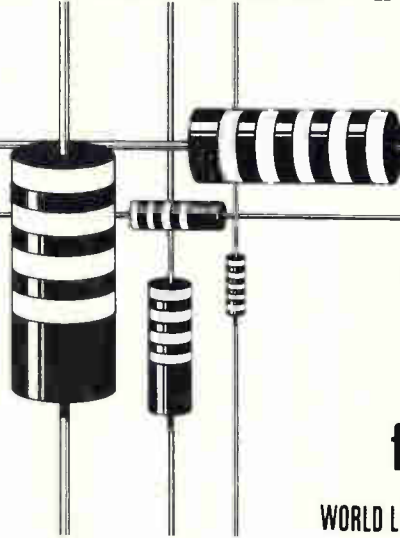

Allen-Bradley hot-molded composition fixed resistors

WORLD LEADER IN FIXED RESISTORS

Unequaled for reliability—Allen-Bradley hot-molded resistors are *unique* in meeting the requirements of MIL-R-390008 *Established Reliability Specifications* at the highest level—the "S" level. This is true for all four ratings—RCR32 (1 watt), RCR20 (½ watt), RCR07 (¼ watt), and RCR05 (⅓ watt). And over the complete resistance range from 2.7 ohms (10 ohms for ⅓ watt) to 22 megohms.

The distributors listed below are the only authorized Allen-Bradley distributors, and each has added a new dimension of service—fully stocked to give you fast delivery on hot-molded fixed resistors, hot-molded and cermet variable resistors and trimmers, discoidal capacitors, and high-frequency low pass feed-thru filters.

call now!



PHILADELPHIA

ALMO ELECTRONICS CORP.

A Subsidiary of Sterling
Electronics Corporation
Roosevelt Blvd. at Blue Grass Road
Philadelphia, Pennsylvania 19114
(215) OR 6-6000

BOSTON

CRAMER ELECTRONICS INC.

320 Needham Street
Newton, Massachusetts 02164
(617) 969-7700

SAN FRANCISCO

ELMAR ELECTRONICS INC.

A Subsidiary of Wyle Laboratories
2288 Charleston Road
Mountain View, California 94040
(414) 961-3611

LOS ANGELES

KIERULFF ELECTRONICS INC.

A Subsidiary of Ducommun Inc.
2585 Commerce Way
Los Angeles, California 90022
(213) 685-5511

CHICAGO

NEWARK ELECTRONICS CORPORATION

A Subsidiary of Premier
Industrial Corporation
500 North Pulaski Road
Chicago, Illinois 60624
(312) 638-4411

NEW YORK

SCHWEBER ELECTRONICS

Jericho Turnpike
Westbury, New York 11590
(516) 334-7474

©Allen-Bradley Company 1969

EC69-88A

An important Tool for any Engineer...FREE!

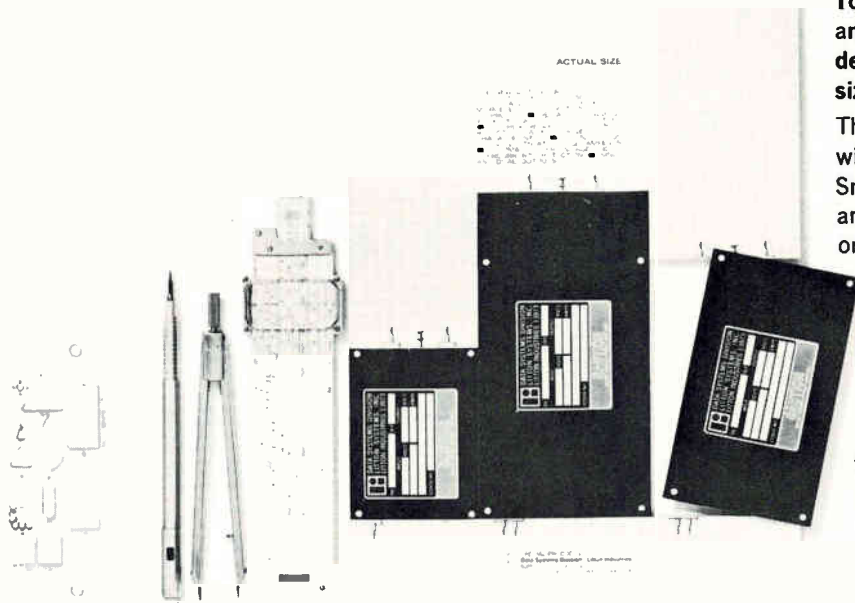

To help you fit Litton Power Supply reliability and performance into your engineering design, we'd like to send you five actual size replicas...FREE

There are no other modular power supplies with the performance to match Litton's. Small size and weight, reliable and efficient. Manufactured to MIL Specs or commercial standards. Choice of slot-range voltage power supplies weighing from .75 to 7 pounds in packages from 8 to 108 cubic inches with power outputs to 300 watts.

Use the inquiry card in this magazine to receive your actual size power supply templates and specifications...FREE.



SPECIAL PRODUCTS
Data Systems Division • Litton Industries
9001 Fullbright Avenue, Chatsworth, California 91311

Circle 223 on reader service card

Perfect Your CCTV System with COSMICAR® lenses



Focal length 15~145mm Aperture f/2.5

A new member to the superb COSMICAR lens family!!

The most efficient **10:1 zoom** lens, unmatched for its optimum performance, both optically and mechanically, with impeccable definition and resolution throughout its entire zoom range.

Also available are scores of other lenses, ranging from 8.5mm to 1,000mm telephoto, zoom and those motordriven among them, for immediate delivery, after being tailored to your specifications.



COSMICAR OPTICAL CO., LTD.

568, Shimochiai, 2-chome, Shinjuku-ku, Tokyo

Cable Address: "MOVIEKINO TOKYO"

New Literature

Calif. 92123, has released a brochure on the SRD-25 MOS p-channel integrated circuit dual 25-bit shift register. [456]

Precision potentiometers. Bourns Inc., Trimpot Products Division, 1200 Columbia Ave., Riverside, Calif. 92507. A new Bee-Line precision potentiometer series is completely described in a six-page brochure. [457]

Operational amplifier. Analog Devices Inc., 221 Fifth St., Cambridge, Mass. 02142. A fold-out data sheet describes a high stability ($2 \mu\text{V}/^\circ\text{C}$ maximum drift) battery powered operational amplifier that draws only microwatts quiescent power, and runs months on a single set of batteries. [458]

Interactive time-sharing services. Westinghouse Electric Corp., P.O. Box 868, Pittsburgh 15230. Benefits and advantages of interactive time-sharing computer services are described in bulletin DB24-350. [459]

Indicator lights. Dialight Corp., 60 Stewart Ave., Brooklyn, N.Y. 11237. Catalog L-160J covers ultraminiature Datalites, a system of indication suited for computer, data processing, and automation applications. [460]

Multimode transceiver. RCA Defense Communications Systems Division, Camden, N.J. Bulletin AN/ARC-142 contains a description and features of a small, lightweight, solid state h-f multimode transceiver. [461]

Microwave reference guide. Philco-Ford Corp., Union Meeting Rd., Blue Bell, Pa. 19422, has published a product reference guide containing information on microwave solid state devices and components. [462]

Multichannel FSK modem. Tele-Dynamics, division of AMBAC Industries Inc., 5000 Parkside Ave., Philadelphia 19131. A versatile digital/frequency shift keyer modem that operates in three modes is described in bulletin 7260. [463]

Time delay module. Product Designs Inc., 111 Cardenas, N.E., Albuquerque, N.M. 87108, offers a release describing its linear adjustment precision time delay module. [464]

Resistor array. Beckman Instruments Inc., 2500 Harbor Blvd., Fullerton, Calif. 92634, has released a four-page catalog sheet describing its model 813 10-bit binary resistor array, specifically designed with resistance values and terminal arrangements that make it usable with Fairchild's $\mu\text{A}722$ 10-bit current source. [465]

Beryllia ceramics. National Beryllia Corp., Cermetrol Division, Haskell, N.J.,

immediate delivery

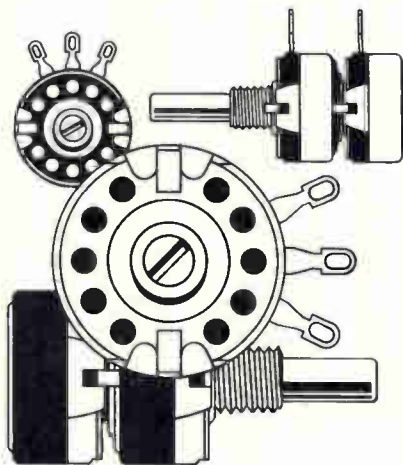

Allen-Bradley hot-molded variable resistors

The famous Type J variable resistor has a solid hot-molded resistance element, which ensures smooth adjustment at all times—resolution is essentially infinite. Low inductance permits the Type J to be used in high-frequency circuits replacing wire-wound controls.

Type J controls are available in single and dual units. Rated 2.25 watts at 70°C in values from 50 ohms to 5.0 megohms, with a wide variety of tapers.

The distributors listed below are the only authorized Allen-Bradley distributors, and each has added a new dimension of service—fully stocked to give you fast delivery on hot-molded fixed resistors, hot-molded and cermet variable resistors and trimmers, discoidal capacitors, and high-frequency low pass feed-thru filters.

call now!



PHILADELPHIA

ALMO ELECTRONICS CORP.
A Subsidiary of Sterling
Electronics Corporation
Roosevelt Blvd. at Blue Grass Road
Philadelphia, Pennsylvania 19114
(215) DR 6-6000

BOSTON

CRAMER ELECTRONICS INC.
320 Needham Street
Newton, Massachusetts 02164
(617) 969-7700

SAN FRANCISCO

ELMAR ELECTRONICS INC.
A Subsidiary of Wyle Laboratories
2288 Charleston Road
Mountain View, California 94040
(414) 961-3611

©Allen-Bradley Company 1969

LOS ANGELES

KIERULFF ELECTRONICS INC.
A Subsidiary of Ducommun Inc.
2585 Commerce Way
Los Angeles, California 90022
(213) 685-5511

CHICAGO

**NEWARK ELECTRONICS
CORPORATION**
A Subsidiary of Premier
Industrial Corporation
500 North Pulaski Road
Chicago, Illinois 60624
(312) 638-4411

NEW YORK

SCHWEBER ELECTRONICS
Jericho Turnpike
Westbury, New York 11590
(516) 334-7474

EC69-89A

Be prepared for

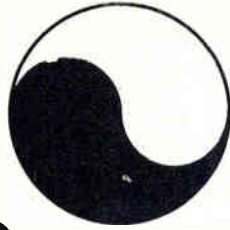

THE CHANGING INTERFACE

Medium and large scale integration are slated to have major impact on the electronics industry. The effects are already being felt — not only on systems and component design — but on fundamental, traditional relationships between equipment builders and component suppliers.

Important trends that will affect your profession, your job, your company, are explored in THE CHANGING INTERFACE, a 150-page illustrated volume to be published shortly by McGraw-Hill's Electronics/Management Center.

In THE CHANGING INTERFACE, leading design engineers and managers, the men responsible for guiding their companies through the next generation of electronics, discuss the problems that LSI/MSI are stirring up — and offer their solutions.

Here are some of the vital topics covered.

- Implications of LSI on the Electronics Market
- The Rationale for an In-House IC Capability
- The Component Maker's Responsibility vs. the System Builder's Responsibility
- Masks and Computer-Aided Design at the Interface
- The Testing Interface
- How IBM and Bell Laboratories Deal with the Interface Problem
- Controversies and Future Trends in LSI

You can reserve a copy of THE CHANGING INTERFACE now at the special pre-publication price of \$6.50 by returning the coupon below. If you send a check now, we'll pay the cost of postage and handling.

Electronics/Management Center
330 West 42nd St.
New York, N.Y. 10036

Attn. Mr. Wayne Cowart

Please reserve my copy of THE CHANGING INTERFACE at the prepublication price of \$6.50.

Name _____ Title _____

Company _____

Company Address _____

City _____ State _____

Check enclosed for \$6.50 Bill me
 Bill Company P.O. Number _____



It's never too early to start saving their hearts

Help your children form good health habits now to reduce risk of heart attack later:

- Encourage normal weight; obesity in youth may persist throughout life;
 - Build body health through regular physical activity;
 - Serve them foods low in saturated fats;
 - Teach them that cigarette smoking is hazardous to health;
 - Make medical check-ups a family routine.
- Set a good example. Follow the rules yourself and guard *your* heart, too.

GIVE...
so more will live
HEART FUND



Contributed by the Publisher

New Literature

07420, offers a comprehensive booklet on ceramic-to-metal components and assemblies for industry. [466]

Extruded lug terminals. Berg Electronics Inc., New Cumberland, Pa. 17070. A catalog describes a complete product line of lug type terminals having an extruded metal column for positive fastening to circuit boards and associated high-rate staking machinery. [467]

Transformer shields. Tapecon Inc., 475 River St., Rochester, N.Y. 14612, has prepared a data sheet (I/IS-519) in which the subject of insulated/isolated transformer shields is thoroughly discussed. [468]

Computer subjects. Electronic Associates Inc., West Long Branch, N.J. A recently revised index to the Applications Reference Library covers a wide variety of analog/hybrid computer subjects. [469]

Video terminal. Ultronic Systems Corp., P.O. Box 315, Moorestown, N.J. 08057. A four-page brochure describes the Videomaster 7000, a general purpose alphanumeric display system that sells for less than \$5,000 per terminal. [470]

Instrumentation amplifiers. Neff Instrument Corp., 1088 E. Hamilton Rd., Duarte, Calif. 91010, has available an illustrated eight-page brochure describing its line of instrumentation amplifiers for measurement and control. [471]

Microwave catalog. Addington Laboratories, 1043 DiGiulio, Santa Clara, Calif. 95050. A catalog listing the latest developments in ferrite components, covers the 3-port tee, 4-port and 5-port circulators, tee isolators and multistage isolators. [472]

Photomultiplier tube housings. Pacific Photometric Instruments, 3024 Ashby Ave., Berkeley, Calif. 94705. A newly revised 16-page catalog on a complete line of photomultiplier tube housings is now available. [473]

IC digital readouts. Farrand Controls Inc., Valhalla, N.Y. 10595, has published a brochure on a line of IC digital readouts for application to a broad variety of machine tools. [474]

Paper dielectric capacitors. San Fernando Electric Mfg. Co., 1501 First St., San Fernando, Calif. 91341. General characteristics and complete ordering data for the complete West-Cap line of paper dielectric tubular and rectangular capacitors are highlighted in a 44-page brochure. [475]

Lead straightener, carrier loader. Barnes Corp., 24 N. Lansdowne Ave., Lansdowne, Pa. 19050. Bulletin PB-1010

now... local stock

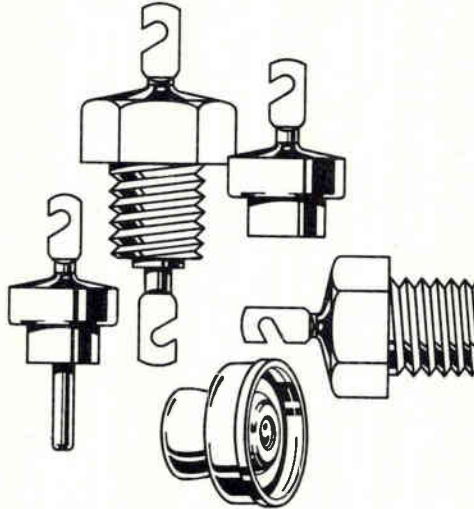

Allen-Bradley discoidal capacitors

Discoidal design provides efficient filtering into the ultra-high frequency range—there are no parallel resonance effects up through 1000 megahertz. Insulation resistance is in excess of 100,000 megohms—assures superior direct current blocking.

Compact in size, yet rugged in construction. These capacitors resist the thermal shock of soldering and require no special handling during assembly. Available in a wide range of capacitance values.

The distributors listed below are the only authorized Allen-Bradley distributors, and each has added a new dimension of service—fully stocked to give you fast delivery on hot-molded resistors, hot-molded and cermet variable resistors and trimmers, discoidal capacitors, and high-frequency low pass feed-thru filters.

call now!



PHILADELPHIA

ALMO ELECTRONICS CORP.
A Subsidiary of Sterling
Electronics Corporation
Roosevelt Blvd. at Blue Grass Road
Philadelphia, Pennsylvania 19114
(215) OR 6-6000

BOSTON

CRAMER ELECTRONICS INC.
320 Needham Street
Newton, Massachusetts 02164
(617) 969-7700

SAN FRANCISCO

ELMAR ELECTRONICS INC.
A Subsidiary of Wyle Laboratories
2288 Charleston Road
Mountain View, California 94040
(414) 961-3611

LOS ANGELES

KIERULFF ELECTRONICS INC.
A Subsidiary of Ducommun Inc.
2585 Commerce Way
Los Angeles, California 90022
(213) 685-5511

CHICAGO

**NEWARK ELECTRONICS
CORPORATION**
A Subsidiary of Premier
Industrial Corporation
500 North Pulaski Road
Chicago, Illinois 60624
(312) 638-4411

NEW YORK

SCHWEBER ELECTRONICS
Jericho Turnpike
Westbury, New York 11590
(516) 334-7474

©Allen-Bradley Company 1969

EC69-90A

Hallicrafters is the company that has created a new dimension in electronic excellence. We're looking for "technovators"—professional electronic engineers with a curious mind, open to the ever expanding horizons of technical innovation.

Our reputation as leader of the electronic communications and counter-measures industry is maintained by our staff of professional electronic engineers. These individuals not being satisfied with yesterday's progress, have an insatiable desire to venture into the realm of electronic innovation.

"TECHNOVATORS"

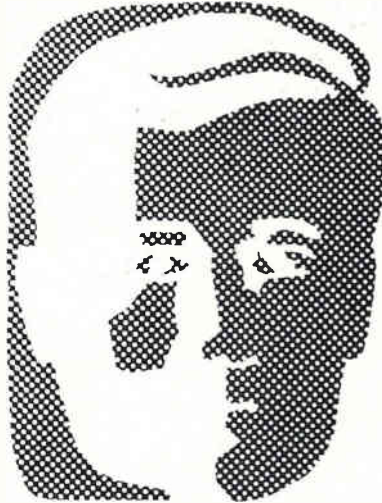

To continue our pursuit of tomorrow's technology, Hallicrafters needs talented electronic engineers who thrive on challenging assignments offered in an atmosphere of intellectual and creative freedom—"technovators" who thrive in an environment of curiosity, controversy, commitment and change.

Specifically, we have openings for EE's in ECM Systems, Solid State, Microwave, Antennas, Communications and Electronics Packaging.

If you're a "technovator"—a thinker ready to make significant contributions to advancing the state-of-the-art, consider working for Hallicrafters, where progress is based on electronic excellence.

Please submit your resume, in complete confidence, to: Professional Placement Director, The Hallicrafters Co., 600 Hicks Road, Rolling Meadows, Illinois 60008.

An Equal Opportunity Employer.

the hallicrafters co.

A Subsidiary of Northrop Corporation



CIRCLE 966 ON READER SERVICE CARD

The Scientists and Engineers served by Corcoran in the last year have found the difference between "a job" and "the job."

- Nationwide. Fee paid.
- Please airmail background to:

JOSEPH P. CORCORAN
Personnel Consultants
505 B Germantown Pike
Lafayette Hill, Pa. 19444
(215) 825-0848

CIRCLE 967 ON READER SERVICE CARD

Don't forget THE BOX NUMBER

when answering the classified advertisements in this magazine. It's our only means of identifying the advertisement you are answering.

CLASSIFIED ADVERTISING
SEARCHLIGHT SECTION
BUSINESS OPPORTUNITIES
USED OR SURPLUS EQUIPMENT

RADAR SYSTEMS GROUND AND AIRBORNE. AUTOMATIC TRACKING ANTENNA SYSTEMS. NIKE AJAX. NIKE HERCULES. M-33. MSQ-1A. MPS-19. MPS-9. SCR 384. TPS-1D. TPS-28. FAA-ASR-2. AIRBORNE SYSTEMS. APN-84. APN-102. APS-20. APS-27. APS-45. DPN-19. DIGITAL COMPUTERS. IBM 650. IBM 704.

LARGEST INVENTORY OF RADAR AND MICROWAVE EQUIPMENT IN THE WORLD.

RADIO RESEARCH INSTRUMENT CO.
45 WEST 45TH ST. N. Y. 10036 212-JU 6-4691

CIRCLE 968 ON READER SERVICE CARD

FUNCTION GENERATORS

We are overstocked. Tremendous savings on latest solid state function generators. Sine, square, triangle, ramp, complex. Laboratory quality. Every item 60% to 90% off. Absolutely will not last. Send for free brochure.

LABORATORY EQUIPMENT SALES
15603 12th So., Seattle, Wn. 98148

CIRCLE 969 ON READER SERVICE CARD

Now **VACUUM PENCIL**

for picking up miniature parts

\$7.50 ea

Selected Distributorships available.

PHILIP FISHMAN COMPANY
7 CAMERON ST., WELLESLEY, MASSACHUSETTS

CIRCLE 970 ON READER SERVICE CARD

LEGAL NOTICE

STATEMENT OF OWNERSHIP, MANAGEMENT AND CIRCULATION
(Act of October 23, 1962, Section 4369, Title 39, United States Code)

1. Date of filing: October 1, 1969.
2. Title of publication: ELECTRONICS.
3. Frequency of issue: Biweekly.
4. Location of known office of publication: 330 West 42nd St., City, County and State of New York—10036.
5. Location of the headquarters or general business offices of the publishers: 330 West 42nd St., City, County and State of New York—10036.
6. Names and addresses of publisher, associate publisher, editor, and managing editor: Publisher, Gordon Jones—330 West 42nd St., New York, N. Y.—10036; Associate Publisher, Daniel A. McMillan III—330 West 42nd St., New York, N. Y.—10036; Editor, Donald Christiansen—330 West 42nd St., New York, N. Y.—10036; Managing Editor, none.
7. The owner is McGraw-Hill, Inc., 330 West 42nd St., New York, N. Y. 10036. Stockholders holding 1% or more of stock are: Paul T. Babson, 330 Beacon St., Boston, Mass. 02116; Barnett & Co., c/o Bankers Trust Company, 16 Wall St., New York, N. Y. 10015; Maxwell M. Goffen, 1271 Avenue of Americas, New York, N. Y. 10020; Donald C. McGraw, Elizabeth McGraw Webster, Donald C. McGraw, Jr. & Harold W. McGraw, Jr., Trustees under Indenture of Trust m/b James H. McGraw, dated 1/14/21 as modified; Donald C. McGraw & Harold W. McGraw, Trustees under an Indenture of Trust m/b James H. McGraw, dated 7/1/37 as amended; Donald C. McGraw, individually; Donald C. McGraw & Catharine McGraw Rock, as Trustees of the Estate of Mildred W. McGraw, all of 330 West 42nd St., New York, N. Y. 10036; Stanford E. Taylor, Hawk Dr., Lloyd Harbor, Huntington, N. Y. 11742.
8. Known bondholders, mortgagees, and other security holders owning or holding 1 percent or more of total amount of bonds, mortgages or other securities: None.
9. Not applicable.
10. Extent and nature of circulation:

	Average No. Copies Each Issue During Preceding 12 Months	Actual No. Copies Of Single Issue Published Nearest To Filing Date
A. Total No. Copies Printed....	83,738	84,984
B. Paid Circulation		
1. Sales through dealers and carriers, street vendors and counter sales.....	77,536	79,637
2. Mail subscriptions.....	77,536	79,637
C. Total Paid Circulation.....	155,072	159,274
D. Free distribution by mail, carrier or other means.....	5,061	4,669
E. Total Distribution.....	82,597	84,306
F. Office use, left-over, unaccounted, spoiled after printing.....	1,141	678
G. Total.....	83,738	84,984

I certify that the statements made by me above are correct and complete.
McGraw-Hill, Inc.
By JOHN J. COOKE,
Vice President & Secretary

New Literature

features 450-021 series lead straighteners and series 450-022 carrier loaders. [476]

Electronic hardware. Positronic Industries Inc., 1906 South Stewart, Springfield, Mo. 65804, has released its 30-page illustrated 1970 handbook of electronic hardware. [477]

D-c amplifier. Solid State Electronics Corp., 15321 Rayen St., Sepulveda, Calif. 91343, has released a data sheet on the model 3051 differential operational d-c amplifier. [478]

Intricate metal parts. Magnetics Inc., Butler, Pa. "Recipe for Success" is the title of a pocket-size, illustrated folder describing the company's photofabrication process for making intricate parts out of thin metals. [479]

Electromechanical components. Allied Devices Corp., 2365 Milburn Ave., Baldwin, N.Y. 11510. Thousands of standard electromechanical components are listed in catalog No. 7. [480]

Flexible glass fiber optics. Corning Glass Works, Corning, N.Y. 14830. Glass flexible fiber optics applications and product descriptions are given in eight-page illustrated bulletin No. 3. [481]

Solid state controllers. Barber-Colman Co., Rockford, Ill. 61101, has available catalog information on a broad line of solid state controllers. [482]

Communications processor. Tec Inc., 6700 S. Washington Ave., Eden Prairie, Minn. 55343. Complete information on the new multipurpose programmable communications system is given in brochure 706. [483]

Panel meters. Modutec Inc., 18 Marshall St., Norwalk, Conn. 06854. Catalog 870 lists well over 3,000 types of panel meters manufactured by the company. [484]

Subminiature indicator lights. Dialight Corp., 60 Stewart Ave., Brooklyn, N.Y. 11237. Two-terminal subminiature indicator lights, designed for mounting in 15/32 in., 1/2 in. and 17/32 in. clearance holes, are described in 12-page catalog L-178D. [485]

Power inverters. Fork Standards Inc., 205 Main St., West Chicago 60185. Four-page bulletin 691 announces a comprehensive line of precise frequency power inverters. [486]

Semiconductor fuses. Airpax Electronics, Cambridge, Md. 21613. A twelve-page catalog introduces Cel-Gard fuses for rectifier, SCR, thyristor, and power transistor protection. [487]

now... no delay

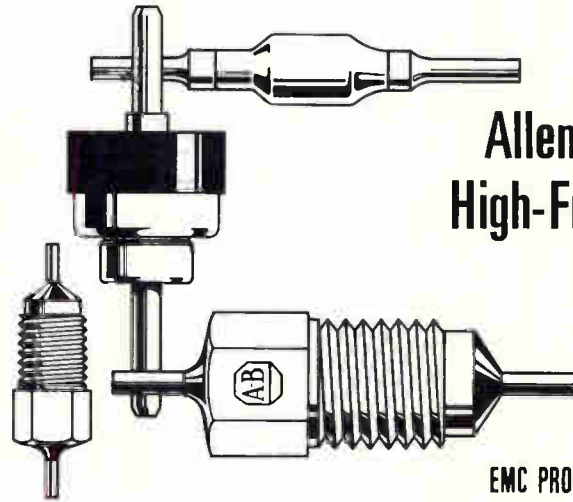

Allen-Bradley High-Frequency Filters

EMC PRODUCT FROM A-B!

These miniature low-pass filters have been specifically designed for use in demanding EMC applications, where the necessary attenuation of undesired high frequencies cannot be obtained with conventional feed-thru capacitors. Attenuations of 75 db or more can be obtained in the frequency range of 50 MHz to 10,000 MHz.

DC working voltages of 200 and 500 volts with feed-thru currents of 10 and 25 amperes, respectively, are featured in this product line.

The distributors listed below are the only authorized Allen-Bradley distributors, and each has added a new dimension of service—fully stocked to give you fast delivery on hot-molded fixed resistors, hot-molded and cermet variable resistors and trimmers, discoidal capacitors, and high-frequency low pass feed-thru filters.

call now!



PHILADELPHIA

ALMO ELECTRONICS CORP.

A Subsidiary of Sterling
Electronics Corporation
Roosevelt Blvd. at Blue Grass Road
Philadelphia, Pennsylvania 19114
(215) OR 6-6000

BOSTON

CRAMER ELECTRONICS INC.

320 Needham Street
Newton, Massachusetts 02164
(617) 969-7700

SAN FRANCISCO

ELMAR ELECTRONICS INC.

A Subsidiary of Wyle Laboratories
2288 Charleston Road
Mountain View, California 94040
(414) 961-3611

LOS ANGELES

KIERULFF ELECTRONICS INC.

A Subsidiary of Ducommun Inc.
2585 Commerce Way
Los Angeles, California 90022
(213) 685-5511

CHICAGO

NEWARK ELECTRONICS CORPORATION

A Subsidiary of Premier
Industrial Corporation
500 North Pulaski Road
Chicago, Illinois 60624
(312) 638-4411

NEW YORK

SCHWEBER ELECTRONICS

Jericho Turnpike
Westbury, New York 11590
(516) 334-7474

©Allen-Bradley Company 1969

EC69-91A

Introducing the 7½ minute prototype.

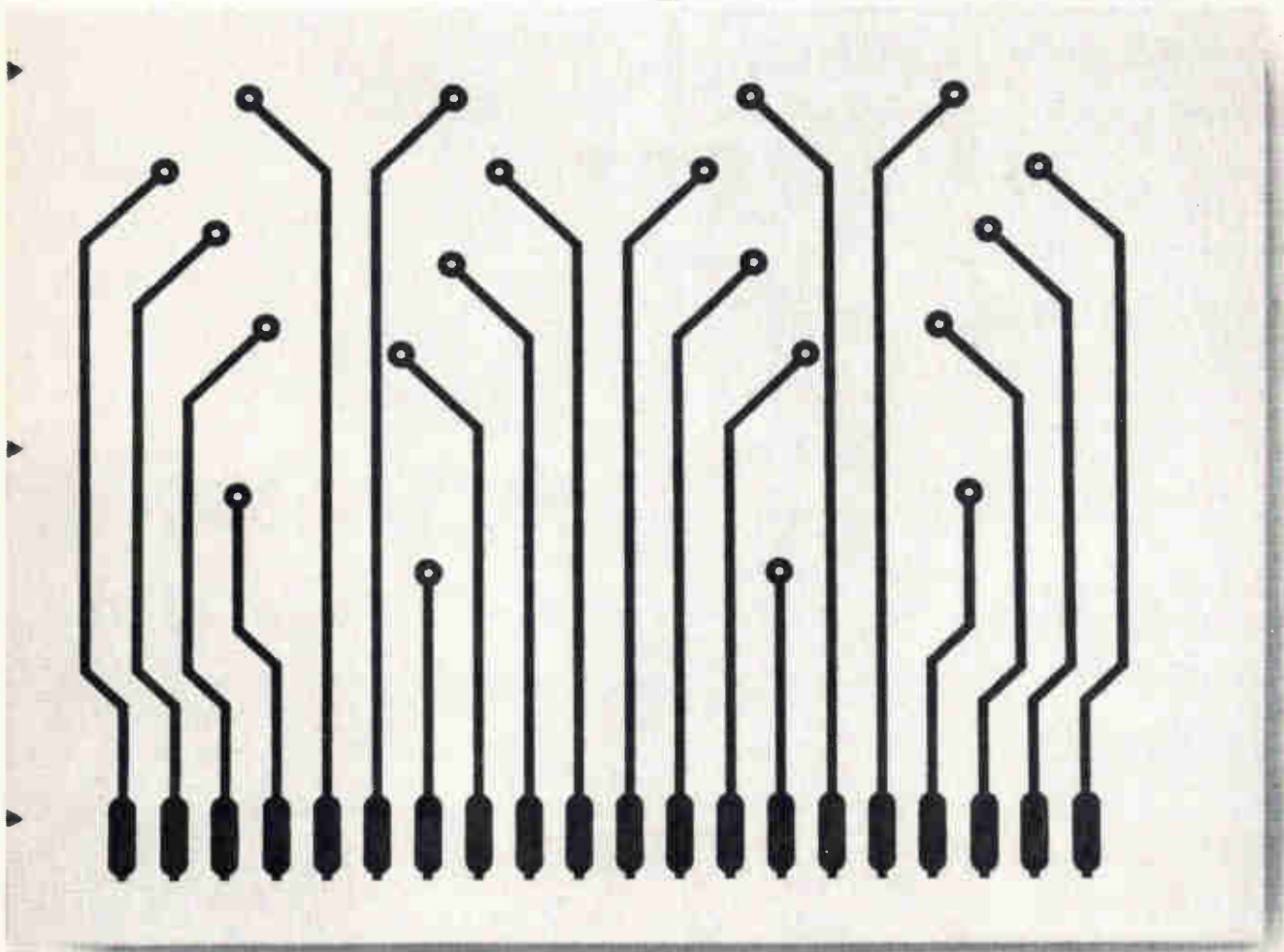

Getting prototype circuit boards used to be the biggest nuisance in design projects.

It took a lot of man-hours, expense, and a lot of space for bulky, awkward equipment.

No more. With Xerox Standard Equipment, chemical resist images can be transferred to copper-clad laminates and prepared for conventional etching—in 7½ minutes flat.

For just pennies per prototype.

And there are no wet, messy chemicals (the xerographic process is

completely dry).

No air-controlled darkroom (the Xerox equipment can be set up in a small corner almost anywhere).

No need for highly-trained technicians (most people can learn to handle it in just 60 minutes).

Of course, the 7½ minute prototype is only one of the ways you can use Xerox Standard Equipment.

If you have another 7½ minutes, we'll explain some of the others. Write Dept. BC14, Xerox Corporation, Rochester, New York 14603.

XEROX

International Newsletter

October 27, 1969

Swiss balk Siemens move

West Germany's electrical-electronics giant, Siemens AG, won't get the Swiss foothold in the European Free Trade Area it's been seeking.

The foothold would have been Secheron SA, whose forte is automatic controls for streetcars and railways. Siemens made a bid for the company but ran into resistance from the Swiss government. The upshot: Secheron, whose sales were \$14 million for fiscal 1968, will join the fold of the ranking Swiss electrical-electronics group, Brown Boveri et Cie.

Infrared display on tv shows up backside IC mask

Belgium's leading semiconductor producer, Manufacture Belge de Lampes et de Material Electronique, expects to speed production of beam-lead integrated circuits through a new mask-aligning technique for back-etching partially processed wafers.

MBLE's method substitutes a large-screen television display for the usual through-a-microscope view of an infrared image. The large display is obtained by mounting a Plumbicon tv pickup tube atop the wafer-mask carrier and beaming infrared light up through the assembly. Researchers who developed the technique at MBLE's parent company, Philips' Gloeilampenfabrieken, say the speedy alignment method is accurate to a few microns.

Seawolf target: test-fire in 1970

A \$12 million contract to Marconi Co. to develop the British Navy's Seawolf shipborne surface-to-air defense system should bring the system to the test-firing stage by the end of next year. Seawolf is the expanded derivative of the Seacat anti-aircraft missile system [*Electronics*, July 21, p. 179], with antimissile capability and fully automatic operation.

Visual guidance of the missile to the target by study of the two images on a tv screen, as in Seacat, is replaced in Seawolf by automatic guidance: the waveforms of the tv images of target and missile are used as a basis to compute trajectory correction commands, which are radioed to the missile. Marconi will be responsible for all of the system's electronics, but will subcontract most of the data-handling development to Ferranti Ltd.

Bosch to produce semiconductors, IC's

West Germany's Robert Bosch GmbH, one of the biggest names in motor vehicle accessories, is getting ready to produce semiconductor devices—including integrated circuits—on its own. Pilot production will be started next spring in a new plant at Reutlingen, near Stuttgart.

The firm stresses that its new products—diodes, transistors, and integrated circuits—are for in-house use only, and that it's not out to compete on the open market. Industry sources feel that Bosch will not become completely independent of outside suppliers.

By producing its own components for automotive use, Bosch is stepping into one of the fastest-growing markets in Europe. Some believe that in West Germany alone the market for active and passive devices for motor vehicle applications will triple by next year from its 1969 value of about \$10 million.

Bosch, which maintains a world-wide manufacturing and sales facility network, already has acquired considerable knowhow in automobile electronics. Several years ago, the firm, together with Volkswagenwerk

International Newsletter

AG, pioneered an electronically controlled fuel injection system which is standard equipment on some Volkswagen and Mercedes cars.

Liquid crystals sandwiched as display device

Joining the race for development of solid state displays is France's Thomson-CSF. The company is working on a liquid crystal display chip, sandwiched in glass, that is expected to be in production in two years for voltmeters and other instruments. Thomson expects the price of the device to be lower than that of readout tubes.

In development for eight months, the device is similar to one that RCA has under development. The French firm has one patent, covering the use of several sandwiched layers of liquid crystals. Thomson's display requires excitation voltages of from 5 to 40 volts over a minimum timespan of 100 microseconds for each point on the chip. This relatively lengthy time lag means considerable work will have to be done before liquid crystals can be used to replace cathode-ray tubes—an entire line on a tv screen is scanned in 60 μ sec.

Converter to show home movies on tv

A small British company, Vidicord Holdings Ltd., plans to market within a year a \$600 converter for running Super-8-millimeter color film through home tv sets. The device, basically a flying spot scanner, measures 18 by 13 by 7 inches. The film cassette fits on top and a lead connects to the antenna terminals of the tv receiver. Initial models will be compatible with the European 625-line scan, but modification to a 525-line scan is possible. Under consideration is a monochrome version that would sell for about \$400. In addition to home movies, the company sees a substantial market in the educational and industrial fields—many instruction rooms already are equipped with tv, and one converter can feed numerous receivers for simultaneous showing.

West Germans building magnet lab

Experiments in solid state physics and in semiconducting and superconducting materials are on the agenda for West Germany's first magnet laboratory, a \$1.4 million installation under construction at Braunschweig's Technical University. When completed in late 1970, the facility will operate with two or three 160-kilogauss, U.S.-supplied coil magnets similar to those at the U.S. National Magnet Laboratory at MIT.

During the second stage of the German project—which is partly financed by the Volkswagen Foundation—the laboratory will have magnets with field strengths above 200 kilogauss.

Did Soviets try automatic docking?

The big questions following the Soviet Union's triple space shot: did they or did they not try out a new, fully automatic docking system, and what happened to it? Navigational experiments were the most important targets of the joint flight, Soviet authorities claimed in their evaluation of results—even more than the first attempts at space welding. But just what the experiments were and what equipment was used remains, as usual, ambiguous. Western space observers in Moscow believe docking definitely was on the program, but for some reason was not carried out. They feel that such a docking attempt might have tested a completely automatic system that would be used, for example, on the unmanned relay rockets bringing supplies to an orbiting space station.

Gunn diodes shoot for new jobs in high-speed digital systems

Japanese team, using planar structure for microwave oscillators, has achieved success with Gunn effect in experimental pulse generators and rectangular-pulse regenerators

Gunn diodes, already performing a number of high-frequency jobs, also may have a future in high-speed digital electronic systems, such as pulse-code modulation communications. Researchers at Japan's Nippon Electric Co. have developed experimental high-speed pulse generators and rectangular-pulse regenerators that utilize the traveling high-field domain of the Gunn effect.

Using a planar, rather than a sandwich-type, structure for fabricating microwave oscillators, the team of Kenji Sekido, Makoto Takeuchi, Yoichiro Takayama, Fumio Hasegawa, and Yoshinobu Hayakawa has produced the first reasonably successful semiconductors of this type.

Spiked. The team's bulk-effect functional device is a two-terminal Gunn diode that exhibits spike-shaped current oscillations. With proper biasing this device can act either as a narrow-pulse generator or as a rectangular-pulse regenerator.

To obtain spike outputs that are narrow with respect to repetition rate, it is necessary that the product nL of impurity concentration and length of the device exceed a figure of about $10^{13}/\text{cm}^2$. This differs from the devices generally used as microwave oscillators, which have a comparable product on the order of $10^{12}/\text{cm}^2$.

Raising the product means that in general the device must have a longer length than standard oscillator diodes—lengths of about 100 microns are common. But the long length increases the difficulty of

cooling the usual sandwich structure—essentially a very short rod of gallium arsenide with ohmic contacts at either end. The middle of the rod is far from the contacts—which can be heat-sinked—and thermal coupling to the surrounding air is poor. For this reason, planar devices perform better. The active region of the Japanese planar device is a thin epitaxial layer deposited on a semi-insulating substrate; the substrate is able to conduct away heat along the entire length of the device to a copper heat sink.

The substrate is chrome-doped gallium arsenide, which has high resistivity consistent with uniform lattice structure for growth of an epitaxial layer without imperfections. Although electrical resistivity is high, thermal resistivity of the substrate is about the same as for the gallium arsenide in the active region. Orientation is in the 1-0-0

direction. Epitaxial n-type layers with carrier densities of one to five times $10^{15}/\text{cm}^3$ are grown in either vapor or liquid phase—but liquid phase growth appears to give better results. Active layer thickness ranges from about 3 to 27 microns.

Most of the diodes fabricated have a film of 0.4-micron-thick silicon dioxide deposited on the surface. The film is selectively etched so that the remaining dioxide forms stripes whose width equals the desired electrode spacing, and whose direction is parallel to the 1-0-0 direction. Heavily doped contact layers are prepared by liquid-phase regrowth from a gallium-arsenide-saturated tin solution. Examination of wafer cross-sections shows that boundaries of active region and electrodes are along the 1-1-1 plane, which intersects the surface of the wafer at an angle of 54° . Gold-germanium ohmic contacts are ap-

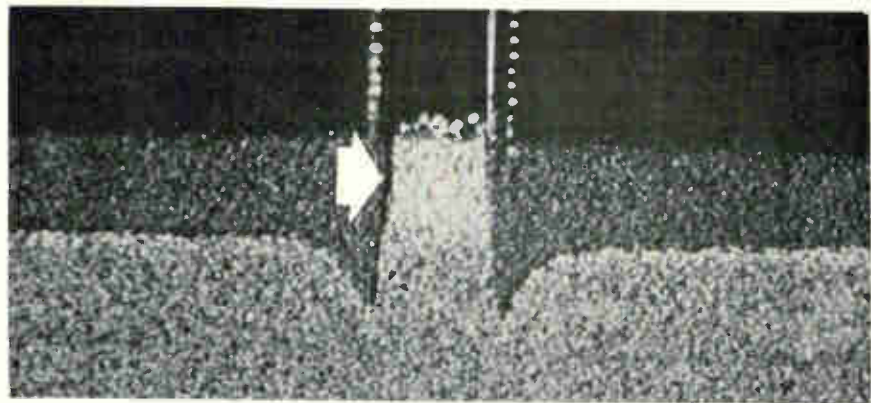

Active region. Planar Gunn diode structure has an active region in the form of stripes, as shown in cross section (above). Dark layers are the electrodes—tin-doped N^{++} regions. Photolithographic techniques are used to delineate the active region, which can be from 3 to 27 microns wide.

plied to the N^{++} gallium arsenide layers.

In operation. Researchers at Nippon Electric last year showed that by injecting a small sinusoidal voltage they could synchronize the frequency of the spiky Gunn oscillations in such devices and change fundamental frequency over a range of about two to one. Ability to synchronize the frequency is important when the device is used as a generator of clock pulses—an oscillator operating in stable cavity can be used to set system frequency. Oscillations are in the order of 1 gigahertz, with pulse widths of 0.2 nanoseconds.

The pulse generator is biased in the negative resistance region. Pulse repetition frequency depends on domain transit time, while pulse width depends slightly on carrier density. As the domain being transported reaches anode and is extinguished, a new domain is nucleated and the process repeats.

For operation as a pulse regenerator, the device is biased just below the threshold. When a small trigger pulse is applied, a high-field domain is nucleated and current through the device falls. Current returns to the original quiescent value after the domain transits the device and is extinguished. Pulse width in this mode is reciprocal of free-running repetition frequency, and is in the range of 0.5 to 2 nanoseconds.

Problems. There are still a number of bugs to be ironed out. For one, there is an insensitive region just above the threshold in some of the diodes in which noisy, incoherent oscillations are produced. This diode type still can be used as a pulse generator, but not for pulse regenerators, where operation extends into the noisy region.

Another problem is fabricating devices with desired impedance level. With voltage at about 30 volts, power dissipation must be kept at moderate levels—and devices have been fabricated with impedance levels of about 1,000 ohms. However, this provides power matching to the 75-ohm circuit generally used in high-speed pulse equipment such as pcm but further work is needed.

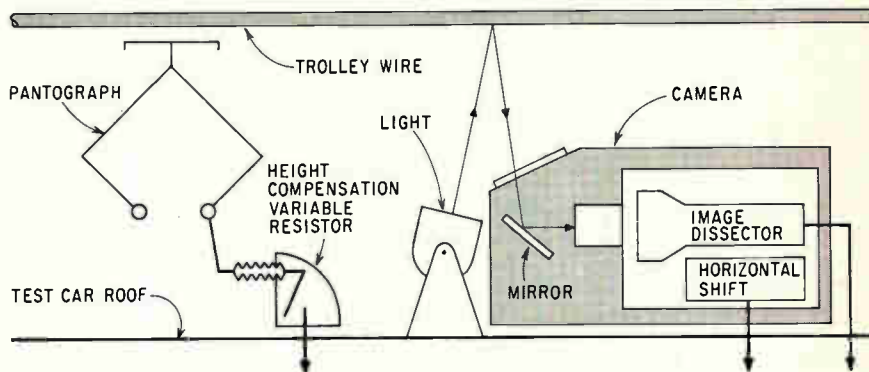

Midnight special. One night a week, test car zips down Tokaido line tracks at 125 mph while image-dissection tv camera checks overhead electrical wire wear.

Wire-sleuthing

Rejecting such modern developments as lasers in favor of a 35-year old superannuated device, Japanese National Railways has come up with a method of measuring wear in railroad overhead electric wires—at 125 miles per hour. What's more, readings are taken every 11 inches, compared with every 82 feet under an earlier method, which also required a four-man team.

Developed jointly with the Hamamatsu TV Co., the system uses an image-dissection television tube, invented in 1934. Even with electron multiplier assemblies, the image dissector is not used in television pickup systems because other tubes, notably the image orthicon, offer higher sensitivity. Where the latter tube scans an image on a charged plate in the tube by an electron beam, the image dissector moves the image, in the form of an electron bundle, across a pickup head.

A flat spot develops and gets progressively wider as the initially round electric wire used in feeding power to railroad trains wears away. When the wire is worn to about 70% of its original area it must be replaced because it is no longer thick enough to withstand the high pull—up to one metric ton—that dampens vibration.

Man-days. Normally, teams of four workers measure wear manually with micrometers. One man does the measuring, the second man holds the ladder, the third writes down data, and the fourth looks out for approaching trains.

Measurements usually are made opposite support poles, which are 165 feet apart, and halfway between poles. This accounts for 20% of all the man-days required for maintenance of power feeding wires—including replacing wires and insulators, and periodic cleaning of insulators.

On standard train lines, with 1,500-volt d-c electrification, measurements can be made under operating conditions because a bamboo ladder provides sufficient insulation. But on the new Tokaido line, with 25,000-volt a-c electrification, power must be turned off before taking measurements; thus they have to be made during early morning hours before the start of the day's service.

The new system is designed to measure at 125 mph. One night a week a test car is driven down the tracks on the Tokaido line at this speed. Because of the new equipment in this car, wear data can be gathered with little labor, except that which is needed to analyze the records after the run has been completed.

The pantograph collector shoe keeps the flat area shiny while the remainder of the wire becomes coated with corrosion products. Since the test car is run at night, the wire can be illuminated from below with a strong return of light from the flat part and almost no reflection from the remainder of wire and surrounding space, providing there is good differentiation (high contrast) between the flat area and remainder of the wire.

Blurring. In initial experiments the image of wire was picked up

by a standard industrial television camera. Good discrimination of the flat was obtained, but because of after-image on the photosensitive surface in the vidicon, the pickup became blurred at speeds above about 3 mph. However, use of an image-dissector tube with electron multiplier that was developed for space applications makes it possible to speed up the measurement, because it has virtually no after-image effect.

In actual operation, a 2,000 hertz horizontal sweep sawtooth voltage is applied to the image dissector, rather than the higher frequency used for standard tv horizontal frequency. No vertical sweep is used, because the car moves between scans. The approximately 500 microseconds of each sweep corresponds to a width scale of 500 millimeters. Thus average output pulses—corresponding to a flat with width in the order of millimeters—is in the order of microseconds. Since 125 mph is about 180 feet per second, measurements of wire widths made on individual sweeps occur at intervals of about 11 inches.

Processing of the signal from the image-dissector is fairly simple: it is first amplified and shaped, then sliced at a preset level to obtain a noise-free pulse signal. The signal goes to a computing circuit, where pulse width is corrected for variations in wire height, and then converted from width to equivalent voltage by a ramp-type converter, which drives the mirror of a photographic-type magnetic oscilloscope.

The system is designed to operate correctly for variations in wire height off the ground between 14.7 feet and 17.7 feet, and for lateral variations of up to 10 inches from the center of the track. Correction is needed for variations in height because the flat area presents a slightly different angle to the camera as wire height varies. The test car is already fitted with a variable resistor mechanically driven by the power-shoe-supporting pantograph to measure wire height—and the signal from the variable resistor is used for correction. A signal from the slicer drives a servo system

that keeps the camera centered on the wire despite lateral variations in wire position; because sweep is not perfectly linear, accuracy is increased if measurement is always made on the same portion of sweep.

Other methods of testing were considered. But because the electrified wire is the source of very strong electrical noise, any measurement method sensitive to electrical noise is precluded. Illumination of trolley wire by laser on one side and measurement of height of shadow on other side was considered—and rejected because of possible damage to either trolley wire or equipment from the roll of test car and severe bouncing at railway switches.

Great Britain

Out of GaAs

In the eight years or so since researchers first realized the possibilities of gallium arsenide as a microwave semiconductor, most of them have been busy with practical development, particularly of the Gunn effect. There's been little time left over to worry whether some other material or combination of materials might offer greater potential for development of electrical effects at speeds usable in microwave systems.

However, at the Royal Radar Establishment, where much of the work that gave Britain a world lead in practical Gunn-effect devices was carried out, Cyril Hilsum and David Rees have worked steadily to develop a full theory about the properties required of an ideal microwave semiconductor—and to see what materials might provide them.

As a result, they have given in-depth theoretical study to two mixed crystal semiconductors, or crystals containing random mixtures of two different but related materials—indium arsenide-gallium arsenide, and indium arsenide-indium phosphide. Then practical work was done with the latter, because theory showed that it should be useful over a wider range of

compositions.

Among other useful characteristics, indium arsenide-indium phosphide exhibits a current-controlled negative-resistance effect, and Hilsum and Rees think the effect will make possible a new type of avalanche diode with current controllable (s-type) negative resistance from d-c up to at least 10 gigahertz. They say it should also be suitable for construction of Schottky-barrier field-effect transistors, and transit-time-mode and anomalous-mode avalanche diodes operating well above the frequency limits of silicon and gallium arsenide.

Theory. Hilsum and Rees took as their starting point the basic limitation of gallium arsenide that carrier electronics will not travel faster than about 2×10^7 centimeters per second however much the electric field strength is increased. As field strength increases above the saturation level, the electrons jump in stages to states of higher energy and greater effective mass so that they slow down, producing the depletion layer that is the basis of the Gunn effect. Hence a semiconductor material required to operate above the practical frequency limit of GaAs must allow higher maximum electron drift velocities before transfer from the initial conduction energy band to higher energy bands occurs.

Ideally the carrier electrons should be light so that they can readily achieve high speed. However, low effective electron mass is always associated with a small energy gap between the valence band and the conduction band, and materials with small energy gaps won't work at room temperatures, so that for everyday practical devices these requirements are conflicting.

However, there is another consideration. The valence band-conduction band energy gap must be smaller than the separation of the conduction bands. This is because the negative-resistance effect requires avalanching to occur readily. If the separation of the conduction energy bands is smaller than the valence band-conduction band energy gap, electrons accelerating under the effect of an increased

field will transfer to higher energy, higher mass states without avalanche. But with favorable gap relationships, no more than a negligible number of electrons will transfer to the higher mass states, making high electron velocities possible.

In practice, the energy gap must be at least 0.75 electron volt for room temperature operation. Combinations of both mixed crystal systems can be found which meet this energy gap requirement, which avalanche before significant transfer from the conduction band to higher energy bands occurs, and which can reach maximum electron drift velocities of three times the maximum velocity in GaAs.

In fact, InAs-InP meets these requirements over a composition range of 30% arsenide, and 70% phosphide to 54% arsenide, and 46% phosphide, more than twice the range of the other system. The Gunn effect occurs towards the high-phosphide end of the range, when the valence band-conduction band energy gap becomes larger than the separation band gaps.

Practice. Among practical devices considered as possible negative-resistance avalanche diodes, Hilsum and Rees have considered a p⁺-n junction diode. Some experimental devices fabricated from 30% indium phosphide and operating at room temperature have shown a voltage drop from 10 volts to three volts for a current increase from 10 milliamps to 40 milliamps. Maximum-to-minimum voltage ratio of about three is encouraging, says Rees, from the point of view of oscillator efficiency. When mounted in a microwave cavity these diodes have excited oscillations up to one gigahertz. Rees says that theoretical maximum operating frequency for similar devices should be at least 10 Ghz.

Closely watched buses

More and more big-city surface transit officials are realizing that to keep their buses running on time they must find some kind of electronic monitoring system using roadside markers and transceiver

equipment. But such systems are costly—at the least, each roadside marker and bus must be connected both to each other and to a home base by a communications link. Hamburg, West Germany, for instance, has spent an estimated \$750,000 for a system to control some 300 buses [*Electronics*, July 11, 1966, p. 177].

Now England's Marconi Ltd. is developing a system that may cut costs by more than half. The key: use of passive roadside markers which the buses scan optically as they pass by.

The markers in this system are merely 8-by-20-inch lamp post-mounted metal plates covered with 18 strips of polarized reflecting material of varying widths. The array of strips is unique to each location and when scanned from top to bottom by a light source on the passing bus, the reflections from the strips are transformed by photodiodes into a binary code. The code passes to a register in a telemetry system in the bus and remains there until it is finally updated by the next marker.

Call signature. The information in the register is scanned periodically by radio from a central control station, using a standard vhf/uhf mobile two-way radio. Each bus has its own two-tone call signature, and upon receiving it the radio automatically transmits the location of the last beacon passed. If the controller wants to speak to a given bus, he dials its code num-

ber and a third call tone is added which cancels the data transmission and signals to the driver to pick up his microphone. Then the mike switches the r-f link from the telemetry channel to a speech channel.

In the control room, a Marconi Myriad computer scans the buses for present position at a maximum rate of 40 per second, and presents the information on a moving-map crt display. The computer also compares actual and ideal situations, and provides a readout of all differences over a selected threshold. Marconi says maximum use of standardized equipment, plus the low cost of the markers, should bring down the price for a 400-bus system to between \$200,000 and \$250,000.

The system, in the experimental stage, had its first tryout earlier this month at Bristol, where city transportation officials appear very interested. In that tryout a Pye two-way radio was used and the light source was a low-power laser. But in operational systems the laser may be replaced by a quartz-iodine or neon light source. The essential characteristic is that the beam must remain adequately concentrated during transmission and reflection over a 30-foot span of road at a rate of two scans per marker at 100 miles per hour. Though this may not be necessary for bus systems in a congested city, Marconi sees applications for the system in many vehicle-control operations.

Bus watch. Crt moving-map display charts bus movements in Marconi system. Buses scan passive roadside markers for location code and transmit it to HQ over standard vhf/uhf radio link.



Electronics advertisers

October 27, 1969

■ Acoplan Corp. Mort Barish Associates	40	Elgin Electronics, Inc. Carr Liggett Adv., Inc.	168	Monsanto Co. Michel Cather, Inc.	31
Airco Speer Electronic Components Hazard Adv. Co., Inc.	166	E/MC Electronics/ Management Center	142, 143, 180, 194	Motorola Semiconductor Products, Inc.	17 to 24
□ Alcatel Agence Rene Sicard	9E	Ries Cappiello Colwell, Inc.		Lane & Wampler Adv., Inc.	
Alco Electronic Products, Inc.	185, 187, 189			Mullard, Ltd.	136
Marketronics Advertising				Parker-Rumrill International, Inc.	
Alfred Electronics Bonfield Associates	128, 129	Fairchild Instrumentation Chiat/Day, Inc.	12, 13	■ National Electronics Incorporated Connor-Sager Associates	34
Allen-Bradley Co.	33, 191, 193, 195, 197	Farinon Electric Jack Herrick Adv., Inc.	7	National Semiconductor Corp. Hall Butler Blatherwick Inc.	80-81
Fensholt Adv. Agcy.		■ Fluke Manufacturing Co., John Bonfield Associates	15	Newark Electronics Corp. Stral Adv. Co.	137
American Potash and Chemical Corp., Rare Earth Div.	133	■ General Electric Co., Electronic Components Sales Operation	10, 11	Nortec Electronic Corp. Paul Pease Advertisers	99
Sidney Clayton Assoc., Inc.		Robert S. Cragin, Inc.		■ Norton Associates Incorporated J.J. Coppo Company	185
□ Ancrona Corp. Wilhelm Bacher Werbung	10E	General Electric Co., Specialty Control Div.	151	□ Olivetti & C. Spa, Ing. C.	8E
Andrew Corp. Fensholt Adv., Inc.	76	Robert S. Cragin, Inc.		Studio Giuiano Blei	
Applied Electronics Communication Associates	147	□ General Instrument Europe S.P.A. Studio Cigiemme	22E	□ Omron Tateisi Electronics Com. Dai-Ichi International Inc.	6E-7E
□ Ates Componenti Elettronici, S.P.A. Publicitas	18E	General Magnetics McCarthy/Sceiba/De Biasi Adv. Agcy., Inc.	9	■ Philbrick/Nexus Research Renaccio Adv. Inc.	1/5
Austron, Inc. Management Communication Consultants, Inc.	188	General Radio Co. Horton Church & Goff, Inc.	2nd Cover	Philco Ford Company, Microelectronics Division	36-37
Automatic Control Div., Cook Electric Co.	183	■ Grayhill, Inc. Carr Liggett Adv., Inc.	181	Aitkin-Kynett Company Inc., The Powercube Corporation Div. of Unitrode	69
Sander Rodkin Adv. Agcy., Ltd.		GRI Computer Corp. Larcom Randall Adv., Inc.	160	Marketing Assistance Inc. Precision Instrument Co.	148
				Hal Lawrence Inc.	
Barnes Corp. Industrial Public Relations, Inc.	188	Hamilton Watch Co. Beaumont, Heller & Sperling, Inc.	174	■ Precision Paper Tube Co. T.W. Blakeslee Advertising	131
■ Barnstead Co., Div. of Sybron Corp.	172	Hayakawa Electric Co., Ltd. Dai-Ichi International, Inc.	154	Radiation Inc. W. M. Zemp & Associates Inc.	57
Creamer, Trowbridge, Case & Basford, Inc.		Heinemann Electric Co. Thomas R. Sundheim, Inc.	6	Radio Corporation of America	4th Cover, 59
■ Beckman Instruments, Inc., Helipot Div.	86	□ Hewlett Packard Europe Techno Scope	19E	Al Paul Lefton Company	
N. W. Ayer/Jorgensen/MacDonald, Inc.		■ Hewlett Packard, Frequency & Time Div. Lennen & Newell, Inc.	2	Radio Materials Company, P.R. Mallory Company	164
Bishop Graphics, Inc. Sol R. Shein Adv.	68	■ Hewlett Packard, International Div. Lennen & Newell, Inc.	1	M.M. Fisher Associates Inc. Raytheon Company, Components Division	155
BIT, Inc.	74, 75	■ Hewlett Packard, Loveland Div. Tallant/Yates Advertising	112	Fuller & Smith & Ross Inc.	
Hill, Holliday, Connors, Cosmopolos, Inc.	165	■ Hewlett Packard, New Jersey Div. McCarthy, Scelba and DiBiasi Adv. Agcy., Inc.	169	Raytheon Semiconductor	67, 120, 121
■ Buckbee-Mears Co. Midland Assoc., Inc.	152	■ Hewlett Packard, Rockaway Div. Culver Adv., Inc.	149	Botsford, Constantine & McCarty Inc.	
■ Bulova Watch Co., Electronics Div. Caroe Marketing, Inc.	152	Honeywell, Computer Control Div. Creamer, Trowbridge Case & Basford, Inc.	38	Redcor Corporation Management Communication Consultants Inc.	150
Bunker-Ramo Corp., The, Amphenol Div.	70, 71	■ Honeywell, Test Instruments Div. Campbell Mithun, Inc.	141, 208	■ RHG Electronics Laboratories Incorporated	181
Marsteller, Inc.				Samuel H. Goldstein Incorporated	184
Burndy Corp. The Gravenston Group, Inc.	123	□ I.E.R. PEMA	11E	■ Rogan Brothers Inc. Christopher Advertising Inc.	16E
		Infoton, Inc.	176	□ Rohde & Schwarz	
Cambridge Thermionic Corp. Chirurg & Cairns, Inc.	181	Maslow, Gold and Rothschild, Inc. Adv.	122	□ Schlumberger Ltd. EMD	2E
■ Captor Corp. Weber, Geiger & Kalat, Inc.	32	INTEL Bonfield Associates		□ Schlumberger SIS	5E
Carpenter Technology Corp. Beaumont Heller & Sperling, Inc.	25	IRC, Division of TRW, Inc. Gray & Rogers, Inc.	83	Sodipa	
C.G.E. Edition "2B" Publicite	65			□ Schlumberger SOMV T.B. Browne Ltd.	4E
Cinch Graphik Division of United Carr Fastener Co.	138	Krohn-Hite Corp. Ingalls Assoc., Inc.	140	□ Schneider R.T. Noirclerc Publicite	27E
Reach McClinton & Co.				Sierra Research Corporation B.P. Myer Associates Inc.	30
Clare & Co., C.P. Reincke, Meyer & Finn Adv., Inc.	26, 27	■ Lambda Electronics Corp.	3rd Cover, 211, 212	Signetics Corp. Sub. Corning Glass Works	119
Clevite Corp./Gaging & Control Div. Carr Liggett Adv., Inc.	124	Michel Cather, Inc.		Cunningham & Walsh Inc.	
Computer Measurements Co., Div. of Newell Industries	156	Ledex, Inc.	162	Siliconix Inc.	72-73
Jones, Maher, Roberts, Inc.		Yeck & Yeck, Inc.		Robertson West Inc.	
Control Data Corp./Magsense Barnes-Champ/Advertising	158	Ledex, Inc., Bramco Controls Div. Yeck & Yeck, Inc.	182	□ Sodico Dumesnil Publicite	15E
■ Cosmicar Optical Co., Ltd. Matsushita, Inc.	192	Litton Industries, Data Systems Div.	192	□ Sogie Études et Creations Publicitaire	17E
Cox Instrument Div. of Lynch Corp. Gray & Kilgore, Inc.	153			□ Solartron Electronics Group Ltd. T.B. Browne Ltd.	3E
□ CRC IRP	21E	■ Mallory & Co., P.R., Mfg. Div. Aitkin-Kynett Co.	186	Soliton Devices Inc. Transistor Division	163
CREI, Home Study Div. of The McGraw-Hill Book Co.	190	■ Marconi Instruments, Ltd. Taylor Adv., Ltd.	12E, 13E	Haselmire Pearson Advertising Inc.	79
Henry J. Kaufman & Associates		□ Marconi & Co., Ltd., Radio Communication Div.	28E	■ Sorensen Operation Raytheon Company	14E
■ Curtis Instruments, Inc. Knudsen • Moore, Inc.	130	Hampshire House, Ltd.		□ Souriau & Cie Ariane Publicite	
		■ Matsuo Electric Co., Ltd. Daiko Adv., Inc.	187	Sprague Electric Company Harry P. Bridge Company	5
Data Memory, Inc. Hal Lawrence, Inc.	144	Memory Technology, Inc. Creamer, Trowbridge, Case & Basford, Inc.	177	■ Stackpole Carbon Company, Electronic Components Division	178
Dialight Corp. Michel Cather, Inc.	62	Mico Instrument Co.	186	Meek & Thomas Inc.	
DuPont de Nemours & Co., Freon Div. N. W. Ayer & Son, Inc.	64			Stewart Warner Microcircuits Inc. Jones Maher, Roberts Inc.	52
Durant Digital Instruments Franklin Mautner Advertising	132			■ Susumu Industrial Co. Ltd. Kyokuto Kikaku Co. Ltd.	185
□ Dynamco, Ltd. Nicholas Daniels Associates	25E			Sylvania Electric Products Inc. Electronics Components Group	43 to 50
				Doyle Dane Bernbach, Inc.	
Eastman Kodak Co., Business Systems Markets Div.	159			Sylvania Electric Products Inc. Parts Division	125
J. Walter Thompson Co.				Doyle Dane Bernbach Inc.	
□ Ebauches S.A. Claude Langel	23E				

In electronics it's Electronics magazine to sell used equipment!

Your advertisement will produce Results in Electronics. Engineers turn to Electronics magazine for the latest technical developments — and for the latest buying information. You can reach them inexpensively in Electronics Searchlight Section.

For information:
Searchlight Section
Classified Advertising Dept.
Post Office Box 12
New York 10036



Synergistics	173
Kalb & Schneider Inc.	
Synthane-Taylor Corporation	139
Gray & Rogers Inc.	
Tally Corporation	51
Bonfield Associates Inc.	
■ Tektronix Inc.	126, 207
Dawson, Turner & Jenkins Inc.	
Tempress Industries Inc.	35
Hal Lawrence Inc.	
Test Equipment Corporation	14
Dean & Bain Advertising Inc.	
Texas Instruments Incorporated,	
Components Group	63, 84, 146
Albert Frank-Guenther Law Inc.	
■ Texscan Corporation	16
Burton Browne Advertising	
Toko Inc.	189
Hakuhodo Incorporated	
TRW Electronics Capacitors Division	61
Fuller & Smith & Ross Inc.	
TRW Semiconductors Inc.	85
Fuller & Smith & Ross Inc.	
■ Trygon Electronics Inc.	66
Technical, Industrial & Scientific	
Marketing Inc.	
■ Tung-Sol Division Wagner Electric	
Corporation	68
Feeley & Wheeler Inc.	
Union Carbide Company, Capacitor	28-29
Windfield Inc. Adv.	
United Aircraft Electronics Components	170
Cunningham & Walsh Inc. Advertising	
■ Williams Precision Metals, Div. of	
Williams Gold Refining Co. Inc.	182
Stahlka, Faller & Klenk Inc.	
Wiremold Company The	184
Charles Brunelle Company	
Xerox Corporation	198
Needham, Harper & Steers Inc.	
Zeltex Inc.	82
Helme Associates Inc.	

Classified & Employment Advertising

F.J. Eberle, Manager	
212-971-2557	
EMPLOYMENT OPPORTUNITIES	196
Corcoran, Joseph P.	196
Hallcrafters Co.	194
EQUIPMENT	
(Used or Surplus New)	
For Sale	
Fishman, Philip Co.	196
Laboratory Equipment Sales	196
Radio Research Instrument Co.	196

■ For more information on complete product line see advertisement in the latest Electronics Buyer's Guide
□ Advertisers in Electronics International

Electronics Buyers' Guide

George F. Werner, Associate Publisher
[202] 971-2310
Robert M. Denmead,
Midwest Regional Manager
[312] MO 4-5800
Cliff Montgomery,
New York District Manager
[212] 971-3793
Regina Hera, Directory Manager
[212] 971-2544
Thomas M. Egan, Production Manager
[212] 971-3140
Carol Gallagher,
Assistant Production Manager [212] 971-2045
Circulation Department
Isaaca Siegel, Manager [212] 971-6057
Research Department
David Strasser, Manager [212] 971-6058

Advertising Sales Staff

Dan McMillan III [212] 971-3468
Associate Publisher
Wallis Clarke [212] 971-2187
Advertising Sales Service Manager
Warren H. Gardner [215] LO 8-6161
Eastern Advertising Sales Manager
Atlanta, Ga. 30309: Michael H. Miller, 1375
Peachtree St., N.E.
[404] 892-2868
Boston, Mass. 02116: William S. Hodgkinson
McGraw-Hill Building, Copley Square
[617] CO 2-1160
Cleveland, Ohio 44113: William J. Boyle, 55
Public Square, [216] SU 1-7000
New York, N.Y. 10036
500 Fifth Avenue
James R. Pierce [212] 971-3615
John A. Garland [212] 971-3617
Michael J. Stoller [212] 971-3616
Philadelphia, Pa. 19103:
Jeffrey M. Preston
Warren H. Gardner,
6 Penn Center Plaza,
[215] LO 8-6161
Pittsburgh, Pa. 15222: Jeffrey M. Preston,
4 Gateway Center, [412] 391-1314
Rochester, N.Y. 14534: William J. Boyle,
9 Greylock Ridge, Pittsford, N.Y.
[716] 586-5040
Donald R. Furth [312] MO 4-5800
Midwest Advertising Sales Manager
Chicago Ill. 60611: Kenneth E. Nicklas
Ralph Hanning 645 North Michigan Avenue,
[312] MO 4-5800
Dallas, Texas 75201: Richard P. Poole, 1800
Republic National Bank Tower,
[214] RI 7-9721
Houston, Texas 77002: Robert Wallin,
2270 Humble Bldg. [713] CA 4-8381
Detroit, Michigan 48226: Ralph Hanning,
856 Penobscot Building
[313] 962-1793
Minneapolis, Minn. 55402: 1104 Northstar
Center [612] 332-7425
St. Louis, Mo. 63105: Kenneth E. Nicklas,
The Clayton Tower, 7751 Carondelet Ave.
[314] PA 5-7285
James T. Hauptli [415] DO 2-4600
Western Advertising Sales Manager
Denver, Colo. 80202: David M. Watson,
Richard W. Carpenter
Tower Bldg., 1700 Broadway
[303] 266-3863
Los Angeles, Calif. 90017: Ian C. Hill,
Bradley K. Jones, 1125 W. 6th St.,
[213] HU 2-5450
Portland, Ore. 97204: James T. Hauptli,
Don Farris, 218 Mohawk Building,
222 S.W. Morrison Street,
Phone [503] 223-5118
San Francisco, Calif. 94111: James T. Hauptli,
Don Farris, 255 California Street,
[415] DO 2-4600
Pierre Braude Tel: 225 85 88: Paris
European Director
Paris: Denis Jacob
88-90 Avenue Des Champs-Elysees, Paris 8
United Kingdom and Scandinavia
London: Oliver Ball, Tel: Hyde Park 1451
34 Dover Street, London W1
Milan: Robert Saidel, Roberto Laureri Jr.
1 via Baracchini Phone 86-90-656
Brussels: Denis Jacob
27 Rue Ducale Tel: 136503
Frankfurt/Main: Hans Haller
Elsa-Brandstroem Str. 2
Phone 72 01 81
Geneva: Denis Jacob
1 rue du Temple Phone: 31 95 60
Tokyo: McGraw-Hill
Publications Overseas Corporation,
Kasumigaseki Building 2-5, 3-chome,
Kasumigaseki, Chiyoda-Ku, Tokyo, Japan
[581] 9811
Osaka: Akihiko Kamesaka, McGraw-Hill
Publications Overseas Corporation, Kondo
Bldg., 163, Umegae-cho Kita-ku [362] 8771
Australasia: Warren E. Ball, IPO Box 5106,
Tokyo, Japan
Business Department
Stephen R. Wells, Manager
[212] 971-2044
Thomas M. Egan,
Production Manager [212] 971-3140
Maury D'Gongora,
Assistant Production Manager [212] 971-2045
Dorothy Carmesin, Contracts and Billings
[212] 971-2908
Frances Vallone, Reader Service Manager
[212] 971-2865



Here's technical achievement for you... better living for you and your family

We are particularly anxious to meet you if you are a Circuit Design Engineer; Packaging and Mechanical Engineer; Electron Optics, Vacuum Technology or Materials and Process Specialist. But whatever your technical strengths, if "roll-up-the-sleeves" engineering appeals to you, we'd like to hear from you.

Here you'll find an environment that emphasizes the individual, and his personal contribution to technical development—contribution by working on projects, not writing about them. Your work will benefit advanced engineering throughout the world. *You* will benefit from technical association with specialists experienced in developing state-of-the-art instrumentation, components and devices.

All Tektronix R & D—financed entirely from our annual sales of approx. \$150 million—is directed toward commercial products. Our community is prosperous, balanced, with a stability of employment not typical of every industrial center. And as for the Green Land we live in—it speaks for itself.

If you're seeking technical advancement and better living for you *and* your family, why not investigate Tektronix?

Write to D. A. Thompson, Tektronix, Inc., P. O. Box 500C, Beaverton, Oregon 97005, or send in the coupon.

.....

• Professional Placement Mgr., Tektronix, Inc.

• P. O. Box 500C, Beaverton, Oregon 97005

• Please send me your Booklet, "Tektronix" Application Form

• _____

• NAME: _____

• _____

• ADDRESS: _____

• _____

• CITY: _____ STATE: _____

• I am interested in: _____

• **Tektronix, Inc.**

• *An Equal Opportunity Employer.*

• _____



Announcing Digitest 500,
the \$250 digital multimeter
from Honeywell.

No kidding. \$250

This world's smallest multimeter may be inexpensive to buy, but that's the only thing cheap about it.

Take capability. Our Digitest 500 gives you five functions (resistance, AC and DC voltages, AC and DC currents), plus 17 ranges to choose from. And it can be operated from 117V 50-60Hz line or an external 12V source. Or consider accuracy: Digitest 500 is five times as accurate as the conventional VOM.

As you can see, we've made it both compact and lightweight (2½ lbs.), by using a large-scale integrated circuit. So the Digitest 500 is just 2¾" x 5" x 9", but has polarity indication, a moving decimal point, an overload indicator and built-in calibration check. Plus overrange up to 100% (on all ranges except 300VAC).

To get a free demonstration – or more details – write Don Anderson, M.S. 206, Honeywell Test Instruments Division, P.O. Box 5227, Denver, Colorado 80217.

Honeywell

Circle 208 on reader service card



Electronics reader service

Warning: The Post Office now requires your ZIP CODE on all mail. Please include your ZIP CODE number when filling out your reply card.

Use these handy post cards for more detailed information on: products advertised, new products, new literature.

Circle the number on the Reader Service post card that corresponds to the number at the bottom of the advertisement, new product item, or new literature in which you are interested.

Please print clearly. All written information must be legible to be efficiently processed.

If someone has beaten you to the post cards, you may obtain the needed information by writing directly to the manufacturer, or by sending your name and address, plus the Reader Service number, to Electronics Reader Service department.

All inquiries from outside the U.S. that cannot reach Electronics before the expiration dates noted on the Reader Service post card, must be mailed directly to the manufacturer. The manufacturer assumes all responsibilities for responding to inquiries. Electronics merely provides and clears requests for information from inquirer to manufacturer.

Correct amount of postage must be affixed for all mailings from outside the U.S.

To subscribe to or to renew Electronics

Fill in the "For Subscriptions" area on the card if you desire to subscribe to or renew your present subscription to Electronics. Send no money. Electronics will bill you at the address indicated on the Reader Service post card.

Multi-product advertisements

For information on specific items in multi-product advertisements which do not have a specific Reader Service number indicated write directly to manufacturer for information on precise product in which you are interested.

22 *For employment inquiries fill in home address. October 27, 1969 Card Expires December 27, 1969 14

Name _____ title _____

Company* _____

Address _____

City _____ State _____ Zip Code _____

For Subscriptions
 new renewal
 3 years \$16.00
 1 year \$8.00

1	20	39	58	77	96	115	134	153	172	191	210	229	248	267	286	305	324	343	362	381	400	419	438	457	476	495	514	962
2	21	40	59	78	97	116	135	154	173	192	211	230	249	268	287	306	325	344	363	382	401	420	439	458	477	496	515	963
3	22	41	60	79	98	117	136	155	174	193	212	231	250	269	288	307	326	345	364	383	402	421	440	459	478	497	516	964
4	23	42	61	80	99	118	137	156	175	194	213	232	251	270	289	308	327	346	365	384	403	422	441	460	479	498	517	965
5	24	43	62	81	100	119	138	157	176	195	214	233	252	271	290	309	328	347	366	385	404	423	442	461	480	499	518	966
6	25	44	63	82	101	120	139	158	177	196	215	234	253	272	291	310	329	348	367	386	405	424	443	462	481	500	900	967
7	26	45	64	83	102	121	140	159	178	197	216	235	254	273	292	311	330	349	368	387	406	425	444	463	482	501	901	968
8	27	46	65	84	103	122	141	160	179	198	217	236	255	274	293	312	331	350	369	388	407	426	445	464	483	502	902	969
9	28	47	66	85	104	123	142	161	180	199	218	237	256	275	294	313	332	351	370	389	408	427	446	465	484	503	951	970
10	29	48	67	86	105	124	143	162	181	200	219	238	257	276	295	314	333	352	371	390	409	428	447	466	485	504	952	971
11	30	49	68	87	106	125	144	163	182	201	220	239	258	277	296	315	334	353	372	391	410	429	448	467	486	505	953	972
12	31	50	69	88	107	126	145	164	183	202	221	240	259	278	297	316	335	354	373	392	411	430	449	468	487	506	954	973
13	32	51	70	89	108	127	146	165	184	203	222	241	260	279	298	317	336	355	374	393	412	431	450	469	488	507	955	974
14	33	52	71	90	109	128	147	166	185	204	223	242	261	280	299	318	337	356	375	394	413	432	451	470	489	508	956	975
15	34	53	72	91	110	129	148	167	186	205	224	243	262	281	300	319	338	357	376	395	414	433	452	471	490	509	957	976
16	35	54	73	92	111	130	149	168	187	206	225	244	263	282	301	320	339	358	377	396	415	434	453	472	491	510	958	977
17	36	55	74	93	112	131	150	169	188	207	226	245	264	283	302	321	340	359	378	397	416	435	454	473	492	511	959	978
18	37	56	75	94	113	132	151	170	189	208	227	246	265	284	303	322	341	360	379	398	417	436	455	474	493	512	960	979
19	38	57	76	95	114	133	152	171	190	209	228	247	266	285	304	323	342	361	380	399	418	437	456	475	494	513	961	980

Business reply mail

No postage stamp necessary if mailed in the United States

Postage will be paid by

Electronics
Reader service department
Box 444
Hightstown, N.J. 08520

First class
 Permit no. 42
 Hightstown, N. J.

22 *For employment inquiries fill in home address. October 27, 1969 Card Expires December 27, 1969 14

Name _____ title _____

Company* _____

Address _____

City _____ State _____ Zip Code _____

For Subscriptions
 new renewal
 3 years \$16.00
 1 year \$8.00

1	20	39	58	77	96	115	134	153	172	191	210	229	248	267	286	305	324	343	362	381	400	419	438	457	476	495	514	962
2	21	40	59	78	97	116	135	154	173	192	211	230	249	268	287	306	325	344	363	382	401	420	439	458	477	496	515	963
3	22	41	60	79	98	117	136	155	174	193	212	231	250	269	288	307	326	345	364	383	402	421	440	459	478	497	516	964
4	23	42	61	80	99	118	137	156	175	194	213	232	251	270	289	308	327	346	365	384	403	422	441	460	479	498	517	965
5	24	43	62	81	100	119	138	157	176	195	214	233	252	271	290	309	328	347	366	385	404	423	442	461	480	499	518	966
6	25	44	63	82	101	120	139	158	177	196	215	234	253	272	291	310	329	348	367	386	405	424	443	462	481	500	900	967
7	26	45	64	83	102	121	140	159	178	197	216	235	254	273	292	311	330	349	368	387	406	425	444	463	482	501	901	968
8	27	46	65	84	103	122	141	160	179	198	217	236	255	274	293	312	331	350	369	388	407	426	445	464	483	502	902	969
9	28	47	66	85	104	123	142	161	180	199	218	237	256	275	294	313	332	351	370	389	408	427	446	465	484	503	951	970
10	29	48	67	86	105	124	143	162	181	200	219	238	257	276	295	314	333	352	371	390	409	428	447	466	485	504	952	971
11	30	49	68	87	106	125	144	163	182	201	220	239	258	277	296	315	334	353	372	391	410	429	448	467	486	505	953	972
12	31	50	69	88	107	126	145	164	183	202	221	240	259	278	297	316	335	354	373	392	411	430	449	468	487	506	954	973
13	32	51	70	89	108	127	146	165	184	203	222	241	260	279	298	317	336	355	374	393	412	431	450	469	488	507	955	974
14	33	52	71	90	109	128	147	166	185	204	223	242	261	280	299	318	337	356	375	394	413	432	451	470	489	508	956	975
15	34	53	72	91	110	129	148	167	186	205	224	243	262	281	300	319	338	357	376	395	414	433	452	471	490	509	957	976
16	35	54	73	92	111	130	149	168	187	206	225	244	263	282	301	320	339	358	377	396	415	434	453	472	491	510	958	977
17	36	55	74	93	112	131	150	169	188	207	226	245	264	283	302	321	340	359	378	397	416	435	454	473	492	511	959	978
18	37	56	75	94	113	132	151	170	189	208	227	246	265	284	303	322	341	360	379	398	417	436	455	474	493	512	960	979
19	38	57	76	95	114	133	152	171	190	209	228	247	266	285	304	323	342	361	380	399	418	437	456	475	494	513	961	980

Reprint service

All Electronics editorial matter available in reprint form:

For reprints of special reports and feature articles see list on right side of this page. Send your order to Electronics Reprint Department at the address indicated. To expedite mailing of your order for single reprints please send cash, check or money order with your order. Allow 3-4 weeks for delivery.

Bulk reprints of editorial matter can be ordered from current or past issues. The minimum quantity is 100 copies. Prices quoted on request: call 212-971-2274, or write to address below.

Warning: The Post Office now requires your ZIP CODE on all mail. Please include your ZIP CODE number when filling out your reply card.

3

Business reply mail

No postage stamp necessary if mailed in the United States

Postage will be paid by

First class
Permit no. 42
Hightstown, N. J.

Electronics
Reader service department
Box 444
Hightstown, N. J. 08520



22 Please Print Clearly October 27, 1969 Card Expires December 27, 1969 14

Name _____ title _____
Company _____
Address _____

For Subscriptions
 new renewal
 3 years \$50.00
 1 year \$25.00

1	20	39	58	77	96	115	134	153	172	191	210	229	248	267	286	305	324	343	362	381	400	419	438	457	476	495	514	962
2	21	40	59	78	97	116	135	154	173	192	211	230	249	268	287	306	325	344	363	382	401	420	439	458	477	496	515	963
3	22	41	60	79	98	117	136	155	174	193	212	231	250	269	288	307	326	345	364	383	402	421	440	459	478	497	516	964
4	23	42	61	80	99	118	137	156	175	194	213	232	251	270	289	308	327	346	365	384	403	422	441	460	479	498	517	965
5	24	43	62	81	100	119	138	157	176	195	214	233	252	271	290	309	328	347	366	385	404	423	442	461	480	499	518	966
6	25	44	63	82	101	120	139	158	177	196	215	234	253	272	291	310	329	348	367	386	405	424	443	462	481	500	900	967
7	26	45	64	83	102	121	140	159	178	197	216	235	254	273	292	311	330	349	368	387	406	425	444	463	482	501	901	968
8	27	46	65	84	103	122	141	160	179	198	217	236	255	274	293	312	331	350	369	388	407	426	445	464	483	502	902	969
9	28	47	66	85	104	123	142	161	180	199	218	237	256	275	294	313	332	351	370	389	408	427	446	465	484	503	951	970
10	29	48	67	86	105	124	143	162	181	200	219	238	257	276	295	314	333	352	371	390	409	428	447	466	485	504	952	971
11	30	49	68	87	106	125	144	163	182	201	220	239	258	277	296	315	334	353	372	391	410	429	448	467	486	505	953	972
12	31	50	69	88	107	126	145	164	183	202	221	240	259	278	297	316	335	354	373	392	411	430	449	468	487	506	954	973
13	32	51	70	89	108	127	146	165	184	203	222	241	260	279	298	317	336	355	374	393	412	431	450	469	488	507	955	974
14	33	52	71	90	109	128	147	166	185	204	223	242	261	280	299	318	337	356	375	394	413	432	451	470	489	508	956	975
15	34	53	72	91	110	129	148	167	186	205	224	243	262	281	300	319	338	357	376	395	414	433	452	471	490	509	957	976
16	35	54	73	92	111	130	149	168	187	206	225	244	263	282	301	320	339	358	377	396	415	434	453	472	491	510	958	977
17	36	55	74	93	112	131	150	169	188	207	226	245	264	283	302	321	340	359	378	397	416	435	454	473	492	511	959	978
18	37	56	75	94	113	132	151	170	189	208	227	246	265	284	303	322	341	360	379	398	417	436	455	474	493	512	960	979
19	38	57	76	95	114	133	152	171	190	209	228	247	266	285	304	323	342	361	380	399	418	437	456	475	494	513	961	980

1

Business reply mail

No postage stamp necessary if mailed in the United States

Postage will be paid by

First class
Permit no. 42
Hightstown, N. J.

Electronics
Reader service department
Box 444
Hightstown, N.J. 08520



To order reprints or for further information, please write to: **Electronics Reprint Department, 330 West 42nd Street, New York, N.Y. 10036.**

To expedite mailing of your order for single reprints please enclose payment with your order.

You may order any of the below listed reprints by key number. Discounts on quantities over 10.

- Key no. R-01 **Computer-aided Design: Part I, The Man-machine Merger.** 16 pages. \$1.25.
- Key no. R-04 **Multilayer Circuit Boards: Sharpening An Imperfect Art.** 7 pages. 50¢.
- Key no. R-05 **Topology Cuts Design Drudgery.** 12 pages. 50¢.
- Key no. R-06 **Report on Japanese Technology: Sony.** 20 pages. 50¢.
- Key no. R-010 **Special Report on Large Scale Integration.** 54 pages. \$1.50.
- Key no. R-011 **Medical Electronics (1967).** 8 part series, 44 pages. \$1.25.
- Key no. R-012 **Special Report on Gallium Arsenide** 17 parts. 32 pages. \$2.00
- Key no. R-016 **Special Report on The Transistor: Two Decades of Progress.** 48 pages. \$1.50.
- Key no. R-017 **Special Report on Ferrites.** 16 pages. \$1.00.
- Key no. R-018 **European Electronics Markets 1969** 20 page forecast report with a 6 page foldout. \$1.00
- Key no. R-019 **U.S. Electronics Markets 1969** 32 page forecast report with 4 page foldout. \$1.00
- Key no. R-020 **1968 Electronics Index to Technical Articles and Authors Free.**
- Key no. R-021 **Infrared Detector Characteristics.** 23 x 11 inch fold-out chart. 50¢
- Key no. R-022 **Active Filters: Part II, Varying the Approach.** 8 pages \$1.00
- Key no. R-79 **MOS Integrated Circuits.** 12 pages. 50¢.
- Key no. R-78 **The Overlay Transistor.** 15 pages. 50¢.
- Key no. R-64 **Field Effect Transistors. Parts I, II, and III.** 64 pages. \$1.00.

If \$70 and up for our new single and dual outputs in five different packages doesn't excite you...

All-silicon DC power supply using integrated circuits to provide regulation system

except for input and output capacitors, rectifiers and series regulation transistors

Increased reliability

through use of integrated circuit which replaces 32 discrete components from conventional designs

Convection cooled

no external heat sinking required

Regulation

line or load $.01\% + 1\text{mv}$

Ripple and noise

250 μv rms; 1mv p-to-p

Wide input voltage and frequency range

105-132 vac, 57-63Hz

Wide temperature range

-20°C to $+71^{\circ}\text{C}$

Temperature coefficient

$.01\% + 300\mu\text{v}/^{\circ}\text{C}$ external programing resistor

$.015\% + 300\mu\text{v}/^{\circ}\text{C}$ internal programing resistor

Lightweight

Overvoltage protection

available as accessory up to 70 vdc

Multi-current-rated

Complete serviceability

all components replaceable

Remote sensing

No overshoot

on turn-on, turn-off or power failure

More current per cubic inch

Remote programing

1000 ohm/v nominal or volt/volt

Series/parallel operation

with similar single or dual units

Completely protected

automatic current limiting

Features of dual output models

Independent operation

Independent remote sensing

Independent remote programing

Series/parallel operation

(master/slave)

Each supply electrically isolated

and floating with respect to ground

Lambda power supplies

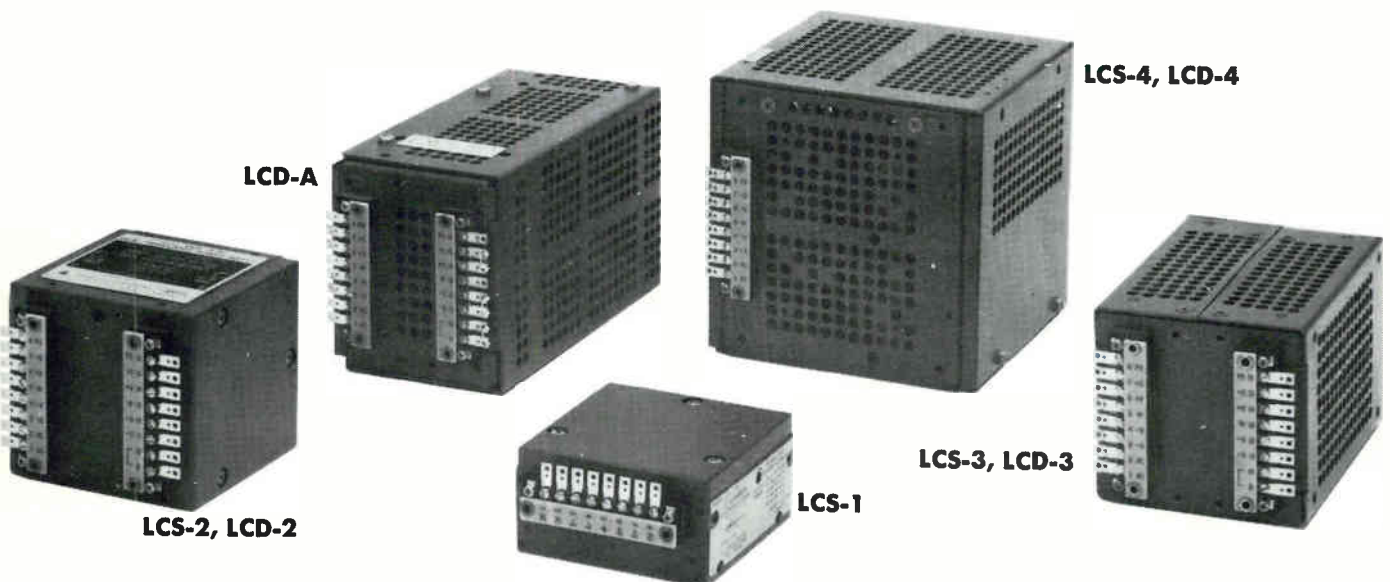

Maybe our 1-day delivery and 5 year

LCS-1 SINGLE OUTPUT MODELS



3⁵/₃₂" x 3³/₃₂" x 1²¹/₃₂"

Model	ADJ. VOLT. RANGE VDC	MAX. MA. AT AMBIENT OF: 1				Price(2)
		40°C	50°C	60°C	71°C	
LCS-1-01A	0-7	275	220	165	110	\$70
LCS-1-02A	0-18	130	130	100	85	70
LCS-1-03A	0-32	90	90	90	50	70
LCS-1-04A	0-60	50	50	50	30	80
LCS-1-05A	0-120	18	18	18	18	85

UNREGULATED POWER SUPPLY



3⁵/₃₂" x 3³/₃₂" x 1²¹/₃₂"

LUS-1-06	180 VDC	25 ma up to 71°C at nominal line voltage for use with up to 7 Nixie® tubes.	\$35
----------	---------	---	------

LCS-2 SINGLE OUTPUT MODELS



3⁵/₃₂" x 3³/₃₂" x 3³/₃₂"

Model	ADJ. VOLT. RANGE VDC	MAX. MA. AT AMBIENT OF: 1				Price(2)
		40°C	50°C	60°C	71°C	
LCS-2-01	0-7	550	455	350	240	\$80
LCS-2-02	0-18	330	275	210	140	80
LCS-2-03	0-32	240	205	155	95	80
LCS-2-04	0-60	145	115	87	57	90
LCS-2-05	0-120	50	50	45	30	90

LCS-3 SINGLE OUTPUT MODELS



3³/₁₆" x 3³/₄" x 5"

Model	ADJ. VOLT. RANGE VDC	MAX. MA. AT AMBIENT OF: 1				Price(2)
		40°C	50°C	60°C	71°C	
LCS-3-01	0-7	1200	1000	750	500	\$90
LCS-3-02	0-18	750	620	480	320	90
LCS-3-03	0-32	400	350	265	170	90
LCS-3-04	0-60	240	190	140	85	99

(Nixie is trademark of Burroughs Corp.)

LCS-4 SINGLE OUTPUT MODELS (Fixed Voltage)



4²⁹/₃₂" x 4²⁹/₃₂" x 5"

Model	FIXED VOLT. RANGE VDC	MAX. AMPS. AT AMBIENT OF: 1				Price(2)
		40°C	50°C	60°C	71°C	
LCS-4-3	3±5%	4.5	3.9	3.1	2.0	\$130
LCS-4-3P8	3.6±5%	4.5	3.9	3.1	2.0	130
LCS-4-4	4±5%	4.5	3.9	3.1	2.0	130
LCS-4-4P5	4.5±5%	4.4	3.7	2.9	1.8	130
LCS-4-5	5±5%	4.4	3.7	2.9	1.8	130
LCS-4-6	6±5%	4.0	3.4	2.6	1.5	130
LCS-4-8	8±5%	4.0	3.4	2.6	1.5	130
LCS-4-10	10±5%	3.2	2.8	2.2	1.3	130
LCS-4-12	12±5%	3.1	2.8	2.2	1.3	130
LCS-4-15	15±5%	2.8	2.6	2.1	1.3	130
LCS-4-18	18±5%	2.6	2.4	2.0	1.2	130
LCS-4-20	20±5%	2.4	2.2	1.9	1.1	130
LCS-4-24	24±5%	2.2	1.8	1.5	0.95	130
LCS-4-28	28±5%	2.0	1.6	1.4	0.85	130
LCS-4-36	36±5%	1.8	1.5	1.3	0.85	140
LCS-4-48	48±5%	1.2	1.1	0.9	0.75	140
LCS-4-100	100±5%	0.46	0.46	0.46	0.34	140
LCS-4-120	120±5%	0.40	0.40	0.40	0.30	140
LCS-4-150	150±5%	0.32	0.32	0.32	0.25	180

LCS-4 SINGLE OUTPUT MODELS (Wide Range)



4²⁹/₃₂" x 4²⁹/₃₂" x 5"

Model	ADJ. VOLT. RANGE VDC	MAX. AMPS. AT AMBIENT OF: 1				Price(2)
		40°C	50°C	60°C	71°C	
LCS-4-01	0-7	3.3	3.0	2.3	1.5	\$130
LCS-4-02	0-18	1.8	1.6	1.2	0.8	130
LCS-4-03	0-32	1.0	0.9	0.7	0.5	130
LCS-4-04	0-60	0.55	0.5	0.43	0.3	140
LCS-4-05	0-120	0.25	0.25	0.22	0.16	140

LCD-2 DUAL OUTPUT MODELS



3⁵/₁₆" x 3³/₄" x 5"

Model	ADJ. VOLT. RANGE VDC (EACH SIDE)	MAX. MA. AT AMBIENT OF: 1				Price(2)
		40°C	50°C	60°C	71°C	
LCD-2-11	0-7	300	240	175	115	\$125
	0-7	300	240	175	115	
LCD-2-12	0-18	160	130	100	65	125
	0-7	300	240	175	115	
LCD-2-13	0-32	120	95	70	45	125
	0-7	300	240	175	115	
LCD-2-22	0-18	160	130	100	65	125
	0-18	160	130	100	65	
LCD-2-23	0-32	120	95	70	45	125
	0-18	160	130	100	65	

guarantee on parts and labor will.

LCD-2 DUAL OUTPUT MODELS Continued

Model	ADJ. VOLT. RANGE VDC (EACH SIDE)	MAX. MA. AT AMBIENT OF: ¹				Price (2)
		40°C	50°C	60°C	71°C	
LCD-2-33	0-32	120	95	70	45	\$125
	0-32	120	95	70	45	
LCD-2-44	0-60	65	52	37	23	170
	0-60	65	52	37	23	
LCD-2-55	0-120	30	30	22	14	170
	0-120	30	30	22	14	

LCD-3 DUAL OUTPUT MODELS

3 3/16" x 3 3/4" x 5"



Model	ADJ. VOLT. RANGE VDC	MAX. MA. AT AMBIENT OF: ¹				Price (2)
		40°C	50°C	60°C	71°C	
LCD-3-11	0-7	700	590	480	340	\$150
	0-7	700	590	480	340	
LCD-3-12	0-7	700	590	480	340	150
	0-18	400	350	300	210	
LCD-3-13	0-7	700	590	480	340	150
	0-32	225	190	160	120	
LCD-3-22	0-18	400	350	300	210	150
	0-18	400	350	300	210	
LCD-3-23	0-18	400	350	300	210	150
	0-32	225	190	160	120	
LCD-3-33	0-32	225	190	160	120	150
	0-32	225	190	160	120	
LCD-3-44	0-60	130	100	70	45	175
	0-60	130	100	70	45	

LCD-A DUAL OUTPUT MODELS

3 3/16" x 3 3/4" x 6 1/2"



Model	ADJ. VOLT. RANGE VDC	MAX. AMPS. AT AMBIENT OF: ¹				Price (2)
		40°C	50°C	60°C	71°C	
LCD-A-11	0-7	1.0	0.9	0.7	0.5	\$155
	0-7	1.0	0.9	0.7	0.5	
LCD-A-12	0-18	0.5	0.45	0.4	0.3	155
	0-7	1.0	0.9	0.7	0.5	
LCD-A-13	0-32	0.35	0.3	0.25	0.2	155
	0-7	1.0	0.9	0.7	0.5	
LCD-A-22	0-18	0.5	0.45	0.4	0.3	155
	0-18	0.5	0.45	0.4	0.3	
LCD-A-23	0-32	0.35	0.3	0.25	0.2	155
	0-18	0.5	0.45	0.4	0.3	
LCD-A-33	0-32	0.35	0.3	0.25	0.2	155
	0-32	0.35	0.3	0.25	0.2	
LCD-A-44	0-60	0.2	0.18	0.14	0.12	180
	0-60	0.2	0.18	0.14	0.12	
LCD-A-55	0-120	75 ma	75 ma	75ma	60 ma	200
	0-120	75 ma	75 ma	75ma	60 ma	

Write, wire or call for new 72-page catalog



LCD-4 DUAL OUTPUT MODELS

4 29/32" x 4 29/32" x 5"



Model	ADJ. VOLT. RANGE VDC	MAX. AMPS. AT AMBIENT OF: ¹				Price (2)
		40°C	50°C	60°C	71°C	
LCD-4-11	0-7	1.8	1.5	1.2	0.7	\$190
	0-7	1.8	1.5	1.2	0.7	
LCD-4-12	0-18	1.0	0.8	0.65	0.4	190
	0-7	1.8	1.5	1.2	0.7	
LCD-4-13	0-32	0.6	0.53	0.4	0.24	190
	0-7	1.8	1.5	1.2	0.7	
LCD-4-22	0-18	1.0	0.8	0.65	0.4	190
	0-18	1.0	0.8	0.65	0.4	
LCD-4-23	0-32	0.6	0.53	0.4	0.24	190
	0-18	1.0	0.8	0.65	0.4	
LCD-4-33	0-32	0.6	0.53	0.4	0.24	190
	0-32	0.6	0.53	0.4	0.24	
LCD-4-44	0-60	0.33	0.3	0.24	0.15	240
	0-60	0.33	0.3	0.24	0.15	
LCD-4-55	0-120	0.12	0.12	0.12	0.075	240
	0-120	0.12	0.12	0.12	0.075	
LCD-4-152 Fixed	15±5%	1.5	1.3	1.0	0.6	220
	15±5%	1.5	1.3	1.0	0.6	

OVERVOLTAGE PROTECTION ACCESSORIES (Separate OV required for each output)



Model	ADJ. VOLT. RANGE VDC	FOR USE WITH	Price (2)
LC-OV-10	3-24		\$20
LC-OV-11	3-47	LCS-1, LCS-2, LCD-2, LCS-3, LCD-3	20
LC-OV-12	3-70		25
LM-OV-1	3-8	Fixed Voltage	30
LM-OV-2	6-20	LCS-4, LCD-4	30
LM-OV-3	18-70		30
LH-OV-4	3-24	LCD-A & wide	35
LH-OV-5	3-47	range LCD-4, LCS-4	35
LH-OV-6	3-70		35

NOTES: (1) For operation at other than 57-63 Hz, consult factory for ratings and specifications. (2) All prices FOB Melville, N. Y. All prices and specifications subject to change without notice.

One day delivery—90% of all models

Guaranteed for five years material and labor

These are new reduced prices effective November 1, 1969.

LAMBDA
ELECTRONICS CORP.
A Veeco Company

TYPICAL RESPONSE CHARACTERISTICS.

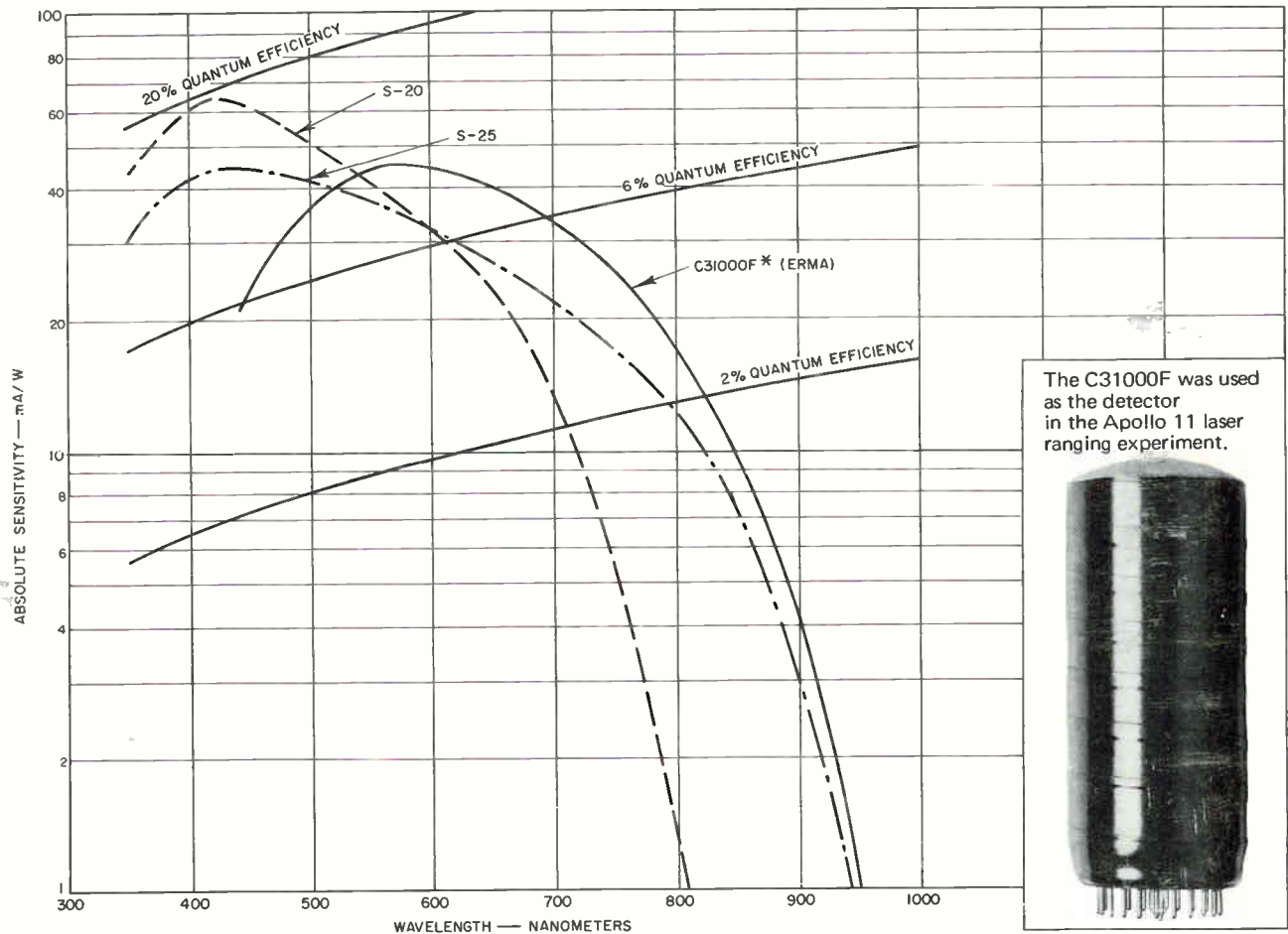

The C31000F was used as the detector in the Apollo 11 laser ranging experiment.



NEW! EXTENDED RED RESPONSE RCA-C31000F QUANTACON PHOTOMULTIPLIER

The C31000F is new! It's an Extended-Red, Multi-Alkali cathode version of the previously-announced C31000D. C31000F is recommended for applications in the red area of the spectrum, particularly laser detection and Raman spectroscopy. The latest addition to the RCA QUANTACON photomultiplier family, it is characterized by the use of Gallium Phosphide as the secondary emitting material on the first dynode.

Gallium Phosphide boosts the single electron resolution of this newest RCA QUANTACON photomultiplier as much as 10 times over that of tubes using conventional dynode materials. As a result, it is possible for this 2" dia. light detector, whose prototype is the industry-famous 8575, to discriminate between light-producing phenomena that generate one, two, three, or four photoelectrons.

Developed by RCA, the use of Gallium Phosphide places the C31000F and other RCA QUANTACON photomultipliers at the forefront of devices that can reveal nuclear, astronomical and biochemical events never seen before.

For more information on this 12-stage device, and other RCA QUANTACON photomultipliers, including the C31000D and the 5-inch C70133B, see your local RCA Representative. For technical data on specific types, write: RCA Electronic Components, Commercial Engineering, Section J19P-2/ZP1R, Harrison, N. J. 07029. In Europe, contact: RCA International Marketing S. A., 2-4 rue du Lièvre, 1227 Geneva, Switzerland.

*Typical Q.E. at 860 nm is 1.4%, corresponding to a radiant sensitivity of 10 mA/W. C31000E is the flat-faceplate version of the C31000F which has a curved faceplate.