

Designer's guide to RC active filters 86

Op amp testing made easy 94

Undiced wafers boost computer's reliability 98

\$1.00 A McGraw-Hill Publication

July 21, 1969

Electronics®

*Fast,
faster...
Schottky
diodes
come
of IC
age*

MOSES I
BOX 956
MIC CONM ELEC
CLER
55954 44886 02-71

Inductors for all temperatures

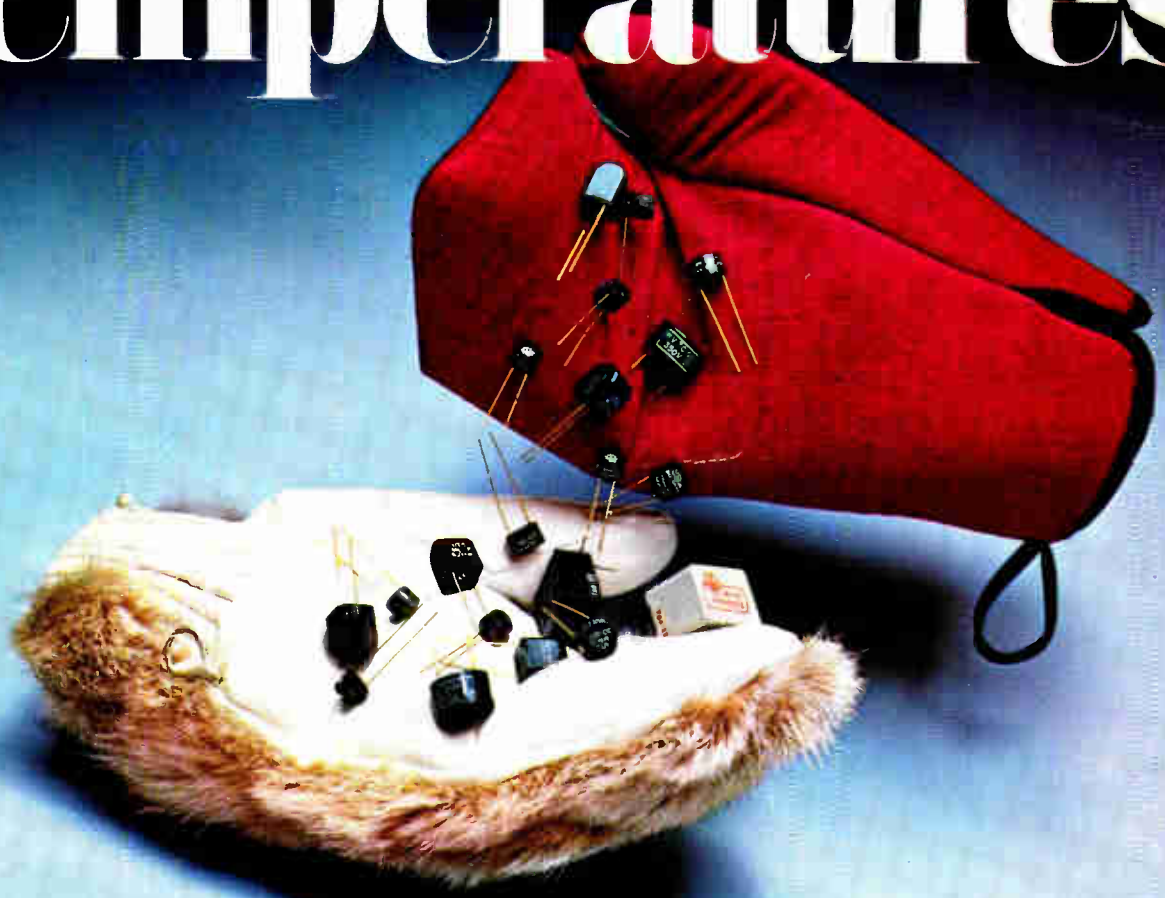

UTC high Q coils give you better inductance stability over any temperature range

That's a tough claim to back up!

We do it by meticulously controlling every process variable that can affect temperature stability of an inductor. We pay special attention to every detail of design and manufacture—winding methods, materials compatibility, stabilization processes, assembly and impregnation—details other manufacturers ignore. Over any temperature range you specify, UTC inductors will outperform all others.

Available from our catalog are high Q inductors with guaranteed stability from -55°C to $+130^{\circ}\text{C}$. Adjusted inductance

tolerances are as tight as $\pm 1\%$ on standard inductors. Select from hundreds of inductors made to MIL-T-27B. If your specific need cannot be supplied, we'll tailor an item to your specifications.

When your designs call for better inductance stability, UTC is the answer. Check your local distributor for immediate off-the-shelf delivery or contact United Transformer Company, Division of TRW INC., 150 Varick Street, New York, New York 10013.

TRW
UNITED TRANSFORMER COMPANY

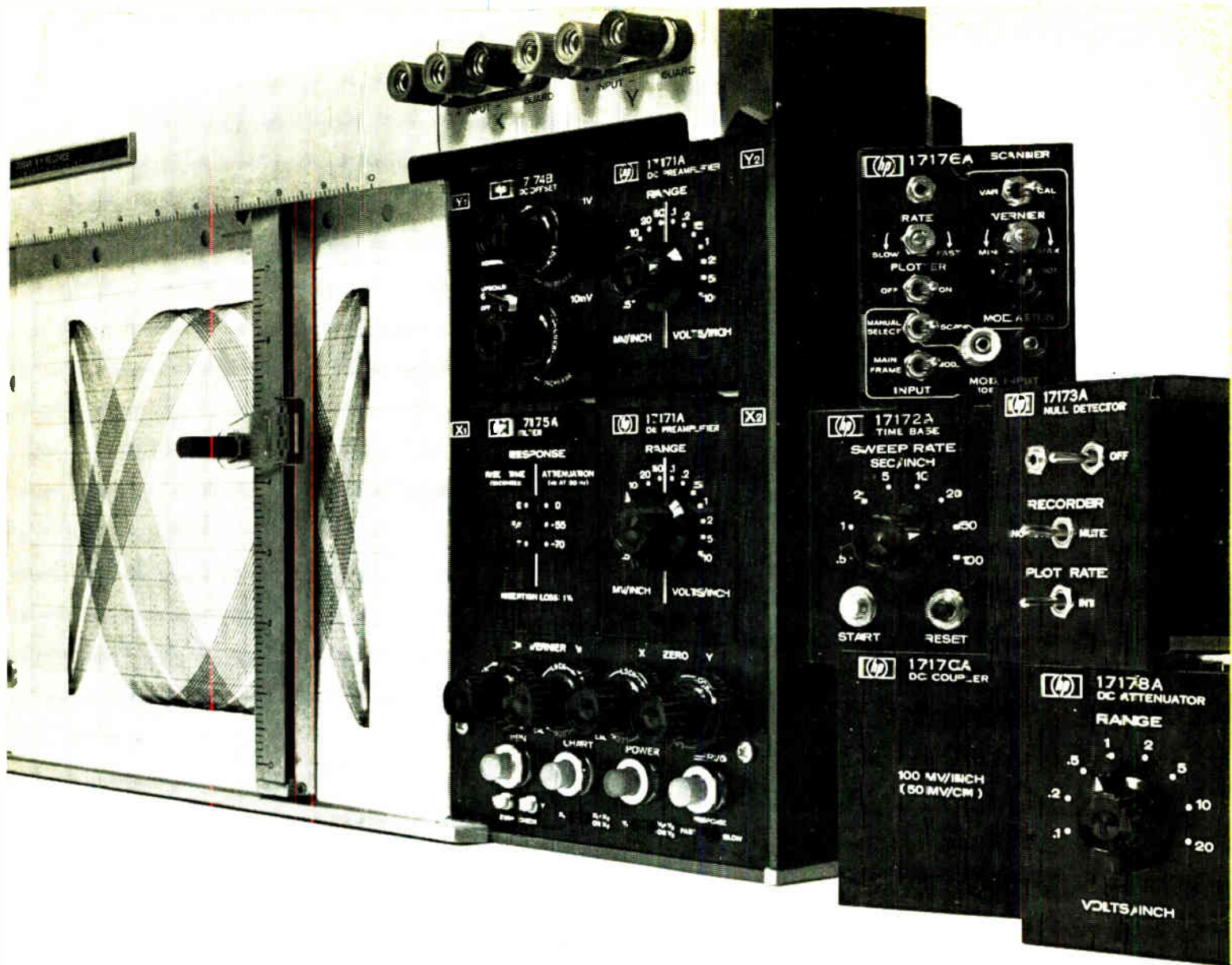

To make our new small X-Y Recorder act big, just plug in a couple of these.

HP's new 7034A is as trim as you can make an 8½" x 11" X-Y recorder. But size is the only thing small about it. The frame has all the features and versatility of our big X-Y Recorder. Such as 1500 in/sec² acceleration and 30 in/sec slewing speed, to catch transients most X-Y recorders miss. Guarded circuits to reject ac and dc common-mode signals. Exclusive, silent electrostatic paper hold-down to eliminate slippage. Disposable ink cartridge to eliminate mess and make color changes easy. And zero set/check for fast verification of zero position without removing or shorting the input signal. High dynamic performance is

matched by the flexibility we've achieved with our unique plug-in concept: two may be used in each axis, and can be cascaded. With eight plug-ins to choose from, you can add to your measurement capabilities as the need arises.

With the Time Base plug-in, you can capture X-T or Y-T data at ½ sec/in to 100 sec/in sweep rates. Expand low-level signals for detailed study with the DC Preamplifier. Suppress steady-state dc to reveal small-signals using the DC Offset plug-in. Plot single channel data at 50 points/sec with the Null Detector and accessory point plotter. Plot two channels independently with the Scanner.

Eliminate ac signal components over 50 Hz with the Filter plug-in. And for more run-of-the mill recording jobs, try our low-cost DC Attenuator or DC Coupler.

You'll be glad to know that the price on this new X-Y Recorder is also small: just \$1195 for the basic instrument. Plug-in prices start at \$25. For all the big details, contact your local HP field engineer. Or write to Hewlett-Packard, Palo Alto, California 94304; Europe: 1217 Meyrin-Geneva, Switzerland.

HEWLETT  PACKARD

GRAPHIC RECORDERS
Circle 1 on reader service card

There was a time when network analysis was a long, drawn-out process — consisting of *measuring* amplitude and *interpreting* phase response.

Now, with the HP 675A/676A network analysis system, you get a complete characterization of your network. You have **both** phase and amplitude information on a swept basis to 32 MHz — and you save hours of time because you can see changes in phase and amplitude responses as you make adjustments. Add the HP 11138A impedance measuring accessory for making complex driving point impedance measurements on a swept basis — and you have a complete network analysis system.

You can use this analysis system for your circuit design checking, operational amplifier characterization, crystal characterization, classroom demonstrations and many other applications. The system is completely programmable for automatic or computerized production and quality analysis testing.

The 675A Sweeping Signal Generator has a 10 kHz to 32 MHz range with settings anywhere in this range for single or continuous sweep. The 676A Phase/Amplitude Tracking Detector adds a full 360° phase measurement capability and an 80 dB dynamic amplitude range.

Channel A and B outputs on the 676A provides simultaneous amplitude measurements of two devices for comparison. Amplitude A-B and

PHASE A-B make difference measurements easy. Outputs can be easily calibrated in linear dB and linear phase on a low frequency oscilloscope or X-Y recorder.

Get complete characterization of your network with the HP 675A/676A network analysis system. Call your HP field engineer for complete specifications. Or, write to Hewlett-Packard, Palo Alto, California 94304. Europe: 1217 Meyrin-Geneva, Switzerland. Price: 675A, \$2250; 676A \$1275; 11138A, \$175.

HEWLETT  PACKARD
SIGNAL ANALYZERS

099/14

Now You Can Completely Characterize Your Networks to 32 MHz

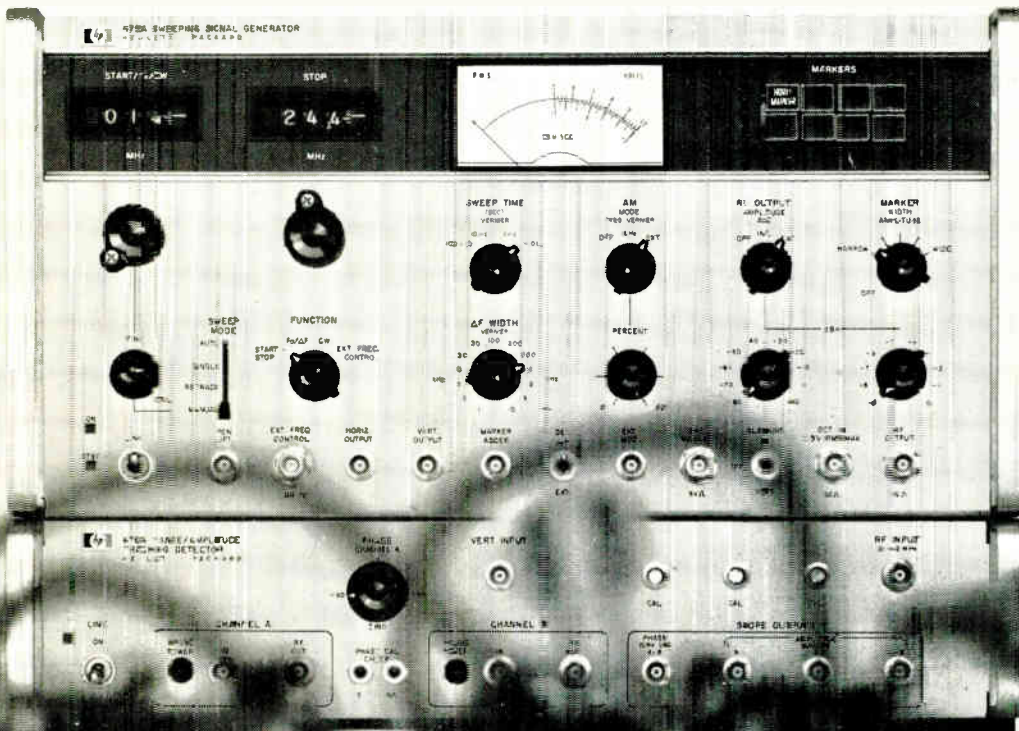

News Features

Probing the News

- 115 **Avionics:** I/CNI hanging by a thin thread
121 **Space electronics:** Late show will put Mars on tv

U.S. Reports

- 37 **Government:** Defense budget cut by Senate committee
38 **Government:** Aircraft spending sliced; Technology expenditures reduced
39 **Space electronics:** Flight programmer for Tacsat
42 **Space electronics:** Meteorological satellite for 1970's
42 **Manufacturing:** Using i-r to detect bonding flaws
44 **Manufacturing:** Spray-on battery
46 **Military electronics:** Manpack version of carrier landing system
50 **Advanced technology:** Small computer for large fast Fourier analysis
52 **Computers:** Navy wants single airborne machine
54 **For the record**

Electronics International

- 181 **West Germany:** Flicker noise tester developed by US subsidiary
182 **Japan:** Logic from linear circuits
182 **Great Britain:** Ferrite plus platinum wire for memories
183 **Western Europe:** Computer gap
184 **Sweden:** Industry danger signs

New Products

- 131 **In the spotlight**
131 **Low-cost counters** have premium specs
136 **Components review**
136 **Video inverters** for EDP market
141 **Instruments review**
141 **Binary signals control ratio box**
144 **Semiconductor review**
144 **Fairchild linear-IC family bows**
152 **Microwave review**
152 **Logic controls signal generator**
157 **Production equipment review**
157 **Shaker produces sine motion**
160 **Subassemblies review**
160 **Hybrid regulator handles 120 v**
164 **IC's stabilize power modules**

Technical Articles

- Solid state** 74 **Schottky diodes make IC scene (cover)**
With reproducibility problems licked, these devices make attractive elements; they permit unusual component combinations, save chip real estate, reduce power dissipation, and enhance production yields
R.N. Noyce, R.E. Bohn, and H.T. Chua, Intel Corp.
- Circuit design** 81 **Designer's casebook**
▪ Peak detector senses bipolar inputs
▪ Photodiode coupled pair isolates DTL from a relay
▪ FET buffer boasts high speed and performance
▪ Pulse train frequency varied as duty cycle stays constant
- Circuit design** 86 **Active filters: part 11 Varying the approach**
Depending on the application, RC networks can be modified to produce the desired second-order transfer functions; two capacitors and two resistors usually suffice
Jack W. Mullaney, Avco Corp.
- Instrumentation** 94 **Adapter lets digital IC tester check on operational amplifiers**
Variable interface circuit between device and tester is switched, under program control, to make required parameter measurements
Robert McIntyre, Amelco Semiconductor
- Computers** 98 **Cellular redundancy brings new life to an old algorithm**
With LSI MOS circuitry that includes hundreds of identical processors, and with the almost-forgotten dinary algorithm, a block-oriented computer promises great reliability at low cost; processing is from left to right
Joseph O. Campeau, Litton Systems

Departments

- 4 Readers Comment
8 Who's Who in this issue
14 Who's Who in Electronics
23 Meetings
31 Editorial Comment
33 Electronics Newsletter
61 Washington Newsletter
166 New Books
168 Technical Abstracts
172 New Literature
179 International Newsletter

Electronics

Editor-in-Chief: Donald Christiansen

Senior staff editors

Technical: Stephen E. Scrupski
News: Robert Henkel
International: Arthur Erikson

Managing editor: Harry R. Karp
Art director: Gerald Ferguson

Senior associate editor: Joseph Mittleman
Assistant managing editors: Eric Alken, H. Thomas Maguire, Howard Wolff
Senior copy editor: Frederick Corey Senior staff writer: John Johnsrud

Department editors

Advanced technology: William Bucci, Richard Gundlach
Communications: John Drummond, Raphael Kestenbaum
Computers: Wallace B. Riley, George Weiss
Design theory: Joseph Mittleman
Instrumentation: Owen Doyle
Military/Aerospace: Alfred Rosenblatt; Paul Dickson (Aerospace)
New products: William P. O'Brien
Solid state: George Watson, Stephen Wm. Fields

Domestic bureaus

Boston: James Brinton, manager; Gail Farrell
Los Angeles: Lawrence Curran, manager; Ralph Selph
Washington: Ray Connolly, manager; Paul Dickson, Lois Vermillion

Foreign bureaus

Bonn: John Gosch
London: Michael Payne
Paris: Arthur Erikson
Tokyo: Charles Cohen

Copy editor: Edward Flinn
Staff writer: Peter Schuyten

Assistant art director: Charles Ciatto
Production editors: Susan Hurlburt, Arthur C. Miller

Editorial research: Virginia Mundt

Editorial secretaries: Lorraine Longo, Claire Goodlin, Barbara Razulis, Vickie Green, Bernice Pawlak, Patricia Bispham

McGraw-Hill News Service

Director: Arthur L. Moore; Atlanta: Fran Ridgway; Chicago: Robert E. Lee
Cleveland: Arthur Zimmerman; Dallas: Marvin Reid
Detroit: James Wargo; Houston: Barbara LaRoux
Los Angeles: Michael Murphy; Pittsburgh: Louis Gomolak
San Francisco: Margaret Drossel
Seattle: Ray Bloomberg; Washington: Charles Gardner, Daniel B. Moskowitz, Herbert W. Cheshire, Seth Payne, Warren Burkett, William Small, William D. Hickman
McGraw-Hill World News Service

Bonn: Robert Dorang; Brussels: James Smith; Hong Kong: Kate Mattock
London: John Shinn; Mexico City: Gerald Parkinson; Milan: Ronald Taggiasco, Jack Star
Moscow: Jack Winkler; Paris: Robert E. Farrell, Stewart Toy
Rio de Janeiro: Leslie Warren; Tokyo: Marvin Petal

Reprints: Gail Niles

Circulation: Isaaca Siegel

Publisher: Gordon Jones

Assistant to the publisher: Wallace C. Carmichael

Electronics: July 21, 1969, Vol. 42, No. 15

Published every other Monday by McGraw-Hill, Inc. Founder: James H. McGraw 1860-1948.
Publication office 99 North Broadway, Albany, N. Y. 12202; second class postage paid at Albany, N. Y.
and additional mailing offices.

Executive, editorial, circulation and advertising addresses: McGraw-Hill Building, 330 W. 42nd Street,
New York, N. Y. 10036. Telephone (212) 971-3333. Teletype TWX, N.Y. 710-581-4235. Cable address:
MCGRAWHILL N.Y.

Subscriptions solicited only from those professionally engaged in electronics technology. Subscription rates:
qualified subscribers in the United States and possessions and Canada, \$8.00 one year, \$12.00 two years,
\$16.00 three years; all other countries \$25.00 one year. Non-qualified subscribers in the U.S. and
possessions and Canada, \$25.00 one year; all other countries \$50.00. Air freight service to Japan \$50.00
one year. Single copies: United States and possessions and Canada, \$1.00; all other countries, \$1.75.

Officers of McGraw-Hill Publications Company: Joseph Allen, President; John R. Emery, J. Elton Tuohig,
Senior Vice Presidents; Gordon L. Jones, Jr., Group Vice President; Vice Presidents: John R. Callahan, Editorial;
Paul F. Cowie, Circulation; John M. Holden, Marketing; David G. Jensen, Manufacturing;
Jerome D. Luntz, Planning & Development; Robert F. Marshall, Administration; Robert M. Wilhelm, Finance.

Officers of the Corporation: Shelton Fisher, President and Chief Executive Officer; John L. McGraw, Chairman;
Robert E. Slaughter, Executive Vice President; Daniel F. Crowley, Donald C. McGraw, Jr., Bayard E. Sawyer,
Senior Vice Presidents; John J. Cooke, Vice President & Secretary; Gordon W. McKinley, Vice President &
Treasurer.

Title registered in U.S. Patent Office; © Copyright 1969 by McGraw-Hill, Inc. All rights reserved. The contents
of this publication may not be reproduced either in whole or in part without the consent of copyright owner.

Subscribers: The publisher, upon written request to our New York office from any subscriber,
agrees to refund that part of the subscription price applying to copies not yet mailed.
Please send change of address notices or complaints to Fulfillment Manager; subscription
orders to Circulation Manager, Electronics at address below. Change of address notices
should provide old as well as new address, including postal zip code number. If possible,
attach address label from recent issue. Allow one month for change to become effective.

Postmaster: Please send form 3579 to Fulfillment Manager, Electronics,
P.O. Box 430, Hightstown, New Jersey 08520

Readers Comment

Aesthetics' role

To the Editor:

Regarding your reply to Sidney V. Soanes' letter on standards and style [July 7, p. 7], the reasons you give for not conforming to standards have to be the most asinine statements ever.

Technical accuracy first, please!
Then aesthetics.

R.E. Hildebrand
Cottkill, N.Y.

Reader Hildebrand questions *Electronics'* practice of not following certain standards, such as capitalizing the letters in such abbreviations as μf and hz . We agree with Mr. Hildebrand that technical accuracy comes first, but we feel that the use of lower case letters wherever possible not only improves the readability of our articles, but makes it easier for us to communicate with our readers. In no way does the use of lower case impugn technical accuracy; it merely makes it simpler to digest.

Stereo 8 vs. cassette

To the Editor:

Your article on tape recorders [June 9, p. 139] needs some clarification concerning Stereo 8.

You state that Stereo 8 requires expensive prerecorded tapes. But according to those manufacturers who sell both prerecorded cassettes and Stereo 8 tapes, the manufacturing cost of the Stereo 8 tape is less than that of the cassette cartridge.

You also say a drawback of the Stereo 8 endless loop system is that it cannot be operated fast forward, as can the cassette. Practically all of our equipment has the fast forward feature, which spins the tape at $4\frac{1}{2}$ times its natural speed.

At last month's Consumer Electronics Show in New York, Lear Jet Stereo announced both an auto unit with record and a home unit with record in Stereo 8. Lear is also finalizing the engineering for a reversible Stereo 8 cartridge that,

...want a tantalum capacitor with proven performance?

Buy TYPE 150D TANTALEX[®] SOLID-ELECTROLYTE CAPACITORS



INFORMATION RETRIEVAL NO. 514

More Sprague solid tantalum capacitors are in use than all other brands of solid tantalums combined. Hermetically-sealed in metal cases. Value-packed performance characteristics—low impedances at high frequencies, low dissipation factor, minimal capacitance drift with temperature, practically no change in capacitance with life. Low leakage current limits. Investigate new higher capacitance ratings.

48C-9144

All the advantages of tantalum...at low cost!

Type 196D Dipped Solid-Electrolyte Tantalex[®] Capacitors



Actual Size

INFORMATION RETRIEVAL NO. 515

Here's a capacitor design that admirably fills the need for low-cost yet dependable solid tantalum capacitors suitable for printed wiring boards. Straight leads as well as crimped leads are readily available to meet your manufacturing needs.

Covering a broad range of capacitance values from .1 μ F to 330 μ F, with voltage ratings from 4 to 50 VDC, Type 196D Capacitors are protected by a tough insulating coating which is highly resistant to moisture and mechanical damage.

For complete technical data on Type 150D Tantalex Capacitors, write for Engineering Bulletin 3520F. For information on Type 196D Capacitors, request Bulletin 3545A. Write to: Technical Literature Service, Sprague Electric Co., 35 Marshall Street, North Adams, Massachusetts 01247.



Sprague[®] and '®' are registered trademarks of the Sprague Electric Co.

THE BROAD-LINE PRODUCER OF ELECTRONIC PARTS



What can you expect from a **\$395** pulse generator?

- 0.2-Hz to 20-MHz PRF
- 25-ns to 2.5-s duration
- 5-ns rise/fall time
- ± 10 -volt outputs across 50Ω
- ± 1 -volt DC offset
- Independent control of amplitudes and offsets for + and - pulses
- Square-wave output
- Amplitude fully analog-programmable
- Period and duration modulatable

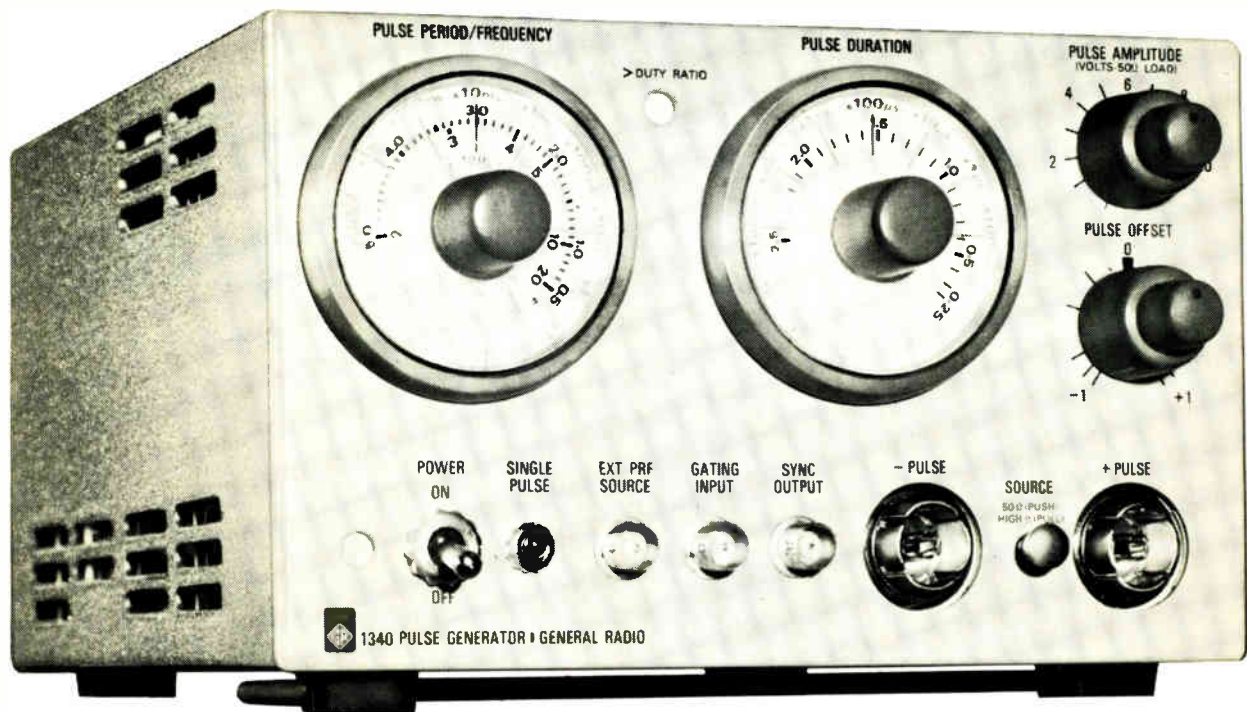

You get all these features and more in the NEW 1340 Pulse Generator. For more information call your nearest GR District Office, or write General Radio, West Concord, Mass. 01781. Telephone (617) 646-0550. In Europe Postfach 124, CH 8034 Zurich 34, Switzerland.

GENERAL RADIO

Readers Comment

when completed, will give it re-winding possibilities.

The Stereo 8 player has fewer parts and is less complex than a cassette player. If the Stereo 8 player were made monaurally, it would cost less than the cassette. And, when a cassette is made stereophonic, it costs more than a Stereo 8.

Ed G. Campbell

Vice president
Lear Jet Stereo Inc.
Detroit

■ Even if the manufacturing cost of prerecorded eight-track tapes were less than that of cassettes, as Mr. Campbell contends, the selling price apparently isn't. In a random sampling of retail outlets in the New York City area, Stereo 8 tapes were priced at \$6.95 each, compared with \$5.95 for cassettes. According to retailers, this is the price pattern everywhere.

As for an eight-track stereo tape player with fast forward feature, we haven't found one on the market. *Electronics* called Lear Jet's sales office in Detroit only to be told that while the company has such a unit under current development, "it won't be ready for awhile."

A bigger job

To the Editor:

Comparing the Technical Communications Corp.'s digital signaler with the Army's RADA communication system [June 9, p. 51] is some-

what like comparing an abacus to a computer. The fact that RADA, which is being developed by the Martin Marietta Corp., uses considerable bandwidth is due simply to the comprehensive communications tasks and capability required by the system. For example, in direct user-to-user communications, the RADA subscriber unit has 148 available channels, providing better than 250 simultaneous conversations; not one or two as is attributed to the TCC system.

Also, in addition to normal voice communications, RADA has the capability to transmit facsimile, teletypewriter and data information—as well as busy override and conference calls—with full security. And, at the same time, RADA affords the user anti-jam protection.

Edward J. Cottrell

Director of public relations
Martin Marietta Corp.
Orlando, Fla.

Flat denial

To the Editor:

The June 23 issue of *Electronics* reported that RCA will spend \$17 million within the next year to expand its semiconductor operation at Mountain Top, Pa., to manufacture thick-film integrated circuits [p. 34].

There is no basis in truth or fact for this statement.

Arnold M. Durham

Manager, news and information
RCA Electronic Components
Harrison, N.J.

Applications Power*



FETS IN TUNABLE FILTERS

Problem: To design a low cost, light-weight voltage tunable filter.

Solution: Use FETs as Voltage-Controlled Resistors (VCRs). Here is one approach:

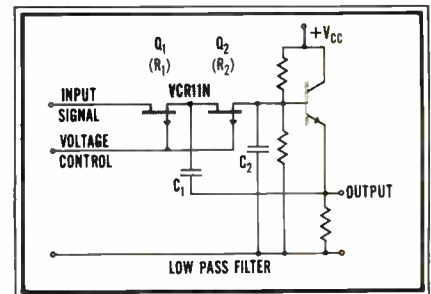

With this circuit you can have a tuning range up to 20:1 with a roll-off of 12 dB/octave. Weight is in the ounce-plus region and size is about 1½ cubic inches. Here are the design conditions and equations:

$$R_{in} > 10X_{C2}$$

$$R_o < 0.1X_{C1}$$

$$R = R_1 + R_2$$

$$M^2 = C_1/C_2$$

$$r_{ds} = \text{FET drain-source resistance,}$$

$$= \frac{r'_{ds}}{1 - V_{GS}/V_P}$$

$$r'_{ds} = r_{ds} \text{ with } V_{GS} = 0.$$

$$\omega_n = \text{Corner frequency,}$$

$$= \frac{1 - V_{GS}/V_P}{r'_{ds} M C_2}$$

* If you need a voltage tunable filter, and cost, size, weight and low power consumption are important considerations, give us a call for fast applications assistance. That's applications power: Products and service! Ask for Extension 19.

Siliconix
incorporated

1140 W. Evelyn Ave. • Sunnyvale, CA 94086
Phone (408) 245-1000 • TWX: 910-339-9216

SUBSCRIPTION SERVICE

Please include an *Electronics* Magazine address label to insure prompt service whenever you write us about your subscription.

Mail to: Fulfillment Manager
Electronics
P.O. Box 430
Hightstown, N.J. 08520

To subscribe mail this form with your payment and check new subscription renew my present subscription

Subscription rates: qualified subscribers in the U.S.: 1 year \$8; two years, \$12; three years, \$16. Non-qualified: 1 year \$25. Subscription rates for foreign countries available on request.

CHANGE OF ADDRESS

ATTACH LABEL HERE

If you are moving, please let us know five weeks before changing your address. Place magazine address label here, print your new address below.

name _____

address _____

city _____

state _____

zip code _____

Who's Who in this issue



Campeau

A veteran of 13 years with Litton Industries, Joseph O. Campeau did the story on the block-oriented computer that begins on page 98. He's a graduate of the Case Institute of Technology (now Case-Western Reserve). At the moment, Campeau is doing further research work on combining parallel-processor computer organization with large-scale integration.

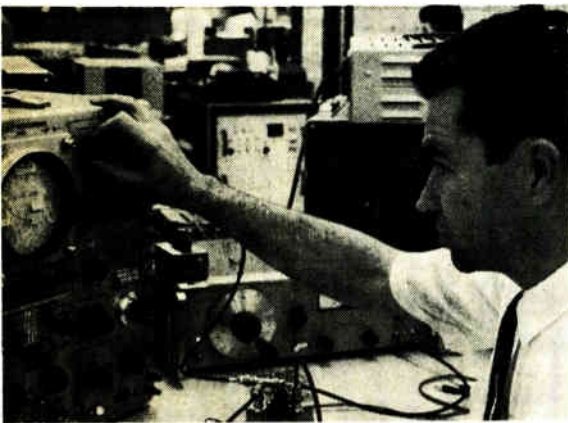

McIntyre

Projects outside his sphere of direct responsibility fascinate Robert McIntyre, engineering project manager for digital circuits at Amelco. One such involvement is detailed in the article on an adapter for an IC tester (page 94) in this issue. An alumnus of Georgia Tech, he started his career with Texas Instruments' Apparatus division. Later, he worked at Honeywell, heading the inertial guidance group. Mullaney joined Amelco in 1965 as discrete device product manager.

Mullaney



Active filters are but the most recent professional preoccupation of Jack W. Mullaney, who wrote the story on this subject that begins on page 86. During his five-year career in electronics, he has designed musical instrument amplifiers, a space vehicle skin-ablation sensor, and a frequency-division telemetry system. Mullaney holds bachelor's and master's degrees from the University of Cincinnati; he's currently doing research for his doctorate.



Bohn

Chua

Noyce

A talented triumvirate shares credit for the cover story (page 74) on Schottky-diode IC's, which will be made commercially available by Intel within the next few weeks. Robert Noyce, president and founder of the company, holds 15 patents on semiconductor methods, devices, and structures, including application of photoengraving to semiconductor devices, evaporated aluminum interconnections, and diffused-junction isolation for IC's. He holds a doctorate in physical electronics, and has filled a number of top executive slots, the latest, before starting Intel, being group vice president at Fairchild. Richard E. Bohn, who earned his M.S. at Ohio University, spent eight years with Transitron before joining Intel. He has extensive experience in process development and the design and testing of semiconductor devices; Bohn is co-holder of a patent covering TTL IC structures. H.T. Chua, who has a master's degree from Cal, worked at National Cash Register and Fairchild Semiconductor before signing on with Intel. He holds two circuit patents.

Now from Sprague Electric!

Your custom pulse transformer is a standard DST* transformer

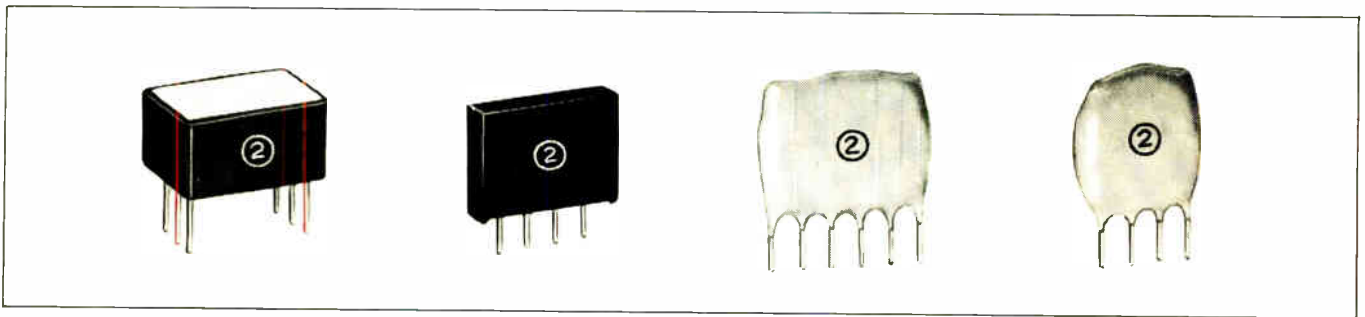

Some of the case styles in which Sprague DST Pulse Transformers are available. Note the in-line leads.

You can select the transformer design you need from the new Sprague DST Family, a fully-characterized series of Designer Specified Transformers which Sprague Electric has pioneered. It's easy. Start with the two basic parameters dictated by your circuit requirements: primary (magnetizing) inductance and volt-second capacity.

New Sprague engineering data gives basic information from which all nominal sine wave parameters are derived. This data allows you to specify the one transformer from thousands of possibilities which will optimize performance in your application.

Design Style A minimizes magnetizing inductance change as a function of temperature. Typically it's $< \pm 10\%$ change from 0 to 60°C; $< \pm 30\%$ from -55 to +85°C.

Design Style B and C give you broad band-pass characteristics, and still keep magnetizing inductance change $< \pm 15\%$ from 0 to 60°C.

Design Style D is fast. Associated leakage inductance and coupling capacitance are kept at a minimum. This style is just what you need for interstage and coupling devices in computer drive circuits.

The Sprague DST Series packs a lot of transformer into minimum volume packages — epoxy dipped for minimum cost, or pre-molded. The 100 mil in-line lead spacing is compatible with integrated circuit mounting dimensions on printed wiring boards.

To solve your pulse transformer design, start now. Write for Engineering Bulletin 40,350 to the Technical Literature Service, Sprague Electric Company, 35 Marshall St., North Adams, Massachusetts 01247.

*Trademark

SPRAGUE COMPONENTS

PULSE TRANSFORMERS
THIN-FILM MICROCIRCUITS
TRANSISTORS
CAPACITORS
RESISTORS

INTEGRATED CIRCUITS
INTERFERENCE FILTERS
PULSE-FORMING NETWORKS
TOROIDAL INDUCTORS
ELECTRIC WAVE FILTERS

CERAMIC-BASE PRINTED NETWORKS
PACKAGED COMPONENT ASSEMBLIES
BOBBIN and TAPE WOUND MAGNETIC CORES
SILICON RECTIFIER GATE CONTROLS
FUNCTIONAL DIGITAL CIRCUITS



Sprague and ® are registered trademarks of the Sprague Electric Co.

TTL.

PDQ.

RSVP: Your National distributor

Gates

DM8000N (SN7400N)	Quad 2-Input, NAND gate
DM8001N (SN7401N)	Quad 2-Input, NAND gate (Open Collector)
DM8003N (SN7403N)	Quad 2-Input, NAND gate (Open Collector)
DM8010N (SN7410N)	Triple 3-Input, NAND gate
DM8020N (SN7420N)	Dual 4-Input, NAND gate
DM8030N (SN7430N)	Eight-Input, NAND gate
DM8040N (SN7440N)	Dual 4-Input, Buffer
DM8050N (SN7450N)	Expandable Dual 2-Wide, 2-Input AND-OR-INVERT gate
DM8051N (SN7451N)	Dual 2-Wide, 2-Input AND-OR-INVERT gate
DM8053N (SN7453N)	Expandable 4-Wide, 2-Input AND-OR-INVERT gate
DM8054N (SN7454N)	Four-Wide, 2-Input AND-OR-INVERT gate
DM8060N (SN7460N)	Dual 4-Input expander
DM8086N (SN7486N)	Quad Exclusive-OR-gate

Flip Flops

DM8501N (SN7473N)	Dual J-K MASTER-SLAVE flip flop
DM8500N (SN7476N)	Dual J-K MASTER-SLAVE flip flop
DM8510N (SN7474N)	Dual D flip flop

Counters

DM8530N (SN7490N)	Decade Counter
DM8532N (SN7492N)	Divide-by-twelve counter
DM8533N (SN7493N)	Four-bit binary counter
DM8560N (SN74192N)	Up-down decade counter
DM8563N (SN74193N)	Up-down binary counter
DM8520N	Modulo-n divider

Decoders

DM8840N (SN7441N)	BCD to decimal nixie driver
DM8842N (SN7442N)	BCD to decimal decoder

Shift Registers

DM8570N	Eight-bit serial-in parallel-out shift register
DM8590N	Eight-bit parallel-in serial-out shift register

Miscellaneous

DM8200N	Four-bit comparator
DM8210N	Eight channel digital switch
DM8220N	Parity generator/checker
DM8820N	Dual line receiver
DM8830N	Dual line driver
DM8800H	Dual TTL to MOS translator
DM8550N (SN7475N)	Quad latch

TTL devices for industrial applications. Stocked in depth—available immediately, through National distributors. For our TTL Specification Guide and pricing, write or call National Semiconductor, 2975 San Ysidro Way, Santa Clara, California 95051. (408) 245-4320. TWX: 910-339-9240. Cables: NATSEMICON.

National/TTL

P.S. We've got low power TTL too. Meets 883 mil standards; off-the-shelf availability.

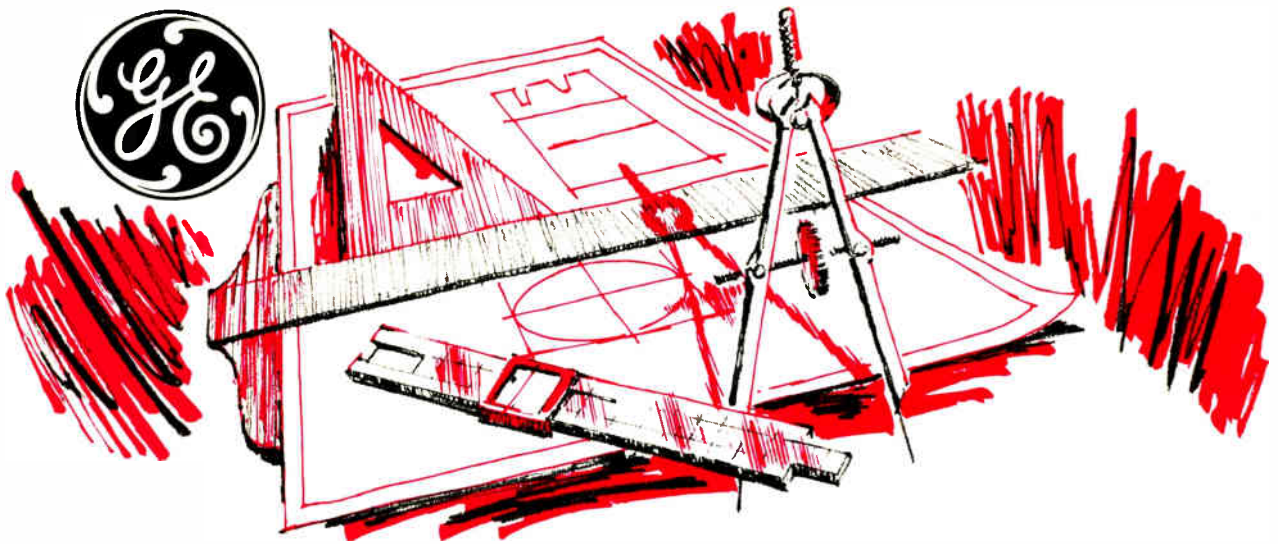

New 25 amp triac offers several exceptional performance features

GE has extended its broad thyristor line with the addition of a new 25 ampere triac. SC60 (stud-mounted) and SC61 (press-fit) offer several exceptional features:

Current rating 25A RMS
Voltage 200V, 400V, 500V rating
Surge current 250A Peak
Commutating 5V/μ sec. dv/dt MIN.
Static 200V/μ sec. dv/dt TYP.

The SC60/61 triac can handle up to 6KW at 240 volts and is compatible with PA424 and PA436 IC's for control of heaters, lamps and motors.

SC60/61 is well suited to high volume use in residential and industrial space heating, large lamp-dimming controls, temperature control in copying machines and many other applications. For details, circle 503.



Pin-sized Lodex® magnet

Now get proved Lodex® permanent magnets in sizes smaller than a pin

When designs call for tiny (even less than 1 millimeter) permanent magnets, GE has the answer. GE can produce powerful micro-miniature magnets at low cost—and in complex configurations, too.

The magnets are made of proved Lodex material. This exclusive GE product makes it possible to produce magnets in tiny, intricate shapes meeting extremely tight physical and magnetic tolerances.

Close piece-to-piece physical and magnetic uniformity often eliminates the need for final testing of the end product. These magnets are the perfect answer for such precise applications as reed switches.

For details, circle 504.

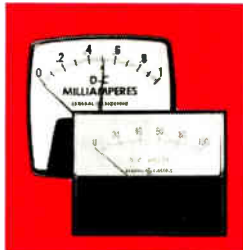

General Electric meter relays give you reliability at lower cost

Reliable performance at lower cost makes GE your best meter relay choice.

Functions include energizing alarms; close differential relaying; and controlling temperature, power, speed and frequency.

Proved GE design is better three ways:

- New contactless control action. Solid-state, light sensitive switch means simple, reliable control.
- "Piggyback" control module. Plug-in design saves installation time.
- Choice of styles. Easy-reading BIG LOOK® or low-profile HORIZON LINE® meter relays.

Applications range from critical monitoring in hospital intensive-care units to deep-well drilling control.

For details, circle 505.



100-CFM unit

Get reliable cooling for computer cabinets with proved GE fan assemblies

GE cooling fan assemblies offer years of continuous duty without maintenance. Available in two sizes, these blower fans feature all-angle operation and efficient air flow.

Small 90 and 100 CFM fans have KSB33-frame Unitized® motors and fit an opening 4¾" square. Near perfect bearing bores, accurate shaft-bearing alignment and metered oil bearings virtually eliminate bearing wear for long motor life.

GE's 500 CFM fan mounts on a 9.7" diameter bolt circle through holes in its aluminum venturi. Its KSP11-frame unit-bearing shaded-pole motor provides quiet, long-life operation.

For more information, circle 506.



New GE transistor is the ideal epoxy replacement for "hermetic" devices

General Electric's GET transistor series is a new answer to design problems. GET is the newest addition to GE's proved family of epoxy-encapsulated transistors dating back to 1962 . . . over 7 years of epoxy experience.

GET is the ideal epoxy replacement for "hermetic" devices . . . no expensive redesign needed. The new D32 package conforms to TO-18 mounting patterns and is available in these silicon planar passivated models:

GE Model	Type	JEDEC No.
GET706, 708, 914	NPN	2N706, 708, 914
GET2221, 2222	NPN	2N2221, 2222
GET3638, 3638A	PNP	2N3638, 3638A
GET2869, 3013, 3014, 3646	NPN	2N2869, 3013, 3014, 3646
GET929, 930	NPN	2N929, 930

GE's quality epoxy forms a true chemical bond with metal to provide increased resistance to moisture and vibration damage. Low profile package means smaller circuits and lower cost.

For more information on GET and GE's "specials" capability, circle 508.

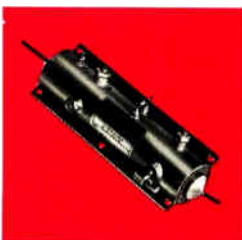

Check this new GE transmitter design

GE's C2003C transmitter is a Microwave Circuit Module containing a master oscillator and power amplifier using planar ceramic triodes.

It is one of many GE MCM's that help reduce design cycles, provide retrofit and lead to improved system performance.

C2003C benefits: meets performance and military requirements of the transmitter portion of IFF transponder

- permits two transmitters to function in space formerly used by one
- light weight
- significantly smaller
- simplified heat sinking
- excellent frequency stability with wide variations in antenna VSWR. For details, circle 507.

11 more

electronic components tailored for designers

General Electric components are engineered for reliability and cost effectiveness. No other single manufacturer offers such a wide selection of quality electronic components as General Electric. Specify GE in your designs.

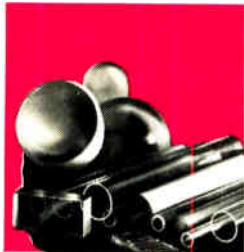

GE fused quartz and fused silica add design flexibility to many applications

Highest purity GE Fused Quartz is being applied in crystal pulling, zone refining, semiconductor diffusion and research laboratory. And many new electronic applications are constantly being developed.

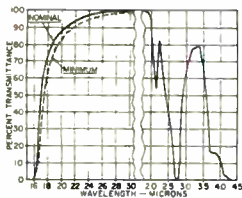

Transmittance Curve—151 Fused Silica for 1cm thickness*

GE type 151 Fused Silica, for critical optical jobs, is a schlieren grade material offering highest ultra-violet transmission.

Type 151 is one of five optical grades available. It is ideal for use in laser optics, absorption cells, spectrophotometer optical elements and schlieren photography.

For technical data and application assistance, circle 509.

*Excluding surface reflection losses



Tough, dependable indicating lights come in four sizes for varied application

GE has a broad assortment of low cost, high quality indicating lights (CR103, type H) that come with four mounting hole diameters for varied applications — 5/16", 15/32", 11/16" and 1". They all feature Lexan® (polycarbonate resin) lenses which diffuse light, eliminate "hot spots" and are virtually unbreakable.

Lens shapes include crown, spherical, torpedo and cylindrical. Lamps and lenses for most models install from the front without removing the assembly or opening the panel.

And a low-cost miniature indicating light (the CR103 HE) has been added to the line for applications where space is at a premium and minimum cost is essential.

The CR103 H line is perfect for applications such as panel indicators, lab equipment, appliances, meters, gauges, timers, and illuminated pointers and indicators for dials.

Get full-line details, circle 510 on the reader service card.



Innovative design gives GE Klystrons greater bandwidth, gain and efficiency

An experienced team of GE specialists uses innovative techniques to produce high-power Klystrons with greater bandwidth, gain and efficiency.

The Klystron above is just one example of GE's high-power pulsed microwave amplifier used in applications such as radar and particle accelerators.

GE Klystron designs can be developed in tunable and broadband types for all frequencies from UHF to X-band. They feature metal-ceramic construction, integral ion pumps and modular design for long life, low operating costs, and economical repair.

Put GE's team to work on your special Klystron application.

For details, circle 511.



New GE integrated voltage regulator smoothes ripple and protects IC's

GE's new integrated voltage regulator (IVR) is a monolithic IC that helps your power supply deliver constant, ripple-free voltage for solid-state circuit components. The device operates as a shunt regulator over a range of 10 to 40 volts at up to 400mW avg. power.

Total Avg. Power 400mW
Voltage 10-40W
Peak Current 1A
(10 sec pulse width, 1% duty cycle)
Operating Temp. Range -15C to +125C
Temp. Coefficient of rated voltage .03%/°C typ.

Housed in the standard epoxy TO-98 package, GE's IVR is a low-cost means to stabilizing voltage for solid-state circuits. Applications are found in auto radios, TV ripple filters and as a reference amplifier for high-power regulation. The IVR can also be used where other voltage regulation methods have been too costly for high-volume use.

For details, circle 512.



Get over 1/2 farad at 5 volts with GE computer-grade capacitors

GE 86F500 high-capacitance computer-grade capacitors provide up to 540,000 µf at five volts (34,000 µf at 100 volts) in a single case.

These units are excellent when large blocks of capacitance are required, as in power supply filters.

86F500 units are rated for continuous duty at 65C or at 85C with proper voltage derating. GE's computer-grade capacitors provide highest capacitance per case size, high ripple current capability, low ESR and long life.

Units are available in nine case sizes — diameters 1 3/8" to 3" with lengths up to 8 5/8" — for operation up to 100 VDC.

For details, circle 513.

LOOK TO GENERAL ELECTRIC—your best source for more in electronic components.

ELECTRONIC COMPONENTS SALES OPERATION

GENERAL  ELECTRIC

Tells time
...and
keeps it!

CURTIS INDACHRON
ELAPSED TIME
INDICATOR



SHOWN
ACTUAL SIZE

Here's infallible warranty validation. The Curtis Elapsed Time Indicator. Put this time keeper on any product you make, and it keeps a cumulative account of total usage — on the record.

Ideal for: warranty validation; developing mean-time-to-failure data; and scheduling preventive maintenance.

DC operated for less than \$2.00 (moderate production), this reliable, accurate instrument could well save you thousands, greatly increase customer satisfaction. Find out more today — for your own protection.

WRITE OR CALL

Curtis

INSTRUMENTS, INC.

200 Kisco Avenue
Mount Kisco, N.Y. 10549
(914) 666-2971

Who's Who in electronics



Van Poppelen

The new man at the helm as general manager of Fairchild's Semiconductor division, F. Joseph Van Poppelen Jr., 41, isn't taking command from C. Lester Hogan at the most propitious time, but things could be a lot worse, too. Van Poppelen moved into the top spot in the Mountain View, Calif., division after a wave of layoffs there and in Korea that has lopped some 1,600 from the payroll—1,000 in Korea alone.

Morale is bound to be sagging with the layoffs, and the Signetics Corp. hopes to displace Fairchild as the No. 3 supplier of digital integrated circuits this year. But, says Van Poppelen, "I don't believe the name of the game is what your sales rank is. You have to be a volume leader and maximize your earnings. We're the technological leader in the world in the semiconductor industry today, but we're not the manufacturing cost leader."

That's a situation Hogan began to change and Van Poppelen intends to see through.

Bullish. On the bright side, Van Poppelen is projecting a 1969 sales increase of more than 30% over last year, and in another 90 days, he says, the division will have the control of world-wide production costs he believes is needed to realize top profit on each product line. The di-

vision's accounting was formerly done on a plant-by-plant basis.

Now that accounting is done by product line. "We have to give the product manager an effective accounting system so that he knows what his costs are," Van Poppelen asserts. "In DTL, for example, the crystals are grown here in Mountain View, the wafers go to South Portland, Me., where the diffusion is done, then to Hong Kong or Shiprock, N.M., for assembly, and back to South Portland for shipment. The South Portland product manager has to know what the total costs are so that he and his product-marketing manager have the information they need to run that business—the DTL business."

Once the cost-accounting system is implemented, the new general manager, who stepped into his spot after nine months as vice president for marketing, says products will have to be ranked by priority according to their potential payback. "We'll be pushing the daylight out of MSI; we're the leaders now. We'll also continue to exploit diodes and power transistors."

He sees memories as another big growth area, and says Fairchild will be a major factor in the business. As for MOS, says Van Poppelen, "it will take some sizable commitments by the big boys. We've made the facilities commitment, but it will take more."

"Talk about technology all you want, but it's the people who run the plant." That, basically, is the keystone of the policy followed by general manager Howard T. Steller to bring the Philco-Ford Microelectronics division to the threshold of a dramatic turnaround, one that will see 1969 sales top 1968's by 50%. And possibly the most dramatic detail of the picture is the metal oxide semiconductor outlook: yields now are 50 to 60 times better than they were before the MOS operation was moved to Lansdale, Pa., from Santa Clara, Calif.

Buddies. That MOS improvement can be used to illustrate Steller's methods. With a background in the

The Fine Art of ONEUP MANSHIP

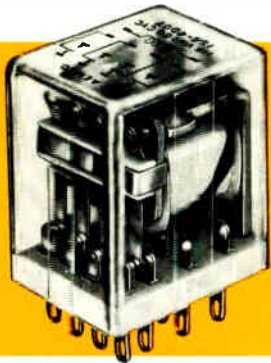

ONEUP

4PDT Miniature 3 Ampere Industrial Relay—Type 156

All features of competitive models, *plus* U/L recognition through 240 VAC instead of a mere 125 VAC.



ONEUP

General Purpose 1,2&3PDT Industrial Relay—Type 157

All features of competitive models, with U/L recognition through 240 VAC, potential recognition through 600 VAC. Superior electrical performance.

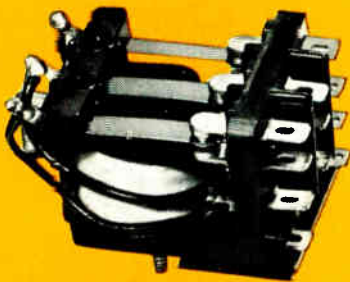

ONEUP

Magnetic Latching, General Purpose, 1,2&3PDT Industrial Relay—Type 157

Same electrical parameters as standard Type 157. Modern approach to magnetic latching does not employ hard permanent magnets.



ONEUP

1&2PDT Coaxial Crystal Can Relay—Type 153

Only Coaxial Crystal Can Relay that will switch above 500 MHz with VSWRs below 1.2. Now improved to switch 2000 MHz with low VSWRs.

Who's ONEUP? MIDTEX/AEMCO . . . and *YOU*, when you get in touch with the MIDTEX/AEMCO distributor in your area. CALL ONE UP!

MIDTEX  **AEMCO DIVISION**
INCORPORATED

10 STATE STREET
MANKATO, MINNESOTA
56001

PROGRAMMERS/TIME DELAY RELAYS/MINIATURE COAXIAL RELAYS/INDUSTRIAL RELAYS/MERCURY-WETTED CONTACT RELAYS

New VICTOREEN Mini-Mox Resistors for higher resistance/size ratios

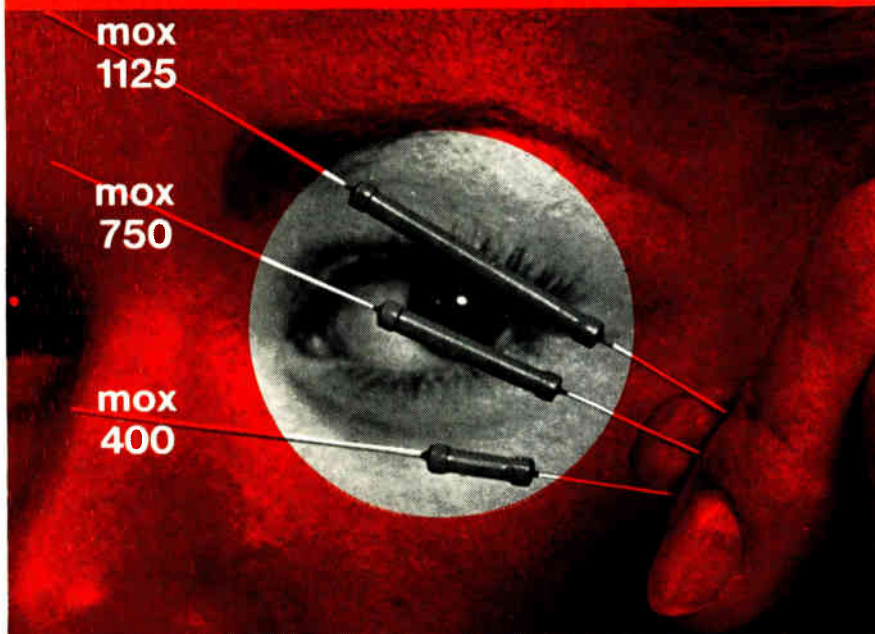

We promised you a wider range of quality Victoreen MOX (metal oxide glaze) resistors for sophisticated electronic applications. And we're delivering on our promises, too, for we're now in volume production on the subminiature Mini-Mox resistor line. Just eyeball these specifications:

Model	Resistance	Rating @70°C	*Max. Oper. Volts	Length Inches	Diameter Inches
MOX-400	1-2500 megs	.25W	1000V	.420±.050	.130±.010
MOX-750	1-5000 megs	.50W	2000V	.790±.050	.130±.010
MOX-1125	1-10,000 megs	1.00W	5000V	1.175±.060	.130±.010

*Max operating temp 220°. Encapsulation — Si Conformal.

*Applicable above critical resistance.

Stability is better than $\pm 2\%$ for 2000 hours at full load, shelf-life drift less than 0.1% per year. Standard tolerances are 1 to 10% depending on resistance value. $\frac{1}{2}\%$ resistors in limited values, on request.

So let your circuit design imagination run rife. Victoreen MOX and new Mini-Mox Resistors can satisfy all your requirements for ultra-critical applications involving high voltage...high impedance...high stability...high wattage. Check our Applications Engineering Department today. Call (216) 795-8200.

A-3876

VICTOREEN INSTRUMENT DIVISION
10101 WOODLAND AVENUE • CLEVELAND, OHIO 44104
EUROPE: ARMDALE HOUSE, THE PRECINCT, EGHAM, SURREY, ENGLAND • TEL: EGHAM 4887



Who's Who in electronics

social sciences rather than engineering, his first work experience was in industrial relations. It was there, he says, that he learned lesson No. 1: "People working for you must be motivated, made to feel they're part of the team. And close communication is the way to let them know—something, incidentally, that's one of industry's big problems." So by applying that principle and demanding hard work and close quality control, Steller and his people brought the yield problem under control. Not only that, but the move east helped in several ways. "For one thing," says Steller, "we were out of that Peninsula job-hopping atmosphere; when our engineers go to lunch in Blue Bell or Lansdale we're sure they're going to return. For another, we now have our manufacturing and R&D together where quality can be more closely controlled."

Moreover, Steller has emphasized maturity and experience in hiring engineers. "They have an average of 14 years apiece with the company," he points out. Coupling this with a refusal to ignite any technological fireworks merely to light the sky brightly but briefly ("We're here to make a profit; we are going to sell proven devices that we can deliver"), Steller apparently has come up with a formula that's making Philco-Ford executives in Philadelphia and Dearborn forget past debacles.

On the horizon for Steller is accelerated MOS activity (now 10% of Philco's business, trailing bipolar), greater attention to the automotive market (the division must compete with outside suppliers even for Ford business), and greater growth in the Spring City, Pa., operations (hybrid and microwave devices and electro-optics). Steller says his division will soon become a second source for Fairchild's 9300 series of bipolar medium scale integrated register, multiplexer, and coder circuits; also upcoming is a Philco version of Texas Instruments' 54/74 transistor-transistor logic. This will flesh out Philco's own line of diode-transistor logic.



We can guide you to the easiest wire and cable buy for peripheral equipment.

Brand-Rex has been the leading supplier of wire and cable for major computer systems for 20 years. And if you manufacture computer peripheral equipment, this leadership can work for you a number of ways. You save shopping around, because Brand-Rex has designed and makes available the broadest selection. You can get what other people call "custom" designs at little or no extra cost from us. We're already making it, or can come up with it easily by modifying an existing design. (Brand-Rex engineers turn out as many as 3,000 new versions of wire and cable in a year.)

U.L., MIL-Spec. and other approvals? No strain. Brand-Rex has more U.L. approvals on computer wire and cable than anybody else. Plus the lab and Q.C. facilities to get new ones . . . fast.

Our people catch on to your needs the first time around because they've been around.

Write for our catalog on "Business Machine Wire and Cable" Brand-Rex Division, American Enka Corp., Willimantic, Conn. 06226. Phone 203 423-7771.

Connect for tomorrow. BRAND-REX

MAGNETICS



The Bettmann Archive Inc.

BY ARNOLD



EH? HOW'S THAT AGAIN? When a telephone was truly a luxury and you had to bend both ears to understand the guy on the next block, you paid for it in spades. Today, your friend comes through clear as a bell—from across the continent—thanks to repeater coils that reamplify the gab and Arnold MPP loading cores that eliminate cross talk between closely spaced wires. Elsewhere in communications, Arnold supplies iron-powder and soft ferrite threaded cores for radio/TV, tape cores as circuit inductors and Alnico magnets for a host of communication uses.

Forward-looking manufacturers always look to Arnold for high-quality magnetic materials, design, technology, components. Magnetic cores. Powder cores. Laminations. You ask. We'll supply. The best in magnetic materials.

Other Arnold products are also widely used in communications: Soft ferrite cores Tape and Bobbin cores Alnico and Arnox® permanent magnets Supermendur cores.



Write for your free guide to the only complete line of magnetic materials.



ARNOLD

SPECIALISTS IN MAGNETIC MATERIALS

The Arnold Engineering Company, Main Office: Marengo, Ill.
Branch Offices and Representatives in Principal Cities

Electronics Profit.

How McGraw-Hill's new
Electronics/Management Center
can help you improve it.

We've created a unique information system for the management of companies in and around electronics.

We call it the Electronics/Management Center.

E/MC combines the specialized experience of the publishers of *ELECTRONICS* Magazine, with the broadly-based facilities of McGraw-Hill, one of the world's largest corporations devoted to increasing man's knowledge.

In thirty years of electronics experience, we've accumulated the background and talents to produce the problem-solving tools you need. The kind that are essential when living with lasers, making your way through the implications of Large-Scale Integration, and meeting the technical revolutions yet to come.

Supplement To Internal Systems

For your company, we'll plan, execute, and analyze custom projects—to meet an objective of general, technical, or marketing management. Or to establish a new objective.

Our system is sufficiently diverse to serve as a prime and total information source. Or, it can supplement the most sophisticated company capability. In fact, it may be more efficient to "buy" certain kinds of information from us than it is to "make" it yourself.

Often, we can be faster. Or less

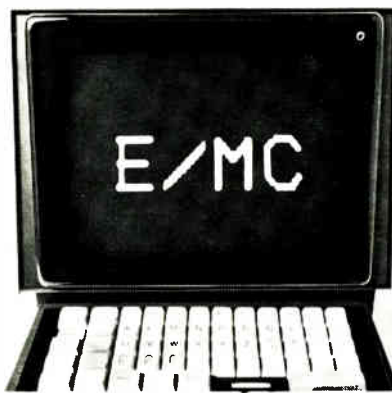

expensive. Always, we can be more objective.

Independent Technical Group

In technical matters, we can provide important assistance without adding overhead or over-loading your present staff. We offer the services of a national organization of university-based scientists and engineers with a long list of accomplishments.

Full Marketing Assistance

We can help you reduce marketing risks, too.

It's difficult to move around the electronics industry without bumping into both customers and competitors in the same corridor. We can probe new market potentials without revealing your identity. Or conduct research in an area not too familiar to your own staff.

We can do it in a neat package that combines access to the market with complete maintenance of confidence.

We can also supply those complex services you'd like to have created outside if you could find someone who speaks your language. Services like seminars, to educate customers, or train technical and marketing staffs, or develop management skills.

Weekly News Service

Management will also find our weekly news service an invaluable working tool. In minimum reading time each week, the *Electronics/Management Advisory Service* can keep your company current on the important electronics developments around the world. Market changes, prices, contracts, finances, significant trends, even a telephone number to call for person-to-person consultation—all the essentials to provide an information base on which to make top management decisions. For the next week. Or the next five years.

If you believe, as we do, that better information can help make your company more profitable, and you would like to know more about our services, write to: Electronics/Management Center, 330 West 42nd Street, New York, New York 10036.

E/MC
Electronics/Management Center
A McGraw-Hill Information Service

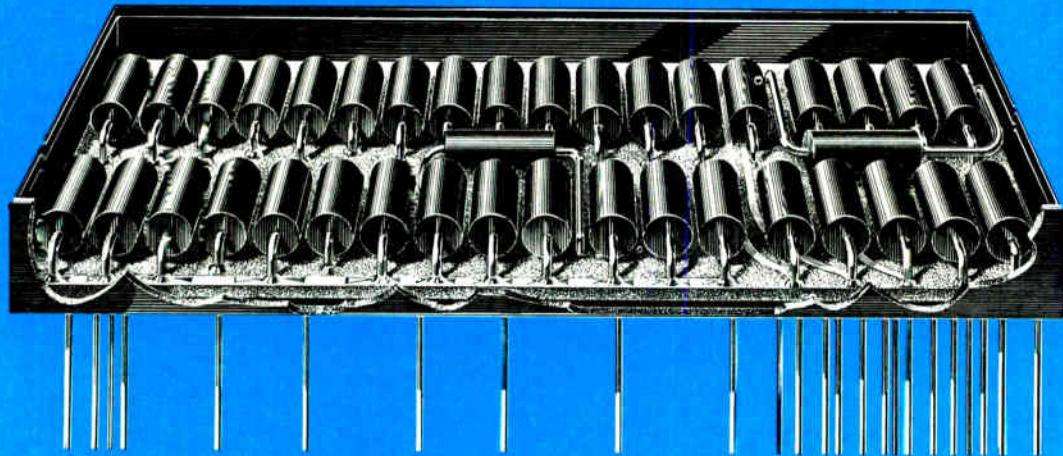

16 million hours of test time without a single failure.

ITC Riedon precision wirewound resistors combine this high reliability with close temperature coefficients, close tolerances, fast rise time and small size.

More specifically, they give you:

- Stability to 0.002%, provided by actually fusing resistance elements to terminations. Thermal emf is negligible.
- Standard temperature coefficient of 0 ± 10 ppm/°C above 100 ohms to 0 ± 30 ppm/°C for 0.1 to 9 ohms between -65°C and $+150^{\circ}\text{C}$.
- Standard tolerance range from 1% down to 0.005%, measured at 25°C .
- Operation to 175°C , made possible by unique hot encapsulation, which eliminates virtually all moisture and voids.
- Rise time as fast as 10 nanoseconds up to 100KHz frequency input. (This puts

wirewounds where metal film was once the only solution.)

This performance should come as no surprise. Riedon originated the molding process for encapsulating resistors in epoxy. They were first to produce a molded epoxy encapsulated precision wirewound resistor that exceeded MIL-R-39005 and MIL-R-38100. They have qualified to the latest military specifications covering "Hi-Rel" parts (a failure rate of less than 0.01%/1,000 hours at 125°C and 60% confidence level).

These same resistors go into Riedon networks. We design and package

them in ladders, voltage dividers, analog-to-digital converters, operational amplifiers or miniaturized components. Combined with capacitors, conductors or diodes in a hermetically sealed package, one ITC Riedon element can replace 20 or more individual items.

We have a new 12-page folder that tells the full performance story of Riedon resistors. Why not send for a copy? ITC Riedon, a division of Industrial Technology Corporation, a subsidiary of Republic Corporation, 7932 Haskell Avenue, Van Nuys, California 91406 (213) 873-3464.



ITC RIEDON 



What is Bunker-Ramo collecting 3 miles under the ocean?



Deep Sonar Breadboard



Several Deep Acoustic Systems

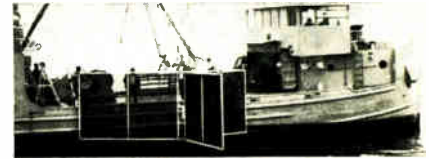

Sea Test of Torpedo Tracking System Array

Reliable Acoustic Path data . . . vitally significant in developing advanced deep-operating sonar systems for use in anti-submarine warfare and oceanography.

Bunker-Ramo's extensive knowledge of the ocean's inconstant properties related to propagation, reverberation and ambient noise as well as its effects on materials enable us to set the pace in the field of oceanology.

In the past 10 years we developed many unique products and services . . . expendable acoustic sonar systems that utilize our special knowledge of Reliable Acoustical Path phenomena

. . . deep moored fixed acoustic buoy systems . . . oceanographic data collection and processing . . . off-shore navigation equipment . . . checkout instrumentation, data displays . . . signal processing techniques . . . miniature hydrophones . . . ASW avionics . . . portable torpedo tracking and testing systems . . . sound velocimeters . . . at-sea testing . . . as well as the design and manufacture of equipment using advanced pressure-insensitive microelectronics.

If your program requires integrated system engineering or development of special-purpose equipment — or both — contact Bunker-Ramo.

THE BUNKER-RAMO CORPORATION
DEFENSE SYSTEMS DIVISION
 8433 FALLBROOK AVENUE • CANOGA PARK, CALIFORNIA 91304

AN EQUAL OPPORTUNITY EMPLOYER

Meetings

Wescon: Semiconductors by the Bay

The burgeoning impact of semiconductors is reflected in the 23 technical sessions to be held at the Western Electronic Show and Convention (Wescon), August, 19-22 at the Cow Palace in San Francisco. Eleven sessions deal in some way with semiconductor devices—whether it be automatic handling of them, the use of integrated circuits in active filters, how one designs high-frequency circuits up into the microwave region with computer assistance, the special world of metal oxide semiconductors, or the changing interface between IC manufacturers and systems designers.

In both the Wescon sessions and those associated with the International Electronic Circuit Packaging Symposium held concurrently August 20 and 21, the industry's growing desire to be rid of the problems associated with lead bonding are evident because both will devote a session to the topic. Those attending the packaging symposium will hear cases for flip chips, beam leads, and spider bonding by representatives of Intersil, Raytheon's Semiconductor operation, and Motorola's Semiconductor Products division, respectively, plus a talk on production equipment for these new packages by Hans Wagner, technical director of Hugel Industries. Beam leads, spider bonding, and IBM's solid-logic technology will also get a workout in a Wescon session entitled "handling microcircuits automatically."

Computer help. Microwave semiconductors will come in for a fair share of attention in two Wescon sessions: "Current Solid State Microwave Devices and Circuits," and "Computer-Aided Design of High-Frequency Circuits." The latter includes papers on computer design of gallium-arsenide impatt diodes and microwave IC's, plus one on computer-aided small-signal transistor modeling. The former will offer papers on ultrahigh-frequency microcircuits, bulk gallium-

arsenide and impatt microwave sources, and microwave transistor amplifier design.

The session on "MOS IC's: a Critical Review," could cause some sparks because of the controversial nature of some of the speakers and the companies they represent: Glen Madland of the Integrated Circuit Engineering Corp., who will discuss the designer's dilemma; Larry Drew of the Viatron Computer Systems Corp., whose topic is "In-Depth User-Vendor Dialogue Is a Must;" and Alvin Phillips of Autonetics, who will do some crystal-ball gazing in a talk entitled "The Promise of Things to Come." Both Viatron and Autonetics have been the target of critics in the industry because of skepticism that Viatron will succeed with its System 21, and doubt that Autonetics—a military-oriented entity—will make a go of its new commercial microelectronics products division.

The technical portion of the program also reflects the increasing emphasis on production equipment, instrumentation, and display technology evident in the exhibits at recent Wescon shows. There are sessions on high-speed oscilloscope recording, automatic production of semiconductors, large system data displays, and instrumentation for high-speed phenomena.

Among the top semiconductor manufacturers, only Signetics is bucking the trend away from Wescon exhibits; the firm will introduce 181 new IC's at the show.

For information contact Dalton W. Martin, Vidar Corp., 77 Ortega Ave., Mountain View, Calif. 94040.

Calendar

Conference on Instrumentation Science, Instrument Society of America; Hobart and William Smith College, Geneva, N.Y.; July 28-Aug. 1.

(Continued on p. 24)



ASW Engineers: Sound Us Out About A Career.

- **SONAR SYSTEMS DESIGN** — Interactions between medium and reliable acoustic pattern systems design.
- **SR. CIRCUIT DESIGN** — Electro-acoustic detection systems — active & passive. Sound Interesting?

Call or send resume to:
D. O. Kalal (213) 346-6000 Ext. 251



THE BUNKER-RAMO CORPORATION
DEFENSE SYSTEMS DIVISION
8433 FALLBROOK AVENUE • CANOGA PARK, CALIFORNIA 91304

AN EQUAL OPPORTUNITY EMPLOYER



How to Buy a Good Power Supply Without Spending a Bundle . . .

Take a long look at the Abbott line of over three thousand standard models *with their prices listed*. The unit shown above, for instance, is the Abbott Model AL6D-27.6A, a DC to DC converter which puts out 28 volts of regulated DC at two amps and sells for only \$220.00. Other power outputs from 5 to 240 watts are available with *any output voltage from 5 volts to 10,000 volts*, all listed as standard models in our catalog. These converters feature close regulation, short circuit protection, and hermetic sealing for rugged application found in military environment.

If you really want to save money in buying your power supply, why spend many hours writing a complicated specification? And why order a special custom-built unit which will cost a bundle — and may

bring a bundle of headaches. As soon as your power requirements are firmed up, check the Abbott Catalog or EEM (see below) and you may be pleasantly surprised to find that Abbott already has standard power supplies to meet your requirements — *and the prices are listed*. Merely phone, wire, or write to Abbott for an immediate delivery quotation. Many units are carried in stock.

Abbott manufactures a wide variety of different types of power supply modules including:

- 60 ∞ to DC, Regulated
- 400 ∞ to DC, Regulated
- 28 VDC to DC, Regulated
- 28 VDC to 400 ∞ , 1 ϕ or 3 ϕ
- 60 ∞ to 400 ∞ , 1 ϕ or 3 ϕ

Please write for your FREE copy of this new catalog or see EEM (1968-69 ELECTRONIC ENGINEERS MASTER Directory), Pages 1727 to 1740.

abbott transistor

LABORATORIES, INCORPORATED

5200 W. Jefferson Blvd./ Los Angeles 90016
(213) WEBster 6-8185 Cable ABTLABS

TO: Abbott Transistor Labs., Inc., Dept. 87
5200 West Jefferson Blvd.
Los Angeles, California 90016

Sir:
Please send me your latest catalog on power supply modules:

NAME _____ DEPT. _____

COMPANY _____

ADDRESS _____

CITY & STATE _____

Meetings

(Continued from p. 23)

Seminar on Case Studies in System Control, IEEE; University of Colorado, Boulder; Aug. 4.

Joint Automatic Control Conference, IEEE; University of Colorado, Boulder, Colo.; Aug. 5-7.

Third Annual Contemporary Filter Design Seminar, University of Missouri, Columbia, Mo.; Aug. 5-8.

International Photoconductivity Conference; Stanford University, Palo Alto, Calif.; Aug. 12-15.

Western Electronic Show & Convention (Wescon), IEEE; Cow Palace & San Francisco Hilton Hotel, San Francisco; Aug. 19-21.

Symposium on Programing Languages Definition, Association for Computing Machinery; San Francisco; Aug. 24-25.

Defects in Electronic Materials for Devices, Metallurgical Society of the American Institute of Mining, Metallurgical, and Petroleum Engineers; Statler-Hilton Hotel, Boston; Aug. 24-27.

ACM National Conference and Exposition, Association for Computing Machinery; San Francisco Civic Center; Aug. 26-28.

Cornell Biennial Conference on Engineering Applications of Electronic Phenomena, IEEE; Cornell University, Ithaca, N. Y.; Aug. 26-28.

Education and Training Technology International Convention, IEE; London, England; Sept. 2-6.

Electrical Insulation Conference, IEEE; Sheraton-Boston Hotel & War Memorial Auditorium, Boston; Sept. 7-11.

European Microwave Conference, IEE; International Symposium on Man-Machine Systems, IEE; St. John's College, Cambridge, England; Sept. 8-12.

Convention of the Society of Logistics Engineers; Cape Kennedy Hilton Hotel, Cape Kennedy, Fla., Sept. 9-10.

Petroleum & Chemical Industry Tech. Conference, IEEE; Statler Hilton Hotel, Los Angeles; Sept. 14-17.

International Telemetry Conference, International Foundation for Telemetering, Sheraton Park Hotel, Washington, D.C.; Sept. 15-17.

Conference on Trunk Telecommunications by Guided Waves, IEE; London, England; Sept. 15-17.

(Continued on p. 26)



Desk-type hp 9100A programmable calculator. Provides dynamic range from 10^{-98} to 10^{99} with resolution to 10 significant figures, and a memory which accommodates 196 program steps. Printed circuit board from calculator shows extensive use of Allen-Bradley hot-molded resistors.

"We specify Allen-Bradley hot-molded resistors for quality, reliability, price and delivery"

Hewlett-Packard

TYPE BB 1/8 WATT

TYPE CB 1/4 WATT

TYPE EB 1/2 WATT

TYPE GB 1 WATT

TYPE HB 2 WATT



A-B hot-molded fixed resistors are available in all standard resistance values and tolerances, plus values above and below standard limits. A-B hot-molded resistors meet or exceed all applicable military specifications including the new Established Reliability Specification at the S level. Shown actual size.



ALLEN-BRADLEY
QUALITY ELECTRONIC COMPONENTS

The computer-like capabilities in this compact hp Model 9100A Calculator have placed severe demands on component performance. Reliability must be of the highest level.

Allen-Bradley hot-molded resistors completely meet the challenge. This is shown by the fact that they satisfy the requirements of the latest MIL-R-390008A Established Reliability Specifications at the *highest* level—the S level. This is true for all three ratings—the 1 watt, ½ watt, and ¼ watt—over the *complete* resistance range from 2.7 ohms to 22 megohms!

The unsurpassed performance of A-B resistors results from an exclusive hot molding manufacturing technique. The equipment is fully automatic—developed and used only by Allen-Bradley. The "built-in" precision control ensures the highest uniformity from resistor to resistor—year after year. Physical properties are constant. Performance is predictable.

For complete specifications on this quality line of hot-molded resistors, please write to Henry G. Rosenkranz and request Technical Bulletin 5000. Allen-Bradley Co., 1201 S. Second St., Milwaukee, Wis. 53204. Export Office: 1293 Broad Street, Bloomfield, N. J., U.S.A. 07003. In Canada: Allen-Bradley Canada Limited.

Life insurance for all light beam galvanometers. Only \$135 per channel.

The 1-172 Universal Galvanometer Driver Amplifier is probably the most important advance this year in oscillography. And for one basic reason. It safely permits the use of oscillographs in applications where only oscilloscopes were economically practical.

With the 1-172, you no longer face the expense and inconvenience of galvo damage and repair. If an overload condition occurs, the galvo automatically goes to a safe maximum deflection, and the trace is broadened to indicate overload.

Furthermore, the amplifier protects *all* existing light beam galvanometers.

The cost for our 2-channel, portable model is only \$270. Not much more than the price of a good galvo. The 4-channel model costs twice as much, but can still be delivered within 45 days.

For all the facts and possibilities, call our nearest office. Or write Bell & Howell, Pasadena, California 91109. Ask for Bulletin Kit 3313-X1.

CEC/DATA INSTRUMENTS DIVISION



BELL & HOWELL



Meetings

(Continued from p. 24)

Solid State Devices Conference, IEE; University of Exeter, Exeter, Devon, England; Sept. 16-19.

Symposium on the Biological Effects and Health Implications of Microwave Radiation, Biophysics Department of the Virginia Commonwealth University, Bureau of Radiological Health, Environmental Control Administration, and U.S. Public Health Service; Richmond, Va.; Sept. 17-19.

Annual Broadcasting Symposium, IEEE; Mayflower Hotel, Washington; Sept. 18-20.

Joint Power Generation Conference, IEEE, American Society for Mechanical Engineers; Charlotte, N.C.; Sept. 21-25.

Annual Intersociety Energy Conversion Engineering Conference, IEEE, American Society for Mechanical Engineers; Statler Hilton Hotel, Washington; Sept. 21-26.

Ultrasonics Symposium, IEEE; Chase Park Plaza Hotel, St. Louis, Mo.; Sept. 24-26.

Short courses

Numerical Solutions in Heat Transfer and Fluid Mechanics, Pennsylvania State University, University Park; July 27-Aug. 1. \$200 fee.

Applications of Computers to Automated Design, University of Michigan, Ann Arbor; July 27-Aug. 1. \$225 fee.

Computers and Modern Process Control—a Course for Engineering Production Managers, Purdue University, Lafayette, Indiana; July 28-Aug. 1. \$150 fee.

Call for papers

Asilomar Conference on Circuits and Systems, Naval Postgraduate School, University of Santa Clara, and Stanford University, IEEE; Asilomar Hotel and Conference Grounds, Pacific Grove, Calif., Dec. 10-12. Oct. 3 is deadline for submission of abstracts to Prof. Shu-Park Chan, Department of Electrical Engineering, University of Santa Clara, Santa Clara, Calif. 95053.

Seoul International Electrical and Electronics Engineering Conference, IEEE; Seoul, Korea, Sept. 2-4, 1970. Jan. 31 is deadline for submission of papers to Prof. Sung Kae Chung, Chairman of Technical Committee, c/o KIST, P.O. Box 131, Cheong Ryang Seoul, Korea.

tricky tapers...

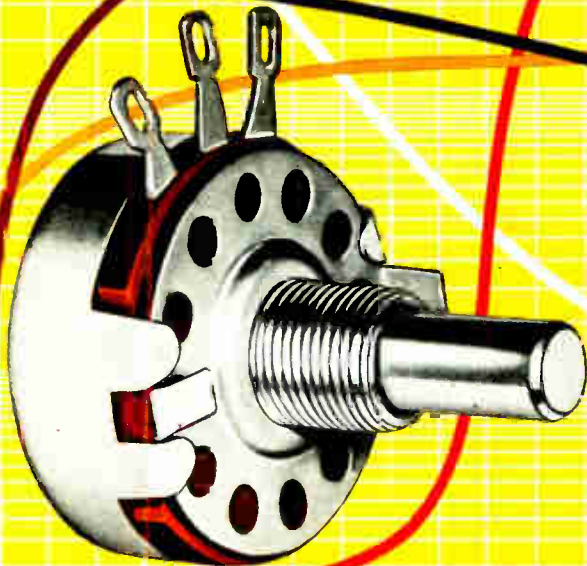

Allen-Bradley Type J
hot molded variable resistor
shown twice actual size

Allen-Bradley Type J potentiometers offer tapers designed to your special needs!

■ When standard tapers fail to provide the control you desire, Allen-Bradley Type J potentiometers have the unique capability to provide a virtually limitless variety of curves to meet your specialized requirements. While not a precision device that is continuously taper-trimmed to very close tolerances, Allen-Bradley's control of the resistance-rotation characteristics during production assures a high degree of conformity.

Allen-Bradley Type J potentiometers have a solid hot molded resistance track made by an exclusive process which was pioneered and perfected by A-B. This solid resistance track assures smooth adjustment at all times—with none of the discrete changes in resistance that are encountered in wire-wound units. And being essentially noninductive, Type J controls can be applied in high frequency circuits where wire-wound units are useless. Furthermore, A-B's solid molded resistance track assures low noise and long life.

For more complete details, please write: Allen-Bradley Co., 1201 S. Second St., Milwaukee, Wis. 53204. Export Office: 1293 Broad Street, Bloomfield, New Jersey, U.S.A. 07003. In Canada: Allen-Bradley Canada Limited.

COMPLETE LINE OF FRONT PANEL CONTROLS AND TRIMMING RESISTORS

The Allen-Bradley family of controls can meet virtually any requirement. There are hot-molded composition and cermet types. Single-turn and multi-turn units. Types to meet military requirements. There are ultra-compact units, and units that offer special tapers and special resistance. Standard resistances are from 50 ohms through 5.0 megohms. Operating temperatures from -65°C through $+150^{\circ}\text{C}$ can be met. All A-B controls feature smooth adjustment with almost infinite resolution and low inductance for high-frequency operation.

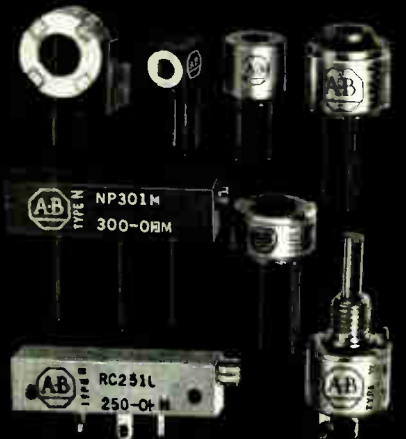

ALLEN-BRADLEY
QUALITY ELECTRONIC COMPONENTS



©Allen-Bradley Company 1969

Circle 27 on reader service card

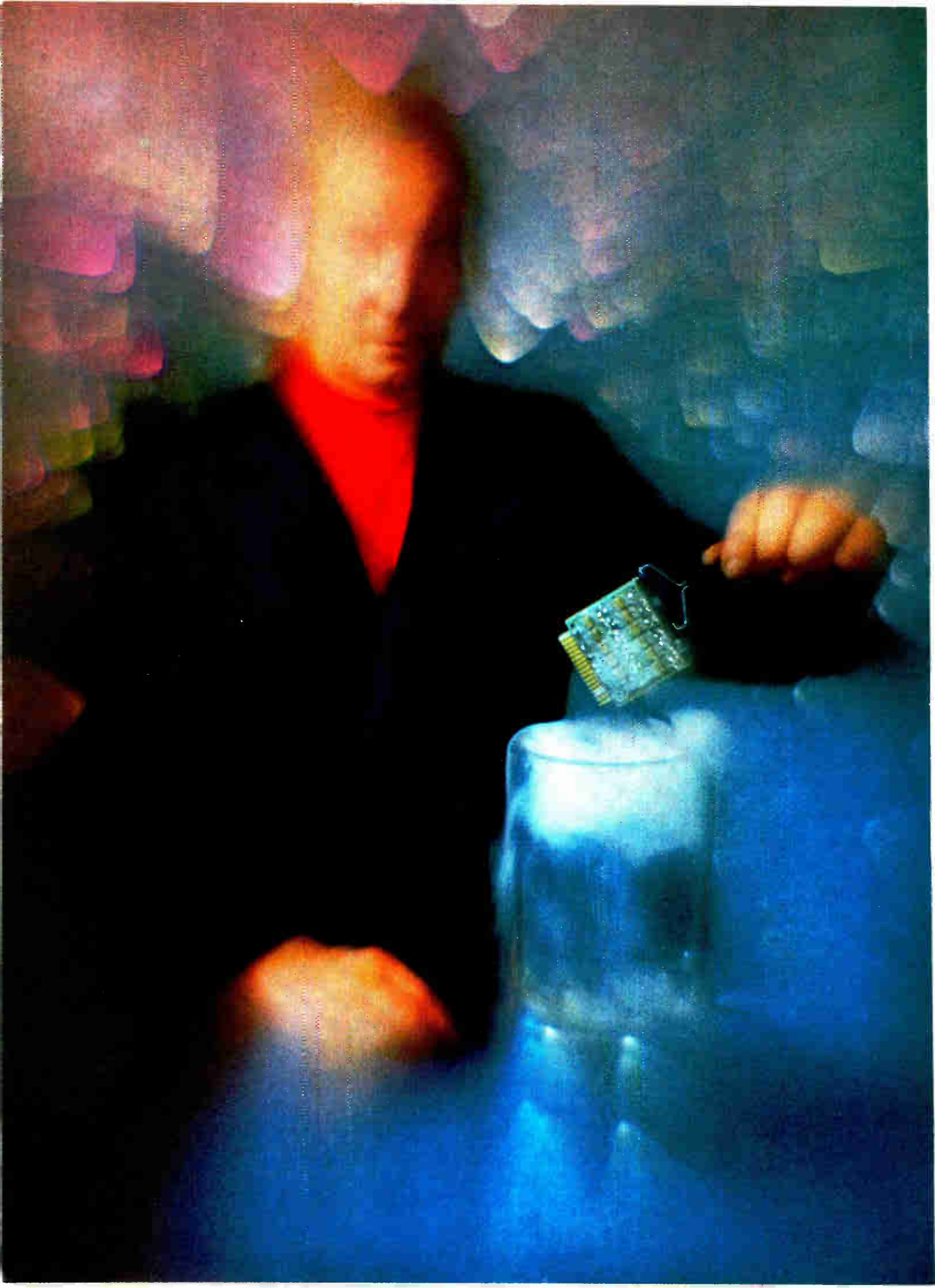

Honeywell computers won't say "Uncle..." that's Ultramation

How much punishment will Honeywell computers take? To find out, we put our DDP-516 computer and μ -PAC logic modules to the test — abuse that would stop ordinary equipment cold.

At the Spring Joint Computer Conference, we pulled a μ -PAC module out of an operating DDP-516. Then dipped the module in liquid nitrogen at -320°F . Then placed the frost-covered unit back into the computer and restarted the program . . . 178 times with the same module . . . with zero failures!

Next we belted a Ruggedized DDP-516 computer with several hundred bone-crushing blows from a 10-pound sledge hammer. Everyone from husky engineers to a black-belt karate champ took a whack. Max mum force: 28g! The computer didn't miss a beat.

This same ruggedized computer recently passed grueling qualification tests at Avcc's test lab. The computer was shaken, shocked, rocked, frozen, baked, swept to a 10,000-foot altitude and bombarded with sudden changes in power input. It still wouldn't quit. Result: certification that the computer meets applicable military and shipboard specifications.

We still don't know how much punishment it takes to make our equipment say "Uncle." That's Ultramation . . . the ultimate in reliability from Honeywell.

Write for new literature. You'll get details on the Ruggedized DDP-516 (now including electromagnetic-interference suppression as standard) and μ -PAC logic modules. Honeywell, Computer Control Division, Framingham, Mass. 01701.



Honeywell
AUTOMATION

Circle 29 on reader service card

Light Sensors



Any bright ideas?

How about a detector to track the sun, moon and stars for an inertial navigation system. Or an optoelectronic array to read punched cards and tape. Or in recognition equipment such as credit card readers, check recorders and bill changers.

Maybe a brushless motor needed in an explosive environment, or a tone generator for an electric organ. And there are burglar alarms, optical sound track readers and infrared film recorders. Also accelerometers and gyros. And instruments for measuring gas, liquids and even freight packages.

TI's light sensors are 1000 times faster than the electromechanical

devices they replace and they're up to 20 times more reliable.

TI has eleven light sensors and two light emitters in its line of preferred semiconductors. That means they're "application proven," in volume production and are readily available from distributor and factory stocks.

For TI's *Preferred Semiconductors and Components* catalog, write Texas Instruments Incorporated, PO Box 5012, MS 308, Dallas, Texas 75222.

Or simply circle reader service card number 160.



TI Preferred Light Sensors and Emitters		
LIGHT SENSORS	PACKAGE/LENS	SENSITIVITY
1N2175	Elongated/Round	0.1 mA
LS400	Elongated/Round	1.0 mA
LS600	Std/Round	0.8 mA
TIL601	Std/Round	0.5-3 mA
TIL605	Std/Flat	0.5-3 mA
TIL602	Std/Round	2-5 mA
TIL606	Std/Flat	2-5 mA
TIL603	Std/Round	4-8 mA
TIL607	Std/Flat	4-8 mA
TIL604	Std/Round	7 mA
TIL608	Std/Flat	7 mA
LIGHT EMITTERS	PACKAGE/LENS	POWER OUTPUT
TIL01	Std/Round	50 mW
TIL09	IR/Flat	500 mW

TEXAS INSTRUMENTS
INCORPORATED

Editorial comment

A question of bad business

Manufacturers representatives, by their own estimates, account for 30% to 50% of all electronic components and subassemblies sold in the U.S. Yet, the reps are often treated as orphans by the very manufacturers they represent. The reps complain loud and often, mostly on these points:

- **Attention, service and delivery.** Says one rep: "Many principals [manufacturers] are production and engineering oriented. They aren't flexible when a customer requires service other than what the principal considers normal." Another says it's impossible to create a sense of urgency on the part of most principals.

- **Communications.** Most reps assert that it takes too long to get a response from the factory office and that frequently rush requests for information are completely ignored. One suggests that communications are too sloppy. "I'd appoint one person at the plant to handle all communications with some or all of the reps, and give that person authority to see that rep inquiries are expedited," he says. Delays can cost sales, he points out.

- **Manufacturers' employees.** Employees of principals who are assigned to deal with reps are often

condemned for inability and complacency. Sales correspondents, in particular, are singled out for criticism because they are relatively inexperienced; some have no sales experience whatsoever.

- **Technical support.** About half of the reps surveyed by *Electronics* decry the inadequacy of technical literature. Others point to the complete lack of manufacturer-sponsored technical training for the reps' own staffs (50% or more of whom are usually engineers).

U.S. manufacturers are under fire from overseas, too. A Swedish rep says U.S. principals don't give letters from overseas the same priority as those from the U.S.; some foreign letters are even downgraded because of poor English. This, he points out, could mean a loss of potential business to the manufacturer. Sales meetings, he says, deemed by U.S. manufacturers as an absolute must for both their own salesmen and their U.S. reps, are often overlooked completely for their overseas reps.

While not all manufacturers can be taken to task by their reps, many clearly can. And the first steps toward resolving these problems lie with them. It's simply a matter of good business. ■

Ending conference boredom

Many attendees of this year's IEEE Computer Group Meeting held in Minneapolis came away sadly disappointed. They had traveled from distant points only to be served up a hodge-podge of papers that were either too old or too theoretical, or simply lacking in significance. The frustration was all the keener for those who had attended the session last year in Los Angeles and the one a year earlier in Chicago. Those highly successful conferences lived up to their advanced billing as information exchange meetings aimed at helping hardware-oriented computer engineers.

Where did this year's meeting go wrong? Perhaps it was because many of the conference organizers and speakers came from universities—some 40% this year, compared with less than 5% in 1968.

Next year's meeting may also be wanting, but for different reasons. Its theme, "Engineering and Design of Memories and Peripherals," is a tall order. Perhaps too tall. The committee may find that trying to cover both memories and peripherals does justice to neither. For the first time, too, the conference will have a hardware exhibit. The exhibit may enhance the conference, but some engineers fear that administering the exhibit will be at the expense of improving the technical program. They

want a program that's not only stronger, but one that is so strong the conference could become as prestigious as the International Solid State Circuits Conference, which, incidentally, bars commercial exhibits.

In contrast to the IEEE Computer Meeting, the Fall Joint Computer Conference, sponsored by the American Federation of Information Processing Societies, promises an all-out war on meeting tedium. Its organizers promise papers that not only meet the most rigorous technical requirements, but are "audience oriented and dynamic" as well. Authors of accepted papers will be urged to attend a pre-FJCC seminar where they will be given tips on how to present a paper orally and how to use visual aids. At the conference itself, authors will be expected to use their written paper merely as a starting point. The oral version could conceivably turn out to be an illustrated presentation of selected highlights. Speakers will be required to submit their visual aids for review before presentation.

We applaud the FJCC committee's concern for conference attendees. Perhaps the 1970 IEEE Computer Conference committee, as well as others who face similar challenges, would do well to take a page from FJCC's book. ■

Is your passive component supplier as reliable as his components?

He's fine at meeting industry specifications. Even exceeding them. But what about customer service? Does he sometimes act as if that's a necessary evil? And have you been telling yourself that you have to put up with this kind of an attitude in order to be sure of getting components that are truly reliable?

Then it's time you learned about us. We're one of the leaders in component reliability—and we deliver in every other area as well. You bet we meet deadlines—speed samples—maintain competitive prices—and provide prompt technical assistance. If this kind of extra reliability would be a nice innovation, why not put us to the test. Give us an urgent request for technical assistance. Or an urgent

order. Write AIRCO SPEER ELECTRONIC COMPONENTS, St. Marys, Pennsylvania 15857. Then watch us perform.



The passive innovators at **AIRCO** Speer

Speer resistors Resistor and conductor paste Jeffers JC precision resistors Jeffers JXP precision resistors and networks Jeffers inductors Jeffers capacitors PEC variable resistors and trimmer potentiometers.

Circle 32 on reader service card

Electronics Newsletter

July 21, 1969

Samsco pushes 621B to commercial use . . .

The Air Force apparently is trying to broaden support for the 621B navigation-satellite program by emphasizing the system's potential use in commercial aviation. A pending Space and Missile Systems Organization (Samsco) contract with Boeing includes computer-simulated flight tests modeled on a 747 and other commercial planes, and at least one advanced military aircraft. Another contract, with Grumman, will center on naval air operations.

The 621B will probably go to the contract definition phase by late summer or early fall.

Meanwhile, Magnavox is negotiating with Samsco for a correlation-receiver development contract that was to go to Hughes Aircraft. Magnavox is developing the receiver, but Hughes was to have an administrative role. TRW is also working on a receiver and will deliver a breadboard version to Samsco, as will Magnavox.

. . . as airline eyes Navy's Omega setup

At least one airline is interested in the Navy's Omega navigation system to get around the higher cost of inertial navigation systems. Continental Airlines or its subsidiary, World Airways, will begin flight tests early in August with an airborne Omega package built by Northrop's Electronics division (formerly Nortronics). Northrop has a contract for 140 Omega receivers for Navy ship use, and is developing the Navy's airborne version, which includes a computer in the same box with the receiver. One of the units will be installed in a Boeing 707, possibly for polar flights to London and back from a West Coast airport.

Northrop officials estimate a commercial airborne Omega system will cost less than \$50,000 per copy as opposed to about \$100,000 for an Arinc 561 inertial navigation system. Loran and Decca systems are more accurate than Omega, which operates at 10 kilohertz, but they don't offer the worldwide coverage that Omega will boast when all eight transmitters are on the air by fiscal 1972.

NASA aims laser of its own at moon

The Air Force Cambridge Research Laboratory will not be alone in conducting lunar ranging experiments by bouncing laser beams off the corner reflector that Apollo 11 astronauts are to leave behind on the moon [*Electronics*, June 23, p. 57]. NASA will perform lunar ranging studies using a laser that packs more power into a shorter-duration pulse than the 1-gigawatt unit built by Hughes for the AFCRL experiments. The NASA-sponsored investigative team, headed by the University of Maryland's Carroll O. Alley, will use a ruby laser made by the Korad department of Union Carbide's Electronics division.

The ruby system develops 1.75 gw, has a pulse width of 5 nanoseconds or less (vs. 10 for Hughes), and a pulse repetition rate of 20 pulses per minute. It will be pumped through the 107-inch telescope of the University of Texas McDonald Observatory at Fort Davis, Texas.

The long-term studies are aimed at determining how much the moon wobbles out of its orbit, the distribution of the moon's interior mass, and continental shifts on earth. The experiment might also shed more light on the "Chandler wobble," the earth's wobble on its axis, which some scientists believe is related to earthquakes.

Electronics Newsletter

Bay's firm to sell time-share system

Thomas Bay, former general manager of Fairchild Semiconductor who resigned when C. Lester Hogan joined Fairchild, has been named board chairman of Central Data Systems of Sunnyvale, Calif.

Central Data is going after the time-sharing computer market. **Bay feels time sharing is growing so quickly that it's becoming profitable for companies to own their own computers rather than depend upon service bureaus.** His firm will enter the market in nine to 12 months with a 32-bit computer which Bay calls one of the few designed with time sharing applications foremost—"it's not just a revamped general-purpose machine." A 30-to-50-terminal system would cost "significantly less than half a million," Bay says.

Officials wrestle with Tacan award

In a battle that has turned into a political hot potato, high Pentagon officials are trying to decide whether Hoffman Electronics, Motorola, or ITT should supply 526 AN/ARN-84 microminiaturized digital Tacan navigational units. The contract is worth between \$12.5 million and \$15 million.

Hoffman was believed to be the winner when ITT protested what it called the Navy's failure to evaluate all technical criteria. Insiders say the Navy is preparing a rebuttal to ITT's charges, while Hoffman is reported to be confident that it will be the winner despite the delay and controversy.

1,400 at Sperry join engineers' union

The International Union of Electrical and Machine Workers (IUE), flushed with success, is forging ahead with its plans to organize engineers and engineering assistants, claiming it will announce more victories before year's end.

Latest win came at Sperry Gyroscope in Great Neck, N. Y., where the union picked up 1,400 engineering personnel earlier this month. It's the union's biggest engineering haul so far, topping the 700 engineers who joined late last year at Western Electric's Kearny, N.J., plant.

Within the next two weeks, the IUE hopes to pick up another 200 Sperry engineers in a separate election. Spearheading the effort to organize engineers in electronic and electrical areas in Sanford V. Lenz [*Electronics*, March 31, p. 123], a young engineer whose contention is that engineers are ripe for unionization.

Addenda

Following Lockheed's decision to develop a growth system for the L-1011 that could provide both area and long-range inertial navigation [*Electronics*, July 7, p. 33], Litton is taking a cut at the area and terminal navigation problem. **Some 30 vor stations will be catalogued into the computer associated with Littons LTN-51 inertial navigation system.** The computer samples and locks to a given station, taking bearing and distance data to update the inertial position. . . . As MOS sales grow, so does the list of firms offering such devices. **Latest to be added is Amelco Semiconductor,** which has available the first in a series of p channel MOS FET's. . . . RCA is preparing specifications for competitive procurement of microwave hardware, towers, and direct-dialing equipment for the Alaska communications system. **Those will be the three major packages involved in expanding the phone system purchased from the Government for \$28.4 million.** It had been run by the Air Force.

MEET THE MC1596G "PRIVATE EYE"

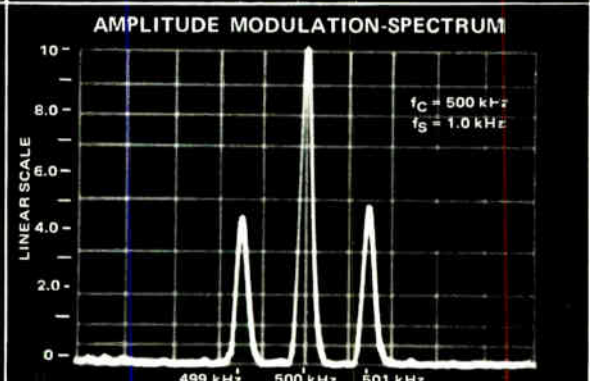
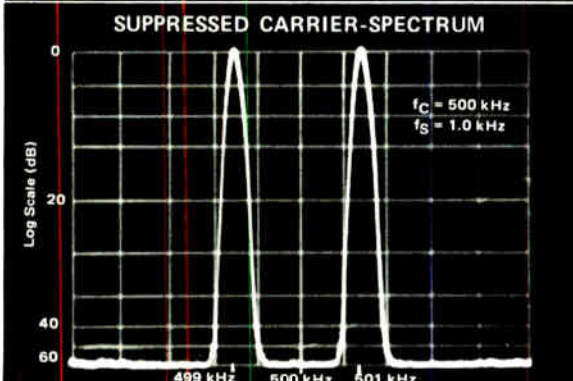
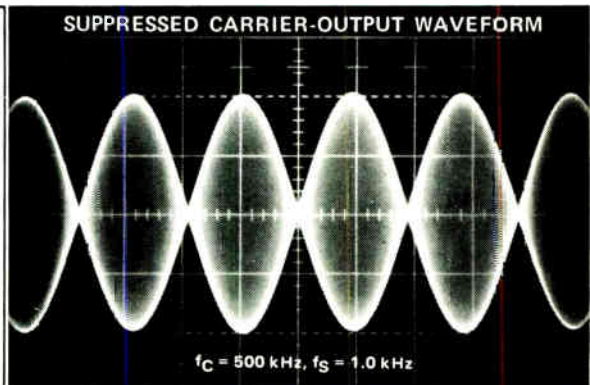
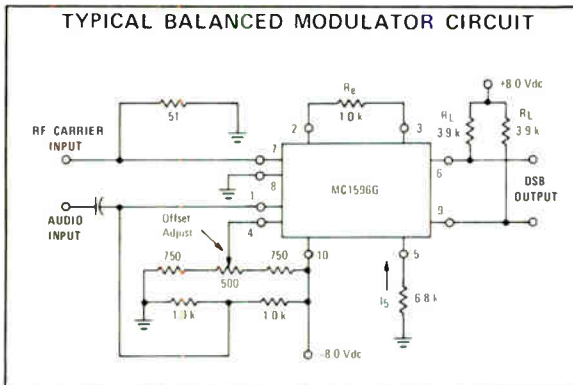

For Hire in Your "Detecting" Jobs!

What's the caper? Synchronous Detection? FM Detection? Phase Detection? MC1596G is the monolithic Balanced Modulator/Demodulator that can handle all of them, and then some. Other capabilities include: Suppressed Carrier and Amplitude Modulation plus chopper applications.

Here are the credentials for the MC1596G that make possible "better than discrete" design performance at the low, 100-up price of \$4.80.

- Closely-matched transistors "on the chip"

provide higher Carrier Suppression in Balanced Modulator applications . . . like 60 dB (typ) at 0.5 MHz - and, the MC1596G drastically reduces spurious signals.

- Adjustable gain and signal handling.
- Balanced inputs and outputs.
- High common-mode rejection—85 dB (typ).

MC1596G comes equipped with a 10-pin metal package - - for both industrial and military activities - - and operates over the full range of temperatures, from -55 to $+125^\circ\text{C}$. You can put the MC1596G to work on your case by talking to your Motorola Semiconductor distributor. Call him today.

—where the priceless ingredient is care!



MOTOROLA
Integrated Circuits

Motorola Semiconductor Products Inc. / P.O. Box 20912 / Phoenix, Arizona 85036

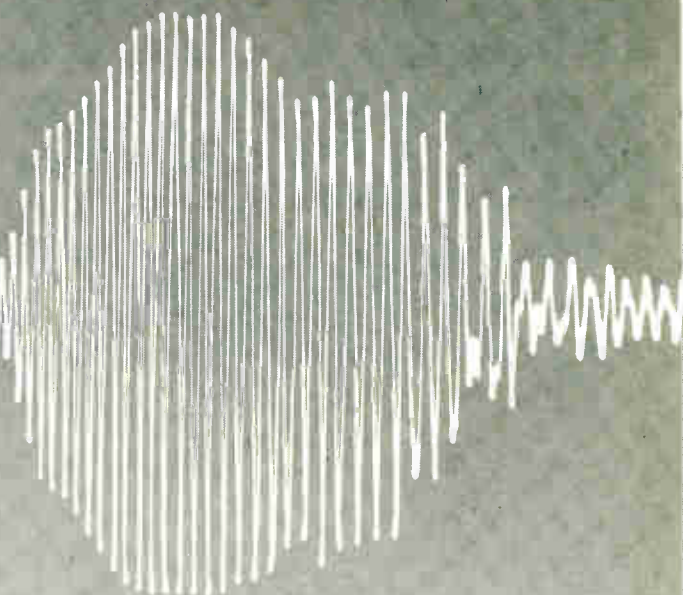
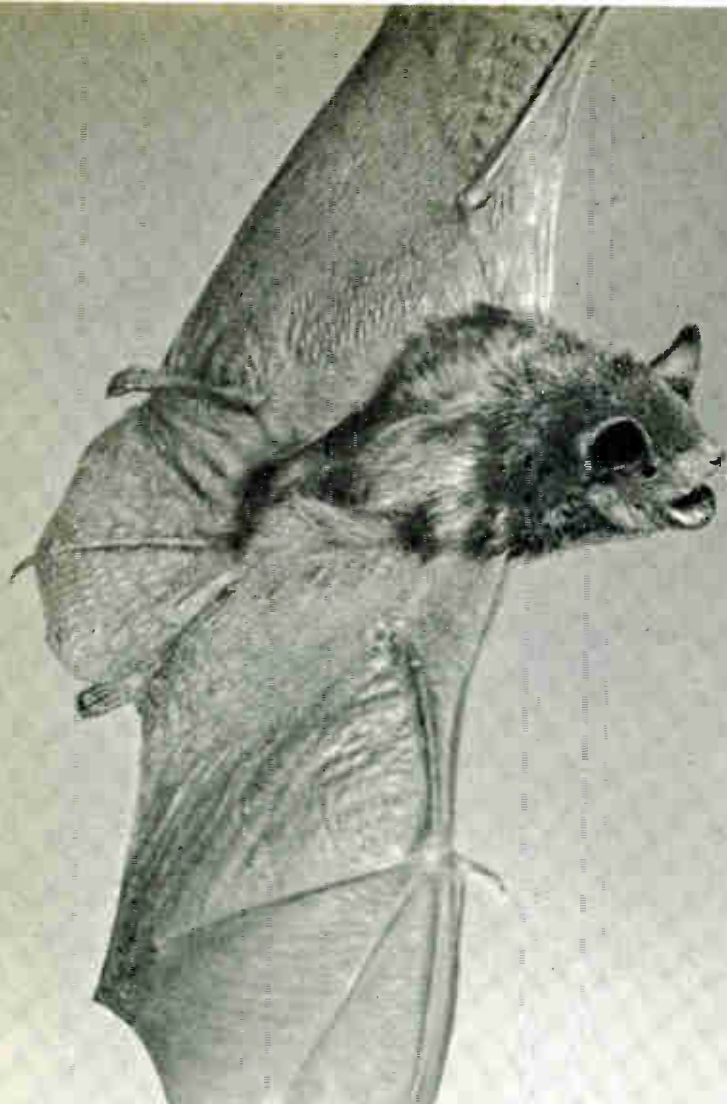

ANALYZE EVEN THE MOST COMPLEX SIGNALS . . .

Recent research into the cry of the bat provides us with an unusual opportunity to demonstrate the ability of our Correlation Function Computer and Fourier Analyzer to analyze and sometimes derive unsuspected information from a complex signal.

The experimenter's objective was to characterize the bat's acoustic transmission to shed light on its sonic signal processing mechanisms. Through the use of the Correlation Function Computer, he derived the autocorrelation function of the cry and found that the bat's range discrimination success curve mirrored the envelope of the autocorrelation of its cry. This supports the hypothesis that the bat ranges by crosscorrelating its transmission with the returned echo.

The experimenter next processed the autocorrelation function through a PAR™ Fourier Analyzer to obtain the power spectrum of the cry. This spectrum is being studied to gain additional insight into the acoustic physics of the bat's vocal apparatus.

Whether you are working with bat cries or other phenomenon such as velocities in flowing turbulent fluids, potentials in an active plasma, pressure density in a boiling fluid or current flow across a reverse biased p-n junction, let us familiarize you with this powerful signal processing system. Write Princeton Applied Research Corporation, P.O. Box 565, Princeton, New Jersey 08540, or call (609) 924-6835.

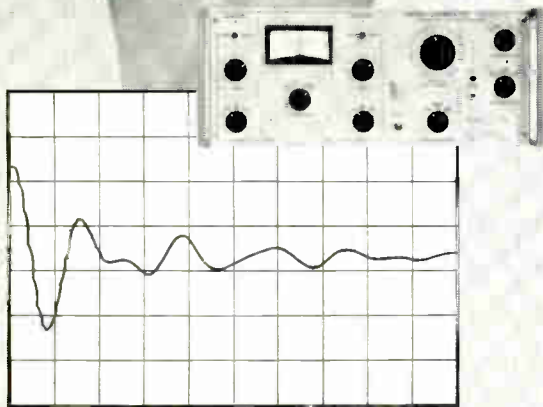

Autocorrelation of bat cry defined by Model 100 Correlation Function Computer (Price: \$8,500.)

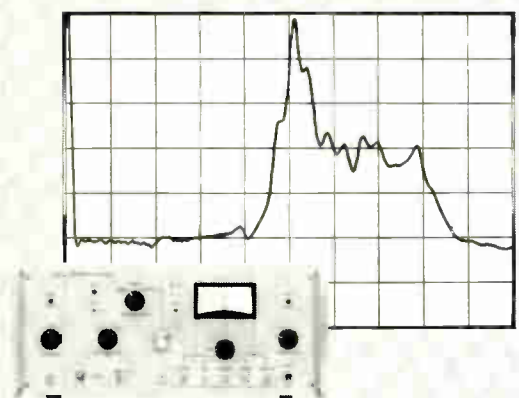

Power spectral density of bat cry transformed from autocorrelation function by Model 102 Fourier Analyzer (Price: \$2,950.)



PRINCETON APPLIED RESEARCH CORPORATION

Military budget takes it on the chin

Senate committee cuts a billion dollars from Pentagon request, sending seven major programs down the skids

The Senate has delivered the first blow to the Pentagon's fiscal 1970 budget request, a billion-dollar chop. And by its action, the Armed Services Committee gave the Nixon Administration its first warning that Congress is in fighting trim, reacting to growing public criticism of military spending.

The \$12.7% cut in Defense Secretary Melvin Laird's request for \$8.22 billion for research, development, test, and engineering (RDT&E), dropping it to \$7.18 billion, is considered by military researchers as far more significant than the Congressional threat to the much-publicized Safeguard ABM system. "That's just one system," explains a Pentagon aide. "But this R&D cut is going to hurt many, many more, programs in a variety of technologies if it stands in the final appropriation."

Current betting on Capitol Hill is that the cut will stand in the final Senate appropriation, if it isn't cut further on the floor. And the House, which has yet to act, is not expected to be much more open-handed as it, too, feels the backlash of public outrage with the Vietnam war.

Asked more. Considering that RDT&E requests for aircraft, missiles, ships, and tracked vehicles was one budget area where the Nixon Administration sought to increase, rather than cut, President Johnson's last budget—Laird proposed a \$48.3 million boost—the Senate action surprised Pentagon leaders. They anticipated that earlier voluntary economies achieved by canceling the Air Force manned orbiting laboratory and the Army's AH-56A helicopter would mollify the likes of Armed Services Committee chairman John Stennis (D.,

Miss.). And they also knew that Stennis was appreciative of the fact that today's defense dollar buys approximately 25% less than it did five years ago.

Nevertheless, Stennis read the mood of his colleagues and temporarily shed his customary hawkishness to concur in cutbacks, many of them on a program-by-program basis.

The result was an authorization of \$1.64 billion for the Army, some \$210 million less than requested; \$1.93 billion for the Navy, a cut of \$290 million; \$3.1 billion for the Air Force, a cut of \$510 million; and \$468.2 million for DOD agencies, a cut of \$32 million.

The casualty list. In addition to the already scuttled MOL and Cheyenne helicopter programs, seven major programs heavily oriented to electronics were effectively killed by the Senate, while five others were seriously wounded.

▪ The Army's SAM-D missile, with Raytheon as prime contractor,

lost \$75 million as the committee indicated the program lacked urgency in view of existing inventories—including Raytheon's ongoing improved Hawk.

▪ The Army's heavy-lift helicopter lost all its \$15 million—a blow to Boeing Vertol—again because of existing inventories of medium-lift choppers and what committee sources term "poorly defined requirements."

▪ The Navy lost all \$66 million requested for RDT&E for the E-2C aircraft. Reason: existing aircraft can do the job and the redundancy is not worth the outlay.

▪ The \$20 million proposed to start an underseas long-range missile system (ULMS) was scrubbed because Senators didn't think the post-Poseidon system warranted the expense when Poseidon itself is not yet operational.

Also needing redefinition at the DOD level, claims the Senate body, is an assessment as to just how many air-to-ground stand-off missiles the Air Force needs. Until that evaluation is made, the new AGM-X3 lost its beginning fund of \$3 million. Similarly, the Air Force lost \$15 million for RDT&E on the RF-111; another million for its light intratheater transport, and, of course, \$400 million for MOL—although it recouped \$100 million for "special activities," the innocuous title assigned to unmanned ferret and reconnaissance satellites, boosting it to nearly \$260 million.

Among the wounded were the Army's problem-riddled main battle tank '70, a joint effort with West Germany on which our allies have virtually given up. It was cut from \$45 million to \$30 million for R&D. The Navy's S-3A antisubmarine warfare aircraft (Vsx) was dropped

Curtains for Awacs?

The Air Force's airborne warning and control system (Awacs) took what could be a fatal blow from Senate budget cutters. They lopped \$45 million from the program, leaving but \$15 million to "keep the radar technology alive." Shock waves will be felt in Seattle at Boeing, where layoffs of engineers in other programs are already under way. The firm's aerospace facility has been having its problems recently, having lost out in the Viking competition. It's also waiting for a production contract on the SRAM missile, while the supersonic transport plane program is mired in doubt.

U.S. Reports

\$25 million to \$140 million because of "Navy delay in selecting a contractor," a political backfire forced on the service by the DOD to prevent selection of Lockheed being disclosed while Lockheed's Cheyenne helicopter award was being canceled for cause. Also hit was the Navy's advanced surface missile system, cut 65% to \$25 million until priorities are better defined.

The long count

While military researchers were jolted by the Stennis committee's R&D recommendations, aircraft procurement specialists rolled with the anticipated punches that canceled such major programs as the A-7 subsonic tactical fighter—whacking off nearly \$375 million for the 128 "D" versions for the Air Force and another \$104 million for 27 of the Navy "E" model. The Air Force also saw \$136 million eliminated for the F-111D's Mark 2 avionics for 68 planes.

The Air Force, though, bounced back somewhat with money to purchase 120 more McDonnell Douglas F-4E phantoms.

As for the costly Mark 2 avionics for the costly F-111D, the Air Force—some of whose leaders expected to lose the aircraft itself—gained a favorable decision. While ordering the service to bring the Mark 2 program "to an orderly halt," the committee recommended making "economical use of equipment already in production to equip sufficient aircraft to have a useful force"—and then the Air Force can take the money "saved" on the avionics and apply it to "partially offset the large unit cost increases" in the planes.

Battle ahead. Unlike the recommended RDT&E cuts, though, the F-111 procurement decision—along with others—is likely to encounter challenges on the floor of both houses.

Among those others:

- A \$224.6 million Navy procurement increment leading to 287 F-14A fleet defense fighters. The fiscal 1970 request, however, covers six planes at \$15.5 million a crack plus R&D for the successor



Shot down. That crash you heard was the Senate Armed Services Committee telling the Navy and Air Force they couldn't have new versions of the A-7.

to the \$3 million Phantom.

- Restoration of \$123.5 million for two more nuclear subs after it was deleted from the Johnson Administration's request. This brings funding to nearly \$595 million.

- A \$377.1 million request for a third Nimitz class nuclear attack carrier.

Secure ships. Safer from the budget cutters are the funds for two nuclear frigates (DXGN), a \$196 million procurement package for one ship and nearly \$68 million for advanced procurement on a second; \$318 million for five new destroyers (DX); and \$17.6 million in lead-time funds to support a program for eight. Conceived as an eventual 200-ship purchase, the DX class is getting high praise as the "first ship to sail as a completely integrated weapons system, with the naval tactical data system, the latest in antisubmarine electronics, 3-D radars, heavier weapons and higher speeds."

Though the Army suffered relatively little in the Senate's estimate of this special procurement bill for aircraft, missiles, ships, and vehicles, the related electronics subsystems won some and lost some.

A \$28 million slash in the OV-10 Mohawk observation helicopter, for example, left \$5.3 million in for acquisition of the ground electronics to be applied to other programs. Similarly, the \$25 million

cut eliminating two experimental training planes left \$6.6 million in for purchase of ground simulators, with more electronics, instead.

On the other hand, continuing problems with the M-60 medium tank deferred that program and wiped out \$3.8 million for a laser rangefinder for the tank's target acquisition and fire control system. And, again, the Army's funds for its air defense control and coordination system were cut more than half to \$8.5 million, while another \$8.5 million for the AN/TPX-46 radar interrogator was cut completely because of classified technical problems.

A final hook

Any meaningful assessment of what's likely to happen to various segments of technology in fiscal 1970 military science spending has to be based on two of the seven fundamental categories into which such funds are divided. For the electronics industry, the categories labeled "defense research sciences" and "other equipment" are perhaps most significant.

In the defense research sciences area—a catch-all for relatively basic studies in physics, electronics, math, astronomy, and materials—a \$37 million cut by the Senate

Armed Services Committee will leave a bit more than \$580 million for military in-house labs, industry, and university studies. The Army will get \$169.9 million after a \$12.5 million cutback; the Navy \$145.1 million following a \$15 million chop; the Air Force \$142.7 million after a \$16 million cut; and DOD agencies such as Advanced Research Projects Agency and John Foster's Defense Directorate of Research and Engineering are left with \$122.5 million after a \$7.5 million reduction.

The "other equipment" budget took a \$175 million beating, mostly in electronics, leaving an authorization of almost \$1.14 billion. While most of the \$70 million Air Force cutback is accounted for by Awacs (\$45 million), another \$5 million slice from ground electronics is leveled directly at Rome Air Development Center's programs in and out of house.

Fingering Army. "Other equipment" funds for the Army—whose effort has escalated markedly through the Electronics Command to meet Vietnam demands—was slashed \$45 million to a \$318 million level. And the Senators pinpointed specific areas where they saw waste and wanted cuts. One was the quick-reaction-capability contract area in general, and electronic warfare in particular. Developed for Vietnam programs, quick-reaction crash programs are deemed no longer necessary. Other Army electronics efforts marked for cutback include: counter intelligence, identification friend or foe, airborne and ground surveillance and target acquisition, night vision, and missile electronics.

The Navy got \$245 million of its \$280 million request along with the recommendation it could afford to limit its efforts in ocean engineering, underseas surveillance, target surveillance, and "certain other electronics developments."

As to the defense agencies, they were left with \$260 million after a \$25 million reduction that could be applied to the nuclear weapons test program, nuclear monitoring research—the old Project Vela, overseas defense research (Project Agile), and a number of sensors.

Space electronics

Straight and narrow

Spin-stabilized satellites use jet thrusters to maintain attitude and keep their antenna beams aimed accurately. Such accuracy is especially important to the Air Force's tactical communications satellite (Tacsat) because its data is picked up by small antennas carried by field units.

To fire Tacsat's thrusters with pinpoint accuracy, engineers at the Hughes Aircraft Co., builder of the satellite, have built large scale integration into a digital differential analyzer adder they designed using MOS technology.

The flight-control programmer that went aloft in Tacsat last February 9 probably represents one of the earliest applications of LSI to satellites. The programmer, along with a phase-lock loop using the same kind of adders, permits the 360° circumference of the satellite to be divided into very small angle increments

over which a thruster can be fired to move the vehicle precisely in relation to signals received from an earth sensor. These increments can be 0.1° or less.

Leftover. The programmer was originally developed for the advanced Syncom (Syncom 2) commercial communications satellite built by Hughes, but because it predated LSI, it was too heavy and was abandoned in favor of ground control of the thruster. Ground control for Tacsat, however, was rejected because of the possibility of interference with commands to the spacecraft, says Philip Toorvald. He heads the digital controllers and data-processing section in the Hughes Data Systems division, where the flight-control programmer was designed by Louis Bonilla.

The system aboard the initial Tacsat uses digital differential analyzer adders and shift registers made to Hughes design by the General Instrument Corp.; later adders will be manufactured by Hughes at Newport Beach, Calif.

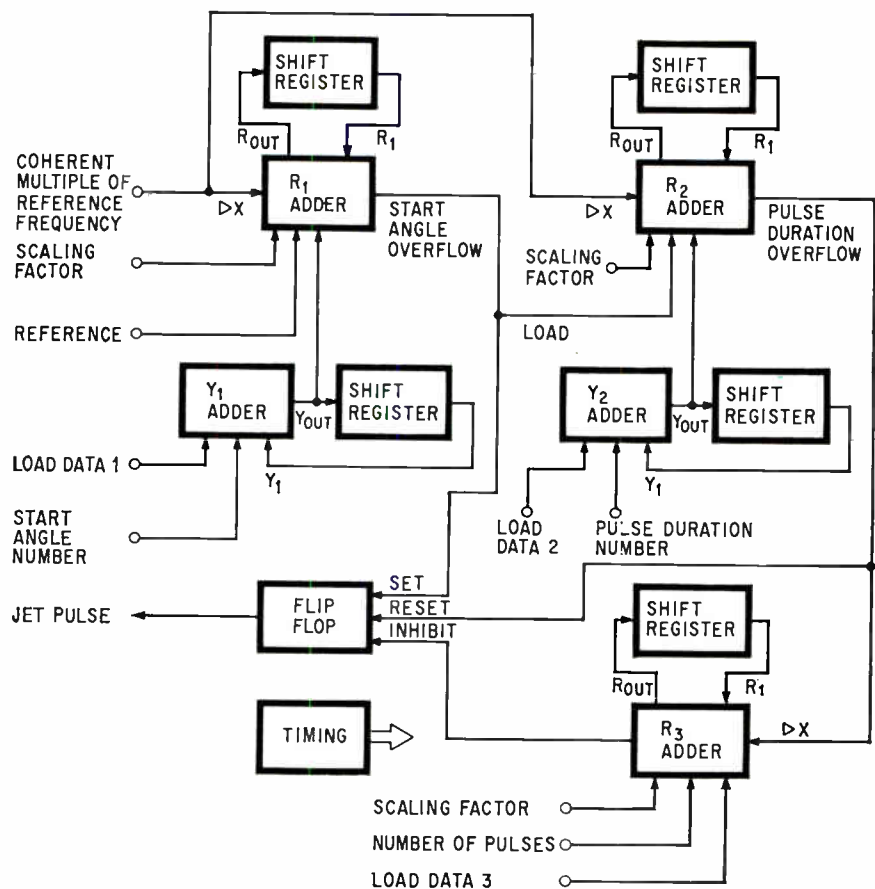

Adder. Hughes' Tacsat DDA. Scaling factor determines shift register size.

now there are 3 time & tool-saving double duty sets

New PS88 all-screwdriver set rounds out Xcelite's popular, compact convertible tool set line. Handy midgets do double duty when slipped into remarkable hollow "piggyback" torque amplifier handle which provides the grip, reach and power of standard drivers. Each set in a slim, trim, see-thru plastic pocket case, also usable as bench stand.

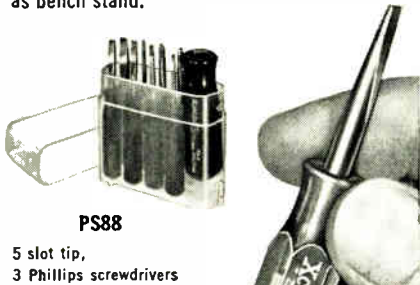

PS88

5 slot tip,
3 Phillips screwdrivers

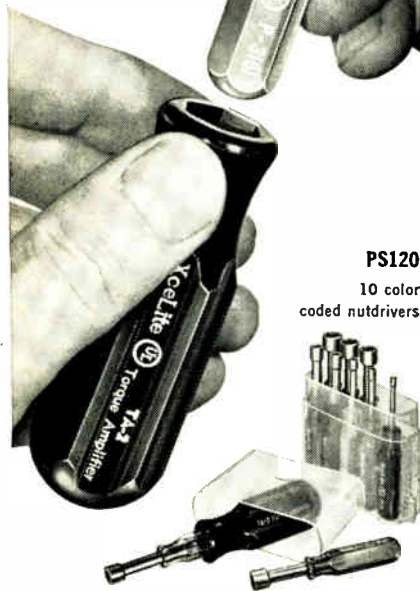

PS120

10 color
coded nutdrivers

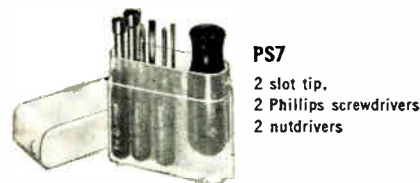

PS7

2 slot tip,
2 Phillips screwdrivers,
2 nutdrivers

WRITE FOR CATALOG SHEET N563



XCELITE INC., 130 Bank St., Orchard Park, N.Y. 14127. In Canada Contact Charles W. Pointon Ltd.

U.S. Reports

Each adder consists of 230 MOS field effect transistors forming the equivalent of 155 gates. The controller for a single jet thruster consists of just six monolithic chips—2½ MOS adders, 2½ MOS shift registers, and one bipolar integrated circuit containing two flip-flops. This subsystem performs a function that's about four times more complicated than the pre-LSI version intended for Syncom 2, which incorporated 231 parts.

The jet-firing sequence is triggered by ground command. Once that command "arms" the control system, the reference pulse derived from the phase-lock loop corresponding to the sensor's output starts the firing sequence. Before the sequence begins, however, three binary numbers are stored by ground command in 2's complement form in the dynamic 16-bit shift registers: one corresponds to the start angle of the firing, which is equal to a preset number of pulses after reception of the earth sensor pulse; another corresponds to the desired pulse duration, which is related to the number of degrees of satellite spin through which the firing should continue; and the third corresponds to the number of times the thruster is supposed to fire to move the spacecraft in the right direction. In effect, the adders and shift registers work as programmable counters.

Ready-count. Much of the timing of the sequence is provided by the two inputs from the phase-lock loop—the earth sensor reference number and a coherent frequency that is a binary multiple of that frequency, which quantizes the satellite's 360° revolution into precise angles. These are represented by the number of counts after the reference pulse is received before the system should fire a thruster.

Once the system has been programmed, and a ground command received to start a sequence, reception of the earth sensor reference signal from the phase-lock loop initiates the program timing. The word that was stored in the register associated with the Y₁ adder—corresponding to the start angle—is shifted nondestructively into the register associated with the R₁

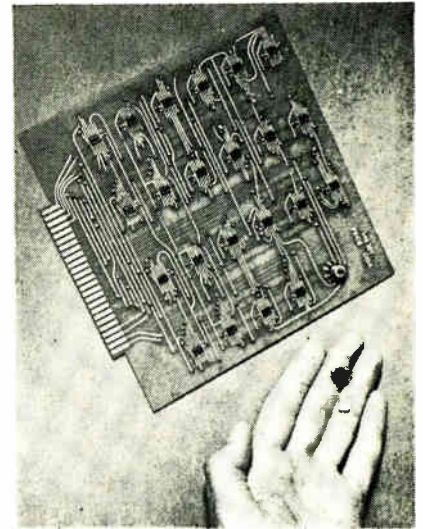

In hand. Hughes engineers shrunk DDA adder logic to one chip in 22-lead flatpack, shift registers to one chip in round package. Board holds logic needed before LSI was available.

adder. On the pulse after the reference pulse, the R₁ adder begins counting the number of pulses from the phase-lock loop coherent frequency signal, adding the count to the contents of the R₁ register. That register overflows, signifying the start angle, and triggers the bipolar flip-flop. The flip-flop opens a solenoid that allows gas to escape from the thruster.

The pulse duration command stored in the Y₂ register is nondestructively transferred to the R₂ register when start angle overflow occurs. This register also accepts data from the coherent frequency corresponding to the angle through which the satellite should be moved, finally overflowing when the preloaded limit for the pulse duration has been reached. This pulse-duration overflow resets the flip-flop to stop the thruster.

An R₃ half-register containing the preloaded 2's complement of the number of jet firings needed to complete a satellite maneuver is incremented by each pulse-duration register (R₂) overflow. It overflows when the limit is reached, causing the R₃ half adder to inhibit the flip-flop, preventing any further thruster firings until the next earth sensor pulse is fed into the control system from the phase-lock loop. Then the entire sequence—arming

weighs 7 lbs . . .

. . . the new
SONY®/TEKTRONIX®
portable oscilloscope

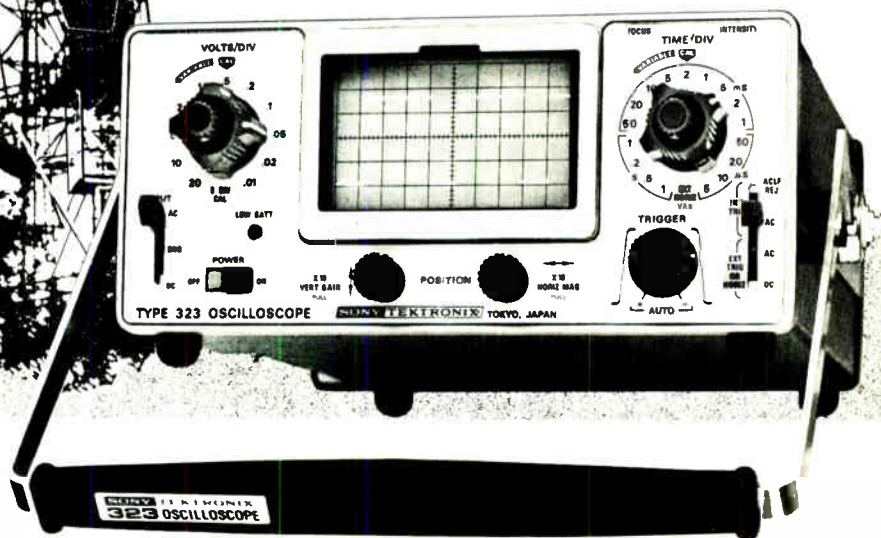

The SONY/TEKTRONIX Type 323 Portable Oscilloscope weighs 7 lbs, is 4 1/4 inches high, 8 1/2 inches wide and 10 5/8 inches deep. It operates from self-contained batteries for up to 8 hours. With this compact, lightweight instrument, a user may move from one remote application to another without concern for power connections.

The Type 323 is especially well suited for maintenance of remote microwave installations, mobile communications equipment, aircraft and marine instrumentation, production control equipment, etc.

Batteries are rechargeable overnight (16 hours) by simply plugging the instrument into an AC outlet. The built-in charger will provide a fresh power source for use the next day. The Type 323 may also be powered from DC, 6 V to 16 V, up to 4.5 watts, and 90 to 136 VAC or 180 to 272 VAC, 48 to 440 Hz, up to 14 watts.

This solid-state portable oscilloscope also provides performance!

Bandwidth is 4 MHz at 10 mV/div deflection factor. For low signal level applications, 1 mV/div at 2.75 MHz is provided. Sweep rates are 1 s/div to 5 μ s/div, extending to 0.5 μ s/div with the X10 magnifier. A single control knob permits automatic or manual level sweep triggering, positive or negative slope. With no input the automatic trigger mode provides a bright baseline reference at all sweep rates. A 6 X 10 (1/4-inch div) internal non-illuminated graticule permits parallax-free measurements.

The Type 323 is designed for severe environments. Performance specifications are maintained within an operating temperature range of -15° C to $+55^{\circ}$ C. It also passes shock, vibration and humidity tests which simulate environments "portable" instruments are likely to encounter.

Your Tektronix Field Engineer will demonstrate the performance of the Type 323 in your application at your convenience. Please call him or write: Tektronix, Inc., P.O. Box 500, Beaverton, Oregon 97005.

Type 323 Portable Oscilloscope (including batteries) \$960
U.S. Sales Price FOB Beaverton, Oregon



Tektronix, Inc.

committed to progress in waveform measurement

We'll stack these components up against anybody's!

TEC's reliable ones, ideally suited for "point-of-load" regulation, for power distribution for TTL, DTL, op-amps, etc.

When your system requires excellent source to circuit and circuit to circuit isolation and protection, nothing beats the SPACE PROVEN RELIABILITY of these TEC components.

VR Series
Low Cost
Hybrid Regulator
2X DIP Size

Dual Converter
9646-101
Single inputs
Dual outputs

Low Cost
Unregulated power
sources

Write for TEC notes on "point-of-load" regulation including specs and prices



P.O. Box 910
Boulder Industrial Park
Boulder, Colorado
(303) 442-3837

U.S. Reports

Space electronics

and loading—begins again if a different duration or number of pulses will be required the next time that thruster fires.

Son of ATS

The applications technology satellite (ATS) program was set up as a test bed for developing new hardware for space applications missions. The program has yielded proven hardware in a number of areas and is now spinning off a separate satellite program due to become operational in the 1970's: the synchronous meteorological satellites. They'll allow weathermen to continuously watch cloud patterns associated with severe storms, monitor tropical weather systems—including hurricane development, and compute wind velocities.

Requests for proposals for two prototype synchronous meteorological satellites have been written by NASA's Goddard Spaceflight Center; best guess by insiders is that they will be issued before the end of the summer. The spacecraft will be launched by Delta vehicles and limited to 950 pounds in orbit; size and complexity will be analogous to either Intelsat 3 or the ATS 1 and 3 satellites. Says an official at Goddard, "Hughes, TRW, and Philco-Ford are all interested in bidding and there may be one or two more." Plans now call for the first launch in 1971.

Brains. The main sensor package will be a spin-scan telescope system containing an infrared radiometer employing refractive optics, and a black and white camera using reflective optics. The package is now under development by Hughes in Santa Barbara, Calif., as part of the Tiros operational satellite improvement program. The telescope package offers resolution of a half mile in the infrared and four miles for black and white. A contract with Hughes to develop a package for the first meteorological craft is expected within a month. Since the i-r radiometer is a tough pacing item for the package, NASA is planning to have an

extra spin-scan camera from the technology satellite series ready should delivery slip.

Meanwhile, the Department of Commerce's Environmental Science Services Administration, which is working closely with NASA on the program and which will take over as it becomes operational, would like to add another package to the prototypes. Called the environmental monitoring package, it would contain electron and proton measurement equipment, solar X-ray measurement equipment, and a magnetometer. At present, NASA is working on the details for the extra sensors and will hold space for them.

Manufacturing

Eye that bonds

Integrated circuits are becoming more and more reliable, but the search for failure mechanisms goes on. One cause that's been known for some time has generally defeated attempts to overcome it—flawed bonding between an IC and its package.

In Kovar flatpacks, an IC is bonded to its substrate by a combination of heat and ultrasonics. A good eutectic alloy form is laid down on the substrate and another alloy coats the bottom of the IC chip. With the Kovar at about 375°C to 400°C, the chip is placed on the substrate to heat, then vibrated ultrasonically to make the bond. Thermocouples measure the critical temperature at the bond.

Flaw in the ointment. In theory this makes a firm mechanical contact between package and substrate, and also allows heat generated in the IC to be carried off into the package heat sink.

In practice, joints made with the bond too cold or too hot prevent heat from dissipating. The heat collects within the IC as hot spots that cause burnout. Burn-in racks help weed out some of these defective circuit-package combinations, but not all. And until now there's been no easy way to check the bond, since it can't be seen, or to

RELAYS

NEW MIL-R-6106

- One-Inch Cube
- 4PDT-10 Amps
- 28VDC-115VAC
- All Welded

IT'S BABCOCK'S BR30

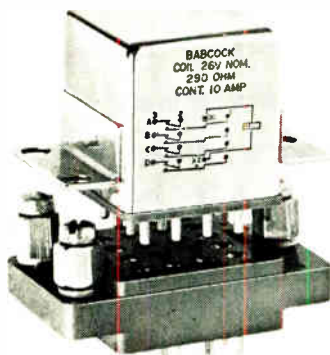

Babcock's new Model BR30 is a miniature, all-welded, 4PDT relay . . . designed specifically to meet the requirements of MIL-R-6106 (MS-27400)—and to be completely interchangeable with other models of this type. Characterized by reliable op-

eration in environmental extremes, this new relay is the first developed by Babcock to meet the needs of airframe applications. Performance is outstanding . . . to 200g's shock, 30g's vibration, over a temperature range of -70°C to $+125^{\circ}\text{C}$, for a minimum of 100,000 operations. All welded construction, inside and out, assures a contaminant-free unit. Plug-in and solder-hook versions are offered; qualified relay sockets also available.

The Model BR30 is a new relay for new applications . . . and it carries the same mark of proven Babcock dependability. Your assurance that it's better because it's Babcock.

The Babcock Model BR30 is a brand new MIL-R-6106 relay . . . featuring a new symmetrical magnetic circuit. Utilizing two permanent magnets, this system provides a positive holding force, undisturbed by shock and vibration extremes . . . and

dependable switching action throughout the life of the relay.

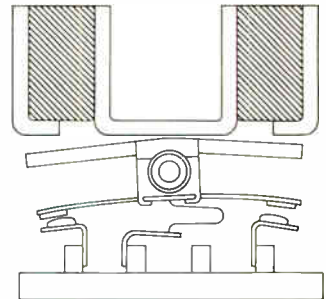

Coil design has also undergone some innovation. AC versions have been fabricated such that coil frequency is operational from 60 Hz to 400Hz, without degradation of ratings.

SPECIFICATIONS

Contact Rating (@ 28VDC, 115/208VAC 400Hz).....	Resistive: 10amps. Inductive: 8amps.
Overload.....	D.C. 40amps. A.C. 60amps.
Rupture.....	D.C. 50amps. A.C. 80amps.
Coil Voltages.....	6, 12 and 28VDC, 115VAC
Shock.....	200g's (6ms.)
Vibration.....	30g's, 70-3000Hz
Operation Temp.	-70°C to $+125^{\circ}\text{C}$
Pull-In Power.....	600mw
Operate/Release Time.....	15ms, max.
Bounce Time.....	1ms, max.
Life.....	100,000 operation, min.

Get complete information on the new Model BR30 . . . contact Babcock Electronics Corp., Relays Division, Subsidiary of Esterline Corp., 3501 Harbor Blvd., Costa Mesa, Calif. 92626. CALL COLLECT (714) 540-1234 or TWX 910-595-1517.

Challenging opportunities for relay-switch engineers.



NEW! POWERTEC HP* POWER SUPPLIES

5V @ 30A



2 watts/in³

*High Performance

3Ø 400 Hz MILITARY FAMILY

This ultradense full Mil-E-5400 family was designed to meet the most advanced airborne and ground logic applications.

This advanced design was accomplished without producing RFI or switching noise problems in your system.

All units contain remote sense, a full protection package including over-current and over-voltage.

Some outstanding features are:

- 1.7" Max. Height
- 2 Watts / IN³
- Up to 75% Efficiency
- 24 Different Models



CUSTOM POWER SYSTEMS

Powertec's experts are capable of solving your most difficult power conversion requirements.

POWERTEC DIVISION

9168 DeSoto Ave., Chatsworth, Calif. 91311
Phone (213) 882-0004



AIRTRONICS
CORPORATED

U.S. Reports

prevent flaws.

But a small Massachusetts company may have an answer to bonding problems. Vanzetti Infrared & Computer Systems of Dedham has developed a technique to monitor bonding temperature more accurately than anything now used, one which may prevent bad bonds.

Riccardo Vanzetti, president of the firm, has developed a technique for viewing the surface of a die during bonding with an optical fiber and an i-r detector diode. Vanzetti says, "The chip is essentially transparent to the infrared produced during the bonding process and by monitoring this we can gauge the temperature at the bond."

Measure. In experiments, Vanzetti has passed optical fibers through the vacuum collet which holds the chip in place during bonding and taken i-r measurements right from the IC's surface. Watching the diode's output on an oscilloscope shows that its response is more accurate than a thermocouple's and that it is more sensitive to quick changes in temperature.

This isn't entirely the fault of the thermocouple since its bulk requires that it be installed, for example, on one of the ultrasonic probe tips used to vibrate the chip during bonding. Since the probe is far bigger than an IC, the thermocouple usually winds up measuring probe temperature rather than IC temperature. Also, the time needed to heat or cool the probe tip adds to the thermocouple's response time.

Though the amount of i-r detected by the diode sensor will vary with the IC metallization pattern (metal will block some of the i-r), calibration with an oscilloscope can prove what Vanzetti claims is an almost certain indication of a solid bond.

Viewed on the scope, the temperature of the IC gradually increases during bonding, almost levels off—then suddenly takes a sharp jump upward. The jump occurs when the gold eutectic material becomes molten and heat is directly conducted from the substrate to the IC by conduction.

This is when the best possible bond forms.

Theory. On an assembly line, an operator could run the bonder at temperature for a few seconds, then let the assembly cool. But so far this is hypothetical since the thermocouples now used neither measure the temperature of the chip itself nor spot the quick increase in its temperature at the time of bonding.

Vanzetti figures that use of the infrared monitor would just about eliminate the bubbles and voids caused in overheated bonds, as well as cold nonconductive bonds. Though the technique has been tried on only a few dozen chips, both Texas Instruments and General Electric are interested in it for reliability insurance and may ask Vanzetti to equip some of their bonders with the i-r sensor system for evaluation.

Vanzetti also is thinking of selling his sensor system to bonder makers and may develop a product within the next few months. For now, he is collecting data comparing the reliability of bonds made with his sensor with those made the old way.

Manufacturing

Spray power

A nine-month-old company, Gould Ionics, has developed a solid electrolyte battery that can be sprayed on a printed-circuit board in thicknesses down to 1 mil. Not only that, the company says, but the battery has an almost unlimited shelf life.

The battery is formed by successively spraying a silver-carbon-electrolyte anode, a rubidium silver iodine electrolyte, and a proprietary non-iodine base cathode, using an inert organic solvent.

To demonstrate one potential application, company engineers sprayed a 3-cell, 1.5-volt, 0.030-inch-thick battery on a camera flash cube, eliminating the need for a separate battery. Although voltage is low—0.53 volts per cell compared with 0.66 volts per cell for a conventional iodine battery—the thin-

HYBRIDS

bridge the op amp generation gap

Philbrick/Nexus combines the best of monolithic and discrete technologies to create the now generation of op amps — the hybrids. They're micro-miniature and low cost, yet their overall performance is equal to or better than their discrete predecessors. And, built-in stabilization simplifies circuit design by eliminating external components.

1402 — high performance FET for battery applications

The 1402 features a quiescent current drain of only 500 μ A with a power supply voltage range of -4V to -24V, full output frequency of 80 KHz and output capability of +14V at +5mA with \pm 15V power supply. TO-8 case; 0.5" diameter, 0.14" high. Price: \$50 each in 1-9 quantity

Other hybrids offering interesting performance characteristics:

1404 offers the lowest power drain (50 μ A) of any general purpose hybrid on the market. \pm 2.5 to -15 volt operation. Produces 1 mA output. Size: 0.75" \times 0.45" \times 0.20" high. Price: \$49 each in 1-9 quantity.

1406 is a small (TO-8 case) fast general purpose op amp. Price: \$26 each in 1-9 quantity

1407 is a low cost high performance FET which features a gain band width product of 30 MHz. Full output frequency is 100 KHz. TO-8 case. Price: \$63 each in 1-9 quantity.

1408 is a low cost differential FET input. Size: 0.6" \times 0.6" \times 0.25" high. Price: \$30 each in 1-9 quantity.

Q25AH is a wideband, high reliability FET. 1,000,000 hours logged without a single failure. TO-8 case. \$180 each in 1-9 quantity.

No other manufacturer offers as wide a variety. Ability to innovate, design and manufacture will continue to provide a greater variety of hybrids from Philbrick/Nexus than you'll get from any other single source.

For complete specifications and technical assistance, contact your Philbrick/Nexus field engineering representative or write, Philbrick/Nexus Research, 22 Allied Drive at Route 128, Dedham, Mass. 02026.

THE ALL NEW 1969-1970
PHILBRICK/NEXUS
CATALOG IS NOW AVAILABLE.
WRITE FOR YOUR
COMPLIMENTARY COPY
AND BE SURE TO VISIT US AT
WESCON BOOTHS 2022, 2023, 2024



PHILBRICK/NEXUS RESEARCH

A TELEDYNE COMPANY



Semiconductor Burn-in

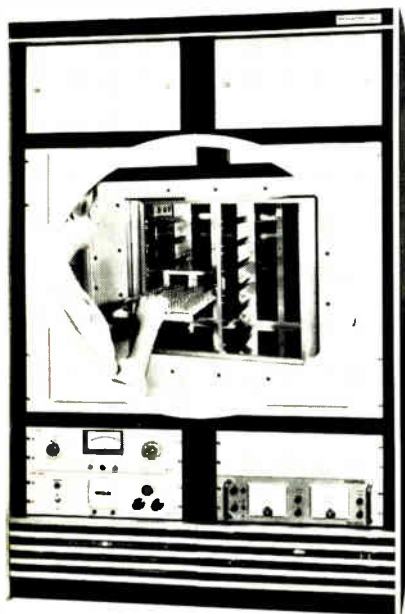

Economical TEC power aging and life test systems save you time and money

Test Equipment Corporation has for years designed and developed sophisticated environmental test equipment. This experience plus total "in-house" capabilities offers both manufacturer and user significant time and cost savings for semiconductor burn-in and life test.

Total "in-house" TEC manufacturing capabilities range from printed circuit boards, fixturing and socketing to NASA-approved machine shop, electrical assembly and micro-welding facilities. This makes possible extremely fast turn-around, thus saving valuable time and money.

In addition, TEC develops, builds and operates for customers complete "in-house" power aging and test facilities capable of meeting the most stringent requirements.



To discover how TEC burn-in systems and "in-house" facilities can help you, please write for this descriptive brochure.

Test Equipment

CORPORATION
P.O. BOX 20215, DALLAS, TEXAS 75220 • 214/357-6271

U.S. Reports

film power supply has the advantage of being sprayable in unusual geometries and restricted spaces. It is also rechargeable. Gould engineers believe the current density, 200 microamperes per square centimeter, can be greatly increased. Work now under way on the non-iodine cathode is to improve current density by several orders of magnitude, they add. And, unlike liquid electrolyte batteries, the battery poses no hazard to circuitry from leakage. Since no iodine is used in the cathode, shelf degradation from iodine diffusion is eliminated.

Pick a spot. Gould says there should be numerous applications for the battery in the semiconductor field, since it can be selectively sprayed on different portions of a circuit board to provide miniaturized power isolation. The developers also foresee possible uses in aerospace computers as a secondary power source to prevent memory loss in cases of brief emergency power failures.

Gould Ionics was formed last November by Gould-National Batteries and North American Rockwell. The company also holds the license to basic patents on a solid-state, electrolyte, pellet-type battery with a 10-year shelf life that can operate over a range from -65°F to 165°F .

Military electronics

Little Rascals

With an \$18.1-million Navy production contract for the AN/SPN-41 all-weather carrier landing system safely hooked, Airborne Instruments Laboratory is zeroing in on the Marine Corps with a version for tactical helicopter use. It's a microwave system the Cutler-Hammer division calls Rascal, for remote area scanning beam approach and landing.

The company has also delivered a prototype ground station and two or three airborne receivers to the Army Electronics Command for test and evaluation under a \$500,000 contract. But the immediate

potential for Rascal with the Marine Corps is much greater since the corps has a special operating requirement for 50 ground stations and 300 airborne receivers for helicopters and light S/TOL craft.

Honeywell's simplified tactical approach equipment (State) has the advantage of being more readily available, according to military sources, while Airborne Instruments must scale down its Army test version from an estimated 100 pounds per package to the 25-pound level. However, Naval Air Systems Command, home of the SPN-41, is pushing the Airborne Instruments concept because of its clear compatibility with the shipboard version plus its ability to handle multiple aircraft coming in on different glide slopes at the same time. Limitations of the State system, says a Navy source, are its 5° minimum glide slope, below which multipath effects could occur, and its single-angle approach setting which is manual.

Package. Where the Navy SPN-41 will use separate transmitters on the 13 attack carriers and 10 ground stations with terminals to handle the 1,000 aircraft which will be

\$6.3 million isn't bad

Though the FAA figures it would need three to four times its present budget to develop an acceptable all-weather landing package for commercial use, Airborne Instruments Laboratory isn't too downcast. The reason: it has picked up a \$6.3 million FAA pact for 99 improved solid state instrument-landing systems, plus another \$256,920 for 15 radar display interference suppressors. Seventy-six of the systems will be completed packages, including a localizer for generating a signal defining the runway centerline extended, glide-slope signal for angle of descent, and two marker beacons for the approach paths. The remaining 23 systems have a localizer and one marker only. All are Category I; they permit landing with visibility as low as a half mile and descent to a "decision height" of 200 feet. Deliveries, to begin in 15 months, will take about three years.



Photographed in Vietnam by Howard Sochurek

When you need a new way to see in the dark...

bring ERIE in early.

The jungle night falls fast for a pilot downed behind "Charlie's" lines. But rescue choppers no longer wait for morning light to find him. The infrared IRIS portable night vision device that actually intensifies available light... even starlight... thousands of times. From the start, those working on this project have relied on the Research Engineers and component capability of ERIE TECHNOLOGICAL. Our new sub-miniature high voltage supply is at the heart of the system. Proof, once again, that whatever your area of electronics, it pays to bring ERIE in early.

ERIE TECHNOLOGICAL PRODUCTS, INC.

644 West 12th Street, Erie, Pennsylvania 16512
Area Code 814-456-8592

Better solutions come from Weatherford

Try these for starters: TTL. Military Transistors. Discretes.

The Trend is TTL. And we've got just what you need to stay out in front of this fast-moving game: Texas Instruments' new TTL brochure—the most detailed handbook yet on these increasingly-popular devices. In its 80 pages is complete data on industry's broadest TTL family, some 166 different circuits, many of them in a choice of packages and temperature ranges. You'll also find loading tables and informational guidelines on the application and use of leading MSI functions. As an extra convenience, it is color-coded for easy reference and simpler device selection. We've got a free copy waiting for you. Or circle 150 on the Service Card.

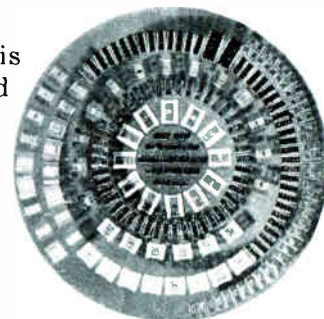

Only TI's military-qualified power transistors qualify for off-the-shelf delivery. If you now go directly to a manufacturing source for military-qualified power transistors and still wait weeks for delivery,

come to us. We can get them to you fast! Availability is excellent

because inventories are in great shape. And your choice is broad,

16 devices: JAN 2N497, JAN 2N498, JAN 2N656, JAN 2N657, JAN 2N1714-JAN 2N1717, JAN 2N1049A, JAN 2N1050A, JANTX 2N1724, JAN 2N1724, JANTX 2N1722, JAN 2N1722, JAN 2N389, JAN 2N424.

TI makes many other planar and epitaxial planar power devices which, while not military-qualified, can meet stringent military requirements.

So stop marking time—shoot an order our way. Or for pricing and delivery data on all TI power transistors, check with us.

TI's discrete dual transistors: proven, reliable, ready to go. When applications—like operational or differential amplifier designs—demand extremely high stability, take a close look at TI's dual transistors. They provide better thermal tracking with extremely low drift and a stability that just can't be achieved with a matched pair of separate transistors. TI's dual transistors are available for high and low current applications in NPN duals, PNP duals and complementary pairs in TO-5, TO-18 and dual flat packs. Pick what you need from this broad selection: 2N2639-2N2644, 2N2802-2N2807, 2N2913-2N2920, 2N2972-2N2979, 2N3347-2N3352 and 2N3806-2N3811. Contact us for data sheets on TI's discrete dual transistors or circle 151 on the Service Card.

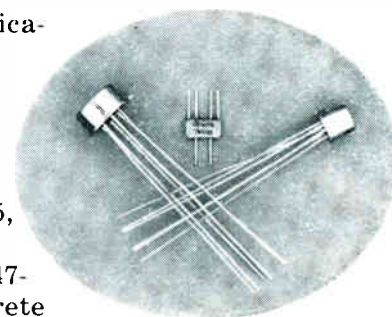

For better solutions, call your authorized TI distributor



R. V. WEATHERFORD CO.

DISTRIBUTORS OF ELECTRONIC COMPONENTS AND EQUIPMENT

ANAHEIM, CALIFORNIA

1550 Babbitt Street
714-532-6741
714-547-7521

GLENDALE, CALIFORNIA

6921 San Fernando Road
213-849-3451

PALO ALTO, CALIFORNIA

3240 Hillview Drive
Stanford Industrial Park
415-321-5373

PHOENIX, ARIZONA

1917 North 25th Drive
Carson Industrial Center
602-272-7144

POMONA, CALIFORNIA

1095 East 3rd Street
714-623-1261
213-966-8461

SALES OFFICES: San Diego, California, 714 278 7400 • Seattle, Washington, 206-762-4200



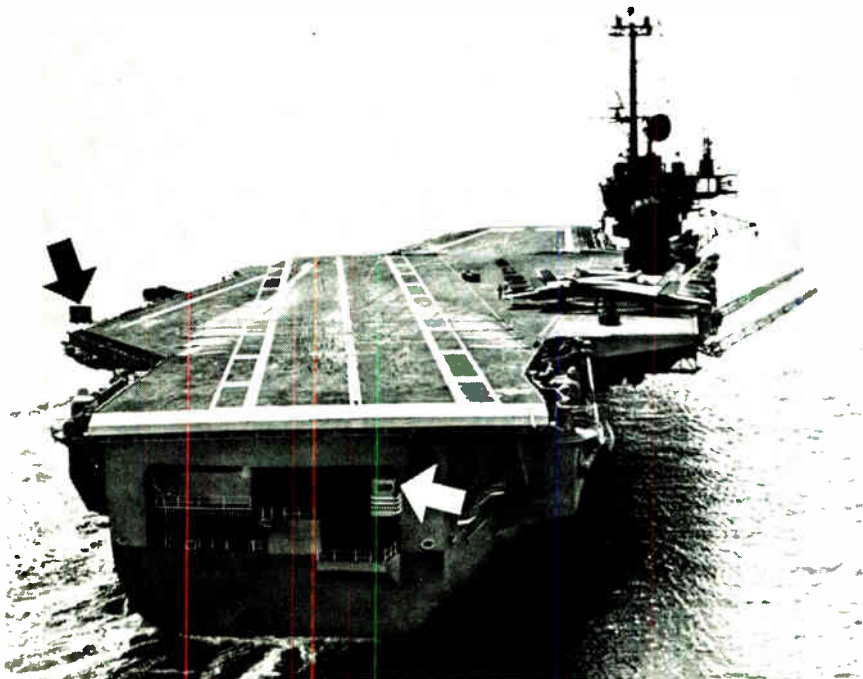

SPNoff. Airborne Instruments Laboratory is offering a manpack version of the Navy's SPN-41 all-weather landing system to the Army and Marine Corps. Above, the full-size version installed on the USS Independence. Black arrow indicates elevation station; white arrow shows azimuth station.

fitted with AN/ARA-63 receivers, the Marines and Army are considering a single transmitter for both functions. The tactical ground system would consist of two 35-pound units plus an operational third distance-measuring transponder, says Joseph E. Woodward, deputy director for the company's Transportation division.

One appealing aspect of the system for Army and Marine tactical aircraft, according to Woodward, is that they have no systems competitive in the narrow bandwidth of 15.4 gigahertz to 15.7 GHz in which both Rascal and SPN-41 operate. Navy aircraft—particularly the A-6 Intruder—on the other hand, have fire-control radars operating in that frequency spectrum.

Elevation and azimuth of the man-portable system is designed with beamwidths of 3° and 4° respectively, with coverages of 0.12 and ±10°. A distance measuring unit with 360° coverage would have a capacity of 50 aircraft. Data rate would be 4 hertz and operation with internal batteries is put at two hours.

Though Navy costs to outfit its 1,000 planes under the first production award for SPN-41 are estimated to run about \$8,000 apiece, over and above the twin-transmitter landing stations, the Marine Corps cost for a sealed-down system is estimated at about \$4,000 to \$6,000.

From this point of view of the Federal Aviation Administration, however, that figure is still too high. "To backfit aircraft with an all-weather landing system like this," says one FAA executive, "could cost \$50,000 per plane, plus another \$250,000 for each airport installation." In the eyes of the FAA—operating with less than \$1 million a year for R&D in this area—that's too much.

For Vigen? Meanwhile, foreign market potential for variations of SPN-41 has narrowed to Sweden, says Woodward, following last-minute deferment of a French purchase of two advanced instrument landing systems for civilian test and evaluation.

The Royal Swedish Air Force wants a tactical instrument-land-

**your best buy
in D.C. . . .**



from any angle

For the mini-price of \$90, you can choose from three compact, well regulated, constant voltage/current limiting laboratory power supplies. And, for only \$25 more, 3 additional models are available with constant voltage/constant current. We call them BENCH supplies.

These stable battery substitutes are packaged in molded, high-impact plastic cases with an interlocking feature for stacking. They can be rack mounted with an accessory kit.

Check the following specs for proof of quality at no sacrifice in performance.

Outputs 0-10V @ 0-1A, 0-25V @ 0-.4A, 0-50V @ 0-.2A
Regulation 4 mV, Load or Line
Ripple 200 μ V rms/1mV p-p (DC to 20 MHz)
Stability 0.1% +5 mV for 8 Hours
Size 3 1/4" H x 5 1/4" W x 7" D

HEWLETT  PACKARD

POWER SUPPLIES

112 Locust Avenue
 Berkeley Heights, New Jersey 07922

LOW COST AUTOMATION takes many forms

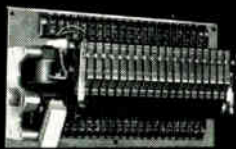
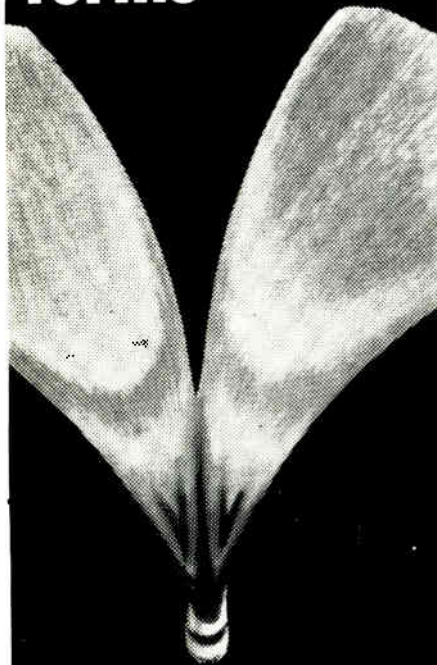

With this super-simple MT Sequence Programmer you control up to 19 independent 10 amp load circuits in a predetermined sequence with random inputs. The MT isolates... interlocks... remembers... it's almost a computer. Should be the beginning of every control circuit design... eliminates many costly components.

Send for new Bulletin 910

GW Eagle Signal Division
E.W. Bliss Company
Davenport, Iowa 52803
A GULF-WESTERN COMPANY

Service-In-Depth...
Local Engineering, Stock, Repair

U.S. Reports

ing system for its new hot fighter, the Saab Viggen. According to Woodward, Airborne Instruments is to deliver a prototype package in October under a \$500,000 contract. This should lead to a 3-to-4-year contract around 1971 worth "several million dollars" to outfit the 170 Viggens in the RSAF. Sweden can either buy the package outright or license Saab for production there.

Advanced technology

More merrily

For high-resolution fast Fourier analysis, or transform the more data samples the better. Sadly, large samples and small computers—which would mean high resolution at a low price—haven't yet been combined in a single package. So analysis of more than 2,000-odd samples requires a large computer and memory, meaning that many potential users in solid state physics, X-ray crystallography, radio astronomy, and other areas can't afford it.

But Computer Signal Processors of Burlington, Mass., has developed a system cable of fast Fourier on data as complex as 32,000 10-bit word samples. When marketed, the system could cost as little as \$30,000, or about a third the price of more complex systems aimed—ironically—at applications using shorter samples. The system's 32,000-word sample capability means it could resolve two-thirds of 1 hertz in an analysis of the audio band from 20 hz all the way up to 20,000 hz.

Add a disk. The company uses a Varian 620-I minicomputer with a 4,000-word memory—but has attached a 1.5-megabit disk store to hold both data and processing routines. There's no trick to adding the disk memory, though. Computer Signal spokesmen note that the tough part came in linking the bulk memory and the small processor through buffers and software to create the illusion of a main memory far larger than the 620-I's 4,000 words of core.

Taking cues from larger and more complex systems, Donald N. Graham, director of software and systems analysis, adopted an approach like paging in which data and subroutines are stored in blocks on the disk and transferred into and out of core as needed.

During the parts of the process leading up to fast Fourier transform itself—collection of data, scaling, multiplications, and so on—dual 1,023-word core buffers stand between main memory and the disk store. While the data in one is being processed, the other is dumping data back onto the disk in processed form, erasing, or filling itself with new routines or data about to be used.

This speeds processing by effectively halving the disk storage system's latency time—that is, it gives the illusion of reading out information twice as fast as normally possible with the disk.

Because the operations performed on the data are sequential, says Graham, this system could use assembly language coding to permit data and subroutine instructions to be interleaved in the mass memory and called up as needed. "As we finished each step—say scaling—we could add an almost Fortran-like 'go to' or 'load' instruction keyed to the next subroutine or block of data," the executive points out.

Fast shuffle. It's also convenient in fast Fourier transform to process sections of data in an arbitrary order, he adds, and since the data is already in blocks it's simple to do this. "It amounts to breaking up processing into about 10 subprocesses," he says, "and moving to the next block wanted—but not necessarily the next one stored." Graham calls this shuffling and emphasizes that it helps speed processing.

The fast Fourier transform processing itself also is sped up through a proprietary version of the Cooley-Tukey fast Fourier transform algorithm. Graham says it takes advantage of "shortcuts and symmetry that the basic algorithm overlooks, and lets the system do the transform in fewer operations than the pure Cooley-

**The industry's tiniest 5 watt zener...
has double
the
surge capacity
of an
ordinary
10 watt...**

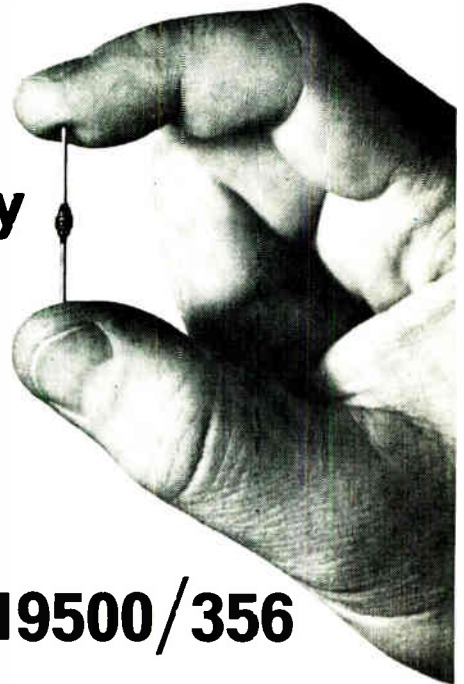
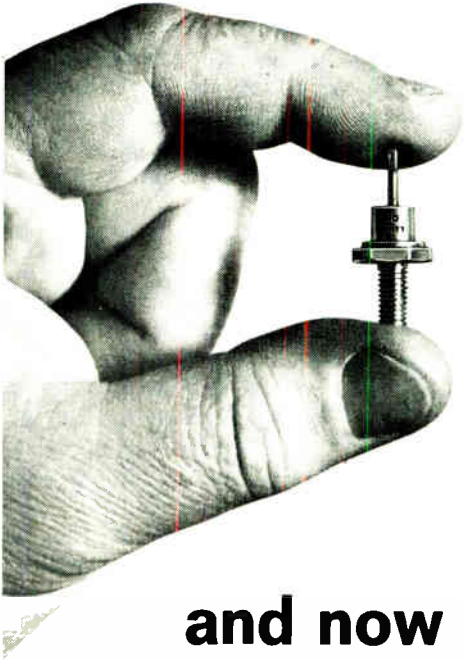

and now meets MIL-S-19500/356

**Unitrode's tough JAN Type 1N4954 Series
has fused-in-glass reliability,
voltage ratings from 6.8 to 400V,
and is available from stock**

- Surge capacities to 10,000 watts — 1 microsecond
- Surge current capability up to 40 Amps
- Sharp knees, voidless glass construction
- Price competitive to conventional 10 watt zeners
- Solves MIL-STD 704 surge problems
- No plastics, epoxies, silicones, oxides, gases or solders are used.
- ... and TX soon to come

580 Pleasant Street, Watertown, Mass. 02172 (617) 926-0404

UNITRODE



**TOUGH AS ALL GET-OUT
FROM THE INSIDE OUT**

With the silicon die metallurgically bonded between terminal pins of the same thermal coefficient, the hard glass sleeve is fused to the entire outer silicon surface.

Result — a voidless, monolithic structure.

**HARD GLASS FUSED
TO SILICON SURFACE**



**TERMINAL PINS METALLURGICALLY
BONDED DIRECTLY TO SILICON**



For fast action call Fred Swymer COLLECT at (617) 926-0404
Or if you're not in that big a hurry, check off the reply card
and get our new complete diode catalog C-107.

LOW COST AUTOMATION takes many forms

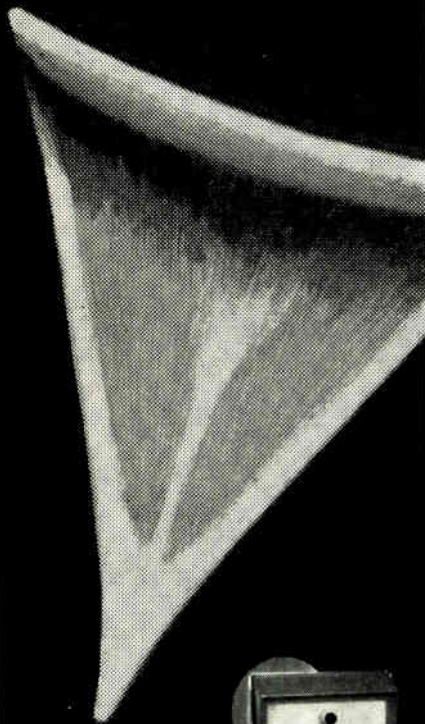

New plug-in Cycl-Flex 2 & 3 digit totally solid state I/C counters. 100% accurate. Up to 1200 counts per minute. Available in higher count rates. Easy-to-set thumb wheels.

Get Catalog 15, describing these and 560 other forms of low-cost automation.

GW Eagle Signal Division
E.W. Bliss Company
Davenport, Iowa 52803
A GULF • WESTERN COMPANY

Service-In-Depth ...
Local Engineering, Stock, Repair

U.S. Reports

Tukey method would require.”

Thus the system does a complete 32,000-sample fast Fourier transform in about 40 seconds—20 of which are used to transform information to and from the disk store. The whole operation can take up to 80 seconds of machine time if other operations like weighting and normalization of data are added. Data collection and readout naturally are slower, limited by the duration of the sampling period and by plotter and printer speed.

Although the system was originally designed for a far different—proprietary—application, the company may have an unsuspected market for it in petroleum geology. Though the samples used in that kind of seismic analysis are usually short, 4,000 to 8,000 words, data is stored in tracks since it's taken from multiple geophone sensors.

Graham figures that little revision would be needed to turn the processor into what could be the wildcatter's fast Fourier computer —“Just operate on each track in sequence,” he says, “and do the transform at the end of each track” —thus taking some mineral exploration from the hands of computer-rich oil companies, and giving it back to small businessmen at \$30,000 a throw.

Computers

EDP for all hands

The Naval Air Systems Command—currently working with more than 35 developing computer systems—decided a bit more than a year ago to look at a more general approach to computer design. The idea: a modular digital computer system that could do all airborne computer chores for all naval aircraft in the 1975-1985 period. Now that concept is a full-fledged program, called advanced avionics digital computer, that's becoming an element in advanced naval aircraft now on the drawing boards.

According to Ron Entner, program manager, the project will demonstrate the ability of byte-functional modularity to meet pro-

jected computer needs in every conceivable aircraft system from close support attack to air rescue. Basic to development of the system is the idea of combining technologies and methodologies projected for the time period of the computer's active life. Among them are LSI, MOS, thick film, Fourier spectral analysis and synthesis, variable word length, and built-in test and self-repair.

Entner believes that the result will be a system that can be set up to meet a continuous range of requirements—from a simple unit processor to a multiprocessor or bulk parallel processor—using a minimum number of standard block modules. All contingencies would be covered with 20 to 30 basic parts. Entner says, “We can expect drastic reduction in computer costs as we will be using off-the-shelf, mass-produced modular hardware.” He adds that much of the saving will come from reduced design work.

Better. Although it is still early in the development process, thought is being given to some of the unique offerings which may be produced by the system. Two mentioned already are a voice command interface and analog checks for predicting digital failures. At this point, on paper at least, the system offers advantages over other existing and planned airborne computer schemes. For example: it promises an improvement of better than five orders of magnitude over existing computers in operation and maintenance. Entner says it was measured against a computer now under development, though he won't mention the system, and theoretically offers an average of 10.1 improvements in all categories.

Plans now call for a “determination of feasibility” for the Navy airborne computer in 1973 at which time detailed specifications would be written and development of a demonstration model would begin. Presently, the Navy hopes to keep its costs under \$10 million to the point of determining feasibility. Should the program pan out, it could become the basis for all naval avionics systems for a decade.

We built these tape recorders to play, not to play with!

When you're recording data, you don't want to waste time playing nursemaid to a temperamental tape machine. So we built the HP 3950/3955 Analog Recorders to play tape, not games.

Through simple design and rugged construction, we cut out almost all of the finicky adjustments and maintenance operations required for most recorders.

Routine maintenance on the HP 3950/3955's runs less than one-fifth of that needed for most of the machines you might be considering.

The HP 3950/3955's low initial price, plus the sharply reduced operating costs that come with minimum downtime, make it an attractive buy for a wide variety of scientific, medical and

industrial applications.

If up to five times less tape recorder maintenance and downtime looks good to you, ask your local HP field engineer about our HP Model 3950 and 3955 Analog Recorders. Or write Hewlett-Packard, Palo Alto, California 94304; Europe: 1217 Meyrin-Geneva, Switzerland.

Misalignments that might interrupt your work on other machines are eliminated by a cast aluminum frame, machined to precise dimensions on a numerically controlled milling machine. Tape transport components are mounted to this frame on precisely indexed bosses, and neither shimming or other adjustments are required in the field.

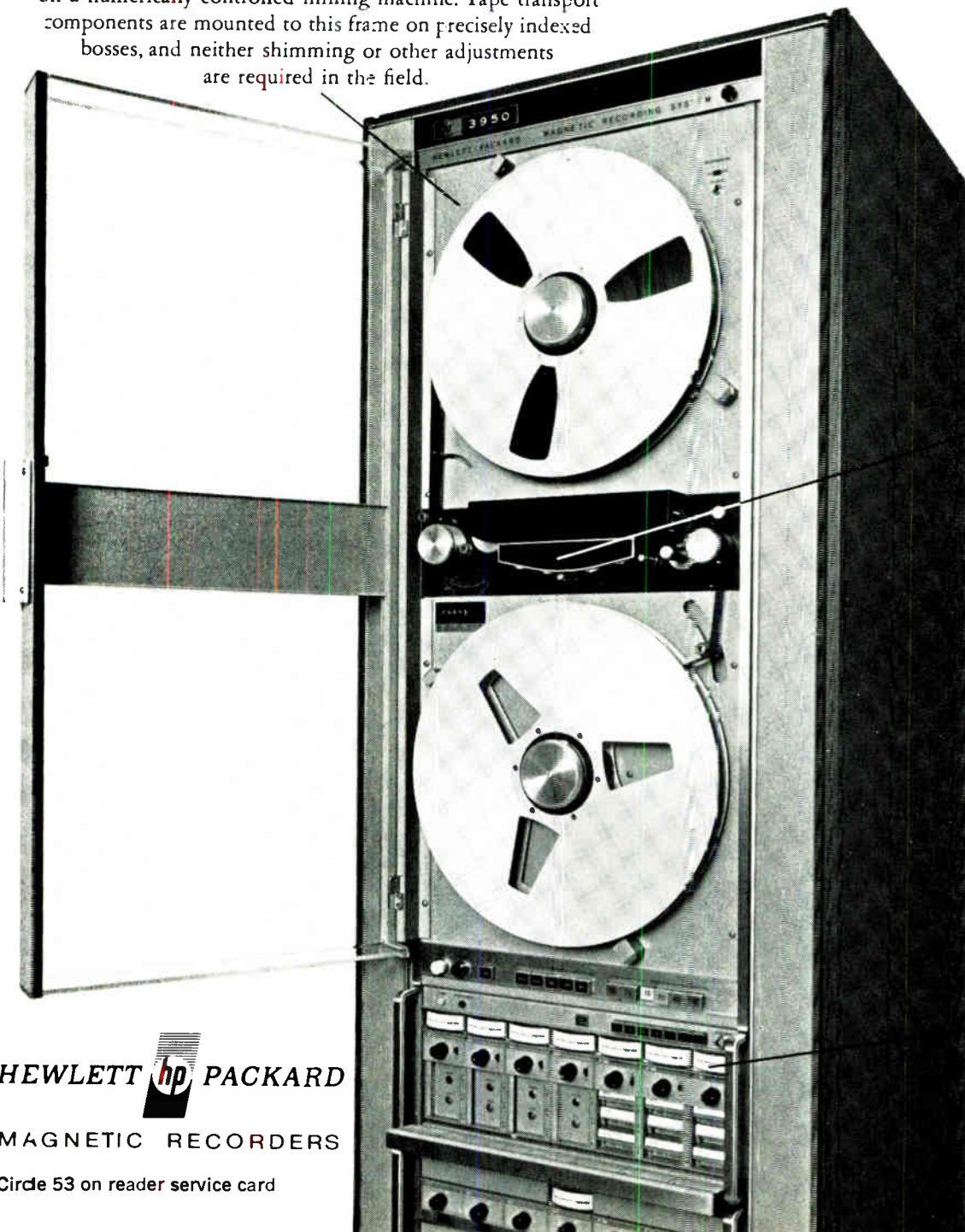

An instrumentation quality, open loop tape drive ends the need for complex servo systems and vacuum or blower buffer chambers. The simple, uncluttered tape path assures easy cleaning and loading. Both IRIG 7 and 14 channel models are available, with the 7 channel model expandable to 14.

Front panel monitor meters, test signal selectors and test I/O connectors for all record and playback electronics are readily accessible.

HEWLETT  PACKARD

MAGNETIC RECORDERS

Circle 53 on reader service card

LOW COST AUTOMATION takes many forms

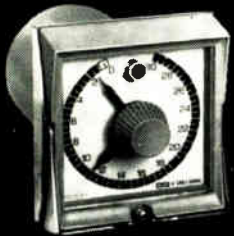
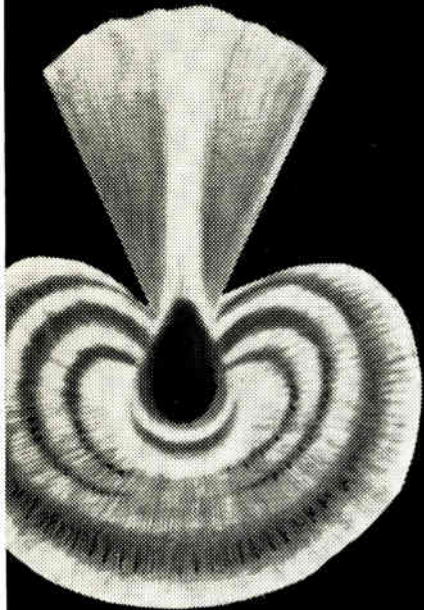

Our famous plug-in Cycl-Flex® electromechanical and solid state time and count controls cut down-time... are replaceable in 5 seconds or less.

Get the facts on these and 560 other forms of low-cost automation. Send for Catalog 15.

GW Eagle Signal Division
E.W. Bliss Company
Davenport, Iowa 52803
A GULF + WESTERN COMPANY

Service-In-Depth...
Local Engineering, Stock, Repair

U.S. Reports

Since the concept is modular, new technology could be slipped into the computer in the form of a compatible new module.

One aspect of the future of the computer envisioned by the Navy is to prevent one company from getting an inside track for the computer or for any one element. In short, says Entner, no prime contractor is planned. Should the program go to fruition, however, many companies would participate. Thus far, over a dozen firms are at work and a score more have expressed interest in upcoming contracts for developing certain elements.

Five firms—Hughes, Westinghouse Aerospace, General Electric, Honeywell, and IBM—are providing unfunded studies of the concept to the Navy. Raytheon and Westinghouse are doing funded systems studies, Sylvania and Litton Data Systems are under contract for memory development studies, several LSI development contracts are under negotiation and will be announced shortly, and Systems Consultants Inc. is working on an instruction repertoire.

Jobs. In the next few months, a number of contracts will be awarded in such areas as LSI packaging concepts, design of a multiprocessor, input-output concepts, computer simulation, memory development, and continued systems analysis.

Entner says that the program really boils down to nine parallel development efforts: modular digital multiprocessing; modular bulk-parallel digital processing; advanced memory technology; input-output, conversion, preprocessing, and communications concepts; advanced programing concepts; microelectronic technology development; microelectronic packaging development; advanced avionics systems requirements studies; and automated design and programing concepts. He points out that as far as possible all data generated will be kept unclassified and the rest disseminated on a need-to-know basis. The request for proposals being readied for LSI packaging contracts stipulates that the Navy will not consider proposals of proprietary packages.

For the record

On the wing. Although no one would characterize it as a mass exodus or anything even close to it, the fact is that during the past year a number of Texas Instruments' brighter stars have left the Dallas-based firm for what they hope are greener pastures. Latest to leave is Jon Eberle, corporate market research director, who is moving over to the Intermed Corp., a one-year-old medical electronics firm started by another former Tier, Thomas Walker. Other recent departures include G.W. Paxton, former manager of TI's opto-electronics department, who, along with three of his TI colleagues—J.D. Crowner, G.D. Clark Jr., and J.P. Wheeler—founded Spectronics Inc. to manufacture opto-electronic and infrared systems.

Meanwhile, IBM has filed legal proceedings against the newly-formed Cogar Corp., its president, George Cogar, and 66 former IBM employees who now work for Cogar. The suit alleges that Cogar is using IBM trade secrets to build computer equipment. Cogar maintains that the action is really aimed at preventing other IBM middle management from leaving the company for jobs in other parts of the data-processing industry.

Ready. National Semiconductor's recently announced series of linear IC's tested to MIL-STD-883 will be followed in two weeks by an 883 low-power TTL family, and later this year by an 883 MOS family. The advantage of these products, National claims, is that the customer doesn't have to order custom IC's to meet 883 requirements; the specs for the circuits are already written and they're available off the shelf.

Stamp of approval. NASA's "line certification" program, in which process control specifications are established for IC manufacturers to assure uniform quality and reliability, is starting to shape up. NASA is ready now to certify the first three companies: Texas Instruments, National Semiconductor, and Amelco.



SPEED WINS THE BALLGAME!

In computers, too, time is money: and the lowest computer time often wins the ballgame. So if speed is important to you, why settle for typical TTL times of 13 nanoseconds when you can have typical ECL II times of 4 nanoseconds?

At Stewart-Warner, the high-speed logic of the future is available today. We are now announcing another 14 new ECL II's in both the industrial series (1000) and military series

(1200). We have previously announced 14 circuits in these two ultra-high-speed series, as well as 11 ECL's in the high-speed 300 and 350 series.*

Since ECL's offer the designer the same functional capability and design freedom as he has with the slower TTL logics, there's no longer any need to compromise when speed is important...especially when Stewart-Warner ECL prices may be lower than what you have been paying for TTL's.

For more information, send for our ECL data sheets. And, for off-the-shelf delivery, call your local Stewart-Warner Microcircuits Distributor.

All Stewart-Warner ECL's interchangeable with Motorola MECL and MECL II units.

STEWART-WARNER SYMBOL OF
COMPANIES **SW**
PRESTIGE
STEWART-WARNER MICROCIRCUITS, INC.
730 EAST EVELYN AVENUE, SUNNYVALE, CALIFORNIA 94086
PHONE 408/245-9200 TWX 910 339 9210

Visicorder--recording

When we designed our original Honeywell Model 906 Visicorder back in 1956, we didn't start with an idea of how it would work.

We started with the idea of what it should do: give you *immediate* readout of high-frequency analog data.

So instead of using a conventional recording technique (with chemicals, ink or vapor), our Model 906 was designed around a whole, new, unconventional technique . . . of recording on light-sensitive paper, which then developed on exposure

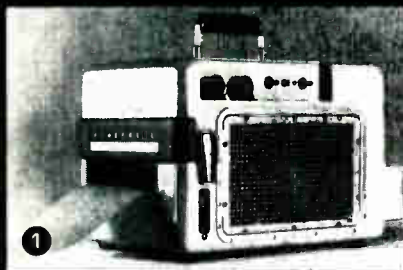

to an ambient light.

Since then, we have seen this "unconventional" technique become the most widely accepted system in

oscillography, an accomplishment that might have been enough to content most manufacturers.

But not Honeywell. We expanded this technique to fit virtually any application, by introducing Visicorders of greater capacity.

Then we introduced Visicorders with added convenience features and increased versatility, including a new fiber-optics recorder.

And then we introduced a complete range of accessories, such as our microfilm recorder accessory (that provides expanded resolution,

1 Model 906: 6" compact, "handyman" Visicorder
2 Model 2206: 6" battery-powered, portable, Visicorder

3 Model 508A: 8" Visicorder with takeup unit
4 Model 2106: 6" laboratory Visicorder

5 Model 1204: Visiprinter accessory
6 Model 2400: Microfilm recorder accessory
7 Model 1912: 12" high-performance Visicorder

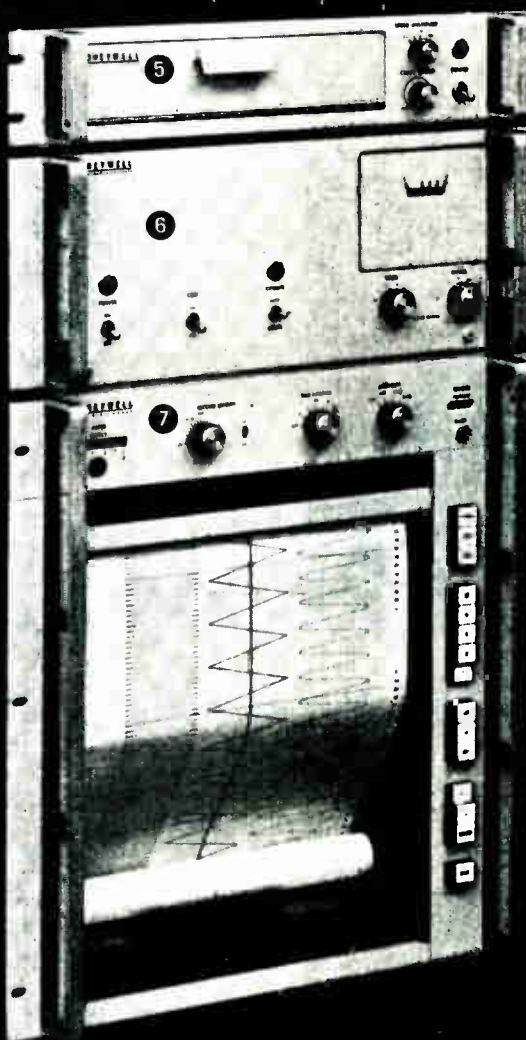
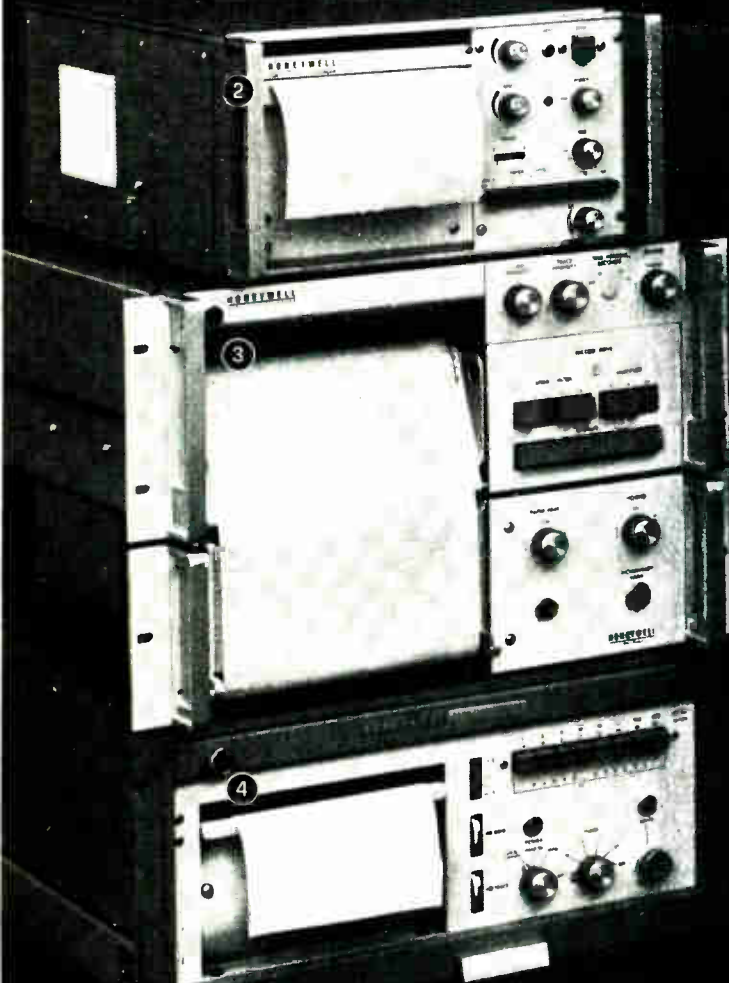

Regional Sales Offices:
Albuquerque, NM (505) 345-1656
Dave Dimick
Chicago, IL (312) 674-9770
Eldred Jones

solutions since 1956

reduced record storage space, increased economy, and a permanent record; and our Visiorder, a digital printer accessory that allows you to record digital data, along with the analog traces on any Visicorder.

And then, finally, we complemented this line with a variety of signal conditioning instruments, including amplifiers, attenuators, strain gage and thermocouple control units. Plus a wide selection of thermocouples and Statham transducers.

Until now, today, when we can

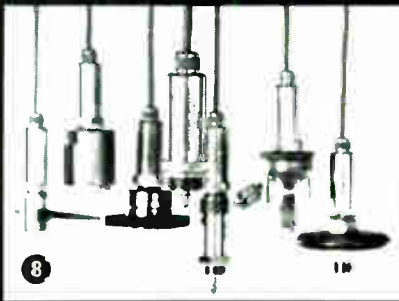

honestly say that we offer the world's finest and most complete line of direct recording light beam oscillographs, systems and accessories.

Which means that a Honeywell engineer can provide the solution to any recording problem, no matter the size or complexity.

And that from small portables to 36-channel Visiorders, DC to 1 MHz, Honeywell can deliver, install and maintain any size system.

For more information, call your nearest regional sales manager listed below, or write: Honeywell Test Instruments Division, P.O. Box 5227, Denver, Colorado 80217 (303) 771-4700.

- 8 Statham Transducers
- 9 Model 1108: 8" general purpose Visicorder

- 10 Model 1806: Fiber-optic recording oscillograph
- 11 Signal Conditioning

Honeywell

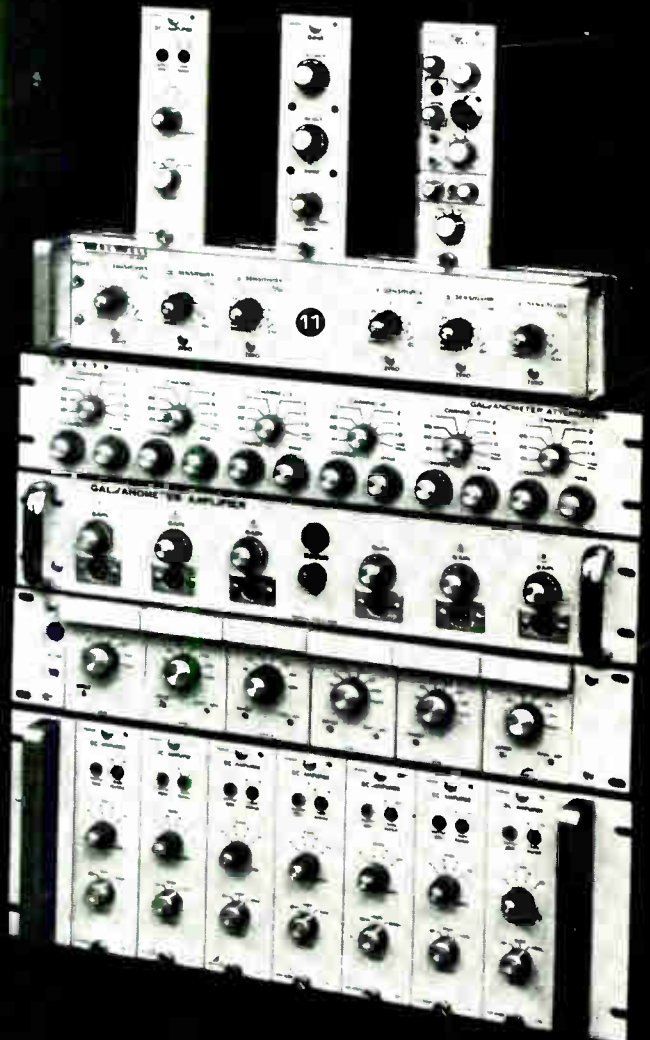
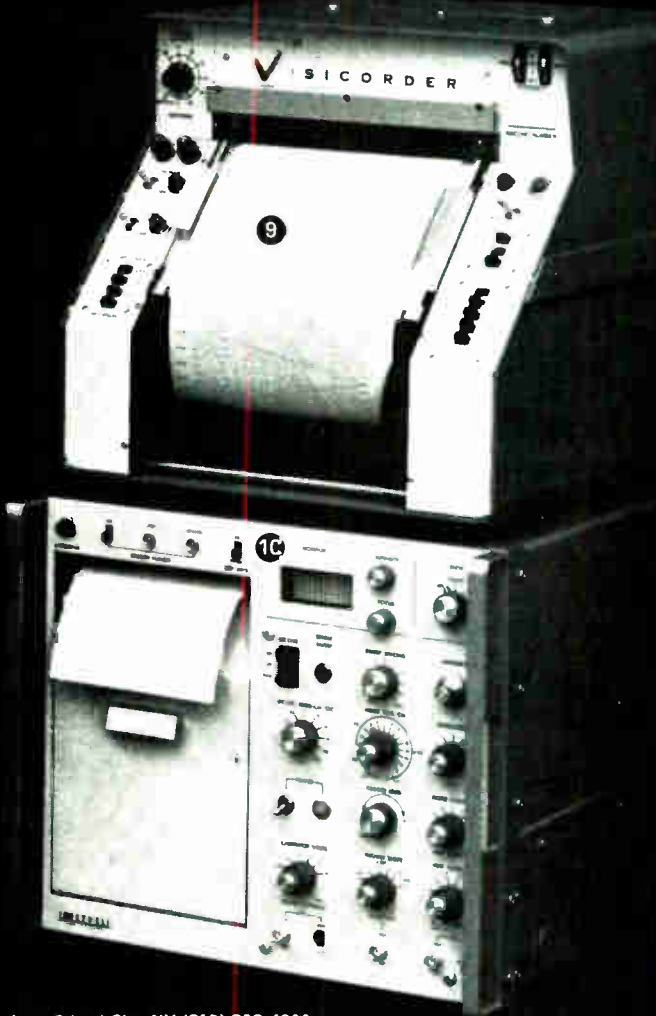

Long Island City, NY (212) 392-4300
John Paul
Los Angeles, CA (213) 724-3500
Durke Johnson
McLean, VA (703) 893-4560
Bill Schmick

See us at WESCON, Booths 1306-1309.
Circle 57 on reader service card

BELDEN...new ideas for moving electrical energy

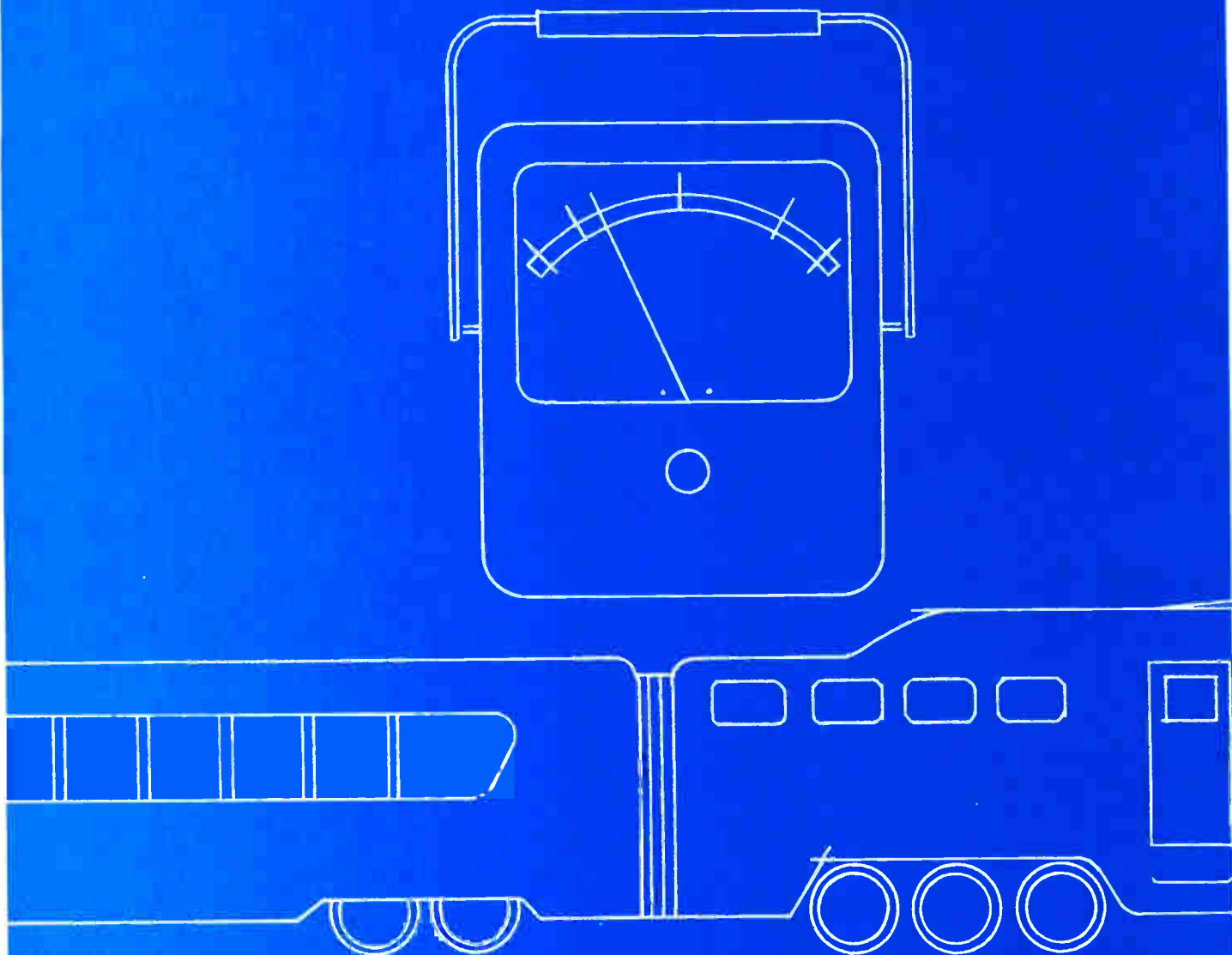

Belden's systems savvy is



BELDEN

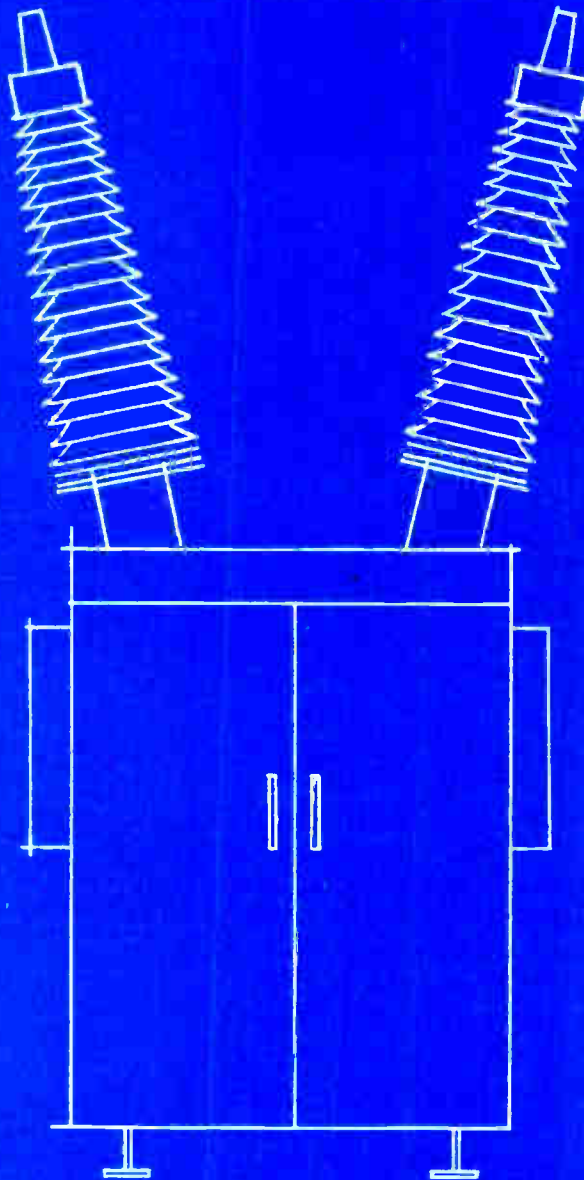
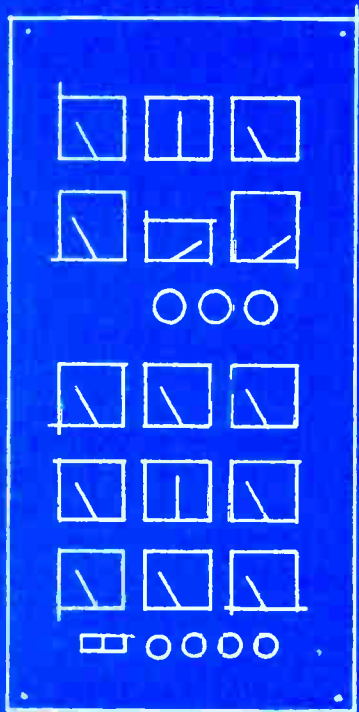

no big deal

It's a lot of little deals, that add up to something big. Like lower costs. Fewer production headaches. Enhanced product reliability. By poking and probing into your product's electrical system and the way it's manufactured and used, Belden Wire Systems Specialists may be able to suggest a wire or cable that costs less. Or that lasts longer, or that takes up less space*. Or maybe they'll suggest a different put-up that saves you assembly time. Or a solution to a stripping problem. They'll also offer you one responsible source for all your wire needs. Because we're the

people who make all kinds of wire for all kinds of systems. So if you're making plans or having problems, get yourself a good deal. Call or write: Belden Corporation, P.O. Box 5070-A, Chicago, Illinois 60680. And ask for our catalog, and the reprint article, "Key Questions and Answers on Specifying Electronic Cable."

*For example: Beldfoil® shielding in Belden cable. It isolates conductors better than anything yet. And it's thinner. You can pack more conductors into a conduit . . . hold down size and weight.

G-2-B



MICROWAVE IC MODULES PROGRESS REPORT #8: PRODUCTION

Sperry Rand's PACT (Progress in Advanced Circuit Technology) program has moved microwave integrated circuits and modules out of the laboratory and onto the production line. As far as we know, Sperry Rand is the first company in the industry to take this revolutionary step.

Our functional assignment was to design the world's first radar performance analyzer for end-to-end testing of doppler radars. For a Navy program, our customer wanted a portable tester that could exercise navigation radar without radiating energy and without making any interconnection with the aircraft. Since size, weight and power consumption are critical, all the microwave functions were integrated. The result: three microwave integrated modules replacing 32 conventional microwave components.

At one time or another, Sperry Rand had produced fully integrated versions of every microwave component in the test set. Why not reduce the whole circuit to integrated modules? First, integrated modules have fewer interconnections, and are therefore more reliable. Second, integrated modules cost less to produce than present day collections of discrete components. Third, by making all of the circuit elements ourselves, we sidestepped a lot of procurement problems.

Development of the microwave integrated circuit modules for the doppler test set proved to be well within Sperry Rand's capability.

The unit works well. In the old days (last month) the microwave section would have occupied 90 cubic inches. Today it takes up 3 cubic inches. Our ferrite-

substrate modules have a low-pass filter, 6 circulators, 11 attenuators, 5 diodes, 2 mixers, 2 converters and 4 thermistors. The old way would have required 25 more flange connections than the integrated modules use. The microwave circuit functions within the same tight tolerances that it would have under the older technology.

Now that we're delivering integrated modules, you can't afford to pass up our experience. In fact, if we're not helping design your microwave system, it's probably obsolete.

A letter will start us working on your next system improvement. Write: Sperry Microwave Electronics Division, Sperry Rand Corporation, P. O. Box 4648, Clearwater, Fla. 33518 or call us at (813) 784-1461.

ABOVE RULER: The old way. Thirty-two conventional microwave components.

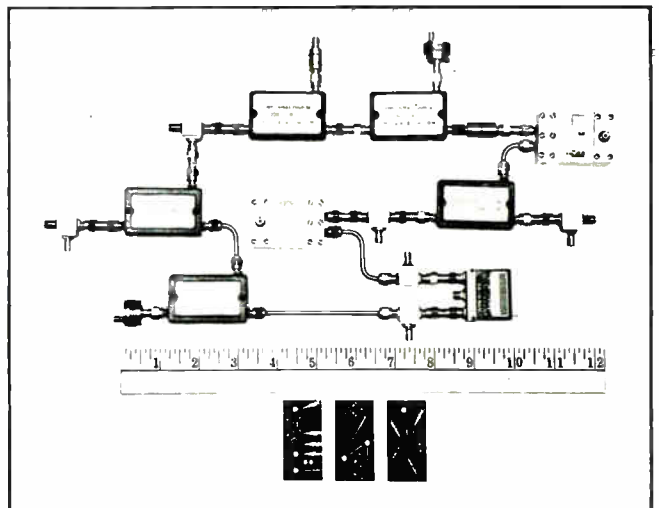

BELOW RULER: Sperry's new way. Three integrated modules. Lighter, less expensive, more reliable.

*For faster microwave progress,
make a PACT with people
who know microwaves.*

SPERRY
MICROWAVE ELECTRONICS DIVISION
CLEARWATER, FLORIDA

Washington Newsletter

July 21, 1969

Senate wants DOD to keep it posted on program costs

Not only is the Senate tightening its grip on the Pentagon by slashing military spending [see p. 37], but now it wants quarterly reports on costs of major weapons systems. Mississippi Democrat John Stennis, chairman of the Armed Services Committee, puts it this way: "We can save more by following these contracts from the time they originate on through, than we can by trying to pick up the spilled milk from the floor."

Two Republican members of Stennis' committee—Richard S. Schweiker of Pennsylvania and Milton R. Young of North Dakota—want the Senate bill funding development and procurement of aircraft, missiles, ships, and combat vehicles to require original estimates; updated estimates with explanation of any changes in price, delivery, or performance schedules; a listing of procurement options and their costs—plus an independent General Accounting Office audit of the DOD figures. With support from Stennis, Senate acceptance of the new controls seems guaranteed. As one Capitol Hill source puts it: "Mel Laird and especially David Packard have said most of these weapons problems could be controlled by instituting good business practices. Now they're being taken at their word."

HEW tries to pick number 1 to 5...

An embattled and battered Department of Health, Education, and Welfare—still smarting from Secretary Robert Finch's recent embarrassments by the White House on staff appointments and education desegregation—is encountering problems in another area: color tv X-ray radiation.

The 15-man committee of industry, labor, medicine, and Government representatives set up to advise HEW's Bureau of Radiological Health on radiation standards has unanimously rejected the bureau's proposal that limits be dropped to 0.1 milliroentgens per hour at "any point accessible to an individual" from the present level of 0.5 mr at 5 centimeters from the set. Committee arguments are that the standards are too severe for industry and that existing instrumentation is not capable of accurately measuring such low levels.

HEW also proposes that all receivers be labeled with the manufacturer's name, plant identification, production date, certification of compliance, and a warning of radiation hazard. Producers importing sets from Japan, Taiwan, Hong Kong, and other Asian plants are opposed to those labeling provisions.

... as it moves in on medicine men

As the Bureau of Radiological Health girds for the color tv radiation controversy, HEW is also preparing tough radiation standards for medical and dental X-ray and fluoroscopic apparatus. Before coming up with these by January, the department will again consult its advisory committee on what is expected to be a tough combination of warning labels, exposure standards, periodic equipment performance checks, and precisely written user manuals.

Tough provisions for microwave ovens have already been presented to the committee. Based on the contention that interlocks which cut off oven power when the door is opened are often inadequate, HEW has proposed "a minimum of two interlocks that are mechanically and electrically independent of each operation." Detailed specs are being worked up to make the two interlocks foolproof. Also called for: quality control and test procedures, exposure standards, and cautionary labeling.

Washington Newsletter

Three CAS systems race toward tests

Even though tests of three collision avoidance systems (CAS) are right on schedule, they can't be completed fast enough for airlines that want to install them and manufacturers who see a good-sized market opening up. Flight testing began this month in Baltimore with systems built by Bendix, McDonnell Douglas, and one by a Sierra Research-Wilcox Electric team.

Martin, which is running the test program for the airlines, has started the initial tests—to determine if the three systems can operate compatibly. Once this is done, Martin will begin a 12-part program that will generate 2 million data points over 500 hours of flight testing. The entire CAS program, including the test hardware, is costing the airlines more than \$12 million. Tests should be finished by the end of the year.

Cost of CAS is higher than many would like, but the Air Transport Association is predicting that CAS will go for about \$30,000 per set for commercial airliners and around \$10,000 each for a simpler general aviation version. ATA is hoping that the price of both will drop as manufacturers gain production experience.

GSA eyes unbundling as chance to save

The General Services Administration, which did \$338.4 million worth of business with IBM during fiscal 1969, expects to bargain hard when it sits down to talk about new contracts with the giant computer maker. The reason: IBM's "unbundling"—separation of equipment and service prices. While a 3% price cut would mean only \$10.1 million to the GSA, which handles all Federal procurement of general-purpose computers, the agency fully intends to see even that saving reflected in new deals for lease, purchase, and maintenance. In any event, says the GSA, fiscal 1970 agreements probably won't be reached before the fall.

Jifdats award still up for grabs

The Navy has let the fiscal year come and go without naming a developer for the joint in-flight data acquisition and transmission system (Jifdats). The oft-delayed program, cut back a few months ago from a two-phase development and production program that could have cost as much as \$250 million to a development effort only, was to get off the ground by June 30 at the latest.

Three firms are competing: Hughes Aircraft, Motorola, and Northrop. The development award for the triservice procurement is expected to be worth anywhere from \$25 million to \$50 million. Industry insiders are convinced the technical judgment has been made and that price is delaying an award. One source, however, says that he wouldn't be surprised if the announcement were stalled until Congress adjourns to avoid the flak coming from Capitol Hill on new awards these days.

In Jifdats, data gathered by a variety of aircraft sensors will be sent over a data link either to a real aircraft or directly to the ground, giving the services near real-time reconnaissance.

Addendum

The Army's Safeguard Systems Command is quietly making plans to counter a new problem uncovered in its searching review of the controversial ABM system's performance. The problem: In a rapid, large-scale nuclear exchange, how to separate outgoing interceptor missiles from incoming enemy warheads. The Army's proposed solution seems simple: Add an infrared sensor capability to tracking radars to monitor the hot exhaust of interceptors.

Let's put an end to op-amp compromise

Eight new versions
of the 741 let you
match the op amp
to your design,
instead of
vice versa.

Send for new technical data
on all these units, as well as
Transitron's improved 709
series, the TOA1709, TOA4709,
TOA7709, and TOA7809, all now
offered with short circuit
protection.

1

Need the 741 with complete internal compensation?
Ask for TOA1741 — direct mechanical and electrical
replacement for the μ A741.

2

**Need the 741 with variable bandwidth to 5 MHz and
variable slew rate to 5.0 volts/ μ sec?**
Try the TOA1741W — Using one external capacitor for
maximum performance flexibility.

3

**Need the 741 with internal compensation, plus 20X lower
input bias current, 20X lower input offset current,
10X higher input Z?**

There's nothing like the TOA7741 — featuring min. input Z
of 3 megohms, max. input bias current of 30 nA, max. input
offset current of 10 nA.

4

**Need a 741 with variable bandwidth to 5 MHz & variable
slew rate to 10 v/ μ sec PLUS 20X lower input bias — 20X
lower input offset current — 10X higher input Z?**

Use the incomparable TOA7741W — with an external
capacitor for performance flexibility, plus same input
characteristics as TOA7741.

5

Need any of the above in industrial temperature ratings?
Ask for TOA2741, TOA2741W, TOA8741, and TOA8741W
respectively.

Transitron
electronic corporation
168 Albion Street, Wakefield, Massachusetts 01880

the
GIANTTM
GENERAL INSTRUMENT ADVANCED NITRIDE TECHNOLOGY
among RAMs

GIANT 32-bit static RAM – the first Random Access Memory directly compatible with TTL, DTL and MOS, expandable in all directions, is also the lowest priced.*

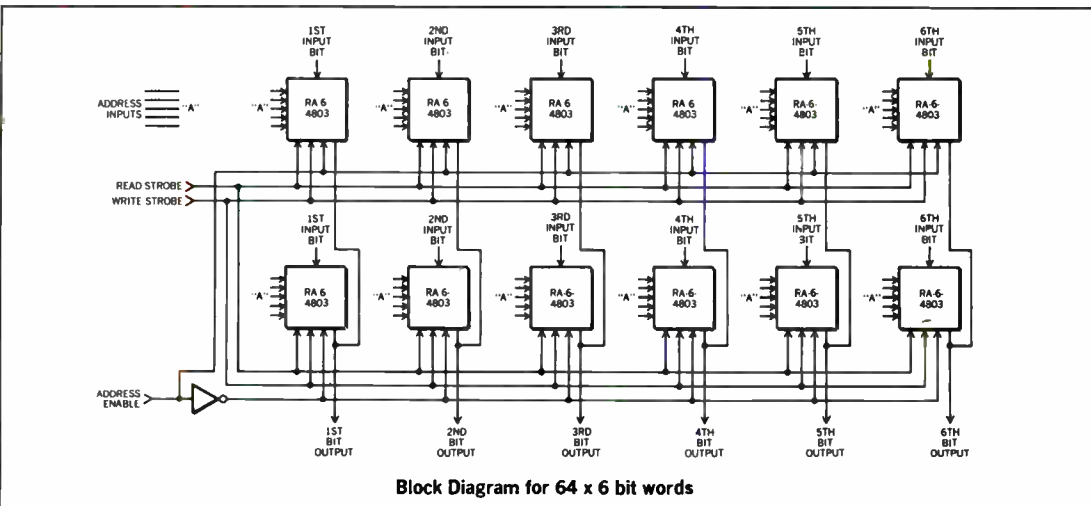
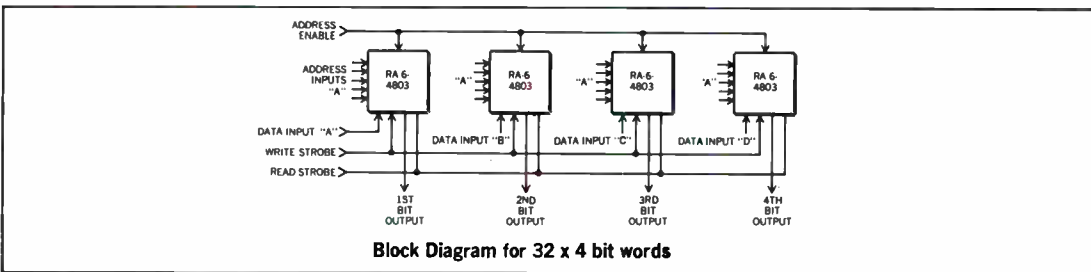
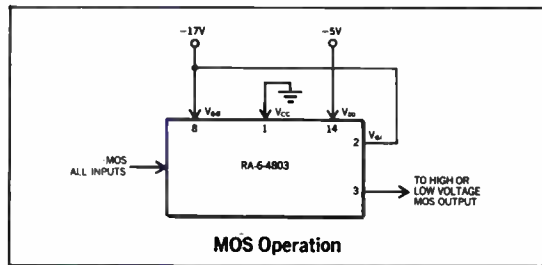
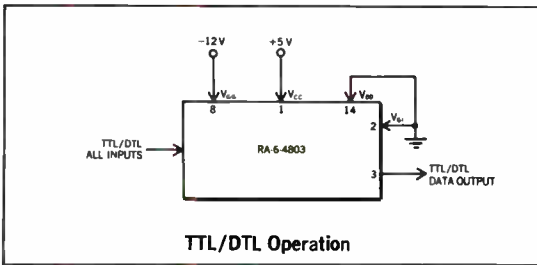

The GIANT 32-bit RAM stands far above the others. Designed for both large and small memory system applications, it is the latest addition to General Instrument's exclusive GIANT family of LSI devices. Present in the 32-bit RAM are all the advantages inherent to products of the General Instrument Advanced Nitride Technology (GIANT). These include: the elimination of interface circuitry, a reduction in the number of system power supplies, a reduced parts count and fewer interconnections, lower power dissipation, increased operating frequency and an increased operating temperature range.

A most significant feature of this GIANT RAM—and of every standard GIANT product—is the V_{oi} terminal, which gives the user a choice of interfacing directly with TTL/DTL or MOS.

The GIANT 32-bit RAM is a monolithic circuit containing 32 DC storage flip-flops with 5-bit address decoding for both read and write. It is intended for use in medium and large

arrays as a scratch-pad memory and as a replacement for core memory systems. Upon application of the correct binary address and strobe pulse, any one bit word may be updated or read out on the corresponding data-in or data-out terminal.

Included in the features of the GIANT 32-bit RAM are: low power dissipation of 90 mW, high speed, non destructive read-out (NDRO), and a full military temperature range of -55°C to $+125^{\circ}\text{C}$.

The GIANT 32-bit RAM is immediately available from your authorized General Instrument Distributor.

For full information write, General Instrument Corporation, Dept. R, 600 West John Street, Hicksville, L.I., N.Y. 11802.

(In Europe, write to General Instrument Europe S.P.A., Piazza Amendola 9, 20149 Milano, Italy; in the U.K., to General Instrument U.K., Ltd., Stonefield Way, Victoria Road, South Ruislip, Middlesex, England.)

*\$11.80 each in quantities of 100 pcs. for the RA-6-4803 in a 14-lead dual in-line or 14 lead flat pack.



No other general purpose counter is so useful in so many ways. No other counter offers you so many accessories to fit so many measurement jobs.

First, you can get the Model 5248M with a time base that's stable to better than 5 parts in 10^{10} per day, a precision frequency standard in itself. You can measure any frequency from dc to 135 MHz to 8 places ± 1 count. Or use to 18 GHz at the same accuracy with simple plug-ins.

You can measure period, multiple period average, frequency ratio, multiple ratios, or you can scale frequencies or totalize.

With accessories that plug into the front panel you can:

Resolve time interval to 10 nanoseconds.

Measure to 18 GHz with a 1 Hz resolution in 4 seconds.

Measure CW or pulsed signals out to 18 GHz.

Prescale for direct readout to 350 MHz.

Increase sensitivity to 1 millivolt.

Make dc voltage measurement up to 1000 volts.

Normalize readings to engineering units or perform high speed batch counting or control.

And with the newest plug-in, the 5268A Frequency Multiplier, you can make high accuracy low-frequency measurements as much as 1000 times faster

You can get much more out of this counter. Because you can put much more in.



than you ever could before.

Plug-in accessory performance is unequalled. Even the 18 GHz heterodyne converter is completely free of spurious responses. And the transfer oscillator plug-in operates on a new principle which offers versatility, range (50 MHz to 18 GHz) and performance you can't get elsewhere. Add-on accessories even further extend counter usefulness by permitting manual measurements to

40 GHz or automatic measurements from 0.3 to 12.4 GHz.

The 5248M is but one member of a series of 10 closely-related models based upon the highly popular 5245L Counter. All models use the same accessories. And you'll get the same quality and field-proven design no matter whether you choose the top-of-the-line 5248M for \$3300, the original 5245L for \$2480, the economy model 5246L for \$1800 or any of the

seven other models.

For a 32-page guide to the highly versatile "5245 Series" call your local HP field engineer. Or write Hewlett-Packard, Palo Alto, California 94304; Europe: 1217 Meyrin-Geneva, Switzerland.

HEWLETT  PACKARD
ELECTRONIC COUNTERS

02904

Circle 67 on reader service card



Now...from
G-R
Industries
...a totally
new breed
of
system
control
computer

gn-909

DIRECT FUNCTION PROCESSOR

gn-909

6 3

DESCRIPTION REGISTER

15 14 13 12 11 10 9 8 7 6 5 4 3 2 1 0

SEQUENCE COUNTER

MEMORY ADDRESS

MEMORY BUFFER

DATA DISPLAY

15 14 13 12 11 10 9 8 7 6 5 4 3 2 1 0

You have never seen a computer like this before

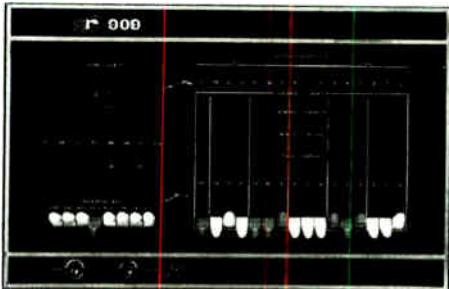

The GRI 909 is the first truly innovative approach to computer architecture since the general-purpose computer was first applied as a control device. It goes beyond traditional design to provide a new level of power and flexibility. A true system controller, it provides the only logical answer to many of the basic problems that face system designers . . . problems like these:

PROBLEM #1

The Real World Interface

In spite of claims to the contrary, the typical small computer is designed primarily as a calculating device, not as a controller. The system designer, after describing his system functionally, must either transcribe his design into the non-functional language of the computer with all its expressed and implied constraints, or turn over the programming responsibility to a specialist whose background usually is not related to the system application. Result: substantial expense, long delays and occasionally, built-in software limitations.

No problem with **gn-909**

The GRI 909, designed as a system controller, is organized functionally. *ALL* data registers, whether associated with the processor, firmware options or input/output devices, are equally accessible to the system designer. *ALL* data registers may be incremented, shifted or algebraically tested: the traditional arithmetic operator, with its associated registers, is optional. The GRI 909 programming language is tailored to the functional organization of the processor itself. Input/output devices are operated with

the same basic language code. The system designer can both design a system and implement its application in this functional language.

PROBLEM #2

The Data Flow Maze

Conventional computer architecture is designed around an instruction repertoire, with maximum computing power as the major criterion. The input/output instructions are a secondary consideration and instruction power is limited. The flow of data in and out is impeded by the "implied" operations of the instructions. Free communication between internal computer elements and external devices is not possible.

No problem with **gn-909**

Here the problem is solved by extending the I/O bus system into the heart of the central processing unit itself. Data is free to flow directly between devices external to the computer and the arithmetic unit, memory, or any of the internal registers without stopping along the way in special accumulators. This free direct flow cuts down on time consumed in moving data about, and reduces or eliminates the need for temporary storage. A unique advantage is GRI 909's ability to perform certain simple operations — increment, complement, shift left or right — on the fly.

PROBLEM #3

The Black Box Hang-Up

Once a computer is selected the system designer is locked into a pre-established set of capabilities. The CPU is essentially a black box, and there is little that can be done to alter its basic structure. If the system requirements change to include say a "hardware multiply", or "hardware square root", or "hardware byte swap", or "hardware anything", the only alternative is to go to a bigger, more expensive computer possibly requiring a complete new interface design with all new software.

No problem with **gn-909**

The GRI 909 has provision for the addition of firmware options. And by

firmware we mean, not merely the substitution of read-only memory for software, but a broad range of hard-wired plug-in functions which can replace a variety of software routines. This gives the system designer complete freedom to adapt the computer to changing system needs, and to evaluate trade-offs between speed and economy in individual cases.

Basic characteristics

The GRI 909 cannot be fully evaluated in conventional computer terms. But for those who like to play the numbers game, the following characteristics are listed:

- Full Cycle Time: 1.76 μ sec for a 16-bit word
- Memory Reference Instruction: 32K directly addressable — not page oriented.
- Memory Addressing Modes:
 - A. Direct Mode: Single Address Instruction, 32 bits (16 bit op. code, 16 bits address)
 - B. Immediate Mode: 32 bits (16 bits op. code, 16 bits data)
 - C. Deferred Address Mode: One level of indirect addressing with 32K of auto-indexable locations
- Every device in the system, both inside and outside the computer, is directly addressable by programmed instructions.
- Direct memory access channel is available on the same data and control lines as the programmed input/output channel (I/O rate: 1.76 μ s/word). No DMA multiplexer is required for multiple DMA devices.
- Priority interrupt system has full capability to be used as a single channel interrupt or as a full hardware interrupt at the option of the system designer.

The GRI 909 with 4K 16-bit words of memory and ASR33 Teletype sells for under \$10,000. Basic units start at \$3600.

August deliveries will include: basic assemblers which can be assembled in the GRI 909 or the IBM 360, programming aids, math routines and utility routines.

Let us tell you more — Because GRI 909 is a completely new breed of computer, it is impossible, here, to cover its many unique features and their implications for the system designer. If you build control or instrumentation systems let us tell you what GRI 909 can do for you. For a copy of our new brochure write to:

G-R INDUSTRIES, INC.



76 Rowe Street,
Newton, Mass. 02166
(617) 969-7346

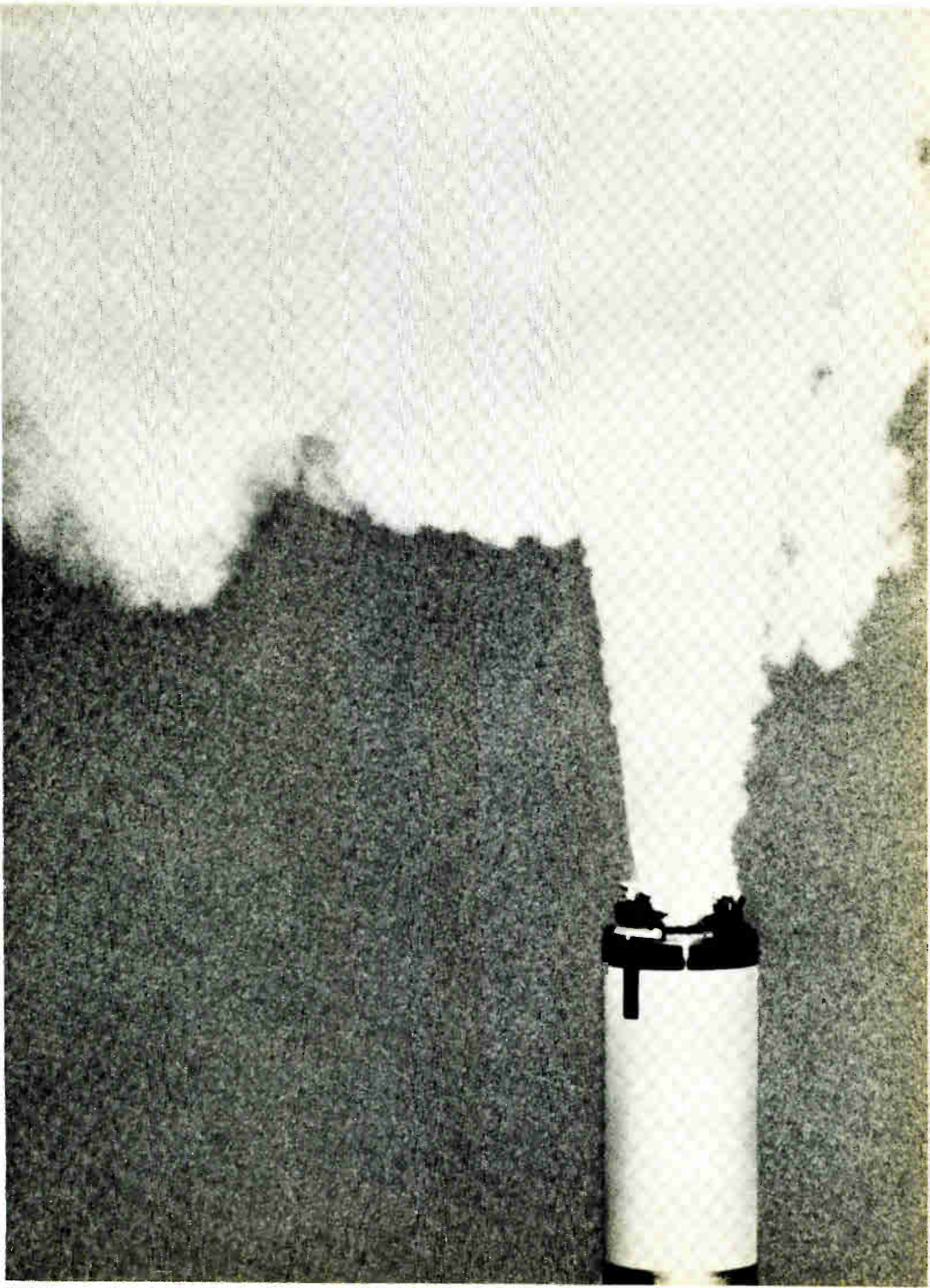

A lot of our connectors will be going up the tube.

They're the new low profile, light-weight connectors made by ITT Cannon going up with the Poseidon missiles through the tubes of our nuclear powered submarines.

This miniature-circular KJ connector series meets the rigorous requirements of the Fleet Ballistic Missile System with an operating temperature range from -85°F up to $+392^{\circ}\text{F}$. And high contact density and environmental resistance make our KJ connectors perfect mates for both commercial and space age applications.

One of the exclusive features in this MIL-C-38999 designed series is the LITTLE CAESAR® rear-release contact retention assembly. It permits contacts to be crimped, inserted and extracted from the rear — making installa-

tion a snap. And within this lightweight, low profile KJ series, you have a choice of 3 to 128 contacts in 33 different layouts. You can pick from 8 shell sizes (10 through 24) and 9 styles. Three of them are hermetic versions with contact sizes from 16 through 22. KJ connectors will intermate with comparable types, already in use. So whether your connector application is sea or airborne, our new KJ series is the perfect mate.

The Cannon® KJ connector line is completely tooled and available *now* on a short lead-time basis.

Write to: ITT Cannon Electric, a division of International Telephone and Telegraph Corporation, 3208 Humboldt Street, Los Angeles, California 90031.



CANNON ITT

This readout tube never tells a lie

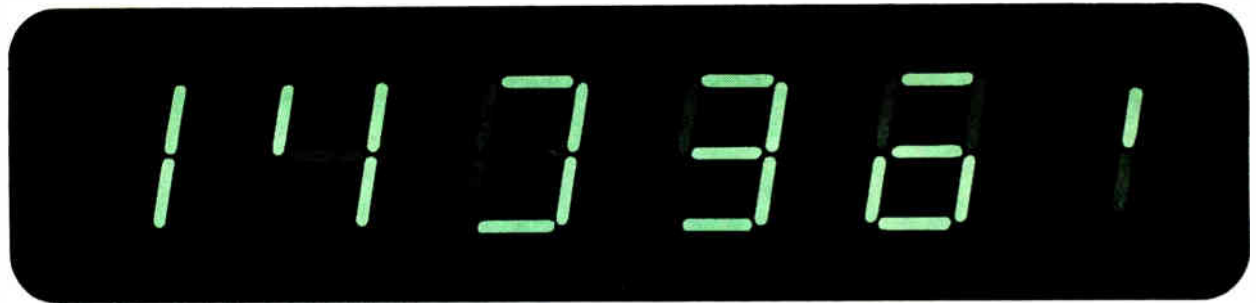
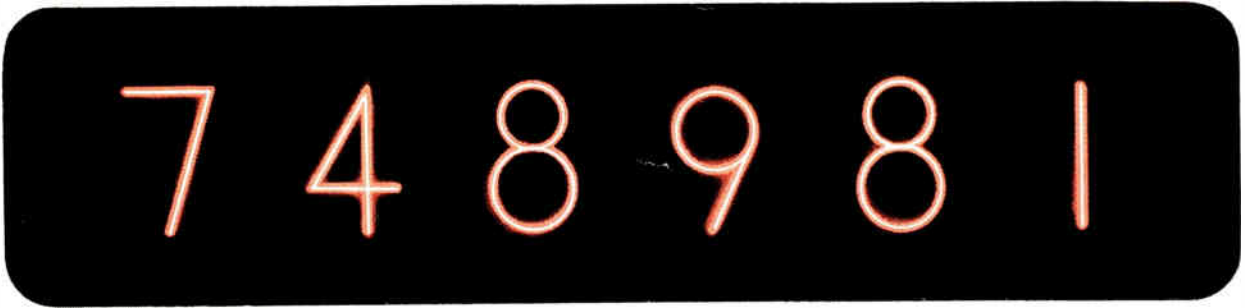

Others do

(and you never know when they fail)

Whatever data you input, a NIXIE® tube reads out. Exactly! You always have reliably accurate readouts, with no risk of a 1 when there should be a 7, a 0 instead of an 8, or a 3 instead of a 9. Rather than tell a lie, honest NIXIE tubes give you no reading ... protect you against false readouts caused by multiple segments that break down, blank out ... and don't indicate that they're wrong. You never know when they are faulty.

Selecting a readout display involves more than truth, so weigh every aspect. Check NIXIE tubes for their unmatched reliability, their proven long life (over

200,000 hours), natural readability, and uniform brightness (200 ft. lamberts, with no chance of partial fade-outs). See how only NIXIE tubes are unaffected by static charge ... meet mil specs ... offer unsurpassed packaging and design flexibility (no extra top leads required for decimals). All this, in the most complete and advanced line of tubes and accessories. No wonder NIXIE tubes lead the field.

For information, call or write: Burroughs Corporation, Electronics Components Division, P.O. Box 1226, Dept. N5, Plainfield, N. J. 07061; tel. (201) 757-5000.



the leader
in the world of displays

Burroughs



Technical Articles

**Schottky diodes
make IC scene
page 74**



Because they don't store charge, Schottky diodes can expand the horizons of digital integrated circuits. Diode-transistor logic, for example, can be made as fast as transistor-transistor logic and emitter-coupled logic. Moreover, power dissipation is reduced, and it's possible to come up with unusual componentry combinations on a chip. These devices also make large-scale

integration easier to achieve since more functions can be handled in less area. Another virtue of Schottky diodes centers on the fact that they can enhance production yields. On the cover are two of the first commercially available Schottky-diode IC's which will be introduced in the next few weeks by the Intel Corp., a new concern that's been concentrating on this field.

**Active filters: Part 11
Varying the approach
page 86**

Active RC filters have now reached a stage in their development where they perform at least as well, if not better, than their passive RLC counterparts. They are smaller, require less power, afford better stability and selectivity, and are free from undesired parasitic coupling or nonlinear inductor effects common to most passive networks. Moreover, since they lack inductors, active filters can be easily tuned, and they can be built economically as integrated circuits. The only difficulties involved center on selecting the best active filter for a particular job; the article includes a four-page gatefold containing circuits of 24 practical IC active filters.

**Adapter lets
digital IC tester
check op amps
page 94**

Addition of a simple, versatile interface fixture to automatic testers for digital integrated circuits permits checkouts of such linear devices as operational amplifiers. The tester can be programed to interconnect the amplifier terminals with appropriate load and feedback resistors to apply the correct supply voltage and make voltage and current measurements of the device being checked.

**Cellular redundancy
brings new life
to an old algorithm
page 98**

Litton's block-oriented computer is built of giant undiced wafers, each of which contains many independent processors operating in parallel. The principal operating algorithm, however, dates back 20 years or more and was once abandoned in favor of the well-known binary system. The Litton design promises greater reliability at lower costs than competitive approaches.

**Color tube
boosts scope's scope**

Coming

Resolution and convergence present difficulties when a color television tube is used as the display element in an oscilloscope. But the reward for solution is a three-channel unit with red, green, and blue traces.

Schottky diodes make IC scene

With reproducibility problems licked, these devices make attractive elements; they permit unusual component combinations, save chip real estate, reduce power dissipation, and enhance production yields

By R.N. Noyce, R.E. Bohn, and H.T. Chua

Intel Corp., Mountain View, California

Schottky diodes, because they don't store charge, open new worlds to digital integrated circuits. Diode-transistor logic with Schottky diodes can be made as fast as transistor-transistor logic and emitter-coupled logic. What's more these devices reduce an IC's power dissipation and permit unusual combinations of components on a chip. They also make large-scale integration easier to achieve because more functions can be performed in less area. Not the least of their virtues is the fact that they can increase production yields.

For all these advantages, Schottky-diode IC's have not been commercially available. Intel Corp., however, has concentrated on their development and is now making Schottky diodes that are stable and reproducible. The company has committed Schottky IC's to commercial production, and has found that they live up to expectations. Their first Schottky IC will be introduced in the next few weeks.

Structurally, the Schottky diode is little more than a metal in contact with a semiconductor. As long as aluminum is used for the metal, formation of Schottky diodes in a monolithic IC is compatible with standard processing. Some provision is needed to prevent high-field effects at the edge of the metal contact, but this too is compatible with standard processing. In fact, once reproducibility problems have been solved, Schottky diodes actually simplify processing of high-speed digital IC's because gold doping is eliminated.

The Schottky diode has been around in one form or another for a long time—the crystal detector in early radios, for instance. The modern device, which gets its name from the German scientist who developed the first valid theory of metal-semiconductor rectification, can be used to enhance the performance of existing IC designs as well as to develop entirely new configurations with exceptional features.

In the forward-biased p-n junction, current is carried by holes flowing from the p-type material into the n-type material, and electrons flowing from the n to p material. Either case results in an excess of minority carriers near the junction. If the voltage is reversed these carriers will flow back across the junction, creating a high current until the supply is exhausted. In other words, the p-n junction can't be turned off immediately.

In a Schottky diode made of aluminum on n-type silicon, essentially all of the forward current is carried by electrons flowing from the semiconductor into the metal. They quickly come into equilibrium with the other electrons in the metal, so there is effectively no stored charge to prevent rapid switching. Another major point of difference between the Schottky and the p-n junction diode is that the former has lower forward voltage for a given current.

In a practical circuit the Schottky diode is placed in parallel with the base-collector junction of an npn transistor; the metal electrode is connected to the base and to the n region of the collector, where it forms a rectifying contact.

Since the Schottky diode has a lower forward voltage compared with the collector-base junction, the diode clamps the transistor and diverts most of the excess base current through the Schottky diode, preventing the transistor from saturating. There's no charge storage, either in the transistor or diode.

Clamping techniques have been used in the past to prevent charge storage. Most are variations of the Baker clamp proposed in 1956.¹ In this scheme, a germanium diode shunts the collector-base junction of a silicon transistor to prevent it from being forward-biased; some charge is still stored in the germanium diode. The Schottky IC employs clamping but charge storage is eliminated.

In the past, other efforts to improve switching

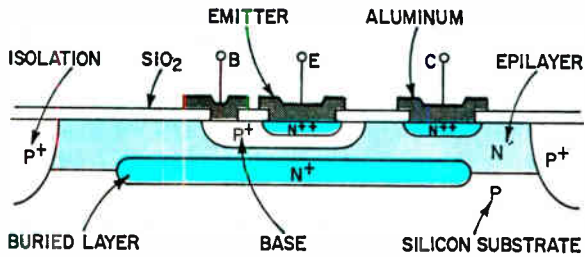

CONVENTIONAL NPN TRANSISTOR

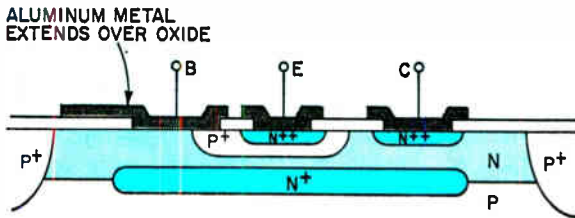

SCHOTTKY EXTENDED-METAL TRANSISTOR

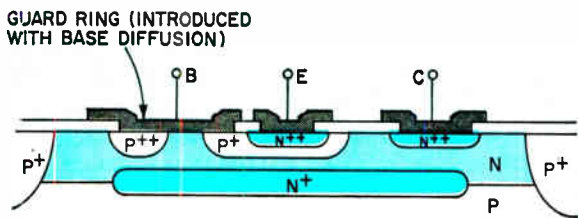

SCHOTTKY GUARD-RING TRANSISTOR

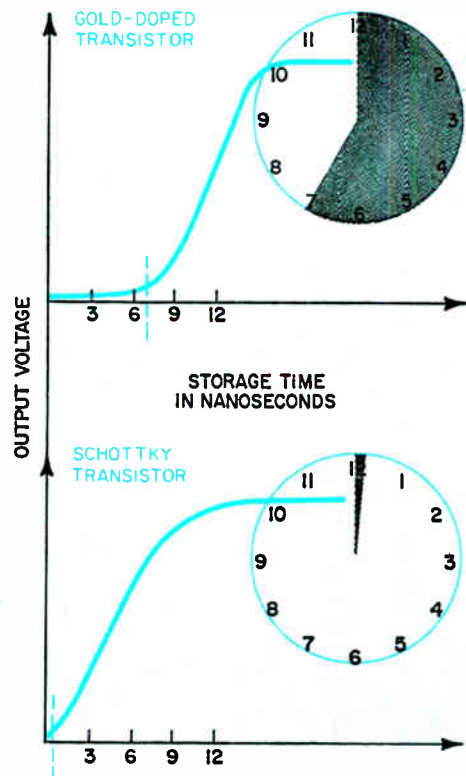

Double duty. In a Schottky transistor a Schottky diode is in parallel with the collector-base junction. The base metal is also the anode of the diode; the collector diffusion is also the diode cathode. Edge effects can be avoided with the extended-metal or guard-ring structure. The curves compare storage time of the gold-doped and Schottky transistors. The former uses up 7 nsec of recombination time before it can change state; the Schottky transistor responds almost instantaneously.

speed by reducing or avoiding stored charge have taken two approaches: process innovation and novel circuit design.^{2, 3, 4}

Attempts to minimize storage time through novel circuit designs have had varying success. The most familiar is current-mode switching, which avoids saturation (and hence charge storage) by controlling the collector current so that the collector-base junction never goes into forward conduction. Current-mode logic is fast—propagation time through a gate can be as low as 1 nanosecond—but when such IC's are assembled in a system, they will oscillate unless precautions are taken to control their input impedance characteristic.

Off the gold standard

The standard processing approach to charge-storage reduction in conventional IC's is gold doping. Since gold acts as a recombination center, it reduces the lifetime of minority carriers; that is, it shortens the time for recombination of holes and

electrons. Intentional reduction of minority carrier lifetime is somewhat ironic. In the early days of transistors, much effort was expended in increasing the minority carrier lifetime to increase current gain and decrease junction leakage.

Unfortunately, the gold diffusion has some highly undesirable side effects. It tends to reduce gain (h_{FE}). If this value gets too low, the IC's won't function because the transistors either don't saturate or have excessive turn-on delay. The manufacturer can use a narrower base to get higher h_{FE} , but this can lead to excessive junction leakage.

The Schottky process sidesteps this problem. Without the need for gold doping, low storage time and high h_{FE} can be achieved simultaneously.

Another difficulty with gold doping is the lack of selectivity—if one transistor must be high speed, all the others on the chip have to be high speed too. But with the Schottky process, fast and slow devices can be mixed on the same chip. This freedom of choice in component characteristics is exploited

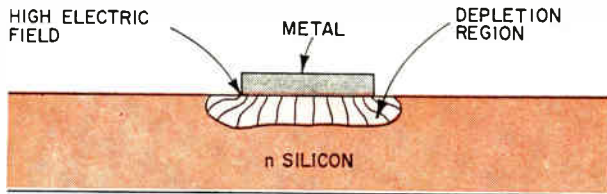

REGULAR DIODE

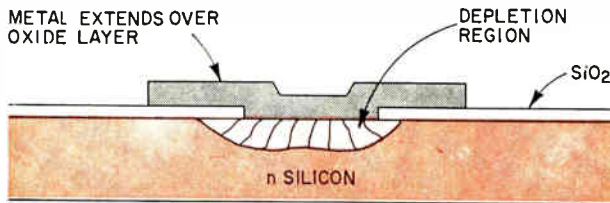

EXTENDED-METAL

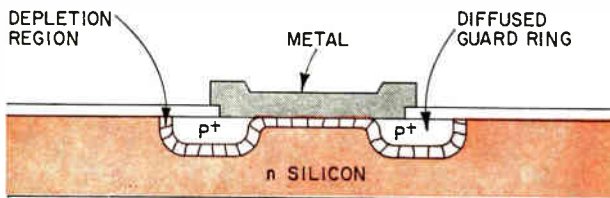

GUARD-RING

Edge effect. The high field concentration at the edge of the regular Schottky structure can cause spurious currents. These can be avoided by means of the extended-metal structure or the guard ring.

in some of Intel's new products.

But before Schottky diodes could be successfully integrated manufacturers had to resolve some dilemmas; diode characteristics were often grossly different from theoretical predictions and devices were not reproducible. The cause, it has since been found, is the high electric-field concentration at the periphery of the metal electrode, as shown above. This field, through the mechanism of tunneling, can lead to spurious currents that dominate the ideal diode characteristic. Because the shape of the edge varies from one device to another, the magnitude of these excess currents can vary greatly.

Two solutions to this problem were recently proposed.^{5, 6, 7} In one, the metal electrode extends over the silicon-dioxide passivating layer. With this dielectric layer between the metal and the semiconductor, the electric field at the periphery of the electrode is greatly reduced, and the diode has ideal characteristics.

In the other solution, the edge of the metal extends over a diffused p⁺ guard ring. This also reduces the field, and moves it away from the edge of the electrode so that it can't affect the diode. Again, the characteristics are ideal.

Electrically, the aluminum-silicon Schottky diode differs somewhat from the diffused p-n junction

diode in its d-c forward current-voltage characteristic, shown at right. The forward voltage of the Schottky diode at any given current is 200 to 300 millivolts less than that of the junction diode, making it an ideal low-voltage clamp.

Another major difference is the recovery characteristics, opposite page at bottom. The Schottky diode storage time is effectively zero, in contrast to typical values of 6 nsec for the gold-doped junction diode and 30 nsec for the junction diode without gold doping. In all three cases, the voltage across the diode decays with the same R-C time constant once the stored charge recombines.

The Schottky transistor is simply an npn IC transistor, produced by conventional photolithography, diffusion, and epitaxial growth techniques with an Al-Si Schottky diode in parallel with the collector-base junction. The base contact of the transistor serves as the metal contact of the diode and the collector region of the transistor serves as the n region of the diode. It's convenient to regard the npn-Schottky diode combination as a single device and to represent it by a single symbol:



To form the Schottky transistor, the base-contact opening is extended beyond the base diffusion and over the collector region. When the aluminum metalization is deposited, it simultaneously functions as the contact to the base region and the anode of the Schottky diode. To prevent high field concentration, the metal can either be extended over the passivating oxide or terminated over a p⁺ guard ring, which can be diffused into the chip at the same time as the base, as shown on page 75.

One big difference between the Schottky transistor and the conventional gold-doped npn device is in offset voltage, which is lower for the latter—typically 120 millivolts vs. 250 mV. However, the saturation voltage need not be excessive because of this large offset; by controlling both device geometry and processing, $V_{CE(sat)}$ can be kept to 0.5 volt at 20 ma collector current and 1 ma base current. And because the Schottky diode has a lower temperature coefficient than the emitter-base diode, $V_{CE(sat)}$ decreases with increasing temperature.

This behavior of the Schottky diode amounts to partial temperature compensation of the emitter-base diode and hence of $V_{CE(sat)}$. It helps to maintain a high worst-case logic 0 noise margin at high temperature when the Schottky transistor drives fan-out circuits that operate at a $2V_{BE}$ logic threshold as standard DTL and TTL IC's do.

The storage time of a Schottky transistor is effectively zero, as shown on page 78, in contrast to typically 7 nsec for a gold-doped device and 34 nsec for a non-gold-doped unit. Moreover, storage time hardly varies with temperature. At 125°C,

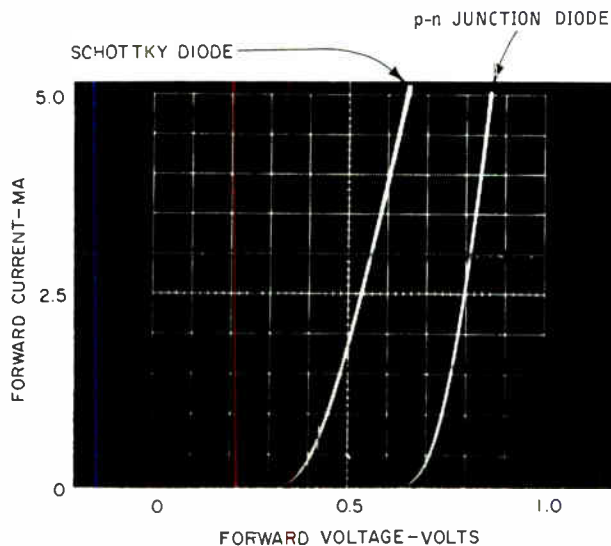

Forward characteristic. At 1 ma forward current, voltage drop is 0.45 volts for the Schottky diode, 0.74 volts for the p-n junction diode.

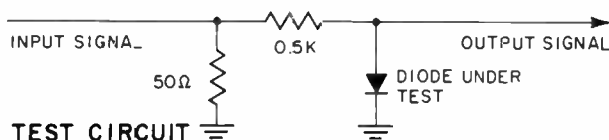

No storage. Transient characteristic shows that the Schottky diode, unlike p-n junction diodes, has essentially zero storage time.

it's still less than a nanosecond, whereas the gold-doped storage time doubles to 15 nsec at that temperature.

Aside from much faster switching speed, Schottky diodes offer the IC designer a greater range of devices to choose from. Because gold doping can't be done selectively, the designer has at his disposal only one active component: a fast switching npn transistor whose emitter-base and collector-base junctions can be used as diodes. But since the Schottky process doesn't require gold doping, the

designer has seven active components to choose from. And he can mix them at will—fast- and slow-switching devices can be placed on the same chip. In both the Schottky and the gold-doped transistor, various levels of resistivity are available in the bulk material, as well as in the isolation, emitter and base diffusions for use as resistors.

Advantageous options

The Schottky diode across the base-collector junction of the npn transistor is an almost ideal active switch with less than 1 nsec storage time and high amplification. Without the Schottky diode, the device becomes a charge-storage npn transistor characterized by low saturation voltage, high inverse gain (h_{FE}), and lengthy recovery time.

Substrate pnp transistors can be diffused into the chip too; these can have h_{FE} of 10 or more and are ideal for input buffering. Lateral pnp transistors can be formed as well—with and without Schottky-clamped collectors to provide fast or slow recovery time. These devices are useful as current sources and for voltage translation.

Then there are SCR's. Like transistors, these can be diffused into the chip in both charge-storage and Schottky-clamped versions, each of which can be optimized for different purposes. They make efficient bistable elements and give a high functional density to integrated shift registers and counters.

And, of course, there are diodes—emitter-base, charge-storage, and Schottky—each with different characteristics.

With just the Schottky diode and transistor, it's easy to upgrade old IC designs. Take DTL, for instance. If, without changing any of the resistor values, the basic DTL gate is modified with Schottky components as shown at top of page 80, the performance of the gate is improved as follows:

- Less sensitivity to power supply variations, since the circuit will continue to function at a lower minimum supply voltage. This is because, when all inputs are in the high state, the voltage at the base of Q_1 is typically 0.3 volts lower that it would be in the gold-doped counterpart.
- Less sensitivity to temperature variations because of the compensating effect of the Schottky diode temperature behavior.
- Faster switching; the gate turns on faster, and storage time is less than 1 nsec, remaining so throughout the operating temperature range.

In addition, modified DTL circuits can be fabricated at better yield (and lower cost to the user) because h_{FE} is higher and leakage is lower than in the gold-doped version.

The Schottky version of the TTL gate also has some important advantages over its gold-doped counterpart:

- Lower input inverse leakage current, typically less than 0.1 microampere. This is made up of the reverse-bias leakage of the emitter-base junction and the input clamp diode; there is no contribution from inverse h_{FE} since the collector base junction

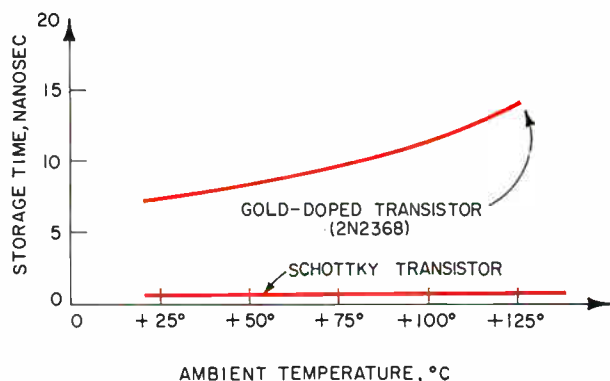
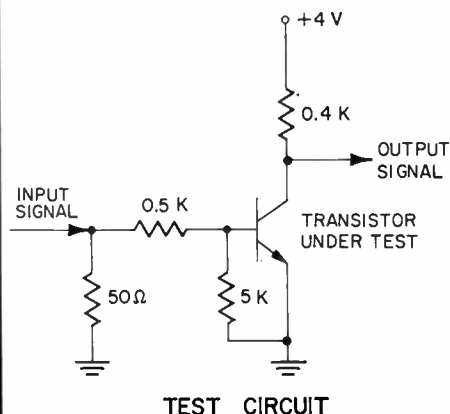
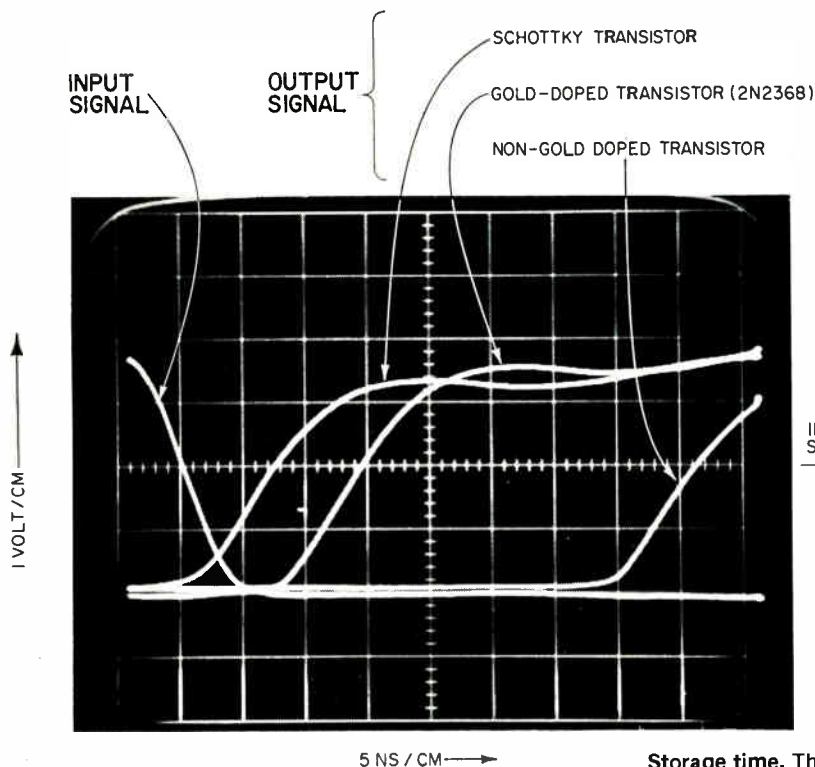

Storage time. The Schottky transistor, because it doesn't store charge, responds much more rapidly to an input signal (top traces, ambient temperature 25°C). This difference becomes even more pronounced at high temperatures (bottom curves).

over TTL, given equal speeds, is that the outputs of the DTL gates can be OR-tied. Moreover, DTL doesn't create heavy current transients in the power supply during switching.

The input current to this Schottky DTL gate is low, typically 250 microamperes. This presents a very small load to the driving gate. As a result, each gate can drive a large number of similar gates—fan-out can be 25 or more. If the two 200-ohm resistors are used as a terminating resistance for a 100-ohm line, there will still be enough current left to drive 10 gates.

Another novel circuit is the binary divider on page 80, bottom right. It combines the best of the slow and fast worlds: the Schottky transistors that comprise the flip-flop switch at high speed, and the slow charge-storage transistors serve as temporary-data-storage elements.

Bridge work

The special advantages of these circuits, and of the Schottky process that makes them possible, are particularly applicable to complex circuits. One such IC built at Intel is a 64-bit high-speed scratchpad memory. It's organized as 16 words by 4 bits; each of the 16 words is addressable through its own binary decoder. It has four data inputs, four address inputs, and four outputs. If it's required, the outputs can be OR-tied with the outputs of other memory

of the input transistor never becomes forward biased.

- Less line reflection, since the input clamp diodes—now Schottky diodes—have a lower forward-bias voltage.

- Lower power dissipation because no charge is stored (and wasted) in the transistors.

- Higher output high level, by approximately 0.3 volt.

Although the Schottky process significantly improves many of the existing circuits, its real potential lies in entirely new designs. For example, by designing from scratch with the Schottky process in mind, a DTL gate can be made just as fast as TTL. An example of such a circuit is shown on page 80, bottom left.

When the circuit is loaded with two-200-ohm resistors, as shown, the switching speed is about 5 nsec, comparable to that of the fastest TTL circuits commercially available. The advantage of DTL

Components compatible with the Schottky process

TYPE	SYMBOL	PROFILE	PRINCIPAL CHARACTERISTICS
SCHOTTKY NPN TRANSISTOR			STORAGE TIME < 1 NSEC $V_{CE(sat)} = 0.2$ TO 0.4 VOLT $h_{FE} = 60$
CHARGE-STORAGE TRANSISTOR			STORAGE TIME > 20 NSEC $V_{CE(sat)} < 0.1$ VOLT h_{FE} INVERSE > 2
SUBSTRATE PNP			$H_{FE} > 10$
LATERAL PNP			$H_{FE} > 2$
LATERAL PNP WITH SCHOTTKY COLLECTOR			STORAGE TIME < 1 NSEC
CHARGE-STORAGE SCR			STORAGE TIME > 20 NSEC $V_{ON} < 0.1$ VOLT
SCHOTTKY-CLAMPED SCR			STORAGE TIME < 1 NSEC $V_{ON} = 0.2$ TO 0.4 VOLT
EMITTER-BASE DIODE			$V_F = 0.6$ TO 0.8 VOLT
CHARGE-STORAGE DIODE			STORAGE TIME > 20 NSEC
SCHOTTKY DIODE			$V_F = 0.3$ TO 0.5 VOLT STORAGE TIME < 1 NSEC
DIFFUSED RESISTOR			$\rho_s = 100$ TO $200 \Omega/\square$
COLLECTOR-PINCH RESISTOR			$\rho_s = 400$ TO $1000 \Omega/\square$
BASE-PINCH RESISTOR			$\rho_s = 2$ TO $10 \text{ K}\Omega/\square$

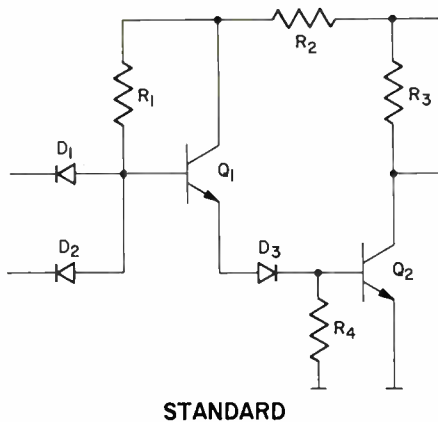

STANDARD

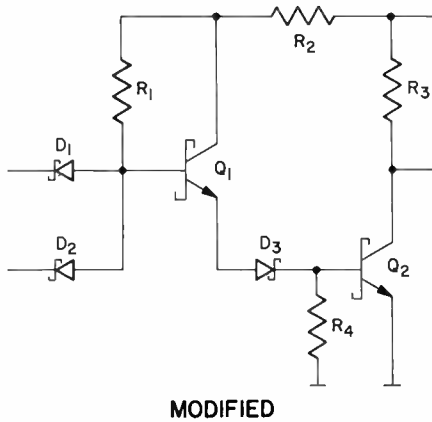

MODIFIED

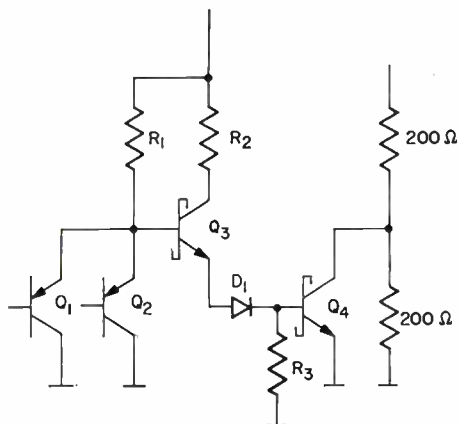

CLOCK

Updated. Modifying the standard DTL gate with Schottky diodes and transistors (top) affords significant performance improvement.

The new DTL. Without gold doping, many components become available to the IC designer. In the DTL gate at bottom left, input loading is reduced an order of magnitude by the substrate pnp's that replace the input diodes normally used.

Simplified. With the Schottky process, a binary counter stage (bottom right) is simple and occupies a small chip area. This is because charge-storage transistors (Q_1 and Q_2 , which are incompatible with the gold-doped process, can be used to store information.

integrated circuit chips.

The input load is equal to one unit TTL load, and the output can sink 20 milliamperes. The access delay—from address input to data output—is less than 50 nsec under a 20 ma resistive load. Power dissipation, including address buffering, decoding, sensing, and control logic, is typically 6 milliwatts per bit.

These specifications represent major improvements over gold-doped IC performance. Because storage time has been eliminated by the Schottky process, the input-to-output propagation delay has been reduced by as much as 40% for certain critical delay paths. And the variation in propagation delay due to temperature change is considerably less than in a gold-doped circuit. The higher h_{FE} values that result from the Schottky process also help keep propagation delay constant with temperature. This is particularly important for circuits that operate at low temperatures where large increase in delay, due to low h_{FE} , is a chronic problem in gold-doped IC's.

Another advantage of this higher-valued h_{FE} distribution is that transistors can be designed for higher forced-beta conditions, and power dissipation is therefore lower. For the bipolar logic-buffer chip, for example, power dissipation is reduced by about 30%.

Most significant, perhaps, the Schottky process

has resulted in higher functional density and smaller chips. A comparison of the Intel 64-bit memory with an equivalent gold-doped circuit is revealing: Although the gold-doped IC is made with the same mask tolerances, the Schottky version uses a 30% smaller chip.

With all that they have going for them—high speed, greater functional density, and flexibility of design—Schottky-diode IC's certainly appear to have a bright future.

References

1. R. Baker, "Maximum Efficiency Switching Circuit", M.I.T., Lincoln Lab., Lexington, Mass., Report TR-110, 1956.
2. K. Tade et al., "Reduction of the Storage Time of a Transistor Using a Schottky Barrier Diode", PROC. IEEE, 55, pp. 2064 - 2065, 1967.
3. E.R. Chenette and R.A. Pedersen, "Integrated Schottky Diode Clamp for Transistor Storage Time Control", PROC. IEEE, 56, pp. 232 - 237, 1968.
4. A. Tarui, Y. Hayashi, H. Teshima and T. Sekigawa, "Transistor Schottky-Barrier-Diode Integrated Logic Circuit", Journal of Solid-State Circuits SC-4, pp. 3 - 12, 1969.
5. A.Y.C. Yu and E.H. Snow, "Surface Effects on Metal Silicon Contacts", Journal of Applied Physics 39, 3008, 1968.
6. M.P. Lepselter and S.M. Sze, "Silicon Schottky Barrier Diode with Near Ideal Characteristics", Bell System Technical Journal, 47, 195, 1968.
7. R.A. Zettler and A.M. Cowley, "The p-n Junction-Schottky Barrier Hybrid Diode", IEEE Trans. on Electron Devices, Ed-16, 58, 1969.

Designer's casebook

Designer's casebook is a regular feature in Electronics. Readers are invited to submit novel circuit ideas and unusual solutions to design problems. Descriptions should be short. We'll pay \$50 for each item published.

Peak detector senses bipolar inputs

By Charles A. Herbst
Consultant, Dumont, N.J.

Most digital tape systems take the bipolar pulses from the tape head, amplify them, feed them through a full-wave rectifier to make them unipolar, and then apply them to a peak detector. The extra process of rectifying the bipolar input pulses can be eliminated through the use of a complementary peak detector which will deliver a pulse at each

peak of the input sine wave.

Transistors Q_1 and Q_2 form a complementary peak detector which detects an input signal over a range of 2 to 8 volts peak-to-peak and over a frequency range from 5 to 15 kilohertz. Q_3 and Q_4 clip the detectors output and deliver rectangular pulses whose trailing edges represent the peaks of the input wave.

Q_5 and Q_6 are pulse amplifiers that deliver stable pulse widths whose leading edges represent the peaks of the input waveform. These pulses are fed to Q_7 and Q_8 which form a NOR gate and which convert the bipolar input pulses to unipolar negative-going output pulses. The width of the output pulses is independent of the input frequency or amplitude, and is determined by the time constant of the RC networks at the input to Q_5 and Q_6 .

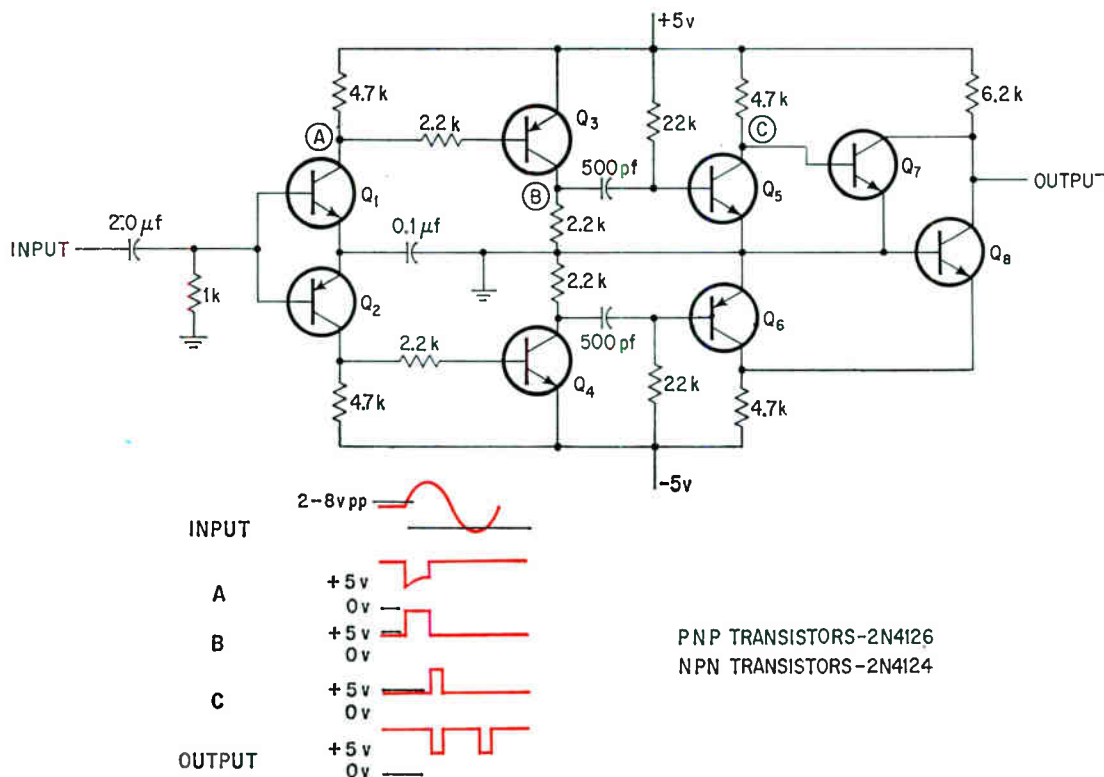

Going both ways. The peak detector generates an output pulse for any bipolar input signal in the range from 2 to 8 volts peak-to-peak. This eliminates the need to rectify the input signal first—an extra step when standard peak detectors are used. The delay of the output pulse from the input peak is 10 microseconds at 5 kilohertz.

Photodiode coupled pair isolates DTL from a relay

By William Otsuka

Monsanto Co., Cupertino, Calif.

Many undesirable effects such as ground currents and spikes can arise in relay circuits. Photodiode coupled pairs eliminate many of these nuisances; ground currents are nonexistent since the relay needs no ground. In addition, the optical coupling provides a high isolation resistance of 100 gigohms between the diode-transistor logic and the relay circuit which does away with troublesome relay noise and spikes.

The light-emitting diode portion of the coupled

pair is driven by an input signal which produces light whose intensity is proportional to the signal current. The photons are transmitted to the photodiode detector via a light pipe. Any variation in the input signal produces a proportional change at the output of the photodiode, which is normally operated with reverse voltage bias to provide the required voltage swing.

When the output signal of the diode-transistor logic is high, Q_1 is turned on, and no current flows in the light-emitting diode. No light to the detector causes the photodiode to be at its maximum impedance of 5 gigohms. Therefore, Q_2 cannot conduct, which in turn prohibits Q_3 from conducting. Since Q_3 provides the current path for relay K_1 , the relay will not be energized. When the output of the DTL goes low, the circuit response is so fast K_1 energizes in a time virtually dependent on the mechanical relay response alone.

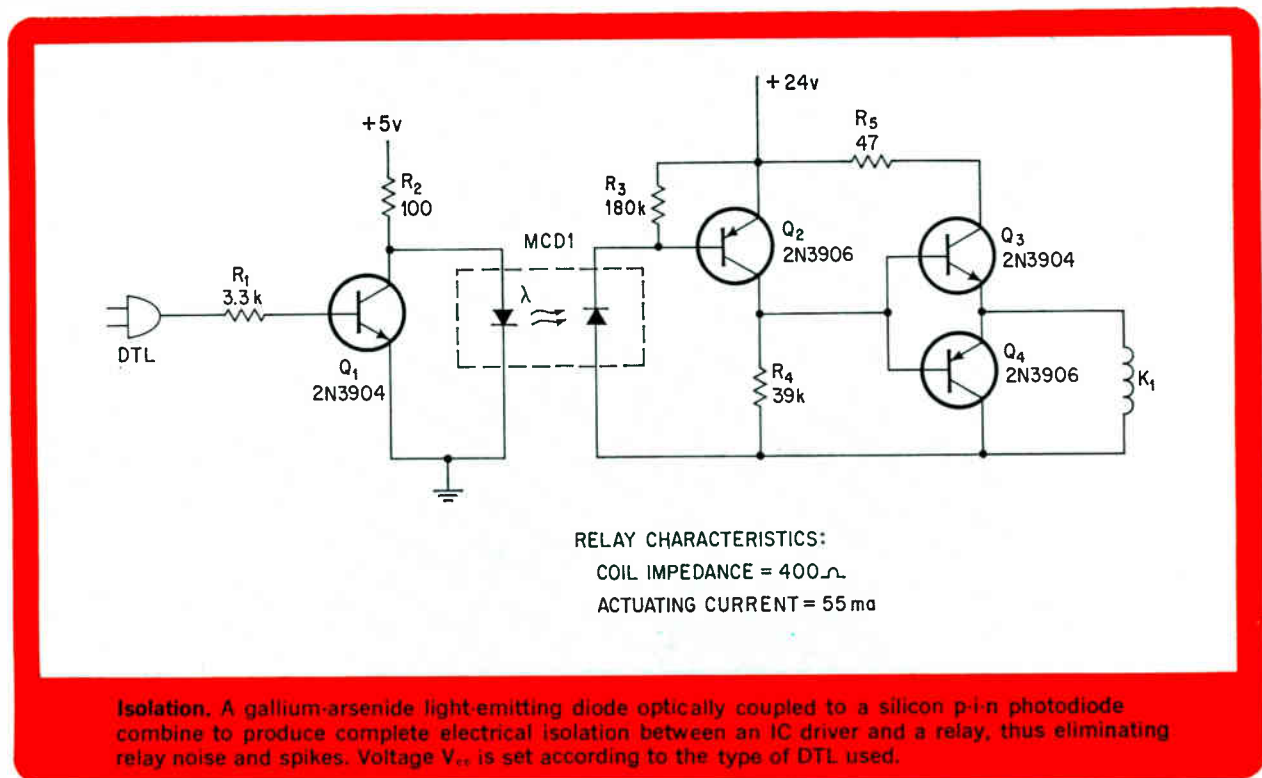

FET buffer boasts high speed and performance

By Dan Atlas

Singer-General Precision Inc., Little Falls, N.J.

High speed field effect transistor operational amplifiers, frequently found in sampling circuits and analog memories, are outperformed by a simple buffer circuit that settles in 50 nanoseconds to .1% of its final value, that slews at rates up to 300 volts per microsecond, and that is unconditionally stable with moderate capacitive loading. A hybrid

transistor quad provides tight thermal tracking, and two FET's, one connected as a source follower and the other as a constant-current source, minimize drift.

Temperature compensation is performed by the current source composed of Q_2 and R_2 . Since the drain current is much larger than the bipolar input offset current, the reflected current variations due to load and temperature changes have a negligible effect on the FET temperature compensation.

The source follower Q_1 yields a zero offset and a drift coefficient typically 20 microvolts/ $^{\circ}\text{C}$, comparable to that obtained by connecting the transistors as a differential pair. The zener diodes D_1 and D_2 enhance the transient response, linearity, and power supply rejection of the input stage by a bootstrap action. Thus the bootstrapped current

source Q_2 is prevented from differentiating a fast signal transition, and its power supply rejection is improved by the constant drain-to-source voltage. The linearity and power supply rejection are also improved by bootstrap action on the drain-to-source voltage of Q_1 , essentially eliminating the reverse amplification factor, h_{re} . The input capacity is greatly reduced by the improvement in the frequency response caused by the bootstrap action of the circuit.

The dynamic performance of the amplifier is enhanced by the lack of closed-loop feedback. The buffer's transfer function contains two poles at approximately 40 megahertz. The Bode plot is essentially flat from d-c to 40 Mhz, at which point the roll-off assumes a slope of approximately -12 decibels per octave.

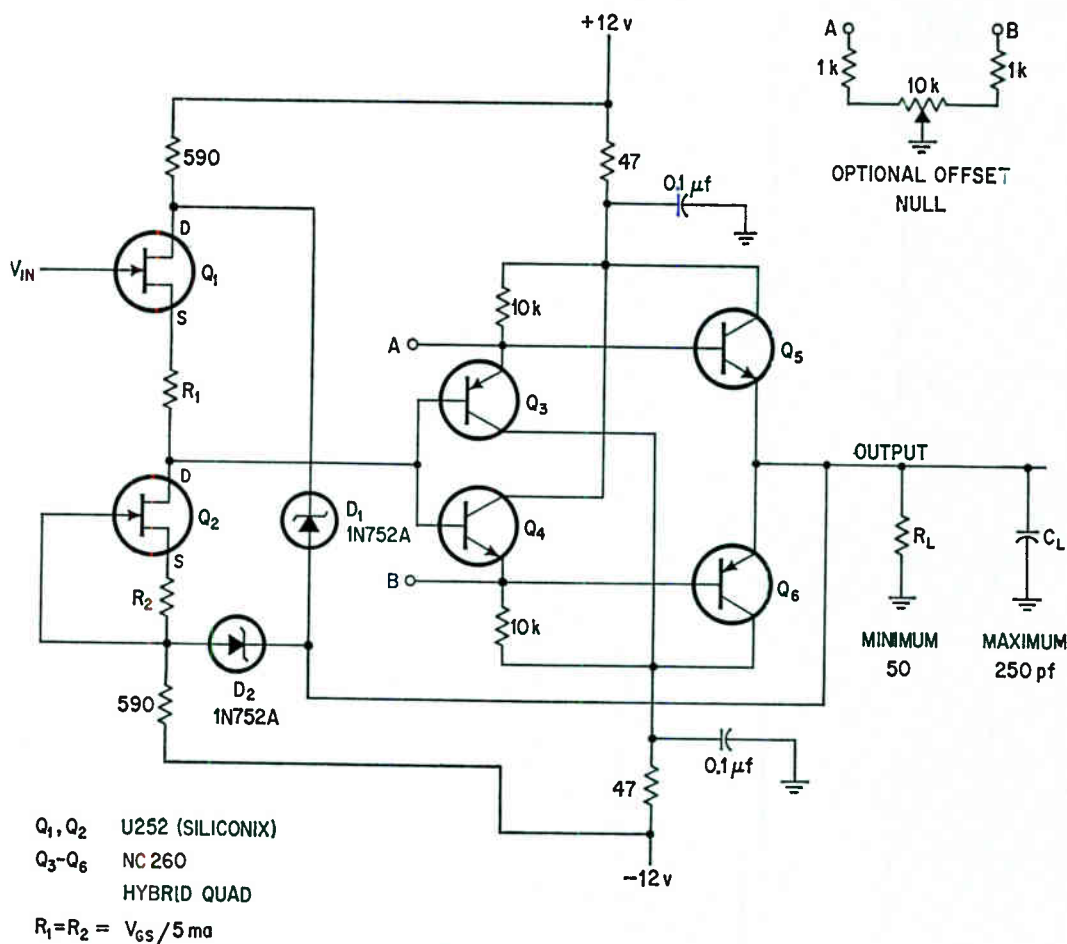

Fast: Two FET's, one connected as a source follower and another as a constant current source, drive a transistor quad to produce a buffer with fast settling time, good drift, and thermal stability. An optional potentiometer can be connected to A and B to null the offset voltage.

Pulse train frequency varied as duty cycle stays constant

By William Ross

Fairchild Semiconductor, Mountain View, Calif.

A pulse converter consisting of a single shot multivibrator coupled to an integrator delivers an output pulse train of frequency equal to the input while maintaining a constant duty cycle. Any desired duty cycle can be obtained by adjusting a voltage control at the input to the integrator. This circuit allows the frequency of a pulse generator to be varied over a wide range without simultaneously readjusting the pulse width control.

The duty cycle can be varied from 7% to 93% over the full frequency range. The frequency range is determined by capacitor C_1 which gives a 10 to 1 range for each value chosen. Thus if C_1 is equal to 500 picofarads, the converter operates from 100 kilohertz to 1,000 khz. However, at the upper range of frequency and when low duty-cycle settings are used, a phase shift develops between the input and output pulses.

When the multivibrator is triggered, it produces an output pulse whose width is determined by C_1 and the amount of charging current fed to the capacitor from transistor Q_1 . An integrator, coupled to the one shot, produces an output voltage inversely proportional to the duty cycle of the input pulse at its non-inverting input and directly proportional to the voltage set by resistors R_1 through R_4 at the inverting input.

For any input pulse frequency, a desired duty cycle can be set at the output of the multivibrator by adjusting the voltage at the inverting input of the integrator. If the input pulse frequency is increased, and the multivibrator pulse width remains constant, the duty cycle of the output pulses will increase. The integrator senses this duty cycle increase and responds by producing a lower d-c voltage at its output. This voltage is applied to the base of Q_1 producing a higher output level from the transistor and forcing more current into the timing capacitor C_1 causing the multivibrator to put out a narrower pulse. In this manner the duty cycle thus returns to the desired level that it previously had.

By compensating for a change in the input frequency, the circuit maintains a duty cycle that remains constant to within 2% of the preset value over a frequency change of 10 to 1.

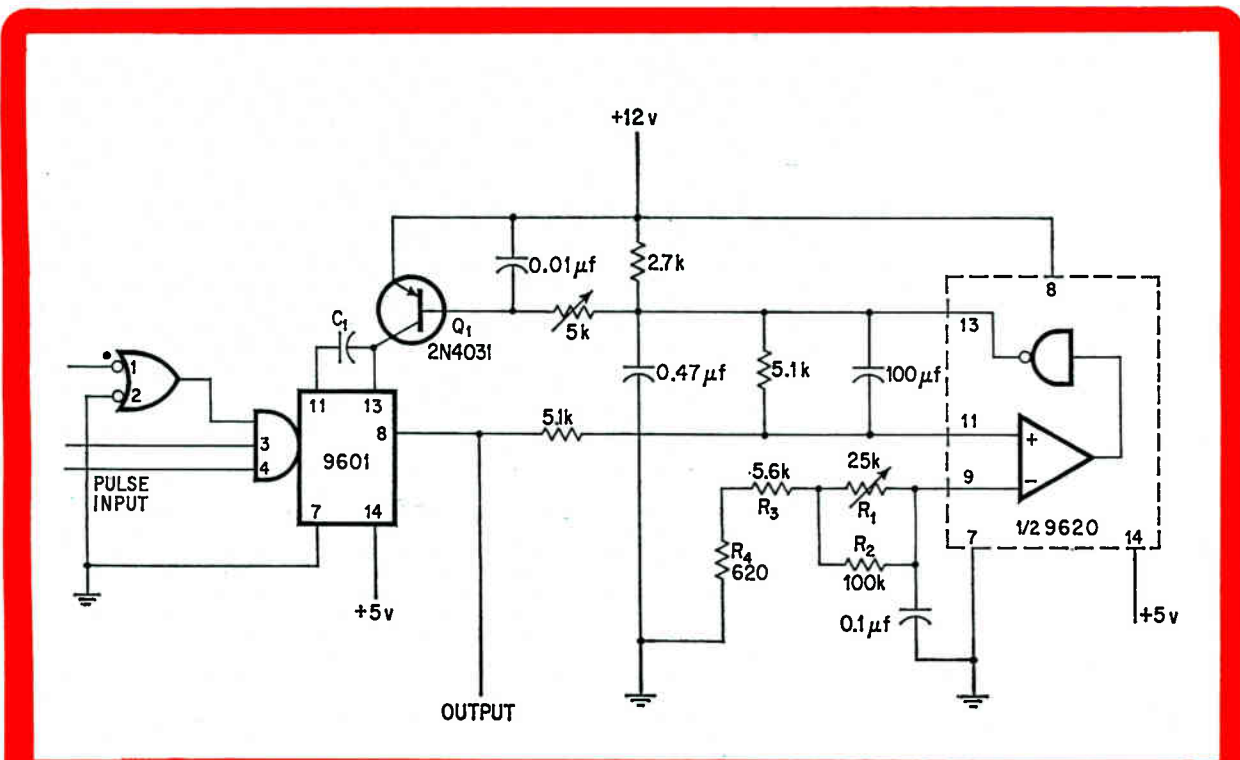

One setting. For any input pulse frequency, a desired duty cycle can be obtained by adjusting the voltage at the input to the integrator. If the input pulse frequency increases, the duty cycle of the output pulse will tend to increase, but the integrator senses this increase and produces a lower d-c voltage at its output.

Bypass your problems

or...how Components, Inc. can help clean up digital pulses in a small way

The problem of unpremeditated switching noise is apt to crop up in even the best of IC and hybrid logic arrays, once they are plugged into the system. When it does, the designer has the option of redesigning the circuitry or simply filtering out the spurious noise at appropriate stages. The second approach, although less heroic, is often more practicable if filter components can be found which are sufficiently economical of both space and cost.



to 125°C, they are available in values from .001 to 220 mfd., with axial or radial leads.

Need a Two-Way Street? . . .

C.I.'s Non-Polar Minitan capacitors are available for use where ac or occasional voltage reversals are present. Unlike other non-polar solid-tantalums, these little capacitors were designed as non-polars from the ground up. Result: 1) they are available in standard, rather than off-beat capacitance ratings; 2) they are 1/2 to 1/4 the size of other units; 3) they are extremely reliable, even with frequent voltage reversals.

When the squeeze is on . . . call Components, Inc. If you have a space problem, C.I. has the capacity to solve it. We offer more subminiature case styles and ratings than anyone else in the business. We welcome requests for samples, performance and reliability data, and application assistance. Standard prototypes normally shipped within 24 hours. Write or call today for data or samples.

C.I.'s Minitan® Series, world's smallest electrolytic capacitors, are a natural solution here, just as they are wherever size and performance are critical. These micro-miniature, solid-tantalum electrolytics provide ideal physical and electrical properties for computer bypass and filtering applications. They are compatible with thick-film and integrated circuitry in both size and reliability, and present extremely low impedance and excellent temperature stability. Rated for use from -55°C

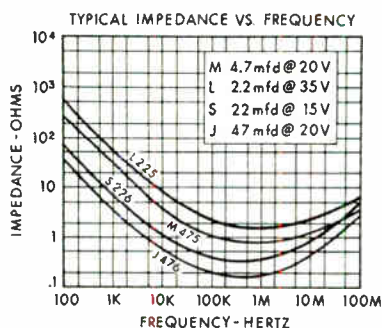

MINITAN MODULAR

(Also available with axial leads)

	U
	F
	M
	L
	S
	J

0047 MFD @ 35 VDC to 220 MFD @ 3 VDC
(others available from .001 MFD @ 50 VDC)

(ACTUAL SIZE)

MINITAN NON-POLAR

(Also available with axial leads)

NF	
NM	
NL	
NS	

10 MFD @ 35 VNP to 33 MFD @ 4 VNP
(others available from .001 MFD @ 50 VNP)

(ACTUAL SIZE)

COMPONENTS, INC.
CAPACITOR PRODUCTS
BIDDEFORD, MAINE 04005 — TEL: (207) 284-5956 — TWX: 710-229-1559

Active filters: part 11

Varying the approach

Depending on the application, RC networks can be modified to produce the desired second-order transfer functions; two capacitors and two resistors usually suffice

By Jack W. Mullaney

Electronics Division, Avco Corp., Cincinnati, Ohio

Without a doubt, active RC filters have reached a point in their development where they now perform as well as, if not better than, their passive RLC counterparts. They are smaller, require less power, afford better stability and selectivity, and are free from undesired parasitic coupling or nonlinear inductor effects common to most passive networks. Moreover, since they lack inductors per se, active filters can be tuned easily. And, they can be built as low-cost integrated circuits.

The only question still remaining is not whether active filters can do the job, but what type would do it best. Unfortunately, there is no clearly defined answer, for there can be as many variations of active filters as there are applications—it is simply a matter of tailoring the filter to suit the task.

Should a designer, for example, seek a transfer function comparable to that of an RLC network, he can do so by cascading active RC networks. He simply chooses from networks such as RC ladders that provide real-axis poles and zeros, RC notch filters that produce finite complex zeros, or RC active peaking networks that produce finite complex poles. The peaking network, which is among the most widely used filter types, is described by the transfer function:

$$G(s) = \frac{K(s/\omega_o)^n}{(s/\omega_o)^2 + s/Q\omega_o + 1} = \frac{N}{D}$$

where,

- ω_o = radian break-frequency response,
- $n = 0, 1, \text{ or } 2$ producing a low-pass, bandpass, or high-pass filter, respectively,
- Q = quality factor = amount of peaking for a bandpass filter.

Two things are known about any network pro-

ducing such a second-order transfer function.

- The value of $n=0, 1, \text{ or } 2$ —in the equation depends on the input-output terminals and is not a direct function of the network. Thus, if a network can be designed to produce the equation's denominator, the numerator can be produced easily by having the engineer choose the correct pair of input-output terminals.

- Since the denominator is a second-order polynomial, only two resistors and two capacitors are needed for such a function.

Most commercially available active filters contain three capacitors and three resistors. But this leads to a cubic denominator that is as difficult to optimize as it is to factor. However, with a filter having but two resistors and two capacitors, the designer need only contend with a second-order transfer function. Unity gain amplifiers are assumed for the active components because such devices have the highest stability and are the simplest to implement. Stability, which stems from the device's maximum feedback, is enhanced because it isn't dependent upon associated components.

Based on this assumption, a general network can be developed as shown at the top of page 91 that will produce a second-order transfer function with two resistors and two capacitors. A unity voltage amplifier output is inserted in series with each passive component and a unity current amplifier output is added across each component. Since these amplifiers are ideal, they are represented as controlled sources whose inputs do not disturb the circuit. This network, as it stands, represents the most feasible combination of the required components.

Neither the input nor the output points are specified because any choice would produce the same denominator. Inputs could be voltage sources in

Continued on page 91

Ju y 21, 1969

15

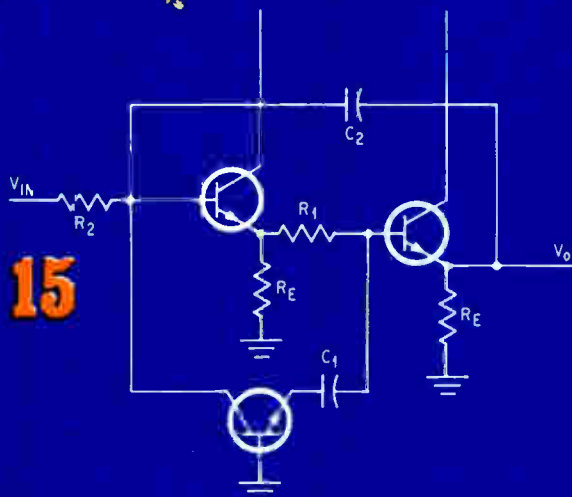

LOW PASS N = 1

16

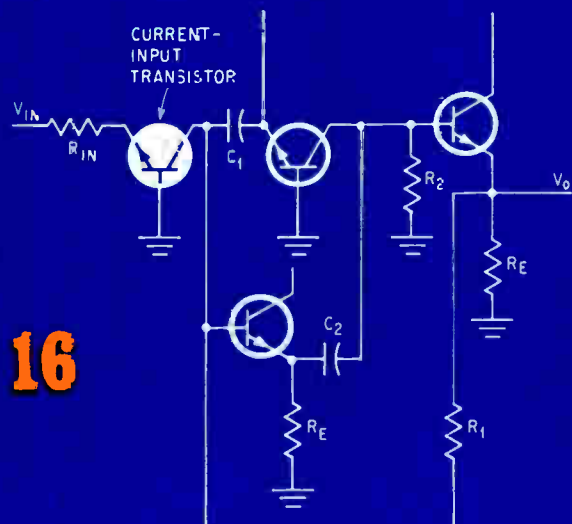

$$\text{BANDPASS } N = \sqrt{\frac{R_1 R_2}{R_{IN}}} \cdot \left(\frac{C_1 + C_2}{\sqrt{C_1 C_2}} \right) \left(\frac{s}{\omega_0} \right)$$

$$4C_1 = 3C_2 \quad R_1 = 0.7R \quad R = \sqrt{Z_{IN} Z_{OUT}}$$

$$Q = \frac{1}{\sqrt{\frac{C_1}{C_2}} \left(\sqrt{\frac{R_1}{R_2}} - \sqrt{\frac{R_2}{R_1}} \right)}$$

17

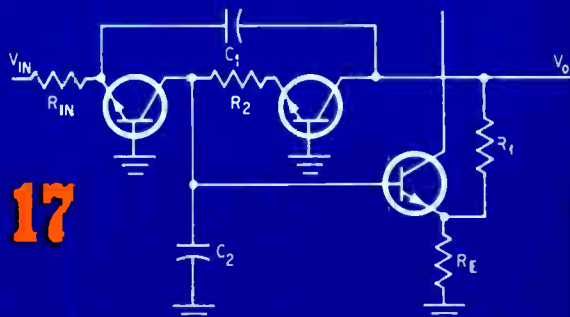

$$\text{LOW PASS } N = \frac{R_1 + R_2}{R_{IN}}$$

18

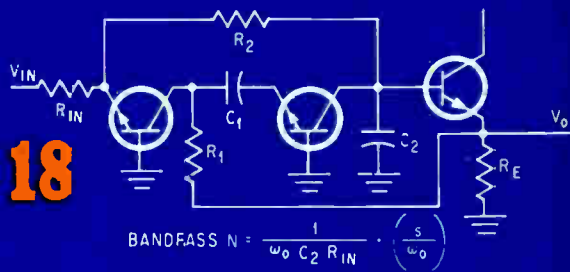

$$\text{BANDPASS } N = \frac{1}{\omega_0 C_2 R_{IN}} \cdot \left(\frac{s}{\omega_0} \right)$$

19

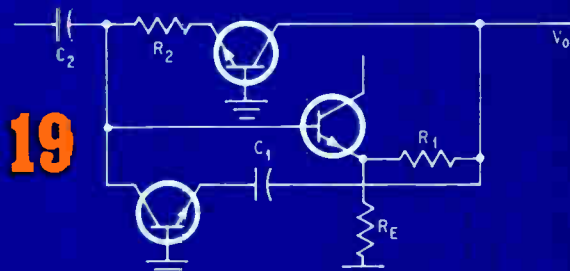

$$\text{BANDPASS } N = \sqrt{\frac{C_2}{C_1}} \cdot \frac{R_1 + R_2}{\sqrt{R_1 R_2}} \cdot \left(\frac{s}{\omega_0} \right)$$

20

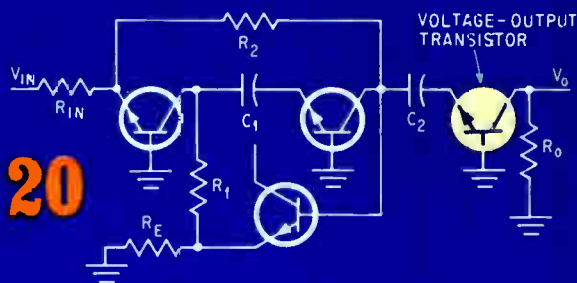

$$\text{HIGH PASS } N = \frac{R_0}{R_{IN}} \cdot \left(\frac{s}{\omega_0} \right)^2$$

$$4R_1 = 3R_2 \quad R_1 = 0.5R \quad R = \sqrt{Z_{IN} Z_{OUT}}$$

$$Q = \frac{1}{\sqrt{\frac{R_2}{R_1}} \left(\sqrt{\frac{C_2}{C_1}} - \sqrt{\frac{C_1}{C_2}} \right)}$$

Negative feedback. Networks 15 through 24 contain three internal amplifiers each and have high Q's. They have the same component value ratios as networks 8 through 14 plus independent Q and ω_0 adjustment—resistors fine-tune Q and capacitors fine-tune ω_0 in networks 15, 16, 23 and 24. In networks 17 through 20, 22 and 23, capacitors fine-tune Q, and resistors fine-tune ω_0 .

-a wide choice for the designer

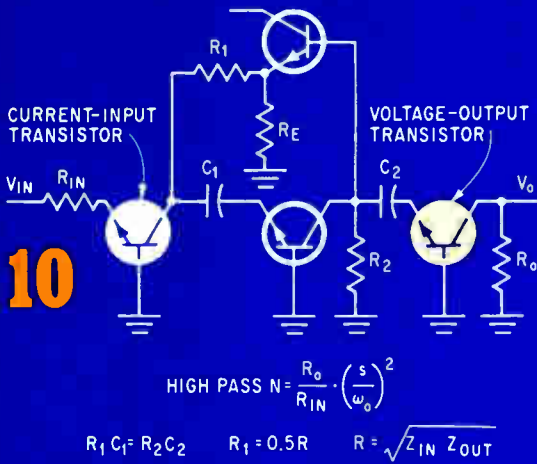
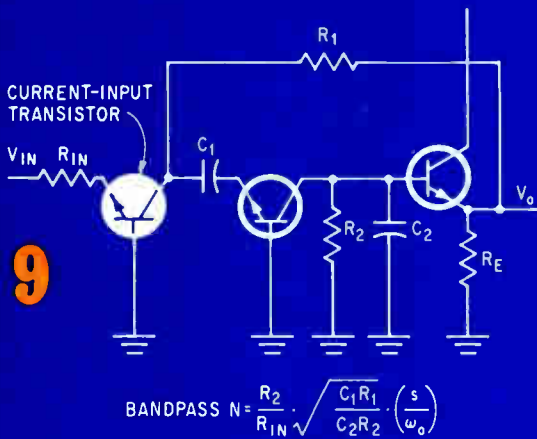
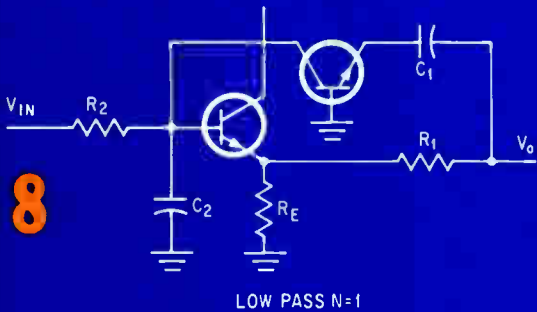

$$Q = \frac{1}{\sqrt{\frac{C_1 R_1}{C_2 R_2}} + \sqrt{\frac{C_2 R_2}{C_1 R_1}} - \sqrt{\frac{C_1 R_2}{C_2 R_1}}}$$

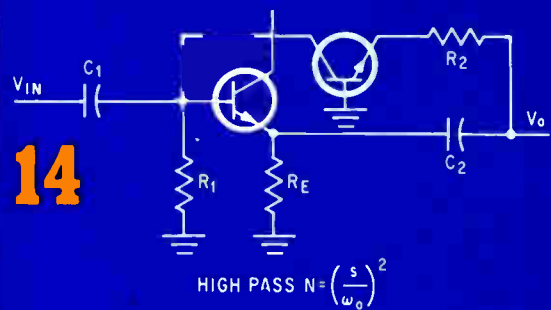
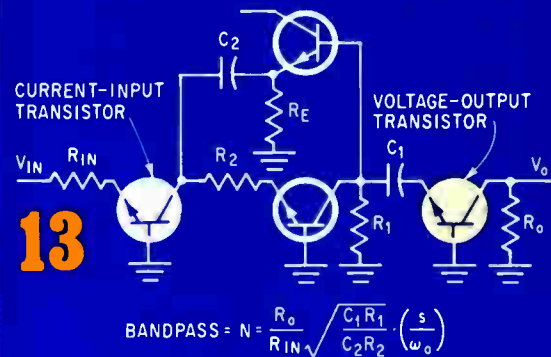
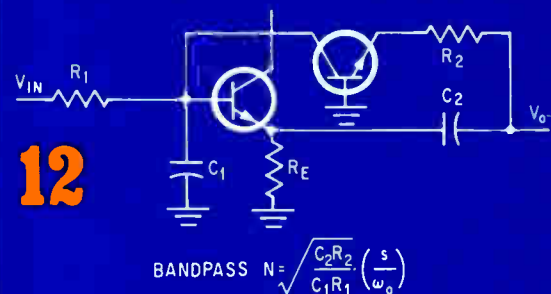
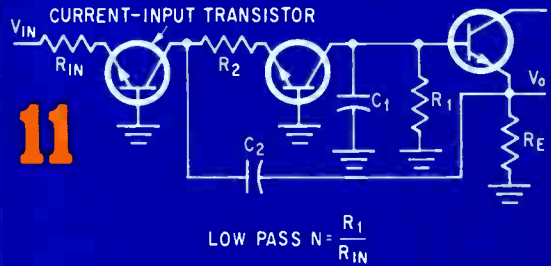

$$Q = \frac{1}{\sqrt{\frac{C_1 R_1}{C_2 R_2}} + \sqrt{\frac{C_2 R_2}{C_1 R_1}} - \sqrt{\frac{C_2 R_1}{C_1 R_2}}}$$

Positive feedback. Networks 8 through 14 contain two internal amplifiers each and are capable of high Q values. These filters require low ratios of component values, approximately 2:1. All can be built in IC form.

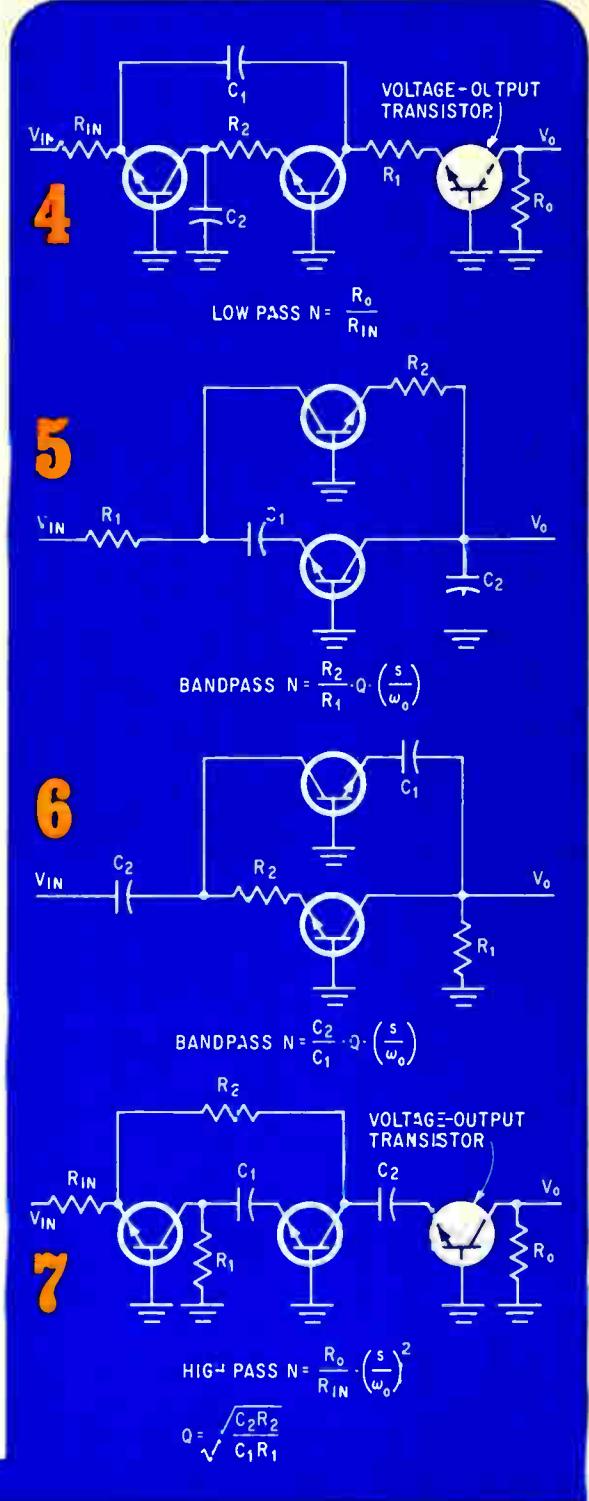
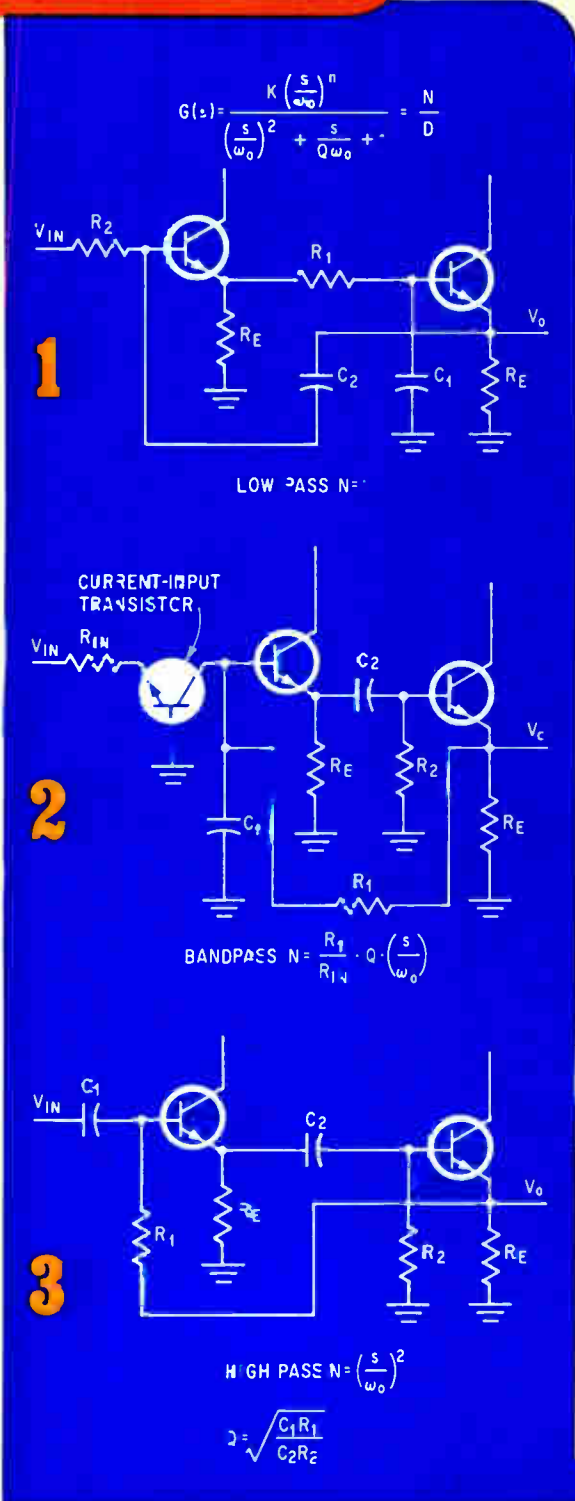

Low Q. Networks 1 through 7 have low Q values and cannot oscillate. All require large ratios of component values. Voltage amplifiers drive the filters 4 through 7; current amplifiers drive networks 1 through 3.

21

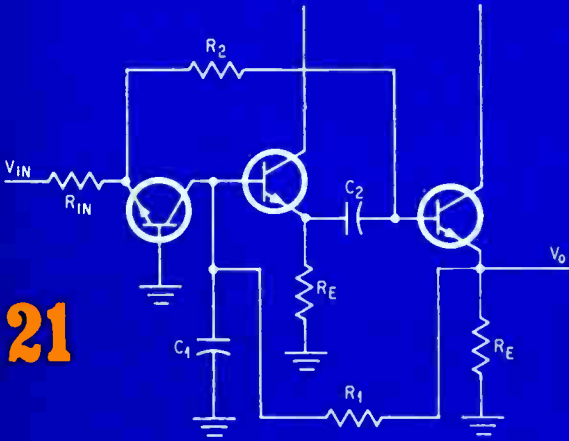

$$\text{BANDPASS } N = \frac{1}{\omega_0 C_1 R_{1N}} \left(\frac{s}{\omega_0} \right)$$

22

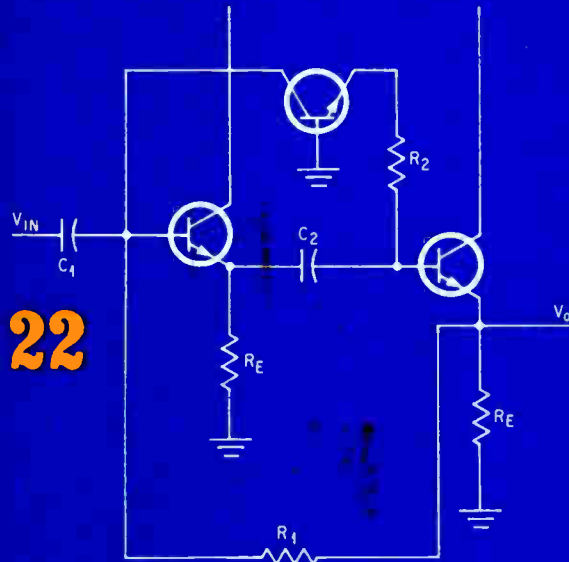

$$\text{HIGH PASS } N = \left(\frac{s}{\omega_0} \right)^2$$

$$4R_1 = 3R_2 \quad R_1 = 0.5R \quad R = \sqrt{Z_{IN} Z_{OUT}}$$

$$Q = \frac{1}{\sqrt{\frac{R_1}{R_2} \left(\sqrt{\frac{C_1}{C_2}} - \sqrt{\frac{C_2}{C_1}} \right)}}$$

23

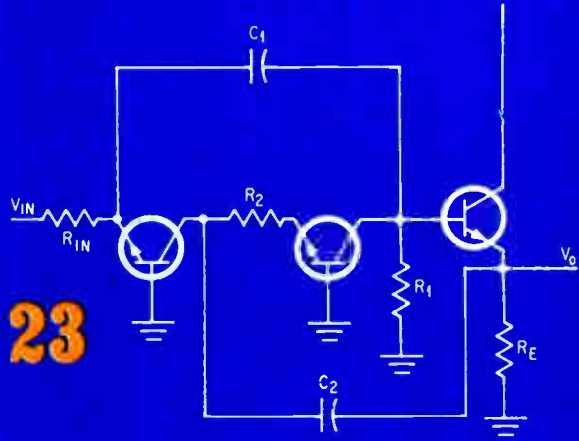

$$\text{LOW PASS } N = \frac{R_1}{R_{1N}}$$

24

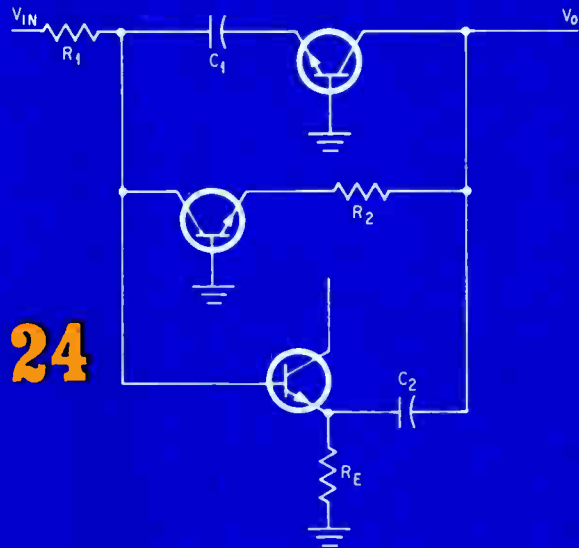

$$\text{BANDPASS } N = \sqrt{\frac{R_2}{R_1}} \cdot \left(\frac{C_1 + C_2}{\sqrt{C_1 C_2}} \right) \left(\frac{s}{\omega_0} \right)$$

$$5C_1 = 8C_2 \quad R_1 = R \quad R = \sqrt{Z_{IN} Z_{OUT}}$$

$$Q = \frac{1}{\sqrt{\frac{C_2}{C_1} \left(\sqrt{\frac{R_2}{R_1}} - \sqrt{\frac{R_1}{R_2}} \right)}}$$

How to select a filter

Suppose a designer wants a low-pass, high-Q filter whose transfer function is second order. Filters 15, 17, and 23 are among those that would be appropriate. The designer chooses the filter that yields N , actually a gain factor, needed in the over-all transfer function. For example, filter 17 provides an N of 10 when $R_1 + R_2$ is 10 times R_{IN} . In networks 17 and 23, capacitors fine-tune Q and resistors fine-tune ω_0 . The reverse is true for network 15. Should a high-pass network be desired, filter 20 and 22 would do. In both networks, N is a function of ω_0 . And since both use negative feedback, oscillation isn't a serious problem.

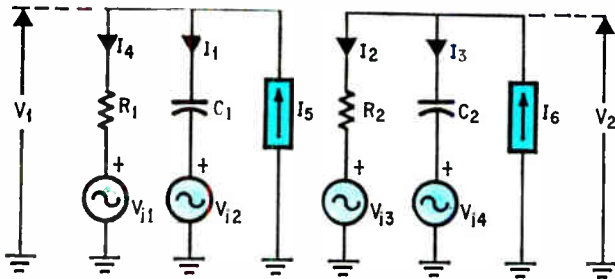

$$V_{11} = g_{11} V_{IN} + g_{12} V_1 + g_{13} V_2$$

$$V_{12} = g_{21} V_{IN} + g_{22} V_1 + g_{23} V_2$$

$$V_{13} = g_{31} V_{IN} + g_{32} V_1 + g_{33} V_2$$

$$V_{14} = g_{41} V_{IN} + g_{42} V_1 + g_{43} V_2$$

$$I_5 = g_{51} I_{IN} + g_{52} I_1 + g_{53} I_2 + g_{54} I_3 + g_{55} I_4$$

$$I_6 = g_{61} I_{IN} + g_{62} I_1 + g_{63} I_2 + g_{64} I_3 + g_{65} I_4$$

Continued from page 86

series with a component, or current sources in parallel with a component.

Outputs could be node voltages or branch currents. The constants (g_{jk}) associated with each source-amplifier are either 0 or 1, with 0 signifying the absence of a signal and 1 signifying the presence of a signal. When some of the constants are 0, high Q 's can be obtained from the filters that result.

Based on this model, there are eight different network groups that can theoretically produce high Q 's using only two capacitors and two simple unity gain amplifiers. The eight possibilities correspond to these constant values:

$$k_1 = k_3 = 0, \quad k_2 = k_4 = 1$$

$$k_2 = k_4 = 0, \quad k_1 = k_3 = 1$$

$$k_1 = k_4 = 0, \quad k_2 = k_3 = 1$$

$$k_2 = k_3 = 0, \quad k_1 = k_4 = 1$$

$$k_1 = 0, \quad k_2 = k_3 = k_4 = 1$$

$$k_2 = 0, \quad k_1 = k_3 = k_4 = 1$$

$$k_3 = 0, \quad k_1 = k_2 = k_4 = 1$$

$$k_4 = 0, \quad k_1 = k_2 = k_3 = 1$$

For consistency, the networks are arranged to produce the desired transfer function as voltage gains. In some cases, this meant the addition of one or two transistor stages to change input-output currents to input-output voltages. A working model of any network however, necessitates the addition of transistor biasing, which is accomplished by one or more of the following techniques:

- Adding base-emitter resistors for grounded-base transistors.
- Adding resistor dividers to the bases of grounded-base transistors to eliminate any of the bypass capacitors.
- Changing any of the grounded resistors into

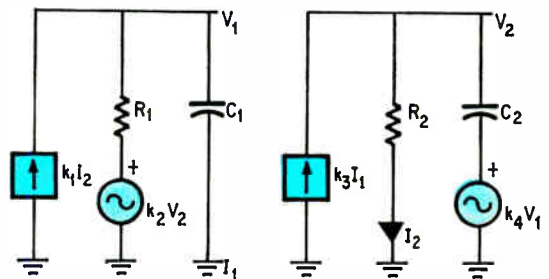

$$G = \frac{N}{D} \quad D = \left(\frac{s}{\omega_0}\right)^2 + \frac{1}{Q} \left(\frac{s}{\omega_0}\right) + 1$$

$$\omega_0 = \frac{1}{\sqrt{R_1 R_2 C_1 C_2}}$$

$$Q = \frac{\sqrt{R_1 R_2 C_1 C_2}}{C_1 R_1 + C_2 R_2 - (k_1 R_1 + k_2 R_2)(k_3 C_1 + k_4 C_2)}$$

General network. Two resistors and capacitors are connected to form a model for representing the transfer function of an active filter. The denominator of the transfer function depends only on the network elements and not the input-output terminals.

supply-to ground resistor dividers.

- Adding grounded-base transistors as d-c current supplies.

A wide choice

Based on the general model, the eight network groups yield 24 active filter designs (see foldout chart) that produce a second-order transfer function. Seven of these circuits provide low Q values and 17 yield Q 's reaching toward infinity. Some of the circuits are negative-feedback designs in which

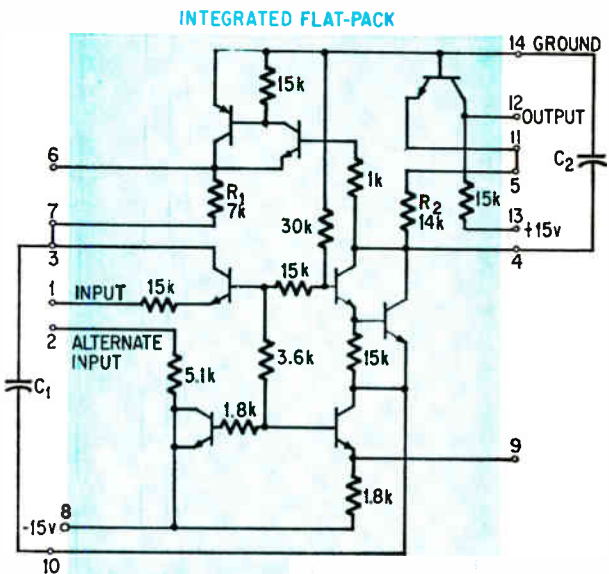

Biasing helps. Optimum active filter design includes a biasing arrangement that minimizes sensitivity to thermal and power-supply variations.

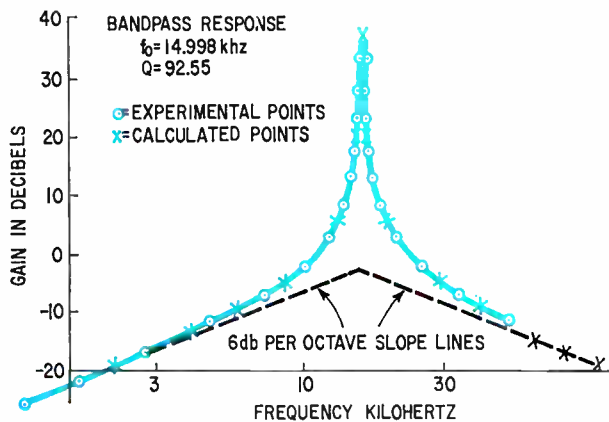

Response curve. Two-pole bandpass filter response is free of measurable spurious signals to at least 60 decibels below the peak of the curve.

Passive vs. active filters

	RLC	Active
Volume, cubic inches	1 L, 0.0842 1 C, 0.016 1 R, 0.0044 <hr/> Total 0.105 plus impedance amplifier	1 IC, 0.005 2 C, 0.032 2 R, 0.0088 <hr/> Total 0.045 plus power supply
Power drain, milliwatts	Power drain of impedance amplifier	13 from -15 volts regulated 4.5 from +4 volt nonregulated <hr/> Total 17.5
Frequency stability with 1% regulated supply	Not applicable	225 ppm
Thermal frequency stability (-55°C to +100°C)	140 ppm/°C can be compensated to 0.1%	130 ppm/°C can be compensated to 0.05%
Center frequency, f ₀	15 khz	15 khz
Q	100	100

some care must be exercised by the designer, and still others are circuits in which the Q can be adjusted by one component rather than two. In all cases, however, the desired transfer function is produced without restrictions on either the Q or the break frequency, ω_0 .

How it works

For a practical explanation how the 24 networks perform, consider an amplifier having an input-to-output resistance ratio of 10^6 , a gain of 0.999 and a feedback factor of 10^{-3} .

When networks 1 through 7 were analyzed with these amplifier parameters, it was found that only low Q values were possible. These networks are easy to implement and won't oscillate regardless of the resistor and capacitor values. To select a new input terminal, the designer merely connects the transistor in a new position—such as a common emitter, a collector, or a base. This changes the value of n and, in turn, changes the frequency response of the filter.

Networks 8 through 24 have sufficient positive feedback to result in oscillation if improperly designed. Since this means that each is capable of producing infinite values of Q, a different optimization procedure is employed. First, ideal amplifiers are used in the design for infinite Q. Then, the ideal amplifiers are replaced with the defined practical amplifiers. Next, by tuning the resistors and capacitors, the designer alters the response and reduces the Q. Since RC values are specified for infinite Q using ideal amplifiers, the network that is least affected by the use of practical amplifiers is the one with the highest resultant Q. That network is least sensitive to variations in the active devices and therefore the most stable, within the limits of the passive components available. When analyzed in this manner, the Q results for the circuits 8 through 24 are 83.3 for 8 to 10, 73.2 for 11 to 14, 96.2 for 15 to 20, 79.1 for 21 and 22, and 21.2 for 23 and 24, respectively. This value of Q represents a figure of merit for the stability.

The networks with the two highest Q values—networks 15 to 20, 23 and 24—require three amplifiers within the feedback circuitry. These are capable of parasitic oscillation and therefore require careful design. Adequate designs can be developed with networks 8 to 10, which have a Q of 83.3, since they require two transistors each and aren't significantly less stable than the two highest valued networks. In networks 15 through 24, the Q's can be adjusted by one component rather than two—this is desirable if parasitic oscillations are not an important contributing factor.

Designing a bandpass filter

As an example of a bandpass filter, consider network 9, which is selected arbitrarily. A biasing arrangement is chosen that results in a minimum sensitivity to thermal and power-supply variations. The schematic, at the bottom of page 91, is an IC active filter with two external capacitors.

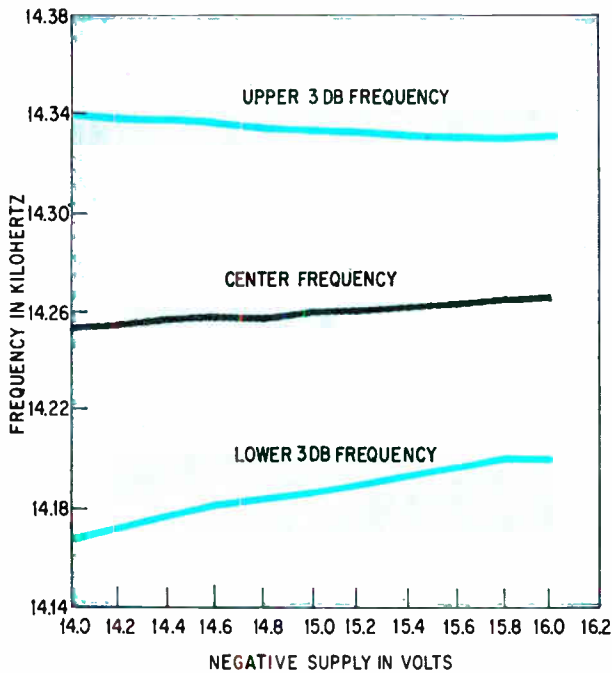

Power-supply changes. When the negative power supply varies by 1.5 volts, the frequency response deviates by only 0.07 percent.

is intended to be a-c or zener-diode coupled to its source and load. The input impedance is a 15-kilohm input resistor. An external resistor, however, may be connected to the alternate input lead for levels between 300 ohms and 1 megohm without affecting the frequency response. A separate supply powers the output stage for good load isolation. The output impedance, even when changed, has no effect on frequency response.

Adjusting the gain

Gain, K , is directly related to the output-to-input impedance ratio and may be adjusted to a convenient level, but the output current level must be kept below 50 microamperes (or 0.75 volt root mean square into the 15-kilohm load) for linear operation. The power consumption of the device is 17.5 milliwatts from the negative 15-volt supply and 4 mw from the positive 15-volt supply. By decreasing the positive supply voltage to 4 volts, total power consumption is reduced to 13 mw, which doesn't affect frequency response.

The tuning elements in the network are C_1 , C_2 , R_1 , and R_2 , and the resonant frequency is

$$f_o = \frac{1}{2\pi \sqrt{R_1 R_2 C_1 C_2}}$$

and the Q is given by

$$Q = \frac{R_1 C_2}{C_2 R_2 - C_1 R_1}$$

Tuning is accomplished by varying either the re-

sistors or the capacitors, and the thermal stability is enhanced because Q depends solely upon the ratio of like components.

By using a network configuration whose response curve is essentially insensitive to the active device parameters and biasing resistors, the filter itself is essentially insensitive to temperature and supply voltage variations. The transistors were selected for a minimum beta of 165, but no other tolerances were set on the active parameters. The diffused biasing resistors, all but R_1 and R_2 , are components having 10 percent tolerance and having a temperature coefficient of about ± 0.25 percent per degree centigrade. Such wide components make the device easy to make. Resistors R_1 and R_2 have high thermal stability as do capacitors C_1 and C_2 .

The filter tunes to any frequency from d-c through 40 kilohertz, with any Q up to about 2,000, the circuit shows no tendency to oscillate. The upper frequency limit is controlled by the minimum intrinsic capacitance distributed in the IC, which resonates the 7- and 12-kilohm resistors. These resistor sizes were chosen by the designer in his bid to achieve low-value capacitors for resonant frequencies in very-low and audio bands.

Response of this two-pole bandpass filter design follows the ideal unnormalized curve of

$$\text{Gain} = \frac{K \omega_o s}{s^2 + \frac{\omega_o}{Q} s + \omega_o^2}$$

and is completely free of measurable spurious responses to at least 60 decibels below the peak. In the plot of the frequency response as a function of temperature, only the half power points and the peak frequency are drawn. The bandwidth is given by the separation of the upper and the lower curves; the 130 parts per million per degree centigrade slope of the curves can be corrected by changing R_1 , R_2 , or C_1 , C_2 . This results in a variation of less than 0.04 percent over the temperature range of -55°C to 100°C .

If a zero temperature-coefficient capacitor and temperature stabilized torroid are used in an LC filter, its Q varies by about 6 percent over the temperature range and its resonant frequency varies by about 0.1 percent as compared to 0.05 percent in the compensated active filter for the same temperature conditions.

Variations in the negative supply on the filter response can be observed from the plot. A variation of 1.5 volts in the regulated supply produces a frequency variation of less than 0.07 percent. Variation in the positive supply, however, doesn't affect the response. The frequency stability of this active filter is therefore better than an RLC filter and has a frequency-response curve that cannot be distinguished from an ideal RLC filter.

Reprints of this report are available at \$1 each from Electronics Reprint Dept., 330 W. 42nd St., New York, N. Y. 10036. Copyright 1969, Electronics ®, a McGraw-Hill publication.

Adapter lets digital IC tester check on operational amplifiers

Variable interface circuit between device and tester is switched, under program control, to make required parameter measurements

By Robert McIntyre

Amelco Semiconductor, Mountain View, Calif.

By adding a simple but versatile interface fixture, automatic testers for digital integrated circuits can be used to check such linear circuits as operational amplifiers. The tester can be programmed to interconnect the amplifier terminals with appropriate load and feedback resistors, to apply the proper supply voltages, and to make voltage and current measurements at the appropriate points. Using a unit like the Fairchild Model 4000, the results of each test can be compared with the specification limits supplied by the op amp manufacturer; devices will be accepted or rejected, depending on how well they measure up.

All necessary checks can be made with just a few variations of the master interface circuit, shown at the top, page 95, with the op amp connected through pins E and F. Power comes in through pins M and N. Pins K and L are output lines. Resistor values shown are for the Amelco 809 amplifier. Any circuit compensation that's needed is attached directly to the test socket. This compensation may be greater than indicated by the information on the op amp data sheets because of the capacitances associated with the relatively long leads to the test points.

Offset voltage and power-supply rejection ratio (PSRR) and common-mode rejection ratio can be handled by the other circuit shown on page 95. In the case of the former two, pins D and G are grounded. However, for measuring CMRR, they're tied to the system input. Depending on the gain that's desirable, any of pins A, C, and J are tied to the output.

Offset voltage is measured by closing a d-c feedback loop with a gain of, say, 100 and checking the output voltage. The offset voltage equals one one-

hundredth of this value. If the input currents are small and well-balanced and the input resistors are also small, bias current errors are small enough to be ignored. It isn't feasible to find the offset voltage by connecting a differential metering line directly across the input because the meter error is on the order of the voltage being detected. Inaccuracies resulting from the finite value of open-loop gain can normally be held to less than 1%. The only other significant error—common to each variation of the test circuit—involves resistor tolerances. High-accuracy, wire-wound devices should be used to minimize this difficulty.

The measurement of PSRR depends on successive offset voltage measurements. After the first output voltage measurement is made and stored in the sample-and-hold circuit of the automatic tester, the power supply voltage is jumped to a new level. The corresponding change in the offset voltage is then measured, producing the PSRR value. Because it shares the circuit, the PSRR measurement is subject to the same errors as the offset voltage check. For accuracy, the power supplied— V_{cc} and V_{ee} —should be varied by as large a magnitude as possible.

Common-mode rejection ratio is measured with a variation of the circuit, shown, next page, that has been used in manual test setups for a number of years. This circuit is essentially a voltage follower with a differential gain of $(R_2 + R_1)/R_1$. If R_1 is very small, the effects of offset current are negligible and the output signal equals the input signal plus the product of the common-mode error and the differential gain.

The CMRR specifications for a particular op amp are checked by first applying the specified positive

common-mode range voltage, e_{cm} , to the input and sampling the output. The input is then changed to the negative limit and the change in the output is measured. Whether or not the CMRR falls within the specification limits is determined from the relationship shown between the output and the input signals.

Inaccuracies in this measurement are primarily attributable to the difficulties involved in measuring a fairly small deviation on a rather large voltage range. Say the CMRR spec is 80 decibels, the system gain is 100, and the applied voltage is changed by 20 volts. In this case, the output must be measured to within only 200 millivolts on the 100-volt scale. It would be better, however, to reduce the input voltage change to 10 volts so that the next lowest range, the 10-volt scale, could be used.

In checking dynamic range, input pin E is either grounded or the feedback loop is left open. The unused resistors in the circuit can be used as the output load—individually or in parallel. Alternatively, the amplifier can be loaded with the current source usually present in the automatic tester itself. However, if a particular op amp requires it, a special resistor can always be added to the network and used only as a load.

Exacting

For the input current test, there are no approximations; the measurement is made directly on an open-loop op amp. The inputs are supposed to be grounded but, since one is to be measured, it must be connected to a zero-volt supply and the current measured. The lowest range available on the power supply is 1 volt full scale so the error is about a millivolt. The actual current error is equal to the voltage error divided by the differential input impedance. Common-mode error is very small.

Another way to make this measurement is to connect both inputs and double the current specification limit. The current that's measured is for the parallel inputs. Under these conditions there is no differential input voltage to cause any error and, since an op amp has a large value of common-mode input impedance, the error due to the very small common-mode signal—about 1 millivolt—is negligible compared to the measurement error. With most automatic test equipment, measurement error is at least as good as 0.1% of full scale.

For measuring input-offset current, pins C and H are grounded and pin J is tied to the output. Pin-pairs A-E and F-H are shorted for one-half of the test and opened for the other half. The result is the circuit, at the top, left, page 96. In this test, a loop gain of 100—a convenient value—is chosen and the output-offset voltage is measured first with, and then without, a resistor in each of the input lines. The difference in the output-offset divided by 100 times the value of the series resistor equals the input-offset current. (The difference is, of course, determined by the sample-and-hold circuit in the automatic tester.)

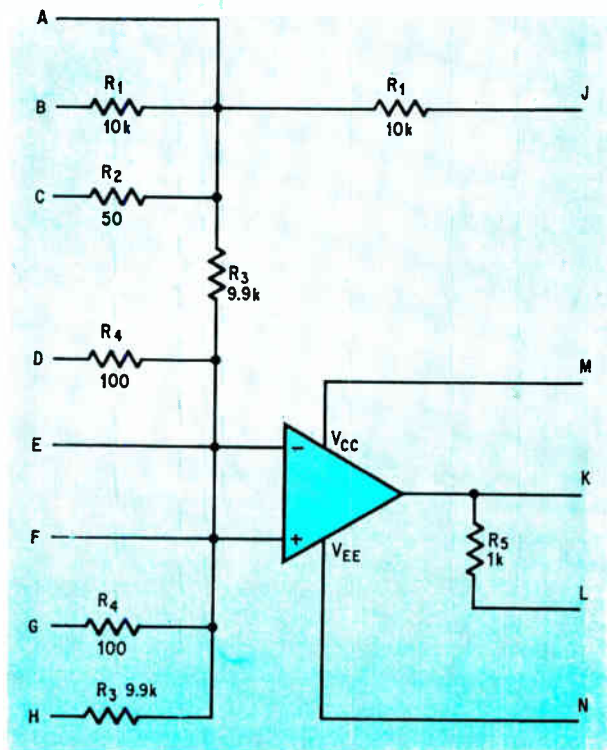

Interface. Resistor network is interconnected by automatic digital IC tester to form the individual circuits needed to measure op amp parameters.

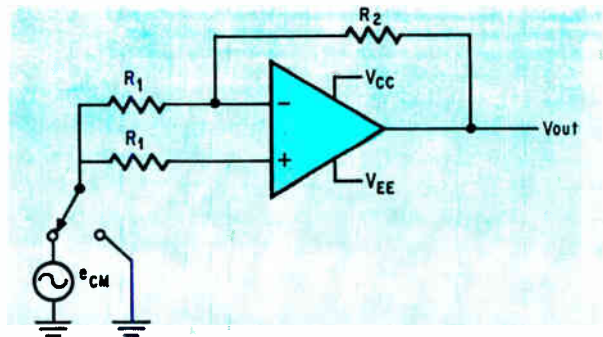

$$V_{off} = \frac{(V_{out})R_1}{R_2 + R_1}$$

$$PSRR = \frac{\Delta V_{out}}{\Delta V_{supply}} \times \frac{R_1}{R_2 + R_1}$$

$$CMRR = \frac{e_{CM}}{e_{CM} - e_{OUT}} \times \frac{R_2}{R_1}$$

Three-way switch. Offset voltage and power-supply rejection ratio can be determined using grounded circuit; limit voltage is applied for common-mode rejection ratio.

There is no noticeable forcing-function error in this test. However, the sample-and-hold system generally has an overall accuracy of 0.1% of full scale. The resistor tolerances are important;

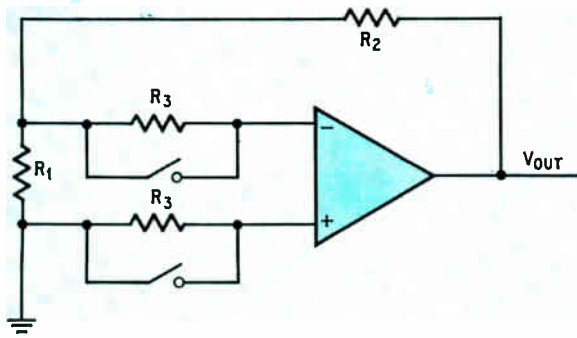

$$I_{OFF} = \frac{\Delta V_{OUT}}{R_3} \times \frac{R_1}{R_2}$$

Valuable tool. Shorts on the input resistors of this circuit help determine value of input-offset current.

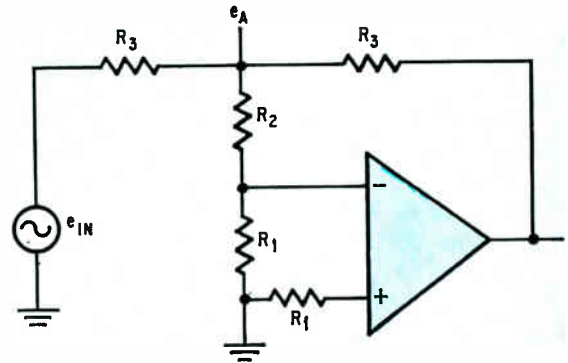

$$A = \frac{e_{IN}}{e_A} \left(\frac{R_2 + R_1}{R_1} \right)$$

Case in point. Pin A is the metering point for determining the gain of an op amp under test.

they affect the match of the series input resistors and along with the feedback resistors determine the value of the loop gain. The finite gain value affects the reading as well.

Gainful employment

For measuring gain, the automatic tester grounds pins D and G, connects pin J to the output pin K and pin B to the input supply, as shown in the upper right. The metering point is at pin A. Ideally, the way to make the gain measurement would be to get the ratio of the output voltage to the input voltage. But instead of making these two separate measurements, the op amp is put into a feedback loop that forms a unity gain inverter. If errors are neglected for the moment, then the output voltage equals the system input voltage. With the applied input voltage (and hence the output voltage) known, all that must be measured is the voltage at the op amp input. Unfortunately, it's too small to detect with the meters in the automatic tester.

However, the gain-measuring circuit puts a voltage divider between the junction of the input and feedback resistors (pin A) and the amplifier input terminal. The result is that the voltage at pin A, e_A , equals the small input voltage multiplied by the voltage divider ratio $(R_2 + R_1)/R_1$, and this can be easily measured by the automatic tester.

If, for example, a -10 -v signal is applied to the system's input resistor, the output is close to $+10$ volts. If the input is then jumped to $+10$ volts, the output should also swing by 20 volts. And the voltage change measured at the summing point A is proportional to the reciprocal of the open loop voltage gain.

Variations in the input signal supply lead to a small error in the gain value as does the sample-and-hold circuit which must operate over a small portion of the full-scale range.

Input impedance of the op amp is measured

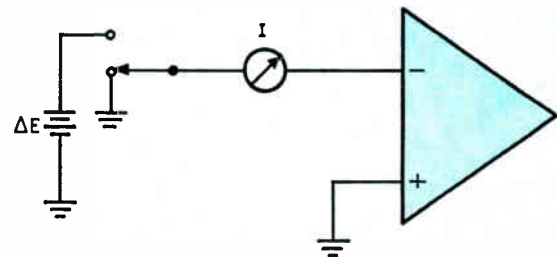

$$R_{IN} = \frac{\Delta E}{\Delta I}$$

Solo. Single circuit measures input resistance directly.

with the direct circuit shown above; no external resistors are needed. With input pins E and F grounded, the automatic tester measures the current flowing into one of the inputs. Next, the voltage on the monitored input is changed by a small amount and the resulting change in current is measured. The input resistance of the op amp equals the known voltage change divided by the current change it produces.

Any offset in the signal source applied to the input is unimportant because its effect is cancelled out by the successive measurements. Consequently, the measured value of the input signal should be accurate to within the meter's 0.1% of full scale accuracy. But if the measured input is very much below the full-scale reading on the meter, the signal's value is off by several percentage points. Still another source of detection error is in the sample-and-hold circuit.

Unfortunately, there is no effective automatic technique for measuring the output resistance of the op amp. But in most applications, the circuitry is designed so that the output resistance may be neglected. ■



**EASILY
NUMBER 1-
234567
890**

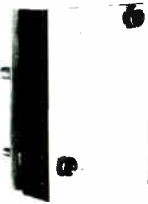

Easy to see. From across the room. Or up close. The EDP Modular Numeric Readout. Series 100 compact. Designed for high performance and versatility. A long life of 150,000 hours. And the viewing angle? Up to 170°. Easy in price too! You can choose the options: Color lens variations. All hardware for lens and panel mounts. Even for walls and ceilings. Easy to install or replace. And the price is easy to live with. Or did we mention that?

*EDP's individual readout blocks permit you the flexibility of varying configurations. Horizontal. Vertical. Stacked in banks. Make it easy on yourself. The Series 100 seven segments character forms numerals 0 thru 9. And modules are available with decoder / driver. Storage. Polarity / hold. Decimal point. Or color. The size (1.3" deep) is as small as the price. We **did** mention that, didn't we? Easy to see why you **should** be interested. Let us tell you more. Or show you!*



EDP CORPORATION

1900 NORTH MILLS AVENUE
OPLAND, FLORIDA 32503

Cellular redundancy brings new life to an old algorithm

With LSI MOS circuitry that includes hundreds of identical processors, and with the almost-forgotten dinary algorithm, a block-oriented computer promises great reliability at low cost; processing is from left to right

By Joseph O. Campeau

Litton Systems, Inc., Woodland Hills, Calif.

An array computing system called the block-oriented computer (BOC) attains new heights of reliability at low cost through the use of hundreds of small identical cells. Each of these cells is a complete processor with arithmetic and control functions. This concept of cellular redundancy permits the cells to be interconnected under software control in any of a large number of configurations.

The BOC is built exclusively of large-scale integrated metal oxide semiconductor circuits on wafers an inch or more across. In all, there are more than 100,000 MOS transistors; each wafer contains typically 36 cells. These cells are interconnected, via a one-layer metallization pattern on the wafer, at the same time the circuit elements within the cell are interconnected. The wafers are left intact; there is no dicing.

Unlike the "natural" right-to-left processing that has prevailed since the early days of computers, the BOC uses a more efficient technique called the dinary power-increment algorithm. This algorithm computes from left to right, beginning with the most significant bit [see "D as in dinary," p. 100]. The reverse order makes the most significant bit of the result available for subsequent processing before the individual computation has produced the least significant bit. In the so-called natural or conventional method, the entire process must be completed before a subsequent step can begin.

Thus, for example, in the BOC, the most significant bit of the product of two numbers is immediately available at the multiplier's output so that other processing cells can initiate additions, subtractions, further multiplications, or other operations. The multiplier continues its operation while the other steps in the computation are under way.

The dinary technique is an old idea that fell into disuse. Its resurrection can be traced to the stepped-up interest in LSI and parallel processing, to which the algorithm lends itself. The name, dinary, originally referred to an essentially binary process that used +1 and -1 for digits instead of 1 and 0. In the BOC, the original process has been modified to use +1, 0 and -1; numbers are transferred between cells using these digits, but are stored within cells in conventional binary form. Litton's development of the BOC is being funded in part by the U.S. Air Force Avionics Laboratory.

The cell, diagramed on page 104, resembles a digital differential analyzer. The cell can, and in fact does, operate as a DDA when required by a particular problem. But it is also capable of much more powerful processing. Where a single DDA is limited to an output that is the integral of its input, the BOC cell can also multiply, take square roots and perform other arithmetic functions.

With an array of identical cells, a failure of one cell affects only that portion of the computation that it handles. Software techniques permit such a cell to be replaced by another. The concept of cellular redundancy differs markedly from conventional approaches.

Some approaches require at least two and sometimes three or more of the same vital elements: so that a failure of one doesn't bring down the entire system. And in others, there are complete standby systems that idle unless and until the primary systems fail. Thus, traditional approaches could require 100% or more additional hardware. But with the cellular approach, as in the BOC, the extra hardware totals no more than a few percent.

Because the cells are independent processors,

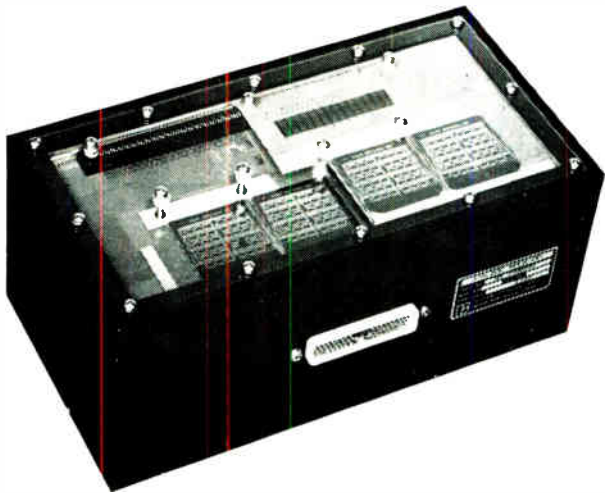
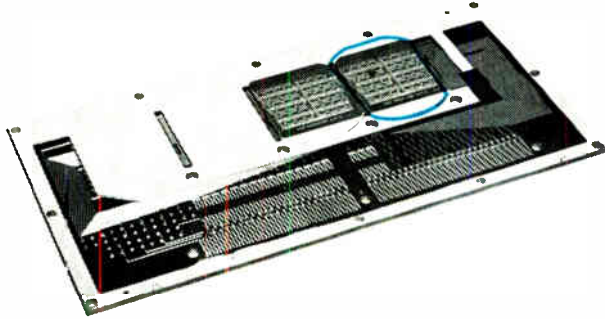

Tray and system. In the upper photo, two wafers on a tray are visible; they are 1½ inches across and contain 36 cells each. One wafer is outlined in color. Lower photo shows assembled computer minus top cover.

they are quite large by today's integrated circuit standards. And because they can be interchanged by software, they need not be cut apart after several of them have been fabricated on a single wafer of silicon. This presents a yield problem.

At today's state of the art, yield is rather low when making large MOS arrays. But there are several ways to compensate for low yield. Dicing the wafer into smaller arrays is but one method. If any of these smaller units are defective, they can be discarded. Another calls for leaving the large wafer intact, but not defining the interconnections between cells until after defective cells have been identified. The defective cells are then left out of the interconnection process. This discretionary-wiring approach, which is favored by Texas Instruments, requires at least one additional layer of metalization.

In the approach, taken by engineers at Litton's Guidance and Control Systems division, both dicing and the extra layer of metal are avoided. The entire wafer is tested after it is mounted on a thick etched circuit board. Only flawless cells are connected into the system.

In Litton's original interconnection method, [Electronics, June 24, 1968, p. 47], address lines were brought out from each cell to test pads at the edge of the wafer. Although the cells them-

selves are relatively large and complex, the wiring between cells is minimal; and because each wafer carries only 36 cells, the total number of pads at the edge of the wafer is relatively small. These pads provide access to all the arithmetic units, which are exercised one at a time to weed out the defective ones. Those that pass the test are then interconnected on the circuit board. This wiring approach, like TI's, is discretionary. But it's external rather than internal.

Because the cells are identical, it doesn't really matter which cell is which; the cell acquires an identity only after its address lines have been externally connected to selection circuits.

In a method now favored by Litton engineers, ultrasonic bonding connects the "good" cells to the wafer's main busing system without bringing selection lines to the edge of the wafer. Bonding directly to the wafer may seem harder than the external-wiring technique, but it really isn't. There are only a few points inside each cell that need be tested, and today's automatic probing and bonding machines complete the task in short order. Moreover, this approach enables later rejection of cells that originally tested "good" but develop defects during operation.

Four on a side

Four wafers are mounted on one side of an etched circuit board, and four more on the reverse side; wafers are interconnected via the etched conductors and plated-through holes. The entire assembly—eight wafers and a board mounted in a metal rim called a "tray"—plugs into a back panel;

Continued on page 102

TRADITIONAL
REDUNDANCY -
100% INCREASE
IN PARTS



CELLULAR
REDUNDANCY -
 $\frac{100}{N}$ % INCREASE
IN PARTS

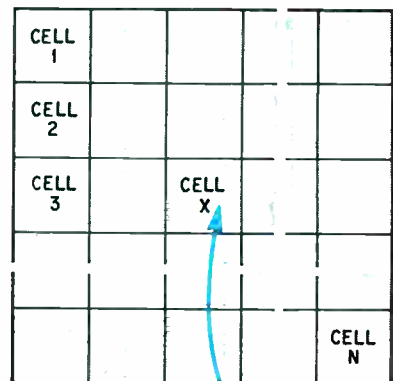

Economy. With cellular redundancy, much less extra hardware is required for standby capability in case the basic system fails. Whole unused computer systems must be kept on hand with the traditional approach.

D as in dinary

Discarded nearly two decades ago and left to languish among the forgotten, the dinary algorithm has only recently become the center of renewed interest. But the algorithm has been collecting dust for so long that most engineers today would be hard pressed to find out what it is; few texts or dictionaries make reference to it. What, then, is it?

In essence, the dinary algorithm is based on a notation that resembles conventional binary notation except that the individual digits can be either positive or negative. Any quantity within a prescribed range, such as -1 to $+1$, is represented as a string of signed digits, each weighted with an appropriate power of 2, just as in conventional binary notation.

When used with incremental inputs whose magnitudes vary systematically, this notation enables a cell in the voc to build up to a result in no more than n iterations—whereas a digital differential analyzer, using binary representation and fixed increments, can require as many as 2^n iterations.

Every operation in a voc cell involves three quantities—two inputs and an output. The particular configuration developed at Litton uses registers for one input, Y , and one output, Z —which consists of an R register plus its overflow—and depends on the output register of a preceding cell to hold the second input, X ; but for illustrative purposes this explanation assumes the existence of three registers in the cell for the three quantities.

The voc, like all other fixed-point computers, works only with a restricted range of numbers, such as 0 to 1, positive or negative. Problems involving larger numbers must be scaled down to fit this range. And in the dinary algorithm, the overflow logic implementation is simpler when the numbers are all positive. Therefore the range of input numbers is restricted to lie between $-\frac{1}{4}$ and $+\frac{1}{4}$, and the binary representations of these numbers are arbitrarily increased by $\frac{1}{4}$ when stored in the cell registers so that they lie in the range 0 to $\frac{1}{2}$. This makes the range of the R register 0 to 1; when the R register shifts left, corresponding to a multiplication by 2, the range becomes 0 to 2. This shift occurs in every minor iteration.

The original arbitrary increase of $\frac{1}{4}$ on each input becomes $\frac{1}{2}$ when the inputs are combined, and 1 when the R register shifts. Thus, correcting for this increase gives the true output range, -1 to $+1$.

Stored numbers in all three registers are in con-

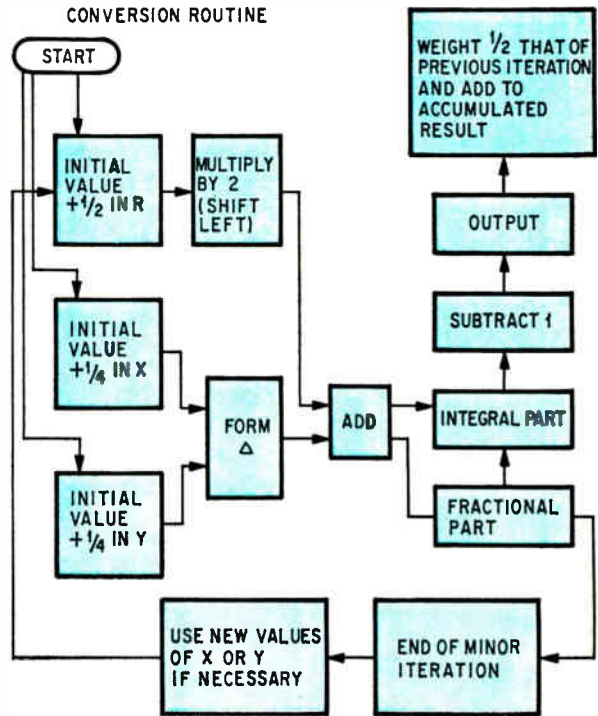
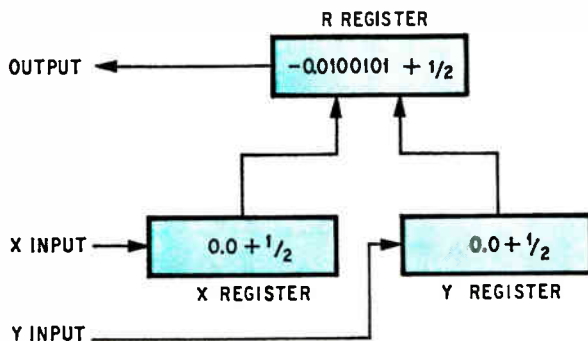

ventional binary form; but the R register overflows in bit pairs, or power increments, which are transmitted to the next cell. At this point, they are added to whatever partial or previous results are already stored in binary form.

The cell's operation is described by

$$z_i + R_{i+1} = (X_i + 2^{-i}x_i)y_i + Y_ix_i + 2R_i = 2R_i + \Delta$$

where z_i is the power increment overflowing from the R register at the end of a minor iteration. R_{i+1} is the remainder in the R register, for the start of the next minor iteration. The quantity Δ is the state of the inputs for a minor iteration.

One of the simplest operations that the cell performs is the conversion of a number from conventional binary form into power increment form, as shown in the flow chart above. If the number has seven binary positions, the conversion requires seven minor iterations, which produce seven power increments or 14 bits.

Suppose the number to be converted is the fraction $-37/128$, which, in true binary form, is -0.0100101 . It is initially brought in through one of the two inputs and transferred to the R register. As an input, it has $\frac{1}{4}$ added to it; the other input, which is nominally 0, is coded as $\frac{1}{4}$. These additions and codings are simple logic operations on the two most significant bits of each number. The transfer into the R register adds these numbers together, with a result that is greater by $\frac{1}{2}$ than the true value—or $+0.0011011$ in binary.

With the number to be converted in the R register, as shown at left, the inputs are reset to 0, and Δ becomes $\frac{1}{2}$, or 0.100000 in binary. R is then

Binary to power-increment conversion

l	R _i (coded)	2R _i	2R _i + Δ	z _i	R _{i+1}	z _i true	Accumulated total	*Original binary number = -0.0100101 Add ½ to store in R = +0.1000000
1	00.0011011*	00.011011	00.111011	00	.111011	-1	-0.1	Coded form = +0.0011011
2	00.111011	01.11011	10.01011	10	.01011	+1	-0.01	This number in power increment form becomes the digits in the z _i column: 00 10 01 00 10 01 00
3	00.01011	00.1011	01.0011	01	.0011	0	-0.010	These power-increment digits accumulate in their original binary form** in the next cell.
4	00.0011	00.011	00.111	00	.111	-1	-0.0101	
5	00.111	01.11	10.01	10	.01	+1	-0.01001	
6	00.01	00.1	01.0	01	.0	0	-0.010010	
7	00.0	00.0	00.1	00	.1	-1	-0.0100101**	

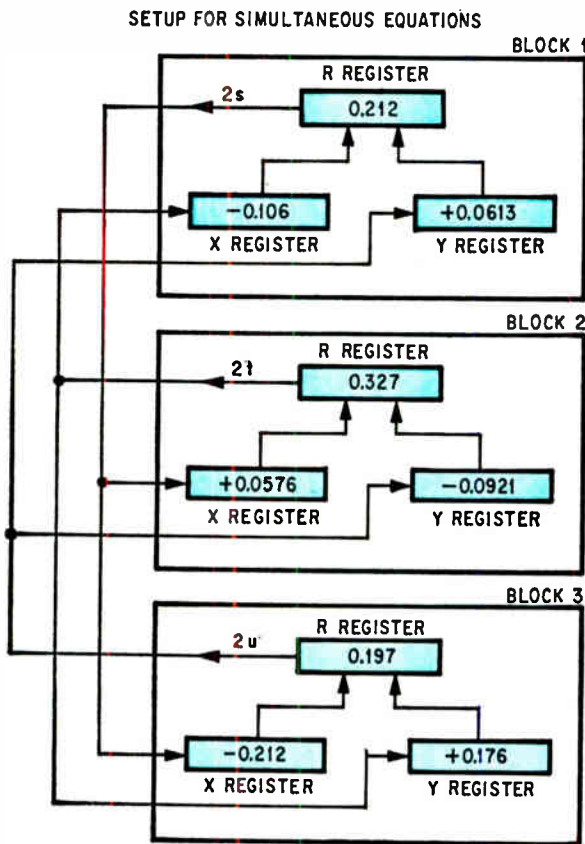

multiplied by 2, which is simply a one-bit shift to the left. Then Δ is added, giving the result as 00.111011.

This result has a coded $z = 00$ to the left of the binary point, and a remainder $R_{i+1} = .111011$ to the right. The next step is to subtract 1 from the coded z to get the true z , another simple logic operation. The binary equivalent of the true z is the first bit of the result, or -0.1 ; it shows up in the following cell, transmitted to that cell in power increment form. This is the end of the first minor iteration.

The process is then repeated with the new value of R_i , which is the R_{i+1} just found. This time the coded z is 10, corresponding to a true z of $+1$. But this power increment corresponds to the second most significant digit; when this power increment is added

to the previous result, the total is -0.01 .

On the third iteration, the value of z is 01 coded or 0 true. The third most significant digit added to the preceding result thus produces a total of -0.010 . The table above shows the rest of the process with all seven power increments and the result, appearing in binary in the following cell, having the same form as the original binary number.

The processing from left to right is evident. It works because the power increment 11 never appears, so that no carry can ever propagate beyond the bit just to the left of the one being processed. Therefore, at the end of any minor iteration, the result is in error by no more than one bit position.

This conversion example illustrates the operation of a single cell and of the binary algorithm in its simplest form. But for a better understanding of how powerful the algorithm can be and how it can reduce the number of steps required to solve a problem, consider, for example, the solution of three linear algebraic equations in three unknowns:

$$\begin{aligned} 2s &+ 0.106t - 0.0613u = 0.212 \\ -0.0576s + 2t &+ 0.0921u = 0.327 \\ 0.212s &- 0.176t + 2u = 0.197 \end{aligned}$$

These equations are more readily solved in the voc if they are rewritten as:

$$\begin{aligned} 2s &= 0.212 - 0.106t + 0.0613u \\ 2t &= 0.327 + 0.0576s - 0.0921u \\ 2u &= 0.197 - 0.212s + 0.176t \end{aligned}$$

This set of equations requires three cells of a voc, which are initially loaded with the coefficients of equations. One cell corresponds to each equation; in each cell the constant term goes in the R register and the fractional coefficients are the X and Y inputs. Each cell's output is the term with coefficient 2; this is connected to the corresponding inputs of the other cells.

In practice, of course, the coefficients would be entered in coded binary form. If each number was expressed to 15 binary places and 15 minor iterations were taken with the connections shown in the configuration at the left, the results would be available at the outputs of the three R registers with an accuracy of four or more decimal places. Again, after each minor iteration, the most significant digit appears first. Thus, accuracy is built up as the operation continues on to the final digit.

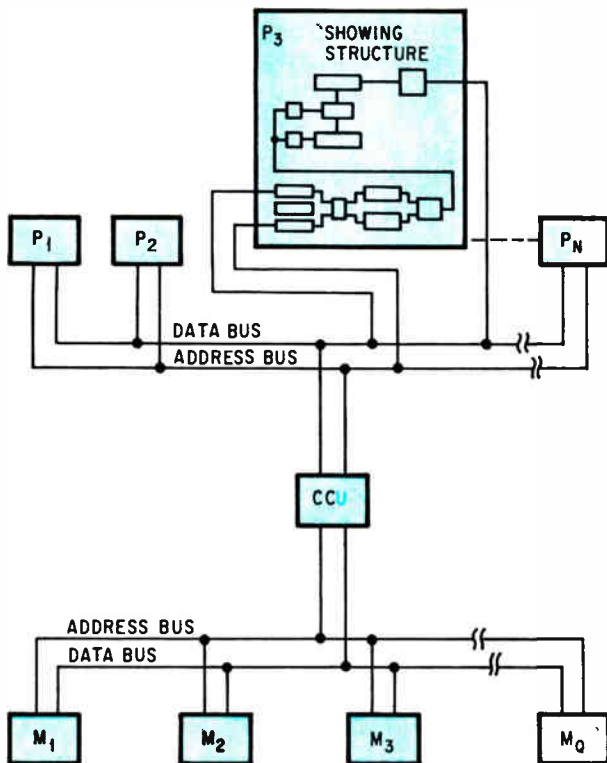

Three kinds. Litton's block-oriented computer contains both identical processor cells and identical memory cells, plus one central control unit.

Continued from page 99

the computer as a whole consists of several of these trays connected on the back panel.

Some of the interconnections between wafers, especially those on different trays, are quite lengthy, but the contribution of these long lines to capacitive delay in the circuits isn't serious. The highly convoluted routings of metallic interconnections on the wafers add up to more length, and more capacitance, than even the longest back-panel wire. Though this may be a bit hard to swallow for engineers accustomed to designing with discrete components and conventional integrated circuits, it nonetheless is a fact of life in LSI.

Theoretically, a computer having almost any degree of capability could be put together with a sufficiently high number of identical cells. But this could prove impracticable. When it comes to semiconductor real estate, a few specialized cells—notably those that store data—would be in order. In fact, semiconductor circuits are more often required for storage than for processing.

Certain input-output functions are also performed better by specialized cells. A case in point is an analog-to-digital converter, which requires a holding register that would just be in the way in the arithmetic unit. This holding register and a multiplexer are easily incorporated on the wafer; but because of accuracy requirements, the comparator and summing network are made from standard integrated circuits. As development continues, these and other functions may be designed into specialized wafers.

If, in the presence of defective cells, a system with cellular redundancy is to operate, or, better yet, repair itself in the event of a failure, it must possess certain characteristics.

For one thing, the hardware or cells should be autonomous so that a defective cell doesn't affect its neighbors. This isolation of the individual cells, and it's simply that, is in a hardware sense only; software isolation is neither necessary nor desirable, because, in general, one cell's output is another input.

Another necessary trait is the capability of the software to weed out defective cells in the event of failure during operation. Without this property, the output of a defective cell would generate failures in other cells, causing error propagation.

Still another requirement is that the cells on an individual wafer be interchangeable so that any cell can replace any other cell.

With these requirements as a guide, it would appear a single computer qualifies as a cell, and it does. But single computers aren't often used in arrays. The more-or-less identical circuits of which such computers are built—NAND gates, for example—don't qualify as cells, because they aren't autonomous. Moreover, in most cases, defective "cells" can't be eliminated through software.

If a cellular system is to do the same job as a noncellular system and in the same length of time, the overall task must be broken down into many smaller tasks. Each cell must work on only one part of the job at a given time. With a job thus simplified, the cells too can be relatively simple.

In its present design, Litton's block-oriented computer contains a number of identical processing cells and a number of identical memory cells. The memory cells are silicon nitride MOS circuits that Litton developed [*Electronics*, April 14, p. 50]. They are connected through a single central control unit, as shown above. The processing cells, like the memory cells, are interchangeable. Through separate paths, cells of the same type can communicate with each other without going through the control unit.

The control unit, the only noncellular part of the Litton system, is, perhaps, the weakest link because it lacks redundancy. But since it can be looked upon as a single cell in itself, the probability of its failing is much smaller than that of any of the many identical cells. If a failure does occur on the wafer, chances are that it will involve one of the many redundant cells rather than the one control cell.

The bus that interconnects the processing cells is in two parts, one for address and the other for data. These correspond to two modes of operation—scalar and matrix, respectively.

When in the scalar mode, the processing cell's activity is temporarily suspended while it either receives data from a memory cell or transmits results to a memory cell; transmissions to and from unlike cells—memory and processing—are routed through the control unit. An address on the

bus identifies the source and the destination of incoming data; the address of an individual cell is established when it is initially tested.

During the matrix mode, the cells that received data during the scalar mode start the processing, using the binary algorithm, and transmit intermediate results to one another on the data bus.

The registers and logic in the cells are implemented in four-phase low-threshold MOS circuits driven by a 500-kilohertz clock. This is the frequency now being used, but higher clock rates may yet be introduced.

Overflowing registers

At the heart of the cell, shown at right, are two registers called, as in a digital differential analyzer, the Y and the R registers. Each is 32 bits long. Data first comes into the Y register one bit at a time through a block labeled ΔY . The contents of the Y register are then added serially to increments ΔX and the result placed in the R register. Two clock periods, each nominally 2 microseconds wide, are required for each one-bit addition; one word time comprises the 64 pulses that transfer a full 32-bit word from Y to R in 128 μsec . One clock pulse pair constitutes a minor iteration and one word time is a major iteration.

In a digital differential analyzer, the output is the overflow from the R register, caused by adding an increment that forces a carry from the most significant bit position. In the BOC, however, this overflow can be caused either by such an addition, by a one-bit shift of the R register's contents to the left relative to the Y register, or by both. This R-register shift isn't possible in a DDA.

As a result, two bits overflow at once from the R register at the end of each minor iteration; these bits can be any of the combinations 10, 01, or 00. (The combination 11 never occurs because of restrictions on the range of the numbers involved.) These overflows look like binary representations of 2, 1, and 0; but the binary algorithm causes each pair to be larger by 1 than its true value, so the overflow bits correspond to +1, 0, and -1.

Each overflowing bit pair is called a power increment. The reason: when considered as the i -th digit of a number, its weighted value is $\pm 2^{-i}$ or 0 when the number is scaled with the binary point to the left of the most significant digit. Because a power increment can have any one of three values, it requires two binary digits to represent it; these bits are communicated from cell to cell one at a time along the data bus.

The unique feature of the binary algorithm lies in the fact that the first time the R register overflows during a major iteration, its output is the most significant power increment of the result—not the least significant digit, as in conventional algorithms. Subsequent overflows produce successively less and less significant digits, which are simply added on to the end of the previous overflow, down to whatever level the particular operation requires—and the operation can be halted at any point. As

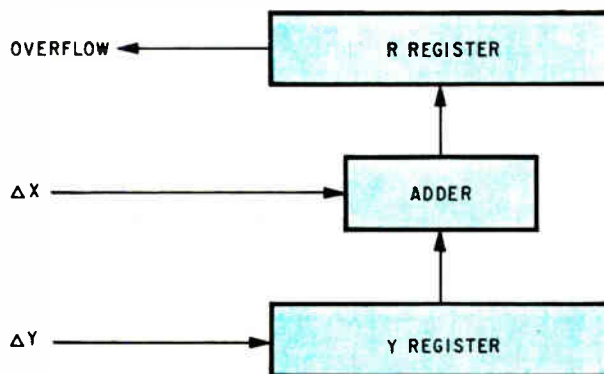

Relative shift. Two registers in each cell look like those in a DDA, but can shift relative to each other.

a result, the most significant increment is available for further processing immediately, before the less significant increments are produced, and calculations requiring less precision can be completed faster than those that must be carried out to the very end.

When a cell gates its output onto the data bus, it does so in parallel with 31 other cells. Outputs of the various cells are timed so that they don't interfere with one another. On any given wafer, there are four of these buses, each of which carries the output of 32 cells—which, in general, won't all be on the same wafer. (It's next to impossible today to get 32 good cells out of 36 on a wafer; even a 50% yield is still several years away.) An additional bus is connected outside the wafer to one or more of the four output buses. As a result, the data on the output buses is multiplexed in both time and space—the receiving cell has to look at the right bus at the right time to get the right data.

Each cell has three sets of input circuits, so that it can look at any of the buses up to three times during any one word cycle. Data can be taken from one bus three times, from three buses simultaneously, or from two or three buses at different times. What the cell does depends on its requirements at particular moment. The data enters either a buffer or an up-down counter, and thence to the ΔX or ΔY register.

When the cell operates as a digital differential analyzer, the contents of the Y register are added to power increment ΔX one bit at a time. The sum goes in the R register. And when the register overflows, the analyzer's output approximates the integral of the Y register's input. Both registers shift, but they remain in step with each other throughout every computation.

Here is where the binary algorithm's flexibility comes into play. By shifting the R register relative to the Y register, the algorithm enables the R register to develop quantities other than the integral of the input—for example, products and quotients.

In both analyzer and binary modes, the R register's output is stored in a two-bit register called

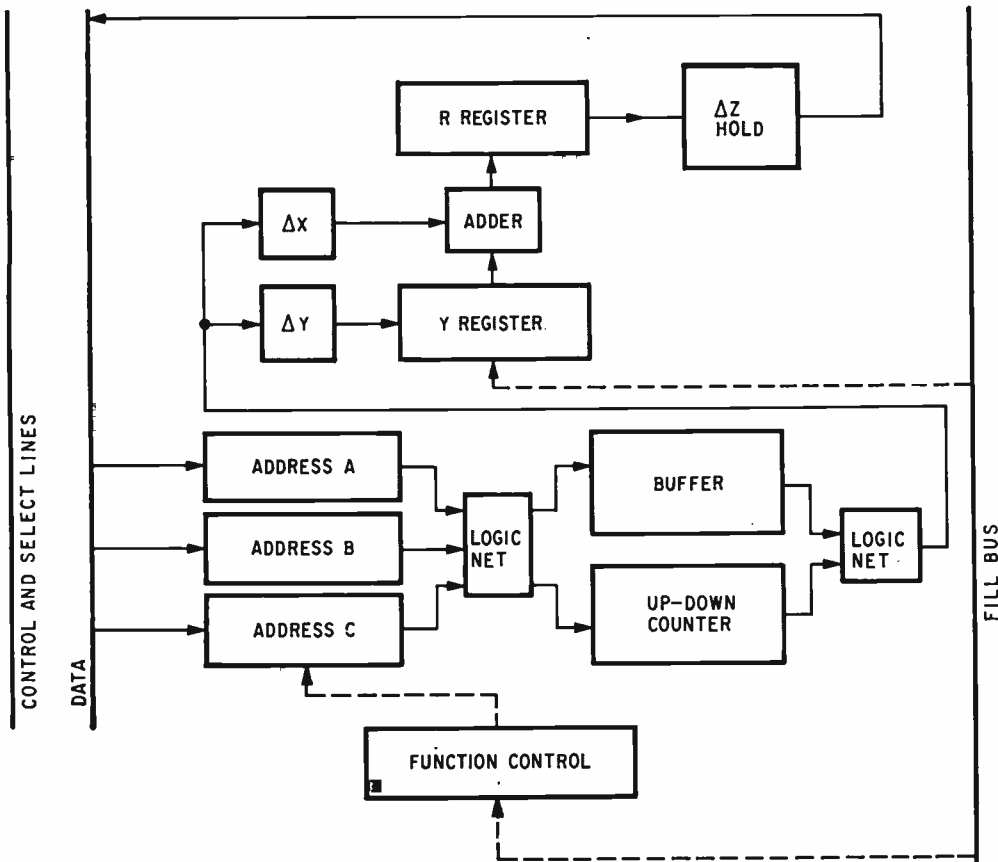

Unit cell. The two registers shown in the diagram on the preceding page receive data from three address registers via a buffer register or an up-down counter. The address registers, in turn, pick up other cells' outputs that appear on the data bus.

the ΔZ hold. Upon the arrival of a control command the output power increment is transmitted to another cell. This same command identifies the cell that receives the output.

Self-healing

The advantage of using cellular redundancy is that it enables the computer to offset critical failures by either substituting one cell for another or switching to a different mode of operation—all under program control. In some cases, the system's operation isn't affected, while in others, it's degraded slightly but stays on the air.

If a sensor fails in the missile-guidance application, for example, configuration control can modify the program so that data from an alternate sensor will be used; data from the faulty sensor is thus ignored. Failure in a primary navigation mode, such as in the inertial mode, for example, might result in a switch to dead reckoning.

If a particular cell fails, the program can recover the system through its fail-soft capability. For example, if the module performing the inertial navigation computation fails, but the inertial data sensors continue to work, the program can direct a cell that has previously been executing a less essential function to drop it and take over the navigation task.

True self-healing occurs when the system replaces a faulty cell with a previously unused identical cell. In effect, the system reprograms

itself to accept data from only the replacement cell. Thus, the system continues on its course without dropping any functions or changing any operation. But this can be achieved only when the cells are completely autonomous.

Autonomy, of course, is never ideal. There are always gates through which data passes from a cell onto a bus; when a cell fails, the gates are closed and its data is simply bypassed. But should the gates themselves fail, the faulty cell could play havoc with the system. Happily, this is unlikely to happen. The transistors in these gates account for only 1% of the total number of transistors in the cell, and they can override the fail-soft feature only if they develop short circuits both from source to gate and from gate to drain.

With cellular redundancy, the system's maintainability and serviceability is enhanced because the location of a failure is pinpointed and displayed automatically. Moreover, since different elements can perform the same functions, mission reliability is far better than in systems that either are non-redundant or have conventional redundancies.

System reliability, however, is decreased somewhat by the cellular-redundancy approach. Spare cells add to the system's total number of components, and the failure rate of an aggregate of individual elements is proportional to the total number of elements. But, by the same token, system reliability is decreased less by cellular redundancy than by conventional redundancy. ■

Only magicians need apply.

Dear Signetics:

I want to work all sorts of magic. With MSI. So I'm applying for your applications booklet, "Designing with MSI." The one that helps work wizardry with all these Signetics arrays: decoding/gating and steering functions, counters, shift registers, memories, adders.

So send me your magic-making ideas, time-savers, new designs. Right now. Today. Or I'll turn you into a two-inch toad.

Name _____

Company _____

Address _____

City _____

State _____

Zip _____

More
complex magic
from

Signetics  **MSI**

Signetics Corporation / 811 F. Arques Ave., Sunnyvale, Calif. 94086 / A subsidiary of Corning Glass Works

MAGNECRAFT DOES IT AGAIN...

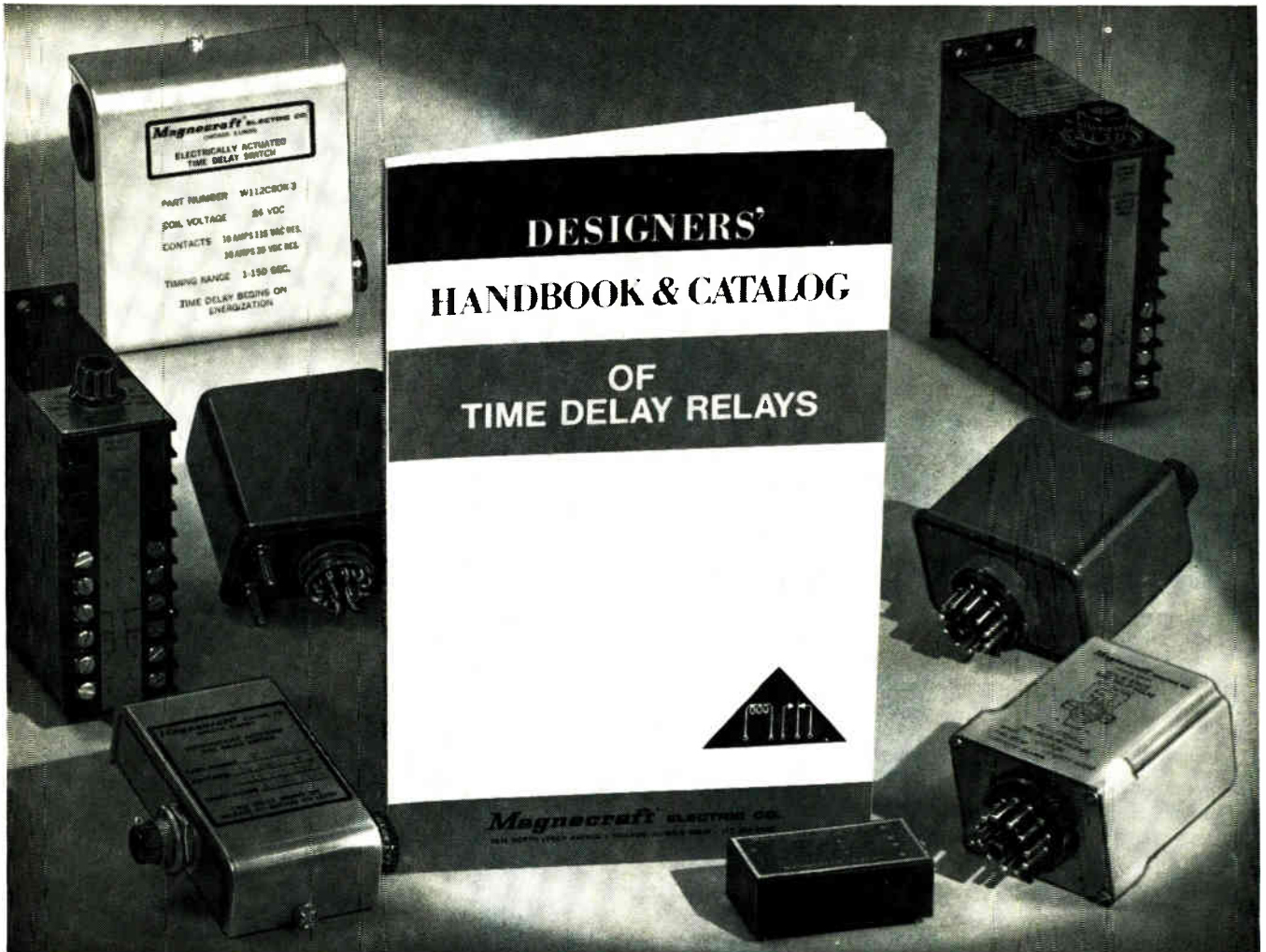

WITH ANOTHER INDUSTRY CLASSIC

After compiling the most authoritative handbook on dry reed and mercury-wetted relays, Magnecraft has done it again! This time we've produced the first comprehensive designers' handbook and catalog on TIME DELAY RELAYS.

Purpose of this reference book is to aid the design engineer in his responsibility to correctly specify the proper time delay relay for a given application. We have gathered together as much technical material as possible on time delay relays such as push button, air dashpot, reed, solid state (hybrid) and true solid state. Included within these 80 some pages are a glossary of terms, principles of operation, applications and design requirements as well as specifying and testing data.

Free copies are available to qualified designers, engineers and others involved in the electrical or electronic fields. Printing of this first edition is limited, so write for your copy soon.

Magnecraft® **ELECTRIC CO.**

5575 NORTH LYNCH AVENUE • CHICAGO, ILLINOIS 60630 • 312 282-5500

THE 5000 PERM TOROID

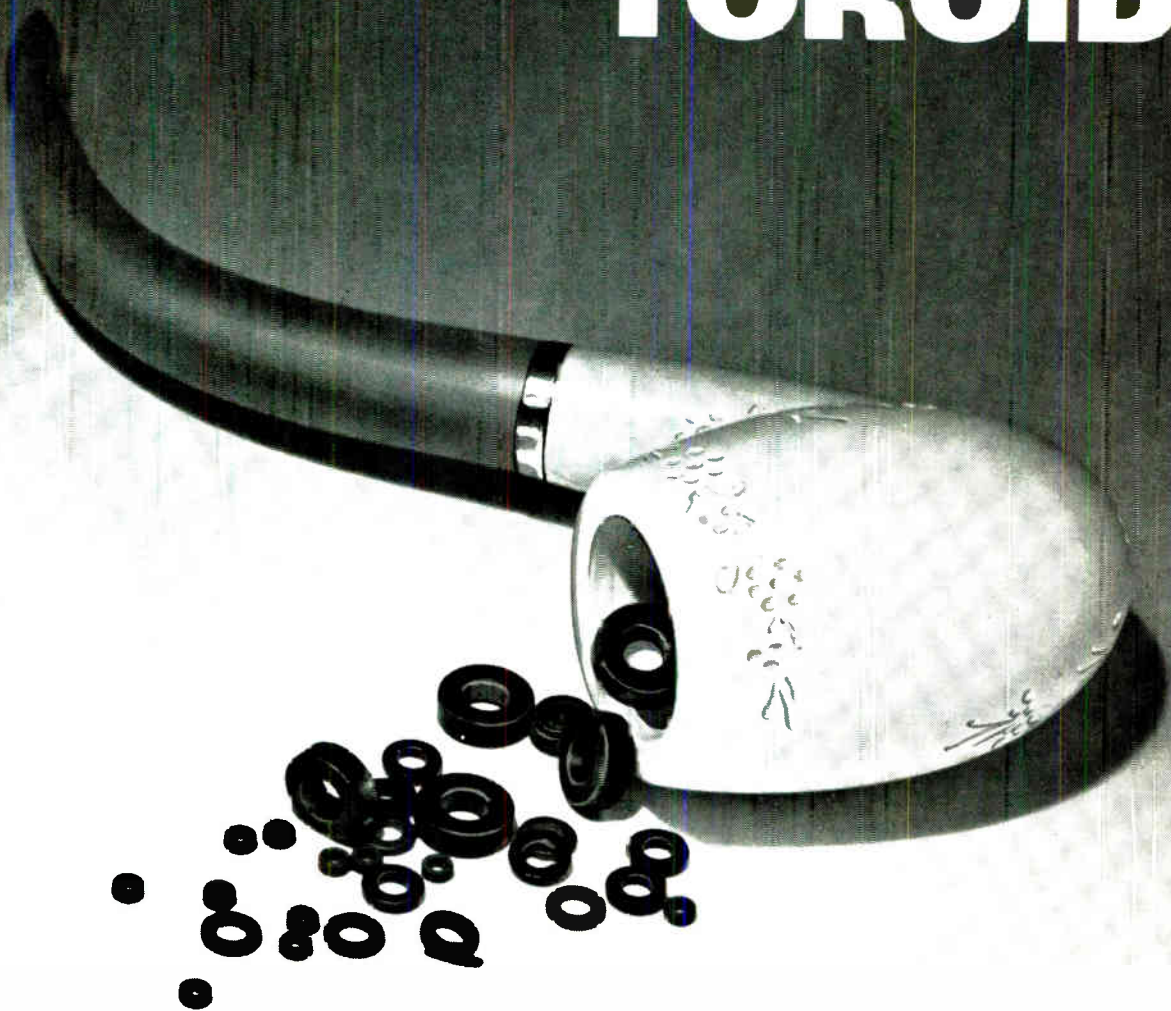

NO LONGER A PIPE DREAM

That's right. 5000 initial permeability. And we mean it!

Perhaps your designs for pulse transformers have gone up in smoke for want of a powerful enough material. Well, now you've got it. And then some. Stackpole Ceramag® 24H ferrite material.

Ceramag® 24H is a precision engineered product. Exact processing, density checks, rigid kiln controls and precise

sintering. You get more out of it simply because we put more into it.

Here are a few more conservative characteristics. Maximum permeability, 6900. Typical. Saturation flux density, 4100 gauss and residual magnetism of 850 gauss. If curie point is significant to your operation, how about one of 175° C. Then there's temperature coefficient. Ceramag® 24H goes $\pm 0.700\%/^{\circ}\text{C}$ at -25°

C to 25° C and $-0.450\%/^{\circ}\text{C}$ at 25° C to 75° C. And all of this with a disaccommodation factor of 1.4×10^{-6} .

Ceramag® 24H is ready. Are you? Drop us a line and we'll send you some even more interesting facts about this fantastic new material. And the charts to prove it. Stackpole Carbon Company, Electronic Components Division, St. Marys, Pa. 15857. Ph: 814-834-1521



STACKPOLE
Electronic Components Division

ALSO A LEADER IN THE MANUFACTURE OF QUALITY FIXED COMPOSITION RESISTORS

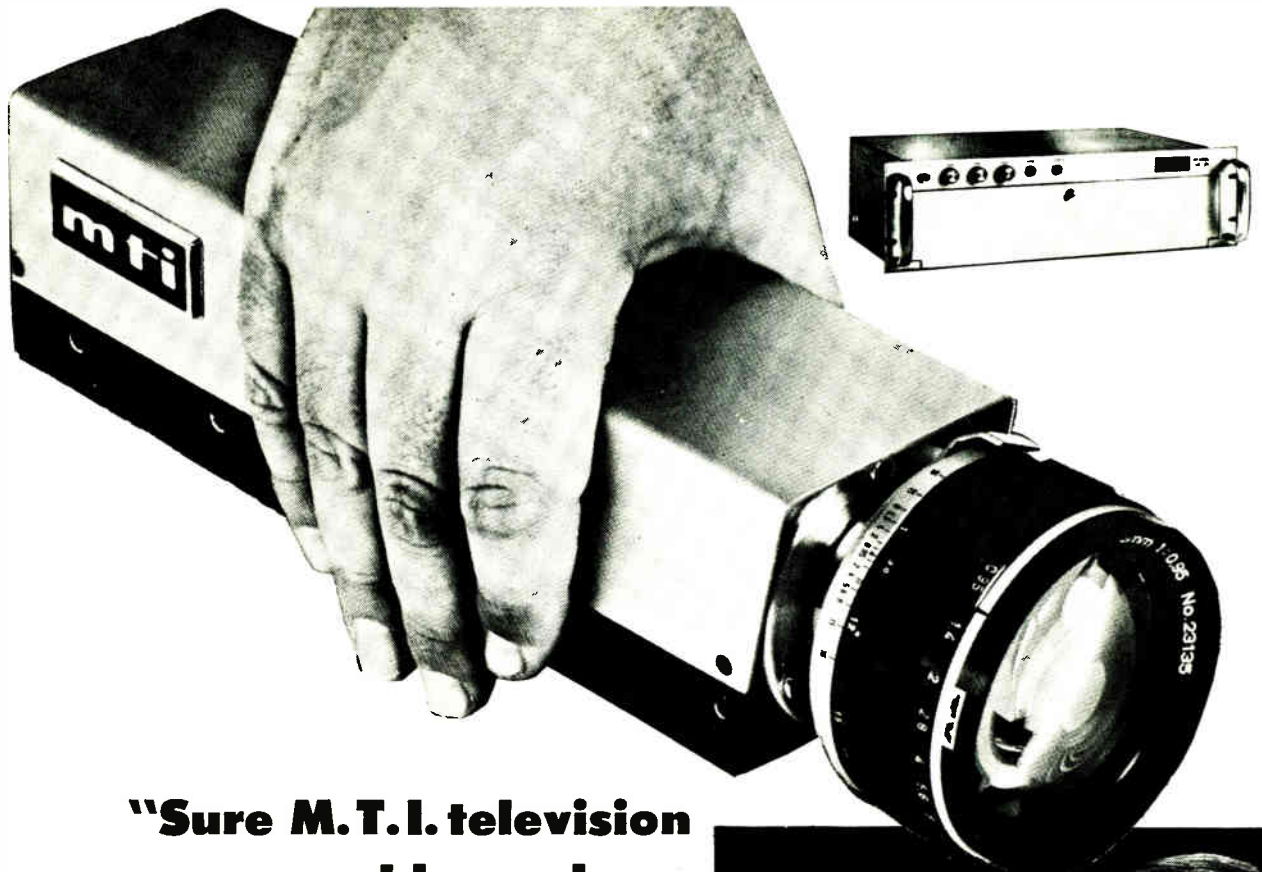

"Sure M.T.I. television cameras are problem solvers . . . but what about the total light range?"

Here it is . . . 20,000:1 Dynamic Light Range with our VC-20 Series TV cameras now only \$2950.

Our VC-20 Series television cameras feature the exclusive Quantum Light Sensing Circuit that automatically adjusts sensitivity and pedestal . . . compensates for light changes in excess of 20,000:1. After an extensive survey, the VC-20 Series cameras were created to solve specific user problems. The solutions became our design objectives . . . their attainment, our performance specifications. If this more than meets your needs, that was our intention.



After all, we have an image to live up to!

Prominent features of VC-20 Series Vidicon Cameras are: ● Quantum Light Sensing—20,000:1 Dynamic Light Range ● Cool, Compact Separate Head: 2 3/4 x 2 3/4 x 9 3/4, 3.5 pounds, 3 watts ● Regulated Vidcon Heater Supply ● Automatic Pedestal Circuitry ● Precision Alignment Coils ● Unique Low Noise Radial Preamp ● Multiple Scan Rates ● High Uniform Resolution



mti MARYLAND TELECOMMUNICATIONS

Division of KMS Industries, Inc.
10534 York Road, Cockeysville, Md. 21030. 301/666-2727. TWX 710/862-2644.

More M.T.I. Problem-Solvers:
● Image Orthicon Cameras
● Integrating Orthicon Cameras
● PC-20 Series Plumbicon Cameras
● Infra-Red Vidicon Cameras
● General Purpose Vidicon Cameras

Over 5.5 million hours of field operation history have proved the performance and reliability of Hewlett-Packard cesium beam frequency & time standards. And now that HP 5061A Cesium Beam Standards have demonstrated a mean time between failure (MTBF) greater than 25,000 hours, we've increased the warranty from one to three years, including the cesium beam tube.

Specifications are tighter, too. The absolute accuracy guarantee of $\pm 1 \times 10^{-11}$ now includes the effects of temperature from 0 to 50°C and magnetic fields up to 2 gauss. And not only is the long-term stability guarantee improved to $\pm 5 \times 10^{-12}$, but it, too, now applies for three years.

A slightly modified version of this atomic clock continued to meet its specifications after surviving the 400 lb. hammer blow shock test (Mil-S-901C).

In addition, the Hewlett-Packard cesium beam standards have proved their capability in on-line critical high performance systems such as LORAN C and Omega Navigation, APOLLO Tracking, various national laboratories, calibration stations, and around-the-world time synchronization experiments. To date, "commercial cesium atomic clock performance" is based on Hewlett-Packard cesium beam standards.

If you have a demanding need for a precision, portable, primary frequency or

time standard, there's only one proven choice: the 5061A. No other commercially-available frequency and time standard can substantiate such a reliability and accuracy record. Sample and see.

Price of the 5061A as a frequency standard is \$14,800; add \$1500 for clock option. For complete details call your local HP field engineer or write Hewlett-Packard, Palo Alto, California 94304; Europe: 1217 Meyrin-Geneva, Switzerland.

HEWLETT  PACKARD
FREQUENCY STANDARDS

02913

**We tightened the specs
on this atomic clock.
And tripled the 1-year warranty.**

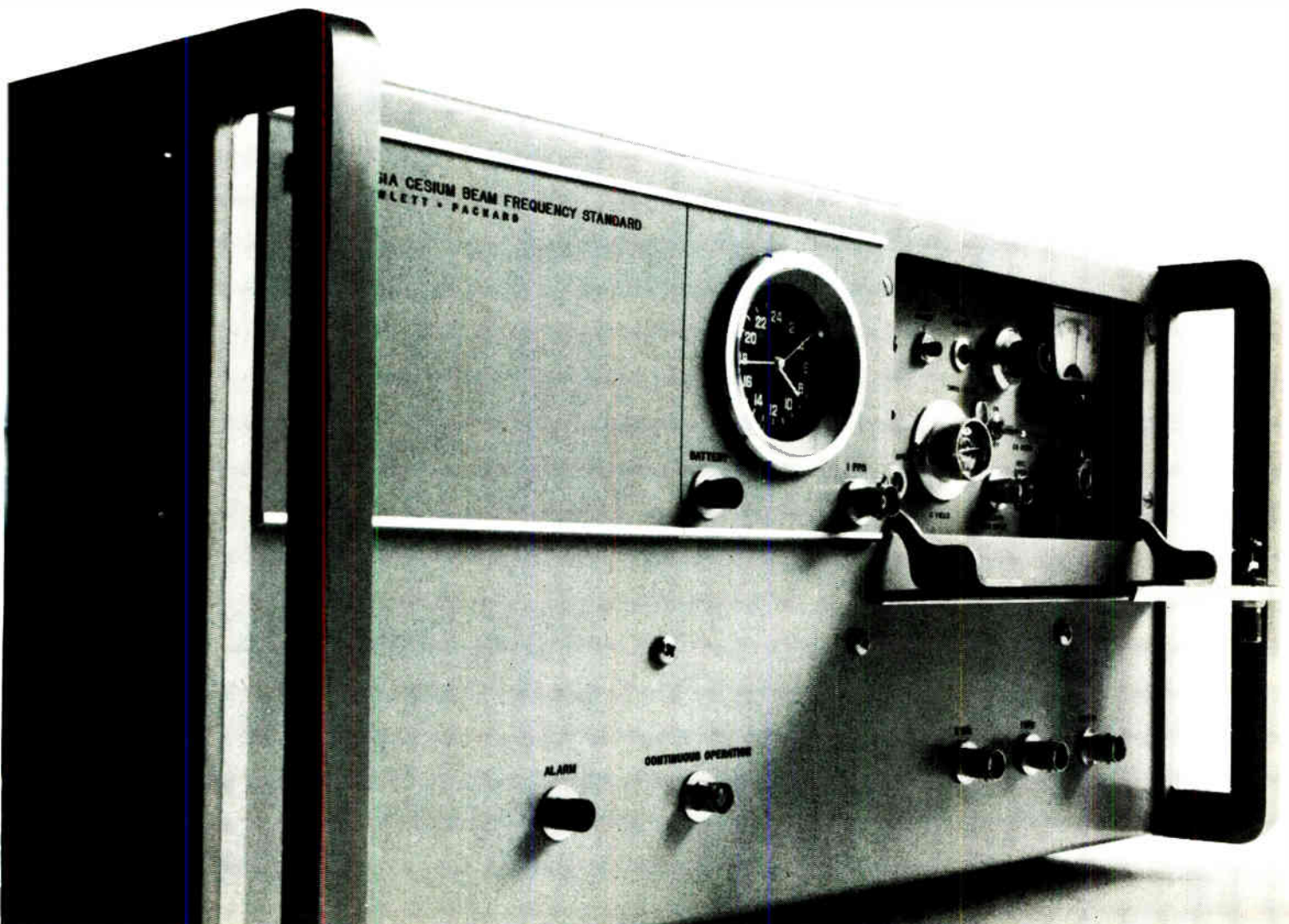

The D/A for stingy engineers



You want to convert from 4 bits at 25 MHz; or 9 bits at 10 MHz (or anywhere in between); and be ± 2 millivolts accurate in less than 90 nanoseconds.

But you also want to vary external bias and reference from dc to 25 MHz.

That way, your converter can be used as a function generator, a modulator, or a programmable attenuator.

But you want to pay only \$1480 to \$1760 for any of six models.

You're not stingy. You're thrifty.

You want our HS-2000 Series D/A Converters.

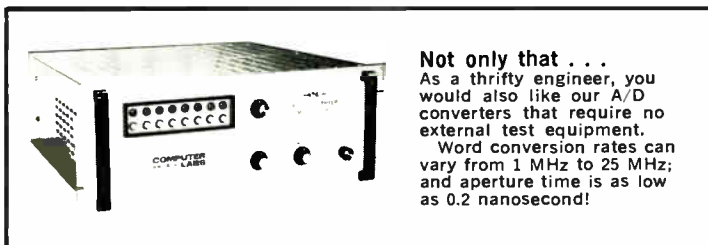

Not only that . . .
As a thrifty engineer, you would also like our A/D converters that require no external test equipment.
Word conversion rates can vary from 1 MHz to 25 MHz; and aperture time is as low as 0.2 nanosecond!

COMPUTER LABS

for tomorrow's technology today

(919) 292-6427 • 1109 SOUTH CHAPMAN ST.
GREENSBORO, N. C. 27403

Our package deal is a complete fabrication.

We make every part of our hermetic integrated circuit packages in our own plants.

We have to

It's the best way we can be sure that every one will measure up to specs. Both ours and yours.

Take, for example, our off-the-shelf dual in-line package. It uses our own special blend of hard glass and alumina to get the best properties. High electrical insulation, thermal shock resistance, hermeticity, and a thermal expansion that matches the metal alloy parts.

It meets Mil-specs and can be plated to your requirements

If this package doesn't suit your needs, we'll design one to your specs.

Each hermetic package gets to you in first-class condition. No bent or shorted leads. No excess glass-ceramic flow.

In short, the perfect package deal.

*Sylvania Metals & Chemicals, Parts Division,
Warren, Pa. 16365.*

SYLVANIA
A SUBSIDIARY OF
GENERAL TELEPHONE & ELECTRONICS



If Custer had General Electric Computer Time-Sharing Service . . .

. . . it might have been Sitting Bull's last Stand.

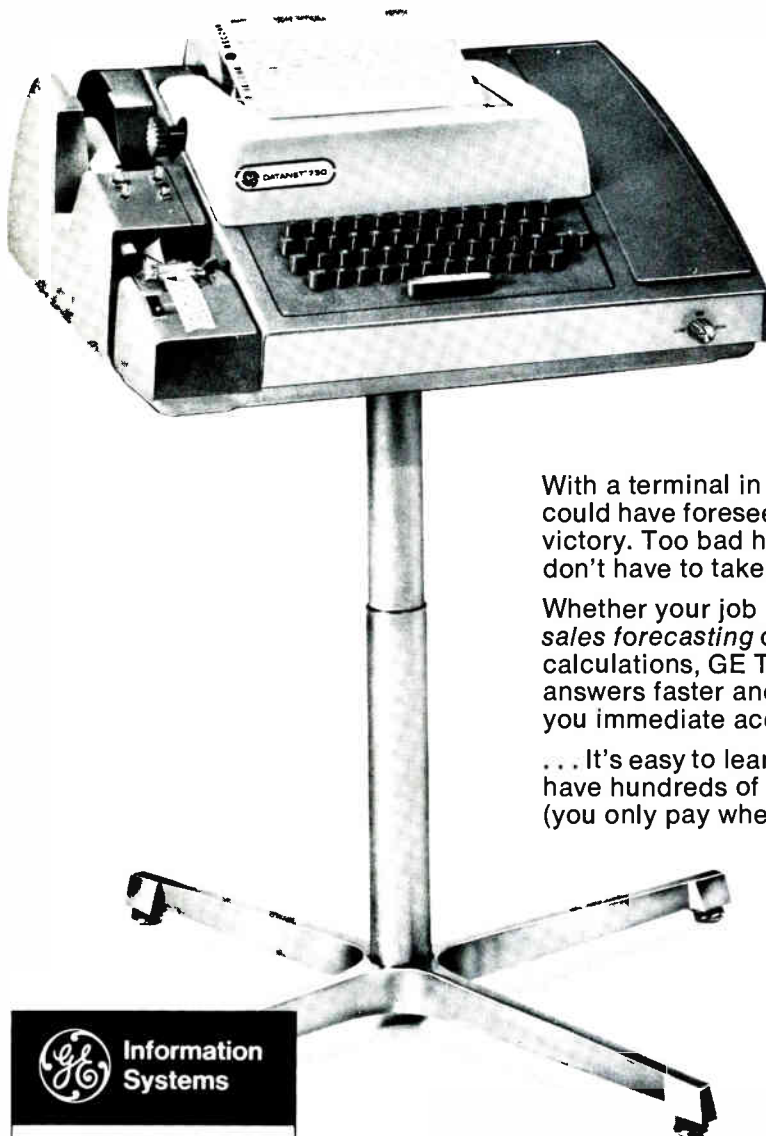

With a terminal in his orderly room (you can put one anywhere), he could have foreseen the disaster on paper and achieved a real victory. Too bad he risked all on instinct alone. Fortunately, you don't have to take chances when you solve your business problems.

Whether your job is *risk analysis* (like Custer's), *product design*, *sales forecasting* or *market research*, if it involves tedious and costly calculations, GE Time-Sharing Service can help you get the right answers faster and easier than any other method. How? By offering you immediate access to a problem-solving computer.

. . . It's easy to learn (GE does the training). It grows with you (we have hundreds of ready-to-use computer programs). It's inexpensive (you only pay when you use the service). And, it is from General Electric, world leader in Time-Sharing Service, already serving over 100,000 people like you.

More facts? Call toll-free: 800-243-0355 (In Conn: Call collect 853-3600) or write General Electric, Box 291-49, Schenectady, N. Y. 12305. Outside U.S.A., write: Canadian GE Information Systems Dept., 214 King St. West, Toronto 1, Ont./Australian GE Pty. Ltd., 103 York St., Sydney, NSW 2000/European Information Service Operation, G.E.T.S. Co., 42 Ave. Montaigne, Paris 8e, France.



Information
Systems

World Leader
In Time-Sharing
Service

Circle 112 on reader service card

GENERAL  **ELECTRIC**

Heights of
integrated circuits.
Thin films on
metals and ceramics.
Thickness
of transparent films,
foils and coatings.
Paper surface
characteristics.
Depth of etchings.
Roughness of
"smooth" surfaces.

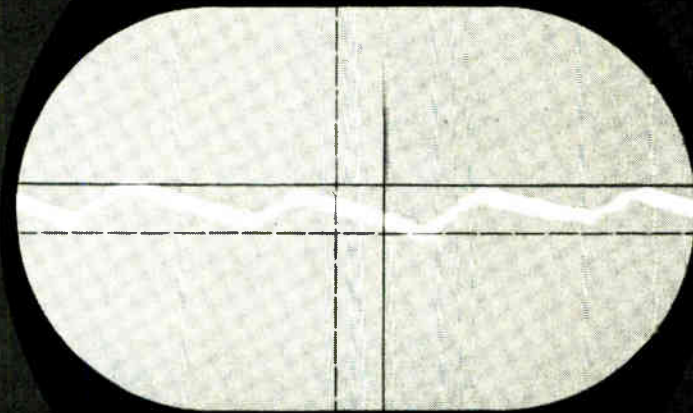

Measuring
microscopic differences?

Use a microscope.

It won't hurt
a thing.

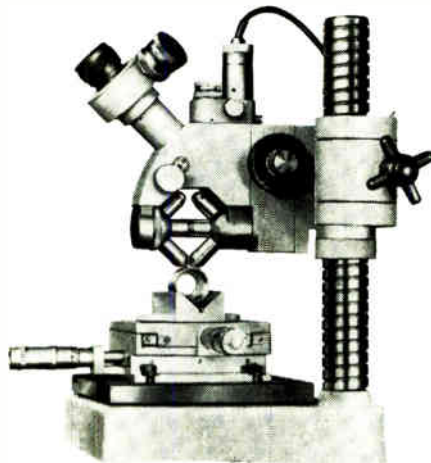

Completely non-destructive and amazingly accurate measurements of surface roughness and film thickness can be taken optically. And with such ease that even a completely inexperienced technician can learn how in minutes.

The instrument that does it is the ZEISS Light Section Microscope. Its principle is simple: a razor-edge beam of light is projected so that when viewed through the microscope it clearly profiles the surface. Then, by fine-tuning a reference line coupled to a micrometer, you can easily obtain direct readings of irregularities ranging from 0.000040 to 0.016 inch. Or find the thickness of transparent films by simply reading the difference between the top and bottom surfaces and factoring in the refractive index.

For permanent records or reference standards, a camera attachment permits you to take Polaroid® or 35 mm photos.

We think we've only begun to explore the possibilities of this unique quality control instrument. If you'd like to exchange ideas, or obtain complete information, just write Carl Zeiss, Inc., 444 Fifth Avenue, New York, N. Y. 10018.

Nationwide service.

ZEISS

THE GREAT NAME IN OPTICS



ATLANTA, BOSTON, CHICAGO, COLUMBUS, DENVER, HOUSTON, LOS ANGELES, PHILADELPHIA, ST. LOUIS, SAN FRANCISCO, SEATTLE, WASHINGTON, D. C.

Circle 113 on reader service card

Breakthrough in watts per pound.

New High Power Lightweight TWT Offers Duty Factor up to 4% at S-Band.

Litton's new L-5135 TWT is designed for critical applications such as intermediate or final amplifiers in ECM systems, drivers for crossed field amplifiers or other higher power amplifier applications. It features high duty factor, long pulse capability, low cost alnico PPM magnets and high Mu grid for fast rise time/low voltage pulsing.



Shown approximately one-half actual size.

Weighing only 7 lbs, the L-5135 achieves up to 4% duty at 1.0 kilowatt minimum power output over the full 2.0 to 4.0 GHz frequency range. Performs reliably under the environmental extremes of MIL-E-5400, Class 2, and is ideal for airborne and other similarly demanding applications. For additional information on the new L-5135 and other Litton TWT's, write Electron Tube Division, 960 Industrial Road, San Carlos, California 94070 or call (415) 591-8411.

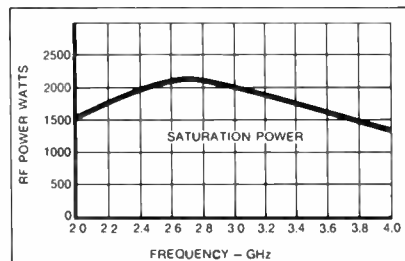
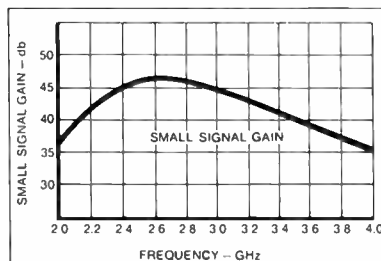

LITTON INDUSTRIES
ELECTRON TUBE DIVISION

I/CNI hanging by a thin thread

The Air Force scrapes together money for low-cost, demonstration system to sell combined communications, navigation, and identification concept

By Alfred Rosenblatt

Associate editor

Avionics is at once a blessing and a curse for airmen. On the one hand, such equipment allows them to communicate, navigate, and identify friend or foe. On the other, however, since gear has, over the years been developed individually by many different suppliers, "systems" are bulky jumbles of heavy black boxes and antennas ill-suited to the close quarters of an airframe. Increasingly dissatisfied with this state of affairs, the Air Force wants to combine communications, navigation, and identification functions in one digital system with a common waveform that would drastically reduce—from as many as 30 to six or so—the number of separate elements required to handle these functions effectively aloft.

Last month, the Air Force's ambitions along these lines seemed a step closer to reality; the service received bids for a so-called thin-thread version of an integrated communications, navigation, and identification—or I/CNI as it's known—system. Though the Air Force would not say how many companies actually bid, close to 40 showed up for a briefing conference this spring. Their interest over both the short and long runs is understandable.

If the I/CNI concept is eventually accepted, not only the Air Force but also the Army, Navy, and Marines would probably be directed by the Department of Defense to implement the system. Commercial airlines as well as other nations, might also be involved. At stake over the long run: billions of dollars worth of orders for new types of avionics equipment, including special-purpose satellites to enable

I/CNI to operate globally. But for the moment, Pentagon budget cutters are hacking away at research and development appropriations, and Air Force planners don't anticipate an operational I/CNI system for another ten or possibly 15 years.

Basis. But whenever money finally becomes available, the system's design will be based on data accumulated from the upcoming thin-thread work. "The thin-thread system will be a demonstration test bed whereby concepts, signal structures, and hardware can be tested, proved, and measured," says

Richard Alberts, I/CNI program manager in the Avionics Laboratory's plans office at Wright-Patterson Air Force Base. "The big idea is to check the validity of the theories and studies that have been done previously."

The Air Force is asking for a minimum of five to 10 sending and receiving sets to handle CNI functions. Satellites won't be used in the tests; they'll be simulated with three aircraft. Meaningful data from the tests should be available in about two years, according to Alberts. Industry will provide the

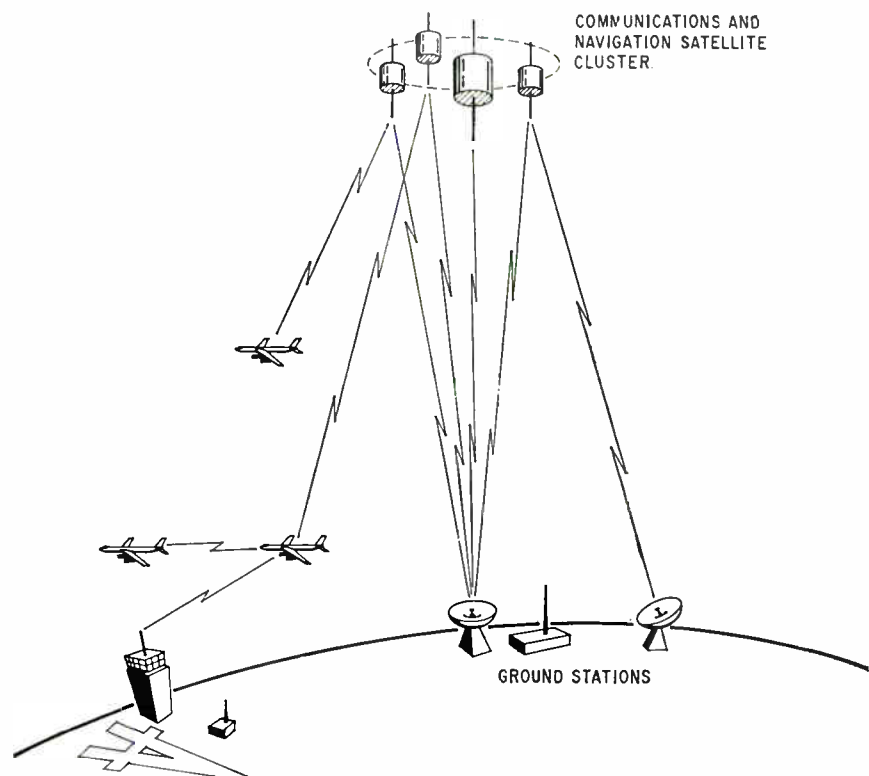

Scope. Integrated communications, navigation, and identification system Air Force wants encompasses aircraft, satellites, and ground stations.

ATTENUATE & MODULATE, 250 MHz- 12.4 GHz for \$550!

Model E-150 shown 1/2 size



For less than half the cost elsewhere, the Alfred Model E-150 PIN Modulator provides electronically controllable attenuation in one unit over a broad frequency range with wide dynamic range and low SWR at all attenuation levels.

The E-150 replaces four single band units for maximum economy and flexibility. To provide control and power signals for one or two PIN modulator units, Alfred offers the Model E-150P PIN Controller. Using the E-150P, attenuation and modulation can be varied continuously. The PIN Controller provides both local and remote operation. Price of the E-150 is \$550; the E-150P, \$175.

For more information, call your Alfred sales engineer or write Alfred Electronics, 3176 Porter Drive, Palo Alto, California 94304. Phone: 415-326-6496. TWX: 910-373-1765.

ALFRED ELECTRONICS

apparatus, test plan, and the engineering services to keep equipment going; the Air Force will perform the flight tests.

So far, about \$2 million has been spent for I/CNI studies, according to Harry Davis, the Air Force's deputy undersecretary for technical operations. There's about \$4 million in the fiscal 1970 budget request still to go through the congressional mill, he says. He won't disclose how this is to be divided between the two principal Air Force agencies assigned to the program—the Avionics Laboratory and the Electronic Systems Division/Mitre team at Hanscom Field.

Other sources are not so reticent. The lab is budgeted for around \$1 million, while ESD is asking \$3.5 million for a Tactical Air Command concept called PLRACTA—position, location, reporting, and control of tactical aircraft [*Electronics*, July 7, p. 34]. But PLRACTA, formally Cassoff—for control and surveillance of friendly forces—in turn a variation of ESD's 407L program still has to get Pentagon approval, Davis notes. Industry sources who have followed the evolution of PLRACTA call it "a device for getting new money for an old program," and are obviously dubious as to how far it will get.

Wedge. The thin-thread I/CNI system will be applied to the mission requirements of PLRACTA, according to William J. Sen, acting chief at ESD's CNI system complex office. "Not only are we going to be experimenting with the hardware, we'll be trying to learn how an I/CNI system could affect tactical command-and-control operations," Sen says. Thus, if successful, the thin-thread system will do more than prove the worth of the I/CNI concept—it will be a very important sales tool. "Advocates and entrepreneurs would try to show other possible users what a good thing they've got going," says an Air Force source. Planners working on Awacs (for airborne warning and control system) would probably take a thorough look at I/CNI, he says, bringing into the fold not only TAC but also the Air Defense Command.

Because of the lead time needed to develop appropriate satellites for an operational I/CNI system, an airborne system like Awacs—

Payoff

An integrated communications, navigation, and identification (I/CNI) system would provide all avionics functions digitally in one secure radio link. Navigation signals would be combined with communications and IFF (identification friend or foe) signals. Globally the system would offer:

- Navigation accuracy to within 600 feet, with even better local accuracy.
- Timing to within one microsecond.
- Propagation reliability exceeding 90%.
- Secure access for over 100 simultaneous users.
- Communications at 2,400 bits per second.

should it be built—could serve as an interim exchange point for I/CNI transmission, the source continues. This would add significantly to the total amount of available position, location, and identification data.

Additional sales aids for I/CNI may be forthcoming from a \$50,000 study contract recently awarded by the Avionics Lab to RCA. The pact calls for the company to computer-simulate a weapons-delivery mission, using data that could be made available from I/CNI.

Sen compares the thin-thread I/CNI-cum-PLRACTA demonstration to simulation of a "boundless radar system—one with a near global reach when applied to friendly forces. It would help position-locate aircraft, forward air controllers—perhaps even ships and vehicles—and forward this data to a command-and-control center. Since command and control could be performed with a larger view of the conflict, air power could be applied more judiciously."

Thick and thin.

However, PLRACTA will not be the entire gauge for success or failure of the thin-thread system, according to Sen. "Our original mission analysis revealed the I/CNI approach would be adequate for the task, so we expect less worry on this score than in the technological end," he says. "I suspect that what hitches occur will come early as we try to tie the advanced technology of the thin-thread sys-

tem's components together for the first time. We'll be looking hard at the aggregate system to see that all the parts mesh successfully.

"We expect them to fit well, but we must make sure with hardware," Sen continues. "For example, our predictions once showed that a phased-array would outperform other antenna types on Tacsat. But when we built both an array and a mechanically despun system, the latter won by several decibels of gain. We never would have found this out if we hadn't built the hardware—and that's what we are doing in a very austere way with the thin-thread I/CNI."

An austere system will have less capacity than the set-up the Air Force is eventually aiming for, according to Sen. It will have less bandwidth and more boxes as well. Some specifications will also be derated from what the service wants operationally. But he says, "The thin-thread will buy us enough to extrapolate the performance of the larger, refined I/CNI systems, as well as their impact on command-and-control procedures."

Content. The austerity of the thin-thread version does not bother Alberts of the Avionics Lab; it's just what he wants. He sees the test bed starting largely with off-the-shelf equipment—computers, displays, r-f units, antennas, and perhaps new types of spread-spectrum signal processors. With ground stations and relay aircraft the system will provide the combined CNI functions. Alberts anticipates the system will expand in an evolutionary manner—with, for example, as many as three or four generations of signal processors and other hardware—until it fits into a complete satellite environment.

"Look for a continuing set of experiments over the next several years," Albert says, "involving not only C, N, and I but other functions such as collision avoidance, instrument landings, station keeping, altimetry, inertial systems, updating and weapons delivery. These experiments will all be aimed at determining how accurate the integrated system must be and how it should be implemented."

There's plenty of technology at hand to implement I/CNI, argues the Air Force's Davis. Indeed, he

sees no difficulties that cannot be overcome. "The problem is the fundamental matching of a large number of possibilities with traffic capacity and spectrum space, he says. "There are a lot of designs. Now, how do you pick one to meet the requirements . . .?"

There may also be obstacles other than mere technology. "The real problems could be psychological," says an industry source. "By that I mean, getting the communications people together with those in navigation. The former don't want anything in their signal that might cause problems, and the latter group thinks the same way. Breaking down these barriers could be harder than solving any technical problems."

Wave of optimism

Nonetheless, some technical problems still have to be solved. For example, developing a common waveform that can accommodate each of the three functions is a key element in the design of an integrated system. In February, IBM and Magnavox each received \$150,000 seven-month study contracts from the Air Force's Rome Air Development Center to check the tradeoffs and approaches involved in achieving such a goal.

Magnavox is studying a frequency-hopping/pseudo-noise technique; IBM, time-hopping/pseudo-noise. "The problem is to develop a waveform on which all types of information can be impressed," points out Irving R. Gableman, head of advanced planning at Rome. "Also, the waveforms must be expandable as the system grows in size and complexity. Multiple access and transfer problems, system accuracy and capacity, noise invulnerability, and security of IFF information must all be considered in the two studies."

In addition to C, N, and I information, the waveform may have to accommodate telemetered data on pilot and aircraft status, notes ESD's Sen. "We might even want to monitor the sparkplugs in number two engine," he says. Sen wants a format that will allow plenty of room for growth.

Check list. The operating frequency of the system has still to be selected; it will probably be in the 1 to 10 gigahertz range, says

KEEN CRYSTAL DETECTORS

10 MHz to 12.4 GHz
±0.5 db Response
SWR less than 1.5



With flat frequency response and low SWR, Alfred broadband crystal detectors, Models 1001, 1002, and 1003 provide top performance in your leveling, power measurement, broadband RF detection and reflectometer requirements.

Brief Specifications.

Frequency Range: 10 MHz-12.4 GHz

Frequency Response: ±0.5 db full range

SWR: Less than 1.5 full range
Sensitivity (no load); Power input required to produce 0.1 v rectified output—no greater than 0.4 mw

Square Law Response: Within ±0.5 db, low level to 1 mw input when properly terminated.

Maximum Input Power: 100 mw

Connectors: Input, Model 1001 Type N, Model 1002 OSM, and Model 1003 APC-7 output BNC.

Price: \$115 with BNC, \$160 with OSM Connector, and \$175 with APC-7 Connector.

For more information, call your Alfred sales engineer or write Alfred Electronics, 3176 Porter Drive, Palo Alto, California 94304. Phone: 415-326-6496. TWX: 910-373-1765.

ALFRED ELECTRONICS

More Power

than you
ever
pressed
into a
heat sink
before!



35 and 44 amps! Two new Tung-Sol diffused junction silicon power rectifiers in the JEDEC DO-21 package.

Both feature high surge capability and they cost less than equivalent-rated, stud-mounted units. Plus the economy of pressfit installation.

Use this coupon to get complete information in only a couple of days.

Quick-Action Coupon

Tung-Sol Division/Wagner Electric Corporation
630 W. Mt. Pleasant Avenue
Livingston, N.J. 07039

Please send data on new high power pressfit rectifiers:

35 amp 44 amp both

Name _____

Company _____

Address _____

City _____ State _____ Zip _____

RADC's Gableman. Propagation problems are known here and there's available spectrum. Bandwidths greater than 200 Mhz could be desirable. In this microwave range, it's possible to get good gain and directivity in the satellite antenna. The antenna in the aircraft would have to have some form of directivity as well. In a large, cargo-carrying aircraft it might be possible to put a dish on a pedestal and point it at the satellite. But this isn't feasible in small, supersonic fighters in which there's little room for excess baggage and where radome bumps can cause aerodynamic problems.

The solution will undoubtedly be some sort of conformal array, with electronic beam steering, that can fit into any aerodynamic shape. This problem remains to be solved, and the Air Force is funding work in the field. Other technology areas to be probed, according to ESD's Sen, include:

- Advanced digital processing and software for the so-called core computer aboard the aircraft.
- Burst communications concentrating on higher peak powers.
- Precision clocking, an extremely important consideration since the avionics, satellite, and ground station equipment must be in almost perfect synchronization. This could mean airborne time standards that are as good as any now on the ground. Alternately, there could be less costly standards which could be updated by ground stations without excessive drift between updates.

The precise clocking that's needed is similar to what's being used in collision-avoidance systems under development by the Air Transport Association. As a result, the I/CNI system under development has a built-in collision-avoidance capability.

Bird watching. The type of satellite to be used with an I/CNI system and the deployment thereof is also up for grabs. Gableman, who headed the group doing a feasibility study for the Air Force last year, says a final system might consist of clusters of two types of satellites—one to handle communications, the other navigation. A communications satellite at synchronous altitude could be the nucleus about which three navigation

satellites might revolve. At synchronous altitude, three communications satellites could, of course, cover most of the globe. There's also the possibility of having one general-purpose satellite that could be used for odd jobs.

In the initial stages, the satellite would be a large wide-band repeater, according to Gableman. Processing capabilities could be added later for such tasks as cleaning up waveforms, addressing, and making computations, he says.

The services already have satellites under development that could be used with an I/CNI system. But progress has been slow on the Air Force's 621B Navsat system, and 16 satellites would be required. Much the same is true of the tri-service Tactical Communications Satellite (TacSatCom) program.

One up. There's a general belief that any company working on current satellite programs could have a headstart on I/CNI. Preliminary studies made by the Space and Missile Systems Organization (Samsco) indicate the eventual melding of the Tacsat communications role and Navsat into an I/CNI system is being considered, according to a Samsco spokesman. "A later decision may be made to design a satellite combining navigation, communication, and other functions; or, the I/CNI system could be a mix of communications and navigation satellites," says the Samsco informant.

There are also indications the Air Force is rethinking its satellite requirements for I/CNI, possibly even considering letting a commercial system do the job. "We used to be pretty damned fussy about having our own birds," says one Air Force man. "But times are changing. Money is tight; Congress is raising hell about the military-industrial complex; and anyone who jammed or destroyed those satellites would automatically be taking step one of World War III—at which point whether you have I/CNI or not doesn't matter a hell of a lot."

In short, the Air Force seems to be willing to trade off its independent-satellite requirement to get moving on an I/CNI aircraft system, perhaps gaining support from commercial satellite interests at the same time.

Solo in One Hour



Easy-to-operate 1-kw SSB/ISB transmitter

Even an inexperienced operator can learn to operate the Granger 1-kw SSB/ISB Transmitter in 60 minutes. And this compact transmitter is so reliable you can trust it to get the message in and out of remote areas of the world for many years.

A single switch on the solid-state exciter changes channels, and retuning is automatic . . . it takes an average of 30 seconds. Its 8 channels can be pre-set at random frequencies from 2 to 18 MHz. Mode capabilities are: USB, LSB, AME and CW. An optional adapter provides ISB; MCW and FSK capability can be added.

The Granger Model 180 is used for point-to-point, shore-ship, radiotelephone, and TTY communications. This transmitter, together with Granger HF receivers, forms the heart of reliable communication systems. Write for more information.



GRANGER
COMMUNICATION SYSTEMS DIVISION

1601 California Avenue, Palo Alto, California 94304
1 Brooklands Road, Weybridge, Surrey, England
1-3 Dale Street, Brookvale, N.S.W. 2100, Australia

How to get low noise and high gain without buying two transistors.

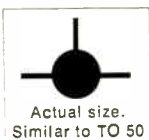
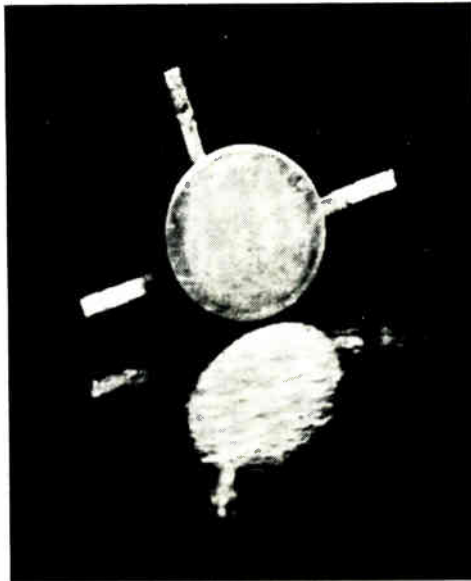

The new Fairchild MT2500 small-signal S-band transistor was designed for amplifier and micro-

wave receiver front ends. No other transistor available today can touch it for noise and gain performance.

And we're talking about performance, not just specs. Up till now

you've been able to get low noise at one bias level. Or high gain at another. With the MT2500, you get low noise *and* high gain with no trade-offs. At 2GHz, noise is guaranteed under 5dB and gain is guaranteed greater than 7dB.

Write today for "Fairchild Microwave Transistors/S-Parameters," a brochure that will get you off the

drawing board a lot sooner. Then give your circuits a boost with the MT2500. It's available in volume from your local Fairchild distributor. Give him a call.

Fairchild Semiconductor/A Division of Fairchild Camera and Instrument Corp. Mountain View, Calif. 94040 (415) 962-5011

FAIRCHILD
SEMICONDUCTOR

TWX: 910-379-6435

Late show will put Mars on tv

Jet Propulsion Lab has reversed an earlier decision and Mariner spacecraft will carry equipment for real-time, network-compatible shots of red planet

By Lawrence Curran

Associate editor

When the first sequence of pictures taken of Mars by Mariner 6 are read out July 29 at the Jet Propulsion Laboratory in Pasadena, Calif., a little after 6:00 p.m. Pacific Daylight Time, television viewers across the country will probably get a look at what's coming back at the same time project scientists do. This "quick-look" video—a first for a project of this sort—will be provided largely through the efforts of a JPL "tiger team" that has been working long into the nights since it was decided only three months ago to provide the quick-look data to the networks.

Realizing that television viewers would need something pretty compelling to get them back to their sets after the Apollo 11 adventure, JPL officials reversed a decision made about a year ago not to provide real-time video readout for Mariners 6 and 7. The first of the two spacecraft encounters Mars July 31; Mariner 7's near encounter is due August 5. But far-encounter picture-taking begins a few days earlier for both.

When real-time, network-compatible readout of the Mars photos was first proposed last year, officials vetoed the idea for two principal reasons: It wasn't needed for scientific purposes. And there was no assurance the hardware could be built and checked out in time; the project would represent one more potential problem area in an already tight timetable.

Even so, JPL officials appreciated the limitations of the equipment that had handled the Surveyor program, and authorized its updating

for Mariners 6 and 7. When the go-ahead was given to convert the all-analog Surveyor equipment, the tiger team went to work building an interface for the scan-converter and film-recorder portion of the Surveyor apparatus, converting it to an all-digital system.

Moving on. Ralph Johansen, a systems design engineer on the tiger team, says his group has taken over the bulk of the quick-look video functions of the JPL image-processing laboratory, as well as about 85% of the quick-look scientific data processing. The digital interface for the formerly all-analog Surveyor system was built in just three weeks.

Even before coming on line last August as the quick-look Mariner '69 processing facility, the team had proposed the real-time display of Mariner photos for network television viewers. The proposal was dusted off April 14 when JPL officials went for it. It's reliably reported, although unconfirmed by lab sources, that the move was made when program officials learned they couldn't get live coverage of the Mariner 6 and 7 returns unless network executives were assured their viewers would be provided a look at the Mars images as soon as those watching the monitors at JPL were. JPL Director William Pickering himself is said to have asked for the real-time network quick-look capability.

Once the nod was given, the tiger team stepped up its efforts. Johansen says the scan converter associated with the film recorder hadn't been used since the Surveyor pro-

gram ended. The data rate from lunar distances was higher than the 16.2-kilobit pulse-code-modulated bit stream that will come from Mariners 6 and 7. This had to be taken into account in devising the new system. In addition, the pictures coming from the latest Mars explorers are composed of 934 by 704 discernible points. The Surveyor-vintage scan converter would have provided video images with only about 250 by 250 discernible points, Johansen says, giving a low-resolution display. The new video display will resolve 512 by 480 points.

Busy signals. "We decided to look for a direct digital-to-tv compatible interface," Johansen observes. "I must have made about 50 phone calls before reaching Data Disc Inc. in Palo Alto. Chuck Masters, general manager of the company's Display division, was the first person I reached who understood our hardware needs. I never seemed to get past the front office people elsewhere." The conceptual system design, with Data Disc's model 5209 fixed-head parallel digital 72-track disk memory as the critical ingredient, was worked out in just three days. Johansen credits Masters with making a significant contribution to that design. Detailed logic for the system was designed in a few more days.

Masters describes the Data Disc memory as essentially a refresh buffer that can take in data at a low transfer rate and provide repetitive readout at a very high transfer rate. The data coming from the Mariner cameras is stored

CTS cermet resistor networks

...with

NEW 16-lead dual-in-line package

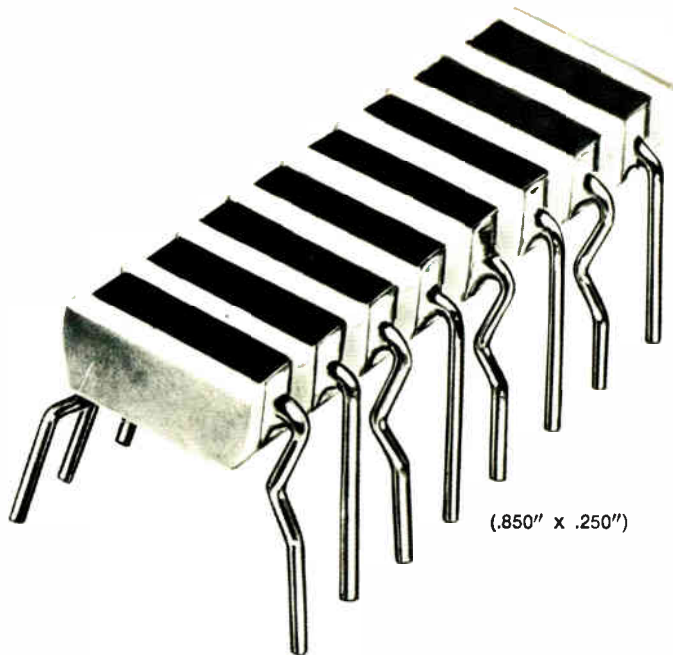

(.850" x .250")

■ Add more circuitry...up to 16-lead dual-in-line packages...with these new CTS space-saver cermet resistor networks. Specifically designed to simplify automatic insertion and reduce your assembly costs. Easy to hand mount, too.

Series 760 DIP Resistor Networks provide ...14 or 16 lead packages...up to 15 resistors per module with an infinite number of circuit combinations...extremely good environmental specifications...5 lbs. pull strength on leads. A natural to combine with active devices to form hybrid circuits. .100" lead spacing.

Series 750 Cermet Resistor Networks offer ...three basic sizes and an infinite number

of circuit combinations...excellent environmental characteristics...5 lbs. pull strength on leads...and are available with or without active devices...lead spacing, .125".

Check CTS low prices and fast delivery schedule...2 weeks for prototypes; 4-6 weeks for production quantities. See the prices listed below!

More flexibility...CTS packages can be delivered without organic cover coat. You trim for circuit balance in your plant.

Ask your CTS sales engineer for data. Or write CTS of Berne, Inc., Berne, Indiana, 46711. Phone: (219) 589-3111.

CTS CORPORATION
Elkhart, Indiana



Quantity	SERIES 750			SERIES 760			
	4-pin 3 resistors	6-pin 5 resistors	8-pin 7 resistors	9 resistors (14 pin module)	11 resistors (14 pin module)	13 resistors (14 pin module)	15 resistors (16 pin module)
10,000 piece price	14.4¢ ea. (4.8¢/ resistor)	19.5¢ ea. (3.9¢/ resistor)	24.5¢ ea. (3.5¢/ resistor)	41¢ ea. (4.5¢/ resistor)	43¢ ea. (4¢/resistor)	45¢ ea. (3.5¢/ resistor)	55¢ ea. (3.7¢/ resistor)
1,000 piece price	28.8¢ ea.	39.0¢ ea.	49.0¢ ea.	82¢ ea.	86¢ ea.	90¢ ea.	\$1.10 ea.

Prices shown are $\pm 2\frac{1}{2}\%$ tolerance, ± 250 ppm/ $^{\circ}$ C from 50 ohms through 1 megohm standard TC. (Also based on circuits with all resistors screened simultaneously on one side of the substrate.)

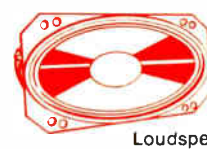
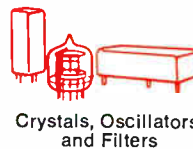
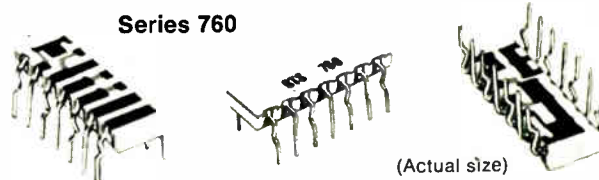
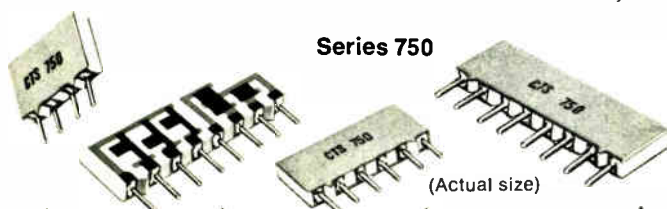

at an input rate of about 15,900 six-bit elements per second from four channels.

As Mariner 6 approaches Mars, its cameras will be turned on 48 hours before the nearest pass by the planet. At that point, the spacecraft will be within 2,000 miles of the surface. The shutter snaps every 42.4 seconds, generating a data rate of 113.4 kilobits per second—too fast for the pcm telemetry link's peak rate of 16.2 kilobits per second. For this reason, the picture data is to be stored in an onboard analog tape recorder and played out later—usually about 24 hours later when the spacecraft is in view of the 210-foot dish at Goldstone, Calif. Thirty-three pictures will be taken during this first far encounter of Mariner 6; 17 will be taken at the second far encounter beginning 22 hours before near encounter. These shots will be read out in Pasadena about seven hours before near encounter.

Camera work

The video display Johansen's team has put together will also be able to take every seventh bit of data from a picture as it's gathered by the camera and have this ab-

breivated data transmitted in real time over the 16.2-kilobit telemetry link. The picture derived from the data will have lower resolution than the complete picture stored on tape aboard the spacecraft, and won't be available to the networks. However, it will probably give project scientists a clue as to how good the complete picture will be long before they receive it.

As the spacecraft approaches near encounter, the science platform will be rotated to take 24 pictures during the near pass across the planet. These will be read out about 24 hours later, whereupon the data transmission will stop for 24 hours until the Mariner 7 far-encounter picture-taking sequence begins.

Starting point

But the quick-look video facility swings into action the minute the picture data is transmitted by a microwave link from Goldstone to Pasadena. At this point, the data is in a comma-free, biorthogonal code at 86.4 kilobits per second into which it was converted aboard the spacecraft to aid in eliminating noise. At JPL, it is run through a correlator that puts out the raw

pcm bit stream at 16.2 kilobits. At this point, two Univac 1219 computers go to work on the data. The first handles the data-recognition task, putting the raw bit stream into telemetry-frame and word-frame synchronization. This machine also makes a tape library of the data, as well as driving the film recorder and scan converter.

Second effort. Johansen says all quick-look hard-copy—Polaroid or 70-mm images—is taken from the film recorder. The second Univac 1219 accepts the coded pcm data from the first and drives the Data Disc memory. It also creates a duplicate tape library.

Johansen says one of the difficulties his team faced was the relatively slow speed of the computer (2-microsecond cycle time). "Trying to match the slow computer output to the fast data rate of a disk was a big problem. Our solution was to choose a fast memory that could be loaded slowly and read out quickly. We also decided that the data wouldn't be updated on a line-by-line basis, but in columns."

Each point, or pixel, in the Mars picture is defined by six bits of information. The disk stores four dif-

Simplified block diagram of JPL video display system

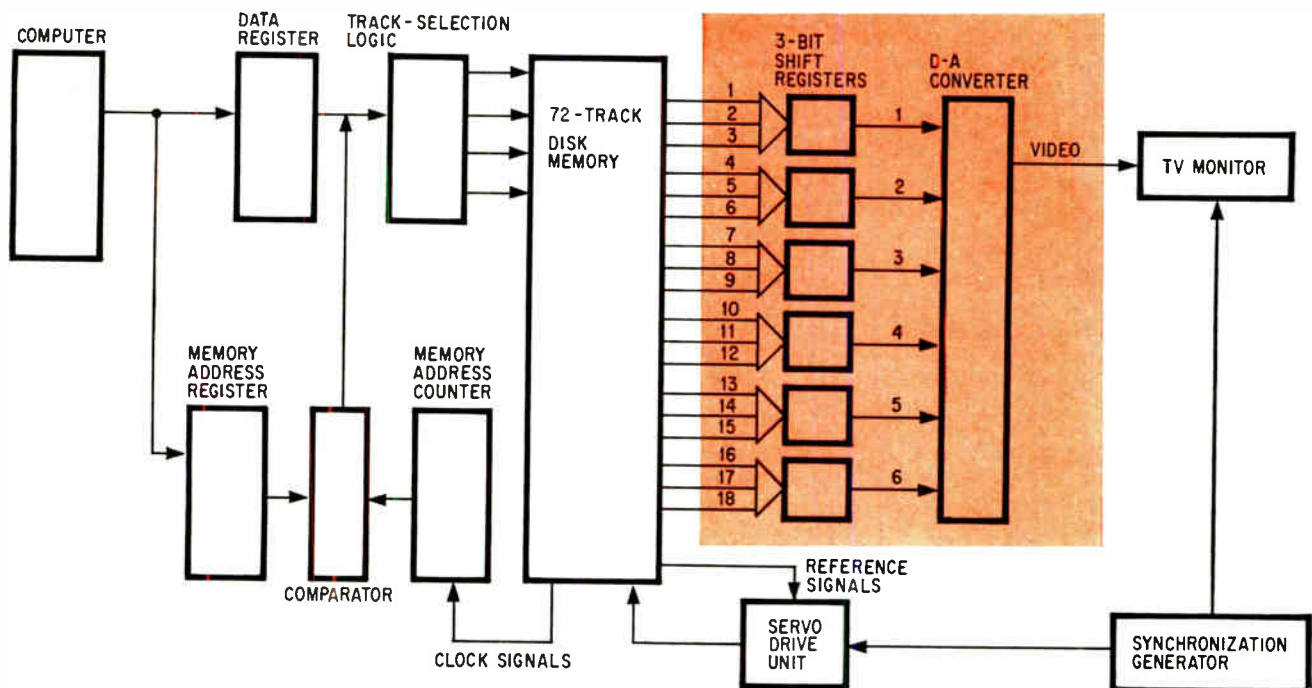

Working model. Tinted area in simplified block diagram of JPL video display system represents logic hardware required to make a single image; it's repeated four times. There are 18 tracks of data coming off the disk at 3 Mhz, multiplexed and multiplied by three to provide the 6-bit word that defines one point of the picture at 9 Mhz.

TRYGON HAS THE POWER

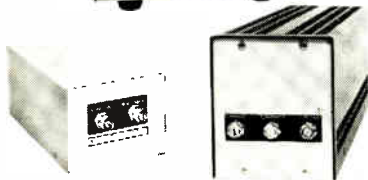
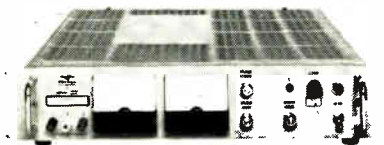

**to deliver new
Liberator slot range
systems power
in rack-mount and
modular units..from \$89**

Now the Liberator wide-slot line is even wider. We've added new LVS low-power modules in voltage ranges from 2.5-5.5V to 115-161V, and up to 2.1 amps, at prices as low as \$89. Optional rear mounting OV protection module. Plus new low-price LHS half-rack power supplies with ratings to 115-161V and up to 25A; and up to 70A with the L3R/L5R Liberator Rack series.

- All silicon design—precision performance
- 0.01% regulation—high stability
- Low noise for IC and systems applications
- ¼ and ½ rack; full rack; modular and metered models
- Adjustable current limiting and foldback protection—OV protection option
- Integral meter and control options
- Convection cooling—no temperature derating to 60° C
- Remote sensing and programming

Liberators offer the ultimate in systems versatility when combined in any of TRYGON'S five mix-n-match rack adapters. Up to 7 DC outputs—more performance versatility—combine any of these with TRYGON'S famous Series I Module Power Supplies.

For full details on these and many more, write today for your free copy of Trygon's brand-new Liberator Power Supply Brochure.



TRYGON POWER SUPPLIES

111 Pleasant Avenue, Roosevelt, L.I., N.Y. 11575
Trygon GmbH 8 Munchen 60, Haidelweg 20, Germany
Write for Trygon 1969 Power Supply Handbook.
Prices slightly higher in Europe.

ferent pictures, any one of which can be selected for transmission to the networks over four separate video channels by the principal investigator.

Data Disc's Masters says each track on the disk has its own read-write head, complete with write, read, and clock electronics that operate to provide encode data, write data, read data, decode data, reclock input data, and reclock output data. As the data comes from the second Univac 1219 computer, it's fed to both a data register and a memory address register. The logic in the digital interface between the computer and the disk memory also includes a memory address counter and track-selection logic, plus a comparator between the memory address register and memory address counter.

Inside jobs

When a track on the disk for storing data selected by the computer compares with the memory address supplied by the memory address counter, the comparator puts out a write-enable strobe to the track selection logic, and the initial data point from the data register is written onto the disk. Subsequent write strobes come from a 212 counter, which determines where subsequent data is stored.

Masters says there are two reference marks on the disk separating it into fields A and B. Field A contains all the information in the odd-numbered scan lines. There are sectors that correspond to the line numbers—1, 3, 5, 7, and so on to 525. Field B contains all the information for the even-numbered sectors—2, 4, 6, 8 and so on up to 524. But instead of storing all elements in the sector representing line 1, the computer directs that only the first bit of each line be stored—the first bit of line 1, then 212 counts later, the first of line 3, and so on through 525; the same holds true for the even-numbered sectors or lines.

The disk runs at 1,800 revolutions per minute. At that rate, it stores one picture element per line, or sector, every 1/30 second, or 525 elements. The disk's bit rate is about 3 megahertz, which is incompatible with the 9-Mhz rate required for commercial television. As a result, for each of the four

video channels, provision is made to boost the signal to 9 Mhz.

Numbers game. The disk puts out six groups of three tracks of data for each television picture at a 3-Mhz rate. Each of these groups is fed to a 3-bit shift register, where multiplexing takes place and the signal is boosted by a 3-times clock signal provided by the disk. The shift register output is the multiplexed (from 18 lines to 6) and multiplied (from 3 Mhz to 9 Mhz). The signal then goes to a high-speed digital-to-analog converter, which provides the video output.

A synchronization generator provides a signal simultaneously to the tv monitor and to the servo drive unit controlling the disk rotation to synchronize the timing of the disk and the scanning of the display.

Because the data is being organized into vertical columns instead of horizontal lines, any column can be randomly read out or updated in 1/30 of a second. Or, the screen can be refreshed each second—the time it takes for one complete disk revolution.

The system will operate in two modes—line-at-a-time or picture-behind. In the latter, while picture number two is accumulating on tape at JPL, the brightness and contrast of picture number one can be sharpened in the disk memory. This can't be done in the line-at-a-time mode. Johansen says, for example, that of the four video channels, A and B could be operating in line-at-a-time while channels C and D are working in the picture-behind mode.

He observes that even though the Mariner photography will be black and white, techniques are being worked out so that channels B, C, and D will carry red, green, and blue hues to enhance Martian surface features, although the color technique won't be available to the networks. Johansen adds that "the unit is intended to be used in scientific interactive computer graphics after the missions are completed."

For the hardware that already existed, JPL had to buy only about \$45,000 worth of new equipment to provide the real-time, network-compatible readout; \$31,000 went for the disk memory and about \$14,000 for additional logic. ■

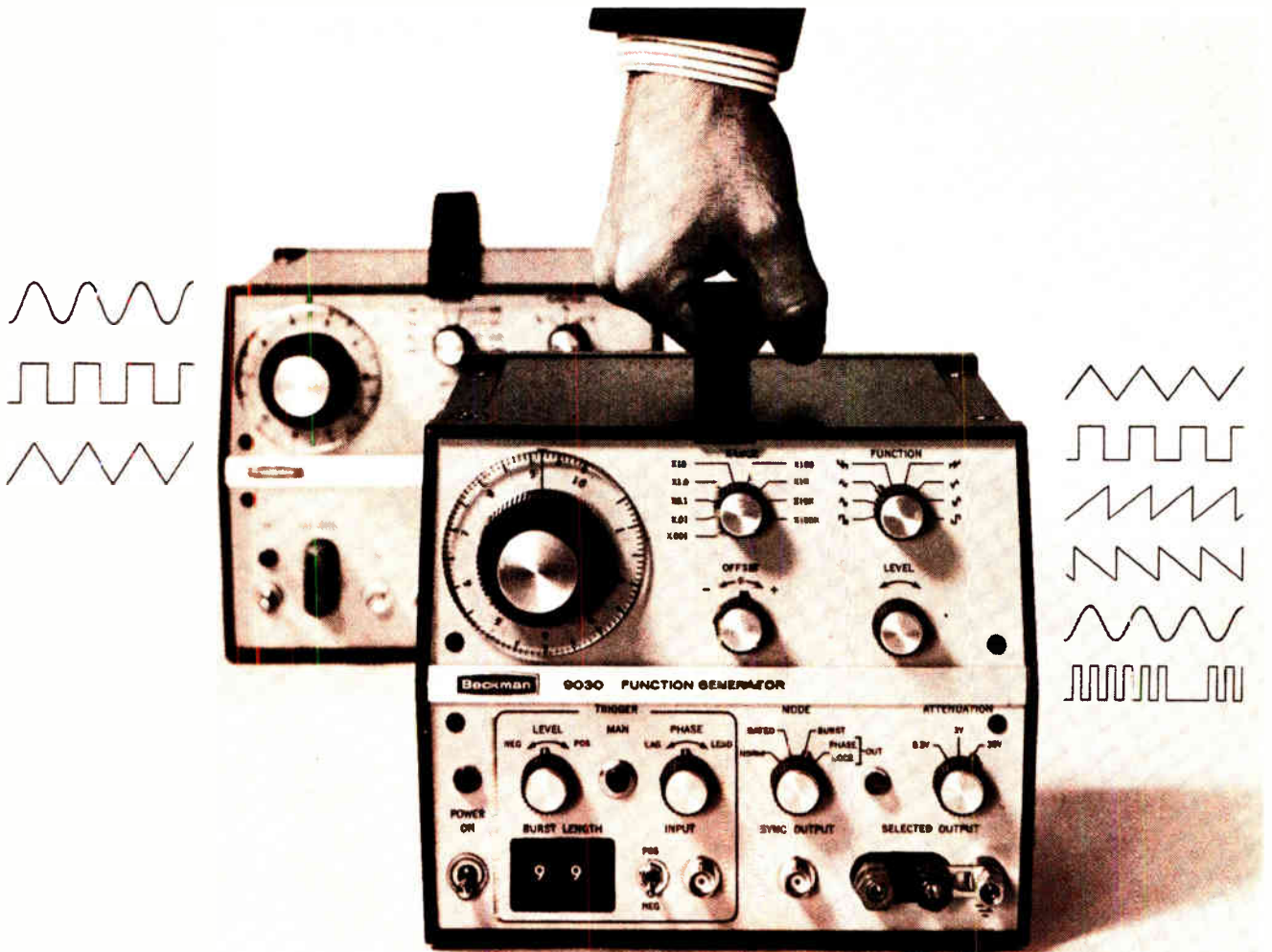

Take a good look...

at the Beckman Models 9010 and 9030 Function Generators.

If you're looking for an exceptional low-cost function generator, take a look at the Beckman 9010: a tough little competitor (sine, square, and triangular waves at 0.005 Hz to 1 MHz, with external VCO control and dc offset for \$495.00).

But if you want much more, and your requirements include:

- four basic functions *and* their complements, with an external GATE control mode, continuously variable over a frequency range from 0.0005 Hz to 1 MHz.
- eight unipolar and bipolar outputs, adjustable to 30 volts p-p in three attenuator steps, in addition to dc offset and external VCO control.
- a BURST mode to generate 1 to 99 positive and negative waveforms upon receipt of a trigger input.
- a PHASE LOCK mode to synchronize the instrument in frequency and phase with an external signal from 10 Hz to 1 MHz, then take a *good* look at the Model 9030 (only \$895.00).

Like the 9010, the 9030 is rugged enough for any production or bench environment. It's drip proof, dust proof and shock proof, and stackable, portable and rackable. (8½" H x 7" W x 10" D.)

For your system or component testing, use a 9010 to initiate the burst functions of the 9030 — and rack them together with standard Beckman hardware.



Now that you've seen what the 9010 and 9030 Function Generators can do for you, there's no need to keep looking. Just contact your local Beckman office, sales representative or factory direct. (A special 3½" rack chassis is available for both instruments upon request.)

Beckman

INSTRUMENTS, INC.

ELECTRONIC INSTRUMENTS DIVISION

RICHMOND, CALIFORNIA • 74804

INTERNATIONAL SUBSIDIARIES: AMSTERDAM; CAPE TOWN; GENEVA; GLENROTHES, SCOTLAND; LONDON; MEXICO CITY; MUNICH; PARIS; STOCKHOLM; TOKYO; VIENNA

Bendix Vacuum Equipment

Choosing is easier when you choose from the broadest line around.



High-vacuum Coaters

The specific applications of Bendix systems are unlimited. Economy coaters can be used in any operation which requires a bell-jar vacuum system. In microelectronics, optics and environmental experimentation and testing. In research, pilot plant development and production operations. In industry and university laboratories. Available from stock.



High-capacity Vacuum Coater

New bell-jar vacuum system designed specifically for quantity production of evaporated thin films. With AutoMate™ Control to eliminate valving errors. Solid state control of evaporation circuit that can easily be adapted to fully automatic operation. Ten-inch pumping system with multi-coolant baffle. All in an extremely compact package that can handle 32 lenses (2" diameter) per cycle at 1.5 work loads per hour.

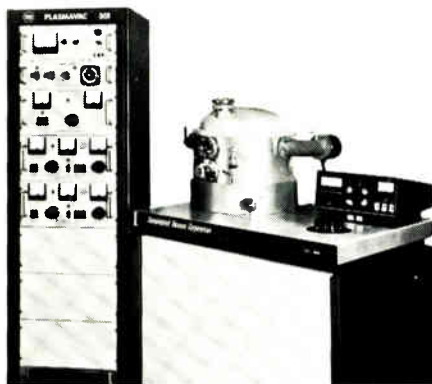

PlasmaVac® 501 Sputtering Systems

PlasmaVac, batch-type sputtering systems produce thin films in pilot-production quantities. A feature of the system is the AutoSrate® fixture which will handle up to 64 wafers per run. Crossfire Discharge,™ an exclusive Bendix CVC development, gives improved film uniformity and increased sputtering rates. All fixturing components, including the substrate holders and the shutter, are easily disassembled without tools and lifted from the vacuum chamber for easy maintenance.



PlasmaVac® 400 with AutoMate Control

New Bendix CVC systems bridge the laboratory/production interface. The PlasmaVac 400 (above) is a process development tool which can be used in a high-volume inline production system. You can develop your thin-film sputtering process in the laboratory and use the same unit as a modular segment of your production system. And you can scale up your operation to large volume by adding modules as needed, or buy a custom system designed to meet your specific process requirements.

And Bendix has the largest line of vacuum equipment available from a single source. In coaters, everything from 14-inch vertical to 72-inch horizontal. Fully automatic, semiautomatic and manual. In pumps, sizes and types to suit every conceivable research and industrial application. From basic diffusion to the latest in ion and sublimation pumps. In gauges, models to measure every degree of vacuum our equipment can make. McLeod, Pirani and Hot-filament in a variety of ranges. Plus a full line of accessories, from valves, baffles and traps to "O" rings and seals.

The size and variety of the Bendix line allows spot comparisons, makes your final choice easier. Make it easy on yourself by finding out more about Bendix CVC Vacuum Equipment. Start by checking out the equipment here. And write: The Bendix Corporation, Scientific Instruments and Equipment Division, 1775 Mt. Read Blvd., Rochester, New York 14603.



High-vacuum Vapor Pumps

Bendix offers you 23 standard metal oil vapor pumps, more than anyone else. A dynamic line incorporating the latest advances such as the new WHITE HAT, an oleophobic, polymer-coated cap, which significantly reduces back-streaming in BlueLine™ diffusion pumps. Also we have a wide range of ion and sublimation pumps. Check the chart and ask for more information on the pump range that interests you most.

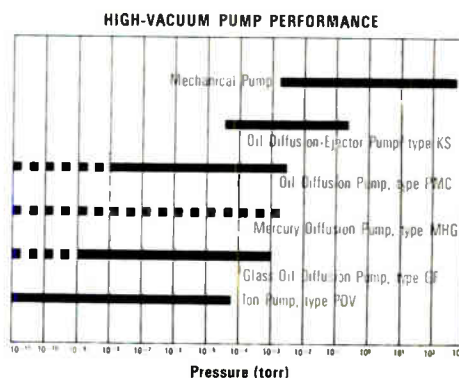

NOTE: Broken line indicates performance with baffle. The lower pressure limit of a diffusion pump without baffle can be extended several decades by using proper techniques.

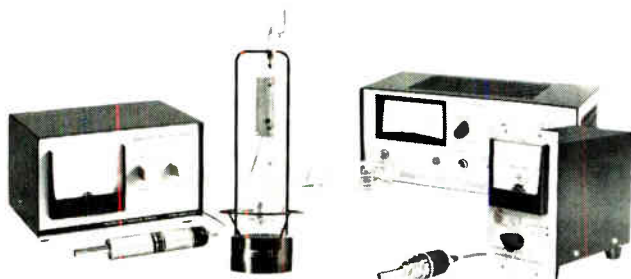

High-vacuum Gauges

The Bendix line of precision high-vacuum gauges covers every conceivable requirement in the atmosphere to 2 x 10⁻¹¹ torr pressure range. Write for bulletins describing each of the following types: McLeod Gauges, Pirani and Thermocouple Gauges, Magnevac® Gauge, Cold-cathode Gauges, Hot-filament Gauges.

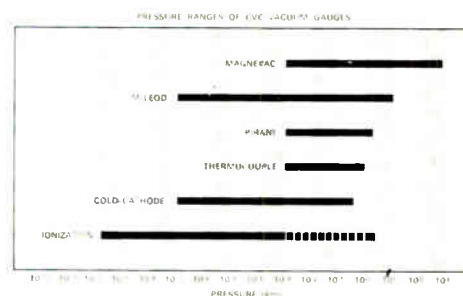

Other Bendix Equipment

Here's just a sample of the full Bendix line of complementary high-vacuum equipment. If it has anything to do with vacuum, it has everything to do with us.

- Baffles
- Base Plates
- Bell Jars and Accessories
- Component Pumping Packages
- Distillation Apparatus
- Electron Beam Equipment

- Materials for Thin-film Deposition
- Space Chambers
- Traps
- Vacuum Fluids
- Vacuum Furnaces
- Valves



Now, ready for you in quantity.

The new Delco Radio DTS-701 and 702 NPN triple-diffused silicon high voltage transistors. They were designed for the tough requirements of off-line deflection in large screen TV.

However, they're built and tested for extra reliability in all high energy circuits. Proved by the surest peak energy capability rating in the business: Pulse Energy Testing.

And right now, they're available in both production and sample quantities.

Why will you want to use the Delco 701 or 702?

For the tough jobs—high inductive load switching or for circuits subject to transients or fault conditions.

For reduction of weight, size and component costs. Circuit complexity and number of components are reduced, so assembly costs go down, too. And fewer components mean higher reliability.

So now you know. The pioneer in high voltage silicon power has done it again.

For prices, samples or complete data, just call us or the nearest Delco Radio distributor listed below.

SEMICONDUCTOR DISTRIBUTORS

ALA., BIRMINGHAM • Forbes Distributing Company, Inc.
(205)-251-4104

ARIZ., PHOENIX • Sterling Electronics, Inc. (602)-258-4531

CAL., LOS ANGELES • Kierulff Electronics, Inc. (213)-685-5511
• Radio Products Sales, Inc. (213)-748-1271

CAL., PALO ALTO • Kierulff Electronics, Inc. (415)-968-6292

CAL., SAN DIEGO • Milo of California, Inc. (714)-232-8951

COLO., COLORADO SPRINGS • L. B. Walker Radio Co. (303)-636-1661

COLO., DENVER • L. B. Walker Radio Co. (303)-935-2406

COLO., ENGLEWOOD • Hyer Electronics Co. (303)-771-5285

FLA., MIAMI • Mountain Electronics, Division of
Mountain National Co. (305)-634-4556

FLA., WEST PALM BEACH • Mountain Electronics Division of
Mountain National Co. (305)-883-5701

ILL., ROSEMONT • F-J-R/Midwest, Inc. (312)-678-8560

ILL., SKOKIE • Merquip Electronics, Inc. (312)-282-5400

IND., INDIANAPOLIS • Graham Electronics Supply, Inc.
(317)-634-8486

MD., BALTIMORE • Radio Electric Service Co. (301)-539-3835

MASS., NEWTON • The Greene Shaw Co., Inc. (617)-969-8900

MICH., KALAMAZOO • Electronic Supply Corp., (616)-381-4626

MINN., MINNEAPOLIS • Stark Electronics Supply Co. (612)-332-1325

MO., KANSAS CITY • Walters Radio Supply, Inc. (816)-513-7015

MO., ST. LOUIS • Electronic Components for Industry Co.
(314)-647-5505



1200V - 3.0A
800V - 0.5A

DTS-701

Collector to emitter voltage (V_{CE0})	800V
Sustaining voltage (V_{CE0} (sus))	600V min.
Emitter to base voltage (V_{EB0})	5V
Collector current (I_C)	500mA
Base current (I_B)	100mA
Power dissipation (P_T)	25W

DTS-702

Collector to emitter voltage (V_{CEX})	1200V
Collector to emitter voltage (V_{CE0})	1000V
Sustaining voltage (V_{CE0} (sus))	750V min.
Emitter to base voltage (V_{EB0})	5V
Collector current (I_C)	3A
Base current (I_B)	1A
Power dissipation (P_T)	50W

Available in solid copper. JEDEC TO-3 package.

Kokomoan's Regional Headquarters

Union, New Jersey* 07083
 Box 1018 Chestnut Station
 (201) 687-3770
 Chicago, Illinois* 60656
 5151 N. Harlem Avenue
 (312) 775-5411
 Santa Monica, Calif.* 90401
 726 Santa Monica Blvd.
 (213) 870-8807
 Detroit, Michigan 48222
 57 Harper Avenue
 (313) 873-6560



THE KOKOMOANS ARE IN POWER
DELCO RADIO
 DIVISION OF GENERAL MOTORS
 KOKOMO, INDIANA

N.J., CLIFTON • Eastern Radio Corporation (201)-471-6600
 N.M., ALBUQUERQUE • Hyer Electronics Company (505)-265-5767
 • Sterling Electronics Inc. (505)-247-2486
 N.Y., BINGHAMTON • Federal Electronics, Inc. (607)-748-8211
 N.Y., NEW YORK • Harvey Radio Co., Inc. (212)-582-2590
 N.Y., WOODBURY, L.I. • Harvey Radio Company, Inc. (516)-921-8700
 OHIO, CINCINNATI • United Radio, Inc. (513)-761-4030
 OHIO, CLEVELAND • The W. M. Pattison Supply Co., Industrial
 Electronics Division (215)-411-3000
 OHIO, DAYTON • F-J-R/Ohio, Inc. (513)-278-9411
 OKLA., OKLAHOMA CITY • Radio, Inc. (405)-235-1551
 OKLA., TULSA • Radio, Inc. (918)-587-9124

PENN., PHILADELPHIA • Almo Electronics, Division of
 Sterling Electronics (215)-676-6000
 PENN., PITTSBURGH • RPC Electronics (412)-782-3770
 TEXAS, DALLAS • Adleta Electronics Company (214)-742-8257
 TEXAS, FORT WORTH • Adleta Electronics Co. (817)-336-7446
 TEXAS, HOUSTON • Harrison Equipment Co., Inc. (713)-224-9131
 UTAH, SALT LAKE CITY • Hyer Electronics Company (801)-437-3681
 VA., RICHMOND • Meridian Electronics, Inc. (703)-353-6648
 WASH., SEATTLE • Kierulff Electronics, Inc. (206)-763-1550
 WASH., TACOMA • C & G Electronics Co. (206)-272-3181
 CANADA, ONT., SCARBOROUGH • Lake Engineering Co., Ltd.
 (416)-751-5980

AIRPAX

MULTIPOLE PROTECTOR with SINGLE TOGGLE ACTUATION

Airpax multipole APG magnetic circuit protectors operate with a single toggle handle, a feature which greatly simplifies panel mounting and provides a lower cost, compact unit with high operating dependability. Internal coupling assures instant action of all protectors should an overload occur in any protected circuit.

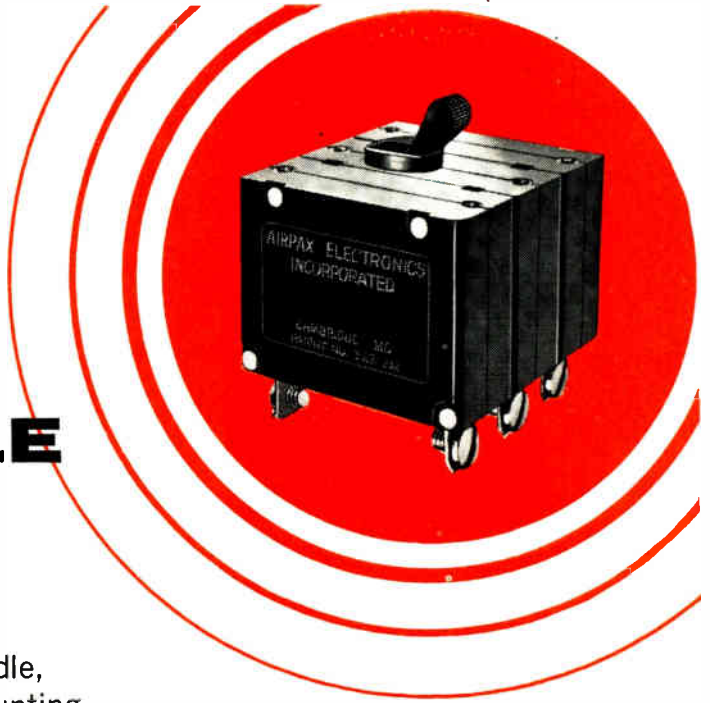

FEATURES

- Current ratings from 20 mA to 30A.
- Voltage ratings to 250 volts, 60 and 400 Hz and to 50 volts dc.
- Series, shunt and relay types, auxiliary switch available on series type.
- Choice of trip delays; trip free operation.
- Individual poles need not have identical characteristics.
- Quick connect or machine screw terminals.
- Available with 1, 2 or 3 poles.
- Electromagnetic operation with magnetic-hydraulic delay.

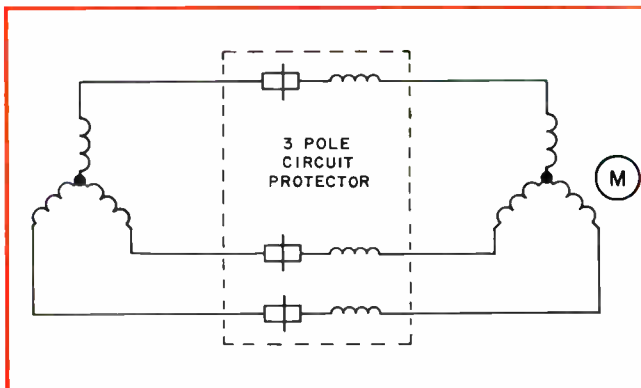

THREE PHASE MOTOR PROTECTION

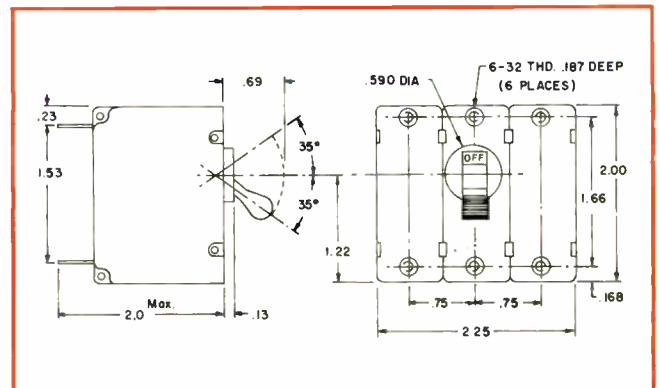

DIMENSIONAL DRAWING

AIRPAX ELECTRONICS

CAMBRIDGE DIVISION, CAMBRIDGE, MARYLAND 21613

PHONE (301) 228-4600

TELEX 8-7715

TWX 710 865-9655

Low-cost counters have premium specs

Phase-locked stability and high input sensitivity are included in a line of counter-timers that start with a basic price of \$575

By James Brinton

Associate editor



Counting on counters. The 1192 line of counter-timers aims at lower end of price-applications spectrum. Units measure up to 32 Mhz with stability of 2×10^{-9} per month. The instruments will be introduced in August at Wescon.

The marketing talk around the General Radio Co. sounds more like Detroit than Route 128. Such phrases as “buyer’s market,” “every dollar counts,” and “low price for options” seem more at home in an automobile showroom than in the West Concord, Mass., offices of General Radio. Nevertheless, those are the terms bandied about by company officials when they talk about their new counter-timer line, the 1192 series.

“The new series is aimed at the buyers’ market,” says Robert A. Boole, marketing research manager. With counter-timers selling at about a \$50-million-a-year clip, Boole likens this to a consumer market where, as he is quick to point out, “every dollar counts.”

Says Boole: “Base price must be low to begin with and must be followed by low prices for options.”

Market first. With an avowed goal of developing a line characterized by high-performance at aggressively competitive prices, General Radio started with marketing and sales strategies. Next, the company studied what was already on the market. Only after all this did the company decide on price and performance tradeoffs for the actual design. The result: a line of counters whose performance is comparable to that of counters in the \$1,000-range—such as Hewlett-Packard’s model 5216A and Monsanto’s model 103—but at prices ranging from \$575 to \$845.

General Radio has even turned

to discount pricing. The purchase of only two units nets a 3 percent price cut; 100-unit lots win a 20 percent cost reduction.

Counters in the 1192 series are aimed at the lower end of the price-applications spectrum. Nevertheless, the series covers a gamut of applications largely because the 1192’s are available with five-, six-, or seven-digit readouts, and with or without binary-coded-decimal outputs. The seven-digit version costs \$200 more than the five-digit unit, and bcd output adds \$50.

Every unit in the line measures frequency over a range of d-c to 32 megahertz, with 100-microsecond to 10-second gate times; each times both periods and intervals to 0.1 μ sec resolution and performs sim-

Convert any X-Y scope into a curve tracer: \$595*

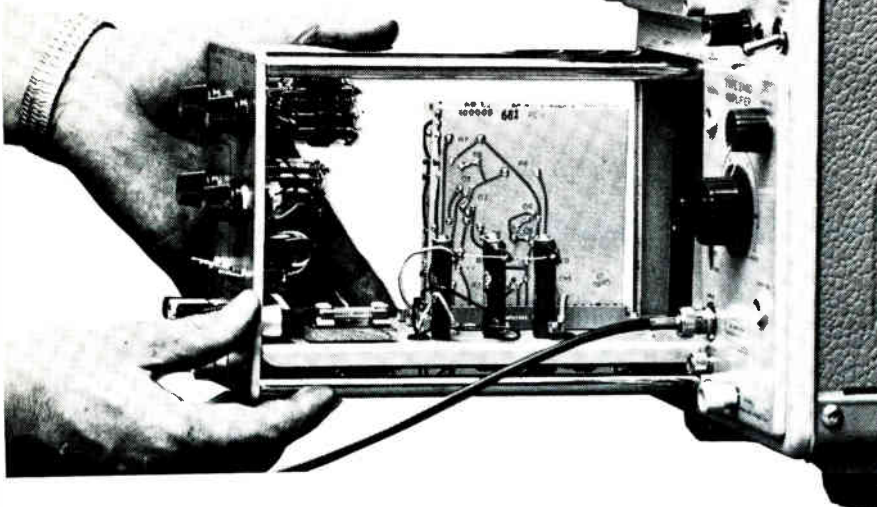

Now U-Tech's plug in and console units are all your oscilloscope needs to become a curve tracer. Save 1/2 to 1/3 the cost!

For the price of one curve tracer, you can now buy two to three of these U-Tech units that use the facilities of your present scope to display the dynamic characteristics of both NPN and PNP transistors, N Channel and P Channel junctions, FETs, MOS-FETs, bipolars, uni-junctions, diodes, tunnel diodes and SCRs.

Ask your distributor about these U-Tech curve tracer units or order direct from:

*Prices apply to purchase and shipments within U.S.A. fob Salt Lake City, Utah



U-Tech plug-in Model 681: \$595.00*. For use with Tektronix 560 series Oscilloscopes.

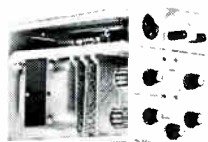

U-Tech plug-in Model 682: \$615.00*. For use with Tektronix 530, 540, 550, 580 series Oscilloscopes.



U-Tech Console Model 683: \$625.00*. For use with any X-Y Oscilloscope.

U-TECH

A Division of Industrial Physics and Electronics Company

4190 South State Street, Salt Lake City, Utah 84107 Tel. (801) 262-2663

Yes, send me curve tracer model.....

Enclosed is: Check P.O. Bill me Send literature

NAME _____ TITLE _____

COMPANY NAME _____

COMPANY ADDRESS _____ PHONE _____

CITY _____ STATE _____

... features evolved over two decades ...

ple counting.

Like the H-P 5216A, the 1192 series has a 10-Mhz crystal-referenced time base. However, most counters that are cost-competitive with the 1192's use power-line frequency as a reference. As a result, their accuracy falls short of the 1192's.

Input sensitivity is 10 millivolts out to 25 Mhz, and 20 mv to 32 Mhz. General Radio claims sensitivity of the 1192 series is 10 times that of similarly priced units, and is at least equal to that of the H-P 5216A—but over double the 5216A's 12.5-Mhz range.

Input impedance is about 1 megohm shunted at 27 picofarads. But with a \$26 accessory probe, the P6006, the impedance rises to 10 megohms shunted at 7 pf.

Watershed. According to Richard W. Frank, who headed the design group, many of the 1192's features evolved from the company's counter efforts that date back to the early 1950's.

The time base, for example, is a 5-Mhz crystal oscillator multiplied by two to provide a 10-Mhz reference. It is the same oscillator used in General Radio's model 1191 counter that sells in the \$1,300-\$1,500 range. Its drift is claimed to be about three times less than that of competing counter-oscillators: less than $3 \times 10^{-7}/^{\circ}\text{C}$ over a temperature range of 0° to 55° C. Stability is 2×10^{-6} per month.

Frank says General Radio is the only firm that both demands 100 percent tests of oscillator crystals by the manufacturer and performs 100 percent incoming inspection tests.

"Each crystal is automatically tested to obtain its temperature-coefficient plot," says Frank. "These are among the most tightly specified crystals in the industry."

New phase. The 1192 also offers phase locking, a feature rarely found in its price range. Frank explains that since a high-frequency crystal was used to optimize time resolution, phase locking was added to slave the counters to distributed lower-frequency standards found in some factory production lines. "It only takes an extra semiconductor or two," he says, "and since phase

With EECO 2D computer-automated plug-in IC Hardware...

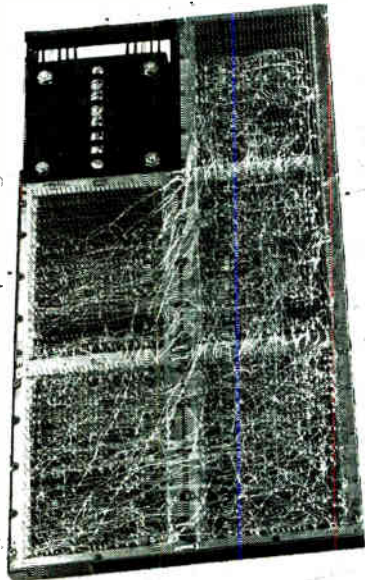

less than 30 days separate schematic and final system...

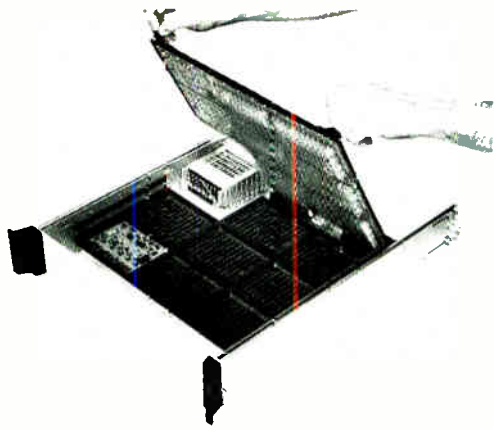

When you specify EECO 2D Hardware a computer converts your "Pin Logic List"* into a wire plan and checks for errors and omissions before wiring begins. EECO plugs in the IC's, machine Wire-Wraps the back-planes and in days...your schematic is a drawer of working electronics with all necessary computer generated support documentation.

EECO 2D Hardware System provides more than time savings...it's up to 30% more economical...and it's versatile...ready for digital or analog IC's, discrete components, MSI or LSI. It offers higher density — up to 768 IC's and a power supply fit in one 3-1/2" high standard drawer.

Your first step is simple...just phone, write or circle the reply number.

*You simply choose the module and write the signal name by each pin number. You don't worry where the wires go or the order of listing.

Catalog available

See EECO 2D
at Wescon Booth
numbers 3814 thru 3817



ELECTRONIC PRODUCTS DIVISION

ELECTRONIC ENGINEERING COMPANY OF CALIFORNIA

1441 EAST CHESTNUT AVENUE • SANTA ANA, CALIFORNIA 92701 • (714) 547-5651

Circle 133 on reader service card

NEW

BUY YOUR EMI FILTERS DIRECT FROM THIS FILTER GUIDE!

✓ SPECTRUM OFFERS 30 dB WHERE
FORMERLY YOU COULD BUY ONLY 5 dB

✓ ALL QUALITY FILTERS... REALISTICALLY PRICED

✓ SPECTRUM FILTERS ARE AVAILABLE
FOR IMMEDIATE DELIVERY

CURRENT RATING (A.M.P.)	VOLTAGE RATING (125°C)	INSERTION LOSS			PARTS SHOWN ACTUAL SIZE	SPECTRUM PART NO. (USE WHEN ORDERING)	PRICE* (EACH)
		30kHz	1MHz	10MHz			
10	100	-	-	5	42	51-712-001	2.90
10	100	-	-	5	50	51-712-003	5.60
10	200	-	-	5	45	51-714-004	1.60
10	100	-	12	30	50	51-714-007	4.90
10	500	-	-	5	45	51-719-001	2.40
15	50	15	44	60	70	51-717-001	7.25
15	50	15	44	60	70	51-343-003	8.65
10	50	20	60	70	70	51-301-030	12.80
25	500	-	-	10	55	51-702-003	1.32
25	750	-	-	10	50	51-715-001	2.50

SEND ORDER DIRECT
TO OUR FAIRVIEW PLANT...

OR CALL JOHN LANE
814/474-5593

QUANTITY PRICE BREAKS
QUOTED ON REQUEST



SPECTRUM CONTROL INC.

152 EAST MAIN ST. • FAIRVIEW, PENNSYLVANIA 16415

VISIT SPECTRUM'S EXHIBIT AT WESCON - Booth 4707

lock discriminates against noise, the user gains the advantage of a cleaner reference in his counters." Competing units use the distributed, and presumably more noisy, signal as the prime reference.

A second input channel is included to allow normalizing the counter readout to a given time or frequency. "Thus the user can read a ratio of two input frequencies, or set the second frequency arbitrarily to get a rational fraction of, for example, 60, which would allow measuring quantities in a units per minute fashion," according to Frank.

The user who needs to reach 500 Mhz can add a scaler to his 1192. General Radio is also introducing a redesigned version of its 1157 scaler, called the 1157B, that is capable of frequency division at both 10:1 and 100:1.

Reach without breach. "Thus, for measurements up to about 320 Mhz," says Frank, "the user can divide by 10 rather than 100 and save a digit of resolution. With the old scaler, the user would have lost two digits automatically as he switched into the 100-to-1 mode."

The scaler, however, does move the instrument into the 50-ohm regime, causing a great reduction in input impedance. "But this just means you need a little more power or a low source impedance," says Frank. And even with the scaler in place, counter sensitivity still equals the 100 mv industry average for counters.

The bcd output is fully buffered, in 1-2-4-8 code at standard diode-transistor-logic levels—about 9 milliamps sinking current. The accessory list includes in addition to the scaler, a data printer, a bcd-to-analog converter, and digital data-acquisition equipment.

The 7½-pound units measure 13.5 by 3⅞ by 8.5 inches in the bench-top version and without scaler, 19 by 3.5 by 12.75 in rack configurations. The counters will be introduced at Wescon next month. Prices for bench-top models are: five-digit readout, \$575; six-digit readout, \$675; and seven-digit readout, \$775. For a rack mount, \$20 is added; for bcd output, \$50. The 1157B scaler is priced at \$850.

General Radio Co., West Concord, Mass. 01781 [338]



Solitron announces

10 AMP AND 20 AMP

**INDUSTRIAL PNP
Power Transistors!**

**10 AMP
SERIES**

Type Number TO-3	Type Number TO-66	RATED BREAKDOWN VOLTAGES			PERFORMANCE SPECIFICATIONS					
		BV _{CBO}	BV _{CEO} (SUS)	BV _{EBO}	h _{FE}		V _{CE} (sat) Volts	V _{BE} (sat) Volts	I _{CEX} μA	
					@ I _C = -5.0A V _{CE} = -5.0V	@ I _C = -5.0A I _B = -0.5A	@ I _C = -5.0A I _B = -0.5A	V _{EB} = -1.5V (REV. BIAS)		
Min.	Min.	Min.	Min.	Max.	Max.	Max.	Max.	Max.	@ V _{CE}	
2N5737	2N5739	-60	-60	-5	20	80	-0.5	-1.2	-10	-60
2N5738	2N5740	-100	-100	-5	20	80	-0.5	-1.2	-10	-100

**20 AMP
SERIES**

Type Number TO-3	Type Number TO-66	RATED BREAKDOWN VOLTAGES			PERFORMANCE SPECIFICATIONS					
		BV _{CBO}	BV _{CEO} (SUS)	BV _{EBO}	h _{FE}		V _{CE} (sat) Volts	V _{BE} (sat) Volts	I _{CEX} μA	
					@ I _C = -10A V _{CE} = -5.0A	@ I _C = -10A I _B = -1.0A	@ I _C = -10A I _B = -1.0A	V _{EB} = -1.5V (REV. BIAS)		
Min.	Min.	Min.	Min.	Max.	Max.	Max.	Max.	Max.	@ V _{CE}	
2N5741	2N5743	-60	-60	-5	20	80	-1.5	-1.5	-10	-60
2N5742	2N5744	-100	-100	-5	20	80	-1.5	-1.5	-10	-100

For complete information, contact:

Solitron DEVICES, INC.

1177 BLUE HERON BLVD. / RIVIERA BEACH, FLA. / (305) 848-4311 / TWX: (510) 952-6676

Lower price widens amplifier's uses

Two video inverters, one with a slew rate of 750 volts per microsecond and the other featuring fast settling, are aimed at data processing field

Cutting prices is one of the surest ways of satisfying customers. And when the customers are willing to accept lessened performance, the price cut is that much sweeter. This is what the Data Device Corp. is doing for its customers.

Last year, the company brought out a pair of video inverting amplifiers that were priced in the neighborhood of \$150. In the process of

selling these amplifiers, the company discovered a sizable demand for similar but less expensive amplifiers from designers willing to trade off a little performance.

To meet this demand, Data Device is offering the VA 21 and the FS 21 video inverting amplifiers—identical to the older units in design but built with components that cost less and have tolerances

that are lower. As a result, the VA 21 sells for \$65 in small quantities, and the FS 21 goes for \$75.

The VA 21 has a slewing rate of 750 volts per microsecond and its response is flat out to 12 megahertz. The rolloff is 6 decibels per octave and the minimum gain-bandwidth product is 80 Mhz.

Data Device says that the VA 21 can be used in video summing net-

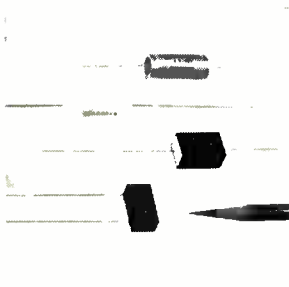

Polystyrene film dielectric capacitors designated Deltafilm AS are for such applications as low-frequency tuned circuits, analog computer reference capacitors, and precision timing and integrated circuits. They operate over the temperature range of -55° to $+85^{\circ}$ C, and come in ratings of 25, 35, 50, 100 and 200 wdc. Dearborn Electronics Inc., Box 530, Orlando, Fla. [341]

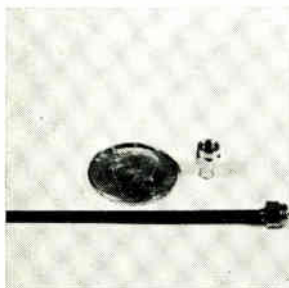

Miniature straight plug connector 2902-6013 is a 3-mm device. Vswr is limited only by the performance of the mating connector. Mechanical design eliminates snap ring coupling nut retention, greatly increasing reliability. The connector meets or exceeds MIL-C-39012A (SMA). Price is 50 cents each in quantity. General RF Fittings, Cove Road, Port Salerno, Fla. [345]



Hermetically sealed Vactrols series VTL1 are a line of photon isolators available in six types from 1.5 v with incandescent lamps through 115 v with neon. They are useful for signal isolation, audio level controls, scr and triac turn-on, and noiseless switches. Price is \$1.05 in quantities of 10,000. Vactec Inc., 2423 Northline Industrial Blvd., Maryland Heights, Mo. [342]



Power transformer model 20P provides almost any required output voltage between 5 and 350 v a-c at 20 w output power. The Mil-Spec 60 hz units have a wide variety of uses in military and industrial systems. They are encased in steel containers and measure $2 \times 2\frac{3}{8} \times 3\frac{1}{8}$ in. Abbott Transistor Laboratories Inc. 5200 W. Jefferson Blvd., Los Angeles [346]



Pi-type filters series FC1410 through FC1413 are available in current ratings of 0.1, 0.25, 0.45 and 1 amp. Pi construction offers 60 db attenuation per decade of frequency from cutoff. Filter size is 0.540 in. in length and 0.375 in. in diameter. Price is \$9.75 in 100 piece quantities; delivery, stock to 4 weeks. Filters & Capacitors Inc., 425 N. Fox St., San Fernando, Calif. [343]

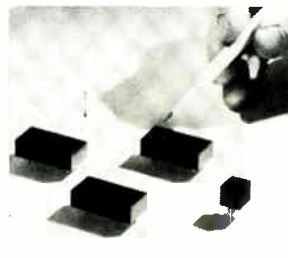

Seven-pole monolithic crystal filters come in 4 models: 6457MA, 6457MB, 6458MA, and 6458MB. Center frequencies are 10.7 Mhz ± 0.7 khz, 10.7 Mhz ± 1 khz, 21.4 Mhz ± 0.7 khz, and 21.4 Mhz ± 1 khz, respectively. The 3 db bandwidths are 6, 15, 6, and 15 khz minimum, respectively. Maximum ripple is 1 db. Damon Engineering Inc., 15 Fourth Ave., Needham, Mass. [347]

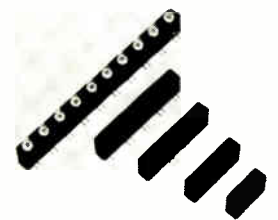

Multisocket receptacles are for bi-pin subminiature lamps. Five basic receptacles containing 2, 3, 4, 5 and 10 sockets permit block-building of indicator lamps to any number or readout pattern. Units plug into p-c boards with a 0.100-in. grid. Receptacles are molded from a glass-filled thermoplastic with beryllium copper contacts. Chemelec Products Inc., Cherry Hill, N.J. [344]

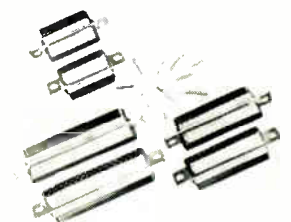

Subminiature connectors Royal D Mark III are for use in military and industrial equipment. They come in 9, 15, 25, 37 and 50 contact configurations. The No. 20 contacts are rated at 5 amps and accommodate No. 20, 22 or 24 stranded wire. Devices incorporate a rear release crimp-on, snap-in contact assembly. Cinch Mfg. Co., 1026 S. Homan Ave., Chicago [348]

What's the best Monolithic Chip Capacitor?

Centralab Mono-Kap*

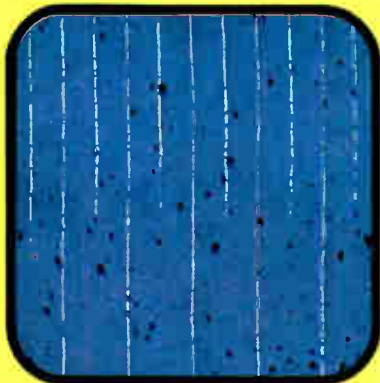

CENTRALAB MONO-KAP

See for yourself.

ACTUAL MICROGRAPHS OF RANDOMLY SELECTED MONOLITHIC CHIP CAPACITORS.

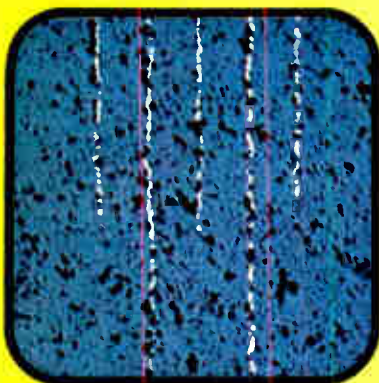

COMPETITOR A

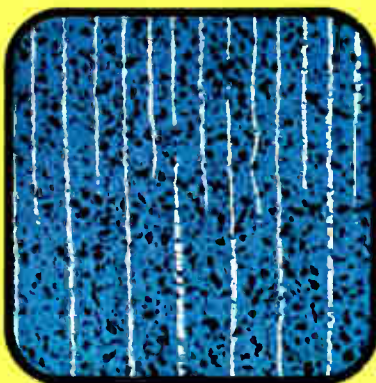

COMPETITOR B

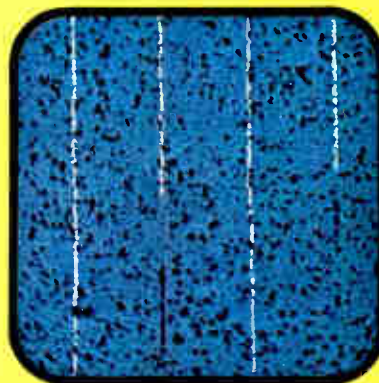

COMPETITOR C

The superiority of Centralab Mono-Kap chips is clearly visible . . . pin holes that destroy reliability and long life are virtually eliminated. The beauty and superiority of these new monolithic chip capacitors is much more than skin deep, too. Centralab is alone in testing 100% for flash, insulation resistance, dissipation factor and capacitance. We also manufacture our own ceramics, thick film microcircuits and a broad line of capacitors. As a designer of microcircuits, Centralab developed the Mono-Kap to increase the scope of

circuits we could manufacture. Centralab's Mono-Kaps have been tried and proven in a wide variety of industrial and military microcircuits. We have a wide variety of materials, physical sizes and capacitance values, all priced competitively and delivered in as little as four weeks. If seeing is believing, and you'd like a closer look, call on your local Centralab Representative for samples and product data. Have requirements for encapsulated Mono-Kaps with terminations? Send your specifications to Centralab, Application Engineering Dept.

*TM



CENTRALAB

Electronics Division
GLOBE-UNION INC

5757 NORTH GREEN BAY AVENUE
MILWAUKEE, WISCONSIN 53201

M-6919

New

Grayhill "Excellent 50's"

A new generation of Tiny Rotary Switches with practically unlimited variations

"Excellent 50's"

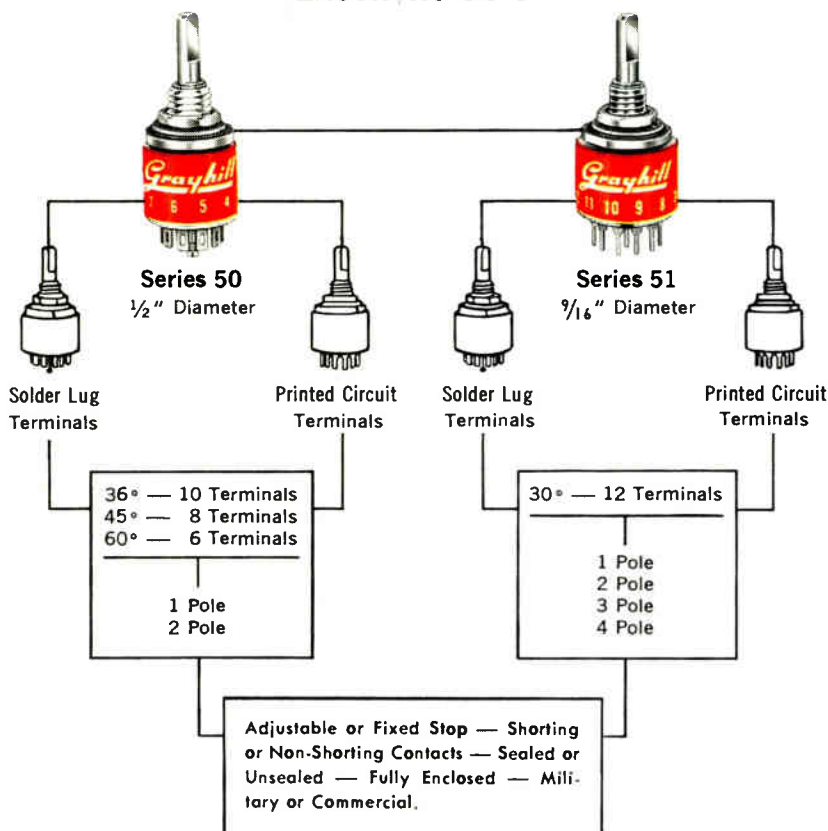

Meets requirements of MIL-S-3786/20



Send for technical sheets fully describing the Grayhill "Excellent 50's".

Another Grayhill innovation developed to unusually exacting criteria required by a highly classified application.

NOW — the proven superiority of this new, versatile generation of Grayhill Rotary Switches — the "Excellent 50's" — is being made available to the commercial market through increased facilities. They are available from stock.



523 Hillgrove Avenue
LaGrange, Illinois 60525
Area Code 312, Phone 354-1040

... the Difference Between Excellent and Adequate

works, in deflection-control amplifiers, and in data processors.

The FS 21 is similar to the VA 21, but features fast settling—0.5% of the output's final value within 100 nanoseconds, and 0.05% within 1 μ sec. The FS 21 is designed for use in digital-to-analog converters, sample-and-hold circuits and pulse amplifiers.

Both amplifiers share certain specifications; an output of 20 millamps at 10 volts, a voltage



Many uses. The VA 21 video amplifier can be used in television and in data processing systems.

drift of 20 microvolts per degree centigrade, a current drift of 0.5 nanoamp/ $^{\circ}$ C, and an operating range of -10° C to $+50^{\circ}$ C. Both units are 1.8 by 1.2 inches by 0.8 inch.

Delivery time is three weeks.

Specifications for VA 21 at 25 $^{\circ}$ C

Voltage gain, open loop, d-c at 1-kohm load	92 db min 100 db typical
Frequency for full output, inverting only	8 Mhz min, 12 Mhz typical
Frequency for unity gain, inverting only	80 Mhz min, 120 Mhz typical
Slewing rate, inverting only	500 V/ μ sec min 750 V/ μ sec typical
Output	± 10 v min ± 11 v typical ± 20 ma
Input voltage	
Initial offset	adjustable to 0
Balance trim pot	50 kohms
Drift vs Temperature	20 μ v/ $^{\circ}$ C typical 35 μ v/ $^{\circ}$ C max
Drift vs time	1.0 na/24 hours
Input current	
Initial offset	5 na typical 20 na max
Drift vs temperature	0.5 na/ $^{\circ}$ C typical 1.0 na/ $^{\circ}$ C max
Input impedance	
Differential	250 kohm min 350 kohm typical
Capacitance	6 pf
Input noise, broad-band to 10 khz	5 μ v rms typical
Power requirements	
Voltage	± 15 v
Quiescent current	± 15 ma typical ± 25 ma max
Peak full-load current	± 45 ma

Data Device Corp., 100 Tec St., Hicksville, N.Y. 11801 [349]

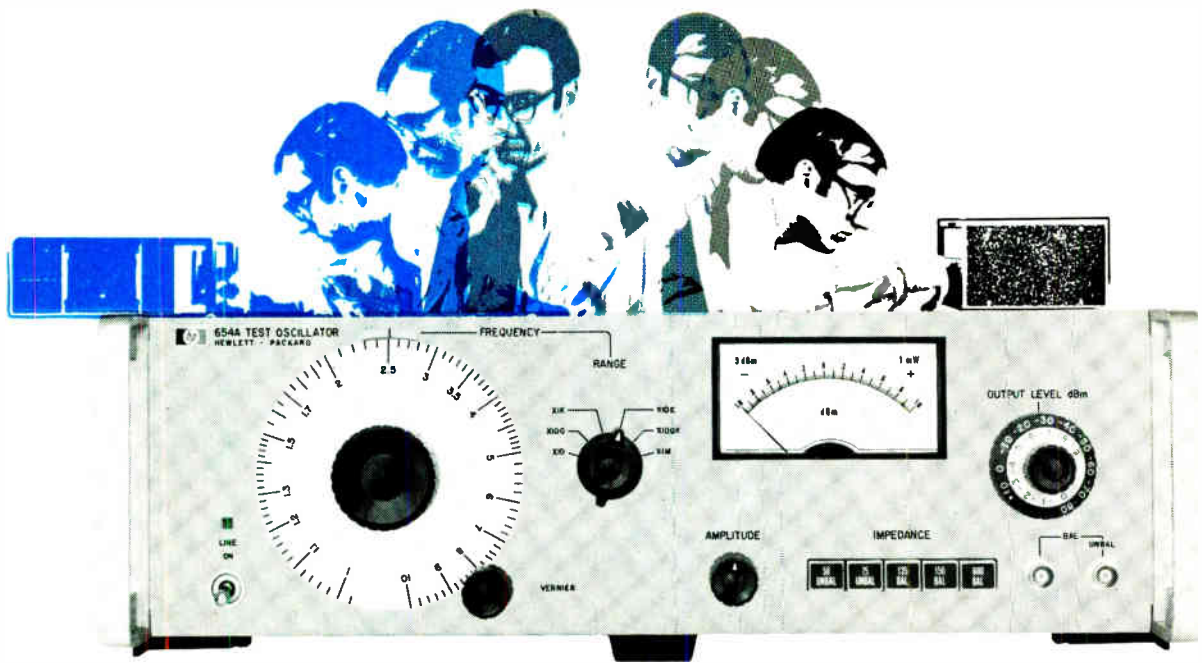

HP Test Oscillators... the step-savers!

Dollar for dollar, HP's 650 series of test oscillators provides the best performance in the 10 Hz to 10 MHz range—and saves you steps while doing it.

This series matches your performance requirements with the right price to give you the test oscillator that best suits your needs.

In the 650 series, you get test-quality amplitude and frequency stability. Once you have these oscillators set up you don't have to waste steps constantly checking them!

With the 652A, a X20 expanded scale lets you monitor output amplitudes to within 0.25% over the entire 10 Hz to 10 MHz frequency range. The readings on the upper-most expanded scale are in percent. This added convenience lets you get a quick reading of % deviation for frequency response of the device under test—in one easy step. (Price HP 651B, \$590; HP 652A, \$725)

The next big step-saver is for people who are tired of tweaking up their oscillator level every time they change frequency. The HP 654A has automatically controlled 0.5% level flatness from 10 Hz to 10 MHz. Eliminates the need to verify and adjust the oscillator output after each frequency change. You are free to concentrate on system performance instead of system input.

But that's not all, with the 654A you get pushbutton selection of 135, 150, or 600 Ω balanced outputs—or 50 or 75 Ω unbalanced. The combination of an expanded meter scale and a sensitive output level control assures you of extremely accurate output resolution. Add it all up and you have the 654A—the best general purpose test oscillator available today. (Price \$875).

Anyone have a special television application? Well, that's where the step-saving HP 653A comes in. It has

the inherent accuracy and ease of operation of the 654A. It also has many special built-in video capabilities for A2 type television system measurements. Too many to cover here—but if you want more information, just ask. (Price \$990)

If you want to put your test oscillator dollar to the best use, and save steps at the same time—call your local HP Field Engineer or consult your HP catalog. For data sheets, write Hewlett-Packard, Palo Alto, California 94304. Europe: 1217 Meyrin-Geneva, Switzerland.

099/72

HEWLETT  PACKARD
S I G N A L S O U R C E S



Heads: You win.

Tails: You win again.

Elco rack-and-panel connectors give you a better head start
And a choice of tails.

The head start is the connecting end of an Elco connector: the patented Varicon™ contact that fully meets the requirements of MIL-E-5400. The four mating surfaces of this unique contact are coined to an exceptional hardness and wipe clean with each make. Once the contacts are joined, the inherent springiness of the gold/nickel-plated phosphor bronze and the fork-like design make a superior, gas-tight fit.

Because the contacts are free floating, they align perfectly. A few contacts or 100 or more, all fit precisely together every time, over a long service life. There's no contact chatter. Nobody else gives you a contact head quite like the Varicon.

And nobody else gives you the choice of tails you get with Varicon. You can wire-wrap, crimp, clip, stake, or solder them. Whatever terminating technique or combination of techniques your assembly lines are set up for, we'll furnish the appropriate tail. If staking or crimping is your style, we

can supply the equipment too. Manual or automatic. Purchase or lease.

Elco rack-and-panel connectors come in standard rectangular models, or as miniature connectors, or in modular units. You can have them with 2 Varicon contacts, or up to 140, or anything in between.

In short, our line of Varicon rack-and-panel connectors has a lot going for it. Except price. Though it's a precision component, the Varicon contact is easily produced in high speed progressive dies. There's no expensive machining, no waste. When you can turn out millions of Varicons a week, you don't have to charge a fortune for them.

There's a lot more to be told about Varicon connectors. It's all in our 28-page rack-and-panel connector guide, and we'll be happy to send you a copy. Just write, wire, call, or TWX us. Elco Corporation, Willow Grove, Pa. 19090. (215) 659-7000. TWX 510-665-5573.



.078" Taper Tab



Solder/.098" Taper Tab



Wire Wrap Tail
.024" x .050" x .567"



Wire Wrap Tail
.024" x .050" x .760"



Crimp (Loose contact)

ELCO Rack-and-Panel
Connectors



Digital signals rule programmable ratio box

Either binary or bcd commands can change output-input ratio in steps of 0.0001; two multiwinding transformers do the scaling

A bit of failure is sometimes a blessing. Take the case of North Atlantic Industries Inc. and its programmable a-c ratio boxes.

North Atlantic started making them five years ago, says Jack Heaviside, the company's chief engineer. When the boxes worked, which was unusual, they worked well. "They just weren't reliable," says Heaviside. "The relays in the

programming section couldn't stand up to constant use."

But three years ago, North Atlantic engineers replaced the relays with switching networks made with bipolar and field effect transistors. And with the change came reliability, according to Heaviside.

North Atlantic, however, had never put the ratio boxes on the open market. Every unit made was

shipped to the Bendix Corp. But the Bendix response has been so good, says Heaviside, that North Atlantic is now offering the ratio boxes as off-the-shelf items to all takers. The first unit will bow at Wescon next month.

Called the 507, the instrument works with a 115-volt, 400-hertz input. The output-input ratio can be varied from 0.0000 to 1.0000 in

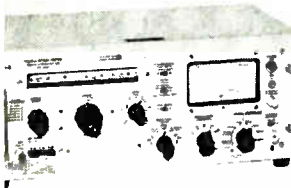

A-m/f-m modulation meter AFM2 features solid state circuitry and line or battery operation. It is wide range in both the carrier frequencies covered (5 to 1,002 Mhz) and the modulation frequencies accepted (0 to 200 khz). Applications are in measurement of f-m and a-m levels of r-f generators and transmitters. The London Co., 811 Sharon Dr., Cleveland [361]

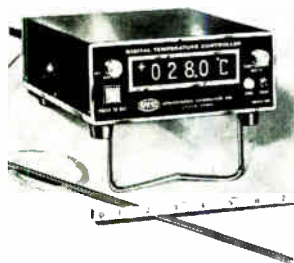

Digital temperature controller model 920 is for use with a variety of environmental testing and production line chambers. It operates over the temperature range of -60° to $+160^{\circ}$ C, with an accuracy of 0.5° C. and a resolution of 0.1° C. The controller circuit is preadjusted to minimize thermal overshoot. Electronic Research Co., W. 75th St., Overland Park, Kan. [362]

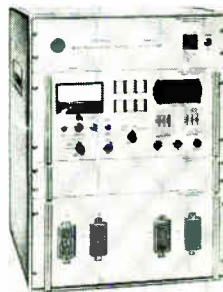

High speed circuit testers models QC410 and QC430 incorporate memory systems that simultaneously sense any intermittent discontinuities which may occur in any circuit. Duration of a discontinuity can be as short as 1 μ sec. Units measure 26 x 19 1/2 x 21 3/4 in. Prices range from \$6,750 to \$12,550. Automation Dynamics Corp., 35 Industrial Parkway, Northvale, N.J. [363]



Multitester model NH-65 is a 21-range, 20,000 ohms/volt d-c unit that features a mirrored scale, safety diodes for overload protection, ultrasensitive 0.44 μ a D'Arsonval movement, and an easily read 2-color scale. Unit uses 1% matched precision resistors. It measures 4 1/2 x 3 3/8 x 1 1/2 in., weighs less than 2 lbs. Mura Corp., 355 Great Neck Rd., Great Neck, N.Y. [364]

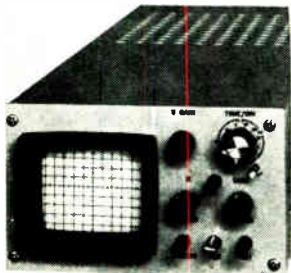

Ultracompact flexible crt display model 8602 has 11 sweep ranges selectable by a front panel control. Panel size is 3 1/2 x 5 3/4 in. with useful screen area 4 x 5 cm. Three sets of sweep ranges are available: 1 μ sec/div. to 2 msec/div., 10 μ sec/div. to 20 msec/div., and 100 μ sec/div. to 200 msec/div. Infodex Inc., 7 Cherry Ave., Waterbury, Conn. 08702 [365]

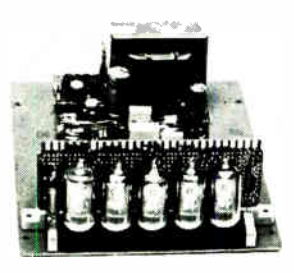

Digital panel meter 3302 is capable of reading from 0000 to 3999 with 0.05% accuracy. It is useful for indicating phase or angular rotation (360°), temperature ($3,200^{\circ}$ F), optical density (3.999), and weight (40,000 lbs in 10 lb increments). Prices start at \$295 with delivery in small quantities from stock. Electro-Numerics Corp., 2191 Ronald St., Santa Clara, Calif. [366]

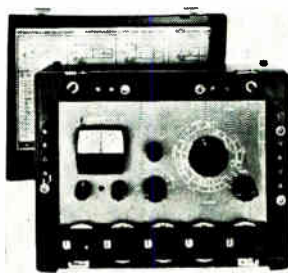

Potentiometric voltmeter - bridge model 300A offers 0.01% accuracy in all of its measurement and ratio functions to provide the desired 10:1 accuracy ratio for calibrating 0.1% instruments. It affords the user 5 d-c voltmeter ranges, 8 ammeter ranges, and 10 resistance ranges. Electro Scientific Industries Inc., 13900 N.W. Science Park Dr., Portland, Ore. [367]



Ruggedly-built a-c current leakage tester model 229 offers a performance approximating the normal perception curve to within ± 1 db and it will measure leakage currents as small as 5 μ a. Ranges cover a-c current: 0-0.3, 1, 3 and 10 ma; and a-c voltage from 0 to 150 v. Accuracy is $\pm 2\%$ at 60 hz. Price is \$90. Simpson Electric Co., 5200 W. Kinzie St., Chicago 60644 [368]

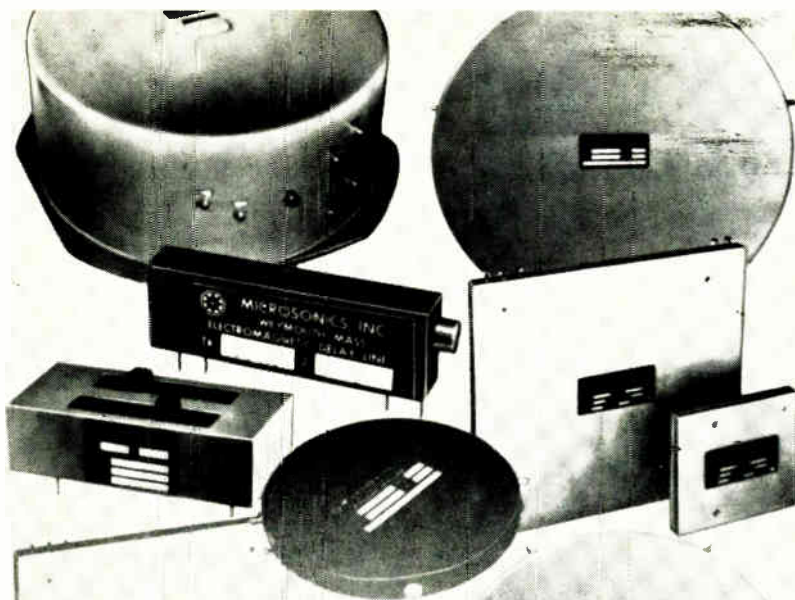

**LC & DC • DISPERSIVE • DIGITAL
MAGNETOSTRICTIVE • QUARTZ
GLASS • VARIABLE • TAPPED
LC & DC • DISPERSIVE • DIGITAL
MAGNETOSTRICTIVE • QUARTZ
GLASS • VARIABLE • TAPPED
LC & DC • DISPERSIVE • DIGITAL
MAGNETOSTRICTIVE • QUARTZ
GLASS • VARIABLE • TAPPED
LC & DC • DISPERSIVE • DIGITAL
MAGNETOSTRICTIVE • QUARTZ
GLASS • VARIABLE • TAPPED
LC & DC • DISPERSIVE • DIGITAL**

MICROSONICS

*for proven design, reliability &
performance in*

DELAY LINES

Serial Memories



Write for Bulletins today

MICROSONICS

60 Winter Street, Weymouth, Mass. 02188

Tel: 617 337-4200

A division of the Sangamo Electric Company

steps of 0.0001. Either a binary or a binary-coded-decimal signal controls the ratio, and switching from one ratio to another takes no more than 20 microseconds.

Ins and outs. Inside the 507, along with the switching network, are a pair of transformers, each with 26 windings. The 507's a-c input is applied to a primary and the digital input, be it in binary or bcd form, continually switches the appropriate secondary into the output circuit.

One advantage of setting up ratios with transformers instead of with some type of resistive network is better stability, says Heaviside. The 507's long-term stability is 0.01%.

Another advantage of the trans-

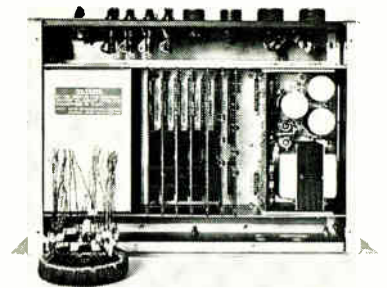

Transformer action. Setting up the 10,000 possible ratios is the job of only two transformers.

former approach, he points out, is a low output impedance—25 ohms for the 507. Thus, a designer needn't connect an amplifier to the 507's output nor make allowances for loading errors.

And transformers help at the front end, too; the 507's input impedance is high—300 kilohms.

Double role. Besides acting as a ratio box, the 507 can also work as a digital-to-analog converter. After all, changes in its a-c output directly reflect changes in its digital input. North Atlantic sees the 507 being used in both ways.

Two probable applications are as a link between a computer and analog instruments, and as a ratio box in automatic test systems, particularly aircraft checkout systems.

The 507's price is \$3,000, and delivery time is eight weeks.

North Atlantic Industries Inc., Terminal Drive, Plainview, N.Y. 11803 [369]

RUB-OUT PROOF

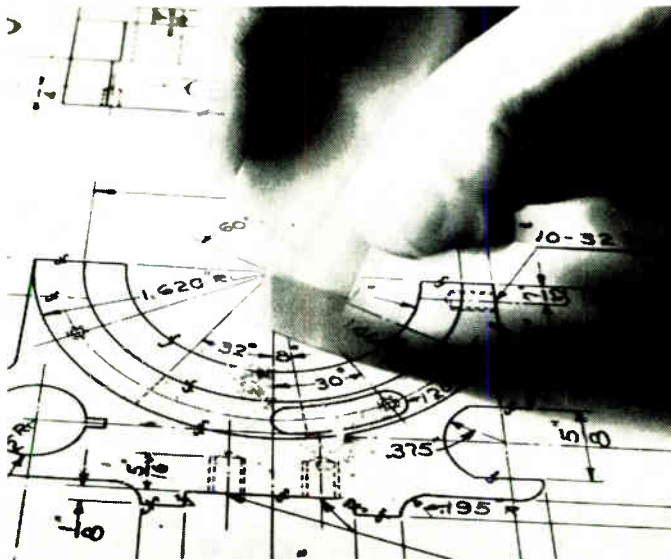

After as many as 10 changes,
KODAGRAPH ESTAR Base Films
still won't tell on you.

That's right. KODAGRAPH ESTAR Base Films have surface toughness that stays ahead of your eraser. This rugged matte drafting surface retains its "tooth" under repeated same-area changes, and always maintains its smooth acceptance of your ink and pencil lines.

You'll really like working with ESTAR Base Films.

They're easier to handle and correct. For example, KODAGRAPH Wash-Off Film wet-erases in seconds with a drop of water and a few swipes of your eraser. And it's so easy to process; you can count on getting your prints back faster than ever before.

KODAGRAPH ESTAR Base Films are designed by Kodak to make you and your work look good. Next time, order them from your reproduction department or blueprinter. Your local Kodak Technical Sales Representative can show you the full line this week. Or write: Eastman Kodak Company, Business Systems Markets Division, Rochester, New York 14650.

Kodak

DRAWING REPRODUCTION SYSTEMS BY KODAK

Fairchild introduces family of linear IC's

Instrumentation op amp has high-gain npn and pnp transistors on single chip; a-c trigger minimizes rfi in control applications

Linear IC's represent a segment of the integrated-circuit market that has had only a few significant product introductions in many months. Fairchild Semiconductor will end the lull by taking the wraps off 11 new linear IC's at seminars in major cities beginning Aug. 4.

One of them, an instrumentation operational amp, designated the μ A725, incorporates some advanced

technology and design innovations resulting in low noise, exceptionally high gain and a geometry that optimizes the circuit's temperature characteristics and transistor matching. The new line also includes the μ A742 zero-crossing a-c power control circuit, the dielectrically-isolated and radiation-resistant μ A744 op amp, the μ A735 low-power op amp, and the μ A715

high-speed op amp. The 715, which has been stocked since June, is a year late to market because it had to be sent back to the drawing board for a new solution to compensation network problems (*Electronics*, May 12, page 34).

The advanced technology in the 725 allows a typical open-loop voltage gain of 3,000,000, compared with the 45,000 of the typical

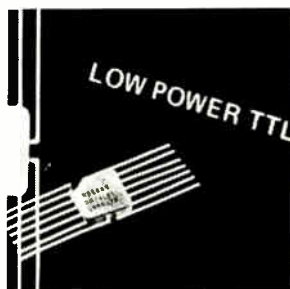

Low power TTL IC's DM75L (-55° to $+125^{\circ}$ C) and DM85L (0° to 70° C) are dual JK flip flops for military use. They are manufactured utilizing a monometallic interconnect system and aluminum metalization and wires. The chips are alloy mounted and standard visual inspection is per MIL-STD-883, National Semiconductor Corp., San Ysidro Way, Santa Clara, Calif. [436]

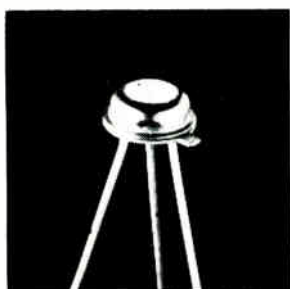

Field-effect transistor CMX740 offers an on-resistance of 2.5 ohms maximum and handles short-duration very high current pulses up to $\frac{1}{2}$ amp minimum. On and off times are typically 50 and 75 nsec respectively. Unit takes 100 times more radiation than a bipolar transistor before its on-resistance is doubled. Crystalonics, A Teledyne Co., 147 Sherman St., Cambridge, Mass. [437]

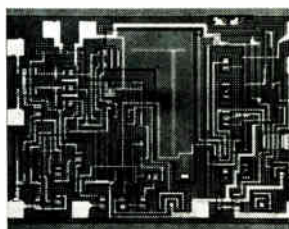

TRANSITRON TSA1150 SENSE AMPLIFIER

Sense amplifiers TSA1150 (military) and 2150 (commercial) with flip-flop outputs convert low level differential pulses from core memories into higher level data compatible with digital logic circuitry. They incorporate a threshold circuit with a narrow window of uncertainty for the amplitude discrimination of incoming signals. Transitron Electronic Corp., Wakefield, Mass. [438]

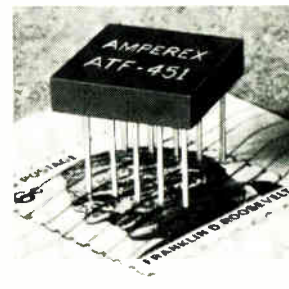

Hybrid quad digital-analog ladder switch ATF-451 is intended for use in binary and BCD coded voltage summing ladders up to 14 bits with $\frac{1}{4}$ least significant bit accuracy. It has an on-resistance of only 4 ± 1 ohm from -25° to $+85^{\circ}$ C and offset voltage of 1 mv max. It measures $0.550 \times 0.550 \times 0.160$ in. Price is \$9 each. Amperex Electronic Corp., Cranston, R.I. [439]

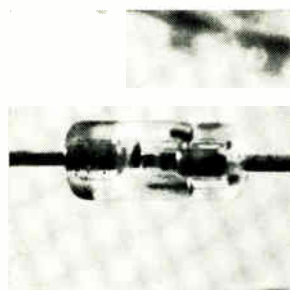

Planar passivated silicon diode MA4-A200 utilizes two Schottky barriers and a p/n junction. It has the high breakdown voltage (greater than 25 v) and operating temperature characteristics of silicon, combined with the low turn-on voltage of germanium and the ultrafast speed of a Schottky barrier device. Microwave Associates Inc., 999 E. Arques Ave., Sunnyvale, Calif. [440]

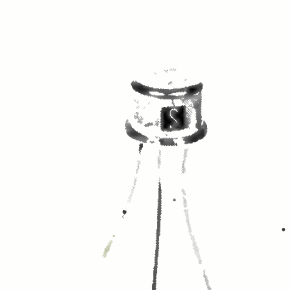

Power transistors SDT6100 come in a TO-5 case. They have switching time less than 60 nsec and rise time less than 10 nsec. V_{ceo} is 40 v. Beta at 2 amps is 20 to 60. Maximum collector current is 5 amps. Units feature planar construction and are typically $f_r = 500$ Mhz. They are available from the factory. Solitron Devices Inc., 1177 Blue Heron Blvd., Riviera Beach, Fla. [441]

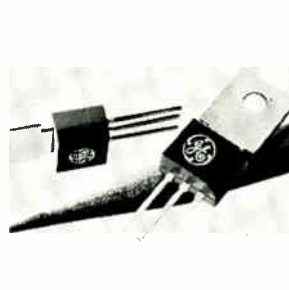

Complementary silicon power tab transistors D40D (nnp) and D41D (pnp) are encapsulated with brown and black silicone, respectively, for easy identification. Both offer collector saturation voltages of 0.5 v typical at 1 amp. Units are for output stages of medium power stereo amplifiers, and drivers for higher power amplifiers. General Electric Co., Syracuse, N.Y. [442]



Plastic silicon diode called Vidiode is $\frac{1}{15}$ the size of conventional damper tubes used in tv horizontal sweep circuits, yet is capable of rectifying 5,000 v a-c at frequencies up to 15,000 hz and delivering an average forward rectified current of 300 ma. Advantages include increased picture size and improved brightness. Scientific Components Inc., 350 Hurst St., Linden, N.J. [443]

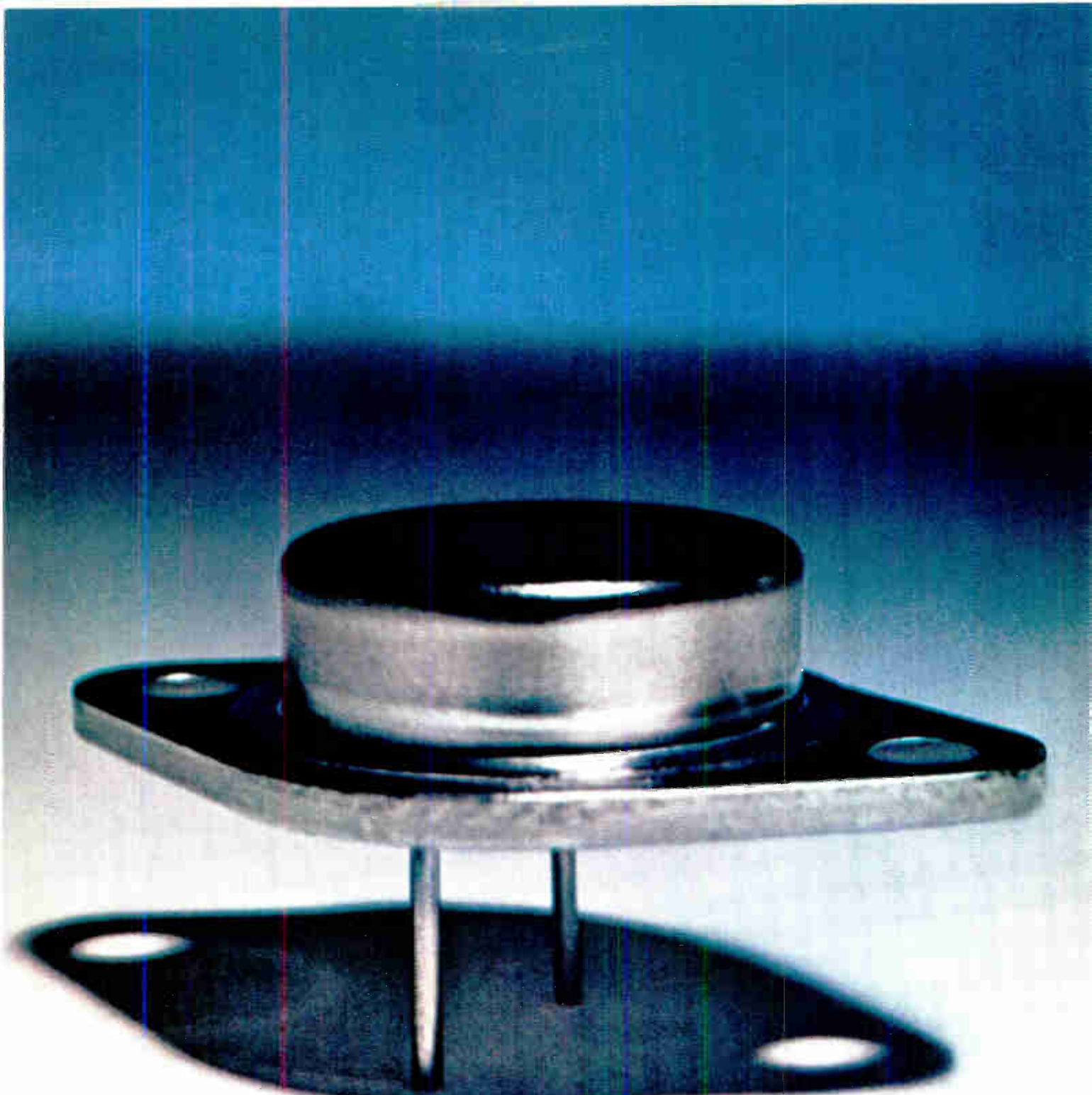

We're available

**Get up to 1000 units of
2N3773 and 2N3054 transistors
in less than two weeks.
Now from Westinghouse.**

What's more, we'll also give you fast service on larger orders. However many it takes to fill your total requirements.

Our 2N3773, 2, 1 (TO3) is a family of 30-amp diffused transistors for high power switching and amplifying applications. They offer a wide selection of voltage and gain.

Our 2N3054 (TO66) is a 4-amp device used to drive our

2N3773, or as the output stage in low-to-medium power applications.

For complete data — and a large ready supply — of any and all of these transistors, contact your local Westinghouse Sales Office or Westinghouse Semiconductor Division, Youngwood, Pa. 15697.

You can be sure... if it's

Westinghouse 

Do you know what regulation to expect from your brute force regulator design?

Figure it with ease using your free nomograph from Semcor.

This is the first of a series of application nomographs to be offered by Semcor in the coming months to help you solve your design problems quicker and easier. Circle our number and we'll send yours today.

Excellence begins with Capability

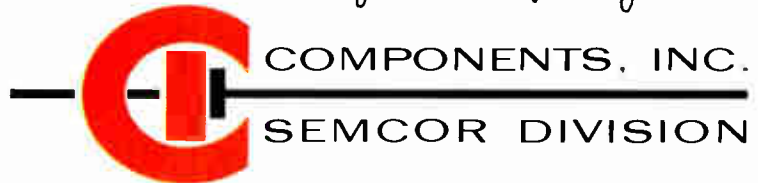

3540 W. OSBORN ROAD / PHOENIX, ARIZONA 85019
PHONE 602-272-7671 / TWX 910-951-1381

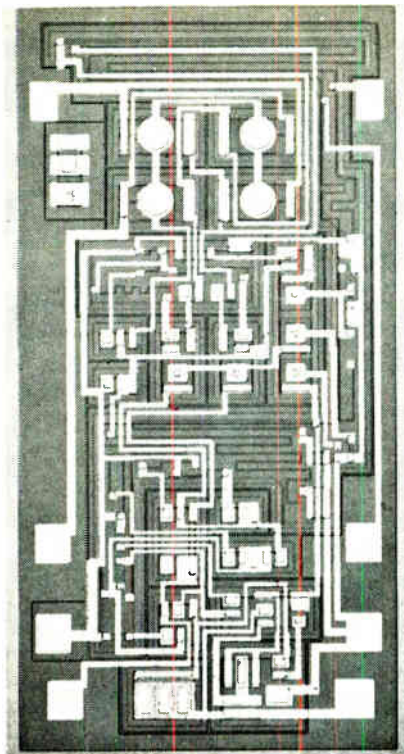

Isolated. The 725's 4 input transistors, at top, are remote from output.

μ A709. Mike Markkula, linear IC marketing manager, says many in the semiconductor industry have maintained that an open-loop gain of even one million couldn't be achieved on a single monolithic chip.

In addition, the input noise current of 0.6 picoampere is far better than the 709's typical 10 picoamps. The circuit is designed for use in temperature controllers, transducer amplifiers, and control systems for precision displays, among other applications. Therefore system noise is a big factor because users will be seeking precision gain from a low-level signal. Thus the 725's typical common-mode rejection of 120 decibels vs. the 709's typical figure of 90 db will be an important consideration.

Symmetrical. The rectangular chip measures about 100 by 50 mils, with the four input transistors on the opposite end from the output transistors, but with both these stages on the center line of the device. Markkula says the significance of the design is that it gets around the temperature problems of a linear circuit that has an output stage asymmetrically laid out in relation to the input stage. In such a device, the temperature

BIG PRINT-OUT CAPACITIES COME IN SMALL MDS PACKAGES

MDS 2200 and 3200 Digital Strip Printers are high-speed, parallel entry recorders that give you a choice of 22 or 32 print columns . . . speeds to 40 lps . . . print drums with a variety of character choices . . . and numeric or alphanumeric print-out.

The MDS 3200 series features a two-chassis package. Printer mechanism in one unit, electronics in a separate unit, for local or remote operation of the printer.

On both models, paper loading and inspection are quick and easy . . . the printer mechanism slides out of the cabinet on glide rails.

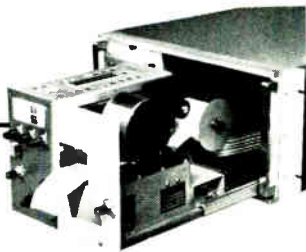

Easy does it!
The complete mechanism slides forward for inspection and paper loading!

Ask for: Complete specifications and information available in MDS folder-file.

FOR MORE—MEET YOUR MAN FROM MDS

MOHAWK **MS**
DATA SCIENCES CORPORATION
OEM MARKETING

P. O. Box 630, Palisade St., Herkimer, N.Y. 13350

Telephone 315/866-6800

Every MDS Office is an OEM Marketing Office

Digital Strip Printers • Buffered Tape Units

High-Speed and Low-Speed Line Printers

Card Punches and Readers

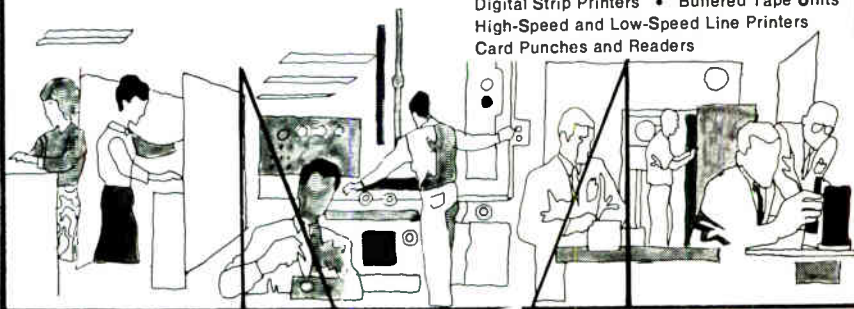

Circle 191 on reader service card



Small

Wonder!



But you don't have to wonder why the Deutsch RSM is the most-wanted of all sub-miniature push-pull connectors. No other unit handles more wires in less space. Or treats them so gently while still maintaining excellent electrical engagement. Push-pull, quick-disconnect coupling. And—quick delivery! Call your local Deutschman for more details. This "small wonder" is another component of ITS... the Deutsch Integrated Termination System.



DEUTSCH ELECTRONIC COMPONENTS DIVISION

Municipal Airport • Banning, California 92220 • Telephone: Area Code 714 • 849-6701

COPYRIGHT, 1969 DEUTSCH ELECTRONIC COMPONENTS DIVISION



IS ELECTRONICS ALL AMERICAN?

Not when we have more than 80,000 non-American readers.

Or you can point the finger at our international advertisers. They consistently place more advertising in **ELECTRONICS** than in any other worldwide electronics publication.

And *we* can point (with pride) to our editorial staff in 64 different

countries. They're responsible for our **ELECTRONICS INTERNATIONAL** section. It's a new identity for an increasingly monolithic market.

ELECTRONICS INTERNATIONAL gives advertisers the opportunity to pinpoint this market with fractional as well as full pages. Subscribers are prime prospects for worldwide ad-

vertisers in every segment of the market.

Proof of **ELECTRONICS'** importance to non-American readers can be found in their loyalty (more than 88% read 3 out of every 4 issues).

If you're in the international electronics market, **ELECTRONICS INTERNATIONAL** wants YOU!

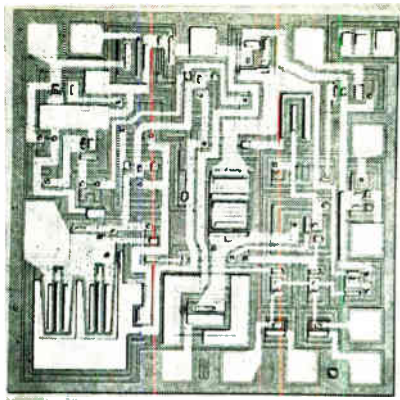

In control. The 742 is designed for industrial and consumer jobs.

gradients across the chip as power is supplied to the load tend to affect the input stage unevenly, affecting input offset voltage negatively.

By cross-coupling the 725's input transistors, laying them out in quadrature about the central point of the input stage, and putting them as far away from the output stage as possible, Fairchild engineers believe they've cancelled out temperature-gradient effects. Input offset voltage is typically 0.5 millivolt vs. about 2 millivolts for last year's best mil-spec op amps, according to Markkula.

Linear designers were formerly faced with the problem of not being able to build high-gain npn and pnp transistors on the same chip; Fairchild's Mike Scott, assistant marketing manager, says the firm has been able to put both types into the 725, with npn's in the input stage and pnp's in the second stage. The secret: using silicon nitride passivation and increasing bulk lifetimes of both kinds of transistors. Nitride, he says, cuts down on the recombination problem and leads to better current gain in the transistors. This is the first time Fairchild engineers have disclosed they're using nitride in linear IC's.

The 725, in a TO-5 can, will sell for \$37.50 in quantities of 100 or more. Markkula says companies making op amp modules sell the same kind of component for \$150 to \$250. Input voltage range is ± 14 volts. Power supply range is ± 3 volts to ± 22 volts. Input voltage drift is 0.5 microvolt.

Power control. Turning to the 742, Markkula says there's long been a need for monolithic IC's to control a-c power, which has been

Light metal fastening ...without holes

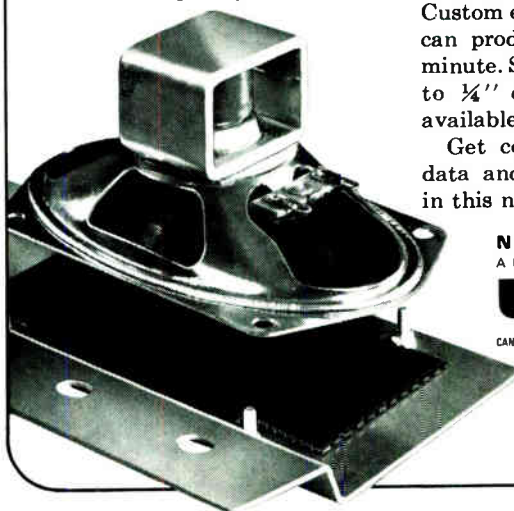

NELSON® end-welded studs are state-of-the-art fasteners for light gauge panels and enclosures. They're installed faster, simpler and at lower in-place cost than any device requiring holes. No drilling, staking, through-bolting, sealing. Locate studs wherever the best design dictates—on steel as thin as .016", .040" for aluminum.

In the example shown, Nelson studs replaced throughbolting and adhesive bonding, returning 105% on the investment in the first year.

Standard stud welders operate at a production rate of 8 welds per minute. Custom engineered, automatic systems can produce up to 45 fastenings per minute. Standard studs, to 1/4" diameter, are available from stock.

Get complete design data and specifications in this new brochure.



NELSON STUD WELDING CO.
A United-Carr Div. of TRW Inc., Lorain, Ohio 44055



CANADA Ontario - WEST GERMANY PECC Boltenschweis, Gevelsberg, Westphalia

Circle 192 on reader service card



Deutsch 460 series connectors combine the best of two worlds. They offer a low-cost Tri-Kam, bayonet-lock coupling, designed to MIL-C-26482, plus the high-reliability of silicone inserts constructed to NAS 1599. **Positive lock . . . rear release!** You get them both when you plan your designs with Deutsch 460 series connectors. The 460 family is completely compatible with all the Deutsch components that comprise the Deutsch Integrated Termination System (ITS). The 460 series is adaptable to standard MS accessory hardware and is intermateable and interchangeable with existing MIL-C-26482 bayonet locking connectors. Write for your 460 Data File or contact your local Deutschman.



DEUTSCH ELECTRONIC COMPONENTS DIVISION

Municipal Airport · Banning, California 92220 · Telephone: Area Code 714 · 849-6701

COPYRIGHT, 1969 DEUTSCH ELECTRONIC COMPONENTS DIVISION

Tantalum Foil



3 ways better
than solid in
non-polar
applications

- smaller than solid tantalum
- more reliable than solid tantalum
- delivers more microfarads than solid tantalum

Design is the big difference between General Electric's Type 29F non-polar tantalum foil capacitor and an equivalent solid tantalum capacitor. A design that's specifically for **non-polar** applications.

GE Type 29F non-polar tantalum foil is about half the case size of an equivalent solid, yet accepts voltage and current variations in either direction. And from one small, single roll that in no way impairs the inherent reliability characteristics of tantalum foil. (Totally unlike its bulky solid counterpart that requires two slugs connected back-to-back and, in most cases, within a single case.)

The difference doesn't end with just size and reliability. Consider microfarads. GE tantalum foil delivers 50 percent more microfarads per case size, in practically all cases, when compared with solid tantalum.

So for your next non-polar application, contact your General Electric Sales Representative and ask to see the Type 29F tantalum foil capacitor. It could make a big difference. In size. In reliability. In microfarads. Electronic Capacitor and Battery Dept., Irmo, S.C.

430-36

GENERAL  ELECTRIC

done with black boxes, relays and silicon controlled rectifiers. The 742 a-c trigger or triac is the first linear IC that incorporates the zero-crossing feature, rather than phase control, to fire an SCR or triac with a minimum of radio-frequency interference. That's important when the thyristor it's controlling starts up a motor in a range of applications from diffusion furnaces to washing machines. The device is being used at Fairchild itself to control power to the heating element in diffusion furnaces.

A synchronization signal from the load, fed back to the 742 when the load current is at zero, is sensed by a zero-crossing detector and triggers the thyristor when rfi will be at a minimum. The 742 has a peak output of 2 amperes, which Markkula says is enough to control an scr that, in turn, controls one megawatt. The device runs in voltages—d-c supply or a-c line—from 28 volts up. Price is \$4.95 in lots of 100, with dual in-line package.

Isolation. Because of the sensitivity of the applications, particularly military systems, for which the dielectrically-isolated 744 op amp is designed, Fairchild spokesmen don't discuss critical specifications. They say that its electrical characteristics are somewhere between those of the 709 and 741. The circuit also features absence of "latch-up" and provides short-circuit protection. The 744's thin-film silicon-chromium resistors have better stability with time and temperature than do most radiation-resistant 709 op amps that use nichrome resistors, says Scott. The 735, a micropower op amp, dissipates about 90 microwatts, far less than the 741's 50 milliwatts, which has been the best typical level in the industry to date.

Rounding out the line are a low-cost color tv demodulator, the μ A746; a dual 741, designated the μ A747; a 741 without internal compensation, designated the μ A748; a dual-channel sense amplifier for core memories, called a μ A731; a dual general-purpose a-c amplifier, called μ A745; and a dual op amp with specs similar to the 709 except that its 5-megahertz bandwidth is better than the 709's 1 Mhz, and so is its speed.

Fairchild Semiconductor, 464 Ellis St., Mountain View, Calif. 94040 [444]

PLUGMOLD®

MULTIOUTLET ASSEMBLIES

FOR ELECTRICAL CONVENIENCE IN ELECTRONIC INSTALLATIONS

In electronic cabinets at the Kennedy Space Center, Plugmold 2000 multioutlet sections provide outlets at each side for test equipment, lamps, etc. For similar convenience in *your* installation, choose from the complete line of Wiremold surface wiring systems.



THE WIREMOLD COMPANY / HARTFORD, CONN. 06110

Circle 193 on reader service card

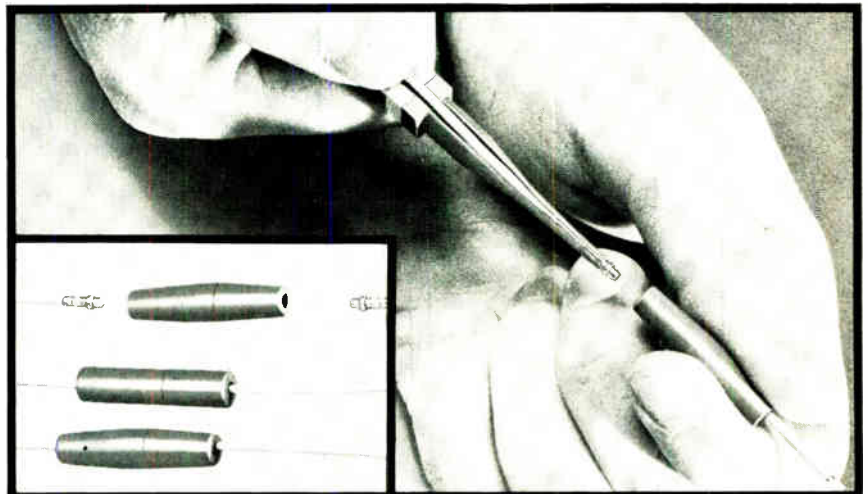

Nicer than Splice!

We know you aren't out to win any beauty contests when making wire-to-wire connections. But you'd get the prize anyhow with Deutsch Jiffy Junctions! Their soft, form-fitting, wire-hugging rubber cylinders flex, insulate, seal. Better than the wires themselves? Snap your wires in place and forget all about them. They won't shake loose, pull apart or turn brittle. Jiffy Junctions make one-to-one unions. Multi-Junctions for three-to-one combinations. As important members of your Integrated Termination System (ITS) they're Deutsch little sisters — both nicer than splice!



DEUTSCH

ELECTRONIC COMPONENTS DIVISION

Municipal Airport • Banning, California 92220 • Telephone • Area Code 71 • 849-6701

COPYRIGHT, 1969 DEUTSCH ELECTRONIC COMPONENTS DIVISION

Signal generator comes under digital control

L- and S-band instrument is designed for automatic testing of communications receivers; accuracy is put at $\pm 0.002\%$

Signal generators, despite their usefulness for testing and calibration, are usually found lacking when used on the production line. Time is at a premium and calibration isn't always as accurate as it should be. Errors are the result.

To eliminate this source of error, the Kay Electric Co. has introduced the model 1522 L- and S-band telemetry f-m signal gen-

erator whose output frequency is digitally controlled. Moreover, both the output signal level and IRIG (interrange instrumentation group) channel selection can be controlled remotely. According to Arnold Seipel, design engineer at Kay, the 1522 will become part of computer-controlled testers.

Output frequency is programmable in 100-kilohertz steps from

1,400.0 to 1,599.9 megahertz for L band and from 2,200.0 to 2,299.9 Mhz for S band. Control is achieved with a three-decade binary-coded-decimal logic signal or by contact closure. Output level is 0 dbm—or 1 milliwatt—and attenuation is provided in 1-decibel steps down to -120 dbm. Programming is by contact closure. Continuously variable attenuation from

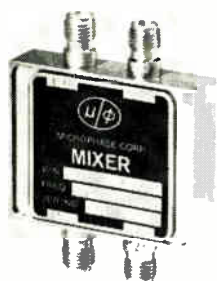

Balanced mixers series 2000 cover the frequency range from 1 to 12.4 Ghz with 15% bandwidth. Noise figures vary between 7 and 9.5 db with isolation typically 10 db. The mixers use beam-lead Schottky-barrier-type diodes, welded into the circuit and passivated. Size is 1.50 x 1.25 x 0.375 in. and weight is less than 1 oz. Microphase Corp., 35 River Rd., Cos Cob, Conn. [401]

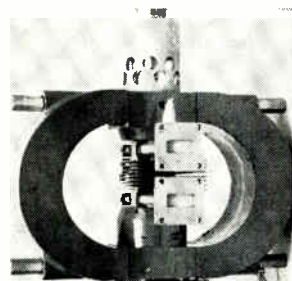

Five-cavity pulsed klystron amplifier model V-24E is for use as a final power amplifier in high-resolution coherent radar systems. It delivers a peak output of more than 50 kw over any specified 100-Mhz tuning range between 9 and 10 Ghz. It features a high gain of at least 54 db and a 1-db bandwidth of 40 Mhz. Varian Associates, 611 Hansen Way, Palo Alto, Calif. 94303 [402]

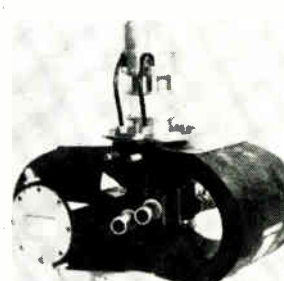

Two pulsed-type Amplitron tubes are announced. The 8774 is capable of 100 kw peak power over the frequency range 2725 to 2875 Mhz. The QKS1343 is capable of power output levels from 0.5 to 1.5 Mw over a frequency range of 5.4 to 5.9 Ghz. Both are integral magnet tubes with waveguide input and output. They use forced liquid cooling. Raytheon Co., Waltham, Mass. [403]



Step attenuators series TA-1150 are offered typically in 10 db, 50 db and 100 db units with steps of 1 db, 5 db and 10 db respectively for use from d-c to 18 Ghz. In a typical test at L-band, less than 0.5° phase distortion was noticed relative to a unit with zero db attenuation. Units are smaller than a 2 in. cube. Solitron Microwave, 37-11 47th Ave., L.I.C., N.Y. [404]



Ultraminiature 3 db 90° couplers are offered in octave bandwidths from 30 Mhz to 8 Ghz. Maximum isolation for the series is 18 to 20 db. Maximum vswr is 1.20 to 1.25. Maximum insertion loss is as low as 0.2 db. Power handling capability is 200 w average and 5 kw peak. Units measure 1.4 x 0.25 x 0.14 in. Anaren Microwave Inc., 478 E. Brighton Ave., Syracuse, N.Y. [405]



High sensitivity detectors are for use from 1 to 12.4 Ghz over full octave ranges. The XG series is supplied with replaceable point contact diodes; the XH series, with replaceable Schottky diodes. Minimum tangential sensitivity is -50 dbm; recommended bias, 30 μ a; output capacitance, 8 pf. Price is from \$55. Microlab/FXR, 10 Microlab Rd., Livingston, N.J. 07039. [406]

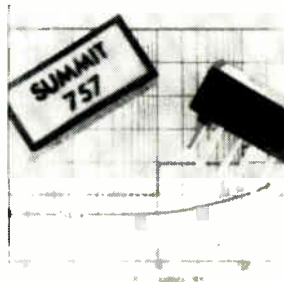

Miniature double balanced modulator model 757 features port-to-port isolation of greater than 50 db and conversion loss of less than 5 db. Other features are low intermodulation, wide dynamic range, and a thermal epoxy bedding for the diode quad which maintains this performance over -55° to 100° C. Summit Engineering Corp., Box 115, Bozeman, Mont. [407]

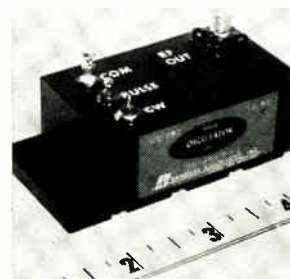

Solid state oscillator DG623 functions as either a c-w or pulsed oscillator for telemetry bands from 2,200 to 2,300 Mhz. It features a minimum output of 2 w pulsed, and 1 w in c-w mode. Input is 30 v d-c at 375 ma (max.). Frequency shift is less than 10 Mhz over a temperature range of -20° to +55° C. Sanders Associates Inc., Box 907, Nashua, N.H. [408]

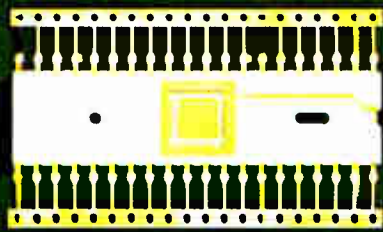

40 leads
1.050 row center

Chip area
.215 x .211

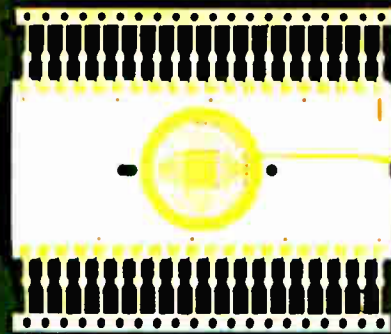

40 leads
1.050 row center

Chip area
.215 x .211

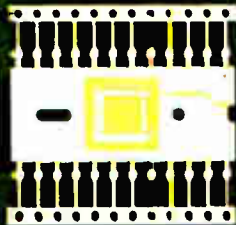

20 leads
.525 row center
Chip area
.215 x .211

20 leads
.525 row center
Chip area
.215 x .211

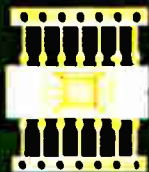
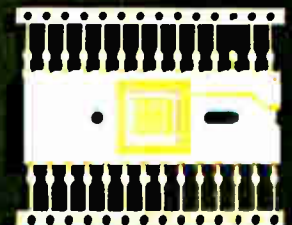

10 leads
.262 row center
Chip area
.125 x .117



10 leads
.262 row center
Chip area
.125 x .117

New ALSiPAK STANDARD Packages

Shown Actual Size

The monolithic construction of the new ALSiPak® package gives rugged RELIABILITY. It eliminates problems of hermeticity and has greatly improved strength. It has superior thermal conductivity because there is no glass in this package.

The leads are brazed to the metallized ceramic on the bottom which allows maximum chip cavity and bonding room. The number one lead and every fifth lead are identified inside the cavity for your convenience. Within limits, the standoff height can be tailored to meet special needs. The same basic lead frame is used on all packages. ALSiPak packages are dimensionally accurate and uniform with an index hole and slot for your automated handling. All packages having the same lead row spacing use the same lid. Solder preform tooling and metal lid tooling are available for each package.

Standard designs have the seal ring and chip pad grounded to No. 1 lead. For a slight extra charge you can have seal ring and/or chip pad connected to any other specified lead(s). Electrical flexibility is provided by a disconnect notch which can electrically isolate both the seal ring and chip pad.

The standard ALSiPak packages shown here have been in production for a number of months. They have been developed through many prototype production steps. We are indebted to engineering and production men in leading electronic firms for their collaboration and excellent recommendations. Other sizes and styles are in development and will be standard when demand and developments indicate.

We are now in volume production and can discuss realistic deliveries. Tell us what you need and we can work out firm schedules.

CODE IDENT. NO. 70371

American Lava Corporation 3M

PHONE 615 265-3411 • CHATTANOOGA, TENNESSEE 37405, U.S.A.

A SUBSIDIARY OF 3M COMPANY

For service, contact American Lava representatives in Offices of Minnesota Mining and Manufacturing Company in these cities (see your local telephone directory): Boston: Needham Heights, Mass. • Chagrin Falls, Ohio • Chicago: Elmhurst, Ill. • Dallas, Tex. Indianapolis, Ind. • Laurens, S. C. • Los Angeles, Calif. • Metropolitan New York: Riegelsfield, N. J. • Up-State New York and Canada: Phoenix, New York • Orange, Conn. • Philadelphia, Penna. • Roanoke, Virginia • St. Louis: Lee's Summit, Mo. South San Francisco, Calif. • International: c/o American Lava Corporation, Chattanooga, Tenn. 37405, U.S.A. • TELEX 558432.

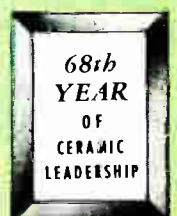



INDIANAPOLIS IS TRANSPORTATION

Indianapolis is 20 automobile and truck equipment manufacturers . . . 5 aerospace manufacturers . . . and 10 other plants producing equipment for boats, bicycles, road builders, and rail roads.

Indianapolis is international headquarters for 3 major moving van lines . . . over 100 established motor carriers operating in and out of the city . . . direct air and rail service to most cities . . . and 7 Interstates—more than any other city.

Indianapolis is on the move . . . perhaps that's why 35 members of the transportation industry have selected Indianapolis for manufacturing sites. For information, for assistance on sites, buildings and other data, write **John Hardy, Dept. 123, Area Development Director, or call collect (317) 635-6868.**

*Companies over 1000 employees

INDIANAPOLIS *Power & Light* COMPANY

INDIANAPOLIS, INDIANA 46206

0 to 3 db is also provided. IRIG channel selection is programed with contact closure.

Stability. Besides the 1522's programming capability says Seipel, the signal generator has a very stable carrier frequency. Accuracy is $\pm 0.002\%$ after a half-hour warm-up. Stability, which includes drift and incidental frequency modulation, is ± 2 khz peak for one minute, ± 5 khz peak for 10 minutes, and ± 15 khz for one hour. Residual frequency modulation is said to be 1.5 khz on L band and 2.0 khz on S band.

To achieve this level of accuracy, phase-lock techniques are employed. A 1-Mhz crystal oscillator is used as a reference. This frequency is divided down to either 2.5 khz for L band or 1.666 khz for S band, and fed to a phase comparator. The phase comparator drives a differential amplifier, which controls a 300-to-350-Mhz voltage-controlled oscillator (vco). The vco's output is mixed with a 50-Mhz frequency-modulated signal, and the sum is selected and multiplied by either a factor of 4 for L band or a factor of 6 for S band. The result is the output signal.

In the control loop, the vco output is also mixed with a 275- or 300-Mhz signal from another crystal oscillator. Here, the difference signal is divided by 10 and fed to a digital control circuit, the output of which is fed back to the phase comparator to close the loop. The digital control circuit allows the 100-khz step control of the output frequency.

Specifications for the 1522 include 1.5-db peak-to-peak leveling across each band, and 50-ohm output impedance into a type N connector. Spurious signal output is 50 db below the calibrated output level, harmonic outputs are 20 db below calibrated output, and peak f-m deviation is ± 3 Mhz. Internal modulation inputs are provided for IRIG channels 1 through 21; frequency accuracy is $\pm 2\%$, and harmonic distortion is less than 0.5%.

External f-m input impedance is 1,000 ohms shunted by 45 picofarads.

Delivery time is from six to eight weeks; price is \$4,900.

Kay Electric Co., Maple Ave., Pine Brook, N.J. 07058 [409]

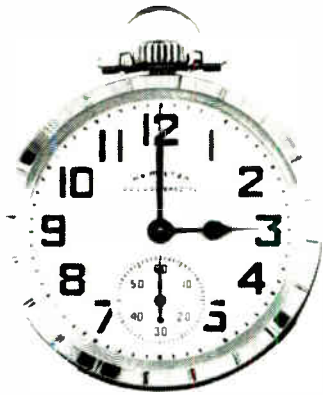

actual size

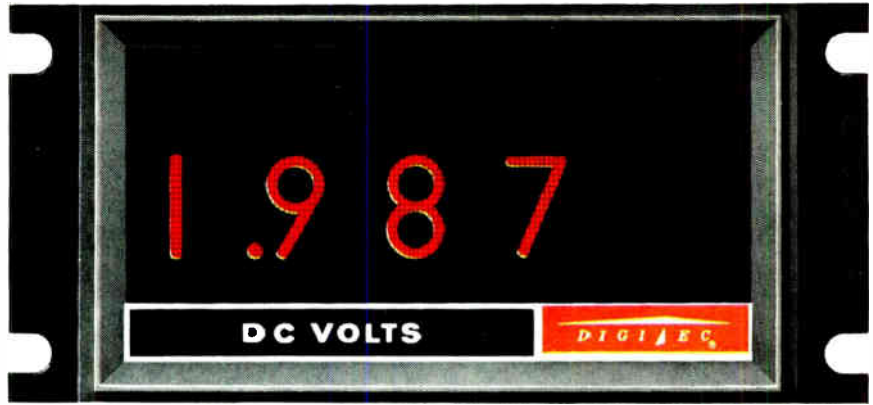

NEW Series 270

...time to go DIGI/EC

with the smallest, low cost, all solid state digital panel meter

- Size: 2 1/16" x 4 1/2" x 7 7/8"
- Accuracy 0.1%
- D.C. Ranges from 200MV and 20 μ A
- Non-blinking display
- High Input Z 100M Ω
- 100 μ V/ digit resolution
- Fast sample rate
- Completely self-contained
- Reading retention
- B.C.D. option

\$195
QTY. 1-9

\$129
QTY. 100

DIGI/EC by UNITED SYSTEMS CORPORATION

Representatives
Throughout the World

918 Woodley Road • Dayton, Ohio 45403 • (513) 254-6251

Circle 199 on reader service card

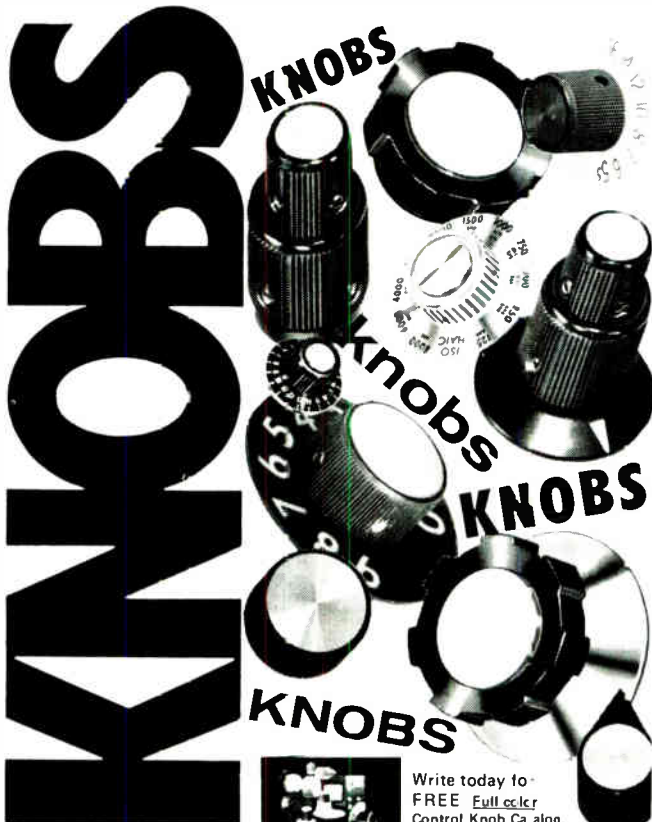

Outline your requirements for quotation and FREE knob sample

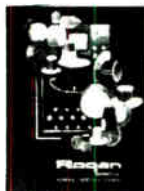

Write today to
FREE Full color
Control Knob Catalog

Rogan
BROTHERS INC

8031 N. Monticello Ave.
Skokie, Illinois 60076
312/675-1234

Circle 200 on reader service card

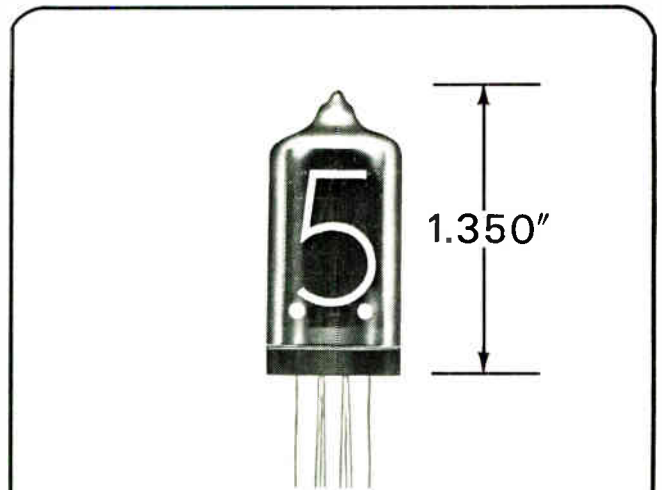

NEW NL-950 READOUT TUBE

Replaces: B-5750 B-5855 B-5859

- made in Geneva, Illinois U.S.A.
- request bulletin

NATIONAL
ELECTRONICS, INC.

a varian subsidiary

PHONE: (312) 232-4300 • GENEVA, ILLINOIS 60134

Circle 198 on reader service card 155

Is the 901 counter-timer just too good to be true?



Shown with optional 1.3-GHz plug-in.

NO!

But we can't blame you if you think so.

Picture a state-of-the-art, 200-MHz, universal counter-timer selling for \$250 to \$1000 below the competition. Having trouble? Picture won't focus? Of course not. Cheap price tags usually mean cheap products.

Focus in again. This time, picture technological breakthroughs—new circuitry and new components that the competition hasn't caught up with yet. Now, see how easy it is to make a better product and sell it for less, too?

How much better is the CMC 901? Take a look. Range: 200 MHz (instead of 125 or 135) without prescaling or plug-ins. Gate times: $1\mu\text{sec}$ to 100 sec instead of to just 10 sec. TIM: built-in, with a resolution of 10 nsec instead of 100. Input sensitivity: 20 mV instead of the usual 50 or 100. Readout: 9 decades not just 8.

But specs aren't everything. How about the Model 901's "universality"? Besides counting to 200 MHz directly

(and 1.3 GHz or 3.3 GHz with optional plug-ins) the 901 also scales signals, measures time interval, period, and multiple-period average. It provides frequency and multiple-frequency ratios as well as total count; and, as an optional extra, it can be operated completely by remote control. The basic price tag? Just \$2475. So we can't blame you if you're skeptical, but would you be happy if you bought a lesser model and paid more?

For the full facts, circle the reader service card.

COMPUTER MEASUREMENTS COMPANY



12970 Bradley/San Fernando, Calif. 91342/(213) 367-2161/TWX 910-496-1487

A weight-and-see approach to stress testing

Weights enable mechanical vibrator to produce sinusoidal motions while applying up to 7 g's of force; vibration frequency is 50 hz

For stress testing of electronic gear, nothing beats the mechanical shaker table for low cost. The trouble with these shakers however, is that neither the predictability nor the repeatability are sufficient for precise measurements. One answer has been to use electronically-controlled vibrators, which require specially trained operators. But this is a costly approach.

Engineers at the Ogden Technology Laboratories, however, have come up with another—and less expensive—answer. The Monterey Park, Calif., company is offering a mechanical complex-wave vibration machine that gives sinusoidal motions—but costs only \$2,600. It can test-shake electronic assemblies at up to 2,000 hertz and can apply forces variable from 2 to 7 g's.

The vibrator, which Ogden calls the Rotocon RC-4-50/2000, can be used on production lines for sub-assembly or final assembly stress testing. Once the vibrator is adjusted, an on-off switch and a timer are the only controls an operator need touch.

A series of 9-pound cylindrical steel weights are encased in three-sided steel enclosures attached to

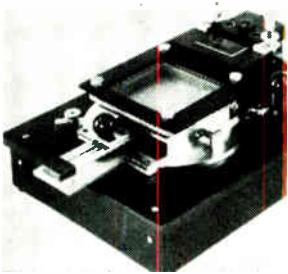

Manual contact printer developed for the thick film industry is for substrates up to 2 in. square by ¼ in. thick. It accommodates any frame or etched mask up to 8 x 10 in. Snap-off separation of printed pattern is obtained by parallel motion of the frame assembly on vertical die set pins and bushings. Engineered Technical Products, P.O. Box 1465, Plainfield, N.J. 07061. [421]

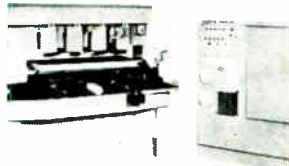

High production, p-c board drilling machine series 6000 features high accuracy. It is a tape controlled 4-spindle machine with 20 x 20 in. X-Y table travel and a 2-axis numerical positioning control system with tape punch, joy stick, optics for programing and a part programing feedback system that eliminates drilling errors. Digital Systems Inc., E. Edna Place, Covina, Calif. [422]

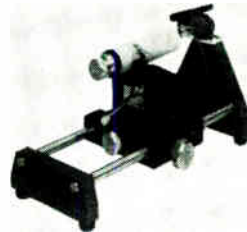

Percussive arc, butt welding bench fixture model ABF-202 features a joy stick adjustment for exact parts positioning and a single-lever control for wire retraction and firing operations. Moving the single control, which replaces individual Y and Z controls, saves substantial time in wiring multiple connectors. Protronic Industries, Inc., 2415 S. Manchester Ave., Anaheim, Calif. [423]



Semiautomatic air abrasive resistor trimmer for hybrid circuits operates on a 3 second prober/shuttle cycle. With a 1 second average trim time, the production rate of the model RA-650 is 900 units per hour. Accuracies of 0.5% or better over a range of 10 to 100,000 ohms can be obtained, depending on the measuring bridge. Axion Corp., 6 Commerce Park, Danbury, Conn. [424]

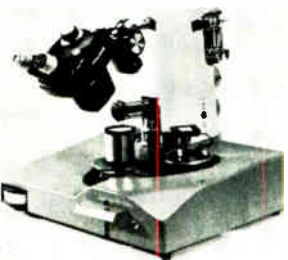

Mechanical die bonder model 642 reduces chip waste and speeds bonding. The die is picked up from a mirrored dish and placed precisely with the proper orientation onto the workpiece. Then a low frequency scrub is applied that assures a firm, void-free bond. Scrub force can be varied as needed for different-size chips. Kulicke and Soffa Industries Inc., Ft. Washington, Pa. [425]

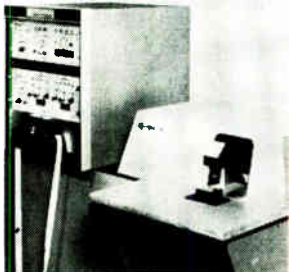

Precision high speed system for programmed automatic control and X-Y positioning of a focused laser beam is for application in laser trimming of thick film resistors and other laser processing operations. Positioning accuracy is within 0.1 mil per inch. A programmed digital actuator controls stepping motor indexing. Electroglas Inc., 150 Constitution Drive, Menlo Park, Calif. [426]



Toroidal coil winder model TO-125CE offers fast flexible changes in set up. The winder handles a wide range of finished coils from 0.035 in. i-d to 5 in. o-d using virtually every type of wire ranging from 16 to 50 Awg. Circuitry is all solid state with push-button controls arranged for operator convenience. Leeson Corp., Coil Winding Machinery Division, Danbury, Conn. [427]

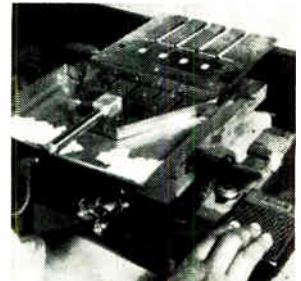

Thick film engineers can screen as many as 4 substrates at a time using an ejector mechanism that is tied in with the screen printer through a cam timer mechanism. At the end of the cycle, the substrates (usually ¼ x ¼ in.) are pushed forward automatically. Rates are as high as 2,500 printed substrates per hr. Aremco Products Inc., Box 145, Briarcliff Manor, N.Y. [428]

Time \$haring Economy

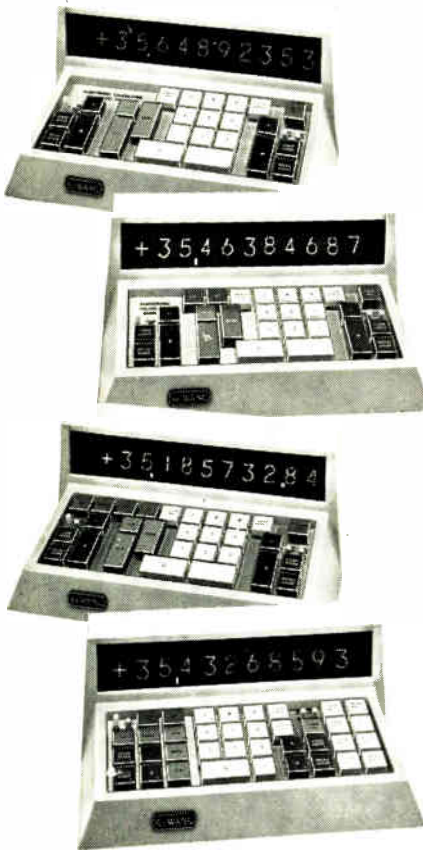

Model 200
General Business Calculator
 Half-cent round off, +, -, ×, ÷, reciprocals, percentages, chain multiplication, weighted averages, automatic extension, etc. Two independent adders, a product register, large readout display and automatic floating decimal point.
\$860.00 per station*

Model 210
Statistical Calculator
 All the features and functions of the Model 200 plus \sqrt{x} and x^2 by single keystroke for $\sum x$, $\sum x^2$, $\sum y$, $\sum y^2$, $\sum (x+y)$, $\sum x \cdot y$, $\sum \sqrt{x}$, and $\sum \frac{1}{x}$
\$970.00 per station*

Model 320
General Purpose Calculator
 All the features and functions of the 210 (except half-cent round off) plus $\log x$ and e^x by single keystroke for more advanced statistical, scientific and engineering calculations.
\$1282.50 per station*

Model 360
Extra Storage Calculator
 All the features and functions of the Model 320 plus four extra data storage registers for complex calculations without re-entry of intermediate results.
\$1497.50 per station*

*Four keyboards operating simultaneously from a single electronic package

...exclusively with Wang electronic calculators

You'll get more for your money when you need more than one calculator. Wang's unique multiple-keyboard concept lets up to four operators utilize the electronic speed of its "brain" simultaneously like large time-shared computers. The briefcase-size "brain" can be located anywhere up to 200 feet from the compact keyboards. Choose any of the models above when you want economy without sacrificing performance. **JUST ANNOUNCED! Model 301 Column Printer; plugs into any of the models above to validate input and permanently record output.**



Dept. 7H, 836 North St., Tewksbury, Massachusetts 01876 • Tel. 617 851-7311

Call today!

(201) 272-7160	(301) 588-3711	(314) 727-0256	(512) 454-4324	(615) 266-5055	(714) 234-5651
(203) 288-8481	(301) 821-8212	(315) 463-9770	(513) 531-2729	(615) 889-1408	(716) 381-5440
(205) 881-5360	(303) 364-7361	(317) 631-0909	(515) 288-5991	(615) 523-8648	(717) 236-4782
(206) 525-2000	(304) 344-9431	(404) 633-6327	(516) 437-2500	(616) 454-4212	(805) 962-6112
(212) 682-5921	(305) 563-8458	(412) 366-1906	(517) 835-7300	(617) 851-7311	(808) 536-5359
(213) 776-2985	(309) 674-8931	(414) 442-0160	(518) 463-8877	(617) 542-7160	(813) 877-6590
(214) 361-7156	(305) 841-3691	(415) 692-0584	(601) 982-1721	(702) 322-4692	(816) 444-8388
(215) 642-4321	(312) 297-4323	(502) 426-1116	(608) 244-9261	(703) 595-6777	(817) 834-1433
(216) 333-6611	(313) 352-2144	(505) 255-5775	(612) 881-5324	(703) 359-6320	(918) 747-0018
			(614) 488-9753	(713) 666-2451	(919) 272-5683

the vibrator's top plate. The table top becomes the fourth side of the enclosure. Once during each revolution of the drive system, the weights bounce off a rubber pad at one end of their capsule and strike the table top. This action produces a series of shock pulses that contain usable harmonics of the 50 hz generated by the drive system; a ½ horse power motor spins the weights in contrarotation at 3,000 revolutions per minute, thus generating the 50-hz vibrational frequency.

Adjustable. As long as the components under test, together with their mounting brackets, equal 120 pounds, the vibrations are predictable. Weights can be added to

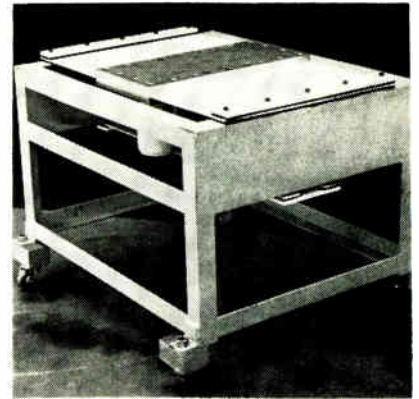

All shook up. Vibrator offers low-cost answer to simulating known stresses on the production line.

raise the test weight of light equipment and assemblies to the 120-pound level.

Adjustment of frequency and g forces is provided by altering the rotation of the spinning weights and the throw of the encapsulated weights.

According to Ogden engineers, encapsulated weights need checking only about once every three months, thus affording a high level of test repeatability. When adjustment is needed, the job can be done with an accelerometer, band-pass filter and rms voltmeter.

Sound-muffling enclosures, which limit noise to 75 decibels, are optional. Delivery time is up to six weeks.

Ogden Technology Laboratories, 573 Monterey Pass Rd, Monterey Park, Calif. [429]

evening classes won't fit your schedule?

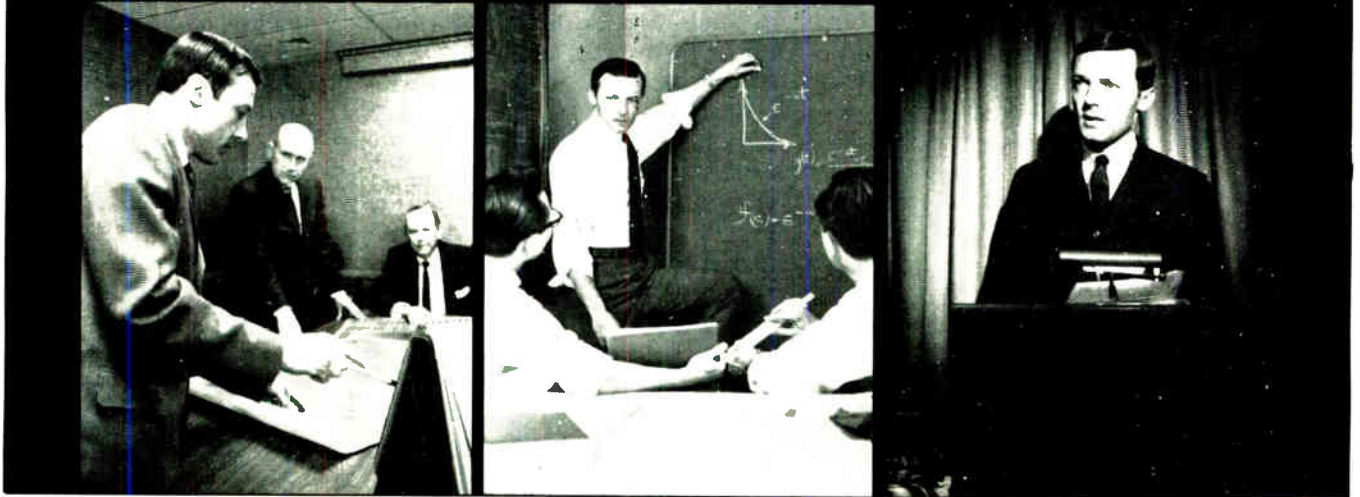

here's a practical way to keep up with new developments

Are irregular hours, travel and family obligations keeping you from attending classes—even though you worry about becoming technically obsolescent? Check into the Special Programs in Electronics for Engineers developed by CREI, the Home Study Division of the McGraw-Hill Book Company.

These are not simply courses, but comprehensive programs in advanced electronics offering major electives in such fields as:

Communications Engineering, Aeronautical and Navigational, Television Engineering, Automatic Control Engineering, Missile and Spacecraft Guidance, Radar and Sonar Engineering, Nuclear Instrumentation and Control, Computers.

Industry-recognized CREI Programs make it possible for you to catch up on new developments in electronics through study in your own home, at your own pace,

your own schedule. Free book gives complete information and details of technical material covered. For your copy, mail coupon below or write: CREI, Home Study Division, McGraw-Hill Book Company, Dept. 1870H, 3224 Sixteenth St., N.W., Washington, D.C. 20010.

Founded 1927



Accredited Member of the National Home Study Council



CREI, Home Study Division, McGraw-Hill Book Company
Dept 1870H 3224 Sixteenth St., N.W.
Washington, D.C. 20010

Send me free brochure describing CREI Programs in Electronics for Engineers.

NAME _____ AGE _____

ADDRESS _____

CITY _____ STATE _____ ZIP CODE _____

COMPANY _____

TITLE _____

Thick-film voltage regulators given muscle

Capable of tighter output voltage tolerances than monolithic IC units, one hybrid version handles 120 volts and another handles 59 volts

In the race between monolithic IC's and hybrid thick-film circuits for high-power honors in voltage regulators, the monolithics have had the lead—the highest-rated units, are capable of handling as much as 45 volts. Now, Beckman Instruments Inc.'s Helipot division has pushed the hybrids ahead with two voltage regulators. Model 807 handles from 30 to 59 volts and

model 808, from 60 to 120 volts. Both are rated at 0-to-150-milliamperere load current.

John Cole, a Beckman project engineer, says two monolithic regulators, in series, can be run at 60 volts. But, he points out, the operating characteristics of both devices are degraded, and the operation of the dual circuit is governed by the specifications of one or the

other integrated circuit.

Beckman engineers cite as a big advantage in their hybrid regulator the capability of adjusting for tolerances. This can't be said of monolithic regulators, says Lyle Pitroff, sales engineer at Beckman. According to Pitroff, the zener diode reference in monolithic regulators usually has a tolerance of about 5 percent. And he points out, be-



Linear positive follower amplifier and current booster model 9510 provides the user with true 100 Mhz bandwidth. It can be used with virtually any operational amplifier to increase the output driving capability without upsetting the stability of the op amp. Minimum slewing rate is $\pm 2,000$ v/ μ sec. Single units cost \$56. Optical Electronics Inc., P.O. Box 11140, Tucson 85706 [381]

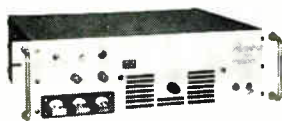

Constant current a-c supply model 250S-CC provides 250 v-a output with full power current ranges of 0.6, 10, 50, and 200 amps. Current is adjustable from zero to maximum within any range and is regulated to better than 0.5%. Variable frequency ranges are from 10hz to 10 khz. Industrial Test Equipment Co., 20 Beechwood Ave., Port Washington, N.Y. [382]



Infrared detectors series J-10 operate at liquid nitrogen temperature and cover the wavelength range from the visible through $5\frac{1}{2}$ microns. The photosensitive element is of single crystal indium antimonide. Sensitivities are available to 20×10^{10} cm/w at 5 microns with time constants of less than 2 μ sec. Judson Research and Mfg. Co., Conshohocken, Pa. 19428 [383]



Solid state synchro to linear d-c converter model 1637 can replace gear trim servos in dozens of applications at a 90% savings in price and size. Operating temperature is -55° to $+85^{\circ}$ C. Temperature stability is 0.8 minutes/ $^{\circ}$ C. The converter is 2.6 cu in. and sells for under \$100 in lots of 1,000. Transmagnetics Inc., 134-25 Northern Blvd., Flushing, N.Y. [384]



Wideband analog multiplier model 105 has 10 Mhz -3 db bandwidth and a 250 v/ μ sec slew rate. It is capable of a full power response of 20 v peak-to-peak out to 4 Mhz. Accuracy is specified to be 1% for 4 quadrant operation. Unit is short circuit protected and suited for p-c mounting. Hybrid Systems Corp., 95 Terrace Hall Ave., Burlington, Mass. [385]



Servo amplifier 972A needs no external components, yet drives a 9-w, 400-hz servo motor. Size is $1 \times \frac{3}{4} \times \frac{5}{8}$ in. Transfer gain is X500, input impedance 20 kilohms, and required B+ only ± 28 v, d-c unregulated. Heat sinking is through the base. The circuit is overload-protected and rfi-quiet. Price is \$110 in lots of 1,000. Industrial Control Co., Farmingdale, N.Y. [386]

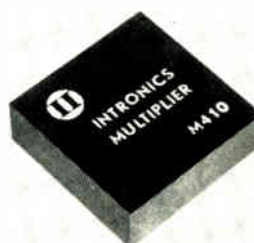

Multiplier model M410 can be used for multiplying, dividing, squaring or square rooting. Bandwidth is d-c to 600 khz, 100 khz full output. Accuracy is better than 1% with external adjustments. High temperature stability is 0.03%/ $^{\circ}$ C. The unit measures 1.5 x 1.5 x 5 in. Price in lots of 100 is \$46; delivery, from stock. Intronics Inc., 57 Chapel St., Newton, Mass. [387]

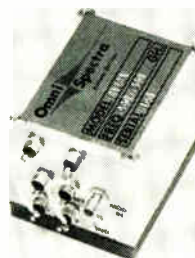

Voltage tuned solid state oscillator 0S8128A maintains linearity of ± 1 Mhz from the best straight line over a frequency range of 460 to 560 Mhz with power output of 10 mw minimum. Frequency stability is held to ± 1 Mhz from -30° to $+85^{\circ}$ C. Tuning voltage is ± 8 v d-c at 5 ma max. Omni Spectra Inc., 253 S. Hinton Ave., Scottsdale, Ariz. [388]

Signalite

Sets The Pace In Gas Discharge Tubes and Glow Lamps

Signalite started supplying neon glow lamps as an indicator device a most two decades ago. Since then Signalite developed the neon lamp into a circuit component that has solved problems in areas from voltage regulation to photo cell drivers . . . from SCR triggering to unregulated power supplies.

Today, Signalite is a leading source for Neon Glow Lamps as indicators and circuit components.

Today, Signalite is a leading source for spark gaps designed to transfer energies and act as voltage sensitive switches.

Today, Signalite is a leading source for noise tubes and miniature noise sources for noise figure test equipment and monitoring system receiver sensitivities.

Only Signalite offers you this in-depth experience, capability, facility and technology in gas discharge devices and glow lamps . . . backed by an R&D program to explore new markets and devices.

Signalite Application Engineers are available to you. Share your design problems with them. They'll choose the right product for your application or design custom units to meet unique requirements.

Yours For The Asking . . . brochures on neon lamps, spark gaps, noise sources. Application Newsletter on technique and application of these products.

A General
Instrument
Company



Signalite

INCORPORATED

1933 HECK AVENUE
NEPTUNE, NEW JERSEY 07753



IR LED'S

Great little performers: 1.5 mW min. @ 100 mA.

And all the power they need is .15 W.

Fast, too. Switching time is light-quick — typically 1 nanosecond.

Long life and reliability are assured by our with-it planar solid-state technology.

Put those features together with their instant availability and you've got a good reason to call Schweber, Kierulff, K-Tronics or Semiconductor Specialists.

Get all the details about our four varieties of IR LED's by writing to us at 10131 Bubb Road, Cupertino, California 95014.

Monsanto

cause the IC's resistors are either diffused or pinch resistors, they can't be trimmed once the device is made.

"We have the same 5 percent tolerance in the zener reference," Pitroff says, "but we can easily adjust for it by trimming the final resistor after the semiconductor devices are attached to the substrate." This results in an output voltage tolerance of 1 percent.

Except for the voltage rating, both the 807 and the 808 have identical specifications. Both regulators achieve up to 4 watts at 25°C case temperature and 1.6 watts in free air at 25°C.

Sample and compare. A triple Darlington circuit having a high current gain is used in both devices. The circuit's input current is the difference between the constant current from a current source and an amplifier output current. The current source operates between an unregulated input voltage source and a common line to produce an initial regulated constant current that is essentially independent of variations in the input voltage. A transconductance amplifier samples part of the output voltage, which is determined by an output divider, and compares it with a precision reference voltage to determine the amplifier output current. When the output voltage is greater than the reference voltage, the amplifier output current increases.

A single transistor operates as a current-limiting amplifier, which is controlled by an external resistor network. Pitroff says the regulators are literally short-circuit proof. Although the output voltage is predetermined, it isn't permanently tied to the output terminal. The user, says Pitroff, can add pass transistors to increase the output current capability without altering the output voltage.

The models 807 and 808 have an output voltage stability of ± 0.5 percent and an output voltage temperature coefficient of ± 0.015 percent per degree C. Input voltage is a minimum of 6 volts above the output voltage, and the maximum is 150 volts. Both models are priced at \$35 each in quantities under 10.

Helipot division, Beckman Instrument Inc., 2500 Harbor Blvd., Fullerton, Calif. 82634 [389]

VISHAY LOWERS THE COST OF HIGHER RESISTANCE VALUES



NOW TO 50K

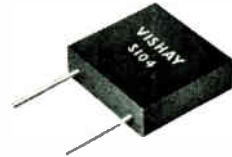

NOW TO 100K

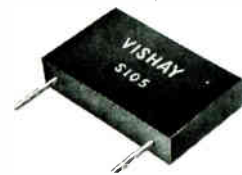

NOW TO 150K



NOW TO 200K

Now Vishay extends resistance values of its standard styles by 66% . . . lets you use a precision resistor that's smaller and costs less than the larger size you needed before!

You get these savings without a single compromise of Vishay's unique spec package . . . the "no-trade-off" performance specs that only Vishay can offer.

- Tolerance (Abs.): to 0.005% ■ TC (any value): $0 \pm 1 \text{ ppm}/^\circ\text{C}$. (0° to $+60^\circ\text{C}$) ■ Stability: Shelf 25ppm/yr. (50/3 yrs.), Load $< 0.02\%$ max. (0.15w. @ 125°C ., 2000 hrs.) ■ Speed: 1ns., no ringing (non-inductive) ■ Noise: Non-measurable

This complete Data Catalog tells how Vishay does it, where you can use them and gives complete spec data on Vishay Precision Resistors. Send for your free copy today.

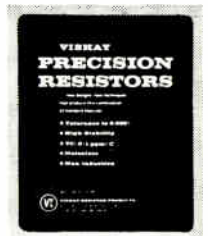

VISHAY RESISTOR PRODUCTS

a division of Vishay Intertechnology, Inc.



63 LINCOLN HIGHWAY
MALVERN, PA. 19355

PHOTOSENSORS AND LED_s FROM ENL

SILICON PHOTODIODES

Types 663, 671

- Large-area 5 and 10 mm diameter detectors
- High sensitivity, low capacitance, fast response
- Guard-ring structure assures low leakage current and low noise
- 10 ns response time, .3 to 1.1 micron sensitivity
- Suited for 1.06 μ radiation detection
- Hermetically sealed packages. Also available in monolithic four quadrant arrays.

Type 622 (3.0 ns response time)

- Totally depleted PiN structure

- Response time, 3.0 ns; sensitivity, 0.5 amp/watt
- High reverse breakdown voltage allows high optical background operation
- Available in 1 mm diameter or 1.7 mm square sensitive area
- Packaged in TO-46 housing with flat window

Detector-Op Amp (Model 682)

- Low-noise silicon detector with hybrid operational amp in TO-5 package
- Sensitive area 2 mm x 2 mm
- Typical peak response 2.5 x 10⁴ volts/watt with 400 KHz bandwidth
- Unit price \$50 each



Special Photodiode Products

- Enhanced blue response photodiodes with greater than 90% quantum efficiency at 4000Å
- High density mosaic photodiodes with active area arranged in binary form
- Staggered 2-line arrays with 0.003 x 0.003 inch areas, 0.006 inch center-to-center, completely integrated with operational amplifiers

PHOTOTRANSISTORS

The industry's most complete phototransistor line designed to economically and flexibly fill most industrial and commercial optoelectronic sensing applications from single units to high density uses. Models 916L and W offer maximum sensitivity in hermetically sealed can with lens.

Molded epoxy encapsulated units give lowest cost for high volume applications.

Flat window units with wide field of view accommodate fiber optics interfacing. All devices are silicon, npn, planar, high gain phototransistors.

Applications in industrial control, intrusion detection, punched card or tape readers, position sensors, industrial counting, photo choppers, and shaft encoders.

Device	Package (see photo)	Quantity Price	
		1-99	1000 +
916E	3	\$ 1.70	\$0.52
916L	1	\$10.50	\$4.20
916W	2	\$10.50	\$4.20
917E	4	\$ 4.75	\$1.90
918L	5	\$ 6.25	\$2.50
918W	6	\$ 6.25	\$2.50
918E	7	\$ 4.75	\$1.90

VISIBLE AND INFRARED LIGHT EMITTING DIODES (LEDs)

Low Cost GaAs

- Designed to complement the high density application phototransistor line
- Available in packages as illustrated
- 0.9 micron emission matches peak silicon response
- Package selection provides highly directional or divergent output beams
- Also available for military or space applications

GaP

- Designed to emit in the green region of visible spectrum (5600Å) coinciding with peak response wavelength of the human eye
- Desirable for visual display and optical film writing
- Packaged in glass diode (DO-7) or molded epoxy lens (TO-18)

- Also available: Red Emitting GaP Diodes (6900Å)

Diode	Package (see photo)	Quantity Price	
		1-99	1000 +
473 (GaAs)	1	\$ 6.25	\$ 2.50
404E (GaP green)	3	\$50.00	\$20.00

Optically Coupled Isolators (Model 3N 903)

- Specially combined high gain phototransistor and GaAs LED
- Provides signal transfer where electrical isolation is necessary
- Current transfer ratio typically greater than 1.0 due to high sensitivity and efficient optical coupling
- Packaged in single-ended 4-lead TO-18 housing

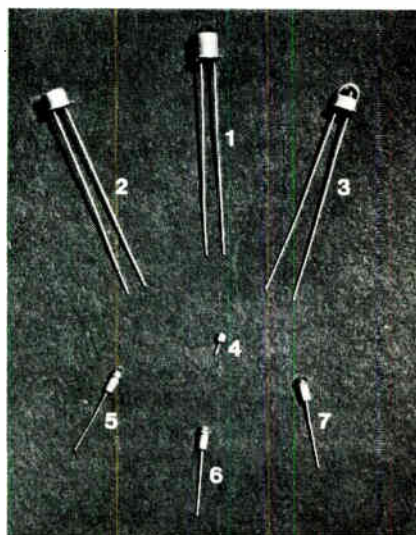

Complete product literature and price information on request.

Also available, long wavelength detectors: Ge, InAs, InSb to provide response to 7 μ .



ELECTRO-NUCLEAR LABORATORIES, INC.

115 Independence Drive, Menlo Park, Calif. 94025 • Phone (415) 322-8451

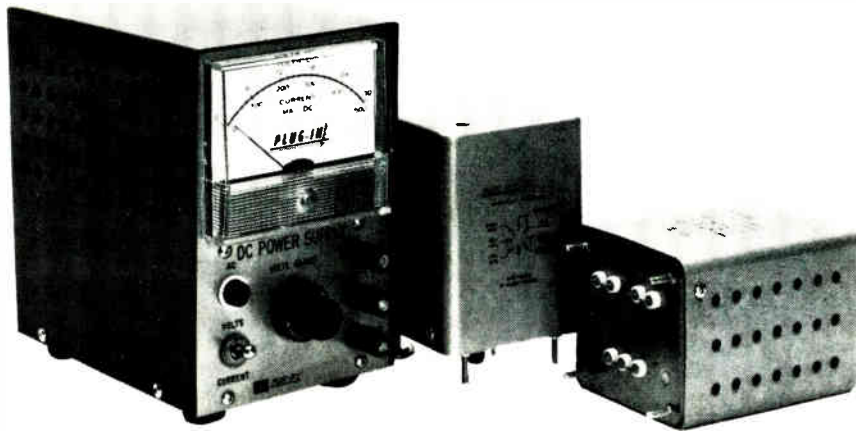

Regulated DC Power Supplies—from stock!

PRICES START AT UNDER \$50.

Single and dual output voltages up to 6 watts.

Wide range and slot voltage models.

Solder header and plug-in styles.

New Rosemount Plug-In dual voltage models are available with up to 175 MA DC output rating. Ideal for integrated circuits and operational amplifiers.

Our new wide range (10 volt adjustable) DC power supplies can serve multiple uses without sacrificing performance.

Further, ripple specifications have been improved on many slot voltage styles, and the output current rating of the silicon transistorized laboratory power supply has been increased to 500 MA.

All outputs are floating, individually adjustable, and have short circuit and reverse current protection.

FOR ORDERING INFORMATION,
REQUEST CATALOG 5000B, JUST OFF THE PRESS.



**ROSEMOUNT
PLUG-IN, INC.**

1416 Lebanon Road
Nashville, Tenn. 37210

(615) 244-1330

New subassemblies

Power-module line is keyed to IC's

112 models are offered, all using building blocks; regulation is 0.005%

A combination of quality specifications, modular construction, integrated circuits and low price make for an attractive price-performance package. This is just what Deltron, Inc., has done in designing its N-series power modules, which will be introduced by the company next month at Wescon.

In all, the N-series consists of 112 models, which range in price from \$79 to \$289, depending on case size. Eight case sizes are available in 14 different power ratings. The smallest case measures 5-by-5-by-4 $\frac{3}{4}$ inches; the largest measures 9-by-9-by-8 $\frac{1}{4}$ inches. The power capacity of the smallest case ranges from 3 volts at 3.8 amps to 48 volts at 1 amp. The largest case handles power combinations ranging from 3 volts at 36 amps to 48 volts at 12 amps. Input power may vary from 105 volts to 120 volts a-c at 45 to 440 hertz.

Each module in the N-series has a line and load regulation of 0.005 percent, which the company says is ten times better than that of comparably priced units. This regulation level stems from an IC regulatory system, which also prevents thermal transients from affecting stability. Rms ripple and noise are held to 500 μ volt and the temperature coefficient is 0.02 percent. The units also feature adjustable cutback current limiting with automatic recovery after overload is removed.

With accessories, N-series power modules can be turned into complete power supply systems. Two metered panels (\$35 to \$37 each), five back adapters (from \$20 to \$42), a crowbar (\$30) and five blank panels (from \$4 to \$9) are available.

Deltron Inc., Wissahickon Ave. North Wales, Pa. 19454 [390]

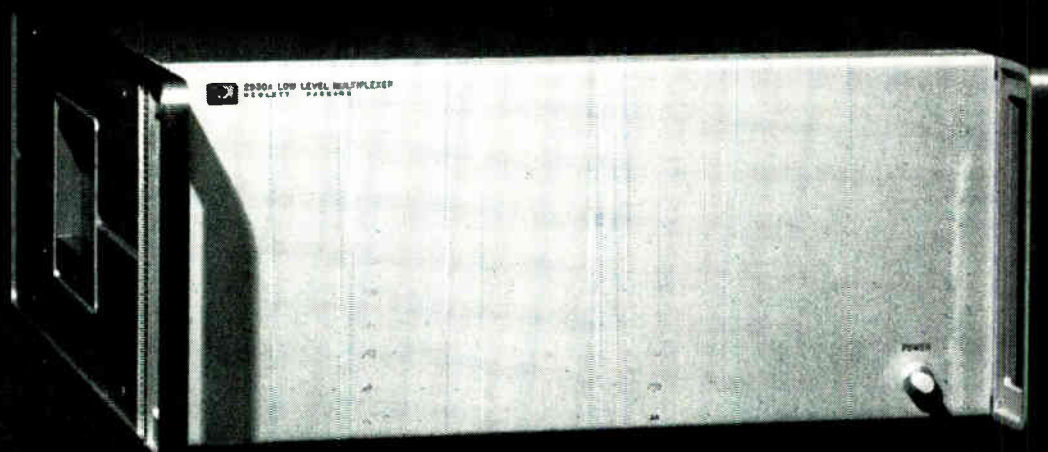

The Much-Better Multiplexer

There's only one multiplexer that can boost millivolt-level signals to 10-volt levels at switching rates to 20 kHz—with 120 dB common mode rejection and cross-talk below 100 dB.

It's the Hewlett-Packard 2930A Low-Level Multiplexer, featuring MOS FET switches and a fast-recovery amplifier that settles in 40 microseconds. Channel gain can be programmed in 11 binary steps from 10 mV to 10 V. For noise rejection or bandwidth limiting, there's a choice of nine plug-in second and third order presampling filters.

And interfacing with any A-to-D converter and 16-bit or 12-bit computer is straightforward through one of five plug-in interface cards.

Channel capacity is plug-in expandable from 3 to 64 channels in the mainframe; several multiplexers can be controlled through one computer I/O channel. Ask your HP field engineer about other advantages of the HP 2930A Low-Level Multiplexer. Or write Hewlett-Packard, Palo Alto, California 94304; Europe: 1217 Meyrin-Geneva, Switzerland.

HEWLETT  PACKARD

DATA ACQUISITION SYSTEMS

06906A

Circle 165 on reader service card

TUBULAR,
BULKHEAD
MOUNTING TYPE

RFI/EMI FILTERS

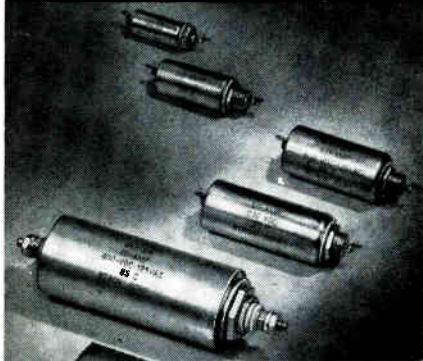

Rtron

Cylindrical Style Interference Filters

that reduce or eliminate unwanted noise or signals. Small size, light weight, maximum attenuation. Voltage current or insertion loss characteristics required, determine physical size. Maximum isolation of terminals and high frequency performance are assured by threaded neck design for bulkhead mounting. Feed-thru capacitor circuitry conservatively rated for both military and commercial applications.

Rtron corporation

P.O. Box 743 Skokie, Illinois 60076

- Send catalog and prices.
- Have Representative call for appointment.
- Specifications enclosed on Multi-circuit or custom design filters. Send estimate.

Name _____

Firm _____

Address _____

City _____

State _____ Zip _____

New Books

Network coverage

Introductory Topological Analysis of Electrical Networks
Shu-Park Chan
Holt, Rinehart and Winston Inc.,
482 pp., \$15.95.

If there is a single book that effectively covers the topic of topological analysis, then this could be it. Essentially a compilation of the author's lecture notes, the book nevertheless provides a basic introduction to the subject. Moreover, the author wisely included some of the significant new results in topological analysis of active networks, and flow-graph applications to linear systems.

Matrix theory appears throughout the book because the author believes that today's engineer will use a digital computer for solving his problems—and matrix theory is required. Circuit theory and control systems are stressed as the two

major applications of topology.

Unless the reader has had a course in matrix algebra and linear transforms, he will have to consult the appendix, which contains discussions of determinants, matrixes, and linear equations, together with their proofs. The appendix can also serve as a handy "refresher."

The first three chapters constitute an introduction to the theory of linear graphs. Beside basic definitions, these chapters describe theorems, network matrixes, and duality. Chapter 4 deals with the matrix formulation of network relationships through loops, nodes, and state equations.

In the remaining chapters, the author describes topology for passive networks both with and without mutual inductance. Switching theory and single-contact networks are also discussed. A brief introduction to topological synthesis is also offered.

Recently Published

Technological Forecasting and Long-Range Planning, Robert U. Ayres, McGraw-Hill Book Co., 237 pp., \$12.50

A discussion of procedures used by forecasters in the electronics, missile aerospace and nuclear fields. Examples of both good and bad forecasting are given. Methods covered include morphological analysis, extrapolation of trends, and heuristic and intuitive forecasts.

Antenna Theory, Robert E. Collins and Francis J. Zucker, McGraw-Hill Book Co., 666 pp., \$24.50

The first of a two-volume text, this book is a compendium of chapters from 19 authorities in the field. It is written as a graduate-level text with exercises and sample problems, but would also be useful for working engineers. Subjects covered include uniformly spaced arrays, linear antennas, conical and spheroidal structures, slot antennas, and open waveguides.

Random Processes, Communications and Radar, William M. Brown and Carmen J. Palermo, McGraw-Hill Book Co., 325 pp., \$15.50

Covering such topics as optimum filtering, detection theory, and information

theory, this book centers on the problem of determining performance limitations of communications and radar systems. Applications and practical results are also discussed.

Introduction to Numerical Control in Manufacturing, Raymond E. Howe, American Society of Tool and Manufacturing Engineers, 170 pp., \$8.85

A primer on numerical control, the book discusses the evolution of the field's technology, elements and systems, and applications to metal-cutting and other machines. It is the first in a series of books on N/C planned by ASTME.

Physics of Semiconductor Devices, S.M. Sze, John Wiley & Sons, 787 pp., \$19.95

Intended for first-year graduate students in electrical engineering and applied physics, and for solid-state-device research scientists, this text can also serve as a reference book on most of the important semiconductor devices. It deals with the operational parameters and the physics of operation of semiconductor devices, particularly in the microwave area; it includes microwave transistors, Impatt diodes, Gunn oscillators, opto-electronic devices, and interface devices such as Schottky diodes and MOS structures. In addition, 30 tables of important material and device characteristics can prove useful.

ADAC

A Versatile New Computer-Controlled Data Acquisition and Control System

...starting at less than \$30,000!



...with
plug-in
expandability!

Start with the basic ADAC, and you have a compact, hard-working system which will acquire analog data from a variety of sources, and process and store the data in an integral general-purpose digital computer for a broad range of recording and control applications. And all this at a price well below other currently available models.

Now, expand ADAC to provide for added inputs and a variety of recording and monitoring devices. It's easy with Astrodata's unique new *Intercoupler*. In most cases, your "custom" output requirements probably already exist as standard designs for ADAC. Inexpensive, too — little or no engineering charges and volume production techniques reduce expansion costs to the minimum.

Whatever your particular application... seismic studies, spacecraft checkout, nuclear reactor monitoring and control, petrochemical process analysis and control, etc.... ADAC can easily and inexpensively be your solution. Get full details today on this new, versatile data acquisition and control system.

Write or call...

ASTRODATA

Astrodata Inc., 240 E. Palais Rd., Anaheim, Calif.; (714) 772-1000.

Circle 167 on reader service card

KEPCO

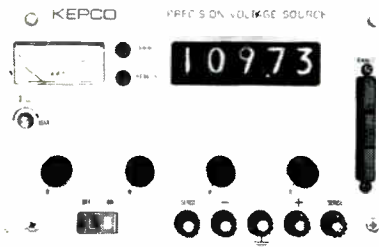

Model PVS 100-1M-Price \$875.00

DIGITALLY CONTROLLED VOLTAGE

KEPCO'S PRECISION VOLTAGE SOURCE features a 4½ digit voltage readout with four rotary selectors and a three-button decade range switch. The combination provides 100 microvolt sensitivity in ranges of:

0.0000 — 1.0999 volts
00.000 — 10.999 volts
000.00 — 109.99 volts

Model PVS 100-1M is a husky power supply capable of delivering 100 watts with a source impedance less than 1 milliohm at d-c. Line variations (105-125V a-c) have less than 0.0005% effect on the output setting and the oven-controlled reference, reduces temperature effects to 0.005% per °C.

The overall accuracy of 0.02% qualifies the Precision Voltage Source as a working standard for low cost voltage calibration.

For systems, the output can be programmed by remote 1-2-4-8 BCD switch closures.

**with KEPCO
IT'S CONTROL!**

For complete specifications
write Dept. CA-14



131-38 SANFORD AVENUE • FLUSHING, N.Y. 11352
(212) 461-7000 • TWX # 710-582-2631

168 Circle 168 on reader service card

Technical Abstracts

LSI Design

Threshold logic for LSI
J.H. Beinart, D. Hampel, K.J. Prost
and R.O. Winder
RCA Laboratories
Princeton, N.J.
L.J. Michael
USAF Avionics Lab
Wright-Patterson Air Force Base

Previous research and development efforts in digital monolithic integrated circuits and arrays have been almost exclusively concerned with Boolean logic. However, by introducing threshold gates, fewer gates and interconnections are needed. Replacing logic subsystems such as registers, adders, counters, or control logic originally designed with common NOR logic, by subsystems containing threshold gates grants an average savings in gate count of three to one. Moreover, the number of connections between gates is reduced by a factor of two.

The advent of integrated circuits has made the threshold gate economically competitive with conventional gates. This results from the ability of the threshold gate to maintain close resistor ratios, close beta and V_{be} matching, and the importance of the total chip area rather than the number of active components.

A threshold gate is a digital circuit that produces a high output only when the weighted sum of its high inputs exceeds a prescribed value—the threshold. The inputs and outputs are restricted to binary values, and each input is assigned a weight, usually unity, but sometimes two or three. A majority gate is a special case, where each input has unity weight and whose threshold is half the number of inputs. An individual threshold gate can produce a much more complex switching function than can the conventional Boolean gates—NAND, AND, NOR, and OR.

In a program sponsored by the Air Force Avionics Lab, RCA set itself to develop a new family of threshold gates amenable to LSI. The objective of the program: bring forth a simple, low power threshold gate that can be built in modular form from an array

An inside look
at **AUSTRON**
Tuning-Fork
OSCILLATORS

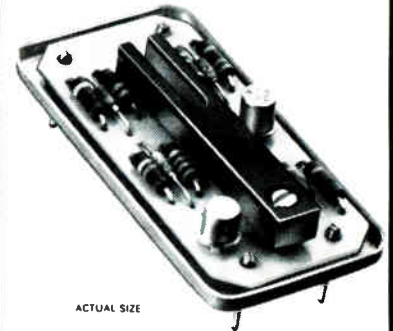

From the outside, most tuning-fork oscillators look alike. *But what's inside counts most!* Austron's TFO's are built to highest performance and reliability standards — from the inside out! Check these benefits:

- Frequency range — 50 Hz to 50 KHz
- Stability — .2% to .001%
- Direct DTL or TTL compatibility
- Microwatt input power
- On-time deliveries per your requirements

Call us to supply all your needs in TFO's
XO's, TCXO's and tuning-fork filters.



AUSTRON INC.
10214 NORTH INTERREGIONAL HIGHWAY,
AUSTIN, TEXAS 78753
TELEPHONE (512) 454-2581

Circle 211 on reader service card



**Cinch introduced 39 new products last year
...but we won't sell you any of them.**

**because every one
was custom designed
for a Cinch customer.**

And each one was designed to meet a special requirement. It may have been an extra-tight tolerance, unusual plating configurations, or even price. No matter what your special requirement might be, Cinch can not only design the connector you need—but we can build it too—on dependable delivery schedules. Cinch production capabilities, in plastic molding, selective plating and assembly are unequalled.

Why not let us build a connector for you that we won't sell to anyone else?

Contact any Cinch Electronics Group sales office or Cinch Manufacturing Company, 1501 Morse Ave., Elk Grove Village, Illinois, 60007 (312) 439-8800

C 6916

CINCH

DIVISION OF UNITED-CARR

**CINCH
ELECTRONICS
GROUP**

CINCH MANUFACTURING CINCH-GRAPIK, CINCH-MONADWOCK, CINCH-NULINE AND PLAXIAL DIVISIONS OF UNITED-CARR INC. A SUBSIDIARY OF TRW INC.

VACTEC Vactrols

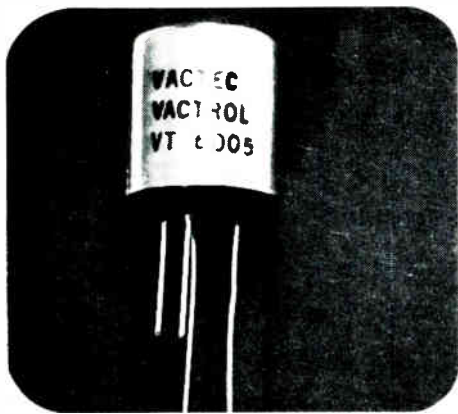

The standard of the VACTROL line is the inexpensive aluminum case, epoxy sealed VACTROL. Six types from 1.5v (incandescent) through 115v (neon). Less than \$1.00 in quantities of 1000.

VACTROL is one of several photon isolators (photocell-lamp modules) on the market. Competitors include Raysistors, Photomods, and Datacells. But none is better than VACTROL.

VACTROL lamps are the same as competitors (we all buy from the same suppliers). But because Vactec makes photocells exclusively, you'll find ours provide the finest, most consistent quality, characteristics, and service.

VACTROLS combine the same photocells we supply for critical camera applications, with the best lamps we can obtain. VACTROLS come up short in only one department. Price. And you don't mind that, do you?

**A complete line for every requirement:
LED, Incandescent, and Neon Types.**

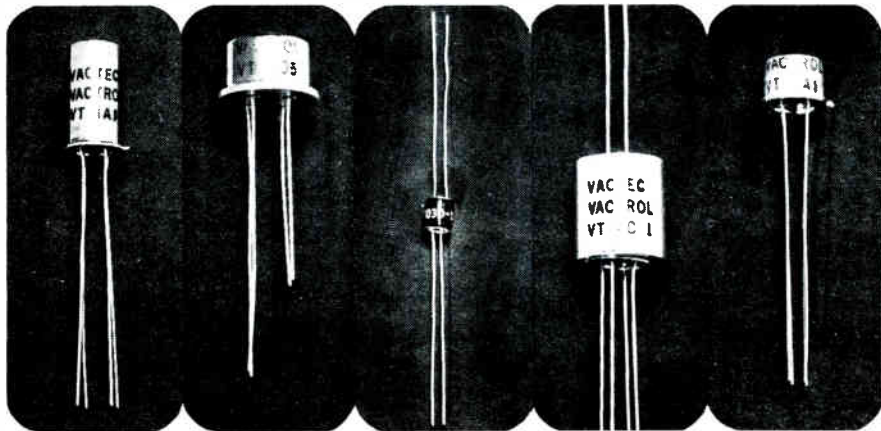

Hermetic TO-5

New hermetically sealed, welded enclosure with glass to metal feedthroughs. Between 25¢ and 30¢ more than standard low cost Vactrols in modest quantities. Available in low voltage (incandescent) and high voltage (neon) types. Bulletin PCD 4C3.

LED

Substitute a light emitting diode for the conventional lamp in photon isolators. VT 008-5 is hermetically sealed (modified TO-8). VT 030-18A is a TO-18 axial device, epoxy sealed. Extremely low signal requirements compared to conventional lamp devices. All solid state. No filaments to vibrate or burn out. Less than \$7.00 in volume.

Dual Isolated Photoconductor LED

An isolated dual element photoconductive cell coupled with a light emitting diode. Cell elements track to within 2% over 3 decades of illumination. Expensive compared to the others. Useful in making linear isolators, multipliers, and dividers. Demonstrates our commitment to the complete Vactrol line.

Low Profile TO-5 LED

Coming soon. New TO-5 LED Vactrol in a complete hermetic seal like the VT 008-5, in a smaller TO-5 package. Similar characteristics. Anticipated price less than \$6.00 in volume.

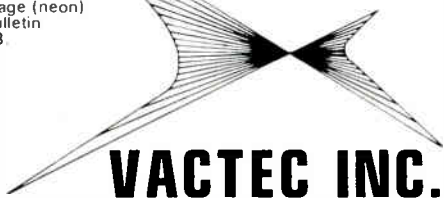

VACTEC INC.

2423 Northline Ind. Blvd. Maryland Hts., Mo. 63042 Phone (314) 432-4200

Specializing in standard Cds, Cdse, and Se cells, Custom engineering for every photocell need. Listed in EBG under "Semi-Conductors" and in EEM Sec. 3700.

170 Circle 170 on reader service card

Technical Abstracts

of subcircuits. A further aim was a report, written for the logic designer, to introduce the new methods of design needed to use threshold gates.

These objectives have been met. Basically, the approach enables a designer to produce a broad range of threshold functions in LSI form. The result is a more efficient chip area than the one possible from a logic design that uses Boolean function gates. There's no penalty involved in the use of these gates; high speeds are possible and the power-speed product per gate is compatible with alternate bipolar transistor circuit approaches.

Presented at the National Aerospace Electronics Conference (Naecon), Dayton, Ohio, May 19-21.

Soft landing

Digital letdown computer for vertical guidance
Bruce E. Mann
Lear Siegler Inc.
Santa Monica, Calif.

A real-time digital letdown computer calculates the guidance-command information necessary to direct a VTOL (vertical takeoff and landing) aircraft along a three-stage vertical path. The computer uses range and altitude information to determine the aircraft's position with respect to the desired path and calculates the altitude error.

The computer's speed requirement is achieved with transistor-transistor logic. Size and cost requirements are met by organizing the computer serially. The computer is capable of adding or subtracting two 18-bit words in 18 μ sec, multiplying and dividing words of the same length in 288 μ sec and taking the square root of a 30-bit word in 480 μ sec. An integrated scratch-pad memory provides fast access during read and write cycles.

In addition, by using successive approximation analog-to-digital conversion, analog inputs are multiplexed to one converter providing eight 12-bit digital outputs in 400 microseconds.

Present at the IEEE Computer Group Conference, Minneapolis, Minn., June 17-19.

Electronics | July 21, 1969

GEM

GOVERNMENT ELECTRONICS MARKET

TO BID OR NOT TO BID? ON IFB'S RFQ'S RFP'S

THAT IS THE QUESTION
ANSWERED EACH MONDAY
IN GEM WEEKLY REPORT

WRITE OR PHONE: 203-561-7800

DMS

100 Northfield, Greenwich, Conn. 06830
McGraw-Hill Publications

Circle 213 on reader service card

Get the Latest Facts On Electronic Packaging & Encapsulation Techniques

Electrical
Insulation
Conference

Attend the Electrical Insulation Conference for how-to-do-it workshop on molding, vacuum, spraying, thermoforming, conformal coating, melting, fluidized bed, foaming, pyrolytic coating, and other encapsulation techniques. Also, sessions on microwave and printed circuit materials, potting compounds, insulating films for SC devices and ICs, etc. Plenty of exhibits to see and other activities, too. Plan to come—Sept. 8-11 1969, Sheraton-Boston Hotel, Boston. Write or circle inquiry number for free booklet

FREE

ELECTRICAL INSULATION CONFERENCE
BOX 270 • LIBERTYVILLE, ILL. 60048 USA

Circle 212 on reader service card

FULLY TRANSISTORIZED

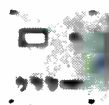

ACCURACY
RELIABILITY
LITTLE POWER CONSUMPTION
EASY OPERATION
EASY MAINTENANCE
DESIGNED FOR
INTEGRATED AUTOMATION
ELECTRONIC CONTROL SYSTEMS
DATA LOGGERS
(MANUFACTURED UNDER
HOKUSHIN LICENSE — JAPAN)

GENERAL SPECIFICATIONS

- Unified signal 2 ... 10, 4 ... 20, 0 ... 5, 0 (Input-Output) ... 10, 0 ... 20 mA etc.
- Load resistance 0 ... 3 Kohms
- Ambient temperature $-10^{\circ} \dots +60^{\circ}\text{C}$ (for field instruments)
 $-10^{\circ}\text{C} \dots +45^{\circ}\text{C}$ (for panel instruments)
- Power supply 200 or 220 V ($+10 \dots -15\%$) A.C. or 60 c/s)

ELECTRONIC CONTROL SYSTEMS INCLUDE:

- Temperature transmitters with
 - thermoresistance ($-200 \dots +500^{\circ}\text{C}$)
 - thermocouples ($0 \dots +1600^{\circ}\text{C}$)
 - radiation pyrometer ($+600 \dots +2000^{\circ}\text{C}$)
- Pressure transmitters with
 - Bourdon tube ($0 \dots 350 \text{ kgf/cm}^2$)
 - capsule ($0 \dots 1 \text{ kgf/cm}^2$)
 - bellows ($0 \dots 1000 \text{ mm Hg}$)
- Differential pressure transmitters with
 - bell ($0 \dots 100 \text{ mm H}_2\text{O}$)
 - bellows ($0 \dots 400 \text{ mm}^2\text{H}_2\text{O}$)
 - bellows ($0 \dots 35000 \text{ mm H}_2\text{O}$)
- Area type flow transmitters: $0, 24 \dots 54, 94 \text{ m}^3/\text{h}$
- Electromagnetic flow transmitters: $0, 41 \dots 1770 \text{ m}^3/\text{h}$
- Displacement type liquid level transmitters: $0 \dots 2000 \text{ mm}$.
- pH transmitters: $0 \dots 12 \text{ pH}$
- Water quality, psychrometer, mol ratio, concentration transmitters
- Miniature indicators
- 120 and 250 mm scale one and two point recorders
- Multipoint (2, 3, 6, 12) recorders
- Calculators and accessories: square root extractors, multipliers, dividers, adders-subtractors setters, program setter, integrators, signal limiters, manual control stations etc.
- Controllers —continuous (PI-PID) with and without indicators
 - Multipoint on-off controllers
 - Relay amplifiers
- Electro-pneumatic converters
- Computers: —multi-point scanner
—data logger

MASINEXPORT

Bucuresti — România Str. Matei Millo 7
Cables: MASEXPORT — Bucuresti
Telex: 216

Circle 171 on reader service card

171

FAST—10 MHz PRECISION



Analog Multiplier

The new M510 multiplier is a moderately priced, epoxy encapsulated transconductance multiplier featuring very fast operation with excellent linearity and temperature stability. The 5 MHz full output frequency and 10 MHz response suit the M510 to modulation, correlation, display systems, and other applications requiring fast performance.

- 5 MHz Full Output
- DC to 10 MHz
- 1% Accuracy
- 300 V/ μ s Slew Rate
- No Adjustments
- True 4 Quadrant
- 2 x 3 x 0.62 Inches

SPECIFICATIONS (25°C, ± 15 V)

Output functions	XY/10, X ² /10
Linearity X	0.5% max
Linearity Y	0.25% max
Input voltage X, Y	± 10 V to common
Input impedance X, Y	10 k Ω , common
Output (short protected)	± 10 V, 10 mA
Output impedance, dc	1 Ω max
Frequency response	
Small signal (−3 dB)	10 MHz min
Full output (20 V p-p)	5 MHz min
Gain temperature stability	$\pm 0.02\%$ /°C max
Offset temperature stability	± 1 mV/°C max
Power requirement	± 15 Vdc, 50 mA
Price (1-9)	\$295

See us at WESCON — Booth 2209



TWX 710-335-6835
(617) 332-7350

57 CHAPEL STREET, NEWTON, MASS 02158

New Literature

Alphanumeric teleprinter. Clary Corp., 320 W. Clary Ave., San Gabriel, Calif. 91776, has issued a color brochure on the Informer model SP-20 alphanumeric teleprinter, a compact, lightweight unit.

Circle 446 on reader service card.

Integrated circuits. Raytheon Co., 350 Ellis St., Mountain View, Calif. 94040. An 86-page illustrated catalog describes the company's line of integrated circuits. [447]

Shielded conduit fittings. Danex Corp., 60 Tomlinson Rd., Huntingdon Valley, Pa. 19006. A four-page brochure covers a complete line of emi-rfi shielded conduit fittings for red and black line communications. [448]

Tv relay links. RHG Electronics Laboratory Inc., 94 Milbar Blvd., Farmingdale, N.Y. 11735, offers eight-page product bulletin 69C on its solid state tv microwave relay links. [449]

Tantalum capacitors. Sprague Electric Co., 35 Marshall St., North Adams, Mass. 01247. Engineering bulletin 3703A contains complete details on hermetically sealed tantalum capacitors for operation up to 175° C. [450]

Linear IC testing. Teradyne Inc., 183 Essex St., Boston, Mass. 02111, has published a 12-page brochure on its new J263 computer-operated linear circuit test system. [451]

Digital-to-analog switch. Hallex Inc., 3500 W. Torrance Blvd., Torrance, Calif. 90509, has published a specification sheet on the model HX630 quintuple digital-to-analog switch. [452]

Ferroresonant power supplies. Electro Engineering Works, P.O. Box 338, Forestville, Calif. 95436, has available a technical paper describing high-voltage ferroresonant power supplies. [453]

Electron spectrometer. Varian, Vacuum Division, 611 Hansen Way, Palo Alto, Calif. 94303, announces a 12-page brochure describing the Auger electron spectrometer. [454]

Power instruments. Lambda Electronics Corp., 515 Broad Hollow Road, Melville, N.Y. 11746, has released a 16-page catalog on a line of all-silicon, convection-cooled power instruments for lab and test instrument use. [455]

IC encapsulation. National Semiconductor Corp., 2950 San Ysidro Way, Santa Clara, Calif. 95051, has available a reliability report on transfer mold encapsulation of integrated circuits. [456]

Computer applications catalog. Pulse Engineering Inc., 560 Robert Ave., Santa Clara, Calif. 95050. The 1969

computer applications catalog contains a complete listing of pulse transformers and delay tubes. [457]

Test accessories. Pomona Electronics Co., 1500 E. Ninth St., Pomona, Calif. 91766, has released its 1969 general catalog of electronic test accessories containing 375 products. [458]

Magnetic pickups. Airpax Electronics, P.O. Box 8488, Fort Lauderdale, Fla. 33310, has released a selection chart for choosing the correct magnetic pickup for speed measuring applications. [459]

Digital data logging. Invac Corp., 26 Fox Rd., Waltham, Mass. 02154. A 10-page brochure describes the series DL-100 digital data logging system. [460]

Oscillators. Greenray Industries Inc., 840 W. Church Rd., Mechanicsburg, Pa. 17055. An 82-page catalog includes new models in the frequency standards field, voltage-controlled oscillators, and temperature-compensated oscillators in low profile miniature sizes. [461]

Cabling systems. The Singer Co., 314 E. Live Oak Ave., Arcadia, Calif. 91006, has published a brochure depicting cabling systems designed for extreme temperature, pressure, and radiation environments. [462]

General purpose relay. Price Electric Corp., Frederick, Md. 21701, has released a data sheet on its new miniature general purpose relay, a 4 pdt 3 amp device. [463]

Surge voltage protectors. Siemens America Inc., 350 Fifth Ave., New York 10001, offers a six-page brochure describing its complete line of gas-filled surge voltage protectors. [464]

Semiconductors. Hughes Semiconductors, 500 Superior Ave., Newport Beach, Calif. 92663. A 1969 catalog gives complete specifications on all the company's semiconductors. [465]

High power pulse twt's. Varian, TWT Division, 611 Hansen Way, Palo Alto, Calif. 94303. A 10-page brochure describes a line of high power pulse twt's covering the 0.5 to 16.5 Ghz frequency range. [466]

Clips and sockets. Eldema, 18435 Susana Rd., Compton, Calif. 90221. Q-series clips and sockets for inexpensive, convenient mounting of C-lite cartridges are highlighted in a four-page brochure. [467]

High-temperature materials. Aremco Products Inc., Box 145, Briarcliff Manor, N.Y., has available high-temperature materials chart No. 523. [468]

Lever switches. Switchcraft Inc., 5555

Reticles

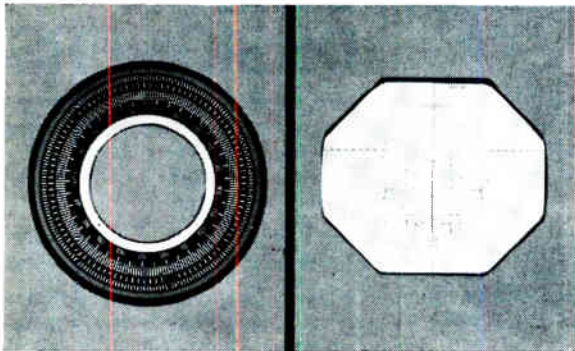

Precision etching of glass reticles, scales and other critical tolerance items is a specialty at Buckbee-Mears. We etch polished or water white plate, crown or flint glass to $\pm .0001$ " with lines filled permanently with a choice of compounds if required. We etch flat, concave or convex surfaces.

May we tell you more? See your Buckbee-Mears technical representative, or call or write Bill Amundson, our industrial sales manager.



**BUCKBEE - MEARS
COMPANY**

245 E. 6th St., St. Paul, Minn. 55101 / (612) 227-6371

Circle 214 on reader service card

Make your own break.

You can take a lot of the chance out of your future by including yourself in the Electronics Manpower Register.

When you do, your experience and talents become part of a nationwide computerized placement service.

Our computer is programmed to give every registrant the same look for every opening. With your prior approval, you'll be considered for every opportunity that matches your resume.

All you have to do is send one to:

Electronics Manpower Register
Electronics
330 West 42nd Street
New York, N.Y. 10036

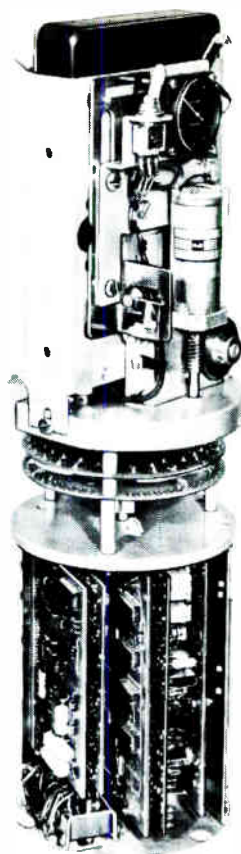

Oceanographic applications module with tape recorder, analog-to-digital converter, output register, programmer and multiplexer.

Braincon's recording artists.

Going places.

Braincon Corporation's new line of digital tape recorders for data acquisition systems upstages the others where low cost and high performance count.



Typical portable tape recorder for in-field data logging of industrial and scientific parameters.

- Flexible recorder programming to suit customer format and data rate
- Models for analog or digital input
- High capacity (up to 1/2 million characters)
- Lightweight all-weather models
- Convenient, reuseable tape cartridge
- Low cost per data point
- Self-contained, rechargeable battery pack
- Optional visual display for recorded data
- Unprecedented low system cost

For additional information, contact:

BRAINCON

a subsidiary of **GENERAL TIME**
Progress in the World of Time



MARION, MASSACHUSETTS 02738 / (617) 748-1085

Circle 173 on reader service card

173

LOWEST COST . . . FULL WAVE BRIDGE RECTIFIERS & ASSEMBLIES

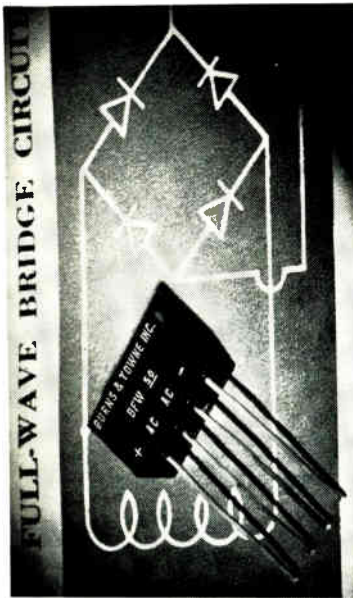

Burns & Towne pre-packaged rectifier circuits represent a significant cost savings over individual components used in multi-rectifier units. Yet, you are always assured of quality and reliability. The low cost BFW family of single phase full wave bridges . . . features high current capability of up to 2.0 amps.

Part No.	Max. PRV (volts)
BFW-50	50
BFW-100	100
BFW-200	200
BFW-300	300
BFW-400	400
BFW-500	500
BFW-600	600
BFW-800	800
BFW-1000	1000

Call or write for full specifications and price data.

BURNS & TOWNE INC.
18-36 Granite St.
Haverhill, Mass. 01830. Tel (617) 373-1333

New Literature

N. Elston Ave., Chicago. Solutions to operator error, fatigue, and other critical human engineering problems are described in lever switch catalog S-309a. [469]

Microwave components. Integral Industries Inc., P.O. Box 667, Lansdale, Pa. 19446. An eight-page brochure covers a line of solid state r-f microwave components. [470]

Antenna systems. Cubic Corp., 9233 Balboa Ave., San Diego, Calif. 92123, has prepared a brochure to describe its capability in the area of today's sophisticated antennas. [471]

Laser power supplies. Hadron Inc., 300 Shames Dr., Westbury, N.Y. 11590, has published a four-page illustrated data sheet on its line of power supplies for solid state lasers. [472]

Trimmer capacitors. LRC Electronics Inc., 901 South Ave., Horseheads, N.Y. 14845, has released its latest catalog featuring 28 new miniature trimmer capacitors. [473]

BITE indicators. A.W. Haydon Co., 232 N. Elm St., Waterbury, Conn. 06720. A four-page bulletin covers a complete line of BITE (Built-In-Test-Equipment) indicators. [474]

Data communication system. Ultronic Systems Corp., P.O. Box 315, Moorestown, N.J. 08057. Bulletin U2569 describes and illustrates the Ultracom data communication system, which eliminates the high cost of multiple leased transmission lines. [475]

Resolvers. Weston-Transcoil, Worcester, Pa. 19490, offers a folder on representative size 8 data transmission resolvers, including a temperature-compensated transmitter. [476]

Isolating coupler. Iso-Switch Corp., 2955 Randolph St., Costa Mesa, Calif. 92626, has available a new product and application bulletin on the Iso-Switch, an isolating coupler for digital data transmission circuits. [477]

Crystal filters. Dietz Design Inc., 100 Electronics Pkwy., Belton, Mo. 64012, has available a bulletin covering standard models as well as custom designed crystal filters. [478]

Current interrupters. Macarr Inc., 4360 Bullard Ave., Bronx, N.Y. Two new models of current interrupters for alkaline copper plating are described in bulletin EP-103. [479]

Key punch. Oneida Electronics Inc., P.O. Box 46, Yorkville, N.Y. 13495, has issued a bulletin describing the Telecard I key punch/data terminal that will both prepare and transmit cards. [480]

Opportunities for CIRCUIT DESIGNERS

Expanding activity on long-range programs and advanced projects has created many stimulating growth-assignments for Circuit Designers at Hughes.

Some of our most urgent requirements exist in the following areas:

- Development of high-power airborne radar transmitters, the design of which involves the use of the most advanced components
- Design of low-noise radar receivers using parametric amplifiers and other advanced microwave components
- Design of digital radar signal processing subsystem circuits, including range and speed trackers, doppler filter banks and a variety of display circuits
- Design of high-efficiency power supplies for airborne and space electronic systems
- Development of telemetering and command circuits for space vehicles and communications satellites

Requirements: an accredited Engineering degree, a minimum of two years of directly relatable experience and U.S. citizenship.

For immediate consideration, please airmail your resume to:

MR. ROBERT A. MARTIN
Head of Employment
Hughes Aerospace Divisions
Dept. 47
11940 W. Jefferson Blvd.
Culver City, Calif. 90230

HUGHES

HUGHES AIRCRAFT COMPANY
AEROSPACE DIVISIONS

An equal opportunity employer—M & F

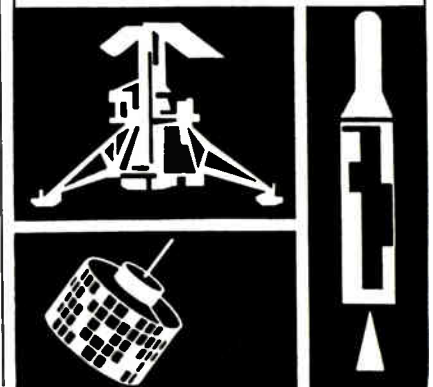

Make your own break.

You can take a lot of the chance out of your future by including yourself in the Electronics Manpower Register.

When you do, your experience and talents become part of a nationwide computerized placement service.

Our computer is programmed to give every registrant the same

look for every opening. With your prior approval, you'll be considered for every opportunity that matches your resume.

All you have to do is send one to:

Electronics Manpower Register
Electronics
 330 West 42nd Street
 New York, N.Y. 10036



EMPLOYMENT OPPORTUNITIES

ENGINEERS

The leader in the field of amorphous semiconductors and originator of Ovonic offers challenging engineering positions for qualified individuals with hardware design experience in computer memory, logic, or display subsystems.

ENGINEERING MANAGEMENT—Assistant to the Director of Engineering, with major responsibilities in the development of new products, including circuit design, testing procedures, and marketing evaluation and representation. Should be hardware-oriented with engineering project management experience in a computer oriented field.

ELECTRONIC DESIGN ENGINEERS—Responsible for the design, development and testing of new products incorporating amorphous semiconductor devices. Outstanding opportunities for creative designers with hardware experience in memory, logic, display, or automatic testing systems.

Top salaries and excellent fringe benefits for those who qualify. Please submit your resume to the Personnel Dept.



Energy Conversion Devices, Inc.

1675 W. Maple Rd., Troy, Mich. 48064

An Equal Opportunity Employer

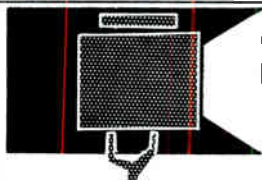

SEARCHLIGHT SECTION

- CLASSIFIED ADVERTISING • BUSINESS OPPORTUNITIES
- USED OR SURPLUS EQUIPMENT

*Somebody—
Somewhere*

needs your idle equipment!
 Reach that buyer quickly and economically thru the

“SEARCHLIGHT SECTION”

The meeting place of Used Equipment Buyers and Sellers

Minifluid DISPENSER
 AIR OPERATED
 for miniature potting and encapsulating

Available in 3 sizes
 6cc - 12cc - 30cc

\$34.00^{UP}

PHILIP FISHMAN COMPANY
 7 CAMERON ST., WELLESLEY, MASSACHUSETTS 02181

CIRCLE 955 ON READER SERVICE CARD

FUNCTION GENERATORS

We are overstocked. Tremendous savings on latest solid state function generators. Sine, square, triangle, ramp, complex. Laboratory quality. Every item 60% to 90% off. Absolutely will not last. Send for free brochure.

LABORATORY EQUIPMENT SALES
 15603 12th So., Seattle, Wn. 98148

CIRCLE 954 ON READER SERVICE CARD

RADAR SYSTEMS GROUND AND AIRBORNE. AUTOMATIC TRACKING ANTENNA SYSTEMS. NIKE AJAX. NIKE HERCULES. M-33. MSQ-1A. MPS-19. MPS-9. SCR 584. TPS-1D. TPS-2B. FAA-ASR-2. AIRBORNE SYSTEMS. APN-84. APN-102. APS-20. APS-27. APS-45. DPN-19. DIGITAL COMPUTERS. IBM 650. IBM 704.

LARGEST INVENTORY OF RADAR AND MICROWAVE EQUIPMENT IN THE WORLD.
RADIO RESEARCH INSTRUMENT CO.
 45 WEST 45TH ST. N. Y. 10036 212-JU 6-4691

CIRCLE 956 ON READER SERVICE CARD

Watch—
 the Searchlight Section
 for Equipment Opportunities

CIRCLE 953 ON READER SERVICE CARD



We have been placing B.S., M.S. and Ph.D. **ELECTRONIC ENGINEERS** in fee paid positions throughout the U.S. since 1959. Send resume today or request confidential application. We are graduate engineers, working full time . . . for you.

ATOMIC PERSONNEL, INC.
 Suite L, 1513 Walnut St., Phila., Pa. 19102
 AN EMPLOYMENT AGENCY FOR ALL TECHNICAL FIELDS

CIRCLE 952 ON READER SERVICE CARD

— RATES —

DISPLAYED: The advertising rate is \$79.00 per inch for all advertising appearing on other than a contract basis. Contract rates quoted on request.

An advertising inch is measured 7/8" vertically on a column—3 columns—30 inches to a page.

UNDISPLAYED: \$3.60 per line, minimum 3 lines. To figure advance payment count 5 average words as a line. Box numbers—count as 1 line.

Discount of 10% if full payment is made in advance for 4 consecutive insertions.

Not subject to Agency Commission.

Send new ads to:

ELECTRONICS

Class. Adv. Div., P.O. Box 12, N.Y., N.Y. 10036



Once we all took lessons in ultrasonics from the porpoise. But today, thanks to Branson's 23 years of concentration in the field and laboratory, what once seemed an obscure principle has now been applied as a practical working tool.

How far have we come? Yesterday's scientific phenomenon has become a full line of Branson Ultrasonic

Cleaners ranging from standard and custom units to rugged production-proven systems... plus a regular line of degreasers, and conveyerized and automated cleaning systems.

Result: Branson can handle cleaning from bulky castings to the most delicate electronic components.

If there's Ultrasonic Cleaning in your

future, don't you need someone with ultrasonic cleaning in his past? Find him at Branson.

Branson Instruments Co. a subsidiary of Smith Kline & French Laboratories, Progress Drive, Stamford, Connecticut 06904

BRANSON

For sound ideas in cleaning, testing and measuring

The silent world of working sound.

International Newsletter

July 21, 1969

Coordination in European quality control faces delay

Chances that France, Great Britain, and Germany will have a components quality control pact in force next year look slim.

The proposed pact would make quality control tests by a national laboratory in one country valid in the other two countries. Britain and Germany, though, still have to set up national quality control schemes. And French officials say they have no intention of reworking their own setup if the British and the Germans adopt different schemes. The French have an industry coordinating committee which establishes specifications and acceptance standards for components. Manufacturers then can have a production run of a component sampled and tested by an independent national laboratory, which certifies whether the whole lot qualifies as acceptable or not.

Negotiators for the three countries have set a target date of 1970 for agreement on standards and acceptance test procedures for passive components. But French industry officials think it will be 1971 at the very earliest before there'll be any sort of tripartite quality control recognition even for passive components.

British data bank goes commercial

Look for a fast growth in commercial data banks to supplement in-house computer-aided design programs. Britain's Racal Research Ltd. expects to be the first to offer a computer-based data bank service covering common electronic components.

When Racal's new computer-run service starts up this fall, it will give subscribers fast retrieval of data on components being considered in electronic design projects. The information needed for decision making—the component's price, dimensions, and performance parameters, as well as equivalent circuit performance—will be supplied in minutes. The system is designed to find the data and send out replies within two hours.

Customers will be able to access the bank, located at Racal's Tewkesbury laboratories by telephone, telex, or commercial data link. Initially, the service will be limited to common components—resistors, diodes, capacitors, and the standard transistors. Later, less common components, such as field-effect transistors, will be added to the data bank.

Two more navies to see through Seacat's eyes

The British Navy will not be the only one using the missile fire control television equipment developed by Marconi Co. Ltd. for Britain's Seacat surface-to-air missile. Contraves AG, Zurich-based military systems specialist, has become the first commercial customer for the equipment. Contraves plans to install \$850,000 worth of the equipment in fire control systems for delivery to two other navies—as yet undisclosed.

The television equipment is a key link in a missile visual guidance system. In Seacat use, it works like this: The television camera, hooked to an optical system, follows the target under the guidance of a radar system. When the missile enters the picture, an operator can direct it toward the target with a joystick control—or positional data can be taken automatically from the television signal and used to calculate trajectory correction signals.

Marconi's package includes television camera and optical system, a control unit and an image display. The camera unit can accommodate different vidicon tubes: regular for daylight, a secondary electron conduc-

International Newsletter

tion model for use in moonlight, or the latter plus an intensifier for use down to low starlight levels.

Belgrade in bid to join Intelsat

Yugoslavia may become the first Eastern Bloc nation to join Intelsat. Belgrade has already applied to the World Bank for a loan to start construction of a ground station. Should the loan be approved, Belgrade will more than likely follow it up with a formal application for admission to the international satellite consortium—as either a full or as an associate member.

Rumania is also weighing Intelsat membership. And the subject is certain to come up during President Nixon's stopover in Rumania later this month.

Leasco order boosts British computer maker

An order by Leasco World Trade for 30 Modular One small computers establishes Britain's Computer Technology Ltd., designers and builders of the machine, as serious competitors along with Honeywell, Hewlett-Packard and Digital Equipment for the small, fast machine market. Leasco will use the \$140,000 machines as the basis of its own European time-sharing network. Before the Leasco order, which runs over 30 months, the company had sold only a small number of machines—in one's and two's. Another sizeable order, for machines intended to process remote radar data for air traffic control displays, is likely to come later this year.

Modular One is a natural for time sharing and real-time applications. It offers high speed (750 nanosecond cycle time, capable of further reduction by an instruction overlap facility), plus program-protected memory organization, a feature generally confined to larger computers such as PDP 10, SDS's Sigma 5 and Honeywell 832. One disadvantage, though, is a softness in software back-up. Company has simply lacked funds to develop it. Thus, to date, buyers are organizations able to provide most of their own software.

Japanese develop high-power twt's

Three Japanese companies are in a hot race to develop new traveling-wave tubes for domestic use—and the results may well spawn a lucrative export product.

As Japan pursues a policy of switching all television broadcasting to uhf, the repeater-translator units used instead of CATV in the mountainous country must be reequipped. The smaller repeater-translators can get by with transistor—or conventional—output stages and the medium-sized units can use available traveling-wave tubes with outputs of 30 to 100 watts. But there are hundreds of repeater-translators with outputs in the 100 to 500 watt range, that will have to be replaced with larger uhf output units, or even two more units, because of the propagation differences between uhf and vhf. In addition, the number of television stations will expand because of the shift to uhf, adding fuel to the traveling-wave tube development race.

The Nippon Electric Co., the Tokyo Shibaura Electric Co., and Hitachi Ltd., have developed tubes with 3,000 watt output, rated at 1,000 watts in repeater-translator service. And they are working on both smaller and larger power versions, with an eye to satisfying the differing needs of other countries around the world.

Fast way to test for flicker noise

West German subsidiary steals a march on its American parent, develops transistor tester suitable for use on the production line.

For all the talk about international exchange of ideas, it's still a rare event when an overseas subsidiary of a large U.S. company beats its parent to a technological advance. This is especially true when it comes to testing and manufacturing techniques, usually adopted in toto by the subsidiary.

Texas Instruments Deutschland GmbH has just pulled off such a coup. Dissatisfied with conventional methods of testing for flicker noise, including those used back home in Dallas, it has come up with a transistor flicker noise tester that gives a reading in one second, rather than up to 50 seconds.

Because it takes so long to check each transistor, it's no wonder that quality control engineers at most semiconductor plants shy away from testing for flicker noise. Now, TI's new device means that flicker noise testing need no longer be confined to research labs, but can be a regular step in transistor production or quality control—at assembly line speeds.

Flickering. It's primarily makers of consumer electronic products who need to know a transistor's flicker noise characteristics, which can spell the difference between good and poor performance of equipment operating in the audio spectrum. Just what causes flicker noise is not known exactly. Researchers believe it results from spontaneous resistance variations in the transistor's barrier layers and from random changes in surface conditions, especially at the pn junction. And because of minute differences in component structure that crop up during the manufacturing process flicker noise is more pronounced in some transistors than in others.

Whatever its causes, flicker noise

is a nuisance. Its level is highest in the audio range, particularly in the 10- to 1,000-hertz portion. With increasing frequency, however, flicker noise decreases. Thus, it is often called "1/f" noise.

But it's at the low end of the audio spectrum that many transistors must operate. Low-frequency types are used, for example, in tape recorder playback units, hi-fi radios, and in high-quality I-F preamplifiers used in sound-studio gear. Requirements for such equipment sometimes call for bass signals to be boosted by as much as 20 db relative to frequencies in the center portion of the audio spectrum.

Speedy. Finding a low-flicker transistor in a certain batch has been a hit-or-miss affair for equipment makers. All too often equipment must be torn down, already

installed transistors replaced because they exhibit excessive flicker.

TI's flicker noise tester will put an end to this. It allows 100 percent transistor screening, thus insuring delivery of batches with acceptable flicker noise.

With the new equipment, designed by Wolfgang Sodtke of the company's applications lab, the transistor to be checked is placed in a test socket, and one second later its flicker noise figure can be read off a voltmeter. Prior to testing each batch of transistors, the typical operating point and the source impedance with which the devices will eventually operate are set at their specific values.

The reduction in test time is primarily the result of using an amplifier that broader band than laboratory flicker noise testers. In such testers noise power contained in

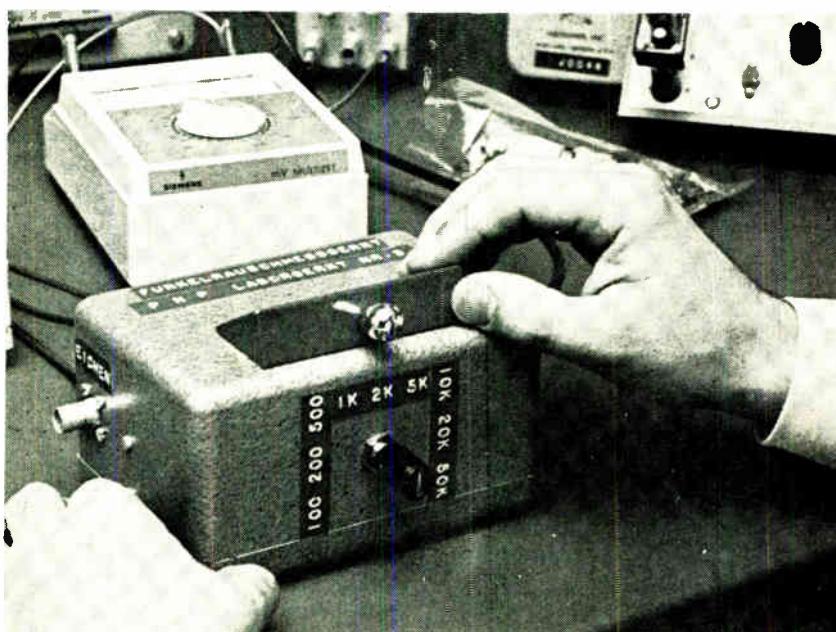

Enclosed. Transistor under test forms first stage of three-stage amplifier circuit. Cover is held down to shield device from stray fields.

a very small portion—from 1 to 10 hertz wide—of the noise spectrum is extracted and amplified. With such highly selective amplifiers it takes from 10 to 50 seconds for a valid measurement to settle down—too long for large-volume transistor test operations.

TI's new tester, on the other hand, uses a bandwidth on the order of 50 hertz, giving a response time of only one second.

Japan

Illogical logic

Building switching circuits out of linear circuits for large-scale integration appears to be a contradiction in terms. But workers at the Electrical Communication Laboratory of the Nippon Telegraph and Telephone Public Corporation and the IC Division of Nippon Electric Co. Ltd. have jointly announced a direct-coupled linear circuit that features low power dissipation, high speed, and few circuit elements per gate.

Although the basic building block of the new logic circuit has neither threshold voltage nor stable logic levels, these attributes of normal logic circuits appear if several stages are connected in cascade.

Basic elements of the circuit are NOR gates consisting of two or more transistors with their emitters and collectors connected in parallel. Gates of individual transistors are used for inputs. The circuit resembles that used in current mode logic, or emitter coupled logic, except that the transistor connected to a reference voltage source is removed—which eliminates the current switching feature of CML.

Update. Although the designers don't say so, the new circuit might also be considered an improved version of the direct-coupled transistor logic that was used some years ago. Use of the resistor in the emitter circuit and selection of the proper value of circuit supply voltage prevents driving the transistor into heavy saturation or into the cutoff region—and also prevents the current hogging problem that

plagued designers of the old DCTL circuit.

This same choice of parameters limits circuit gain to slightly more than unity. That is, when driven by an identical circuit the output voltage change is almost exactly equal to the input voltage change—and transfer characteristics are essentially a straight line without the transitions at either end that normally characterize switching circuits.

It is this almost linear transfer characteristic that helps give the circuit fast response, because a small change in input signal is able to initiate a change in output signal. In most other types of logic circuits with normal switching-type transfer characteristics, the output does not start to change until input change is large enough to push a transistor into its active region.

Together. With stages in cascade, the output voltage of one stage is the input voltage of the following stage, and stable logic level is developed at the points where the two sets of transfer voltage curves intersect. In experimentally fabricated circuits, emitter resistors of 100 ohms and collector resistors of 140 ohms are used, giving the two logic levels. In these circuits, power supply voltage of about 1.1 volts was chosen, and logic swing is about 0.4 to 0.5 volts. Average power consumption per stage is about 2 milliwatts, and propagation delay per stage averages about 2.4 nanoseconds. This gives a propagation-delay/power-consumption product one-tenth that of smaller conventional circuits.

Thus the circuit meets the requirements for LSI use, which include high speed, low power consumption, and simple basic circuit. Because LSI design minimizes pickup of noise, difference in temperature between different circuit elements, and changes in device characteristics, it is possible to use low values for power supply voltage and logic swing.

Storage of energy that usually occurs in transistors driven into saturation, or heavily OFF, has also been minimized in the new circuit. The lack of stored energy con-

tributes to fast response, but also lowers noise immunity, because smaller energy pulses are sufficient to trigger circuit operation.

The small noise margin and relative lack of noise immunity means that this circuit is only ideal for logic functions within the confines of a LSI chip. It may also be suitable for hybrid LSI circuits consisting of several ordinary or medium scale integrated circuit chips within one package, but tests are still underway. Between packages it is necessary to convert to conventional logic, such as CML or TTL.

Researchers think one example of design might include a logic hierarchy, with the new circuit used for logic functions within chips, CML used for driving other packages on the same printed circuit board, TTL used where signals must be transmitted through back-board wiring, and cable-driver circuits used between bays.

Great Britain

Down to the wire

Though plated wire is leading the pack in the search for a high-speed yet low-cost alternative to toroidal ferrite core stores, the race is not yet over. Researchers are still examining other methods of storing a 1 and a 0, in the hope of finding something even easier to make in large quantity with consistent quality. In England the Scientific Instrument Research Association

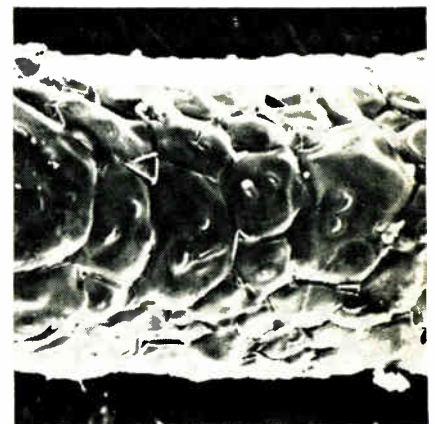

Overcoat. Ferrite deposit on 5-mil platinum wire shows graininess.

(SIRA), Elliott-automation Ltd., and Plessey Co. Ltd. are involved in a project under general control of Royal Radar Establishment to see if a practical store element can be made by depositing a coating of ferrite grains on platinum wire.

In theory, ferrite coated wire has similar electrical properties to plated wire, but in continuous strip form could be more economical to produce because deposition is, in principle, simpler than plating.

Also, ferrite materials retain their magnetic characteristics indefinitely, whereas the alloys used for plating tend to deteriorate with time, losing their magnetic properties. Thus, ferrite coated wires should be useful where virtually indefinite store life is desirable.

Finally, the coating process can be used to make arrays of biax-type storage elements with cross-point dimensions only about one-quarter or one-third normal biax dimensions, with a corresponding reduction in drive currents and hence in drive electronics. Engineers at RRE think this may be the main practical application of coated stores.

So far, SIRA and Elliott has each developed a coating technique and built trial hardware. SIRA's is based on electrophoresis—deposition of charged particles held in suspension in a fluid. Elliott uses electrostatic deposition of particles suspended in air. Plessey researchers have contributed to the SIRA technique, supplying the expertise on ferrite preparation and treatment.



Ringed. Electrostatic deposition gives average 0.5-mil layer.

RRE is evaluating specimens built by both methods. Though the results are not in, it looks as though the electrostatic method may have an edge in making single wires. However, electrophoresis may be better for making arrays.

Wet method. SIRA's deposition technique developed from electrophoretic method commonly used to deposit ceramic films on wire. Green magnesium manganese ferrite particles are suspended in an organic fluid such as nitroparaffin. The solution contains traces of iodine which is absorbed by the particles and gives them a positive charge. The mixture is circulated through a deposition chamber containing a platinum wire array—the cathode—surrounded by a cylindrical wire mesh anode. When a field strength of about five hundred volts per centimeter is set up between anode and cathode the ferrite particles migrate towards the cathode and adhere to it.

Because ferrite has a high resistivity compared to the fluid, when a particle is deposited there is a reduction of field in the adjacent fluid which has the effect of stimulating deposition of particles in the surrounding higher field regions. SIRA says this results in very uniform deposition—less than one per cent variation in thickness over the cathode—without any external shaping of the electric field, so that the process automatically tends to create a coating with regular electrical characteristics.

The 40 by 40 arrays made so far were built up in two stages. Platinum wires, 2 mils in diameter, running in one direction are wound on a frame and ferrite coated to a depth of about 1 mil. The wires running in the other directions are then wound on the frame, and the whole lot further coated and sintered. By this means, a thousandth of an inch gap is established between the planes of wire without any danger of short circuits caused by platinum-to-platinum contact.

Electrostatic. In Elliott's alternative "dry" method, the continuous 5-mil diameter wire forms the cathode and runs vertically upwards through a positively charged wire ring anode. Both cathode and an-

ode are enclosed in a chamber, which is connected by a narrow pipe to another chamber containing magnesium manganese zinc ferrite powder. The powder is maintained as a cloud—and given a positive charge—by vibration and injection of dry oxygen. The pressurized powder travels through the connecting pipe into the space between cathode and anode, where it migrates towards the cathode. The deposition chamber is followed by an on-line sintering furnace. This apparatus can make smooth, uniformly coated wire at rates up to 3 centimeters per second for short lengths, but so far uniformity cannot be maintained to plated wire standards over long lengths.

Western Europe

A gap is a gap

It took two years and several re-writings, but a prestigious study of the international computer technology gap now being completed proves one thing—there is no technological gap. It's true that a gap exists, says the report by the Organization for Economic Cooperation and Development, but it's an abyss in marketing—and one so wide that European countries will never be able to bridge it.

The OECD's team of experts cautions countries that would like to fight U. S. computer dominance by launching their own hardware industries to remain spectators. It has become a herculean task to fight the American giants.

Instead, the report urges medium-sized countries to follow the example of Switzerland and Australia, which have concentrated on harnessing foreign computers to imaginative new tasks—a field as challenging and probably more rewarding than machine building. The information revolution is similar to the printing revolution, the OECD experts argue. It's not who makes the presses that counts, but what books are printed.

Rivals. The OECD study seems to cast doubt on the long-range success of national efforts like

those in France and Japan to build independent hardware industries that can compete with American firms. But it concedes that these two programs are probably worthwhile because they use computer manufacturing as a "focus point for all the other advanced industries", thus stimulating development of electronics components, scientific instruments and telecommunication equipment.

Still, the OECD experts don't advise existing European and Japanese computer makers to throw in the towel. They urge:

- Inter-company and inter-country cooperation to overcome the fragmentation of the European market.

- Greater use of American-style "technico-economic forecasting," which they say could develop into a common discussion of strategy, particularly in relation to fourth generation time-shared systems.

- More consultation by non-American firms with their customers to estimate future hardware and software needs.

- Language standardization to reduce the ever-increasing costs of software development. Though standardization would inevitably reduce the efficiency of computers, the machines have adequate speed for most commercial applications to permit a degree of wasteful operation, says the report.

What gap? To support its thesis that a technological gap in computers doesn't really exist, the report argues that IBM's machines generally have not been the most technically advanced on the market. Instead they sell well because of the American company's "excellent software and first-class sales, maintenance and training service." European firms are just as capable of making advanced computers, the study says, as shown by the success of sophisticated Olivetti and Elliott Automation machines.

But the commercial hegemony of IBM—to which the OECD grants 75 percent of the world market—is self-perpetuating, says the study. New customers have a marked reluctance to look beyond IBM due to the safety factor of its reputation, and old clients don't want to

switch suppliers because they would lose investments in personnel skills and programs.

IBM is where it is because it got there first—and with a good measure of U. S. Government help, the report notes. It adds rather pessimistically: "There is little likelihood that the missed opportunities of the past can be redeemed," thus hinting that the U. S. will dominate the computer industry more or less permanently.

Sweden

Trouble ahead

When Sweden's Minister of Industry Krister Wickman late last year announced he was launching a study of the future of the nation's electronics industry, there were skeptical Swedish eyebrows raised.

Up to that time, the government had concentrated its attention on industries in trouble or facing severe foreign competition, such as textiles, shoes and shipbuilding. Now, Krister Wickman—considered a socialist empire builder by disgruntled conservative businessmen—was eyeing an industry that had no apparent serious problems.

After some months of investigations, a specially-appointed team within the Ministry of Industry came up with its first report on the electronics industry. Armed with the report, Wickman called in top executives of the dozen largest electronics firms and spokesmen for industry organization—and told them some serious dangers were lurking behind the industry's complacency.

Synergism. For one thing, the report criticized Sweden's production of semiconductors as "extremely modest". Indeed, the entire components industry was felt to be disastrously weak. The report noted that many private companies and researchers fear that this could mean serious disadvantages in the long run for Swedish industry.

Stressing the increasing need for intimate contacts between manufacturers of components, particularly of large-scale integration, and

systems manufacturers, the report said, "many in the industry feel these contacts can be effective only if there is a domestic component industry. Some even maintain that the Swedish electronics industry is at a crossroads: if a qualified com-



Minister. Sweden's Krister Wickman sees dangers facing home industry.

ponent industry is not launched within the nation, companies will be forced to keep out of production of certain equipment."

Citing an example, the report bluntly warned that if the Swedish computer industry wants to maintain its "satisfactory" position, contact with component development, particularly in integrated circuits, is necessary.

The report said that from a purely technical viewpoint, conditions are good for launching a domestic component industry. The greatest difficulty, however, is to judge the direction of production, which types of components to make, and methods of manufacture.

What now. Nothing is expected to be done in the very near future. The next meetings between Krister Wickman and other government officials and industry won't be held until the autumn. In the meantime industry is closely studying—and trying to read between the lines—the ministry's report.

Electronics advertisers

July 21, 1969

Abbott Transistor Labs. Inc. Technical Adv. Agency	24	Electronics Management Center	148	Philbrick/Nexus Research	45
Airco Spear Electronic Components	32	Ries Cappiello Colwell Inc.		Kenaccio Advertising Inc.	
Hazard Advertising Co. Inc.		Erie Technological Products Company Inc.	47	Phillips N. V. Pitt/Ema Division	2E
Airpax Electronics Inc.	130	Arthur Schmidt International Inc.		Marsteller International S. A.	
Weich Mirabile & Co., Inc.				Powertek Division of Airtronics	44
Alfred Electronics	116-117	Fairchild Semiconductor Inc.	120	Cordova Associates	
Bonfield Associates		Chiat/Day Inc.		Princeton Applied Research Corporation	36
Allen Bradley Company	25-27			Mort Barish Associates Inc.	
Fensholt Adv. Agency		General Electric Company, Capacitor Division	150	Radio Corporation of America	4th Cover
American Lava Corporation, Sub. of Minnesota Mining & Mfg. Co. Designers Incorporated	153	Robert S. Cragin Incorporated		Al Paul Lefton Company	
Ammon Instruments Inc.	186	General Electric Company, Electronic Components Sales Operation	12-13	Rogan Brothers, Inc.	155
Culver Advertising Inc.		Robert S. Cragin Incorporated		Christopher Advertising Inc.	
Arnold Engineering Company	18-19	General Electric Company, Semiconductor Products Division	112	Rosemount Engineering Company	164
Buchen Advertising Inc.		Robert S. Cragin Incorporated		Colle & McVoy Adv. Agcy., Inc.	
Astrodata Inc.	167	General Instruments Corporation	64-65	Semcor Division Components, Inc.	146
Jansen Associates Inc.		Semiconductor Products Division		Marketing & Corporate Communications Inc.	
Ates Componenti Elettronici, S. P.A. Publicitas	8E	Norman Allen Associates			
Austron Inc.	168	General Radio Company	6	Signalite Inc. Sub. of General Instrument Corporation	161
Management Communications Consultants Inc.		Horton, Church & Goff Incorporated	68-69	McCarthy, Scelba, DeBiasi Adv. Agency Inc.	
		G-R Industries Incorporated		Signetics Corp. Sub. Corning Glass Works	105
Babcock Relays Div. of Babcock Electronics Corporation	43	Larcom Randall Advertising Inc.		Cunningham & Walsh Inc.	
Jansen Associates Inc.		Granger Associates	119	Silec Electronique	7E
Beckman Instruments Inc.		West Associates		Publicite Y Ch. Lambert	
Electronic Instrument Division	125	Grayhill Incorporated	138	Siliconix Inc.	7
Hixson & Jorgenson Inc.		Merchandising Advertising Inc.		Graphics West	
Belden Corporation	58-59			Solitron Devices Inc.	
Fensholt Advertising Inc.		Hewlett Packard, Frequency & Time Division	66-67, 109	Transistor Division	135
Bell & Howell Electronic Instrumentation Group CEC Division	26	Lennen & Newell Incorporated		Haselmeir Pearson Advertising Inc.	
N.W. Ayer/Jorgensen/MacDonald Inc.		Hewlett Packard, Loveland Division	2, 139	Spectrum Control Inc.	134
Bendix Corporation, Scientific Instruments & Equipment Division	126-127	Tallant/Yates Advertising		Altman-Hall Associates	
MacManus, John & Adams Inc.		Hewlett Packard, Mt. View	53	Sperry Rand Corporation, Sperry Microwave Electronics Division	60
Braincon/General Time	173	Lennen & Newell Incorporated		Neals & Hickok Inc.	
Alden Advertising Agency Inc.		Hewlett Packard New Jersey Division	49	Sprague Electric Company	5-9
Brand-Rex	17	McCarthy, Scelba, DiBiasi, Adv. Agency Inc.		Harry P. Bridge Company	
Creamer, Trowbridge, Case & Basford Inc.		Hewlett Packard, Palo Alto Division	165	Stackpole Carbon Company, Electronic Components Division	107
Basford Inc.		Lennen & Newell Inc.		Meek & Thomas Inc.	
Branson Instruments Inc. Industrial Division	178	Hewlett Packard San Diego Division	1	Standard Condenser Corporation	166
Van Sant Dugdale & Company Inc.		Lennen & Newell Inc.		R.N. Johnson Advertising	
Buckbee-Mears Company	173	Hewlett Packard Waltham Division	188	Stewart Warner Microcircuits Inc.	55
Midland Associates Inc.		Culver Advertising Inc.		Jones, Mahar, Roberts Inc.	
Bunker-Ramo Company	22-23	Honeywell Computer Control Division	28-29	Sylvania Electric Products Inc. Parts Division	111
Diener & Dorskind Incorporated		Creamer, Trowbridge, Case & Basford Inc.		Doyle Dane Bernbach Inc.	
Burns & Towne Inc.	174	Honeywell Test Instruments Division	56-57	Syntronic Instruments Inc.	186
Hall Karmatz Associates, Inc.		Campbell Mithun Inc.		Burton Browne Advertising	
Burroughs Corporation, Electronic Components Division	72	Hughes Aircraft Company	174	Tektronix Inc.	41
Conti Advertising Agency Inc.		Foote Cone & Belding Inc.		Dawson, Turner & Jenkins Inc.	
Carl Zeiss	113	Indianapolis Power & Light	154	Test Equipment Corporation	46
Michel-Cather, Inc.		Ruben, Montgomery & Associates Inc.		Dean & Bain Advertising Inc.	
Centralab Division of Globe Union Inc.	137	Intronics Inc.	172	Texas Instruments Incorporated, Components Group	30, 48
The Brady Company		Marketing Assistance Inc.		Albert Frank-Guenther Law Incorporated	
Cinch Manufacturing Company	169	ITC Riedon A Div. of Industrial Technology Corporation a Subsidiary of Republic Corporation	21	Transformer Electronics Company	42
Stral Advertising Company Inc.		Van Der Boom, McCarron Adv.		Wolff & Weir	
Computer Measurements Company	156	ITT Cannon Electric	70-71	Transitron Electronic Corporation	63
Jones, Maher, Roberts Inc.		MacManus, John & Adams Inc.		Larcom Randall Advertising Inc.	
Components Inc.	85			Trygon Electronics Inc.	124
Larcom Randall Adv. Inc.		Kepeco Incorporated	168	Kameny Associates Inc.	
Computer Labs	110	Weiss Advertising		Tung-Sol Division, Wagner Electric Corporation	118
Wrenn Studio				Feeley & Wheeler Inc.	
CREI, Home Study Div. of the McGraw-Hill Book Co.	159	Litton Industries Inc. Electron Tube Division	114		
Henry Kaufman & Associates		MacManus, John & Adams Inc.		United Systems Corporation	155
CTS Corporation	122			Advertising & Merchandising Inc.	
Reincke, Meyer & Finn Inc.		Magnecraft Electric Company	106	United Transformer Company, Division of TRW Inc.	2nd Cover
Curtis Instruments Inc.	14	Mills, Fife & McDonald Inc.		Fuller & Smith & Ross Inc.	
Knudsen Moore Inc.		Maryland Telecommunications Inc.	108	Unitrode Corporation	51
		Bernard Sandler Adv., Inc.		Silton, Brothers Inc.	
Dale Electronics Incorporated	3rd Cover	MasInexport	171	U-Tech, A Division of Industrial Physics & Electronics Co.	132
Sub. of Llonel Corporation		Publicom Romanian International		Ross Clay Advertising	
Swanson, Sinkey Ellis Inc.		Publicity Agency			
Delco Radio Division of General Motors Corporation	128-129	Metrimplex	3E		
Campbell-Ewald Company		Huntex			
Deutsch Company	147, 149, 151	Microsonics Incorporated	142		
Smith & Hemmings Advertising		S. Gunnar Myrbeck & Company			
DMS	171	Midtex/Aemco	15	Vactec Incorporated	170
		Chuck Ruhr Associates Advertising		Colman & Associates Advertising	
Eagle Signal Division of Gulf & Western Company	50, 52, 54	Miller-Stephenson Chemical Co. Inc.	187	Victoreen Instrument Company, The	16
Feeley & Wheeler Inc.		Michel-Cather Inc.		Palm & Peterson Inc.	
Eastman Kodak Company, Business Systems Markets Division	143	Mohawk Data Sciences Corporation/OEM Marketing	147	Vishay Resistor Products	162
J. Walter Thompson Company		MacFarland Associates Inc.		Alpern Communications	
EDP Corporation	97	Monsanto Company	162		
Lawrence Associates		Michel-Cather Inc.			
Eldorado Electrodata Corp. of Concord	187	Motorola Semiconductor Products Incorporated	35	Wang Laboratories	158
Moore-Mayhew Advertising		Lane & Bird Adv. Inc.		Impact Advertising Inc.	
Elco Corporation	140			Westinghouse Electric Corporation	
Schaefer Advertising Inc.		National Electronics Incorporated	155	Semiconductor Division	145
Electrical Insulation Conference	171	Connor-Sager Associates		Pritchard Wood Associates, Inc.	
Lincoln R. Sumelson		National Semiconductor Corporation	10-11	Wire mold Company The	151
Electro-Nuclear Laboratories	163	Hall Butler Blatherwick Inc.		Charles Brunelle Company	
Hal Lawrence Inc.		Nelson Stud Welding	149		
Electronic Engineering Company of California	133	George Z. Griswold Advertising		Xcelite Inc.	40
Marketing Directions Inc.				Harold Warner Advertising Inc.	

YOKE SPECIALISTS

FOR INFORMATION DISPLAYS

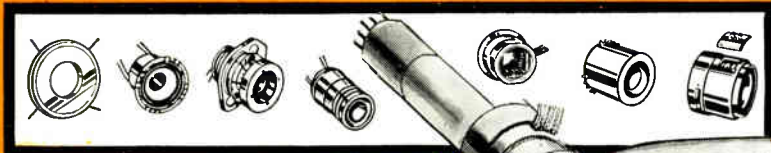

Syntronic's devotion to precision and attention to detail assure skillfully engineered deflection yokes in prototype or full production quantities. A complete line of value engineered yokes offer cost saving solutions to your CRT projects. Consult scientifically oriented Syntronic Yoke Specialists for the right yoke for your display.

***syntronic* INSTRUMENTS, INC.**
 100 Industrial Road, Addison, Ill.
 Phone: Area 312, 543-6444

Circle 216 on reader service card



APT-1; 1 cu. in.,
 3.15 oz. (actual size)

More torque, Less weight in moving coil mechanism

Highly stable, linear and accurate mechanism for indicating, control or recording systems. 18-0-18° linearity is 1%. Coil design with over 75% of winding "working" in high energy, uniform field air gap assures greater accuracy. Coil system weighs 0.85 gm, develops 26.4 mmg of torque; 31:1 T/W. Mechanism offers negligible vibration pivots and jewels — custom damping — wide range of sensitivities.

AMMON
 AMMON INSTRUMENTS, INC.
 345 Kelley St., Manchester, N.H. 03105

186 Circle 186 on reader service card

Advertising Sales Staff

Frank E. LeBeau [212] 971-6464
 Advertising Sales Manager

Wallis Clarke [212] 971-2187
 Assistant to sales manager

Donald J. Austermann [212] 971-3139
 Promotion Manager

Warren H. Gardner [215] LO 8-6161
 Eastern Advertising Sales Manager

Atlanta, Ga. 30309: Michael H. Miller, 1375 Peachtree St., N.E.
 [404] 892-2868

Boston, Mass. 02116: William S. Hodgkinson
 McGraw-Hill Building, Copley Square
 [617] CO 2-1160

Cleveland, Ohio 44113: William J. Boyle, 55 Public Square, [216] SU 1-7000

New York, N.Y. 10036
 500 Fifth Avenue
James R. Pierce [212] 971-3615
John A. Garland [212] 971-3617
Michael J. Stoller [212] 971-3616

Philadelphia, Pa. 19103:
Jeffrey M. Preston
Warren H. Gardner,
 6 Penn Center Plaza,
 [215] LO 8-6161

Pittsburgh, Pa. 15222: Jeffrey M. Preston,
 4 Gateway Center, [412] 391-1314

Rochester, N.Y. 14534: William J. Boyle,
 9 Greylock Ridge, Pittsford, N.Y.
 [716] 586-5040

Donald R. Furth [312] MO 4-5800
 Midwest Advertising Sales Manager

Chicago, Ill. 60611: Kenneth E. Nicklas
 Ralph Hanning 645 North Michigan Avenue,
 [312] MO 4-5800

Dallas, Texas 75201: Richard P. Poole, 1800 Republic National Bank Tower,
 [214] RI 7-9721

Houston, Texas 77002: Robert Wallin,
 2270 Humble Bldg. [713] CA 4-8381

Detroit, Michigan 48226: Ralph Hanning,
 856 Penobscot Building
 [313] 962-1793

Minneapolis, Minn. 55402: 1104 Northstar Center [612] 332-7425

St. Louis, Mo. 63105: Kenneth E. Nicklas,
 The Clayton Tower, 7751 Carondelet Ave.
 [314] PA 5-7285

James T. Hauptli [415] DO 2-4600
 Western Advertising Sales Manager

Denver, Colo. 80202: David M. Watson,
 Tower Bldg., 1700 Broadway
 [303] 266-3863

Los Angeles, Calif. 90017: Ian C. Hill,
 John G. Zisch, 1125 W. 6th St.,
 [213] HU 2-5450

Portland, Ore. 97204: James T. Hauptli,
 Don Farris, 218 Mohawk Building,
 222 S.W. Morrison Street,
 Phone [503] 223-5118

San Francisco, Calif. 94111: James T. Hauptli,
 Don Farris, 255 California Street,
 [415] DO 2-4600

Pierre Braude Tel: 225 85 88: Paris
 European Director
 Paris: Denis Jacob
 88-90 Avenue Des Champs-Elysees, Paris 8
 United Kingdom and Scandinavia
London: Oliver Ball, Tel: Hyde Park 1451
 34 Dover Street, London W1
Milan: Robert Saidel, Roberto Laureri Jr.
 1 via Baracchini Phone 86-90-656
Brussels: Denis Jacob
 27 Rue Ducale Tel: 136503
Frankfurt/Main: Hans Haller
 Elsa-Brandstroem Str. 2
 Phone 72 01 81
Geneva: Denis Jacob
 1 rue du Temple Phone: 31 95 60

Tokyo: McGraw-Hill
 Publications Overseas Corporation,
 Kasumigaseki Building 2-5, 3-chome,
 Kasumigaseki, Chiyoda-Ku, Tokyo, Japan
 [581] 9811

Osaka: Akihiko Kamesaka, McGraw-Hill
 Publications Overseas Corporation, Kondo
 Bldg., 163, Umegae-cho Kita-ku [362] 8771

Business Department
Stephen R. Weiss, Production Manager
 [212] 971-2044
Thomas M. Egan,
 Assistant Production Manager [212] 971-3140
Dorothy Carmesin, Contracts and Billings
 [212] 971-2908
Frances Vallone, Reader Service Manager
 [212] 971-2865

Classified & Employment Advertising

F.J. Eberle, Manager
 212-971-2557

EMPLOYMENT OPPORTUNITIES 177

Atomic Personnel, Inc. 177

Energy Conversion Devices 177

EQUIPMENT
 (Used or Surplus New)
 For Sale

Fishman Co., Philip 177

Laboratory Equipment 177

Radio Research Instrument Co. 177

■ For more information on complete product line see advertisement in the latest Electronics Buyer's Guide
 □ Advertisers in Electronics International

Electronics Buyers' Guide

George F. Werner, Associate Publisher
 [212] 971-2310

Robert M. Denmead,
 Midwest Regional Manager
 [312] MO 4-5800

William A. Capuzzi,
 New York, New England District Manager
 [212] 971-3793

Regina Hera, Directory Manager
 [212] 971-2544

Thomas M. Egan, Production Manager
 [212] 971-3140

Circulation Department

Isaaca Siegel, Manager [212] 971-6057

Research Department

David Strassler, Manager [212] 971-6058

**ELDORADO INVENTED THE MICROWAVE
SAMPLING COUNTER TECHNIQUE**

Now:



- Model 970 — \$2250.00
- 20 Hz to 3.0 GHz
- 9 D git Display
- Resolution — 0.1 Hz
- —13 DBM Sensitivity



- Model 980 — \$1990.00
- 3.0 GHz to 18.0 GHz
- 5 Digit Display
- Resolution — 1 MHz
- —17 DBM Sensitivity

SEE US AT WESCON BOOTH 1722-23

GSA LISTED

ELDORADO

ELDORADO ELECTRODATA CORPORATION

601 CHALOMAR ROAD • CONCORD, CALIF. 94520 U.S.A. • TEL. (415) 686-4200 • TWX 910-481-9476

Circle 217 on reader service card

improve MTBF with MS-180

MS-180 FREON® TF Degreaser increases the reliability of electronic equipment by removing grease and dirt. Use MS-180 on the production line or in your maintenance program to clean up assemblies, components and connections. It's safe to apply



even while equipment is operating. MS-180 is available in 16-oz. cans for plant use, convenient 6-oz. cans for field service kits. You can try it—FREE—merely by writing for a sample on your company letterhead.



miller-stephenson chemical co.,inc.

Route 7, Danbury, Conn. 06813

© Du Pont TM

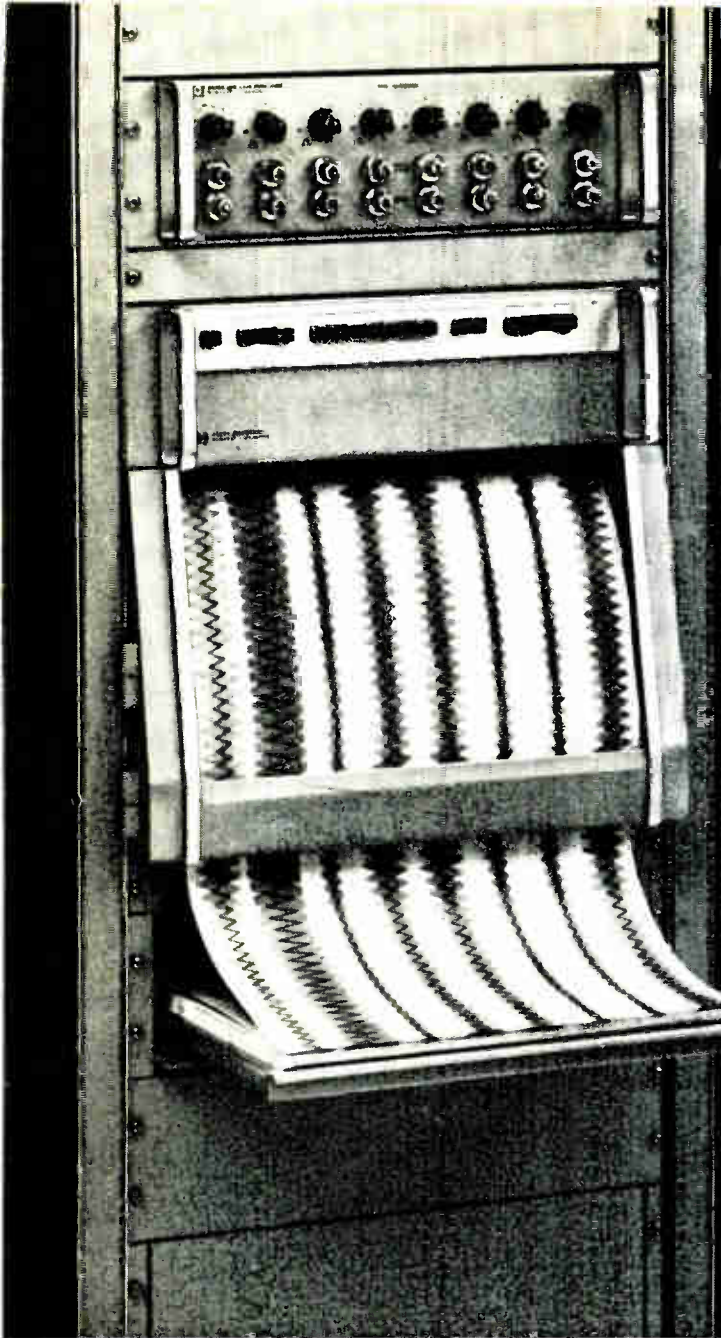

this... *

and this... **

and this, too... ***



Choice of precision signal conditioning in multi-channel units or single channel plug-ins.

Fourteen electrically controlled chart speeds

Internal 1 Sec. and 1 Min. timers and marker

Front access to secondary calibration adjustments.

Remote control for paper drive, chart speeds, and marker



Modular construction of electronic and mechanical sub-assemblies for easy on-line servicing in the rack
Individual galvanometer on each channel

Rugged, laminated pen with tungsten carbide tip

Core magnet galvanometers assure no inter-channel interaction

Low-paper interlock shuts off chart drive

Contactless capacitive pickup near pen tip for accurate feedback

Modulated low-pressure ink system assures constant trace width

Disposable ink cartridge can be changed with recorder running



Roll or Z-fold chart paper without expensive options . . . you can change from one to the other quickly and easily

True rectilinear recording
Thin-line, high quality trace



Plus . . . instant data retrieval on Z-fold paper. For help with your recording problems call your HP field engineer or write for full information on HP 7800 series recording systems. Hewlett-Packard, Waltham, Mass. 02154; Europe: 1217 Meyrin-Geneva, Switzerland.

What more could you ask for?

HEWLETT  PACKARD

RECORDING SYSTEMS

Circle 188 on reader service card

General Railway
Signal Company
uses both silicone
and vitreous coated
Dale Resistors



Now...rugged Dale Wirewounds with your choice of coatings!

Coating makes a difference in the performance of industrial power wirewounds. That's why it's easier to call Dale when you're not sure what's best for your application. We make both silicone (HL) and vitreous (VL) coated models. Before coating they're identical. HL models receive multi-layer coatings of a special silicone formulation. This low-temperature process has less effect on resistor windings - and we sell more HL resistors where customers are primarily concerned with maintenance of tolerance and low TC. Our vitreous enamel coating is baked on to provide maximum resistance to moisture and chemical action - and VL sales are highest where these conditions are a factor. Today many companies - like General Railway Signal - make good use of Dale's single-source capability for power resistors. You can, too.

12 Different Silicone (HL) and Vitreous (VL) Models



HL/VL 3-225 watts, .1 ohm to 1.3 Meg., $\pm 5\%$ tol.*



HLT/VLT 11-225 watts, .1 ohm to 1.1 Meg., $\pm 5\%$ tol.



HLW/VLW 3-20 watts, .1 ohm to 80K ohms, $\pm 5\%$ tol.*



HLZ 40-375 watts, .13 ohm to 25 ohms, $\pm 10\%$ tol.



HL/VL Flat 24-95 watts, 1 ohm to 150K ohms, $\pm 5\%$ tol.*

MIL. SPEC. All HL and VL models meet or exceed the requirements of MIL-R-26 and MIL-R-9365C where applicable.



HLM/VLM 10-20 watts, .1 ohm to 51K ohms, $\pm 5\%$ tol.

$\pm 10\%$ below 1 ohm



HLA 10-225 watts, 1 ohm to 100K ohms, $\pm 5\%$ tol.

*For fast price and
delivery information,
phone 402-534-3131.*



DALE ELECTRONICS, INC.
1300 28th Ave., Columbus, Nebr. 68601
In Canada: Dale Electronics Canada, Ltd.



Circle 9C1 on reader service card





Connections... Our communications TWTs can help you make the right ones— up to X-band.

We're among the old-timers for continuous service to the TWT industry. Our first traveling-wave tube? We introduced it in 1956. And over these 13 years, we've had our share of successes. That's why, for microwave relays above 10 GHz, you can have confidence in our recommendation of the traveling-wave tube with integral PPM focusing as one of the best ways to make the right communications connections.

You can choose from types that handily cover those carrier bands. AI378 and its variants—designed to your special requirements—are typical. Others include:

AI317	0.75—1.0 GHz	20 W
4053	1.0—2.0 GHz	10 W
4054	1.7—2.7 GHz	20 W
AI310*	2.0—6.0 GHz	3 W
AI378†	7.9—8.4 GHz	20 W

*Any octave band in this range
†Any 500 MHz band up to 13 GHz

These traveling-wave tube designs can be optimized to fit any special requirement. Each focusing structure, for example, is custom-fitted to the tube, adjusted entirely at the factory. Temperature compensation is built-in. For these reasons, RCA TWTs demonstrate greater linear power range and enjoy longer life.

As low-level drivers in point-to-point troposcatter systems, RCA integral traveling-wave tubes are superior to the "plug-in" bottle approach in the high bands. An added plus: RCA TWTs can be made integral with their power supplies or separate.

Our line offers complete design flexibility because RCA can provide variants to suit particular specifications. For technical data on specific types, see your local RCA Representative or write: RCA Electronic Components, Commercial Engineering, Section G-19Q-3, Harrison, N. J. 07029.

