

Rotating memories offer fast access 96
Identical resonators trim filter costs 102
Navy secures millimeter-wave transceiver 108

\$1.00 A McGraw-Hill Publication

May 26, 1969

Electronics®

**Special
report
on r-f
power
transistors**



142 K55956 44R06 02-71
R KISSLER
BASIC COMM ELEC
BOX 956
MOSES LAKE WA 98837

Pulsepower

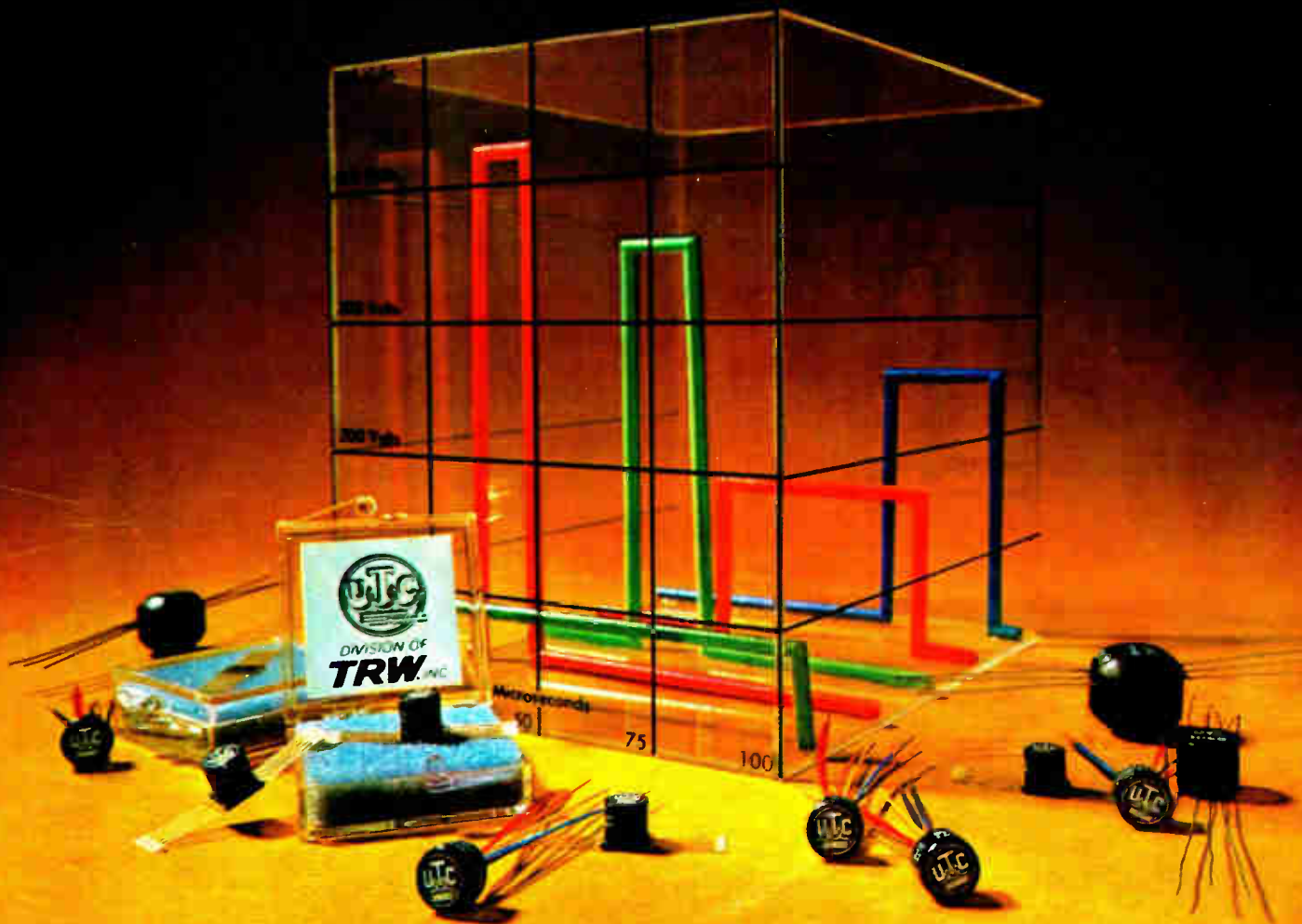

UTC miniature transformers assure high pulse integrity at ET constants exceeding 7500 volt-microseconds

The high ET constants of UTC miniature pulse transformers give you fast rise time plus low droop at highest peak-power for size in the industry. That's pulsepower.

UTC's BIT-P and PIP standard lines are the smallest metal-encased pulse transformers made. Unique structures, plus manufacturing controls, enable UTC pulse transformers to achieve high flux densities and unrivalled temperature stability. All units are individually adjusted in a standard blocking oscillator circuit, assuring parameter uniformity unavailable elsewhere.

UTC's broad lines cover most pulse applications. Note particularly: use in high-gain, low-level, high-density packaged circuits made possible by high shielding of units; SCR di/dt failure reduction due to fast rise time and high pulse-

energy capability. The units are also suitable for wide-band applications of 1 kHz to 100 MHz.

UTC's metal-encased standard lines exceed MIL Grade 6 (MIL-T-21038B). They're ruggedized, hermetically sealed, and electromagnetically shielded. Molded units to MIL Grade 7, Class S temperature (+130°C), are available with a dielectric strength of 1250 volts. Where special parameters are needed we'll tailor them to your circuits.

When your design calls for pulsepower—high pulse integrity—UTC has the answer. Check your local distributor for immediate off-the-shelf delivery, or contact United Transformer Company, Division of TRW INC., 150 Varick St., New York, New York 10013.

TRW
UNITED TRANSFORMER COMPANY

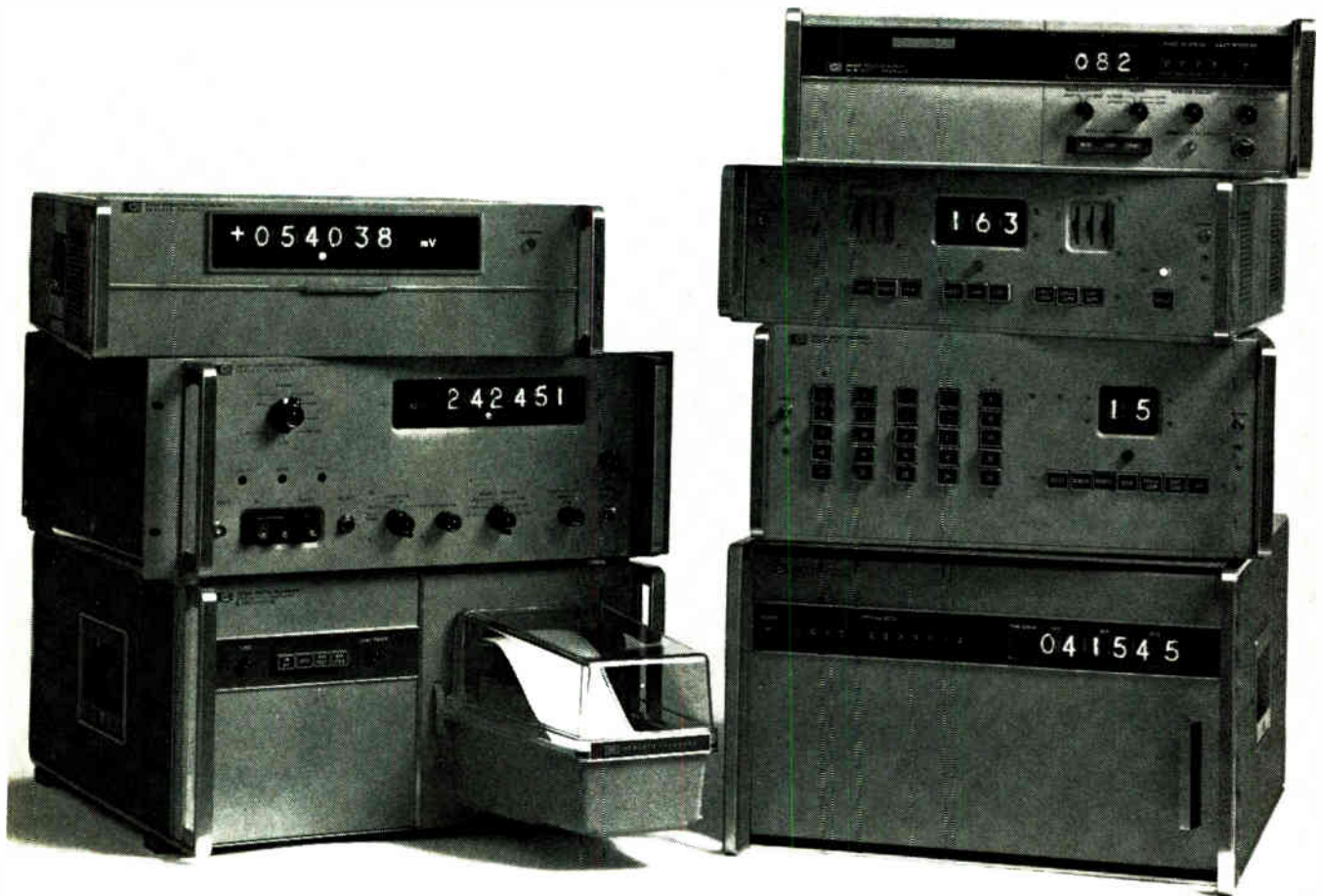

The In Group

When you need a data acquisition system, the simplest, safest way to get it is to start—and finish—with Hewlett-Packard. All from the same source. You get off-the-shelf delivery; no costly special engineering required; complete systems—system components—proved in the field.

Large or small, complex or simple, fast or slow, computerized or not—you can buy

your data acquisition system right off our data sheet. Even if your requirements are unconventional or way out, we can deliver a system that will fill your need.

For a complete run-down on all the members of our systems group, call your HP field engineer. Or write Hewlett-Packard, Palo Alto, California 94304; Europe: 54 Route des Acacias, Geneva.

HEWLETT  PACKARD

DATA ACQUISITION SYSTEMS

Four Reasons Why — HP's new low-cost scopes belong in your lab:

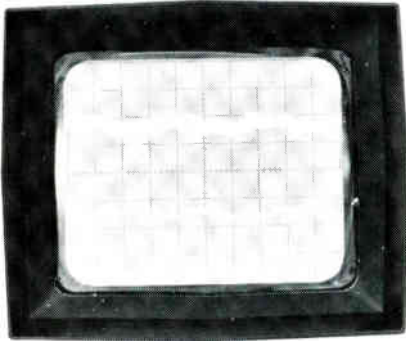

100 μ V Sensitivity

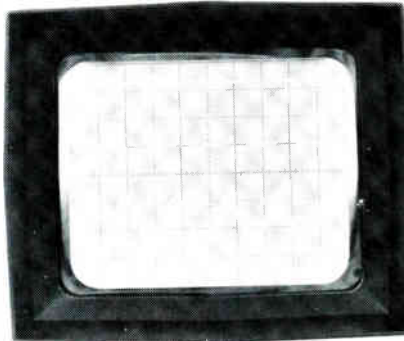

Dual Trace

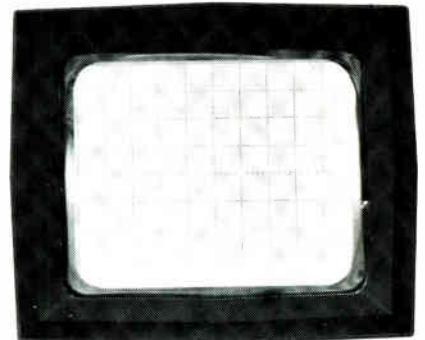

Flicker-Free Variable Persistence

HEWLETT *hp* PACKARD
OSCILLOSCOPE SYSTEMS

089-13

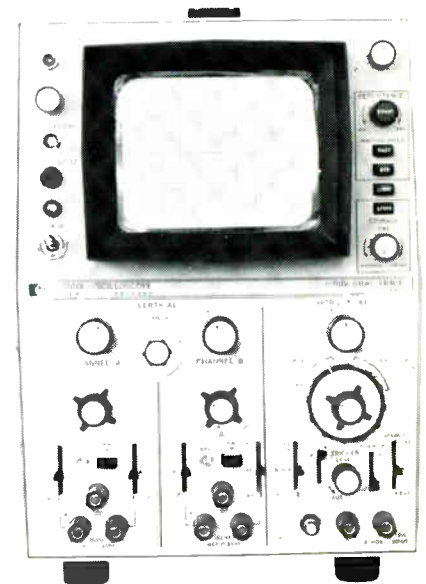

All-Solid-State Reliability

Get the scope you need at a price you can afford! This new low-frequency scope system has an all-new design from the inside out to give you solid-state reliability in the dc/500 kHz range. You get the better performance, greater sensitivity, low noise, and reduced drift that increases your measurement confidence and decreases your measurement time.

In the HP 1200 series, you can choose from 14 models to get single or dual trace, 100 μ V/cm or 5 mV/cm sensitivity in either cabinet or rack models. You can even get an X-Y display.

Add to these, HP's exclusive variable persistence and storage—a first for low-priced, low-frequency scopes. And, only variable persistence gives you completely flicker-free displays

of all your low frequency measurements—no flicker means no eyestrain.

All of these new scopes have single-ended or differential input on all ranges, high common mode rejection ratio, complete triggering versatility, internal graticule, external horizontal input, dc-coupled Z-axis, beam finder—many of the features you normally find only on the high-priced, high-frequency scopes.

As a result, the 1200 series gives you the best performance of any scope in its price range.

All models are available as lightweight (under 30 pounds) cabinet or 5¼" high rack mounts. Power consumption of only 33 to 65 watts eliminates the need for cooling fans.

Small size and low power requirements mean an HP 1200 scope fits into your operation easier—bench or system.

For complete information on how these new all-solid-state scopes can solve your low frequency measurement problems, contact your nearest HP Field Engineer. For additional data, see page 500 of your 1969 HP catalog. Or, write to Hewlett-Packard, Palo Alto, California 94304. Europe: 1217 Meyrin-Geneva, Switzerland.

Price: HP 1200 series, \$540 to \$1800.

News Features

Probing the News

- 117 **Computers:** Air operations planning goes automatic
123 **Communications:** Pay tv gets in the broadcast picture

U.S. Reports

- 49 **Integrated electronics:** Silicon-gate technique may make MOS IC's eligible for real-time data processing
50 **Advanced technology:** 500-picosecond pulses compressed to 270 psec; acoustic surface-wave transducer generates 1.15-Ghz fundamental waves
51 **Manufacturing:** Yag laser forms diode
52 **Lasers:** Parametric oscillator tuned with optics; q-switch with no moving parts
54 **Government:** Classified research presents problems for universities
54 **Memories:** Brighter holographic future
56 **Space electronics:** Proposal request for ERTS; interest grows in aeronautical services satellite
60 **Oceanography:** Doppler sonar wed to inertial navigator
62 **Instrumentation:** Preprocessing bandwidth analog data
65 **Companies:** New top man at Electro-Optical Systems

Electronics International

- 183 **Great Britain:** Marconi-Elliott opts for beam-lead-hybrid MSI; Commons committee questions defense R&D contracting practices
184 **Australia:** Industry chides government on research policies
185 **West Germany:** Needles propelled by magnets print out for calculator
186 **France:** Show time for the Concorde
186 **Japan:** Laser in feedback loop of oscillator makes a rangefinder that goes all the way to zero

New Products

- 133 **In the spotlight**
133 Fluidic logic controls IC handler
137 **Components review**
137 Relay has wide triggering-range
141 **Instruments review**
141 Test set does double duty
143 Magnetometer with lab accuracy
145 **Production equipment review**
145 Measuring IC mask coordinates
149 **Data handling review**
149 Machine processes magnetic cards
152 IBM markets high-speed modem
154 Fourier unit doubles as computer
159 **Subassemblies review**
159 Gated op amp does variety of jobs
163 **Semiconductor review**
163 Diodes for push-button tuning
165 Power zener dissipates 100 kw

Title R registered U.S. Patent Office; © copyright 1969 by McGraw-Hill Inc. All rights reserved, including the right to reproduce the contents of this publication in whole or in part.

Technical Articles

Solid state 84

R_x for r-f power transistors (cover)
Wattage and frequency ratings provide the glamor, but collector efficiency, gain, input Q, immunity to load mismatches, and related features that often get lost in the promotional shuffle remain important elements in the design equation
Richard Gundlach, Associate editor

Circuit design 91

Designer's casebook

- One-shot multivibrator requires no standby power
- Loop gain measurements made with paired amplifiers
- Q-multiplier circuit uses op amp with LC feedback
- Curve trace improves indication of IC performance
- BIFET circuit yields time delays up to 30 hours

Computers 96

Rotating disks and drums

set peripheral memories spinning

Rotating units' fast access times give them an edge over magnetic tapes. But picking the best one for a specific application isn't easy, requiring detailed knowledge of the hardware and software involved
Michael French, BCD Computing Corp.

Circuit design 102

Identical resonators

cut ceramic i-f filter cost

Computer-derived design tables ease selection of complementary capacitors for low-volume use
Franz L. Sauerland, Clevite Corp.

106

Nonstop limiter absorbs transients

Series type regulator uses power transistor in full-wave bridge to get a controllable impedance function for a-c equipment
Martin Kanner, Grumman Aircraft

Communications 108

Millimeter waves for ships

Navy tests portable transceiver for tactical use that transmits at 37.5 Ghz; receiver sensitivity enhanced by f-m with feedback
Rudof Marso and Anthony Mondloch, Sylvania Electronic Systems

Departments

- | | | | |
|----|--------------------------|-----|--------------------------|
| 4 | Readers Comment | 37 | Electronics Newsletter |
| 8 | Who's Who in this issue | 71 | Washington Newsletter |
| 14 | Who's Who in electronics | 166 | New Books |
| 26 | Meetings | 172 | Technical Abstracts |
| 35 | Editorial Comment | 174 | New Literature |
| | | 181 | International Newsletter |

Electronics

Editor-in-Chief: Donald Christiansen

Senior staff editors

Technical: Stephen E. Scrupski
News: Robert Henkel
International: Arthur Erikson

Managing editor: Harry R. Karp
Art director: Gerald Ferguson

Senior associate editor: Joseph Mittleman
Assistant managing editors: Eric Aiken, H. Thomas Maguire, Howard Wolff
Senior copy editor: James Chang

Department editors

Advanced technology: William Bucci, Richard Gundlach
Communications: John Drummond, Raphael Kestenbaum
Computers: Wallace B. Riley, George Weiss
Design theory: Joseph Mittleman
Instrumentation: Owen Doyle, Walter Barney
Military/Aerospace: Alfred Rosenblatt; William F. Arnold (Military); Paul Dickson (Aerospace)
New products: William P. O'Brien
Solid state: George Watson, Stephen Wm. Fields

Domestic bureaus

Boston: James Brinton, manager; Gail Farrell
Chicago: Frederick Corey, manager
Los Angeles: Lawrence Curran, manager
San Francisco: Walter Barney, manager; Peter Vogel
Washington: Robert Skole, manager; Paul Dickson, William F. Arnold

Foreign bureaus

Bonn: John Gosch
London: Michael Payne
Tokyo: Charles Cohen

Copy editor: Edward Flinn
Staff writer: Peter Schuyten

Assistant art director: Kenneth L. Dix
Production editors: Susan Hurlburt, Arthur C. Miller

Editorial research: Anne Mustain

Editorial secretaries: Lorraine Longo, Claire Goodlin, Barbara Razulis, Vickie Green, Bernice Pawlak

McGraw-Hill News Service

Director: Arthur L. Moore; Atlanta: Fran Ridgway; Chicago: Robert E. Lee
Cleveland: Arthur Zimmerman; Dallas: Marvin Reid
Detroit: James Wargo; Houston: Barbara LaRoux
Los Angeles: Michael Murphy; Pittsburgh: Louis Gomolak
San Francisco: Margaret Drossel
Seattle: Ray Bloomberg; Washington: Charles Gardner, Daniel B. Moskowitz,
Herbert W. Cheshire, Seth Payne, Warren Burkett, William Small, William D. Hickman

McGraw-Hill World News Service

Bonn: Robert Dorang; Brussels: James Smith; Hong Kong: Wes Perry;
London: John Shinn; Mexico City: Gerald Parkinson; Milan: Ronald Taggiasco, Jack Star;
Moscow: Jack Winkler; Paris: Robert E. Farrell, Stewart Toy
Rio de Janeiro: Leslie Warren; Tokyo: Marvin Petal
Reprints: Gail Niles

Circulation: Isaaca Siegel

Publisher: Gordon Jones

Assistant to the publisher: Wallace C. Carmichael

Electronics: May 26, 1969, Vol. 42, No. 11

Published every other Monday by McGraw-Hill, Inc. Founder: James H. McGraw 1860-1948.
Publication office 99 North Broadway, Albany, N. Y. 12202; second class postage paid at Albany, N. Y.

Executive, editorial, circulation and advertising addresses: McGraw Hill Building, 330 W. 42nd Street
New York, N. Y. 10036. Telephone (212) 971-3333. Teletype TWX N.Y. 710-581-4235. Cable address:
MCGRAWHILL N.Y.

Subscriptions solicited only from those professionally engaged in electronics technology. Subscription rates:
qualified subscribers in the United States and possessions and Canada, \$8.00 one year, \$12.00 two years,
\$16.00 three years; all other countries \$25.00 one year. Non-qualified subscribers in the U. S. and
possessions and Canada, \$25.00 one year; all other countries \$50.00. Air freight service to Japan \$50.00
one year. Single copies: United States and possessions and Canada, \$1.00; all other countries, \$1.75.

Officers of McGraw-Hill Publications Company: Joseph H. Allen, President; John R. Emery, J. Elton Tuohig,
Senior Vice Presidents; Gordon L. Jones, Jr., Group Vice President; Vice Presidents: John R. Callahan, Editorial;
Paul F. Cowe, Circulation; John M. Holden, Marketing; David G. Jensen, Manufacturing;
Jerome D. Luntz, Planning & Development; Robert F. Marshall, Administration; Robert M. Wilhelmy, Finance.

Officers of the Corporation: Shelton Fisher, President and Chief Executive Officer; John L. McGraw, Chairman;
Robert E. Slaughter, Executive Vice President; Daniel F. Crowley, Donald C. McGraw, Jr., Bayard E. Sawyer, Senior
Vice Presidents; John J. Cooke, Vice President & Secretary; Gordon W. McKinley, Vice President & Treasurer.

Title ® registered in U.S. Patent Office; © Copyright 1969 by McGraw-Hill, Inc. All rights reserved. The contents
of this publication may not be reproduced either in whole or in part without the consent of copyright owner.

Subscribers: The publisher, upon written request to our New York office from any subscriber,
agrees to refund that part of the subscription price applying to copies not yet mailed.
Please send change of address notices or complaints to Fulfillment Manager; subscription
orders to Circulation Manager, Electronics at address below. Change of address notices
should provide old as well as new address, including postal zip code number. If possible,
attach address label from recent issue. Allow one month for change to become effective.

Postmaster: Please send form 3579 to Fulfillment Manager, Electronics,
P.O. Box 430, Hightstown, New Jersey 08520

Readers Comment

Strange words

To the editor:

Your magazine recently used a rather strange word without explanation. The word was "cepstrum" [April 14, p. 162]; I suspect your writers left out the word's explanation because they couldn't find it in any technical dictionary. Yet it's coming into rather common use in connection with digital means of spectral analysis; your readers may be interested in how it was coined, along with a number of similar words.

Although I am sure he will deny it, John Tukey [half of the so-called Cooley-Tukey, or Fast Fourier, algorithm] is responsible for several such words. Many of them appear in Chapter 15 of the book entitled "Time Series Analysis," edited by Murray Rosenblatt, and published by John Wiley, 1963. This chapter, written by M.J.R. Healy, J.W. Tukey, and myself, is entitled, "The Quefrency Alanysis of Time Series for Echoes: Cepstrum, Pseudo-Autocovariance, Cross-Cepstrum, and Saphe Cracking."

Of the many words defined in this chapter, "cepstrum" has probably become most common. Originally the word referred to the power spectrum of the log power spectrum. "Pseudo-autocovariance" was so called (by me) to describe the Fourier cosine transform of the log power spectrum. In common use by others, however, the word "cepstrum" has come to mean the process originally called pseudo-autocovariance. That is to say, "cepstrum" is now used to mean the Fourier cosine transform of the log power spectrum.

Another word that appears now and then is the verb, "to hann." This was also originated by Prof. Tukey in the book he co-authored with R.B. Blackman, "The Measurement of Power Spectra" (Dover, 1958). This word describes a smoothing operation used in power spectrum analysis, and is named after the Austrian meteorologist, Julius von Hann.

With the advent of the Fast Fourier transform, a large family of digital computations that had pre-

...want a complete proportional power controller?

Sprague VECTROL[™] Series VPC OFFERS OUTSTANDING PERFORMANCE

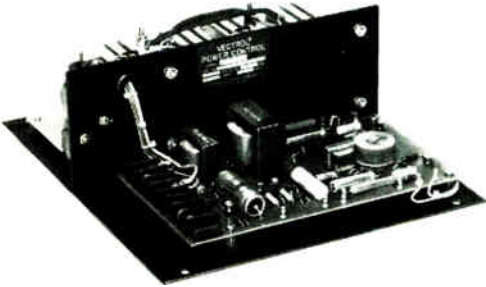

No snap-on . . . smooth phase control from zero. Easily adapted to closed-loop systems. Operates into primary of transformer or resistive load. Full-wave balance within 1°. High power . . . 1-100 KVA (A-C or D-C output). Protection networks . . . dv/dt . Adjustable to all standard inputs. Solid state trigger. Soft start. Current limit, operational amplifier, reference voltage, and zero voltage switching available as separate options.

INFORMATION RETRIEVAL NO. 511

45V-0136

...need a reliable wirewound resistor?

Specify ACRASIL[®] PRECISION/POWER RESISTORS



INFORMATION RETRIEVAL NO. 512

Excellent stability and reliability, even under extended load life, extremely high humidity, and other adverse operating conditions. Expansion coefficient of silicone coating is closely matched to that of ceramic base to insure against damage to resistance winding. Coating provides exceptional protection against moisture, shock, vibration, fungus. Available with standard and non-inductive windings. Resistance tolerances as close as $\pm 0.05\%$.

For complete technical data on Series VPC Power Controllers, write for Engineering Bulletin 1014. For information on Acrasil Resistors, request Bulletins 7450A and 7450.1. Write to: Technical Literature Service, Sprague Electric Co., 35 Marshall St., North Adams, Mass. 01247.

48R-0118



[®]'Sprague' and [®]' $\text{\textcircled{S}}$ ' are registered trademarks of the Sprague Electric Co.

THE BROAD-LINE PRODUCER OF ELECTRONIC PARTS



Our new panel meter is a slim bargain.
2³/₄" deep. \$149.*

Presenting our new digital panel meter. A low-cost little package that's the perfect replacement for old-fashioned panel needle meters. This DVM measures with accuracy to 0.1% of reading ± 1 digit, 100 μ V resolution, 100 megohms impedance, auto-polarity, and numerals you can read from thirty feet away. You install it in seconds. It fits a 4" x 2³/₄" opening. And as a result of a new and unique design concept, the unit is only 2³/₄" deep. Calibrate it just

once. And save when you update every meter on every panel: \$199 in single units. \$149 in lots of 100.* \$129 in lots of 1,000.

This new DVM is ready to slip in now wherever panel meters are used. For detailed information and a complete set of specifications, write Tyco Instrument Division, Tyco Laboratories, Inc., Bear Hill Industrial Park, Waltham, Massachusetts 02154. Or call (617) 891-7000.

TYCO

Who's Who in this issue



Kanner

Designing flexible safeguards into aerial electronic systems ranks high on any list of engineering priorities. Martin Kanner, who wrote the article on a non-stop limiter that absorbs transients (page 106), has done just this. Now with the Grumman Aircraft Engineering Corp., Bethpage, N.Y., he developed the device for application in an airborne camera system while working at the Fairchild Camera & Instrument Corp.'s Long Island, N.Y., installation.

To combine his interests in both engineering writing and computers, Michael French, author of the article on rotating memories that begins on page 96, last year joined the BCI Computing Corp., a consulting firm. Among other duties, French, who earned a bachelor's degree in electrical engineering from Brown University in 1962, evaluates and reports on new processors and peripheral equipment for clients.



French



Marso

Mondloch

High-frequency problems have occupied Rudolf Marso and Anthony Mondloch, co-authors of the millimeter-wave transceiver Sylvania developed for the Navy (page 108) most of their professional lives. Marso, an engineering specialist in the company's microwave millimeter lab, has worked on receivers, acquisition servo logic, and telephone multiplex circuitry for an automatic antenna-tracking millimeter communications system. In addition, he has investigated f-m with feedback and phase-lock loop demodulation techniques. Mondloch was project engineer on the 37.5-gigahertz transceiver. He has also conducted propagation tests at 53 Ghz and worked on systems in this range.

Well-traveled is the word for Franz L. Sauerland, who wrote the article on how identical resonators can cut ceramic i-f filter costs (page 102). A graduate of the University of Aachen in Germany, he holds a master's from Case Institute. Sauerland has also taught at the University of Chile in Santiago.

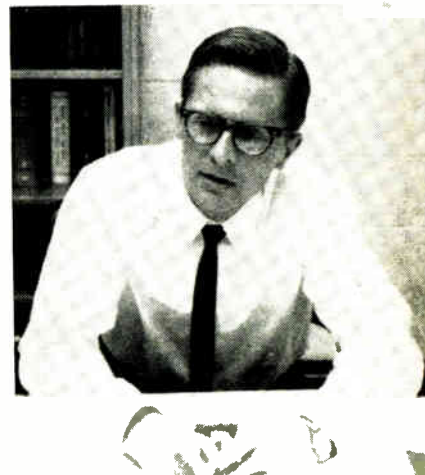

Sauerland

IRRAVIN™

INSULATED WIRE

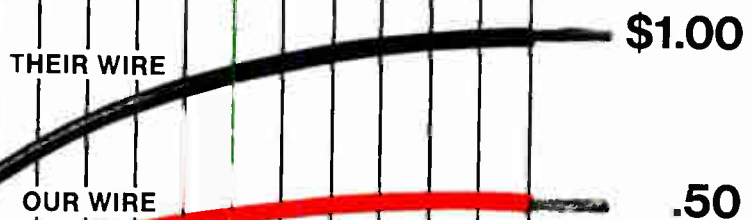

Cuts cost of solder-iron resistant wire by 50%.

IRRAVIN insulated hook-up wire resists hot solder iron damage and high ambient heat. Yet, it sells for less than half of the other leading high temperature wires. You cut costs without cutting corners.

And that's only part of the savings possible. You also get longer lengths for faster production with less scrap (up to 50,000 ft. of continuous lengths available), lower inventory costs (IRRAVIN hook-up wire is a universal wire—easily replaces a host of other "specials").

So, you see using IRRAVIN wire is like getting half your order free!

IRRAVIN wire is not a cheap wire—just costs you less. What's more, IRRAVIN wire is great on crush, cut through and abrasion resistance, no need of outer jacketing. It is U.L. Listed and conforms to MIL-W-16878.

Want a sample for comparison? Write: ITT Wire and Cable Division, Surprenant Products, International Telephone and Telegraph Corporation, Pawtucket, Rhode Island 02862. In Europe: ITT Europe-Components Group, Lister Road, Basingstoke Hants, England, United Kingdom.

IRRAVIN—the wire that stops the grumbles.



Have a good application?
Enter our Pot-O-Gold Contest.

Write for your
entry form today.

WIRE AND CABLE **ITT**

Five ways to improve communications

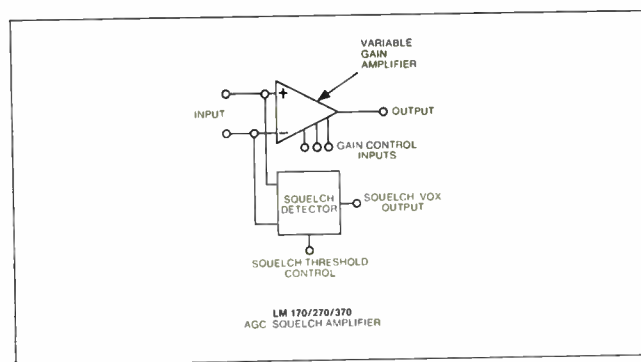

LM370. A simple squelch and AGC circuit. Gain reduction range is 80 dB typical. Supply voltage from +4.5 to +24V. Supply drain is 18mW at +4.5V. For airborne or mobile communications systems. Also doubles as a constant amplitude audio oscillator, transmitter or tape recorder VOX, or variable gain DC amplifier for analog computation.

Price \$2.95.*

*In hundred up quantities. Also available in full military temperature ranges.

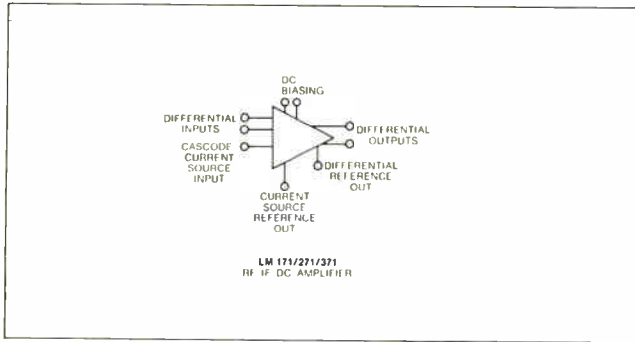

LM371. An RF/IF amp with 100 MHz power gains of 24.6 dB as an emitter coupled limiting amplifier and 27.5 dB as an AGC'd cascode. Versatile. Thousands of applications beyond its basic tuned RF/IF functions. Ideal as monolithically matched building blocks in DC, audio, video and logic applications. Priced at \$2.75.*

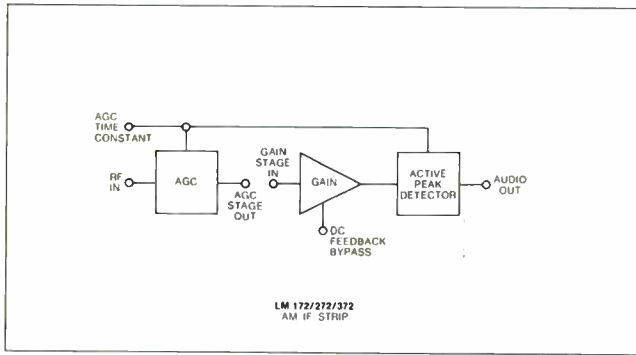

LM372. A very efficient, low power drain, AM/IF strip. 60 dB AGC range at frequencies up to 2 MHz. Draws only 8.4 mW from a +6V supply. 50 μ V AGC knee. Self contained detector and AGC loop. Ideal for AM/IF below 2 MHz, or audio/sonar untuned applications. Priced at \$2.50.*

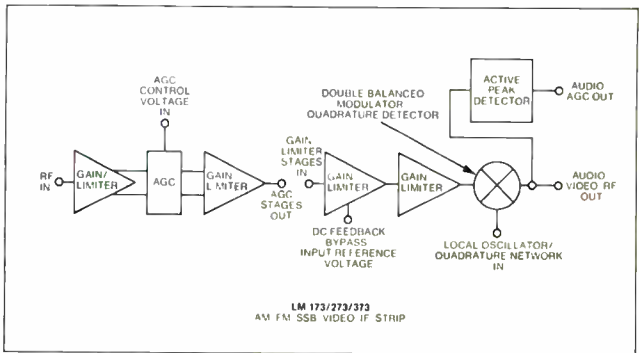

LM373. A single IF strip that can be externally connected to do all the things needed in AM, FM or SSB reception at IF's up to 12 MHz. Versatile. Connected for AM, it amplifies, detects and performs AGC with few external components. Four emitter coupled limiting stages for FM. A quadrature detector with large audio outputs for very narrow band deviations. Provides balanced product detector and audio-operated AGC in SSB mode. Makes a good video amp with built-in AGC or gating. Priced at \$2.73.*

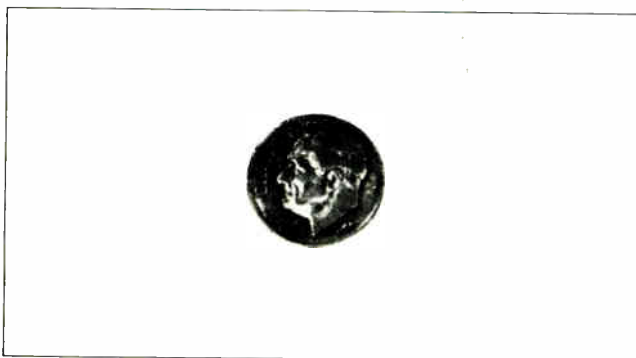

SPEAK Call your National representative or distributor for parts off the shelf and for full specification and applications information. We've got sheafs of applications notes on each of these outstanding communications circuits. Drop the word and they're yours. National Semiconductor Corporation, 2975 San Ysidro Way, Santa Clara, California 95051. (408) 245-4320 TWX: 910-339-9240. CABLES: NATSEMICON.

National/Linear

**For stronger, smaller, lighter
PM motors, our alnicos
pack quite a charge.**

INDIANA GENERAL *We make it easy for the design engineer.*

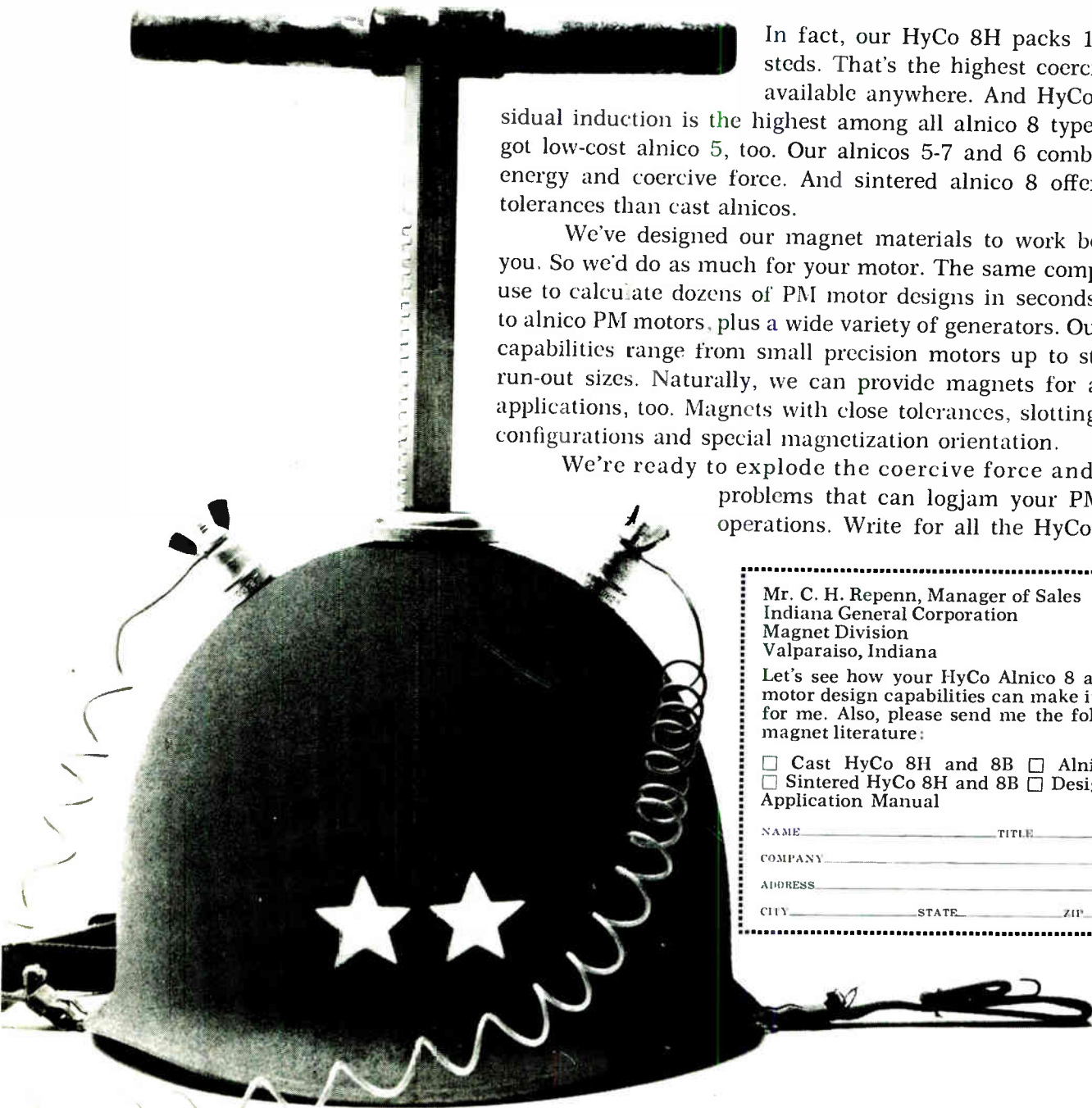

In fact, our HyCo 8H packs 1900 oersted. That's the highest coercive force available anywhere. And HyCo 8B's residual induction is the highest among all alnico 8 types. We've got low-cost alnico 5, too. Our alnicos 5-7 and 6 combine high energy and coercive force. And sintered alnico 8 offers closer tolerances than cast alnicos.

We've designed our magnet materials to work better for you. So we'd do as much for your motor. The same computer we use to calculate dozens of PM motor designs in seconds applies to alnico PM motors, plus a wide variety of generators. Our design capabilities range from small precision motors up to steel mill run-out sizes. Naturally, we can provide magnets for all these applications, too. Magnets with close tolerances, slotting, varied configurations and special magnetization orientation.

We're ready to explode the coercive force and design problems that can logjam your PM motor operations. Write for all the HyCo details.

Mr. C. H. Repenn, Manager of Sales
Indiana General Corporation
Magnet Division
Valparaiso, Indiana

Let's see how your HyCo Alnico 8 and PM motor design capabilities can make it easier for me. Also, please send me the following magnet literature:

- Cast HyCo 8H and 8B Alnico 5-7
 Sintered HyCo 8H and 8B Design and Application Manual

NAME _____ TITLE _____
COMPANY _____
ADDRESS _____
CITY _____ STATE _____ ZIP _____

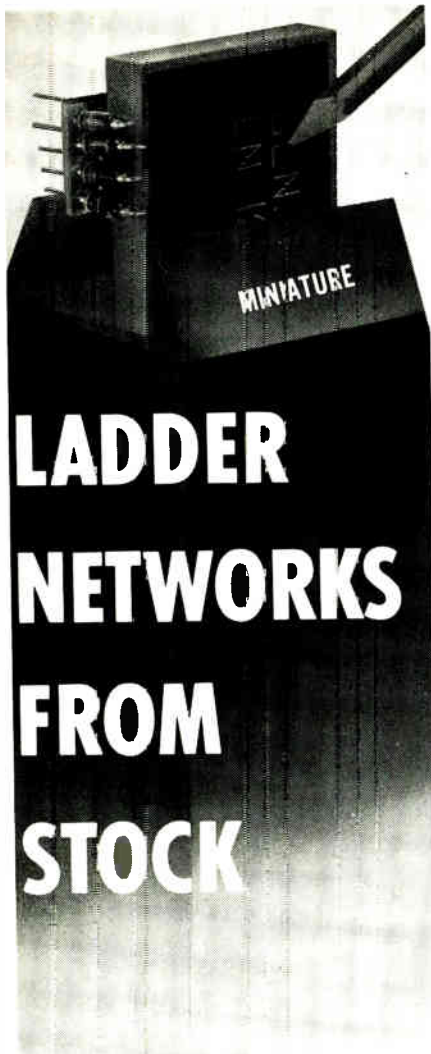

- 8 to 17 Bits
- 1/2 LSB Accuracy
- Switch Impedance Compensated
- Military / Commercial
- 1" x 1.40" x 0.2"
- 30 Volt Input
- R/2R, Binary, Mod. Binary
- \$15 to \$110*

*f.o.b. Mt. Vernon, N.Y., domestic

Write or 'phone for complete technical data.

General Resistance, Division of Chronetics,
500 Nuber Avenue, Mt. Vernon, N.Y. (212)
292-1500. In Europe: 39 Rue Rothschild,
Geneva, Switzerland (022) 31 81 80.



Who's Who in electronics



Fairchild's Grant

Security analysts had it laid right on the line by Fairchild Camera & Instrument last December: its weak-sister divisions were hurting because of lack of effective and timely cost, production, and inventory control; overoptimistic sales forecasts; marginal pricing strategies; and poor marketing. Earlier this month, Alan J. Grant, who was hired away from his post as president of the Lockheed Electronics Co. to become a group vice president of Fairchild in charge of the East Coast divisions plus the Instrumentation division, produced a five-point plan to correct the weaknesses:

- An operational income of a specified percentage of before-tax return on sales. The exact percentage is classified, but Grant says he expects to beat it anyway.

- Implementation of stronger managerial control systems. In some cases, Grant says, divisional managers have never been asked to state their own goals; and some were reluctant to do so when he asked them to.

- Continued extrapolation of semiconductor techniques to black-box and systems hardware.

- Initiation of a five-year development plan.

- Initiation of an executive selection and development plan. Fairchild has considerable stock leverage in this respect, Grant says—perhaps with a touch of irony. To

lure him from Lockheed, where he was the youngest vice-president of the parent corporation (he is 43), Fairchild gave him a restricted, stockholder-approved five-year option on 5,000 shares at \$10 a share, and 30,000 shares at \$76.19. (Fairchild is now selling in the high 80's.) Grant's salary is \$80,000 a year.

Ex-Litton. Grant is a "Lido" (Litton Industries dropout). He was head of that corporation's Guidance and Control division in 1964-65, until he fell out with Litton boss Tex Thornton. Before going to Litton, he had held a number of key management positions at the Autonetics division of the then North American Aviation Corp. He was assistant general manager of navigation systems during the building of the D37 computer for the Minuteman missile, and head of its Computer and Data Systems division when Autonetics brought out its ill-fated commercial computer.

A longtime foe of radical patent-reform measures has become Patent Commissioner with major responsibilities for reshaping the office.

William E. Schuyler Jr., a Republican who has been in private patent law practice in Washington, D.C., has taken over from Edward Brenner, a Democrat who headed the office for five years.

Brenner has been pushing drastic patent-reform legislation to bring U.S. laws into line with those in foreign countries. Schuyler has been leading the opposition, favoring, instead, a moderate reform program and the preservation of major portions of the existing law.

Advocates of drastic reform argue for freer world trade and more protection for the small inventor. Schuyler and his followers have claimed, however, that the U.S. patent system works better than any in the world and therefore other countries should get in step with this country.

Change needed. Schuyler and Brenner agree that patent procedures must be streamlined and applications procedures must be

We frame up some of the biggest people in the industry.



Our lead frames are used by most of the major semiconductor manufacturers.

And there are good reasons why.

They've learned that they can depend on Sylvania. For a quality product. For fast service in large production quantities. (We turned out more than 100-million frames last year).

We make lead frames for all types of semiconductor packages—flat packs,

dual-inline packages and plastic encapsulated types.

We make them out of nickel, steel, Rodar,[®] and other glass-sealing alloys.

We make them fast and we make them accurate.

And we're the only supplier that can give you a choice of photo-chemical machined parts or die-stamped parts. Whichever suits your needs the best.

That's why some of the biggest people in the industry like being framed up by us. Wouldn't you?

Sylvania Metals & Chemicals, Parts Division, Warren, Pa. 16365.

SYLVANIA
A DIVISION OF
GENERAL TELEPHONE & ELECTRONICS

We predict our
4-402 bonded strain gage
won't make all others
obsolete.

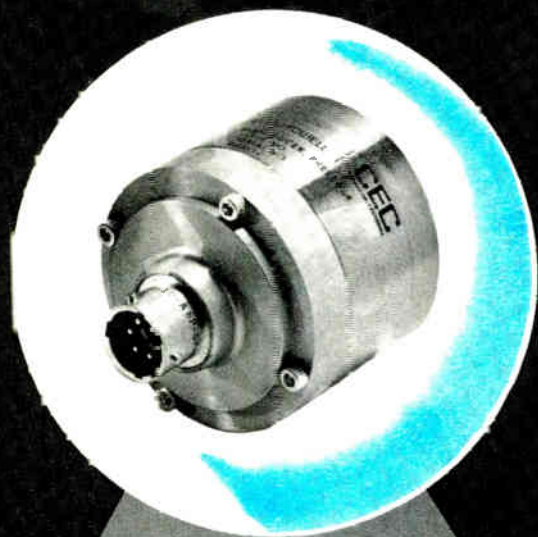

Just very, very nervous.

Because the new 4-402 is more than just an unusually good accuracy transducer at a surprisingly reasonable price.

It also comes in standard ranges from 0-10 PSI through 0-5000 PSI.

Standard units are available in gage or absolute configurations.

Connection for an external shunt is also standard.

You can order it either bolted or with a welded pressure chamber.

And CEC reliability is included in the cost.

All of which is artfully calculated to get you to call our nearest office.

Or write Bell & Howell, Pasadena, Calif. 91109. Ask for Bulletin Kit 3329-X2.

CEC/TRANSDUCER DIVISION



BELL & HOWELL

Who's who in electronics

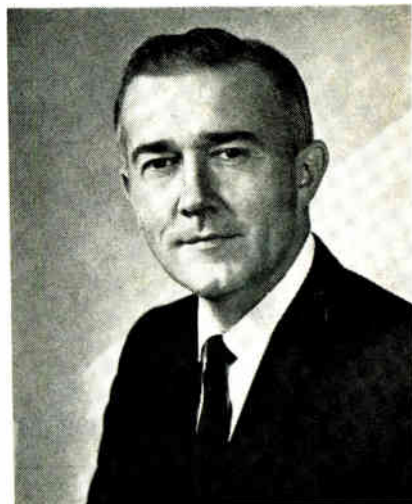

Patent Commissioner Schuyler

sped. Efforts by Brenner have resulted in cutting the "pendency" time (the time elapsed from filing an application to its issuance) from 30 months to about 24 months, and he was working toward an 18-month pendency. Patents in technologically active areas such as electronics often have a longer pendency.

One of Schuyler's first acts will be to formulate a position for the Nixon Administration on the patent-reform bill now pending on Capitol Hill. The bill, introduced by Sen. John McClellan (D., Ark.), is complex, with two provisions stirring up most of the controversy:

- It would modify the first-to-invent rule, so that an applicant for a patent may not go back into his records more than two years, if challenged, to prove he was first.
- It would place foreign inventors on the same basis as U.S. inventors by including permission to cite research done abroad.

Brenner favored both provisions or more drastic ones. Schuyler has hinted that he may seek modifications in the bill, striking out the two controversial provisions.

Schuyler favors a Nixon Administration proposal to call an international conference in Washington for April 1970 to negotiate the treaty. He points out, however, that the U.S. has special responsibilities in patents: the U.S. is the only country whose patent office receives more applications from its citizens than from foreigners.

LS series is two instruments in one

Expand the capability of your laboratory

With this plug-in



it becomes
a high precision
power differential
voltmeter



LS
power source

ONE
DAY
DELIVERY
ALL
MODELS

With this plug-in



it becomes
a metered
high precision
power supply



FEATURES OF THE HIGH PRECISION POWER DIFFERENTIAL VOLTMETER

- Draw power as you measure voltage...
The first and only differential voltmeter to furnish high stability power output while being used as a voltmeter...no need for a separate power supply.
- Plus all power supply specifications

FEATURES OF THE METERED HIGH PRECISION POWER SOURCE

- 0.0005% plus 100 μ V Regulation — best of any high stability power supply in this price range.
- Ripple — 35 μ V rms; 100 μ V p-p.
- Accuracy — 0.01% + 1mV.
- 2 Meters — monitor both voltage and current simultaneously and continuously.
- Twice the power — in a convenient 1/2-rack package.

- Guaranteed for 5 years — the only 5-year guarantee that includes labor as well as parts. Guarantee applies to operation at full published specifications at end of 5 years.



- Multi-Current-Rated — for 30°C, 40°C, 50°C, 60°C — Covers temperatures most often encountered in laboratory work.
- 5 Models — with ranges of 0-10, 0-20, 0-40, 0-120, 0-250VDC — Wide selection of ranges to suit your specific needs.
- Illuminated digital readout Millimatic™ gang dialing — 5-digital voltage dials with automatic decade switching provides convenient precise adjustment (200 μ V resolution over entire range).
- Only 5 1/4" high — convenient half-rack size for rack or bench use.
- Stability — 0.001% + 100 μ V for 8 hours.
- All silicon-designed for maximum reliability.

- Convection-cooled — no blowers, no external heat sinks.

- Remote programming — by changes in voltage or resistance for convenience in systems, test equipment and automatic equipment applications.

- Auto Series/ Auto Parallel — with Master-Slave tracking.

- Constant voltage/Constant current.

- Completely protected — short-circuit proof; continuously adjustable automatic current limiting.

- Overvoltage protection — available as low cost add-on accessory.

- Rubber feet — provided for bench use.

- AC Input — 105-132VAC, 47-440 Hz (derate dc output current 10% at 50 Hz) 205-265VAC at no extra charge. ("V" option)

- Fungus Proofing Option — Add suffix "R" to model number and add \$20.00 to price



- Mount in Rack Adapters — LRA-1 (\$60.00) or LRA-2 (\$35.00). Rack adapter LRA-1 only is available with chassis slides mounted. Add suffix "CS" to rack adapter model number and \$50 to price.

Basic Non-Metered Model	Voltage Range	Max. Amps at Ambient of (1)					Price
		30 C	40 C	50 C	60 C	(2)	
LS-511	0-10VDC	2.8A	2.5A	2.1A	1.7A	\$375	
LS-512	0-20VDC	1.8A	1.6A	1.3A	1.1A	375	
LS-513	0-40VDC	1.0A	0.9A	0.75A	0.6A	375	
LS-515	0-120VDC	0.33A	0.29A	0.25A	0.21A	375	
LS-516	0-250VDC	0.1A	0.09A	0.08A	0.07A	380	

Metered Accessory	
Model	Price
LS-FM1	\$55
LS-FM2	55
LS-FM3	55
LS-FM5	55
LS-FM6	55

Diff. VM Accessory	
Model	Price
LS-DM1	\$85
LS-DM2	85
LS-DM3	85
LS-DM5	85
LS-DM6	85

Over Volt. Protect.		
Model	Adj. V. Range	Price
LHOV-4	3-24	\$35
LHOV-4	3-24	35
LHOV-5	3-47	35

NOTES:

- 1 Current rating applies over entire voltage range. Ratings based on 55-65 Hz operation. Derate current 10% for 50 Hz.
- 2 This price is for non-metered Precision Power Source. Addition of Metered Accessory Plug-In (next two columns) is necessary to have Metered High Precision Power Supply. Addition of Differential Voltmeter Accessory Plug-In to the basic model is necessary for the unit to function as a High Precision Differential Voltmeter.

 **LAMBDA**
ELECTRONICS CORP.
515 BROAD HOLLOW ROAD, MELVILLE, L.I., NEW YORK 11746
TEL 516-694-4200 TWX 510-224-6484 CABLE VEECOVAC PLAINVIEW NY

← See additional equipment inside

Circle 17 on reader service card

Better solutions come from Weatherford

Try these for starters: TTL. DTL. General Purpose Diodes.

The status quo isn't quo any more on TI's TTL delivery. TI has now substantially expanded its TTL manufacturing capacity and more of these circuits are coming our way. Delivery is better than ever on TI's 17 Series 54L/74L low power circuits, 26 Series 54/74 standard gates and flip-flops, 13 Series 54H/74H high speed circuits and 23 TTL/MSI types. They all come in TI's dual-in-line plastic package; most also come in the military-rated flat-pack and ceramic DIP. With this wide selection to choose from and delivery picking up, TI is your best TTL bet. Call us and find out more.

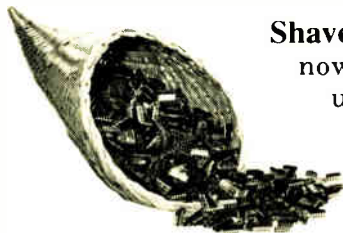
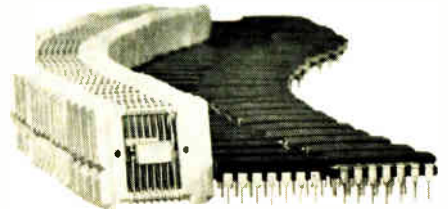

Shave delivery time on TI's DTLs by placing big orders with us. You can now get your big orders for TI's plastic DTLs filled faster. Just contact us directly. Availability of these devices is such that we are primed to accept and handle large DTL orders without delay (and we still welcome small orders). Because TI makes 20 DTL circuit types in the dual-in-line plastic package, we can provide exactly the functions you need. You can count on economy *and*

reliability. Some 1700 users have put more than 30 million TI plastic devices into tough jobs for a total of 30 billion operating hours. Big order or small, for the wide choice in dependable DTLs delivered fast, try us.

General Purpose Diodes – TI's big 12 sub for hundreds. Here's how to save considerable work and worry selecting general purpose diodes.

There are more than 1000 general purpose diodes in the world today, yet a mere dozen TI types – 1N456-58, 1N482-85,

1N645-49 – will do the lion's share of the work. TI's big

12 come in low- and high-conductance types. The low conductance diodes are now of planar wafer construction, giving higher stability and lower leakage in the pico-amp range. For TI's data sheets on these 12 workhorse general purpose diodes, circle 318 on the Service Card.

12 come in low- and high-conductance types. The low conductance diodes are now of planar wafer construction, giving higher stability and lower leakage in the pico-amp range. For TI's data sheets on these 12 workhorse general purpose diodes, circle 318 on the Service Card.

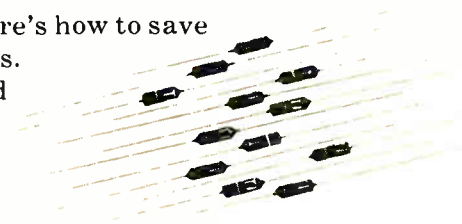

For better solutions, call



R. V. WEATHERFORD CO.

DISTRIBUTORS OF ELECTRONIC COMPONENTS AND EQUIPMENT

ANAHEIM, CALIFORNIA
1550 Babbitt Street
714 532-6741
714 547 7521

GLENDALE, CALIFORNIA
6921 San Fernando Road
213 849 3451

PALO ALTO, CALIFORNIA
3240 Hillview Drive
Stanford Industrial Park
415 321-5373

PHOENIX, ARIZONA
1917 North 25th Drive
Carson Industrial Center
602 272 7144

WEATHERFORD
ELECTRONIC
PLUS

SALES OFFICES: San Diego, California, 714 278 7400 • Seattle, Washington, 206 762 4200



Pretty nice, for a circuit breaker.

And you can have our Model JC in any color you want—so long as it's white or gray.

Either way, you get a hydraulic-magnetic circuit breaker that's handsome enough to put right out there on the front panel. At an attractive OEM price, too.

Heinemann hydraulic-magnetic protection, of course, has an appeal all its own. Precise current ratings from 0.020 to 30 amp. Temperature-stable trip points. Choice of time-delay (or non-time-delay) characteristics. Optional special-function internal circuits that let you use the breaker as a control element.

And don't forget our five-year warranty. We don't.

You can get more information about our rocker-handle JC breaker by writing for Bulletin 3380. Heinemann Electric Company, 2600 Brunswick Pike, Trenton, N.J. 08602

HEINEMANN

If it's color you're after, you can code our Series JA breaker with any of nine different hues, from flash yellow to electric blue. Write us for Bulletin 3350.



33 reasons why we're No. 1 in DVMs.

Dollar for dollar we shipped more DVMs last year than anyone else, including the industry giant.

One of the reasons is our Model 5700. It's the DVM used by laboratories to calibrate other DVMs. Without question it's the

best DVM on the market.

But since not everyone needs the kind of performance and features offered by the 5700, we offer 32 other models. Models for labs and for production lines, bench units and systems' units, militarized models,

four digit DVMs and five, from \$1150 to over \$8,000. (In fact, with plug-in modules you can come up with 300 different configurations.) In short, we make a model for every application and every budget. All as part of our standard line.



And every DVM we make is put together on the same production line, by the same people, using many of the same components and boards. In fact, quite often the assemblers don't know in advance which models they're assembling.

Which means that we've got to build every DVM as though it were our most expensive, over \$8000, unit.

And that may be reason number 34 why we're No. 1 in DVMs.

For a detailed description of our 33 models, write Dana Laboratories, Inc., 2401 Campus Drive, Irvine, Calif. 92664

DANA

...and another MTOS first!

2048 BIT ROM

READ ONLY MEMORY

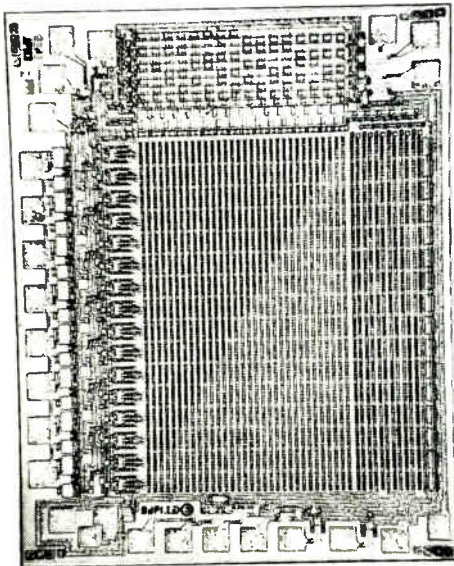

Now, for the first time – off-the-shelf customized LSI memory chips organized for low-cost, quick-turn-around, mass production . . . available only from General Instrument.

- Outputs can drive TTL, DTL or MOS without interface hardware
- Up to 11 bit decoding matrix
- Expandable to 2048 x 8 ROM modules without additional hardware
- Power Dissipation 120 mW @ 1MHz
- 1 microsecond access time
- Non-volatile, non-destructive memory

General Instrument's exclusive 2048 bit ROM (Read Only Memory) cell is a four phase MTOS array consisting of 11 bits of two dimensional addressing (5 and 6 bits respectively) and 8 outputs. It permanently stores 2048 bits of information in a 64 bit x 32 bit matrix positioned into 8 segments, each of which contains an 8 bit x 32 bit matrix and an output stage. The ROM chip outputs have internal "wire-or" capability which allows the formation of ROM modules without any other component

< 1 PER BIT*

ROM ORGANIZATION CHART						
No. of Outputs Per Chip	No. of Bits of Addressing Used Per Chip	No. of Bits Available For Chip Select	No. of Bits Per Word	No. of Words Per Chip	No. of Chips Per Module	Total Bits Per Module
1	11	—	1	2048	1	2048
2	10	1	2	1024	2	4096
4	9	2	4	512	4	8192
8	8	3	8	256	8	16384

additions. This organization permits an extremely wide range of operating variations with a modular capability applicable to virtually all ROM systems.

Since any and all changes to the ROM chip, both data pattern and "chip-select," are made by alteration to a single mask only, low cost, quick-turnaround time is guaranteed for customized ROM circuits.

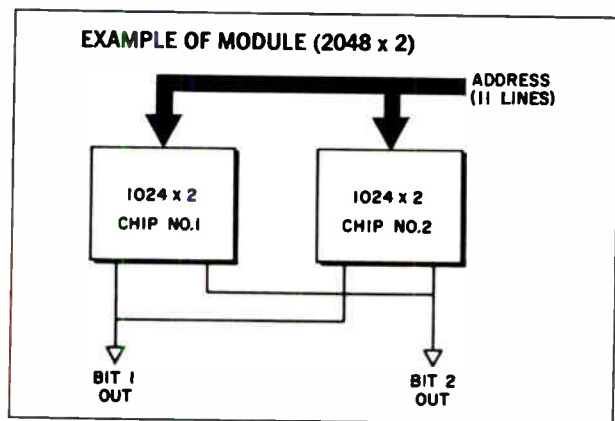

General Instrument's 2048 bit ROM cells are designed to undercost and outperform cores, drums, delay lines and complex logic functions, while providing dramatic savings in space and weight.

Write for full information. (In Europe, to: General Instrument Europe S.P.A., Piazza Amendola 9, 20149 Milano, Italy.)

*At quantities in excess of 25,000 ROMs.



GENERAL INSTRUMENT CORPORATION • 800 WEST JOHN STREET, HICKSVILLE, L. I., NEW YORK

TODD cost cutting system power supplies!

More watts/in³/°C/\$

\$69⁰⁰
M
SERIES



FEATURES:

- Full rating with no external heat sink required
- 71 Degree C Operating Temperature
- 5 MV RMS Ripple
- .01% Regulation
- Short Circuit & Overload Protection
- 5 year warranty
- Designed to Meet MIL Environment Specifications
- OverVoltage Protection option

Available:

- "M" Series to 1.1 amps \$69
- "A" Series to 3.7 amps \$99
- "B" Series to 5.0 amps \$115
- "C" Series to 7.5 amps \$135

For complete information, contact your local Todd representative or write to:

ATC

TODD PRODUCTS CORP.
28 Laurel Street
Hicksville, N.Y. 11801

Meetings

Communicators head for the hills

If you doubt that 260 papers can be squeezed into a three-day conference, then come to the IEEE's International Conference on Communication (ICC) in Boulder, Colo., June 9-11. There, in the warm and dry altitude of the Rockies, you'll find the reason for the prodigious number of presentations—half are short, eight-to-ten-minute talks.

The fifth ICC, this year's meeting will present, for the first time, sessions on oceanographic communications (including a paper on the requirements for a national buoy system) and spectrum sharing. This session, dwelling on the economic, regulatory, and legal aspects of the spectrum usage, will present talks on the FCC's tightening control over interfering r-f devices, marketable spectrum rights, and the use and management of the "electrospace."

The Mallard project, a four-nation tactical communications project, will be the subject of a panel discussion aimed at setting precedents for international communications needs.

Sssh. Four papers will deal with noise suppression in wideband overland transmission wire, with the accent on minimizing interfer-

ence in television, and noise measurements. In another group of papers on microwaves, Bell Telephone Laboratories will reveal its mobile-communications work at 900 megahertz with accompanying increased channel capacity.

Data transmission techniques will be covered by seven papers, while Bell Labs engineers will discuss their new No. 2 electronic switching system.

Other sessions will be devoted to communication theory, satellite systems, radio relay measurements, switching controls, digital transmission systems, solid state device applications, electromagnetic compatibility, antennas and coupling devices, and modulation and filtering techniques.

A new induction radio system developed in Japan will be the concern of one of the four papers in the vehicular communications session, while a number of representatives from firms abroad are scheduled to contribute to the discussion on multiple-access communications satellite systems.

For information contact Martin Nesenbergs, Institute for Telecommunication Science, R-614, Boulder, Colo. 80302.

Computer Group studies real time

It's really time for real time—or so the IEEE Computer Group thinks as it prepares for its third annual conference. This one will be held at the Leamington Hotel, Minneapolis, Minn., June 17-19. The conference's theme is "Today's World of Real Time Systems," and if the meeting measures up to its 1967 and 1968 predecessors, it ought to be a real humdinger.

Much of the interest this year centers on the use of computers on patients by doctors in hospitals, applications that go well beyond such administrative tasks as printing paychecks for orderlies or keeping track of how much a patient should

be charged for this or that drug. Four sessions lasting two days will be devoted to hospital data systems. They include papers ranging from "By-Products of a Hospital Payroll System" through "A Hybrid Computer for Automatic Scoring of Human Sleep" to "Surgical Intensive Care Process Control System."

Data communications and time-sharing are two more conventional examples of real-time systems, and both are represented in the program. The former will include, for example, a discussion of design considerations that are involved in

(Continued on p. 28)

"ALLEN BRADLEY HOT-MOLDED RESISTORS ENHANCE THE QUALITY STANDARD OF OUR DATA-RECORDERS."

Mohawk Data Sciences Corporation

MDS The time reduction achieved by the MDS Data-Recorder method of computer input preparation demands continuously reliable operation. And this in turn demands the highest standards of performance from each and every component.

Allen-Bradley fixed composition resistors were a natural selection. Made by an automatic hot-molding technique—developed and used exclusively by Allen-Bradley—A-B resistors afford the ultimate in uniformity. From resistor to resistor—year in and year out—physical and electrical properties are unvarying. Predictable. Always of the highest order.

Performance records are equally excellent. For example, Allen-Bradley hot-molded resistors meet the requirements of the new MIL-R-39008A Established Reliability Specification at the *highest* level—the S level. And this is true for *all* three ratings—the 1 watt, ½ watt, and ¼ watt—and over the *complete* resistance range from 2.7 ohms to 22 megohms.

For complete specifications on this quality line of hot-molded resistors, please write to Henry G. Rosenkranz, and request a copy of Technical Bulletin 5000. Allen-Bradley Co., 1201 S. Second St., Milwaukee, Wis. 53204. Export Office: 1293 Broad St., Bloomfield, N.J., U.S.A. 07003. In Canada: Allen-Bradley Canada Ltd.

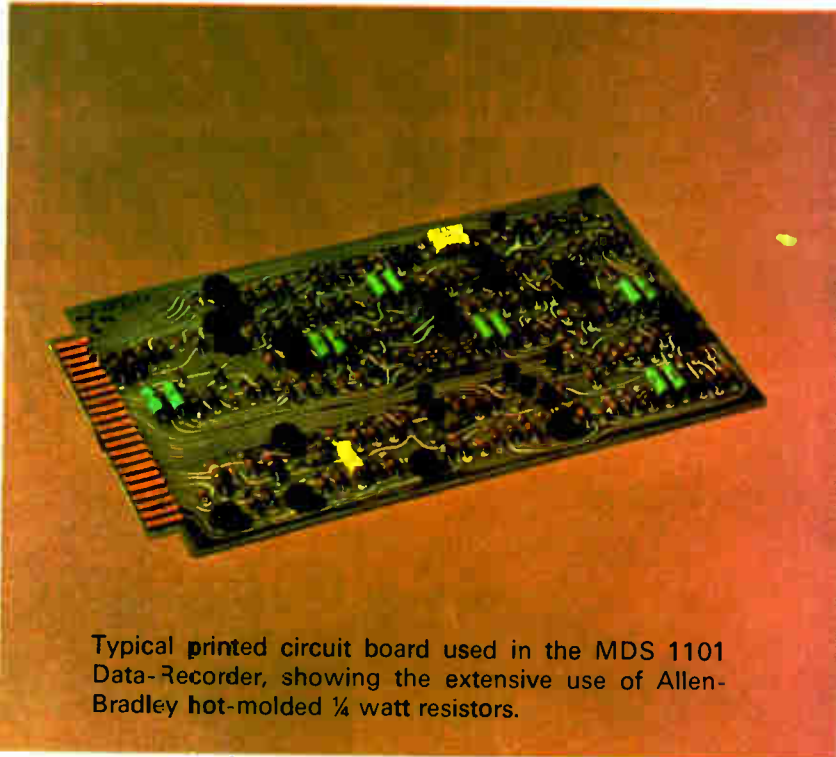

Typical printed circuit board used in the MDS 1101 Data-Recorder, showing the extensive use of Allen-Bradley hot-molded ¼ watt resistors.

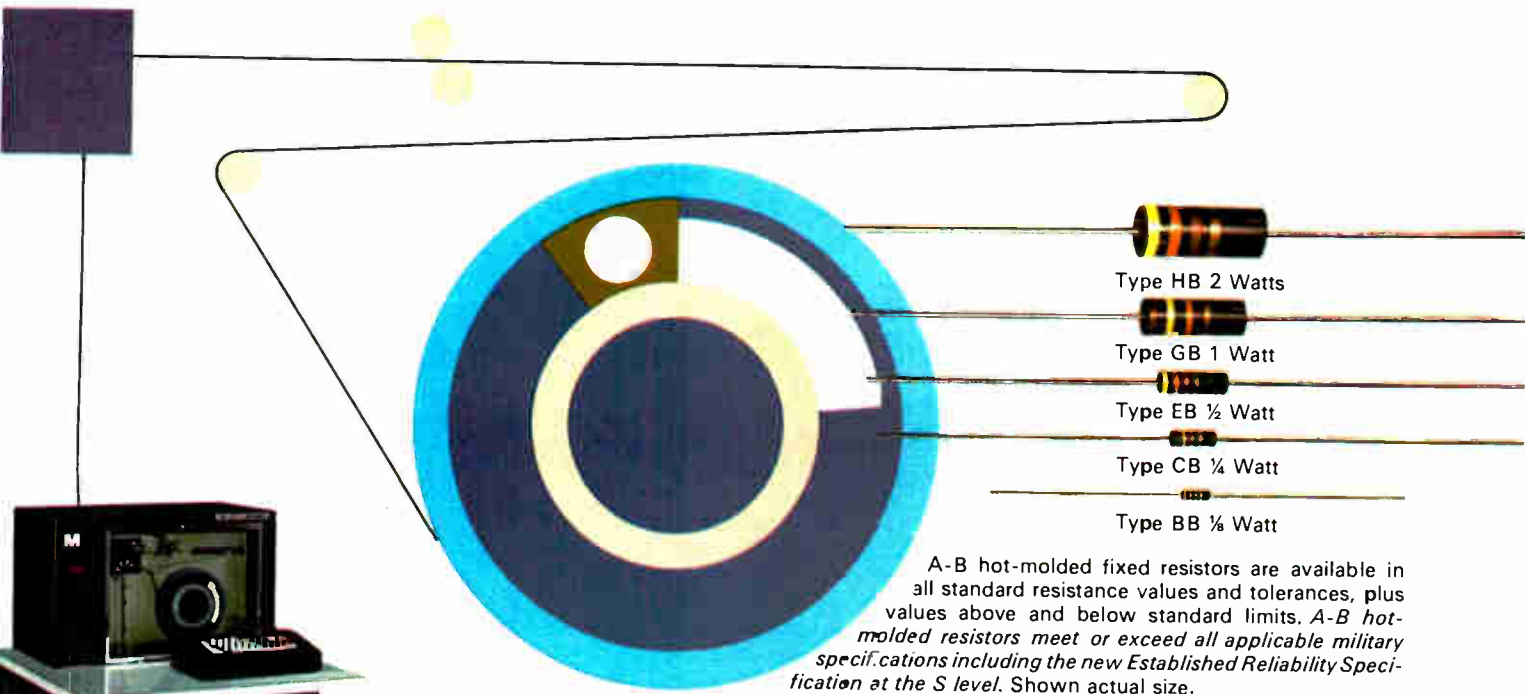

A-B hot-molded fixed resistors are available in all standard resistance values and tolerances, plus values above and below standard limits. A-B hot-molded resistors meet or exceed all applicable military specifications including the new Established Reliability Specification at the S level. Shown actual size.



Mohawk 1101 Data-Recorder permits transcribing of data from source documents direct to ½" computer magnetic tape.

©Allen-Bradley Company 1968

EC 6821



ALLEN - BRADLEY
QUALITY ELECTRONIC COMPONENTS

Circle 27 on reader service card

When you need a relay to meet these specifications:

MS 27245 MS 27247 MIL-R5757/23

Specify this:



Conelco Style 7 Relay DPDT 10 amp military

You can't get a better 10 amp relay for your money than the Conelco Style 7. It was developed specifically for the aerospace industry.

So it's durable and dependable. For 3-phase AC requirements, an arc chamber is used to assure trouble free operation to 100,000 times, minimum. And all welded construction makes it absolutely reliable for the most stringent avionic applications. Independent tests have proven that the Style 7 Relay stands up against the effects of altitude, vibration and temperature extremes.

We've got a Style 7 Relay designed specifically for your needs. Send for our exclusive Select and Specify Chart.

FEATURES:

All welded construction for positive contamination control.
20% smaller than similar relays.
Arc chamber: -10 amp AC rating 115 volts single and three phase with case grounded.

CHARACTERISTICS:

DPDT 10AMP 28VDC/115VAC res.
Coil: 565 MW typical: 26.5VDC 300 ohms
Ambient temp: -65 to +125 C
Vibr: 20G up to 2000 Hz
Shock: 50G 11msec
Mil-Spec: MS 27245 MS 27247 MIL-R 5757/23

PRICE ELECTRIC COMPANY

A Division of North American Philips Corporation
relays and electromechanical devices / Conelco switching devices
Frederick, Maryland 21701 / (301) 662-5141 / TWX (710) 826-0901

Meetings

(Continued from p. 26)

conversational typewriter terminals. In the latter session both large and small systems will be discussed.

Teamwork. A good deal of doubling up appears in the preliminary program. Several authors' names appear more than once, and the titles of some papers suggest that their authors are colleagues—for example, the two papers dealing with the simulation of IBM's 4 pi aerospace computer.

These two papers on the 4 pi are also examples of something new in the IEEE computer conferences—two sessions specifically devoted to software, and two others whose content suggests that they are strongly software oriented. One of the objectives of the Computer Group, when it started its series of conferences two years ago, was to establish a forum for hardware-oriented computer people. Before that time most well-known meetings sinned in one of two ways: either they catered to too wide a variety of computologists, like the semiannual Joint Computer Conferences, or they wandered into electronic areas far removed from the world of computers—for example, the Solid State conferences every February. Could the IEEE computer group be drifting down one of those primrose paths?

For information contact D.L. Epley, U. of Iowa, Iowa City, Iowa 52240.

Calendar

Magnetic Powder Core Seminar, Metal Powder Industries Federation; O'Hare Inn, Chicago, June 2.

Microelectronics Conference, IEE; Congress Theatre, Eastbourne, England, June 3-5.

Design Automation Workshop, Association for Computing Machinery, IEEE; Hotel Carillon, Miami, June 8-12.

Pattern Recognition Studies, Society of Photo-optical Instrumentation Engineers; Holiday Inn and Coliseum, New York, June 9-10.

Chicago Spring Conference on Broadcast and Television Receivers, IEEE; Marriott Motor Hotel, Chicago, June 9-10.

(Continued on p. 30)



Here's your answer to shock and vibration problems

■ Allen-Bradley Type R adjustable fixed resistors are unexcelled for holding precise settings through extreme conditions of shock and vibration. This unusual ruggedness is the result of a manufacturing process—perfected and used only by Allen-Bradley—which hot molds the resistance and collector elements, terminals, and insulating material into an almost indestructible component. Thus, the controls can be mounted by their own rugged terminals *without* additional support.

The solid resistance track assures such smooth control that it approaches infinite resolution. Its smoothness cannot be compared with the abrupt wire-wound turn-to-turn resistance changes which may cause circuit transients. Since Type R controls are essentially non-inductive and have low distributed capacity, they can

be applied in high frequency circuits where wire-wound controls are impractical. The Type R molded enclosures are both dustproof and watertight, permitting encapsulation after adjustment.

Allen-Bradley Type R controls are suitable for use from -55°C to $+125^{\circ}\text{C}$ and are rated $\frac{1}{4}$ watt at 70°C , 300 volts max. RMS. Available as standard in total resistance values from 100 ohms to 2.5 megohms with tolerances of $\pm 10\%$ or $\pm 20\%$. As special, can be furnished down to 50 ohms. Technical Bulletin B5205 contains complete specifications. Please send for your copy today: Allen-Bradley Co., 1201 South Second Street, Milwaukee, Wis. 53204. Export Office: 1293 Broad Street, Bloomfield, New Jersey, U.S.A. 07003. In Canada: Allen-Bradley Canada, Ltd.

Allen-Bradley Type R Adjustable Fixed Resistors—Shown actual size

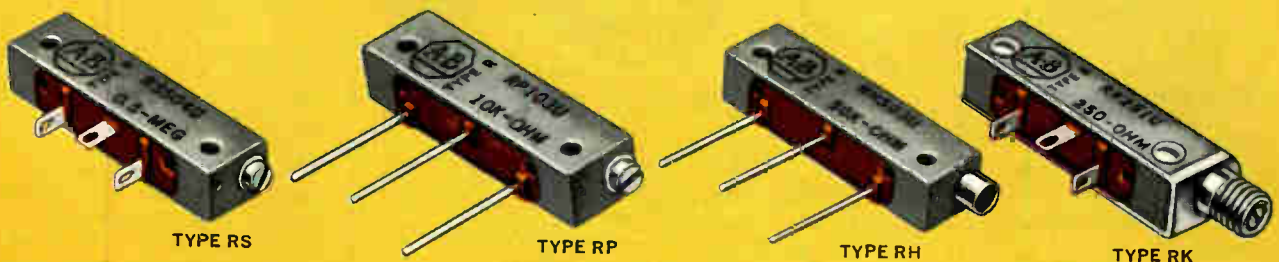

ALLEN-BRADLEY
QUALITY ELECTRONIC COMPONENTS

WATERS
proudly introduces...
the
**Second
Generation**
in conductive
plastic performance...
MystR[®]

MIL-R-39023

Tomorrow is here today in the "Second Generation" performance of MYSTR — Waters' exclusive new Conductive Plastic resistance material. Compare these parameters!

- Infinite Resolution
- Resistance Ranges from 10 ohms to 5 megohms
- Excellent Linearities
- Output Smoothness — less than 0.1%
- Rotational Life — upwards from 10 million cycles.
- Dither Life in excess of 400 million cycles
- Operational temperature to 150°C
- Hysteresis <0.25°

From Waters now — a complete line of MIL Spec qualified potentiometers, standard or custom, wirewound, linear or non-linear or with MYSTR Conductive Plastic.

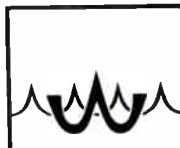

WRITE
FOR NEW
CATALOG

WATERS MANUFACTURING, INC. WAYLAND, MASS. 01778

Meetings

(Continued from p. 28)

International Communications Conference, IEEE; University of Colorado, Boulder, June 9-11.

Federal Research and Development in the 70's—its Need and Scope, National Security Industrial Association, State Department West Auditorium, Washington, D.C., June 11-12.

Consumer Electronics Show, Consumer Products Division of Electronic Industries Association; New York Hilton and Americana Hotels, New York, June 15-18.

Data Processing Conference and Business Exposition, Data Processing Management Association; Queen Elizabeth Hotel, Montreal, Canada, June 16-19.

Electromagnetic Compatibility Symposium, IEEE; Berkeley Cartaret Hotel, Asbury Park, N.J., June 17-19.

Short courses

Industrial Noise and Engineering Control, Pennsylvania State University, University Park; June 1-6; \$200 fee.

Vacuum Technology, George Washington University, Washington, D.C.; June 16-20; \$275 fee.

Numerical Analysis and Digital Computer Methods in Engineering Systems, University of California, Los Angeles; July 14-18; \$275 fee.

Call for papers

NEREM-69, Northeast Electronics Research and Engineering Meeting, IEEE; Sheraton Boston Hotel and the War Memorial Auditorium, Nov. 5-7. July 1 is deadline for submission of papers to program chairman, IEEE NEREM-69, 31 Channing Street, Newton, Mass. 02158.

Conference on Applications of Simulation, Association for Computing Machinery; International Hotel, Los Angeles, Dec. 8-10. July 7 is deadline for submission of papers to Philip J. Kiviat, program committee chairman, the RAND Corp., 1700 Main Street, Santa Monica, Calif. 90406.

Ultrasonics Symposium, IEEE; Chase Park Plaza Hotel, St. Louis, Mo., Sept. 24-26. July 15 is deadline for submission of papers to C.K. Jones, Westinghouse Research & Development Center, Beulah Road, Churchill Borough, Pittsburgh, Penn. 15235.



Sprague Semiconductor Chips and Packages. Illustration: 3 wafers, 8 packages, many chips

Semiconductor chips. Packages. One source. Sprague.

Every device in the Sprague Semiconductor line is available in chip form. Transistors. Integrated circuits. Even precision nickel-chromium resistor networks. Just about everything you need to build your own hybrids.

And from the Hermetic Seal Department, flatpacks to put them in. From $\frac{1}{4}$ " x $\frac{1}{4}$ " to 1 inch square. From

6 leads to 40. Standard and ready for off-the-shelf delivery. Your custom package design can be made to order, too.

Make Sprague your one source when you're making your own hybrids. If you're going to put down our chips, put them in our packages.

Call Sprague Info-Central (603) 224-1961 extension 255

Get data on Sprague's chips and packages. Write to: Semiconductor Division, Sprague Electric Co., Pembroke Road, Concord, N.H. 03301. Or circle the reader service number below.



455-9120R1

**Reliability is 756 little dents
and one big one.**

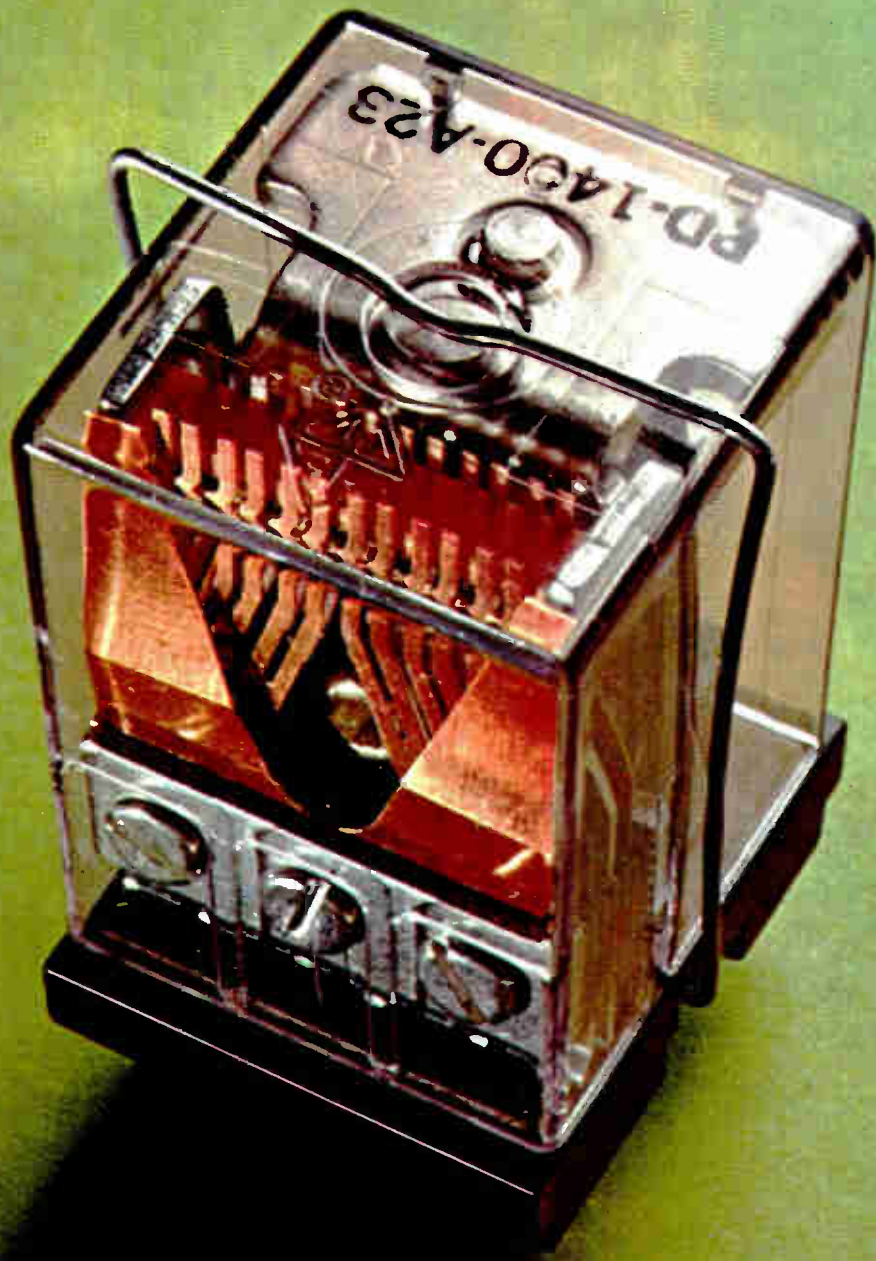

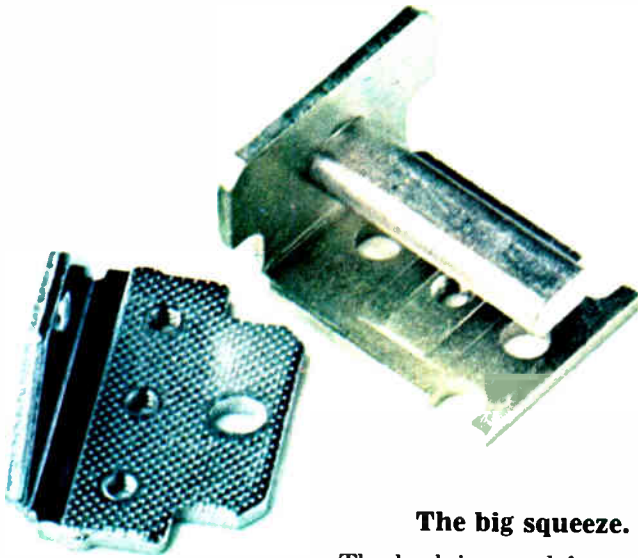

The big squeeze.

The heelpiece and frame are the backbone of our Class H relay. The slightest squiggle or shimmy out of either and the whole relay is out of whack.

756 tiny dents on the heelpiece, plus one big one on the frame, make sure this'll never happen.

They're the result of planishing, a big squeeze. Planishing is an extra step we go through in forming the pieces to add strength and stability by relieving surface strain. It also makes the parts extra flat.

This takes the biggest press in the industry and the biggest squeeze. Both exclusively ours.

A different kind of coil.

The heart of a relay is the coil. If ours looks different, it's because we build it around a glass-filled nylon bobbin. It costs us more, but you know how most plastic tends to chip and crack.

Also, moisture and humidity have no effect on glass-filled nylon. No effect means no malfunctions for you to worry about. No current leakage, either.

The coil is wound on the bobbin automatically. No chance of human error here.

We didn't forget the solder.

We use a solderless splice. That's because solderless splice connections are sure-fire protection against the coil going open under temperature changes, stress, or electrolysis.

A solderless splice is more expensive to produce, so it's usually found only on the most reliable relays. AE is the only manufacturer to use this method on all of its relays.

Finally, we wrap the whole assembly with extra-tough, mylar-laminated material. A cover is not really necessary here; but why take chances?

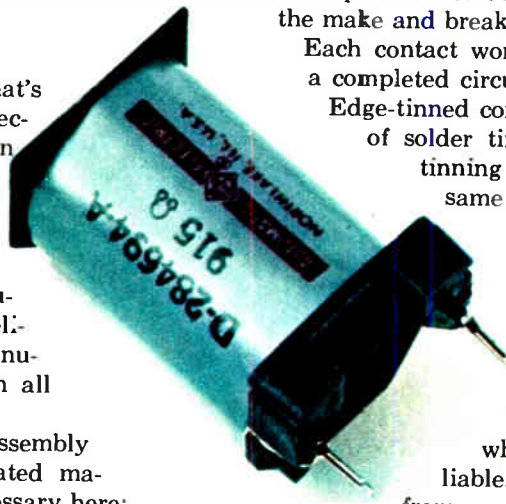

Springs and other things.

We don't take any chances with our contact assembly, either. Even things like the pileup insulators (those little black rectangles) get special attention. We precision mold them. Other manufacturers just punch them out.

It makes a lot of difference. They're stronger, for one thing; and because they're molded, there's no chance of the insulators absorbing even a droplet of harmful moisture. Finally, they'll withstand the high temperatures that knock out punched insulators.

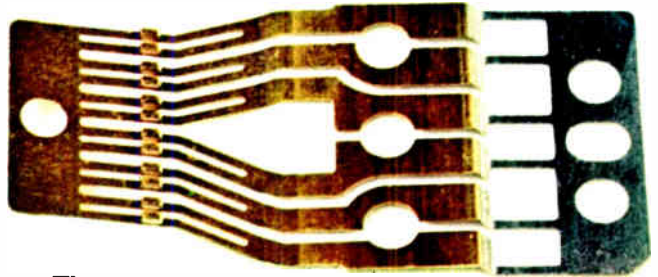

Then there are the contact springs.

Ours are phosphor-bronze. Others use nickel-silver. Our lab gave this stuff a thorough check, but found nickel-silver too prone to stress-corrosion. Atmospheric conditions which cause tarnish and ultimately stress corrosion have almost no effect on phosphor-bronze.

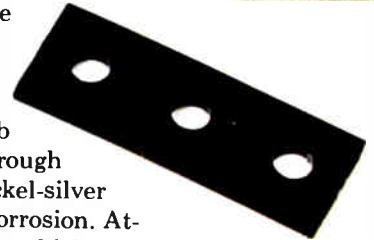

Two are better than one.

Our next step was to make sure our contacts give a completed circuit every time. So we bifurcate both the make and break springs.

Each contact works independently to give you a completed circuit every time.

Edge-tinned contact springs save you the job of solder tinning them later. Also, edge-tinning enables you to safely use the same relay with sockets or mounted directly to a printed circuit board. A simple thing, but it takes a big chunk out of the inventory you have to stock.

Etc. Etc. Etc.

There's a lot more to tell about what makes our Class H relay reliable. Now we're waiting to hear from you. Automatic Electric Company, Northlake, Ill. 60164.

AUTOMATIC ELECTRIC

SUBSIDIARY OF GENERAL TELEPHONE & ELECTRONICS

Circle 33 on reader service card

Convert your present scope into a curve tracer: \$595.00*

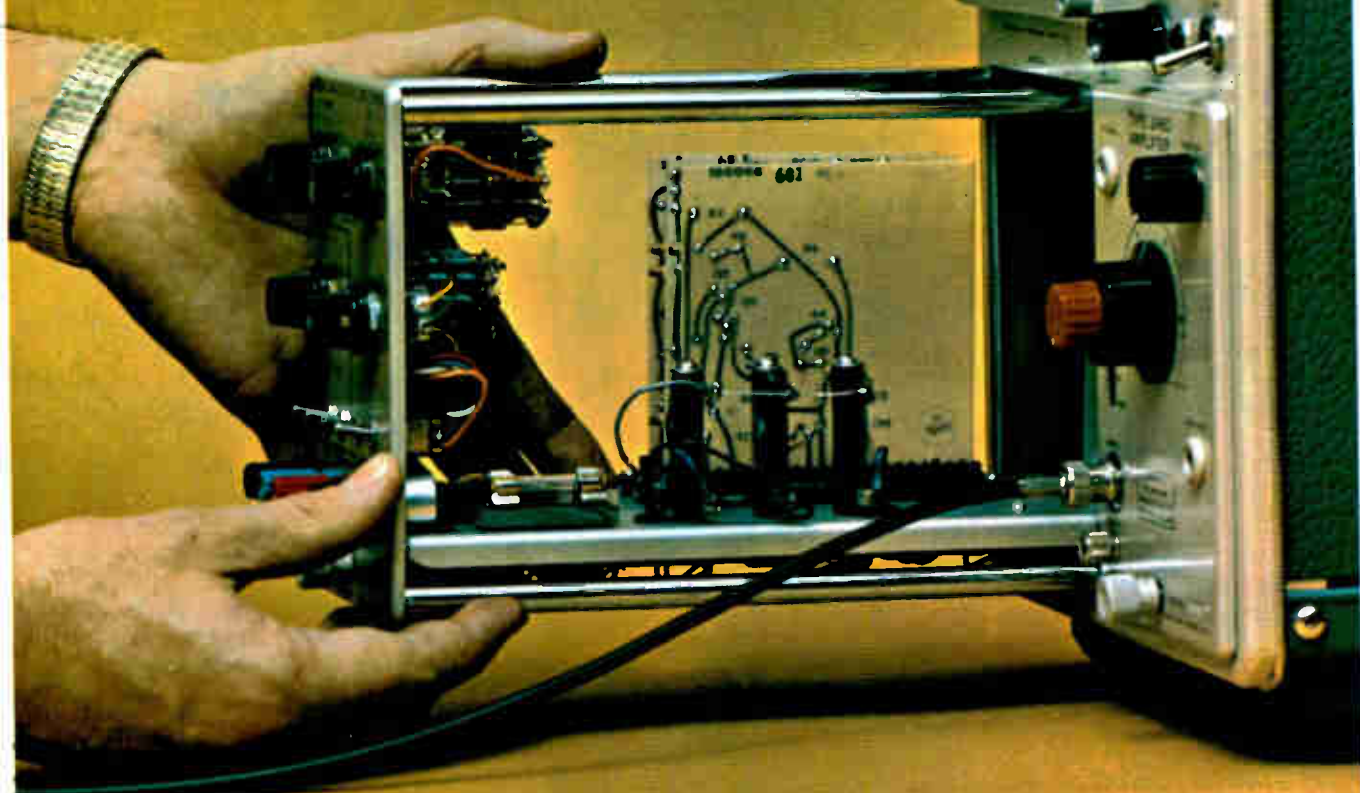

The first plug-in unit that transforms an existing scope into a curve tracer—at 1/2 to 1/3 the cost!



U-Tech plug-in Model 681: \$595.00*. For use with Tektronix 560 series Oscilloscopes.



U-Tech plug-in Model 682: \$615.00*. For use with Tektronix 530, 540, 550, 580 series Oscilloscopes.



U-Tech Console Model 683: \$625.00*. For use with any X-Y Oscilloscope.

*Prices apply to purchases and shipments within U.S.A. fob Salt Lake City, Utah

Now you can expand your present Oscilloscope to include curve tracer capabilities. U-Tech plug-in and console units enable any X-Y Oscilloscope to display the dynamic characteristics of both NPN and PNP transistors, N Channel and P Channel junctions, FETs, MOS-FETs, bipolars, unijunctions, diodes, tunnel diodes and SCRs.

So, if it wasn't in the budget before, now it can be, and even if you were planning for a curve tracer, you can now buy two, possibly three, of these units for the price of any other characteristic curve tracer.

Ask your distributor about these U-Tech curve tracer units or order direct

U-TECH A Division of Industrial Physics and Electronics Company
 4190 South State Street, Salt Lake City, Utah 84107

Yes, send me curve tracer model _____

Enclosed is: Check P.O. Bill me Send literature

Name _____ Title _____

Company Name _____

Company Address _____

City _____ State _____ Zip _____

Editorial comment

A wildly absurd proposal

A moratorium on technological research and innovation was suggested to Sen. Edmund Muskie's subcommittee on intergovernmental affairs, which is looking into the problem of technology and environment. The witness who proposed the two-year moratorium was W.H. Ferry, vice president of the Fund for the Republic at the Center for the Study of Democratic Institutions, Santa Barbara, Calif.

Mr. Ferry's contention is that the nation's land, water, and other natural resources are being destroyed through the uncontrolled application of technology. "What good," he asked, "will color television in every room and outposts on the moon be to our grandchildren if their air is unbreathable, their water

undrinkable, and their dwelling half buried in their own debris?"

Few will dispute Mr. Ferry's motives in asking that question, or deny the trends which compelled him to raise it. But the solution does not lie in a cessation in research and innovation. It lies partly in the enactment of legislation which would guarantee the wise application of existing technology, but depends also on the application of brand new technology.

Mr. Ferry's reasoning is unclear. Even a proposal calculated only to rouse the public ought to be based on reason.

In offering his proposal, Mr. Ferry himself called it "wildly absurd." We agree that it is. ■

Circumventing incompetence

The Peter principle is fast becoming as well-known in management circles as Parkinson's classic laws. But we're not sure it's universally applicable to the electronics industry. Laurence J. Peter, an Associate Professor of Education at the University of Southern California, has determined that the proliferation of incompetence at all levels of a hierarchy is due to a simple principle: "In a hierarchy every employee tends to rise to his level of incompetence."

Many of us, he notes, gain a promotion or two and in the process move from one level of competence to another. But eventually we are promoted to a job we cannot handle. Eventually an organization is dominated by the following corollary to the Peter principle: "In time every post tends to be occupied by an employee who is incompetent to carry out its duties." Fortunately, few companies reach this saturation point, but on their way to it, Professor Peter observes, it follows that useful work is accomplished only by those employees who have not reached their level of incompetence.

Professor Peter, in the course of formulating his principle, inadvertently founded a new science which he calls hierarchiology (the study of hierarchies). An underlying rule not expressed by the professor, but one which seems to be implicit in hierarchiology, is that promotion is the only route to business and social acceptance. Merely doing a competent job—or even a superior job in one's present post—will not suffice.

Often people to whom Professor Peter describes his revelatory principle are reluctant to accept it, searching for and sometimes insisting they've discovered exceptions. These apparent exceptions are not exceptions, Professor Peter insists, and in his recently published book* he describes several of the techniques that are used by large corporations to make it seem as if an incompetent employee was not really incompetent (he is given a longer title, for example, and moved into an office in a remote part of the building).

While we agree that Professor Peter—with ample good humor—has managed to define salient reasons for the proliferation of incompetence, we nevertheless believe we have isolated some exceptions to his principle. It strikes us that the electronics industry, with its high level of technology, fosters such exceptions. We know engineers whose major reward comes from doing a thorough job and who'd reject a promotion if it meant they'd be further removed from the creative aspects of engineering. We've watched companies like General Radio, Hewlett-Packard, and Siliconix deemphasize employee grade and instead reward creativity and excellence at all levels.

Professor Peter might assert that these cases do not constitute true hierarchies. Perhaps he'd be right. But we'd recommend them as a circumvention of his principle—and a cure for incompetence. ■

* The Peter Principle, by Laurence J. Peter and Raymond Hull, William Morrow and Company, 1969

Hardly a lab or production test line is without a Datapulse 101 or 110B pulse generator. If you select pulse generators you should know why:

Thousands of users have discovered that the compact 101 delivers unusually high performance for only \$395. And they recognize that years from now, the 101's specs will still be a match for most pulse test needs: rep rates to 10 MHz, 5 ns rise, simultaneous $\pm 10V$ outputs, width and delays to 10 ms, double pulses, and sync/async gating.

But when you want to tailor waveshapes to order, you need the unequalled control offered by the 110B: rep rates to 50 MHz, variable linear rise and fall from 4 ns to 500 μs , full baseline offset, 10 ns to 5 ms width, -10 ns to +50 ms delay, simultaneous $\pm 10V$ outputs, complement capability, paired pulses, and gated bursts. It all means that the 110B can simulate just about any pulse or waveform that can occur in circuits operating to 50 MHz. And it sells for a modest \$1250.

And talk about reliability! Just ask one of the thousands of 101 and 110B users. Then ask us for a demonstration. Write Datapulse Division, Systron-Donner Corporation, 10150 W. Jefferson Blvd., Culver City, California 90230. (213) 836-6100.

Meet the general-purpose pulsers you're most likely to see at work



Still first. Two of 144 Systron-Donner instruments

Electronic counters	Digital voltmeters
Pulse generators	Digital panel meters
Microwave frequency indicators	Microwave signal generators
Digital clocks	Laboratory magnets
Memory testers	Data acquisition systems
Analog computers	Microwave test sets
Time code generators	
Data generators	

Circle 36 on reader service card

SYSTRON  DONNER

Electronics Newsletter

May 26, 1969

GI to make op amps for LSI hybrids . . .

The semiconductor giants are marshaling their forces for the marketing battle over the next level of integrated circuits—LSI hybrids. The devices, containing bipolar and MOS chips and employing thin- and thick-film technology, will permit increased complexity while holding chip size to a practical level.

General Instrument, long a leader in hybrid and MOS technology, is cranking up a bipolar IC facility at its Hicksville, N.Y., plant. The first units, expected to come off the line by the end of July, will be operational amplifiers of the 709 variety. These monolithic IC's will not be sold individually; rather, they'll be used in GI's LSI hybrids.

. . . as Raytheon offers beam-lead circuits off the shelf

To make LSI hybrid production profitable, manufacturers want beam-lead devices. And Raytheon's semiconductor operation, which has been selling some beam-lead dice to a few customers for the past year, is transferring such activity from the developmental area into production. In August it will announce off-the-shelf availability of several lines of circuits. Marketing manager Marshall Cox expects the major customers to be military contractors and systems houses that have developed in-house hybrid facilities. He says that beam-lead will account for a million dollars in business for Raytheon in the last six months of 1969.

Initially, Raytheon will offer 709 and 741 operational amplifiers, plus 930 DTL and SUHL 2 and RAY 3 TTL integrated circuit chips, and some diodes and transistors. They will be sold through selected franchised distributors who will provide benign environmental conditions for chip storage.

Navy to test digital signaler

The Navy will begin sea trials in mid-June of a new digital signaling system that promises two vital advantages: it would cut drastically the time needed to establish voice links between ships, and it may double ship-to-ship channel capacity.

Made by the Technical Communication Corp. of Lexington, Mass., 12 of the so-called semiautomatic signalers will be installed aboard destroyers in a multiaccess, self-organizing, discrete-address communications network.

Instead of time-consuming voice call-ups, acknowledgements, and error-prone authentications, the signaler needs only the push of a button and, within a few seconds, a voice link is established. Included is a modem permitting the combination of several communications networks into one pair of frequency channels, thus opening formerly wasted parts of the radio spectrum.

Eight asked to quote on new sensor for heading, attitude

American Airlines has beaten Arinc's airlines electronics committee to the punch: American sent out a request for quotation to eight firms for a heading and attitude sensor even before the committee had a chance to approve the specifications for the new sensor.

The sensor, tentatively designated HAS-1 would replace existing vertical and directional gyros and provide roll, pitch, and stabilized heading outputs. American's avionics specialists expect it to be 10 times as

Electronics Newsletter

accurate as the gyros, and to cost a maximum of 50% more—about \$12,000.

HAS-1 will be used to retrofit American's existing jet fleet and will also go aboard the McDonnell Douglas DC-10's and Boeing 747's currently on order. In terms of size, it will be interchangeable with Arinc Characteristic-561 inertial navigation systems (such as Litton's LTN-51 and AC Electronics' Carousel IV). American Airlines officials say that the sensor might later be coupled with an inertial sensor and that the combination could provide something close to the "junior inertial navigation system" many airlines and airframe manufacturers have been seeking.

Motorola introducing thin-film components for hybrid IC's

Motorola's Semiconductor Products division is about to become a major supplier of passive thin-film components for hybrid circuits. First products will be inductors and resistors, with capacitors close behind.

The resistors and capacitors will be made with beam leads to lower inductance at high frequencies, and Nichrome resistors ranging in ratings from 2 ohms to 10,000 ohms will be available from stock on 40-mil-square chips. The spiral inductors will be on 10-mil-thick ceramic substrates 0.125 to 0.25 inch square with ratings from 20 to 220 nanohenrys and Q's of about 20.

Prices haven't been worked out, but one official says: "If someone is making cermet resistors for 50 cents in quantity, we'll have to match that."

Fairchild target: power device market

Look for an aggressive effort by Fairchild Semiconductor to take over a big portion of the power semiconductor market now dominated by Motorola. Fairchild intends to become the number one factor in the power industry, according to Ralph Miller, marketing manager for power discrete devices. The company will aim for entertainment, automotive, computer, industrial, military, and aerospace applications.

At first, Fairchild will second source well-known devices. Later the company will come in with complementary pnp versions of the standard devices and a plastic-encapsulated product line.

And in the fourth quarter of this year, a family of 1,400-volt transistors will be marketed. Miller acknowledges that his company is "getting in late in the game," but claims that Fairchild's technical innovations [*Electronics*, Feb. 17, p. 56] will turn the tide.

Cheyenne death could hurt Teledyne

The Army's cancellation of Lockheed California's contract for the AH-56A Cheyenne helicopter could mean a substantial loss for Teledyne, producer of the integrated helicopter avionics system (IHAS), principal package for the heavy gunship. Military sources estimate the loss could run to more than \$90 million for the company over a long-term procurement.

However, a Teledyne official noted that the business was more potential than actual. IHAS, he pointed out, is fundamentally a Navy program developed for Boeing Vertol's CH-46 and CH-53A whirlybirds. Teledyne has already received about \$70 million in development and production funds for IHAS, the last an \$8 million production award last year for the AN/ASN-77 central computer. Follow-ons are expected.

Nevertheless, it's no secret that Teledyne was gearing up to put IHAS in the 375 Cheyennes that Lockheed hoped to sell to the Army, which was picking up 40% of the Navy development tab for the avionics system.

EL DEVICES

ICs cut decoder/driver size and cost.

Two integrated circuit packages handle memory and decoding functions in new driver for electroluminescent devices.

All of the switching and memory functions required to drive seven-segment electroluminescent readouts are wrapped up in two integrated circuits in Sylvania's new SM-158, SM-159 decoder/driver. In the decoder section, the integrated circuit replaces 34 diodes and 21 resistors. The memory IC unit takes the place of eight discrete transistors, four

diodes and 36 resistors.

But replacing a large number of discrete components is only part of the advantage of this new IC design. The ICs also provide higher reliability, greater versatility, smaller size and lower cost. Among the new versatile features are a lamp test facility, lamp intensity modulation capability, leading/trailing edge

zero suppression and full decoding of all 16 BCD input combinations. The decoder/driver is completely TTL and DTL compatible.

The SM-158 and SM-159 come ready to use on a $1\frac{7}{8}'' \times 1\frac{3}{4}''$ modular printed circuit board. The complete device package measures only $\frac{1}{2}''$ high with flying leads. Both models can be supplied with either sockets or flying leads. The SM-158 is a decoder/driver without memory and the SM-159 is a complete package with memory included. The memory IC can be added to the SM-158 at a later date if it is desired. The memory unit is a clock gated 4-bit storage register and data transfer through the register may be accomplished when the clock is in a high state.

Both the SM-158 and SM-159 can be supplied in Mil-spec versions.

CIRCLE NUMBER 300

Small size and higher reliability are among the features of Sylvania's new EL decoder/driver.

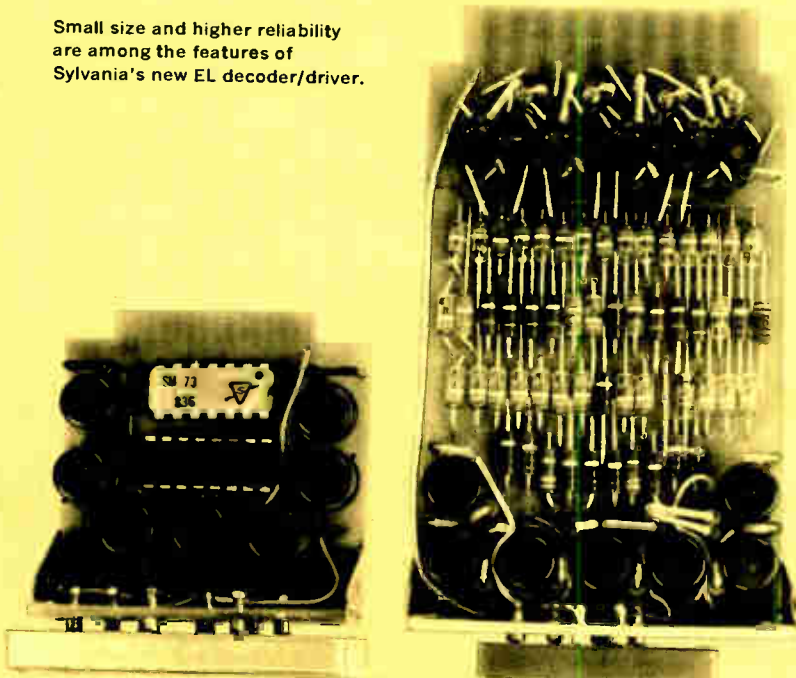

This issue in capsule

Microwaves

Parallel junctions boost varactor performance.

Television

Now, series-string for color picture tubes.

CRTs

Multibeam tube gives brighter characters.

Circuit Modules

Designing with NAFl modules? Talk to us.

Integrated Circuits

How to use the SM-60 for bidirectional data transmission.

Hybrid Microelectronics

IF amplifiers pack high gain into a small package.

Manager's Corner

What is good customer service?

MICROWAVES

Parallel junctions boost varactor performance.

Family of tuning devices offers high Q, high capacitance and low inductance.

Instead of building varactor diodes with large-capacitance junctions, we've come up with a method of paralleling a number of smaller junctions on the same chip. This gives us a higher Q and lowers the inductance of the device as well.

Take for example, our new D5940 and D5950 varactor diode families listed in the tables. The D5940 devices have a Q of 1400 at 50 MHz and -4 Volts DC. At 1 GHz, the Q is a minimum of 70. The circuit used to make the Q measurements is shown in Fig. 1. The range of capacitance variation is better than seven to one.

The D5950 family of varactors has a Q of 1000 at 50 MHz and -4 Volts DC, and the capacitance tuning range is eight



Construction of tuning varactor junction.

Fig. 1. Test circuit used for measuring Q of microwave varactors.

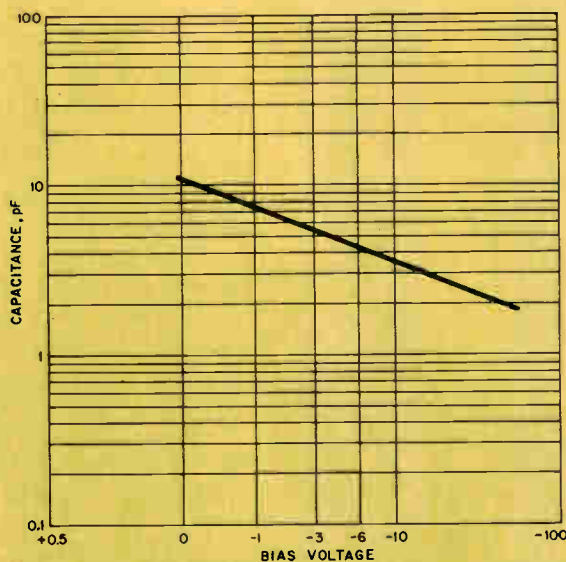
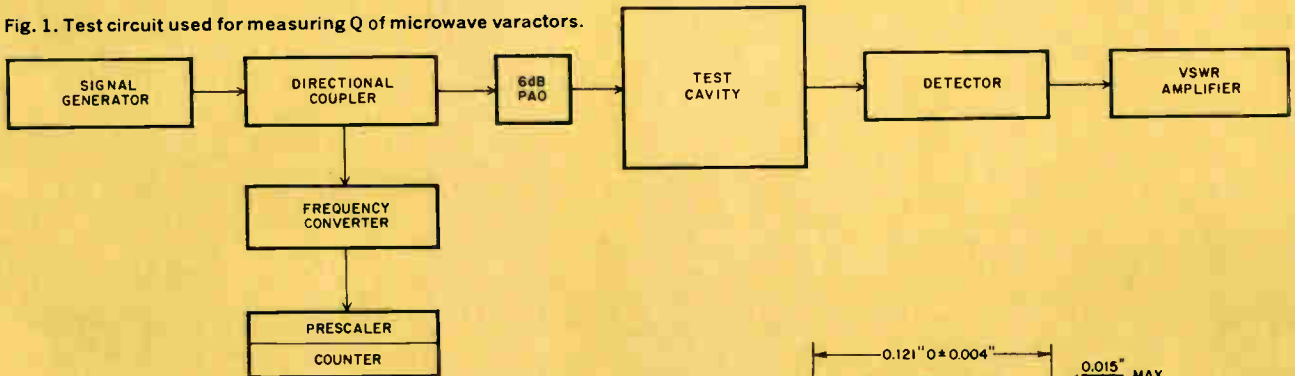

Fig. 2. Typical performance curve for microwave tuning varactor.

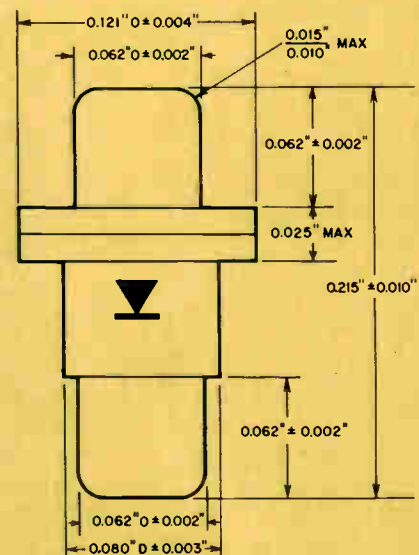
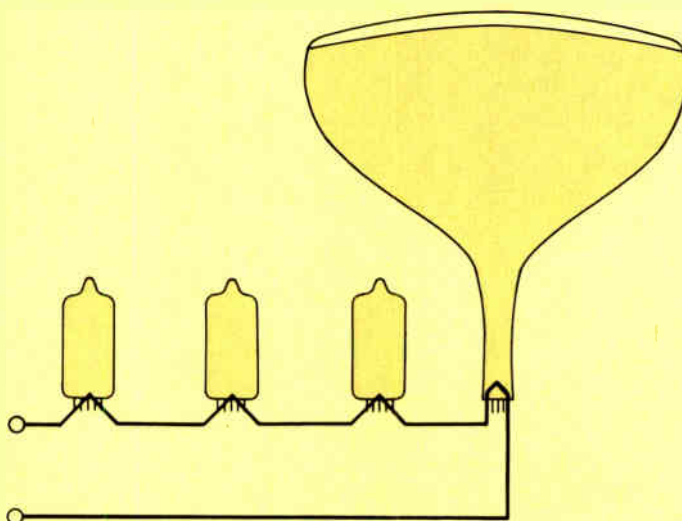

Fig. 3. Microwave tuning varactors are available in 023 package.

TELEVISION

Now, series-string for color picture tubes.

Our entire *color bright 85*[®] picture tube line is now available with a weight and cost saving series-string filament.



You can eliminate an expensive filament transformer and associated circuitry by designing your new color TV sets around Sylvania's *color bright 85* series-string picture tube. This new 12.6 Volt, 450 mA heater is available in all color tube sizes.

Now, you can have all of the advantages in color sets that have been previously limited to black-and-white sets. These advantages include getting rid of the bulky filament transformer with an overall chassis weight reduction. Although the new filament design will have its biggest advantages in the design of lightweight portables, it can also bring cost cutting advantages to larger sets.

When you order our series-string color picture tube, the only thing that is changed is the filament. You still get Sylvania's high-quality *color bright 85* picture tube design.

That means you are getting the brightest phosphor system—the Sylvania-developed europium-activated yttrium-vanadate phosphor treated with selected activators.

And to make the tube brighter still, you get a phosphor deposited by Sylvania's patented dusting technique. Putting the phosphor down by dusting permits the use of larger phosphor particles—and larger particles mean brighter dots.

Dusting also minimizes the chances of contaminants entering the phosphor system during processing. It also helps prevent phosphor deterioration and crackup of the crystal structure.

With all of these advantages plus the added feature of series-string operation, Sylvania's *color bright 85* picture tubes are your best bet for a high-quality picture at the lowest possible cost.

Microwave Tuning Varactors

D5940 series, 023 package, BV=60V

Type Number	Total capacitance (0 VOLTS) C _{T0}	C _{J0} / C _{J-60}	Q (50 MHz, -4v dc)
D5940	1.0	≥7:1	≥1400
D5940A	2.0	≥7:1	≥1400
D5940B	3.0	≥7:1	≥1400
D5940C	4.0	≥7:1	≥1400
D5940D	5.0	≥7:1	≥1400
D5940E	6.0	≥7:1	≥1400
D5940F	10.0	≥7:1	≥1400
D5940G	15.0	≥7:1	≥1400
D5940H	20.0	≥7:1	≥1400
D5940J	30.0	≥7:1	≥1400

Microwave Tuning Varactors

D5950 series, 023 package, BV=90V

Type Number	Total capacitance (0 VOLTS) C _{T0}	C _{J0} / C _{J-90}	Q (50 MHz, -4v dc)
D5950	1.0	≥8:1	≥1000
D5950A	2.0	≥8:1	≥1000
D5950B	3.0	≥8:1	≥1000
D5950C	4.0	≥8:1	≥1000
D5950D	5.0	≥8:1	≥1000
D5950E	6.0	≥8:1	≥1000
D5950F	10.0	≥8:1	≥1000
D5950G	15.0	≥8:1	≥1000
D5950H	20.0	≥8:1	≥1000
D5950J	30.0	≥8:1	≥1000

to one. Both families are available with total capacitances in a range from one to thirty pF.

A typical performance curve for both families of varactor diodes is shown in Fig. 2. Note that the capacitance variation with voltage is a log-log linear plot. That's no accident. We grow our own diode wafers in our own epitaxial furnace to achieve this characteristic. We also use glass passivation techniques to protect the finished product.

Packaging of microwave products is a key factor in obtaining good performance. Both of our varactor diode families are available in an 023 package (shown in Fig. 3), an 023 package without tabs, or in an 075 picomin package. A LID (leadless inverted device) package will be available in the near future.

Both the D5940 and D5950 varactor diode families will find wide application in microwave systems. You can use them anywhere you have a circuit to tune—in local oscillators, tunable filters and phase shifters, avalanche diode and Gunn diode oscillators.

CRTs

Multibeam tube gives brighter characters.

New seven-beam, single-gun CRT gives a seven-times increase in display brightness.

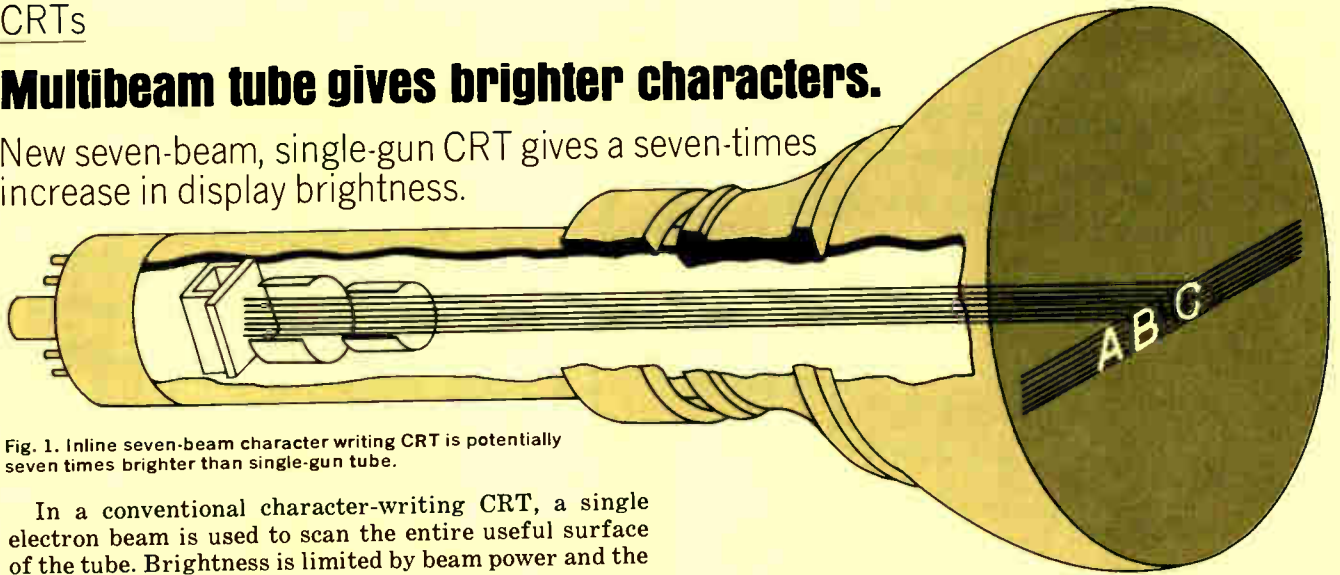

Fig. 1. Inline seven-beam character writing CRT is potentially seven times brighter than single-gun tube.

In a conventional character-writing CRT, a single electron beam is used to scan the entire useful surface of the tube. Brightness is limited by beam power and the scanning rate.

In our new SC-5239 five-inch CRT we've come up with a new technique for increasing brightness or scanning speed. The SC-5239, shown in Fig. 1, is a single-gun cathode-ray tube having seven electron beams. These multiple electron sources increase the brightness potential of a particular display tube by a factor of seven.

Each electron beam can be individually modulated and all may be simultaneously varied in intensity with a single variable control grid bias.

A typical application of the SC-5239 is shown in Fig. 2. A filament is used to heat the cathode which is common to all of the electron beams. An individual control grid element is returned to a bias control potentiometer. Separate video amplifiers are used for each of the seven control grids. Modulation levels on the order of 20 Volts are typical.

The accelerating grid, G₂, is maintained at approximately 300 Volts, but since it is a factor in the electron optics system it may be desirable to provide a variable potentiometer with a range of about 20 percent of the design center value.

Since alphanumeric character writing is done simply by scanning lines across the face of the CRT and blanking and unblanking each beam at appropriate points, high-speed "diddle" is eliminated. The yoke current for horizontal scan which is normally a step function, now becomes a sawtooth current. This eliminates the step and settling-time problem commonly associated with single-beam operations.

The multibeam CRT is designed to form characters by a 7-dot-high matrix. Because seven separate beams contribute to the writing of each character, the tube has a potential brightness seven times that of a single-beam tube. Or, to look at it another way, the multibeam tube, maintaining the same brightness, can write characters seven times as fast.

We can also produce tubes with more than seven beams for other matrix forms. Typical applications for these tubes include computer and graphic displays for viewing under high ambient light conditions, hard copy readout of information, and film recording of data.

CIRCLE NUMBER 303

Fig. 2. Circuit arrangement for using seven-beam CRT.

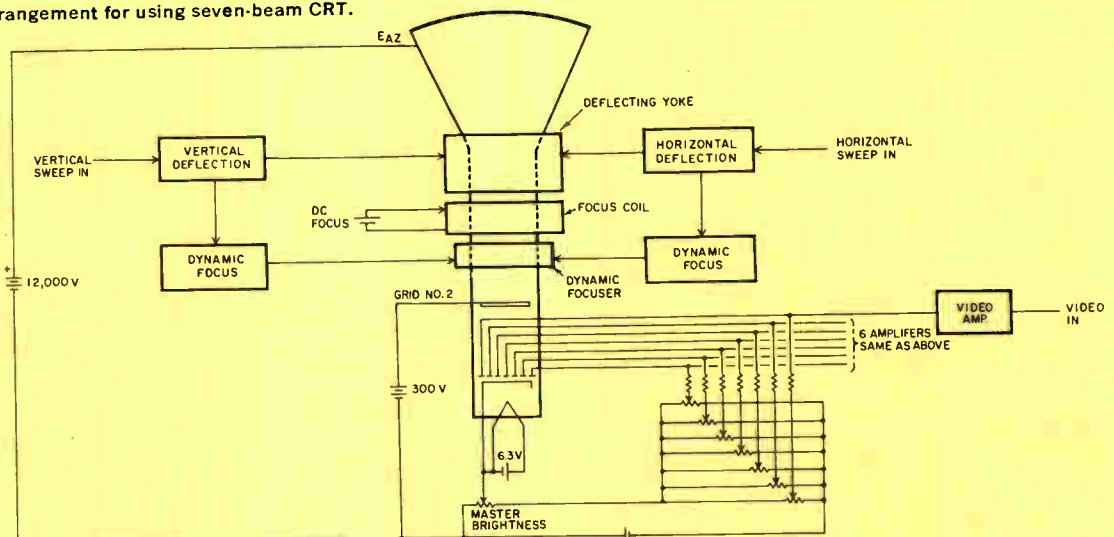

CIRCUIT MODULES

Designing with NAFI modules? Talk to us.

We have seventy-eight types of modules for use in the Navy's standard hardware program.

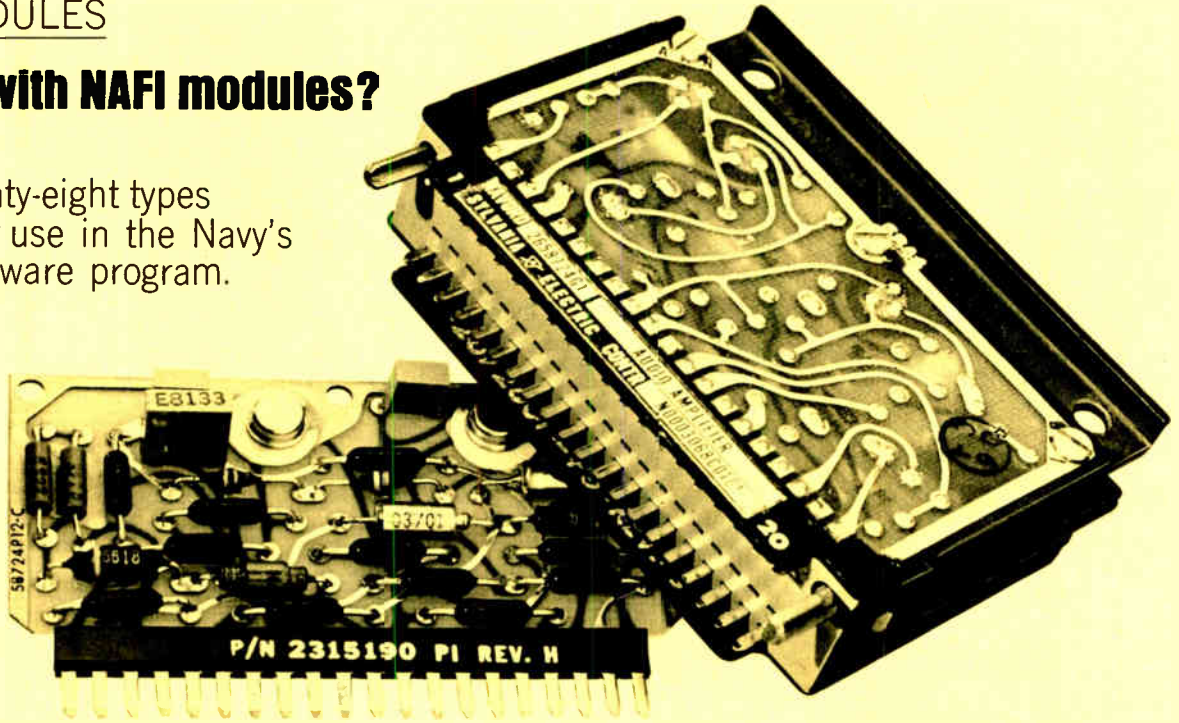

Typical NAFI module is built to Navy specifications.

NAFI modules have been developed under the Navy's standard hardware program and are being used in the Poseidon program. They're also finding wide acceptance for use in other systems.

As a qualified supplier in the Poseidon program, Sylvania has developed a broad line of modules including digital, linear and power functions as well as passive devices. Since this family of modules is already developed, you will find many advantages including time saving in breadboarding new systems.

Other advantages include reduced parts inventory, since the same types of modules are used over and over in many systems. Lead time is also reduced due to established manufacturing processes, common tooling and production techniques as well as utilization of existing circuits. Development costs and time for new systems are also decreased.

Since many thousands of modules have been produced under the standard hardware program, users gain increased and established reliability. (Reliability requirements on NAFI modules are 30,000 hours' minimum operating life.)

Another advantage gained in the quality area is that makers of NAFI modules must maintain their qualification through periodic testing by government quality assurance personnel. This relieves the systems user of this costly task.

If you are considering the use of NAFI modules in your system design it will pay to talk to us. Using Sylvania as your source of supply has many advantages. For one thing, we've got a lot of background in producing circuit assemblies. We've supplied more than 68,500 Type III modules for the Polaris program. We've made over 400,000 circuit logic assemblies and over 8,000,000 cordwood modules for secure communications equipment. And we've also produced more than 525,000 circuit assemblies for the Navy Technical Data System.

With that kind of experience you can be sure that we can produce the modules you need when you need them.

Not only do we have an outstanding reputation as a large volume producer of circuit assemblies, but we have design capabilities as well. Actually, we've designed a number of the functionally specified types in the series.

The table shows just a few of the many NAFI modules now in production. If you would like full information on all seventy-eight units, let us know. We will be glad to tell you all about them.

CIRCLE NUMBER 304

Typical Standard Hardware NAFI Modules

Key Code	Part Number	Module Name	Description
ADE	2658626	Diode Module	20 Diodes, Forward Volt. 1.20 VDC at 200 mA. 75 V Reverse Voltage, Reverse Recovery Time 8ns
ADF	2658627	Driver, Lamp/Relay	Load 280 mA; Programmable Output Grounds; Four Circuits Per Module
ADH	2658629	J-K Flip Flop	5 Per Module Inputs: J, K, C, S, R, Output: QQ Logic (1) 3.8 Min; Logic (0) 0.4 Max.
AAJ	2658630	Amplifier, Buffer	Gain 1.0, 1.43, 6.6, 8.14 V/V (Adjustable Gain); Phase Shift at 400 or 800 Hz 0.1 Deg.
BDA	2658634	Nand, 12-2 Input	12 Independent 2 Input, Oper. Freq. 4 MHz V Out Logic (1) Min. 3.8V, V Out Logic (0) Max. 0.4V
BDD	2658637	One Shot, 0.10 to 1.5 μ s	Pin Programmable: 0.1 μ s to 1.5 μ s In Increments of 0.1 μ s. 2 Circuits per Module
CDC	2658644	Receiver, Line DC	Differential Input, Standard Logic Level Output: \pm 5V \pm 10% P.S.
HRP	2658658	Relay Module	25 V Coil, Relays Replaceable; 5/Module
TAY	2658693	Gate, or Read/Write	Supply Voltages \pm 6 and -36VDC, Input Signal; Frequency 280-840 KHz at 0.25 to 20 mVPP
WDV	2658707	Write Gate Generator	DC Supply, Volt +5.0, -36. OVDC; Input 0 to 5.5V Write Current Output Logic (1) -27.9 to -37.75V

INTEGRATED CIRCUITS

How to use the SM-60 for bidirectional data transmission.

Versatile integrated circuit controls data flow in two directions over single line.

Here's an unusual application for our SM-60 four-bit storage register. It takes advantage of the many special features built into this device.

The diagram shows how four SM-60s can be used to transmit and receive data in two directions over a single line. The circuit works like this: When the enable line (E) of the left transmitter is at "1", data from Q₄ is entered on the line and transmitted to the right receiver. At this time the clock for the left receiver is held at "0", thus preventing the data from the line from entering the left receiver.

At the same time, the clock for the right receiver is in

a "1" state, permitting the data to enter. The enable for the right transmitter is at "0", preventing the data in the right transmitter from going out on the line.

To change the direction of transmission the right transmitter is enabled and the clock is raised on the left receiver. Both the left transmitter and the right receiver are held in the "0" state to block them from transmitting or receiving data.

The features of the SM-60 that make this simple circuit application possible include the fact that it has a free collector output. This enables you to tie directly to a bus. The enable control gives you the ability to remove a logic "0" from the line so that other devices can use the line. Another feature, the buffered latch, prevents signals from other sources on the output line from feeding into the inputs of a device and changing the latched information. The high sink capability of the SM-60 allows the use of appropriate terminations to cut down on reflections on the line.

Because of its versatility, the SM-60 storage register can be adapted to a variety of functions. Why don't you try it out in your system? It might just turn the trick.

CIRCLE NUMBER 305

Four SM-60s provide two-way data flow over a single line.

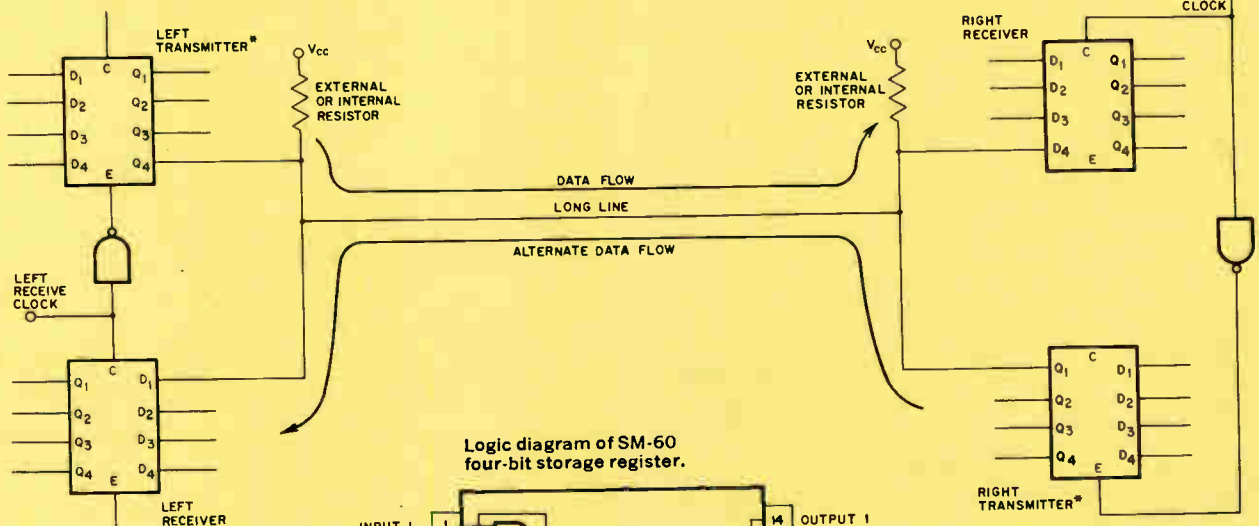

Logic diagram of SM-60 four-bit storage register.

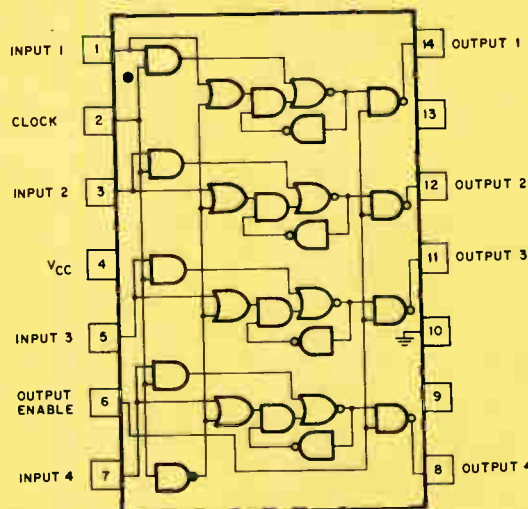

HYBRID MICROELECTRONICS

IF amplifiers pack high gain into a small package.

One-inch-square hybrid microcircuit gives gains up to 50 dB without instability.

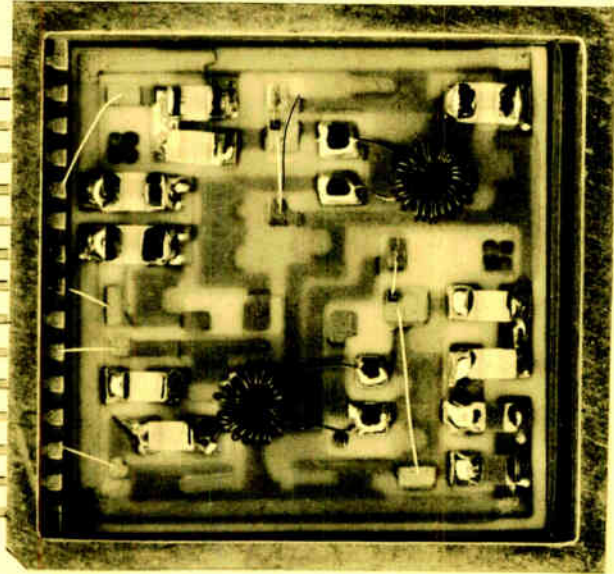
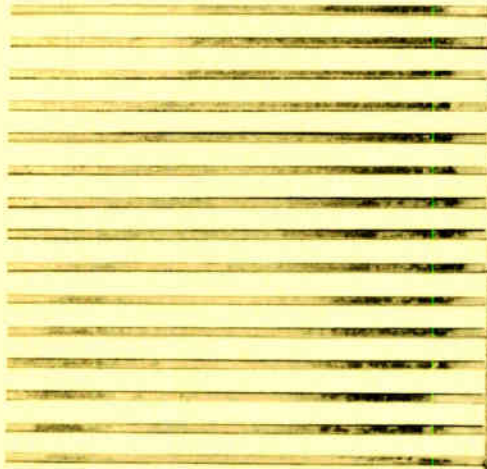

Hybrid microcircuit IF amplifier is packaged in a 1" x 1" x 1/8" module.

When you've been building IF amplifiers for communications and video systems for over six years, you develop quite a bit of expertise. We know, because we've been doing it.

We can tailor our hybrid microcircuit designs to meet your requirements in bandwidth, phase response, center frequency, skirt shape, gain and AGC characteristic. And we can do it anywhere in a frequency range from 10 to 250 MHz.

Typical IF amplifier characteristics (MS-500)

Center frequency	30 MHz
Bandwidth	7 MHz
AGC range	50 dB
Gain	26 dB
Noise figure	14 dB
Input impedance	68 ohms
Output impedance	150 ohms max.
Environment—full MIL range	
Package: 1" x 1" flat pack	

Take for example, the MS-500 30-MHz IF amplifier shown in the photograph. This little (1" square) gem has a lot of features that make it the circuit to use. For instance, built-in ground planes, top and bottom, make it a fully shielded package.

Electrically speaking, it provides 26 dB of gain without instability. Automatic gain control covers a range of 50 dB, giving 24 dB of attenuation with full AGC. The unit has a 7 MHz bandwidth and a 14 dB noise figure. These characteristics make it an ideal unit for use in AM and FM communications systems.

And what's more, our 30-MHz IF amplifier meets Mil-spec 750 and will withstand up to 20 g shock and 1500 g vibration.

Why don't you talk to our engineers about your IF amplifier design requirements. Our microcircuit know-how and support technology allow us to develop many variations of basic IF amplifier designs.

CIRCLE NUMBER 306

SEE OUR SPECIFICATIONS IN
VSMF
MICROFILM CATALOG FILE

Use Sylvania's "Hot Line" inquiry service, especially if you require full particulars on any item in a hurry. It's easy and it's free. Circle the reader service number(s) you're most interested in; then fill in your name, title, company and address. We'll do the rest and see you get further information by return mail.

BUSINESS REPLY MAIL
No Postage Stamp Necessary if Mailed in the United States

FIRST CLASS
Permit No. 2833
Buffalo, N. Y.

POSTAGE WILL BE PAID BY

Sylvania Electric Products Inc.
Sylvania Electronic Components
1100 Main Street
Buffalo, New York 14209

Dept. D 4 4

MANAGER'S CORNER

What is good customer service?

It is easy to provide good customer service when everything is going smoothly. It is when things go wrong that a supplier's customer service gets put to the test.

At Sylvania Semiconductor Division we are very conscious of our reputation for good customer service and we are constantly working to maintain this reputation. It would be a lot easier to provide good customer service if all of the responsibility for it could be placed on one man in the organization. However, in the dynamic semiconductor business that just isn't possible. Customer service requires the active cooperation of many people and many departments. Marketing and sales must translate the customer's need for the other departments. Production people must be ready and willing to alter production schedules to meet customers' needs. The engineering staff must accept the challenge of meeting difficult specifications. Quality control people must be able to devise test programs and equipment which will assure that desired quality levels are maintained.

An example of this type of cooperative effort occurred recently in our plant. A manufacturer could not get delivery on integrated circuits from his supplier. His production line was in danger of shutting down and he came to Sylvania for help.

Helping him involved making some engineering changes in one of our standard circuits, revising produc-

tion schedules to fit his product on the line, and modifying our test procedures to meet his specifications.

Through the cooperation and coordination of the marketing engineering, quality control and production departments the needed circuits were flowing off the production line within three days after the problem was handed to us. That's what we think of as good customer service.

Of course, not all service problems are caused by the customer. Sometimes, the sources of the problems are on the manufacturer's side. What the manufacturer is willing to do about these problems is also a good measure of customer service.

For example, a recent snowstorm in the Boston area closed down the airports for three days. We had one customer with an urgent need for delivery.

Our solution? One of our engineers hand-carried the needed circuits to the nearest operating airport—in New York City. Delivery was made on schedule. But it took that little bit of extra effort by an individual to carry the job through. It is that little bit of added effort that marks the difference between good customer service and bad.

Good customer service requires taking an aggressive stand on solving problems, whether created by the customer or the supplier.

We like to think that all our people take this requirement seriously and supply the extra effort that makes good customer service.

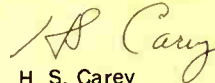

H. S. Carey
Supervisor of Distribution Services, Semiconductor Division

This information in Sylvania Ideas is furnished without assuming any obligations.

SYLVANIA

GENERAL TELEPHONE & ELECTRONICS

NEW CAPABILITIES IN: ELECTRONIC TUBES • SEMICONDUCTORS • MICROWAVE DEVICES • SPECIAL COMPONENTS • DISPLAY DEVICES

D 4

NAME _____ PLEASE PRINT

TITLE _____

COMPANY _____

ADDRESS _____

CITY _____ STATE _____ ZIP _____

Circle Numbers Corresponding to Product Item

300	301	302	303	304
305	306			

Please have a Sales Engineer call



HOT LINE INQUIRY SERVICE

Need information in a hurry? Clip the card and mail it. Be sure to fill in all information requested. We'll rush you full particulars on any item indicated.

You can also get information using the publication's card elsewhere in this issue. Use of the card shown here will simplify handling and save time.

A Solid State Alternative to Electrometer Tubes

.01 pA Bias Current ... \$50 (Model J, 100 lot)

- ✓ PHOTOMULTIPLIER TUBES
- ✓ BIOLOGICAL & CHEMICAL TRANSDUCERS
- ✓ LONG TERM INTEGRATORS
- ✓ ELECTROMETERS
- ✓ FLAME DETECTORS



Now you can replace those old-fashioned, noisy, none-too-stable vacuum electrometer tubes with brand new, solid-state varactor bridge op-amps from Analog Devices. The models 310 and 311 are small encapsulated modules which generate no heat, require no filament supply and are free of microphonic noise.

In addition to the incredibly low bias current (10^{-14} A), Voltage drifts are small, noise is minimized and the cost is low. Two basic types are available.

The model 310 is an inverting amplifier for current sources . . . perfect for transducers such as gas chromatograph flame detectors, photomultiplier tubes, ion and radiation detectors, etc. which produce current outputs. The 310 is also ideal for long-time integrators and small-rate differentiators.

Model 311 is a non-inverting amplifier designed for high impedance voltage sources such as occur in the glass electrodes of pH cells and other scientific apparatus. Low capacitance sample-and-hold devices and high impedance buffer amplifiers can also be simply constructed from the 311.

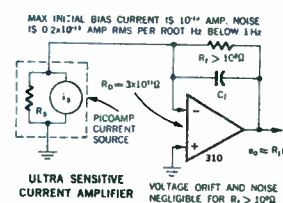
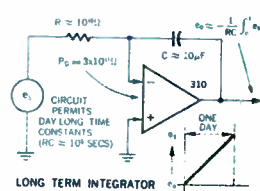
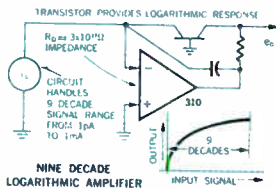
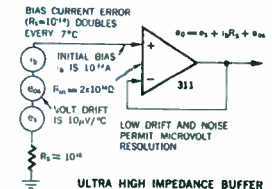
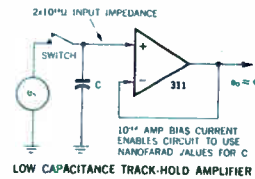
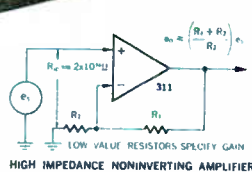

HOW VARACTOR BRIDGE AMPLIFIERS WORK

Amplifier input, e_{in} , varies varactor capacitances, unbalances bridge, and develops pump voltage output proportional to bridge unbalance. After low noise AC amplification, the output pump voltage is phase-sensitively demodulated to restore correct polarity, then further boosted by the DC amplifier. Matched low leakage varactors inherently eliminate $1/f$ noise, give excellent offset and drift specs, and provide 3×10^{11} ohms differential input impedance. Transformer coupling is responsible for the amplifier's advanced common mode characteristics.

Contact Analog Devices Application Engineering Department or your local representative for detailed literature, evaluation samples, or application assistance.

SPECIFICATIONS (typical @ 25°C ± 15VDC)	310 J/K	311 J/K
OPEN LOOP GAIN DC rated load, min	10 ⁵	10 ⁵
RATED OUTPUT	±10V, ±5mA	±10V, ±5mA
INPUT OFFSET VOLTAGE		
Avg. vs. temp (10 to 70°C) max	±30μV/°C, (J) ±10μV/°C, (K)	±30μV/°C, (J) ±10μV/°C, (K)
Warm-up drift	75μV (15 min)	75μV (15 min)
INPUT BIAS CURRENT (signal input only) ¹		
Initial, 25°C, max	±10fA	±10fA
Avg. vs. temp vs. supply voltage	±1fA/°C ±2fA/%	±1fA/°C ±2fA/%
INPUT IMPEDANCE		
Differential	3 x 10 ¹¹ Ω 30pF	3 x 10 ¹¹ Ω 30pF
Inverting input (to common)	—	10 ⁹ Ω 20nF
Non-inverting input (to common)	—	10 ¹⁴ Ω 2pF
INPUT NOISE		
Voltage, .01 to 1Hz, p-p	10μV	10μV
1 to 100Hz rms	10μV	10μV
Current, .01 to 1Hz, p-p	1fA	1fA
1 to 100Hz, rms	2fA	2fA
COMMON MODE CHARACTERISTICS		
Max safe differential voltage	±300V	±300V
Common mode rejection @ ±25V	NA	10 ⁵
PRICE 1-9	(J) \$75 (K) \$125	(J) \$75 (K) \$125
10-24	\$70 \$113	\$70 \$113

¹Negative input for 310, positive input for 311.



221 FIFTH ST., CAMBRIDGE, MASSACHUSETTS 02142

Noisy Signal?

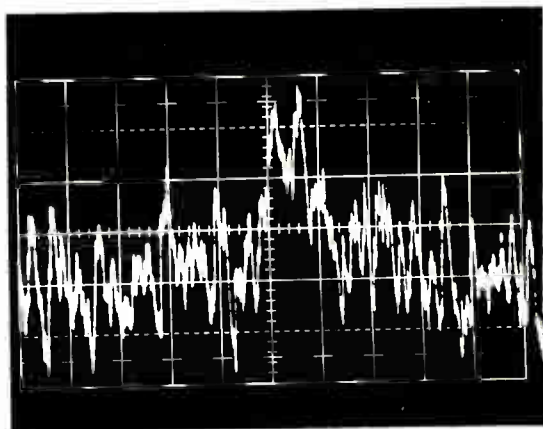

Extract it with a PAR Waveform Educator™

The PAR Waveform Educator is a signal averager used to extract repetitive signals from noise. For complete information or to arrange a demonstration of this instrument, which is priced at only \$4,200, write Princeton Applied Research Corporation, P.O. Box 565, Princeton, New Jersey 08540, or call (609) 924-6835.

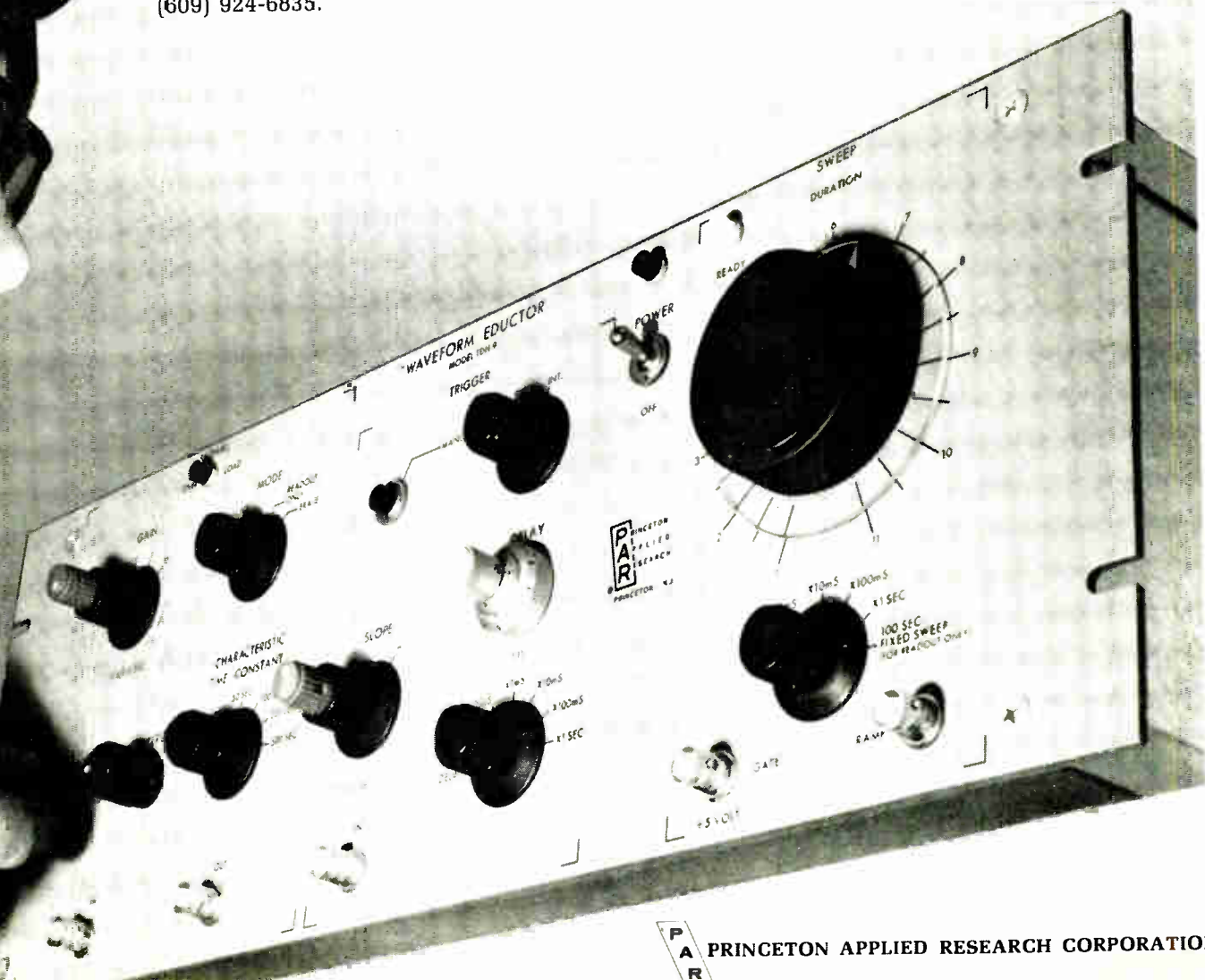
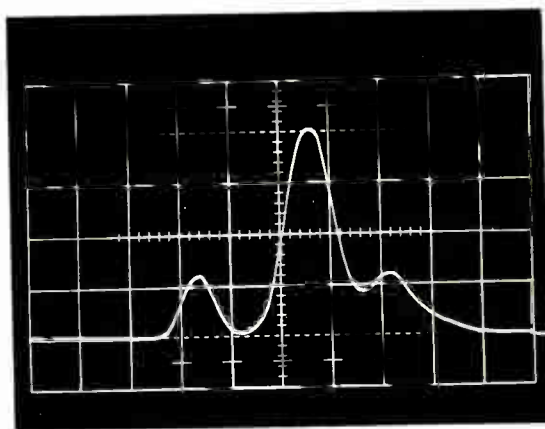

MOS moves onto high-speed track

Self-aligning technique eliminates overlap, drastically cuts capacitance; use of silicon as gate metal grants a reduction in threshold voltage

Although metal-oxide-semiconductor integrated circuits are generally regarded as slow devices, a manufacturing technique developed at Fairchild Semiconductor may make them eligible for real-time data processing. Fairchild's silicon-gate technique speeds MOS by reducing the gate capacitance to a negligible level. "This means that we can about double the speed of MOS circuits using this scheme," says Harry Neil, MOS product marketing manager. "Static circuits now run at 1.5 megahertz. We'll get 3 Mhz." The first circuits made by the technique, a multiplexer and several shift registers, will be marketed in July.

Another technique, ion implantation, accomplishes the same reduction in gate capacitance [*Electronics*, Nov. 11, 1968, p. 55]. However, the silicon gate technique is simpler, much faster, and requires less expensive equipment. It also produces some desirable side effects.

In the conventional MOS fabrication process, silicon dioxide is first deposited on the chip. Then the oxide is etched by photolithography so that the drain and source can be diffused into the silicon substrate. Next, the oxide is etched off the gate region and regrown at high temperature to a desired thickness. Finally, aluminum is evaporated onto this new oxide to form the gate electrode.

Lineup. The trouble with this conventional method is that two masks have to be aligned: one for the diffusion pits and one for the gate electrode. To make sure that the gate occupies the right position with respect to the drain and source, there must be some overlap—0.1 mil for each mask. The

net result is that the separation between drain and source can't be less than 0.4 mil.

In the new method, the oxide is grown over the wafer as before. But then a layer of polycrystalline silicon is deposited on top of the oxide. Now, with one masking step, the diffusion pits can be etched out and the gate electrode delineated—the structure is self-aligning because the drain and source

a channel that can be only 0.2 mil wide."

One side benefit is a reduction in threshold voltage. The work function associated with the conventional structure (aluminum on silicon dioxide on silicon) adds about 0.3 volt to the threshold voltage. But the silicon gate structure "actually goes the other way—it subtracts 0.3 volt," Neil reports.

And Q_{ss} (stored charge) is much

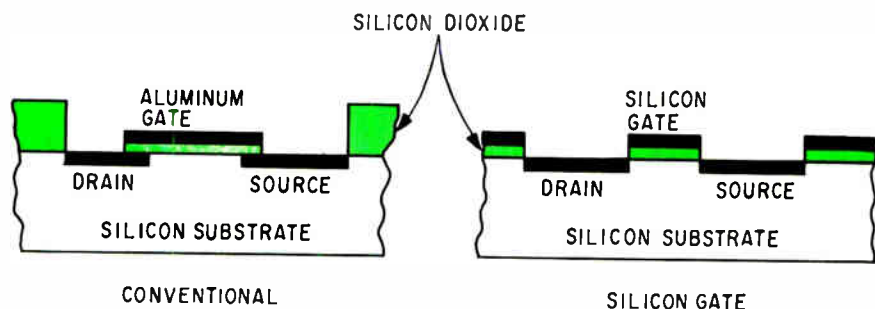

No overlap. Because the silicon gate is self-aligning no overlap over the drain and source is necessary. A passivating oxide or nitride must still be put on the exposed silicon, but its thickness doesn't have to be controlled precisely and it can be deposited at low temperature.

diffusion follows the gate electrode formation. The silicon gate, unlike the conventional aluminum, can easily withstand the 1,100°C or 1,200°C temperatures used for diffusion. (During the drain and source diffusion step, the poly silicon gate is exposed to the dopant too, and it's converted from an insulating material with about 40-ohm-centimeter resistivity to a conductor with 1 ohm-cm resistivity.)

"The only diffusion we have to worry about," says Neil, "is just the side diffusion, which is practically nil—something in the neighborhood or 2 or 3 angstroms. So we cut down on the feedback capacitance drastically. We also get

less with the silicon gate. Although Q_{ss} adds about 0.3 volt to the threshold in the conventional structure, it adds only one-tenth that amount with the silicon gate. The net effect is a device that can change state at only 1.5 volts.

Keep cool. The silicon gate process grants another benefit: the wafer isn't exposed to high temperatures after the drain and source diffusion. (There's no need for thermal regrowth of the gate oxide.) This means that bipolar transistors can be formed in the wafer and not have their characteristics degraded by subsequent processing—the base width stays well defined. Neil reports that Fairchild can

U.S. Reports

build bipolar transistors with a beta of 50 to 100 and frequency of 400 Mhz on a silicon-gate MOS wafer. These bipolars can be distributed around the MOS circuit to act as clocks.

With bipolar transistors combined with silicon-gate MOS FET's, a 10 Mhz shift rate should be attainable. Adds Neil: "Then we begin to get into a real-life situation in the processor. It looks very attractive." Fairchild hopes to introduce these IC's toward the end of the year.

Fairchild expects prices for silicon-gate circuits to be about the same as for conventional ones. Since the processing after photo-etching and diffusion isn't critical, "you're not going to affect yield by it," Neil says.

Fairchild doesn't plan to use silicon nitride as the insulating material between gate and substrate: thresholds already have been severely reduced with the silicon gate. Although several IC manufacturers favor Si_3N_4 as a means of reducing threshold, Fairchild engineers believe that use of nitride would only increase the gate capacitance and introduce hysteresis problems.

The real value of Si_3N_4 , in Fairchild's view, is as a passivating material. By putting Si_3N_4 on top of the silicon gate structure (rather than in the middle), the circuit will be protected from the bugaboo of sodium ion contamination, but won't be susceptible to the undesirable effects that occur when nitride is utilized in a high-field region.

Advanced technology

Light squeeze

How do you widen laser use in such areas as controlled nuclear fusion, optical pulse-code modulation, high-speed optical sampling, and multiphoton processes? Simply narrow the pulses to sub-picosecond duration. Two Bell Labs researchers, John Hansen and Michael Dugay, have taken an important first step by chirping 500 psec pulses from a mode-locked helium-

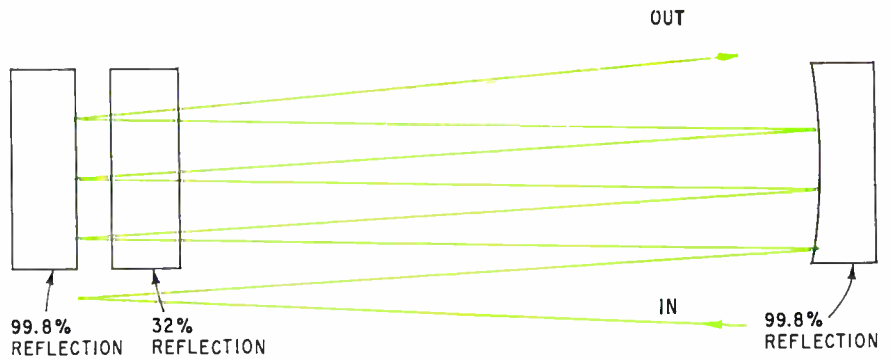

Reflections. Chirped pulse passes through mirror at left, which reflects some energy to mirror at right. By adjusting cavity spacing to resonate at certain wavelengths, frequencies forming pulse's leading edge stay longest in cavity, catching up with frequencies forming trailing edge.

neon laser, passing them through a dispersive element in a manner analogous to that used in microwave radar, and compressing the pulses to 270 psec.

Although this isn't the first time optical pulse compression has been reported, it's the first time anyone has deliberately tried to accomplish it in a controlled process. Last year E.B. Treacy of the United Aircraft Research Laboratories attempted to undo the internal f-m distortion observed in picosecond pulses produced from a dye mode-locked glass laser. He passed the mode-locked pulse through a pair of diffraction gratings and compressed it. However, the passive mode-locking process is quite complicated and so far no one else has reported that his experiment has been repeated.

Passing. In contrast, Bell Labs worked out an easily repeatable and controlled process. They passed pulses from an actively mode-locked He-Ne laser through a lithium niobate crystal, applying a 100 megahertz r-f signal to the crystal, thereby periodically changing its index of refraction. To chirp the pulse (that is, shift its components over a band of frequencies), the researchers adjusted the phase of the r-f signal so that it peaked as the optical signal passed through the center of the crystal. Adjusting the r-f signal phase so that it is at maximum positive as the optical pulse reaches the crystal center causes the index of refraction to decrease as the pulse enters. Thus, the pulse's leading edges are shifted upward in frequency while the trailing edges are shifted down-

ward. The pulse was down-chirped in the Bell Labs experiment so that its bandwidth increased from 1.5 Ghz to 2.8 Ghz.

Next, the chirped optical signal was sent through a dispersive cavity—a structure first proposed by Francois Gire and Pierre Tournois of Thomson-CSF in France. As the pulse bounced back and forth in the cavity—four times in the Bell Labs experiment—its frequency components were delayed by unequal amounts so that the leading edges caught up with the trailing edges, thus compressing the pulse.

Larger mirrors in geometries suitable for optical delay lines will permit a greater number or reflections and, therefore, narrower pulses. And it should be possible to cascade pulse compressors for still greater compression and peak powers.

Making ripples

Surface-wave acoustic technology has been hailed by many as the key to miniaturizing signal processing components — theoretically about 100,000 times—as well as providing easy access to the extremely wide-band information being processed. The reason is that the acoustic waves travel about 100,000 times slower in an appropriate substrate than the electromagnetic waves that generate them. What's more, they travel along the substrate's surface where they can be transduced out quite easily anywhere along the propagation path.

For the past year or so most work

has been around 100 megahertz. Now IBM has an experimental acoustic surface-wave transducer that generates fundamental waves at 1.75 gigahertz, probably the highest fundamental operable frequency transducer of that kind ever developed.

A delay line using two of the transducers on a lithium niobate substrate had a bandwidth of 70 Mhz for 2.2 microseconds of delay, and a total insertion loss of 25 decibels. This included the bidirection and mismatch loss of the transducers, and the propagation loss of the LiNbO_3 substrate between them. Not only that, but it was accomplished on a piece of substrate approximately 0.3 inch long by 0.03 inch wide, making it the smallest functioning interdigitated transducer. It has 25 pairs of interleaved aluminum fingers, each 0.3 micron wide with a 0.7 micron gap between interleaving fingers, fabricated on y-cut, z-oriented lithium niobate or y-cut, x-oriented quartz substrates.

Since the optical mask projection could not have achieved the very sharp resolution required for these frequencies, electron-beam techniques were used to expose a specially developed photoresist emulsion. An electron-beam column was built specifically for such fabrication and scanning electron microscopy. It employs a lanthanum hexaboride gun, some five times brighter than the standard tungsten "hairpin" high-resolution lens system, and a precisely controlled x-y table that moves the specimen beneath the beam. And the beam can be focused to within 0.003 micron.

Think. Actually, this is only the start for IBM. A 3-Ghz transducer is on the bench, and researchers feel confident they can go up to 6 Ghz. For a simple transducer structure, the bandwidth is related to the center frequency divided by the number of pairs of transducer fingers. However, using a log-periodic structure, the bandwidth can be extended: for example, the 1.75 Ghz transducer's bandwidth could be upped to 37%. This would result in a time-bandwidth product of 1,425, which corresponds to a delay time of 2.2 microseconds and a

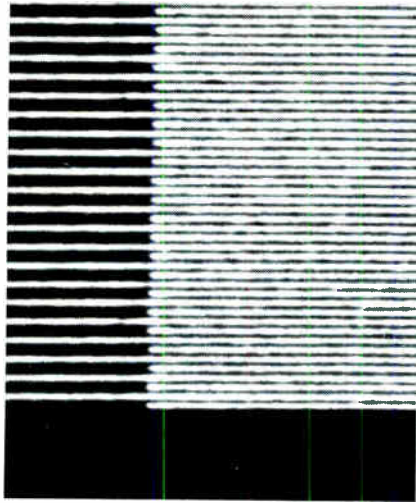

Tiny fingers. Electron-beam techniques produce interdigitated surface-wave transducer with fingers 0.3 micron wide for use at 1.75 gigahertz.

bandwidth of 646 Mhz. And when the 6-Ghz transducers become available, time-bandwidth products of 4,850 will be possible.

Of course, at these higher frequencies the propagation loss will increase: for LiNbO_3 , 3db/ μsec at 1.75 Ghz, 12 db/ μsec at 3.5 Ghz, and 48 db/ μsec at 7 Ghz; for quartz, which is much cheaper than LiNbO_3 , the figures are 7db/ μsec at 1.75 Ghz, 28 db/ μsec at 3.5 Ghz, and 112 db/ μsec at 7 Ghz. Propagation loss is unavoidable, but efficiency can be improved.

According to Eric G. H. Lean, the IBM research scientist who designed and tested the transducers, this is done by properly juggling several transducer parameters. By adjusting the ratio of the finger width both to the separation between the edges of the interleaving fingers and to the finger's length, the transducer radiation resistance can be brought much closer to the conventional driving source impedance of 50 ohms. This adjustment minimizes the mismatch loss, but must be accomplished while keeping the sum of the finger width and the distance between interleaving fingers constant once the operating frequency is determined.

IBM is also looking into the non-linear effects of these waves for mixing, amplifying, and channeling for use in frequency shifters, memories, and acoustic lenses.

Manufacturing

Focus on diodes

Along with ion implantation, laser beams offer a way around some of the problems encountered in fabricating integrated circuits by diffusion techniques. The intense, short pulse from a q-switched laser can form components in IC's without changing the properties of the surrounding semiconductor material and offers the possibility of more precise control of impurity distribution in the material.

But only ruby lasers have been used experimentally to form diodes; and ruby lasers can be q-switched only once every few seconds. Most recently, IBM fabricated diodes by this method. Now Bell Labs has used a q-switched yag laser to alloy an aluminum thin film into n-type silicon, forming a diode whose performance is comparable to that of commercial germanium—although not silicon—types. Because the yag laser can be pulsed thousands of times a second, this opens up the possibility of mass producing some components in IC's with the laser.

One mask. At the moment, Bell's interest is purely experimental because many problems remain. But the economic possibilities are intriguing. It might eventually be cheaper, for instance, to use only one mask to fabricate two similar IC's and then use the laser to form, say, blocking diodes in one of the circuits. If the yag laser were used in conjunction with an acousto-optic deflector it could form thousands of such diodes a second.

In the Bell Labs technique, aluminum is deposited on the silicon surface, then the laser is fired, causing the metal and crystal to melt and mix together. As the mixture solidifies, the silicon acts as a host to the metal and apparently regrows as a single crystal in the region near the diode junction. However, this mechanism is not clearly understood.

Leakage currents of the laser-formed diodes are 10 microamperes at 10 volts, breakdown characteristics are sharp, and switching times are 1 nanosecond—comparable to those of the best p-n switch-

U.S. Reports

ing diodes. Thus, the performance of these early experimental devices is adequate for many circuit applications.

Melvin Cohen and Francis Harper, who did the experiments, are using lasers to form diodes in other semiconductor materials.

Lasers

New tune

A year after Stephen E. Harris of Stanford University demonstrated the tuning of a parametric oscillator by heating a lithium niobate crystal [*Electronics*, Aug. 19, 1968, p. 48], two of his graduate students have tuned with purely optical techniques.

Harris used a lithium niobate crystal—previously a Bell Telephone Laboratories group had worked with barium sodium niobate—to split a laser beam into signal (visible) and idler (infrared) frequencies. These two frequencies add up to the original signal: when the crystal is heated, the idler wavelength decreases and the signal increases.

The Stanford graduate students, Joel Falk and James E. Murray,

mounted the entire parametric cavity on a movable table and tuned the signal frequency derived from a ruby laser over a range of 1.20 microns to 1.05 microns by rotating the cavity horizontally, relative to the laser. Corresponding idler wavelengths were 1.64 microns to 2.05 microns. It is the change in the angle at which the ruby laser beam enters the LiNbO_3 crystal that changes the idler and signal frequencies. A year ago, Harris achieved continuous-wave parametric oscillation that was potentially tunable all the way from 5 microns to 0.6 micron.

More to come. Rotating the cavity was an experimental technique. The angle between the pump and the resonator axis could also be changed by electronic beam-deflection techniques, Falk and Murray point out. With electronic deflection, the system could be tuned very rapidly over a large bandwidth. In the experiment, tuning was confined to the infrared, but a greater range could be achieved by heating the crystal as well as deflecting the beam.

The deflection angles are chosen so that the idler frequency remains in the resonant cavity, reflected back and forth between mirrors at each end. The pump and signal

frequencies are deflected out of the cavity through an optical prism. Falk and Murray have consistently obtained 25% energy conversion from the pump mode to the resonant idler and nonresonant signal modes, and they have occasionally observed such energy conversion as high as 45%.

“With appropriate antireflection coatings on the crystal and the prism, the system could achieve 100% output coupling,” adds Stanford’s Murray.

The system’s parametric cavity consists of dielectric mirrors 12 centimeters apart with reflectivities greater than 95% over the idler wavelengths. The LiNbO_3 crystal, grown especially for the project by the Stanford Materials Science group, was 1.4 cm long and antireflection coated at idler wavelengths.

Switch in time

Giant laser pulses are commonly obtained by rotating one of the mirrors forming the feedback cavity out of alignment so that the laser can’t oscillate. An excess of atoms is then stored in an excited state; they give up their energy in a burst when the mirror is rotated back into place. This type of q-switching—until now the only kind that could be controlled practically—suffers from two drawbacks: pulse repetition rates are limited to 1 or 2 kilohertz and reliability is low because a mechanical drive is required.

However, Bell Telephone Laboratories now has a q-switch without moving parts that costs no more than the rotating-mirror type, and allows pulse repetition rates up to 50 khz. An acousto-optic device, it consists of r-f drive circuitry, a quartz transducer, and a fused silica block.

Applying r-f to the quartz launches a 40 megahertz wave in the silica. As the laser beam travels through the silica—at a Bragg angle relative to the acoustic wave—it is scattered by the periodic refractive index changes, and it escapes from the laser cavity. This keeps feedback loss large enough to prevent the laser from oscillating, and an

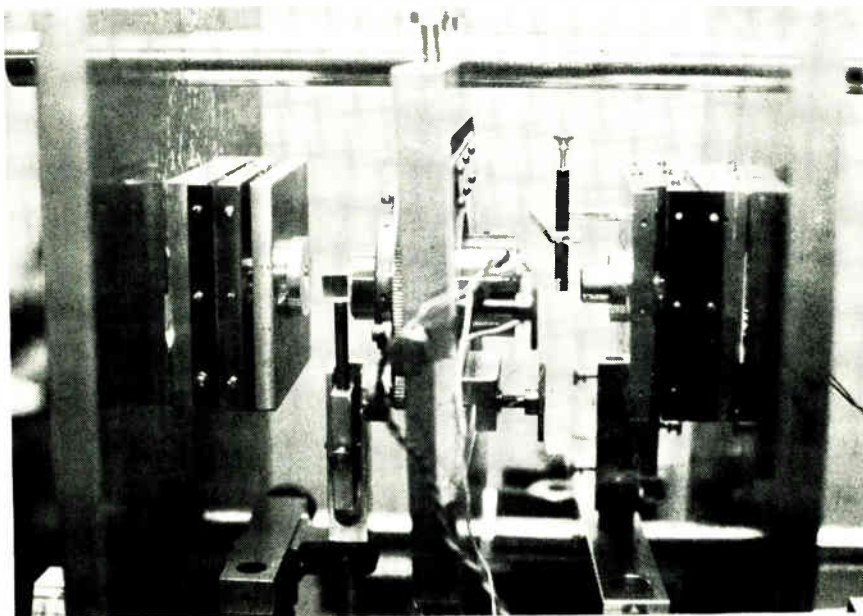

Turning on. Using this equipment, two Stanford University graduate students have tuned a parametric oscillator using optical techniques. The pair worked with a ruby laser.

Semtech Silicon Rectifiers & Assemblies



"Cool Power"

Semtech Corporation manufactures a complete line of silicon rectifiers and devices. Offering unique packages — designed to solve old and new circuit problems efficiently, reliably and at low cost.

Semtech has a continuing research and development program, utilizing inter-related technologies, to guarantee state-of-the-art rectifiers and assemblies. The new "Metoxilite" rectifier is just such a device — the result of years of intensive materials research and testing. Fashioned from metal oxides, this new device offers impermeable monolithic construction and advanced electrical characteristics.

Unique devices introduced by Semtech include:

- SEMPAC® (100 to 1000V) ■ MINISTAC (1 to 7kV) ■ COMPAC (50 to 3000V) ■ MINISTIC (10 to 40kV) ■ SLIMPAC® (2.5 to 45kV) ■ ALPAC® (50 to 600V) ■ STACFAC (500V to 25kV)
- "METOXILITE" (100 to 1000V) ■ A complete line of Multipliers (up to 50kV).

For complete information, contact your nearest representative and get your free copy of Semtech's 1969 Silicon Rectifier Catalog. All products listed in our catalog are available for immediate delivery.

San Francisco—941 E. Charleston, Suite 10, Palo Alto, California 94303 / (415) 328-8025
Chicago—1404 La Grange Road, La Grange, Illinois 60525 / (312) 352-3227 / TWX: 910-623-1895
Dallas—402 Irving Bank Tower, Irving, Texas 75060 (214) 253-7614
New York—116-55 Queens Blvd., Forest Hills, New York 11375 / (212) 263-3115 / TWX: 710-582-2959
European Sales—Bourne A. C. Alpenstrasse 1, Zug, Switzerland / (042) 4 82 22/73



SEMTECH

CORPORATION

652 Mitchell Road, Newbury Park, California 91320
(805) 498-2111, (213) 628-5322 / TWX: 910-336-2664

©SEMPAC, SLIMPAC and ALPAC are registered trademarks of the Semtech Corporation.

U.S. Reports

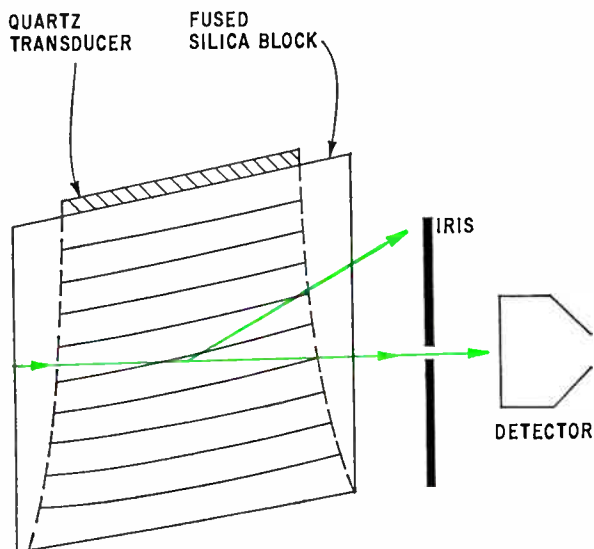

Outbursts. Q-switched laser pulses, commonly obtained with rotating mirrors, now can be formed with acousto-optic devices at rates up to 50 khz. Speed, simplicity, and cost make switches good commercial bets.

excess of atoms is excited. Each time the r-f is turned off—up to 50,000 times a second—the laser emits a pulse.

To reduce noise, which becomes a problem at high repetition rates because of uneven heat dissipation, the researchers surrounded a rod of yttrium aluminum garnet with a water jacket. As a result, pulse amplitude at the 50 khz repetition rate is said to vary by no more than 1%.

The Bell researchers believe that acousto-optic q-switches of this type will eventually replace rotating mirror units because of superior performance and reliability and because all the component materials are readily available. Ronald Chesler, Joseph Geusic, and Michael Karr developed the switch.

Government

A classified question

Now that Stanford University trustees have taken the bull by the horns and decided to sever university ties with the Stanford Research Institute, and MIT's 22-man panel is weighing that school's future in classified military work, the Pentagon says it's beginning to worry a bit.

Although most schools stopped accepting classified research for their own labs at the end of the Korean War, university-administered research centers, including

the eight Federal Contract Research Centers (FCRC) of which MIT's Lincoln Laboratory is one, have always accepted this kind of work.

In one respect the Pentagon's worry is justified. As one official puts it, "It's always nicer to assign research and development work to someone who won't be connected to the production aspects of a contract. The university centers fill the bill exactly; they're completely unbiased." And John S. Foster, the Defense Department's director of research and engineering, is emphatic in his support for the centers. Foster is on record as saying that his department did not intend to dilute or reduce DOD funding to the FCRC's.

Small deal. On the other hand, Foster and his colleagues at the Pentagon may be brewing a temp-est in a teapot. For example, in terms of dollars, the Defense Department spent about \$122.7 million in 1968 at university labs for unclassified applied research and only \$88.1 million at university-administered centers, not all of which was for classified work. This compares with a total 1968-applied DOD research budget of about \$1.9 billions.

Electronics industry spokesmen, of course, are quick to point out that if the universities stopped accepting all classified research, their firms could easily pick up the slack.

However, the Stanford decision to sever ties with its research institute may point the way for other

schools which, like MIT, are grappling with the thorny question of what to do about their research centers' classified work. One highly-placed MIT source, for instance, says that it's quite possible that both his school's Lincoln and its Instrumentation Labs might become independent much like the Mitre Corp.

The other possible course of action is that Federally-supported, but university-administered, research centers like the FCRC's be placed under direct control of a Government agency, a sort of technological and scientific Tennessee Valley Authority.

Foster himself has conceded the possibility of transforming the centers into Government-administered institutes. In fact, he indicates that his department will be working with the Bureau of the Budget on the question.

Memories

Sounding a light note

Holographic memories have become more serious candidates for storing information in electronic telephone switching systems thanks to an acousto-optic deflector that can shift a laser beam to any of 80 positions in a microsecond.

Developed by Douglas Pinnow of Bell Telephone Laboratories, the deflector includes a single-crystal lithium niobate transducer bonded to an alpha iodic acid crystal. When the lithium niobate is driven by an r-f signal with a center frequency of 140 megahertz, it launches an acoustic wave of that frequency in the alpha iodic acid. The ultrasonic wave modulates the crystal's index of refraction, thereby deflecting an incident laser beam by an amount proportional to the acoustic frequency.

Previous acousto-optic beam deflectors used water as the deflection medium and were limited to bandwidths of 40 Mhz. Bell is using its deflector in an experimental holographic memory that has a capacity of 4 million bits—any of which can be read in a microsecond. In its

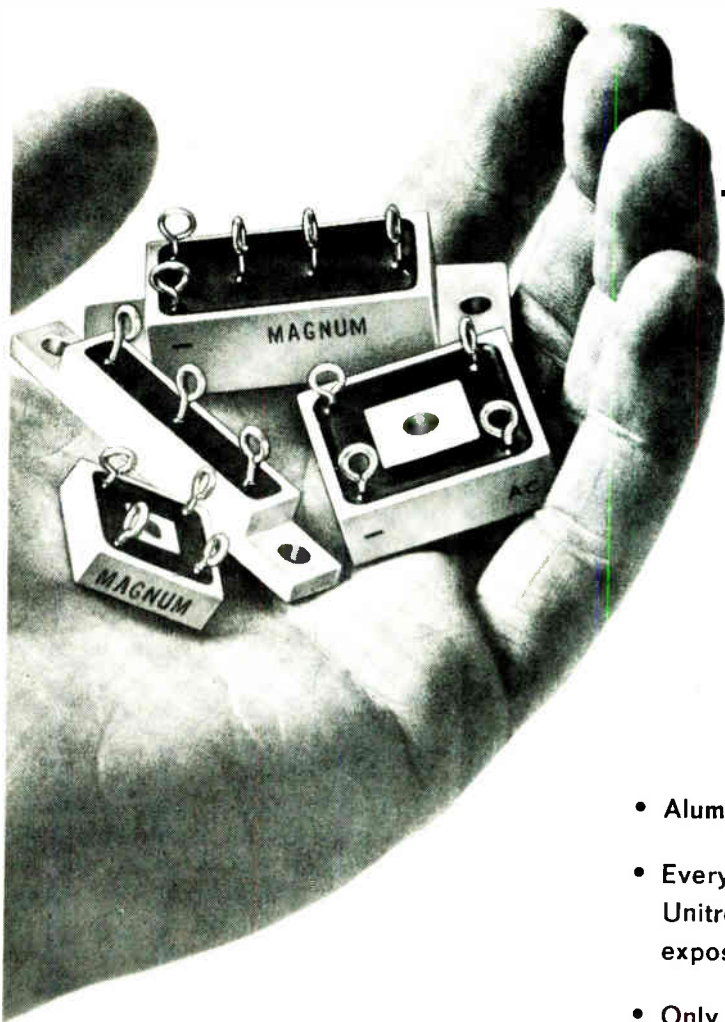

The "inside-out" bridge --
the first 25 amp
rectifier assemblies
designed for reliability
from the inside out...
and priced competitively

- Aluminum package optimizes heat dissipation.
- Every chip individually fused in glass in a complete Unitrode monolithic package, so . . . silicon is not exposed to possible contamination by plastic filler.
- Only controlled avalanche rectifiers used.
- Terminal pins directly connected to silicon make direct thermal path — not only to case, but to lead wires — thus lower junction temperatures.

#678 Series Three Phase 25 Amp Bridges
#679 Series Single Phase 25 Amp Bridges
#680 Series Single Phase 10 Amp Bridges
#681 Series 15 Amp Doubler and Center Tap Rectifiers

PIV'S to 600V.
4 different packages
6 circuit configurations
All available in regular,
fast, or ultra-fast recovery

THE MAGNUM RECTIFIER ASSEMBLY by

UNITRODE

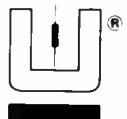

580 Pleasant Street, Watertown, Massachusetts 02172 • (617) 926-0404

IN ITS HEART, YOU KNOW IT'S RIGHT . . .

HERE'S WHAT IT
LOOKS LIKE INSIDE

Even before it's potted, the Magnum has all the toughness, reliability, and electrical characteristics of the unique Unitrode fused-in-glass diode as the heart of its construction.

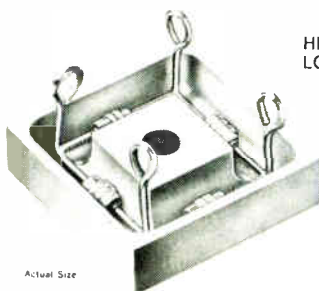

Actual Size

HARD GLASS FUSED TO
SILICON SURFACE



TERMINAL PINS METALLURGICALLY
BONDED DIRECTLY TO SILICON

HERE'S WHAT IT
LOOKS LIKE INSIDE
THE INSIDE

With the silicon die metallurgically bonded between terminal pins of the same thermal coefficient, the hard glass sleeve is fused to the entire outer silicon surface. Result — a voidless, monolithic structure.

For fast action, call Dave Greene COLLECT at (617) 926-0404.

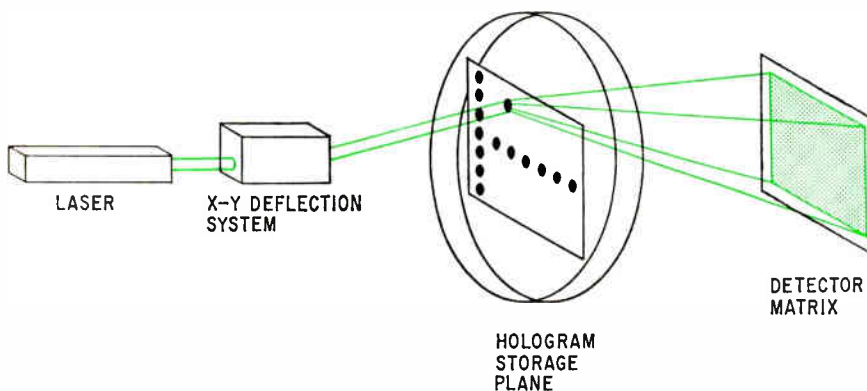
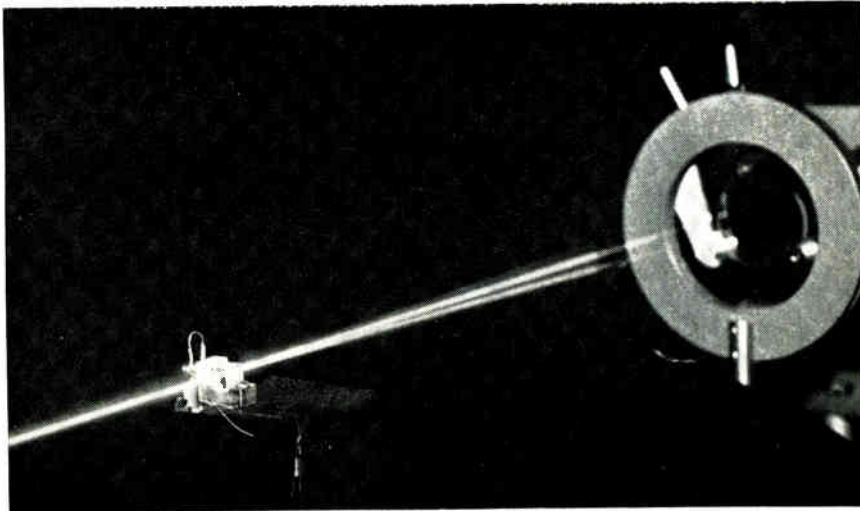

Bits and beams. Acousto-optic deflector can shift laser beam to hologram in microsecond, thus reconstructing 10,000-bit image on matrix of phototransistors. Photo shows one such deflector shifting beam to 80 positions on transparency attached to glass.

present form the memory does not include facilities for writing in data.

Move the beam. Two deflectors in series move the beam of an argon laser along the x and y axis so that it illuminates any of 1,024 holograms on a 32 by 32 array. As the beam passes through the holographic film it projects the reconstructed hologram—binary ones and zeros—onto an array of phototransistors; they, in turn, convert the optical image to electrical signals. Each hologram contains 10^4 bits of information.

Bell is investigating this technique as one possible alternative to the magnetic twistor memories now used in electronic telephone switching systems. Holographic memories may be more economical for the high-capacity, fast-access memories that will be needed in future ESS systems.

Bell believes it should be pos-

sible to increase the bandwidth of the deflector so that it can access a 100 by 100 array of holograms, thereby reading out any of 10^8 bits of information in a microsecond. The capacity of the program store in ESS is 5.8 million bits, and the access time of the 16 twistor modules is about 5 microseconds.

Limitations. It is primarily the amplifiers used to drive the lithium niobate transducer that set present bandwidth limitations. The alpha iodic acid crystal can be used with bandwidths up to 500 Mhz, and the lithium niobate can handle acoustic waves up to that frequency; since the single-crystal transducer must be fabricated half an acoustic wavelength thick, present technology doesn't permit going to a higher frequency.

The deflector also shows promise for laser display systems. While its present resolution isn't up to that

of rotating mirror deflectors, it could be made adequate for Picturephone displays where only 250- instead of 500-line resolution is required. One possible application would be the projection of a Picturephone signal on a large screen at business conferences.

Present plans are to use lead molybdate as well as alpha iodic acid. The latter material dissolves in water and must be protected from the atmosphere by a fused silica covering. Moreover, the alpha iodic acid decomposes above 110°C . In contrast, lead molybdate doesn't have these shortcomings, is stronger mechanically, and otherwise offers similar performance.

Space electronics

Earth angels

The extra-long-awaited requests for proposals for Earth Resources Technology Satellites A and B have been released. The dozen firms that requested copies have until June 18 to present their proposals to Goddard Spaceflight Center.

The request for proposal contains no big surprises and is close to what everybody had expected [*Electronics*, May 12, p. 98]. However, the document does bear some reading between the lines. For instance, nowhere does it specify whether an existing spacecraft or an entirely new one will be used. Says an official of NASA's space applications program, "This was done so as not to encourage or discourage an entirely new design for the spacecraft." But it does spell out the contents of the satellite sensor payload: a multispectral television system (RCA's return beam vidicon), a multispectral point scanner (either one under development by Hycon Manufacturing Co. or another by the Hughes Aircraft Corp.) and contractor-developed data collection system. The request neither asks for nor rules out other sensors for the first two satellites.

As expected, NASA came up with very specific stipulations for the

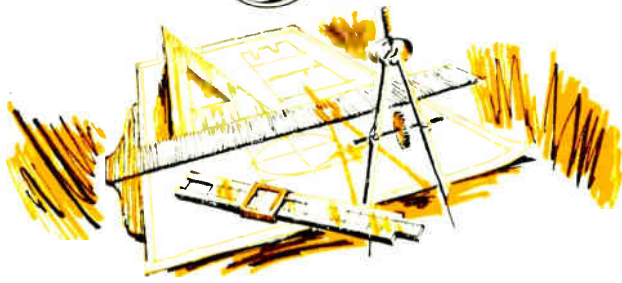

5 more electronic components tailored for designers

General Electric components are engineered for reliability and cost effectiveness. No other manufacturer offers such a wide selection of quality electronic components as General Electric. Specify GE in your designs.

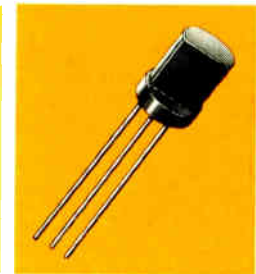

General Electric's programmable UJT lets you control the key parameters

GE's D13T is a programmable unijunction transistor (PUT) with characteristics (η , R_{B1} , I_B , I_C) that can be selected to fit your circuit. Just two circuit resistors give the D13T1 and T2 programmability which permits the designer to:

- reduce a risk of thermal runaway
- use PUT in battery and other low-voltage circuits
- use base 2 as low impedance pulse output terminal
- use PUT in high volume applications.

Especially suited for long-interval timers, D13T2 features very low leakage and peak point currents. D13T1 is for more general use in high gain phase controls and relaxation oscillators.

Both are 3-terminal planar passivated PNP devices in the low-cost plastic TO-98 case. Circle number **513**.



Pin-sized Lodex magnet

New—Lodex® permanent magnets in microminiature sizes

When designs call for tiny (even less than 1 millimeter) permanent magnets, GE has the answer. GE can produce powerful microminiature magnets at low cost—and in complex configurations, too.

The magnets are made of proved Lodex material that consists of elongated single domain iron cobalt particles bonded in a lead matrix and pressed to final dimensions at room temperature without the use of high temperature fabrication or heat treatment. This exclusive process makes it possible to produce Lodex magnets in very small or intricate shapes meeting extremely tight physical and magnetic tolerances.

Close piece-to-piece physical and magnetic uniformity often eliminates the need for final testing of the end product. These GE magnets are often the perfect answer for such precise applications as reed switches or magnetic pick-ups.

For more information, circle number **514**.



New transmitter design gives high performance to IFF and ATC transponders

GE's new C2003C transmitter is a Micro-wave Circuit Module (MCM) containing a master oscillator and power amplifier using planar ceramic triodes.

It is just one of many MCM's now available from GE to help reduce design cycles, provide retrofit and lead to improved system performance.

Other benefits include: meets performance and military requirements of the transmitter portion of IFF transponder significantly smaller than earlier designs permits two transmitters to function in space formerly used by one light-weight simplified heat sinking excellent frequency stability with wide variations in antenna VSWR.

For more technical information on this and other MCM's from General Electric, circle magazine inquiry number **515**.



actual size

GE makes the only 150-grid relay that performs the AND-logic function

GE's 3SBR 4-pole relay is the only one available that performs the AND-logic function without any additional circuitry or components. Nine different input conditions control the relay's operation.

The 3SBR is another addition to GE's proved family of 150-grid relays for mil spec applications. It features all-welded construction, small size and a low profile—only 0.32" high. The 3SBR is available with a choice of coil ratings, mounting forms and headers.

For more technical data, circle number **516**.



Rechargeable nickel-cadmium batteries give design flexibility—long life

Get lasting battery power and versatility suitable for many industrial and consumer applications. Types include sealed, pressure-relieved and vented cells. Custom designs to your specifications are also available.

Nominal ratings range from 0.1 amp-hours to 4.0 amp-hours in sealed cells and up to 160 amp-hours in vented types at the one-hour rate.

GE nickel-cadmium cells feature unique construction providing a very high discharge rate capability.

See how GE's proved line of nickel-cadmium batteries can increase your circuit performance. For more information, circle magazine reader card number **517**.

LOOK TO GENERAL ELECTRIC—your best source for more in electronic components.

ELECTRONIC COMPONENTS SALES OPERATION

GENERAL ELECTRIC

285-52

U.S. Reports

ability of the satellite. For starters the designer must provide for a minimum payload capacity of 450 pounds and a volume of 10 cubic feet. It will go into a 496-knot circular 99° sun-synchronous orbit and will be required to give near global coverage every three weeks. Each satellite must have a minimum operating lifetime of one year and will make observations of the same place at the same hour. The satellites will be launched nine months apart and, as currently planned, will be identical. The booster will be the long-tank Thor with an improved Delta second stage. By the time of the first ERTS launch, that configuration will be rated to orbit 1,600 pounds of payload.

Goals set. Perhaps the most interesting aspect of the request is that 12 specific goals for the total ERTS program are spelled out. It states in addition: "The applications stated . . . impose vividly varying and to some extent, conflicting requirements on sensors, spacecraft design, and other technological aspects of the ERTS mission." It says that "optional compromises" will have to be made in getting all these applications together on a near term basis and some will have to be reserved for the second generation.

In other words, through the request NASA is committing itself to a tough program of which the launches of ERTS A and B are only the start.

The applications ordered for the satellite program fall into three categories: agriculture; geology and geography; and oceanology and hydrology. The four agricultural goals are: measurement and identification of species; agricultural growth rate; factors relating to stress on crops and forests; and assessment of crop vigor and health leading to yield predictions. For the geologist and geographer the satellites will offer improved classification of geological characteristics; accurate monitoring of time-variant phenomena, such as population movements, transportation flow and hazards (air pollution, for one); and measurement of hydrological parameters, such as

soil moisture and snow depth. In the realm of the oceanologist and hydrographer the applications are sea state measurement; location and tracking of major ocean currents; mapping of sea ice; detection of specific phenomena such as oil slicks and fish; and shoreline analysis.

While much of the data can be gathered by the ERTS A and B sensors, five important goals will have to wait. For example, NASA plans to measure sea state measurement with passive microwave radiometry and track ocean currents with infrared scanning radiometers; neither of the first two ERTS will carry either of these devices. (This equipment will probably be tested on Nimbus and Itos satellites prior to use on a second generation set of ERTS.)

Aeronautical ante

Early proposals and discussions between the airlines and the Communications Satellite Corp. didn't get very far in establishing a vhf aeronautical services satellite system. Though there was interest all around, the cost looked prohibitive: the Federal Aviation Administration wouldn't commit itself to the plan and Comsat was having trouble selling it to its partners in the International Telecommunications Consortium. So Comsat has made a new proposal to the airlines that gives every indication of pleasing all parties.

The new proposal offers the system to the airlines at a reduced rate with a larger payload. All Comsat will say about the price is that ways have been found to make substantial reductions in earlier working figures for the two-ocean system. Says one airline official: "We'd get satellites over each ocean, full ground station support, guaranteed launch, and guaranteed service for five years—all for \$42 million."

According to E.J. Martin, Comsat's manager of advanced systems, the plan calls for an all-vhf satellite with a payload of more than 300 pounds put into orbit by an improved Delta launch vehicle. The birds would contain eight channels

apiece, or four vhf voice-grade communications channels. The new proposal is directly related to those made by Philco-Ford, Hughes, and North American Rockwell for the satellite last fall. Says Martin: "The cost per channel has gone down drastically."

One less. Last year the airlines balked at the estimated cost of \$55 million. The latest offer is basically the same—it works out to \$1.5 million per channel per ocean per year—considering that the airlines are offered only three of the four channels. Intelsat will lease the fourth to foreign carriers. Reportedly, this arrangement, besides making the airlines perk up, has gone a long way to satisfy Intelsat.

Says Comsat's Martin, "The key to getting the thing going is still finding the people to pay for it." Officially, Robert W. Meier, chief of the FAA's Communications Development division, says: "We're interested but have no funds in this year's budget, nor is any money planned for next year." Unofficially, the FAA has asked Aeronautical Radio Inc. to determine whether the system can be used for air traffic control: an airlines task force has met twice and will give its report to the FAA in June. In short, to obtain funds, the FAA will have to convince Congress and the Bureau of the Budget that there is a need for such a program. The airline communications people are preparing arguments for the FAA to use. (Presumably they have experience; they have been doing some cheerleading to get their own management enthused.)

Other pieces are falling into place. Two foreign carriers—Qantas and Japan Air Lines—have agreed to foot their part of the bill on the Pacific segment of the system. Says an official of a U.S. transoceanic carrier. "We've got aircraft coming off the assembly line outfitted for satellite service, and we want the service. The question is how will the ice be broken: by us, by the Government, or by both of us together?"

Going to L. Meanwhile, the Government—through NASA and the FAA—is moving quickly into L-band technology. The FAA has awarded

These RCA Triacs will turn you on

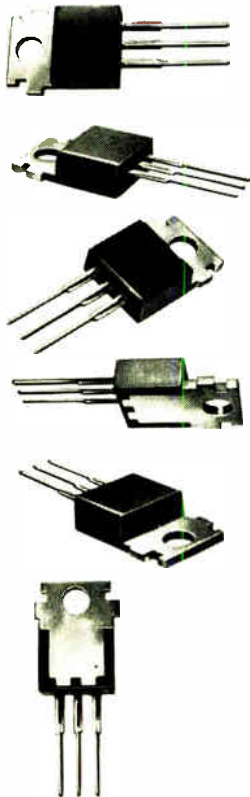

Choose New RCA 8 Amp Triacs for On-Off or Variable Phase Control of Power Into Resistive or Inductive Loads

Now's the time to think in terms of more than electro-mechanical controls and turn on with Triacs! Not just any triac—but the new RCA-40668 and RCA-40669. Both feature the unique RCA hermetic chip in the popular, easy-to-mount RCA VERSAWATT package . . . and at prices that are just as popular. Use the RCA-40668 for 120 V per 1-kW capability, the RCA-40669 for 240 V per 2 kW. With either, look what you get:

- Commutating dv/dt capability of 10 V per μs (typ.) permits operation into inductive loads.
- Critical rate of rise of off-state

voltage — 300 V per μs (typ.) for 40668 and 250 V per μs (typ.) for 40669 — minimizes false triggering caused by line transients.

- 100 A single-cycle in-rush current capability handles start-up surge loads readily.
- 8 A (RMS) capability at a case temperature of 80°C.
- 4 modes of gate control allow design flexibility and simplicity with either positive or negative DC logic.

For relay replacement, relay protection, motor speed controls and the like — in switching or phase control applications — for use in such devices as comfort control

systems, vending machines, appliances — turn to and turn on with RCA Triacs.

The RCA-40668 for 120 V per 1-kW operation is just 98¢ (1,000 units) and the RCA-40669 for 240 V per 2-kW capability is \$1.10 (1,000 units). See your local RCA Representative or your RCA Distributor for details. For technical data, write RCA Electronic Components, Commercial Engineering Section RN5-4, Harrison, N. J. 07029.

RCA

RELAY CONTACT PROTECTION

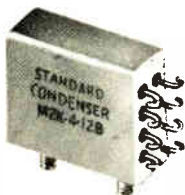
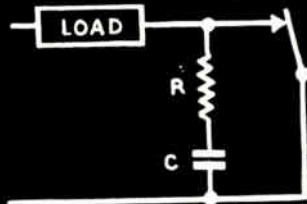

FOR THE ULTIMATE
IN RELAY LONGEVITY

R-C Networks designed to meet your individual requirements. Standard Condenser Arc Suppressors reduce damaging build-up on relay contacts and will greatly prolong the life of relays in your equipment.

Standard Condenser guarantees complete R-C Network compatibility with your present or proposed system.

Send specifications or, if you desire further information, write:

Standard

CONDENSER CORPORATION

Dept. EL-5, 1065 W. Addison St.,
Chicago, Ill. 60613 • 312-327-5440

U.S. Reports

Boeing a \$350,000 contract to study and test L-band communications in conjunction with the applications technology satellites. The initial contract sign earlier this month will cover the costs of outfitting a KC-135 Aircraft for the tests. The FAA is already planning associated contracts, one of which would outfit another test plane.

Two weeks ago NASA's Goddard Spaceflight Center sent out requests for a design definition study of experimental L-band ground equipment also as part of the ATS-F satellite program.

Oceanography

Sea legs for doppler

Marine explorers charting the ocean bottom are often hampered by the relatively short range of line-of-sight land-based radio navigation aids, the absence of even those aids, or the inaccuracies of gyrocompasses.

To fill those navigational lapses, engineers at the Guidance and Control Systems division of Litton Industries took a doppler sonar sensor with an inertial navigation system and integrated the sensor-system with a satellite receiver to pick up position-fixing signals from the U.S. Navy Navigation Satellite System. Called the Litton Marine Navigator, it delivers accuracies to within 300 feet at satellite update time. Actually, Litton guarantees a margin of position uncertainty no greater than 600 feet under specific conditions. Warren Wanamaker, manager of Navy and marine programs marketing at the Litton division, says 12 of the \$357,000 navigators have been sold.

Speed and depth. The guarantee—considered conservative by Litton—is based on the ability of the ship to get a position update from the satellite on an average of every 110 minutes and also on the assumption that the ship, moving at about 5 knots, is in water no more than 600 feet deep. The Baltic and North Seas, large areas of the Mediterranean and South China Seas,

and most continental shelf waters are less than 600 feet deep.

The system works in deeper water, but isn't quite as accurate because the ship's velocity in deep water is calculated in relation to the unknown velocity of currents in the water mass under the ship rather than being calculated on doppler sonar returns from the bottom. When the ship moves to waters deeper than 600 feet, the system switches automatically from the bottom-return mode to the water-volume reverberation mode.

Within the depth limit, the inertial navigation unit and its associated general-purpose computer could do the marine navigation job without additional equipment because it can give velocity, position, and precision heading data. But its error increases proportionally to the square root of time because of Schuler oscillations in the system. These oscillations can be damped out by adding the doppler sonar inputs, which give the ship's velocity precisely.

In the bottom-return mode, the operator activates the integrated system, entering the ship's position and up to 50 interim destinations. The inertial platform automatically levels and aligns the system to north. Then, north-south and east-west velocity are computed by integrating accelerometer signals and by solving the navigation equations in the computer, which has a multiply time of 53 to 57 microseconds and 8,000 words of memory.

The route. True heading of the inertial platform azimuth gimbal is digitized and fed to the computer and a display panel. Sonar doppler velocities—fore-aft, port-starboard, and up-down—are supplied to the computer and resolved through true heading and trim. The doppler sonar transducer sends four beams to the ocean bottom in 300-kilo-hertz pulses. A velocimeter, that measures the speed of sound in water, calibrates the signals. And this information is also given to the computer. The resolved and calibrated sonar doppler velocity is compared with the inertially determined velocity, and the difference

In microwave diodes, nobody likes surprises. When you buy from Varian you know what you're getting: We build every lot of diodes to your specification and 100% inspect it to make sure that spec is met. There is no product sorting. You never get a diode that's been downgraded from a tougher specification. Our exclusive material selection, production and QA procedures insure the high yields necessary to guarantee you on-time delivery at the highest acceptance rate — bar none — in the industry. We make tuning diodes, multiplier, switching and step-recovery diodes, paramp and oscillator diodes, either Impatt or Gunn-effect type. We build them to a standard tolerance of $\pm 10\%$ or at special tolerances to $\pm 3\%$. And we package them in any of over 30 different case configurations or deliver them in chip form. So get the diode you really need, every time, from more than 30 Electron Tube and Device Group Sales Offices throughout the world, or from our



varian
solid state micro-
wave project

Solid State
Microwave Project,
Beverly,
Massachusetts.

**You get
what you
specify.
Every time.**

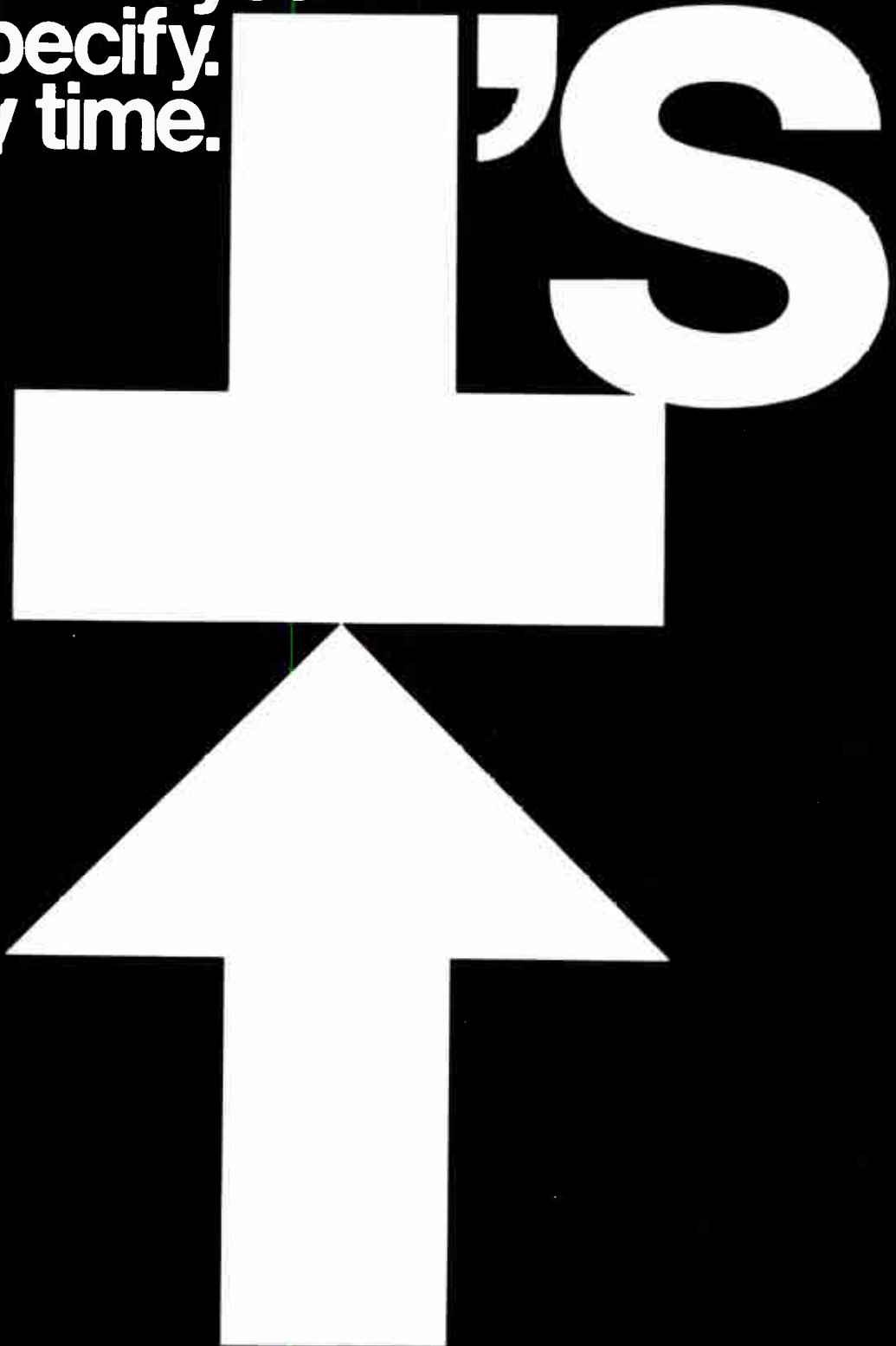



WANT LOW-COST d-c POWER?

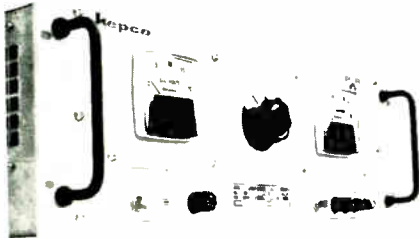

Model PR 15-30M

KEPCO'S GOT IT!

Check out Kepco's line of partially regulated (PR) power supplies. They feature the Kepco ferroresonant power transformer "Flux-O-Tran"® for low cost, 1% line regulation.

MODEL	VOLTS	AMPS	PRICE
PR 15-10M	0-7.5-15	0-10	\$378.00
PR 15-30M	0-15	0-30	552.00
PR 38-5M	0-19-38	0-5	357.00
PR 38-15M	0-38	0-15	520.00
PR 80-2.5M	0-40-80	0-2.5	357.00
PR 80-8M	0-80	0-8	499.00
PR 155-1M	0-78-155	0-1	357.00
PR 155-4M	0-155	0-4	473.00
PR 220-3M	0-220	0-3	473.00
PR 310-0.6M	0-165-310	0-0.6	378.00
PR 310-2M	0-310	0-2	473.00

If you have 3 Φ power you can get up to 2 kW at about 50 cents per watt.

MODEL	VOLTS	AMPS	PRICE
PR 20-100AM	0-20	0-100	\$1,103.00
PR 40-50AM	0-40	0-50	940.00
PR 50-40AM	0-50	0-40	940.00

For complete specifications write Dept. CG-14.



131-38 SANFORD AVE. • FLUSHING, N.Y. 11352
(212) 461-7000 • TWX # 710-582-2631

U.S. Reports

provides a feedback error signal to correct the inertial unit.

The north-south and east-west velocities provided by the inertial system are integrated and converted to latitude and longitude information for display, and to northing and easting pulses that drive the x-y plotter included in the ship-board system. The satellite receiver usually searches continuously, acquiring and tracking the satellite signal automatically. That signal is also fed to the computer, the ship's position is determined, and the marine navigator is reset. Displays show the range and bearing information the helmsman needs to steer to his next interim destination. They also present continuously updated latitude, longitude, and heading information.

The system isn't hampered by bad weather or ionospheric scattering of radio navigation signals. And in comparison with a conventional gyrocompass, the marine inertial system provides a heading accuracy of 0.05° vs 1°, and has an across-track error of only 150 feet after 90 minutes vs. 1,500 feet for a gyrocompass with a heading accuracy of 1°. Furthermore, heading information in the inertial unit is not affected by ship motions; such motions produce errors in gyrocompasses.

Instrumentation

Cutting tape

Wide bandwidth analog data can be digitized for computer processing by running tape at slow speeds and feeding the data into an analog-to-digital converter. Such a method is limited by the bandwidth—typically 6 megahertz—of the video tape recorder that is acquiring the data. The vtr's can be ganged to increase the apparent bandwidth, but the output of several recorders operating at peak bandwidth presents a horrendous processing task.

Some users of high-speed data are looking for ways to process the data before it is recorded. If a tracking radar, for instance, sees pulses with a video bandwidth of 10 Mhz or so, at a repetition rate

of only 1 kilohertz, it has nearly a millisecond to process data between each 1-microsecond burst of information. American Astrionics Inc., a Palo Alto, Calif., systems house that has developed a number of high-speed components, suggests that a high-speed a/d converter, coupled with a semiconductor memory, can utilize that dead time to save tape and time during processing.

The company already makes thick-film a/d converters that operate at 10 Mhz; it is under contract to develop a 30-Mhz device, and one customer has asked for a 50-Mhz rate. But American Astrionics is not solely in the components business. It also makes a memory and a digital demodulator, and is currently negotiating with the maker of a high-speed tape recorder based on the Newell principle, in which tape is moved at a thousand feet per second by a driving capstan against which two tape reels are butted.

Conversion. The new system consists of the a/d converters, an MOS shift register bank, and the record electronics in the data acquisition mode, and the digital demodulator plus more shift registers in the processing mode. The shift registers in the acquisition section are to store high-speed data while it is being strobed out at a speed that tape recorders and computers can accept. In the radar example given, a 20-Mhz a/d converter could take twenty 50-nanosecond samples during the microsecond that the radar return pulse lasted. The converter could have any desired accuracy from 6 to 10 bits; if it were 8 bits, for example, the data would be fed into a 20-word-by-8-bit shift register memory and recirculated while it was being strobed out at 20 khz.

Actually, explains AAI vice president John Wood, interchannel time base errors and longitudinal errors tend to skew data on the tape; to alleviate this problem, the data would be strobed out slightly faster than 20 khz, and small gaps would be left between each recording of a radar burst.

Data off the tape goes to a digital demodulator, consisting of an operational amplifier, a limiter, and

Low Cost AC Calibrator

Don't let the low cost of \$975 fool you. The AC Calibrator HP Model 6921A provides you with a constant voltage or a constant current output. Select from .1 to 280 V rms in 4 ranges or .1 mA to 5A in 5 ranges, all with an accuracy of .25% under load conditions. Power is another plus feature; you get up to 28 watts output. Standard output frequencies of 60Hz, 400Hz or 1kHz are provided, with 50Hz available as an option. Proven applications for the Model 6921A AC Calibrator include calibration of ac meters and ac devices. The relatively high output power of 28 watts and the ability of the calibrator to operate into reactive loads, makes it particularly suitable for calibrating large, moving-vane meters and for multi-unit calibration of meters on the production line.

For complete specifications on the 6921A and other HP meter calibrators, write for our new file folder, or contact your local HP Sales Office Hewlett Packard, New Jersey Division, Greer Pond Road, Rockaway, New Jersey 07866. In Europe: 1217 Meyrin-Geneva.



HEWLETT  PACKARD
WORKING STANDARDS

Literature Available Upon Request



**AC CALIBRATOR
MODEL 745A**
Programmable
Signal Generator

335



**AC/DC METER
CALIBRATOR
Model 6920B**
Four Calibrators
In One Case

336

Circle No. for details 334



"Show and Tell"

nimo™ wins the "Show and Tell" of the readout art. A single plane presentation of four bright, legible decades delivered at the low, low price of \$3.50 per decade. No contest.

nimo™, an electronic display tube only 1.135" in diameter, boasts 3/8" high characters, variable brightness, temporary data storage . . . but primarily a price tag *no one can touch*.

The Tell portion

	nimo™ 4-decade tube	gas discharge 4-decade display
Cost per decade	\$ 3.50	\$ 3.95
Mounting Hardware	3.50	2.00
Driver/Decoder	3.75	4.50
Power Supply	3.15	5.00
Total cost per decade	\$13.90	\$15.45

All figures relate to 1,000 quantity.

We can tell you many additional features inherent only in the **nimo™**, four decade display tube, but the real proof of the story is the *show* portion.

IEE Sales Representatives (listed opposite), will be happy to schedule a demonstration so they can "Show and Tell" you why **nimo™** is the only way to display. Call now!

The uncommon readout.



Industrial Electronic Engineers, Inc.
7720 Lemona Ave., Van Nuys, California 91405
Telephone: (213) 787-0311 • TWX 910-495-1707



**Ready to
"Show and Tell"**

- | | |
|--|---|
| <p>ALABAMA
Huntsville
Mekco Associates, Inc.
Tel. (205) 881-3721</p> <p>ARIZONA
Phoenix
Gramer & Company
Tel. (602) 279-1231</p> <p>CALIFORNIA
Los Angeles
IEE Factory Sales Office
Tel. (213) 787-0311
Belmont
IEE District Sales Office
Tel. (415) 591-2551
San Diego
L. L. Stoakes, Inc.
Tel. (714) 274-6281</p> <p>COLORADO
Englewood
Hyer Associates, Inc.
Tel. (303) 771-5424</p> <p>CONNECTICUT
North Haven
Kitchen & Kutchin, Inc.
Tel. (203) 239-0212</p> <p>FLORIDA
Orlando
Mekco Associates, Inc.
Tel. (305) 841-2215</p> <p>ILLINOIS
Chicago
Magnuson Associates
Tel. (312) 622-6322</p> <p>KANSAS
Leawood
Poly-Onics, Inc.
Tel. (913) 648-4173</p> <p>MARYLAND
Towson
Biechler Associates, Inc.
Tel. (301) 825-8222
Rockville
Biechler Associates, Inc.
Tel. (301) 762-6210</p> <p>MASSACHUSETTS
Lexington
Kitchen & Kutchin, Inc.
Tel. (617) 862-8230</p> <p>MICHIGAN
Southfield
S. Sterling Company
Tel. (313) 357-3700</p> <p>MINNESOTA
St. Paul
Magnuson Associates
Tel. (612) 227-8495</p> <p>MISSOURI
Hazelwood
Poly-Onics, Inc.
Tel. (314) 837-0597</p> | <p>NEW JERSEY
Wayne
B. B. Taylor Corp.
Tel. (516) 223-8000</p> <p>NEW MEXICO
Albuquerque
Hyer Associates, Inc.
Tel. (505) 265-5961</p> <p>NEW YORK
Baldwin
B. B. Taylor Corp.
Tel. (516) 223-8000
Rochester
Ossmann Component
Sales Corp.
Tel. (716) 442-3290
Syracuse
Ossmann Component
Sales Corp.
Tel. (315) 454-4477
Red Hook
Ossmann Component
Sales Corp.
Tel. (914) 297-7773
Vestal
Ossmann Component
Sales Corp.
Tel. (607) 785-9949</p> <p>NORTH CAROLINA
Burlington
Mekco Associates, Inc.
Tel. (919) 226-7177</p> <p>OHIO
Cleveland
S. Sterling Company
Tel. (216) 442-8080
Dayton
S. Sterling Company
Tel. (513) 298-7573</p> <p>PENNSYLVANIA
Narberth
Biechler Associates, Inc.
Tel. (215) 667-1827
Pittsburgh
Russell F. Clark Co.
Tel. (412) 242-9500</p> <p>TEXAS
Dallas
Norvell Associates, Inc.
Tel. (214) 357-6451
Houston
Norvell Associates, Inc.
Tel. (713) 774-2568</p> <p>UTAH
Salt Lake City
Hyer Associates, Inc.
Tel. (801) 487-7747</p> <p>WASHINGTON
Seattle
Electronic Sales
Corporation
Tel. (206) 932-0330</p> |
|--|---|

associated phase lock, decoding, and formatting circuitry that prepares the data for a computer. The op amp equalizes the signal, compensating for nonlinearities in the tape deck. The signal then goes to a standard limiter circuit that squares off the frequency-modulated pulses. From the limiter, the signal goes to a code detector, a phase lock oscillator, and a digital logic section.

The shift register bank of the data-acquisition section contains logic that inserts a three-bit code to ensure frequent flux changes on the tape even though the signal may consist of a string of ones or zeroes. The detector picks up this code and generates an interrogation pulse for a phase selector. The phase lock oscillator also sends a phase signal to the selector, which then produces a clock pulse that is phase-locked as well as frequency-locked to the data pulse. This clock is the other input to the digital logic; it strobes the limiter output into a formatter to be converted into nrz form for the computer.

Together. The data and clock pulses can be used to drive a display by feeding them to a time-base stabilization unit consisting of a bank of shift registers. The registers are static MOS devices, and data is held in them until all have reached a count equal to the number of words in the data block; no matter when data may have entered any given register, all 20 registers can be strobed out synchronously. Since more data is available for the registers before one set of contents may have been completely strobed out, two parallel registers are multiplexed for each track.

Wood says that AAI is interested in the Newell recorder because its high speed permits a greater bit-packing density. Newell specifies 1,000 inches per second, but the machine has reportedly been operated at speeds up to 5,000 ips. Where rotary head vtr's have a density of 5,000 bits per inch, the Newell machine can pack up to 24,000 bits per inch, Wood says.

The Navy, the Air Force, and the National Aeronautics and Space Administration are all investigating preprocessing systems for radar

and tracking stations, Wood says; but he believes that the method is practical wherever it is necessary to acquire a lot of high-speed data for processing. Analog methods not only require an elaborate formatting system, but also produces warehouses full of tape to be processed.

Companies

In the eye

For Joseph Neustein, 48, it will be a difficult act to follow. He succeeded Sanford Sigoloff, 38, when Sigoloff resigned as president of Electro-Optical Systems, a division of the Xerox Corp., to form the CSI Corp.

Neustein is just the third president of the firm founded by Abe Zarem in 1956. Zarem, too, recently resigned—as a Xerox director and EOS board chairman—but both Sigoloff and Neustein insist the Zarem-Sigoloff break won't be cataclysmic.

Sigoloff says: "Many of the key management people had associates who could do the same jobs. They should respond to Neustein's leadership and make certain they do better in sales and earnings than we did. I hope they do."

Upcurve. And grow it must to match the record of the Sigoloff years, during which sales climbed at a rate of 25% to 30% a year—from between \$8 million and \$9 million in 1963 to a reported \$44 million in 1968. Sigoloff is generally credited with transforming EOS from a company that got nonrecurring Federal research and development contracts into a well-balanced business.

Sigoloff chose not to continue under the Xerox umbrella because all roads led back east from the Pasadena, Calif., home of EOS to Rochester and New York City. He was asked to relocate but "elected not to take a position in the East that limited my personal growth even though it meant a promotion. My management style is better served in a small environment." Hence, CSI Corp., whose initials have no particular significance. Former EOS or Xerox personnel



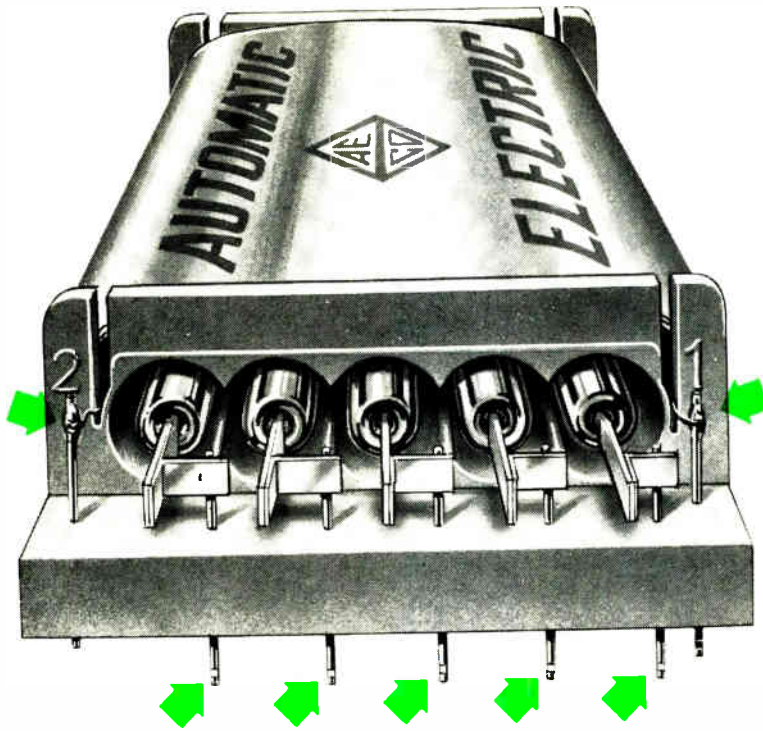

Groov-Pin[®] Terminals Are Simpler... More Reliable... Lower in Cost

Groov-Pins rather than stamped or formed press-fit terminals are used in a new line of Correeds* developed by Automatic Electric Co., Northlake, Ill., a subsidiary of General Telephone & Electronics.

Here's why they are producing important savings for AE:

- Stamped or formed terminals require end-for-end and side-for-side orientation for assembly. Groov-Pins can be inserted from either end.
- Stamped or formed terminals need soldering projections for each connection. Groov-Pins can be soldered or welded anywhere.
- Groov-Pins also permit a simpler plastic mold for nylon relay coil forms. Hard-to-remove core pins and locking slots are eliminated.

If you design or make relays, connectors, or other hardware, find out how Groov-Pins can simplify your product and dramatically cut costs. Write to Groov-Pin Corporation, 1121 Hendricks Causeway, Ridgefield, N. J. 07657. Telephone (201) WH 5-6780.

*Automatic Electric's name for Dry Reed Switch Modules



Automatic Electric uses Groov-Pin terminals in its new Correeds. They are now available to AE's telephone company customers. Correeds have as many as 14 terminals, so a cost cut here means savings for the company. Groov-Pins lock in the Correeds' coil form by a cold flow of nylon into three swaged grooves. Notches at both ends make it easy to wrap and solder leads from the Correeds.

GROOV-PIN CORP.
FASTENER DIVISION

U.S. Reports

who are helping form CSI are David Traitel, Donald Taffi, and Victor Moss.

Their aim: to form or acquire companies with products or services varying from medical electronics, to telecommunications, to leisure activities. But Sigoloff readily admits that he doesn't know what opening moves CSI will make because the planning isn't complete.

Turning again to EOS, Sigoloff maintains the key is whether the firm can remain a balanced business. He says Xerox regards it as half its R&D pool, even though a good deal of that R&D talent is supported by Federal contracts. EOS's technology helps solve Xerox problems and start new venture groups, such as the medical diagnostics operations recently spun off as a separate Xerox division. Sigoloff is convinced Xerox will continue to look to those EOS skills more than to its manufacturing skills.

For his part, Neustein credits Sigoloff with leaving EOS with its biggest backlog and says 1969 will be its greatest sales year. Neustein is projecting \$50 million. "He taught us how to operate in the fixed-price Federal market and to do more manufacturing. Now we've reached the maturity in electro-optical systems that Abe Zarem set out to achieve. My aim is to make EOS one of the most significant firms serving Federal electro-optical systems needs while still supporting Xerox."

Says Neustein: "EOS will continue to manufacture, but to make a profit you have to do R&D, prototypes, systems, and production quantities."

For the record

New direction. The Monsanto Co. is going into the microwave diode business, and its first products are a series of C- and X-band Gunn diodes having outputs from 25 to 100 milliwatts c-w. The devices which are circuit tunable require an input of 12 volts d-c and work at about 3% efficiency. Unit prices for the diodes, which are being manufactured in St. Louis, range from \$82 for a 25-mw C-band

diode to \$185 for a 100-mw X-band device.

That elusive 98%. Max Palevsky, Scientific Data Systems president, looks to his firm's merger with the Xerox Corp. to give SDS the financial muscle needed to go after the 98% of the computer market it doesn't serve. Specializing in scientific machines, SDS now intends to try business computers.

Sky's the limit. Research and development performance by electronics firms will rise 10% this year over last, according to McGraw-Hill's annual survey of business' plans for research and development expenditures. As in the past, the aerospace industry leads all others with a \$6.4 billion R&D outlay this year. It will maintain that lead with a \$7.2 billion effort in 1972, approximately 32% of all R&D done by industry. In second place is the electrical machinery and communications industry which is expected to increase its R&D performance from \$4.6 billion this year to \$5.7 billion, or 25% of the total, by 1972. This year, electronics firms spent 84 cents of every R&D dollar on development; 1 cent and 15 cents went to basic and applied research, respectively.

Do it yourself. A mini-computer that permits the user to do his own customizing is waiting in the wings. Made by Wilkinson Computer Sciences of Bedford, Mass., the machine is aimed at the user who wants only one to 10 computers and at the larger firm that wants something to tinker with as it develops its own systems. Two big selling points, says president Max Wilkinson, are price—\$8,810—and the machine's cabinet with its 40% empty space. Wilkinson compares his machine with \$14,000-and-up models such as the Varian 620-I, Lockheed Mac, and Hewlett-Packard 2114A. Dubbed the WCS-881, the Wilkinson computer has an 8-bit byte and is capable of double-precision (16-bit) arithmetic. Its basic memory has 4,096 bytes, expandable to 65,356, with 1-microsecond cycle time; it can control up to 512 external input-output devices.

NEW VACTEC "PLASTIC" PHOTOCELLS

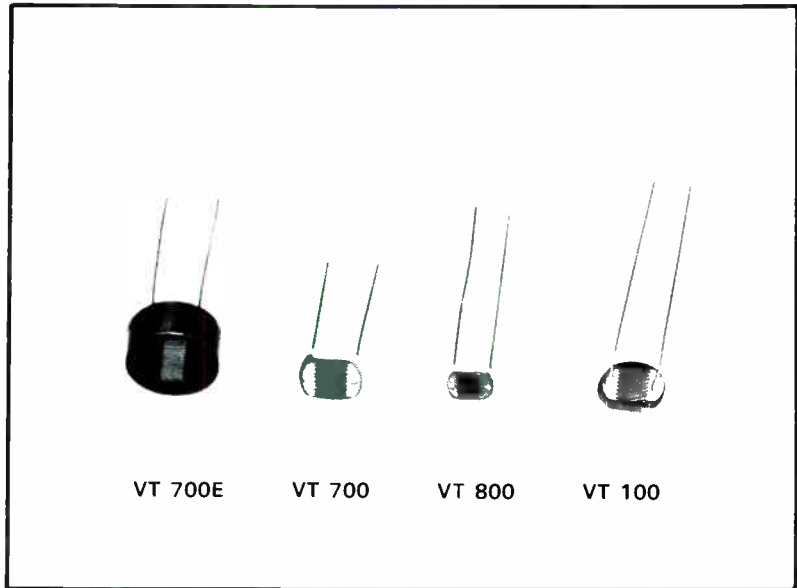

Actual size, priced as low as .25 each (± 33% tolerance) in 100,000 quantities.

Low Cost Way to Meet Most Photocell Requirements

Are you spending up to a dollar for photocells when Vactec can satisfy your needs for far less? Here's a complete line made the same, and with the same quality characteristics and precise tolerances as their metal cased counterparts. Yet they cost about *half* as much, because instead of sealing, they are protected by a thin transparent plastic coating.

Vactec "plastic" cells are conveniently controlled by ambient light, or from closely coupled low voltage lamps for remote control. Special processing provides resistance to humidity, making these devices suitable for indoor industrial and commercial applications like controlling relays in line voltage circuits; switching SCR's on or off; phase control in proportional circuits; or as feedback elements for motor speed controls in consumer appliances

GENERAL SPECIFICATIONS

Material	Two Cdse and three Cds materials, including the new type 3 with exceptionally high linearity and speed.
Voltage Maximum	(dark 300V.)
Dissipation at 25°C	200 mw (VT 100) 250 mw (VT 700 and VT 700E) 125 mw (VT 800)
Ambient	−40°C up to +75°C
Resistance	Wide range as low as 600Ω at 2 F.C.

Write today for Bulletins PCD-41, 57, 57E, and 58.

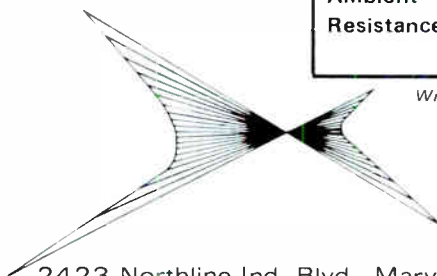

VACTEC, INC.

2423 Northline Ind. Blvd., Maryland Heights, Missouri 63042
(314) 872-8300

Specializing in standard Cds, Cdse, and Se cells. Custom engineering for every photocell need. Listed in EBG under "Semi-Conductors" and EEM Sec. 3700

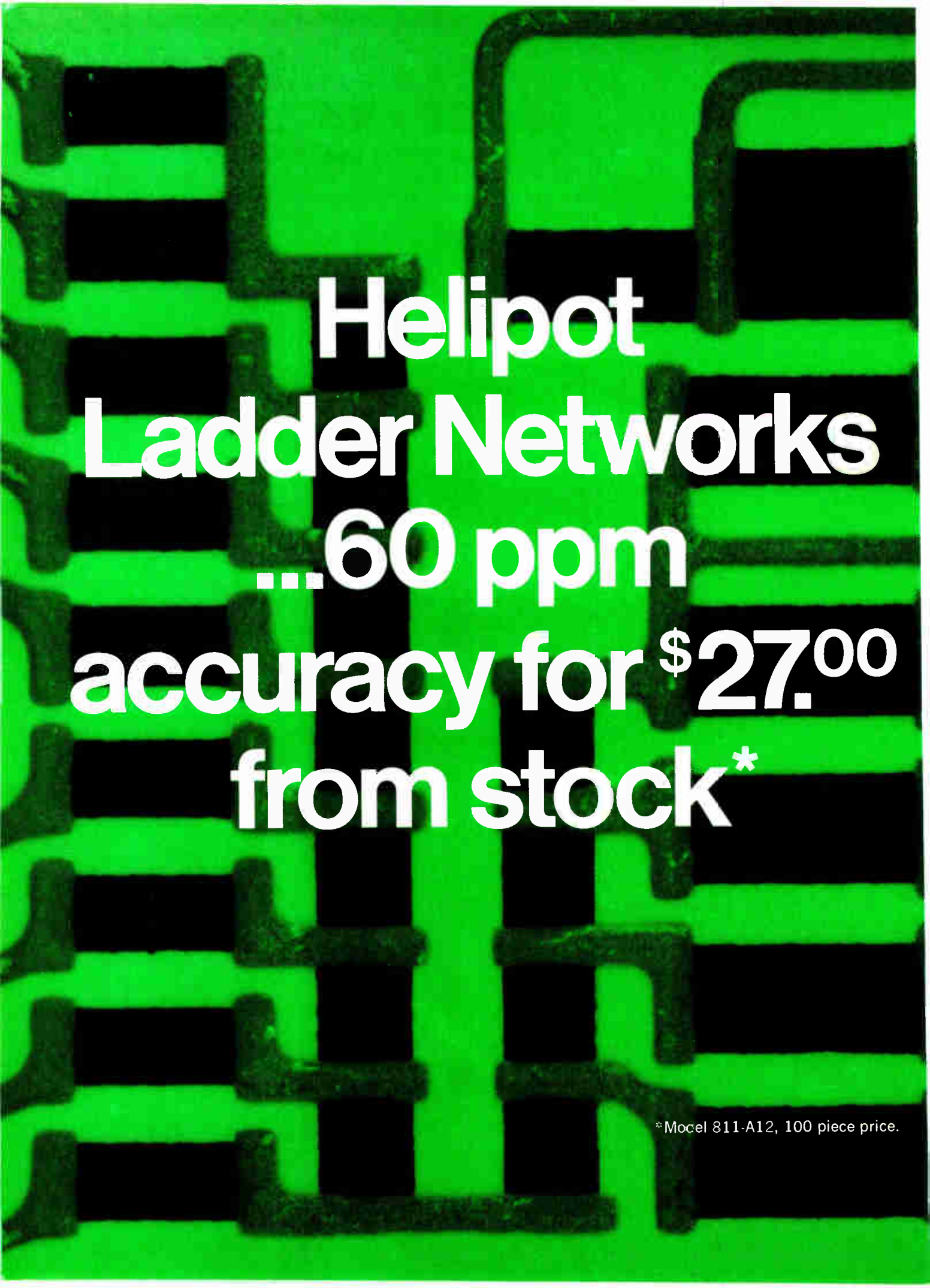

**Helipot
Ladder Networks
...60 ppm
accuracy for \$27.00
from stock***

*Model 811-A12, 100 piece price.

Helipot offers the widest variety of off-the-shelf miniature ladder networks. From low cost networks with 9-bit accuracies to precision 14-bit units. Either binary or BCD designs. And with a variety of stock resistance values and a selection of standard temperature ranges.

They typically feature:

- 60 ppm accuracy (initial worst case accuracy at 25°C)
 - 0.6 ppm/°C tempco
 - 50 nanosecond settling
 - 20 ppm per year stability
 - low profile

They are constructed of Helipot's exclusive cermet thick film passive elements and fused to alumina substrates at extremely high temperatures. By screen printing all resistors on each network simultaneously, uniform electrical characteristics and excellent stability are achieved. In addition, every unit is 100% tested at 5 temperature points and serialized accuracy tapes are available for only \$1.00 more.

For more information, contact your local Helipot Sales Representative or Distributor or circle the Reader Service No.

Beckman®

INSTRUMENTS, INC.

HELIPOD DIVISION

FULLERTON, CALIFORNIA • 92634

INTERNATIONAL SUBSIDIARIES: AMSTERDAM, CAH TOWN, GENEVA, GLENROTHI, SCOTLAND, LONDON, MEXICO CITY, MUNICH, PARIS, STOCKHOLM, TOKYO, VIENNA

Model 811:
A 12-bit Binary Ladder Network for use in DAC/ADC applications requiring fast switching and high accuracy over a wide temperature range.

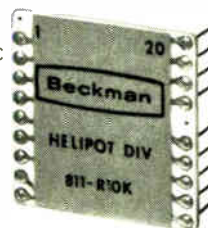

Model 812:
A 12-bit R-2R Binary Ladder Network specifically designed for MOSFET switch applications.

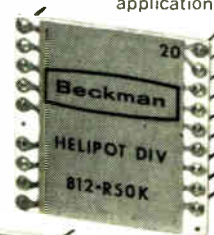

Model 813:
A Conductance Ladder designed to be used with Fairchild's μ A722 10-bit current source.



Model 814:
An Ultraprecision 14-bit R-2R Binary Ladder Network with accuracies to +30 ppm from -20° to +80°C.



BCD Ladder Networks are also available in many standard configurations.

Circle 69 on reader service card



MICROWAVE IC PROGRESS REPORT #7: COMMUNICATION MODULES

Sperry's PACT (Progress in Advanced Component Technology) Program is developing a fully-integrated transmitter/receiver/duplexer module for an airborne communications array at X-band. The program has contractual support from the Air Force Avionics Laboratory, USAF, Dayton, Ohio.

The function of the phased array system is to establish communications between aircraft and synchronous satellite repeater stations, which in turn are linked to a ground station network and to other aircraft. This makes it possible for the crew of an airplane to be in constant contact with anybody, worldwide. Handy for all sorts of missions and indispensable in the event of conflict.

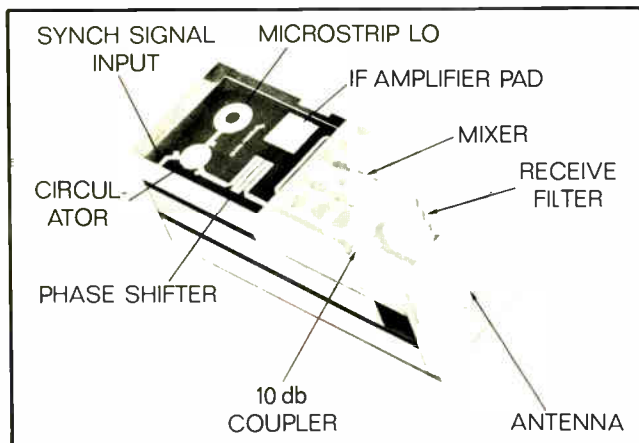

RECEIVER CIRCUIT FOR COMMUNICATIONS MODULE

Within the confines of each phased array element, which is less than an inch square and three inches long, is a complete transmitter/receiver/duplexer. Essentially composed of a signal source, a receiver, a mixer and an antenna, the module utilizes Sperry's advanced thinking throughout.

SPERRY
MICROWAVE ELECTRONICS DIVISION
CLEARWATER, FLORIDA



The rf circuitry is photo etched on metallized ceramic substrates 0.055 inches thick. Conductors are vacuum deposited gold on top of chromium. Follow-up plating produces half-mil thick strips. Transmission efficiency can be gauged by measuring rf energy loss, which, in this case, is no more than 0.15 db per inch.

Transmitter signals are generated by a Sperry Avalanche Transit Time Oscillator (ATTO), discussed in Progress Report #1. Energized by a DC voltage, the ATTO yields a 1-watt CW, X-band signal at an efficiency of 5%.

Sperry's gallium-arsenide Schottky-barrier diodes do the active conversion work in the receiver and the "rat-race" hybrid handles the signal with a single sideband noise figure of better than 6.5 db over a 12% bandwidth. (Sperry hybrid work was discussed in Progress Report #5.) Signal processing and control circuitry design has been materially aided by a Sperry-developed computer program.

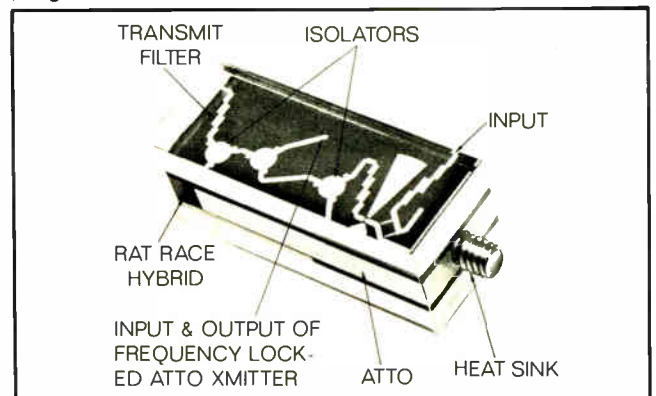

TRANSMITTER CIRCUIT FOR COMMUNICATIONS MODULE

What we have accomplished for the Air Force, we can accomplish for your microwave system, regardless of frequency or operational mode. At Sperry, PACT is more than a clever acronym. Our business is **microwaves**, and our goal is to provide customers with ways of accomplishing microwave functions.

May we hear from you about your system requirement?

*For faster microwave progress,
make a PACT with people
who know microwaves.*

Washington Newsletter

May 26, 1969

Task Force report finally emerges

Yielding to Congressional pressure, the Nixon Administration last week released the report of the task force on telecommunications policy. It allowed the House Commerce committee to accept the report as part of its hearing record while the committee was considering cable television legislation. CATV, mobile radio operators, and the Communications Satellite Corp. were eager to get the report out as it contained recommendations favorable to them.

The Republican Administration was careful not to endorse the report, only to make it available for the public record. Communications carriers and broadcasters, on the other hand, urged the report be buried.

Even without Administration blessing, the report will have a major impact on a wide range of communications problems. Its details have long been reported in the press, and friends and foes of the report's findings had begun using it as a lever to shape future Federal communications policy.

Delay in naming new FCC chairman

Even though his term will expire June 30, FCC Chairman Rosel Hyde will probably remain at the job for at least a few months more. The reason: the President needs more time to select Hyde's successor. Currently, four candidates are in the running for the ticklish post: Robert Button, director of the Communications Satellite Corp.'s policy planning; Abbott M. Ashburn, deputy chairman of the Intelsat conference; Clay T. Whitehead, a White House communications aide, and FCC Commissioner Robert E. Lee. All four, like Hyde, are Republicans.

Harsha snipes at Army contract award

Republican Congressman William H. Harsha has joined the growing list of legislators who are investigating Pentagon procurement practices. His first target is an electronics buy made by the Army Electronics Command from Packard-Bell which the Ohio representative contends adds up to "... a giant hoax which has cost the U.S. taxpayer an estimated \$3 million more than necessary."

Harsha's initial broadside is aimed at a deal involving a transponder test set identified as AN/APM-123. While Packard-Bell was being paid \$6,500 apiece for the test sets, Harsha claims an unsolicited bid came in offering the set for \$4,700. Further, Harsha says that when the Army finally opened the contract to competitive bidding after buying 1,100 sets over a three-year period, two bids came in, one from Multronics Inc. of Rockville, Md., and the other from Hydrospace Systems of Cedar Rapids, Iowa, for \$2,074 and \$2,075 respectively.

IBM awaits more money for head-up holographic display

IBM's Systems Development division would like to finish its work on a head-up holographic cockpit display for the Office of Naval Research, but the Navy is short of research funds. IBM feels that its work in creating a holograph of an aircraft carrier for all-weather carrier operations has gone well and hopes it will be able to get into hardware development, optimization of characteristics, simulator operation, and flight testing in its next phase with the Navy.

In lab operations, thus far, IBM says it has met all the requirements for an operational system including all six degrees of freedom appearing in

Washington Newsletter

carrier landings. Key elements of the lab system include a vidicon camera, a gallium arsenide laser and a 4- by 5-inch holographic plate.

Not content with waiting for future funding from the Navy, IBM has also presented its findings to NASA's Electronics Research Center and to the airlines with the hopes of broadening interest in the scheme.

Outlook for NASA budget brighter . . .

NASA officials are looking forward to a significant change in attitude in Congress as a whole now that the House Science and Astronautics committee authorized a \$3.9 billion budget for the space agency. This is \$133.7 million above the amount set by President Nixon in April and \$88 million above the original budget set by President Johnson in January. Traditionally, the House committee is NASA's toughest hurdle in its annual budgetary go-around with Congress.

Major beneficiary of the improved budget authorization is the Office of Manned Space Flight: amounts for Apollo and Space Flight Operations have been jumped \$116.4 million from the original January request.

. . . as ERTS gets nudge from Karth

Rep. Joseph Karth (D., Minn.) undoubtedly made enemies at NASA when he carried on long and loud about the way the agency has been dragging its feet on the Earth Resources Technology Satellite program. Now through his efforts as chairman of the House subcommittee on space science and applications, he is trying guarantee no more slowdowns by almost doubling the amount going into the ERTS program.

In the Johnson and Nixon budgets, \$11.6 million was to go for earth applications aircraft, and another \$14.1 million was to get the satellite program going. Now the authorization, through the efforts of Karth, reads the same for aircraft operations, but the total for the satellite program is now \$24.1 million. Further, the provision specifically states that this extra money "is to be spent only for the Earth Resources Technology Satellite project." In other words, NASA will be obliged to spend the money on ERTS or not spend it at all.

Airlines push FAA on Category II

The airlines, under the aegis of the Air Transport Association's all-weather operations committee, are pressing the FAA to hold up its end of the bargain to make airports capable of all-weather operations.

The ATA group says the airlines are far ahead of the FAA in equipping for Category II landings. In 1963 the FAA listed 29 airports for Category II qualifications. Since then, the ATA charges, only one airport has been fully qualified while another nine have been given only partial Category II qualification. The airlines say that in the same time period 1,400 aircraft have been equipped with more than \$37 million worth of hardware.

Addenda

Last year Congress told the National Bureau of Standards to see if the metric system could work in the U.S., but gave no money to get a program started. The lawmakers have now allocated \$2.5 million for the three-year study, starting with \$700,000 next year. . . . The House Government Operations Committee has passed legislation which would bring computers into operation in Congress. One of the most important aspects of the bill is a provision for establishing compatible computer systems between Congress and the Bureau of the Budget to keep both sides of Government informed during all phases of the Federal budget cycle.

High efficiency / High reliability industrial and lab power supplies

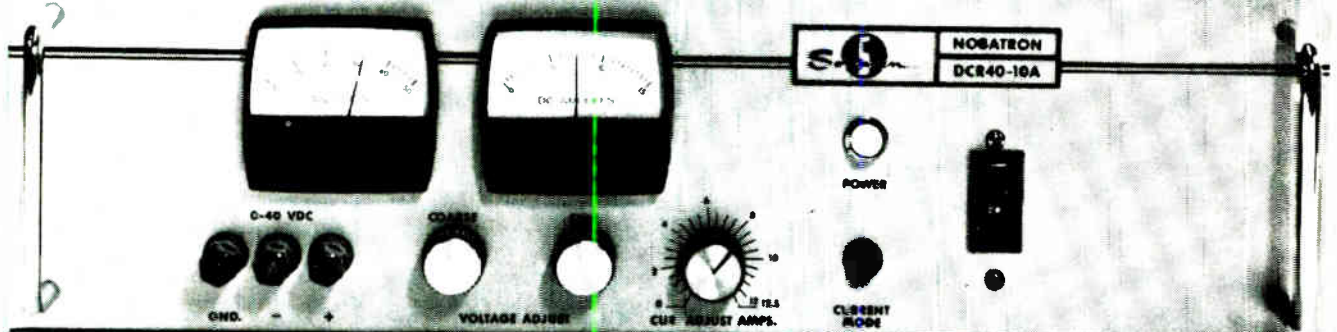

The DCR Series is composed of 34 models — 9 models with power levels of 400 and 800 watts are available, from stock, at 0-40, 0-60, 0-80, 0-150 and 0-300 Vdc in the 5¼" high package utilized by the model DCR 40-10A.

Other features include: ■ compliance with RFI specifications MIL-I-26600 and MIL-I-6181D ■ $\pm 0.075\%$ voltage regulation for line and load changes combined ■ voltage and current regulation with auto-

matic crossover ■ adjustable current limiting with automatic recovery ■ optional overvoltage protection ■ remote sensing and remote programming.

For more information contact your local Sorensen representative or; Raytheon Company, Sorensen Operation, Richards Avenue, Norwalk, Connecticut 06856.

Tel: 203-838-6571;
TWX: 710-468-2940;
TELEX: 96-5953

RAYTHEON



Any chips off the new IC?

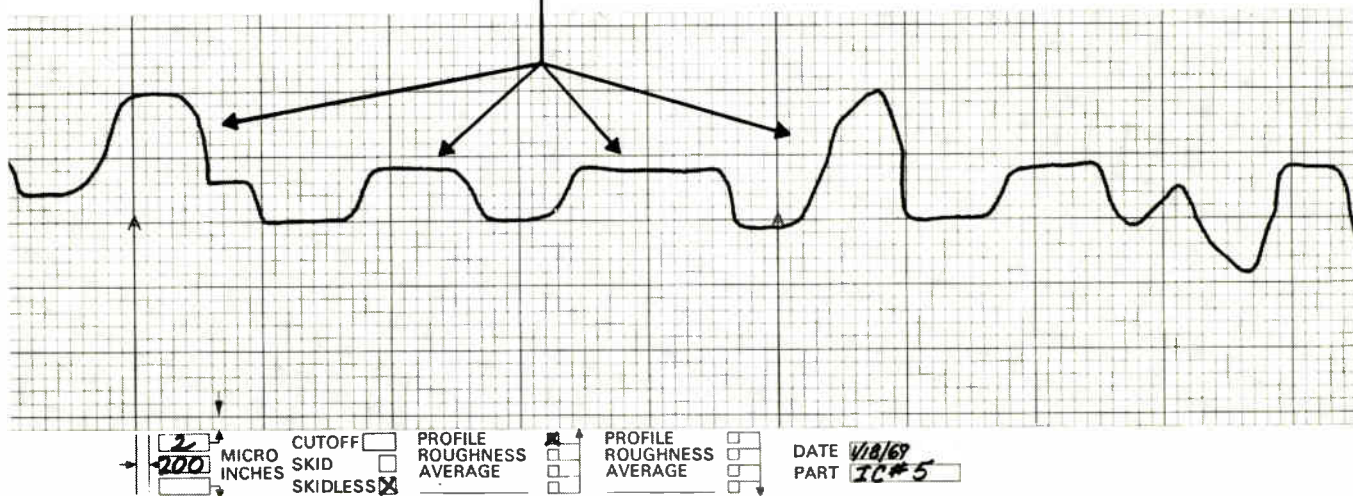
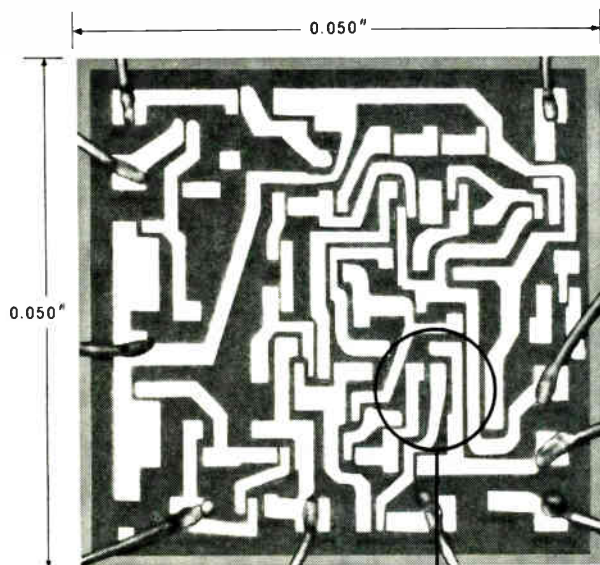

Non-destructive Clevite Surfalyzer tells you for sure. Shows deposit thickness, steps and true surface profile of a 0.500" diameter IC on a chart 3 feet long! And we haven't scratched the surface!

Never will either.

The stylus of the Surfalyzer adds the required light touch to surface measurement—glides across delicate circuit deposits at just 0.05 grams. Picks up the slightest imperfection . . . provides an undistorted view of the IC surface.

Note the extra-wide rectilinear channel. And the engineered chart paper that allows actual dimensional measurement of deposit on substrate. And the razor-sharp smudge-

proof trace. It's all part of our plan to provide IC manufacturers and suppliers with the most accurate, easy-to-read, easy-to-use surface recording system.

Have we done it? You be the judge. Write for complete details and the name of your nearest distributor. There's one close by waiting to demonstrate this extraordinary test equipment. Clevite Corporation, Gaging & Control Division, 4601 N. Arden Drive, El Monte, Cal. 91731. Phone: 213-442-7755.

Clevite Surfalyzer 150
Surface Measurement System



Recorder



Drive



Control

CLEVITE

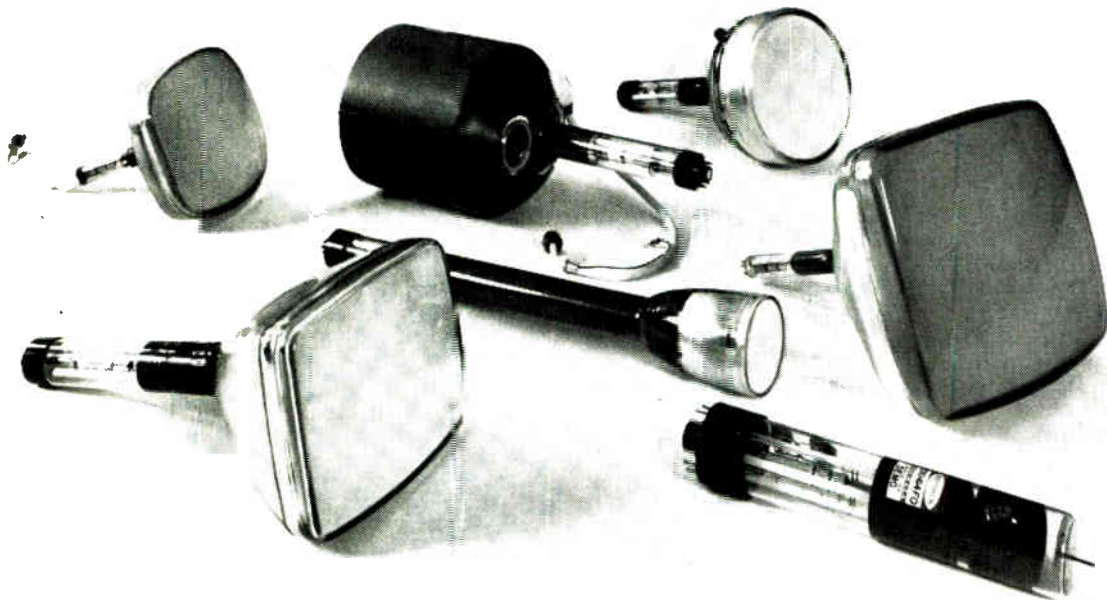

These men specialize in developing CRTs for your toughest applications.

Together, they have a wide range of capabilities for cathode-ray tube design, application, and manufacture. In fact, they've developed CRTs for radar and avionics displays • air-traffic control and ground-support equipment • computer terminal CRT displays • large-screen and simulation display systems • flying spot scanners and photo recorders —among others.

They daily produce a large number of Dataray* CRTs in a wide

range of standard and special types, in screen sizes from 2" to 24", and in all available phosphors. They also supply combination electrostatic and magnetic deflection types for writing alphanumeric while raster or random scanning.

For complete information on Dataray CRTs, call or write: *Raytheon Company, Industrial Components Operation, 465 Centre Street, Quincy, Massachusetts 02169. Tel: 617 479-5300.*

Tubes shown: CK1387P- for airborne cockpit display; CK1437P- with rear window for combined photo-recording and operator display; CK1355P- airborne display tube with anti-corona high-voltage connector; CK1439P- for computer CRT displays; QV367 test CRT for phosphor investigation; CK1447P- narrow-neck, high deflection sensitivity CRT for computer displays; CK1414F- Symbolray™ monoscope for alphanumeric generation.

*Registered trademark of Raytheon Company



the state-of-the-art resistor tester

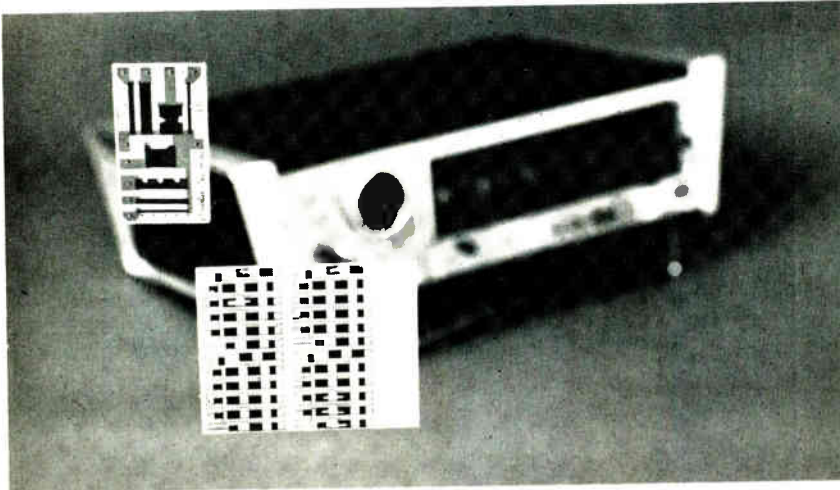

State-of-the-Art resistors require comparable test equipment. This is why Biddle produced the Model 803. It is the only precision resistance tester geared specifically for today's critical applications — limit testing, precision trimming and measuring, both absolute and ratio. Until now this has required a complexity of instruments and a compromise in performance. The 803 changes all that. This single instrument does the work of what is now a subsystem, and it does it more accurately, reliably, economically and faster.

Operation. The test resistor is connected directly to the 803, and compared against the desired value. A visual, interpreted indication of whether it is high, low or within preset tolerances is given, and, to control trimming and handling equipment, corresponding electrical signals appear on appropriate output lines.

Precision. The 803 is the only complete 5 digit resistance tester available. In addition,

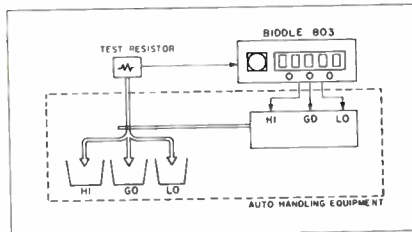

tion, it has a 10% overrange, and at the lower end, tolerances can be set beyond the fifth digit. In the 100 Ω range, for instance, the 803 can look at a $\pm 60\mu\Omega$ tolerance window.

Accuracy. The 803 is exceptionally accurate in all modes of operation. Each unit is factory calibrated to 10 PPM and rated at 60 PPM for thirty days. Yearly accuracy is within 150 PPM without calibration.

Deviation Accuracy. Limit testing and trimming require tolerance ranges and automatic decision. This imposes a critical

need for deviation measurement—the accuracy with which tolerance limits can be recognized. The 803 provides these advantages:

1. With the precise divider network of the 803, deviation resistances are perfectly linear, whereas conventional bridges have substantial non-linearity at wide limits.
2. Tolerance limits in the 803 are set with a ten turn pot rather than marked off on a meter scale.
3. All decision circuitry is solid state. It doesn't have the drift or tracking problems of a meter, and it is free from human error and the inaccuracies of hanging photo-devices on a meter scale.

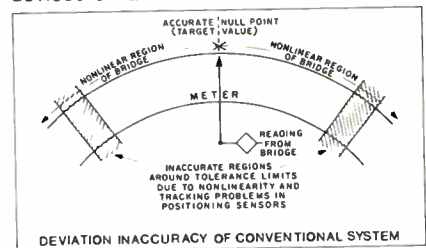

Speed. Testing speed is limited only by the handling equipment. For precision trimming, the 803 will respond in milliseconds, and in completely automatic systems it can comfortably test better than 1800 resistors an hour.

Versatility. The standard 803 has six ranges from 100 Ω to 11 M Ω . In addition, the options are almost unlimited: 10 Ω range; direct reading temperature coefficient; BCD output; etc. In fact, no matter how special your problem is, in all likelihood, the 803 can be adapted to solve it. Why not call us and see?

JAMES G. BIDDLE CO.
Plymouth Meeting, Pa. 19462
(215) 646-9200



\$2,240

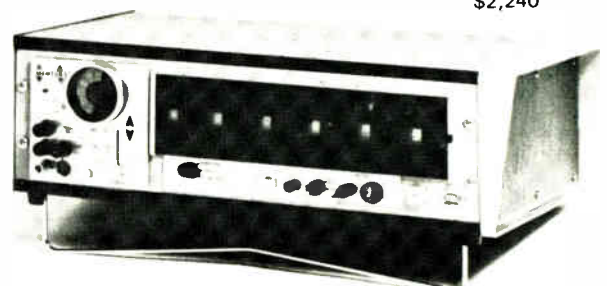



Introducing THE PIGGY-BACK THERMAL SWITCH that uniquely combines two thermostats in one hermetically sealed package.

TI's thermal magicians have already solved aircraft temperature control problems with this two-in-one technique. One in a constant speed drive; another in a cabin air conditioning system — both applications requiring high temperature warning, backed up by overheat protection. We could have done both jobs with solid state devices. But why go to that

expense when we could meet specifications with two low-cost electro-mechanical thermal switches packaged in welded and brazed immersion probes?

Our unique piggy-back technique provides a number of options. Parallel, series or separate circuitry. Open or close on temperature rise. A wide range of

temperature settings, differentials and tolerances.

Can TI's thermal magicians solve your next temperature control problem with a single or multiple electro-mechanical device? It costs nothing to find out. Write TI Control Products Division, Attleboro, Mass. 02703 or phone (617) 222-2800 Ext. 318



TEXAS INSTRUMENTS
INCORPORATED

Wide dispersion spectrum analysis without *unwanted* responses... Singer Model SPA-3000

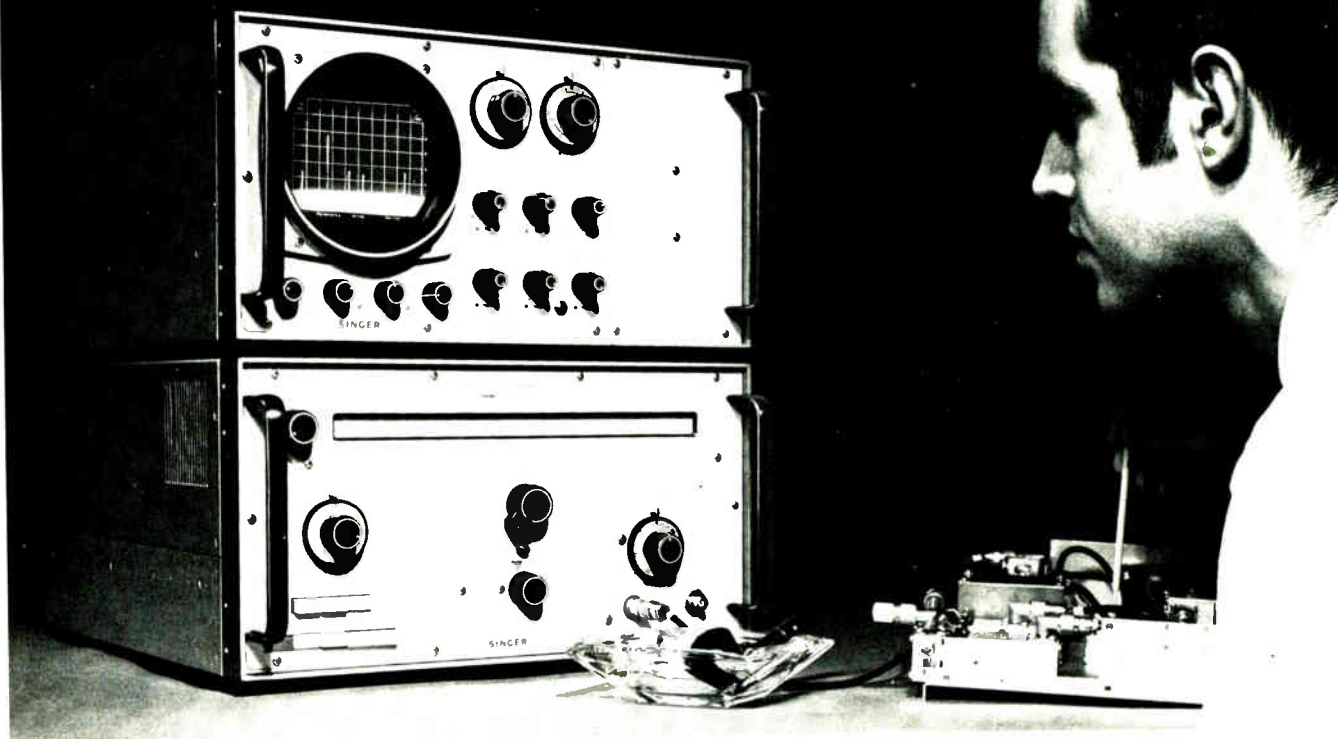

With some spectrum analyzers you have to play a guessing game, in order to identify the true responses from the ones which are analyzer generated and displayed.

The Singer Model SPA-3000 Microwave Spectrum Analyzer eliminates guesswork and displays *only* signal inputs. When aligning a communications band frequency quadrupler on the competition's equipment you could see as many as six extra (unwanted) responses. On the SPA-3000, with the analyzer set for 3 GHz dispersion around a 1.7 GHz center frequency, the 1.55 GHz quadrupler signal and its harmonics are displayed . . . *no more and no less*. The other unit set at its maximum dispersion of 2 GHz (ours is 3 GHz) around a 1 GHz center frequency displays six extra internally generated signals.

Only five of these responses are real.

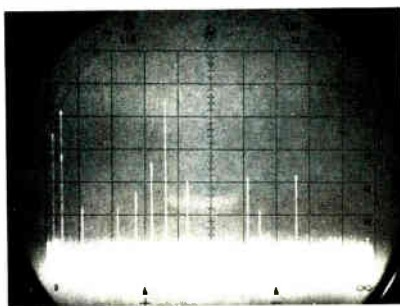

But which five?

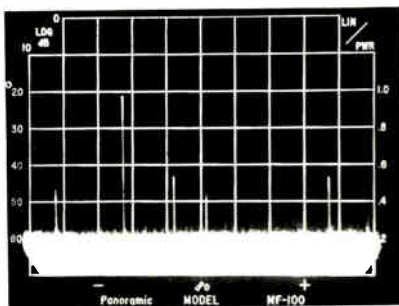

The five presented on the SPA-3000

- **Phased locked display**—for narrow-band signal analysis. It is fool proof, because there is only one control and a positive lock indicator light to observe. Signals can be displayed over the entire 10 MHz to 40 GHz band with 1 kHz of resolution.
- **Unique log amplitude scale**—enables the measurement of narrow band pulse spectrums in a 1 MHz bandwidth mode for maximum sensitivity and dynamic range.

Frequency domain measurements are explained in Singer Instrumentation's new Application/ Data Bulletin SA-11. Copies are obtainable by contacting your nearest Singer Field Representative or by writing directly to The Singer Company, Instrumentation Division, 915 Pembroke Street, Bridgeport, Connecticut 06608.

SINGER

INSTRUMENTATION

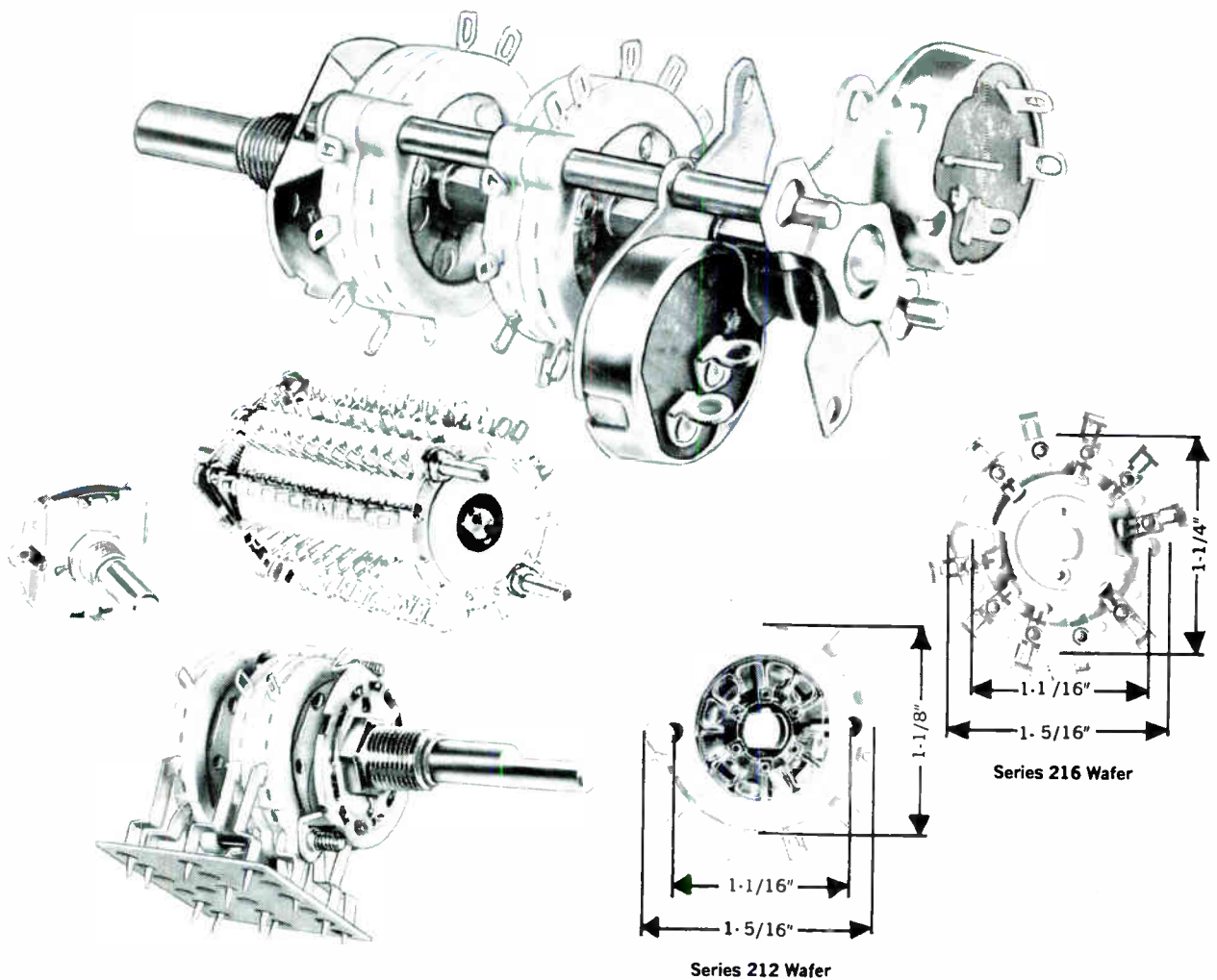

These are the facts that make CTS Switches the engineer's choice

NO BREAKAGE•They don't break on production lines or on finished equipment if dropped or jarred...CTS glass alkyd wafers are not brittle like phenolic... easy to handle.

NO SHIFTING•Precision molded construction eliminates mechanical shifting of stator circuitry and terminals.

MORE COMPACT•No spacers needed when stacking wafers... Maximum switching capability with minimum depth... Smaller diameter—only 1 1/8" (Series 212 wafers)

VERSATILITY OF CIRCUITS•Many circuit variations available due to varied rotor contact configurations.

External jumpers eliminated by CTS internal connectors between adjacent positions.

AVAILABILITY OF POWER SWITCHES•Available with 4 types of power switches and/or numerous potentiometers.

SUPERIOR INSULATION•Glass alkyd is superior to phenolic insulation.

- Soldering heat can't loosen terminals.
- Meet MIL-S-3786 A&B, Style SR03 (Series 211, 212 and 215)
- Balanced contact spring.
- Natural solder barrier provided by glass alkyd insulation.

Which Detent best fits your requirement?

Detent	Application	Cycle Life	Switching Torque
Type 211—Star Wheel Detent	Highest quality applications	250,000	10-50" oz.
Type 215—Double Ball Detent	Quality instrument applications	100,000	6-35" oz.
Type 212—Hill and Valley Detent	Home entertainment and low cost instrument applications	25,000	20-48" oz.
Type 212 ND—Die Cast Detent	Lowest cost applications	20,000	18-40" oz.



4-6 WEEKS DELIVERY

CTS CORPORATION
ELKHART, INDIANA 46514

® Phone: 219, 523-0210. TWX: 810-294-2256

Western Source
CTS Electronics, Inc.
(formerly Chicago Telephone of California, Inc.)
1010 Sycamore Avenue
S. Pasadena, California 91031
Phone: 213, 254-9141
TWX: 910-321-4060

Canadian Source
CTS of Canada, Ltd.
Streetsville, Ontario
Phone: 416, TA 6-1141

Our newest recording star: Honeywell's 5600.

Versatility · price · portability · all the makings of a great performer.

This "Jet-Pack" portable offers full-size 14-channel, 16-track recording capability yet fits easily under the seat of a commercial jet.

And its versatility is in true 7600 tradition: the 5600 converts from tape widths of ¼", ½" and 1" on all standard reels up to 10½" and provides a choice of FM, direct and digital electronics. Plus seven electrically switched speeds.

Low-mass, high-performance capstan servo drive delivers a faster response than is



found with other drive systems. And the 5600 may be powered from virtually any commercial source as well as two different battery voltages: 12 volts and 28 volts.

These features were previously found only in large recording systems. Now, they can be yours for half the price, starting at \$6,500.

For more information on this "go anywhere, do anything" portable tape recorder, call Bud Corbin (collect) at (303) 771-4700 or write: Mail Station 222, Honeywell, Test Instruments Division, P. O. Box 5227, Denver, Colorado 80217.

Honeywell

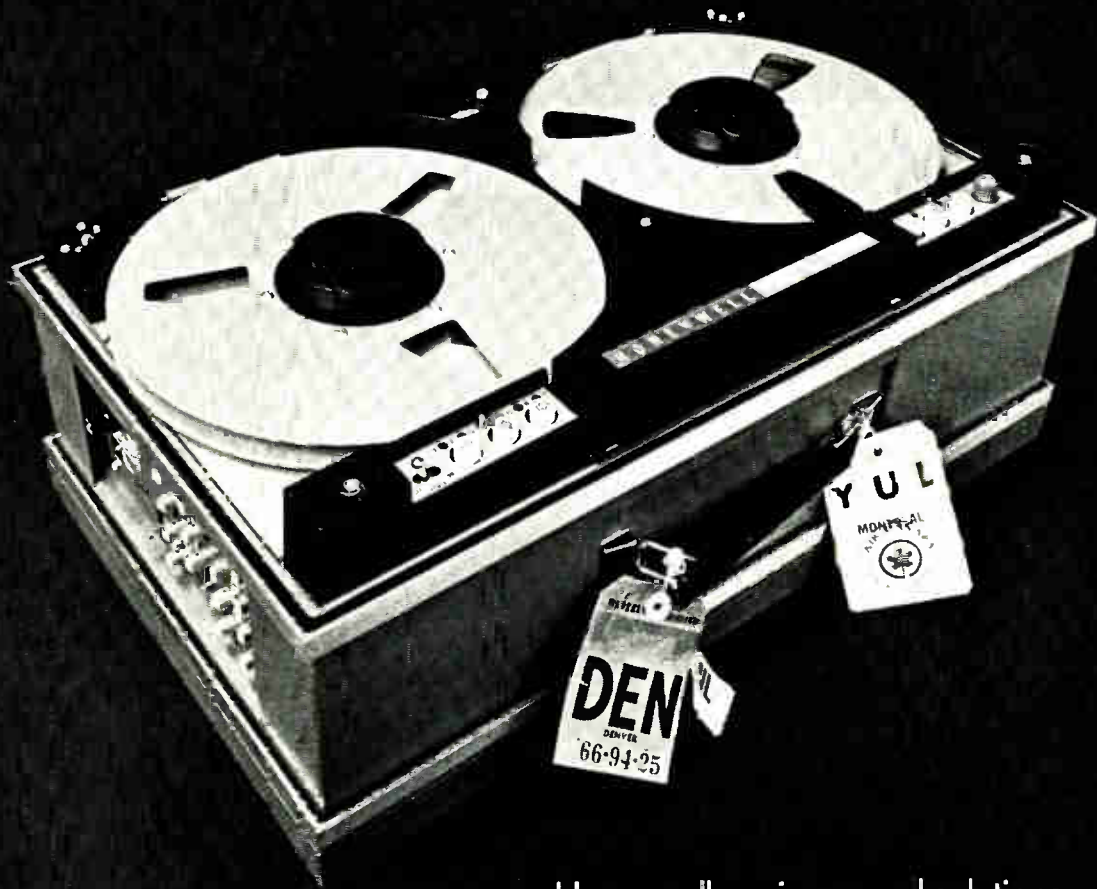

Honeywell engineers sell solutions

Pick the
BEST IC
for the job

Problem: Four DC to 30 kHz signals from high impedance sources must be summed into a $2k\Omega$, 100 pF load. The output is to be a guaranteed minimum ± 12 volts over the full frequency and military temperature range. The logical choice would be a Radiation RA-909. But amplifier offset current drift must not exceed $2 \text{ nA}/^\circ\text{C}$. Pick the Best IC for the job.

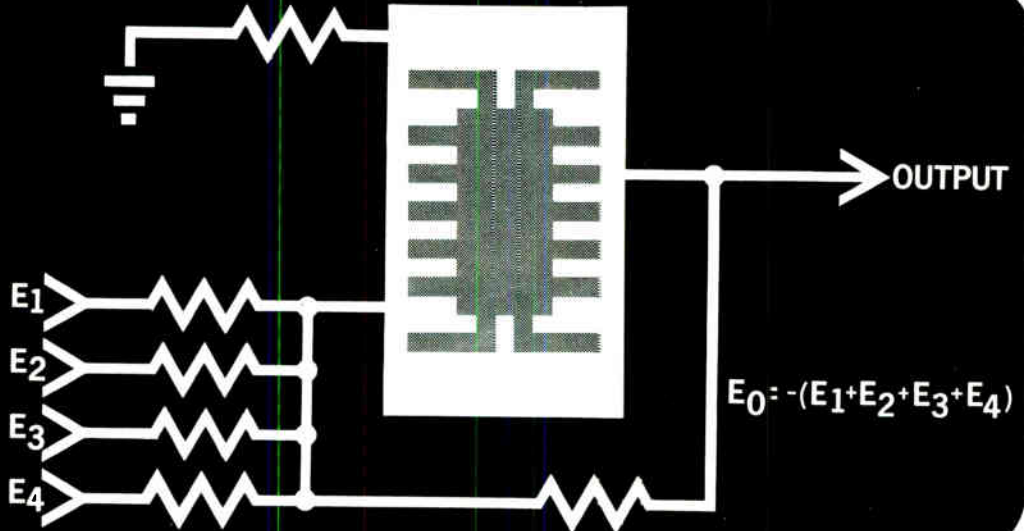

the **BEST** Solution:

THE NEW RA-909A COMPENSATIONLESS OPERATIONAL AMPLIFIER

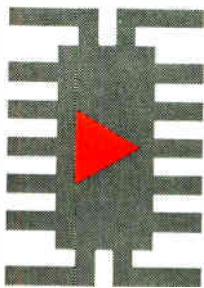

Drift error is very low in the new dielectrically isolated compensationless RA-909A. Between -55°C and $+25^\circ\text{C}$ offset current drift is a low $2 \text{ nA}/^\circ\text{C}$. From $+25^\circ\text{C}$ to $+125^\circ\text{C}$... an even lower $0.5 \text{ nA}/^\circ\text{C}$! And Radiation guarantees less than $15 \mu\text{V}/^\circ\text{C}$ offset voltage drift over the military temperature range. Compare this performance with any 709 type op amp over this extremely wide operating frequency range. You'll pick the Best op amp for the job. The RA-909A.

Like the RA-909, no external compensation is needed. Dielectric isolation and good circuit design eliminates the need for compensation. The RA-909A is in both a TO-99 package and a TO-86 flatpack configuration. A direct replacement for 709 type op amps.

Contact your nearest Radiation sales office. Let us help you pick the Best IC for the job.

WE MAKE THE **BEST IC** FOR THE JOB

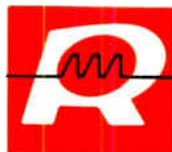

RADIATION
INCORPORATED
SUBSIDIARY OF HARRIS-INTERTYPE CORPORATION
MICROELECTRONICS DIVISION

RADIATION SALES OFFICES: P. O. Box 476, Lexington, Mass. 02173, (617) 862-1055 • 600 Old Country Road, Garden City, N.Y. 11530, (516) 747-3730 • 2600 Virginia Ave. N.W., Washington, D.C. 20037, (202) 337-4914 • 6151 W. Century Blvd. Los Angeles, Calif. 90045, (213) 670-5432 • Saratoga, Calif., (408) 253-5058 • P. O. Box 37, Melbourne, Fla. 32901, (305) 727-5430 • International Sales: Marketing Department, P. O. Box 37, Melbourne, Fla. 32901, (305) 727-5412

This readout tube never tells a lie

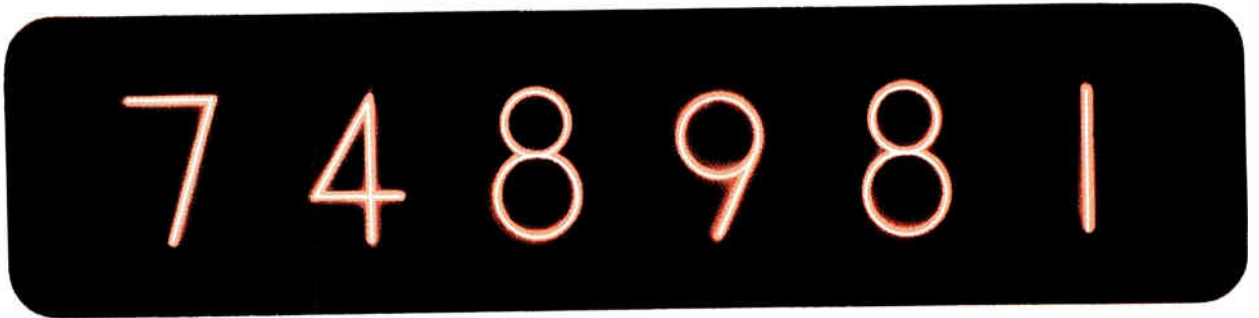

Others do

(and you never know when they fail)

Whatever data you input, a NIXIE® tube reads out. Exactly! You always have reliably accurate readouts, with no risk of a 1 when there should be a 7, a 0 instead of an 8, or a 3 instead of a 9. Rather than tell a lie, honest NIXIE tubes give you no reading ... protect you against false readouts caused by multiple segments that break down, blank out ... and don't indicate that they're wrong. You never know when they are faulty.

Selecting a readout display involves more than truth, so weigh every aspect. Check NIXIE tubes for their unmatched reliability, their proven long life (over

200,000 hours), natural readability, and uniform brightness (200 ft. lamberts, with no chance of partial fade-outs). See how only NIXIE tubes are unaffected by static charge ... meet mil specs ... offer unsurpassed packaging and design flexibility (no extra top leads required for decimals). All this, in the most complete and advanced line of tubes and accessories. No wonder NIXIE tubes lead the field.

For information, call or write: Burroughs Corporation, Electronics Components Division, P.O. Box 1226, Dept. N5, Plainfield, N. J. 07061; tel. (201) 757-5000.



the leader
in the world of displays

Burroughs



Technical Articles

**Rx for r-f
power transistors
page 84**



Brute-force wattage and frequency ratings are clearly the favorite topics of r-f power transistor manufacturers—at least in their promotional efforts. Nonetheless, features like collector efficiency, input Q, immunity to load mismatches, and high power gain are important elements in the device design process, especially from users' point of view. Off-the-shelf items can already boast

impressive specs. But knowledgeable observers anticipate state-of-the-art devices capable of 30 watts at 1 Ghz by 1970, and, some say, 5 watts at 3.5 Ghz is within reach. On the cover is a TRW chip capable of 2 watts at 3 Ghz with a gain of 5 db and a typical collector efficiency of 33%.

**Rotating disks
and drums for
peripheral memories
page 96**

Increasingly, rotating magnetic disks and drums are replacing tape in computer peripheral memories because of faster access times. Capacities of the rotating units range from 1 million to 700 million bits; access times from 8.7 to 225 milliseconds; costs from 0.5 to 0.02 cents per bit. The very versatility of rotating memories can, however, produce confusion because of the many choices that can and must be made before selecting a disk or drum for a particular job.

**Identical resonators
cut ceramic
i-f filter cost
page 102**

Designers of consumer goods can now apply ceramic band-pass filters as fixed tuned replacements for conventional i-f transformers, using a universal-type filter approach. Ceramic units provide better selectivity than standard i-f transformers, have lower insertion loss, never need alignment, and because they're smaller are ideal for solid state circuit applications.

**Millimeter waves
for ships
page 108**

The Navy specified a system providing two-way communication up to 15 nautical miles in a tactical package. To satisfy these specs, Sylvania built a solid state 37.5-Ghz unit that transmits a highly directional signal, using an antenna with a 5-inch aperture. Varactor multiplier chains and the use of transmitter power for the receiver's local-oscillator signals kept the size down. F-m with feedback demodulation was used to increase receiver sensitivity, permitting operations in light rain or fog.

**CAD—a problem child
comes of age**

Coming

Though perhaps oversold during its formative years, computer-aided design has lost none of its early promise. Up close, however, some of the knottier problems—programing, modeling, and graphics—are beginning to look more formidable than once appeared to be the case.

R_x for r-f power transistors

Wattage and frequency ratings provide the glamor, but collector efficiency, gain, input Q, immunity to load mismatches, and related features that often get lost in the shuffle remain important elements in the design equation

By Richard Gundlach

Associate editor

High-frequency power isn't quite everything in the r-f transistor game though the field's promotion campaigns make it clear that this is the way many manufacturers prefer to keep score. Whacking great amounts of wattage are all very well on paper. But all too often customers are the ones mousetrapped on the power play.

The engineer, who succumbs to the lure of transistor power claims, when he builds his mighty mite into a circuit, may find the efficiency and power gain are so low he must heat-sink the little gem to the wall to keep it cool. Moreover, there's a good possibility the device will have to be driven with almost as much power as it puts out.

Clearly, to be worth anything at all, power designs call for finesse, as well as brute force. High collector efficiency, high power gain, low input Q, fair immunity to load mismatches, and related features head most lists. The upshot is that a number of inter-related compromises and tradeoffs are necessarily involved in the r-f transistor design process.

Geometries provide a convenient case in point. Regardless of what route is taken—overlay, interdigitation, or combinations thereof—the active emitter region must be comparatively large to handle the currents required for high power. At the same time, however, the area must be minimized to reduce capacitance. So what's needed is a high emitter-edge-to-area ratio.

As a practical matter, the power output of an r-f power transistor chip is limited by two major considerations: the ability to increase the active-to-physical base-area ratio and the ability to make the chip's input impedance high enough to efficiently match conventional circuit impedances at the required power output.

On the other hand, a device's upper-frequency capability can be increased by maximizing the

active-to-physical area of the base. This value is, however, limited by base transit time, as well as by how high the output-to-input impedance level can be made before the input impedance becomes too low to match. The latter factor explains why low-power devices with relatively high input impedances usually operate at higher frequencies.

At present, the power-frequency state-of-the-art extends to the following off-the-shelf items: 100 watts at 150 megahertz; 20 watts at 1 gigahertz; and 10 watts at 2 Ghz. But this August, TRW Semiconductors will unveil a device that goes to 2 watts at 3 Ghz. What's more, the company is developing units designed to get power gain at 6 Ghz, while RCA is working for the Signal Corps on a 5-watt 3.5-Ghz transistor. In addition, RCA has a 2-watt device at 2.7 Ghz with 5-db power gain and a collector efficiency of 40% operating on the bench.

John Tatum, operations manager for r-f power devices at ITT Semiconductors, anticipates state-of-the-art devices by 1970 capable of 30 watts at 1 Ghz. By using a 2-Ghz f_T and an optimized emitter-periphery-to-base-area ratio, he says, 5 watts at 3.5 Ghz is within reach. "In fact, our 3TE610 should put out 150 watts at 76 Mhz right now using 40 volts," asserts Tatum. "With further geometry modifications, it should do so at 28 volts." Richard Battisti, assistant plant manager at TRW Semiconductors says that octave bandwidths at 3 Ghz will be available by mid-1970, but at lower power levels of perhaps a watt or so. He also expects a few watts at 6 Ghz to be a standard with his company by this date.

However, Roger Webster, manager of Microwave R&D for Texas Instruments, thinks such transistors, while feasible, are more than a year away. Robert Borawski, operation manager for h-f products at Motorola, says it'll be mid-1972 before octave bandwidths are achieved in 3-Ghz power transistors.

time, particularly at vhf and uhf frequencies.

Thomas Moutoux, manager of power transistor operations at Fairchild Semiconductor, says his company is going to stripline in various sizes, using conventional electrical isolation. Fairchild is also exploring the possibility of using industrial diamond, which has excellent thermal properties. TRW, ITT, and Motorola favor the stripline package with four radial leads and heat-dissipation stud.

Engineers at the Microwave Semiconductor Corp. favor the stripline package, but will offer coax packages as well because of customer requirements. "We've tried to combine the advantages of both coax and stripline in our Stripac design," says Ron Rosenzweig, president of the company. Stripac is a multiplanar structure consisting of a metallized disk of beryllia to conduct heat away from the chip to an external sink and a ceramic spacer with a hole in it that houses the transistor chip. Placing the input and output stripline-type leads on different planes reduces the input-to-output capacitance, enhancing the isolation and making the device more stable. In addition, since the input and output leads act as distributed transmission lines, rather than additional lead inductance, the device's broadbanding capability is increased.

Most manufacturers believe future packages must

electrically bring the external circuitry closer to the transistor chip. Larger and shorter low-inductance wire bonds will help; eliminating these wires altogether would be an even more constructive step. For openers along these lines, ITT uses stud-mount (LIS) or solder-down (TOPLIS) packages that have wide, low-inductance leads—or none at all—with large metal areas for soldering. In addition, the emitter is connected to the case to provide a common ground, thereby eliminating the isolating washer or higher inductance isolation that would otherwise be required. TRW also plans to extend power-frequency limits through improved packaging—for example, using flip chips to reduce lead inductance and building the impedance-matching networks right on the chip.

The next step many experts foresee is the placement of the chips on a substrate close to the circuit in a hybrid or modular form that minimizes the effects of packaging on performance. In some cases—for example, ITT's LIS and TOPLIS styles—a portion of the package has disappeared so users can just about solder to the chip. Other manufacturers, like RCA, have incorporated the matching circuitry and transistor chip in a single package [*Electronics*, April 14, 1969, p. 100].

Several manufacturers sell transistor chips, either

Second thoughts

At the dawn of the solid state age, engineers shied away from using common-base configurations for amplifiers because such designs involved instability and oscillation problems. They reasoned that since the mode tended to oscillate anyway, it should be used strictly for this purpose; common emitters would do nicely for amplifiers. Besides, the common-emitter configuration had more gain at frequencies below f_T than did the common base. Many veteran engineers, particularly those who were exposed to this rationale during the early days of r-f power transistors, think that the oscillation problems still exist on the same scale.

This is no longer the case, however, and semiconductor device and applications pros are now leaning toward common-base configurations for amplifier design, especially when operating near the f_T of the device. Donald Carley, RCA's manager of h-f device engineering, concedes that the early r-f power transistor packages did have a rather large amount of lead inductance that caused all kinds of instabilities. But he says things are changed. And according to Hon C. Lee, an applications engineering leader at RCA, the common-base configuration is best for microwave amplifiers. He cites several reasons.

For one thing, common-base operation is less prone to the common-emitter burnout failures caused by low-frequency oscillations. It's true that low frequency oscillations can occur in any configuration, but the common-emitter configuration is particularly susceptible. The reason: low-

frequency gain is much higher in the common-emitter configuration; moreover, the highly capacitive base-emitter junction and input r-f choke form a resonant circuit at low frequency. In addition, the frequency at which the gain starts to fall off is much higher in the common-base configuration—a feature which makes it easier to broadband.

When operating at uhf and microwave frequencies, package parasitics must be considered part of the transistor's characteristics. In the common-emitter configuration, the total collector-to-base feedback capacitance can produce a negative input impedance—the harbinger of oscillations. However, in the common-base configuration this capacitance is no longer in the output-to-input feedback path, but in shunt with the output circuit. Since the degenerating effect of the base parasitic inductance can also produce a negative input impedance, common-base operation is possible only when this inductance is minimized.

Engineers at the Microwave Semiconductor Corp. also believe that common-base amplifiers will stage a comeback. In fact, they are characterizing all microwave transistors in the common-base configuration and will supply common-emitter information only if the customer specifically requests it. "It's really a cleaner mode of operation," says Ron Lesnick, application engineer at msc. "When we look at the swept frequency response of the same transistor in both configurations on a spectrum analyzer, there's far less instability for the common-base configuration."

Key specs for r-f power transistors

Transistor type	Mfr.	Characteristics						
		Freq. (Mhz)	P _o (watts)	P.G. (db)	η _c (%)	Package style	Vcc (volts)	Input Q
TA2758	RCA	30	85 (PEP)	13	40 (min)	SWS	28	2
2N5691	TRW	50	40	8	60 (typ)	SWS	12.5	1
2N4130	ITT	70	50	8	66 (typ)	TO-3	28	2
MSA8506	Fairchild	150	25	5	65 (typ)	SWS	12	NS
3TE609	ITT	150	50	8	70 (typ)	SWS	28	1.1
3TE610	ITT	150	100	8	70 (typ)	SWS	40	1.1
MM1699	Motorola	175	40	6.5	60 (min)	SWS	12.5	1.7
2N5643	Motorola	175	40	9.1	60 (min)	SWS	28	1
S3035	UA	400	1	9	70 (typ)	SWS	12	NS
TA7344	RCA	400	18	6	65 (typ)	SWS	28	1
3TE445	ITT	400	20	6.5	50 (min)	LIS (GE)	48	NS
V410	UA	400	20	6	60 (min)	TO-60	28	2
2N5637	Motorola	400	20	5.8	60 (min)	SWS	28	2
2N5701	TRW	470	20	3	60 (typ)	SWS	12.5	5
2N5178	TRW	500	50	5	60 (typ)	SWS (GE)	28	7
2N4429	UA	1,000	1	5	45 (typ)	SWS	28	NS
KS4001	KMC	1,000	1	10	50 (min)	SWS	20	NS
MM4430	Motorola	1,000	2.5	6	45 (min)	SWS	28	2
2N4431	UA	1,000	5.6	5	50 (typ)	SWS	28	14
S1050	UA	1,000	10	5.5	50 (typ)	SWS	28	10
2N5596	TRW	1,000	20	5	55 (typ)	SWS	28	15
TA7205	RCA	1,200	10	11	30 (min)	Coaxial	28	2
L-195	TI	1,500	5	10	50 (typ)	SWS	28	20
MSC2001	MSC	2,000	1	10	45 (typ)	Stripline	28	2
2N5470	RCA	2,000	1	6	30 (min)	Coaxial	28	1
2N5483	TRW	2,000	5	4	33 (min)	SWS	28	5
TA7205	RCA	2,000	5	7	40 (min)	Coaxial	28	3.5
L-207	TI	2,400	3	4	35 (typ)	SWS	28	NS
MSC2403	MSC	2,400	3	6	40 (typ)	Stripline	28	3
PT6635	TRW	3,000	2	5	33 (typ)	Stripline	28	10

SWS — Stripline with stud.
 GE — Grounded emitter.
 NS — Not specified on data sheet.
 LIS — Low inductance stripline
 PEP — Peak envelope power

UA — Electronic Components Div. Of United Aircraft.

MSC — Microwave Semiconductor Corp.

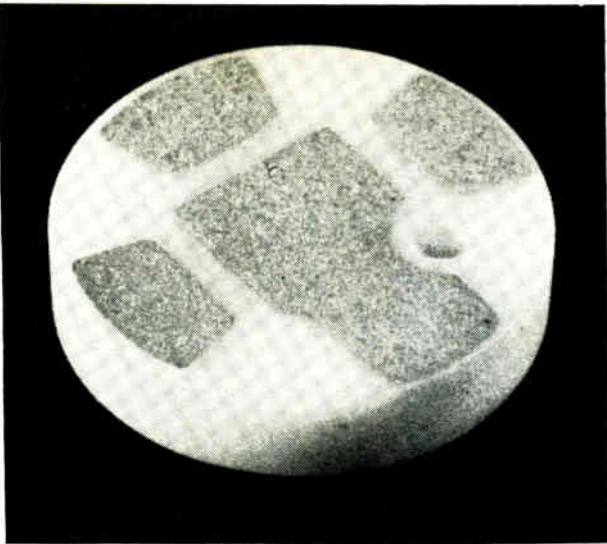

Easy to handle. Beryllia wafer includes terminals and heat sink, easing chip mounting and r-f testing.

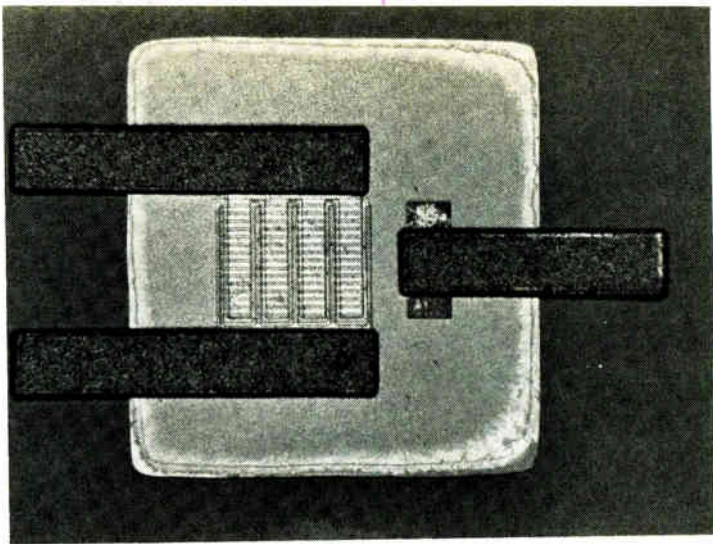

Extension. United Aircraft's beam-leaded r-f power chip puts out 3 watts when it's heat sunk.

alone or mounted on a heat-sinkable wafer, for use on customers' own substrates. The Electronic Components division of the United Aircraft Corp., in addition to a line of discrete r-f power transistors, offers chips in any of several forms. The hybrid circuit house, without an r-f transistor capability, can get chips to mount on substrates. Those who don't

want to do die bonding, can buy chips already mounted on a small beryllia carrier. And for those with a substrate and circuitry, United will supply the chip and do the bonding.

Every manufacturer agrees that for good broadband capability, the input Q of an r-f power transistor should be as low as possible over a very wide frequency range. But by no means do all of them live up to the beliefs to which they so willingly pay lip service.

The input Q is the ratio of the reactive part of the input impedance to its real part. A good broadband device should have a reactive part that is essentially zero across the band of interest and a real part equal to the impedance of the matching circuits. Unfortunately, devices such as these don't exist in the real world. The engineer is usually faced with matching to a combination of capacitive chip and inductive lead-out wires that goes from capacitive reactance to inductive reactance as frequency increases, often crossing over in the frequency band of interest.

ITT's Tatum believes the frequency at which this crossover occurs should be kept as high as possible—at least outside the band of interest. To this end, both the Q and the lead inductance should be as low as possible. However, if the value of the input capacitance prevents this, for convenience, the crossover frequency should be set about mid-band in the matching circuit.

Match or burn

Several manufacturers rate a few of their devices for no damage under infinite v_{swr} at all phase angles. But an engineer not using these paragons must face up to the possibility of burnouts due to load mismatches. When the load impedance is different from the transistor's output impedance, some of the power, which under matched conditions would be dissipated in the load, is reflected back into the transistor. Under such conditions, the transistor has to dissipate the extra power, increasing its temperature and making burnout more likely.

Some users have isolated the transistor from the

A number of deficiencies

To users' chagrin, r-f power transistors are still not properly characterized by an Electronic Industries Association format. The one now in use, developed by the Joint Electron Device Engineering Council in 1967, requires the manufacturer to specify such parameters as d-c beta, reverse leakage current, and small-signal current gain. However, it's possible to ignore such important r-f parameters as large-signal impedances, as well as to sidestep specifying the lead inductance. As a result, two apparently indistinguishable transistors with the same 2N number may vary widely in their r-f performance.

Under the EIA format, the user has little assurance that similarly registered devices will have equivalent r-f characteristics—except possibly power output. Moreover, gain specifications could be tightened. For example, John Tatum, IRR's operations manager for r-f power, says that neutralized circuit configurations should never be allowed, claiming that under the existing system one company was able to register devices that had some of the emitter inductance tuned out.

Manufacturers and users have complained about inadequate registration requirements since the first 2N number was issued five years ago. But no one has taken the lead in trying to change things. Some producers are apparently content with the status quo because they can obscure inadequate performance with the rudimentary d-c specs. Others, though influential in the semiconductor field, have only token stakes in r-f power devices and aren't overly concerned about investing time and effort in change.

changing load with a ferrite isolator. But it's difficult to obtain wide bandwidths in this manner, particularly at the lower frequencies. Moreover, when it's necessary to push tens of watts, the isolator's insertion loss of greater than 1 db is intolerable.

Another tack is to install circuitry that senses a high vswr and then reduces the collector voltage to minimize the possibility of burnout. Using this scheme, engineers at Fort Monmouth report having had no trouble protecting a 25-watt amplifier under any type of mismatch. What they do is to sense the output vswr with a reflectometer and feed back a signal to the control circuitry of a voltage regulator, which reduces the collector voltage approximately 5 to 10 microseconds after the mismatch occurs.

Insurance policies

Most knowledgeable sources agree that using emitter-ballast resistors does keep a transistor from destroying itself under a short-term mismatch—high load vswr—conditions. Resistors can be either diffused or deposited onto the emitter sites. The latter technique seems best since, if one of the emitter sites should overheat, a diffused resistor could short out and create a hot spot. A deposited resistor would simply vaporize, resulting in a slight performance degradation, rather than instant death. An emitter-ballast resistor on each individual emitter site makes for even slighter degradation in the event of failure.

Many engineers are convinced the only way to feel even relatively confident of survival under high-vswr conditions is to use emitter-ballast resistors to promote current sharing and to make sure the transistor's thermal capacity far exceeds the required power output rating. ITT, for example, uses a transistor with a 50 watt thermal capacity and Nichrome stabilizing resistors for its 23-watt device, rated for infinite vswr at all phase angles.

Hotly contested

Although there's still much to learn about characterizing and solving thermal instability problems certain facts are available. To wit: Higher power devices are more prone to thermal failures due to hot spots, and using multiple chips in parallel doesn't help. Even if chips are selected from the same wafer, under load mismatches, the burden invariably seems to shift to only one. This creates a hot spot that causes failure. Test data also reveals that hot-spotting becomes more acute as the collector voltage is increased; thermal scanning checks have shown that the hot spots which occurred at a certain power output when using a collector voltage of 28 volts, cropped up at much lower power outputs when the voltage was raised to 30 volts.

To get really high power at low frequencies—say, 100 watts at 30 Mhz—many users will consider high-power single transistors. (At higher frequencies, this is not always the case.) But most manufacturers believe using quadrature couplers to combine several low power devices is the best way to

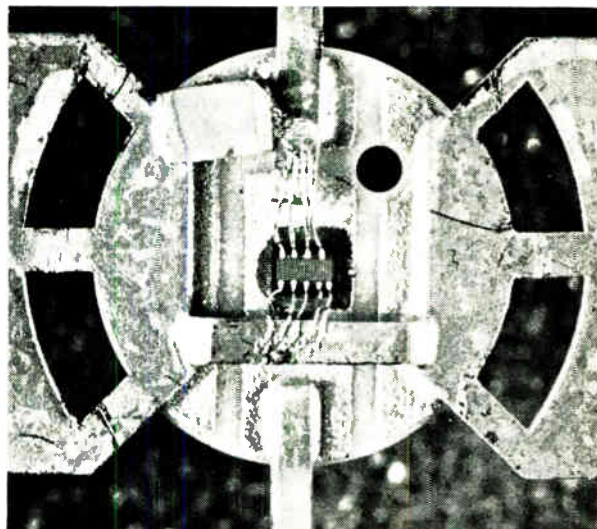

Broader. A capacitor directly across the emitter and base extends the bandwidth of United Aircraft's devices.

get higher power with some reliability. If, for instance, one of the transistors were to fail, performance would degrade only slightly. The question seems to center on the level at which it makes sense to stop building higher-power transistors and start combining lower-power devices. As devices get close to the 100-watt mark, their impedances drop to fractions of an ohm, and it's tough to efficiently match conventional 50-ohm values. At such power levels combining is a must. There are good arguments for combining at both high (100 to 150 watts) and low-power (10 watts) levels. There's a

Transistor applications	Frequency (Mhz)
Military marine & amateur communications—AM/FM/SSB	2 — 30
Citizens band communications	27
Mobile communications	25 — 50
Military & mobile comm. FM/SSB	30 — 76
CATV	50 — 216
Commercial & military aircraft	76 — 150
VHF mobile, marine, ECM, & sonobuoy	148 — 225
Military communications & telemetry	225 — 400
UHF mobile, ECM, UHF & L-band fuses	400 — 1,000
DME, L-band telemetry	1,000 — 1,500
S-band phased-array radar, Telemetry, collision avoidance radar	1,500 — 2,300

Specialties of the house

Although approaches and design philosophies may differ in detail, most manufacturers of r-f power transistors are agreed that it makes better sense to angle their wares for specific, rather than general-purpose, applications. As a result, devices are now being developed in the h-f, vhf, uhf, and microwave frequency ranges for use in cable, or community, antenna television systems, single-sideband radio gear, aircraft apparatus, land-mobile equipment, and the like.

There are just too many tradeoffs to consider when making a general-purpose device, according to rrr. John Tatum, the company's operations manager for r-f power devices says: "General-purpose devices aren't really competitive. Take, for example, a transistor to be operated at 12 volts. You can use a transistor that has a 100-volt breakdown rating; however, its saturated power output will be much lower than one designed for a lower breakdown voltage. Following the general-purpose philosophy, you'd wind up with a transistor usable for a wide range of voltages but with only, say, 5-watts output at 12 volts. However, if the same size chip were optimized for 12-volt operation it would have a 15-watt capability."

Diversity. Though RCA has developed a 100-watt transistor at 76 Mhz for the Signal Corps, the company doesn't intend to concentrate just on raw power. Future efforts will be directed toward developing high-frequency devices with high gain and collector efficiency, as well as tailoring transistor designs for particular outlets. RCA's products chart breaks the line down into four basic categories: power amplifiers for 6 to 13-volt operation; units for 24 to 28-volt operation; wide-band amplifiers and power oscillators. Each of these categories is subdivided into power-frequency classifications. For example, the TA2758, RCA's only plastic package is designed for communications equipment in the 2 to 32-Mhz region. It has an internal-package diode which can be used as a temperature sensor; with an appropriate external

network this diode can insure that the transistor's bias stays fairly constant so that the transistor usually operates in a linear region—a must for SSB operation. In addition, each of the 540 emitter sites has its own individual ballast resistor, a feature that guards against disastrous burnouts resulting from impedance mismatches.

Objectives. RCA is aiming its microwave transistors at a number of outlets, including traveling-wave tube amplifier replacement, distance-measuring equipment overseas radio relay links, and collision-avoidance radar for aircraft. Donald Carley, manager of h-f engineering, also thinks there's a market for r-f power transistors in phased-array radar.

The microwave Semiconductor Corp. is trying to capture some of the same outlets as RCA. The firm is looking toward the custom microwave market—above 1 Ghz—and hopes to supply both chips and discrete devices for use in telemetry, radar, electronic countermeasures, and iff systems, as well as communications links.

Short ranges. On the other hand, some manufacturers plan to follow a narrower path. Both Fairchild and Motorola are concentrating on devices for the communications bands and plan to produce units that deliver about 50 watts at 50 Mhz, 40 watts at 175 Mhz and 25 watts at 470 Mhz. These firms, as well as Texas Instruments Incorporated haven't any plans to build bigger transistors since they feel that, if more power is required, several units in parallel with separate tuning networks can fill the bill more economically than a single large device.

The Electronic Components division of United Aircraft is looking to the mobile communications market, particularly in the 30 to 76-Mhz and 150 to 175-Mhz ranges. According to Donald Diehl, products manager, the company hopes to supply a new line of 12-volt r-f power transistors, with emitter ballasting, to provide 1, 5, 10, and 20 watts at these frequencies.

definite correlation between companies' stands on this matter and what they sell. ITT and TRW, for example, which already have high-power devices favor combining at the upper levels; the Microwave Semiconductor Corp. believes that 10 to 12 watts is about the maximum for single chips.

Plastics' place

A majority of r-f power transistor manufacturers agrees that hermetic seals are superior to plastic, but their reasoning varies. The military doesn't like it, some say. Others complain most plastic lacks good thermal expansion properties.

Some of the basic problems with plastic are:

- High moisture penetration—water can get inside the package and forms an aluminum oxide, which acts as an insulator.

- Interaction with transistor chip—impurities in the plastic can react with the chip at high temperatures even when the transistor is in storage.

- Thermal expansion rates different than metal—since the chip-bond wires rapidly heat and cool when operated class C—because of the current pulses—they expand and contract at different rates than the plastic surrounding them. This subjects the bond wires to tremendous stresses.

If plastic transistors fail when subjected to the 10 temperature cycles required by the military, severe environments—for example, an average taxicab radio, which transmits about 100 times every 24 hours—present formidable challenges indeed. Under this kind of usage, a plastic transistor would, over a five-year span, effectively be temperature-cycled more than 175,000 times. ■

Designer's casebook

One-shot multivibrator requires no standby power

By Eric J. Hoffman

Applied Physics Laboratory, Silver Spring, Md.

In many applications one-shots spend most of their time in the standby state, and if power is at a premium as in medical and aerospace projects, the standby current drain can be a source of unwanted power dissipation. The circuit shown has negligible power consumption in the standby state, and also provides strong noise immunity.

With no input present, all transistors are off, and capacitor C_1 is charged to 12 volts. When a positive 6-volt pulse is delivered to the input, Q_2 saturates, pulling the emitter of Q_1 about 12 volts below ground. Q_1 turns on and supplies current to C_1 through R_2 and R_3 . Q_1 's emitter begins to rise ex-

ponentially from -12 volts toward a positive voltage determined by the voltage divider R_2 , R_3 , and by the impedance of Q_1 .

The current through R_2 saturates Q_3 which then supplies current to keep Q_2 saturated. The output rises to a positive voltage with a rise time of about a 100 nanoseconds. Since Q_2 is latched on by Q_3 , the input pulse is no longer needed and can return to ground.

Q_1 's emitter continues to charge until it reaches about -0.6 volt. Q_1 turns off, thereby turning off Q_3 and Q_2 . As Q_2 starts to come out of saturation, C_1 charges through R_4 , causing a slight voltage rise across D_2 . This rise causes Q_1 to draw even less current, and regeneratively turns off all three transistors. C_1 now recharges to 12 volts, and the one-shot is ready for another input pulse.

The pulse width is directly proportional to C_1 but only approximately proportional to R_2 because of the current coming from R_3 . For the values shown, the pulse width is 1 second. By reducing C_1 , pulse widths down to 5 microseconds can be obtained.

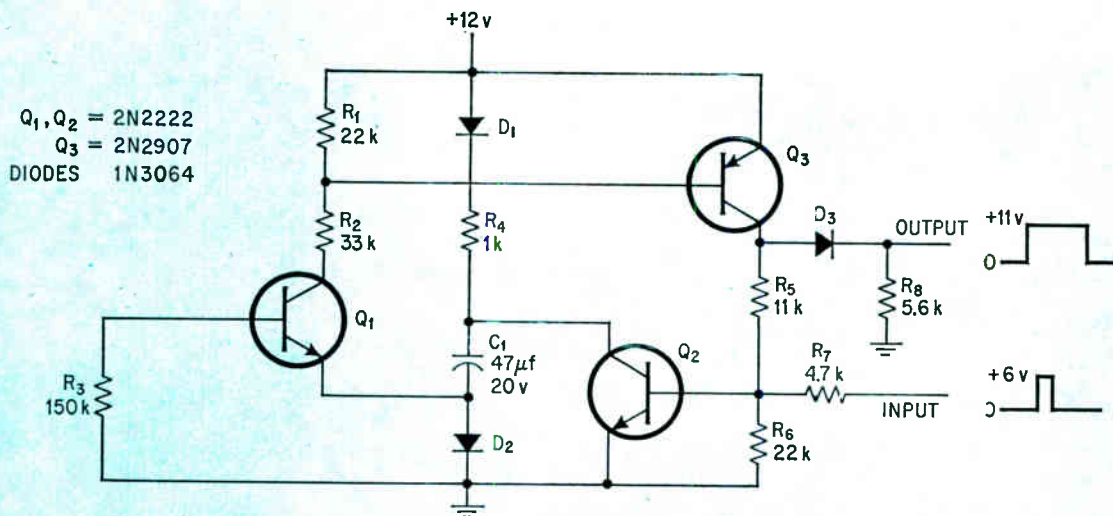

No idle waste. The supply current drawn by the one-shot multivibrator in the quiescent state consists only of transistor and capacitor leakage currents—about 30 nanamps. Pulse widths as small as 5 microseconds can be obtained by reducing capacitor C_1 .

Loop gain measurements made with paired amplifiers

By Kamilo Feher

RCA Victor Co., Montreal

Engineers often have to make loop gain measurements of feedback amplifiers to evaluate the amplifiers' stability. The problem, though, is how to open the loop and still keep the amplifier operating. The easiest way is to connect the amplifier to another one with the same characteristics.

The closed-loop amplifier is opened between points 1 and 2 in the diagram prior to measuring its loop gain and phase. The impedance at 2 must be exactly the same after the loop is opened as it was before. To do this, a second closed-loop amplifier is opened between points 3 and 4 and connected to point 2 in the first amplifier's loop, as shown by the dotted line. The load at 3 now has the same complex function of frequency as 2 originally had, and measurements can thus be made at points 1 and 2.

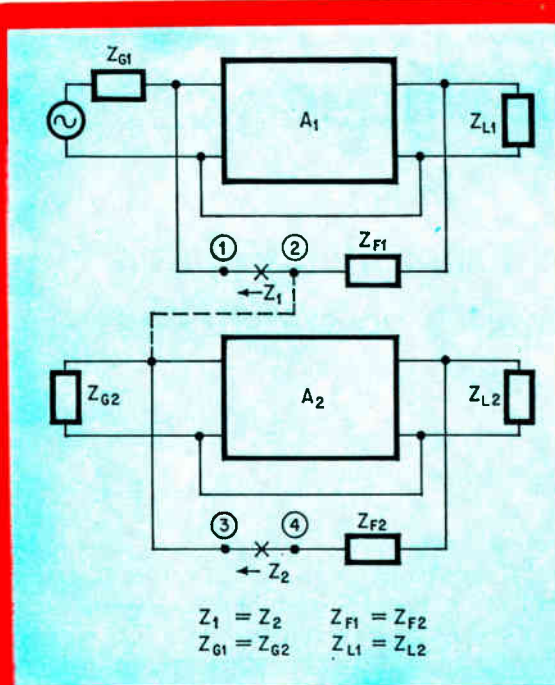

Holding fast. The impedance at point 2 must be exactly the same after the loop is opened in the first amplifier as it was before.

Q-multiplier circuit uses op amp with LC feedback

By Richard C. Gerdes

Optical Electronics Inc., Tucson, Ariz.

Communication receivers and active filters used in low level measurements often need some means of varying the tuned circuit's Q (the ratio of the resonant frequency to the frequency difference of the upper and lower -3-decibel points). Increasing the Q will decrease the -3-db bandwidth resulting in a higher gain at resonance. A simple way of doing this is by the operational amplifier scheme shown.

The tuned amplifier stage consists of an op amp and a parallel LC network in its feedback path. The op amp has an essentially open loop gain at the frequencies of interest. The LC circuit has a high impedance at resonance equal to ωL or $1/\omega C$. The circuit's gain at resonance is $\omega L/R_1$ or $1/\omega R_1 C$.

The Q of the circuit can be increased by introducing positive feedback at the non-inverting input of the op amp and adjusting the potentiometer.

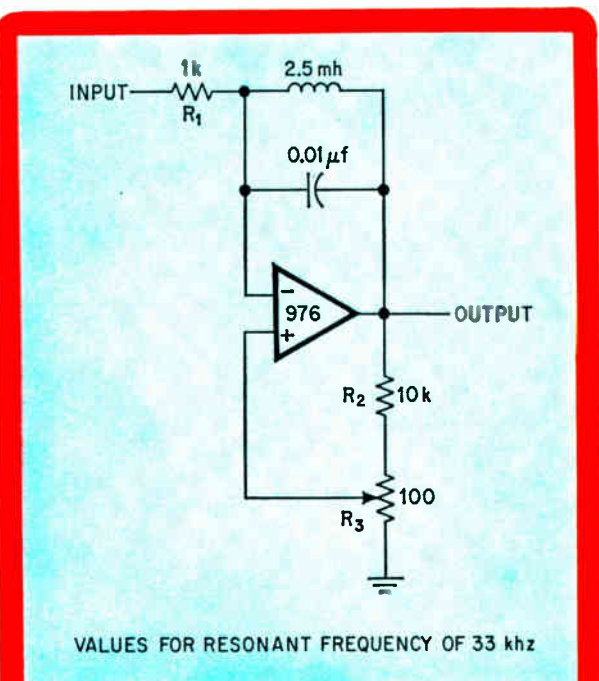

VALUES FOR RESONANT FREQUENCY OF 33 khz

Tuning in. The operational amplifier affords the designer more flexible input circuitry and a low output impedance. The circuit operates up to 3 megahertz.

Curve tracer improves indication of IC performance

By R.A. Aldrich

Fairchild Semiconductor, Mountain View, California*

Some integrated circuits can be used for special applications as low-cost line drivers if the output voltage-current characteristics are known. These figures can be calculated from the manufacturer's circuit schematic, but since wide deviations from the typical component values occur, direct observations with a curve tracer are more useful.

The output V-I curves of DTL and TTL circuits

* Now with Anderson Jacobson, Inc., Mountain View, California

can be observed by the following method. The circuit's input is connected to its ground, which is left floating, so that the grounded-emitter output transistor cannot turn on. A NAND gate is shown with typical output V-I curves. The curve tracer's zero voltage setting should be set in reference to the operating power supply voltage, V_{cc} , since the curve tracer measures the voltage from the output to V_{cc} .

Load lines can be drawn to find the output voltage for various resistive loads to ground. For example, a typical output voltage for a 100-ohm termination would be 2.5 volts; an output voltage for a 50-ohm termination would be 1.7 volts. Thus, the TTL gate might be used as a low-cost line driver for limited-distance data communications, using for example, twisted pair cable with approximately 100 ohms characteristic impedance or coaxial cable with 50 to 100 ohms characteristic impedance.

TTL GATE OUTPUT V-I CURVE

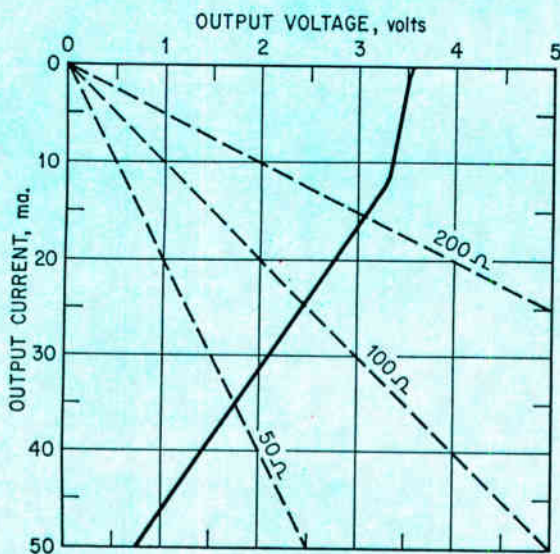

COLLECTOR SWEEP POLARITY - PNP

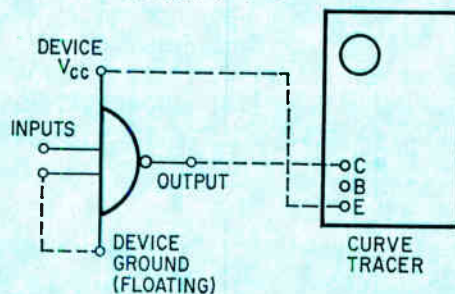

TEST SET-UP

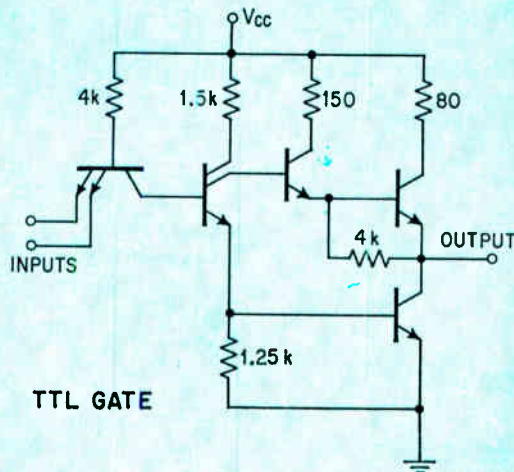

Getting the picture. The output voltages of a micro-circuit for various resistive loads can be obtained from the circuit's V-I curve by drawing in the load lines. The circuit's input is connected to its ground, which is left floating, so that the grounded-emitter output transistor cannot turn on.

BIFET circuit yields time delays up to 30 hours

By G. Black and K.C. Smith

University of Toronto, Canada

By minimizing its dependence on temperature and its gate leakage current, the field effect transistor circuit shown can cause time delays of up to 30 hours repeatable to within 1%. The circuit can also be used to measure small currents such as FET gate leakage currents in the picoamp region.

Assuming capacitor C_1 is initially uncharged, the 15-volt supply begins to charge the capacitor through R_1 . The voltage at the source of Q_1 follows the voltage on C_1 with a constant offset of 4v from the gate-source offset voltage (V_{GS1}) of Q_1 .

The output voltage of Q_1 combined with R_2 provides a current source which drives the tunnel diode. When reset, the tunnel diode is in its low voltage state. As the voltage on C_1 rises, the current in the tunnel diode increases until it reaches its peak current, I_p . At this point, it rapidly switches to its high voltage state which turns Q_4 on.

Q_5 acts as an electronic reset-start control without providing additional loading to the RC charging circuit. When Q_5 is on, C_1 discharges through the

forward biased gate-source junction of Q_1 and the saturated transistor Q_5 . When Q_5 is turned off, Q_1 resumes its normal operation and C_1 begins to charge. Thus the time delay begins when Q_5 's base circuit is opened by the switch, and lasts until the collector of Q_4 drops from V_{cc} to saturation.

For a 70-minute delay, typical values are: $R_1 = 10^{11}$ ohms, $C_1 = 0.1$ microfarads, $R_2 = 18$ kilohms, $I_p = 500$ microamps, $V_{GS1} = 4$ volts, and $V_{cc} = 15$ volts. For 30-hour delay: $C_1 = 1.0 \mu f$ and $R_2 = 28k$.

To obtain long time delays, certain restrictions must be imposed. One is minimizing gate leakage current. This can be done by connecting Q_2 , a matched FET, as shown. The measured net leakage current of the FET pair was 3 picoamps. This now puts an upper limit on R_1 , 10^{11} ohms. Secondly, the leakage resistance of C_1 must be greater than 10^{13} ohms, dictating the use of polystyrene capacitors.

R_2 provides continuous variation of time delay. C_2 reduces the possibility of an accidental triggering of Q_4 by noise from the tunnel diode.

Time-delay dependence on temperature was minimized in three ways. A tunnel diode with a low temperature coefficient was used. The dual transistor arrangement of Q_1 , Q_3 (BIFET) together with the constant current source generator (CL₁) was used to produce a small drain-source current in Q_1 . Finally, Q_1 and Q_2 are properly matched so their gate leakage currents track with temperature.

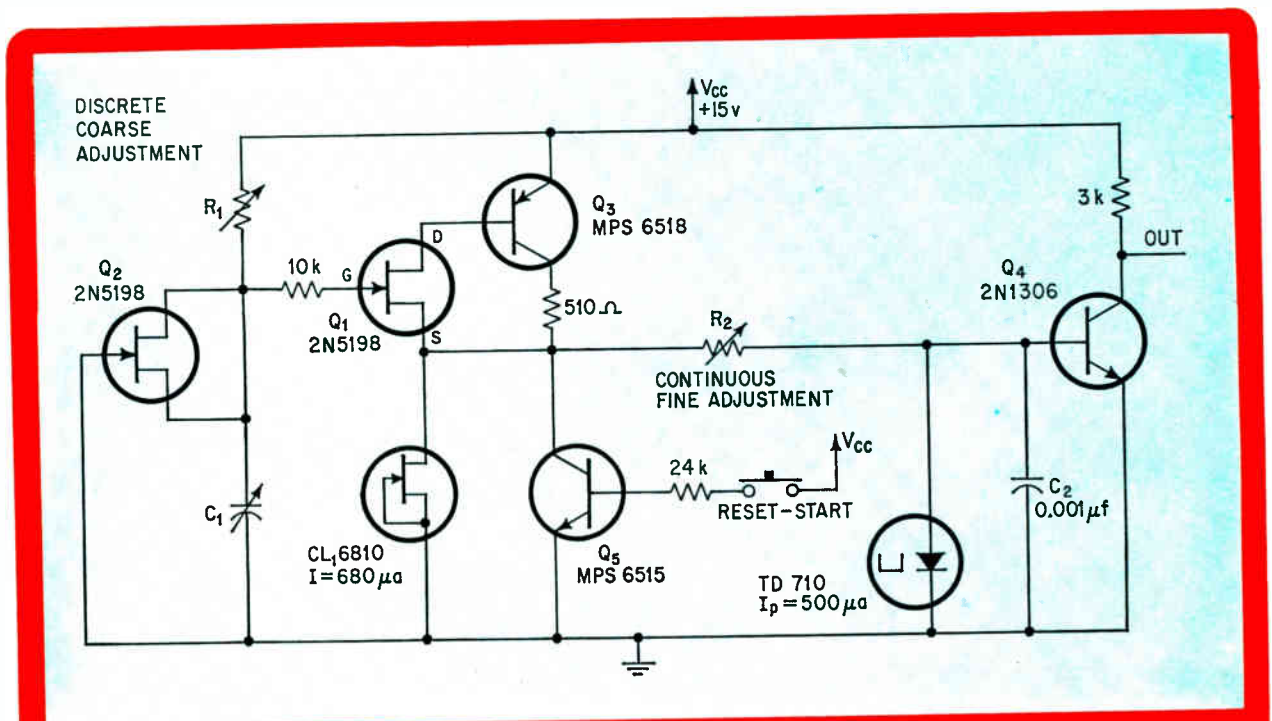

Small stuff. Besides being used for long time delays, the circuit can also measure small gate-leakage currents of FET's. By removing R_1 and Q_2 , Q_1 's leakage current can be converted into a time delay. With feedback from the output to the reset input, a current-to-frequency converter can be made.

Throw the book at us.

If your customers are throwing the book at you about MIL-STD-883, stop ducking.

We can lick your problem.

Because Signetics is one company that understands 883. And designs to it. In fact, we've been gearing up for this hard-nosed testing for the past five years.

For instance, if you need an immediate source for those hard-to-get 5400's to MIL-

STD-883, try us. In fact, Signetics can spec just about anything you want—DCT, DTL, TTL, MSI or linear; you name it.

Go ahead: really throw the book. We won't even flinch.

P.S. Speaking of books, we've got a package deal: a 5400 handbook, along with a guide that spells out what 883 is all about. Yours for the writing.

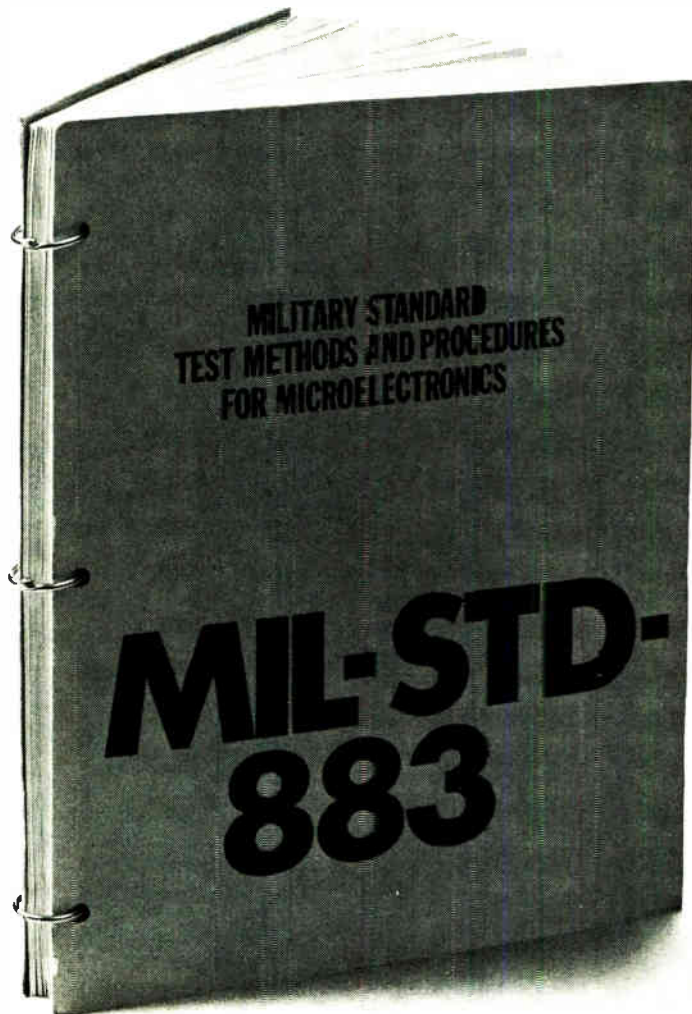

Signetics

Signetics Corporation/811 E. Arques Ave., Sunnyvale, Calif. 94086/A subsidiary of Corning Glass Works

Rotating disks and drums set peripheral memories spinning

Their fast access time gives them the edge over magnetic tapes, but picking the best one for a specific application isn't easy and requires detailed knowledge of their hardware and software

By Michael French

BCD Computing Corp., Deer Park, N.Y.

Growing in versatility, rotating disks and drums are more and more displacing magnetic tape as peripheral memories. But from the same versatility, confusion can arise simply as a result of the wide variety of technical choices that must be made before selecting a disk or drum for a particular job.

Should the memory be disk or drum? Should it be removable or non-removable, serial or parallel, self clocked or externally clocked? Ought the heads to be of the "flying" or in-contact type, movable or assigned one to a track? What kind of head switching arrangement should be selected? Should the records be of fixed or variable length?

The applications, of course, dictate the response to these questions—though engineers in the industry by no means always agree on the answers. For the technology's moved pretty fast in a comparatively short time and some of the basics—why heads "crash" onto drums, for example—aren't completely understood. In fact, it was only three years ago that IBM introduced its 2311 rotating removable disk memory that's since become the industry standard. Today, at least 20 firms make the disk packs and another 10 the compatible drives.

Rotating memories now have capacities ranging from 100 thousand to 4 billion bits, access times from 8.7 to 225 milliseconds, and cost from 0.5 cents to 0.02 cents per bit.

The ability to buy rotating memories from several different sources has acted as an important spur to growth. Another important factor has been the price drop accompanying higher recording densities and faster data transfer rates made possible by such advances as higher efficiency codes.

But perhaps the biggest boost has come from the increase in time sharing on large computers and

real time data processing on miniature units. Both of these have created a need for peripheral memories with much faster access times than those offered by tape transports. Because such transports must read every record serially, access times are very long—on the average about a minute for a 1,200-foot reel of tape. In a disk or drum, on the other hand, where movable heads needn't read everything preceding a record, average access times are 87 milliseconds.

Thus, for real time applications like program swapping or airline reservation data banks, the rotating type memory is the only practical periph-

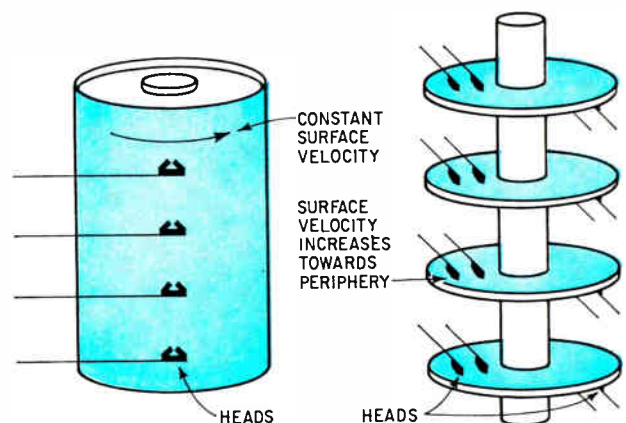

Uniform flow. Because every track on a drum memory is the same distance from the rotating center, surface velocity and, therefore, air currents under the flying heads are uniform. In disks, however, surface velocity and air flow rate increase toward periphery, making head design difficult.

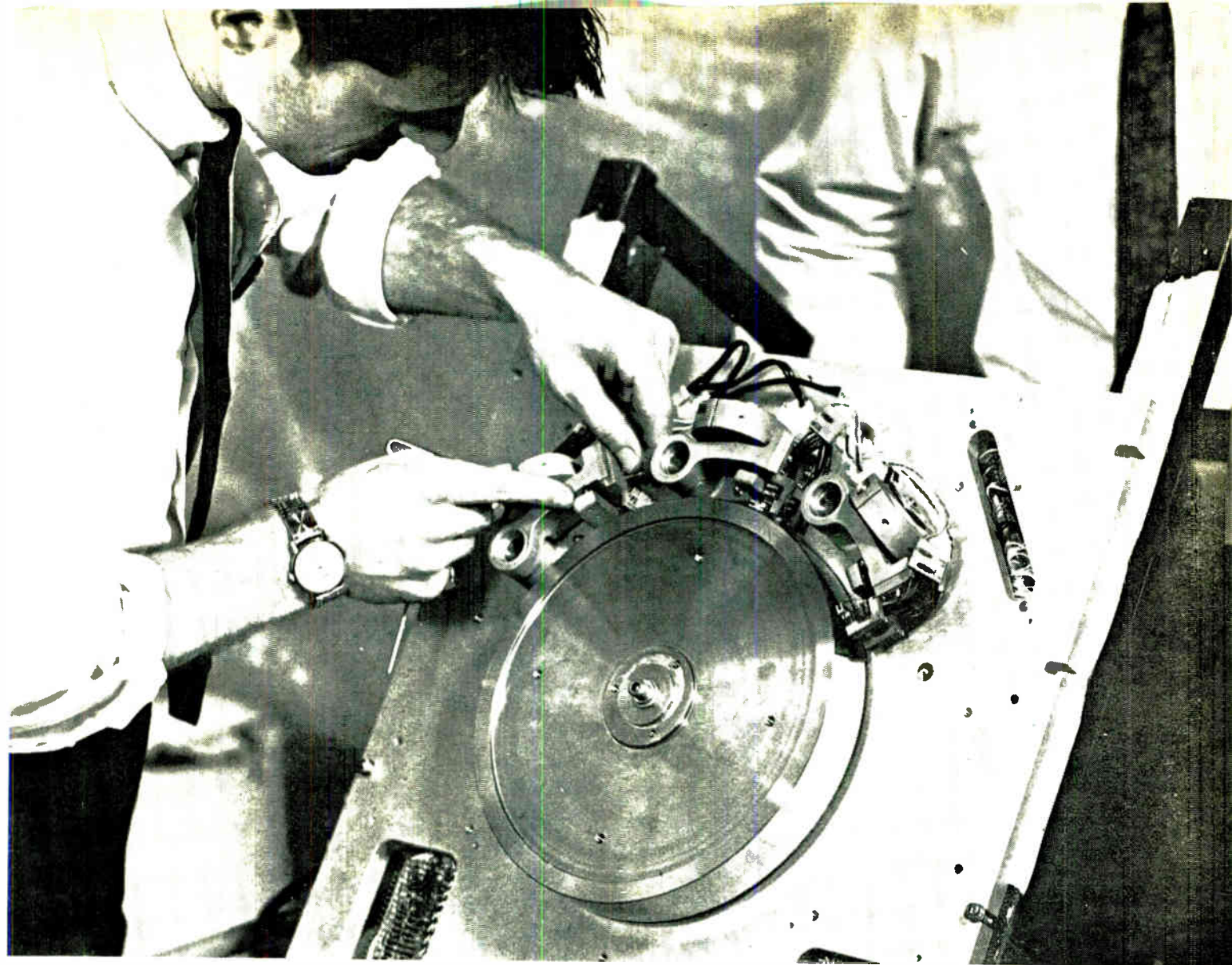

Low capacity. This low cost drum memory, made by Bryant, stores 1.2 million bits on 32 data tracks and has an average access time of 8.5 milliseconds.

eral storage media. And for applications, such as the sorting or merging of files, the need for considerably faster access time usually rules out tape.

One of the more controversial choices is that between head per track and movable track memories. Total access time of the first depends only on the times it takes to switch a head into the read or write mode—about 2 to 20 microseconds—and on the “latency time.” The latter refers to the time it takes the desired portion of a particular track to rotate into position under a head. On the average, heads are half a rotational period away, and latency time averages between 8.7 and 16.5 milliseconds.

Movable head memories, however, include another delay because heads must travel from one track to another. On the average this takes between 50 and 225 milliseconds so that these memories are an order of magnitude slower than the head per track type. However, since the movable types use much fewer heads, they're also much less expensive.

For instance, IEM's 2311, a 60 million bit mem-

ory, has only ten heads along a comblike arm and a one-in-ten selection matrix. All of the heads are positioned simultaneously, each one over a track on one of ten disk surfaces. (The total number of tracks available for reading or writing at one head position is called a cylinder.) This type memory costs about \$26,000 and has a latency time of 12.5 milliseconds.

General Instruments' Magnefile Division offers a lower capacity and higher priced memory that stores 20 million bits. The higher price arises from the use of 512 separately mounted flying heads, one for each track, giving a total access time of 8.5 milliseconds.

Magnefile's director of marketing Richard Martin, says, “In practice it's been proven that head per track memories can improve system data processing and throughput time by a factor as high as 10 to 1 over moving head memories. With central processing unit time being sold by the microsecond, computer efficiency versus application will be the

major consideration, with basic hardware cost, within reasonable bounds, no consideration at all.”

However, this opinion—typical of many in the industry—needs qualifying. Certainly, head per track memories are more economical for capacities under about 10 million bits because the cost of moving-head drives outweighs that of extra heads. But for most applications, where capacities over 50 million bits are required, it’s too costly to include heads for each track and it calls for a very complex switching matrix.

However, in the 10 to 50 million bit range—where the bulk of the market is—the choice isn’t at all clear. The economics vary with the application and the relative importance of speed and cost. Moving head memories that are compatible with the IBM 2311, for example, shift heads from one track to the next in 20 microseconds and travel an average distance (over 70 tracks) in 75 to 50 milliseconds. This includes time for removing mechanical brakes on heads and for damping out mechanical vibration. For applications, such as commercial time-sharing, the total access time of 87 milliseconds is sufficiently short and, since the computer isn’t being used to perform other operations, doesn’t raise costs.

Maneuvering for economy

Most of today’s slow capacity units—offered by firms like Data Disk, Information Data Systems, and Alpha Data for as low as \$5,000—are head per track memories. But for capacities between 5 and 50 million bits, some companies are selling compromise units that have movable drives with more than one head on each surface. Bryant Computer, the Computer Peripheral Corp., and National Cash Register make files that can read between a third and a sixth of their total storage capacity without moving their heads. And access time is less than with conventional moving head units because any single head doesn’t have to move as far from one track to another. These memories cost about 30% less than comparable-capacity head per track units. And for some applications, access times can be reduced still further by writing records that are needed together on the same or adjacent cylinders.

A decision to use a movable head memory can, however, rule out drums, which are most often head per track units. For those who can use the IBM compatible disk memories, there are the advantages of lower cost and the choice of buying from a variety of suppliers.

Many disks have another advantage over drums—they can be removed from the memory and stored. This property is desirable for computer applications where alternate programs are used. For example, a computer might process payroll one day a week and perform engineering and production control tasks the remainder of the week.

However, for those applications that demand high reliability, very low error rate, and rugged construction, drums are the clear choice. Their long lifetimes—over 100,000 hours—and low error rates—

HEAD PAD RETRACTED

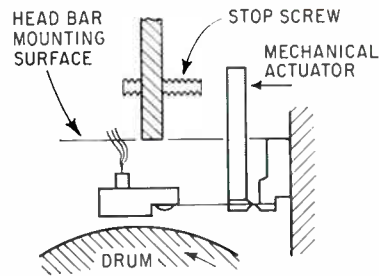

REPRESENTATIVE OSCILLOSCOPE TRACE



HEADS APPROACHING ROTATING DRUM

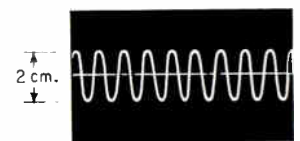
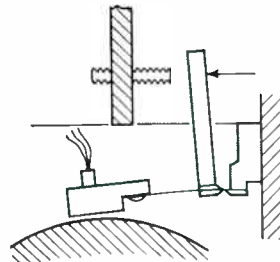

OPERATING POSITION

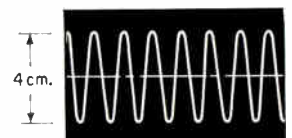
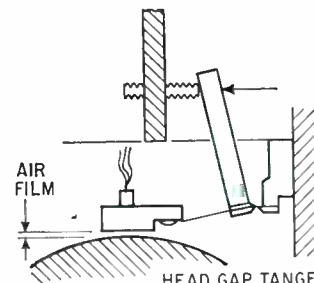

HEAD GAP TANGENT
MAXIMUM SIGNAL AMPLITUDE

ADJUSTABLE STOP BACKED OFF TOO FAR

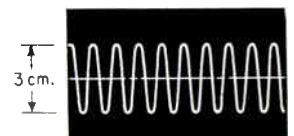
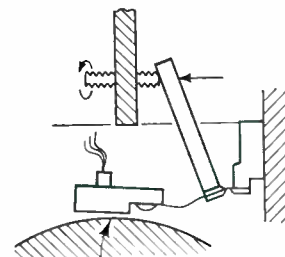

HEAD GAP NO LONGER TANGENT
SIGNAL AMPLITUDE REDUCED

Flying low. In disks and drums, flying type heads ride a few millionths of an inch above rotating surface on film of air. When brake is removed, mechanical actuator moves forward until it is stopped by screw and, at the same time, head approaches surface, which starts to rotate. Amplitude of read or write signal is maximum when head gap is tangent to surface. If adjustable stop is backed off too far, signal amplitude decreases.

less than one transient error in every 10^{13} bits—derive from their relative immunity to head crashes. When heads smash onto the surface of a rotating disk or drum—instead of “flying” on a layer of air a few millionths of an inch above—magnetic material gets scraped off. Dust particles and mechanical instabilities are the chief causes of such crashes. Particles get between the head and surface where they act as abrasives that scour off magnetic material or they interfere with the head aerodynamics.

Drums minimize abrasion and head crashes because they're sealed and, therefore, keep out dust. (Removable disk memories, of course, can't be sealed.) While most non-removable disk memories aren't sealed, one line of disk memories—from the Digital Development Corporation—operates in a helium atmosphere and offers very high reliability. Equally important, drum heads are all the same distance from the rotating center, thereby guaranteeing a laminar airflow that's more than sufficient to keep the heads flying. By contrast, the flow of air under disk heads changes for each track and is small close to the disk center.

Drums have two other advantages: they rotate faster than disks (up to 24,000 rpm) and thus have faster access times and they can be packed with more information. Their potentially higher packing density results from their stronger head playback signal, which permits accurate readout of signals even though flux transitions are very close together.

Getting strong signals onto and out of today's narrow tracks and thin emulsions requires that heads either contact disk and drum surfaces or fly about 50 to 200 millionths of an inch above them. At these close distances it's just not feasible to position heads mechanically.

At first, air was blown through a hole in the head to maintain the surface to head spacing. But gradually these hydrostatic type heads have been replaced by hydrodynamic types. These fly above the surface on a film of air that's dragged along by the moving disk or drum. (The moving surface under the heads of an IBM 2311 disk memory, for example, generates a steady current of air since it travels at a rate of 64 to 93 miles an hour.)

Users of disk or drum memories don't have much choice in selecting types of flying heads, though they ought to be familiar with the problems that can come up. For instance, a power failure could cause the spring loaded heads to crash if the memory doesn't include a fail-safe retraction system. Fortunately, most drum and disk memories do. Also, if the head altitude isn't adjusted properly, playback signal level drops sharply. Another problem arises from mechanical vibration of the head. This modulates the amplitude of the playback signal, affecting both the memory's peak detectors and phase shifting networks. Good quality drum memories have modulation levels below 10%.

Almost every rotating memory sold today uses diode matrices to select signals from one head out of many. Noise is kept to a minimum by mounting amplifiers close to the read heads and connecting

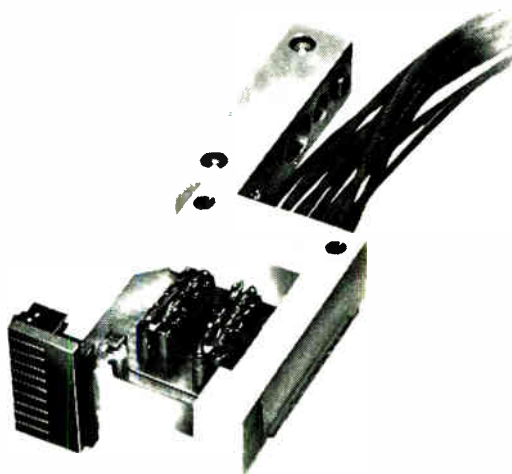
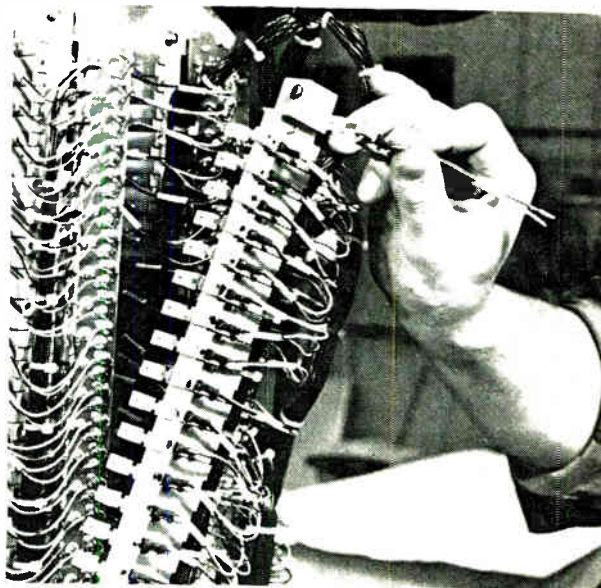

Modular. In the Bryant AHO drum memory, heads are arranged 16 to a bar. This head per track unit offers access times as low as $8 \frac{1}{3}$ milliseconds, and capacities up to 59 million bits. In another, more recent version, at right, heads are grouped nine to a pole piece to provide a more stable flying surface.

them with twisted pairs of shielded wires.

In the moving head types, the number of heads is small enough to allow one dimensional matrix selection. Lowering the head select line causes current to flow through the appropriate diodes. Current flowing from the write amplifier flows in alternate legs of a coil, saturating the track under it. In the read mode, small complementary impedance changes at the heads create differential voltage signals at the read amplifiers.

Head per track memories generally select heads in a two dimensional matrix. Heads, in an eight by 16 group, typically are mounted in a flying pad, which offers a larger and more stable aerodynamic surface than would individual heads. In the read mode, current flows from the source at the read amplifier through one of eight pairs of npn tran-

EXTERNALLY CLOCKED CODES

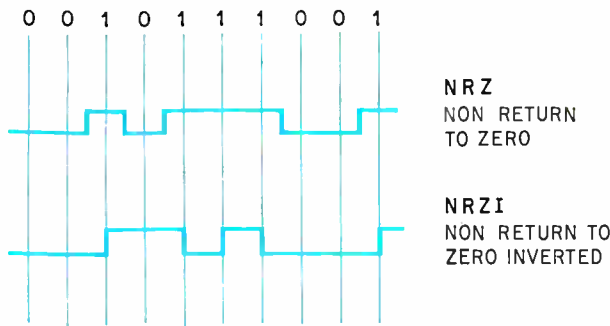

SELF CLOCKED CODES

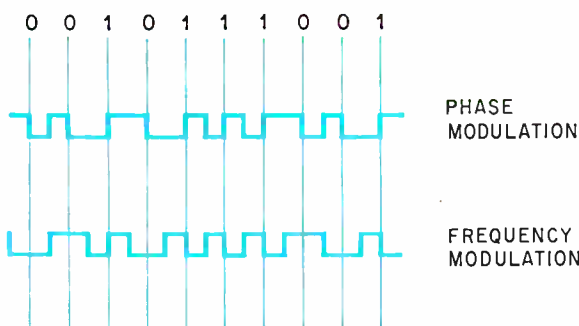

HIGHER EFFICIENCY CODES

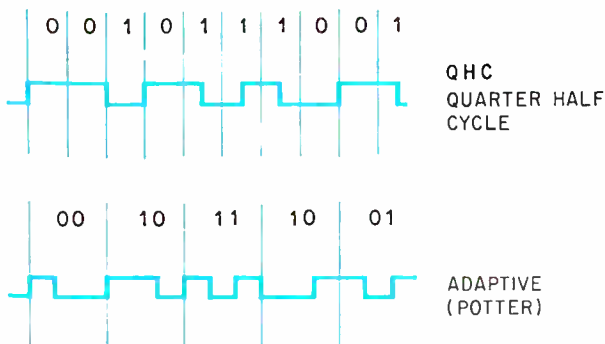

Ins and outs. Several types of codes are used for writing and reading in rotating drums and disks. Simplest are the NRZ and NRZI externally clocked codes. In the first, 1's are recorded as magnetic flux saturations in one direction, 0's as saturations in the opposite direction. In NRZI, only 1's are recorded as flux transitions. Phase modulation notes direction of flux transition in cell middle, whereas frequency modulation notes presence or absence of transition. Higher efficiency codes offer higher bit packing densities but are economical only for high capacity memories. Quarter-half-cycle code 0's are written as transitions at end of bit cell, and 1's either as transitions in middle or as no transition. Potter code records two data bits for every three flux transitions.

sisters to the center tap of one of 16 read/write coils and then to ground through one turned-on y-address transistor. Typical track switching times for two dimensional arrays are 25 microseconds, head impedance levels are 500 to 1,000 ohms in series with 10 to 20 microhenries, and write currents are 70 to 120 milliamperes.

Telling time

Rotating memories offer the user a choice of four general types of clocking schemes and several different code patterns. In the simplest scheme—used on low-cost, low-capacity memories—a separate clock track provides both read and write synchronizing pulses that define the boundaries of the data bit cells. With the NRZ (non-return to zero) and NRZI (non-return to zero inverted) codes, this track provides synchronizing pulses directly in the write mode. Thus, the write clock frequency depends on the speed of the rotating disk or drum, thereby compensating for any variations. In the read mode, the pulse is delayed half a bit cell period to provide the sampling signal for both the output shift clock and the data.

With this external clocking scheme, at high packing densities it's possible for the read-sampling clock pulse and data to get out of phase, producing errors. Also, the NRZ and NRZI codes don't produce pulses in every bit cell and, thus, the read amplifiers have to handle frequencies covering several decades nearly down to d-c.

In the NRZ code, binary ones are recorded as magnetic flux saturations in one direction, binary zeros as saturations in the opposite direction. Thus, this code only requires a flux change when changing from one binary state to the other, and trains of binary ones and zeros produce no read back pulses. In the NRZI code only ones are recorded as flux transitions and a train of zeros doesn't produce pulses. However, there's no timing problem with either code when using seven or nine channel tape recorders because each character contains at least one transition to generate the clock.

Another method—the most common way of recording data in phase-modulation or double-frequency-modulation codes—provides external clocking for writing, and self clocking for reading. Used by most of the major independent memory manufacturers—Vermont Research, the Bryant Computer Corp., and Magnehead, for example—this approach offers the highest recording densities and greatest reliability.

Both codes use up to two flux transitions for each bit cell. Phase modulation decodes data by noting the direction of the flux transition in the middle of the cell; double-frequency modulation, on the other hand, decodes by detecting the presence or absence of a transition in the middle of the cell. To read data, both codes reconstruct the clock from the encoded playback signal and then use the clock to decode the data bits. The codes are self clocking because at least one pulse appears in every data cell period during playback. For example, in dou-

ble-frequency modulation, a binary one equals the clock frequency and a binary zero equals half this frequency. Both f-m and phase-modulation codes are fairly immune to noise and errors from transition shifting.

The IBM 2311 disk memory uses double-frequency modulation and a precision oscillator to provide both read and write timing. Data is transmitted to and from the memory in trains of 150 to 50 nanosecond-duration pulses. This system is reliable and doesn't require separately recorded read- and write-clock tracks on the disk. But it requires two flux transitions to record each data bit. And it's subject to errors caused by variations either in the mechanical tolerances of the disk drives or in the oscillator.

Bits and pieces

Two firms, the Computer Peripheral Corp. and Potter Instrument, are offering higher bit packing densities through codes that require less than two flux transitions per bit. However, due to the elaborate electronics required, these schemes are only economical for memories with capacities over 25 million bits.

Computer Peripheral's method uses a version of the Miller code to obtain one data bit per transition. (In the Miller code, zeros are written as flux transitions at the end of a bit cell; ones are written either as a transition in the middle of a cell if the preceding bit is a one or as no transition if the preceding bit is a zero.)

Potter's adaptive code only records two data bits for every three flux transition periods, but it still offers the highest bit packing densities because it allows flux transitions to be spaced closer together. By contrast, phase- and frequency-modulation codes offer 1,200 bits and 3,000 bits to an inch respectively for flying head and head-in-contact memories.

Single transition per bit codes are harder to implement in memories for several other reasons besides needing additional encoding and decoding digital logic. Their reconstructed clock pulse doesn't appear in the same position in each data cell; the wide bandwidth of their detection amplifiers increases phase shifting, and the lack of symmetry in some data patterns increases error rate.

Yet, as the cost of integrated circuit amplifiers and decoding circuits drop, these codes should become more popular for large memories. At the same time, changing IC technology should favor self-clocked instead of NRZ and NRZI codes in smaller rotating memories.

Even though many rotating memories have separate clock and sector marking tracks—each with its own amplifiers—almost all have only one read amplifier and, thus, transfer data serially. The Vermont Research Corp., for example, sells a 4.2 million bit drum memory that has a bit transfer rate of 1.8 megahertz, or 225 bytes per second. If it had eight read/write amplifiers instead of only one, the bit transfer rate of this memory could be increased

to 14.4 Mhz, or 1.8 million bytes per second.

However, at least with high capacity memories parallel recording increases the possibility of skew (phase shifting) between tracks. In seven or nine channel tape transports, this problem is corrected by delayed sampling signals and, sometimes, by deskewing buffers.

Rotating memories use elaborate formatting schemes to indicate the bounds of fixed- or variable-length data blocks (records) and to synchronize free running external oscillators to detect read-back signals.

It is a usual practice to write "preambles" of one to ten bytes before blocks of data to synchronize the read circuits. And some systems, like the Magnehead drums and IBM disks, include guard bits at the end of each record. Between records there's usually a gap where there are no recorded signals. Envelope detectors in the read circuits identify these gaps as the extreme limits of blocks.

Files with fixed length records are the easiest to address and read since they don't require "count areas," or fields. In this type of formatting, sector blocks or markers are written onto the file by the seller and can't be changed by the user.

Since each record must be bounded by gaps, as the number of records on a track is increased the unusable space becomes greater and the data capacity decreases. Compromises are usually made between tracks containing many short records with many gaps, and tracks with one large record and maximum data capacity.

Signposts

Variable length formats waste even more data capacity. The IBM 2311 disk file uses this framing method. It contains synchronizing bits that indicate the number of bytes in variable data blocks and that note the status of each record. At the beginning of each record a "count area" contains status bits and field length bytes. Status indicators tell whether a track is usable or error prone, for example, if magnetic material has been rubbed off by a head crash. All commercial disk and drum memories have between 2 and 5% of their tracks set aside as spares. When a bad track is discovered, its records are rewritten on a spare.

Formats get quite complicated with very large disk files especially those used for high reliability, fast-access military applications that have redundant storage and storage-access mechanisms. These memories—generally movable head disk files with up to 90 heads per cylinder and parallel access channels—have one set of heads that read and write on one cylinder while another set performs a search for data.

If one data channel or head positioner requires maintenance, data is still accessible through the other channel. One popular disk file of this type, the IBM 2314, has nine independent disk files and packs that store a total of half a billion bits. Any eight of these packs are on-line at any one time. The ninth is a standby. ■

Identical resonators cut ceramic i-f filter cost

Computer-derived design tables supplied by resonator manufacturer ease selection of complementary capacitors for low-volume applications

By Franz L. Sauerland

Clevite Corp., Bedford, Ohio

Not ones to quibble over price, designers of high-performance military and commercial communications equipment have over the years used ceramic bandpass filters as fixed tuned replacements for conventional i-f transformers. Now, these filters are finally getting into the consumer market. Compared with conventional i-f transformers, ceramic filters provide better selectivity, have lower insertion loss, never require alignment and, because they're smaller, are ideal for solid state circuit application.

However, the conventional ceramic filter's design and manufacture represent a special art; each filter resonator must be designed for a particular application, and many different resonator types must thus be made. It was virtually impossible for a user to design and build his own ceramic filters.

But a new universal-type filter design approach can now be used to decrease ceramic filter costs in many low volume applications. Using two or more standard identical resonators and standard capacitors, a radio set designer, for example, can put together his own 455-kilohertz, intermediate-frequency filter, of any complexity, with a continuous range of bandwidth and selectivity. And the required capacitance values for the desired response curves can be determined from a set of design tables supplied by the resonator manufacturer. Many different applications can in this way be served by the same mass-produced resonator. Compared with conventional specially designed ceramic filters, identical resonator filters provide many performance advantages, such as the suppression of spurious responses and a wider range of realizable filter responses. However, these advantages are bought at the expense of additional capacitors in the filter network.

In the equivalent circuit of a basic ceramic resonator, the impedance, Z , is minimum at the resonant frequency of the circuit as expressed by the

well-known equation for resonance

$$f_r = \frac{1}{2\pi \sqrt{LC}}$$

and is maximum at the antiresonant frequency,

$$f_a = f_r \sqrt{1 + \frac{C}{C_s}} = f_r + \Delta f$$

Of the many filter networks that can be selected for the desired bandpass, the ladder filter is the least sensitive to variations in component tolerances and circuit terminations. Most conventional ceramic filters use the configuration at top right, for n ladder branches with one resonator—a different one for each filter characteristic—per branch. The network is costly due to the number of resonators required. In addition, spurious passband is difficult to suppress when many resonators are used. For example, consider the response curves at right for a simple two-resonator ladder filter. The curves refer to different C_{s2}/C_{s1} ratios, where C_{s1} and C_{s2} are, respectively, the shunt capacitances of the resonators in the series and shunt branches. The upper limit for the capacitance ratios that can be practically achieved is about 30, resulting in a stopband rejection of only about 25 decibels.

Unfortunately, this rejection is not enough for most applications. For in the case of high performance filters, it would be necessary to cascade several additional ladder branches to achieve adequate stopband rejection. This type of ladder network becomes economically impractical in the consumer market, which is limited to using no more than two or three resonators.

The spurious responses of the resonators place another limitation on the ladder network approach. These are undesired resonances that occur in addi-

tion to the desired response, and produce gaps in the filter stopband. However, if the resonator geometry is optimized the more serious spurious responses can be suppressed, and the remainder can be shifted to frequencies far away from the filter passband.

High capacitance ratios C_{s2}/C_{s1} require unusual resonator geometries and hence preclude resonator optimization for spurious responses. Consequently, most conventional ceramic filters have problems with undesired responses and usually require a tuned LC circuit in the filter structure or in the i-f circuitry to increase the stopband rejection.

Most of the handicaps of the conventional ceramic filter can be overcome by designs having identical resonators. The identical-resonator filter, on page 104, which has two identical resonators and three capacitors, is electrically equivalent to the simple two-resonator conventional ladder filter. By simply changing capacitance values, the designer can achieve a continuous range of filter responses, including those with higher stopband rejection than a conventional structure could achieve.

Steep skirts

The response curves shown below are typical for identical-resonator filters—note the steep filter skirt produced by the close-in insertion loss peaks at either side of the passband. This feature is lacking in i-f transformers as well as in most crystal and mechanical filters, which produce insertion loss peaks far away from the passband where they are of less help to the passband selectivity.

The peaks in the lower and upper stopband correspond to the resonant and antiresonant frequen-

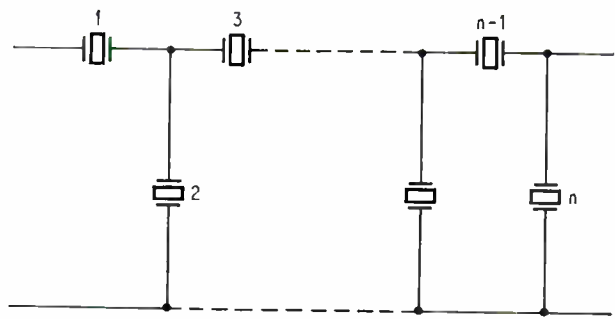

Extension ladder. Requiring a different set of resonators for each desired response, this network consists of n branches with one resonator per branch.

cies, f_r and f_a , respectively, of the resonators and are due to the virtual short circuit of the shunt resonators at f_r , and the virtual open circuit of the series resonators at f_a . The peak bandwidth, P , is equal to the resonator parameter $\Delta f = f_a - f_r$. The frequency stability, 0.1% over a temperature range of -20°C to $+60^\circ\text{C}$, and Q , which is 500, of the resonators assure good filter performance.

The identical-resonator principle can be extended to obtain more complex filter structures. For instance, a filter with 10 identical resonators can produce a response with a 6-dB bandwidth of 20 kHz, a 60/6 dB skirt ratio of 1.4. Sometimes it may also be desirable to include a tuned transformer at the input of the ladder network to provide impedance transformation and d-c conductance.

However, identical-resonator filter fabrication would be difficult without computer-derived design

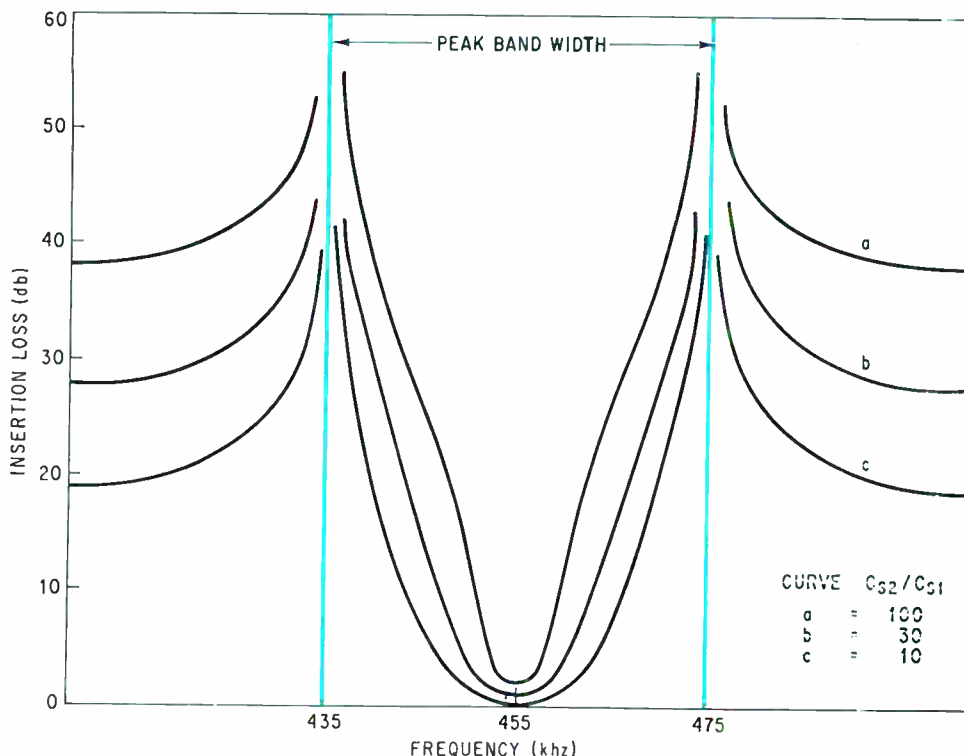

Performance curves. When ratios of shunt capacitance in the series and shunt circuit branches of a simple two-resonator filter are increased, stopband rejection and insertion loss also increase.

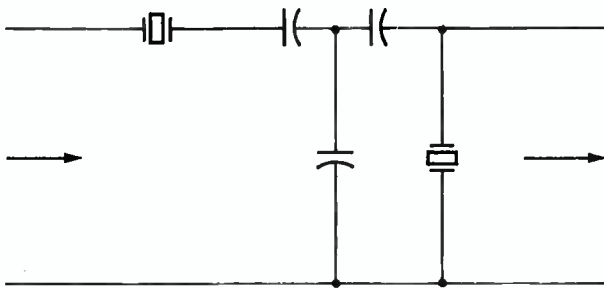

Identity. Designed with two identical resonators and three capacitors, this filter is equivalent to a standard two-resonator ladder structure.

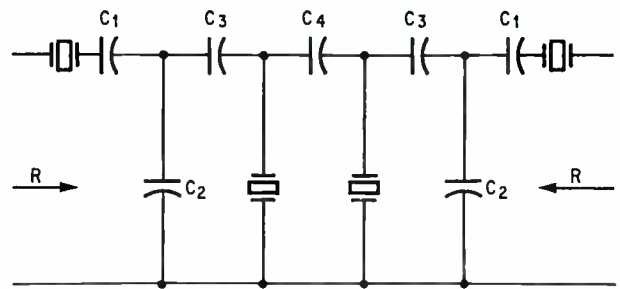

On the table. Precise capacitance values of a four-resonator network can be determined by reference to the manufacturer's computer-derived table.

tables developed to relate filter responses and corresponding sets of capacitor values for specific networks. At present there are two different types of identical resonators that operate at the 455 kHz frequency. Both of these have a shunt capacitance, C_s , of 250 picofarads but they differ in their Δf value, which is 26 and 40 kHz, respectively.

The table at the right lists excerpts of values for a four-identical-resonator network at upper right. In this table, the filter response is specified by the 6-dB bandwidth B_6 , peak bandwidth P , insertion loss IL , minimum stopband rejection S , and the bandwidth B_s measured at the rejection level S . In addition, the table lists the standard Electronic Industries Association capacitor values and the filter termination impedances, R .

Using the table

As an example of how to use the design table, consider the need to design a four-identical-resonator filter like the one at upper right, with $B_6 \geq 7$ kHz, $S \geq 40$ db, and $B_s \leq 22$ kHz. The specifications are first upgraded by 10% in order to compensate for tolerances and environmental effects. Hence, $B_6 \geq 7.7$ kHz, $S \geq 44$ db, and $B_s \leq 20$ kHz. These requirements are satisfied for the line in the table with $B_6 = 7.9$ kHz. The resulting filter response is shown in curve I, at right, referred to zero db at center frequency. Sometimes it may be necessary to interpolate between table entries. This can be done by plotting the table values as continuous functions of B_6 .

The identical-resonator filter is a fixed-tuned device and can't be adjusted after installation. As a result manufacturing tolerances and environmental changes of the filter elements, as well as input and output terminations, must be capable of maintaining the filter performance within practical limits. Computer tolerance studies have been made based on the characteristics of commercially available identical resonators, and on operating temperatures between -20°C to $+60^\circ\text{C}$. They reveal that if the capacitor tolerances stay within $\pm 10\%$, and the filter terminations are within $+100\%$ and -50% of their nominal values, filter response variations will then be within $\pm 10\%$ of the nominal tabulated values for B_6 , B_s , P , S , and $\pm 0.5\%$ for the center

Filter design table

P kHz	B_6 kHz	S db	B_s kHz	IL db	R	C_1 pf	C_2 pf	C_3 pf	C_4 pf
26	2.0	72	20	14.0	720	300	2,200	270	20
26	3.7	61	20	6.6	760	330	1,000	300	39
26	5.8	53	20	4.0	795	360	620	300	62
26	7.9	46	20	2.8	813	390	430	360	91
26	10.1	41	20	2.4	836	390	330	470	120
26	12.3	36	20	2.2	836	360	240	680	150

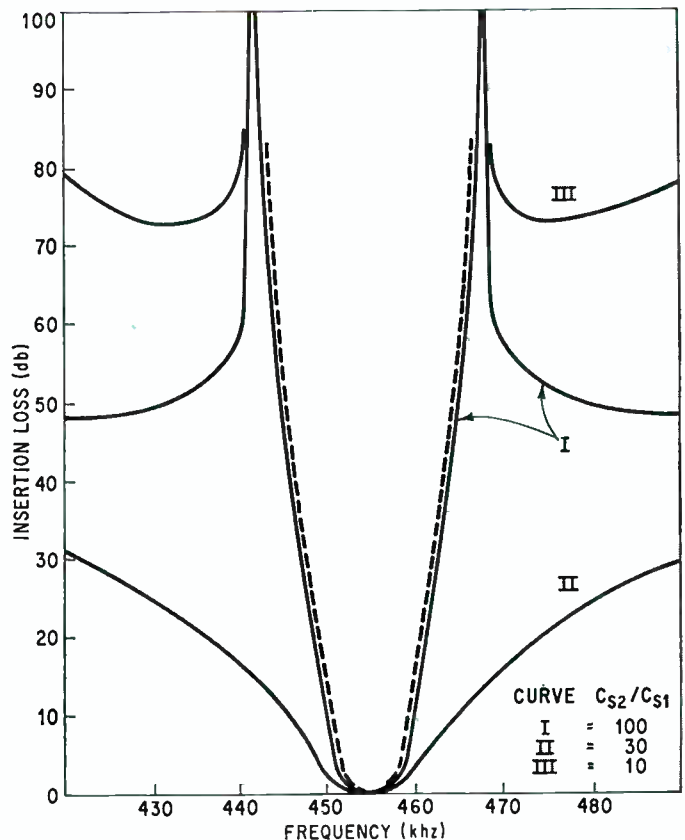

Upgraded. Curve showing response of four-resonator filter with capacitance values selected from design table reflect upgrading of design specs.

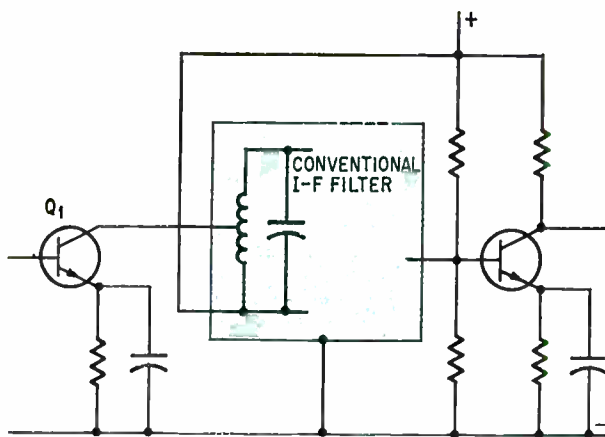

Conventional filter. Input impedance matching is achieved by a tapped inductance which also provides a d-c path for Q_1 's collector current.

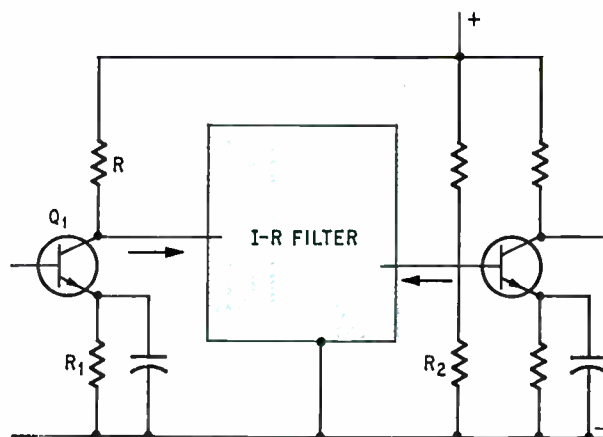

Identical resonator filter. Transistor Q_1 's collector current is provided by R, which also represents the input impedance to the filter.

frequency, while the maximum ripple will be less than 0.5 db.

Hence, the required capacitors may, for example, have a $\pm 5\%$ manufacturing tolerance, with an additional $\pm 5\%$ allowed for temperature variations. Suitable polystyrene, mica, and ceramic capacitors are commercially available.

A conventional approach to i-f circuitry would be to use an identical-resonator filter with an LC transformer at the input terminals. However, in applications with transformerless identical-resonator filters, standard practices must be somewhat modified to allow for the lack of d-c conductance and impedance adjustment at the filter terminals. Usually, the modifications are needed only at the filter input, since the output terminations are easily matched to the impedances—about 0.5 to 2 kilohms for typical solid state i-f circuitry—and generally do not require d-c continuity.

The conditions at the filter input can be demonstrated from the application of a typical conventional filter, shown at left above. The tapped inductance between the filter input terminals serves as an impedance transformer and as a low-resistance d-c path for the collector current of Q_1 .

In the identical-resonator filter application, right, collector current is provided by resistor R, the correct value of which is determined by a compromise between the voltage drop across R and the stage gain. This value may range from 2,000 ohms up to 15,000 ohms in conventional solid state circuits. This is, essentially, the circuit impedance that's "seen" by the filter input, since the internal collector impedance of Q_1 is high compared to R. Hence, the filter input impedance, R_1 , must be matched to R. This can be accomplished by choosing an identical-resonator network with suitable termination impedances from the design table.

Because of their versatility, identical-resonator filters are suitable for most 455 kHz applications and are also useful in dual conversion a-m and f-m radio systems. Their close-in insertion loss peaks comple-

ment the usual Chebychev-type response—with insertion loss peaks at zero and infinite frequencies—of LC or crystal filters in the first conversion stage to produce a highly selective overall response.

In portable radios

The two-resonator filter is suitable for replacing i-f transformers in low-cost portable radios. By adding the selectivity of the identical-resonator filter to that of the r-f stage—assuming a minimum loaded Q of 30 for the r-f stage—an overall selectivity of $B_6 \geq 7$ kHz, $B_{60} \leq 60$ kHz, and a stopband rejection of more than 50 db can be obtained.

The four-identical-resonator filter was designed for a hi-fi receiver with allowance made for selectivity of the r-f stage, and a single tuned i-f transformer following the mixer, and separated from the identical-resonator filter by a gain stage. Curve II of the filter response chart represents the combined selectivity of the r-f and first i-f stages, assuming a loaded Q of 35 for both stages. Curve I is the identical-resonator filter response, and curve III is the nominal overall receiver selectivity, with $B_6 = 8$ kHz, $B_{60} = 20$ kHz, and a minimum stopband rejection of 73 db. This response would also be acceptable for some two-way communications gear, such as citizen-band equipment.

Identical-resonator filters have strongly suppressed spurious responses. If necessary, all their undesired responses—up to about 4.5 megahertz—may be suppressed beyond the minimum rejection level B_s , by assuring that the series resonant frequencies are higher for shunt than for series resonators.

If, for example, the frequency tolerance of standard identical resonators is $f_r \pm \Delta$, then the shunt and series resonators should use the ranges $f_r + \Delta$ and $f_r - \Delta$, respectively. If the undesired responses at frequencies higher than 4.5 Mhz are objectionable, they may be eliminated by incorporating RC low-pass filtering of a single tuned i-f transformer in the i-f circuitry. ■

Nonstop limiter absorbs transients

Series type regulator uses power transistor in full wave bridge to get a controllable impedance function for a-c equipment.

By Martin Kanner

Grumman Aircraft Engineering Corp., Bethpage, N.Y.

A spiky issue in any system is the line transient. How to protect against it? A sensing circuit and a fuse provide the simplest safeguard. But what if the equipment must operate without interruption? Here, fuses are out of the question. The only solution is to design the system to handle the overvoltage. Perhaps the most demanding in this particular design area are airborne military systems which are generally specified to handle long-term voltage transients on both a-c and d-c supply lines.

Once the overvoltage is specified, it would be a relatively easy task, by selecting solid state components and designing circuits, to build a system which can handle a voltage spike. However, this approach has its own problems. For one thing, the cost of these devices, transistors in particular, rises sharply as a function of voltage rating. In addition, the size, weight and power consumption of the final electronics package could prove unwieldy. Rather than overdesign the system, it's better to introduce a small package directly in the line to limit the voltage transients. Such a package should meet the following requirements:

- Minimum power dissipation while protecting against an overvoltage.
- Minimum voltage drop under normal line voltage conditions.
- No interference with the operation of the system being protected during and after exposure to a voltage transient.
- Operating characteristics that can withstand a broad temperature environment.
- Minimum size, weight and cost.

Devices that meet these specifications are generally classed as series regulators or shunt regulators. Shunt limiting with a triac or back-to-back zener diodes and a series resistor would work, but in each case there would be a voltage drop of about 6 volts during normal operation and about 5 times the normal power would be dissipated during the peak transient condition.

Because of these disadvantages, a series type regulator should be used. Under normal line conditions the series impedance is kept as low as possible to minimize the voltage drop across it. When the voltage applied to the electrical equipment exceeds a predetermined level, the excess is sensed and a control signal is developed which increases the impedance of the series element. Essentially the circuit is a feedback loop which maintains a constant voltage, even if an overvoltage is present.

As an example of this concept, consider the limiter circuit shown at the right for an electronic system that normally draws 1 ampere at 115 volts, 400 hertz and has a turn-on surge of 3 amps. The controllable impedance function is accomplished by reflecting the variable d-c impedance of a transistor as a variable a-c impedance through the use of a full-wave bridge rectifier. The circuit is designed to allow for the saturation of the transistor over the normal range of line voltages. The output is fed back and compared to a reference in a summing junction—actually, the transformer. In addition to these signals, the level of the input voltage is also fed forward.¹ When the output voltage exceeds a preset level, an error voltage is developed which is amplified to bring the series transistor out of saturation, maintaining the output at the predetermined maximum level.

Adaptable

This configuration can be adapted through slight modifications to other line frequencies and loads. For example, for the same load on a 60 hz line, only the transformer would have to be redesigned. In addition, by specifying a higher-gain series transistor, two to three times the previously mentioned load current could be handled.

Specifically the circuit works by coupling the feedback output and feed-forward input voltages through resistors R_2 and R_1 respectively to transformer T_1 . T_1 then steps down this combined volt-

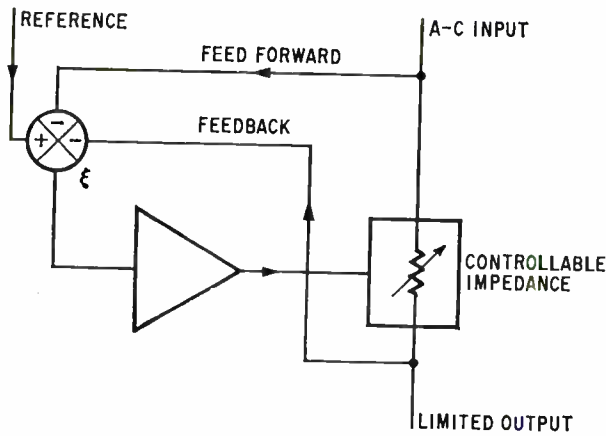

Junction. The transformer acts as a summing point where the reference signal is combined with the feedback and feed forward signals to control Q_1 .

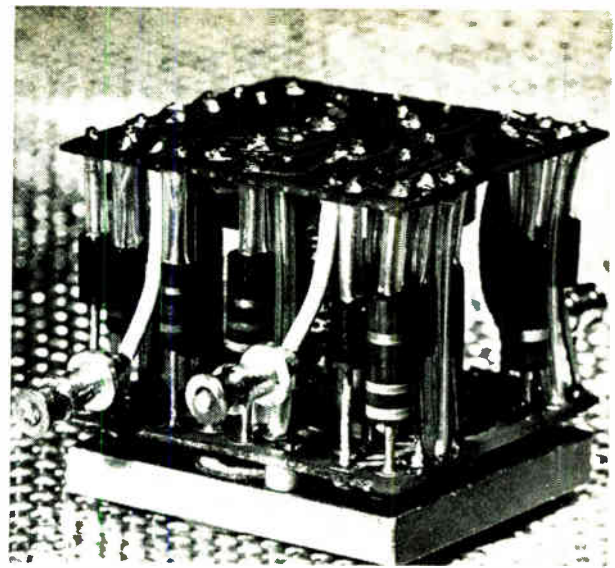

Stacked. When the components are assembled with cordwood construction methods, the entire circuit can be built in a $1\frac{1}{4}$ -inch cube.

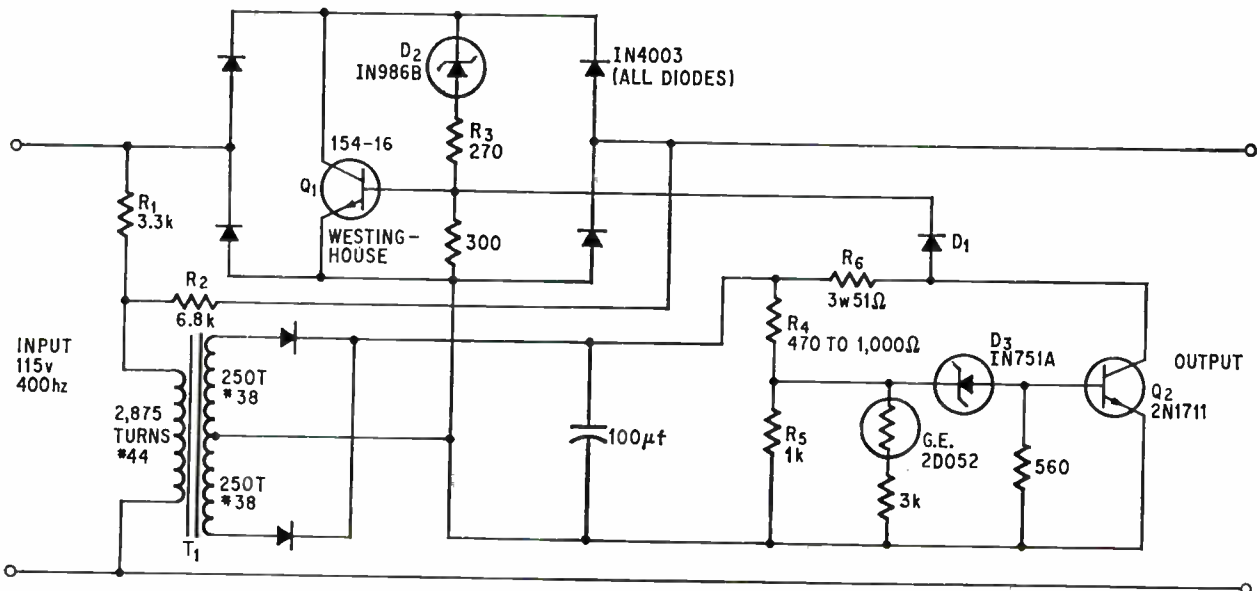

Winding. The two key components in the design are Q_1 and T_1 . Q_1 is a Westinghouse type 154-16, rated at 160 volts and 7.5 amps. T_1 consists of a square stack of EI-187 laminations, and 2,875 turns for the primary and 500 turns center-tapped for the secondary wound on a core of 6-mil oriented silicon steel.

age, and the isolated center-tapped secondary is rectified and filtered. This stepped-down voltage saturates Q_1 thru R_6 and D_1 and at the same time, under normal line conditions, the voltage at the junction of R_4 and R_5 isn't high enough to break down the zener, and therefore Q_2 is cutoff. The value of R_4 is selected so that if the input line exceeds 125 volts rms, D_3 breaks down turning on Q_2 , which brings Q_1 out of saturation. Connecting D_2 and R_3 between Q_1 's collector and base protects Q_1 by limiting the maximum voltage applied across its collector-emitter junction.

Normally, considerable fluctuations occur as a function of the ambient temperature due to the temperature coefficients of the various components. However, a thermistor included in the circuit keeps

these variations within acceptable limits. In the circuit shown, for example, over a range of -40°F to 160°F , the turn on of Q_2 does not vary more than 3 volts rms with respect to the input line.

The complete limiter cost about \$35 when the parts are purchased in lots of 100. The limiter package meets both the physical and thermal considerations. Fabricated using cordwood construction techniques, as shown above right, the complete assembly, including a $\frac{1}{8}$ -inch thick copper heat sink, can be packaged in less than a $1\frac{1}{4}$ inch cube. And operation up to 145 volts can be achieved if the cube is mounted on a large thermal sink.

Reference

1. R.L. Duthie, "Feed forward can improve feedback controls," *Control Engineering*, May, 1959, p. 136.

Millimeter waves for ships

Portable transceiver for tactical military conversations transmits at 37.5 Ghz; use of f-m with feedback increases receiver sensitivity

by Rudolf Marso and Anthony Mondloch

Sylvania Electronic Systems, Williamsville, N.Y.

Pressing the limits of a technology sometimes pays immediate dividends in production of a working device. Witness a solid state millimeter-wave transceiver that puts out 50 milliwatts.

Developed for the Navy by Sylvania Electronic Systems, this set handles conversations over distances of 15 nautical miles. Because the transceiver uses solid state components only, it's portable, highly reliable, and easy to maintain. It's intended for tactical communications, for example, those from a ship to several battle stations on the shore.

Selecting a carrier frequency in the millimeter part of the spectrum made it possible to transmit a highly directional signal using a small antenna. Sylvania achieved the power required for the receiver to pick up a usable signal at 15 miles by designing a varactor multiplier chain. And a little-used technique—f-m with feedback demodulation—increased receiver sensitivity, helping to ensure understandable transmission in light rain or fog. Coupling off transmitter power to the receiver, instead of using another chain as a local oscillator, helped reduce cost.

After demonstrating the feasibility of short-haul millimeter communications with several tests on a prototype transceiver, Sylvania built the present set, incorporating such advances as 350-megahertz power transistors. The new transceiver, the AN/URC-70(XN-1), transmits and receives one voice channel and, at the same time, can detect a tone indicating that another call is waiting. The set is now being modified to handle 12 conversations. The Navy is testing the single channel version.

The set weighs 60 pounds and can be aimed by hand when mounted on a tripod or standard signal searchlight yoke. It has three antennas, two 30-decibel lens-horn combinations for transmission and reception of the communication channel and a 25-db horn for detecting call-alert tones.

Using transmitter power as the local oscillator signal eliminates the need for a tube or multiplier

chain in the receiver. But it also means that the transmitter must be tunable so the calling and called transceivers can be operated at different frequencies. The reduction in size and cost, however, more than compensates for the disadvantage of switching from one frequency to another to set up a conversation.

When the design was begun, the power required for the transceiver could have been obtained either from reflex klystrons or varactor chains of the type developed by Sylvania in other millimeter-wave projects. Klystrons and their power supplies are cheaper, but they require expensive frequency control circuitry, so the over-all cost is as high as that of varactor chains.

In almost every other respect, multipliers have the edge. They operate with much lower input voltages; as a result, their power supplies can be lighter and smaller. They can be tuned by switching in different crystal oscillators; klystrons, on the other hand, must be voltage-tuned and frequency-locked automatically—a complicated procedure. Multipliers are more reliable and more resistant to shock and vibration. Indeed, about the only plus for klystrons is their higher stability under varying temperatures.

The decision to use multipliers determined the choice of modulation. F-m was picked because varactor chains are most stable and linear when they're operated at constant power levels. A-m at a low-frequency point in the chain would preserve stability but not linearity; at a high-frequency point, the modulator components that would be used would cut power sharply.

Another advantage of f-m is that it can improve the carrier signal-to-noise ratio if a high modulation index is used. This is particularly important in reducing the effects of signal fading over water. Tests on the prototype unit showed that fading occurred only for short periods at rates up to a tenth of a cycle per second. Since the signal remained above



Amphibious tests. The Army put a prototype of the transceiver through its paces in ship-to-shore tests near San Diego, Calif. The service removed the scanning antenna to increase portability.

the receiver threshold most of the time, f-m kept noise from increasing during these fading periods.

To ensure understandable transmission in all weather except heavy rain and thick fog, designers set the carrier-to-noise ratio at 10-dB and added a 15-dB margin for fading and bad weather.

To obtain the required ratio, several parameters could normally be varied. However, power output was limited by the state of the art, antenna gain by the need for compact structures, and noise figure by that available in commercial mixers. That left intermediate-frequency bandwidth as the only variable.

This i-f bandwidth can be determined after calculating both the receiver sensitivity, $(kTBF)(C/N)$, and the minimum power transmitted to the receiver and setting them equal to each other. The minimum power at the receiver is the sum of the following

factors: 17 dBm for the 50-mw output power, 30 dB for the transmitting antenna gain, 30 dB for the receiving antenna gain, -153 dB for the free-space loss (which accounts for range and beam spreading without attenuation), and -2 dB for atmospheric loss. Therefore, power at the receiving antenna is -78 dBm.

Thus,

$$[kT(B_{Hz})]_{dBm} + F_{dB} + C/N_{dB} = -78dBm$$

with $kT = -174 \text{ dBm/Hz}$

$$-174 \text{ dBm/Hz} + B_{Hz}(dB) + 13dB + 25dB = -78dBm$$

$B_{Hz} = 58 \text{ dB}; B = 630,000 \text{ Hz}$

Because it's relatively easy to stabilize the output frequency of solid state components, it was feasible to choose an even narrower i-f bandwidth, 400 kilohertz, and this added 2 dB in noise margin. And

Millimeter Power		
	Varactor multiplier chain	Reflex klystron
Power available, mw	50-100	50
Power dissipation, watts	40	50-100
Voltage requirements, volts d-c	+28	2000, -100, -150
Current requirements, amps d-c	1.5	.025 at 2 KVDC
Heater requirements		6.3 VAC at 1 amp
Frequency control	crystal	cavity
Short-term frequency stability	± 2 parts in 10^7	± 1 part in 10^5
Size, ft ³	$\frac{1}{2}$	1
Weight with power supply, lbs.	25	50

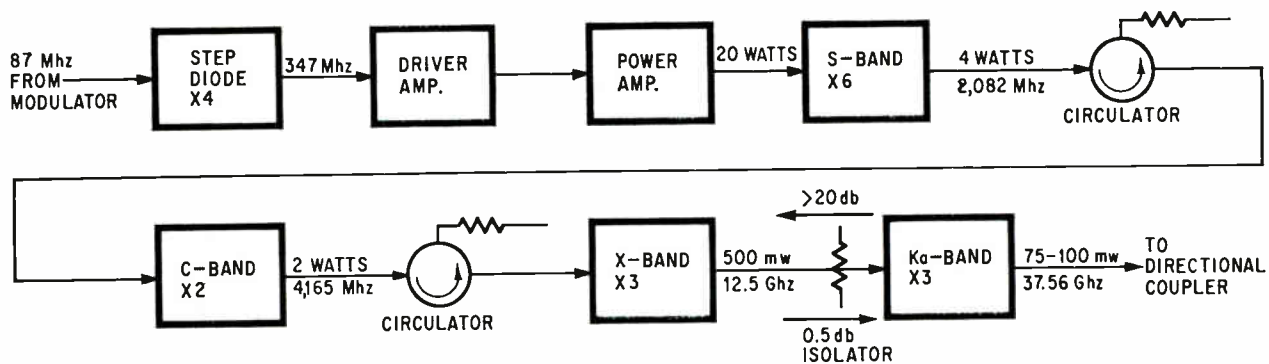

Important link. Varactor multiplier chain uses doublers to maximize efficiency, triplers to conserve space.

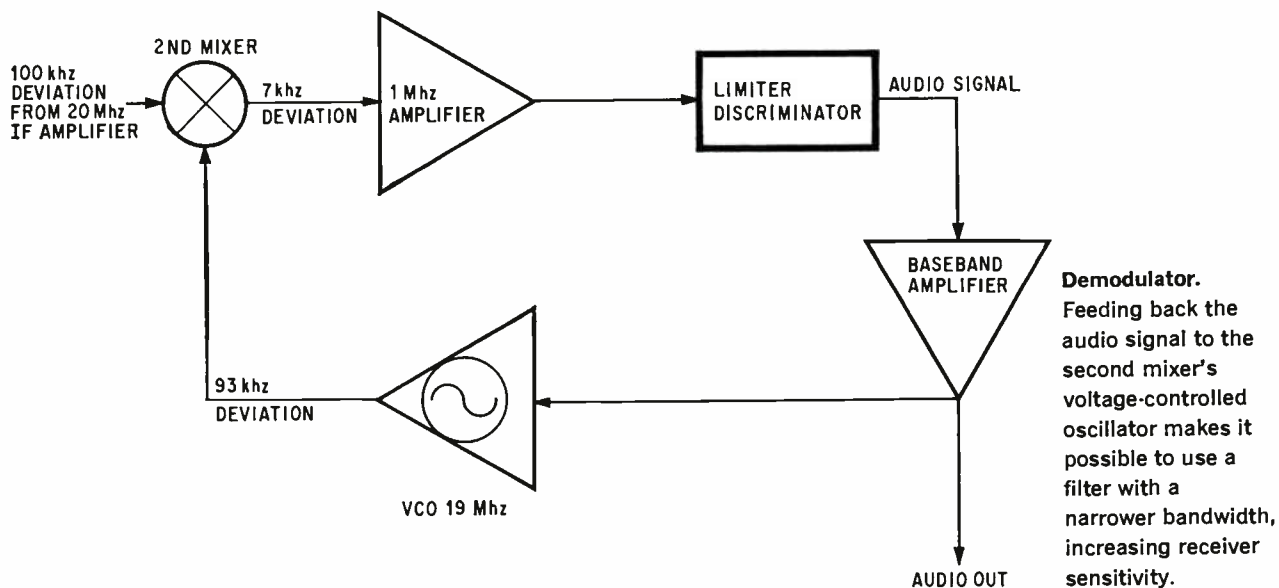

Demodulator. Feeding back the audio signal to the second mixer's voltage-controlled oscillator makes it possible to use a filter with a narrower bandwidth, increasing receiver sensitivity.

f-m with feedback demodulation lowered the receiver threshold, increasing the margin by 5 db.

Within the set's transmitter are a crystal oscillator, modulator, and amplifier. Housed in a proportionally controlled oven, the oscillator operates at about 87 Mhz, with a long-term stability of ± 2 parts in 10^7 . It contains three crystals whose frequencies are multiplied to 37.49, 37.50, and 37.51 Ghz. Switching to the appropriate crystal places the set in the call-receive, calling, or called mode.

Essentially, the modulator is a two-pole bandpass filter. Audio signals vary the bias on the varactor diodes making up the capacitive part of this resonant circuit. Integrating the audio signal before it passes through the varactors gives an f-m, rather than a phase-modulated output.

A step-recovery diode then quadruples the frequency of the modulated signal, and a series of amplifiers boosts its power. At the final amplification stage a parallel pair of 2N5016 transistors provide 20 watts at 347 Mhz.

In the varactor multiplier chain doublers are used to maximize efficiency and triplers to save space. The final tripler circuit was borrowed from another Sylvania design.

The multiplier chain starts with a lumped-circuit doubler and a distributed-circuit tripler module. Their 4-watt 2,082-Mhz output is isolated by a circulator from the next module, a varactor doubler in a stripline configuration. This doubler consists of a low-pass input filter, diode, and a bandpass output filter and uses capacitive fine-tuning screws. A circulator isolates its 2-watt output and simplifies tuning of its 4,165-Mhz signal. A tripler then provides 500 mw at 12.5 Ghz, and a ferrite isolator separates this signal from the final tripler, whose output varies between 75 and 100 mw at 37.5 Ghz.

Power goes to the transmitter antenna and through a 10-db coupler to the receiver mixers. A variable attenuator allows adjustment for increasing or decreasing range to maintain privacy.

Both transmitting and receiving antennas consist of flared waveguide horns, which feed a quarter-zone Fresnel lens. Their 5-inch apertures have 30 db of gain and about 5° beamwidth in both planes, transmitting and receiving vertically polarized signals.

The received signal is combined with the local oscillator signal in a balanced mixer, providing a 20-Mhz i-f. The f-m feedback demodulation circuit

processes the signal further, translating it down to 1 Mhz in a second mixer. The signal is then amplified and demodulated in a limiter-discriminator, which sends the baseband (audio) signal to the headphones and feeds it back negatively to the second mixer's voltage-controlled oscillator.

Since the deviation of the vco frequency corresponds to that of the audio signal, the oscillator reduces the frequency deviation of the input f-m signal. Thus, a narrower filter than required in conventional f-m receivers can be used to pass the 1-Mhz signal. A baseband amplifier and low-pass filter determine the amount of feedback and control the closed loop bandwidth. F-m feedback demodulation increases sensitivity 5 to 60 db beyond that of conventional limiter/discriminators.

As the audio signal leaves the demodulator, it's amplified again and matched in impedance to the transceiver headphones.

To make a call, the operator switches to the CALL frequency. A 1-khz tone then modulates the transmitted signal, and a conventional limiter-discriminator in the call receiver of the second set demodulates this tone, exciting a lamp in an azimuth display. Mechanically linked to a scanning antenna, this display helps find the direction of the calling transceiver. The beamwidth of the scanning antenna—a 25-db standard waveguide horn—is about 8°.

On CALL the transmitted signal is 10 Mhz away from the signal sent from the called set. On offset it's 20 Mhz away. Calling parties stay on OFFSET,

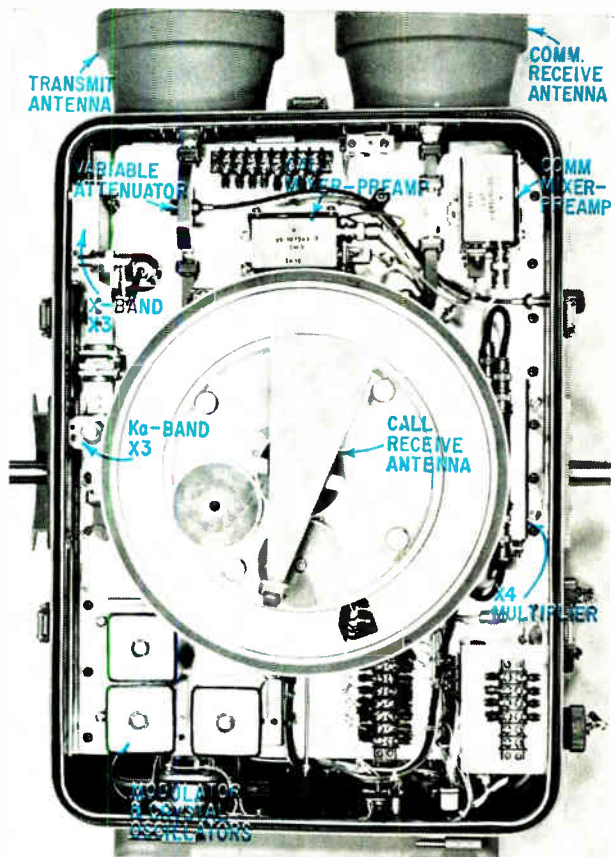

Full turn. Turning on the transceiver causes the scanning antenna to rotate continuously as it searches for call.

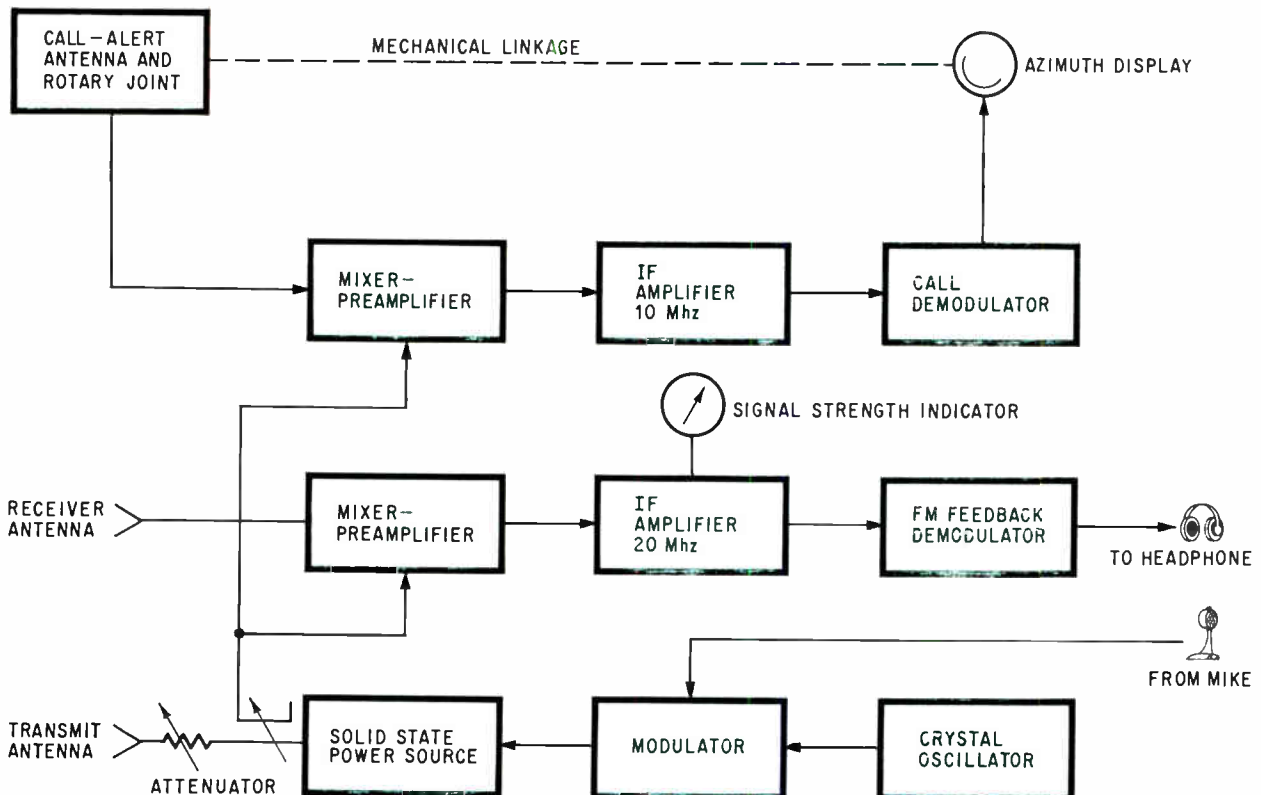

Compact. Using transmitter power as the local oscillator signal for call-alert and receiver mixers is one of the design choices that minimized size and cost.

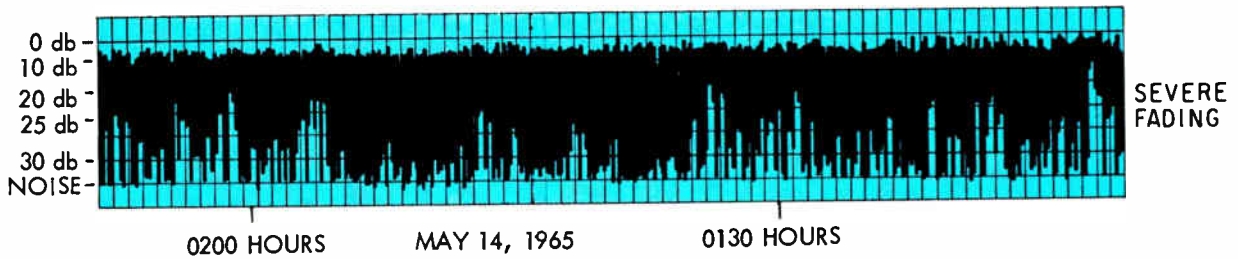
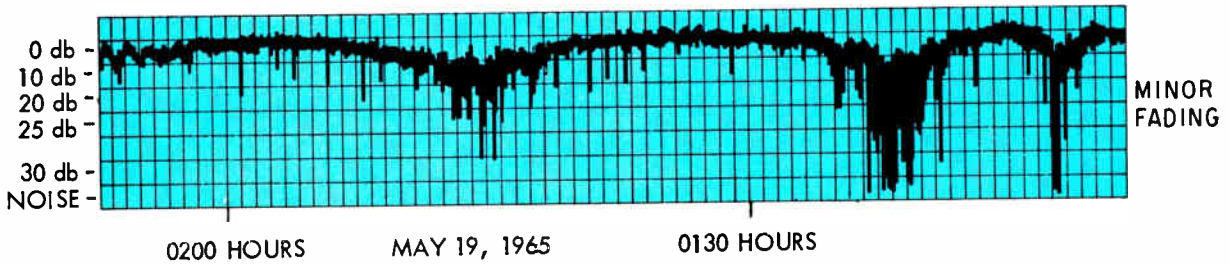
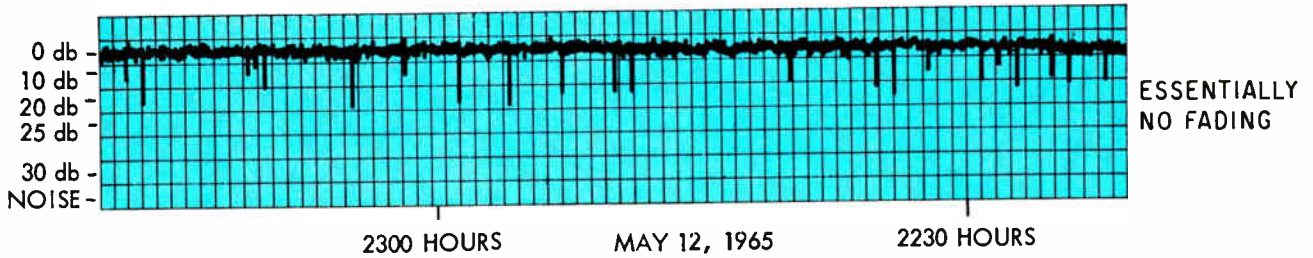

Fading. Transceiver tests in the Chesapeake Bay area show how signal fading varies. Strong fading was very infrequent.

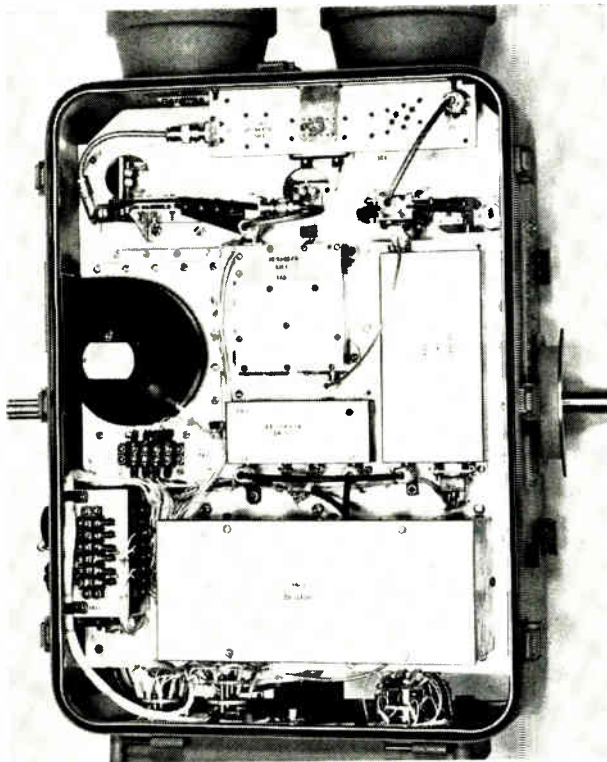

Maintainable. All transceiver circuits are grouped in modules and mounted on the same heat sink.

called parties on NORMAL. Communication can be maintained by keeping the signal strength indicator at maximum or by visual aiming.

Packaging and performance

The millimeter transceiver is designed for easy maintenance and protection against the weather. Whenever possible, printed circuits were used; all receiver circuits except the mixer and all transmitter circuits through the power amplifier are on cards. Everything is grouped into modules, and all transmitter circuits, except the audio portion, are placed in separate boxes to reduce r-f interference and feedback from the high-power signals.

Forced-air cooling and the mounting of heat dissipators on a heat exchanger running the width of the case were necessary to handle the high temperatures developed. Both the case and the audio and signal lines are sealed and protected from r-f interference.

The prototype transceiver was tested near Buffalo, N.Y., Washington, and during an amphibious exercise on the Pacific coast. Understandable voice signals could be transmitted over 15 miles, depending on the antenna height and on the weather. During a test over Chesapeake Bay, the signal faded briefly by amounts ranging from 1 to 30 db. Strong fading, however, was infrequent. ■



Sampling Heads . . .

Plug-ins for a Plug-in

INPUT Z
IN OHMS

10 M
P6010

1 M
RG-58

100 k
S-3 Probe

1.5 k
P6035

300
P6034

50
RG-8, 3 mm

PERFORMANCE CHART — IMPEDANCE VS RISE TIME

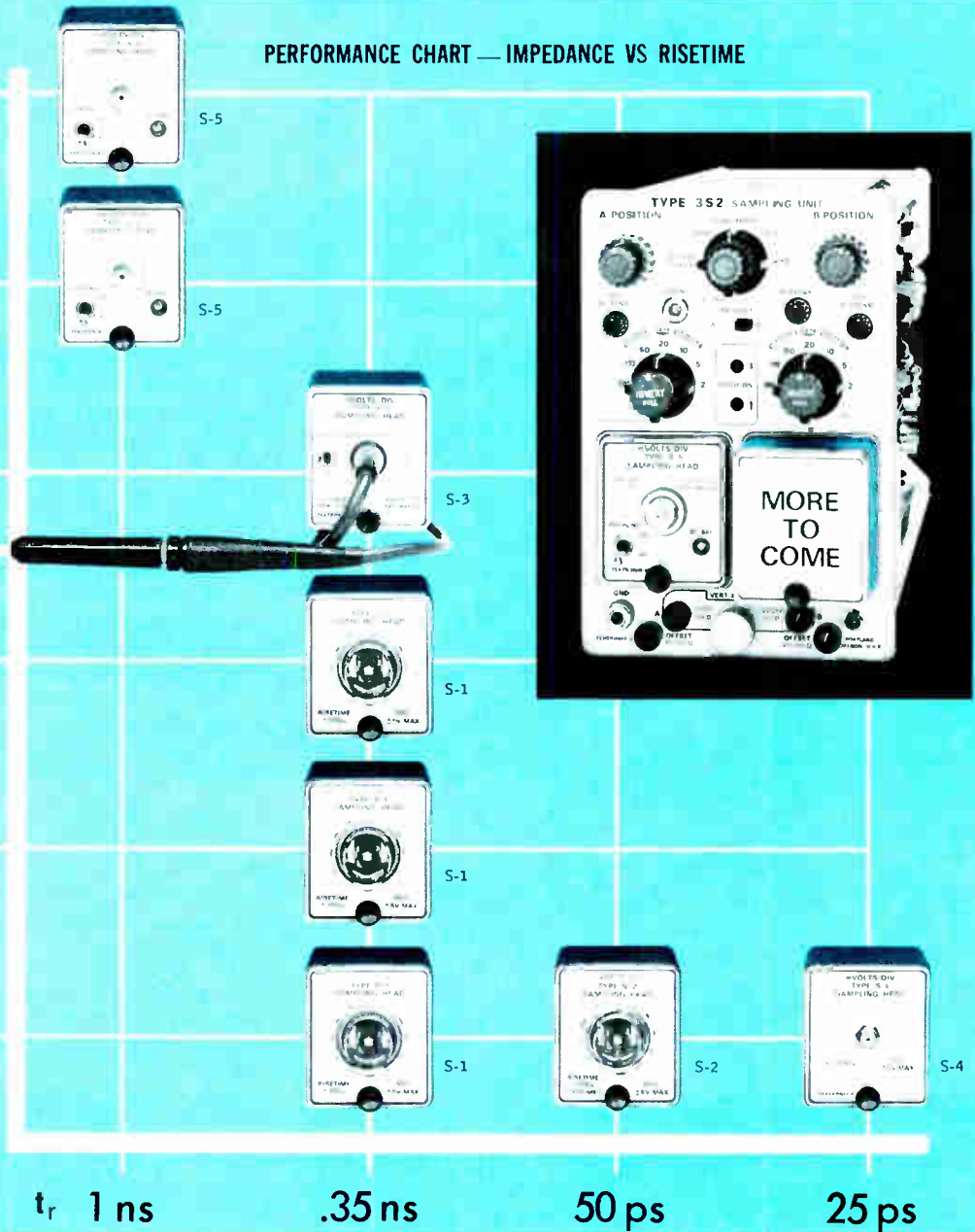

The Type 3S2 Dual-Trace Sampling Unit and the programmable Types 3S5 & 3S6 feature a choice of five sampling and two auxiliary heads, offering a step-ahead in measurement performance, convenience and versatility. Sampling heads are plugged into the Type 3S2 directly or used remotely at the end of a three- or six-foot extender cable. Use of extender cables minimizes the need for signal cables. The ability to put the sampling head at the signal source eliminates cable distortion and permits dual-trace displays of 25-ps signals originating at different locations. A front-panel control provides adjustment of the

interchannel time relationship to compensate for signal delay. Crosstalk between display channels is eliminated by the shielding afforded by completely separate sampling heads. The physical independence of the two channels further permits intermixing of head types. Performance and input configuration may thus be matched to the particular measurement requirement. No longer is it necessary to purchase a complete dual-trace sampling unit when your measurement requirements change.

TYPE 3S2 \$850

OSCILLOSCOPES FOR SAMPLING APPLICATIONS



ANALOG DISPLAYS — DIGITAL READOUT

The Type 568/230 Digital Oscilloscope System provides digital readout of measurements from waveforms that are displayed in analog form on the CRT. They enable the user to make dynamic switching time measurements with greater speed, convenience and repeatability than is possible by making measurements directly from the cathode-ray oscilloscope display. Programmable sampling vertical and sweep units extend the automated measurement capabilities by allowing remote programming of the measurement functions.

TYPE 568 \$ 925
TYPE 230 \$3200

STORAGE DISPLAYS

The Type 564B offers all the advantages of a conventional plug-in oscilloscope, plus a split-screen storage feature. Greater versatility is thus provided in that either half of the 8 x 10 cm display can be independently controlled, allowing stored or conventional displays on either the upper or lower half. The contrast ratio and brightness of the stored displays are constant and independent of viewing time, writing and sweep rates or signal repetition rates. Accepts all 3-series sampling plug-ins.

TYPE 564B \$ 995
TYPE 564B MOD 121N, Variable viewing time, auto erase \$1150

CONVENTIONAL DISPLAYS

Solid-state, large-screen (8 x 10 cm), internal graticule, dual plug-in oscilloscope defines the new Type 561B. Use of solid-state components throughout offers low-heat dissipation for reliable operation. Short-proof circuitry has been designed into all low-level power supplies, providing lower output impedance and minimum signal crosstalk. Accepts all 3-series sampling plug-ins.

TYPE 561B \$560

TYPE 3T2: RANDOM SAMPLING SWEEP

The Type 3T2 Random Sampling Sweep Unit provides advanced, state-of-the-art measurement capability. This unique sampling sweep unit permits observation of the leading edge or other portions of the signal even when used with vertical sampling units that have no delay lines and without a pre-trigger. The advantages of eliminating signal delay lines or pre-trigger requirements are evident:

1. The inherent distortions and risetime limitations of signal delay lines are eliminated.
2. Direct sampling probes may be used for convenient high-impedance in-circuit signal pickup without regard for a pre-trigger.
3. Trigger may occur prior to, coincident with, or after the displayed signal without sacrificing lead-time in the display.
4. Signals with no convenient source of a stable pre-trigger can be observed without display jitter.

TYPE 3T2 \$1000



SIGNAL ACQUISITION

P6010

The conventional scope input impedance of 1 M Ω , 15 pF of the Type S-5 permits use of the P6010, 10X miniature passive probe. The P6010 provides an input impedance of 10 M Ω , 10 pF while maintaining the 1-ns risetime of the Type S-5 at the probe tip. Driven from a 50- Ω source, the P6010 appears as a transmission-line input.

P6010 Included with Type S-5

P6034

The P6034, 10X low-capacitance probe has an input impedance of $\approx 300 \Omega$ at 1 GHz (500 Ω paralleled by an input capacitance of 0.7 pF). The probe risetime of ≤ 100 ps has a minimal effect on the Type S-1 risetime. The P6034 is also useful with the Type S-2.

P6034 Probe \$40

P6035

A higher input impedance (1.5 k Ω at 1 GHz) is provided by the 100X P6035 with its 5-k Ω input resistance and 0.6 pF-input capacitance. The probe risetime of ≤ 200 ps limits the t_r of the Type S-1 to ≈ 400 ps and the Type S-2 to ≈ 200 ps.

P6035 Probe \$40

For a demonstration, call your local Tektronix field engineer or write: Tektronix, Inc., P.O. Box 500, Beaverton, Oregon 97005

U.S. Sales Prices FOB Beaverton, Oregon



Tektronix, Inc.

committed to progress in waveform measurement

Air operations planning goes automatic

Air Force developing computer-based set-up to relieve planners of bookkeeping on tactical missions; its features may be used in advanced management systems

By James Brinton

Associate editor

Tactical air operations rank among the world's tougher planning jobs. The Mitre Corp., a nonprofit Air Force affiliate, estimates that three officers working fast can set up 120 to 130 simple sorties in about five hours. But even laboriously worked-out arrangements, made three to five days in advance because they take so much time, wind up being changed. More often, however, they're scrubbed. Available aircraft can be lost or grounded; new targets with higher priorities may appear; or, human errors can throw a whole series of complex calculations out of whack.

What's needed is a set-up which would take over the time-consuming parts of the planning operation that are susceptible to error. Such a system would make a variety of sortie plans available to a commander. He could choose among these, altering them in whole or part to suit his own judgment or new factors. It would also be fast enough to permit almost real-time planning, cutting down on revisions by slashing the lapse between planning and strike.

Mitre and the Air Force's Electronic Systems division in Bedford, Mass., are now testing the forerunner of just such a paragon—the tactical data automation system (TDAS). TDAS is a display-oriented, multicomputer developmental system able to plan as many as 60 sorties in only 5½ minutes.

During this span, the computer generates fragmentary battle orders (Frag) for up to 140 squadrons, selecting from among as many as 32,000 possible targets with varying priorities. In doing so, it juggles up



Interactive. Using TDAS Air Force officers have more time to actually plan tactical operations since routine bookkeeping chores are done by computer.

to 500 classes of variables including: the number and kind of aircraft available; their ranges, speeds, and payloads; and the types of target and their defenses. The latter involves such questions as whether or not to use electronic countermeasures, what sort of ordnance is available, and the like.

Overview. For strikes scheduled throughout the day, TDAS calculates the round-trip and refit time of aircraft used on earlier missions and then adds these planes to those already available. It also strives to assure that enough planes and ord-

nance of the right kind are dispatched to satisfy a desired kill probability. It's even possible to plan the day's operations in reverse—night and evening strikes first, followed by morning missions.

Mitre officials like project leader Paul E. Dittman point out that the 5½-minute figure is an exception, rather than a rule. "Computers have no way of judging morale factors and their effects on crew effectiveness," he says. "Nor do they pay much attention to special expertise or yesterday's work load. As a result, TDAS is highly interactive and



"Black Magic" FROM Plastic Capacitors

**NEW "LQ" Series
OIL-FILLED
CAPACITORS**
FOR MEDIUM AND HIGH VOLTAGE
APPLICATIONS



- Voltage range, 1000 to 10,000 volts DC
- Power Factor, 0.5% at 60 and 1000 Hz.
- Peak to Peak Ripple Voltage, 20% of DC Voltage Rating
- Designed for continuous operation of 10,000 hours at 65°C
- Black phenolic shell, epoxy end fill
- Axial wire lead terminations
- Excellent corona characteristics

Here's new "Black Magic" from PC, delivering more power and reliability at extremely low cost. Compact size and stability increase their versatility. Quality construction assures peak performance. Intensive testing to insure field performance applications unlimited.

Write for free samples and complete engineering data today!



Plastic Capacitors
INC.

2620 N. Clybourn • Chicago 14, Ill.
DI 8-3735

designed to bring the planning officer into the loop."

John K. Summers, associate project leader, says: "Even with a very careful planning officer, the time needed to plan operations should be shaved by 75%. Two hours worth of conventional manual work would be compressed down to about half an hour with the tactical data automation system."

Equipment roster

The TDAS is built around an IBM 1800 computer with mass memory. Clustered around the central processor are PDP-8 computers made by the Digital Equipment Corp., Maynard, Mass. These units route messages among user stations, to and from the 1800, and among terminal devices at user stations.

Individual PDP-8 computers serve three user stations, each of which has a Sanders Associates 720 display console with keyboard, light pen, and a small amount of memory. DASA Datacall read-only stores allows users to speed storage or retrieval operations at the console by entering preformatted messages—for example, information requests of a specific type. A console views the store as if it were a very fast teletypewriter.

Standby. Data storage is handled at each station by a Kennedy 1400R incremental tape recorder. In addition to recording or reading out data at up to 1,000 characters per second, this unit serves as an emergency miniature mass memory. Should the link between the system's 1800 and the user station be severed, planning could still continue. Hard copy is supplied by a Motorola high speed printer.

Mitre spokesmen claim that just about every Air Force officer who has seen TDAS either wants to get to the display consoles immediately or at least approves of the idea behind the project. But it's not likely that the system will become operational in its present configuration. The hardware lashup at Mitre is simply being used to demonstrate the effectiveness of computerized bookkeeping and interactive data processing.

Prototype. TDAS is also a watershed program for the tactical data management systems which, defense officials say, can be expected during the 1970's. Already some of

FILE TARGET1 UNCLASSIFIED PAGE 001 OF 017

TARGET	TYPE	RP	STOT	LOT	SPK	PKS	P100	P5A
1 20-011	APSC	1A	0215			9		
2 24-011	APSC	1A				18		
3 23-05A	CPS	2C	0200	0250	35	06	12	20
4 5-05A	CPS	2A	0250	0315	35	01	02	03
5 T111A	INT	3A	0300	1200	30	02	04	00
6 T111B	INT	3A	0300	1200	30	01	02	04
7 T111C	INT	3A	0300	1200	30	04	07	11
8 3-05	CPS	2C	0400	0450	035	05	18	16
9 45-05A	CPS	2B	0420	0500	35	01	02	02
10 45-05B	CPS	2B	0420	0500	35	01	02	03

UNCLASSIFIED

One. A planner using TDAS first calls for display of targets and resources. Computer performs weapons calculation, juggling the data on just what's needed to achieve a desired kill probability.

SELECT 3 NEXT TARGET

TARGET	TYPE	RP	STOT	LOT	SPK	PKS	P100	P5A
3 23-05A	CPS	2C	0200	0250	35	06	12	20
4 5-05A	CPS	2A	0250	0315	35	01	02	03
5 T111A	INT	3A	0300	1200	30	02	04	00
6 T111B	INT	3A	0300	1200	30	01	02	04
7 T111C	INT	3A	0300	1200	30	04	07	11
8 3-05	CPS	2C	0400	0450	035	05	18	16
9 45-05A	CPS	2B	0420	0500	35	01	02	02
10 45-05B	CPS	2B	0420	0500	35	01	02	03

Two. The planner elects to deal with T111 targets and calls for his first interactive display. The planned kill probability (PPK) remains blank until officer or computer assign planes.

SELECT 3 NEXT TARGET

TARGET	TYPE	RP	STOT	LOT	SPK	PKS	P100	P5A
3 23-05A	CPS	2C	0200	0250	35	06	12	20
4 5-05A	CPS	2A	0250	0315	35	01	02	03
5 T111A	INT	3A	0300	1200	30	02	04	00
6 T111B	INT	3A	0300	1200	30	01	02	04
7 T111C	INT	3A	0300	1200	30	04	07	11
8 3-05	CPS	2C	0400	0450	035	05	18	16
9 45-05A	CPS	2B	0420	0500	35	01	02	02
10 45-05B	CPS	2B	0420	0500	35	01	02	03

Three. Planner could assign computer to handle T111 targets, but he picks 11 F-5A's, two F-100's, and two F-105's for the strike. PPK meets or exceeds the desired level (DPK) in all cases.



Four. When assignments have been made, the planner reviews operations in many ways. In this particular case, the 54th tactical unit seems overly burdened, so some replanning may well be in order.

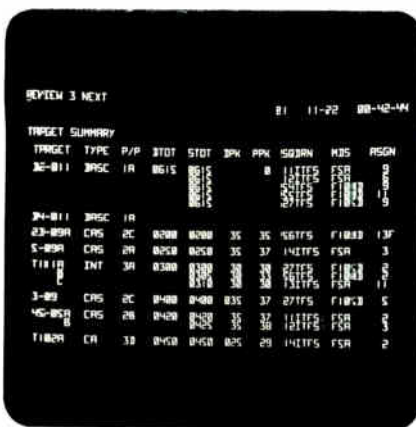

Five. Here, targets and the aircraft assigned to them are displayed for the planner's review. Target D4-011 has a 1A priority but no planes after it, so again some replanning appears needed.

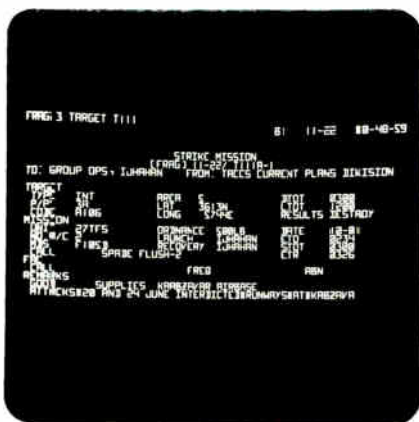

Six. After all required replanning has been taken care of, the planner orders the computer to generate the Frags, or fragmentary battle orders, which will launch squadrons after their targets.

the lessons learned with the system are being applied in the Seek-Data tactical planning system now quietly being used to conduct air operations in Southeast Asia. Other features may be incorporated in the Tactical Air Command's mini-Awacs (for airborne warning and control system) if it is approved.

Six user stations are now available for simulated planning; this summer they'll be ready for wargaming as "the enemy." They can be programed to simulate lost aircraft and supply other effects which will make necessary quick changes in existing Frags. As a result, the system will operate very nearly in real time in response to fast-changing situations.

Plans and procedures

At the beginning of a session, a planner can request that a review of his resources and targets be displayed on his cathode-ray tube. He can then order the computer to generate a Frag for a specific target, or to "Frag all"—supply orders for all strikes as it sees fit.

If the planner elects to work target by target, TDAS first will display a mix of aircraft types from various squadrons, showing how many planes of each type are needed for the desired kill probability. The planner can change the aircraft mix, as well as the squadron from which the planes will come. His choices will either raise or lower the displayed kill probability. When his plans, or those of the computer, match or exceed the kill probability and mesh with the human factors involved in his decision, the planner can store the strike plan and move on.

Disparity. It takes more time to read about the process than it does to perform it. The keyboard and light pen can both be used to revise displayed data quickly, and the computer is continually performing the jobs' complex bookkeeping.

At the end of a session, the planner can ask for a squadron-by-squadron review to see if any unit is overloaded. If not, he orders the computer to generate the necessary Frag orders.

If such a system were operational, the orders would be relayed to squadron headquarters, which would already have supplied the planning center with data on their

your best buy in D.C. . . .



from any angle

For the mini-price of \$90, you can choose from three compact, well regulated, constant voltage/current limiting laboratory power supplies. And, for only \$25 more, 3 additional models are available with constant voltage/constant current. We call them BENCH supplies.

These stable battery substitutes are packaged in molded, high-impact plastic cases with an interlocking feature for stacking. They can be rack mounted with an accessory kit.

Check the following specs for proof of quality at no sacrifice in performance.

Outputs 0-1CV @ 0-1A, 0-25V @ 0-.4A, 0-50V @ 0-.2A
Regulation 4 mV, Load or Line
Ripple 200 μ V rms/1mV p-p (DC to 20 MHz)
Stability 0.1% +5 mV for 8 Hours
Size 3 3/4"H x 5 1/4"W x 7"D

HEWLETT *hp* PACKARD

POWER SUPPLIES

112 Locust Avenue
 Berkeley Heights, New Jersey 07922 21901

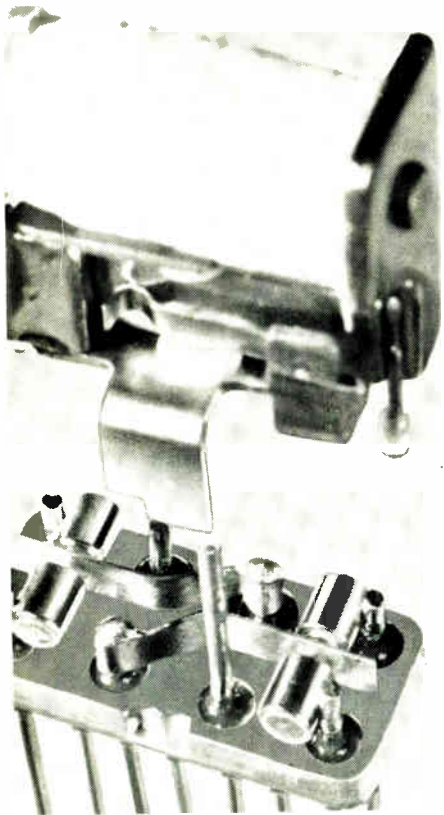

mite-size relays with macro-size contacts

Couch 2X relays are true 1/2-size, yet the contacts are as large or larger than many full and half-size crystal can units. Couch 2X relays meet MIL-R-5757D/19 and /30 specs in 1/25th of a cu. in. Design simplicity and oversize contacts assure the ultimate in performance. Each relay is fully tested. Ideal for missile and aerospace switching applications or wherever reliability in small space is of prime importance. Available in many terminal styles and a wide choice of mountings.



Write for Data Sheets No. 9 and No. 10 today.

	2X (DPDT)	1X (SPDT)
Size	0.2" x 0.4" x 0.5"	same
Weight	0.1 oz. max.	same
Coil		
Operating Power	100 mw or 150 mw	70 mw or 100 mw
Coil		
Resistance	60 to 4000 ohms	125 to 4000 ohms
Temperature	-65°C to 125°C	same
Vibration	20G	same
Shock	75G	same

RUGGED ROTARY RELAYS  Dynamically and Statically Balanced



S. H. COUCH DIVISION

ESB INCORPORATED

3 Arlington St., North Quincy, Mass. 02171

aircraft, men, ordnance, supplies, and the like. Teletypewriter and then high-speed data links would handle this part of the job.

Remote possibilities

The remoting concept may be tested soon when Mitre and the Electronic Systems division test a small-scale TDAS center mounted in a truck. It will offer all the capabilities of the developmental system, including access to an IBM 1800 computer through its own PDP-8 and a high-speed encrypted data link.

The van set-up will also be used to study the concept of mobile planning centers which might become part of the tactical air control system or 407L sometime in the 1970's.

Ancillary aims. TDAS development work is also designed to dig out answers to some of the Air Force's other knotty control and planning problems. Another goal is to stimulate constructive thinking about more advanced data management schemes.

Summers says TDAS is being equipped to plan for interdiction, counter air missions, direct air support, and close air support. In addition, it will be able to handle search and rescue and airlift management. "All of these are tough to do manually and so are good candidates for automated planning," he says.

As the variety and number of missions to be planned rises, manual planning time can increase almost exponentially, says Summers. "But since about 80% of planning is bookkeeping, we shunt the dog-work into the computer and free men to make the final decisions."

Advanced planning. Mitre's tactical data management system department is also working on what Summers calls the travelling salesman problem—a tactical airlift scheduling algorithm which would assure optimal routing of supply aircraft within a theatre.

Also on the way is a TDAS algorithm capable of better than near-real-time operation—up-to-the-second crisis management planning. This suggests eventual hardware needs like real-time data inputs from a variety of battlefield locations—possibly even aircraft—and ultrahigh-speed mass memory. The latter would be needed to assure rapid operation on a quickly

changing data base, while the former means not only high-speed data links to squadron headquarters but also perhaps display-equipped data entry consoles.

Dittman already envisions hand-held data entry devices, so the "data-talky" may be coming soon.

Meanwhile, the Rome (N.Y.) Air Development Center may already have selected the developer of a plated-wire mass memory able to give tactical planners random access to as many as 100 megabits of data. Summers believes such a memory is necessary for crisis-managed fighter operations. The war-gaming to begin this summer or fall, he says, may turn up inadequacies in the speed of the tactical data automation system's present drum mass memories.

"One of our basic goals has been to make the hardware-software system so easy to work with that high level officers—men with experience and understanding—would use the system, rather than being forced to delegate and divide the job among subordinates," he says. "We feel we've succeeded with the TDAS so far; it takes only a few seconds to get needed data to a console now. But in a real-time system, where pressure for speed is much greater, our drum memories may slow the process so much that planners might even be able to outspeed the machine, if not achieve its grasp of detail.

Payoff. Summers eventually anticipates a system of computers, perhaps, interconnected by satellite data links. In the network, information would be exchanged throughout the chain of command, giving planners access to all necessary data, as well as affording subordinates clearer ideas on what's required by their superiors.

Dittman summarizes the advantages when tactical automation comes of age: "Our concepts of tactical air power deployment are about to change. With real-time data management, the Air Force will be able to minimize risk, cut ordnance waste, reduce aborted missions, hit targets of opportunity more often, and quickly analyze post-mission reports to aid 'next-day' strike and airlift planning. It looks like the 1970's will be a great decade for the Tactical Air Command."

The Readable Little Meters

You can even read the littler little one at arm's length.

(Actual sizes)

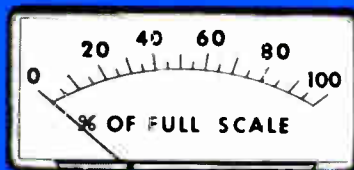

The littler little one.

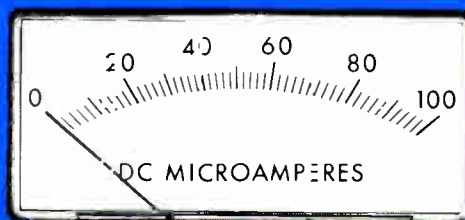

The bigger little one.



Put your left thumb here.



Put your right thumb here.

Honeywell's new Series 80T Panel Meters take up about half the panel space of full-size meters.

But hold this ad out at arm's length and see how easy the meters are to read. (How we ever got such large scales on such small faces without cluttering them, only our designers know.) And we've set the dial up front, so you can see it clearly, even from an oblique angle.

Behind the small face is Honeywell's unique taut-band mechanism - with about

50% fewer parts than a pivot-and-jewel. (One of the parts that's missing is the old space-consuming plastic barrel on the back of the meter.)

The new Series 80T Panel Meters come in 33 standard ranges. And they cost no more than pivot-and-jewel meters. So you don't have to pay a lot to get a little.

(We'd like to send you a catalog. Write Honeywell Precision Meter Division, Manchester, New Hampshire 03105.)

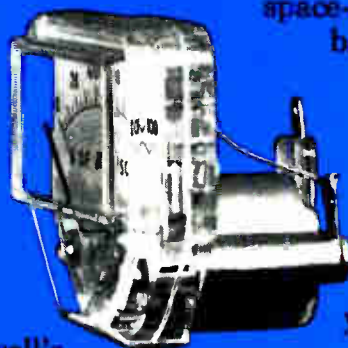

It takes all kinds of meters to make the Honeywell line.

Honeywell

**MDS LOW-COST
PAPER TAPE READERS
MAKE NO COMPROMISE
WITH QUALITY**

These MDS Paper Tape and Card Readers come from specialists in the design and manufacture of compact, reliable Readers. Models in this MDS Series are designed to meet a multitude of needs in programming and control applications.

They are available in models for 5, 6, 7 or 8 channel tape . . . reading speeds from 0 to 60 characters per second . . . bi-directional or uni-directional sensing . . . panel or table mounting . . . all provide star-wheel sensing. A unique dual cross-coupled electro-magnetically actuated pawl system (patented) advances the tape bi-directionally and provides the simplest method of integrating the tape reader into a system.

The star-wheel sensing system used in MDS Readers effects minimum wear on tapes . . . tolerates wide variation in punching . . . reads any type of tape.

For simplicity in design . . . reliability in action . . . specify MDS low-cost Paper Tape and Card Readers.

Ask for: The MDS file-folder on Paper Tape Readers, giving general specifications and more complete information.

FOR MORE — MEET YOUR MAN FROM MDS



MDS 2119 Paper Tape Reader — Speed: 30 cps, bi-direct; Panel Size: 3½" x 11".

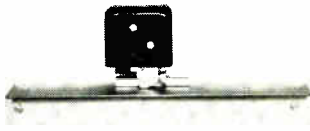

MDS 2131 Edge-Punched Card Reader.

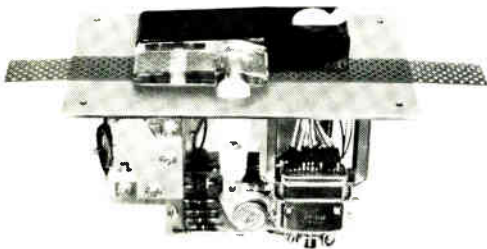

MDS 2153 Horizontal Mount Paper Tape Reader — Speeds of 30 or 60 cps, uni-direct. Reads up to 8 channel punched paper tape.

MOHAWK MDS
DATA SCIENCES CORPORATION
OEM MARKETING

122 EAST RIDGEWOOD AVENUE • PARAMUS, N.J. 07652
Telephone 201/265-7333

Every MDS office is an OEM Marketing office

DIGITAL STRIP PRINTERS • BUFFERED TAPE UNITS
HIGH-SPEED AND LOW-SPEED LINE PRINTERS
CARD PUNCHES AND READERS
PAPER TAPE PUNCHES AND READERS

REGIONAL MANAGER OFFICES

Atlanta, Ga.	Tel. 404/261-8036
Waltham, Mass.	Tel. 617/891-4430
Des Plaines, Ill.	Tel. 312/298-4141
S. San Francisco, Calif.	Tel. 415/761-0750

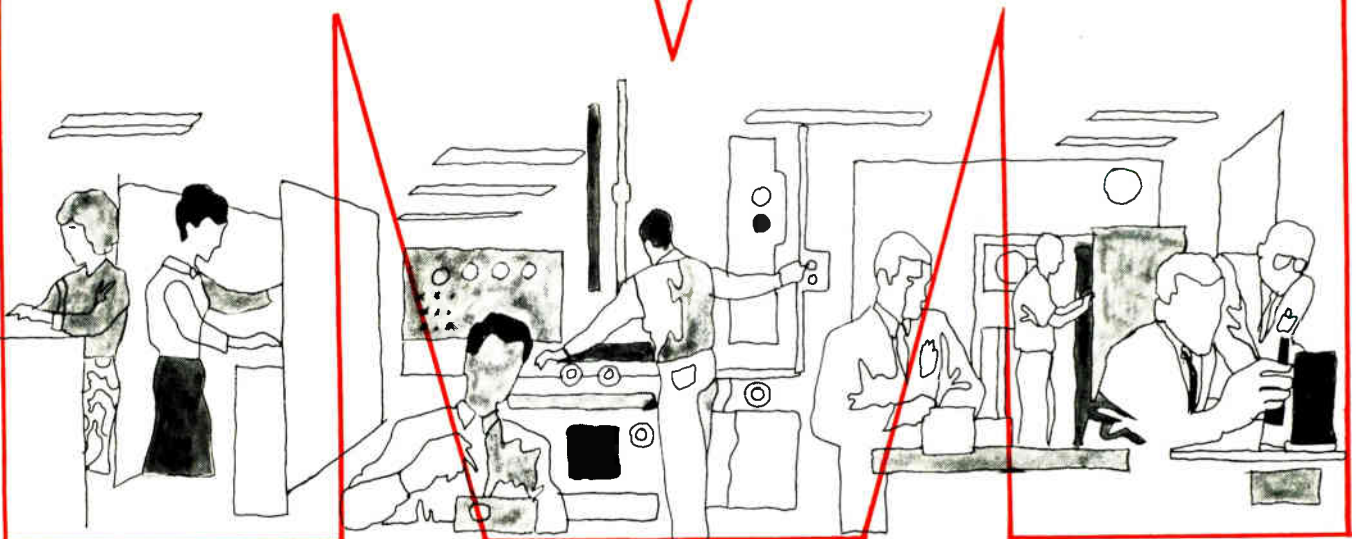

Pay tv gets in the broadcast picture

Technical standards, probably to be based on Zenith's Phonevision system, are due from the Federal Communications Commission by the middle of June

By Frederick Corey

Associate editor

On June 12, the Federal Communications Commission according to the schedule it's set up for itself will announce technical standards for subscription television, or pay tv as it's popularly known. Simultaneously, the agency will begin accepting applications from companies that want to sell this service in major cities—those with at least four commercial channels.

The latest FCC ground rules, included in December's Fourth Order and Report, pave the way for resolution of an issue that's been simmering almost since Eugene F. McDonald, founder of the Zenith Radio Corp., dreamed up the idea of subscription service in 1931 before television's invention. What's more the medium's fate is finally to be decided on the basis of free-market forces.

Alliances. There's never been much of an argument about the viability of the technology involved. Nor, have two or more approaches been vying for acceptance, as was the case with color television. Rather, the battle has been waged—bitterly at times—on purely economic grounds by substantial interest groups with something to win or lose. On one side are the networks and their allies including independent or group operators, publishers with stakes in broadcasting, and, recently, movie houses and chains. On the other, Zenith, its affiliates, and such would-be pay tv entrepreneurs as International Telemeter, TeleGlobe, Skiatron, and TelePrompTer.

Over the years, Zenith has poured some \$15 million into development of its Phonevision pay

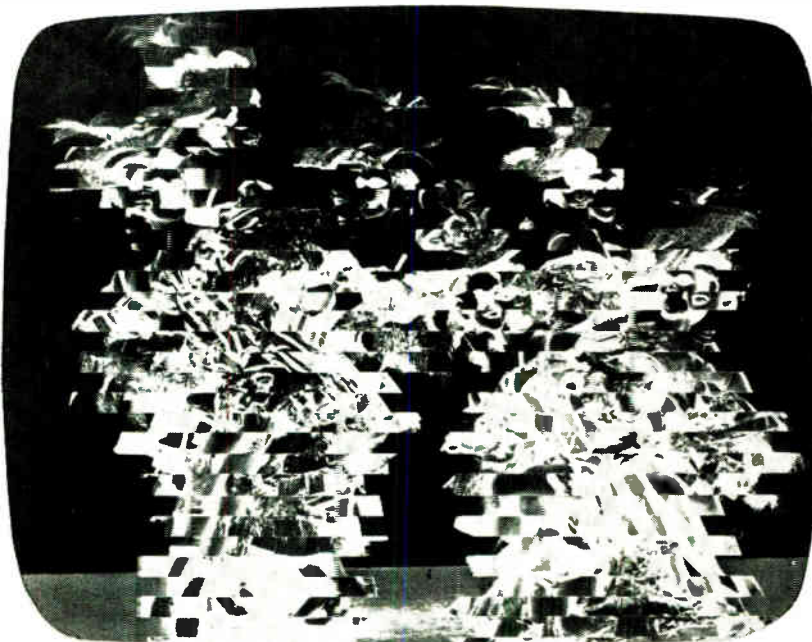

Dance partners. Zenith's Phonevision system scrambles the video into 35 7-line horizontal segments; alternate segments are shifted continuously.

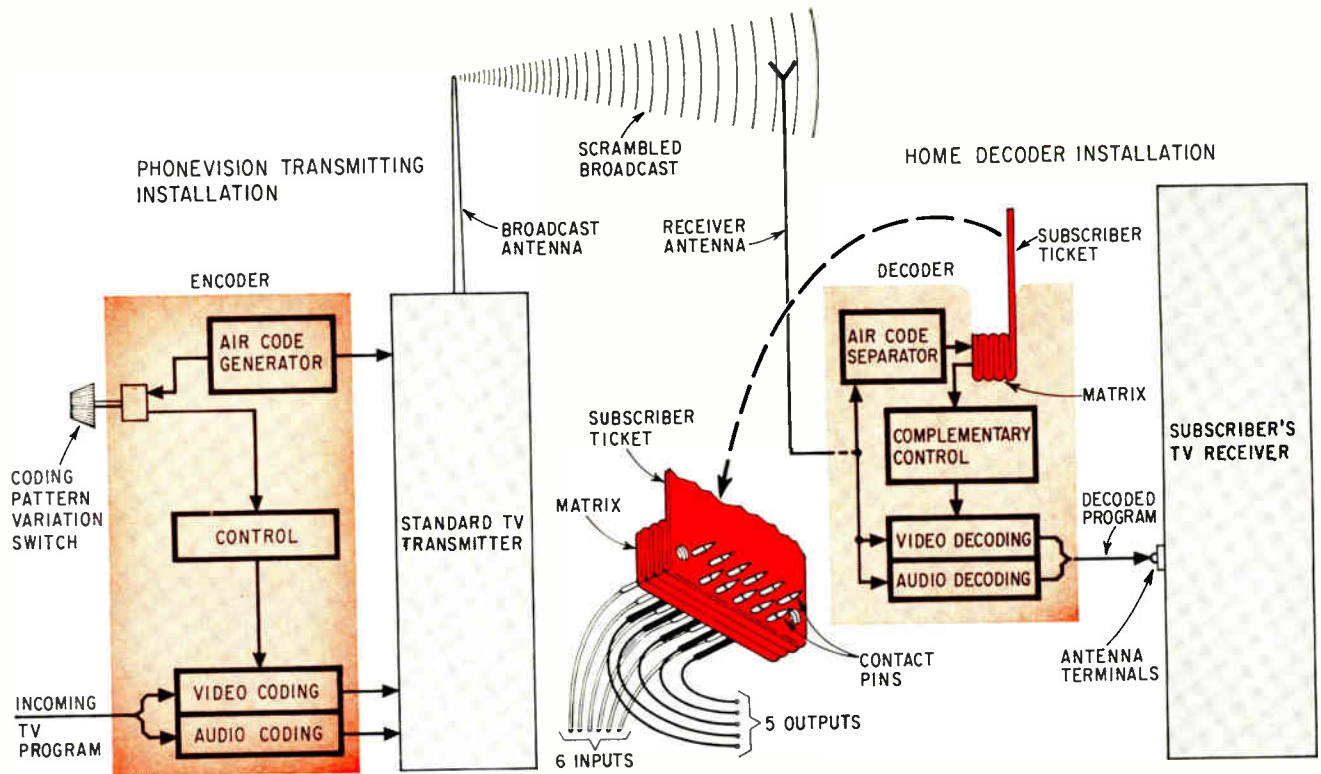

Rule of three. Zenith's third-generation solid state pay tv system includes an audio/video scrambling encoder at the station, a decoder unit to reconstitute incoming signals, and a subscriber ticket that activates decoding and furnishes billing data.

tv service; the solid state system, which can handle vhf and uhf signals in both color and black and white is now in its third generation. It appears probable that the FCC's standards will be tailored to the specifications of this equipment, which has been thoroughly tested, in various versions.

Phonevision has three principal elements: an encoder at the transmitting station that scrambles both the video and audio signals; a decoder unit at the set that unscrambles incoming signals; and a subscriber ticket that triggers the

decoder circuitry and provides billing data. The latter is the subscriber's ticket to turn his tv receiver into an electronic box office.

Step by step

In the encoding process, the video is scrambled by cutting the tv picture into 35 horizontal segments of seven lines each and continuously shifting alternate segments back and forth. At the same time, the positions of the divisions between segments are shifted randomly, producing a visual effect of vertical movement. In addition,

there's a polarity inversion of black and white video signals so that the scrambled picture appears much like a multiexposed photographic negative. The sound is made unintelligible by a simple upward shift of the audio frequency.

In the complementary decoding process, the picture segments not moved during the encoding are shifted. Segments are shifted only once, facilitating reconstitution. Audio decoding is accomplished simply by shifting the incoming audio to its original frequency.

Safety first. Security is essential for the success of pay tv. "Eavesdropping" by either nonsubscribers or subscribers who don't want to pay is prevented by varying the video coding from program to program. Changes are determined well in advance of the telecasts and controlled by the pay tv station.

At the time of the actual telecast, the broadcaster simply adjusts a coding-pattern variation switch. An air code, consisting of a series of at most 10 frequency bursts—each of one horizontal line duration—are generated at random on six different frequencies. These pulses, which control the phase relationships of the coded video signals during the coding process, are

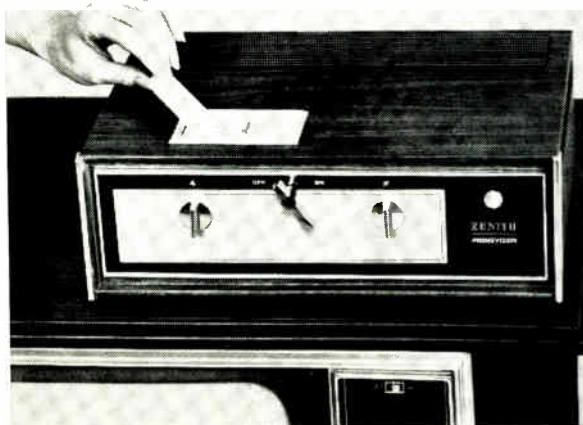

Entry. Subscriber's ticket, which comes through the mails, is inserted in a slot on top of the decoder unit after two-digit code has been dialed to get a pay telecast.

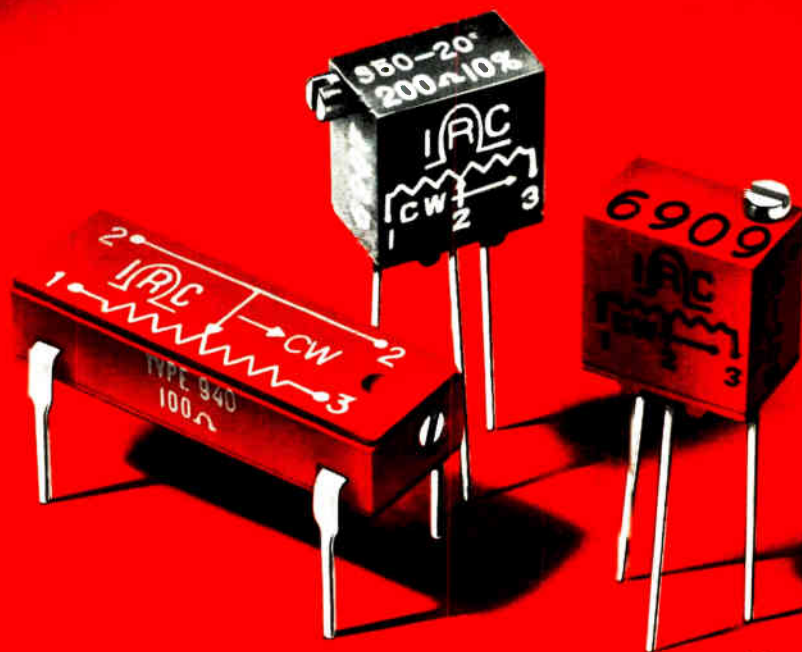

Space-saving trimmers

DIP construction matches IC size. Cuts assembly costs.

5/16" doubles performance of 1/4" trimmer—cuts cost almost in half.

IRC's new precision wirewound trimmer in dual-in-line package simplifies PC board layout. Pin spacing is the same as the popular TO-116 size integrated circuit. It is fully compatible with high-speed automatic inserting equipment.

The sealed, moisture-resistant units meet the environmental requirements of MIL-R-27208. Maximum height is only .200 inches. 1 watt @ 40°C. 10Ω to 20K. ±10% tolerance. TC is ±50ppm/°C.

Pin spacing of these 5/16" square trimmers matches the 1/4" square unit. Only .062" larger on each side they can cut your cost almost in half and give you three times the power rating of the 1/4" and 40% better resolution.

Two types are available—precision wirewound and infinite resolution Metal Glaze. Both are fully sealed and impervious to common industrial solvents because of a silicone rubber shaft seal and epoxy bonding at all seams.

For data and prices, see your IRC Industrial Distributor or write IRC St. Petersburg Division of TRW INC., 2801 72nd Street, North, St. Petersburg, Florida 33733



DIVISION OF TRW INC.

TAKE

12 SMALL LAMPS

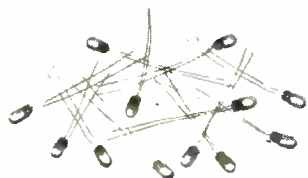

MOUNT

ON A CIRCUIT BOARD



MOLD

A NUMBERED BEZEL



RESULT

A LIGHT MODULE TO
MONITOR TWELVE
COMPUTER CIRCUITS*



*Can be made for a lesser number down to one

We can help you refine your small lamp application. Write, describing the requirement. Tung-Sol Division, Wagner Electric Corporation, 630 W. Mt. Pleasant Avenue, Livingston, N.J. 07039. TWX: 710-994-4865. Phone: (201) 992-1100; (212) 732-5426.

TUNG-SOL®

WHERE BIG THINGS ARE
DONE WITH SMALL LAMPS

© Reg. T.M. Wagner Electric Corporation

Delaying Actions

There's little doubt now that the Federal Communications Commission will authorize pay, or subscription, television. The only real question left involves the timetable for technical standards. The agency however, is playing its scheduling plans close to the bureaucratic vest.

Some observers think the commission has finished the job—essentially putting a stamp of approval on Zenith's Phonevision. There's little reason to believe there are any problems of a technical nature since the system design provided sound during the course of the Hartford experiment. And staff engineers normally solicit suggestions for standards from industry, eventually reworking and refining them to protect what the FCC deems the public interest.

Zenith's Washington lawyer flatly predicts the ground rules will be announced June 12, the date specified in the FCC's Fourth Order and Report. But another school of thought holds that a delay is almost inevitable in view of the issue's controversy quotient. "I wouldn't be surprised to see the commissioners release the technical plans in August when we're all on vacation," says one source.

Most pay tv opponents, particularly members of the House Commerce Committee, are now resigned to defeat. But two diehards, John D. Dingell (D. Mich.) and Watkins M. Abbitt (D. Va.) have put bills in the hopper that would make it unlawful for the FCC to authorize subscription service. At this stage of the game, however, knowledgeable Capitol Hill observers consider these moves as little more than idle threats.

A more serious challenge to the release of technical standards may result from a suit brought by movie theater owners in the Federal district court in Washington that seeks to override the FCC's authorization of pay tv. At the same time, the plaintiffs are asking the commission to stay the release of standards, pending resolution of the case, which is to be argued next month. Had the whole pay tv question not been such a protracted struggle, the agency might well have gone along on this matter. But the smart money is now betting no stay will be granted.

transmitted along with the scrambled video and audio.

The air code, along with two other keys, unlocks the scrambling at the decoder. The one is transmitted at the actual time of a broadcast; the others—a two-digit code and the subscriber ticket—are provided in advance.

The two-digit code, provided through either a program guide, newspaper listing, or both, is dialed on two control knobs on the decoder unit's panel. One has eight numbered dial positions, while the other has 12 alphabetized positions. The subscriber ticket comes through the mails. It includes a field that identifies the subscriber and certifies the validity period of the ticket. Another field records a program purchase each time a subscriber dials in a two-digit code. (An electromechanical device within the decoder punches a predetermined hole to identify the program.) There's also a matrix with circuitry for decoding.

Sandwich. Located at the bottom of the ticket, the matrix consists of eight layers of paper stock and

five strips of conducting metallic foil for circuitry between the layers. The six inner layers and the five metallic strips carry a number of prepunched holes, with the perforation pattern differing from layer to layer.

With the ticket inserted into a slot on top of the decoder and the two-digit code dialed, 11 contact pins—six input and five output—are driven through the matrix, which routes the six different air-code frequencies to the five output pins in a manner determined by the prepunching of the sandwich layers. This pattern is the code for a given subscription program.

At the tv station, subscription telecasts are simply routed through the encoder before being sent out over the air. The decoder, which also serves as a miniature tv set, receives a Phonevision broadcast signal in which the audio and video information are coded. The unit unscrambles both the video and audio and then remodulates the unscrambled program signal on a carrier corresponding to the frequency of the allocated channel.

It's the remodulated signal that is delivered to the subscriber's set.

Although integrated circuits are employed in Zenith's top-of-the-line color receivers, there are no current plans afoot to use them instead of discrete components in Phonevision. Zenith is, however, considering IC's for the next generation system. The big if is whether pay tv will capture the public's fancy. And that's still a big if.

Picture window

According to the rules set down by the FCC, pay tv will be limited to areas already served by at least four conventional, or free, tv channels. And only one subscription station will be allowed to operate in these cities, of which there are 80 in the U.S. Other rules affect programing. Sporting events, except for blacked-out home games already offered on free tv will be denied pay tv for two years; first-run movies older than two years, unless unavailable on free tv, cannot be shown; a minimum of 28 hours of nonsubscription programs must be telecast each week.

Despite such stifling stipulations—sports, movies, and special entertainment are supposed to be pay tv's bread-and-butter—Zenith officials hailed the FCC go-ahead as a landmark decision. Says Joseph S. Wright, Zenith's board chairman: "We believe it (the FCC decision) will pave the way for a new dimension in tv and bring new vitality for the movie-making and entertainment industries, the Broadway theater, and a broad range of cultural box-office attractions, as well as provide a financial boost for independent uhf stations."

Zenith will sell both the decoders and encoders to subscription stations, but will not handle the franchising itself. This will be handled by Teco Inc., an affiliate organized in 1949—two years after Zenith developed its first Phonevision system.

No one in the tv business paid much attention to Zenith's system during the late 1940's or early 1950's since most companies were preoccupied with color standards. But opposition began to coalesce in 1955 when the company staged a successful demonstration of Phonevision in Washington, D.C. A protracted period of in-fighting

New VICTOREEN Mini-Mox Resistors for higher resistance/size ratios

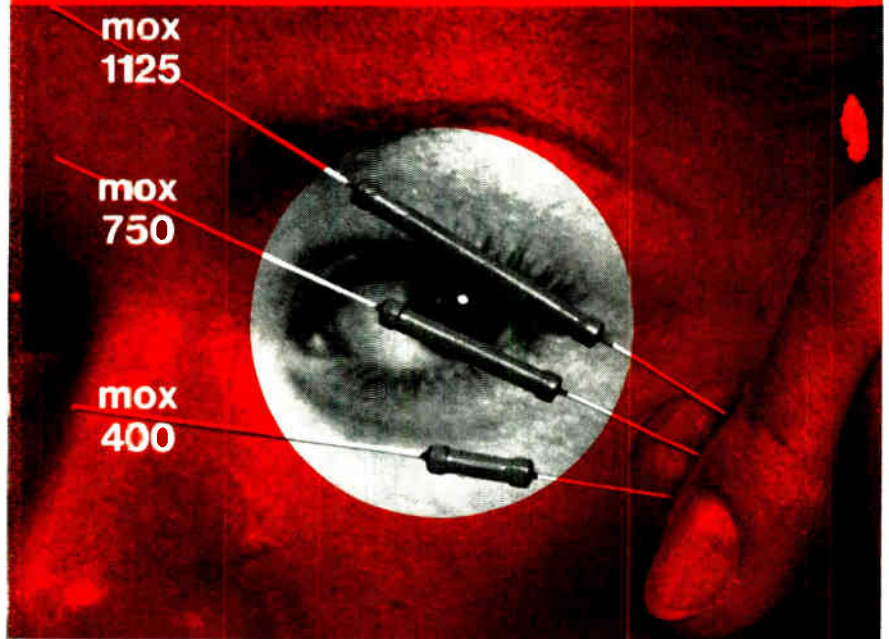

We promised you a wider range of quality Victoreen MOX (metal oxide glaze) resistors for sophisticated electronic applications. And we're delivering on our promises, too, for we're now in volume production on the subminiature Mini-Mox resistor line. Just eyeball these specifications:

Model	Resistance	Rating @70°C	*Max. Oper. Volts	Length Inches	Diameter Inches
MOX-400	1-2500 megs	.25W	1000V	.420 ± .050	.130 ± .010
MOX-750	1-5000 megs	.50W	2000V	.790 ± .050	.130 ± .010
MOX-1125	1-10,000 megs	1.00W	5000V	1.175 ± .060	.130 ± .010

*Max operating temp 220°. Encapsulation — Si Conformal

*Application above critical resistance.

Stability is better than ± 2% for 2000 hours at full load, shelf-life drift less than 0.1% per year. Standard tolerances are 1 to 10% depending on resistance value. ½% resistors in limited values, on request.

So let your circuit design imagination run rife. Victoreen MOX and new Mini-Mox Resistors can satisfy all your requirements for ultra-critical applications involving high voltage... high impedance... high stability... high wattage. Check our Applications Engineering Department today. Call (216) 795-8200.

A-3876

VICTOREEN INSTRUMENT DIVISION
10101 WOODLAND AVENUE • CLEVELAND, OHIO 44104
EUROPE: ARNDAL HOUSE, THE PRECINCT, EGHAM, SURREY, ENGLAND • TEL: EGHAM 4987



RMC DISCAPS

the complete Ceramic Disc line

Over the years Radio Materials Company has maintained its leadership in the production of ceramic disc capacitors. A complete line offering outstanding quality has been the key to continuing growth.

STANDARD

Type C, B, BA, JF, JL and JE

SUBMINIATURE

Type SM, BT, TA and Magnacaps

GREENCAPS

Type CG, JG, and EG

SPECIAL

U.L. Listed Discaps, T.C. High Voltage, High K High Voltage and Dual Section By-Pass

SOLDER-IN T.C. DISCAPS

For application in equipment where lead inductance effects must be reduced to an absolute minimum.

If your application requires special physical or electrical characteristics, contact RMC's Engineering Department.

U.L. LISTED T.C. DISCAPS

Should be specified when the use is an integral part of an antenna coupling network where compliance with Underwriters' Laboratories specifications are required.

RMC
0039

DISCAP
CERAMIC
CAPACITORS

RMC

RADIO MATERIALS COMPANY

A DIVISION OF P. R. MALLORY & CO., INC.
GENERAL OFFICE: 4242 W. Bryn Mawr Ave., Chicago 46, Ill.
Two RMC Plants Devoted Exclusively to Ceramic Capacitors
FACTORIES AT CHICAGO, ILL. AND ATTICA, IND.

ensued among interest groups, but in 1962, Zenith and RKO General Inc. won permission to start a full-scale field test over WHCT, Channel 18, in Hartford, Conn.

Trial by fire. The partners went into this market on a uhf station at a time when few sets were equipped to receive such telecasts. Moreover they faced formidable competition: CBS had an outlet in Hartford and ABC had a station in nearby New Haven. Nevertheless, both Zenith and RKO agreed the game was worth the candle.

The Hartford experiment was never a financial success. In the first three years of operation, the two firms sustained a total operating loss of \$3.5 million. But then there were never more than 5,000 subscriber sets at any one time.

Technically, the Hartford trial established the fact that the Zenith system didn't cause interference either within or without the frequency employed to any greater extent than permissible under FCC standards. Moreover, the equipment didn't cause perceptible degradation in the quality of the video or audio signals to any receivers during either a subscription or non-subscription program. Finally, Zenith's decoders were proved effective, with no known instances of encoded signals being unscrambled by privately-built equipment. Service requirements were minimal, and Zenith is now projecting an average of less than one service call per subscriber per year when the nationwide system gets going next year.

From an economic point of view, the Hartford experiment also proved that, based on certain assumptions, pay tv could become a commercial success. What's more Zenith is confident the medium can broaden the electronics industry's potential for sales growth. Large-screen color receivers made by Zenith and the others should do especially well, say marketing officials, since Phonevision works with any make of set. Moreover, Zenith's Wright asserts pay tv answers the consumer industry's question of, "After color, what?" He says: "The development of subscription tv can well provide the stimulus for the next growth spurt in the consumer electronics industry."

Save the ruins.

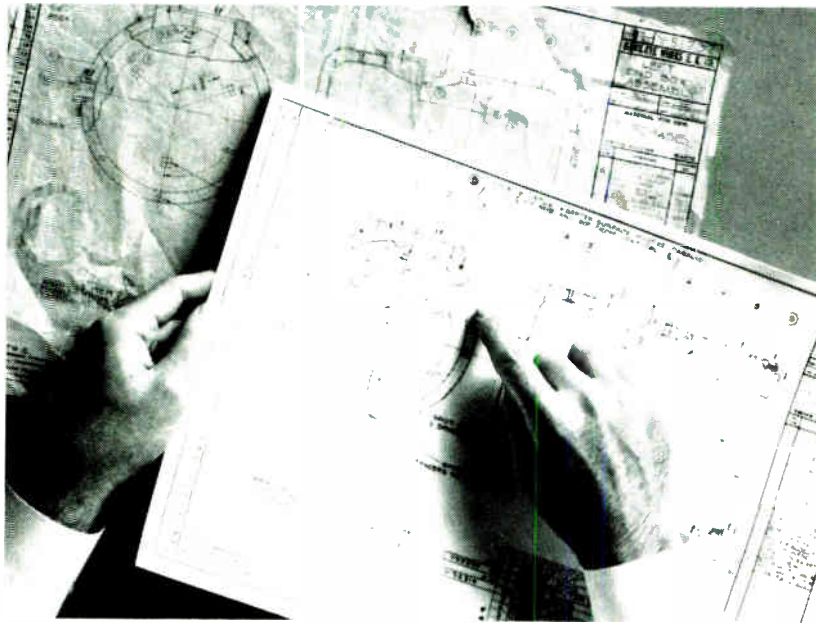

Have your second originals made on KODAGRAPH Wash-Off Film, ESTAR Base. It pays.

Next time you're confronted with a faded, wrinkled, stained, flaky, or otherwise exhausted original drawing, have it restored on KODAGRAPH Wash-Off Film, ESTAR Base.

Your reproduction department or commercial blueprinter will send you back a great second original. One that will last through years of use.

You'll get back a drawing with details in sharp blacks, on which folds and blots have been removed. This highly durable ESTAR Base Film has a fine-tooth matte drafting surface that accepts jewel- or steel-tipped pens, standard pencils—smoothly. Multiple same-area erasures are a snap. You use a drop of water and a touch or two of your eraser.

Check with your Kodak Technical Sales Representative on KODAGRAPH ESTAR Base Films and many other ways to save creative drafting time. Or write us: Eastman Kodak Company, Business Systems Markets Division, Rochester, New York 14650.

Kodak

DRAWING REPRODUCTION SYSTEMS BY KODAK

BELDEN...new ideas for moving electrical energy

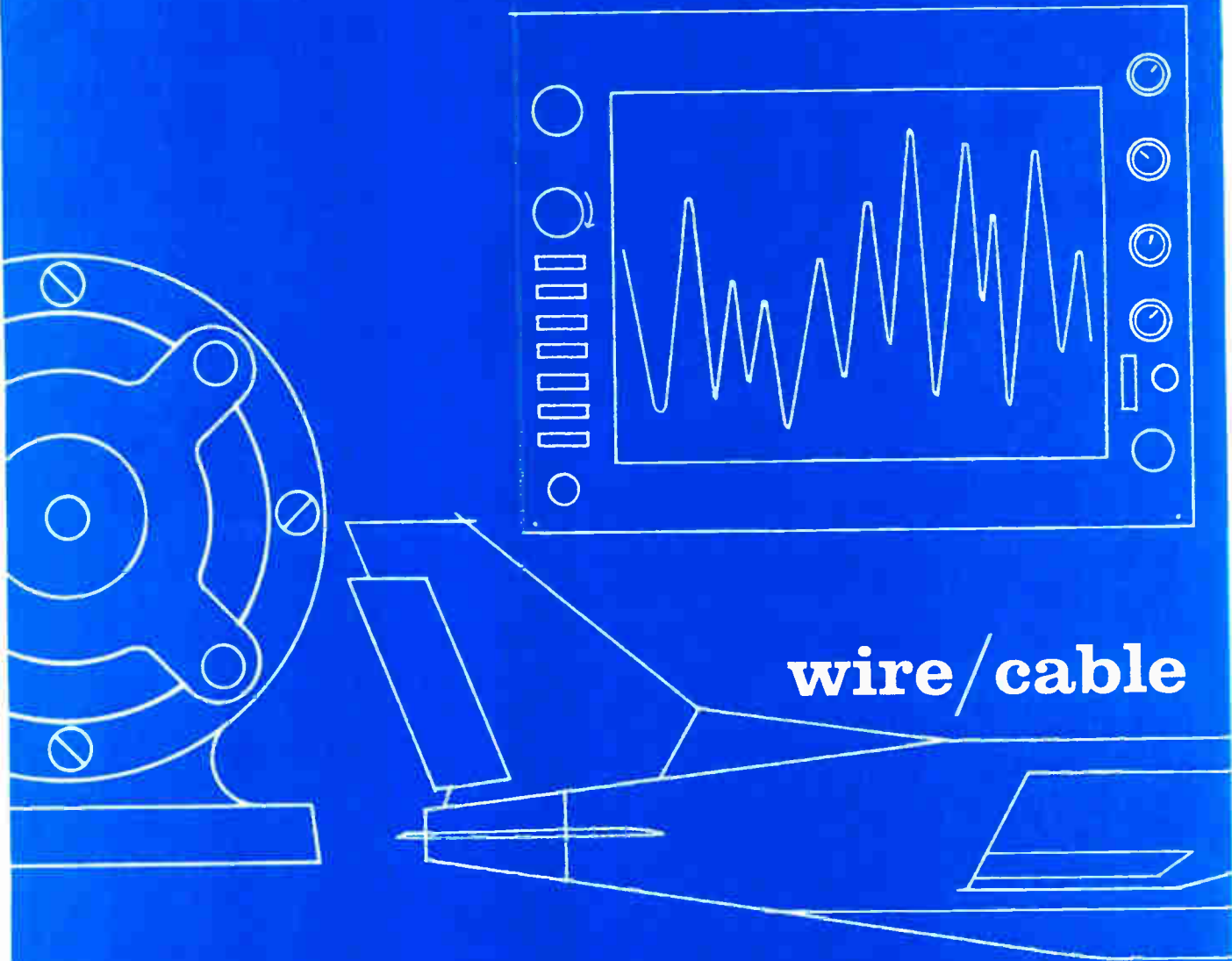

BELDEN

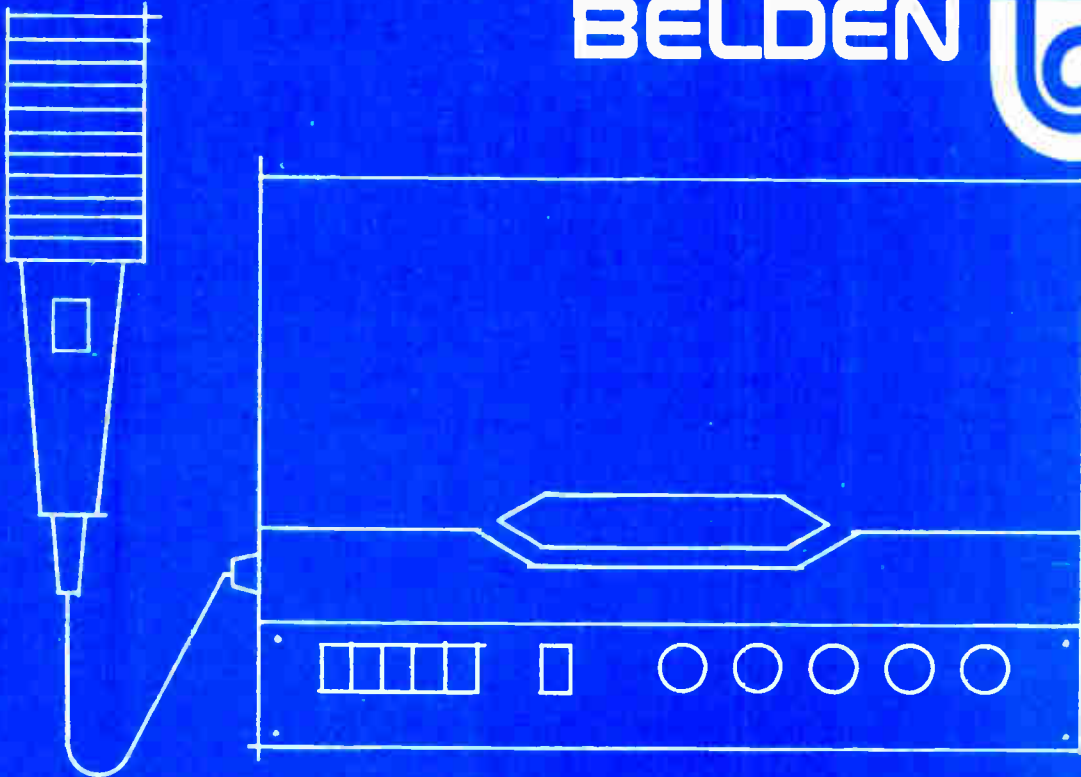

systems turn us on

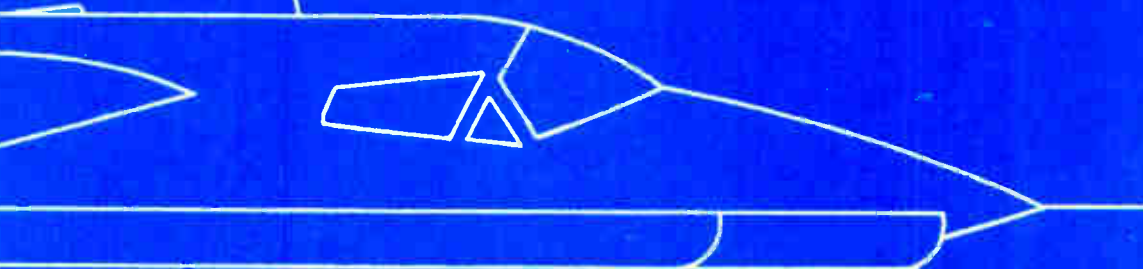

We have an active imagination when it comes to wiring. Because it's sparked by a lot of savvy about wire and cable and its capabilities. With applied imagination we can create fresh ideas that help a customer get a better value for his dollar. Our Wire Systems Specialists are trained to explore every wire-related aspect of a product—compatibility, production, packaging, operating environment . . . the entire system. And then put their imaginations to work. To eliminate a shielding or stripping problem*. Or save money. Or enhance the product's reliability. And whatever type of wire or cable it takes to turn an

idea into reality . . . well, we make all kinds of wire for all kinds of systems. Why not see what we can imagine for your product? Call or write: Belden Corporation, P.O. Box 5070-A, Chicago, Illinois 60680. And ask for our catalog, and the reprint article, "Key Questions and Answers on Specifying Electronic Cable."

*For example: We've insulated some of our lead wire with silicone. So no glass braid protection is needed. This means that stripper blades will last much, much longer. And a potential health hazard to stripper operators is eliminated.

G-1-B

AIRPAX TYPE APL 4-POLE PROTECTOR POLYPHASE CIRCUIT PROTECTION

Protection of equipment in each phase of a three phase circuit is shown in the diagram. An over-current in any circuit trips all protectors. The fourth unit in the protector assembly is controlled by an external relay which may

be actuated by an over-temperature situation such as might occur in an industrial furnace. As this external relay is energized, trip current flows through the fourth protector returning all power circuits to the OFF condition.

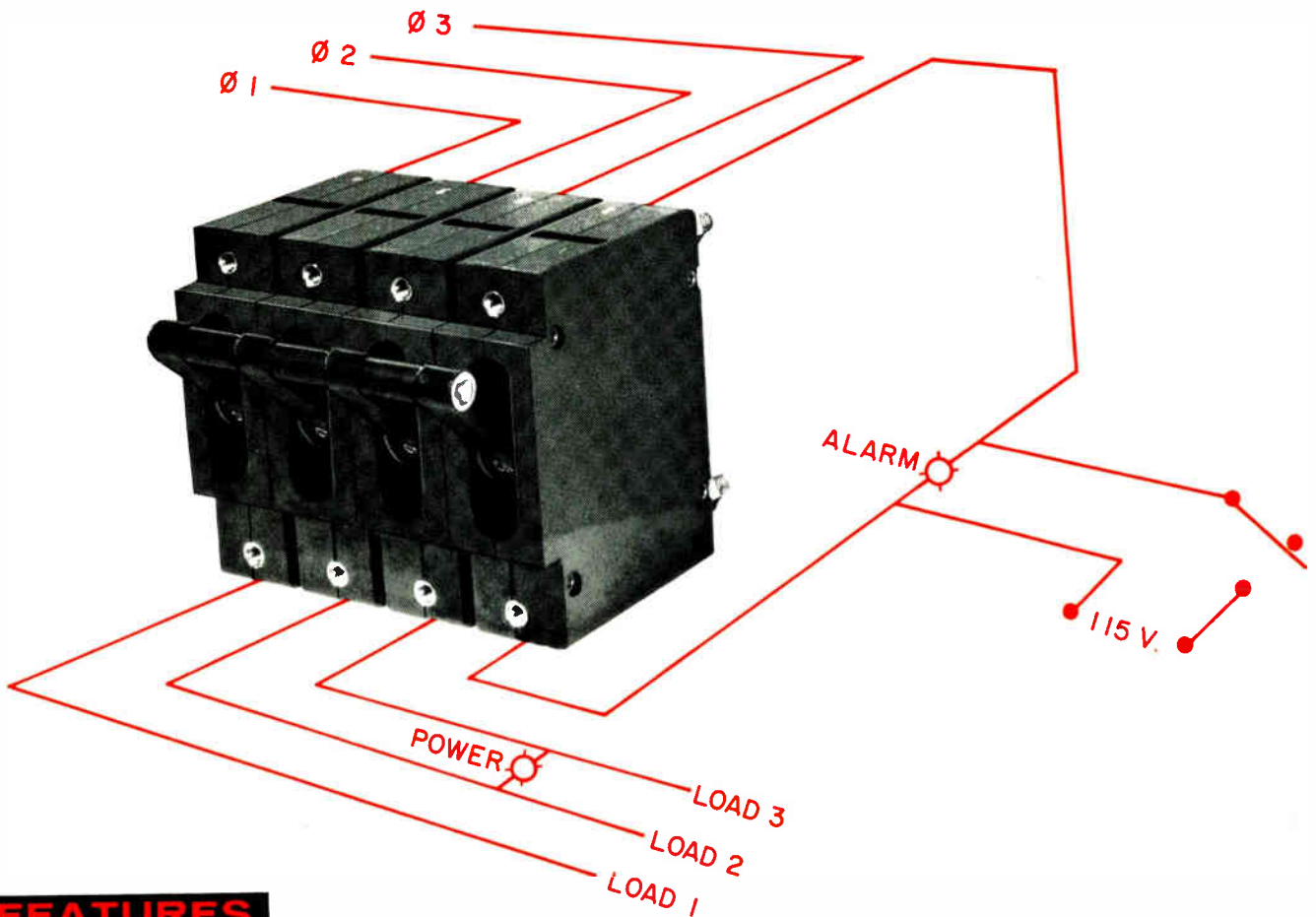

FEATURES

MECHANICAL GANGING — As many as nine protectors can be ganged for interlocked operation. Ratings of individual protectors need not be identical.

HIGH RUPTURE CAPACITY — Construction assures reliable rupture capability to 5000 amperes, 250 V AC, 60 Hz.

TRIP-FREE HANDLE — Trips off on overload; will not reset until overload is cleared.

FAST RECOVERY OF TIME DELAY AFTER TRIP — Delay plunger returns to normal position, by spring action, after trip.

TRIP RATING INDEPENDENT OF TEMPERATURE — Rating remains unchanged in any ambient within operating temperature limits (-40°C to $+85^{\circ}\text{C}$).

CIRCUIT PROTECTION — For loads from .050 to 50 amperes (to 100 amperes with heavier terminals).

AIRPAX ELECTRONICS

CAMBRIDGE DIVISION, CAMBRIDGE, MARYLAND 21613

PHONE (301) 228-4600

TELEX 8-7715

TWX 710 865-9655

With fluidic logic in control, IC handler adds no electrical noise

Machine uses moving air instead of electromechanical parts to feed IC's to a tester and then sort them; \$2,750 unit handles 3,600 circuits an hour

The special ingredient in a new integrated-circuit handler is air. It hushes the noise and keeps the repairman at bay.

The Barnes Corp. used to make an electromechanical handler; this did a fine job of again and again plugging integrated circuits into a socket, waiting until a tester checked out the circuits, and then sorting the IC's. But since it was electromechanical, every time the handler moved an IC, relays would close, motors would turn and cams would rotate. All this clanking generates a lot of electrical noise; these noise signals can get to the terminals of an IC and spoil a test or even ruin the IC.

To get rid of the noise, Barnes engineers have redesigned the handler. Gone are all the electromechanical

components and in their place are air and a fluidic-logic network to control the air. Thirty fluidic modules—AND gates, OR gates, one-shot multivibrators, and flip-flops—are in the controller.

Kenneth Blanchard, a Barnes vice president and a designer of the handler, says that by switching to fluidic logic, the company has made a more versatile unit. "Not all types of IC's were bothered by the noise in our old handler," he says. "But there are some families, like the Fairchild 4000 series, that are really sensitive. And no matter what you're testing, you're going to be worried about noise as long as it's around."

Blanchard thought of keeping the old design and just adding some shielding, but rejected this

approach. "Shielding works," he says, "but it's bulky and expensive. Besides, you're not really eliminating the problem; you're just covering it up."

Noiseless operation isn't the only advantage that fluidic logic brings. Says Blanchard: "Since fluidic gates have no moving parts, they're a lot more reliable than electromechanical parts."

"And we've kept the price down," adds Blanchard. "Most other handlers around go for \$20,000 and up. Ours sells for \$2,750."

The handler is magazine-fed; however, with modifications, it can be bowl-fed. And it loads and sorts up to 3,600 IC's an hour.

Each circuit to be tested is put into a carrier, and the carriers are loaded into a long, thin magazine

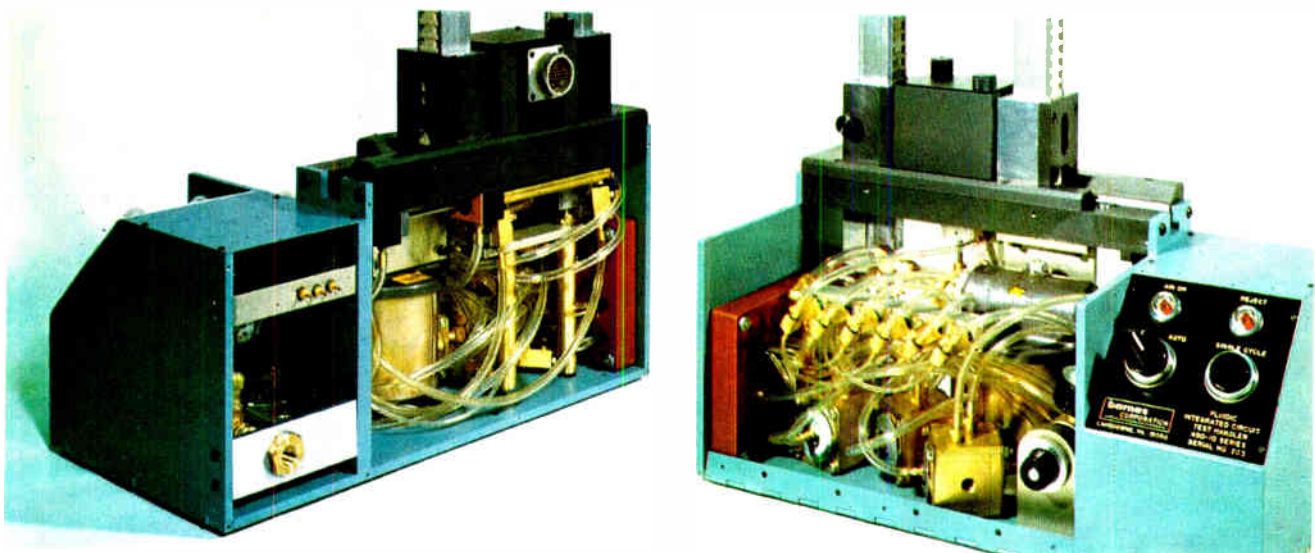

The good shall rise. Sitting in individual carriers, the IC's to be tested are in one of the two magazines (the rectangular vertical tubes on top of the handler). Under the control of a fluidic-logic network, three cylinders move IC's into a test socket. Those that pass the test pile up in the second magazine.



What is Bunker-Ramo's systems design spectrum?



From operational analysis . . .



to on-line experimentation and verification . . .



to operational systems and hardware

Advanced systems concepts, operations research, software development, implementation, modeling, maintainability/reliability analysis, integration, checkout and field support . . . a colorful spectrum of techniques, experience and capabilities necessary to assure total system effectiveness. Some recent examples:

System operational evaluation of the Marine Corps' Tactical Data System (MTDS) . . . system and hardware support for the Navy's precision navigation system . . . satellite navigation analysis . . . Tactical Traffic and System Analysis for the USAF Advanced Tactical C & C Systems . . . advanced application of data processing . . . man-machine interface studies

. . . display and communication systems for future tactical aircraft location and control systems . . . On-Line techniques for Navy command control.

Bunker-Ramo's capabilities in system development are wide-ranging . . . from analysis of the U.S.A.F. Airborne Warning and Control System to development of computer-aided techniques in human engineering . . . from photo interpretation using state-of-the-art-on-line display techniques to automated map-making . . . from highly sophisticated Strategic C & C Systems through quick reaction tactical systems. Want to broaden *your* design spectrum? . . . contact Bunker-Ramo.

THE BUNKER-RAMO CORPORATION
DEFENSE SYSTEMS DIVISION
 8433 FALLBROOK AVENUE • CANOGA PARK, CALIFORNIA 91304

AN EQUAL OPPORTUNITY EMPLOYER

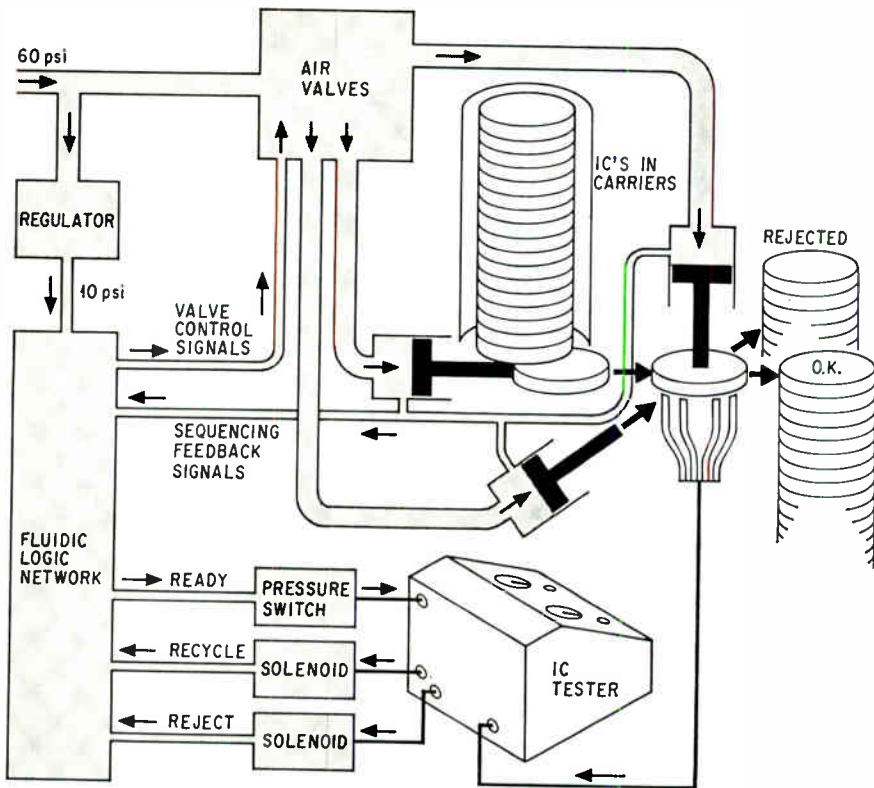

Air force. Air at 60 psi drives both the trio of cylinders that move the IC's and the fluidic-logic network that controls the cylinders. A regulator reduces the air pressure to the 10-psi level used in the logic network.

that's plugged into the handler.

A cable connects the handler's test socket to an IC tester. Except for commands from this tester, the handler uses no electrical energy. It's powered by air coming from a 60-pounds-per-square-inch source. This source feeds the handler's two air networks: a 60-psi network that moves the cylinders that in turn move the IC's, and a 10-psi logic network that controls the cylinders and interfaces with the tester.

Cylinder action. There are three cylinders to do the moving; one pushes the carriers horizontally, one drops and retracts the test socket, and the third flicks bad IC's into a reject bin. The good IC's are piled up on a second magazine.

The testing cycle begins when the horizontal-transport cylinder pushes a carrier out of the magazine and into position under the test socket. A 10-psi signal from the horizontal-transport cylinder tells the controller when the carrier is in position. Upon receiving this signal, the controller tells the test-socket cylinder to move. Down it comes, stopping when the carrier is seated in the socket, connecting the IC to the tester.

Another 10-psi signal goes back to the controller, telling it that the IC is in position. The handler sends another 10-psi air burst to a pressure switch which sends a "Ready" signal to the tester. After checking out the IC, the tester sends either a "Recycle" or a "Reject" command through one of two solenoids to the handler.

On command. If the command is "Recycle," the test-socket cylinder retracts, the tested IC and its carrier are pushed into the second magazine, the horizontal-transport cylinder withdraws, and the cycle begins again.

If the tester says "Reject," the same steps occur except that the reject cylinder moves out, flipping the bad IC into a reject bin.

The handler works with flat packs, dual-in-line packages, and TO cans. When the user wants to switch from one type of package to another, he just changes the test socket and its mounting with a screwdriver.

The handler works with almost any tester.

Delivery time is six weeks.

Barnes Corp., 24 N. Lansdowne Ave., Lansdowne, Pa. 19050 [338]

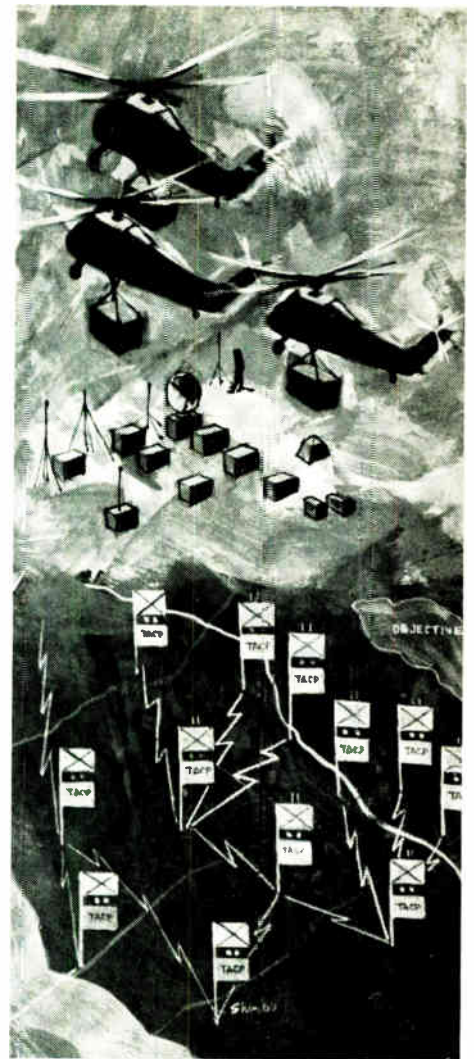

A Career Spectrum (for you) At Bunker-Ramo

■ STATISTICAL COMMUNICATIONS SYSTEMS ANALYSTS

Requirements definition, performance parameters, hardware solutions.

■ COMPUTER/DISPLAY

Systems analysis/design on Command/Control Systems with emphasis on Information Systems.

For prompt consideration
Call collect (213) 346-6000
or send resume (include salary history) to D. S. Kalal



THE BUNKER-RAMO CORPORATION
DEFENSE SYSTEMS DIVISION
3433 FALLBROOK AVENUE • CANOGA PARK, CALIFORNIA 91304

AN EQUAL OPPORTUNITY EMPLOYER

CROWBAR...?



The One Inside is FREE

Not so many years ago, the prudent transmitter engineer discharged a high voltage capacitor bank by dropping a shorting "crowbar" across its terminals. Today's "crowbar" is a protective overvoltage circuit found on DC power supplies — usually at extra cost. Now HP includes a crowbar as standard on its recently updated series of low-voltage rack supplies... at no change in price.

Long established as preferred system supplies for component aging, production testing, and special applications, these supplies have now been redesigned and expanded to meet the stringent demands of today's power supply user. Advantages include low ripple (peak-to-peak as well as rms), well-regulated constant voltage/constant current DC with outputs to 60 volts and 100 amps.

Where loads are critical and expensive the extra pro-

tection — say, against inadvertent knob-twiddling — from a crowbar is invaluable. On all internal crowbars in this series, the trip voltage margin is set by screw-driver at the front-panel.

Performance specifications are: triggering margins are settable at 1V plus 7% of operating level; voltage ripple and noise is 200 μ V rms/10mV peak-to-peak (DC to 20 MHz); current ripple is 5 mA rms or less depending on output rating; voltage regulation is 0.01% resolution, 0.25% or better; remote programming, RFI conformance to MIL-I-6181D.

Prices start from \$350. For complete specifications and prices contact your local HP Sales Office or write: Hewlett-Packard, New Jersey Division, 700 Locust Avenue, Berkeley Heights, New Jersey 07922 or call (201) 464-1234... In Europe, 1217 Meyweg, Geneva.

HEWLETT  **PACKARD**
POWER SUPPLIES

Additional data sheets available upon request



LAB SERIES
smaller package,
lower power,
optional crowbar



CROWBARS
A Technical
Discussion



**1963 Power
Supply Catalog**
— includes total
HP power supply line.

Circle # for details 350

331

332

333

21902B

Solid state relay has wide trigger-range

Accepts input of either polarity from 3 to 200 volts d-c, or 3 to 140 volts a-c; broad applications seen in control jobs

Poor reliability in electromechanical relays as a result of arcing and contact wear has given added impetus to the development and marketing of solid state relays.

One of the newest entries comes from Teledyne Relays. Although not alone in the field (Ohmite, for example, makes a similar relay), Teledyne claims to be first off the mark with a standardized, four-

terminal, broad-capability, all-solid-state relay in production quantities.

Company spokesmen say the device, designated series 6, accepts a universal input of either polarity from 3 to 200 volts d-c, or 3 to 140 volts a-c, and can switch up to 2 kilowatts of resistive or inductive load with a heat sink.

Epoxy encapsulated in a 2- by 2-inch-square, 0.81-inch or one-

inch-high package, the relay has a heat sink mounting surface, and can be chassis mounted with a single bolt. A boss on the mounting surface prevents rotation. Isolation between the input and output, and between mounting plate and contacts is 100 gigohms, with dielectric strength of 1,800 volts a-c (rms).

Output current rating is 14 amperes maximum whether resistive



Tiny decade potentiometer designated DP310 Dekapot is a stacked-decade, coaxial-dial voltage divider. Professional grade components are assembled in the Kelvin-Varley circuit to provide terminal linearity of 50 ppm, high resolution (0.0035%) and constant input impedance. Price is \$100. Electro Scientific Industries Inc., N.W. Science Park Dr., Portland, Ore. 97229. [341]



The TNR series is a solid state time delay (delay on energization) with dpdt relay output, 10 amp resistive at 115 v a-c. It is available with input voltage from 12 v d-c to 230 v a-c and in time ranges from 0.1 to 480 sec. Unit features reset during the timing period without any false transfer of output contacts. Syracuse Electronics Corp., Box 566, Syracuse, N.Y. 13201. [342]

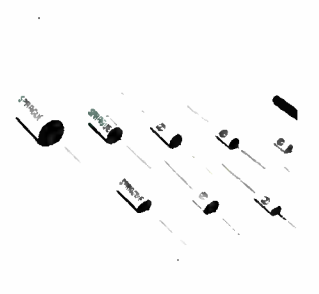

Metalized film capacitors type 431P feature an axial-lead polyester-film capacitor section protected against moisture by an outer wrap of polyester-film tape. They are suited for use in commercial and industrial subassemblies. With capacitance values ranging from 0.0015 μ f to 12 μ f, voltage ratings include 50, 200, 400, and 600 v. Sprague Electric Co., North Adams, Mass. [343]

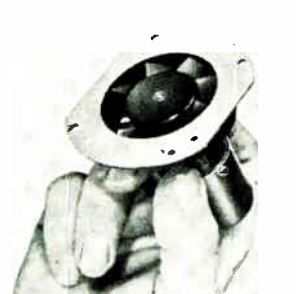

Cooling blower 19A2142 is a 27 v d-c unit that develops 30 cfm of air at 0.86 in. H₂O and contains an integral radio noise filter to meet MIL-I-26600. It is 3 17/64 in. long. Mounting flange is 3/4 in. maximum diameter. Weight is 9 oz. Price in prototype quantities is \$75 with availability from stock. Globe Industries, Division of TRW Inc., 2275 Stanley Ave., Dayton, Ohio. [344]



Eight-contact high voltage connectors in a standard MS type shell feature interfacial seals for each contact providing corona suppression through air excluding engagement. They are suited for high altitude applications to 70,000 ft and temperatures as low as -55°F. Silicone rubber inserts are supplied for normal use. Caton Industries Inc., 648 W. First Ave., Roselle, N.J. [345]

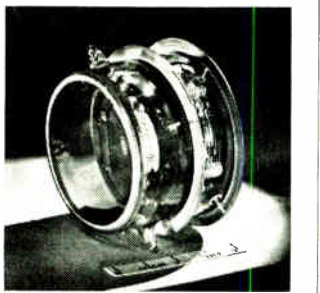

Compact photomultiplier type P10 has been developed for use in restricted spaces. Although the photocathode is a full 2 in. in diameter, the tube is only 2 in. long and 3 in. o-d including the dynode resistors. A low noise, high quantum efficiency visible light bialkali cathode is standard. The tube is fully ruggedized. Johnston Laboratories Inc., 3 Industry Lane, Cockeysville, Md. 21030. [346]



Small, lightweight vaneaxial fan Aximax 1 will provide 12 to 23 cfm at motor speeds between 11,400 and 22,500 rpm when operating at frequencies of 400 hz and above. The unit can also be supplied with a 60 hz motor that will deliver 3 cfm at 3,340 rpm. The airflow-reversible fan measures 1 1/2 x 1 3/4 inches and weighs 4 ounces. Rotron Inc., Hasbrouck Lane, Woodstock, N.Y. [347]



Production mounting sockets 041-007 and 041-008 are for 3- and 4-lead TO transistor packages with either 0.1 or 0.2 in. pin circles. Contact resistance is 0.005 ohm; insulation resistance, 4 x 10¹⁴ ohms; and interlead capacitance, 0.4 pf at 1 Mhz. Operating temperature is -55° to 125°C. Price is from 14 to 38 cents depending on quantity. Barnes Corp., Lansdowne, Pa. [348]

When you've got a load to move,

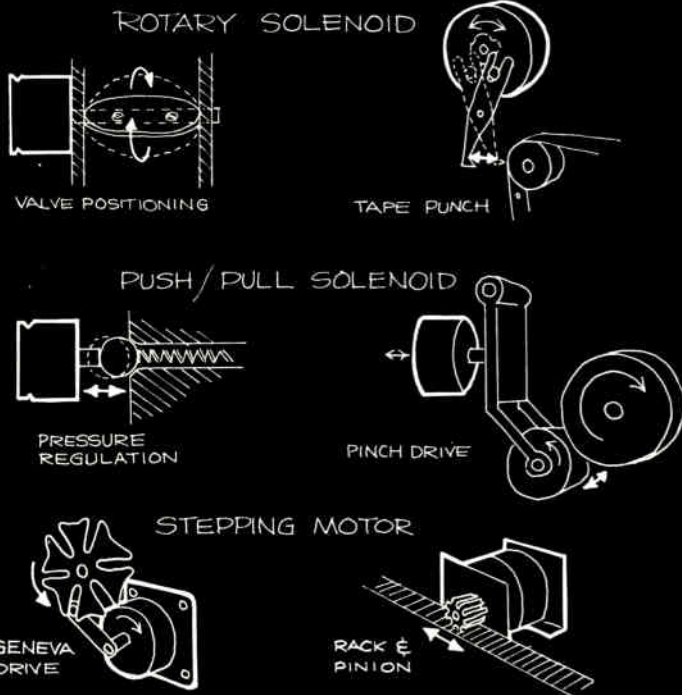

or circuits to switch . . .

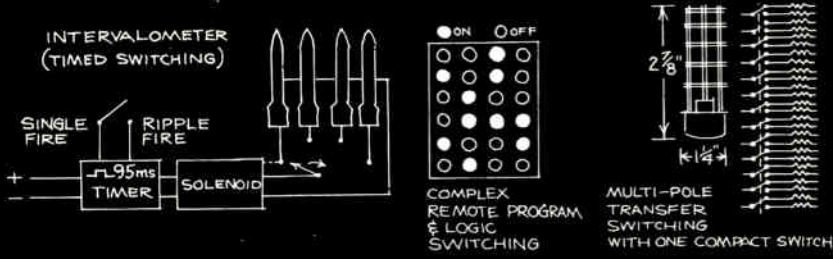

Ledex has the people and the products to make things happen.

Ledex Rotary Solenoids give you fast, direct rotary motion. There's a family of eight sizes with torque all the way up to 117 pound inches. For linear loads, our **Push/Pull Solenoids** respond in less than 10 ms. Both have a compact form factor and there are over 350 stock models to get your prototype off the board and into the shop fast.

Ledex Stepping Motors position loads remotely in predetermined increments over 360°, cw, ccw, or both. You can add a knob for manual positioning. Attach a load on either or both ends. And our newest model gives you 160 ounce-inches running torque.

You'll find versatile **Ledex Switches** everywhere . . . in missile nose cones, laboratory instruments, business machines, even automatic bingo games. They take up very little space to control, transfer, program and check out complex circuits.

For a neat **Packaged Control Solution** to your most complex switch problems, we'll deliver the answer in a small black box, ready to plug in. Chances are, the Ledex combination of people and products have solved an actuating or switching problem much like yours already. Just send us an outline of your problem.



LEDEX DIVISION, LEDEX INC.
 123 Webster Street, Dayton, Ohio 45402 Phone: 513-224-9891

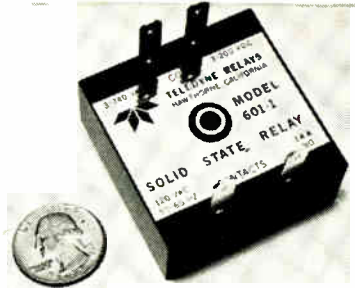

or inductive, and 140 volts a-c (rms), 50-60 hertz maximum. Turn-on time is 5 milliseconds, compared with a typical 250 millisecond pull-in time for mechanical relays handling the same current level. On-resistance is minimal, typically about 100 milliohms.

Roy J. Mankovitz, chief design engineer at Teledyne, says the device has been life-tested through 2 million cycles over four months without failure. The unit has an estimated life of more than 100 million cycles. In contrast, comparable electromechanical relays are limited by mechanical wear to about 100,000 cycles of reliable functioning.

Compatible. The relay's solid-state trigger uses all silicon components, operating on input of less than 1 milliwatt.

When temperature derated for mounting without a heat sink on printed circuit boards, the series 6 will still switch up to 7 amps.

Because the relay has a consistent turn-off and turn-on point, it can also perform function level detection, such as detecting voltage thresholds, and it can in addition be used in go, no-go testers and ground support equipment. Wide application is also anticipated in traffic and temperature control systems, switching in explosive atmospheres, and inductive load control.

Although initially aiming at industrial applications for its relay, Teledyne also has an eye on future military applications. A companion line in the same configuration is now under development for d-c load-voltage switching in military aircraft and missiles.

The relays are scheduled to be in the hands of distributors by July 1. Delivery time for prototype quantities is four to six weeks; production quantities take 10 weeks. Price is under \$20 in quantities over 100.

Teledyne Relays, 3155 West El Segundo Boulevard, Hawthorne, Calif. 90250 [349]



Optimizer

**Off-the-shelf
Full Capacity thyristors
balanced for all parameters
only from Westinghouse.
Try 'em for size.**

With thyristors that meet all critical design parameters — not just a couple—you get reduced equipment size...plus savings on circuit components. And only Westinghouse delivers them.

Our parameter optimization in full capacity thyristors gives you another bonus: more design security. And their compression bonded en-

capsulation (a Westinghouse first) assures low thermal impedance.

Vital statistics: 40 to 550 amps, up to 1500 volts; standard JEDEC and POW-R-DISC packs.

So optimize away! Send for SA-10205. Westinghouse Semiconductor Division, Youngwood, Pa. 15697.

You can be sure... if it's
Westinghouse





The first complete LSI Array Tester ever available commercially . . .

■ **NORTH AMERICAN'S**
LSI TEST
CONSOLE

ECONOMICAL—priced within the budget of companies testing only a few different types of arrays;

VERSATILE—satisfies the needs of both the engineering lab and the factory testing station;

BASIC—operated by factory personnel without the need for programmers;

SENSIBLE—provides complete, proven LSI testing, eliminating the need for costly, prolonged development programs.

for information about pricing, operation and delivery, write or call:

■ **North American Electronic Systems**

DIVISION OF EDUCATIONAL COMPUTER CORPORATION

Sicklerville, New Jersey 08081

Telephone: 609-629-4141

Test set performs double duty

Built to check telephone lines, meter reads noise and transmission levels; range is wide enough to measure voice, program, and carrier systems

One does the job that used to require two instruments. That's the advantage of a specialized voltmeter from the Hewlett-Packard Co. Called the Transmission and Noise Measuring Set, the voltmeter reads both the level of signals sent down a telephone line and the amount of message-circuit noise. According to H-P, an engineer would usually have to reach for

two voltmeters to make these measurements. The reason the meter can go two ways is that both noise-weighting filters and impedance-matching transformers are built into the instrument.

As a transmission-measuring instrument, the meter has a range of 20 hertz to 3 megahertz, wide enough to check out voice, program, and carrier systems. The ac-

curacy is around 0.2 decibel at midrange, and better than 0.5 db at 1 Mhz. Sensitivity is -90 dbm.

The noise-measuring portion has four weighting characteristics—C message, 3-kilohertz flat, 15 kilohertz flat, and program. Any of these characteristics can be selected with a switch.

The set has input jacks to accommodate most commonly-used plugs



F-m test unit model 6275 is a solid state instrument that meets the instrumentation magnetic tape recording needs for a portable, rugged f-m calibrator. It calibrates IRIG Group I (40% deviation) narrow and intermediate band f-m electronics with center frequency carriers up to 432 khz. Price is \$550. Micom Inc., 855 Commercial St., Palo Alto, Calif. 94303. [361]

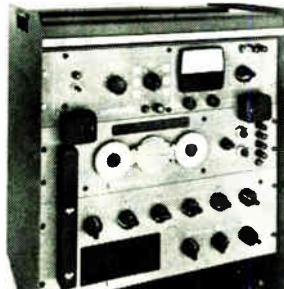

Resistance measuring system 242C enables an engineer or technician to make direct reading measurements with 10 ppm accuracy; 1 ppm comparison of resistors is easily done with 0.1 ppm resolution. Production resistors can be batch tested on a go-no-go basis using meter deflection. Price is \$5,500. Electro Scientific Industries Inc., 13900 N.W. Science Park Dr., Portland, Ore. [362]

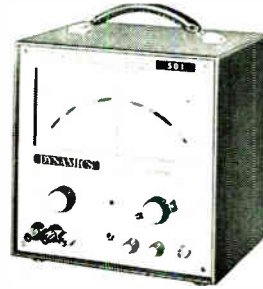

D-c/a-c millivoltmeter model 501 is a battery operated instrument featuring guarded and isolated operation from 1 mv to 1 kv. The meter is center scale for d-c; left scale for a-c. The a-c bandwidth ranges from 1 hz to 100 khz. A 7.2-in. mirror-backed, taut-band meter is used for easy reading. Dynamics Instrumentation Co., 583 Monterey Pass Rd., Monterey Park, Calif. [363]

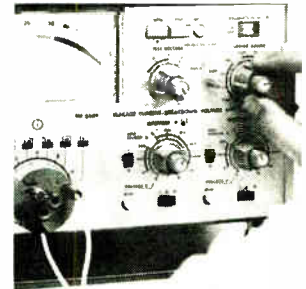

Single instrument meter model PM-6509 makes semiconductor leakage current measurements from 100 pa to 100 ma, and breakdown voltage measurements at up to 1,000 v. The unit can also be used to make resistance measurements of 10 ohms to 100 teraohms, accurate to 3% of reading. Philips Electronic Instruments, 750 South Fulton Ave., Mt. Vernon, N.Y. [364]

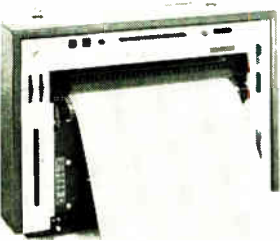

Direct-recording oscillograph series 500 Visigraph is a 1- to 50-channel instrument using paper up to 12 in. wide. Twelve paper speeds, from 160 to 0.25 ips are standard, with 12 additional speeds available as an option. Standard features include an event marker, trace identification, and automatic record length control. Dixon Instruments, Box 1449, Grand Junction, Colo. [365]



Selective expansion meters type SE are available in standard ranges with full scale sensitivities of 10 μ a to 10 amps and 1/10 v to 1,000 v. Selected expansions can be made over any one-tenth portion of the enlarged scale. Accuracy is 0.025% of full scale, and range progression is typically 1/10/100. Solitron Devices Inc., 37-11 47th Ave., L.I.C., N.Y. 11101. [366]

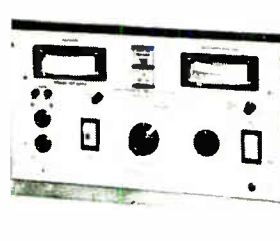

High potential tester model HPT-100 tests insulation characteristics on and/or in transformers, capacitors, cables, motors, rectifiers and related equipment. It tests or measures nondestructively such characteristics as d-c or a-c dielectric strength, d-c or a-c leakage current, insulation resistance and corona levels. GAR Enterprises, 2031 N. Lincoln Ave., Pasadena, Calif. [367]



Compact digital pulse generator PG610 provides output pulses at repetition rates from 10 hz to 2 Mhz in six overlapping ranges. Output is compatible with TTL, DTL and RTL logic levels. It can be operated at high output pulse duty cycle. Dimensions are 2 x 3.75 x 6.25 in. Price (4-9) is \$98.60. Computer Products, 2801 E. Oakland Park Blvd., Fort Lauderdale, Fla. 33306. [368]

**Would the engineer who asked us
to design a marking system to imprint
a TO-115 configuration on electronic
bananas, please call (603) 352-1130.**

It's ready.

**If for some strange reason you're not
making electronic bananas, how about
your transistors, ic's, scr's, diodes,
thyristors or whatever. We can
handle those, too. We've got the
systems, type faces, inks, supplies
and services to mark whatever
you make, and mark it right.
Our problem-solver booklet will
tell you more about us.
Write for it now.**

(before you go bananas).

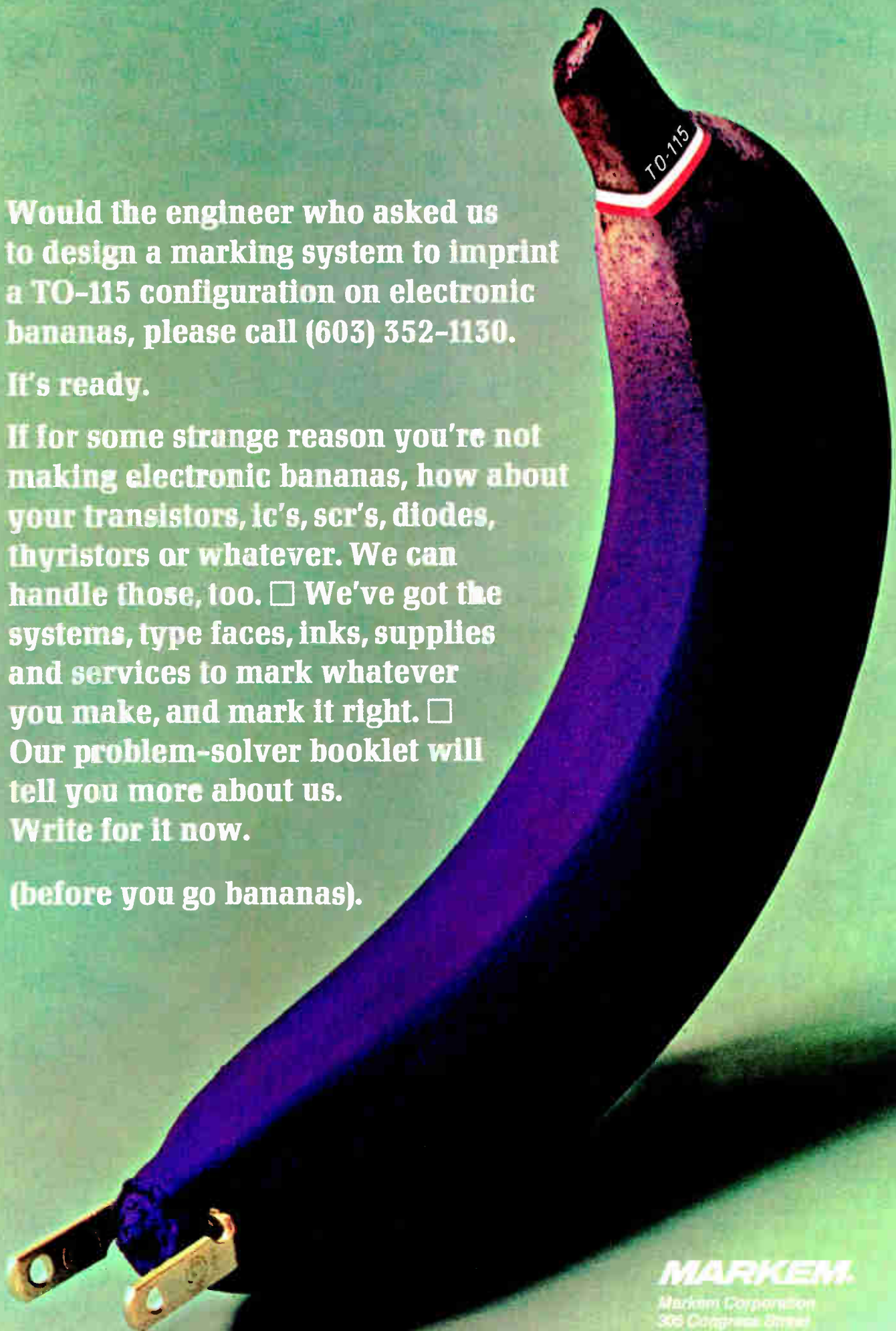

MARKEM.

Markem Corporation
305 Congress Street
Keene, N.H. 03431

Circle 142 on reader service card

United Kingdom Sales Office: Markem U.K. Ltd. Rugby, Warwickshire, England. European Sales Office: Markem Europe B.V. Schiphol Oost, Holland.



Rough duty. The test set is packaged in a rugged case and can be run from a battery or an a-c power line.

and connectors. Inputs are terminated for 135 ohms, 600 ohms and 900 ohms balanced, and for 75 ohms unbalanced.

Noise is measured from the rms characteristics of the meter. Response time is 200 milliseconds. If the noise fluctuates a lot, a smoothing circuit, which increases response time to 500 msec, can be switched into the set.

The instrument is packaged in a splash-proof case that also holds power cords and a headset.

The instrument runs for 150 hours off a dry-cell battery, and can also be powered by 24- and 48-volt batteries, and 110- and 220-volt a-c power lines.

Price of the unit is \$625 and delivery time is eight weeks.

Hewlett-Packard Co., 1501 Page Mill Road, Palo Alto, Calif. 94304 [369]

New instruments

Magnetometer is accurate, stable

Instrument measures magnetic noise and field strength

Observatory accuracy combined with long-term stability is now available in a magnetometer from the Schonstedt Instrument Co.

Designated Model HSM-1, the single-axis instrument is primarily intended as a laboratory standard or research tool. It can be used to measure magnetic noise and the magnetic fields of machinery to be installed aboard aircraft or vessels.

At constant temperature, it has high accuracy and can sense a 0.5 gamma change at any field value between zero and 100,000 gammas. This accuracy is obtained through differential measurement techniques. The unit has a manually controlled field neutralization system with a range of $\pm 100,000$ gammas, and an analog output flux-gate that measures and indicates the difference between the ambient field component and the neutralized field.

The magnetometer sensor is stable within 1 ppm/ $^{\circ}$ C (± 1 gamma) and the unit's electronic system is stable within 0.5 ppm/ $^{\circ}$ C. The magnetometer's wide range measures field-intensity variations from less than 1 gamma to 1 gauss

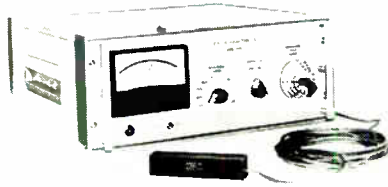

in ambient fields up to $\pm 100,000$ gammas. Accuracy and sensitivity are not affected by 60-hertz fields normally encountered in the laboratory.

Magnetometer outputs are displayed on a panel meter that reads directly in gammas. The meter has 10 ranges from ± 25 to 100,000 gammas, selected from a panel switch. Meter accuracy is $\pm 2\%$ or ± 1 gamma, whichever is greater.

Neutralization accuracy of the magnetometer is $\pm 0.01\%$; neutralization resolution is 0.5 gamma. The magnetometer's reference element is contained in an oven to assure constant operating temperature.

The instrument is housed in a 7 $\frac{3}{4}$ - by 19 $\frac{1}{8}$ - by 18 $\frac{1}{8}$ -inch cabinet and weighs 45 pounds. It comes equipped with a 100-foot sensor cable. Required supply voltage is 115 volts, 60 hz.

Schonstedt Instrument Co., 1775 Wiehle Ave., Reston, Va. 22070 [370]

Model 67 SCR/TRIAC Test System

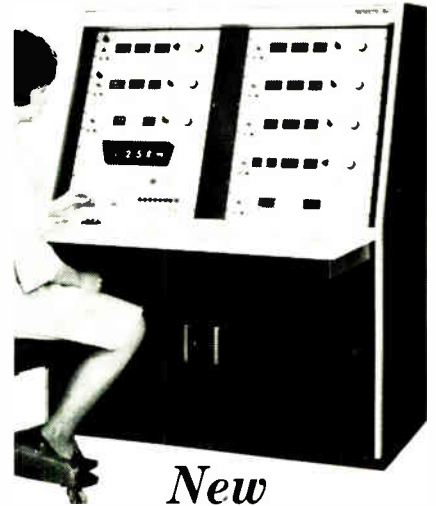

New
low-cost system
gives you full
parameter testing
automatically

The new Test Equipment Corporation Model 67 is the first commercially available high speed automatic SCR/TRIAC test system. It offers full parameter testing with extreme accuracy, yet is priced economically for incoming inspection, production and quality assurance applications. You may specify a choice of up to eight parameter tests.

Wide test capabilities of the Model 67 include a 0-2000 v blocking voltage, 300 amp forward current and linear dv/dt to a maximum rate of 1000 v/ μ sec.

Easy-to-read visual display (inset) gives the operator all test data, or tests may be performed GO/NO-GO. Simple digital thumbwheel switches provide fast, accurate programming of test conditions.

The Model 67 may be customized to particular user requirements to include tape programming, punched out data, etc. Write today for technical and pricing information.

Test Equipment
CORPORATION
P.O. BOX 20215, DALLAS, TEXAS 75220 • 214/357-6271

Anyone can think small.

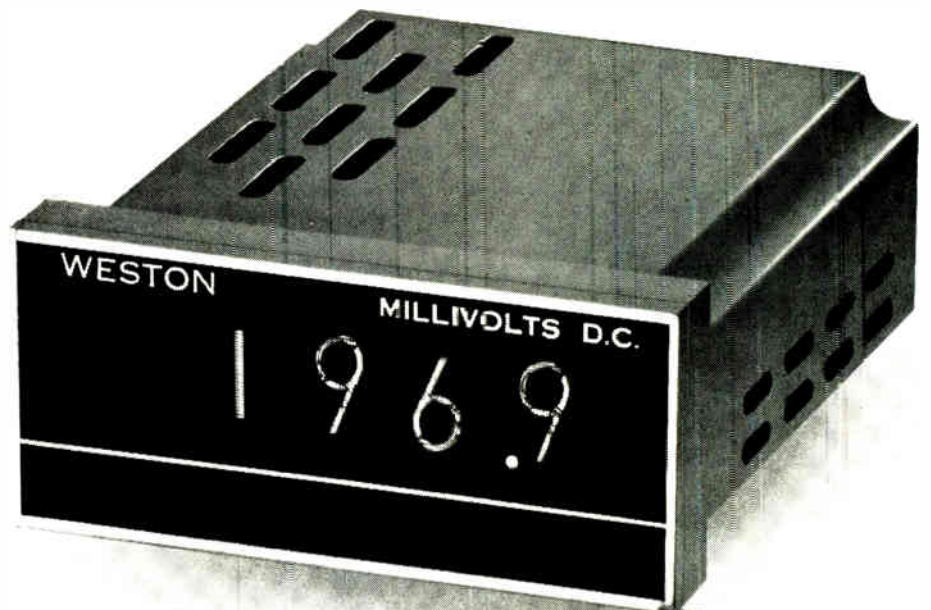

Frankly, we had something bigger in mind.



We built our second generation DPM* to fit into seven square inches of panel. *That's less than any other digital panel meter requires.* But we didn't stop there. The Model 1290 mounts completely from the front of the panel. *The entire chassis pulls out from the front for servicing or replacement.* Even the Nixie** tubes are pluggable! Think of the convenience in continuous systems opera-

tion. Despite the smaller package, Model 1290 has all the features our original DPM is so widely acclaimed for—3-digit plus 100% overrange display, 0.1% ± 1 digit accuracy, circularly polarized window filter, dual slope integration, full-buffered storage display and BCD output. Many of these standard Weston features are still "optional at extra cost" on competitive units. Our new compact

is styled for tomorrow, available today, and priced below \$200 in quantity. Anything else in the industry is just small talk. WESTON INSTRUMENTS DIVISION, Weston Instruments, Inc., Newark, New Jersey 07114.

a Schlumberger company

WESTON®

*U.S. Pat. #3,051,939 and patents pending.
**Registered trademark, Burroughs Corp.

Taking a close look at IC masks

Coordinate-measuring machine achieves total-system accuracy of 0.0002 inch by reducing effects of friction and temperature

The precision of photolithographic masks for integrated circuits can't be accepted on faith. No matter how "precise" the equipment used to prepare the mask, errors can still creep in, and if they're not detected before the mask goes to the production line, time and materials will be wasted.

For IBM's mask inspection needs, Boice Gages Inc. developed a coor-

date-measuring machine. One of the company's Acra-Cord series of customized machines, it's accurate within ± 0.0002 inch—this is a "total-system" accuracy that includes errors from all sources. To get this accuracy in a fast-operating machine, the company uses hydrostatic air bearings to reduce friction and wear to insignificant levels. As a result, the elements of the bear-

ings maintain relative positions within 20 millionths of an inch.

And to minimize temperature-induced errors, Invar alloy is used for the measuring elements and their mounting assemblies. This material has a coefficient of expansion about one-tenth that of steel.

To use the machine, an operator positions a microscope in the x and y directions. The machine indicates

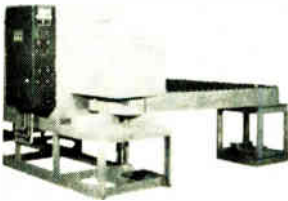

Electrically heated, spindle type conveyor oven P-324 has its own cooling tunnel. Originally designed for epoxy sealing, the heating chamber provides 250° F from a 12 kw heat input capacity. The cooling tunnel has a cooling capacity of 11,000 BTU's. Over-all dimensions are 99 in. wide x 134 in. long x 61 in. high. Grieve Corp., 1330 N. Elston Ave., Chicago. [421]



Assembly machine model 08 automatically feeds, inserts and fastens the connectors and their accompanying eyelets in a flexible circuit at the rate of 25 complete assemblies of 125 components per minute. The machine, with its multiple setting and staking capability, eliminates double or triple handling of the circuit. Edward Segal Inc., 132 Lafayette St., N.Y. [422]

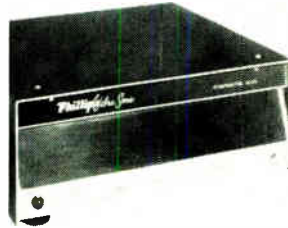

Solid state ultrasonic generators called Cavmatic 25 series have an automatic tuning unit that operates at the loaded resonant frequency of the transducer. They may be used for conveyorized batch or manual production line cleaning and degreasing. They can be frequency and phase locked to one or more units in a series. Phillips Mfg. Co., 7334 N. Clark St., Chicago. [423]

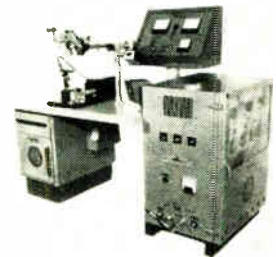

X-Y axis template welding station can handle almost any shape up to a 4 in. diagonal measurement. It is suited for welding of relay cans and miniature switches, for structural joints and hermetic seal. Production rates of 120 units/hr. for relay cans 1/2 x 1 in. are being accomplished. G. H. Silver & Associates Inc., Box 21, Newtonville, Mass. [424]



Bell jar vacuum system model NRC3117 is capable of being tailored to specific thin film process requirements. It can be equipped for resistance evaporation, electron beam evaporation, d-c sputtering and r-f sputtering. Price ranges from \$4,000 to \$20,000 depending upon the number of matched modular options. Norton Co., 160 Charlemont St., Newton, Mass. [425]



Integrated circuit tester model 80 is designed for use in engineering evaluation, incoming inspection and production testing of both digital and linear IC's. It features go/no-go sorting and thumbwheel programming. Approximate price is \$3,500. If only linear IC testing is desired, the price is approximately \$2,000. Test Equipment Corp., Merrell Road, Dallas. [426]

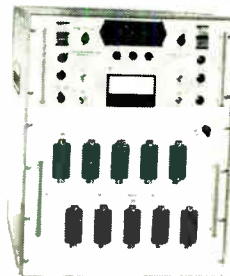

Automatic circuit tester QC320P is for volume production testing. It provides rapid go/no-go checks of back plane wiring, mother boards, harnesses and cables, and multilayer p-c boards. It will check as many as 300 circuits a minute. Accurate continuity resistance checks are assured in the range of 0.5 to 200 ohms. Automation Dynamics, Northvale, N.J. [427]

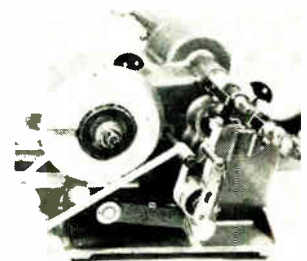

Semiautomatic coil taper model TW-300 applies pressure sensitive tapes to coils and other components. It is completely pneumatic and requires no electrical connections. It completes its cycle in approximately 1 sec or at the rate of 3600 machine cycles per hr. This is 4 times faster than manual methods. Midland Engineering & Machine Co., W. Allen Ave., Rosemont, Ill. [428]

Board meeting for busy designers.



Triad Integrated Circuit Boards packed with applicable Winchester Connectors for breadboarding dual in-line IC Packages.

No need to shop around for the right connector to use with Triad's integrated circuit cards. The applicable Winchester connector is in the same package with the card—ready for you to put together.

Triad has many low cost, fast-delivery cards for breadboarding and testing use: Universal circuit cards, ones for flat packs, TO-5's, dual in-line packages—with or without connectors.

So, if you have a hard time making a "board meeting" with the right connection, phone your nearest Triad Distributor. He can also help you on most of your transformer, inductor and filter requirements. And he'll be happy to give you a handy Triad catalog to boot. Triad Distributor Division, 305 North Briant Street, Huntington, Indiana 46750.

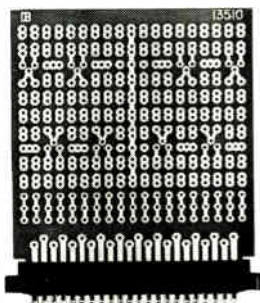

Integrated Circuit Cards

T Triad Distributor Division
of Litton Industries

the location of the microscope on a six-digit alphanumeric tube display. It also provides hard copy on a printout attachment, showing sequence number, x or y axis identification, plus or minus sign, and six-digit reading.

The microscope bracket has a rack and pinion focus slide and a locking dovetail which accepts various microscopes. Boice supplies two optical units with the machine. One is a Leitz dual-image microscope; used with prisms and color filters, this microscope gives highly repeatable measurements. The

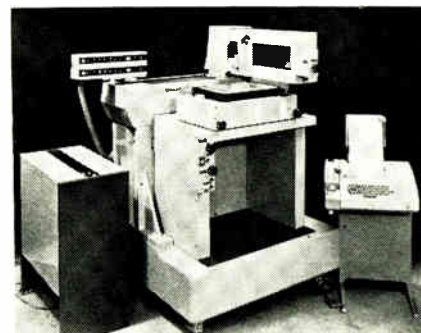

Inspector. Precision optics help operator measure circuit mask.

other microscope is a standard monocular tube with a cross-hair reticle. This microscope has since been fitted with a split-image eyepiece to measure image size directly, independent of measurements being made with the Acra-Cord.

The version for IBM comes with a knee-hole work table, intended to increase operator comfort and decrease fatigue; it allows the operator to work from a seated position at least part of the time during the inspection process. The machine operates on 7 cubic feet per minute of air at 80 psi.

There are special coarse-adjust controls on the IBM version, in addition to the fine-adjust and super-fine adjust controls. These speed up the positioning process considerably and give the operator more fine-adjust range.

For inspection, the mask is mounted on a stage on the work surface. The stage is back-lit with six fluorescent tubes.

The basic machine sells for \$22,000. The optics and the printer are extras.

Boice Gages Inc., Hyde Park, N.Y. [429]

A logic approach for systems having special little wrinkles

If your logic-system design matches up end-to-end with someone's standard products, fine. But if there's a peculiar little wrinkle in there — one that defies pre-packaged answers — we're your people. We supply standard products, and help smooth out wrinkles, too.

For products, we offer PHILCOLOGIC Micromodules in today's most advanced logic module design. Unique three-dimensional format accepts all existing IC's, discrettes, and hybrid combinations. Size is only a fraction of PC-card modules.

Compatible logic lets you freely intermix both digital and analog functions on a common chassis.

For speedier troubleshooting, they offer front access to all input/output terminals as test points. For quicker replacement, color-coded labels identify logic type and family at a glance. For higher reliability, a rugged mechanical design proved in service at NASA Manned Space Center.

And down-to-earth prices.

For wrinkle smoothing, we offer brainpower. It comes in when your system requirement departs the beaten path. Our customer-aid engineers get paid for keeping up with the rapidly changing world of logic, which comes in handy when you need a trail blazed across uncharted design territory. The PHILCOLOGIC Support (PS) design service is available to all our logic module customers.

Product and support system Data File 155 rounds out the story. For your copy, write Product Sales Manager, WDL Division, Philco-Ford Corporation, Mail Station C-41, 3939 Fabian Way, Palo Alto, California 94303. Or call (415) 326-4350, extension 5981.

PHILCO



PHILCO-FORD CORPORATION
WDL Division • 3939 Fabian Way
Palo Alto, California • 94303

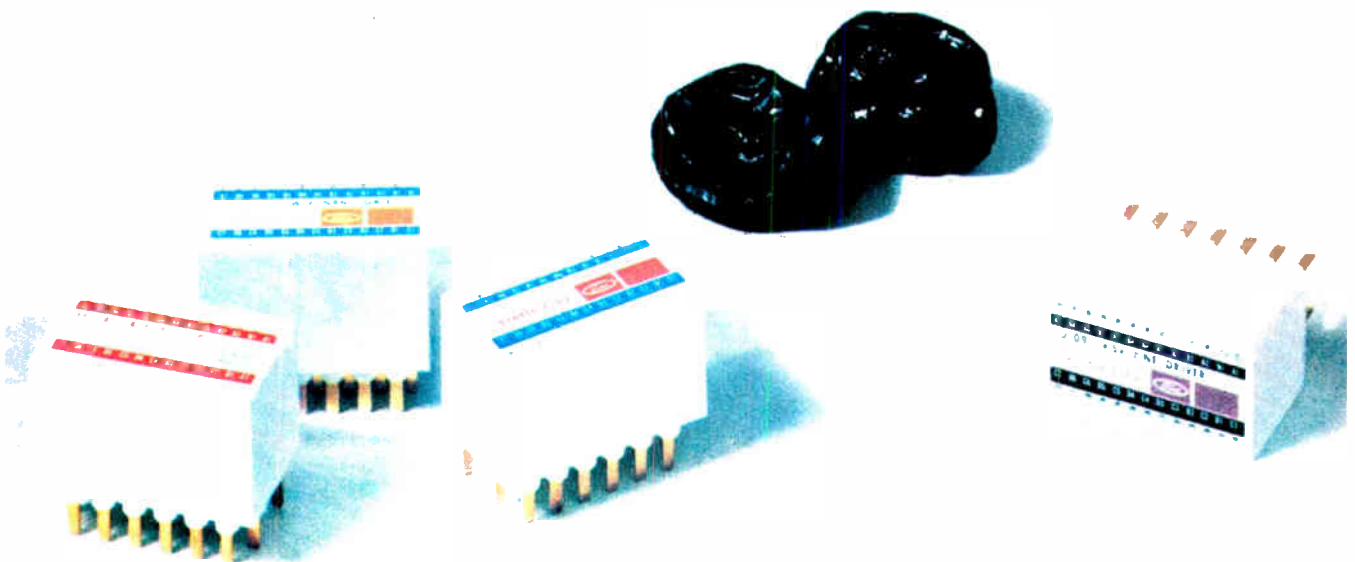



**METALS THAT ILLUMINATE,
NAVIGATE AND COMPENSATE...A
SPECIAL CAPABILITY OF CARPENTER!**

Darkness falls, and a city is "turned on" in the brilliance of manmade light. Through a shroud of fog, an airline pilot safely lands his passengers and crew without ever seeing the runway. Thermo-magnetic behavior of your automobile speedometer stays constant through all extremes of ambient temperature. These everyday conveniences we take for granted all rely on specialty metals for their high degree of reliability. Carpenter produces a total line of electronic alloys that are specified and used with confidence throughout the electronic industry. These alloys include: Temperature Compensator Alloys, Magnetic Core Irons, Controlled Expansion Alloys, Glass Sealing Alloys, Electrical Resistance Alloys, High Permeability Alloys, and others. Why not plot a new course of progress for your products with Carpenter electronic alloys? Call your Carpenter representative now. Steel Division, Carpenter Technology Corporation, Reading, Pa. 19603.

*European Office: Emmastraat 39,
Amsterdam-Z, The Netherlands*

CARTECH CARPENTER
TECHNOLOGY

Magnetic card unit for low-cost processing

Machine handles tape too, is aimed at under-\$10,000 computers; data alterability gives advantage over punched cards, paper tape

Computer peripheral devices in a system are often kept to a speed limit by such hardware as the automatic typewriter, which runs at about 15 characters per second. If this is the pacing item, dependent peripherals that deliver super speeds at high prices are wasted in such a system. That's the philosophy behind the MCT-10, a magnetic card and tape handling unit

designed by Clary Datacomp Systems Inc., to compete with punched card and paper tape equipment. It gives no more performance than the application needs and avoids premium price tags. The MCT-10 will sell for \$1,500 to \$3,000, depending on quantity and configuration.

The initial production models will handle an IBM-sized card, but

with a strip of half-inch magnetic tape on it rather than punched holes. The tape strip accommodates 700 characters comprising bits in 7, 8, or 9 tracks—about eight times more than a conventional punched card, says Donald Savitt, director of research and engineering. By this fall, however, the machine will be equipped with a magnetic tape cartridge that will be

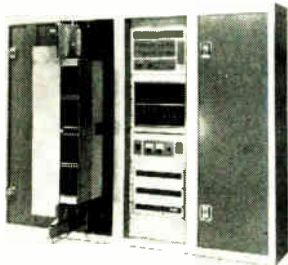

Byte core memory plug is compatible with IBM 360/50, 65, or 75. Memory cycle time is 3.2 μ sec with access of 2 μ sec or less. Memory capacities are $\frac{1}{2}$, 1 and 2 million bytes. The bulk core memory is offered on sale or lease terms with maintenance options. Deliveries will begin first-quarter 1970. Lockheed Electronics Co., 6201 E. Randolph St., Los Angeles 90022. [401]



Highly flexible, computer-driven graphic display system designated ADDS/900 can display tv, radar and other analog inputs simultaneously with computer generated data for stand-alone or remote computer use in scientific research, command and control, management information, dynamic testing, and computer-aided design. Sanders Associates Inc., 95 Canal St., Nashua, N.H. 03060. [402]

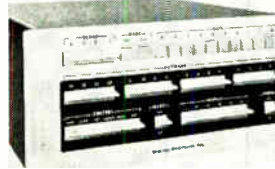

Digital computer Micro 800 is designed for direct integration into control and processing system applications such as data communication, data acquisition, automatic testing and numerical control. It features a 1.1- μ sec full cycle core memory with 220 nsec micro-command execution time. The basic system costs \$2,950. Micro Systems Inc., 644 Young St., Santa Ana, Calif. 92705. [403]

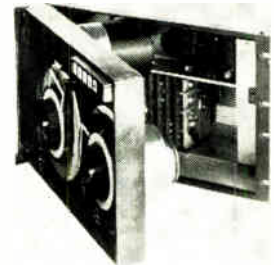

Tape transport model B1830 records incrementally at 1,000 steps per sec and continuously at 75 ips, a data transfer rate of 60 khz. Data packing densities are available at 1600, 800 or 556 bpi. All tapes, on 8 $\frac{1}{2}$ in. reels, are fully IBM compatible, 7 or 9 track, recorded with a ferrite recording head. Bright Industries Inc., 1 Maritime Plaza, San Francisco 94111. [404]

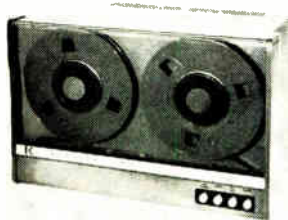

Continuous magnetic recorder model 3100 is a digital read/write unit designed for operation with small computers and peripheral devices. It is available in speeds from 10 to 25 ips. IBM compatibility is maintained for 7 and 9 channels; 200, 556, or 800 bpi operation. Price of the basic unit is \$2,600. Kennedy Co., 540 W. Woodbury Rd., Altadena, Calif. 91001. [405]



High-speed, high resolution analog to digital interface system model 380 consists of a high level (single ended or differential) multiplexer, a sample and hold amplifier and a 15 bit binary A/D converter. The converter can digitize an analog signal to a resolution of 15 bits binary at a speed of 250 khz. Datawest Corp., 7503 E. Osborn Rd., Scottsdale, Ariz., 85251. [406]

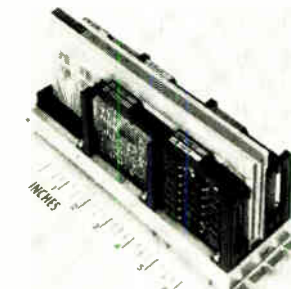

Core memory system ICM-160 is a 4,096-word memory, with 8, 12, or 16 bits per word, and measures 2 $\frac{3}{4}$ x 5 x 9 in. It is field expandable to other word and bit sizes on a modular basis. Full cycle time is 1.6 μ sec with access time of 550 nsec. The system costs as little as 5 cents per bit and can be delivered within 30 days. Honeywell Computer Control Division, Framingham, Mass. [407]

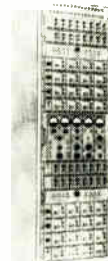

Voice frequency carrier telegraph terminal type 7230A is a full duplex frequency division multiplex system that transmits telegraph data over h-f radio links. It can send and receive 16 channels either sole or dual diversity, or 8 channels quad diversity, at 90 baud. Solid state design and IC's reduce size and weight. Tele-Dynamics, 5000 Parkside Ave., Philadelphia. [408]

Improved brightness solid-state lights are attention-getting panel indicators.



MV10B
Actual Size



MV10A
Actual Size

Solid-state lights from Monsanto are brighter than ever. 1,000 foot-lamberts is typical. They're RELIABLE—1,000,000 hours life*; FAST—1 ns switching time; and SMALL—.10 inch diameter for the MV10A3. SPECTRAL EMISSION is an attention-demanding 6,700 Å red.

Low current requirements, down to 5 ma for 50 ft/L output, make them compatible with low cost integrated

circuits. The long life and solid state ruggedness of these emitters eliminates the need for redundant indicators and in-field servicing, even in the most critical applications.

For more information on our MV10A and MV10B red indicators and other Gallium Arsenide Semiconductors, write or call Monsanto Electronic Special Products, 10131 Bubb Rd., Cupertino, Ca. 95014, (408) 257-2140.

*T_A = 25°C, I_F = 50 ma. Result of step-stress testing with end of life projections.

Monsanto



Unpunched cards. Machine writes and reads data entered on cards in the form of a magnetic code.

read by the same head that now reads the tape strip on the card.

Tape lengths from 50 to 250 feet will be available in cartridges, providing magnetic storage of from 60,000 to 300,000 characters. There are other magnetic card units much faster than Clary's, and other incremental magnetic tape units, but Savitt says he knows of no similar computer peripheral device that can handle both magnetic cards and tape.

Savitt sees the widest use for the MCT-10 in computers costing less than \$10,000; it can provide a handy extension of core memory in such systems. If cards are used, they are fed serially from a 500-card hopper by a stepper motor drive, which has its pulses controlled by diode-transistor-logic integrated circuits. Once the card is in the transport, it can be moved forward or in reverse, or may be moved in and out of the transport as desired. Data may be read, written, or rewritten onto the tape as the card is moving in either direction.

Fast enough. Because the machine is incremental, it can read or write a single character and stop, or the card can be moved at any rate up to 50 characters per second, which Savitt says is fast enough to make it work with entry devices such as typewriters without the need for intermediate buffer storage. When the tape

... can be a terminal
in time-sharing net ...

cartridge is added, its slew mode will offer two internally controlled speeds—133 characters per second or 1,000 per second, which will allow blocks of data to be transferred to or from communication lines and high-speed computers.

The magnetic card provides unit record data. As a unit record it can be individually handled, mailed, sorted, etc. But unlike punched cards, the data on a card can be altered. For example, in a business application, the card might contain a customer's account information. Each time an invoice is written against the account, the customer's balance due would be altered, but no other information on the card would change. On the other hand, with a punched card or paper tape system, a completely new card or new tape would have to be made to update the account. Savitt points out that the MCT-10 is almost soundless in operation compared with the noisier punched card or paper tape units.

With a general-purpose computer, the MCT-10 could be used as an off-line preparation center. With an eight-track tape on the card and 700 characters available, 350 words 16 bits long could be prepared. This would be enough for an assembler program or an application program for a computer with 4,096 words of storage, Savitt observes. Further, with the unit linked to an automatic typewriter, the MCT-10 could be a terminal for a time-shared computer.

The device will handle standard EIA RS-292 cards 3¼ by 7¾ inches, with a half-inch magnetic strip across one side. Visual information may be printed, typed or written on the non-magnetic portion. The purchaser can order the complete assembly including a controller that will link it to the input-output bus of a computer or he can order the mechanical assembly alone, if he prefers to build his own controller.

The firm is quoting 90 to 120 days delivery.

Clary Datacomp Systems Inc., 404 Junipero Serra Drive, San Gabriel, Calif. 91776 [409]

NANOSECOND TIME INTERVAL METER

MODEL CR 42
(1000 MHz DIRECT COUNT)



MAJOR CHARACTERISTICS

- RANGE : 1 nsec to 99 msec.
- 1 NANOSECOND RESOLUTION
- START and STOP : Independent channels with adjustable trigger levels
- 8-DIGIT DISPLAY
- BCD OUTPUT, 8-4-2-1 code, positive true
- CRYSTAL AGING RATE : 1 part in 10⁸/day
- Provision for use of EXTERNAL TIME BASE

For additional information apply to : D. A. T. INSTRUMENTATION ÉLECTRONIQUE
LABORATOIRES de MARCOUSSIS - Route de NOZAY - 91-MARCOUSSIS - FRANCE

LABORATOIRES DE MARCOUSSIS

Centre de Recherches de la CGE
Route de NOZAY - 91-MARCOUSSIS - FRANCE
tél : 920.82.50 - télex : 26.877 LAB-MARCO



NOW...

Hamilton precision metals has added facilities...and is in the Photoformed® Parts business...



BIG!

Hamilton has added a new plant—just to produce precision, Photoformed® parts!

This new facility is equipped with the most modern photo-etching machinery on the market. The new equipment will produce precision parts in large quantities to the highest standard of dimensional accuracy.

Now, you can get from the Precision Metals Division, finished parts to the same degree of precision as world wide metal users have come to expect in Hamilton's strip and foil.

Hamilton offers the advantages of a completely integrated facility controlling every step from melt to finished strip or foil—and now to finished parts. This means that you get the same adherence to metallurgical standards and dimensional accuracy that has become the hallmark of Hamilton.

For the complete story on the capabilities of Precision Metals Division and what it can do for you, write for your copy of the Precision Metals catalog. It's yours for the asking—write today!

PRECISION METALS DIVISION
HAMILTON
WATCH COMPANY • LANCASTER, PA. 17604

Data handling

IBM stakes out bigger share of modem market

4,800-bits-per-second unit for U.S. leased-line systems has error rate of 1:10⁶

The president of AT&T called up the president of IBM—so the apocryphal story goes—to say: “You stay out of the communications business and I’ll stay out of the computer business.”

The call apparently didn’t work, because IBM continues to expand into the communications segment of the data processing business. Close on the heels of its decision to market an electronic telephone exchange in Europe [*Electronics*, April 28, p. 158], the computer giant now introduces its first off-the-shelf modem for U.S. users.

The high-speed modem (modulator-demodulator) is designated the IBM 4872. It is designed to operate on leased telephone lines at 4,800 bits per second, and the company says its error rate is held to one in 1 million bits.

IBM has for years sold built-in modems for use with its computer systems; in fact, its World Trade Corp. subsidiary has been marketing off-the-shelf modems in the European market for some time.

It fits. The new modem is just 6½ inches high, 14 inches wide, and 21 inches long. Errors are reduced by a new digital modulation technique in which single-polarity digital pulses are converted to di-pulses—pairs of positive and negative polarity. A train of di-pulses requires less bandwidth than one of single-polarity pulses. Thus the signal can be filtered and restricted to a 2,400-hertz bandwidth that is sent down the middle of a 4,000-hertz channel. With 1,600 hz between adjacent channels, crosstalk is minimized. The technique eliminates tuning equalization adjustments for background noise in telephone lines and for delay distortion, which occurs when all

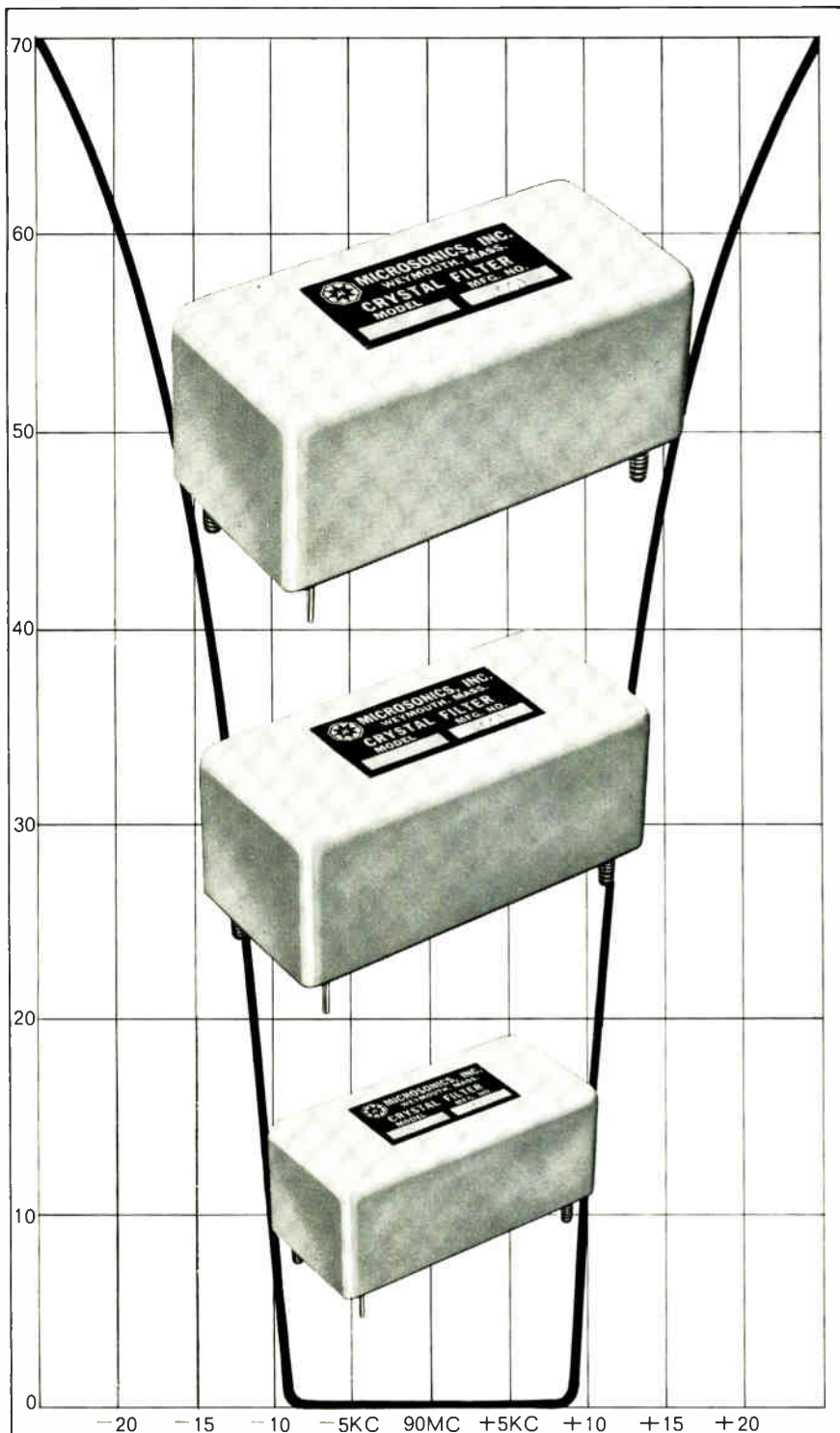

MICROSONICS
*for proven design, reliability &
 performance in*
CRYSTAL FILTERS



Write for Bulletins today
MICROSONICS
 60 Winter Street, Weymouth, Mass. 02188
 Tel: 617 337-4200
 A division of the Sangamo Electric Company

parts of a signal don't arrive at the receiver at the same time.

Modems are needed when computers are linked by telephone lines. IBM's modulation scheme shapes the data spectrum so that the smaller bandwidth is used to avoid noise arising from the edges of the channel.

Built into the 4872 are a switchable fixed equalizer, test pattern generator, and analog and digital test loops for fault isolation. The unit works with two rotary switches that make incremental adjustments through a low to high range of delay distortion that could occur in a C-2 telephone line.

Settings are confirmed with a built-in meter that also indicates the amount of background noise on the line.

The 4872 will sell for \$4,600. Deliveries are scheduled to begin late this year.

IBM Corp. 18100 Frederick Pike, Gaithersburg, Md. 20760 [410]

Data handling

**Fourier analyzer
 is also computer
 of all trades**

Simple reprogramming job
 converts signal processor
 to general-purpose machine

The introduction of the Cooley-Tukey fast Fourier transform algorithm several years ago spurred a number of firms to work on hard-wired systems that would use the algorithm to perform real-time computations of Fourier coefficients. But the Hewlett-Packard Co. balked at the idea of developing a complex machine to handle only a limited set of functions.

Consequently, Hewlett-Packard's model 5450A system, just unveiled after three years of development, can serve as either a preprogrammed Fourier analyzer or a free-standing general-purpose digital computer. The system uses either the H-P



Ultramation: the memory that helps you forget.

Ultramation: the ultimate in automation with Honeywell. It means a new core memory system that helps you forget about initial costs – the Honeywell ICM-160. It delivers 4,096 words with 8, 12 or 16 bits per word for under 5¢ per bit; and is field expandable.

And you can forget about downtime, too.

The ICM-160 has a calculated 40,000 hour MTBF from 0 to 50 °C.

You can forget about space and maintenance problems. The ICM-160 is the smallest (2 3/4" x 5" x 9"), fastest (1.6 µsec full cycle time, 550 nsec access time).

4K-word memory in the under \$5K price range. Modular construction makes it

fast and easy to maintain.

No wonder it's a logical choice for use in mainframe applications as well as special systems – digital controllers, computer peripherals, data communication buffers. Delivery? 30 days is standard. And it arrives with complete documentation – the kind of detailed information you'd expect from a supplier who's been designing and producing core memory systems for over 10 years.

Find out about the memory that helps you forget. Write for complete specs.

Honeywell, Computer Control Division, Framingham, Mass. 01701.

Honeywell
AUTOMATION

**A NEW APPROACH TO EMI FROM SPECTRUM CONTROL—
THE PEOPLE WHO THINK *Electromagnetic Compatibility***

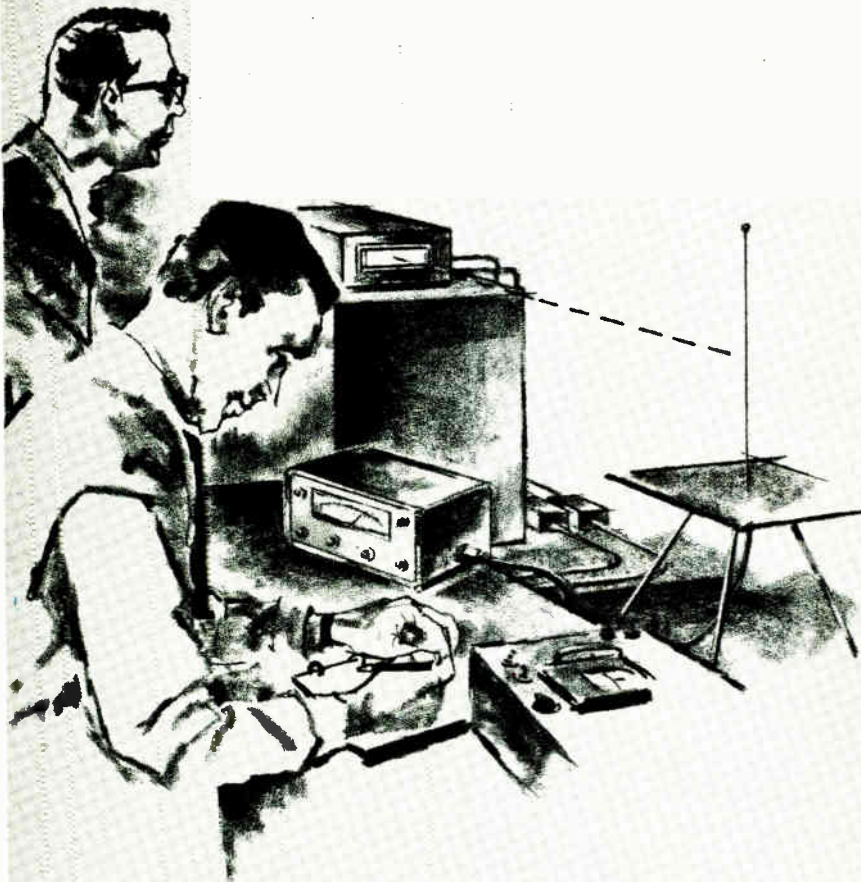

**Professional Testing and Consulting Services
For the Effective, Total Management of ...**

ELECTROMAGNETIC INTERFERENCE

Spectrum Control offers a unique combination of professional consulting services plus a broad range of electronic "hardware," instruments and components ... a capability encompassing the total management of electromagnetic compatibility. Spectrum predicts, identifies, measures and controls interference problems. Our staff engineers work closely with manufacturers ... at their plant site ... or at our fully equipped test facilities. Typical consulting services include, in addition to EMI program management, interference prediction, test plans, control plans, interference identification, and EMI test stand measurements. If you have an EMI problem, as most firms have, call in Spectrum Control TODAY.

Write for literature about
Spectrum's Consulting
Services or call
John R. Lane —
814/474-5593

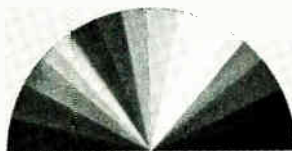

SPECTRUM CONTROL INC.
152 EAST MAIN ST • FAIRVIEW, PENNSYLVANIA 16415

**... little training needed
to use analyzer ...**

2115A or 2116B general-purpose digital processor with an 8K memory. Whenever the system isn't being used as a preprogrammed Fourier analyzer, the operator can flip a front-panel switch and then load programs for other functions by means of a tape reader. And it's through this same tape reader that the computer is reprogrammed for Fourier transforms—an operation taking only a few minutes.

Short courses. According to product development engineer Fred London, no knowledge of computer programming is needed to perform complex Fourier analyses with the H-P system. A "calculator-type" keyboard permits anyone with a knowledge of signal processing to operate the system after only an hour of instruction, he says. And 10 to 12 hours of instruction will suffice for an operator without previous experience in signal processing.

Further simplifying the system's operation is the fact that Fourier analysis almost always requires an iterative series of distinct functional analyses; several wave samples (windows) are analyzed sequentially to identify the frequency of the signal under test. H-P has therefore reserved 100 words of memory to iterate any series of analyses the operator deems appropriate for the sample under test. Once the proper keyboard buttons have been pushed, the system will continue to make the predetermined series of calculations on sequential samples until the operator introduces a program change.

Inputs. The time and frequency data analyzed by the model 5450A can be entered as analog signals through the system's analog-to-digital converter; in digital form through the punched-tape reader; or from a teletypewriter keyboard, sold as an extra. Binary data is collected through the system's binary communication channel.

Hewlett-Packard expects to begin delivery of the system in October and says the price will be about \$49,000.

Hewlett-Packard Co., 1501 Page Mill Rd., Palo Alto, Calif. 94304 [411]



Ultramation...the end of the illogical module

Don't let illogical modules foul up your system. Go the most logical route . . . with Honeywell μ -PAC logic modules. They can bring your system one step closer to ultimate efficiency. That's Ultramation.

What makes Honeywell modules your logical choice? Plenty. Like a dedicated engineering staff with over 14 years' experience in building logic modules. Like documentation that doesn't quit: complete instruction manuals; application, wiring, and assembly notes; comprehensive schematic diagrams, parts lists and logic design aids.

Like a company that offers more than 135 standard modules and accessories (plus hundreds of specials) . . . builds them, stocks them, and offers 72 hour delivery on most. Like quality control and automated testing that results in an unconditional one year warranty on every μ -PAC. Like custom design. Like field trained engineers. Like applications assistance.

Enough logic for you? Then write for complete details . . . and get closer to Ultramation. Honeywell, Computer Control Division, Dept. 15, Old Connecticut Path, Framingham, Massachusetts 01701.

Honeywell
AUTOMATIC

Need a helpful ally, taking on Mil-Spec contracts?

When it comes to military contracts, Brand-Rex can make getting the proper wire and cable the easy part of the job.

We offer an unusually broad range of products from tiny hook-up wires to mighty umbilical cables. Polyethylene, PVC, Kapton, Kynar, Teflon TFE and FEP are a few of the insulations we use regularly.

Brand-Rex's quality control procedures, well-known and accepted by military and aerospace

people, simplifies meeting MIL, NAS and other requirements.

Need an ally in a tough market? Contact the people who've been there for years, supplying cable for practically every major missile system and space shot. Whether your cable requirements are large or small write for the new Brand-Rex Military Specification Wire and Cable catalog.

Brand-Rex Division, American Enka Corp., Willimantic, Conn. 06226, (203) 423-7771

Connect for tomorrow.

BRAND-REX

Circle 158 on reader service card

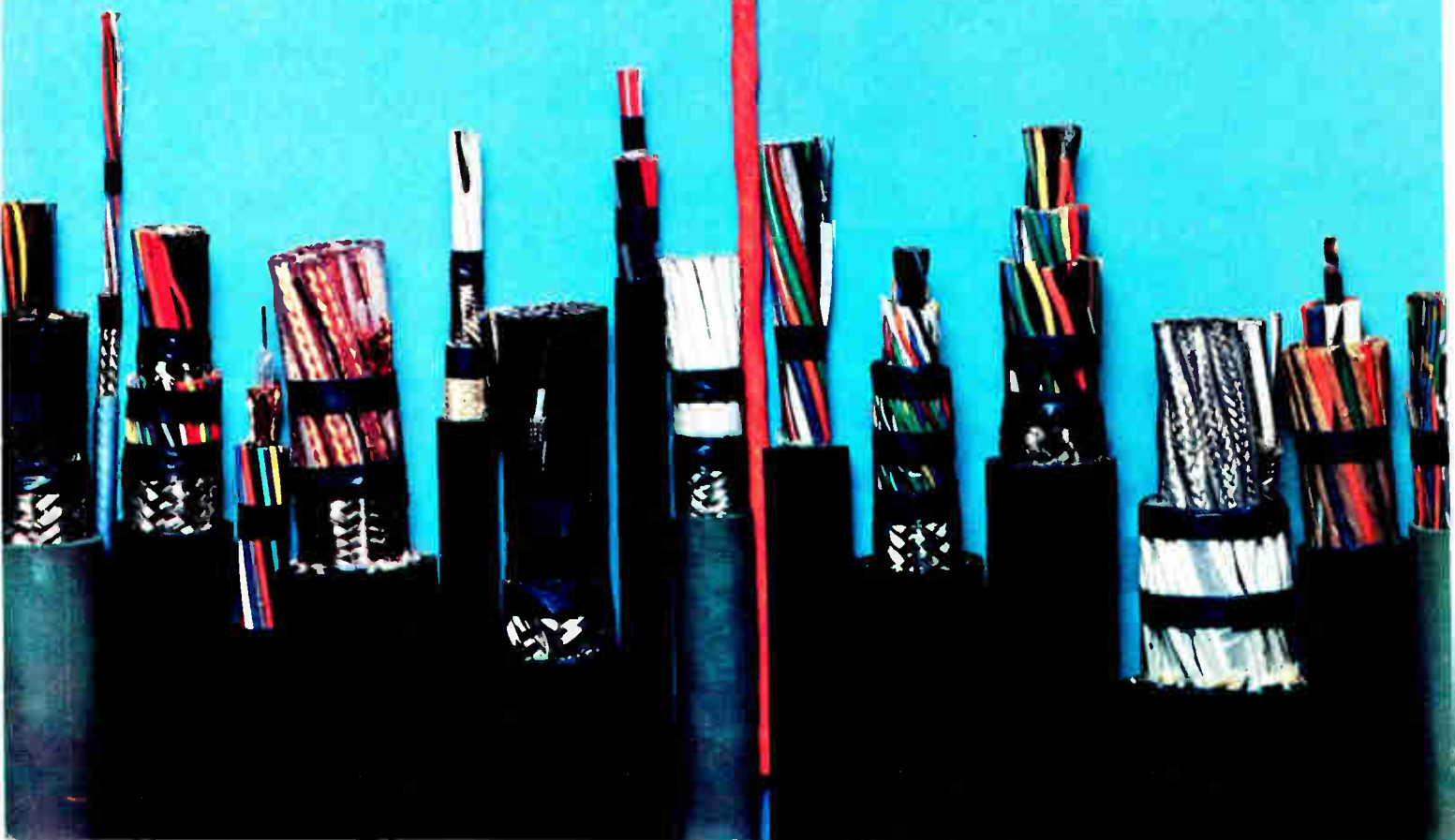
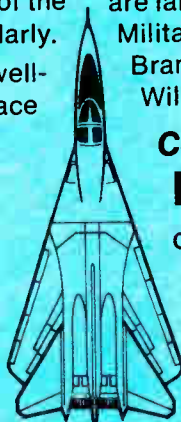

New subassemblies

... and now enter the 'everything op amp'

Gated unit performs integration, summation, track-and-hold, other jobs; it can be used with variety of logic types, including DTL and TTL

A new gated operational amplifier may come close to being some op-amp user's "everything box." It's the model 4850 developed by Philbrick/Nexus Research.

The 4850 can perform integration, summation, tracking-and-holding, reset, and single pole-double throw switching.

At various times, the company has considered calling it a three-

mode integrator, a track-and-hold operator, a gated integrator, or finally, a controlled integrator—a reflection of the 4850's unusually wide applicability.

The 4850 has twin comparators for inputs, each of which controls field-effect transistor switches. A main amplifier with a current driver in the feedback loop around it follows the switches. Also in-

cluded is a so-called bound detector with its own output pin. The comparator input makes input voltage ranges compatible with both diode-transistor and transistor-transistor-logic, but the 4850 isn't held to only using specific input voltages. It operates logically on any voltage which exceeds its reference voltage input by 0.3 volts (maximum input level is ± 15



Wideband multiplier model 105 has 10 Mhz, -3 db bandwidth and a 250 v/ μ sec slew rate. The unit is capable of a full power response of 20 v p-p out to 4 Mhz. No external amplifiers are required. Accuracy is specified to be 1% for 4 quadrant operation. Size is 2.5 x 3.5 x 0.825 in., and weight is under 7 oz. Hybrid Systems Corp., 95 Terrace Hall Ave., Burlington, Mass. 01803. [381]



Universal a-c/d-c regulated power supply model P-5505 features both outputs superimposed over a 50-db noise level filtering. With a d-c regulation of 5 mv and an a-c regulation of 1/4%, the unit is suited for quality control, electronic test, and receiving inspection requirements. Price is \$875. Wanlass Instruments, 1540 East Edinger Ave., Santa Ana, Calif. 92707. [382]



Miniature 5 v d-c modular power supply model PHR-5, using h-f magnetic amplifier techniques, is designed for powering IC's. It is available in 5, 10, and 15 amp ratings, measures 3 1/2 x 3 3/8 x from 1 3/8 to 4 7/8 in. thick, and weighs from 1.6 to 4.9 lbs. It is fully encapsulated to meet MIL-E-5272 C. Arnold Magnetics Corp., 11264 Playa Court, Culver City, Calif. 90230. [383]

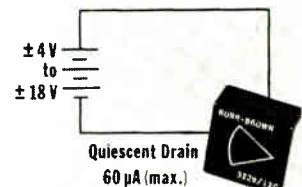

Operational amplifier model 3229/12C combines a guaranteed maximum quiescent power drain of 60 μ a, a wide supply range of from ± 4 v d-c to ± 18 v d-c, an input impedance of 10^{10} ohms, and a maximum drift of 20 μ v/ $^{\circ}$ C. It provides a minimum d-c gain of 90 db and a maximum bias current of 50 pa. Burr-Brown Research Corp., Int'l Airport Industrial Park, Tucson. [384]

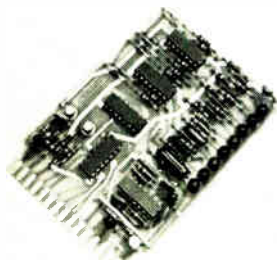

D/A converter model DA231 provides 8-bit conversion from its input data storage register. Digital inputs to the unit accept standard TTL logic levels and require very low drive current (less than 0.2 ma source current, less than 0.1 ma sink current), thus permitting series termination. Price is \$99.90. Computer Products, 2801 E. Oakland Park Blvd., Ft. Lauderdale, Fla. [385]

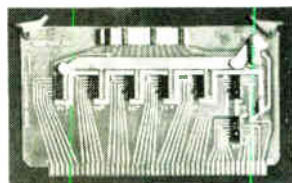

General purpose IC logic assemblies, featuring 86 pin connections, provide extra logic functions within a single card and thus present a comparable price reduction to equipment or system fabricators. Assemblies are available with DTL or TTL circuits that allow user selection to counter noise or speed problems. Cards are 8 x 4 7/8 in. Unitech Inc., 2209 Manor Rd., Austin, Texas. [386]

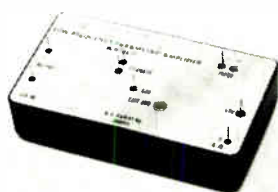

Parametric amplifier model RA-12 is designed for applications in the d-c to 1 khz range where minimum system noise, indiscernible input noise current, high input impedance and high common mode rejection are desired features. Gain, adjustable through external feedback resistors, normally is from 60 to 100 db. Unit weighs 7.5 oz. Texas Instruments Inc., Box 5621, Dallas. [387]

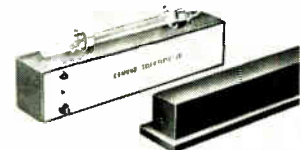

Continuous-wave, helium-neon gas laser model 79002 produces an intense beam of coherent light at 6,328 angstroms with 1 mw minimum output in TEM₀₀ mode. Beam diameter is 1 mm with a maximum divergence of 1.5 milliradian. The laser is mounted in a 3 x 3 3/4 x 15 in. aluminum case. Price is \$220. Edmund Scientific Co., 380 Edscorp Building, Barrington, N.J. 08007. [388]

CRT Display

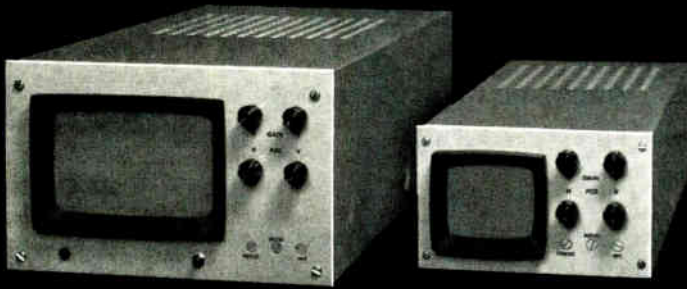

with image-ination

- 66 standard models available.
- Many optional features.
- Design permits great latitude of special modifications.
- Front panel easily removable for custom installation.
- Available as X-Y indicator or with multi-range sweep.

Series 8600 4 x 5 cm screen, 3 1/2" x 5 1/2" front panel, bandwidth 1 MHz.

Series 8620 6 x 10 cm screen, 5 1/4" x 8 1/2" front panel, bandwidth 2.5 MHz.

High level amplifiers also available as separate components.

For full information, write

INFODEX

INCORPORATED

7 CHERRY AVENUE • WATERBURY, CONNECTICUT 06702 • (203) 754-4159

Circle 193 on reader service card

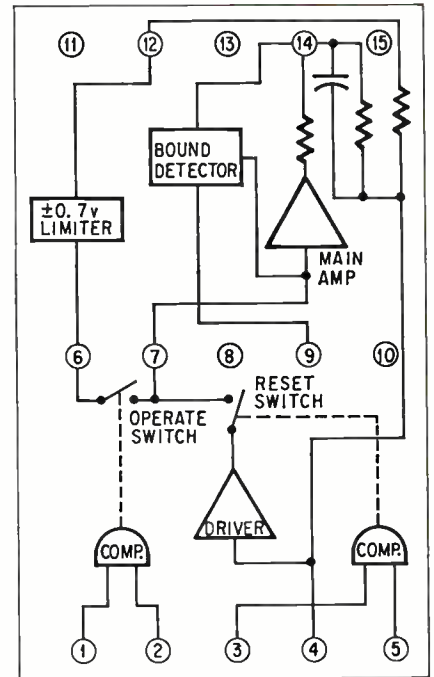
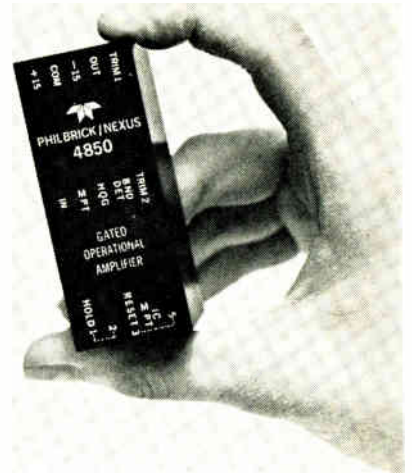

Multi-purpose. Versatility in op amp is provided by the comparator inputs that control FET switches. Pins identified in the photo correspond to those in the drawing.

volts). Also, only 5 microamps are needed to control switching at +3 volts; competing units may need as much as 0.15 milliamps for the same purpose. Thus the 4850 appears to be more sensitive.

According to P/N spokesmen, almost all competing units are without the differential input circuitry used in the 4850. Nor do they offer the variety of input levels possible with the 4850, as they respond only over zero to +3, zero to +5, or zero to -6 voltage ranges. It is said that this limits the types of logic which can be used around competing devices.

Thus the user of the 4850 need

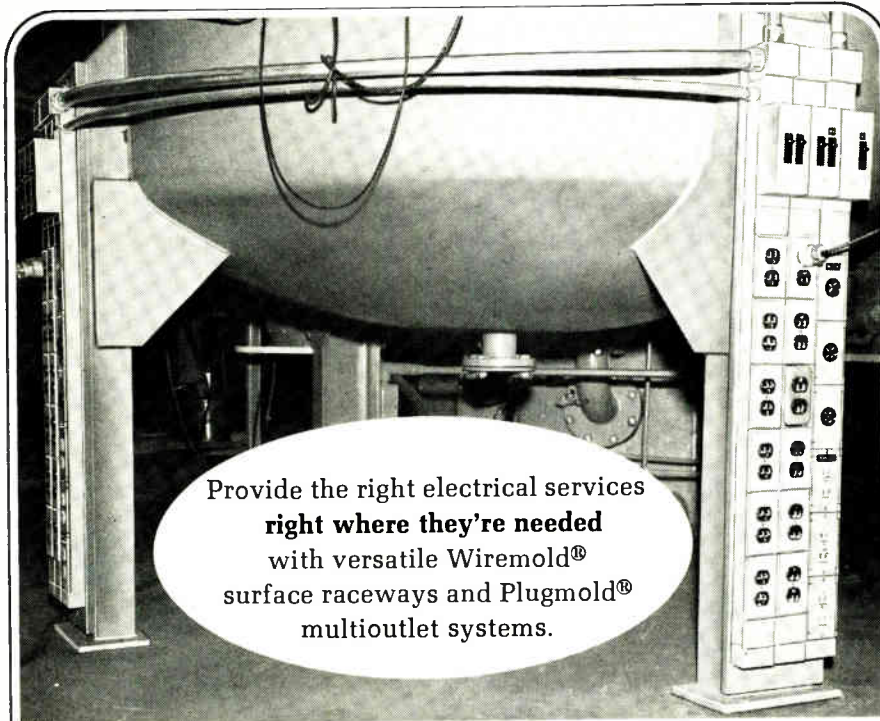

Provide the right electrical services **right where they're needed** with versatile Wiremold® surface raceways and Plugmold® multioutlet systems.

Three runs of Plugmold 3000, on each leg of this rotary accelerator, handle various required voltages in G.E. Space Technology Center.



WIREMOLD

THE WIREMOLD COMPANY / HARTFORD, CONNECTICUT 06110

Send for free literature

... track-and-hold speed can be increased ...

not add comparators to alter an input level to feed his sample-and-hold, integrate or reset module.

Slow decay. In sample-and-hold applications, the 4850 has a typical hold decay rate of 100 millivolts per second per volt—some competing units decay more than ten times faster. Decay versus time (divorced from hold voltage) is about a third that of competing units at 25 mv per second at 60°C.

Aperture time is 800 nanoseconds—16 times wider than some competitors. The 4850's acquisition time is about 10 times greater than competing units, which take 8 microseconds typical.

As an integrator, a module's voltage feedthrough in the reset condition should be as low as possible. Typically the 4850 has ± 0.25 mv feedthrough versus about 6 for competing units. This worst case feedthrough spec is one mv—the competition reaches 20.

Output voltage shift in reset is also small at ± 20 microvolts per °C—about a fifth that of competing units.

Tradeoffs. The 4850's speed on fast track and hold may be a disadvantage. Its maximum frequency for rated output is only 12 kilohertz while competing units reach 50. But P/N spokesmen state that wiring a 10-kilohm resistor around the 4850's current driver increases speed to about 100 khz.

The drawback to this modification is a reduction in input impedance from 100 kilohms to about 10 kilohms.

However, both stability and acquisition time improve, as does noise performance. With the modification, P/N engineers claim that the 4850 will track 5-microsecond pulses.

Gain accuracy could also be a drawback in some tightly specified applications—it is $\pm 0.2\%$. Some competing devices reach $\pm 0.05\%$.

First units are to be delivered late in May, with one-month delivery being quoted. The price is \$175 each for 1 to 9 units.

Philbrick/Nexus Research, a Teledyne Company, Allied Drive at Rt. 128, Dedham, Mass. 02025 [389]

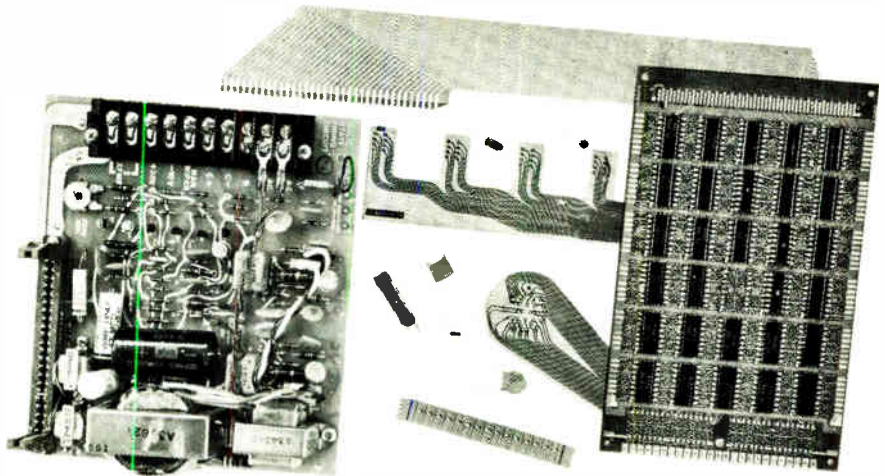

If you solder, cure, seal, fuse, bond or shrink without infrared heat... you're doing it the hard way

Whether your operation is batch or continuous, for clean, fast-response, precisely controllable heating, no other energy source can match infrared heat.

Nor does any other heating method offer such a wide range of standard equipment to fit the exact application as that offered by Research Inc., a pioneer in the field of infrared heating. For example: Modules that focus high-intensity heat onto remote target areas on the order of 1/4"; panel modules that let you design an oven or heating array to any dimension your process requires; parabolic, elliptical and multi-zone heating enclosures in a variety of shapes, types and sizes.

Whatever your application, chances are Research Inc. has standard, off-the-shelf equipment to do the exact job—faster, more efficiently, and at less expense. For proof, we're listing a few applications in which R-I radiant heating equipment already is doing it.

Proven Applications

- Curing thick-film hybrid circuit elements.
- Reflow soldering.
- Sealing tubular, glass-bodied components.
- Curing resistor elements.
- Semiconductor research.
- Joining fuse elements.
- Hermetic sealing.
- Shrinking plastic tube.
- Bonding flexible circuits.

For additional information on any of these or similar applications, contact Radiant Heating Dept.; Research Inc.



R-I CONTROLS DIVISION
RESEARCH INC
BOX 6164 MINNEAPOLIS, MINNESOTA USA 55424

Circle 161 on reader service card

Make your own break.

You can take a lot of the chance out of your future by including yourself in the Electronics Manpower Register.

When you do, your experience and talents become part of a nationwide computerized placement service.

Our computer is programmed to give every registrant the same

look for every opening. With your prior approval, you'll be considered for every opportunity that matches your resume.

All you have to do is send one to:

Electronics Manpower Register

Electronics

330 West 42nd Street
New York, N.Y. 10036

Looking for Fast, High Volume AC and DC Calibration Capability?

Whenever and wherever you need precision, high volume calibration capability for your calibration laboratory, production line, maintenance testing shop — Hewlett-Packard has an instrument that specifically meets your requirements.

Two of these instruments—designed specifically to meet high accuracy and high volume calibration needs—are the hp 740B for DC and the hp 745A for AC. With either instrument, you press a button, turn a dial and you have an instant voltage reference!

High Resolution DC Calibration. The hp 740B DC Standard/Differential Voltmeter delivers output voltage to 1000 V with six digit resolution in discrete steps of 1 ppm of range. Accuracy of $\pm(0.002\%$ of setting $+0.0004\%$ of range) extends over 30 days.

As a differential voltmeter, the 740B measures voltage to 1000 Vdc with an input resistance of $>10^{10}\Omega$, independent of null condition. Accuracy is $\pm(0.005\%$ of reading $+0.0004\%$ of range $+1\mu\text{V}$).

The 740B is also a precision dc amplifier and high impedance voltmeter, and can be used to drive a recorder.

Fast, Accurate AC Calibration—Cut your ac calibration time in half with the state-of-the-art hp 745A AC Calibrator—an excellent choice for pro-

duction line calibration and maintenance testing.

The 745A has a calibrated output voltage with $\pm 0.02\%$ accuracy. It also has a six-digit readout, pushbutton ranging and a continuously adjustable frequency from 10 Hz to 110 kHz.

Eliminate tedious error calculations with the exclusive 745A direct reading percent error scale.

Get full specifications on these and other calibration instruments from your hp field engineer. Or, write to Hewlett-Packard, Palo Alto, California 94304. Europe: 1217 Meyrin-Geneva, Switzerland. Price, 740B, \$2450; 745A, \$4500.

098/18 B

HEWLETT  PACKARD
WORKING STANDARDS



Tuner diodes get 'Made in U.S.' label

ITT redesigns German devices to provide push-button tuning over this country's crowded television and radio bands

Convinced that electronic tuning will soon be adopted by U.S. radio and tv set makers, ITT Semiconductors has begun retooling its plants in Lawrence, Mass., and West Palm Beach, Fla., to produce tuner diodes similar to those made by ITT Internmetall of Freiburg, West Germany. However, the specs are being upgraded to satisfy domestic tv-tuner producers, whose

requirements are somewhat more stringent than those of their European counterparts, largely because of the wider bandspread and overcrowded tv spectrum here [*Electronics*, Jan. 6, p. 88]. Besides those requirements, the "Buy American" mood among U.S. tuner and set makers was a factor in ITT's decision to produce the redesigned diodes in this country.

The tuner diodes, which are to be offered in matched sets of two or more, are the ITT141, ITT142, ITT109, and ITT163. In addition to these, a uhf/vhf band-switching diode, the ITT143, and a temperature-compensated zener diode, the ZTK-33, will be offered to round out the line of devices.

The ITT141 varactor diode is designed specifically for "push-but-

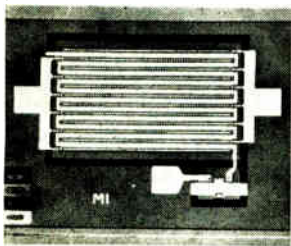

Two p-channel enhancement type MOS FET's are for analog and digital switching. The 3N167 has a maximum drain-source on resistance of 20 ohms; the 3N168 maximum is 40 ohms. The 167 has a drain or source cutoff current of less than 0.5 ma; the 168 less than 1 na at room temperature. Units come in the T0-72 package. Siliconix Inc., 1140 W. Evelyn Ave., Sunnyvale, Calif. [436]

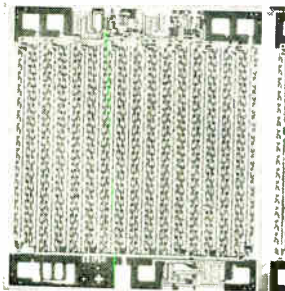

Dynamic MOS shift register type EA1204 is a 256-bit unit that utilizes a two-phase 26-v clock, and exhibits very low power operation at speeds up to 3 Mhz. The voltage-variable, low impedance output buffer properly biased will interface directly with TTL/DTL loads. Price (100-999) is \$30 each. Electronic Arrays Inc., 501 Ellis St., Mountain View, Calif. 94040 [437]

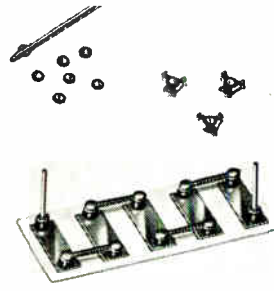

Glass passivated silicon rectifier chips series 2 PC are monolithic, hermetically sealed and void free, suiting them for thick or thin film hybrids. They come in a diameter of 0.09 in. and a thickness of 0.01 in., and are rated at 2 amps with a piv up to 1 kv. Price of the 200 piv 2PC20 is 73 cents each in 1,000 lots. Electronic Devices Inc., 21 Gray Oaks Ave., Yonkers, N.Y. [438]

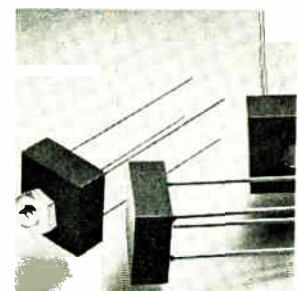

Miniature, single phase, single bridge rectifiers series XP-357 is suited for p-c applications. Three versions are available: self-supporting via leads, with a mounting hole to accept a No. 6 screw, and with a 6-32 x 1/4 in. mounting stud. Units will accept inputs to 700 v rms and withstand piv's to 1,000 v. Sarkes Tarzian Inc., 415 N. College Ave., Bloomington, Ind. 47401. [439]

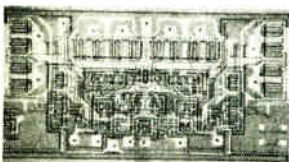

System-interface linear IC's series SN75324 are monolithic 400 ma core memory drivers with logic and decode all in the same packaging. Typical output saturation voltage is 0.65 v. Typical average propagation delay time is 60 nsec. Operating temperature range is 0° to 70°C. Price (100-999) ranges from \$13.70 to \$12.25. Texas Instruments Inc., Box 5012, Dallas 75222. [440]

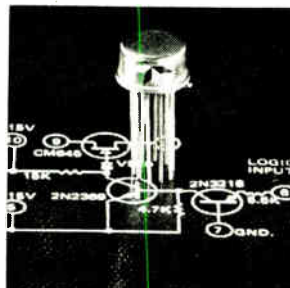

FET switch hybrid IC type CAG13 is for analog gating. It contains two complete circuits in one low profile T0-5 package. Each circuit features 50 ohms maximum on-resistance, ±9 v signal range, 300 nsec typical switching time, and direct operation from DTL or TTL logic. Unit price is \$50 (1-99) and \$33.50 (100-999). Crystallonics, 147 Sherman St., Cambridge, Mass. [441]

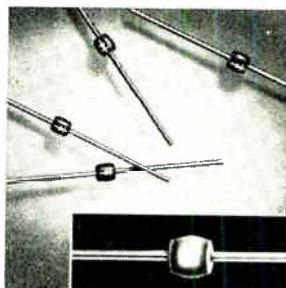

Rectifier series designated Metoxilite (metal oxides) is fused to the metallurgically bonded junction-tungsten pin assembly forming a tough subminiature package. Units can be used in stringent military and space environments or industrial and commercial applications. Current ratings are 6 amps and 3 amps/MIL-STD-750A. Piv is up to 1,000. Semtech Corp., Newbury Park, Calif. [442]

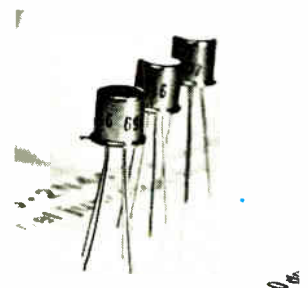

Vhf/uhf FET's 2N3823, 2N4416 and 2N4416A provide 18 db power gain at 100 Mhz or 10 db gain at 400 Mhz. They exhibit a low noise figure of 2 db at 100 Mhz or 4 db at 400 Mhz. Units also feature low capacitance of 0.8 pf and a high gain of 4,500 μmhos. Price is from \$1.70 to \$3.35 in lots of 100 and up. National Semiconductor Corp., 2950 San Ysidro Way, Santa Clara, Calif. [443]

**NO
OIL FILLING
NO
SATURATION AT FULL LOAD
NO
RINGING**

■

**"LOSSYLINE"
SCREEN ROOM/POWER LINE
EMI FILTERS**

"LossyLine" screenroom/power line filters provide unsurpassed EMI suppression by use of a lossy approach. Conventional filters use L-C networks to reflect, reject or transfer unwanted RF energy. Lundy filters use "lossy" elements which absorb and completely dissipate this energy. No chance for it to escape, feedback or leak. By absorbing and dissipating the RF energy, shunt capacitance is minimized and reactive current is negligible. Attenuation does not fall off with current, since there are no saturable inductors.

- No oil leaks to worry about, either. A lossy type filter develops a minimum amount of heat, therefore does not require oil for cooling.

- 100 dB from 14KHz to 100GHz
- Oper. Cur: 25-1000 amps
- Oper. Volt: 110, 220, 240, 440, & 550 VACW
- Freq: 25, 50, 60, 400, & 1000 cps

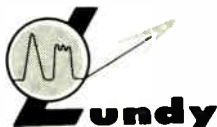

LUNDY ELECTRONICS & SYSTEMS, INC.
Glen Head, New York 11545
516-OR 6-1440 TWX 510-223-0605
See us at EMC Symposium
June 17-19, 1969
Asbury Park, New Jersey

**... high-capacitance-ratio diodes can tune
over entire band of frequencies ...**

ton" tuning in the vhf range. It's a silicon planar epitaxial device that can be used with a set of complementary ITT142 diodes to give complete coverage of the uhf and vhf bands. The diodes dissipate 150 milliwatts at 50°C and have an operating temperature range of 0 to 90°C. Peak reverse-voltage rating is 28 volts.

The electrical characteristics are shown in the table below.

For a set of two matched ITT-141's, the difference in capacitance value at $V_r = 25$ volts is ± 0.1 picofarad; for a pair of ITT142's, it's ± 0.2 pf. The error of matching in

to 0.5 Mhz and $V_r = 1.0$ volt. It comes in an epoxy case.

The ITT143 diode provides a means of electronically switching frequencies between 10 and 1,000 Mhz. It's said to have a small constant differential forward resistance over a wide frequency and current range. It will be priced at 10 cents apiece in volume. The important electrical characteristics are:

Reverse voltage (V_r)	20 volts
Forward current (I_f)	100 ma
Forward voltage (V_f) @ $I_f = 100$ ma,	< 1 volt
Reverse current (I_r) @ $V_r = 15$ v,	< 100 na

Tuner diode characteristics

	ITT141			ITT142			Units	Conditions
	Min	Typ	Max	Min	Typ	Max		
C_j		11			12		pf	$V_r = 3$ v, $f = 1$ Mhz
	2.0	2.2	2.5	2.0	2.5	3.0	pf	$V_r = 25$ v, $f = 1$ Mhz
Q	300			160				$V_r = 3$ v, $f = 47$ Mhz
	80			50				$V_r = 3$ v, $f = 170$ Mhz

the voltage range $V_r = 3$ volts to $V_r = 25$ volts is $\pm 1.5\%$ for the ITT-141 and $\pm 3\%$ for the ITT142. The error of matching for two diodes of different sets can be as high as $\pm 10\%$ for the ITT141 and $\pm 20\%$ for the ITT142. Both devices cost 20 to 30 cents apiece, depending on the quantity purchased.

Like the ITT142, the ITT109 is intended for the vhf/f-m frequency range and is available in matched sets of two, three, or four. Its junction capacity, C_j , is 4.2 — 5.5 pf at $V_r = 25$ volts and $f = 100$ khz. At $V_r = 3$ volts, the typical C_j is 29 pf with a Q of 200 and $f = 47$ khz.

The ITT163, a high-capacitance-ratio diode capable of tuning over the entire a-m broadcast and short wave bands, will be supplied in sets of two or more units.

The device has a capacity ratio of greater than 26 for a voltage range of 0 to 10 volts, and a typical junction capacitance of 260 pf for $V_r = 0 - 1.5$ volts; the minimum is 180 pf at $V_r = 1.0$ volts. Its quality factor (Q) is at least 200 at $f = 0.15$

The ZTK33 zener diode supplies a constant 33-volt temperature-compensated voltage. At $T_j = 25^\circ$ C, the reference voltage is 30 to 36 volts at an operating current of 5 milliamps; its maximum current rating is 10 ma. Packaged in a TO-18 metal case, the ZTK33 has a maximum junction temperature rating of 125° C, and a junction-to-case thermal resistance of less than 0.15° C per milliwatt.

It will be priced at 60 to 70 cents in production quantities, and will be ready for delivery this fall, according to present estimates.

Production will start in June, and the diodes will be available off-the-shelf soon after that. Ready availability to domestic radio and tv producers was another consideration in the company's decision to upgrade earlier specifications and manufacture the diodes in the U.S., says Thomas R. Mills, manager of ITT Semiconductors' recently formed consumer products section.

ITT Semiconductors, 3301 Electronics Way, West Palm Beach, Fla. [444]

**ETCH YOUR OWN
P C BOARDS
AUTOMATICALLY**
(in less than 5 minutes)

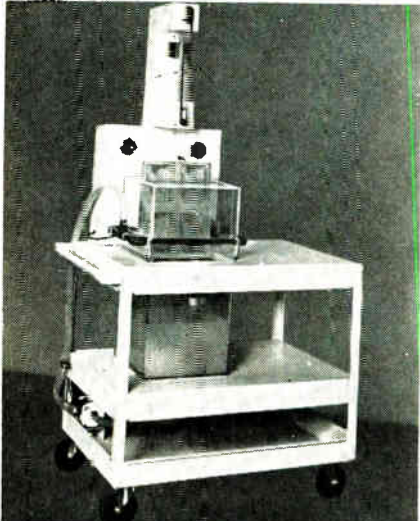

Model No. 201 (illus.), etches two 11" x 14" one-sided boards or one 11" x 14" two-sided board: **\$795**
Pat. applied for

from this →
to 11" x 14"
Shown Actual Size

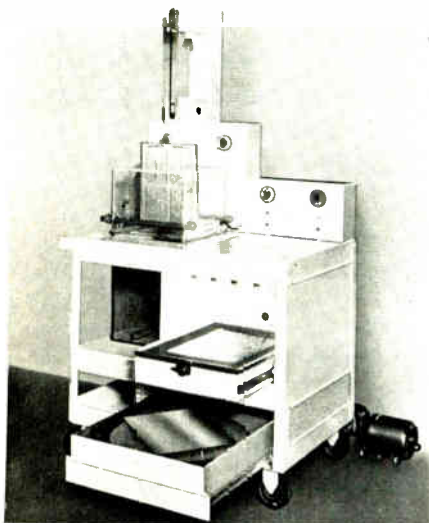

Model No. 205 (illus.) P.C. Processing Lab. has everything but the chemicals. **\$1495**
Pat. applied for

Includes etcher, whirler, infra-red drying oven, vacuum frame and pump, ultra-violet exposure—all assembled into 24"x36" mobile cart. Complete photo processing instructions. \$1495

Model No. 204 Resist Processing Lab. Includes all of above except etcher. \$750

CYCLO-TRONICS, INC.

3858 N. CICERO — CHICAGO, ILL. 60641
TELEPHONE: (312)-282-6141

New Semiconductors

Power zener dissipates 100kw

Transient suppressor aimed at communications systems is hermetically sealed

Ask any designer of solid-state communications gear for aircraft or tactical ground vehicles what's his biggest headache, and he'll probably say, without raising an eyebrow, that it's keeping high energy spikes from ruining his equipment. Unable to get suitable zener diodes for transient suppression, the designers have resorted to using bulky—and costly—banks of low-power devices in various combinations to achieve the required voltage and power ratings.

What's the hang-up in making high-power zeners? Semiconductor men attribute some of the problems to the difficulty in obtaining uniform breakdown without hotspots, as well as controlling resistivity gradient and dislocation density.

The first significant break in overcoming these problems came last year when Delco Radio announced that it had succeeded in developing a device that is rated at 1,000 watts peak power for 50 milliseconds or at 250 watts for continuous power [*Electronics*, March 4, 1968, p. 220]. Called the DRZ-250, the device has a breakdown voltage rating of 36 volts.

Delco engineers went back to the labs in search of higher ratings, came up with an entirely new series of power zeners with voltage ratings of 30 to 50 volts, and dissipation ratings of 100 kilowatts for a 1 microsecond pulse duration and 30 kw for a 1-millisecond duration. The zeners carry a d-c power rating of 300 watts with a case temperature of 120°C. Hermetically sealed by cold welding, the devices, dubbed DPZ30-30R series, have a beveled surface to minimize the effects of impurities and contamination.

Delco Radio Division, General Motors Corp., Kokomo, Indiana 46901 [445]

New Raytheon self-locking devices hold instrument settings against...

**VIBRATION
&
SHOCK
&
SHOCK**

with infinite resolution and zero backlash.

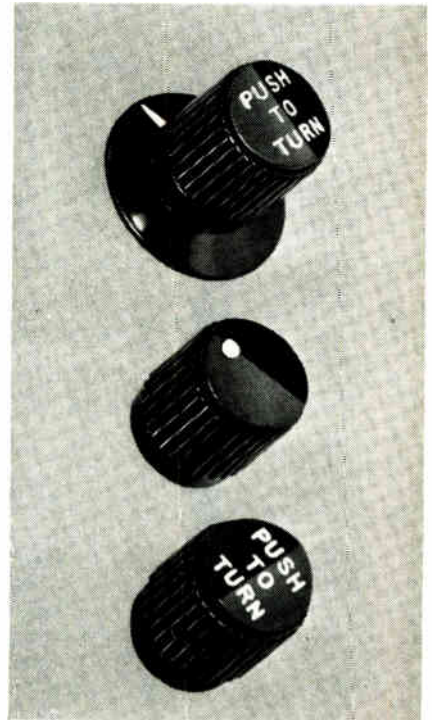

Pushed in, these Raytheon self-locking mechanisms can rotate control shafts in either direction to precise settings. Released, they automatically lock the shaft against vibration, shock, accidental turning. Their simplified, rugged packaging complies with MS91528C and MIL-K-3926B.

Available from your Raytheon distributor, or write for data and prices. Raytheon Company, Industrial Components Operation, 465 Centre Street, Quincy, Massachusetts 02169.

RAYTHEON

Fast Delivery
on Design-Specified

Reed Relays

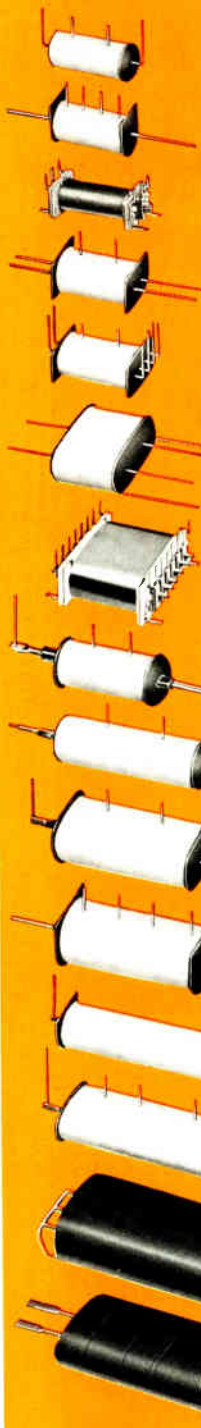

Coto-Coil stocks a huge variety of the finest components for almost every reed relay requirement. Your relay may be tailored to your exact specifications, with virtually "off-the-shelf" delivery, and at the lowest prices.

Write for Catalog and Prices of stock relays. For special requirements give complete details for quotation.



COTO-COIL COMPANY, INC.
54 Pavilion Avenue, Providence, R. I. 02905
Tel: (401) 941-3355

New Books

'Pastel-colored boxes'

Introduction to Electronic Digital Computers

Herbert Maisel
McGraw-Hill Book Co., 395 pp. \$9.95

Although the author didn't intend this book for engineers (he describes computers as "merely a collection of circuits that are wired together, packaged in pastel-colored boxes . . ."), it can give the engineer a good overview of the computer as it's seen by non-engineering users.

The book discusses applications such as medical diagnoses, function fitting, random number generation, linear programming, simulation, theorem proving, pattern recognition, and even checker playing. These are presented with a view toward updating business management.

After the reader is familiarized with the problems and how they might be solved using a computer, the author sets out to equip him with a working knowledge of how to use a computer, specifically the IBM 360 system.

However, his chapters on Fortran IV and PL/1 programming languages just acquaint the student with the basic mechanics of programming with these languages. If the reader wishes a more detailed treatment of these subjects, he must consult the numerous texts listed at the end of each chapter.

The rest of the book is rounded out with descriptions of peripheral equipment such as printers, card readers, tape and disk storage devices, and the cathode ray tube display console—and explanations of how each operates. Also covered is the structure of the 360 system, its interrupt procedures, the program-status word, and flowcharting.

Time-sharing, multiprogramming, and parallel instruction execution are defined and discussed. The flow of information in a computer is described, and a section is devoted to the description of remote terminals.

The appendix lists flowchart symbols, definitions of computer

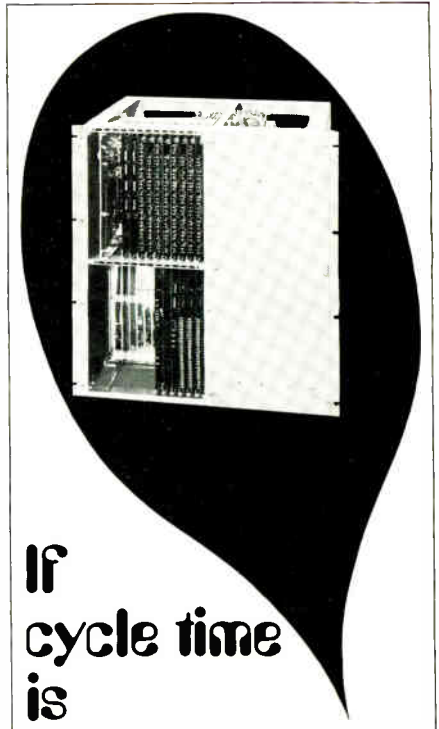

If cycle time is the name of your computer game, read the good news:

Toko Woven Plated-Wire Memory System HS-500 is now available.

Toko's woven plated-wire memory planes and stacks are already well known for their low-cost, high-performance characteristics. Now to be marketed for the first time is Toko's complete memory system, with a capacity of 4096 words by 16 bits expandable to 8192 words and 20 bits. Cycle time is a remarkable 500 ns. Other characteristics are 2D organization, destructive read-out operation, and TTL logic level interface. Cost of the system is remarkably low, and fast delivery can be guaranteed.

Besides this standard woven plated-wire memory system, Toko can undertake the manufacture of custom-made systems according to your specifications. Complete technical details from our New York office.



Head Office: 1-17, 2-chome, Higashi-Yukigaya, Ohta-ku, Tokyo, Japan

TOKO N.Y., INC.
350 Fifth Avenue, New York, New York 10001

evening classes won't fit your schedule?

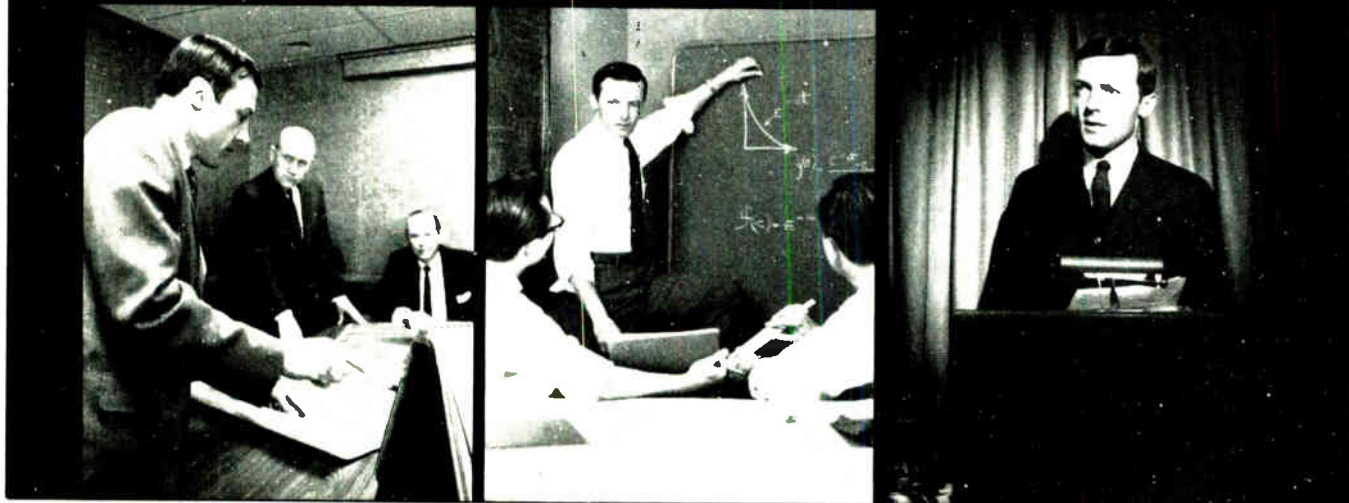

here's a practical way to keep up with new developments

Are irregular hours, travel and family obligations keeping you from attending classes—even though you worry about becoming technically obsolescent? Check into the Special Programs in Electronics for Engineers developed by CREI, the Home Study Division of the McGraw-Hill Book Company.

These are not simply courses, but comprehensive programs in advanced electronics offering major electives in such fields as:

Communications Engineering, Aeronautical and Navigational, Television Engineering, Automatic Control Engineering, Missile and Spacecraft Guidance, Radar and Sonar Engineering, Nuclear Instrumentation and Control, Computers.

Industry-recognized CREI Programs make it possible for you to catch up on new developments in electronics through study in your own home, at your own pace,

your own schedule. Free book gives complete information and details of technical material covered. For your copy, mail coupon below or write: CREI, Home Study Division, McGraw-Hill Book Company, Dept. 1864H, 3224 Sixteenth St., N.W., Washington, D.C. 20010

Founded 1927



Accredited Member of the National Home Study Council



CREI, Home Study Division, McGraw-Hill Book Company
Dept 1864H, 3224 Sixteenth St., N.W.
Washington, D.C. 20010

Send me free brochure describing CREI Programs in Electronics for Engineers.

NAME _____ AGE _____

ADDRESS _____

CITY _____ STATE _____ ZIP CODE _____

COMPANY _____

TITLE _____

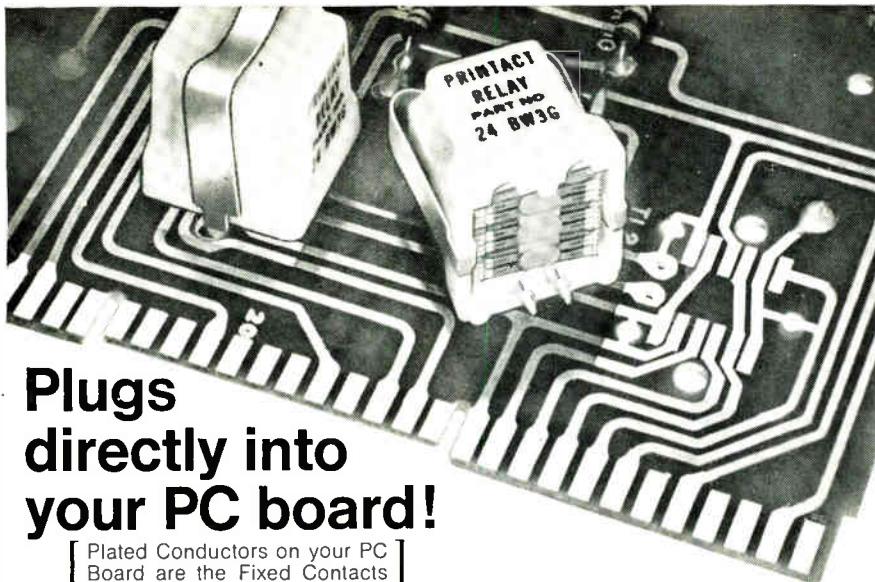

Plugs directly into your PC board!

[Plated Conductors on your PC Board are the Fixed Contacts]

Printact[®] Latching and Non-Latching MAGNETIC RELAYS

Designed for reliability and switching versatility, the Printact is a unique relay. The coil and ceramic magnet are encapsulated in a 7/8" cube for environmental protection. The magnet returns the balanced armature and applies contact pressure. In-line, series-break swingers afford constant impedance, low thermal EMF, and 100,000,000 cycle mechanical life.

Bifurcated contacts, gold alloy or palladium, provide low contact resistance and bounce for switching low level or up to 2 amp. PC board layouts provide up to 4 Form C or 8 pole single throw (4 Form A and 4 Form B) switching. Coils for 6, 12, 24 and 48 VDC are rated 0.5 watt.

For data write or call 212-EX 2-4800.

Printact Relay Division, Executone, Inc., Box 1430, Long Island City, N.Y. 11101

Circle 196 on reader service card

ECONOMICAL Thin Film!

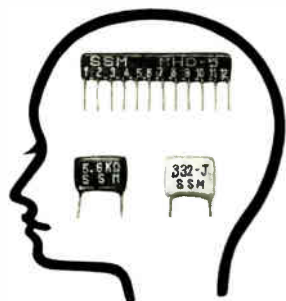

What's needed for memory system is everlasting high accuracy. SSM's components are the very ones satisfying superior reliability.

- Plate-ohm: evaporated metal film resistor.
- Pla-module: thin film modulated C-R circuit.
- Pla-con: organic thin film capacitor by plasma reaction.

SUSUMU INDUSTRIAL CO., LTD.

Minami Bldg. 1-12 Ebisuminami
Shibuya-ku, Tokyo, Japan.
TEL: Tokyo(03) 712-5990
TELEX: No. 246-6270

It's nice to have enough money to retire on. It's also nice to be around to retire.

You want to save a nest egg for your retirement? Fine. Be here to enjoy it.

One way is to have annual health checkups. During which your doctor will check for cancer. Because lots of cancers are curable if spotted in time.

Have a health checkup every year. It'll improve your chances of enjoying your retirement. To a ripe old age.

american cancer society

This Space Contributed by the Publisher

New Books

terms, Fortran-supplied library functions, keywords, and built-in arithmetic functions used in PL/1.

Recently published

Superconductivity, Third Edition, E.A. Lynton, Methuen & Co. Ltd., 210 pp., \$5.00

An introduction to superconductivity, this book presumes no more than an undergraduate physics background. The principle characteristics of a superconductor are described and treated in terms of the most useful phenomenological models. The second part of the monograph discusses the microscopic properties of superconductors, and a final chapter is devoted to superconducting devices.

Real-time Data-processing Systems, Saul Stimler, McGraw-Hill Book Co., 256 pp., \$13.50

Intended for data-processing practitioners interested in calculating and optimizing the performance per dollar of real-time systems, the book develops a methodology for estimating cost and performance for a broad range of applications. The designs of a message-switching system and an automated stock brokerage system are offered as examples, particularly valuable choices in view of current problems in business operations.

The SNOBOL 4 Programming Language, R.E. Griswold, J.F. Poage, I. P. Polonsky, Prentice-Hall Inc., 216 pp., \$6.50

A complete instructional and reference guide, it requires no familiarity with earlier versions of the language. The language itself is a useful tool for compilation techniques, machine simulation, symbolic mathematics, text preparation, natural language translation, linguistics, and—for the cultured reader—musical analysis.

Microwave Components, P.A. Matthews and I.M. Stephenson, Chapman and Hall Ltd., 196 pp., \$9.50

Intended for those with some knowledge of transmission line and electromagnetic theory, this book describes the basic methods of guiding electromagnetic waves at microwave frequencies. Most microwave components, both reciprocal and non-reciprocal, are covered and a few examples of microwave systems are considered.

The State-Variable Approach to Continuous Estimation, Donald L. Snyder, The MIT Press, 114 pp., \$7.50

This book develops a general theory of the estimation of a random process that has been nonlinearly transformed and also affected by noise. The procedures are worked out within the formalism of state-variable modeling techniques and continuous-time, continuous-state Markov processes. Several applications of the theory are made to analog communication systems.

Handlist of Basic Reference Material, Ellen M. Codlin, Robert S. Lawrie, ASLIB Electronics Group, 50 pp., \$3.00

Basic source material is listed in twelve categories: encyclopedias and dictionaries, handbooks and yearbooks, trade directories, books, periodicals, subject bibliographies, abstract journals, standards, tables, component handbooks, technical writing and terminology, and guides to sources of information. It is intended for the reference librarian and emphasizes British material.

Electronics Profit.

How McGraw-Hill's new
Electronics/Management Center
can help you improve it.

We've created a unique information system for the management of companies in and around electronics.

We call it the Electronics/Management Center.

E/MC combines the specialized experience of the publishers of *ELECTRONICS Magazine*, with the broadly-based facilities of McGraw-Hill, one of the world's largest corporations devoted to increasing man's knowledge.

In thirty years of electronics experience, we've accumulated the background and talents to produce the problem-solving tools you need. The kind that are essential when living with lasers, making your way through the implications of Large-Scale Integration, and meeting the technical revolutions yet to come.

Supplement To Internal Systems

For your company, we'll plan, execute, and analyze custom projects—to meet an objective of general, technical, or marketing management. Or to establish a new objective.

Our system is sufficiently diverse to serve as a prime and total information source. Or, it can supplement the most sophisticated company capability. In fact, it may be more efficient to "buy" certain kinds of information from us than it is to "make" it yourself.

Often, we can be faster. Or less

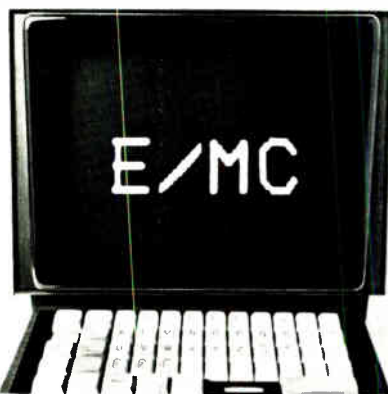

expensive. Always, we can be more objective.

Independent Technical Group

In technical matters, we can provide important assistance without adding overhead or over-loading your present staff. We offer the services of a national organization of university-based scientists and engineers with a long list of accomplishments.

Full Marketing Assistance

We can help you reduce marketing risks, too.

It's difficult to move around the electronics industry without bumping into both customers and competitors in the same corridor. We can probe new market potentials without revealing your identity. Or conduct research in an area not too familiar to your own staff.

We can do it in a neat package that combines access to the market with complete maintenance of confidence.

We can also supply those complex services you'd like to have created outside if you could find someone who speaks your language. Services like seminars, to educate customers, or train technical and marketing staffs, or develop management skills.

Weekly News Service

Management will also find our weekly news service an invaluable working tool. In minimum reading time each week, the *Electronics/Management Advisory Service* can keep your company current on the important electronics developments around the world. Market changes, prices, contracts, finances, significant trends, even a telephone number to call for person-to-person consultation — all the essentials to provide an information base on which to make top management decisions. For the next week. Or the next five years.

If you believe, as we do, that better information can help make your company more profitable, and you would like to know more about our services, write to: Electronics/Management Center, 330 West 42nd Street, New York, New York 10036.

E/MC

Electronics/Management Center
A McGraw-Hill Information Service

This month, you can get this state - of - the - art thyristor ..FREE..

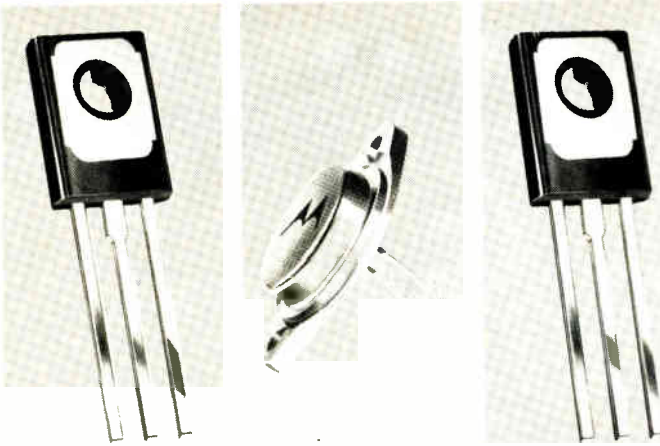

TURN ON 4 A@
—95°C CASE SCR
POWER CONTROL
WITH 200 μ A!
MCR406 Series

DESIGN IN 25 A,
FULL WAVE CON-
TROL WITH A
RUGGED TRIAC!
MAC21 Series

CONTROL
POWER/COSTS
WITH 8 A
PLASTIC SCR's!
2N4441 Series

- Sensitive gate, high current performance
- 30, 60, 100 & 200 V
- Thermopad* packaging, Annular construction
- Low as 51¢, 1,000-up (30 V)
- 25 to 400 V Application
- 75 mA Gate Triggering
- Low-Silhouette, Low θ_{js} Hermetic, TO-41 Packaging
- Ideal for Industrial Designs
- Low Thermal resistance and minimum de-rating
- Maximum, 80 A fault protection
- 50 to 400 V ratings
- Wins "power vs. price" struggle in numerous designs

Scores of high-performance, new-design application possibilities can now be turned on for your consumer/industrial equipment with these state-of-the-art, thyristor power control products . . . the MCR406/407 high-power-at-high-temperature SCR for your low-level consumer, commercial and light industrial designs . . . the MAC21, Triac—"big power" answer to high current speed, light and heat control application problems . . . the 2N4441-43 series for most rugged, high-volume applications.

Evaluate these state-of-the-art devices now — contact your franchised Motorola distributor today — he'll see that your free device choice is returned to you without delay!

*Trademark of Motorola Inc.

— where the priceless ingredient is care!



This month, you can purchase from your franchised Motorola distributor up to 99 of any of the below Motorola thyristor products at 10% off their regular, published 1-99 prices! Example: ten 200-volt, 2N4442, Thermopad SCRs would normally cost \$15 . . . this month, you can get them for \$13.50 — a \$1.50 saving! If you order the maximum 2N4442 quantity of 99 in this special offer, you can save \$14.85!

Mix 'em or match 'em — SCR's, Triacs, triggers, unijunction transistors — whatever device type you need to design better performance into, and take the cost out of, your power control applications you'll find with Motorola . . . especially during this month!

Contact your Motorola distributor today about this money-saving way to evaluate the best, most complete thyristor products in the industry. Fill in the coupon on the following page† and send it to him immediately. He'll see that you receive your units off-the-shelf!

SILICON CONTROLLED RECTIFIERS

Series	Forward Current—Amps	Blocking Voltage Range—Volts	Package	Price Range	Maximum 10% Off Price Saving
2N5060-62	800 (mA)	30-100	Unibloc Plastic	\$.77- .96	9.50
2N1595-99	1.6	50-400	TO-5	2.15-12.35	122.26
2N2322-26	1.6	25-200		2.30- 5.40	53.46
2N4212-16	1.6	25-200		2.15- 4.95	49.00
MCR 406-1 to -4	4	30-200	Thermopad	.90- 1.27	12.57
2N4441-43	8	50-400		1.20- 2.00	19.80
2N4151-98	8	25-600	Case 85 Var.	1.45- 6.89	68.21
2N1842-50	16	25-500	Case 64	3.00-18.10	179.19
MCR 649-1 to -7	20	25-500	TO-41	3.10-13.70	135.63
MCR2818-1 to -7	20	25-500	Pressfit	3.00- 8.85	87.62
MCR2918-1 to -7	20	25-500	Stud	3.40- 9.20	91.08
2N5164-71	20	50-600	Pressfit/Stud	3.30-10.10	99.99
2N2573-79	25	25-500	TO-41	3.40-15.40	152.46
2N681-89	25	25-500	Stud	3.30-20.60	203.94
MCR1907-1 to -6	25	25-400		9.00-29.25	289.58
MCR2835-1 to -8	35	25-600	Pressfit	3.75-12.35	122.27
MCR2935-1 to -8	35	25-600	Stud	4.10-12.75	126.23

TRIACS

Series	RMS Conduction Current—Amps	Blocking Voltage Range—Volts	Package	1-99 Price Range	Maximum 10% Off Price Saving
MAC1-2 to -6	8	50-400	Case 85	2.40- 5.25	51.98
MAC2-2 to -6	8	50-400	Case 86	2.55- 5.40	53.46
MAC3-2 to -6	8	50-400	Case 87L	2.50- 5.35	56.96
MAC4-2 to -6	8	50-400	Case 85	2.05- 3.70	36.63
MAC5-2 to -6	8	50-400	Case 86	2.20- 3.85	38.11
MAC6-6 to -6	8	50-400	Case 87L	2.15- 3.80	37.62
MAC21-1 to -6	25	25-400	TO-41	4.35-13.50	133.65

BILATERAL TRIGGERS

Series	Peak Pulse Current—Amps(max)	Breakover Voltage—Volts(nom)	Package	1-99 Price Range	Maximum 10% Price Saving
MPT20-32	2.0	20-32	Unibloc Plastic 2-Lead	\$.67	\$6.63

UNIUNCTION TRANSISTORS

Series	Intrinsic Standoff Ratio		Package	1-99 Price Range	Maximum 10% Price Saving
	Min	Max			
2N4870-71	0.70	0.85	Unibloc Plastic	\$.75	\$ 7.43
MU4891-94	0.74	0.86	TO-18	.90-1.23	12.18
2N2647	0.68	0.82		3.00	29.70
2N3980	0.68	0.82		3.40	33.66
2N4851-53	0.70	0.85		1.10-2.25	22.28
2N4948	0.55	0.82		1.35	13.37
2N4949	0.74	0.86		2.40	23.76
2N5431	0.72	0.80		5.70	56.43

†Coupon on following page must be filled in and returned to your distributor for free device (200-volt maximum) and/or 10% reduction on 1-99 thyristor order. Reduction will apply this month only to any Motorola thyristor product listed as long as quantity of each product on order does not exceed 99. In case quantity does exceed 99 regular, published, 100-999 list prices will apply to quantities desired.

...and 10% off your order for any of these thyristors from your Motorola distributor!†

(SEE FOLLOWING PAGE)

MOTOROLA
Thyristors

Motorola Semiconductor Products Inc. / P. O. Box 20912 / Phoenix, Arizona 85036

Signals get shaped up

Digital compensation of tape recorder time-base error
R.C. Houts, R.S. Simpson,
and D.W. Burlage
Department of Electrical Engineering
University of Alabama

Magnetic tape recorders used in telemetry systems for temporary storage of signals can yield distortions because of time-base errors. These errors arise from the tape speed's variations caused by high frequency components of flutter.

A time-base error leads to distortion of the analog signal and degradation of the bit synchronization during the transmission of high-rate digital data.

The error can be corrected by using a shift-register buffer operated with feedback control. During playback, the circuit generates a variable delay that compensates for the error. Its operation is based on sampling the data signal and holding the sample values for a fixed time before reconstruction.

The data signal and a constant-frequency pilot signal are recorded on separate channels of the recorder. If the tape skew effects are negligible, both signals will have the same time base perturbation on playback. Sampling the playback signals at instants corresponding to the leading edges of the perturbed pilot signal is equivalent to uniform sampling of the original signal in the absence of a time-base error. Consequently, the original data signal can be recovered by sending the sample values at a uniform rate to the appropriate reconstruction circuit. Since the sampling rate must be several times the nominal bandwidth of the data, the recorder must have sufficient bandwidth to accommodate the pilot signal.

This technique is implemented by converting the sample values to digital form in an a-d converter and storing them in a shift register. The samples are then clocked out of the register at the nominal pilot signal frequency and converted back to analog by a d-a converter. The original signal is reconstructed by smoothing the output with a low-

pass filter. The same technique can be employed with digital data, except the need for converting and reconverting is eliminated.

Presented at the National Telemetering Conference, Washington, D.C. April 22-24.

Ink spots

Living with a thick-film resistor ink series
H.E. Isaak
McDonnell Douglas Astronautics Co.,
Santa Monica, Calif.

The ink used in hybrid integrated circuits for aerospace applications must undergo considerable testing to determine the process boundaries and the proper process sequences. Each sequence depends on the characteristics of the resistor ink, the compatibility of the various materials, and the variations in the circuit parameters.

A research program was carried out using platinum-gold conductor ink and several palladium-silver resistor inks. The first task was to establish what the limitations of the processes might be. Following the recommendations of the ink suppliers, preliminary samples were screened and fired. At the recommended peak firing temperature—690°C—there was severe blistering of the resistors. When the temperature was reduced to 640°C, the blistering stopped but the resistivity was decreased well below the nominal value.

The electrical parameters of principal interest to the investigation were resistivity, temperature coefficient of resistance (TCR), and stability. Stability was defined as the resistance drift that occurs during a 1,000-hour burn-in at 150°C.

The test revealed that the profile shape had very little influence on the resistance, but that the TCR became more negative as the resistance increased. Data on peak temperature reveals that the lower the temperature the lower the resistivity and the more positive the TCR, and that the peak temperature that's required to produce a maximum TCR for the high resistivity inks must be less than 600°C.

Data derived on belt speed in-

dicates that the slower the belt speed the higher the resistivity and the more negative the TCR.

Presented at the Electronic Components Conference, Washington, D.C., April 30-May 2.

Heat rise

A thin film resistance element tailored by thermal oxidation
H.R. Smith and A. Herczog
Corning Glass Works,
Corning, N.Y.

Heating evaporated titanium carbide thin films for about 24 hours raises their sheet resistances up to 10,000 ohms per square and improves their stability to better than 1%. The heated titanium carbide film, which has higher sheet resistance than a titanium film, is a good candidate for IC resistors and capacitors.

During preparation of the films, sintered titanium carbide pellets were vaporized and then deposited on a substrate in a conventional oil-pumped vacuum system at about 10^{-5} Torr. Monitoring film resistance during deposition enabled thickness to be varied between 100 and 5,000 angstroms. It turned out that only films thicker than 1,000 Å—with resistances of about 50 to 100 ohms per square—remained stable during temperature cycling.

To improve properties in films thinner than 1,000 Å, the deposited titanium carbide was repeatedly subjected to temperature cycling from room temperature to 125°C. This subjection raised resistance and improved stability probably because during cycling the surface of the film becomes oxidized. The protective covering on the surface also prevents unwanted oxidation during normal temperature variations and decreases the thickness of the semiconductive film, thereby raising its resistivity.

Heating the films to 260°C increased the film resistance up to 50 times that of its original value. In fact, it proved easier to obtain high resistance films by the oxidation treatment rather than by depositing films whose resistance was high enough without heating.

Films were deposited either on Corning alkali-free glass or on thermally-oxidized silicon wafers. A pattern of aluminum-gold thin film dots on both substrates acted as terminals for resistance measurements.

Presented at the Electronic Components Conference, Washington, D.C., April 30-May 2.

Alumina layer cake

Multilayer alumina circuit boards
W.R. Keller, F.E. Pirigyi, G.R. Cole, and
J.P. Budd
E.I. du Pont de Nemours & Co. Inc.

A multilayer aluminum oxide ceramic substrate with two or more wiring patterns hermetically buried between the layers provides a new way to package monolithic IC's.

The alumina board uses highly conductive noble metals—gold, platinum, and silver—rather than refractory metals—aluminum or tantalum—as the conductors. The

boards contain risers, or vias, that are made of the same high conductivity metal and that interconnect the buried planes with the top and bottom surfaces.

Compared with multilevel boards, made by screening thin insulation at the crossover points and then firing, the new board's layers of dielectric isolation can be many times thicker. The dielectric layers are of the same high alumina composition as is the base substrate. Advantages of this approach include precise layer registration, low capacitance between wiring planes because thick dielectric layers can be used, high voltage levels, good physical strength, and use of the surface in the same manner as standard aluminas.

The multilayer substrate provides improved performance and economy. Functional groups of IC's can be mounted and interconnected in a single package. For

example, one board can accommodate four digital IC's in a single 14 lead dual in-line package. This hybrid, or multichip, technique is an approach to MSI and LSI that circumvents the penalty of the exponential decrease of die processing yield as the chip area is increased. Interconnecting lines are short, so chip density on the substrate is high. Line resistance is low, typically one ohm per inch for buried conductors of 0.010 inch width (0.010 ohms/square). These factors make for minimum signal delay in high speed circuits.

Versatility is provided by designing the buried conductors for general purpose use in a whole class of circuits, and then varying only the top surface's discretionary conductor pattern to produce a given circuit. Retooling costs in manufacture are thereby reduced.

Presented at the Electronic Components Conference, Washington, D.C., April 30-May 2.

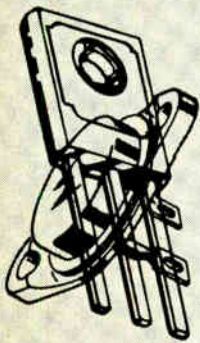

This coupon is the one to use

ALABAMA, Huntsville	Airwork/Gulf Electronics Corp.	(205) 837 6101	NEW YORK, Binghamton	Federal Electronics, Inc.	(607) 748 8211
ARIZONA, Phoenix	Hamilton Electro of Arizona	(602) 272 2601	NEW YORK, Buffalo	Summit Distributors, Inc.	(716) TT 4 3450
CALIFORNIA, Inglewood	Liberty Electronics Corp.	(713) OR 8 8111	NEW YORK, Flushing	Cramer Electronics, Inc.	(212) JR 8 4000
CALIFORNIA, Los Angeles	Hamilton Electro Sales	(310) 870 1771	NEW YORK, Syracuse	Cramer Eastern	(315) 454 9247
CALIFORNIA, Los Angeles	K-Tronics	(213) OV 5 5888	NEW YORK, Westbury, L.I.	Schweber Electronics	(516) ED 4 7474
CALIFORNIA, Mountain View	Emur Electronics	(415) 961 3611	NEW YORK, Woodbury, L.I.	Harvey Radio Co. Inc.	(516) 921 8700
CALIFORNIA, Mountain View	Hamilton Electro Sales North	(415) 961 7000	NORTH CAROLINA, Winston-Salem	Electronic Wholesalers, Inc.	(919) PA 5 8711
CALIFORNIA, San Diego	Hamilton Electro Sales of San Diego	(714) 279 2421	OHIO, Cincinnati	Sheridan Sales Co.	(513) 761 5432
CALIFORNIA, San Diego	Kierulff Electronics, Inc.	(714) BR 8 2112	OHIO, Cleveland	Pioneer-Standard Electronics, Inc.	(216) 432 0010
CALIFORNIA, San Diego	Hamilton Electro Sales	(603) 934 5508	OHIO, Cleveland	Sheridan Sales Co.	(216) 237 9145
COLORADO, Denver	Kierulff Electronics Co., Inc.	(303) 343 7090	OKLAHOMA, Tulsa	Hall Mark Electronics Corp.	(918) TE 5 8458
CONNECTICUT, North Haven	Cramer Electronics Inc.	(203) 239 5641	PENNSYLVANIA, Philadelphia	Radio Electric Service Co. of Pa.	(215) WA 5 6900
D.C., Washington	Electronic Wholesalers, Inc.	(202) WA 3 5000	PENNSYLVANIA, Pittsburgh	Semiconductor Specialists, Inc.	(412) 351 3611
FLORIDA, Miami	Airwork/Gulf Electronics Inc.	(305) 887 6541	TEXAS, Dallas	Hall Mark Electronics Corp.	(214) PL 7 9131
FLORIDA, Orlando	Hall Mark Electronics Corp.	(404) 855 4020	TEXAS, Dallas	Sterling Electronics	(915) 533 7855
GEORGIA, Atlanta	Jackson Electronics Co.	(404) 355 2223	TEXAS, El Paso	Midland Specialty Co.	(713) SU 1 0011
ILLINOIS, Chicago	Allied Electronics Corp.	(312) TA 9 9121	TEXAS, Houston	Hall Mark Electronics Corp.	(713) MO 6 3811
ILLINOIS, Chicago	Hewark Electronics Corp.	(312) 638 4411	UTAH, Salt Lake City	Sterling Electronics, Inc.	(801) 363 5821
ILLINOIS, Chicago	Semiconductor Specialists, Inc.	(312) 279 1000	WASHINGTON, Seattle	W. R. Binz Company	(206) WA 4 6530
IOWA, Cedar Rapids	Deeco Inc.	(515) 365 7551	WASHINGTON, Seattle	Hamilton Electro of the Pacific Northwest	(206) WA 4 6530
KANSAS, Kansas City	Hall-Mark Electronics Corp.	(913) AD 6 4343	WISCONSIN, Milwaukee	Hall Mark Electronics Midwest	(414) 476 1270
LOUISIANA, New Orleans	Sterling Electronics, Inc.	(504) 522 8726			
MARYLAND, Baltimore	Pytron Industries, Inc.	(301) 539 6525	CANADA		
MARYLAND, Rockville	Schweber Electronics	(301) 427 4977	MONTREAL, P.Q.	Casco Electronics Ltd.	(514) 735 5511
MASSACHUSETTS, Cambridge	H & B Electronics, Inc.	(617) 864 0400	MONTREAL, P.Q.	Zentronics (Quebec) Ltd.	(514) 735 2471
MASSACHUSETTS, Newton	Cramer Electronics, Inc.	(617) WO 9 7700	OTTAWA, Ont.	Casco Electronics Ltd.	(613) 729 5118
MICHIGAN, Detroit	Semiconductor Specialists, Inc.	(313) 255 0300	QUEBEC CITY, P.Q.	Casco Electronics Ltd.	(418) 524 3518
MICHIGAN, Detroit	Radio Specialists Co., Inc.	(313) BR 2 4212	DOWNTOWN, Ont.	Casco Electronics Ltd.	(416) 638 5250
MINNESOTA, Edina	Law Bonn Co.	(612) 941 4860	TORONTO 18, Ont.	Zentronics Ltd.	(416) 787 1271
MINNESOTA, Minneapolis	Semiconductor Specialists, Inc.	(612) 866 3434	VANCOUVER, B.C.	Bowlek Electric Co. Ltd.	(604) 685 4028
MISSOURI, St. Louis	Semiconductor Specialists, Inc.	(314) 423 6500	VANCOUVER, B.C.	L. A. Varah Ltd.	(604) 736 6411
NEW JERSEY, Moorestown	Angus, Inc.	(609) 235 1900	WINNIPEG, Man.	Cam Gard Supply Ltd.	(204) 942 0901
NEW MEXICO, Albuquerque	Kierulff Electronics Co., Inc.	(505) 247 1055			

... for a free MCR406/MAC21/2N4441, -42 thyristor unit and/or 10% off your 1-99, Motorola thyristor power control product requirements.

Fill in and send the coupon to your franchised Motorola distributor now!

He's waiting to serve your Motorola thyristor product evaluation needs.

 **MOTOROLA**
Thyristors
Motorola Semiconductor Products Inc.
P.O. Box 20912/Phoenix, Arizona 85036

To: _____ (franchised Motorola distributor)

Furnish Me a Free MCR406 SCR 30V . . 60V . . 100V . . 200V . . MAC21 Triac 25V (circle one) . . 50V . . 100V . . 200V . . 2N4441 50V or 2N4442 200V SCR

I need the following thyristor products at 10% off regular, 1-99 list prices for evaluation/prototyping:

SCR's/ Triacs	Type	Voltage	TRIGGERS	Type	Voltage	UJT's	Type
_____	_____	_____	_____	_____	_____	_____	_____

Name _____ Title _____

Company _____ Div. _____

Address _____

City _____ State _____ Zip _____

Signature _____ P. O. No. _____

(This coupon must be returned to distributor for free unit — 200V maximum — and/or 10%, 1-99 price reduction. Offer void after June 30, 1969.)

New Literature

Delay lines. RCL Electronics Inc., 700 S. 21st St., Irvington, N.J. 07111, offers an engineering handbook featuring lumped constant, distributed constant, and variable delay lines. Circle 446 on reader service card.

Digital data translator. Adtrol Electronics Inc., 116 N. 7th St., Philadelphia 19106, has available a four-page brochure describing model 2804 digital data translator. [447]

Comparator module. Analog Devices Inc., 221 Fifth St., Cambridge, Mass. 02142. A six-page foldout application note and data sheet lists full specifications for the model 350 FET-input comparator. [448]

Crystal filters. Electronics Division of Damon Engineering Inc., 115 Fourth Ave., Needham, Mass. 02194. A series of six data sheets provide information on monolithic crystal filters, band-pass/reject crystal filters, gaussian crystal filters, and monolithic discriminators. [449]

DIP sockets. IFE Division of Plastic Mold & Engineering Co., 25 Tripps Lane, E. Providence, R.I. 02914. Bulletin 691 describes and illustrates a line of wire-wrappable and p-c sockets for 14-, 16-, and 24-lead dual in-line IC's. [450]

Digital decoders. Melabs, 3300 Hillview Ave., Stanford Industrial Park, Palo Alto, Calif. 94304. Single-page technical data sheet 9-213 describes a line of digital decoders [451]

Temperature controllers. Loyola Industries Inc., 155 Arena St., El Segundo, Calif. 90245, offers a four-page sheet covering a new series of solid state, digital set point temperature controllers. [452]

Sweep-lock synchronizer technique. Sage Laboratories Inc., 14 Huron Dr., Natick, Mass. 01760. Included in an eight-page applications guide is a description of the latest techniques using advanced sweep-lock synchronizers. [453]

Shaft angle encoder. Astrosystems Inc., 6 Nevada Dr., New Hyde Park, N.Y. 11040, has available a four-page data sheet describing a completely solid state shaft angle encoder. [454]

Electromechanical components. Sterling Instrument, Division of Designatronics Inc., 76 E. Second St., Mineola, N.Y. 11501. A 576-page catalog, showing more than 44,000 precision electro-mechanical components, features a 120-page technical section. [455]

Digital signal averaging. LeCroy Research Systems Corp., 126 N. Route

Is Bell & Howell handing you a line?

That's the idea.

To offer the one line of instrumentation tape recorders that meets your every requirement— industrial, medical or military.

Here you will find such instruments as the **VR 3360**— the most flexible and rugged of all portable recorders.

The **VR 3400**— now setting new performance records for midband instruments.

The **VR 3700**— first 2.0 MHz laboratory recorder to combine versatility and reliability at a budget price.

And the **VR 5000**— first 2.0 MHz recorder with ± 400 nanoseconds TBE and flutter correction beyond 300 Hz.

Now add Bell & Howell's longer lasting, high performance heads. A complete range of accessories. And 60 full-time service engineers for on-the-spot assistance anywhere in the nation.

Then compare all that with the line someone else is handing you.

No one covers as wide a range of applications for both tape recorders and oscillographs as Bell & Howell. And since the instruments are all available from a single source, a multitude of aggravations can be eliminated.

So when it comes to recording oscillographs, Bell & Howell is also the logical one to come to.



VR 3360



VR 5000



VR 3400



VR 3700

Just the broadest in the business.

For advanced models such as the **CEC 5-124** which offers big recorder capability in a portable, low-cost package.

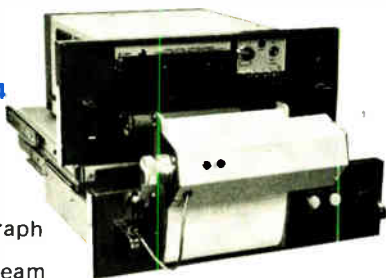

CEC 5-124

Or the "best buy" **CEC 5-126**, the only graph to deliver all the basic capabilities of a light beam oscillograph at a cost approaching that of a direct writing recorder.

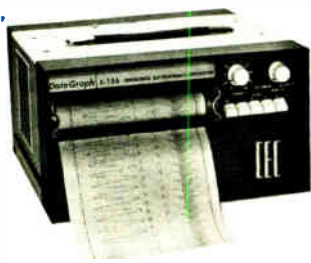

CEC 5-126

And the **CEC 5-133**, first graph to combine the versatility of two instruments in one. Two data setups can be made at one time and recorded simultaneously, or be made alternately and recorded sequentially utilizing full chart width for each.



CEC 5-133

If you want more reasons, you might consider that Bell & Howell has the *only* oscillographs with high impedance galvos. Thus eliminating the need for preamps and driver amps. And significantly reducing panel space, weight, component cost, galvo repairs and setup time.

Accessories, papers and chemicals? Everything you'll need today and probably tomorrow.

For all the facts and specs, call our nearest office. Or write Bell & Howell, Pasadena, California 91109. Bulletin Kit 3323-X1. While you're about it, ask for our brochure of current training courses for both engineers and technicians.

CEC/DATA INSTRUMENTS DIVISION

 **BELL & HOWELL**

New Literature

303, West Nyack, N.Y. 10994, has published application note NPA-1 describing a method for nanosecond pulse signal averaging, a technique for performing analytical measurements upon repetitive waveforms whose parameters are obscured by noise. [456]

Balanced mixers. American Electronic Laboratories Inc., P.O. Box 552, Lansdale, Pa. 19446, has issued technical literature giving detailed specifications of the series MIC-3072 microwave IC balanced mixers. [457]

Special pulse instrumentation. Systron-Donner Corp., 10150 W. Jefferson Blvd., Culver City, Calif. 90230. Special pulse instrumentation and systems designed at the company are described in a four-page facilities and capabilities folder. [458]

P-i-n diodes. Hewlett-Packard Co., 1501 Page Mill Rd., Palo Alto, Calif. 94304. A four-page data sheet describes general-purpose p-i-n diodes series 5082-3000. [459]

Punched tape readers. Electronic Engineering Co. of California, 1601 E. Chestnut Ave., Santa Ana, Calif. 92702. An illustrated eight-page brochure covers the series 3000 military punched tape readers. [460]

Digital tachometers. Airpax Electronics Inc., P.O. Box 8488, Fort Lauderdale, Fla. 33310. Preliminary bulletin DS-1 describes a line of digital tachometers for use in difficult industrial environments. [461]

Silicon controlled rectifiers. KSC Semiconductor Corp., KSC Way (Katrina Rd.), Chelmsford, Mass. 01824, has issued a short form catalog listing the characteristics of approximately 350 SCR's covering the range from 55 to 275 amps rms. [462]

Slip ring catalog. Breeze Corporations Inc., 700 Liberty Ave., Union, N.J. 07083, has published a 24-page catalog entitled "Slip Ring Assemblies and Rotary Switches." [463]

Serial character printer. Adtrol Electronics Inc., 116 N. 7th St., Philadelphia 19106. A single-sheet bulletin contains complete information on the model SCP-6/C serial character printer, which provides a fully digital printout capability for light beam galvanometer oscillographs. [464]

Electronic components. Erie Technological Products Inc., 644 W. 12th St., Erie, Pa. 16512, announces a 32-page catalog covering all the electronic components stocked by its distributors. Copies are available by writing on company letterhead.



the quick way to printed circuits
for full details write to

Tecne Incorporated 661 Brunswick Pike
Princeton New Jersey 08540 USA
Telephone (609) 452-9275

Circle 197 on reader service card

**See 10 or 20
logic levels at one time**

**WITH THE LOGICO™
DIGITAL MONITOR**



Model BPL10

- Can simultaneously monitor 10 or 20 binary circuit points (or more).
- Saves breadboarding time.
- Will not affect the circuitry and can be left in while breadboarding.
- Can be used with TTL, DTL, RTL, ECL integrated or discrete circuitry and with any commonly used voltage system.
- Time related voltages can be grouped for meaningful presentation. Neon indicators light for logic "1", off for logic "0".

Model BPL10 has internal power supply. Price: \$79.50

Model BL10 can be powered from the BPL10, batteries or an external power supply. Price: \$69.50

Also available, Cricket CR4 Audible Digital Monitor which produces audible tone bursts from nanosecond pulses.

INDUSTRIAL INVENTIONS, INC.
RD 2, 463 U.S. Route 1,
Monmouth Junction, N.J. 08852

New Literature

Operational amplifiers. National Semiconductor Corp., 2950 San Ysidro Way, Santa Clara, Calif. 95051. An operational amplifier guide provides basic specifications on a line of military and commercial integrated circuit op amps. [465]

High-current rectifier assemblies. Uni-trode Corp., 580 Pleasant St., Watertown, Mass. 02172. Data sheet T160 covers the Magnum series high-current, controlled-avalanche rectifier assemblies. [466]

Video display terminal. Delta Data Systems Corp., 613 W. Cheltenham Ave., Philadelphia 19126. A low cost crt display terminal featuring full computer systems input/output and video compatibility is described in a four-page brochure. [467]

Teflon-insulated terminals. Sealectro Corp., 225 Hoyt St., Mamaroneck, N.Y. 10543, has available a six-page brochure describing its Riv-Loc series of Teflon-insulated terminals. [468]

Stator winder. Adamatic Inc., 6169 Industrial Court, Greendale, Wis. 53129. Model SW-202 in-slot stator winder, featuring production of 75 stators per hour, is the subject of a two-page, two-color technical bulletin. [469]

Thermocouple thermometer. Doric Scientific Corp., 7969 Engineer Rd., San Diego, Calif. 92111. Four-page bulletin T3-100 covers a digital thermocouple thermometer for process or test variable monitoring. [470]

Process control systems. Westinghouse Electric Corp., P.O. Box 868, Pittsburgh, Pa. 15230, has released 16-page booklet B-9560 on its process control systems capabilities. [471]

Electromagnetic compatibility. Spectrum Control Inc., 152 E. Main St., Fairview, Pa. 16415. A combination of professional consulting services and hardware capability in the total field of electromagnetic compatibility is outlined in a four-page brochure. [472]

Digital panel meters. Datascan Inc., 111 Paulison Ave., Clifton, N.J. 07013, has available a two-page bulletin describing its new generation of 3-digital panel meters. [473]

Transistors and IC's. Intersil Inc., 10900 N. Tantau Ave., Cupertino, Calif. 95014. A 12-page condensed catalog contains product data on a line of silicon transistors and IC's. [474]

A-c regulators. Electronic Research Associates Inc., 67 Sand Park Road, Cedar Grove, N.J. 07009. Catalog 153 covers the RT series Transpac solid-state a-c regulators. [475]



nutdriver set
with Locknut/Screw
adjusting feature

Speeds, simplifies setting of combination locknut/slotted screw adjustments on rheostats and similar controls used in a wide variety of electrical and electronic equipment.

Handle is drilled so you can run an 8" screwdriver blade right through its center and down through the hollow nutdriver shaft.



Ideal for all-around production, maintenance, and service work, this new HSC-1 Set contains eight interchangeable hollow nutdriver shafts in the most popular hex opening sizes from 3/16" thru 9/16"



Really compact! Set is small enough, light enough to carry in your hip pocket. Sturdy, see-thru, plastic carrying case doubles as a bench stand.

WRITE FOR BULLETIN N867

XCELITE®

XCELITE, INC., 130 Bank St., Orchard Park, N.Y. 14127
In Canada contact Charles W. Pointon, Ltd.

Degrease with ease... Spray gunk away with MS-180

MS-180 is a Freon® TF degreasing system conveniently packaged in aerosol cans. Use it in maintenance and on the line to spray grease and dirt away quickly from assemblies, components, connections. It's non-flammable and non-conductive (safe to apply while equipment is operating if you want to save even more time). MS-180 Degreaser is available in 16-oz. cans for plant use and in 6-oz. cans for field maintenance kits. Try MS-180 free. Write on company letterhead for a sample. We'll be big about it and send you the 16-oz. size.

* DuPont reg. TM



**miller-stephenson
chemical co., inc.**

Route 7, Danbury, Conn.



Circle 199 on reader service card

DiGiCATOR[®]

Numeric Readouts and Decoder/Drivers

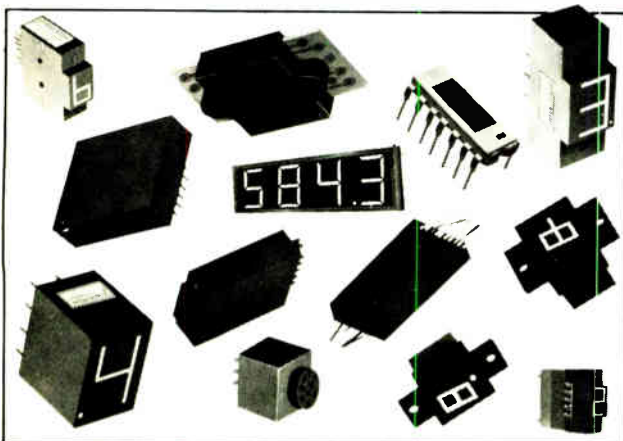

YOUR SOURCE FOR THE MOST EXTENSIVE LINE OF:

BAR-MATRIX DISPLAYS AND DECODER/DRIVERS

**★ MIL-SPEC AND COMMERCIAL
OFF THE SHELF DELIVERIES**

DISCON CORPORATION

1150 NORTHWEST 70th STREET • FT. LAUDERDALE, FLORIDA 33309
PHONE: (AREA CODE 305) 933-4551

Circle 201 on reader service card

New, true dual-beam oscilloscope.



And only \$995*

True dual-beam, portable oscilloscope features line or battery operation. Choice of 15 or 30 MHz bandwidth plug-in Y-amplifiers (23 and 12 nsec rise times).** Solid state unit provides differential input, internal voltage calibrator, and both signal and time delay.

For complete data, write for Bulletin TIC 3318A to Motorola Communications & Electronics Inc., 4501 W. Augusta Blvd., Chicago, Ill. 60651.

*Exclusive of options. **15 MHz amplifier, \$395; 30 MHz amplifier, \$595.



MOTOROLA
Precision Instrument Products

Circle 177 on reader service card

177



EMPLOYMENT OPPORTUNITIES

THE MARKET-PLACE FOR ALL EMPLOYMENT NEEDS

Send New Ads or Inquiries to:
ELECTRONICS
Class. Adv. Dept. P.O. Box 12, N.Y., N.Y. 10036

Solid State Power Conversion Specialists

Pratt & Whitney Aircraft, world's leading producer of dependable jet engines, is currently engaged in an intensive program of research and development in fuel cells. One indication of our progress is the successful performance of P&WA fuel cells in Apollo spacecraft. Another is the cell being developed for various commercial applications under the sponsorship of a group of companies in the gas industry.

In connection with this program we have several career openings affording groundfloor opportunity for qualified specialists. Specifically, we are looking for engineers with 6 to 12 years background in solid state conversion, preferably with 2 to 3 years experience in inverter design. The work is unusually challenging and the group small enough for individual contributions to be obvious.

Areas of activity include:

1. Design and development of low cost commercial inverters in the 5-500 KVA range.
2. Power section and logic design; input and output filter analysis.
3. Overall control analysis.
4. Circuit analysis programs using ECAP, CIRCUS and SCEPTRE.
5. Conventional 60 HZ and high frequency pulse width modulation based on SCR's.

Please send resume and salary requirement to Mr. H. M. Heldmann, Professional Placement, Office A-46, Pratt & Whitney Aircraft, East Hartford, Connecticut 06108. An equal opportunity employer.

Pratt & Whitney Aircraft

**U
A**
DIVISION OF UNITED AIRCRAFT CORPORATION

CIRCLE 966 ON READER SERVICE CARD

What is your problem?

Competent men for your staff? . . . employment? . . . or are you looking for—or offering—a business opportunity of special interest to readers of this publication? You can get their attention—through an advertisement in the Employment Section of Electronics.

Send New Ads to:
ELECTRONICS
Class. Adv. Dept., P. O. Box 12, N. Y., N. Y. 10036

ADDRESS BOX NO. REPLIES TO: Box No.
Classified Adv. Dept. of this publication.
Send to office nearest you.
NEW YORK, N. Y. 10036: P. O. Box 12
CHICAGO, Ill. 60611: 645 N. Michigan Ave.
SAN FRANCISCO, Cal. 94111: 255 California St.

POSITION VACANT

Electronics or electrical engineer with five or more years experience needed to teach in area of electronics engineering technology. Applicant must have B.S. degree (M.S. preferred). Salary commensurate with qualifications. Excellent future. Send resume to: W. E. Little, Chairman, Engineering and Industrial Occupations Division, Illinois Central College, P. O. Box 2400, East Peoria, Illinois 61611.

Need Engineers?

Contact them through this
EMPLOYMENT OPPORTUNITIES section

electronic engineer

The Sperry Rand Research Center has a challenging position for an electronic engineer in the design and building of circuits for operating plasma panel displays. A good all-around circuit designer interested in digital circuit design will be considered. A knowledge of basic computer logic circuitry is desired and familiarity with high voltage electronic components. The individual selected will assist Ph.D. scientists in the laboratory construction of such circuits.

Please send resume of education and background experience in confidence to Mr. R. C. Davis, Employment Manager.

 **SPEYRY RAND**
RESEARCH CENTER
SUDBURY, MASSACHUSETTS 01778

An Equal Opportunity Employer

CIRCLE 967 ON READER SERVICE CARD

RATES

EMPLOYMENT OPPORTUNITIES—\$79.00 per inch, subject to agency commission.

SEARCHLIGHT SECTION—\$39.75 per inch for equipment (Used or Resale), business opportunity, etc. advertising appearing on other than a contract basis. Contract rates on request.

UNDISPLAYED (Not available for Equipment Advertising)—\$3.60 per line, minimum 3 lines. To figure advance payment count 5 average words to a line and 1 line for a publication box number.

Position Wanted — undisplayed rate is one-half of above rate, payable in advance.

Send New Ads or Inquiries to:

Classified Adv. Dept.

ELECTRONICS

P.O. Box 12, New York, N. Y. 10036

SEARCHLIGHT SECTION

- CLASSIFIED ADVERTISING
- BUSINESS OPPORTUNITIES
- USED OR SURPLUS EQUIPMENT

RADAR SYSTEMS GROUND AND AIRBORNE. AUTOMATIC TRACKING ANTENNA SYSTEMS. NIKE AJAX. NIKE HERCULES. M-33. MSQ-1A. MPS-19. MPS-9. SCR 584. TPS-1D. TPS-28. FAA-ASR-2. AIRBORNE SYSTEMS. APN-84. APN-102. APS-20. APS-27. APS-45. DPN-19. DIGITAL COMPUTERS. IBM 650. IBM 704.

 **LARGEST INVENTORY OF RADAR AND MICROWAVE EQUIPMENT IN THE WORLD.**
RADIO RESEARCH INSTRUMENT CO.
45 WEST 45TH ST. N. Y. 10036 212-JU 6-4691

CIRCLE 968 ON READER SERVICE CARD

IF MERGER FITS

your picture, we have a large listed electronic company who will acquire you for cash, stock, or a combination of both. Write:

PUBLIX, LTD.
1737 F Street, N.W.,
Washington, D. C. 20006

CIRCLE 971 ON READER SERVICE CARD

APS/42 CONTRACTORS

Bargain in New (Not Surplus) hard to get Parts Peculiar to APS/42 Radar.

DIVERSIFIED ELECTRONICS CORP.
2130 No. King St. Honolulu, Hawaii.

CIRCLE 972 ON READER SERVICE CARD

New VACUUM PENCIL
for picking up miniature parts
\$7.50 ea.
Selected Distributorships available.

PHILIP FISHMAN COMPANY
7 CAMERON ST., WELLESLEY, MASSACHUSETTS

CIRCLE 969 ON READER SERVICE CARD

SURPLUS IBM EQUIPMENT

FREE catalog of powers supplies, light & switch panels, semiconductors, test equipment, IC's, optics, etc.

GADGETEERS SURPLUS ELECTRONICS, Inc.
5300 Vine St. Cincinnati, Ohio 45217

CIRCLE 970 ON READER SERVICE CARD

Mr. Used Equipment Dealer:

When you advertise in the Searchlight Section . . . You have hired your most persuasive salesman:

He's efficient . . . He thrives on long hours . . . His territory is the entire nation . . . and overseas . . . He doesn't see buyers of used and new surplus equipment: They see him—regularly. They depend on him.

He is Searchlight—The section of this publication where wise dealers advertise and list their stocks for sale.

SEARCHLIGHT SECTION

Classified Advertising Dept.
Post Office Box 12 • New York, N. Y. 10036

Versatility you can use in THERMISTOR PROBES

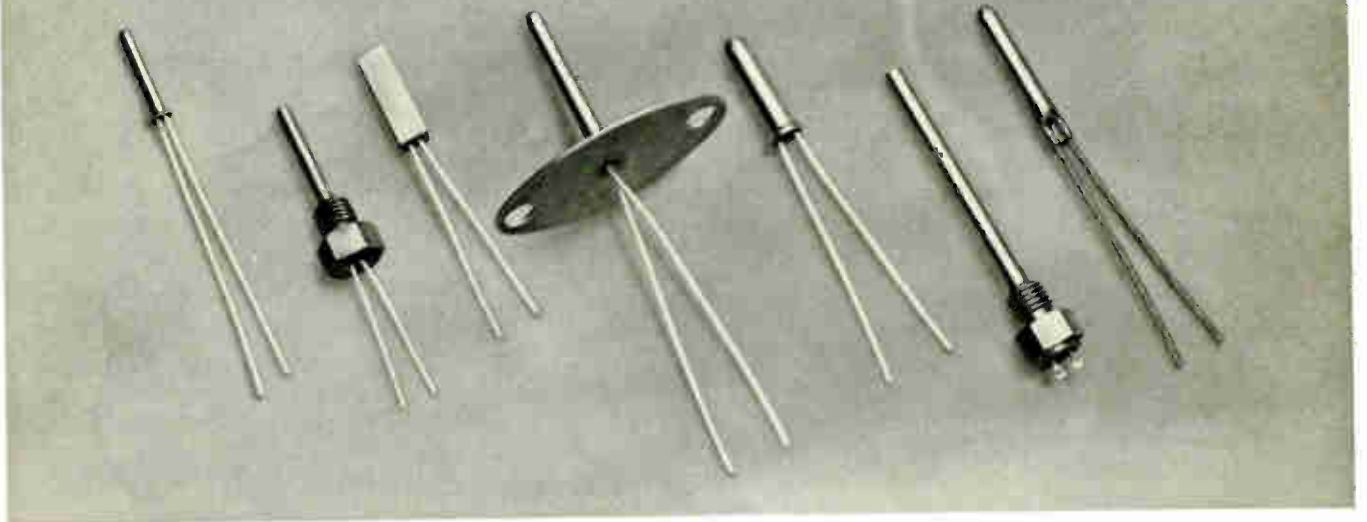

for temperature measurement

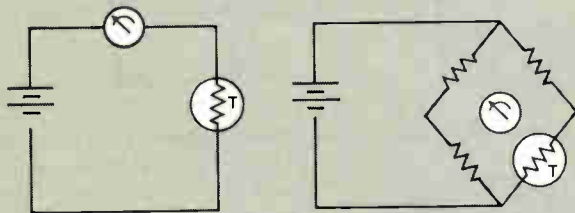

Circuit A

Circuit B

Combining high temperature sensitivity with high signal level, thermistors are ideally suited for temperature sensing. In circuit A, as the temperature of the thermistor increases, its resistance decreases, allowing more current to flow. If additional sensitivity is required, a bridge circuit like that shown at B may be used.

for liquid level detection

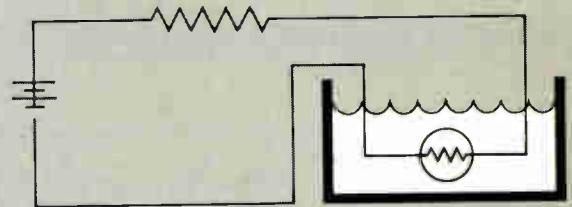

The thermistor is slightly self heated by passing a small current through the unit. The heat developed in the unit is dissipated more rapidly in the liquid than when the thermistor is above the liquid. The resulting change in body temperature results in a change in resistance. This in turn causes a change in the current in the circuit which can be detected by a relay or other means.

KEYSTONE TYPE	THERMISTOR RESISTANCE					
	0°C	25°C	37.8°C	104.4°C	150°C	232°C
370603-62.66-71-S	282.6	100	62.66	8.825	3.308	.8910
370603-119.1-85-S	631.2	200	119.1	14.01	4.800	1.174
370603-375.3-95-S	2132	650	375.3	39.48	12.76	2.826
0503-630-71-S	2750	1K	630.0	88.80	33.26	8.800
370603-1145-103-S	6733	2K	1145	111.1	33.78	6.607
370603-2801-120-S	18.23K	5K	2801	233.6	64.42	11.18
370603-4452-125-S	29.74K	8K	4452	356.2	96.61	16.29
060337-6266-71-S	28.26K	10K	6266	882.5	330.8	89.10
060337-11910-85-S	63.12K	20K	11.91K	1401	480.0	117.4
0503-16920-112-S	105.3K	30K	16.92K	1511	426.4	83.20
060337-37.53K-95-S	213.2K	65K	37.53K	3948	1276	282.6
0503-55.3K-125-S	361.0K	100K	55.30K	4420	1153	189.6
060337-114.5K-103-S	673.3K	200K	114.5K	11.11K	3378	660.7
060337-280.1K-120-S	1.823 meg	500K	280.1K	23.36K	6442	1118
060337-445.2K-125-S	2.974 meg	800K	445.2K	35.62K	9661	1629
050446-556.5K-125-S	3.717 meg	1 meg	556.5K	44.52K	12.08K	2037

All parts 260°C Max. operating temperature.

The probes illustrated above include stainless steel, aluminum, and chrome plated materials in a variety of configurations. Any thermistor listed at the left can be provided in one or all of the above illustrations. In addition, a variety of other designs are available. These probes are used in conjunction with solid state circuitry for liquid level measurement, and for use as sensors to measure temperature of liquids or surface temperatures. For full particulars, write, detailing your proposed application. Keystone Carbon Company, St. Marys, Pa. 15857.

Keystone
First

IN CREATIVE THERMISTOR TECHNOLOGY

International Newsletter

May 26, 1969

British uneasy over MRCA jobs

Some apprehension is developing among British avionics manufacturers about the probable allocation of avionics contracts for the proposed British-German-Italian (and possibly Dutch) multi-role combat aircraft. **The uneasiness is evident even before it's definite that the plane will be built** [*Electronics*, April 14, p. 220]. Because the Germans are likely to want between 600 and 700 aircraft, against 350 for Britain, 200 for Italy and 100 for Holland (if the Dutch cooperate), **the British see the Germans taking the lion's share of avionics contracts if awards are made in proportion to size of production order, as expected.**

This would boost the infant German avionics industry while leaving existing British expertise untapped. Industry men in Britain, still peeved about the boost French avionics derived from Sud's airframe leadership on the Concorde, are pressing their government to include, in any agreement, **some guarantees on avionics work that will favor the British.**

Ironically, British avionics men will be in a stronger position if Rolls-Royce loses the competition with Pratt and Whitney to supply the engine for the combat plane. The British might then retain considerable influence on airframe design and construction as part of their share of the total contract, which they can't hope to do if Rolls gets the rich engine contract. The MRCA is currently at the systems definition stage. The Germans and British are most enthusiastic, the Italians less enthusiastic but likely to cooperate, but Dutch participation is now doubtful.

Missile to bow at Paris air show

Eye-catchers at the Paris Air Show, May 29-June 8, will include an air-to-ship missile developed by West Germany's Messerschmitt-Boelkow GmbH in cooperation with France's Nord-Aviation.

Called the Kormoran, the missile represents West Germany's biggest effort to date in this type of weapons system. It is designed to be launched toward naval targets well before the missile carrier, an F104G Starfighter or an equivalent plane, is within range of the ship's defenses. During the missile's final approach phase, target search is either active or passive: in the active mode, an onboard radar picks up its own transmissions reflected by the ship; in the passive, infrared or homing devices seek out heat or the ship's radar transmissions.

Kormoran is believed to have a maximum range of 9-12 miles.

Olivetti becomes sole owner of semiconductor firm

Italy's giant manufacturer of office equipment, Olivetti, moved more heavily into electronics by buying out its partner to become sole owner of SGS, the thriving Milan-based semiconductor company.

SGS was originally owned in three equal parts by Olivetti, by the Fairchild Camera & Instrument Corp. and by the Italian electronics company, Telettra. The U.S. company sold its one-third share to Olivetti last fall after Fairchild got into a scrap with its European partners over product development. Among reasons for Olivetti's purchase of Telettra's interest, industry observers spot these: a top-level personality clash between the partners; and Olivetti's keen interest in the SGS Research Laboratory, which had been organized with the help of Fairchild.

SGS has five plants, all in Europe, and one under construction in Singapore through which it hopes to crack the Asian and American elec-

International Newsletter

tronics markets. Olivetti officials say they agree wholeheartedly with the SGS plans to become a worldwide manufacturer of discrete semiconductors and integrated circuits, rather than a captive supplier of components for Olivetti. SGS estimates its 1969 sales at \$64 million, a 40% increase over its 1968 total. The company recently developed a **high-level-logic microcircuit** which it expects to produce increased sales to computer manufacturers. Olivetti got out of the computer business and now is looking for a heavy share of the demand for electronic desk calculators, accounting machines, and computer peripheral equipment.

British color tube makers cut to 2

The two smaller of Britain's three color tv tube manufacturers—Thorn Radio Valves and Tubes Ltd. and RCA Colour Tubes Ltd.—have merged to form Thorn Colour Tubes Ltd., owned 51% by Thorn Electrical Industries Ltd. and 49% by RCA Ltd., British subsidiary of RCA of America. The new company shares the U.K. color tube market approximately 50-50 with Mullard Ltd. Thorn's operation within the new company is approximately twice as big as RCA's. For the present, production of tubes will continue at both plants.

Japanese to make IC's for autos

Japan's largest manufacturer of electrical components for automobiles, the Nippon Denso Co., is preparing for extensive use of integrated circuits that it will make under American patents.

Initially, the company plans to design IC voltage regulators for alternators; later it will use the IC's in safety accessories and for control of wipers, directional signals, lights, heater and cooler, and fuel pump. Denso is part of the Toyota Motor Co. group, but only about 12% of Denso stock is owned by Toyota. About half of its sales goes to Toyota.

Denso has applied to Japan's Ministry of International Trade and Industry for authorization to use U.S. patents, but says it can do the design and fabrication on its own. The company seeks permission to use Texas Instruments patents on IC's and discrete semiconductors for a 10-year period, at a royalty of 3.5% of sales. It also plans to use the Fairchild patent covering the planar process.

As reasons for making the devices itself, Denso says that they are special-purpose components not available from established semiconductor manufacturers, also that in-house production will permit it to maintain secrecy of customers' designs. A third reason: the devices will replace electromechanical parts made by Denso, so making their own IC's will retain the value-added content of the company's sales volume.

Addenda

Denmark, Sweden, and Norway will establish a satellite station at Tanum, Bohuslan, Sweden, for overseas telephony, data transmission, and—starting in 1971—for a television link between Scandinavia and Africa . . . Lebanon has reportedly placed a \$500,000 order for 10 of the Crota mobile missile defense systems developed by France's Thomson-Brandt group. Beirut is presumably buying the computer-directed missiles as a defense against hit-and-run attacks by low-flying Israeli planes . . . Matsushita Electric Industrial Co. is setting up a tv production plant in Australia. The Japanese company is renovating the former Singer factory at Penrith, New South Wales. It is the first electronics manufacturing plant to be set up by the Japanese in Australia, and Matsushita's 11th overseas subsidiary.

Hybrids with beam-lead ECL chips are British bet for mid-70's MSI

Marconi-Elliott is readying circuit packages built around 1-nanosecond gates; thick-film interconnections, rather than the chips, make the packages complex

There's little doubt that monolithic large scale arrays will one day be the predominant building block for computer-making. But that day seems quite far off to long-term planners at Marconi-Elliott Microelectronics Ltd., so far off that they've started to work on hybrid medium scale arrays for the markets of the mid-1970's.

Marconi-Elliott won't get into volume production on its new breed of hybrids before 1972. The company's product planners, though, have a good idea of what their MSI will finally look like. And at the Institution of Electrical Engineers' microelectronics conference next week at Eastbourne, the Marconi-Elliott men will outline their progress so far. Marconi-Elliott is the integrated-circuit manufacturing arm of the General Electric Co.-English Electric Co. combine, Britain's largest electronics group.

Marconi-Elliott is aiming at packages that can perform most computing functions in a few nanoseconds at most. That means switching speeds of about 1 nsec per gate and infinitesimal intergate delays. For its fast gates, the company is developing a few straight-forward emitter-coupled-logic monolithic circuits. The complexity will come from multilayer interconnections to beam leads on the chips. With beam leads, Marconi-Elliott figures, bonding to connection pads can be automated. And since there'll be some 20 chips on each hybrid, the beam leads will help beat the heat.

Marconi-Elliott's generation of 1-nsec gates can be traced back to the 3.5 nsec circuits the company

builds under an RCA license. In the speeded-up versions, geometries are shrunk and the diffusions made shallower. The emitter area, for example, was reduced first to one-third, then to one-fourth and finally to one-eighth that of the 3.5 nsec gate. At the same time, the emitter periphery was increased by one-third. Narrower bases have progressively improved propagation frequencies from 600, to 1,200 to 1,400, and finally to 1,500 megahertz.

Actually, says Svein Davidsen, who's in charge of chip develop-

ment, the 1-nsec ECL actually has a propagation delay of 1.1 nsec. Davidsen maintains that even faster circuits could be made; but rather than working for more speed his group has shifted to working for higher yields and more complex circuits. The chips are 0.038-inch square and are fully passivated with silicon nitride so there's no need for a hermetic seal.

Tucked in. To marry the chips for MSI, a research group main-stayed by George Smith has worked out a multilayer interconnection scheme. It starts with a

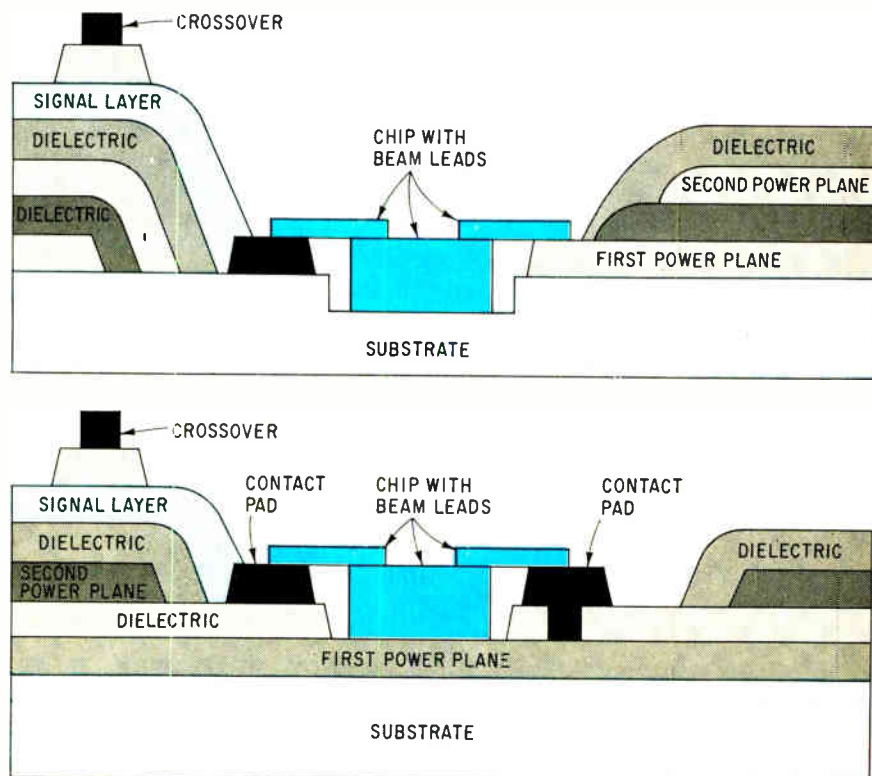

Layers and layers. Marconi-Elliott's ECL hybrids hook up some 20 beam-leaded chips. First version (top) tucks chips into depressions in substrate. Production versions—still years off—may have chips atop first power plane.

Electronics International

1-mil gold layer on a ceramic substrate, typically 3 inches long and 1 inch wide.

This first power plane—or ground plane—has windows in it for the chips. Inside each window are 1-mil-high connection pads for the beam leads. Because the chip is 2-mils thick, each window has below it a 1-mil depression in the substrate to take the chip and give the intimate contact needed for good dissipation.

The second layer is a glass-ceramic dielectric, falling just over the edges of the windows in the ground plane and onto the substrate but not touching the pads. This layer is made as thin as possible but nonetheless must give a decoupling capacitance of about 4,500 picofarads. Above the dielectric comes the second power plane, which also contacts the substrate through the windows but extends only to one connection pad.

Then comes a fourth layer, again a dielectric, which extends so close to the pads that the 1-mil-thick signal tracks laid down above it neatly contact the remaining dozen pads in the window. The last two layers comprise a glass-ceramic dielectric and gold crossover bars.

Direct contact. Pressing precise niches into the substrate to tuck the chips into is, Smith feels, an operation best avoided. So he's figured out an alternative interconnection scheme that puts the chips onto the first power plane. The windows for the chips are opened into a 1-mil dielectric layer above this power plane. The connection pads then are laid down with the second power plane and the remaining layers put down as before.

Rumbles over R&D

Any time a British newspaper or a member of Parliament feels the need to go on the attack, there's always a fat, slow-moving target at hand: government spending for military research and development.

The U.K. budget for defense R&D runs about \$600 million yearly, an eighth of total defense spending. And it's no trouble trotting out horrendous examples of waste

or bungling. The worst in recent years: the TSR 2 bomber, cancelled in 1965 after \$425 million had been spent on it.

The target, though, looks on the way to becoming harder to hit. A Parliamentary committee, set up early last year to probe R&D spending practices, came out this month with some guidelines to get more for the money. Although the government still has to act, the guidelines almost surely will bring some reforms in handling R&D. Most would make defense work a better deal for U.K. companies.

Speedup. One thing the committee wants is a faster go-ahead on development once a preliminary project study has been carried out. Although the government's mulling period is supposed to be three months, it sometimes gets stretched out to a year. Keeping development teams together that long ups the cost of R&D to the government and at the same time shaves profit margins for contractors. Testifying before the committee, Plessey Co. executives said their profit on defense R&D contracts ran only 4%, compared with 15% on commercial contracts.

Delays would be cut, the committee insists, if financial control—now in the hands of the Treasury—were partially shifted to the departments in the Ministry of Defense that have technical control of the projects.

Split. The committee also thinks there would be more R&D to the pound sterling if government research establishments stuck to research and eschewed development. The Royal Radar Establishment and like centers do considerable work in prototypes. The final product, the committee says, most likely would be more economic if the company that is going to produce it handles the prototype.

Another change in the split-up of R&D that the committee wants is a say for industry in the running of some research institutes. At a lower echelon, the Electronics Engineering Association told the committee, it would be a good idea for government labs and companies to do some staff swapping.

Also in the offing, if the govern-

ment follows through on the guidelines, is participation in initial project planning by potential producers of the hardware. This kind of collaboration between defense officials and industry executives—rare now—would make contract pricing more realistic, the committee feels. [See following story and p. 54 for criticism of R&D policies elsewhere.]

Australia

Back talk

Usually when someone Down Under mounts a podium to decry the state of research and development in Australian electronics it's a government official berating industry for not doing enough. But last week found an industry official flailing at the government's record in R&D.

It's the government that's backsliding, not industry, Kenneth S. Brown told the biennial convention of the Institution of Radio and Electronics Engineers at Sydney. Brown, who's technical director of Standard Telephones and Cables Ltd. Australia, an ITT subsidiary that's the country's top electronics exporter, trotted out some convincing figures to make his case.

Australia has much the same government-industry split of R&D funding as the other major English-speaking countries. Industry's share in these countries is 39% in Canada, 36% in Australia, 35% in the U.S., and 33% in Britain. What's more, Brown maintains, Australian companies generally spend relatively as much for research as U.S. companies do: 6% of their sales.

But Brown claims that Australia is surpassed only by the Soviet Union in the percentage of government research money that goes straight to government research facilities; Australian industry gets only 10% of federal R&D funds.

Instead of berating industry, Brown says, the government should revamp its research policy. He says the answer is for the government to make its defense hardware needs known well in advance and let industry propose contract R&D pro-

grams to suit. Thus far, Australia has tended to buy military equipment off-the-shelf from U.S. or U.K. manufacturers.

One of the rare exceptions to this policy was the \$672,000 contract for integrated-circuit development that the Dept. of Supply gave last year to Amalgamated Wireless Australasia, the lone major electronics company controlled by Australian interests. If there were more contracts like this in the offing, Brown says, STC Australia would very likely set up an advanced-electronics R&D center in Sydney. Other major companies on the scene, obviously, would be forced to follow suit and task-taking government officials, presumably, would have to turn to subjects other than electronics R&D.

West Germany

Fast needlework

Buy a \$1,000 electronic desk calculator and most often all you'll get for a readout is a bank of glowing tubes—that is unless the machine is Philips' new P-251. This IC-based calculator prints digits and symbols at a rate of 90 characters per second—the highest speed yet obtained with a serial-type printout device, according to its developers.

The machine was developed at Elektro Spezial GmbH, a Bremen-based subsidiary of Philips' Gloeilampenfabrieken. It is being marketed by Philips Electrológica GmbH, another Philips subsidiary; Hamburg-based Valvo GmbH, still another Philips subsidiary, is the main supplier of the calculator's IC packages.

Dotted lines. Instead of using a metal or plastic wheel or ball with characters etched on the surface—as do some IBM typewriters and Friden desk calculators—the P-251's printing mechanism is based on electronically controlled needles that reproduce digits and symbols as patterns of dots.

The printing mechanism is a triangular unit with seven electromagnets radially arranged along

one side. The unit is installed with its pointed end facing the ribbon—a regular typewriter ribbon. Behind it is the familiar paper roll.

Associated with each of the seven magnets is a needle located inside a small tube. When a magnet becomes energized, the needle shoots forward through a small opening at the unit's pointed end, hits the ribbon, and produces a small dot on the paper behind it. A retract pin pulls the needle back into the tube. Needle movement is only a few millimeters.

When all seven magnets happen to be energized at the same time their associated needles produce a column of seven dots, and when the fully energized printing mechanism moves from left to right—to its next incremental position—another column of dots is produced.

Scanned. In printing out a plus sign, for example, first one magnet is energized producing a horizontal row of dots—half the crossarm—one during each incremental left-to-right movement of the printing mechanism. Then a combination of magnets is energized for printing

out the vertical portion of the plus sign. Finally, a single magnet is again energized for producing the remaining portion of the crossarm.

Using this scan-type principle, the printing mechanism produces characters according to how the calculator's character-generating circuitry is programmed. And the way the character-generating circuitry is programmed depends on what's being fed into the calculator.

Although the printing head is now being applied in the P-251 desk calculator only, it could be used in other printout equipment as well—in computer peripheral devices, for instance. In the desk calculator, with its narrow paper, the speed of the printer can't be fully taken advantage of. But in a computer printer, with wide paper, the speed of the head would be a great thing to have.

Versatile. One big advantage of the new printing head is that it can produce all kinds of characters—even Roman numerals, hieroglyphs, or Chinese ideograms—providing the character-generating circuitry is programmed accordingly. There

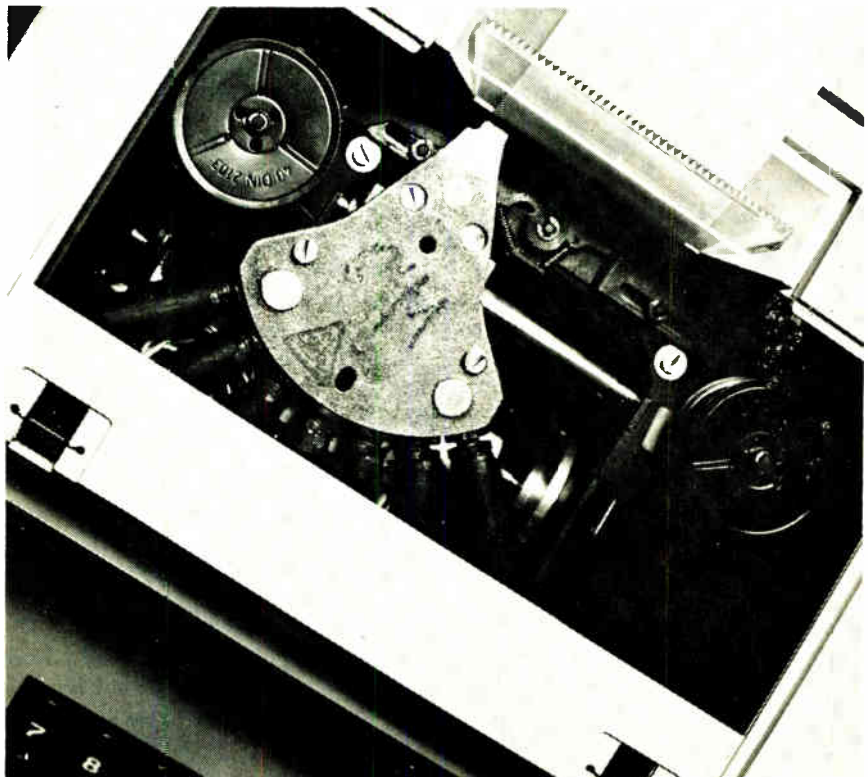

Pointed. High-speed printing head employs seven electromagnets that propel needles onto inked ribbon. Any type of character can be printed.

would be no need to change the printing head.

Except for the way its printing mechanism works, the operating principles of the P-251 are similar to those used in other electronic desk calculators.

France

Supersonic circus

It's hard to see how this year's Paris Air Show can miss as a public spectacle. The stellar attraction for the 11-day aerospace festival that starts later this week will be a double-take flyover of the supersonic transport Concorde—both the French-built and British-built prototypes will wing over Le Bourget Airport at the same time.

On the ground, too, there'll be much ado over the Anglo-French SST. French avionics makers who built hardware for the prototypes will play up their roles as Concorde subcontractors such as U.S. companies tout their contributions to American space spectaculars. The Concorde's prospects are one of the few sure bright spots in the outlook for French avionics makers these days, since military aerospace programs in the country stand to get a reworking.

Although most of Concorde's avionics has been shown before, there will be some new hardware on view designed for the production versions of the SST. One noteworthy item is the engine failure compensation system developed by the Société Française d'Equipments pour la Navigation Aérienne (SFENA).

The system swings into action with rudder-correction signals calculated by its computer when one of the Concorde's jets fails. Without these corrections, the plane could "skid," an unhappy event at supersonic speeds. The prototypes don't have this protection yet; SFENA expects to deliver the first systems in July or August for testing on the SST's.

SFENA also will have at the show its new stability-control computer and its azimuth computer, both for the Concorde's autopilot.

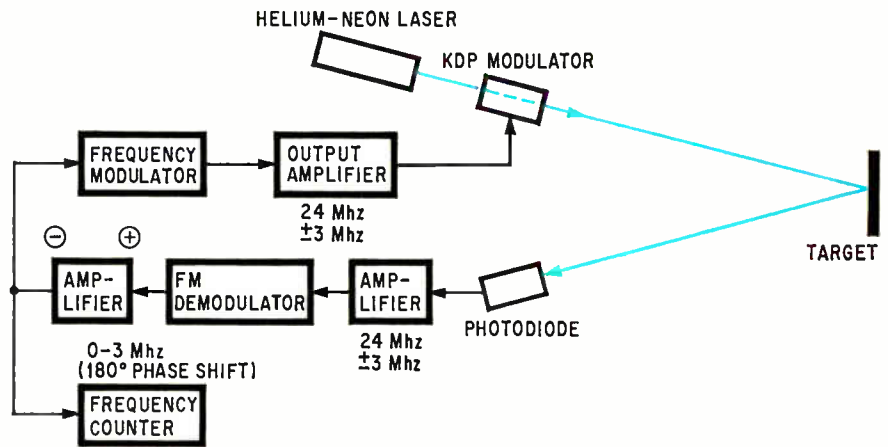

Close up. Laser used as a variable delay line in oscillator feedback circuit makes an optical rangefinder that can handle short distances.

Japan

In the loop

Most laser rangefinders are straightforward: gate out a light pulse, trigger a timing circuit simultaneously, cut the counting when the pulse comes bouncing back from the target, and convert the count into a range reading. It works, unless you need to measure distances down to zero.

To cover the range from zero on out to several hundred meters, other schemes are needed. Taro Uchiyama, Tomo-o Fujioka, and Masatsugu Kobayashi of Keio University have found one that works well and they'll tell about it later this week at the Conference on Laser Engineering and Applications in Washington, D.C.

Slowdown. The Keio rangefinder turns the laser beam into a sort of variable delay line in the feedback loop of an oscillator circuit. The longer the distance to the target, the longer the delay, and the lower the frequency of the oscillator. The oscillator frequency, then, shows the range.

Translating this scheme into hardware is simple. The laser is a standard helium-neon type whose beam is modulated about 20% with a conventional potassium dihydrogen phosphate (kdp) crystal. These are paired with a photodiode and a video amplifier. The amplifier drives the modulator and the photodiode drives the amplifier.

With this setup, the first tried by

the Keio trio, noise in the system modulates the laser beam. The modulation, delayed by the time it takes the beam to get out to the target and back, is amplified and again modulates the beam but with more amplitude. Finally, oscillation starts at the frequency that corresponds to the delay.

Refinements. This simple setup works fine except at distances of about 100 meters. Here the natural frequency of the kdp upsets the frequency-distance relationship. Also, the amplitude of the modulation varies with frequency—to the detriment of the overall stability of the system.

To get around these drawbacks, the Keio researchers shifted to frequency modulation. The oscillation frequency is modulated onto a 24-megahertz subcarrier which in turn drives the kdp crystal. Its natural frequency is 1 Mhz and therefore has no effect at 24 Mhz.

All this, of course, means more hardware: an amplifier tuned to the subcarrier frequency, a discriminator, a baseband video amplifier, a frequency modulator, and an output amplifier to drive the kdp modulating crystal.

The f-m system has been checked at distances up to 150 meters—the longest straightline distance the Keio trio have found for tests near the campus. At the distance, accuracy is 10 parts per million and the oscillation frequency is 400 kilohertz. An engineered commercial version, the researchers say, would be ten times as accurate.

Electronics advertisers

May 26, 1969

Airborne Instruments Laboratory Campbell-Mithun, Inc.	189	□ General Instruments Europe	8E	National Semiconductor Corp.	10, 11
Airpax Electronics, Inc. Welch, Mirabile & Co., Inc.	132	■ General Electric Co., Electronic Components Sales Operation Robert S. Cragin, Inc.	57	Hall Butler Bliatherwick Inc.	
Allen-Bradley Co. Fensholt Adv. Agcy.	27, 29	General Resistance, Div. of Chronetics J. S. Lanza & Assoc.	14	North American Electronic Systems, Div., Educational Computer Corp.	140
■ Analog Devices, Inc. Adastra, Inc.	47	Groov-Pin Corp. Feeley & Wheeler, Inc.	66	George Moll Advertising Inc.	
□ Ates Componenti Elettronici, S.P.A. Publicitas	6E				
Automatic Electric Co., Sub. of General Telephone & Electronics Corp. Marsteller, Inc.	32, 33				
		Hamilton Watch Co. Beaumont, Heller & Sperling, Inc.	152	Philco Ford WDL Division	147
Beckman Instruments, Inc., Helipot Div. N.W. Ayer/Jorgensen/MacDonald, Inc.	68, 69	Heinemann Electric Co. Thomas R. Sundheim, Inc.	21	□ Philips N. V., Plt/Ema Division 2E, 9E, 11E Marsteller International S. A.	11E
Belden Corporation Fensholt Adv., Inc.	130, 131	■ Hewlett Packard, Colorado Springs Div Tallant/Yates, Adv., Inc.	2	■ Plastic Capacitor Inc. Sander Rodkin Adv. Agency Ltd.	118
Bell & Howell, Electronic Instrumentation Group-CEC/Transducer Div. N.W. Ayer/Jorgensen/MacDonald, Inc.	16, 174, 175	■ Hewlett Packard, Loveland Div. Tallant/Yates Adv., Inc.	162	Price Electric Corporation Schaefer Advertising Inc.	28
Biddle Co., James G. A. A. Blundi, Inc.	76	■ Hewlett Packard, New Jersey Div. McCarthy, Scelba & DiBiasi	63, 119, 136	Princeton Applied Research Corporation Mort Barish Associates Inc.	48
Brand-Rex Creamer, Trowbridge, Case & Basford, Inc.	158	■ Hewlett Packard, Palo Alto Div. Lennen & Newell, Inc.	1		
Bunker-Ramo Corp., The Marsteller, Inc.	153	Honeywell, Computer Control Div. Creamer, Trowbridge Case & Basford, Inc.	155, 157	Radiation Inc. W.M. Zemp & Associates Inc.	81
Bunker-Ramo Co. Diener & Dorskind, Inc.	134, 135	Honeywell PMD Div. Batten, Barton, Durstine & Osborn, Inc.	121	Radio Corporation of America 4th Cover, 59	
■ Burroughs Corp., Electronic Components Div. Conti Adv. Agcy., Inc.	82	■ Honeywell Test Instruments Div. Campbell Mithun, Inc.	80	AI Paul Lefton Co.	
				Radio Materials Company, P.R. Mallory Company M.M. Fisher Associates Inc.	128
				Raytheon Company Components Division Fuller & Smith & Ross Inc.	75, 165
				Research Inc. Gordon Rosholt & Company	161
Carpenter Technology Corp. Beaumont Heller & Sperling, Inc.	148	■ Indiana General Corp. Griswold Eshleman	12, 13		
C.G.E. Edition "2B" Publicite	151	Industrial Electronic Engineers Van Der Boom, McCarron, Adv.	64, 65	■ Semtech Corporation Burruss Advertising	53
Clevite Corporation/Gaging & Control Div. Carr Liggett Adv., Inc.	74	Industrial Inventions HMC Assoc.	176	□ Sercel Termost Technique	10E
□ Contelec Mario Willi	7E	Infodex, Inc. S & S Creative Services	160	□ Sescoserm 4E, 5E	
Control Products Div., Texas Instruments Incorporated Horton, Church & Goff, Inc.	77	IRC, Inc. Gray & Rogers, Inc.	125	□ Sfernice Publicitor	12E
Coto Coil Company, Inc. Williams Company, The	166	ITT Wire and Cable MacManus, John & Adams, Inc.	9	■ S.H. Couch Division, ESB Incorporated Culver Advertising Inc.	120
□ CRC IRP	20E			Signetics Corp. Sub. Corning Glass Works Cunningham & Walsh Inc.	95
CREI, Home Study Div. of the McGraw-Hill Book Co. Henry J. Kaufman & Assoc.	167	■ Kepeco, Inc. Weiss Adv.	62	□ Silec Electronic Publicite Y Ch. Lambert	19E
■ CTS Corp. Reincke, Meyer & Finn, Inc.	79	Keystone Carbon Co. Downing Industrial Adv., Inc.	180	Siliconix Inc. Graphics West	7
Cyclo-Tronics, Inc. Bernard J. Hahn & Assoc.	165			Singer Co., The Instrumentation Division	78
				Technical, Industrial & Scientific Marketing Inc.	
				□ Sodeco Publicite Polliand	15E
■ Dale Electronics, Inc., Sub. of Lionel Corp. Swanson, Sinkay, Ellis, Inc.	3rd Cover	■ Lambda Electronics Corp. Michel Cather, Inc.	17, 18, 19	■ Sorensen Operation Raytheon Company Urrutia & Hayes Inc.	73
Dana Laboratories, Inc. Smith-Klitten, Inc.	22, 23	□ Lansdale Transistor Product Promotions Agcy., Inc. Ledex, Inc.	17E	Spectrum Control Inc. Altman-Hall Associates	156
■ Discon Corp. Clay Evans Adv.	177	Yeck & Yeck, Inc. Litton Industries, Inc., Triad Distributor	138	Sperry Rand Corporation, Sperry Microwave Electronics Division Neals & Hickok Inc.	70
		MacManus, John & Adams, Inc. Lundy Electronics & Systems, Inc.	146	Sprague Electric Company, The Harry P. Bridge Company	5, 31
		Beckert/Brown, Ltd.	164	■ Standard Condenser Corporation R.N. Johnson Advertising	60
Eastman Kodak Co., Business Systems Markets Div. J. Walter Thompson Co.	129			■ Susumu Industrial Co., Ltd. Kyokuto Kikaku Co., Ltd.	168
Elco Corp. Schaefer Adv., Inc.	190	Markem Corp. Creamer Trowbridge Case & Basford, Inc.	142	Sylvania Electric Products Inc., Electronic Components Group Doyle Dane Bernbach, Inc.	39 to 46
E/MC Electronics/Management Center Slesar & Kanzer, Inc.	169	□ Metrimpex Hungexpo	14E	Sylvania Electric Products Inc. Parts Division Doyle Dane Bernbach Inc.	15
E. M. I. Electronics Canada, Ltd. Greiner Harries Maclean, Ltd.	188	■ Microsonics, Inc. S. Gunnar Myrbeck & Co.	154	■ Systron-Donner Corporation Bonfield Associates Inc.	36
Executone, Inc., Printact Relay Div. J. A. Richards	168	Miller-Stephenson Chemical Co., Inc. Michel-Cather, Inc.	177		
		Mohawk Data Sciences Corp./OEM Marketing MacFarland Assoc., Inc.	122	Techné (Cambridge) Limited Harrison Wright Associates Limited	176
□ Fairchild Semiconductor Southern Adv., Ltd.	3E	Monsanto Co. Michel Cather, Inc.	150	■ Tektronix Inc. 113 to 116	
		■ Motorola Communications & Electronics Inc. Griswold Eshleman Company	177	Test Equipment Corporation Dean & Bain Advertising Inc.	143
■ General Instrument Corp., Semiconductor Products Div. Norman Allen Assoc.	24 25	Motorola Semiconductor Products Incorporated Lane & Bird Adv. Inc.	170, 171, 173	■ Texas Instruments Incorporated, Components Group Albert Frank-Guenther Law Inc.	20
				□ Texas Instruments France Dumesnil Publicite	16E
				Todd Products Corporation Ira Levine Advertising Associates Inc.	26
				Toko, Inc. Hakuholdo Incorporated	166



the newest shape in receiving antennae

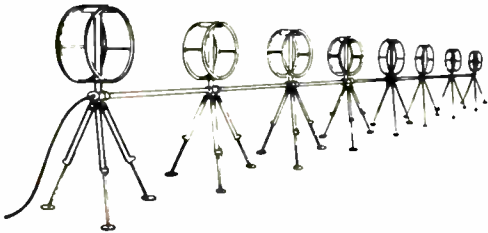

Aperiodic Loop Antennae... in an array composed of eight one-metre diameter untuned balanced loops spaced 13 feet apart... is the newest concept in "active" h.f. receiving arrays developed by E.M.I.

Each loop is fitted with a transistor pre-amplifier in its base, making possible a broad band (2 to 32 MHz) directional array much like a log-periodic or rhombic antenna. The system is only 30 metres long and a few feet wide. As it occupies but fraction of the space required for conventional passive fixed arrays, it is ideal for applications in areas of restricted space or when quick and simple set-up is important.

The new model 8E13 Aperiodic Loop Antenna Array has us rather excited. We would welcome the opportunity to tell you all about it in detail.

E.M.I. ELECTRONICS CANADA, LIMITED

Dartmouth, Nova Scotia, Canada
 Mail: P.O. Box 1005
 Phone (902) 466-7491
 Cables: EMI CAN

■ Tung-Sol Division Wagner Electric Corporation Feeley & Wheeler Inc. Tyco Laboratories Inc., Instruments Division Kenyon & Eckhardt, Inc. Adv.	126 6
■ United Transformer Company, Div. of TRW Inc. Fuller & Smith & Ross Inc.	2nd Cover
■ Unitrode Corp. Silton Brothers Inc. U-Tech, A Division of Industrial Physics & Electronics Co. Ross Clay Advertising	55 34
■ Vactec Incorporated Coleman & Associates Advertising Varian Associates Electron Tube & Device Group Botsford, Constantine & McCarty Inc. Victoreen Instrument Company Palm & Peterson Inc.	67 61 127
Waters Manufacturing Co. Goldman, Daniels Inc. Westinghouse Electric Corporation, Semiconductor Div. Pritchard Wood Associates Inc. Weston Instruments Inc., Newark Division Arndt, Preston, Chapin, Lamb & Keen, Inc. Wiremod Company, The Charles Brunelle Company	30 139 144 160
Xcelite Inc. Harold Warner Advertising Inc.	176

Classified & Employment Advertising

F.J. Eberle, Manager
212-971-2557

EMPLOYMENT OPPORTUNITIES 177-178
 Westinghouse 178

EQUIPMENT (Used or Surplus New) For Sale

Diversified Electronics Corp.	178
Fishman, P. Co.	178
Gadgets Surplus Electronics Inc.	178
Pratt & Whitney Aircraft	177
Publix, Ltd.	178
Radio Research Instrument Co.	178
Sperry Rand Research Center	178

- For more information on complete product line see advertisement in the latest Electronics Buyer's Guide
- Advertisers in Electronics International

Electronics Buyers' Guide

George F. Werner, General Manager
 [212] 971-2310
 Robert M. Oenmead,
 Midwest Regional Manager
 [312] MO 4-5800
 William A. Capuzzi,
 New York, New England District Manager
 [212] 971-3793
 Regina Hera, Directory Manager
 [212] 971-2544
 Thomas M. Egan, Production Manager
 [212] 971-3140

Circulation Department

Isaaca Siegel, Manager [212] 971-6057

Research Department

David Strassler, Manager [212] 971 6058

Advertising Sales Staff

Frank E. LeBeau [212] 971-6464
 Advertising Sales Manager
 Wallis Clarke [212] 971-2187
 Assistant to sales manager
 Donald J. Austermann [212] 971-3139
 Promotion Manager
 Warren H. Gardner [215] LO 8-6161
 Eastern Advertising Sales Manager
 Atlanta, Ga. 30309: Michael H. Miller, 1375
 Peachtree St., N.E.
 [404] 892-2868
 Boston, Mass. 02116: William S. Hodgkinson
 McGraw-Hill Building, Copley Square
 [617] CO 2-1160
 Cleveland, Ohio 44113: William J. Boyle, 55
 Public Square, [216] SU 1-7000
 New York, N.Y. 10036
 500 Fifth Avenue
 James R. Pierce [212] 971-3615
 John A. Garland [212] 971-3617
 Michael J. Stoller [212] 971-3616
 Philadelphia, Pa. 19103:
 Jeffrey M. Preston
 Warren H. Gardner,
 6 Penn Center Plaza,
 [215] LO 8-6161
 Pittsburgh, Pa. 15222: Warren H. Gardner,
 4 Gateway Center, [412] 391-1314
 Rochester, N.Y. 14534: William J. Boyle,
 9 Greylock Ridge, Pittsford, N.Y.
 [716] 586-5040
 Donald R. Furth [312] MO 4-5800
 Midwest Advertising Sales Manager
 Chicago, Ill. 60611: Kenneth E. Nicklas
 Ralph Hanning 645 North Michigan Avenue,
 [312] MO 4-5800
 Dallas, Texas 75201: Richard P. Poole, 1800
 Republic National Bank Tower,
 [214] RI 7-9721
 Houston, Texas 77002: Robert Wallin,
 2270 Humble Bldg. [713] CA 4-8381
 Detroit, Michigan 48226: Ralph Hanning,
 856 Penobscot Building
 [313] 962-1793
 Minneapolis, Minn. 55402: 1104 Northstar
 Center [612] 332-7425
 St. Louis, Mo. 63105: Kenneth E. Nicklas,
 The Clayton Tower, 7751 Carondelet Ave.
 [314] PA 5-7285

James T. Hauptli [415] DO 2-4600
 Western Advertising Sales Manager

Denver, Colo. 80202: Joseph C. Page, David
 M. Watson, Tower Bldg., 1700 Broadway
 [303] 255-5484

Los Angeles, Calif. 90017: Ian C. Hill,
 John G. Zisch, 1125 W. 6th St.,
 [213] HU 2-5450

Portland, Ore. 97204: James T. Hauptli,
 Thomas McElhinny, 218 Mohawk Building,
 222 S.W. Morrison Street,
 Phone [503] 223-5118

San Francisco, Calif. 94111: James T. Hauptli,
 Thomas McElhinny, 255 California Street,
 [415] DO 2-4600

Pierre Braude Tel: 225 85 88: Paris
 European Director

Paris: Denis Jacob
 88-90 Avenue Des Champs-Elysees, Paris 8
 United Kingdom and Scandinavia

London: Oliver Ball, Tel: Hyde Park 1451
 34 Dover Street, London W1

Milan: Robert Saidel, Roberto Laureri Jr.
 1 via Baracchini Phone 86-90-656

Brussels: F.I.H. Huntiens
 27 Rue Ducale Tel: 136503

Frankfurt/Main: Hans Haller
 Elsa-Brandstroem Str. 2
 Phone 72 01 81

Geneva: Denis Jacob
 1 rue du Temple Phone: 31 95 60

Tokyo: McGraw-Hill
 Publications Overseas Corporation,
 Kasumigaseki Building 2-5, 3-chome,
 Kasumigaseki, Chiyoda-Ku, Tokyo, Japan
 [581] 9811

Osaka: Akihiko Kamesaka, McGraw-Hill
 Publications Overseas Corporation, Kondo
 Bldg., 163, Umegae-cho Kita-ku [362] 8771

Business Department

Stephen R. Weiss, Production Manager
 [212] 971-2044

Thomas M. Egan,
 Assistant Production Manager [212] 971-3140

Dorothy Carmesin, Contracts and Billings
 [212] 971-2908

Frances Vallone, Reader Service Manager
 [212] 971-2865

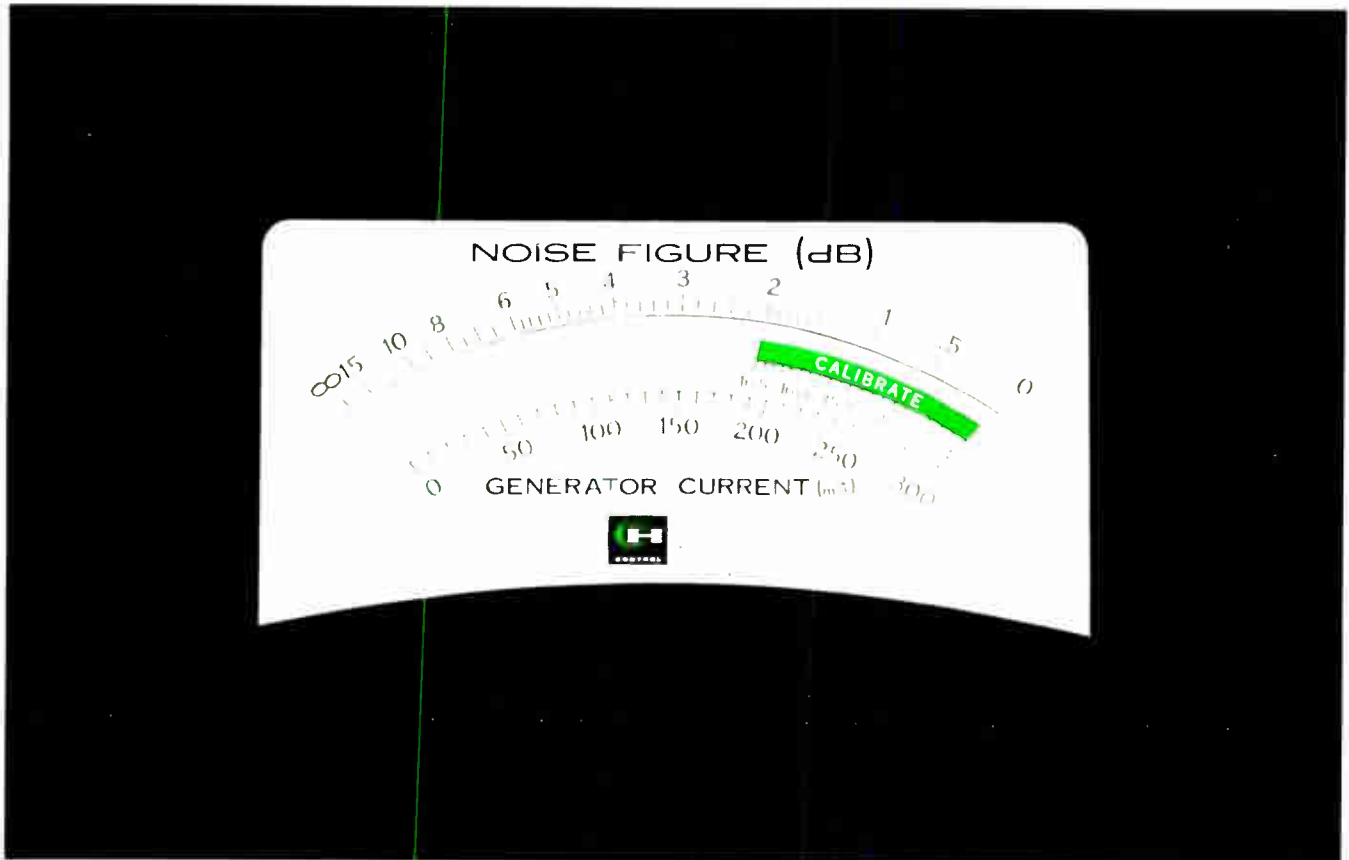

This expanded scale means unmatched accuracy and resolution on AIL's Type 75 Precision Automatic Noise Figure Indicator.



AIL's Type 75 provides automatic noise figure indication from 0 to 33 dB in the RF range from 10MHz to 40 GHz. Price less cabinet: \$1500.

Check our meter scale. You won't find another one like it on an automatic noise figure indicator.

Its expanded readout provides accuracy to ± 0.15 dB, with a resolution of a few hundredths of a dB over the critical lower half of the meter range. And a unique range switch puts any noise figure reading within this expanded portion of the scale.

It's a fact. No other automatic noise figure indicator even approaches this accuracy and resolution.

And here's another exclusive and time-saving feature: only with the Type 75 PANFI can you calibrate to the exact excess noise ratio of the noise generator being used. This means direct indication of actual noise figure without use of correction curves.

Exclusive solid-state design. Unique front-panel light that confirms a sufficient signal level for proper operation. Manual and remote control, too.

All of these features make the Type 75 the only automatic noise figure indicator really suitable for measuring the low-noise receivers of today and tomorrow. See for yourself. Call our "hot line" now to arrange for a demonstration. Just dial 516-595-3216 during East Coast business hours. Or



write for our full line catalog of Microwave Instruments, including the Type 75 Precision Automatic Noise Figure Indicator.

AIRBORNE INSTRUMENTS LABORATORY
DIVISION OF CUTLER-HAMMER INC./DEER PARK, LONG ISLAND, NEW YORK 11723



AIL/
DIVISION

**ELECTRONIC
EXPEDITORS, INC.**
6045 N. Green Bay Ave.
Milwaukee, Wisconsin 53209
Phone: 414-374-6666

**DRW ELECTRONICS
CORP. OF CALIFORNIA**
8339 Hindry Ave.
Los Angeles, California 90045
Phone: 213-673-2200

LECTRONIX, INC.
214 North Second St.
P.O. Box 188
St. Charles, Missouri 63301
Phone: 314-723-1122

**DRW ELECTRONICS
CORPORATION**
100 Milbar Blvd.
Farmingdale, Long Island,
New York 11735
Phone: 516-249-2660

**PYTTRONIC
INDUSTRIES, INC.**
2034 Worcester St.
Baltimore, Maryland
21230
Phone: 301-539-6525

Five places for mil-spec connectors to lose wait.

Getting the Mil-C-26500 and Mil-C-26482 cylindrical connectors you need doesn't take longer any longer.

Now you can get Elco cylindrical connectors, overnight, from any of our five stocking-and-assembling distributors. In any configuration. With from 2 to 61 contacts. Bayonet or threaded.

The connectors are the equal of any mil-spec-meeting cylindrical connector. Only, for you, they're a little more equal. Because you can get them faster without paying extra for the privilege.

And the distributors are as willing and able a group of guys as you'll ever deal with. Give the one closest to you a call; you'll see what we mean.

For more information (like our new cylindrical connector catalog, for instance) or for direct factory assistance, write Elco Corporation, Pacific Cylindrical Connector Div., 2200 Park Place, El Segundo, Cal. 90245, or phone 213-675-3311. TWX 910-325-6602.

ELCO Cylindrical Connectors

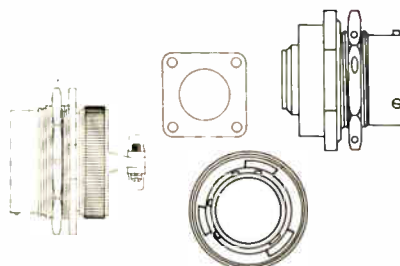

“”

“Funny,
you don't
look
resistive”



Dale reacts faster to your non-standard needs.

The resistive function you design doesn't have to have a standard shape and size...not when you deal with Dale. Look at these examples. The big one is a point for a vending machine can opener. Inside a Dale resistor provides heat for sterilization after each use. The small one is deceptively powerful—capable of 21 watts when heat sink mounted inside a computer to terminate line drive impulses. Of course, your problems will be different. But Dale has a head start toward solving them. Production blueprints on hundreds of special design situations including special packaging, termination, performance extremes, matching let us slash the lead time you'd expect for a non-standard part. Wirewound or film, single component or network, if you can't find it in your catalogs, call Dale first...402-564-3131.

Write for Dale's
**FUNCTIONAL GUIDE TO
NON-STANDARD
RESISTORS**

...listing by function
hundreds of readily
available design combina-
tions involving special
size, shape, performance
and other variables.

**FUNCTIONAL
GUIDE TO
NON-STANDARD
RESISTORS**



DALE ELECTRONICS, INC.

1352 28th Avenue,
Columbus, Nebr. 68601

In Canada, Dale Electronics, Ltd.



New! Multi-Color Performance from RCA Single-Gun CRT's

How many colors do you want in CRT read-out? RCA can give you two, and the shades between, from a single-gun CRT. What's more you have a choice of tube size for the display of all types of visual information – waveforms, alphanumeric, pictorial or any combination of these three.

Here's your answer to air-traffic control systems, military IFF systems, stock market quotation displays, airline and other transportation status boards. Utilize RCA's new capability in teaching machines, electronic test instruments, computer read-out equipment—anywhere a multi-color display makes understanding easier.

The RCA multi-color CRT is made with two phosphor layers. The multi-color performance is obtained through the application of different anode voltages.

Whatever your choice of colors and display, the read-out is as sharp and bright as black and white. And the single electron gun means simple back-up circuitry.

For more information on RCA multi-color CRT's and other RCA Display Devices, see your RCA Representative. For technical data, write: RCA Electronic Components, Commercial Engineering, Section No. E19Q-4, Harrison, N. J. 07029.

RCA

