

At IEEE: the spotlight's on new instruments 98
Optoelectronics lights way to mass memories 108
Simplifying multiresonator yig filter design 118

Electronics®

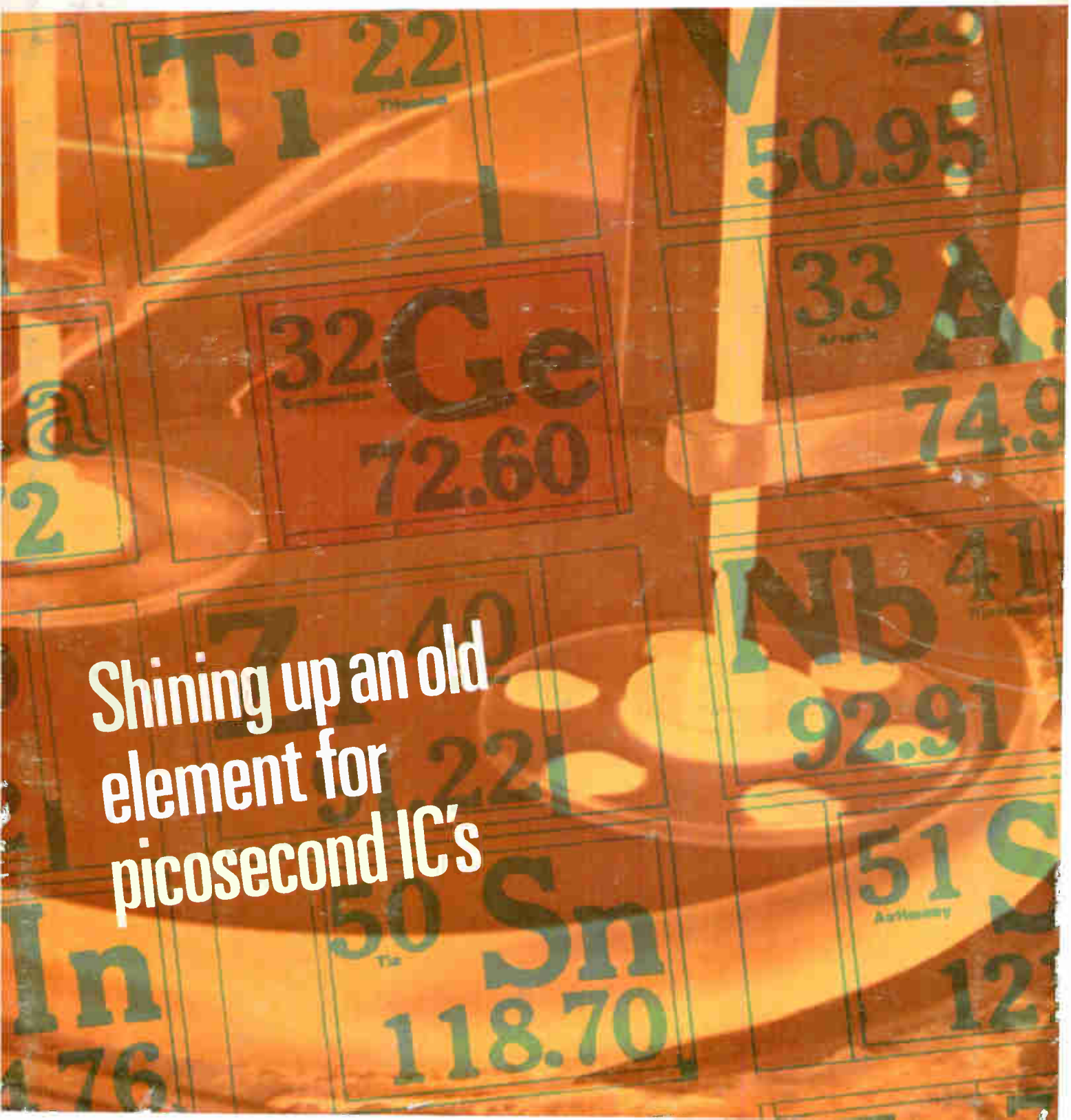

Shining up an old
element for
picosecond IC's

Cornucopia



Get UTC's NEW 1969 Catalog—the quick-and-easy locator for transformers and filters.

UTC's 1969 Catalog is the most comprehensive in our history. Over 1350 standard parts, including audio, power and pulse transformers, inductors, electric wave filters, high Q inductors, magnetic amplifiers, saturable reactors, and similar iron-core inductance devices. Many of these new products are listed for the first time.

Eighty-eight clear pages make it easy to locate and specify the part you need: product lines categorized, product selection guide for each line, engineering specifications and applications, new

drawings, new curves, expanded charts.

Also included are: audio and power application circuitry, plus a lucid digest of the new MIL Specs (MIL-T-27C, MIL-F-18327C, MIL-T-21038B).

The "special" you need is probably a "standard" in the NEW UTC Catalog. All items are immediately available from your local distributor. For your copy of the catalog contact: United Transformer Company, Division of TRW INC., 150 Varick Street, New York, N. Y. 10013.

TRW[®]

UNITED TRANSFORMER COMPANY

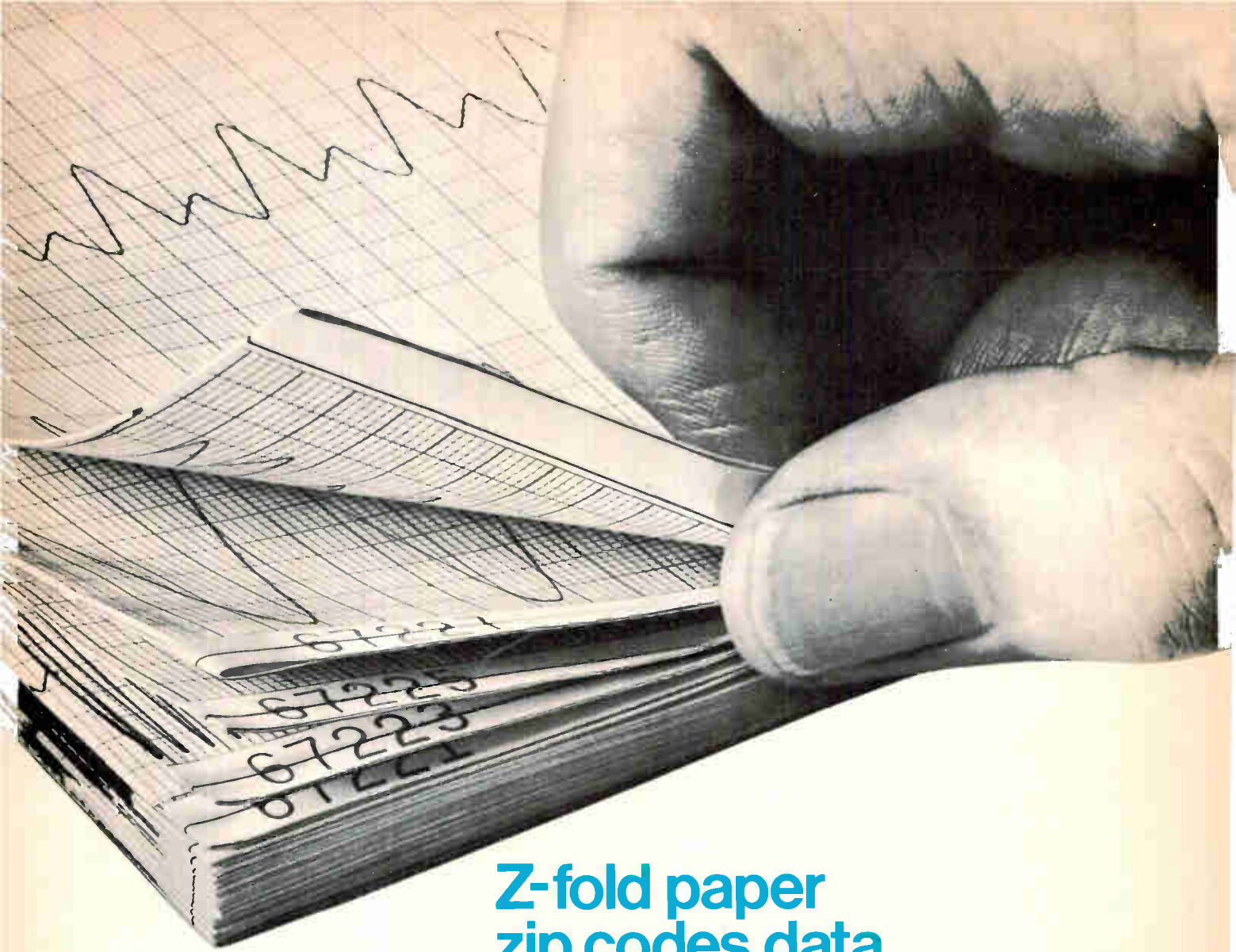

Z-fold paper zip codes data for quick retrieval

Data recorded on Z-fold paper by the Hewlett-Packard 7800 Series Rectilinear Recorder is instantly retrievable. Each page is numbered to simplify reference to recorded data. Z-fold chart packs store easily in their original cartons.

Contactless pen tip sensing and a *modulated pressure ink system* produce traces of equal density from all signals and throughout the recorder's variable speed ranges of .025 to 200 mm. per second. You get *blue ink reproducibility compatible to diazo or any similar process.*

Designed with modular, solid-state electronics, the 7800 Systems provide high-resolution, permanent, rectilinear recording of up to eight variables from dc to 150 Hz.

Eight 8800 Series Preamplifiers provide signal conditioning to the driver-amplifiers which drive the recording pens. The recording system is available with eight different or eight identical preamplifiers of your choice. Frequency



response of the recorder is 150 Hz for 10 div p-p deflection and 58 Hertz maximum for full scale deflection. Maximum ac or dc non-linearity is 0.5% full scale. Additional features include: choice of chart paper in Z-fold packs or rolls; 14 electrically-controlled chart speeds; built-in paper take-up; ink supply warning light; disposable plug-in ink supply cartridge that may be replaced while the recorder is in operation and modular construction for easy maintenance.

For complete information on the 7800 Series, optional and related equipment, contact your local HP Field Office or write Hewlett-Packard, Waltham Div., 175 Wyman St., Waltham, Mass. 02154. In Europe: 1217 Meyrin-Geneva, Switzerland.

HEWLETT  PACKARD
RECORDING SYSTEMS

See the new HP Analog-to-Digital Converter at the IEEE Show

Circle 1 on reader service card

We furnish the building blocks... you design your system. You can go from a single generator to a complex system simply by connecting the building blocks.

The new HP 1900 pulse system is a new generation of plug-in pulse generators—a new all-around bench instrument that solves both high and low voltage rise and fall problems. It is especially suitable for testing magnetic memory devices where high current output is required, or testing MOS logic devices requiring high voltages.

The HP 1900 now provides 50 V, 1 amp pulses into 50 Ω up to 100%

duty cycle, variable rise and fall times from 7 ns to 1 ms, 25 Hz to 25 MHz rate, delay from 15 ns to 10 ms—all for a total price of \$2750. For 2 to 16-bit word format, add the 50 MHz HP 1925A Word Generator. You can use this plug-in to create pseudo-random noise or get a word or its complement in return-to-zero or non-return-to-zero modes. An option makes the 1900 system electronically programmable.

And the new 1900A system is no paper tiger! All its specifications are *working* specs — if anything, conservative.

Plug-in design of the 1900A system allows you to select the best performance combination for your requirements — and modify later to

meet your changing needs. Soon-to-come are new modules providing sub-nanosecond rise and fall times, lower power output stages at much lower prices — and more exotic modules with excitingly new state-of-the-art specifications.

Start designing your pulse generator system today with the *expandable* HP 1900A system. Call your nearest HP field engineer for complete specifications. Or, write to Hewlett-Packard, Palo Alto, California 94304. Europe: 1217 Meyrin-Geneva, Switzerland.

It's expandable — the new HP 1900 pulse system for clean, controllable, high-power pulses!

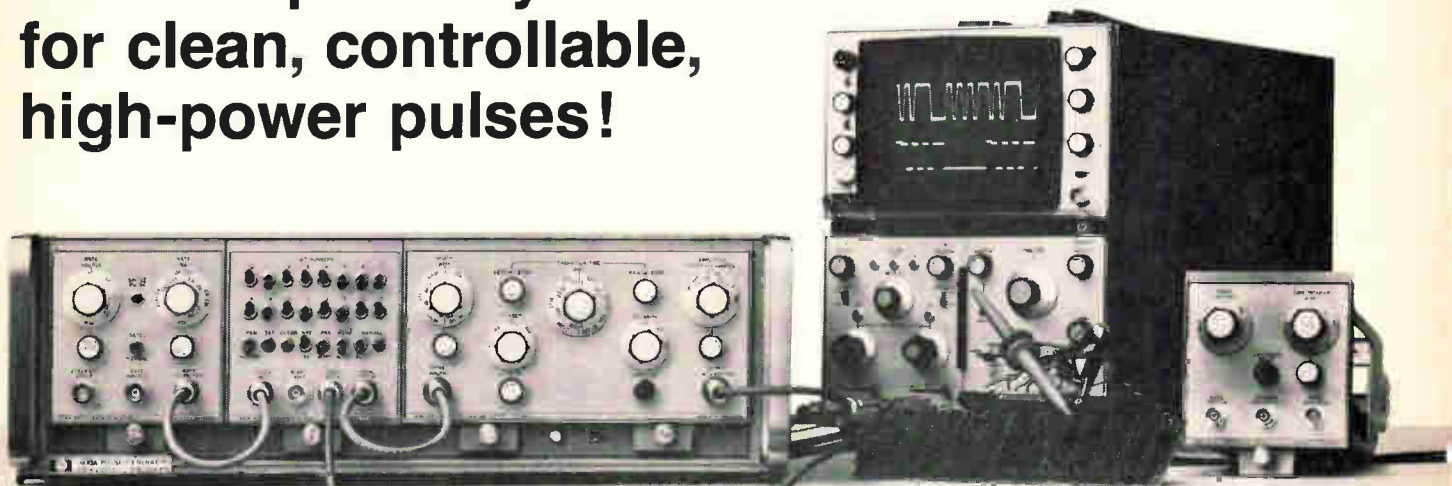

089/1

HEWLETT  PACKARD

SIGNAL SOURCES

Circle 2 on reader service card

On display at IEEE Show.

News Features

Probing the News

- 143 **Markets:** Wall Street looks for systems to ease paper burden
151 **Production:** Companies are welcomed to Mexican border zone

U.S. Reports

- 47 **Manufacturing:** Big push for beam-lead integrated circuits sets up demand for special bonding equipment
48 **Packaging:** Setting a standard
49 **Communications:** Pinpointing whispers
50 **Oceanography:** Open and shut case
52 **Computers:** In the factory; Mini machine
58 **Meetings:** Support for Ovshinsky; LSI under discussion
60 **Government:** Robes of office
62 **For the record**

Electronics International

- 249 **Britain:** Prospects are bright for glow-diode displays; Gunn diode and yig sphere make up two
250 **West Germany:** \$20,000 terminal turns tracings into computer inputs; ceramic tip heats soldering iron and holds it at the right temperature
251 **Japan:** Computer for doctors will come with special package of software
252 **France:** Officials ponder solutions for data transmission explosion

New Products

- 170 **In the spotlight**
170 Epitaxial reactor for silane deposit and barrel reactor bow at IEEE
172 **Components review**
172 Monolithic filter can have 8 poles
175 Comparator with high voltage swing
177 Reed with twist has longer life
181 **Instruments review**
181 Dvm measures low resistance
186 Picoammeter goes digital
189 **Semiconductor review**
189 FET switch is on in 50 nanoseconds
192 Core drivers are IC-compatible
195 **Microwave review**
195 R-f connector extends range
201 **Production equipment review**
201 Data generator copes with MSI
206 Sorter for dual in-line packs
209 **Subassemblies review**
209 Computer display writes fast
212 Amplifier has 2-decade range

Technical Articles

- Advanced technology** 88 **Germanium IC's point way to picosecond computers**
High-speed machines would work at low temperatures; use high-performance thin-film resistors and capacitors; and circuitry would be densely packed on very small chips
Arnold Reisman, IBM Watson Research Center
- Circuit design** 94 **Designer's casebook**
▪ 19 op-amp gains switched without offset
▪ MOS FET prevents loading by pulse stretcher
▪ Sweep circuit triggers on 200 millivolts
▪ Sawtooth generator delivers constant peak
- IEEE Show** 98 **Instruments win top billing with more IC's**
Trends away from analog indicators and toward circuit integration have really taken hold— as has move toward modular construction
Owen Doyle, assistant editor
- New instruments** 101 **Counters, testers, an in-between source, a dvm calibrator, and a signal generator at IEEE**
- Memory technology** 108 **Optical techniques for mass-storage media**
M.D. Blue and Di Chen, Honeywell
- 113 **Optoelectronics: light to read out by**
Richard D. Stewart, General Electric
- Applied design** 118 **Simple path to design of yig filters**
Multiresonator devices can be put together quickly on paper through use of charts to determine input, output, interstage coupling networks; technique is faster than trial-and-error work on the bench
Walter Venator, Airtron Division, Litton Industries

Departments

- | | | | |
|----|--------------------------|-----|--------------------------|
| 4 | Readers Comment | 48 | Index of activity |
| 8 | Who's Who in this issue | 65 | Washington Newsletter |
| 14 | Who's Who in electronics | 216 | New Books |
| 28 | Meetings | 222 | Technical Abstracts |
| 37 | Editorial Comment | 233 | New Literature |
| 39 | Electronics Newsletter | 247 | International Newsletter |

Electronics

Editor-in-Chief: Donald Christiansen

Senior staff editors

Technical: Stephen E. Scrupski
News: Robert Henkel
International: Arthur Erikson

Managing editor: Harry R. Karp
Art director: Gerald Ferguson

Senior associate editor: Joseph Mittleman
Assistant managing editors: Stanley Zarowin, Eric Aiken, H. Thomas Maguire
Senior copy editor: James Chang; Senior staff writer: Howard Wolff

Department editors

Advanced technology: William Bucci, Richard Gundlach
Communications: John Drummond, Raphael Kestenbaum
Computers: Wallace B. Riley, George Weiss
Design theory: Joseph Mittleman
Instrumentation: Owen Doyle, Walter Barney
Military/Aerospace: Alfred Rosenblatt, Paul Dickson
New products: William P. O'Brien
Solid state: George Watson, Stephen Wm. Fields

Domestic bureaus

Boston: James Brinton, manager; Gail Farrell
Chicago: Frederick Corey, manager
Los Angeles: Lawrence Curran, manager
San Francisco: Walter Barney, manager; Peter Vogel
Washington: Robert Skole, manager; Paul Dickson, William F. Arnold

Foreign bureaus

Bonn: John Gosch
London: Michael Payne
Tokyo: Charles Cohen

Copy editors: Larry Miller, Edward Flinn
Staff writer: Peter Schuyten

Assistant art director: Susan Hurlburt, Kenneth L. Dix
Production editor: Arthur C. Miller

Editorial research: Anne Mustain

Editorial secretaries: Lorraine Longo, Claire Goodlin, Barbara Razulls, Vickie Green

McGraw-Hill News Service

Director: Arthur L. Moore; Atlanta: Fran Ridgway; Chicago: Robert E. Lee
Cleveland: Arthur Zimmerman; Dallas: Marvin Reid
Detroit: James Wargo; Houston: Barbara LaRoux
Los Angeles: Michael Murphy; Pittsburgh: Louis Gomolak
San Francisco: Margaret Drossel
Seattle: Ray Bloomberg; Washington: Charles Gardner, Daniel B. Moskowitz,
Herbert W. Cheshire, Seth Payne, Warren Burkett, William Small, William D. Hickman

McGraw-Hill World News Service

Bonn: Robert Dorang; Brussels: James Smith; Hong Kong: Wes Perry;
London: John Shinn; Mexico City: Gerald Parkinson; Milan: Ronald Taggiasco, Jack Star;
Moscow: Jack Winkler; Paris: Robert E. Farrell, Stewart Toy
Rio de Janeiro: Leslie Warren; Tokyo: Marvin Petal
Reprints: Susan Nugent
Circulation: Isaaca Siegel

Publisher: Gordon Jones

Assistant to the publisher: Wallace C. Carmichael

Electronics: March 3, 1969, Vol. 42, No. 5

Published every other Monday by McGraw-Hill, Inc. Founder: James H. McGraw 1860-1948.
Publication office 99 North Broadway, Albany, N. Y. 12202; second class postage paid at Albany, N. Y.

Executive, editorial, circulation and advertising addresses: McGraw-Hill Building, 330 W. 42nd Street
New York, N. Y. 10036. Telephone (212) 971-3333. Teletype TWX N.Y. 710-581-4235. Cable address:
MCGRAWHILL N.Y.

Subscriptions solicited only from those professionally engaged in electronics technology. Subscription rates:
qualified subscribers in the United States and possessions and Canada, \$8.00 one year, \$12.00 two years,
\$16.00 three years; all other countries \$25.00 one year. Non-qualified subscribers in the U.S. and
possessions and Canada, \$25.00 one year; all other countries \$50.00. Air freight service to Japan \$50.00
one year. Single copies: United States and possessions and Canada, \$1.00; all other countries, \$1.75.

Officers of McGraw-Hill Publications: Joseph H. Allen, President; J. Elton Tuohig, Executive Vice President;
David J. McGrath, Senior Vice President-Operations; Vice Presidents: John R. Callahan, Editorial; Paul F. Cowie,
Circulation; John R. Emery, Administration; John M. Holden, Marketing; David G. Jensen, Manufacturing;
Jerome D. Luntz, Planning & Development; Robert M. Wilhelmy, Controller.

Officers of the Corporation: Shelton Fisher, President and Chief Executive Officer; John L. McGraw, Chairman;
Robert E. Slaughter, Executive Vice President; Daniel F. Crowley, Donald C. McGraw, Jr., Bayard E. Sawyer, Senior
Vice Presidents; John J. Cooke, Vice President & Secretary; Gordon W. McKinley, Vice President & Treasurer.

Title © registered in U.S. Patent Office; © Copyright 1969 by McGraw-Hill, Inc. All rights reserved. The contents
of this publication may not be reproduced either in whole or in part without the consent of copyright owner.

Subscribers: The publisher, upon written request to our New York office from any subscriber,
agrees to refund that part of the subscription price applying to copies not yet mailed.
Please send change of address notices or complaints to Fulfillment Manager; subscription
orders to Circulation Manager, Electronics at address below. Change of address notices
should provide old as well as new address, including postal zip code number. If possible,
attach address label from recent issue. Allow one month for change to become effective.

Postmaster: Please send form 3579 to Fulfillment Manager, Electronics,
P.O. Box 430, Hightstown, New Jersey 08520

Readers Comment

Status at stake

To the Editor:

In the article entitled "Engineers accept the risk of layoffs as part of the game in defense field" [Jan. 20, p. 122], you missed a couple of other bad results of this unstable condition. One of these is that the continual changing of jobs results in broad experience but not much depth. Many engineers are consequently not much better off technically than technicians. Excellence almost always results from long periods of diligent effort in the same technical area.

The continual moving noted in the article also contributes to the lack of professional recognition of engineers. The man who moves into the block and stays for a few years and then moves out can hardly be considered a solid citizen like the physician who stays in the same spot for years. Being laid off does not help the engineer's professional standing, either. Real professionals do not have that kind of problem.

I am not sure that Robert Talbott's proposed engineers' union is the needed solution, but certainly a stronger organization is required. Our present professional organizations do a great job in the technical areas but are a complete flop in their approach to the achievement of professional recognition. Polishing our halos while watching for big brother to act just will not bring about the needed change. If we want to be real professionals, we need to lay down some rules to govern our own profession. Both engineering and society in general should benefit.

Fred L. Washburn Jr.
Severna Park, Md.

I-r detectors

To the Editor:

Your survey of infrared detectors [Jan. 20, p. 91] is excellently presented but is unfortunately limited to solid state photoconductor and photovoltaic devices.

This could leave a designer, faced with the problem of selecting

...looking for a specific self-mounting 'lytic?

Choose from TWIST-LOK[®] or WRAP-LOK CAPACITORS



INFORMATION RETRIEVAL NO. 109

Two styles for use in entertainment electronics and other commercial equipment with similar environmental conditions. The widely-used Twist-Lok has integral mounting ears which are twisted after fitting through slots in chassis or mounting plate. The Wrap-Lok has sharp-cornered terminals for wire-wrap type connections.

Both styles have unique sandwich-type end seal and dependable venting system. All connections between terminals and capacitor sections are welded to assure freedom from intermittents or open circuits. Available with bare case, Kraftboard tube, or plastic sleeve.

45C-814B

...need a reliable wirewound resistor?

Specify ACRASIL[®] PRECISION/POWER RESISTORS

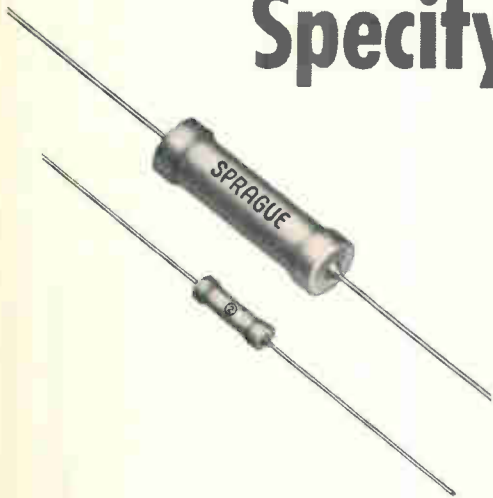

INFORMATION RETRIEVAL NO. 110

Excellent stability and reliability, even under extended load life, extremely high humidity, and other adverse operating conditions. Expansion coefficient of silicone coating is closely matched to that of ceramic base to insure against damage to resistance winding. Coating provides exceptional protection against moisture, shock, vibration, fungus. Available with standard and non-inductive windings. Resistance tolerances as close as $\pm 0.05\%$.

For complete technical data on Twist-Lok and Wrap-Lok Capacitors, write for Engineering Bulletin 3140A. For information on Acrasil Resistors, request Bulletins 7450A and 7450.1. Write to: Technical Literature Service, Sprague Electric Co., 35 Marshall St., North Adams, Mass. 01247.

45R-811B



'Sprague' and '®' are registered trademarks of the Sprague Electric Co.

THE BROAD-LINE PRODUCER OF ELECTRONIC PARTS



Close your DVM credibility gap

...with the new 1822 Digital Voltmeter Calibrator

How well do you trust your DVM? Is its calibration still right? How about its linearity? Is the reading subject to hysteresis? Are you sure what effect input loading has on accuracy? How about the DVM's susceptibility to interfering voltages?

How do you find out? You could tear down your setup and drag your DVM to the standards lab for calibration. But wouldn't it be nice if the standards lab could come to you for a change?

We think we've worked out a way to bring the mountain to Mohammed and get those DVM calibration jobs done with the new GR 1822 Digital Voltmeter Calibrator. Here's an instrument that doesn't need the security blanket of standard lab conditions to do its job — it can come to you. And, conveniently too. All calibration functions are incorporated into one, small, easily transportable instrument.

All you have to do is bring the 1822 to your DVM, select a test voltage range, connect in your DVM, and push a button. Then, sit back and watch while an automatic test program takes your

DVM progressively through its decades. Select input loading or interfering voltages as desired. That's all there is to it. The testing method is in accordance with proposed USASI procedures for DVM's and Ratio Meters (USAS C39-6; soon to be released).

The 1822 is not limited to DVM testing. Anything that measures, transmits, or transduces analog voltages can be checked. And, the 1822 can be remote programmed for use as a systems calibration device.

The 1822 may create a credibility gap between you and your DVM's. But only for a little while. Then you'll swear by DVM's and not at them.

SPECIFICATIONS

DC Calibrating Voltages: 100 μ V to 1111.1 V in 7 decade ranges.

Voltages Available in Each Range: 0.11111, 0.22222, 0.33333, etc., to 1.1111. Zeros can be substituted if desired in the last four, two, or one digits (i.e., 0.30000, 0.33300, or 0.33330). Standard cell output can also be selected (1.018700 to 1.019100 V, adjustable to match standard).

Voltage Accuracy: Six-month accuracy is \pm (30 ppm of voltage + 10 ppm of full range + 3 μ V), except on 1-kV range which is \pm (50 ppm of voltage + 10 mV).

Warmup and Stability: Output essentially within above accuracy after **15 minutes** warmup from cold start. Stability over a 24-hour period is within \pm (20 ppm of voltage + 2 μ V).

Interference Voltages Available: 1, 10, 100 V \pm 10%, dc or peak ac. Choice of common-mode ac and dc (low terminal to case) and normal-mode ac (algebraically added to output). AC voltage is from line or can be provided externally (5-V pk).

Output Impedance: Less than 0.2 Ω above 1 V and 200 Ω below 100-mV in "zero"-ohm position; 1-k Ω , 10-k Ω , or 100-k Ω outputs, switch selectable.

Programmability: Internal automatic program sequences voltages from 1/10 of full scale to full scale and back down again. Maximum voltage range is switch selected. Program begins at maximum range, then drops a range and repeats the program. Process continues until range reaches either a 1-V or 1-mV preselected minimum, or until told to stop. In addition, functions controlling output range, digits and zeros can be remote programmed by switch closure or by "on" signal.

Price: \$2800 in U.S.A.

For complete information, write General Radio Company, West Concord, Massachusetts 01781; telephone (617) 369-4400. In Europe: Postfach 124, CH 8034, Zurich 34, Switzerland.



GENERAL RADIO

Readers Comment

a detector for a particular application, with the erroneous impression that only cryostatically cooled photodetectors can reach the spectral range over 10 microns. Actually, there are commercial thermal detectors that provide a nearly linear spectral response from the visible region to 40 microns and over, and that don't require cooling.

A complementary article covering such uncooled thermal detectors as bolometer, pyroelectric, and ferroelectric i-r cells might therefore be in order.

Alexis Argamakoff
Cannes, France

■ Philip Shapiro of Aerojet-General, author of the piece in question, replies: "The survey covered only solid state quantum detectors. A separate article on thermal radiation detectors would certainly be valuable, as would coverage of such devices as photomultiplier tubes and film. Quantum detectors were chosen for this survey because their high detectivity and short time constants make them attractive for a majority of military applications in spite of the engineering complexities imposed by cryogenics."

Zero-firing

To the Editor:

We have noted a New Products story [Jan. 20, p. 140] in which Omnionics claims that their zero-firing controls are the only commercial proportional controllers using

this technique. Actually, zero-firing SCR power controls have been available since 1963 or so throughout the process-control industry.

Our company, for example, has had them listed in our general catalog for two years now, and we know of several competitors who have been listing them longer than we have. In addition, we offer this feature for 120, 240, and 480 volts a-c, single phase or three phase from 10 amps to 600 amps. A typical 10-amp, 120-volt (60- or 400-hertz) unit would cost about \$92 and would operate up to 40°C.

We have no particular axe to grind — if anything, proportional zero-firing has many operational limitations — but we thought that you should know that this is far from being a new product in the nonaerospace industrial world.

Henry E. Payne
President,
Payne Engineering Co.
South Charleston, W.Va.

Missing in action

To the Editor:

The RCA Electronic Components division has been reported missing from a recent listing of infrared detectors and their suppliers [Jan. 20, p. 93].

Though its name was omitted, RCA does produce a line of phototubes that are sensitive in the infrared region.

Arnold M. Durham
RCA Electronic Components
Harrison, N.J.

Applications Power*

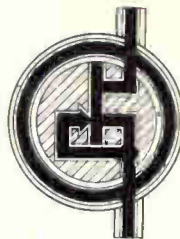

PUTTING CURRENT-LIMITER DIODES TO WORK

Problem: How to provide a linear voltage sweep?

Solution: Provide a constant charging current to a capacitor... with a Siliconix CL diode.

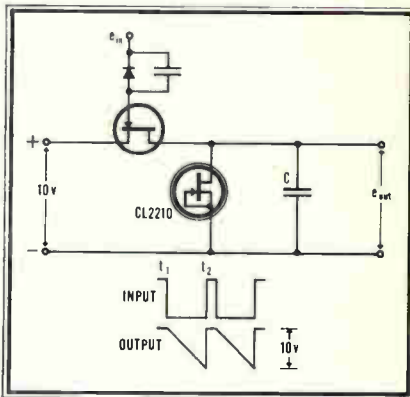

The FET switch is initially closed with C charged to +10v. At t_1 a -10v opens the FET switch. C discharges linearly, due to the constant current characteristic of the CL diode. At t_2 the switch is closed; C is again charged. Sweep time is determined by the values of C and the CL diode. Flyback time depends on C and the FET switch R_{ON} . FET switches are available with R_{ON} as low as 5 ohms!

For immediate applications assistance call the number below; ask for extension 19.

Siliconix
incorporated

1140 W. Evelyn Ave. • Sunnyvale, CA 94086
Phone (408) 246-1000 • TWX: 910-339-9216

*Applications Power: A wide product line and an in-depth applications team to help you over new design hurdles.

SUBSCRIPTION SERVICE

Please include an Electronics Magazine address label to insure prompt service whenever you write us about your subscription.

Mail to: Fulfillment Manager
Electronics
P.O. Box 430
Hightstown, N.J. 08520

To subscribe mail this form with your payment and check new subscription renew my present subscription

Subscription rates: qualified subscribers in the U.S.: 1 year \$8; two years, \$12; three years, \$16. Non-qualified: 1 year \$25. Subscription rates for foreign countries available on request.

CHANGE OF ADDRESS

ATTACH LABEL HERE

If you are moving, please let us know five weeks before changing your address. Place magazine address label here, print your new address below.

name

address

city

state

zip code

Who's Who in this issue



Blue

Chen

Apparently circuitous routes brought together Di Chen and M.D. Blue, co-authors of the article on electro-optical memories on page 108. Chen, who was born in Chekiang, China, got his BS from the National Taiwan University in Taipei, later going on to win a master's at the University of Minnesota and then a doctorate at Stanford. He taught for three years at Minnesota and did research on lasers and magnetism. Since joining Honeywell's research center in 1962, he's been working on laser modulation and magneto-optic effects in ferromagnetic films.

Blue's primary research interests are in the field of solid state physics. At the moment, he's heading a stepped-up program investigating wide-gap semiconductors; this activity resulted in part from prior research in optical memories. Applications efforts have reached the simulation stage—a development Blue sees as a timesaving step toward demonstrating eventual feasibility and getting on to the construction of prototype units.



Reisman

Advancing the state of the art has been Arnold Reisman's preoccupation since he joined IBM's Watson Laboratories in 1953. Author of the article on the ins and outs of designing picosecond computers that begins on page 88, he worked for over three years as program manager in the company's exploratory technology department investigating high-speed machines. Reisman is now on a one-year assignment as an advisor to the manager of technology at IBM's Components division.



Maguire

January is the time when assistant managing editor Tom Maguire alerts domestic bureau managers and department editors to get going on IEEE coverage. Tom, who headed *Electronics'* bureau in Boston for over a decade before being moved to New York in 1967, coordinated the field reporting, which pointed to 1969 as the year of the instrument. As a result, the product preview beginning on page 98 turned into an instrument roundup.



Venator

The need for more detailed design information—particularly a quick and accurate way to determine the coupling requirements of multi-resonator yig filters—impelled Walt Venator to assemble material for the article that begins on page 118. Now assistant national sales manager at Airtron, a division of Litton Industries, he's marketing the ferrite devices he once used in designing filters. Walt anticipates a bright future for yig tuned devices.

Something *New* Has Been Added!

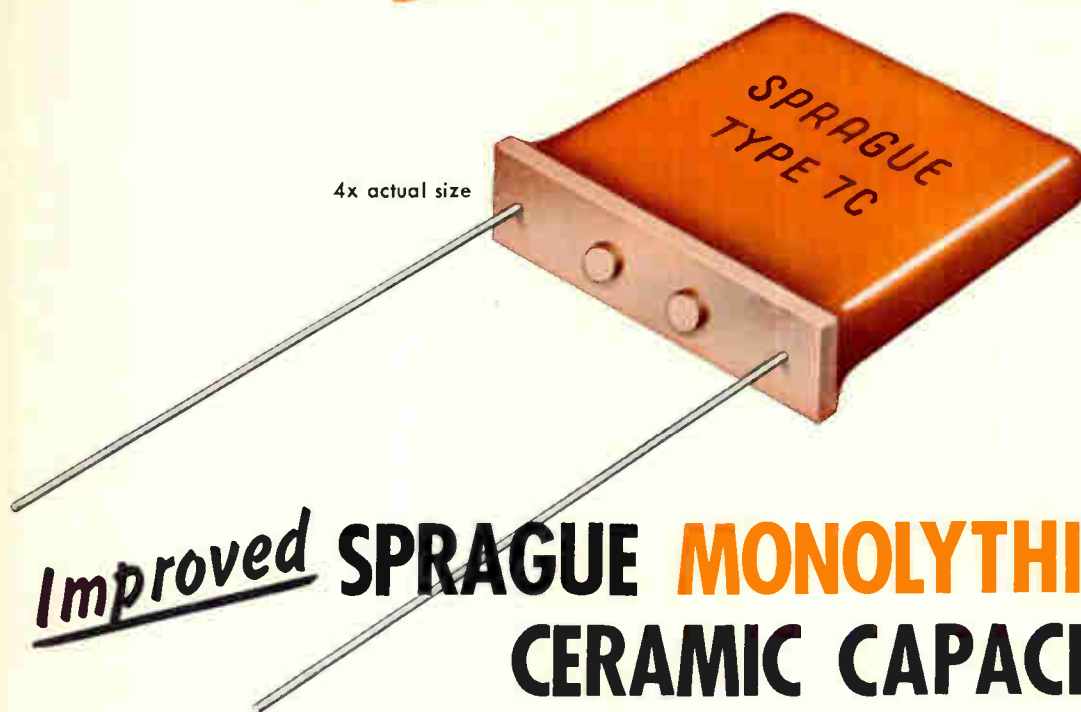

Improved **SPRAGUE MONOLYTHIC[®]** **CERAMIC CAPACITORS** now have a phenolic terminal base

Type 7C Radial-lead Capacitors are made with alternate layers of sprayed ceramic dielectric material and screened metallic electrodes, fired into a solid homogeneous block and coated with a tough phenolic resin. Their new bossed terminal base construction provides these advantages: (1) No resin run-down on leads. (2) Uniform lead spacing is automatically maintained. (3) No dirt and moisture entrapment; degreasing fluid flows freely between capacitor and board.

Body Code	EIA Characteristic	Operating Temperature Range	Maximum Cap. Change over Temp. Range	WVDC	Capacitance Range	Capacitance Tolerance
082	NPO	-55 C to +125 C	±60ppm/°C	50 100 200	51 pF to .024 μF	±20% ±10% ±5% ±2%
075	N750	+25 C to +85 C	-750 ± 120 ppm/°C	50 100 200	.001 μF to .082 μF	±20% ±10% ±5% ±2%
		-55 C to +125 C	Meets MIL-C-20 Char. UJ			
067	X7R	-55 C to +125 C	±15%	50 100	.0018 μF to 1.5 μF	±20% ±10%
023	Z5U	+10 C to +85 C	+22%, -56%	50	.01 μF to 3.3 μF	+80, -20% ±20%

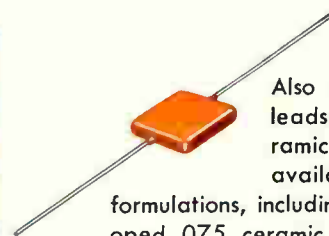

Also made with axial leads, Monolythic[®] Ceramic Capacitors are available in four body formulations, including a newly-developed 075 ceramic material, as described in the adjacent chart.



For complete technical data write for engineering bulletins on Monolythic Ceramic Capacitors to: Technical Literature Service, Sprague Electric Co., 35 Marshall St., North Adams, Mass. 01247.

SPRAGUE COMPONENTS

CAPACITORS
TRANSISTORS
RESISTORS
INTEGRATED CIRCUITS
THIN-FILM MICROCIRCUITS

PULSE TRANSFORMERS
INTERFERENCE FILTERS
PULSE-FORMING NETWORKS
TOROIDAL INDUCTORS
ELECTRIC WAVE FILTERS

CERAMIC-BASE PRINTED NETWORKS
PACKAGED COMPONENT ASSEMBLIES
BOBBIN and TAPE WOUND MAGNETIC CORES
SILICON RECTIFIER GATE CONTROLS
FUNCTIONAL DIGITAL CIRCUITS

SPRAGUE[®]

THE MARK OF RELIABILITY

"Sprague" and "®" are registered trademarks of the Sprague Electric Co.

CUSTOM CIRCUITS OFF-THE- SHELF...

ALMOST.

With Fairchild's new MOS MICROMOSAIC™ arrays, you get low-cost, custom digital subsystems so fast they're almost off-the-shelf.

The key to this lower cost and rapid turnaround time is the new computer-aided design technology we've developed for our MICROMOSAIC arrays. The entire design sequence — logic simulation and verification, cell selection and placement, artwork and test sequence generation — is performed by the computer directly from a logic diagram. Logic cells for the arrays are selected from a library of more than 45 pre-designed MOS functions (using either high- or low-threshold technology for MOS or bipolar interface compatibility). Each completed MICROMOSAIC array consists of only the logic your application calls for.

With MICROMOSAIC arrays, your small, custom computers and special-purpose logic functions for industrial or military control systems can be competitive with standard products on price and delivery. And way ahead on performance. (It offers so much, we're using MICROMOSAIC for some of our own standard products.)

Take the first step toward getting this technology into your systems. Write for our Micromosaic Array Design Handbook today. It'll tell you how much integration we can apply to your system. And give you an idea of how much time and money we can save you doing it.



Fairchild Semiconductor A Division of Fairchild Camera and Instrument Corporation Mountain View, California 94040
(415) 962-5011 TWX: 910-379-6435.



When Pete Sylan was a boy,
if an adjustment wasn't needed
it didn't exist.

“Waste not, want not” was the life mode of technology when Pete Sylvan was growing up in Montclair, N.J. Function outranked form. Substance outweighed style. The Thirties had no room for extravagance, no patience with overdesign. Planned obsolescence was an alien concept and a phrase unknown.

Today Pete Sylvan designs semiconductor test instruments for Teradyne. His list of innovative patents is as long as your arm. Each one of them is as practical as a shoehorn.

Like Pete Sylvan there's a bit of the Thirties in all the designers at Teradyne. Each instrument is created to meet the practical needs of the production line and the quality-control and incoming-inspection operations of the manufacturers, distributors and users of electronic components.

Take adjustments. They don't exist on Teradyne instruments. Not a single trimming potentiometer has ever been used. Calibration is reduced to a simple and infrequent verification procedure.

Circuits with field adjustments are not used either, thereby preventing inevitable, embarrassing and expensive errors or readjustment.

Hard-nosed managers of companies who make, sell or use semiconductors have long since learned a painful axiom: the final cost of one bad electronic component that gets into an assembly is often greater than the purchase cost of the entire lot it came from.

Accept the fact. You're in electronics to make money, not to tickle the creative fancy of an instrument designer. If an adjustment isn't needed, it shouldn't exist. It doesn't at Teradyne, 183 Essex Street, Boston, Massachusetts 02111.

Teradyne makes sense.



Semiconductor Burn-in

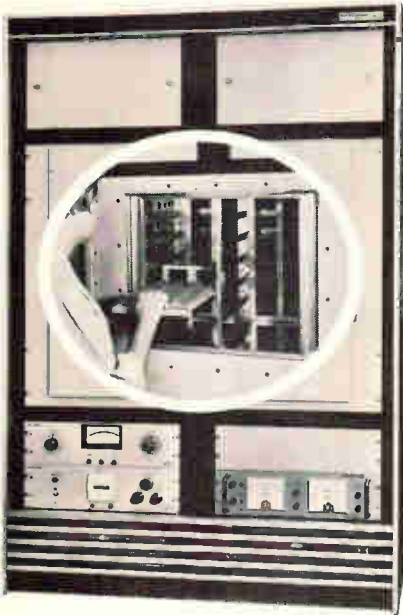

Economical TEC power aging and life test systems save you time and money

Test Equipment Corporation has for years designed and developed sophisticated environmental test equipment. This experience plus total "in-house" capabilities offers both manufacturer and user significant time and cost savings for semiconductor burn-in and life test.

Total "in-house" TEC manufacturing capabilities range from printed circuit boards, fixturing and socketing to NASA-approved machine shop, electrical assembly and micro-welding facilities. This makes possible extremely fast turn-around, thus saving valuable time and money.

In addition, TEC develops, builds and operates for customers complete "in-house" power aging and test facilities capable of meeting the most stringent requirements.



To discover how TEC burn-in systems and "in-house" facilities can help you, please write for this descriptive brochure.

Test Equipment

CORPORATION
P.O. BOX 20215, DALLAS, TEXAS 75220 • 214/357-6271

Who's Who in electronics

Between now and next September, when the plan for the next decade of space exploration is laid on President Nixon's desk, Lee A. DuBridge, 67, is going to be a busy man. The Presidential adviser on science and his still-small staff will be talking to scores of experts and sorting out hundred of ideas in drawing up the document that may be the most important statement of purpose for the national space program since President Kennedy announced the U.S. would place a man on the moon by 1970.

DuBridge announced last month that his group will submit a set of proposals for an "entirely new" space program for the decade following the first manned landing on the moon. "My personal feeling," said DuBridge, "is that a balanced space program is more desirable for the next 10 years than one dominated by a single national goal."

He went on to hint that space applications and unmanned planetary exploration may be most appropriate in the decade ahead.

Special interests. Preparing the document won't be easy; DuBridge's major problem will be to satisfy the needs of NASA, the Pentagon, the National Space Council, and the White House Office of Science and Technology. He is now searching for a new NASA administrator and a new executive secretary for the National Space Council.



DuBridge

Besides space, DuBridge is going to have a great deal to say about such important issues as disarmament, defense, and the application of technology to urban problems. Though the issues he will confront are diverse, they're probably no more so than DuBridge himself. A physicist who has made his greatest mark as an administrator, he has been president of the California Institute of Technology since 1946. Before that he was wartime director of the MIT's Radiation Laboratory, where crucial radar development work was done.

Extra duty. His ties to the Government are as strong as his ties to the academic community. Over the years, he has served on a host of councils and boards exerting great influence on U.S. science policy. Among the many: the General Advisory Council to the Atomic Energy Commission and the Air Force Science Advisory Board. And as president of Cal Tech, his relationship with the space program was close; the institution manages the Jet Propulsion Laboratory for NASA.

There is much speculation as to how his political influence will affect science, but nobody is predicting that he will sell it short. One official at NASA headquarters puts it this way: "We're really in limbo until DuBridge sets things straight. Nobody thinks he'll put us in high gear for a mammoth program, but most of us think he'll schedule a program that will keep us in good health."

"It's not economical for a large company to devote a lot of time to one type of transducer with a total market of \$40,000 to \$50,000 a year," says Ephraim Konigsberg. "They won't be paid back, but I can be."

When he worked for Electro-Optical Systems, he established and managed the biomedical instrumentation department, and made it profitable by specializing in

Helipot building blocks stack up to more convenience and economy.

Helipot's wide and expanding selection of *standard hybrid cermet microcircuits*—locally stocked throughout the country—give you reliable, inexpensive, off-the-shelf solutions to your complex design problems. In addition, Helipot building blocks help eliminate expensive design time and reduce purchasing, stocking, and production to their minimums. Whatever your need, you'll be interested in the new 48-page *Helipot Microcircuits Catalog*. For your copy, simply send a request on your company letterhead.

Beckman®

INSTRUMENTS, INC.
HELIPOT DIVISION

2500 HARBOR BOULEVARD
FULLERTON, CALIFORNIA • 92634

INTERNATIONAL SUBSIDIARIES: AMSTERDAM, CAPE TOWN, GENEVA, GLENROTHES, SCOTLAND,
LONDON, MEXICO CITY, MUNICH, PARIS, STOCKHOLM, TOKYO, VIENNA

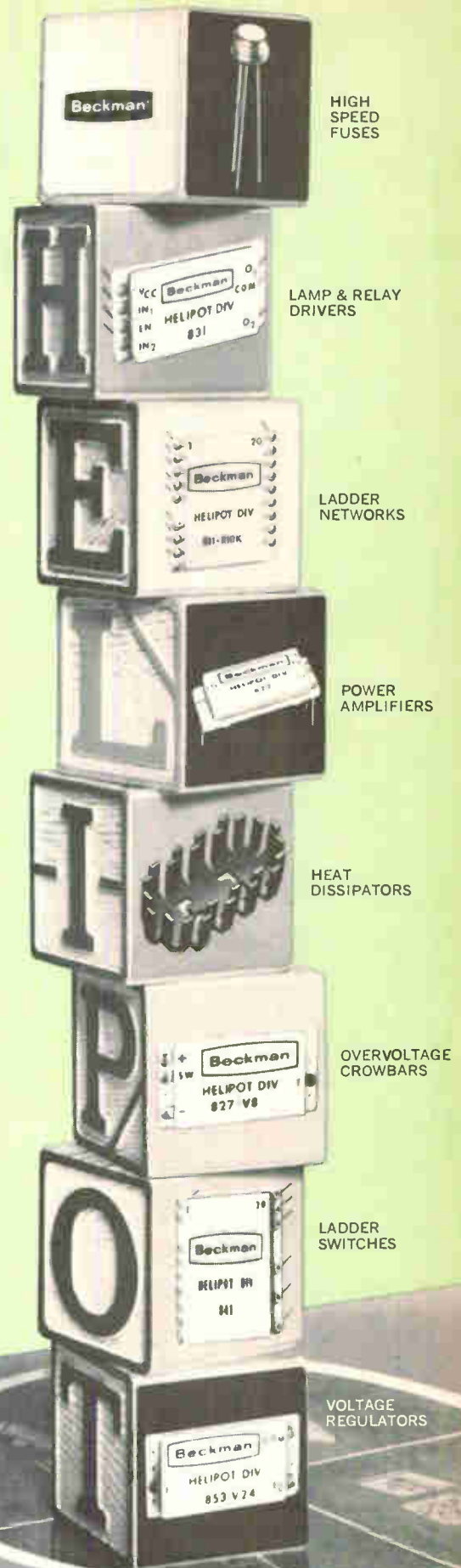

PROBLEM SOLVERS

the HOLE

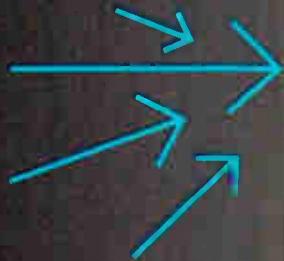

SOLID CARBIDE 1/8" SHANK CIRCUIT BOARD DRILLS Series 260, 262 & 265

Precision drilling with every drill size. 58 drill sizes from 0.005" to 0.125". Maintain location and hole size tolerances to very close limits . . . at drill feeds up to 15 feet per minute. Ends delamination and bur problems. Use same collets and bushings for every drill size. Write for Catalog D67.

Unique four facet drill point for chip-clearing precision penetration.



the METHOD

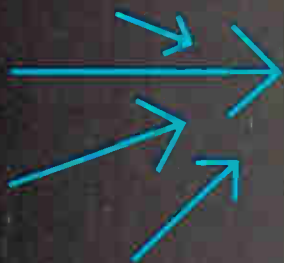

AIR BEARING SPINDLES

Rotational center line runs true to less than 2 millionths of an inch! Speeds up to 100,000 RPM. Totally free of vibration . . . spindle shaft literally floats on air. Friction free with air turbine drive for cool operation constantly! Ideal for circuit board drilling and routing. Also supplied with electric high-frequency drive. Write for Catalog AB68.



the EDGE

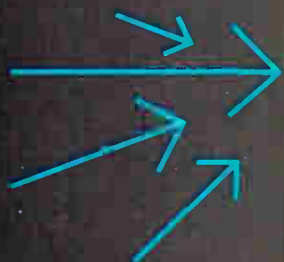

SOLID CARBIDE DIAMOND CUT ROUTERS

Diamond cut teeth, not flute edges, give faster, smoother routing of all materials. Hold closer tolerances, last longer than standard design routers. Cut stacked boards without board flutter. Write for Catalog E68.



THE METAL REMOVAL COMPANY

1859 West Columbia Avenue / Chicago, Illinois 60626
Plants located in CHICAGO • LOS ANGELES • SAN JUAN



MASTER TOOL AND WHEEL MAKERS FOR THE WORLD
END MILLS/DRILLS/REAMERS/BURS/SPECIAL TOOLING

Who's who in electronics

implantable pressure transducers for medical researchers. Then, when EOS sold the line to the Whittaker Corp., Konigsberg, now 44, decided to go into business for himself.

He founded Konigsberg Instruments in January 1968, and finds that Whittaker, with about 60% of a \$250,000 annual market in implantable transducers, is his chief competitor—ironically, with a line he originally developed. With about \$60,000 in sales after the first year, Konigsberg's share of the market is now about 25%.

Many facets. He started his own company because he "didn't want to become an organization man, and because most large companies put you in a sales, engineering, or managerial slot, and I didn't want to abandon any facet of my interest in all three." He thoroughly enjoys working directly with medical researchers to help them solve new pressure-measuring problems.

A researcher recently asked Konigsberg for a low-profile transducer to be implanted in a lamb foetus. He redesigned one of his standard products, built it in two days, and was ready to ship it in five. "In a larger corporation, you have to get approval for this sort of thing, and in my former job, getting approval alone would have taken two weeks—if I got approval. Large corporations want to satisfy human needs, just as I do, but they prefer to satisfy million-dollar-market human needs because they can't afford to sustain more modest ones."

New areas. Konigsberg doesn't expect to become head of a large corporation, but he isn't content to stay at \$60,000, either. He wants to master the manufacture of implantable pressure transducers, hire a manager for that field, then move on to other areas—measuring temperature and blood flow, making telemetry devices—and beyond into clinical medical instrumentation. Each time he develops a new transducer, however, he hopes to turn it over to a product manager and return to the thing he enjoys most—working with a few pioneering researchers in a few selected areas of technology.

MEC INSTRUMENTS

BOOTH NUMBER **3D00**

IEEE Exhibition '69

A new L.F. Signal Generator with instantaneous six figure read-out from 0.005 Hz to 50 Hz.



OUTPUTS		
SINUSOIDAL	Impedance	600Ω ± 2%
	Distortion	Less than 1%
	Level	10V r.m.s. open circuit
SQUAREWAVE	Impedance	600Ω ± 2%
	Level	10V r.m.s. open circuit
TRIANGULAR WAVE	Impedance	600Ω ± nominal
	Level	5V peak to peak fixed

Also on Display. Display Oscilloscope, Wave Analysers, Voltmeters, Oscillators, H.F. Generators, Power Meter, Proximity Switches.

Reader Service Card Number 491

MEC INSTRUMENTS LIMITED

ation Road, High Wycombe, Buckinghamshire, England
one : High Wycombe 21201. Telex : 83243

SMOCORD LIMITED

BOOTH NUMBER **3B21**

IEEE Exhibition '69

ACOS present their smallest stereo ceramic cartridge

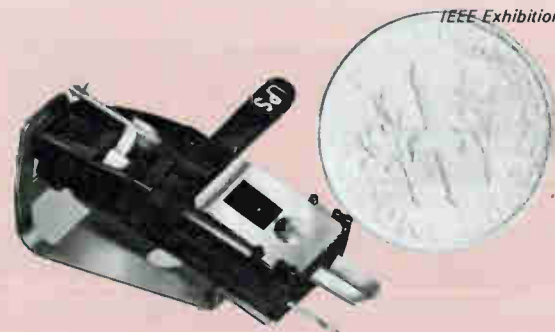

cord has been producing phonograph cartridges for over 30 years. is proud to present one of the smallest stereo ceramic cartridges in the d giving quality performance at competitive prices.

ification includes extended frequency response, outstanding separa- and high compliance, flipunder replaceable dual needles fitted with nd and sapphire tips.

Other Acos products exhibited are—a sound level meter and accessories, accelerometers, an entirely new peak limiting earguard and low cost body hearing aid.

SMOCORD LIMITED
or Cross Road,
am Cross,
ordshire, England.
Waltham Cross 27331
es: 'Acos' Waltham Cross

U.S. Agent for audio components:
Transatlantic Electronics Inc.,
55 Bloomingdale Road,
Hicksville, N.Y. 11801,
U.S.A.

U.S. Agent for hearing aids:
Hearclear Corporation,
Box 12853,
5612 East Broadway,
Arizona 85711,
U.S.A.

Reader Service Card Number 492

ELECTROLUBE LIMITED

BOOTH NUMBER **0100**

IEEE Exhibition '69

Do you have electrical contact problems with your electroplating plant?



corrosion deposits on busbar shoes, rail guides and jig contacts cause high maintenance bills and a headache? Protect your precious ratus (and save your dollars) the same way that many major com- ies all over the world do—by using ELECTROLUBE 2G.

ELECTROLUBE protects because:
It lubricates and conducts electricity, reduces powerlosses.
is stable under extreme temperatures and is both water repellent and chemically inert.

You will save through ELECTROLUBE because:
Maintenance and other running costs are drastically reduced due to dependability of connections and associated switchgear.
There are many other uses for this and the other ELECTROLUBE products, start saving, contact us NOW.

ELECTROLUBE LIMITED
rd Avenue,
gh,
kinghamshire, England
phone: Slough 25574
: 84314 Electrolube
mcom Slough

U.S. Agent:
TRANS ATLANTIC ELECTRONICS INC
55 Bloomingdale Road,
Hicksville,
New York 11801, N.Y., U.S.A.
Telephone: (516) 822 2110
Cable: "Ronette" Hicksville, N.Y.

Reader Service Card Number 493

THE ENGLISH ELECTRIC COMPANY LIMITED

BOOTH NUMBER **4G13**

IEEE Exhibition '69

A sample from one of the world's largest ranges of transducers covering all a.c. quantities and variables.

English Electric transducers, for the conversion of a.c. electrical quantities into d.c. analogue signals, are in use in many parts of the world and form an essential part of the new concept of remote measurement and control for power systems, industry and shipping.
Located near to the a.c. source, transducers are connected via 1-pair telephone-type cables to remote monitoring equipment such as instru- ments, recorders, computers and telemetering schemes.

These transducers are extremely robust and are fully tropicalised. All semi-conductors are heat-treated for stability and stringent tests are applied to every transducer for service reliability.

The English Electric Corporation,
Meter, Relay and Instrument Division,
St. Leonards Works,
Stafford, England.
Telephone: Stafford 3271
Telex: 36240

All shown will be:—

Measuring Instruments
Moving coil, Moving iron and Dynamometer movements in six matching case sizes.

Controllers, Timers and Amplifiers
These devices are designed for use with trans- ducers.

Automatic Portable Methane Detector
Claimed as the only device of its kind in quantity production, this detector continuously monitors the content of methane gas in mines and provides visual alarm when danger level is reached.

The English Electric Corporation,
English Electric Division,
One Park Avenue, New York 10016, U.S.A.
Telephone Number (212) 679 3522
Telex: 2063 224480
Telegraphic "Enelectric" New York.



Reader Service Card Number 494

MULLARD LIMITED

BOOTH NUMBER **3B13**

IEEE Exhibition '69

Electronically tuned Gunn Effect X-Band oscillators with 200 MHz tuning ranges

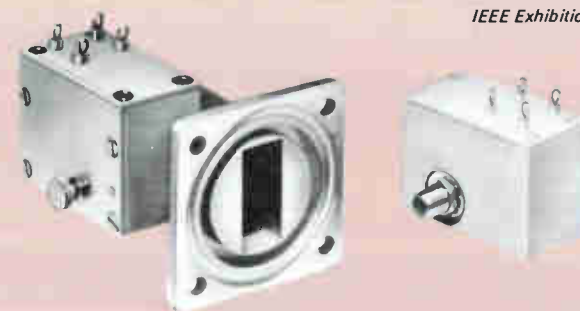

This is one of Mullard's range of advanced products which include infrared detectors, power devices, semiconductors, microwave devices, electron optical devices and magnetic materials. Every product is backed by very comprehensive technical information.

Other examples of advanced technology from Britain's largest manufac- turer of electronic components will be on display at the Mullard booth. Many of the devices featured offer an exceptionally high standard of performance.

MULLARD LIMITED
Mullard House,
Torrington Place,
London, W.C.1, England.
Telephone: (01) 580 6633
Telex: 264341

U.S. Agent:
MULLARD INC.,
100 Finn Court,
Farmingdale,
Long Island,
N.Y. 11735

Reader Service Card Number 495

SALFORD ELECTRICAL INSTRUMENTS

BOOTH NUMBER **4J11**

IEEE Exhibition '69

The Salford "Selectest"— the most functional and up-to-date multi-meter on the market



Designed for the electronics era, the scale is of the eyelash pattern and is 6 in. (152mm) long with knife-edge pointer and mirror inset. Ranges are selected by two rotary multi-position switches. The movement has a critically damped moving coil system with sapphire jewel bearings. The case is tough, two-tone Melamine and the instrument can be used in either

the vertical or horizontal position. Overall size 9½" x 7" x 4½".

SALFORD ELECTRICAL INSTRUMENTS LIMITED
Peel Works, Barton Lane,
Eccles, Manchester,
England.
Telephone: Eccles 5081
Telex: 66711

Other products to be shown include a pocket-sized multi-meter, Electro- lytic Hygrometer, Illumination Meter, Photometer, Quartz Crystal Devices, including Filters, Magnetic Materials and Capacitors.

Reader Service Card Number 496

STANDARD TELEPHONES & CABLES LTD.

BOOTH NUMBER **3C05**

IEEE Exhibition '69

A white noise test set for multi-circuit telephone systems



Prominent amongst the STC exhibits is the 74262 White Noise Testing Equipment (illustrated). This is designed for measuring basic noise and intermodulation noise on multi-circuit telephone systems having band- widths up to 4 MHz (60 to 960 circuits). It can also be used to measure signal-to-noise ratios and the power density of noise signals. It conforms to the latest CCITT proposals and consists of a white noise generator for use at the sending end, and a receiver for making measurements at the far end. Solid state circuits are used throughout.

Also on this stand are the 74834 Distortion Measuring Equipment for measuring amplitude and phase distortion in microwave and other systems, the GTA-9 Power Meter for measuring 1 milliwatt in four circuit impedance up to 200 MHz, the 74357 Digital L.M.S. which measures and automatically displays in digital form the signal level applied to its input, and instruments for use on pulse code modulation systems. Lincompex equipment, which provides high-quality speech on radio- telephone links, will also be exhibited.

STANDARD TELEPHONES & CABLES LIMITED
Transmission Group
Testing Apparatus & Special Systems Division
Corporation Road, Newport, Mon. NPT OWS, England
Telephone: Newport 72281
Telex: 49367

U.S. Agent:
Mr. A. W. Hart
Manager, Testing Apparatus and Special Systems Division
ITT Export Corporation
621 Industrial Park, Paramus
New Jersey 07652, U.S.A.

Reader Service Card Number 497

TREND ELECTRONICS LIMITED

BOOTH NUMBER **4B08**

IEEE Exhibition '69

A portable, mains-operated, digital instrument for testing data-transmission equipment and links

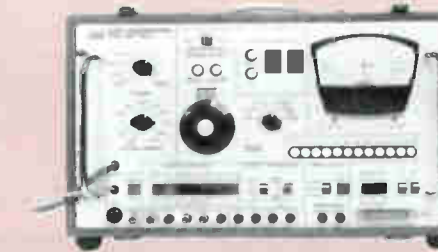

Trend's Data—Transmission Test Set Type 1 was originally developed as the Data Tester 1B for the British Post Office, and is marketed with their permission.

Basically, the instrument comprises a data transmitter, a data receiver, and measuring circuits that provide readings of peak telegraph distortion, bias distortion and error count.

TREND ELECTRONICS LIMITED
St. John's Works,
Tylers Green, High Wycombe,
Buckinghamshire, England.
Telephone: Tylers Green 322 and 654
Telegrams: Trend High Wycombe

The Test Set conforms, in the signals it transmits, its interchange control circuits, its interface connections, etc., to all relevant CCITT recommenda- tions.

The Distortion Generator Type 3 is designed specifically for use with the Test Set Type 1, and extends the usefulness of the latter by providing accurate levels of distortion for application to signals.

Reader Service Card Number 498

WELWYN ELECTRIC LIMITED

BOOTH NUMBER **4G34**

IEEE Exhibition '69

The Welwyn Digital to Analogue Converter



A unique standard building block which allows wide choice of both supply and reference voltages and either unipolar or bipolar configuration.
Britain's leading component manufacturer offers highest quality Resistors, Potentiometers and Hybrid Integrated Circuits, including the Welwyn compatible D-A ladder and switch networks which incorporate precision metal film resistors and thick film hybrid integrated circuits. The basic 4-bit module (illustrated) is especially versatile and may be used to construct a 12-bit binary or 3 decade B.C.D. converter.

SPECIFICATION
Digital Interface: Standard R.T.L., D.T.L. and T*L
Reference Voltage Range: ± 10V Nom (± 17V Max)
Supply Voltage Range: ± 15V Nom (± 20V Max)
Standard Ladder Network Impedance: 10KΩ
Typical Conversion Time: 1μs

Accuracy of 12-bit Binary Converter: Better than ½ bit
Operating Temperature Range: 0 to 70°C.
Size of Basic 4 bit Building Block: 2.020" x 1.145" x 0.620"
Terminal Configuration: 0.1" Grid
Price: \$150.00 per 12 bits

WELWYN ELECTRIC LIMITED
Bedlington,
Northumberland, England.
Telephone: Bedlington 2181. Telex: 53514

U.S. Agent:
WELWYN INTERNATIONAL INC.,
811 Sharon Drive, Westlake, OHIO, U.S.A.

Reader Service Card Number 499

RACAL INSTRUMENTS LTD

BOOTH NUMBER **4C13**

IEEE Exhibition '69

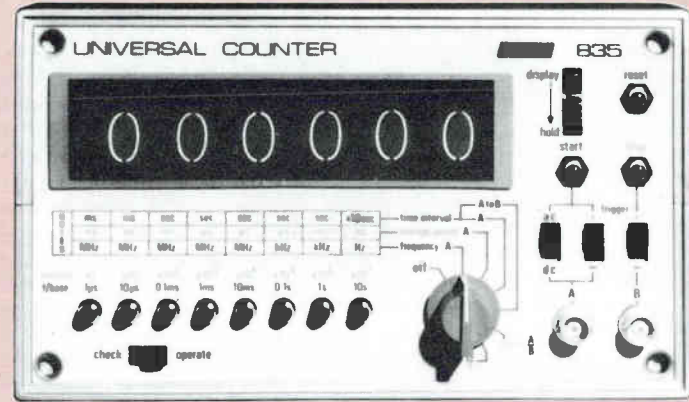

The RACAL model 835 Universal Counter/ Frequency Meter

is a compact high-grade 12.5 MHz instrument at a highly competitive price. Manufactured by Racal Instruments Ltd. who are specialists in digital instrumentation and precise time and frequency generation and measurement equipment, the meter has extensive application throughout all branches of science and industry. Consistent performance, under rigorous conditions, is ensured by the use of high-reliability integrated circuits. Its many

measurement functions include Frequency, Period, Period average, Time interval, Ratio of Time or Frequency, Totalizing and Scaling. Amongst other instruments will be shown the model 810 Decade Divider, which extends frequency range of the 835 to 125 MHz, and the model 815 50 MHz Universal Counter/Timer which has the most comprehensive specification offered by any such instrument.

RACAL INSTRUMENTS LIMITED
Bennet Road, Reading,
Berkshire, England.
Telephone: Reading 84461/5. Telex: 84166
Cables/Grams: Racal Bracknell

U.S. Agent:
EDWIN INDUSTRIES CORPORATION
11933 Tech Road, Silver Spring,
Maryland 20904, U.S.A.
Telephone: (301) 622-0700. Telex: 89-2371
Cables: Edwin Ind.

Reader Service Card Number 501

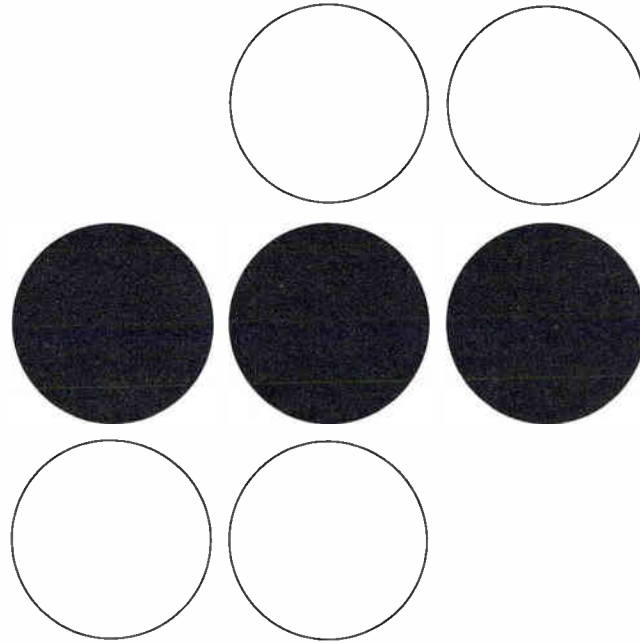

There are 32 good reasons to visit the 1969 IEEE Exhibition— and here are 12 of them!!

Thirty-two British companies are participating in this 1969 IEEE Exhibition and are showing a wide range of extremely competitive products. The participation is co-ordinated by the UK Electronic Engineering Association in the belief that the British Electronics Industry deserves to be better known in the USA for the technical quality and favourable prices of many of its products.

Fourteen companies are directly featured in this inset while the others are either advertising direct or through their agents. Should you miss the show, then you can obtain further details through this Association. Make a note to visit these stands—you'll find it well worthwhile!



Commander H. Pasley-Tyler, CBE, RN (Retd.)
President and Chairman



The Electronic Engineering Association, Berkeley Square House, Berkeley Square, London, W1X 6JU. England

BOOTH NUMBER **4J13**

IEEE EXHIBITION '69

Reader Service Card Number 502

AEI SEMICONDUCTORS

U.S. AGENT
Calvert Electronic International Inc.
220 East 23rd Street,
New York, N.Y. 10010. U.S.A.

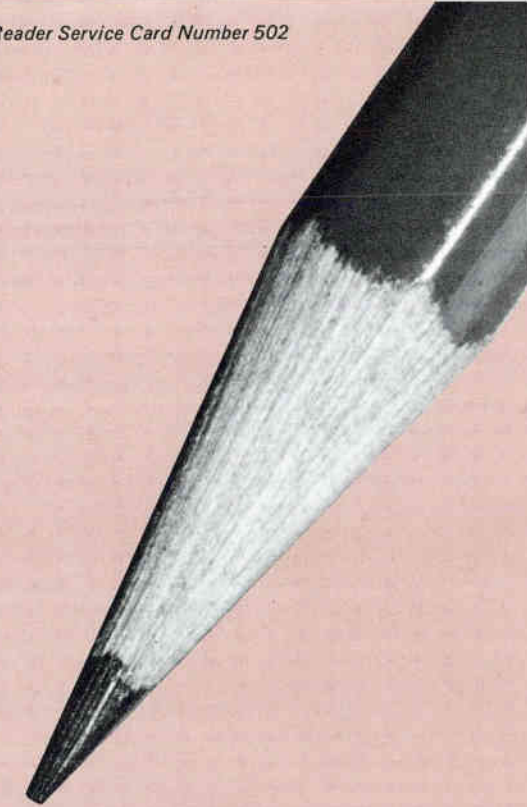

A POINT TO REMEMBER MICROWATT or MEGAWATT

15,000,000 DEVICE HOURS SPENT TO ASSURE TOTAL RELIABILITY

POWER SCR's
* Double
Diffused
* High Voltage
up to 2.5 kV
* Up to 800 amp
capability
* 1000 Volts/
 μ sec, dv/dt
* Down to
5 μ sec
turn-off

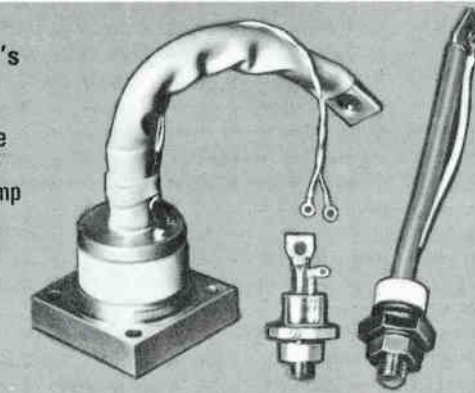

Other products on the company's stand will also include:

- Triacs, up to 25 amperes
- Rectifiers, 200mA to 700 amperes
- Thyristor and rectifier stacks
- Motor speed control stacks
- Environmental control stacks
- Thyristor firing circuit modules
- Voltage reference diodes
- Signal and switching diodes

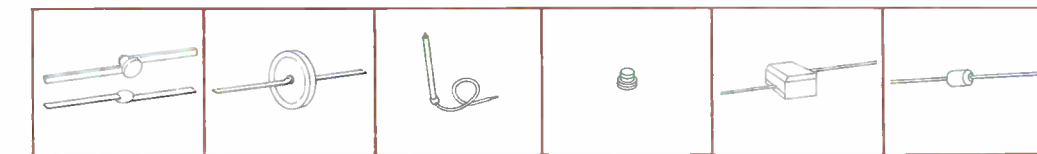

P.I.N. Diodes Down capacitance or RF volt- greater than 1000 volt-
TUNING VARACTOR Q - 200 to 300 at 25 M
AVALANCHE OSCIL DIODES X and Q -

AEI SEMICONDUCTORS is a member of the BRITISH GENERAL ELECTRIC and ENGLISH ELECTRIC Group of Companies

Pye 'Pocketfone' Personal Radiotelephone
New battery economy circuit - Extremely light-weight and compact. Reception free from noise and interference - Minimum of controls - Transmit button automatically extends antenna - Hearing aid socket - Easily accessible batteries.

Pye 'Bantam' Portable VHF Radiotelephone
Fully transistorised transmitter and receiver - Very high performance receiver - Crystal filter selectivity - 0.5W transmitter output - 250mW audio power - Long endurance with rechargeable or dry batteries - Can be used with external antenna to give greater range - Weatherproof.

Pye 'Westminster' Front Mounted Radiotelephone
Completely solid state - 5-W R.F. output - 1-10 channels with solid state switching - Suitable for all climates - Meets all relevant specifications.

Pye 'Westminster' Remote Mounted Radiotelephone
Completely solid state - 5-W R.F. output - 1-10 channels with solid state switching - Illuminated channel indicator - Suitable for all climates - Meets all relevant specifications.

Pye 'Motafone' Radiotelephone
The Motafone is designed with safety in mind - Integrated micro-circuits and 3-channel capability - No projecting knobs on front panel - Finished in non-reflecting black.

Pye 'Pioneer' Radiotelephone
Fully transistorised - For use with automatic, CB manual, or magneto exchanges - Weatherproof cabinet - Unattended operation over long periods - Facility for fitting privacy equipment - Optional single antenna operation.

Pye VHF Radiotelephone Fixed Station
Solid-state receiver and transmitter - 10-15W R.F. output - Field-effect transistors used in receiver - Suitable for all climates - Electronic squelch - Designed to meet all relevant specifications.

Pye UHF Radiotelephone Fixed Station
Solid state receiver and transmitter - 8-10W R.F. output - Very high R.F. selectivity using field-effect transistors - Very low noise factor - Electronic squelch - A.C. or 24V d.c. operation - Suitable for all climates - Designed to meet all relevant specifications.

Pye Single-Sideband Radiotelephone
125W (p.e.p.) R.F. output - Fully transistorised receiver - C.W. facilities provided - Sideband selection by crystal filter - Carrier insertion for a.m. compatibility - Fixed or mobile application - Advanced transmitter design.

Pye 5-Circuit UHF Radiotelephone
Compact 5-circuit radio terminal - Fully transistorised - Frequency-shift signalling - Continuous unattended operation in all parts of the world - Twelve standard plans for terminals and repeaters.

Pye spans the World. Pye Telecommunications is the world's largest exporter of radiotelephone equipment. Pye Radiotelephones are used all over the world to ensure instant contact. Pye research development and quality control really do keep in touch with tomorrow.

PYE COMMUNICATIONS INC.
100 U.S. Hwy. 46,
Mountain Lakes, N.J., 07046.
Tel: (201) 335-8282

PYE ELECTRONICS LIMITED
8550 Darnley Road,
Montreal 9, Quebec, Canada.
Tel: Montreal 731 8501



Reader Service Card Number 500

Beckman Instruments is
one of the most demanding customers
we've ever had.

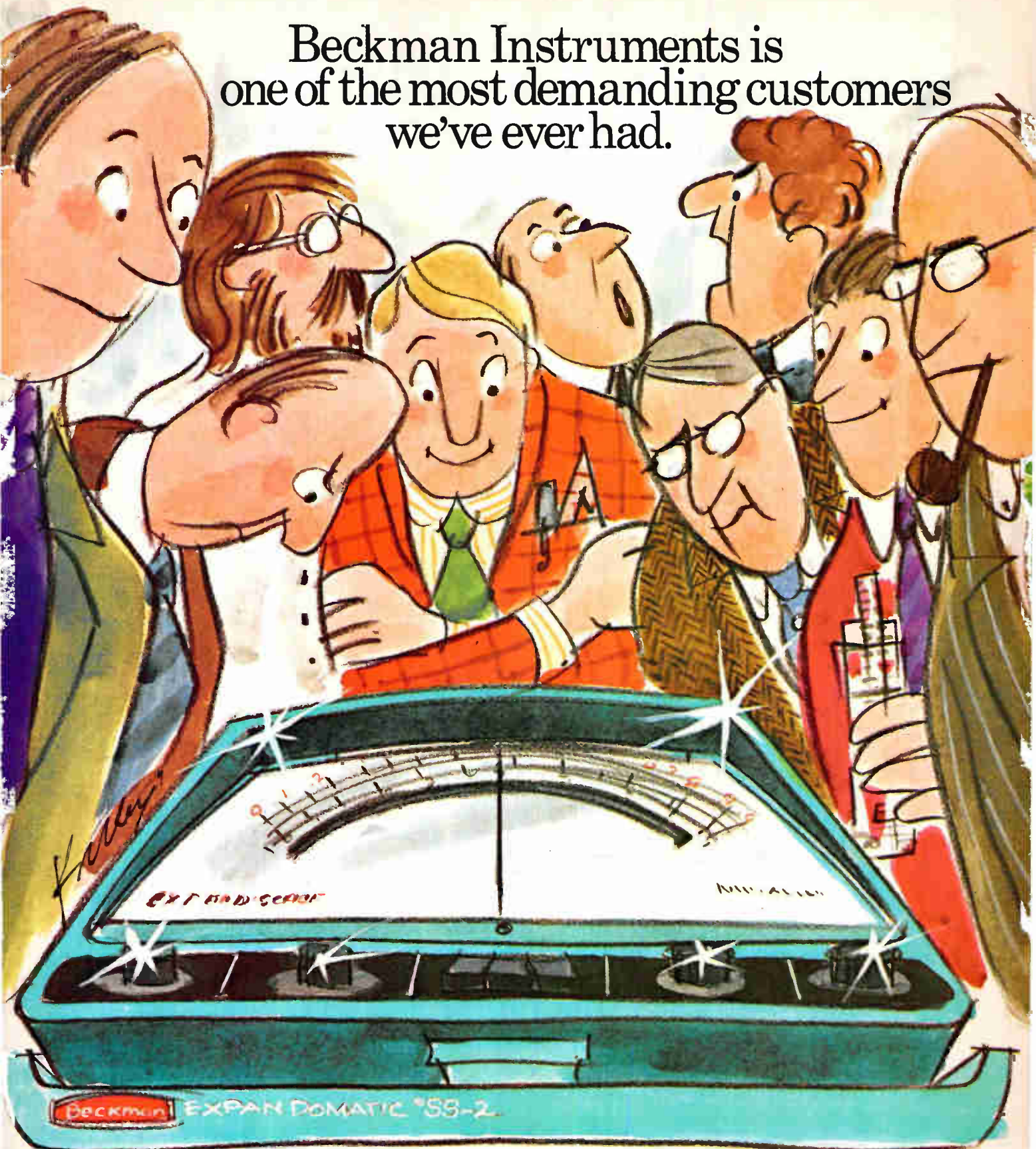

We make so many taut-band meters at Honeywell, that when Beckman Instruments came to us for a taut-band meter, we were pretty confident.

"Take a look through our catalog," we told them. "Just tell us which one you want."

"We've taken a look through your catalog," they told us, "and you don't have the one we want."

Then they told us what they wanted:

They wanted a very special meter to be used as the readout device in a new line of pH instruments that Beckman was designing.

The meter had to have incredible accuracy: To 0.05 pH (0.35% F.S.). A readability within 0.02 pH units. And an 8.1 inch scale. (They were asking us to make the largest meter we had ever made.)

Wow.

Well, Beckman got the meter they

wanted. Because they were demanding.

If you need a very special meter, we suggest you write Honeywell Precision Meter Division, Manchester, N.H. 03105.

Take a look through our catalog. Just tell us which one you want.

And if we don't have the one you want, be demanding.

Honeywell

Circle 23 on reader service card



Insisting on one brand or the right product?

Most big-name producers have their devout followers. Buyers for whom one particular brand holds a magic personal identification. And we happily confess to having our share of partisan clients.

But chances are you are not familiar with our components. Despite the fact that you're almost certainly within arm's reach of them every day.

This is because our work is carefully concealed. Carefully and precisely concealed inside Japan's record breaking products. From the latest super-tanker to the finest new photographic equipment.

Computers and business machines, automotive products and original equipment.

All being produced with a quality and economy hitherto undreamed of. Due, in strictly small way, to the concealed originality of Japan's largest electrical and electronic components producer. OMRON.

Remember the name, should your present faith ever be shaken.

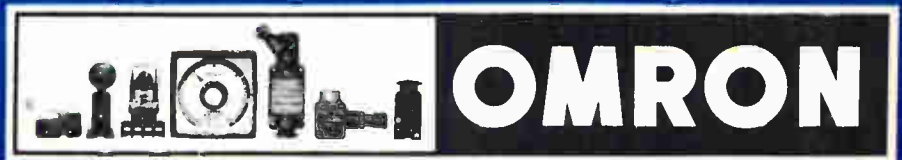

OMRON TATEISI ELECTRONICS CO.

SALES OFFICE /Toa Bldg., 5, Yonban-cho, Chiyoda-ku, Tokyo, Japan
Phone (265) 4611 Telex 25279 Cable Address: OMRONELCO TOKYO

OVERSEAS DISTRIBUTORS:

- AUSTRALIA/H. Rowe & Co., Pty., Ltd. ● AUSTRIA/Carlo Gavazzi GmbH
- ENGLAND/Keyswitch Relays Ltd. ● FRANCE/Carlo Gavazzi S.A.R.L.
- FORMOSA/Hai Nan Trading Co., Ltd. / Sheng Ching Trading Co., Ltd.
- HOLLAND/Carlo Gavazzi N.V. ● ITALY/Carlo Gavazzi S.p.A.
- MEXICO/Schultz Y Cia. S.A. ● SOUTH AFRICA/P.J. Yelland & Co. (Pty) Ltd.
- SWEDEN/Billman Regulator AB Agency Department.
- SWITZERLAND/Carlo Gavazzi A.G. ● U.S.A./Sigma Instruments Inc.
- WEST GERMANY/Carlo Gavazzi Mess-und Regeltechnik GmbH

5 revealing questions to ask hybrid manufacturers:

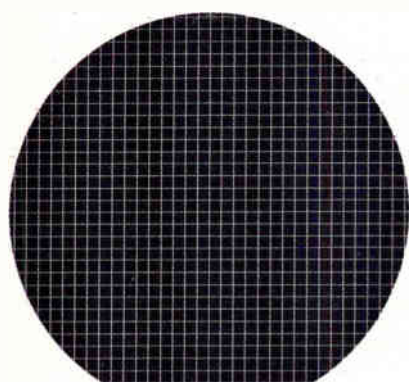

1 Do you manufacture your own chips? Fairchild does. We're the only manufacturer that manufactures, tests and stores our own chips. We test over three million dice in our hybrid facility every month. And we store over 10 million dice, ready to be used right now. Response to any demand is quick and in volume. From Fairchild.

2 How large is your selection of hybrid components? Back to the Fairchild stores, where we've got those 10 million dice. They include everything from simple diodes to complex LSI functions. If you need it, you can get it right now. From Fairchild.

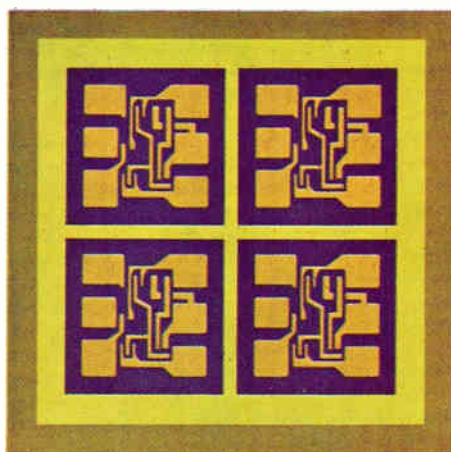

3 Can you offer computer-aided design? Fairchild not only offers, but delivers. If those 10 million single chips in our facility won't do your job best, we give your problem to our CAD group. With our new computer-aided design technology, the whole design procedure

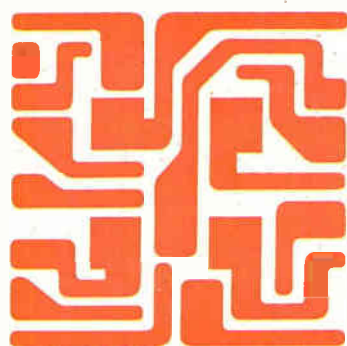

—choosing the logic elements to implement your function, generating diffusion and metalization masks, even setting up functional and electrical test sequences for checking out the completed device—is all handled by the computer. It's just one of the things that

makes our prices the lowest in the industry. Your special functions are available fast and economically. From Fairchild.

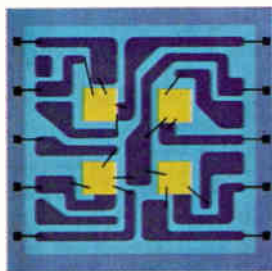
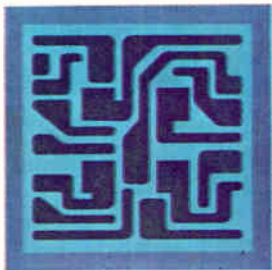
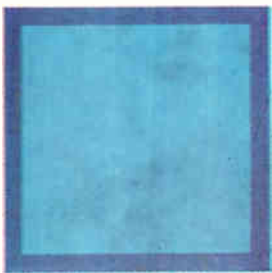

4 Are you limited to any specific technology? Not at Fairchild. We use the technique that's best for you. Thick film for economy. Thin film for accuracy and radiation resistance. Thin film on silicon if the function calls for a lot of active devices—discretes, MOS or LSI—and few passive ones. Whatever's right. From Fairchild.

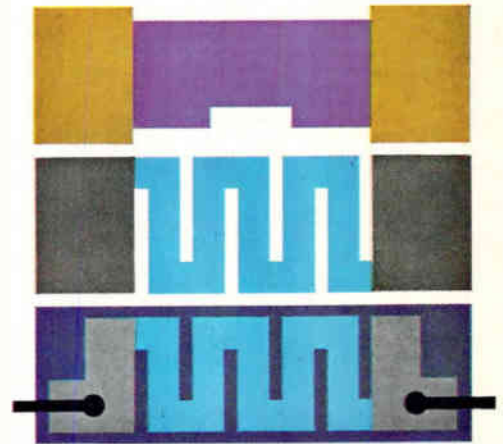

5 Can you make hybrids in production quantities? At Fairchild, we make so many hybrids we've even got a line of standard hybrid functions priced like discretes. Hybrid production is on an assembly line basis, with the lines split according to the complexity of the functions being manufactured. Skills and equipment are matched exactly to the products. The products are right on price, performance and reliability. From Fairchild.

When all the answers are in, you'll find that Fairchild is the only manufacturer that qualifies as a complete hybrid source. For everything. Packages. Products. Substrates. Volume.

If there are more questions, you can get one brochure that has all the answers. Only from Fairchild. Write for it today!

FAIRCHILD
SEMICONDUCTOR

Fairchild Semiconductor / A Division of Fairchild Camera and Instrument Corporation
313 Fairchild Drive, Mountain View, California 94040 (415) 962-5011 / TWX: 910-379-6435

Specify E.S.I.

quadrature hybrid couplers

Our line of 3 db Quadrature Couplers features an equal power split with a 90° phase differential between output ports.

There are 5 models in our current line. All use standard 3mm miniature coaxial connectors.

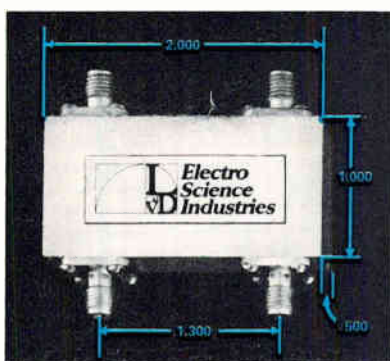

Model	Freq. (GHz)	Typical Isol.	Typical Main Line VSWR
D-5924-L	1-2	28	1.20
D-5924-S	2-4	25	1.20
D-5924-C	4-8	20	1.25
D-5924-X	8-12	18	1.30

Max. Deviation from mean output on all models = ± 0.5 db. Typical mean coupling = $3 + .2 - 0$.

E.S.I. also makes connectors, terminators, filters, attenuators, and Radite.

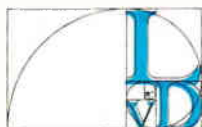

Electro Science Industries

Electro Science Industries, Inc.
300 S. Geddes St., Syracuse, N.Y. 13204
Phone 315-475-2181
TWX: 710-541-0432

Meetings

Magnetics conference attracts international cast

The International Conference on Magnetics (Intermag), scheduled for April 15 to 18 in Amsterdam, is truly international this year, with technical papers listed from all around the world. Because it's being held in the Netherlands, an extraordinarily large number of engineers and scientists from Philips' Gloeilampenfabrieken will be attending and delivering papers. And an unusually large contingent of researchers from Russia, Czechoslovakia, and Rumania will be there.

The emphasis of this year's technical program appears to be on the technology and application of magnetic recording. This area will be explored in sessions on digital and analog recording, magnetic interactions in recording media, unconventional recording systems, and film memory processes. There will also be workshops on magnetic recordings.

Microwave IC's. Attention is also being given to the microwave applications of ferrite substrate lines.

R.L. Hunt, A.C. Blankenship, and R.C. West of Trans-Tech, a U.S. firm, will deliver a paper on microwave integrated circuits, and P. Holst and M. Lemke of Philips' research labs will discuss microwave systems.

The use of computer-aided design to produce magnetic circuits, inductors, and transformers will also grab some of the spotlight. J.J. Suozzi of Bell Telephone Laboratories will outline his work on CAD, and David Nitzan of Stanford Research Institute will describe computer analysis of magnetic cores, among other components.

The technical program clearly reflects the growing attention being given new types of magnetic memories. For example, the topics slated for one session on mass memories range from thin-film work to high-capacity holographic memories.

The meeting is sponsored by the Magnetic Group of the IEEE, and two European technical societies.

For more information, write to Intermag, Congresdienst, Oudezijds Achterburgwal 199, Amsterdam.

Calendar

Particle Accelerator Conference, IEEE; Shoreham Hotel, Washington, March 5-7.

Spring Conference of the American Society for Nondestructive Testing; Biltmore Hotel, Los Angeles, March 10-13.

Medical Engineering and Automation Exhibition, Electronic Engineering Association and the Scientific Instrument Manufacturers' Association; Earls Court, London, March 10-14.

International Colloquium on Data Transmission, Federation Nationale des Industries Electroniques; Paris, March 24-28.

International Convention & Exhibition, IEEE; Coliseum and Hilton Hotel, New York, March 24-27.

Second International Laser Safety Conference, Medical Center of the

University of Cincinnati; Stouffer's Motor Inn, March 24-25.

Semiconductor Device Research Conference, IEEE; Munich, Germany, March 24-27.

Conference on Lasers & Optoelectronics, IEEE; Southampton, England, March 25-27.

Symposium on Engineering Aspects of Magnetohydrodynamics; Massachusetts Institute of Technology, Cambridge, Mass., March 26-28.

The Changing Interface: An IC Systems Seminar, Electronics/Management Center, Park Sheraton Hotel, New York, March 28.

International Components Show, Federation Nationale des Industries Electroniques; Paris, March 29-April 2.

(Continued on p. 30)

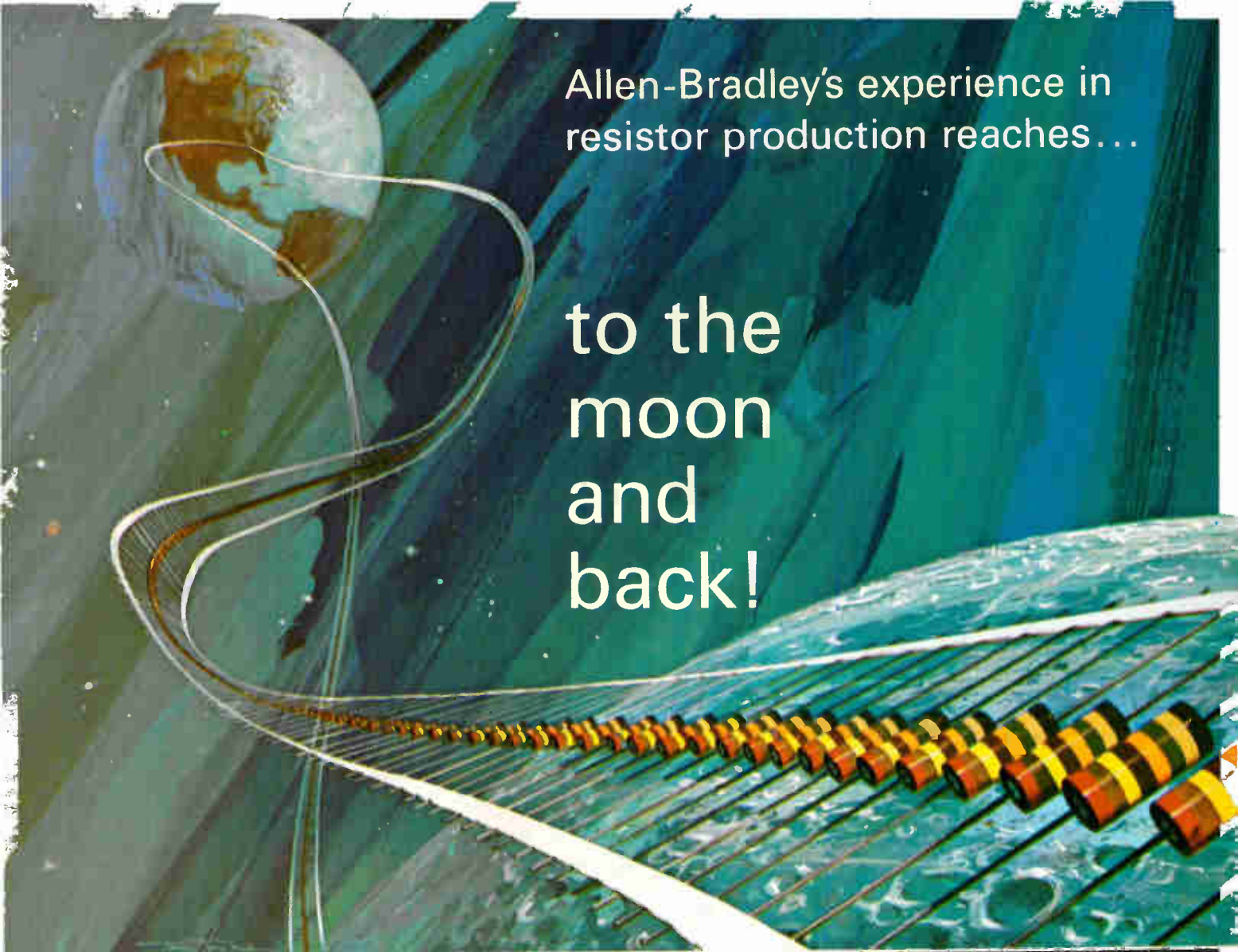

Allen-Bradley's experience in resistor production reaches...

to the
moon
and
back!



TYPE BB 1/8 WATT



TYPE EB 1/2 WATT



TYPE HB 2 WATTS



TYPE CB 1/4 WATT



TYPE GB 1 WATT

A-B hot-molded fixed resistors are available in all standard resistance values and tolerances, plus values above and below standard limits. A-B hot-molded resistors meet or exceed all applicable military specifications including the new Established Reliability Specification at the S level. Shown actual size.

After more than three decades and untold billions of hot-molded resistors, Allen-Bradley has accumulated manufacturing "know-how" which cannot be approached by anyone else. The fact that the resistors made by A-B over the years—if placed side by side—would more than reach to the moon and back, may be impressive. But "how" they are made is the key.

Allen-Bradley resistors are produced by an exclusive hot-molding technique—developed by A-B. They're made by completely automatic machines—also developed, built, and used only by Allen-Bradley. The human element of error is removed. Uniformity is so precise from one resistor to the next—year in and year out—that long-term resistor performance can be closely predicted.

And there has been no known incident of catastrophic failure of an A-B hot-molded resistor.

The reputation for quality and performance established by Allen-Bradley hot-molded resistors is reflected in the fact that they have been an integral part of virtually every U.S. space probe. And they are "on" the moon. No other resistor applications demand a higher measure of reliability.

For detailed specifications on this superior line of hot-molded resistors, please write Henry G. Rosenkranz and request a copy of Technical Bulletin 5000: Allen-Bradley Co., 1201 South Second Street, Milwaukee, Wisconsin 53204. Export Office: 1293 Broad St., Bloomfield, N.J., U.S.A. 07003. In Canada: Allen-Bradley Canada Limited.

EC 6815

QUALITY ELECTRONIC COMPONENTS



ALLEN-BRADLEY

Circle 29 on reader service card

New

Grayhill "Excellent 50's"

A new generation of Tiny Rotary Switches with practically unlimited variations

"Excellent 50's"

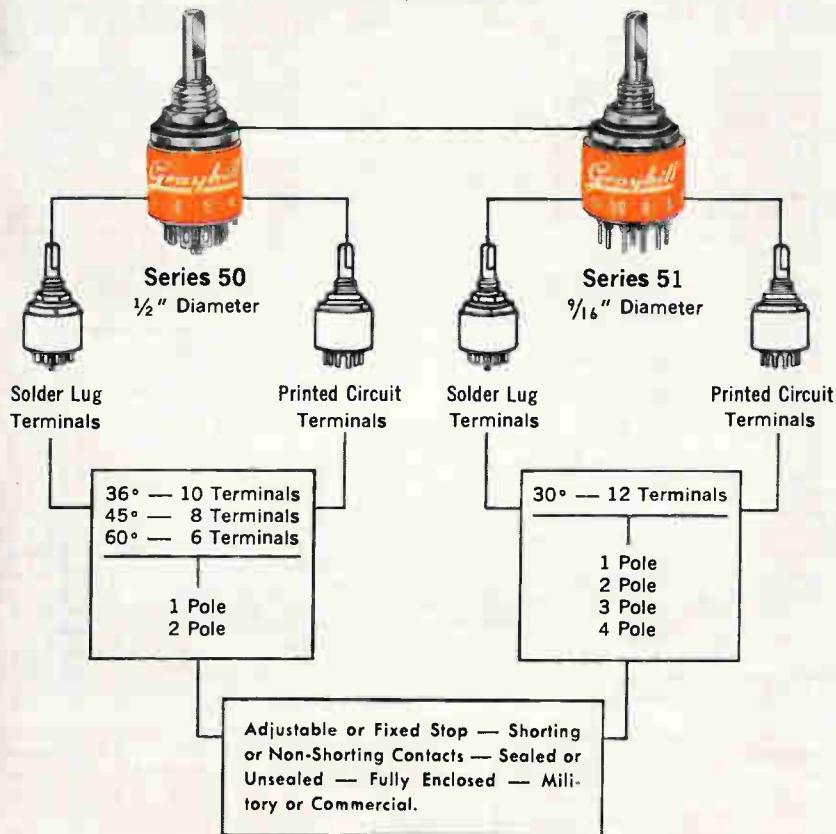

Meets requirements of MIL-S-3786/20

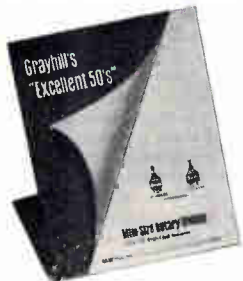

Send for technical sheets fully describing the Grayhill "Excellent 50's".

Another Grayhill innovation developed to unusually exacting criteria required by a highly classified application.

NOW — the proven superiority of this new, versatile generation of Grayhill Rotary Switches — the "Excellent 50's" — is being made available to the commercial market through increased facilities. They are available from stock.



523 Hillgrove Avenue
LaGrange, Illinois 60525
Area Code 312, Phone 354-1040

... the Difference Between Excellent and Adequate

Meetings

(Continued from p. 28)

Vibrations Conference, Association of Mechanical Engineers; Philadelphia, March 30-April 2.

Quality Control Conference, University of Rochester; Rochester, N.Y., April 1.

Numerical Control Society; Stouffer's Motor Inn and Convention Center, Cincinnati, April 1-3.

Mathematical Aspects of Electrical Network Analysis, American Mathematical Society; Providence, R.I., April 2-3.

International Symposium on Computer Processing in Communications. Polytechnic Institute of Brooklyn; Waldorf-Astoria Hotel, New York, April 8-10.

Computer Aided Design Conference, IEEE; University of Southampton, England, April 15-18.

Joint Railroad Conference, IEEE; Queen Elizabeth Hotel, Montreal, April 15-16.

International Magnetics Conference (Intermag), IEEE; RAI Building, Amsterdam, Holland, April 15-18.

International Geoscience Electronics Meeting, IEEE; Twin Bridges Marriott Hotel, Washington, April 16-18.

Conference on Switching Techniques for Telecommunications Networks, IEEE; London, April 21-25.

Conference and Exhibit, Temperature Measurements Society; Hawthorne, Calif., April 21-22.

Spring Meeting, United States National Committee, International Scientific Radio Union, IEEE; Shoreham Hotel, Washington, April 21-25.

Symposium on Circuit Theory, Department of Electrical Engineering and Electronics Research Center; University of Texas at Austin, April 21-22.

RTCM Assembly Meeting, Radio Technical Commission for Marine Services; Hollenden House, Cleveland, April 21-23.

National Telemetry Conference, IEEE; Hilton Hotel, Washington, April 22-24.

International ISA Pulp & Paper Instrumentation Symposium, Instrument So-

(Continued on p. 32)

Foxboro engineers select A-B hot molded potentiometers
"Best repeatability—component-to-component
and setting-to-setting"

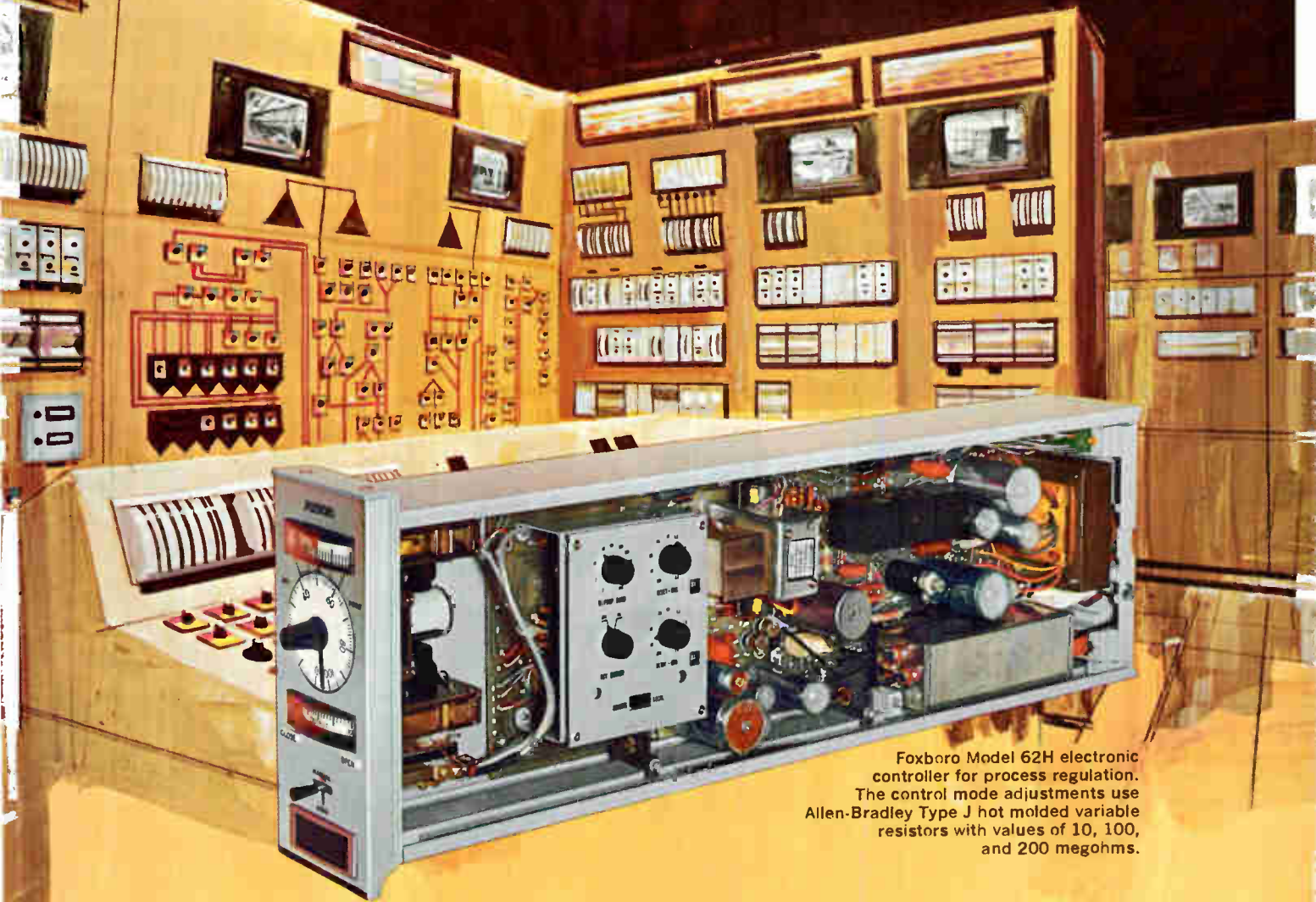

Foxboro Model 62H electronic controller for process regulation. The control mode adjustments use Allen-Bradley Type J hot molded variable resistors with values of 10, 100, and 200 megohms.

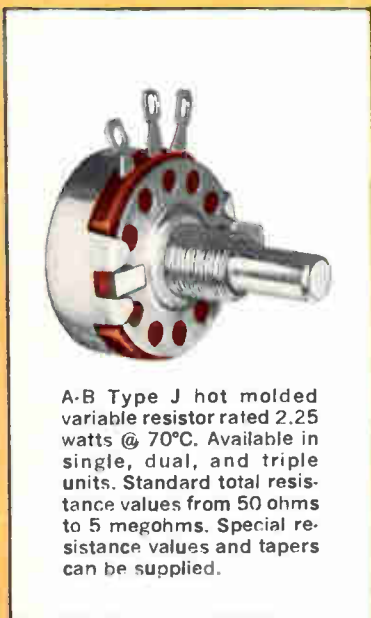

A-B Type J hot molded variable resistor rated 2.25 watts @ 70°C. Available in single, dual, and triple units. Standard total resistance values from 50 ohms to 5 megohms. Special resistance values and tapers can be supplied.

Widely used throughout the process industries, the Foxboro Model 62H Universal Controller is a highly dependable precision instrument. During the years of painstaking development, Allen-Bradley engineers worked closely with Foxboro to provide a potentiometer having unusually high resistance values, which would provide the precise performance required.

Allen-Bradley Type J potentiometers were the answer. They have a solid hot molded resistance track which is produced by an exclusive A-B molding technique that assures extremely long operating life. Accelerated tests—exceeding 100,000 revolutions—show very slight resistance change. Control is smooth at all times with adjustment approaching infinite resolution. There are none of the abrupt turn-to-turn resistance vari-

ations inherent in wirewound controls. Furthermore, Allen-Bradley Type J potentiometers are—for all practical purposes—noninductive, permitting their use throughout the frequency spectrum.

Whether your particular circuit design can be best satisfied with one of the millions of standard Type J variations or whether it calls for unusual resistance characteristics, it will pay you to look first to A-B Type J potentiometers. Their more than 25-year history of providing superior performance is your guarantee of complete satisfaction. For full details, please write for Technical Bulletin 5200: Allen-Bradley Co., 1201 South Second Street, Milwaukee, Wisconsin 53204. Export Office: 1293 Broad St., Bloomfield, New Jersey, U.S.A. 07003. In Canada: Allen-Bradley Canada Limited.



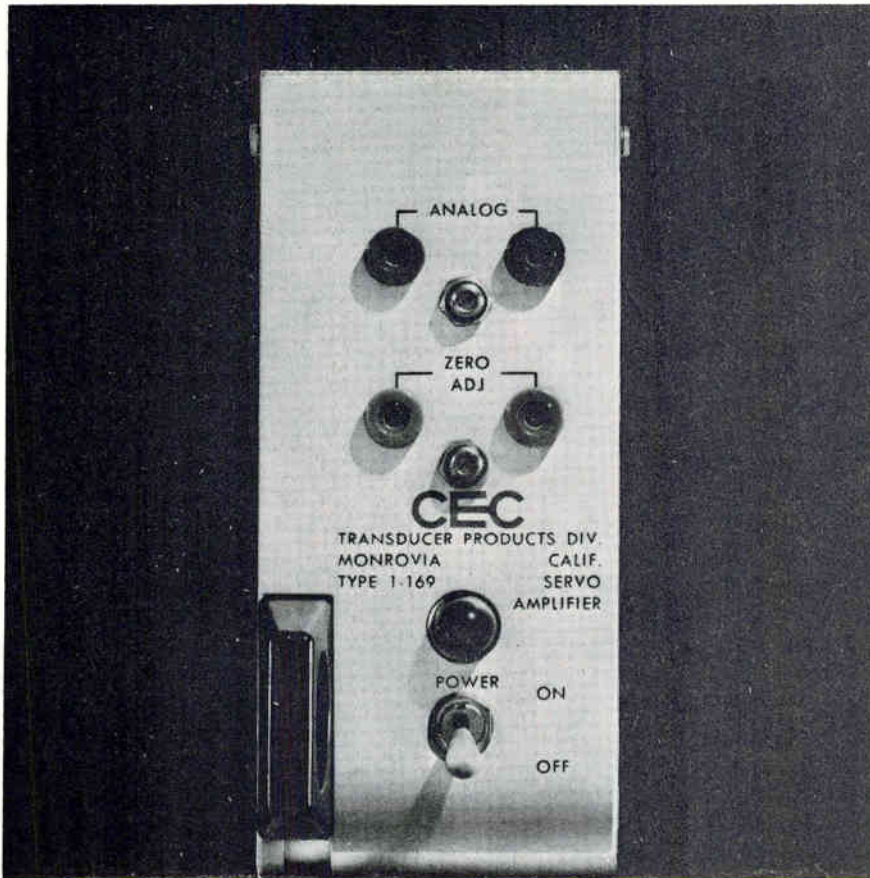

On the face of it - a major improvement in electromanometers.

The new solid state 1-169 is the first servo amplifier to place the adjustment controls for complete system calibration on the *front* panel.

As a result, it is no longer necessary to make zero adjustments on the precision pressure balance.

The 1-169 also offers several other advantages. A response capability of 100 milliseconds. And a compact configuration about one-third the size of previous vacuum tube units.

We don't have to tell you about the greater reliability of solid state components.

But we should add that the 1-169 is fully compatible with the following CEC Precision Force Balance Pressure Transducers: 4-332-0003, 4-334-0001, 4-336-0001 and 4-336-0002.

For all the face-saving facts and specs on electromanometers, call our nearest office or write Bell & Howell, Pasadena, California 91109. Ask for Bulletin Kit 3325-X4.

CEC/TRANSDUCER DIVISION



BELL & HOWELL

Meetings

(Continued from p. 30)

ciety of America; Vancouver, Canada, April 22-26.

Relay Conference, National Association of Relay Manufacturers and Oklahoma State University's School of Electrical Engineering; Oklahoma State's Student Union Building, Stillwater, April 22-23.

Southwestern Conference & Exhibition, IEEE; Convention & Exhibition Center, San Antonio, April 23-25.

Photo-optical Techniques in Simulators, Society of Photo-optical Instrumentation Engineers; South Fallsburg, N.Y., April 28-29.

Symposium on Information Processing, Purdue University's School of Electrical Engineering; Memorial Center, Lafayette, Ind., April 28-30

Short courses

Integrated circuits, University of Michigan, Ann Arbor; June 9-13; \$225 fee.

Laser — quantum mechanics — holography, University of California at Los Angeles; June 23-July 11; \$275 fee.

Digital systems, Center for Advanced Engineering Study, Massachusetts Institute of Technology; Aug. 4-29; \$1,000 fee.

Call for papers

Electronic Components Conference, Electronic Industries Association, Shoreham Hotel, Washington April 30-May 2. April 1 is deadline for submission of abstracts to Dr. J. O'Connell, ECC technical program chairman Electronic Industries Association 2001 Eye St., N.W., Washington, D.C. 20006.

Systems Science and Cybernetics Conference, IEEE; Philadelphia, Oct. 22-24. April 15 is deadline for submission of abstracts to Hugh A. Raymond, Valley Forge Space Technology Center, General Electric Co., P.O. Box 8555, Philadelphia 19101.

ACM Symposium on Programming Languages Definition, San Francisco, Aug. 24-25. April 30 is deadline for submission of papers to Dr. James A. Painter, IBM Research Laboratory, Dept. 978, Bldg. 025, Monterey and Cottle Rds., San Jose, Calif. 95114.



we goofed.



This Howard Cyclohm Fan was engineered to run 10 years. So far it's been running 12 years, 6 months, 21 days.

Our modest 5-year guarantee on Cyclohm Fans and Blowers is based on an engineered lifespan of 10 years. So, what do we tell our customers when they report the fans are still blowing strong 12 or even 14 years after installation? We tell them we goofed—and they benefit.

There's more to the Howard Cyclohm Fans and

Blowers success story than just long life. There's the high reliability of Howard's unit bearing motor that never needs maintenance or re-lubrication. And all metal construction. Indestructible nylon blades. Standard mounting on 4-1/8" centers. UL yellow card listing. And still more. All the facts are in five newly-published bulletins that are yours for the asking. Just write for the Cyclohm Fans and Blowers Information Packet No. EL39, From Howard.



HOWARD

HOWARD INDUSTRIES
MSL INDUSTRIES, INC./MOTOR GROUP
2420 18th STREET, RACINE, WISCONSIN 53403
414-632-2731 TWX 910-271-2387

Flexibility?



Astrodata is...



INSTRUMENTATION PRODUCTS
Tens of thousands of standard products doing very special jobs.

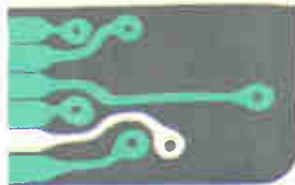

PRINTED CIRCUIT BOARDS
A high quality-high production operation using advanced equipment.



DIGITAL DATA DEVICES
The important peripherals for today's modern computers.



INFORMATION SERVICES
An advanced software capability just leaving the launch pad.

System Flexibility. The 100 KHz Astroverter!

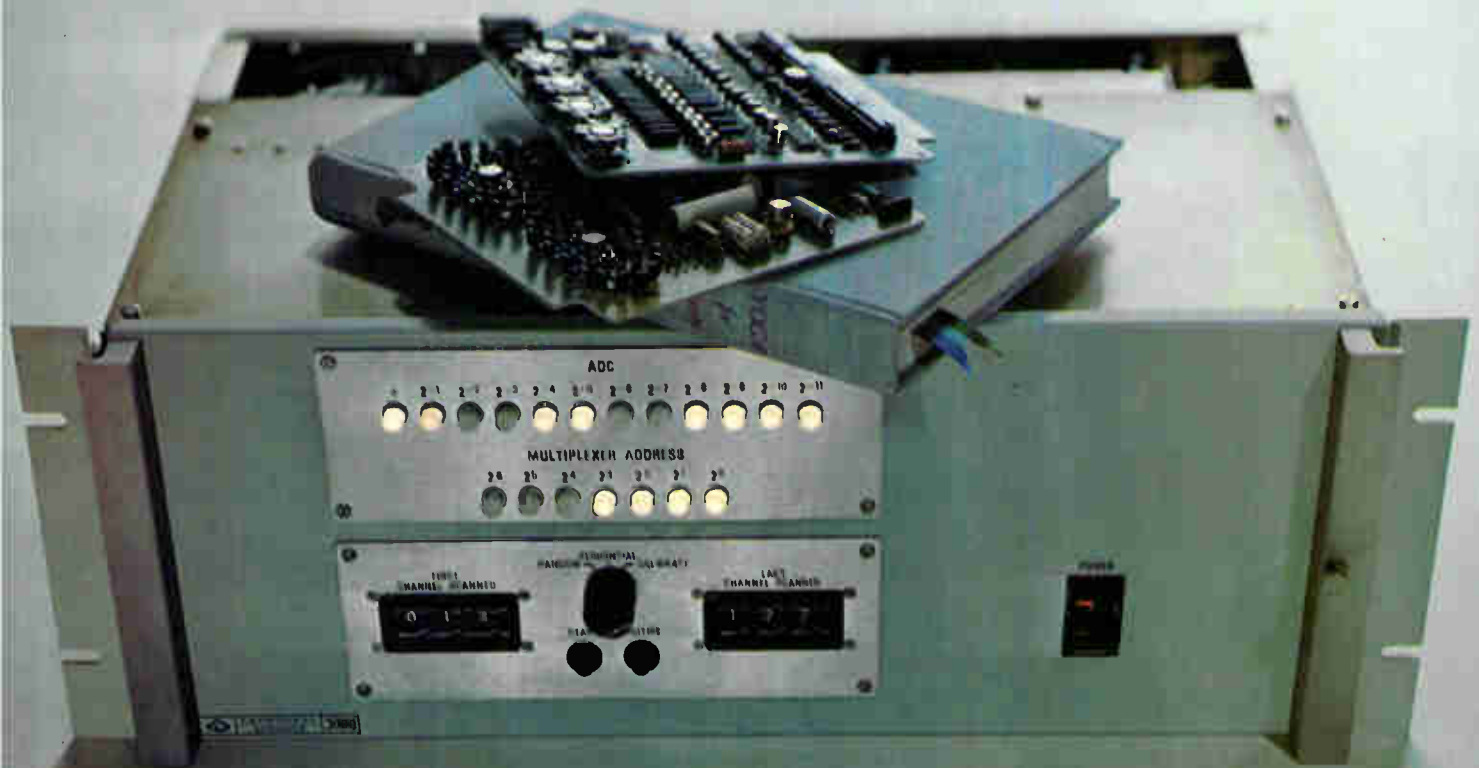

Flexible. That's the word for the Astroverter—an entirely new concept in data system packaging.

It consists of a 7-inch high rack adapter, built-in power supply, 16 card slots, and a whole family of high speed plug-in cards including multiplexers, ADCs, sample and hold amplifiers, buffers, and DACs.

A 12-bit ADC takes only two cards. Add sample and hold with one more card. 16 channels of multiplex fill 1 card slot with expandability to 128 channels. And you still have room for "quick look" DACs. Or fill the card slots with amplifiers or DACs. The combination you need. Configurations are unlimited.

Astroverter is fast, too. 5 microsecond digitizing. Less

than 5 microseconds for multiplexer switching and settling, including sample and hold. A true thru-put rate of 100 KHz!

The price is surprisingly low, too. Like a 16 channel multiplexed ADC system with sample and hold for only \$1,825 including power supply and rack.

No other system combines this flexibility, speed, and economy. No wonder. Astrodata has more systems experience than anyone. Over 350 systems in the field—more than 100 with digital computers.

Circle the reader card for the Astroverter brochure. With it you can specify just the system you need.

Astrodata—Space age technology on the industrial grow.



P.O. Box 3003 Anaheim, California 92803 Telephone (714) 772-1000



DATA AND TELEMETRY SYSTEMS
Over 350 systems delivered—more than 100 using digital computers.



ELECTRONIC SWITCHING SYSTEMS
To multiply the capability of the largest communication companies.



ANALOG AND HYBRID COMPUTERS
The largest hybrid systems in the world have been delivered by Comcor.



TIMING EQUIPMENT
Supplying the free world with more precision instrumentation than anyone.

Circle 35 on reader service card

from the leader in assembly equipment

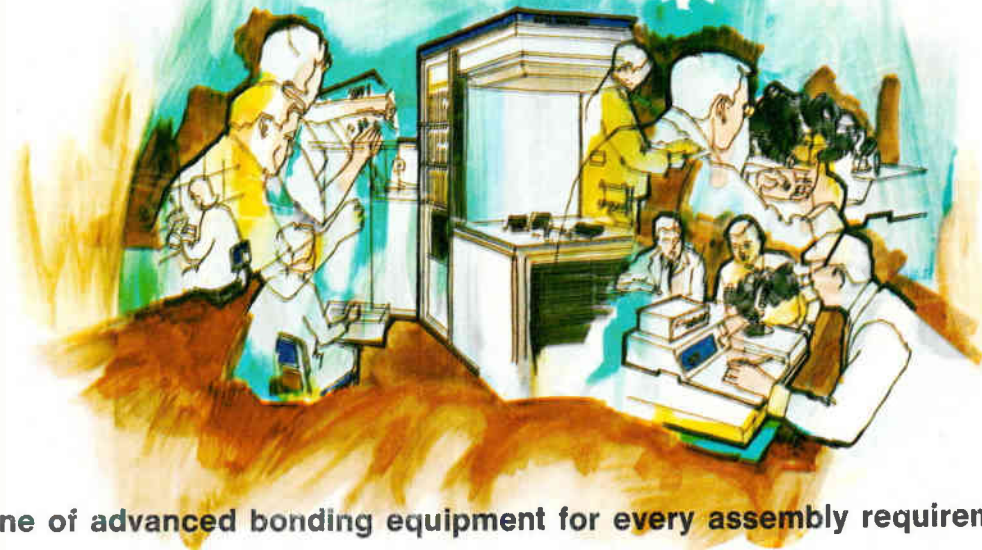

A line of advanced bonding equipment for every assembly requirement.



MODEL 1350 ULTRASONIC WIRE BONDER

- Hybrid circuits up to 3"
- Stitch bonds at multiple levels
- .010" wire bonds with automatic wire cut-off



MODEL 2000 FLIP CHIP BONDER

- Totally automatic bond cycle
- Adaptable to automatic die attach
- Digitally controlled leveling force

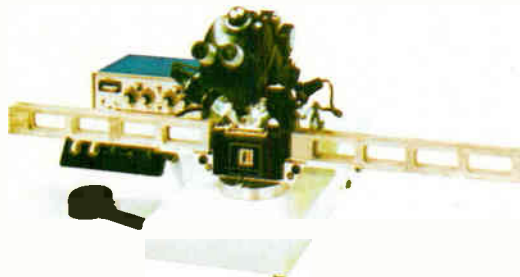

MODEL 1370 RACK FEED ULTRASONIC BONDER

- Hi-speed transistor bonding
- Production bonding of 14 lead IC's
- .010" wires for power device production



MODEL 2100 UNIVERSAL ASSEMBLY MACHINE

- Automatic beam lead bonding
- Thermocompression flip chip bonding
- Reflow soldering with a heated substage

Other Hugle Industries' products include: Horizontal Epitaxial Reactors • Vertical Barrel Reactors • Epitaxial and Diffusion Doping Systems • IR Microscopes • PCD Process Controller



HUGLE Industries

750 North Pastoria Avenue

Sunnyvale, California 94086

(408) 738-1700

Editorial comment

Teamwork for hospital safety

Unwanted leakage paths to the heart, along with stray voltages, may be the cause of a growing number of hospital deaths. Some experts claim that patients undergoing such medical tests as probings with a cardiac catheter run the risk of electrocution [*Electronics*, Feb. 17, p. 92]. The situation is controversial and ill-defined, but these experts insist that existing evidence indicates the need for stringent standards for equipment and techniques.

The problem is obscured by the impossibility of determining whether death has resulted from natural causes or from leakage-current-induced fibrillation. And the exact amount of current that will cause fibrillation is in question. Some experts says as little as 10 milliamps of 60-hertz current, which could result from a voltage transient of as little as 5 millivolts, can be lethal. Furthermore, the medical profession is reluctant to air the details of a problem that could invite lawsuits. On the other hand, the steps that could safeguard the patient seem clear enough. The following are suggested by those who have studied the problem:

- Medical instrumentation designers must build equipment that is reliable, rugged and, as one doctor puts it, "as foolproof as a Coke machine." Particular attention should be paid to the power cord; it should contain a ground wire and a rugged plug with a ground lug, and it should be no more than 10 feet long to limit capacitance. Equipment should also have a dynamic ground fault detector with an alarm.

- The instrument does not live alone; the entire system and its environment must be controlled. A prime need is for an equalizer grounding bus to provide a low-impedance reference ground for all equipment within reach of the patient. Life-support systems should be wired to a "safe power center" such as a standby power generator—preferably one with batteries to bridge the critical seconds-long power gap during switchover to the standby supply. Isolating transformers should be limited in size to control transients, and the primaries and secondaries should be protected by electrostatic shields connected permanently to the equalizer bus.

- The "safest" system can be dangerous in ignorant hands. Medical personnel must be well trained in the use of instrumentation, and particularly versed in its safety features.

- Finally, the safeguards must be standardized and guaranteed, undoubtedly by the Federal Government. Yet a Medical Device Safety Act (not a particularly stringent one) proposed by the FDA

was permitted to languish in committee during the last Congress. Furthermore, when the FDA sent copies of the proposed legislation to industry representatives, it received not a single response.

We urge that manufacturers, hospital administrators, doctors, and technicians pool their expertise to help generate standards that are feasible and fair and, above all, that protect the patient. ■

The numbers game, again

The controversial Stubbing report [*Electronics*, Feb. 17, p. 60] put the electronics industry in the national spotlight by suggesting that the electronics systems for major military aircraft and missile programs are generally substandard and almost always behind schedule.

One trouble with the report is that its only measure of performance was actual mean time between failures as a percentage of target MTBF. No other performance parameters were stated, nor were the actual magnitudes of the MTBF's given. Were target MTBF's for second- and third-generation gear higher than those for first-generation gear? Were the performance parameters to which the latest MTBF's applied more (or less) stringent than the earlier ones? The reader of the report was not told. Small wonder that newspaper reporters concluded that "the performance of the multibillion-dollar equipment started in the 1950's was bad; that of the 1960's is worse."

Unfortunately, the Stubbing report told the Pentagon nothing it did not already know. Nevertheless, Mr. Stubbing gets A for effort. His intentions were to show how the acquisition programs for high-risk electronic systems (defined as those in which at least one major component must be re-designed) might be improved. But the systems he considered were too diverse and complex to compare by means of a simple "numbers game."

The same effort applied to a detailed analysis of the development program for just one of the systems in question might have been more fruitful. It might have shown where systems analysis went astray in predicting MTBF. Perhaps the model for some portion of the system was faulty. Perhaps computer-aided reliability analysis could have been applied to better advantage. A more valuable analysis would have involved digging deeper, not rehashing facts already on record. ■



now...Clare-Quality Industrial TO-5 Relays!

- Only .275" high by .370" maximum diameter



TF Relay
actual size

- Rigid frame keeps elements stable... balanced armature precisely aligned
- High, consistent contact force... low contact resistance
- Form C and 2 Form C contacts
- Speeds to 4 ms
- 10,000,000 operations (min) mechanical
1,000,000 operations at 0.5 amp,
28 vdc resistive
100,000 operations at 1.0 amp,
28 vdc resistive

- Pressurized, hermetically-sealed welded case

New Clare TF Industrial-Type Relays provide true reliability in subminiature relay operation... new compatibility in pcb design—backed by the simple, precision construction in eight types of Clare military relays.

Optimized magnetic circuitry assures maximum contact pressure. Balanced armature design. Withstands shock to 30G... vibration to 10G, without false operation. Serves over temperature range from -55°C to $+75^{\circ}\text{C}$. All welded construction. Pressurized nitrogen atmosphere minimizes arcing, extends contact life.

Design dependable new capabilities for interface, input/output isolation, and buffering into subminiature circuits. Circle Reader Service Number— or ask Clare for Date sheet 759.

C. P. Clare & Co., Chicago, Ill. 60645
... and worldwide



a GENERAL INSTRUMENT company

TYPE TF RELAY CONTACT ARRANGEMENTS

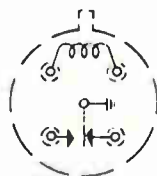

1 Form C,
movable contact
connected to case

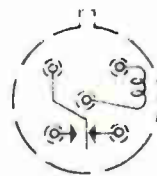

1 Form C,
all contacts
insulated from case

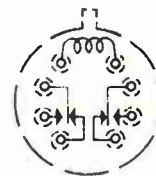

2 Form C,
all contacts
insulated from case



CLARE SUBMINIATURE INDUSTRIAL-TYPE RELAYS

for airborne and ground support equipment, instruments,
process controls, test equipment, communications,
business machines, computer peripheral products

Electronics Newsletter

March 3, 1969

621B gets an A on technical health but a D in finance

Everyone now seems to be agreed on the technical approach to the Air Force's 621B navigation satellite program and to be convinced that its development is within the state of the art. **But there's still the problem of getting enough money to start building.** The secure system will probably be the navigation part of the proposed integrated communications, navigation, and identification system [*Electronics*, August 19, 1968, p. 33], which the Air Force Systems Command is now trying to expand to a full-fledged program.

What makes 621B a strong competitor, and even a threat, to other navigation schemes is that it could provide navigation data to any spot on earth to pinpoint accuracies—within feet.

Two companies funded to make nine-month project definition studies—Hughes and TRW Systems—delivered final reports in January to the Air Force's Space and Missile Systems Organization (Samsco). And both agree with the Aerospace Corp., which conceived the 621B navigation approach, that hardware development should begin immediately.

Samsco had wanted to pick a contractor in fiscal 1969, but the Air Force got only \$500,000 in this year's budget, just enough to keep the program going [*Electronics*, July 22, 1968, p. 34]. This money is being used to pin down system parameters and do more work on thermal noise and jam protection.

The Air Force is looking for a minimum of \$1 million in fiscal 1970 for more studies, but it wants enough to begin hardware development.

\$35 million FAA pact awarded to Univac

The Univac Federal Systems division of Sperry Rand has jumped into a strong position in the market for terminal air traffic control equipment by winning a \$35 million FAA contract for automated radar tracking systems. Called Arts 3, they're to be installed at 62 of the nation's busiest airports. Univac previously supplied the computer for Arts 1, a terminal air traffic control system operating at Atlanta since 1964, and had supplied the computer for the common IFR room at New York's Kennedy International Airport last year.

For the big contract, Univac competed against F&M Systems, Raytheon, Sanders Associates, and Westinghouse. The Arts 3 equipment will be built in modules so that different configurations can be compiled for airports of various sizes [*Electronics*, Feb. 19, 1968, p. 155]. Univac will deliver the equipment on a turnkey basis, with first deliveries scheduled for the end of 1971 and all 62 units scheduled to be in operation at the end of 1973. Major subcontractors are Texas Instruments, which will provide display equipment, and Burroughs, for data acquisition gear.

Honeywell DDP-316 is ready for market

The DDP-316 computer will be marketed within the next two weeks by Honeywell's Computer Control division. A subject of speculation for months [*Electronics*, July 8, 1968, p. 33], the computer is reported to be a 16-bit machine with scientific, remote-terminal, process-control, and networking applications.

Honeywell is said to have priced the computer below \$10,000 and to have equipped it to use powerful software designed for its faster

Electronics Newsletter

and more costly DDP-516. Representing Honeywell's first plunge into the under-\$10,000 class, the new machine may make the first large dents in a market now dominated by the Digital Equipment Corp.

Hughes said to win DSCS-2 contract

The Air Force's Space and Missile Systems Organization is understood to have chosen the builder of the second-generation Defense Satellite Communications System (DSCS-2). Announcement is expected from the Pentagon shortly even though planners can't agree on a mission description for the entire system.

Hughes Aircraft reportedly is the winner of the contract, which would be for six stationary-orbit satellites, including backups, to replace the small initial defense communications satellites now in orbit. One big Hughes advantage was said to have been that the DSCS-2 design bore a definite resemblance to the Intelsat 4 satellite, built by Hughes.

Still confronting the program is a political fight between the services, who operate the tactical communications satellite (Tacsat) just orbited, and the Defense Communications Agency, which would operate the DSCS-2 long-haul communications link. Each seems to have an eye on the other side's satellite communications responsibilities. The services, for example, would like to perform some of the DSCS-2 communications jobs with Tacsat.

Until the mission description can be agreed upon by a triservice committee, the agency, and a team of Pentagon systems analysts, such items as final specifications of ground stations to operate through DSCS-2 can't be decided. Slowed down to a crawl, for example, is an Army request for quotes on a ground terminal for DSCS-2; the request is apparently being written, but the job is going very slowly.

Tacfire to get LSI for data terminals

The Army is in for a bonus as part of its Tacfire (tactical fire-direction) system because the contractor, Litton, has been forced to build the data terminal assemblies in house. The bonus will be mechanization of data modems in the terminals with two MOS LSI arrays instead of the 75 to 80 bipolar flatpaks of transistor-transistor logic in the original.

Litton's Data Systems division decided to build the assemblies after RCA's Defense Electronics division, a team member during contract definition, dropped out.

Sentinel may switch to TTL from RTL

Even after the Sentinel antiballistic missile system has survived its current review—and chances are it will in some form [see p. 66]—the data processing equipment specified for it may be outmoded. In fact, IC-industry sources are wondering if a massive redesign is in the works.

According to one insider, "The time is ripe to redesign the whole thing with TTL. It would be more dependable and cheaper, and the computers' electronic and beam controls could be much faster."

Sentinel now is said to use large quantities of the nearly archaic hybrid RTL.

Addendum

National Video, a high-flying manufacturer of tv picture tubes just a few years ago, may be dying but it isn't quite dead yet. The company, which suspended production indefinitely last week, may be merged with MPI Industries of Jackson, Miss., a maker of wood cabinets for tv sets.

LARGE-SCALE LOGIC

MOTOROLA NEWS about MTTL Complex Elements and their Application

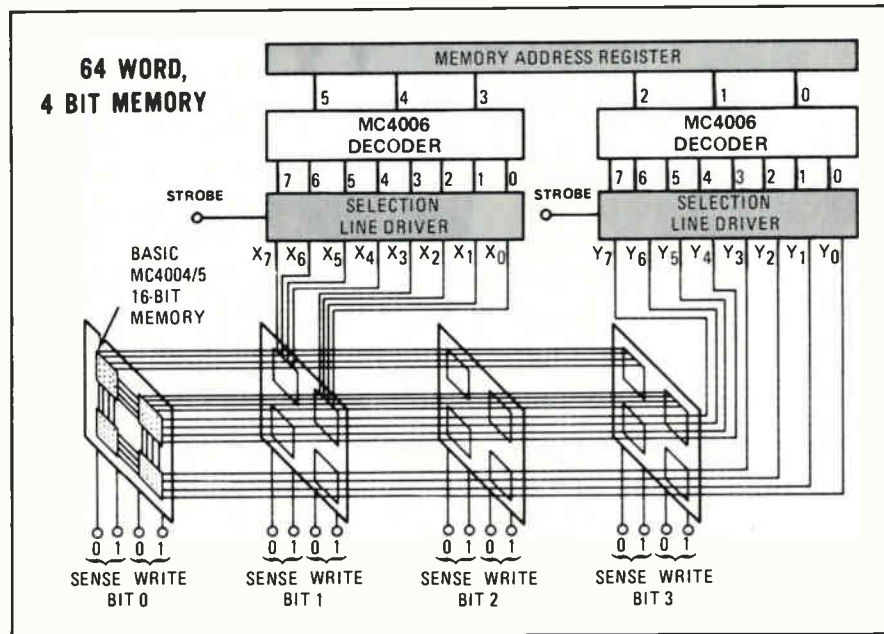

16-Bit Memories Are "Building Blocks" For 100 nS Scratch-Pad Systems

Two 16-bit random access memories, MC4004 and MC4005, provide 16-words of one-bit memory, operating in the NDRO mode. Each of these MTTL memory chips contains 16 flip-flops arranged in a four-by-four matrix, plus two amplifiers and 2 write circuits.

These "building blocks" can be paralleled on a vertical plane, to expand the matrix and provide a larger number of words. In the same manner, the number of bits can also be expanded by paralleling select lines.

Eight select lines provide for the selection of one of the bits by applying a logic "1" level to one of the "X" and one of the "Y" select lines. After selection, information may be written into the bit by applying a logic "1" level to one of the write circuit inputs. Information stored in the selected bit will appear at the output of one of the sense amplifiers.

Under this system, it's easy to design, for example, 128 word, N-Bit Memories for Scratch-Pad Systems, with cycle times of less than 100 nS.

Both of these memories are available in the 14-pin dual in-line as well as the ceramic flat pack.

Circle 318 on reader service card

New Decoder Improves Operating Efficiency, Lowers System Costs!

The MC4006 is a Binary to One-of-Eight Line Decoder. Its unique design philosophy uses a combination of low-level, non-saturating gates and high-level gates with improved TTL transfer characteristics. This technique makes possible complex circuits that combine lower power dissipation, lower parts count and results in greater functional complexity. This increased complexity, resulting in reduced package count, thereby lowers total system costs. In fact, the MC4006 reduces power dissipation and propagation delay time by 50% over conventional TTL design techniques.

Over-all, the MC4006 provides the advantages of complex-function circuits combined with the speed and noise-immunity of T²L for many new applications.

The MC4006 converts three lines of input data to a one-of-eight output. The enable line provides an inhibit capability and also allows the decoder to be expanded for larger decoder systems.

Packaging for the MC4006 is the 14-pin dual in-line and ceramic pack. Circle 319 on reader service card

MTTL Complex-Elements Also Offer System Operating Improvements

The first 3 of 23 new MTTL complex-function integrated circuits — two 16-bit memories and a decoder — are now on distributors' shelves; and, the others are scheduled for introduction during the first quarter of 1969.

These new circuits provide the same system compatibility improvements pioneered by Motorola on its MTTL III line. That is, diode-clamped inputs — to improve the transfer characteristic and reduce "ringing." Flip-Flops contain a unique input network that makes it possible to enter data at any time during the clock cycle, except during set-up and hold times. This network also enables these devices to operate effectively with an unrestricted clock cycle.

To find out more about MTTL complex-function integrated circuits, send for data sheets. We'll also send you the latest application note about their use in a variety of memory applications.

Circle 320 on reader service card

 **MOTOROLA**
Integrated Circuits

-where the priceless ingredient is care!

Motorola Semiconductor Products Inc. / P. O. Box 20912 / Phoenix, Arizona 85036

← Circle 44 on reader service card

45

ASSEMBLE YOUR OWN INSTRUMENTATION SYSTEM 1-2-3

PAR™ Research Instrument Modules (RIM) offer new flexibility, economy and convenience in research instrumentation

1. Select the equipment required for your experiment. The availability of signal processing instruments in modular form enables you to select the specific units required to fill your immediate needs.

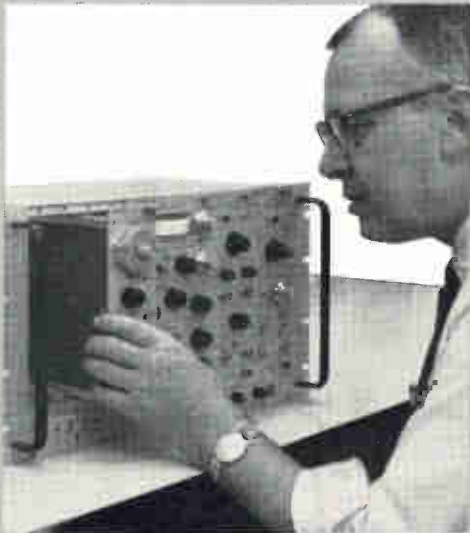

2. Assemble the instrument system you require by plugging the modules selected into a rack-mountable bin which also supplies power to the modules. All Research Instrument Modules are designed to meet the universally-accepted NIM standards developed for modular instruments (AEC TID-20893). These standards greatly simplify assembly of precision measuring systems by providing common power input levels and reducing significantly the need for concern with interface voltages and impedance levels.

3. Operate your assembled system to achieve state-of-the-art signal processing. Then reassemble the modules to form other instrument systems when your current experiment is completed. The ease with which a central stock of modules can form the basis of a rotating set of laboratory instruments permits both rapid experimental set-up and long-term economy of capital outlay. Obsolescence is avoided since the modular assembly can be updated by merely substituting an improved module. Also, system breakdown can easily be remedied with readily available spare modules, greatly reducing maintenance problems.

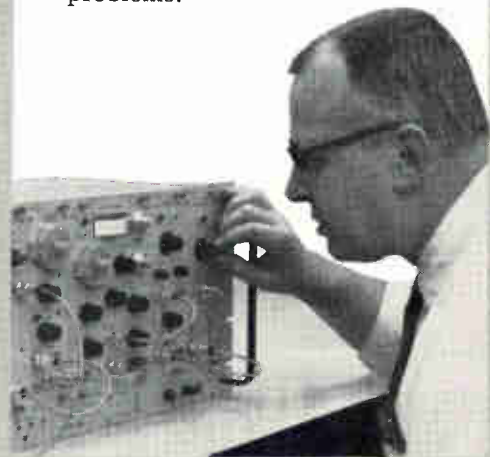

For more information write Princeton Applied Research Corporation, Box 565, Princeton, N.J. 08540, or call (609) 924-6835.



PRINCETON APPLIED RESEARCH CORPORATION

Big push for beam-lead IC's sparks demand for special bonders

One company, in a wobble bonding technique, uses a heated vacuum needle; etch-separating and lining up the chip on a substrate remain problems

The semiconductor industry plans its first large-scale introductions of beam-lead integrated circuits this year; Raytheon and Western Electric already are producing limited quantities [*Electronics*, Dec. 9, 1968, p. 88]. But like flat packs and flip chips, beam leads bring their own problems and among these is the need for special bonders to attach the IC's to hybrid substrates.

Potential users demand bonders before circuits, according to one manufacturer's spokesman. "They saw our beam lead IC's and said, 'Great—but we want to see your bonder before we buy.'" Such reactions triggered development programs at most major IC firms. But the Bell System's work on a bonder stemmed from Bell's involvement in the Sentinel system, which will use the beam-lead designs.

Now two bonders have reached the market and three more are close. Kulicke & Soffa of Fort Washington, Pa., seems to have gotten there first and claims to have sold 25 of their \$7,000 systems.

Endorsed for Sentinel. Though K&S has applied for patents on some parts of its bonder, industry sources say that K&S worked out many of its design features with Western Electric. Thus it's not surprising that it was endorsed for Sentinel system work.

The K&S machine uses thermo-compression to bond beams to substrates. Its bonding tool is a heated vacuum needle shaped to enclose the IC. It picks it up, carries it to the substrate, and then rolls around on the beams like a toy top. Each beam is heated and compressed in turn; it's called "wobble bonding."

The other form of bonding now

in vogue was also originally worked out by the Bell System and uses a conformal bonding tool—it doesn't wobble; it presses straight down, accommodating itself to any irregularities in the IC or substrate.

The Lindberg Heavy Duty division of Sola Basic Industries, Mountain View, Calif., seems to be the only company using this approach. According to applications engineer Howard Spicer, Sola has delivered four of the units. Sola's bonder, at \$14,000, costs twice as much and is more complex than K&S'. Nearly automatic, Sola's only requires the operator to align the IC and press a button—the machine does the rest while a special belt-

like chip handler feeds more IC's to the bonding station.

The lowest priced bonder yet should be announced in a couple of weeks, and though it sells for only \$6,000 and lacks an automatic feed system, it sounds as simple to run as Sola's. Developed by Sprague Electric, it will be sold by Sprague's subsidiary, Micro Tech Mfg., Worcester, Mass.

It uses a wobble bonder vacuum needle combination and substitutes a joystick for Sola's push button. The Micro Tech bonder also will feature independent control of both substrate and IC temperature. According to Sprague's director of research, development, and engineer-



Leading off. Automatic bonders for beam-lead circuits, like this one from Kulicke & Soffa, are just now becoming commercially available.

U.S. Reports

ing, Robert Pepper, there is too little data to make a firm decision as to the best temperature relation between chip and substrate, so the new machine will leave the settings to process control engineers.

What's left undone. The similarities between various bonders extend to a number of common problems that will need solving. One of these is the way in which a chip is lined up on the substrate. Almost all of the bonders use a half-silvered mirror and a stereo microscope to create superimposed images of chip and substrate during alignment. But the images lack contrast, and operators of first-generation bonders may suffer from confusion, eyestrain, and rejects.

According to a Sprague spokesman, the half-silvered glass plate

also distorts when heated, and it must be heated if placed above the substrate. Sprague's answer to this is to set the plate to one side and view the bonding tool and substrate through the plate from an angle. But this makes the perspective confusing and the IC's are more difficult to align, they say.

Sprague is investigating a prism system like that in reflex cameras. They figure that the mass of the prism will make it more immune to heat distortion, and that it could also yield a clearer, brighter image without perspective problems.

Another problem is that of etch-separating the IC's without upsetting their positional relationships. For automatic bonding, the IC's would have to arrive at the machine in near perfect x-y orientation.

There are almost as many methods of doing this (or attempting it) as there are beam lead IC makers, but so far none seem to achieve the needed accuracy. But when this problem is overcome, the way will open for automatic bonders which would pick an IC out of an array, step to an exact location on a substrate, and bond it into the circuit.

A system approaching this ideal condition is being built for a large user of flip-chip IC's by Huggle Industries of Sunnyvale, Calif. Like the Lindberg machine, it is tape or belt fed. But since each chip must be aligned as it's placed on the tape, there's no effort saved.

Huggle may try to adapt the tape feed to a beam-lead bonder it is building, but Donald G. Pedrotti, engineering vice president at Huggle, says that removing the IC's from their wafer carrier and placing them on tape can damage their beams. Thus, in a bonder Huggle will show at the IEEE Show this month, there will be no tape feed.

Sidestep. A possible answer to the automatic alignment problem—or at least an interim solution—may have appeared more than two years ago in Itek's so-called electronic eye, which used a flying spot scanner and comparator to align semiconductor chips [*Electronics*, Nov. 28, 1966, p. 38]. At the time, Itek claimed that the servo-controlled system could position chips in x, y, and z axis to within 0.04 mil—more accurate than is required for today's beam lead automation needs.

Motorola is said to have purchased one for use in its spider bonding process. And Texas Instruments has bought all of Itek's "eye" equipment in a hush-hush, in-house bonder automation program, say industry sources.

Packaging

Setting a standard

There's a variety of planar and plug-in packages available today, but most standard integrated circuits and large-scale integrated arrays have packages with either 14, 22, or 40 leads. Thus the usual package has 7, 11, or 20 leads per

Electronics Index of Activity

March 3, 1969

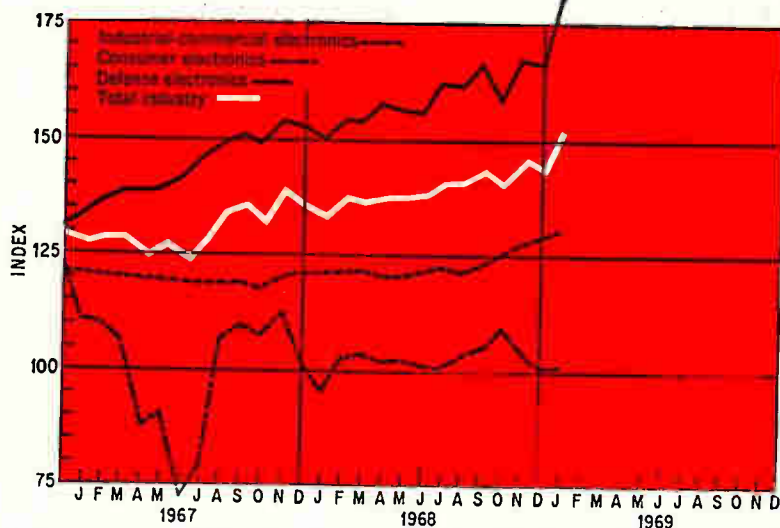

Segment of industry	Jan. 1969	Dec. 1968*	Jan. 1968
Consumer electronics	101.1	100.7	96.2
Defense electronics	181.6	166.1	150.2
Industrial-commercial electronics	129.7	128.2	121.4
Total industry	152.7	143.8	132.5

Electronics production rose 8.9 index points in January from the previous month and a sharp 20.2 points from the year-earlier level. All sectors showed marked gains, with the biggest being registered in the defense area. Defense output climbed 15.5 points from December 1968 and 31.4 from a year before. Consumer production edged up 0.4 point in the month and 4.9 points in the year, while the corresponding gains in the industrial-commercial index were 1.5 and 8.3 points.

Indexes chart pace of production volume for total industry and each segment. The base period, equal to 100, is the average of 1965 monthly output for each of the three parts of the industry. Index numbers are expressed as a percentage of the base period. Data is seasonally adjusted.

* Revised

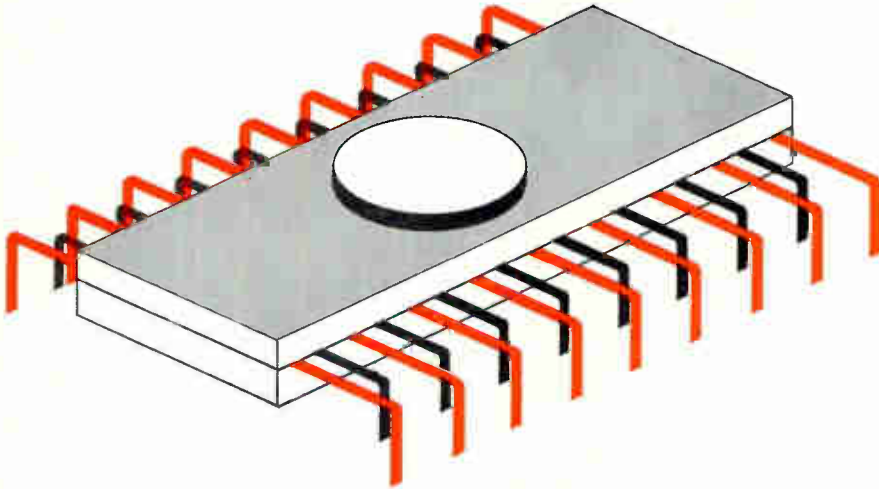

Switch-hitters. Autonetics has designed this standard package for both planar and plug-in circuits.

side. If an IC supplier uses all three types of packages, he has to switch tooling—particularly lead frames—when he goes from the 7- or 11-sided (odd numbers) packages to the 20-sided design. Or the vendor may have a separate production line to handle the 40-lead type.

Recognizing the benefits of handling all lines with one set of tooling, Autonetics engineers have developed and are using a 42-lead package (21 per side) that can be either planar or plug-in and accepts the same lead frames used for 14- and 22-lead packages. David Nixen, chief of research and engineering at the firm's microelectronics laboratory, says he knows of no other package that functions both as a planar and plug-in unit and still conforms to Electronic Industries Association lead-spacing standards.

Hard seal. The new package also eliminates the need for glass-to-metal seal—a prime target of attack by moisture. Its top and bottom plates, both of which are alumina, are pressure-baked and joined under high force by the package manufacturer, “making reliability inherent,” according to Nixen. Six firms bid for the package and two are now supplying it—the National Beryllia Corp. and the Centralab division of Globe-Union.

“Ceramic is about 10 times more resistant to thermal and mechanical stresses than is glass,” Nixen states. He notes that the mechani-

cal stresses involved in handling a glass-sealed package, plus the thermal cycling associated with die bonding, lid-sealing, and burn-in, can weaken the seal and thus threaten hermeticity.

The new package's plate bears the screened conductors that connect the semiconductor die to the outside leads. The die itself (any of the metal oxide semiconductor LSI arrays Autonetics makes) is bonded to a circular floor section made of Kovar, alumina, or beryllia. The lead frame is Kovar. The top plate completely covers the conductors, protecting them against handling damage.

For customers who want electrically “hot” packages, the Kovar floor provides a common interconnect through a circuit board. Customers seeking electrically isolated packages will specify either alumina or beryllia floors; besides giving isolation, beryllia has about seven times the thermal conductivity of alumina. The same tooling is employed for any of these floors.

Round top. Kovar is also used for the package's circular top ring, which provides the hermetic seal. (The usual square lid is subject to stresses at its corners.) The ring is resistance-welded into place by Autonetics. “The process is cheaper than brazing,” Nixen explains. “Brazing dictates use of a preform, which melts away. We can save 6 to 12 cents per package by eliminating the preform.” Beyond that,

Nixen will say only that the 42-lead package costs less than conventional 40-lead units.

Instead of having its leads on 100-mil centers to conform to EIA standards for plug-in packages, the Autonetics package employs the 50-mil centers specified for planar use. But converting the unit to plug-in form is relatively simple, Nixen maintains. In this process, every other lead is bent downward close to the package edge, leaving it as one of a row of plug-in pins on 100-mil centers. The other leads, which extend farther from the package, are bent down to form another row of pins, also on 100-mil centers. Either Autonetics or its customers may bend both rows in one automatic operation, depending on the customers' desires.

Double duty. A Kovar stud connecting the lead frame with the package at each end eases handling and testing. The lead frame doubles as a carrier for the entire assembly after the leads have been automatically severed from the frame. This leaves the leads electrically isolated for probing but protected by the carrier. After testing, the studs are cut automatically and the lead frame/carrier falls away, leaving a sealed and tested assembly.

At less than 2.5 grams, the 42-lead package is about a third the weight of conventional 40-lead units and a third the size.

Nixen believes the new unit is easier to test than the 40-lead types, many of which have a metal webbing between leads in addition to the lead frame. The webbing prevents lead damage before testing, but it dictates an extra step—severing of the webbing from the package along with the lead frame.

Communications

Pinpointing whispers

Almost any kind of radio used by the military can be jammed or intercepted. Very narrow-beam millimeter-wave systems would be immune to such intrusion, but efforts to sell them to the military have generally met with frustration: the



Straight talk. Designer Palle Christensen of Raytheon adjusts his 60-gigahertz transceiver. Narrow-beam signal is hard to jam or interrupt.

components are extremely hard to produce in any quantity and with any reliability [*Electronics*, March 18, 1968, p. 151]. At Raytheon, however, a 60-gigahertz transceiver has been developed, and the designer, Palle S. Christensen, anticipates no production problems.

Raytheon's point-to-point relay has an output of only 15 to 20 milliwatts and an antenna that narrows its beam to only 0.75° to 0.8°. Christensen, manager for electrical design at Raytheon's Communications and Data Processing operation in Norwood, Mass., says that despite its low power, the system's high frequency and narrow beam make it almost impossible to tap or jam. "The idea is to transmit only far enough, and only to the receiver desired," he notes.

No leaks. The 60-Ghz carrier frequency, he points out, "is right in the middle of the so-called oxygen absorption band. Thus our signal is attenuated by tens of decibels for each kilometer it travels—and it's not that powerful to begin with." The narrow beamwidth also helps, by placing almost all the transmitted energy in the dish of the receiver antenna.

Christensen says a 1-kilowatt jammer only two miles away couldn't impair the signal, and adds: "Besides, it will be a while

before anyone can produce that much power at 60 Ghz."

"In fact," he adds, "we didn't expect as much output as we got." Christensen says the two-stage varactor multipliers that make possible the 60-Ghz output were far more efficient than Raytheon had hoped. "We asked for 5 milliwatts, expected 2, and got 15 or 20."

The proprietary multipliers were built by a small West Coast firm that Christensen won't identify. "They are part of our competitive edge," he notes. The West Coast firm makes the multipliers from Sylvania 5200 series gallium arsenide varactors.

Applications. Christensen says the system should find its way into antiaircraft missile batteries, battlefield data processing systems, front-line telephone communications systems, and radar remote operation and surveillance schemes. And it has a long-range chance to replace blinker-light systems—still considered more secure than radio—on ships.

An early application might be transmission of radar video information from several transmitter-receiver sites to a single control center. This is the role of another Raytheon system—the TMR-1 point-to-point link—in the forthcoming TPN-19 advanced radar system for

tactical air control applications.

Several hundred TMR-1's are slated for delivery to the Air Force with the air control system, and Christensen plans to make an add-on module that would contain the multipliers and antenna needed to raise the TMR-1's C-band output to 60 Ghz from 7.5 Ghz.

Compatible. "The TMR-1 thus would be converted to a secure system with a range of about a half-mile," he says. "This would be a low-cost conversion since the TMR-1 would supply modulator, demodulator, i-f circuitry, a local oscillator, and frequency synthesizer."

Since the TMR-1 is modular, the 60-Ghz system would form another plug-in. Spares and replacement parts for all but the frequency multiplier could come out of existing inventories for the TMR-1, says Christensen.

Raytheon hasn't tried to sell its new idea to any of the services yet, but spokesmen feel that the security, bandwidth, and antijam capability should be enough to tempt the services into reviewing their point-to-point communications needs.

Oceanography

Open and shut case

Offshore distribution of natural gas and petroleum, as residents of Santa Barbara, Calif., will tell you, is beginning to proliferate in the waters around the United States. But as firms go farther and farther offshore with their pipelines, it becomes more expensive to provide a reliable and secure way to open and close the valves that control the flow along these underwater routes. Hard wires, used along most lines to carry signals that trigger the valves, get expensive when you start talking about 80 to 100 miles of pipeline.

With this in mind, engineers at the Bendix Corp.'s Electrodynamics division developed a system that locates and actuates these valves by remote sonic signals from a command unit aboard a surface



Damon's got 'em!

Monolithic Crystal Filters.

IMMEDIATE DELIVERY ON "STANDARDS"



Custom designs take a little longer.

If one of the 4 "standards" in the accompanying chart meets the requirements of your communications system, you can forget the delivery problem. Damon is making immediate off-the-shelf delivery of evaluation quantities. In addition, you get all these extra advantages over conventional, multi-component filters: much smaller size, significantly lower price and practically zero failure rate.

Damon also offers a wide variety of computer-assisted custom designs but these take a little longer — 3 weeks from date of order.

For detailed technical brochure on Damon Monolithic Crystal Filters, write Electronics Division, Damon Engineering, Inc., 115 Fourth Ave., Needham, Mass. 02194. Or call (617) 449-0800.

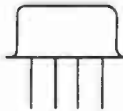
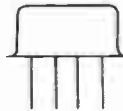
"STANDARD" 4 POLE MONOLITHIC CRYSTAL FILTERS

				
MODEL NO.	6347 MA	6347 MB	6348 MA	6348 MB
Center Frequency	10.7 MHz \pm .5 KHz	10.7 MHz \pm 1 KHz	21.4 MHz \pm .5 KHz	21.4 MHz \pm 1 KHz
Bandwidth, 3 dB	6 KHz min	15 KHz min	6 KHz min	15 KHz min
Bandwidth, 40 dB	24 KHz max	50 KHz max	24 KHz max	55 KHz max
Ripple, Max	1 dB	1 dB	1 dB	0.5 dB
Insertion Loss, Max	3 dB	2 dB	3 dB	2 dB
Spurious Returns	> 40 dB down	> 30 dB down	> 30 dB down	> 20 dB down
Terminations (Resistive)	1.5 kilohms	3.9 kilohms	0.38 kilohms	1.3 kilohms
Ultimate Atten.	55 dB	50 dB	50 dB	45 dB
Op. Temp Range	0°-60° C	0°-60° C	0°-60° C	0°-60° C
Case	T0-8	T0-8	T0-8	T0-5

DAMON

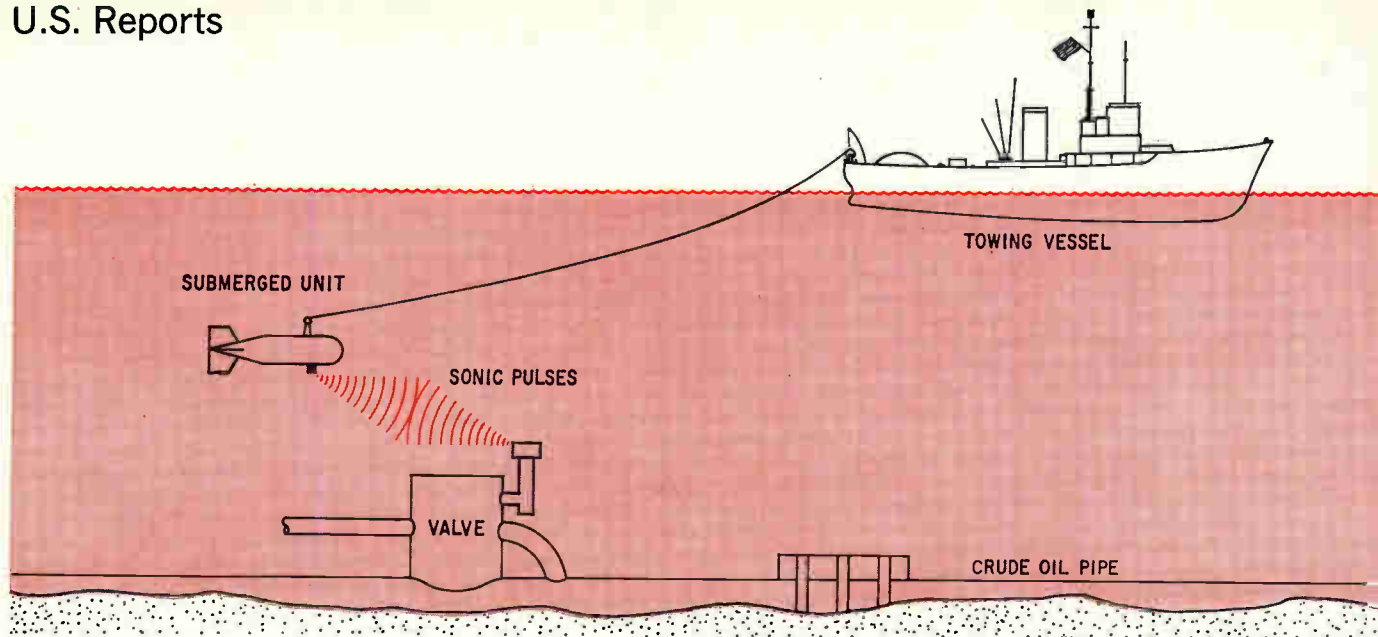

Run silent. Chance of leakage from underwater oil pipelines is reduced by Bendix sonic underwater-valve locator. When in range—half a mile or less—acoustic transducer in torpedo-shaped unit actuates valve.

vessel half a mile away.

Towed unit. Along with a portable display and associated electronics aboard the ship, the system consists of a torpedo-shaped unit linked by wire to the ship. This unit, towed well beneath the ocean's surface, contains an acoustic transducer that actuates an electronics package at the valve. The package contains a hydraulic actuator, a transponder command actuator, a limit switch assembly, and a five-year power supply consisting of a six-volt battery for the receiver as well as a 24-volt supply for the transmitter and control mechanism.

As the ship tows the transducer-bearing unit toward a valve location, an electrical signal from the ship is converted to pulsed acoustic energy. This interrogation code is sent at a discrete frequency—somewhere between 10 and 19 kilohertz. Wallace Haase, program manager for offshore acoustic systems at the North Hollywood, Calif., facility, explains that security against inadvertent, or even deliberate, tripping of the wrong valve is an understandably important consideration. And since no Government agency has jurisdiction over acoustic frequencies, Bendix has had to devise elaborate codes to provide secure operation in a field that may be crisscrossed with pipes operated by different companies.

Three-mile range. The transpon-

der at the valve, preset to react at that frequency, answers the interrogation at one of three frequencies between 8 and 9 khz. When the answer is received, the Nixie-tube display aboard the ship shows the sonar slant range to the target valve as well as the status of the valve—open, closed, or moving between these two positions—depending on which of the three reply frequencies is received. The system can locate a valve from three miles away.

The actual command to open or close the valve is a high-frequency signal somewhere between 78 and 90 khz. Haase says the operate signal is sent at a higher frequency to further enhance security because at 78 to 90 khz a sonar signal is only effective at short range—a half mile or less; longer distances bring on severe attenuation.

When actuating the valve, the surface ship must slow to about two knots in order to reduce radiated noise and to minimize the doppler effect on the command code. But Haase says the company is currently studying the possible use of helicopters in emergency situations such as impending hurricanes where speed is essential.

Bendix, which won't talk about costs, does indicate, however, that one firm operating in the Gulf of Mexico has already agreed to buy the system. Bendix officials are also

talking with 10 other companies who have pipelines there.

Computers

In the factory

Today's automated production lines use any of four types of controllers: relay racks that control operations sequentially, numerical control systems, general-purpose computers, and special-purpose digital systems built from printed-circuit logic modules.

Now there is a fifth.

The new entry is a digital computer called the PDP-14 and it shortly will be introduced by the Digital Equipment Corp., Maynard, Mass. Inexpensive by almost any industry standard, the smallest version of the PDP-14 will sell for about \$4,400 and include a 12-bit processor unit, a 1,000-word read-only memory, one input interface module (32 inputs), one output interface module (16 outputs), power supplies, package, and cable.

The PDP-14 is designed to control the repetitive functions found, for example, on automobile production lines and could control quite large facilities—it is expandable to 4,000 words of memory and up to 24 input or output modules. Accessory modules, such as non-

Semtech introduces... the "METOXILITE*" Rectifier.

Metoxilite is fused to the metallurgically bonded junction-tungsten pin assembly forming a "tough" sub-miniature package. A "state-of-the-art" rectifier that can be used anywhere — you'll see them used in stringent military and space environments, industrial and commercial applications. The Metoxilite rectifier is the result of over three years of applied research and extensive testing. Available in two current ratings — 6 amps / MIL-STD-750A (3 amps @ 55°C / no heat sink) and 3 amps/MIL-STD-750A (1 amp @ 55°C/no heat sink)—the Metoxilite rectifiers feature PIV up to 1000 volts and extremely low reverse leakage with Medium (t_{rr} 2 μ sec) or Fast (t_{rr} 150 nsec) Recovery characteristics.

Exceeds all MIL and space requirements
Electrically approaches theoretical
Available in production quantities
Immediate delivery



*"METOXILITE" — fused metal oxides.

San Francisco—941 E. Charleston, Suite 10, Palo Alto, California 94303 / (415) 328-8025
Chicago—140 N. La Grange Road, La Grange, Illinois 60525 / (312) 352-3227 / TWX: 910-683-1896
Dallas—402 Irving Bank Tower, Irving, Texas 75060 (214) 253-7644
New York—116-55 Queens Blvd., Forest Hills, New York 11375/(212) 263-3115/TWX: 710-582-2959
European Sales—Bourns A. G. Alpenstrasse 1, Zug, Switzerland / (042) 4 82 72/73



SEMTECH
CORPORATION

652 Mitchell Road, Newbury Park, California 91320
(805) 498-2111, (213) 628-5392 / TWX: 910-336-1264

U.S. Reports

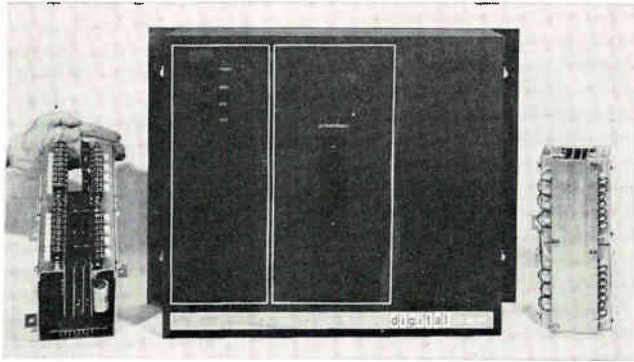

Inexpensive.
Small process-control computer developed by Digital Equipment will sell for about \$4,400.

destructive memories, counters, timers, status displays, and numerical readouts will also be available.

Price comparison. "Our immediate goal is to displace many of the relay-type control systems that now account for up to \$400 million in yearly domestic sales," says project manager John J. Holzer Jr. "Though our price is low compared with relay systems," he says, "our biggest advantage will be reduced downtime. A major auto maker tells us that his relay-operated control systems are out of action about 35% of the time, and reckons that solid state PDP-14's could save him about \$10 million worth of downtime yearly."

Longer life. "System life should be longer as well," he adds. "Relay controllers are good for about two to five years at most while the PDP-14 should last 10 or more."

The company's market researchers also found that about 80% of a relay controllers' downtime was taken up in just finding the trouble. To cut troubleshooting time to a minimum, Digital Equipment will make available a diagnostic read-only memory board that can exercise all the logic in the PDP-14, and a maintenance control board that can be plugged in temporarily to check out the machine's response to its inputs and read-only memory content.

Checkup. "By switching through a combination of inputs, and watching the play of lights on the diagnostic panel, a user can check out the whole PDP-14 and isolate problems fast," says Donald E. Chace, project engineer. "If the fault is too severe to correct on the spot, the processor lifts right out for re-

placement. This should minimize production line outages and for a user with several PDP-14's, the price of a spare should be relatively low at only \$2,000 or \$3,000."

Manufacturers who alter their products frequently should like the PDP-14. The controller's braided wire memory is built by Memory Technology Inc. of Waltham, Mass. [*Electronics*, Dec. 9, 1969, p. 148], and to change the machine's instructions it's necessary only to change the memory. John J. Marino, Memory Technology's president, says that it takes only minutes to exchange one memory board for another.

To automakers, who retool yearly, the plug-in memory could mean great savings, and two automakers already are said to be testing the computer.

With relay systems, a minor model change could mean the complete reconstruction of 30 to 40 relay panels—a major model change might effect as many as 2,000 panels, according to Holzer. Though the cost of a panel varies with application and size, he says that such panels are a cinch to cost more than a new read-only memory's \$200 to \$300.

Programing. Digital Equipment doesn't plan to sell programmed devices but will let the user write his own.

"Starting with the Boolean equations, users can translate their needs into a read-only memory format with a PDP-8L computer and a special compiler program," says Holzer. Large users will probably buy their own PDP-8L's because, he notes, its cost is small compared with the cost of the relay control gear that the PDP-14 replaces.

After the equations are translated into a read-only memory format the user can connect his PDP-8L and PDP-14 and use the -8L's core memory to simulate the -14's read-only memory. Using a program called SIM-14, the two computers are run to debug the program, and afterward the -8L cuts a paper tape that is sent to Memory Technology and translated into a braided wire read-only memory.

Digital Equipment may rent -8L's to small users to aid them in programing.

Application. Though some \$10 million to \$20 million worth of printed circuit logic modules are sold into special-purpose control schemes each year, Holzer figures that the programed flexibility of the PDP-14's read-only memory should suit it to all but a few of the applications now held by logic modules. He expects that the module makers will be forced to build their own machines as their markets dry up.

He also expects to cut into sales of general-purpose computers now used for repetitive control, but states that process control, as is common to the chemical industry—"control applications which involve many accurate analog inputs or instructions"—will remain the province of the general-purpose machine and numerical controllers.

But even numerical control should feel some pinch, as the PDP-14 takes over any repetitive functions that may exist in such systems, he feels.

Mini machine

Ask any engineer who is building, say, a process control system, what his biggest headache is in working a computer into it, and he'll probably tell you it's writing and debugging programs. He's not a programmer, he usually doesn't have one to do the task for him, and while there are a number of small processors available, their manufacturers haven't always taken into consideration this customer's limitations.

But people in the System Prod-

.....YOU ASKED FOR IT.....HERE IT IS!.....

Magnification on both tapes shown:
Vertical 50,000 x
Each Small Div. = 2 microinches
Horizontal 100 x
Each Small Div. = .002"
Cut-Off Wavelength .03"

This Talysurf trace shows a
2.5 microinch surface.

A more polished ceramic
shows a .3 microinch surface.

ALSiBASE

POLISHED CERAMIC SUBSTRATES

Especially processed ALSiBase substrates are now being produced up to 5" x 8" with a ground surface of 10 microinches CLA or better. Smaller substrates on the order of 1" x 3" with surface of 2 or better and substrates of 1" x 1" with surface of 1 microinch CLA or better are now practical. The surface is remarkably uniform with a minimum of voids. These substrates are produced, ground for flatness and thickness control and polished for surface finish under one responsibility.

The basic ceramic is ALSiMag 772, a 99 1/2 % alumina ceramic composition of extraordinary strength and superior electrical characteristics.

PROTOTYPES normally can be hand made at no tooling cost. Consultation is suggested to arrive at the design most desirable for your application.

CODE IDENT. NO. 70371

PHONE 615 265-3411, CHATTANOOGA, TENN. 37405

American Lava Corporation **3M**
A SUBSIDIARY OF COMPANY

For service, contact American Lava representatives in Offices of Minnesota Mining and Manufacturing Company in these cities (see your local telephone directory): Boston: Needham Heights, Mass. • Chagrin Falls, Ohio • Chicago: Elmhurst, Ill. • Dallas, Tex. Indianapolis, Ind. • Laurens, S. C. • Los Angeles, Calif. • Metropolitan New York: Ridgefield, N. J. • Up-State New York and Canada: Phoenix, New York • Orange, Conn. • Philadelphia, Penna. • Roanoke, Virginia • St. Louis: Lee's Summit, Mo. So. San Francisco, Calif. • 3M International: c/o American Lava Corporation, Chattanooga, Tenn. 37405, U.S.A., 615/265-3411.

67th
YEAR
OF
CERAMIC
LEADERSHIP

U.S. Reports

ucts department of Scientific Data Systems have been supplying him logic modules and digital-to-analog and analog-to-digital converters, and they think they know him pretty well. They believe they've taken a big stride toward helping him put together his special-purpose system by introducing their CE 16 and CF 16 digital computers. The two machines differ only in speed and price: 42-microsecond multiply subroutine and \$14,900 for the CF 16 and 126 microseconds and \$12,800 for the CE 16. The prices include 4,096 words of core memory plus an ASR33 teletypewriter and coupler.

Because the machines have a large instruction set—126, including 15 memory reference instructions—the multiply times are software multiply times. Kenneth Isaac, manager of the small-computer program, says, "These are fully signed subroutine times compared with the unsigned, in-line code of four instructions in other small control-

lers." Such a multiply operation requires 10 instructions and 13 memory locations with the SDS machines, compared with 26 instructions and 29 locations in more conventional small computers with a "hardware multiply" option. And that 42- μ sec multiply time on the CF 16 compares with 200 μ sec on a competitively priced 16-bit small computer. The improvement results from eliminating excess data manipulation performed by software in older machines.

Comparison. The SDS machine needs only half as many instructions as other small computers to perform a three-way compare operation. It uses a direct "compare" followed by three "jump" commands for the less-than, equal-to, or greater-than conditions. Other models require eight instructions to carry out the additional steps to perform the subtraction and storage needed when a command routine does not exist.

Norman Meyers, director of the

System Products department, says instructions for a given operation are reduced by building many of them into logic. "These are conventional parallel-bus, 16-bit controllers," he explains, "but we commit some extra hardware to implementing each instruction. We use more logic than competitive machines, but at present integrated-circuit prices, extra logic isn't prohibitive." Both DTL and TTL are used, with DTL NAND gates used for all buses.

Efficiency. Two other advantages of the large instruction set, Meyers says, are that it allows more efficient use of the core memory and input/output system. "Since we've reduced the number of instructions, we can cut the core space needed to store that program, and the user can often get by with the basic 4,096 words."

The I/O is also one of the good things about the machines. There are three priority interrupt lines built in.

"In a process-control application, there may be signals coming from 25 a-d converters with each tied into the interrupt system. Each could ask for priority and have its input stored without interrupting a program. The program would stop, but would pick up at the same point after the priority interrupt."

SDS will supply interface hardware for peripherals such as tape, disk, and punch-card equipment. The firm is playing catch-up with others such as Digital Equipment, Hewlett-Packard, Varian, Data General, and Lockheed Electronics in introducing a low-cost computer, but Meyers believes the large instruction set will give SDS an advantage over the competitive companies.

He says it took so long to come out with a small machine because with the growth expectations for larger, general-purpose computers at SDS, it wasn't immediately clear that there was enough of a market to pursue the smaller-machine business.

Both controllers are 8.75 inches high, 19 inches wide, and 15 inches deep; they're designed to fit in a 19-inch rack. The power supply is

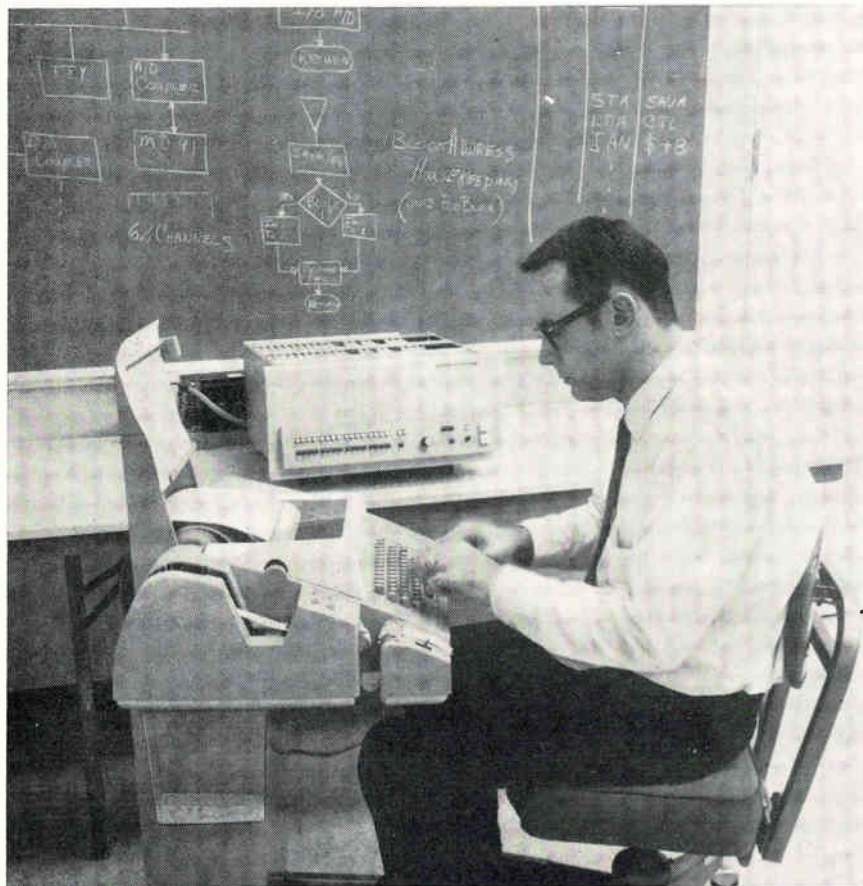

Self-sufficient. Scientific Data Systems introduces small computer that needs less software than comparable machines.

How to build a \$1000 A/D converter for less than \$200.

Start with the Fairchild $\mu A722$ 10-bit A/D-D/A Converter Current Source at \$65. Add \$30 for ten precision resistors*, \$15 for a comparator and \$25 for logic, then spend \$10 tying all these together and testing the completed assembly. For \$145 you've just built a successive approximation A/D Converter that will give you a conversion accurate to 8 bits in $10\mu s$. If you need more accuracy and can give up some speed, tailor the resistors and cut your clock rate — you'll get 10-bit accuracy with a $20\mu s$ conversion time.

The $\mu A722$ is our first linear MSI IC. The chip contains a reference supply and 10 current sources connected to a single summing line through 10 current-steering switches. The built-in reference saves you money; the current steering prevents ringing and yields a switching time of 600ns.

Besides A/D conversion, you can use the $\mu A722$ Current Source for D/A conversion, logarithmic D/A conversion and high-speed hybrid multiplication and division. It will handle more data faster than any comparable system. You can get the $\mu A722$ from your stocking Fairchild distributor. Or, if you're not ready for it yet, send for the complete specs and application notes. They'll give you all the design information you need.

To order the $\mu A722$, ask for:

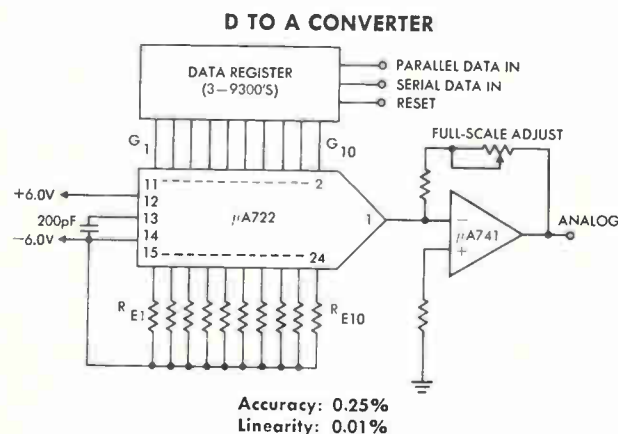

PART NUMBER	PACKAGE	ACCURACY	TEMPERATURE	PRICES		
				1-24	25-99	100-999
U3M7722333	Flatpak	8-bits $\pm 1/2$ LSB	0°C to +55°C	\$97.	\$79.	\$65.
		7-bits $\pm 1/2$ LSB	-20°C to +85°C			
U3M7722334	Flatpak	7-bits $\pm 1/2$ LSB	0°C to +55°C	75.	60.	50.
		6-bits $\pm 1/2$ LSB	-20°C to +85°C			

*Packaged precision networks compatible with the $\mu A722$ are available off the shelf from major resistor manufacturers.

FAIRCHILD
SEMICONDUCTOR

NOW!

5VDC at 1A

IC POWER SUPPLY

for... **24⁰⁰** IN SINGLE QUANTITY

The LIC5-1A is another of Elasco's new series of low-cost, high-quality plug-in power supplies. This power supply is designed to power approximately 25 IC's. The unit delivers 5 volts D.C. at 1 Ampere with regulation and ripple specifications commensurate with integrated circuit requirements. The power supply is manufactured to mount in a standard 5¼" basket, and is available with an overvoltage protection option.

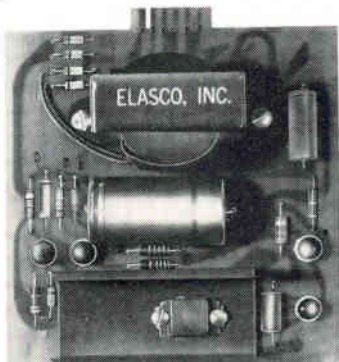

The LIC5-1A power supply is designed for mounting either on a chassis or in a 5¼" IC Basket. As many as 9 units can be mounted in a standard Elasco basket.

FEATURES

- ▲ SHORT CIRCUIT PROOF
- ▲ 71°C OPERATION
- ▲ LOW COST OVERVOLTAGE OPTION
- ▲ DELIVERY: STOCK TO 2 WEEKS

WRITE FOR BULLETIN
269 FOR DATA ON THE LIC5-1A
POWER SUPPLY



ELASCO INCORPORATED
33 SIMMONS ST., BOSTON, MASS. 02120
TELEPHONE 617/442-1600

U.S. Reports

a separate package for each machine, but each weighs just 35 pounds.

Meetings

Support for Ovshinsky

Some confirmation of the claims made for Stanford R. Ovshinsky's rather unconventional work with a glass semiconductor material was presented at the International Solid State Circuits Conference in Philadelphia last month. An electrically alterable but nonvolatile read-only memory has been built at Iowa State University with the material—which is ordinary glass with small amounts of arsenic, tellurium, and germanium added.

The memory's operation is based on the Ovshinsky memory effect. When the molten material is cooled slowly for several hours, it has either of two resistivities and can be electrically switched from one to the other. The resistivity change is a phase change in the material, which acquires crystalline characteristics as it cools. The resistivity the material has when power is turned off is retained when power returns—whether it's minutes or months later.

Another switch. This effect is different from the Ovshinsky threshold effect, for which Ovshinsky has become famous—or notorious—recently [*Electronics*, Nov. 25, 1968, p. 49]. The latter occurs in glass semiconductors that have been cooled quickly.

Again there are two resistivities, but the switch from high to low is made by applying a voltage above a threshold; the reverse change occurs when the voltage is turned off. The threshold effect is bilateral; it can be used in switching circuits [*Electronics*, July 24, 1967, p. 72].

The new developments were reported by Charles H. Sie, who got his doctorate at Iowa State for research on the material and who is now working for Ovshinsky at Energy Conversion Devices in Troy, Mich.

In corridor conversations during the conference, representatives of

Germany's Siemens AG said similar effects have been observed in tellurium oxide.

They didn't report any work beyond the materials level at Siemens, however, whereas work has been done at Iowa State not only on the glass material but on the development of circuits and small memory systems made from the glass material.

LSI under discussion

Opinions vary on the question of who will do what when it comes to putting large-scale integration into practice in new systems. Panelists at the session on custom vs. standard LSI, at the International Solid State Circuits Conference, disagreed on several major points.

First of all, where is the interface—at the mask or at the logic diagram?

It makes a lot of difference.

If it's at the mask, the systems designer will design the mask and turn it over to the semiconductor house, which simply processes the device.

If it's at the logic diagram, the semiconductor maker does all the mask design work.

One panelist, W.R. Raisanen of Motorola Semiconductor, Phoenix, emphasized that it's the systems designer who should design the mask. By 1973, he said, there will be about 1,000 systems companies designing their own masks. In fact, he adds, the people who are serious about MOS LSI are doing it that way now. "Once the systems houses find out how easy it is to design MOS circuits and once they learn how to make the masks, they will go this way." The semiconductor vendor then will simply process the masks and deliver the component.

Job shop. Don Winsted of Signetics, Sunnyvale, Calif., saw it differently. He said that if the semiconductor maker accepts the role of processor his business would become a job-shop operation.

Raisanen's estimate of a typical time was 22 weeks from the first agreement on the product to the

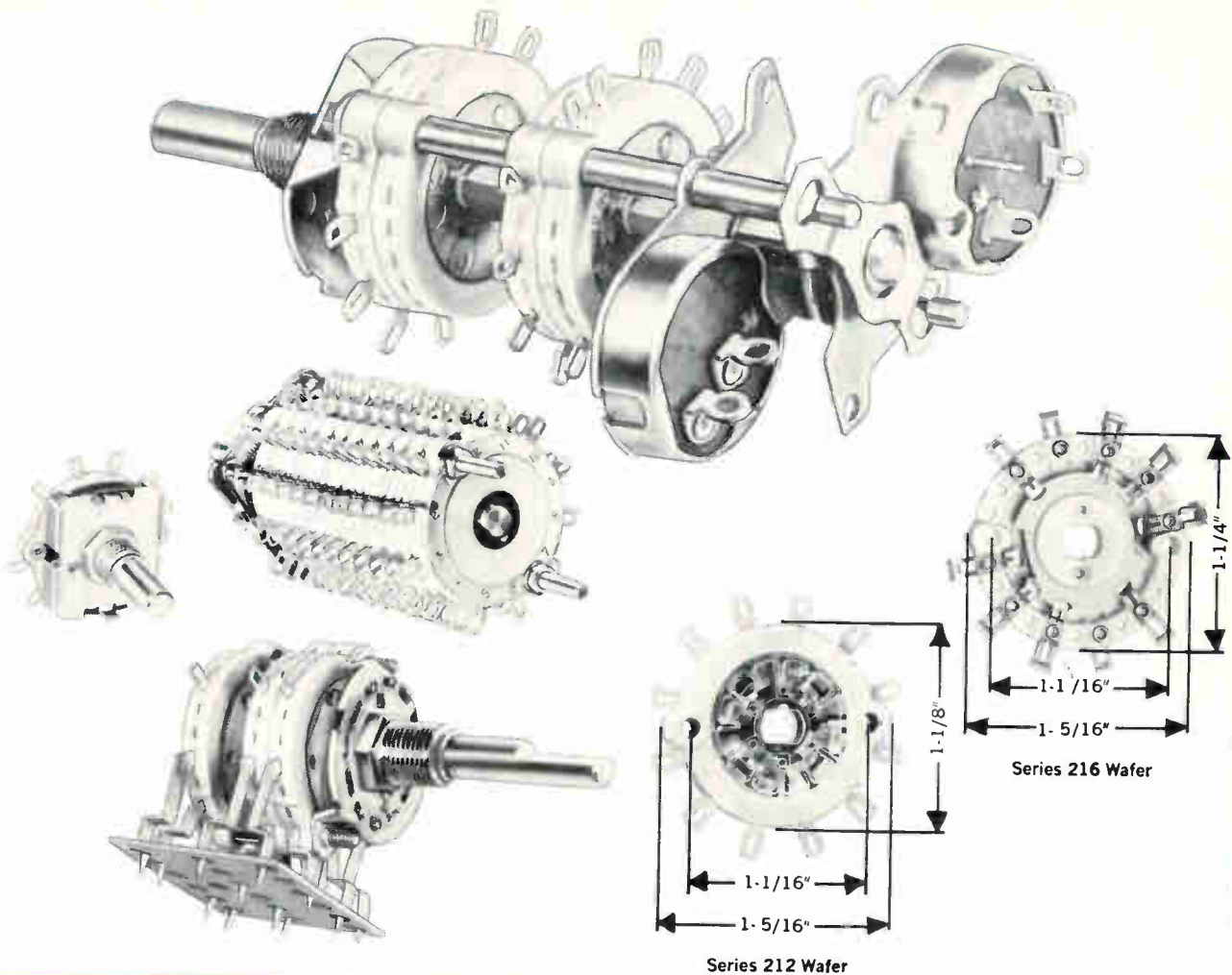

These are the facts that make CTS Switches the engineer's choice

NO BREAKAGE•They don't break on production lines or on finished equipment if dropped or jarred... CTS glass alkyd wafers are not brittle like phenolic... easy to handle.

NO SHIFTING•Precision molded construction eliminates mechanical shifting of stator circuitry and terminals.

MORE COMPACT•No spacers needed when stacking wafers... Maximum switching capability with minimum depth... Smaller diameter—only 1 1/8" (Series 212 wafers)

VERSATILITY OF CIRCUITS•Many circuit variations available due to varied rotor contact configurations.

External jumpers eliminated by CTS internal connectors between adjacent positions.

AVAILABILITY OF POWER SWITCHES•Available with 4 types of power switches and/or numerous potentiometers.

SUPERIOR INSULATION•Glass alkyd is superior to phenolic insulation.

- Soldering heat can't loosen terminals.
- Meet MIL-S-3786 A&B, Style SR03 (Series 211, 212 and 215)
- Balanced contact spring.
- Natural solder barrier provided by glass alkyd insulation.

Which Detent best fits your requirement?

Detent	Application	Cycle Life	Switching Torque
Type 211—Star Wheel Detent	Highest quality applications	250,000	10-50" oz.
Type 215—Double Ball Detent	Quality instrument applications	100,000	6-35" oz.
Type 212—Hill and Valley Detent	Home entertainment and low cost instrument applications	25,000	20-48" oz.
Type 212 ND—Die Cast Detent	Lowest cost applications	20,000	18-40" oz.

4-6 WEEKS DELIVERY



CTS CORPORATION
ELKHART, INDIANA 46514

☎ Phone: 219, 523-0210. TWX: 810-294-2256

Western Source
CTS Electronics, Inc.
(formerly Chicago Telephone of California, Inc.)
1010 Sycamore Avenue
S. Pasadena, California 91031
Phone: 213, 254-9141
TWX: 910-321-4060

Canadian Source
CTS of Canada, Ltd.
Streetsville, Ontario
Phone: 416, TA 6-1141

TODD

cost cutting system power supplies

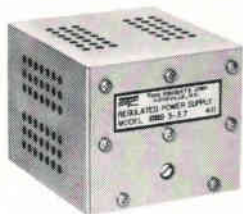

MMS Series

Slot Range

\$69⁰⁰*

FEATURING THE TODD FORMULA FOR
SYSTEM POWER SUPPLY ECONOMY

More watts/in³/°C/\$

More watts / cubic inch

Space saver—only 3³/₄" x 3²¹/₃₂" x 4¹/₂"

More watts / °C

71°C operating temperature. Designed to meet MIL environmental SPECS.

More watts / cost dollar

M Series — your best buy in a system power supply.

7 series — 33 amperes max.

18 models per series

Outputs to 150 Vdc

.01% regulation

.5 mV rms ripple

Remote sensing/programming

5 year warranty — parts & labor

*Slight increase in price for higher voltage units

For complete information, contact your local Todd representative or:

ATC

TODD PRODUCTS CORP.
28 Laurel Street, Hicksville, N.Y. 11801
(516) 822-0784

U.S. Reports

delivery of the first piece to the customer. He said that it now costs about \$16,000 in the initial phase to produce a few samples for a customer, and about the same amount to get the needed quantities to drive the costs down to an acceptable level. Computer-aided design will save about half the \$16,000 initial cost but the rest will not be cut because a computer can't side-step the creative effort.

Raisanen will get another crack at the subject when he appears at the *Electronics Magazine* sponsored Conference on The Changing Interface, March 28 in New York.

Raisanen also expressed skepticism on the future of bipolar LSI, saying that although it was a natural extension of DTL and TTL (which in turn were natural extensions of discrete circuits that users were comfortable with), bipolar LSI may turn out to be another tunnel diode—widely heralded but never living up to the tremendous advance publicity.

Government

Robes of office

The duties of an Undersecretary of the Air Force depend for the most part on the man who occupies the office, and John L. McLucas will bring technical knowhow, administrative experience, and a humanistic attitude to the post. Now president and chief executive officer of the Mitre Corp., Bedford, Mass., McLucas will report to Washington in mid-March.

First approached in late January by Defense Secretary Melvin Laird and Air Force Secretary John C. Seamans, McLucas is said to have bargained hard to get second-in-command responsibility before he accepted. He also made it clear that he wanted to continue his efforts to bring technology out of the military sphere to solve social problems.

But social programs are a personal interest. "Obviously my first preoccupation will be with Air Force needs. It is probable that one of my prime duties will be watchdogging research and development,

and in this area, I'll be working closely with DDR&E (the Defense Department's Research & Engineering office) and John Foster, (the director)," he says.

Old friend. McLucas implies that he might have turned the job down if Foster had been replaced under the Nixon administration. Foster is an old acquaintance of McLucas.

The mechanics of R&D will be scrutinized. McLucas feels that it takes too long to get an idea into operational hardware and involves too much useless paperwork. "I want to see less report writing and more laboratory work," he says. But he makes it clear that he's not out to get systems engineering. "It's the shuttling of paper between the services and DOD systems analysts which should be better supervised." He implies that even before contractors find out about a system, reams of needless documentation already have collected in the Pentagon's files, and it's this he wants to get rid of.

Air Force in the ghetto. McLucas takes a philosopher king's attitude to technology: "It's time we harnessed it to human needs. In some ways we are captives of tools which should be our servants."

Air Force Secretary Seamans is already on record as favoring more spinoff from military programs [*Electronics*, Jan. 20, p. 14], and while this sort of statement is easier for Seamans to back up than for his number-two man, both seem to work from a common point of view. They feel that the country needs to find civilian applications for the costly techniques developed for the military.

But how does a man in the Pentagon aid other branches of Government, like Housing and Urban Development and Health, Education, and Welfare? According to McLucas, "the problems of interagency programs are so severe that often the only recourse is to let the guy with the problem solve it himself—even though you may already have the solution." Differences in point of view and opinion are hard to resolve in Government, he feels.

But already on the Air Force shelves are advanced biomedical

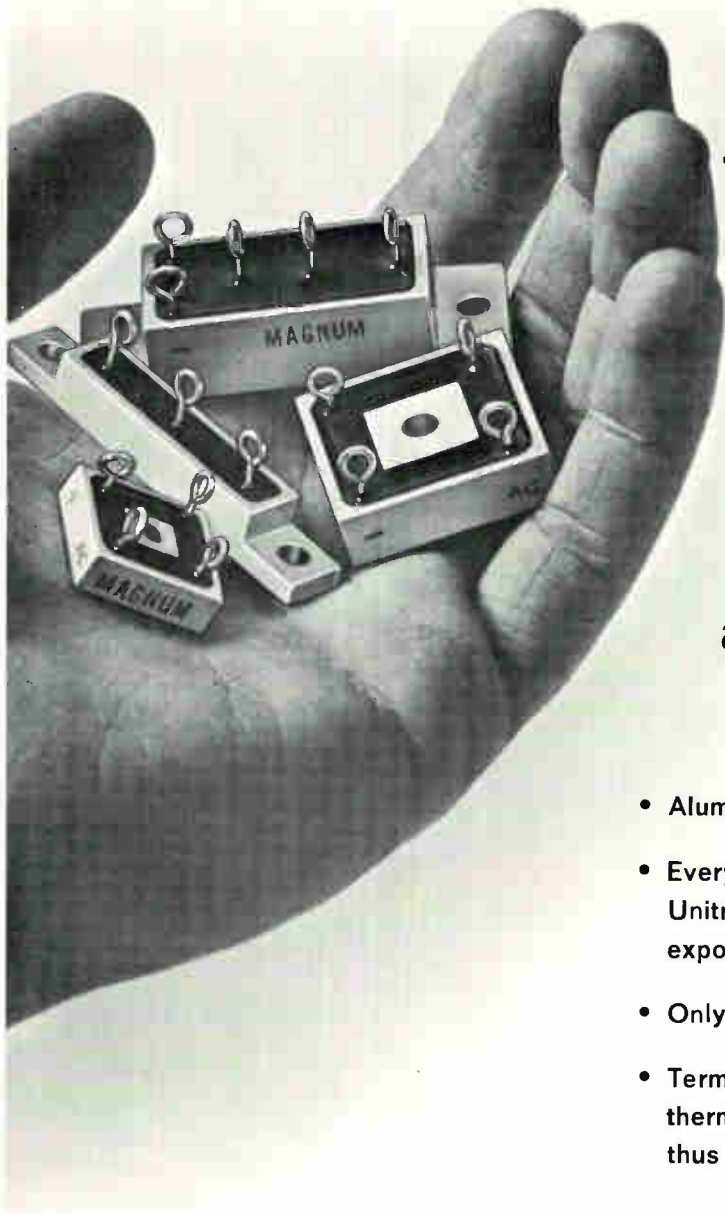

The "inside-out" bridge --
 the first
 high-current
 rectifier assemblies
 designed for reliability
 from the inside out...
 and priced competitively

- Aluminum package optimizes heat dissipation.
- Every chip individually fused in glass in a complete Unitrode monolithic package, so . . . silicon is not exposed to possible contamination by plastic filler.
- Only controlled avalanche rectifiers used.
- Terminal pins directly connected to silicon make direct thermal path — not only to case, but to lead wires — thus lower junction temperatures.

- #678 Series Three Phase 25 Amp Bridges
- #679 Series Single Phase 25 Amp Bridges
- #680 Series Single Phase 10 Amp Bridges
- #681 Series 15 Amp Doublers and Center Tap Rectifiers

PIV'S to 600V.
 4 different packages
 6 circuit configurations
 All available in regular,
 fast, or ultra-fast recovery

THE MAGNUM RECTIFIER ASSEMBLY by

UNITRODE

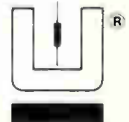

580 Pleasant Street, Watertown, Massachusetts 02172 • (617) 926-0404

IN ITS HEART, YOU KNOW IT'S RIGHT . . .



Actual Size

HERE'S WHAT IT LOOKS LIKE INSIDE

Even before it's potted, the Magnum has all the toughness, reliability, and electrical characteristics of the unique Unitrode fused-in-glass diode as the heart of its construction.



HERE'S WHAT IT LOOKS LIKE INSIDE THE INSIDE

With the silicon die metallurgically bonded between terminal pins of the same thermal coefficient, the hard glass sleeve is fused to the entire outer silicon surface. Result — a voidless, monolithic structure.

For fast action, call Dave Greene COLLECT at (617) 926-0404.

instrumentation, air traffic control schemes that might be of great aid to the FAA, sophisticated electronic data-processing methods, and other techniques. McLucas wants them to be applied widely.

One way of making technology more readily available, without suffering interagency committees, is to open the resources of organizations like Mitre to civilian problems. McLucas began moving in this direction years ago.

During his 32 months as president and chief executive officer of Mitre, he guided the corporation into areas like air traffic control, housing, urban transport, and pollution control. And what couldn't be done during business hours, he worked on in his spare time, especially ghetto capitalism and housing. Meanwhile, he encouraged Mitre employees to do the same. As a result, while Mitre has grown, Air Force support is now only 65% of its income, and the figure is still declining.

As he leaves, Mitre is on the verge of announcing a further redirection of some of its resources into civilian channels, and Mitre spokesmen expect to feel McLucas' influence despite his Pentagon duties.

For the record

Diversification. The Bechtel Corp. is the world's largest engineering construction firm and is known mainly for the dams and bridges it has built. But it's been unobtrusively moving into the microwave power business during the past year. The most recent, though not the biggest, move in this direction was the company's decision to participate with Varian's Eimac division and a large, unidentified paper company in effort to develop a microwave paper-drying machine.

Buyer. The Monsanto Co., a chemical giant but an electronics newcomer, has leaped into the process control business by purchasing The Fisher Governor Co. of Marshalltown, Iowa. To be known as Fisher Controls, the firm will retain present management.

**Compatible...
Moisture Resistant...
Hysol Makes Epoxy
and Urethane Compounds
to Sink, Fly and Click
Anywhere...**

Solve your electronic component insulation and protection problems now with the same HYSOL materials that have been found to be completely compatible in space, underseas and computer components. HYSOL meets or exceeds the most rigid specifications for electronic component protection with a complete line of molding powders and liquids, coating powders and printed circuit coatings. When your program calls for epoxies or urethanes, check HYSOL. Have assurance that HYSOL recommended materials have been thoroughly tested on live components under environmental conditions defined in MIL-STD 750 and MIL-STD 202 in HYSOL's Electronic Testing Laboratory.

HYSOL® THE DEXTER CORPORATION
Write, wire or call HYSOL, Department EM-369
Olean, N.Y. 14760 for application
engineering assistance.



MOLDING POWDERS



COATING POWDERS

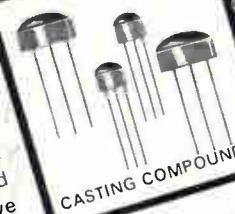

CASTING COMPOUNDS

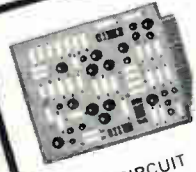

PRINTED CIRCUIT COATINGS

ADVANCED TESTING

1...2...3...

THE WORLD'S MOST ADVANCED
ALL-SOLID-STATE VOM

"601"

It's the first of its kind. Triplet's creative engineering has gone and done it. It has designed and engineered an entirely new concept in All-Solid-State VOM's for fast in-circuit testing of electronic and electrical applications. It has built the new portable Model 601 with Field Effect Transistorized circuitry, push-button and battery operation and with 11 Megohm Input Resistance on all AC-DC voltage ranges. It's ideal for testing IC's, making audio measurements, and usable with Frequencies to 50 KHz.

- 1 14 Ohmmeter ranges with 7 Low-Power ranges at 75 mV DC for transistorized and Integrated Circuits.
- 2 Voltage ranges from 10 mV AC and 100 mV DC full scale; plus AC and DC Current ranges from 10 uA full scale.
- 3 Modern, easy-to-use push-button selection of DC Polarity, AC and Low-Power Ohms functions.

See this new, All-Solid-State (F-E-T) VOM at your local Triplet distributor and you'll be Testing 1 . . . 2 . . . 3

Model 601 (F-E-T) VOM

\$150

Suggested U. S. A. User Net

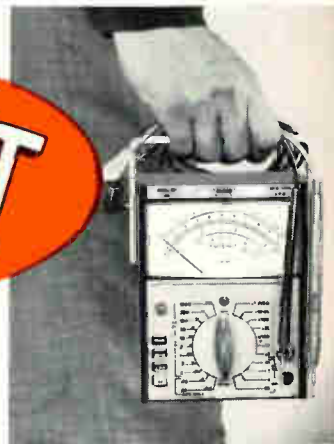

PACT reduces losses 30% for C band microstrip ferrite phase shifters

One of the latest successes scored by Sperry's PACT (Progress in Advanced Component Technology) program is a marked improvement in loss performance of C band microstrip ferrite phase shifters. Non-reciprocal, latching devices in external loop configuration show an improvement in loss characteristics from 3 db to 2 db for 360° shift.

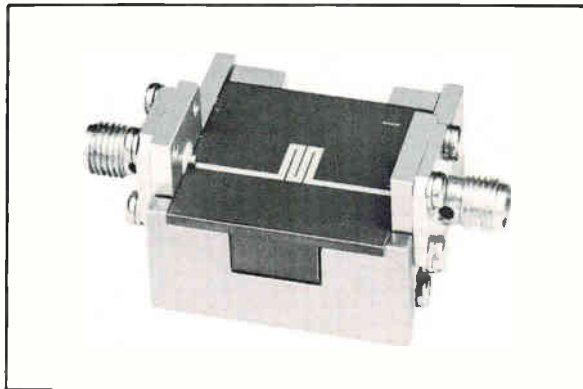

C BAND, NON-RECIPROCAL FERRITE PHASE SHIFTER IN TEST FIXTURE

PACT engineers attacked the problem of improving ferrite planar phase shifter performance by concentrating on two troublesome areas: substrate materials selection and optimum configuration of the microstrip circuitry.

The search for materials was aimed at optimizing and controlling the material characteristics, thus minimizing loss and maximizing phase shift. It led eventually to the selection of aluminum-doped YIG as the most promising material. Circuitry investigations were directed toward maximizing the rf coupling to the ferrite substrate. Meanderlines have been one of the most promising approaches.

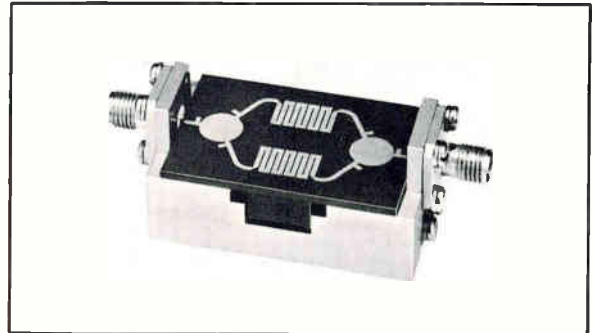

C BAND RECIPROCAL FERRITE PHASE SHIFTER IN TEST FIXTURE

To optimize circuitry configurations, PACT personnel used calculations based on established filter theory for meanderline designs. Complexity of these calculations led to the establishment of a special computer program. The computer not only optimized configurations — it also generated large economies in design time and expense. As a result of the computer operations PACT people were able to increase line-to-line coupling of their devices and effect a considerable loss reduction.

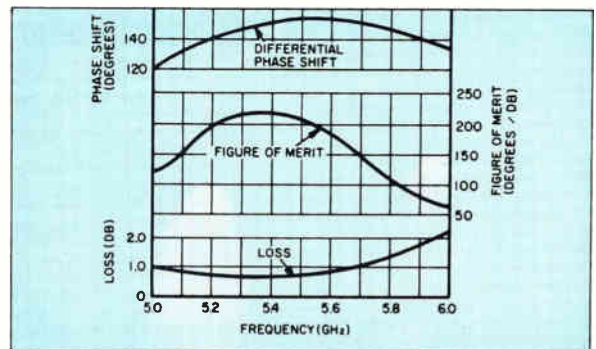

TYPICAL PERFORMANCE OF PACT-DEVELOPED PHASE SHIFTERS

The results of this program have been applied to both reciprocal and non-reciprocal devices. They are also expected to speed Sperry's progress toward commercially available microwave integrated circuits.

To get more information about PACT progress in phase shifters and other areas of microwave IC technology for your application, contact your Cain & Co. representative or write Sperry Microwave Electronics Division, Sperry Rand Corporation, Clearwater, Fla.

*For faster microwave progress,
make a PACT with people
who know microwaves.*

SPERRY
MICROWAVE ELECTRONICS DIVISION
CLEARWATER, FLORIDA

Washington Newsletter

March 3, 1969

Pentagon weighing paper vs prototypes

The Pentagon may return to the old practice of a "faceoff" between competing prototypes before selecting a company to build an item, at least on smaller systems. This would mean junking the approach devised by former Defense Secretary Robert S. McNamara whereby specifications on an item were defined by conceptual and contract definition studies instead of spending money on prototypes. Critics, especially Republicans unimpressed by systems analysis, charge that companies might tend to exaggerate in the heat of competition so that production contracts wind up costing more. They cite the Lockheed C25A transport plane, the Cheyenne armed helicopters, and the Boeing short range attack missile (SRAM) as examples.

Now, under Presidential direction, the Defense Department is seeing if spending more in development means less cost in production. Chances are, however, that the Pentagon would shy away from the high initial cost of funding parallel prototype development for expensive systems.

Bids due in April for satellite laser

The Goddard Space Flight Center plans to have its request for proposals out this week for the laser communications experiment to be carried aboard Applications Technology Satellite F, which will be launched in 1972. Bids will be due in late April. The experiment, the first of its kind, would give the winning firm a nice edge in laser space communications. One insider predicts six to eight bidders.

The procurement will call for identical space and ground hardware using 10.2-micron carbon dioxide lasers. NASA is requiring a 30-pound package able to operate at 30 watts and a minimum 2,000-hour lifetime for the laser. According to Harry Gerwin, project manager for ATS-F, NASA needs a contractor with advanced capability in long-lived carbon dioxide lasers and optical communications.

The basic experiment will involve transmission of laser signals to a satellite for conversion to other signals (such as tv) for return to earth, and sending of nonlaser signals from earth to the spacecraft to be returned as lasers. Later, satellite-to-satellite experiments will be attempted when ATS-G is launched [*Electronics*, Dec. 23, 1968, p. 103].

Viking rfp's ready to sail

Within the next few weeks, NASA's Langley Research Center will issue requests for proposals for the total Project Viking—from development of the Mars spacecraft and orbiters to the collation of data after the two 1973 missions have been completed. The contract will get the lion's share of the total \$325 million expected to be spent on Viking.

With the rfp's about to go out, NASA is moving quickly in other directions on the program. A group of 38 scientists has been appointed to assist in the design and development of instrumentation for the two soft landers which will be deposited on Mars from the Viking orbiters. Eight teams of scientists will work up, by next December, the final plans for the lander experiments. And the titles of the teams indicate for the first time what the landers will investigate.

The Active Biology team will study instrumentation to determine if life exists on the planet; the Imagery group will work on a landed-camera system; Entry Science will determine how atmospheric com-

Washington Newsletter

position can be studied during the descent of the landers; Radio will investigate radio techniques to study Mars. The remaining teams are Ultraviolet Photometer, Seismometer, Meteorology, and Surface Sampling.

Congress may move to realign the FCC

Despite a flurry of headline-making activity in recent months by the FCC, there is a chance that Congress might move to reorganize it.

More and more Congressmen feel that the commission can't respond to the problems generated by new communications technology, and at least one senator thinks that the commission should be reduced from seven to three members. He believes that the liberals and conservatives on the FCC have completely polarized their views after a series of 3-to-3 votes.

The newest member of the commission, H. Rex Lee, is a moderate and is casting the swing vote on many issues. The senator thinks three members would work together more closely and avoid bitter polarization.

Packer quits as P.O. research chief

After nearly three years, Leo S. Packer has resigned as assistant postmaster general for research and engineering. Packer, who insists he never intended to make a career out of the job, apparently felt he accomplished his task of getting the R&E Bureau organized and moving. During his tenure, the postal R&E budget has shot up from \$16 million in 1967 to a \$50 million request for 1970. Packer, who was engineering manager of Xerox before accepting the Post Office job, says he has made no decision yet on whether to take a new Government job or return to private industry.

Sentinel expected to relocate sites

The Nixon Administration will probably approve going ahead with the controversial Sentinel antiballistic missile system but sites for the missile will be moved to isolated areas to mollify infuriated residents near designated cities.

It is believed that the Pentagon had hoped to muster support for the system by placing the sites near cities and claiming the system would defend the populous areas. The brass figured a large number of city Congressmen would become solid supporters of the system since they could use it to make political points with constituents, city politicians, and local contractors. Instead the scheme backfired. City dwellers didn't want the nuclear-tipped missiles anywhere nearby.

Now, the Pentagon hopes that the furor will die down while a committee headed by Deputy Secretary of Defense David Packard reviews the project.

Four firms bid on punch-card job

Four leasing companies have submitted bids to provide the General Services Administration with IBM-made punch-card machinery. IBM, which has been providing the equipment up to now at a cost of about \$37 million annually, did not bid.

The GSA asked for bids in an effort to get better prices through competition [*Electronics*, Feb. 3, p. 57]. Even though IBM declined to submit a bid, this does not mean it is leaving the market: the firm has a running contract with GSA and could wind up with the business if its prices are lowest.

High efficiency / High reliability industrial and lab power supplies



The DCR Series is composed of 34 models — 9 models with power levels of 400 and 800 watts are available, from stock, at 0-40, 0-60, 0-80, 0-150 and 0-300 Vdc in the 5¼" high package utilized by the model DCR 40-10A.

Other features include: ■ compliance with RFI specifications MIL-I-26600 and MIL-I-6181D ■ $\pm 0.075\%$ voltage regulation for line and load changes combined ■ voltage and current regulation with auto-

matic crossover ■ adjustable current limiting with automatic recovery ■ optional overvoltage protection ■ remote sensing and remote programming.

For more information contact your local Sorensen representative or; Raytheon Company, Sorensen Operation, Richards Avenue, Norwalk, Connecticut 06856.

Tel: 203-838-6571;

TWX: 710-468-2940;

TELEX: 96-5953

RAYTHEON



Circle 200 on Inquiry Card

ANALOG DEVICES DOES IT AGAIN!!!

For the past five years Analog Devices has consistently been first to offer state-of-the-art hardware with primary emphasis on *maximum user value*... Now these three NEW amplifiers once more set the pace in the op-amp performance per dollar competition...

LOW COST/GENERAL PURPOSE—\$11

Maximized user value really shows up in this new low cost series. The Model 118 offers performance that was simply unheard of just a few months ago. With every spec "one up" from I.C. types, the 118 is the best value available for literally hundreds of general purpose applications. Not even the spec table tells the whole story. . . A dual input transistor stage, usually found in much higher priced amplifiers, means immunity from "thermal gradient" errors and low noise. Other important advantages are high open loop gain, fast slew rate and low bias current.

Models with 20 volt output swing and 20mA output currents are also available under \$25.

SPECIFICATIONS	118A/K
Open Loop Gain, min	2.5×10^5
Rated Output, min	$\pm 10V @ 5mA$
Full Power Resp. min	100kHz
Slew Rate, min	$6V/\mu sec$
Voltage Drift, max	$\pm 20/5\mu V/^\circ C$
Bias Current, max	$\pm .6/.5nA/^\circ C$
Price (1-9)	\$11/\$21
(10-24)	\$10.50/\$19



CHOPPER STABILIZED OP-AMP—\$64

This new series sets the price standard for sophisticated chopper stabilized op-amps. At \$64 unit price, the 232J is less than half the cost of comparable units available just last year. Performance has also been improved over previous types. . . long term drift tests indicate that initial offset voltage will stay within $5\mu V$ indefinitely and low frequency "flicker" noise has been reduced. Package size is only 0.4" high for card rack mounting.

A selected high performance version designated 232K is available at \$99 unit cost. The units are identical except for initial offset voltage and drift rates ($10\mu V$, $0.1\mu V/^\circ C$) and initial bias current and drift rate ($50pA$, $0.5pA/^\circ C$).

SPECIFICATIONS	232J
Open Loop Gain, min	10^7
Initial Offset, max	$15\mu V$
Voltage Drift, max	$0.25\mu V/^\circ C$
Long Term Stability	$1\mu V/month$
Noise, dc to 1Hz	$1.5\mu V$, p-p
Bias Current, max	100pA
Current Drift, max	$1pA/^\circ C$
Rated Output, min	$\pm 10V @ 4mA$
Price (1-9)	\$64
(10-24)	\$58



ELECTROMETER AMPLIFIER—\$50

The Models 310 and 311 are varactor bridge input amplifiers with ultra low bias currents . . . not exceeding $10^{-14}A$. These new amplifiers offer for the first time a realistic, solid-state alternative to vacuum electrometer tubes. In addition, voltage drift of only $30\mu V/^\circ C$ is 10 times less, and \$50 in hundred lots is highly competitive.

The 310 is for inverting operation and is useful where ultra low currents are measured as is typified by photo-multiplier tubes and gas chromatograph flame detectors. The 311 is essentially identical but is optimized for non-inverting circuits. It is the best choice where voltages from high source impedances are found (pH cells, chemical transducers, etc.)

SPECIFICATIONS	310/311
Open Loop Gain, min	10^5
Rated Output, min	$\pm 10V @ 5mA$
Voltage Drift, max	$30\mu V/^\circ C$
Signal Input	
Input Bias Current	.01pA, max
Input Impedance	10^{14} ohms
Noise (.01-1Hz)	.001pA, p-p
Price (1-9)	\$75
(100 lot)	\$50



These are just three examples of the 19 brand new products which appear for the first time in our new comprehensive catalog for 1969. All have been specifically designed for *maximum user value* . . . get your FREE copy today, available from any sales office or use the Reader Service Card.



SEE US AT IEEE BOOTH 4E-26, 4E-28

Two Twenty One Fifth Street
Cambridge • Massachusetts 02142
Tel: (617) 492-6000 • TWX: (710) 320-0326

 **ANALOG
DEVICES** INC

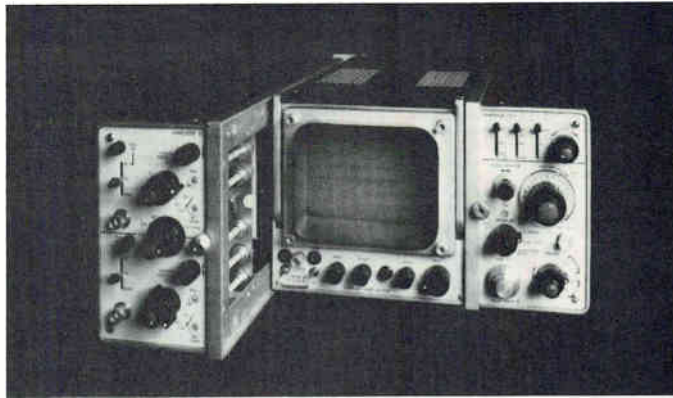

Here's the scope that makes the Jolly Giant green—Data Instruments Model 7100. For the engineer who looks at the trace instead of the nameplate, it has no equal. It's portable, and has a 5 inch rectangular PDA tube with a variety of plug-in amplifiers geared to the most current needs. The unit shown here is 50MHz, dual trace with chopper, alternating and summing modes, and a 10mv/cm sensitivity.

Now, it is true, that for a few hundred dollars more, you can get a midget version from the Jolly Giant. And if you focus on the nameplate, it's very readable. As far as the trace goes, the 7100 is 25% larger and consequently faster and more sensitive. Still, if you can calibrate your eyeballs you can read the midget almost as well.

Almost. But not quite. The 7100 has a much smaller spot and consequently a measurably cleaner trace. Besides all this, the 7100 is built to the requirements of critical military applications. It is ruggedized at no extra cost. And speaking of cost, the main frame is \$880. A series of time bases and vertical amplifiers ranging from \$142 to \$482 gives the unit wide applications including single shot function, TV monitoring, etc.

But why guess. Demonstrate it side by side with the midget trace, and decide which is better—a bigger trace or a bigger nameplate.

Data Instruments Div., 7300 Crescent Blvd., Pennsauken, N.J. 08110

50MHz, portable, plug-in
and you don't need calibrated eyeballs

\$1698

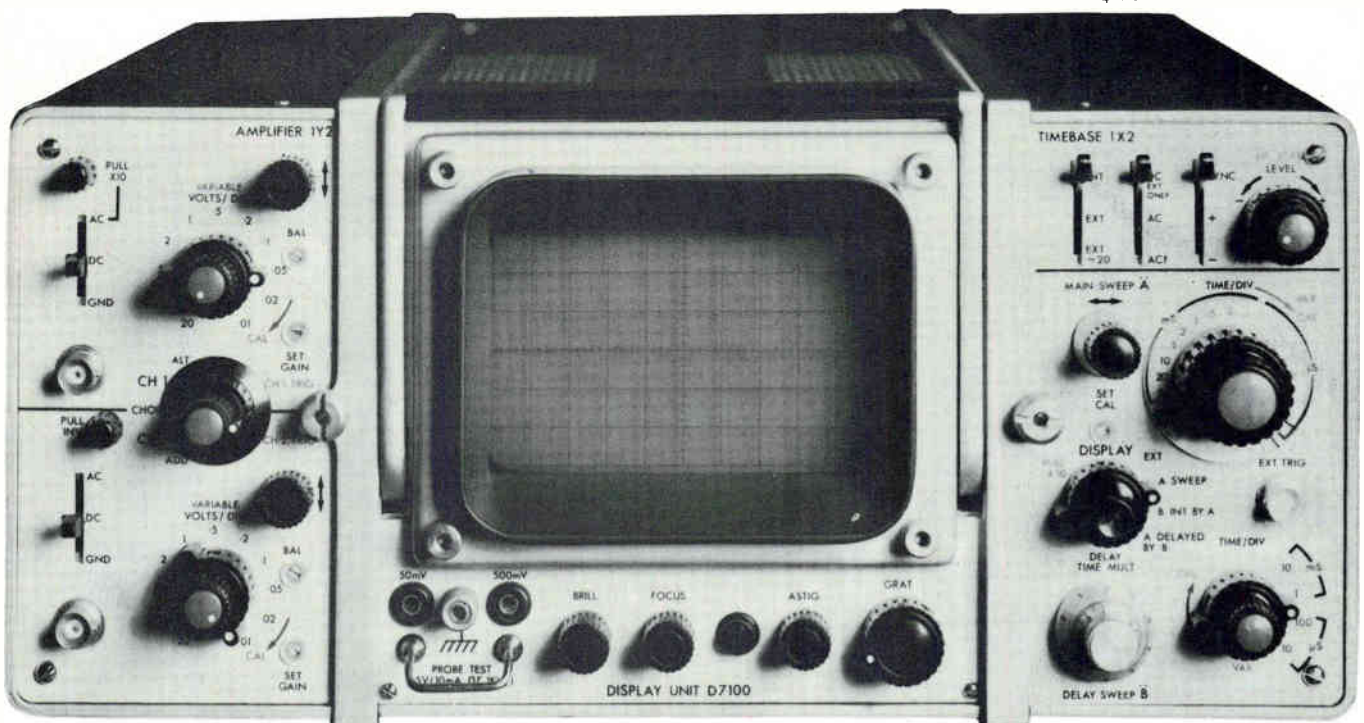

want to
take off
in electronics?

ask us



Components manufactured by O/E/N companies are vital in keeping today's jets flying. On the control panel you'll find pushbuttons, indicator lights, thumbwheel and rotary switches. In communications systems...crystal filters and oscillators, and potentiometers. And elsewhere, from the cockpit to the tail...relays, solenoids and electronic insulation.

Each component is engineered to provide instant, accurate response, as well as compact, clean and readable visual information. We're in ground control equipment, up in the jets, and even beyond...in aerospace. We're a single source of supply for a variety of components used by almost every industry today.

Matter of fact, we're not sure where we'll be next. Our R/D people are a restless lot, never satisfied, always trying to make something better. This constant updating of technology has been O/E/N's driving force.

Here are a few highlights and we'd be pleased to tell you even more about them. Write for individual product literature and/or booklet describing O/E/N, its companies and products.

Reader Service Card No. 310

simpler, better control panels result from Multidex® switches

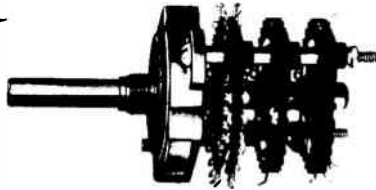

Multidex switches were engineered to meet the increasing demands for flexible and fast designs faced by today's electronic engineers.

This versatile switch line offers an almost unlimited number of variations of the most popular options and features and eliminates much tedious design work for the engineer. In fact, it is his best choice to replace seven older sizes and types of switches. What's more, Multidex switches are smaller and yet provide more contacts (even 32 and 36 positions).

Detent mechanism offering a crisp, uniform action is available in a wide number of throws. Diallyl phthalate insulation is used and Oak-pioneered double-wiping contacts are a further guarantee of dependable operation. If rotary switch design is your job, you'll want full details on the versatile, new Multidex line of rotaries.

OAK MANUFACTURING CO.

Crystal Lake, Illinois 60014

Reader Service Card No. 311

O.K., now...by the numbers!



Zero to nine (optional decimal point) daylight visible and from wide angles...that's LAMP's new filament readout Numeralamp. This 4-volt AC/DC lamp offers 200,000 hours average life. Numerals (0.4" x 0.7") formed by seven tungsten filaments operating at 1800°K., emit 4,000 foot-lambert brightness. Filaments are the type used in Military Standard lamps of high reliability and duration.

Lamps, (2.1" high x 0.83" dia.) sealed in a standard 9-pin vacuum tube base, mount on 1" centers.

LOS ANGELES MINIATURE PRODUCTS

17000 South Western Avenue
Gardena, California 90247

Reader Service Card No. 312

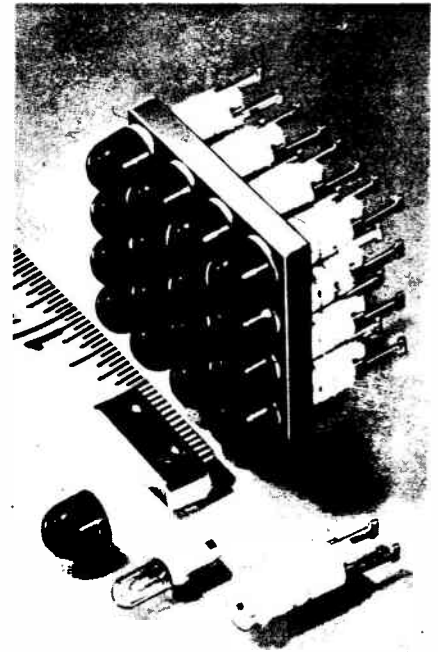

dot-lite lamps aim high

They're a natural for computers, but the extremely small size and high brightness of these bantam-weight indicator lights makes them a logical choice for sophisticated airborne displays as well.

Sixteen of these tiny T-1 units can be mounted in a single square inch of panel space and the lamp base snaps right into the panel mounting holes (without any hardware) on 0.218 centers.

In addition, the T-1 lamp can be replaced in just seconds, from the front of the panel, without tools.

There's no guesswork in replacing lamps either, as far as proper voltage rating is concerned. Lamp ratings range from 1.5 V to 28 V and each base is color-coded for instant identification. Snap-on lens caps are available in a wide choice of colors and shapes.

MARCO-OAK

P. O. Box 4011
207 S. Helena Street
Anaheim, California 92803

Reader Service Card No. 313

midget tick-tock for computers



Compact, inexpensive, versatile—sums up the reasons for designing McCoy's new MC109A1 clock oscillator into computers and peripheral equipment. It's only 1" square by 1/2" high, yet offers output over the entire 30 kHz to 50 MHz range. It holds ± 150 ppm maximum from -55° to $+105^{\circ}$ C. over the 30-650 kHz

range, ± 50 ppm from -55° to $+125^{\circ}$ C. over the 180 kHz to 50 MHz range. Over smaller temperature ranges, even better stabilities are possible.

With an input voltage of only 5 vdc ($\pm 5\%$), this clock oscillator is compatible with DTL, RTL or TTL logic. Meets all requirements of MIL-E-5400, class 2 (commercial versions also available). While the basic styles give general capabilities, all electrical specifications are variable and can be altered for specific requirements. Delivery time is 2-6 weeks, depending on frequency desired.

MCCOY ELECTRONICS COMPANY

Mt. Holly Springs, Pennsylvania 17065

Reader Service Card No. 314



trim your controls with a wee pot

Only 1/4" square, these efficient little wirewound trimming potentiometers still allow a 25 turn screw adjustment... trim over a 10 to 25 k ohm range. They're rated for 3/8 watts @ 85° C., with excellent resolution at all resistances. High temperature diallyl phthalate case—with molded "O" ring moisture resistant seal—eliminates insulation problems.

The units are available with positive clutch stops or optional continuous rotation. Load life of 1,000 hours meets or exceeds MIL-R-27208, Style RT27, requirements. Printed circuit pins meet MIL-STD-1276, Type N2, requirements.

TECHNO COMPONENTS CORP.

7803 Lebona Avenue
Van Nuys, California 91405

Reader Service Card No. 315

insulation problems... call for Fluorglas[®] products



They'll do any job that calls for insulation with high dielectric strength, low dissipation factor...that won't burn, carbonize or support combustion.

Fluorglas products are compatible with all materials, resistant to chemicals and fungus, thermally-stable, moisture-resistant and strong.

They're made in lacing tapes for wire-bundling, yarns for wire wrap and harnesses, adhesive tapes for cable wrap and laminates for microwave uses. You couldn't want much more... write today for Catalog DE-03.

DODGE INDUSTRIES, INC.

Hoosick Falls, New York 12090

Reader Service Card No. 316

turn on... with a tom thumb relay



When space, weight and cost are important, "Versapac" 67 relays fill the bill. These miniature relays do a tremendously big job for their compact, less-than-a-cubic-inch size.

They're the only industrial relays available offering 2 to 8 Form C's, single and bifurcated 3 or 5 amp contacts. They're versatile and adaptable with solder lugs or printed circuit sockets, and a mechanical life tested at over 100-million operations.

Unusually precise adjustments are made possible by the use of Armco steel for the one-piece frame and core. These relays are protected by a clear plastic cover and operate at ambients from -55° to $+71^{\circ}$ C.

HART-ADVANCE RELAY DIVISION

Crystal Lake, Illinois 60014

Reader Service Card No. 317

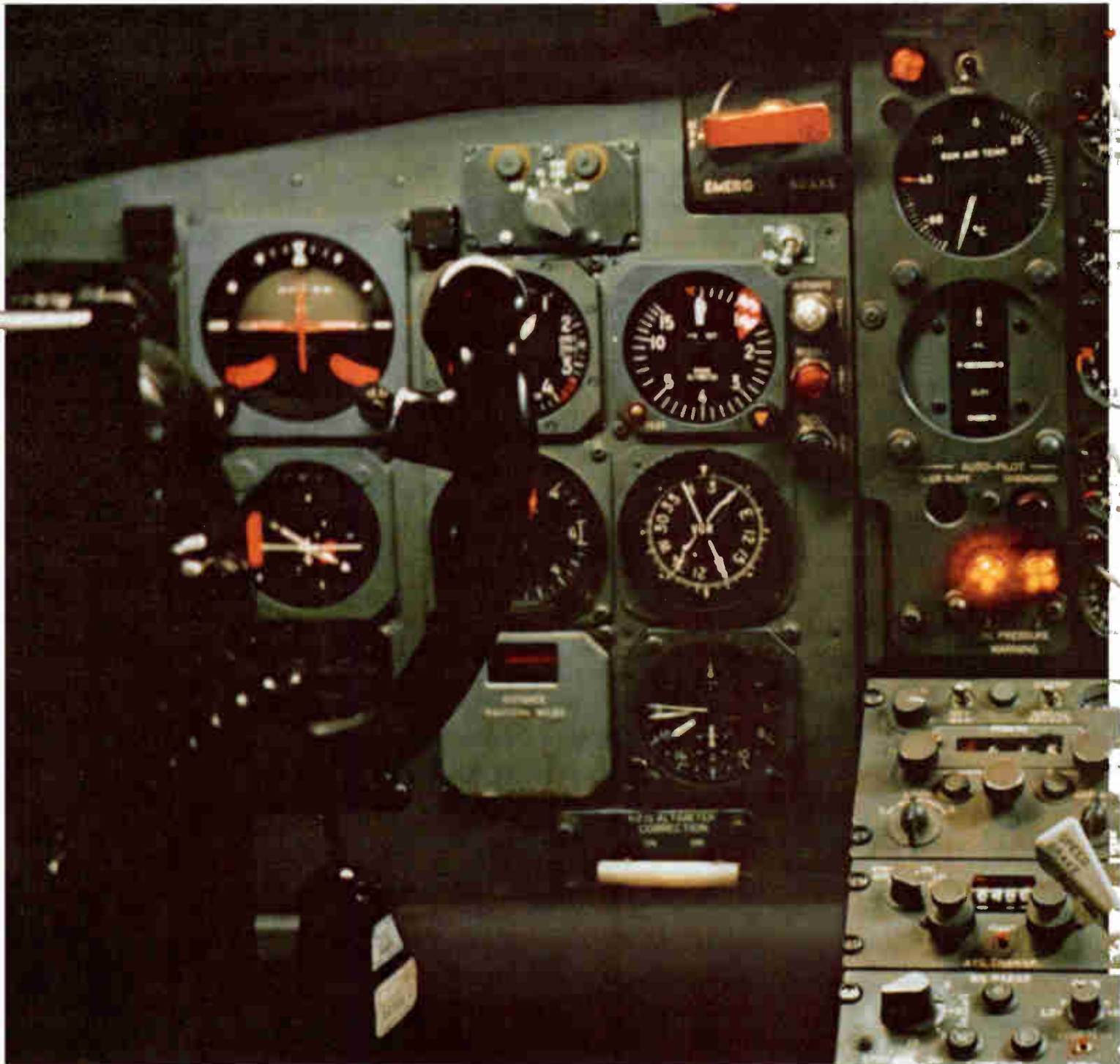

O/E/N IS WORLDWIDE

Electronic components for the free world are supplied by the worldwide operations of fifteen O/E/N subsidiaries and divisions, which operate 24 plants—16 in the U.S. and 8 off shore.

This import-export balance assures domestic customers the same O/E/N quality for their overseas operations, whether from local inventories, U.S. exports or manufactured by O/E/N plants in England, Europe, South Africa and Asia.



O/E/N

OAK ELECTRO/NETICS CORP
CORPORATE OFFICE
CRYSTAL LAKE, ILLINOIS 60014

Can you make practical contributions to the computer sciences?

Our Data Systems Division is continuing its expansion into areas which will present the greatest challenge for the foreseeable future — advanced aerospace weapon delivery, navigation digital and analog computers, advanced analog/digital control and telemetry. Openings exist in a wide variety of disciplines in Laboratories which are responsible for advanced technology, preliminary design and applications, and digital and analog circuitry. All of these require accredited degrees and a demonstrable capacity to do creative design or analysis. Although experience is required for most of the positions, several are open to recent graduates. Opportunities are immediately available for:

Preliminary Design Engineers:

Helpful experience would include: Digital, Analog and Hybrid Systems Applications Engineering; Logical Design; Memory Design (solid state, ferrite or drum); Electro-mechanical Design Engineering; Physical Product Design; Thermal Analysis or Packaging Trade-off Studies.

Automatic Test Program Analysts:

Systems Test, In-flight Self Test, Time-sharing or Maintenance Depot experience would be directly applicable to our openings. A basic understanding of the mathematics involved with circuitry and computers, or weapon systems analysis would be of particular value.

Microcircuitry: Development of hybrid-integrated devices, both digital and linear. Experience with processes and applicable techniques is required.

Circuit Design Engineers: Duties would involve the design of logic and computing circuits, many forms of input/output devices, high-reliability low-power circuits for spacecraft VHF and UHF telemetry.

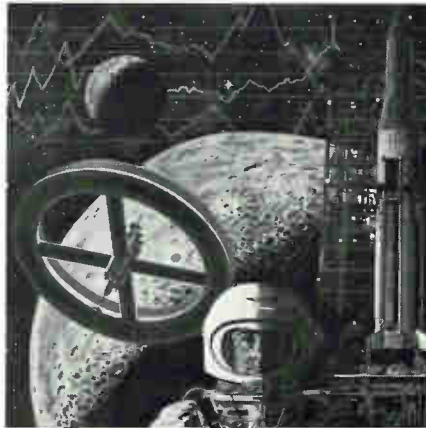

Systems Integration Engineers:

Experience is required in such areas as system integration, system checkout, test equipment, design, test specification and procedure writing.

There are also several openings for Mechanical Engineers and Physicists who have acquired specialized professional experience which is directly applicable to the design or analysis of aerospace digital systems.

Computer Program Design:

Requires experience in the design of real-time command and control programs, or of software programs for execution on an IBM 7094 or GE 635 computer. Responsibilities include: specification, design, implementation, checkout and support of computer programs for a wide variety of applications including: Airborne Navigation & Fire Control, Digital Simulation of Airborne Computer and its environment, Automatic In-Flight & Depot System Testing, Assemblers and Compilers and Automation of Electronic Equipment Design.

For immediate consideration, please airmail your resume to:

Mr. Robert A. Martin
Head of Employment
Hughes Aerospace Divisions
Dept. 71

11940 W. Jefferson Blvd.
Culver City, Calif. 90230

U.S. citizenship is required
An equal opportunity employer - M & F

HUGHES

HUGHES AIRCRAFT COMPANY
AEROSPACE DIVISIONS

**With a
memory
like this
you can
forget the
logic**

FROM YOUR TRUTH TABLE

Inputs								Outputs			
A	B	C	D	E	F	G	H	W	X	Y	Z
0	0	0	0	0	0	0	0	0	1	0	1
0	0	0	0	0	0	0	1	0	0	1	1
0	0	0	0	0	0	1	0	0	1	1	0
0	0	0	0	0	0	1	1	1	1	0	0
0	0	0	0	0	1	0	0	0	1	0	0
0	0	0	0	0	1	0	1	0	1	1	1
0	0	0	0	0	1	1	0	0	0	0	0
0	0	0	0	0	1	1	1	1	0	1	0
0	0	0	0	1	0	0	0	1	0	1	1
0	0	0	0	1	0	0	1	1	1	1	1
0	0	0	1	0	1	1	1	1	0	1	1

TO YOUR MM 521

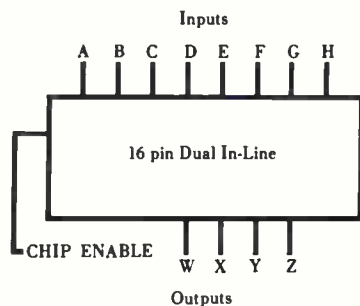

Use the logic easily programmed into our ROM (Read Only Memory) elements. With a minimum of time (typically four weeks), we can set up the simple interconnection metalization pattern your needs dictate and start shipments. Costs about a thousand dollars.

ROM elements are far simpler to make than a new, untried logic design. No logic race conditions; no logic circuit debugging. Our MOS ROM elements are fast, 500 nanoseconds. They operate from ± 12 volt supplies, easily compatible with DTL and TTL.

MM521, 1024 bit element (256 x 4), 16 pin Dual In-Line device, is \$45.00 in 100 quantity. MM522, 1024 bit element (128 x 8), 24 pin Dual In-Line is \$60.00.

Write for a memorable packet of information. National Semiconductor, 2975 San Ysidro Way, Santa Clara, California 95051. (408) 245-4320. TWX: 910-339-9240. Cables: NATSEMICON.

National/MOS

Our new KBM-7 Koldweld® Machine is really fine. It cold welds wire from .0025" to .0126" . . . is hand-operated, with no other power required . . . and is easy loading. It butt-welds, to themselves and each other, practically all non-ferrous metals . . . copper, aluminum, nickel, etc. Like all Koldweld Machines, the KBM-7 produces a perfect metallurgical and mechanical butt weld in non-ferrous metals in seconds—with pressure

alone. No end preparation is necessary and exact end-to-end alignment is assured. With the KBM-7 joining the Koldweld line, there's now a Koldweld unit designed to butt-weld virtually all sizes of wire and rod stock up to half-inch diameter. For further information, write: KOLDWELD, Heintz Division, Kelsey-Hayes Company, Front Street and Olney Avenue, Philadelphia, Pa. 19120.

1. KBM-9
Range #30 AWG (.010")
—#15 AWG (.057")
2. KBM-5
Range #18 AWG (.040")
—#8 AWG (.1285")
3. KIH
Range—up to .187" dia. copper
—up to .25" dia. aluminum
Strip —Min. thickness .020"
—Max. width .750"
4. HRB
Range—up to .375" dia. copper
—up to .500" dia. aluminum
Strip —Min. thickness .030"
—Max. width 1.25"

Our newest Koldweld machine is the finest we've ever built.

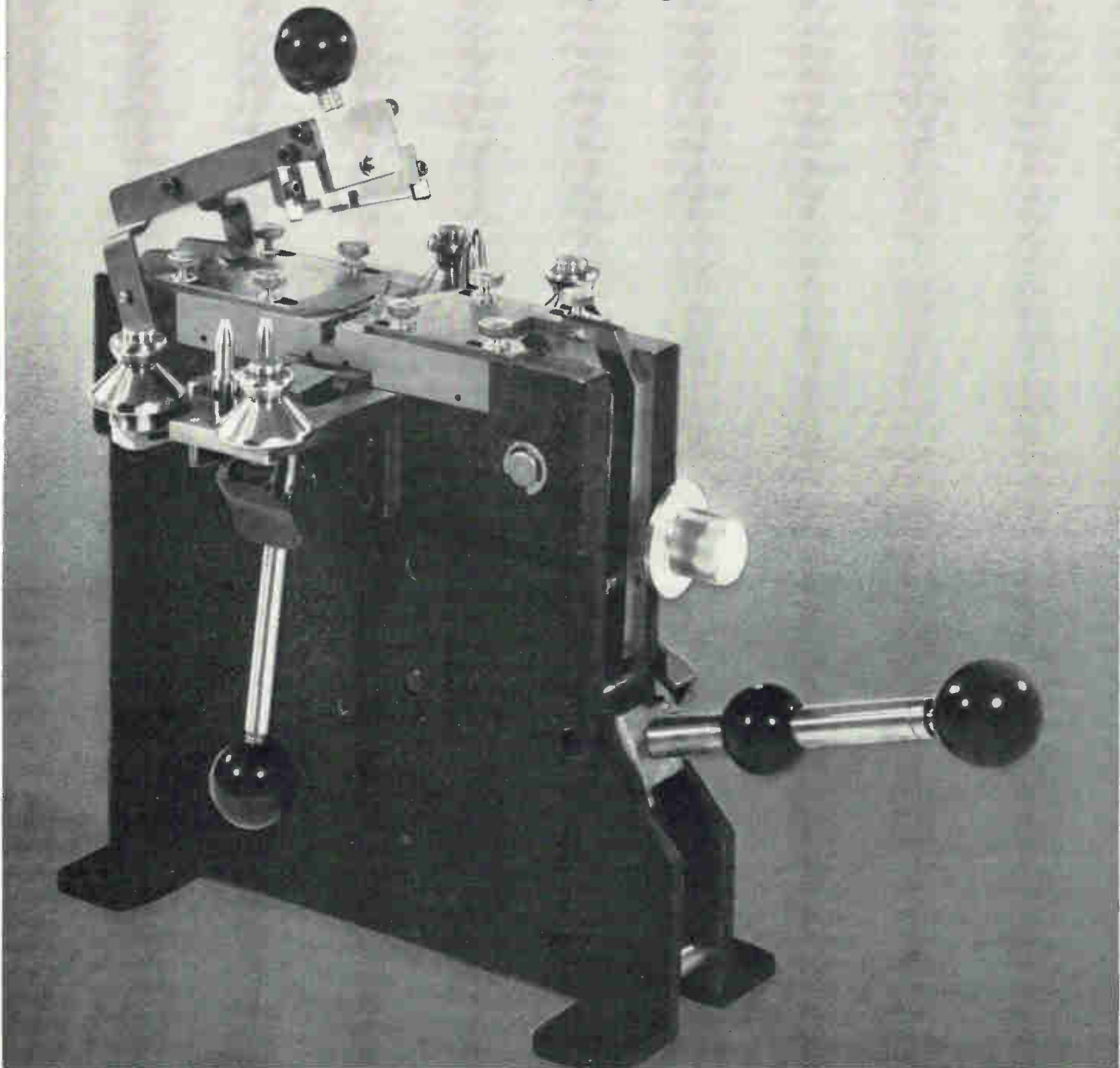

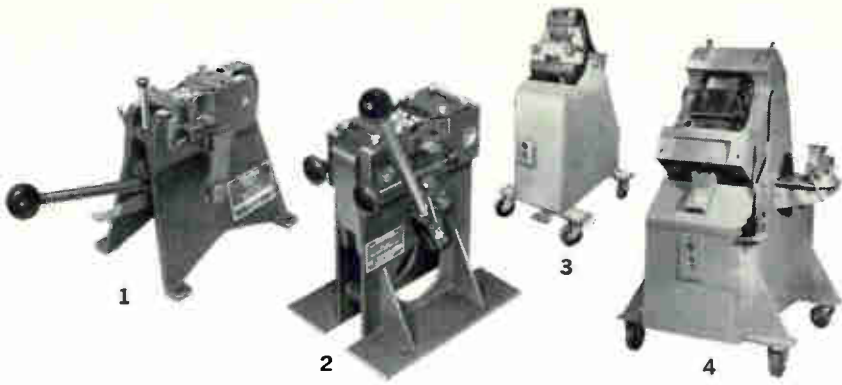

Lapwelding: We also supply lapwelders for welding a wide range of non-ferrous sheet and strip materials. Write for further information.



.0025" fine.

KVH
HEINTZ DIVISION · KELSEY-HAYES

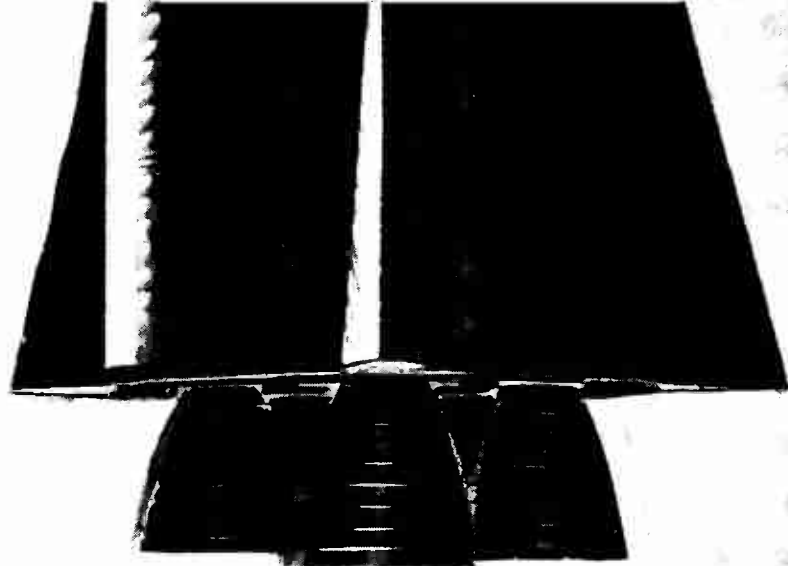

RCA Announces

The industry's first integrated circuits high-reliability program based on MIL-STD-883

Now you can evaluate and design across a broad range of critical applications with integrated circuits processed to the requirements of the first military standard of test procedures for microelectronics.

RCA's high-reliability program — conforming to the test methods and procedures of MIL-STD-883 — covers integrated circuits for aerospace, military, and other critical applications from RCA's major integrated circuit lines: RCA Linear Integrated Circuits; RCA Digital Integrated Circuits; and shortly this program will be expanded to include RCA PDS/MOS (Complementary-Symmetry MOS) Integrated Circuits.

Integrated Circuits in this program are classified in four screening levels corresponding to the three classes of MIL-STD-883. (See chart below.) A comparison of RCA's four screening levels is

illustrated in the flow chart at right.

Comprehensive high-reliability-format data bulletins are now available for the following types:

- HIGH-RELIABILITY VERSIONS OF CA3000, CA3001, CA3006, CA3015A, C3020A
 - 19 HIGH-RELIABILITY VERSIONS OF CD2300 Series DTL in flat pack
 - 19 HIGH-RELIABILITY VERSIONS OF CD2300D Series DTL in dual-in-line ceramic package
- (RCA Levels /1, /2, /3, and /4 are detailed for each type)

Add your name to our mailing list for these bulletins and subsequent high-reliability information. Contact your RCA Representative or write: RCA Electronic Components, Commercial Engineering, Section FK-2-4A, Harrison, N. J. 07029.

RCA Level	MIL-STD-883 Equivalent	Application	Description
Level/1 and Level/2	Class A	Aerospace and Missiles	For devices intended for use where maintenance and replacement are extremely difficult or impossible and reliability is imperative
Level/3	Class B	Military & Industrial— For example in Airborne Electronics	For devices intended for use where maintenance and replacement can be performed but are difficult and expensive
Level/4	Class C (Class B without Burn-in)	Military & Industrial— For example on Ground Based Electronics	For devices intended for use where replacement can readily be accomplished

RCA screening level/1 is equivalent to MIL-STD-883 Class A except that reverse-bias burn-in is performed only in Group B.
RCA screening level/2 is the same as level/1 but radiographic inspection is not performed.

RCA High-Reliability Integrated Circuits Product Flow Diagram

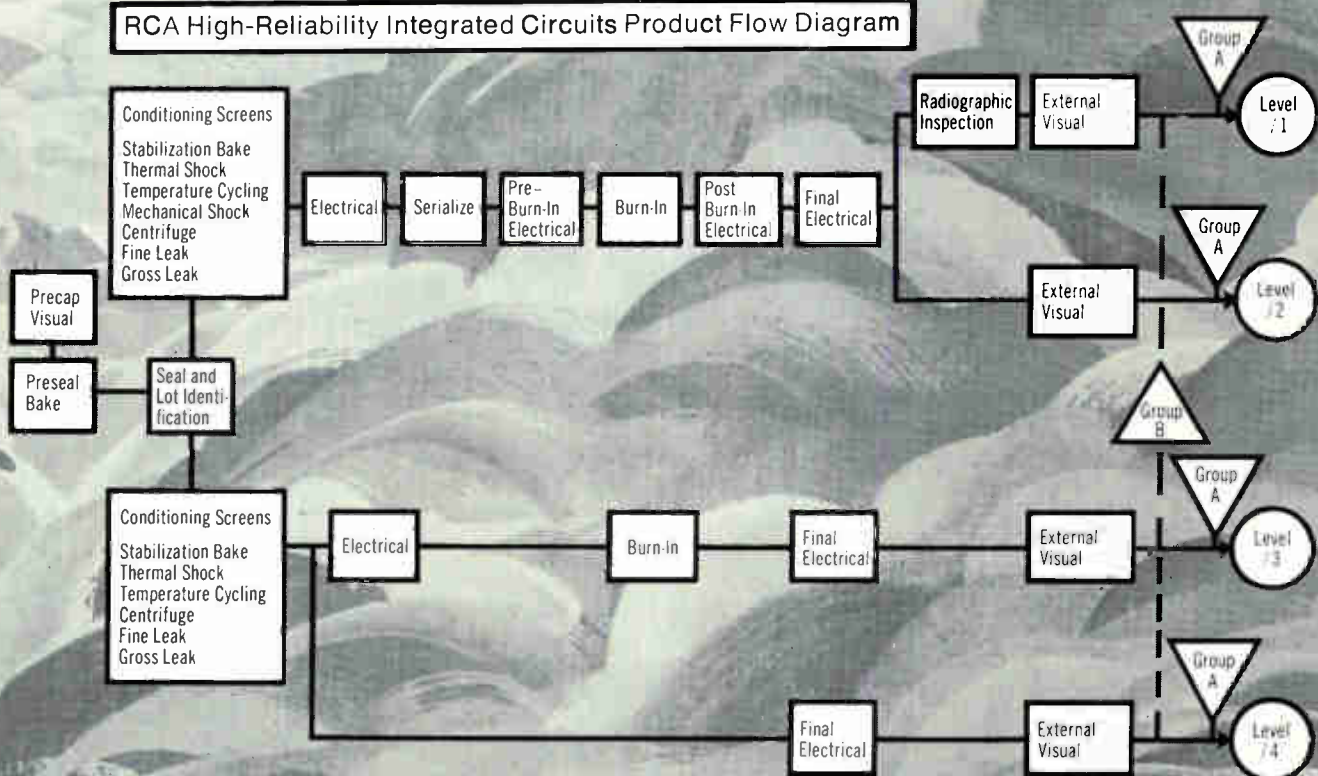

SHRINK BIG.

Litton Puts a 1KW TWT Pulse Amplifier into 1/3 cu. ft.

Electron Tube Division is a leader in mating sophisticated components into integrated equipment sub-systems. This capability includes a working insight of the tube/equipment interface, as well as an understanding of environmental, heat transfer and high density packaging problems.

Among our recent production units are airborne Pulse Amplifier packages utilizing TWT's with 1 KW pulse output, 1-2% duty at S, S-C, C and X-bands. Built modularly, they're designed to achieve small size and weight, and offer self-contained internal cooling and protective circuits.

An example of this packaging is the Model 549 for ECM and radar applications. This X-band equipment is capable of operating in a MIL-E-5400, Class 2 environment, consumes an impressively small 1/3 cubic foot of space and weighs only 25 pounds.

For information about the Model 549 and other TWT Pulse Amplifiers contact Electron Tube Division, 960 Industrial Road, San Carlos, California 94070. (415) 591-8411.

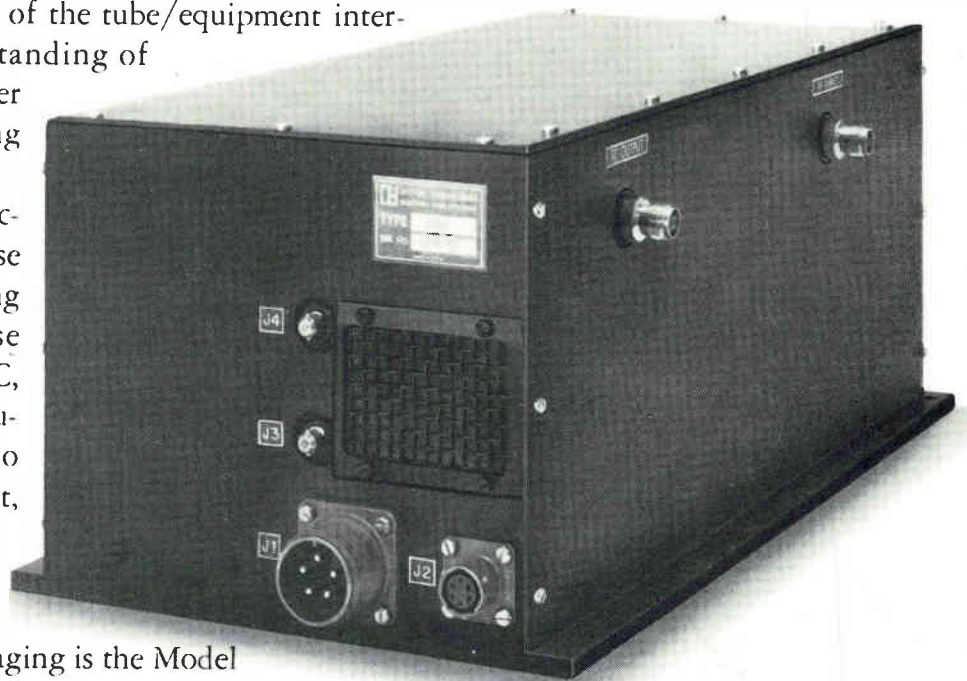

DURING IEEE, VISIT OUR HOSPITALITY SUITE AT THE ESSEX HOUSE.

 **LITTON INDUSTRIES**
ELECTRON TUBE DIVISION

What! Another 8 new counters and pulse generators from CMC?



NO! 8 GREAT CLASSICS

...that can't be beat for price and performance!

You've been hearing a lot about CMC's new state-of-the-art instruments, but maybe you've been overlooking some of our other high-quality precision products. These field-proved and reliable instruments have always been superior to the competition, and now we have improved the performance and reduced the prices of many of them. So before you order something new, check these eight classic instruments from CMC.

Our Model 607 Universal Counter-Timer was a winner at 5 MHz for \$1195. Now—with a 20-MHz range for the same money—our new improved version, the Model 609, has got to be an even better buy! Or take a look at the updated version of our 603 counter—the Model 608. It, too, is the same in everything but performance. Now, for \$740 you get a 15-MHz range instead of 2.5 MHz. And, if you're looking for a high-frequency instrument with a low-frequency price tag, you can't beat our combination Model 738/735.

Here's a fine, field-proved, solid-state frequency meter with a range to 100 MHz that has been selling for \$1775. Now we are offering it to you, complete with a \$350 heterodyne converter plug-in, for less than the old price of the counter alone—just \$1650! Where else can you get 500-MHz performance for such little cost?

So much for counters. But be sure to check our unique target simulator and our pulse and time delay generators. The CMC Model 301 Dynamic Target Simulator is a must for anyone concerned with the calibration or checkout of radar. It's a truly unique off-the-shelf product that may meet your requirements at a fraction of the cost of custom-made special-purpose equipment. And it's almost certain, too, that we have a pulse or time delay generator to meet your needs within your budget.

So for more information and prices on these eight classic instruments from CMC, please turn the page.



Eight Classic CMC Instruments

**ELECTRONIC COUNTERS
PULSE GENERATORS
TIME DELAY GENERATORS
TARGET SIMULATORS**

Newly improved performance and reduced prices make many of these instruments extremely attractive "buys." For full product information, circle the appropriate reader service number.



MODEL 608 Price: \$740.

15-MHz Electronic Counter—Measures frequency and period, determines frequency ratio and totalizes. Frequency range: 2 Hz to 15 MHz. Period and frequency ratio range: 2 Hz to 2.5 MHz. Period average and multiple ratio: 1, 10 and 100. In-line long-life biquinary display. Five decades are standard, a sixth is optional.

CIRCLE NO. 330



MODEL 609 Price \$1195.

20-MHz Electronic Counter—Measures Frequency, period, multiple period average, frequency ratio, time interval, and totalizes. Frequency measurement range: 0 to 20 MHz. Period: 0 to 1 MHz. Multiple period average measurement from 0 to 2.5 MHz, from 10^9 to 10^7 periods in decade steps. 1 MHz crystal time base; stability ± 2 parts in 10^7 per month. Six decade in-line biquinary display, automatically positioned decimal point.

CIRCLE NO. 331

Your local CMC representative will demonstrate these products on your premises at your convenience. Call him or call CMC direct.



MODEL 614 Price: \$1300.

Preset Multi-function Counter—Extends applications to normalizing and multiplication by any preselected constant. Gate time presets to any interval from $10\mu\text{sec}$ to 100 seconds. Gate time presets by remote selection. Direct displays as mph, rpm, ms, per N periods, etc. 614 also measures frequency and period and totalizes. Frequency range: 2Hz to 2.5 MHz. Period and frequency ratio ranges: 2 Hz to 500 kHz. Preset count circuitry operates dependably at frequencies through 300 kHz up to three times as fast as other variable gate time counters. 100 kHz crystal time base; stability ± 2 parts in 10^6 per week. Standard five decade in-line biquinary display (sixth optional) with automatically positioned decimal point.

CIRCLE NO. 332



MODEL 738 Price: (with 735) \$1650.

100-MHz Direct Reading, Frequency Meter Frequency from 10 Hz to 100 MHz measured directly. Seven decade in-line readout. Extends to 500 MHz in 50 MHz steps with Model 735 turret-type, positive switching heterodyne converter.

CIRCLE NO. 333



MODEL 301 Price: \$6330.

Dynamic Target Simulator—Model 301 is a moving target simulator. It is applicable to tracking radars, weapons control systems, or sonar for calibration, production check-out, or operator training.

The standard Model 301 has a target Range from 0 to 1,000,000 feet in one foot increments with 0.1% of setting accuracy. It has a target Velocity from 0.0 to 100,000.0 feet/second in 0.1 foot/second increments with 0.005% of setting accuracy. Target Acceleration can be set from 0.00 to 10,000.00 feet/second/second in 0.01 foot/second/second increments with 0.005% of setting accuracy.

Special versions of the Digital Target Simulator are available with increased accuracies. 301's have also been built with remote-programming capabilities and ruggedized to meet MIL specifications.

CIRCLE NO. 334



MODELS A-10, A-11, A-12 Prices: from \$1070. to \$3120.

Solid-State Delay Generators—A-10 has time delays 0 to 1 sec in 100 nsec increments. Accuracy 0.001% of delay. Jitter less than 1 nsec. Amplitude 10V. Rise time 15 nsec.

A-11 has same features as A-10 with exception of amplitude, 6V and rise time 10 nsec.

A-12 was designed for fail-safe operation in explosives testing or other tests where premature triggering might destroy information. Amplitude, 70V; rise time, 100 nsec.

CIRCLE NO. 335



MODELS B-7B, B-7D, B-7F Prices: from \$695. to \$825.

Basic Pulse Generator—B-7B is a general purpose instrument with repetition rate to 2 MHz and 50V into 50 ohms. Variable rise/fall time control.

B-7D has all specifications of B-7B and simultaneous positive and negative output pulses; separate and independent rise/fall time controls.

B-7F has all B-7B features plus: 2 Hz repetition rate; separate rise/fall time controls; and double pulse output.

CIRCLE NO. 336



MODELS B-14, B-15, B-16 Prices: from \$340. to \$595.

Portable Pulse Generators—Model B-14 is a low cost, portable unit with repetition rate of 20 Hz to 2 MHz. Delay is 0 to 10 msec. Amplitude is 15V into 1k, 8V into 50 ohms. Pulse width of 60 nsec to 10 msec. Rise/fall time is less than 10 nsec fixed.

B-15 has same rise/fall time, delay, and pulse width. Also offers a repetition rate of 5 Hz to 5 MHz.

B-16 offers repetition rate of 20 Hz to 20 MHz. Variable rise/fall times of less than 5 nsec to greater than 200 nsec. Pulse width 15 nsec to 10 msec. Amplitude 10V. Single or pulse pair operation.

Rack mount available for B-14, -15, -16.

CIRCLE NO. 337



A Division of Pacific Industries

12970 Bradley Avenue
San Fernando, California 91342
Phone (213) 367-2161
TWX 910-496-1487

MSI HYBRIDS

In 1967 we started taking the circuit design out of system designing by making MSI available off-the-shelf. Since then, we've developed a series of 12 digital MSI building blocks that do the work of a hundred IC's.

Now we've even one-upped ourselves with MSI hybrids. We pack several MSI chips on a single substrate using multi-layer ceramic for the interconnections. You need fewer external connections to your system, so reliability goes up, and fewer packages, so space needs go down. And our MSI hybrids come to you fully assembled, fully tested, so total system costs go down.

We started on our MSI hybrids by doubling up on our reliable 9304, a Dual Full Adder with a carry propagation delay of only 8ns. Shown are three examples of what this does for you. They're all available now from your stocking Fairchild distributor. Write for complete specifications.

New product number **64.**

SH8080 4-BIT ARITH- METIC UNIT

The SH8080 is a 4-bit ripple-carry adder with a built-in holding register. Typical carry propagation delay is 32ns and the noise margin is one volt. Several units may be connected in series to handle longer words.

The SH8080 uses two Fairchild 9304 dual full adders and two Fairchild 9020 dual J-K flip-flops interconnected on a multi-layer substrate. It is fully compatible with all Fairchild CCSL devices. The SH8080 is available in a 32-lead flat pack and operates over the full military and industrial temperature ranges. You can get it from your Fairchild distributor today. Write for complete specifications.

To order the SH8080, ask for:

Part Number	Temperature Range	Prices		
		1-24	25-99	100-999
HBYS80801XX	-55°C to +125°C	\$120.00	\$96.00	\$79.25
HBYS80809XX	0°C to +70°C	46.00	35.80	30.80

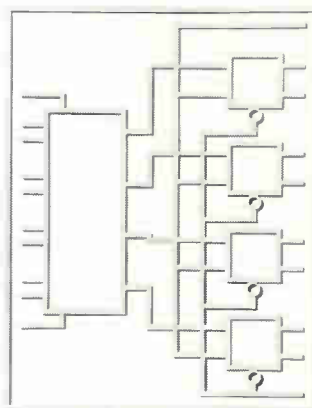

New product number **65.**

SH2204 BYTE PARITY GENERATOR/ CHECKER

The SH2204 Byte Parity Generator/Checker generates parity for an 8-bit byte or checks parity over 9 bits with a typical delay of only 35ns from input to odd parity. For longer words, just connect additional units in parallel.

The SH2204 uses two Fairchild 9304 dual full adders interconnected on a multi-layer substrate. It is fully compatible with all Fairchild CCSL devices.

The SH2204 is available in a 3/4" x 3/4" 14-lead flat pack and operates over the full military and industrial temperature ranges. It's in stock at your Fairchild distributor now.

Write for complete specifications.

To order the SH2204, ask for:

Part Number	Temperature Range	Prices		
		1-24	25-99	100-999
HBK22041XX	-55°C to +125°C	\$68.00	\$54.00	\$48.00
HBK22049XX	0°C to +70°C	32.00	26.00	22.00

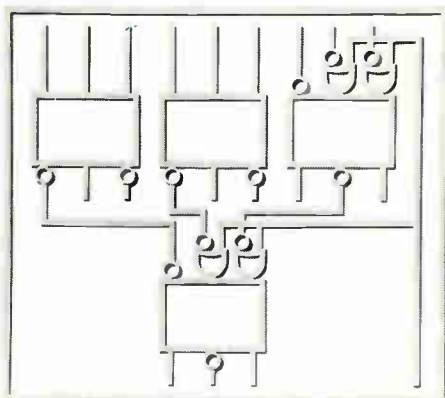

New product number **66.**

SH2205 RIPPLE- CARRY ADDER

The SH2205 is a ripple-carry parallel addition (or subtraction) function block containing four full adders. Typical carry propagation delay is 8.0ns per bit. The circuits are high speed, high fan-out TTL with input diode clamping.

The SH2205 uses two Fairchild 9304 dual full adders interconnected on a multi-layer substrate. It is fully compatible with all Fairchild CCSL devices.

The SH2205 comes in a 16-pin ceramic DIP and operates over the full military temperature range. Your Fairchild distributor has it in stock now. Write for complete specifications.

To order the SH2205, ask for:

Part Number	Temperature Range	Prices		
		1-24	25-99	100-999
HBK22051XX	-55°C to +125°C	\$63.00	\$50.00	\$44.00
HBK22059XX	0°C to +70°C	32.00	26.00	22.00

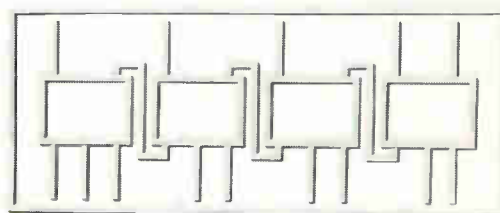

FAIRCHILD
SEMICONDUCTOR

FAIRCHILD SEMICONDUCTOR A Division of Fairchild Camera and Instrument Corporation Mountain View, California 94040, (415) 962-5011 TWX: 910-379-6435

hybrid circuits

from

Burroughs

Burroughs is your preferred source for hybrid circuits

Burroughs, a prime producer of high-volume, high-quality hybrid microcircuits, offers the entire circuit package and its components at competitive prices. Circuits are now available in various configurations with screened resistors and capacitors, as well as discrete components including IC and MSI chips. Burroughs does the whole job, and does it right—enabling you to reduce system size with increased reliability.

Every circuit is custom-designed and fabricated under the eyes of experts in complete in-house semiconductor and hybrid operations—assuring you economy, high reliability, quality control and on-schedule delivery.

Buy your hybrid microcircuits NOW from Burroughs, and discover what Burroughs' one-source circuitry capability can do for you.

We also offer hermetic packaging, computer testing, complete environmental facilities. And we are fully documented to MIL Specs.

Call or write Burroughs Corporation, Electronic Components Division, P.O. Box 1226, Dept. H1, Plainfield, New Jersey 07061. Tel. (201) 757-5000, or contact your nearest Burroughs representative or sales engineer.

- 1./ *Semi-automatic dual latch hybrid test unit for efficient, high-speed tests.*
- 2./ *High-speed resistor abrading process assures $\pm 1\%$ tolerances.*
- 3./ *Modern, contamination-free diffusion operation, atmospherically controlled for maximum quality assurance.*
- 4./ *Multifunctional computerized system performs all forms of AC & DC tests.*

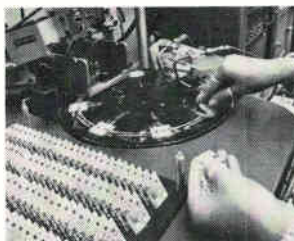

2./



3./

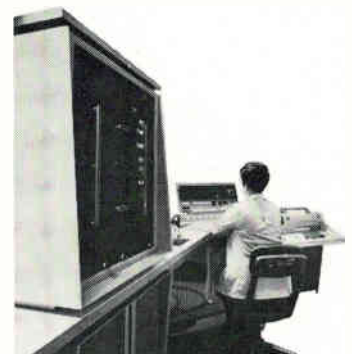

4./



1./

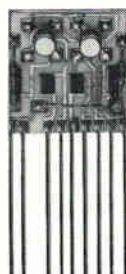

Burroughs



Technical Articles

Germanium IC's point the way towards picosecond computers
page 88



Germanium integrated circuits with switching delays as low as 150 picoseconds have been fabricated with an assist from a number of inventive new processing techniques. At the same time, a good deal of progress has been made in developing other elements that can measure up to the stringent requirements of ultrahigh-speed computers. IBM is seeking to increase circuit packing density with an eye to developing a superfast machine that would operate well below room temperature. Germanium's performance keeps improving down to -150°C , which gives the material an edge on silicon in this application.

Instruments win top billing at IEEE exhibition
page 98

In this year of the instrument, producers—to judge by the evidence of the new wares they're unveiling at the IEEE Show a few weeks hence—are following through on earlier decisions rather than striking off in new directions. For example, integrated circuits have become accepted building blocks, and even bottom-of-the-line meters are being outfitted with digital displays. And most manufacturers continue to respond to customers' demands for plug-ins, as well as for binary-coded decimal and remote-programming capabilities.

Combining light and electronics for mass-storage memories
page 108

In this sixth installment of *Electronics'* special report on computer memories, the first article discusses a number of electro-optic techniques being worked on around the industry; the second delves into the unique advantages of optoelectronic units whose elements radiate light or remain dark as they store binary 1's or 0's.

Charting a simpler course to the design of yig filters
page 118

Coupling bandwidth design charts now give engineers a handy tool with which they can quickly determine requirements for multiresonator yig filters without first having to build and align a device. In addition to determining coupling requirements for as many sections as necessary, the engineer can check insertion loss, off-band isolation, and limiting levels.

Automotive electronics hits high gear

Coming

Solid state controls are now being readied for mass applications in automobiles; discrete devices dominate the picture now, but integrated circuits are moving from the drawing-board into road-ready systems.

Germanium IC's point the way towards picosecond computers

The high-speed machines envisioned would operate at low temperatures and employ high-performance thin-film resistors and capacitors; circuitry would be densely packed on very small chips

By Arnold Reisman

IBM Watson Research Center, Yorktown Heights, N.Y.

Pure speed is an increasingly important factor in the data processing field. The growing demand for time-sharing services is creating a need for computers that can perform logic operations in picoseconds. And an important step towards meeting this need has been taken by the International Business Machines Corp.'s researchers with their recent fabrication of germanium planar integrated circuits having a switching delay of 150 picoseconds.

Headway is being made on other fronts as well. Researchers at IBM and elsewhere have improved thin-film passive-component technology, developed models for signal propagation on the microstrip lines interconnecting circuits, and minimized sys-

tem delay by devising some new high-density packing techniques.

To be sure, there's a price to be paid for squeezing a lot of circuitry into a little space, but germanium is the material that can meet that price. Tomorrow's computers will have to dissipate enormous amounts of power in very small areas, and their complexity will make maintenance difficult and costly. All this points to operation below room temperature to improve device and interconnection reliability and increase the electrical conductivity of interconnections.

Here's where germanium holds the strong suit. Not only is it inherently faster than silicon because of its higher carrier mobility, but its performance,

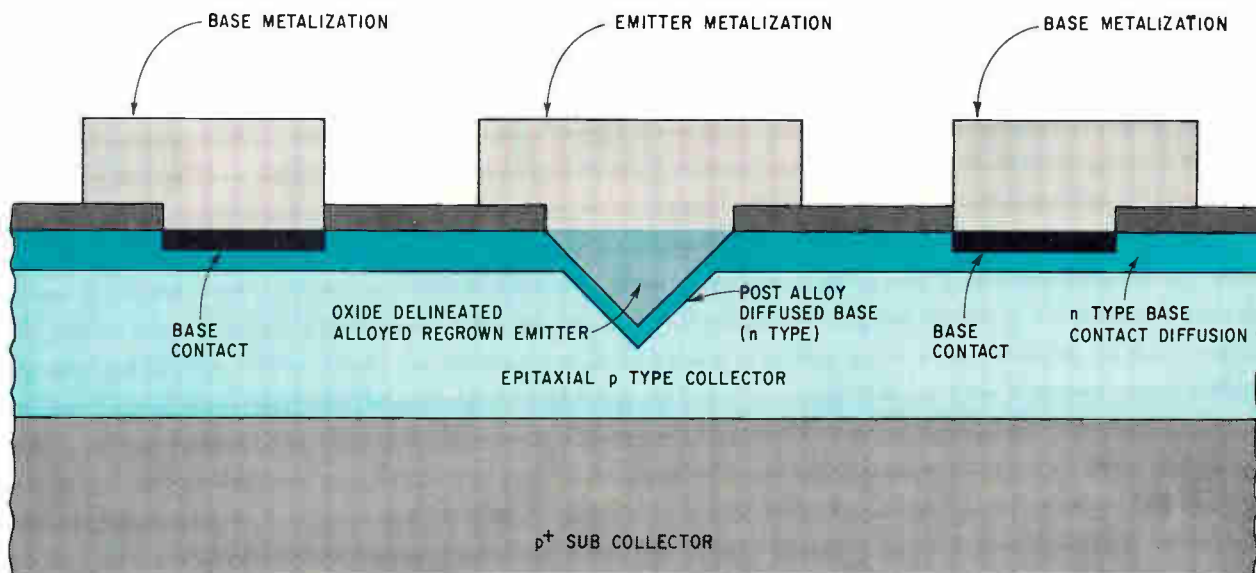

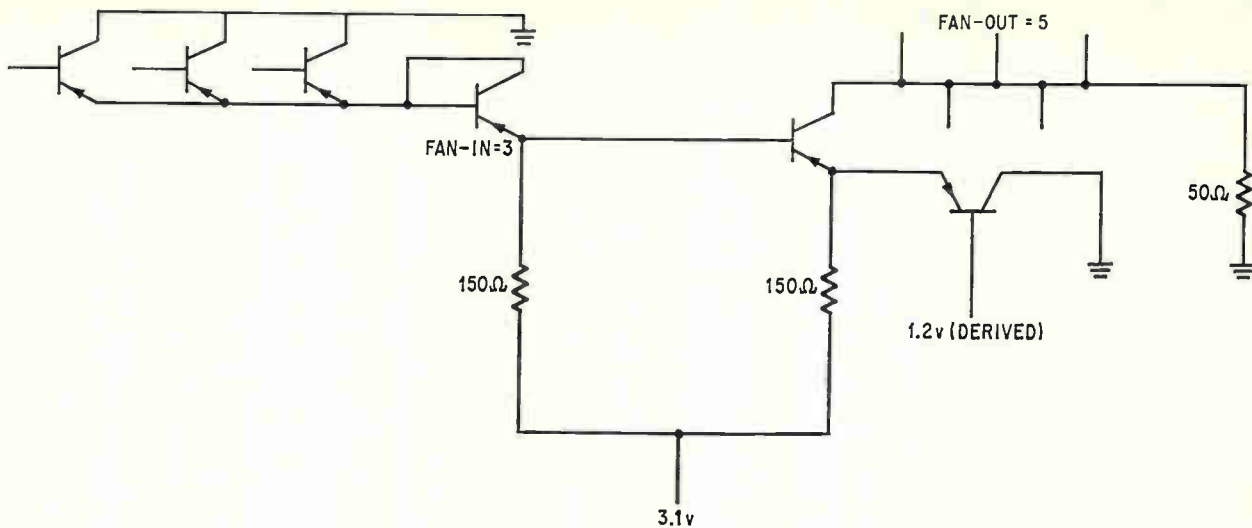

Packing 'em in. Computers operating in picoseconds will not only require faster devices and circuits but very high packing densities. A first step is the fabrication of planar germanium circuits by post-alloy diffusion techniques (a). Circuits such as the one shown (b) have delays of 150 picoseconds. Four similar circuits have been fabricated on a chip (c), but to reduce delay to an acceptable level, 700 circuits have to be squeezed into a square inch (d). And the enormous amount of heat that future high-density packages will dissipate will necessitate low-temperature operation.

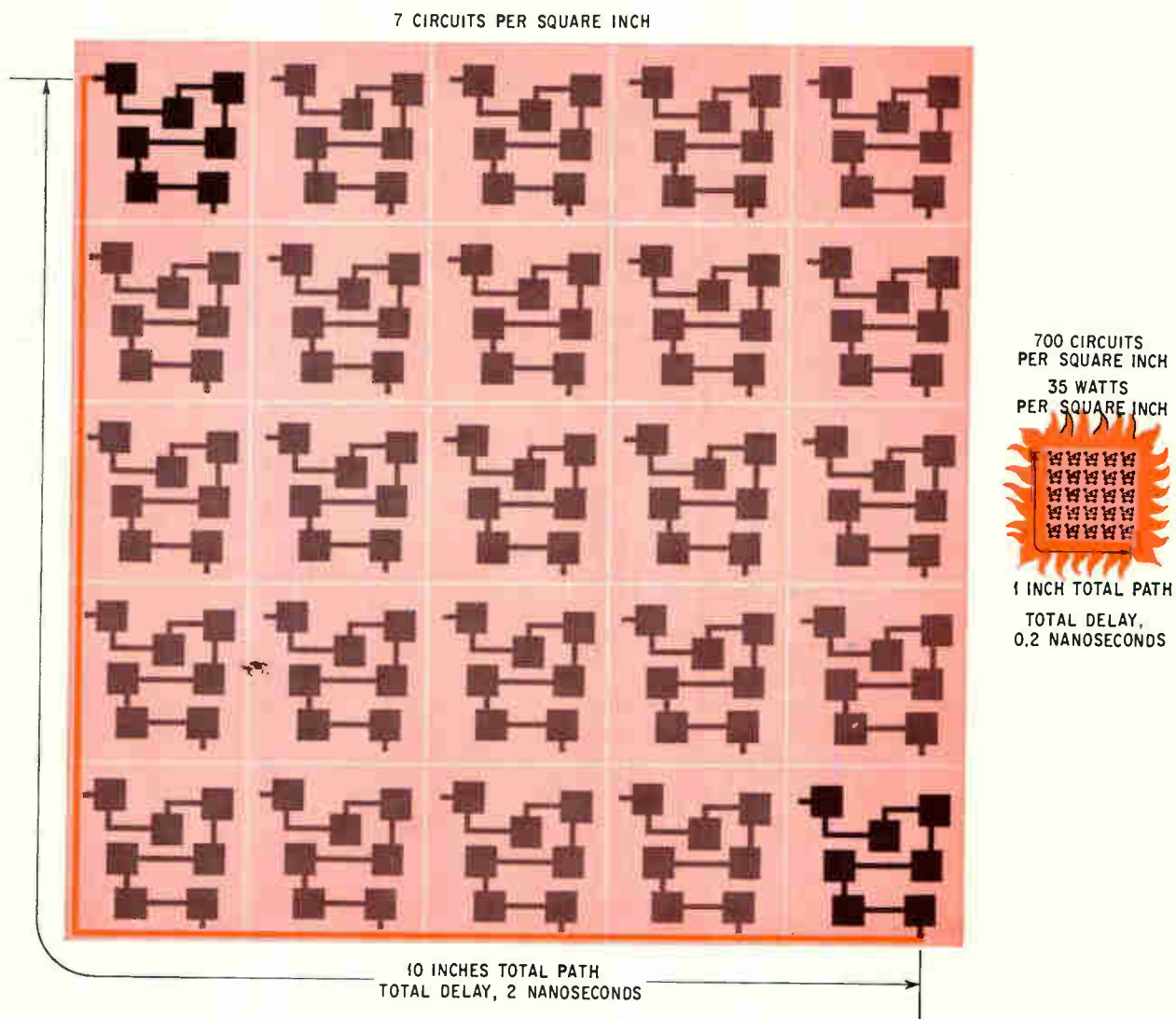

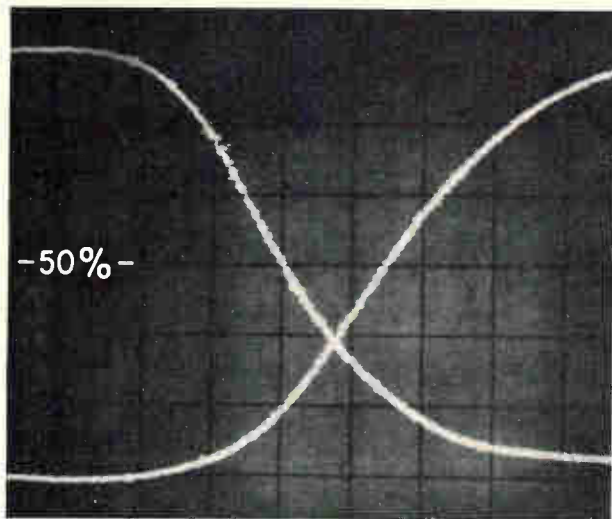

Small delay. Input-output waveforms of germanium IC with 150-picosecond delay are shown on vertical scale of 100 mv/cm and horizontal scale of 100 psec/cm.

unlike silicon's, improves at lower temperatures.

Germanium has been adapted to planar technology as the result of two processes. In the first, introduced by several companies, thin silicon dioxide films are deposited on the germanium by heating and decomposing such compounds as tetra-orthosilicate. This process opens germanium to the oxide masking techniques once restricted to silicon.

In the second, developed by IBM, n- or p-type germanium wafers of all resistivities are polished to a smooth surface, thereby making it possible to grow the planar epitaxial layers needed for IC fabrication. It also permits the epitaxial growth of germanium on semi-insulating gallium arsenide for better component isolation.

In the polishing process, semiconductor wafers are placed face down to contact a mat through openings in a rotating plate. As the plate turns, sodium oxychloride squirts onto the mat, and the combined chemical-mechanical action polishes the wafers to a smooth, planar finish.

The extension of planar technology to germanium has brought with it an option not possible with silicon—the ability to fabricate devices by post-alloy diffusion as well as by the double diffusion technique applied to silicon. In the post-alloy process, emitters and bases are formed in a single operation by evaporating metals doped with n- and p-type impurities onto the epitaxial layer. During a subsequent heating, these dopants diffuse out of the metal at different rates, forming the transistor emitter and base. The process is feasible with germanium because there's an order of magnitude difference between the diffusion constants of the n- and p-type impurities in the material.

One advantage of this process is that contacts can be made directly to the emitter metal. In double diffusion, on the other hand, it's necessary to first metalize the semiconductor contact areas. To do this, the silicon dioxide formed on the contact area

from exposure to the air must be etched away. Unfortunately, etching proceeds laterally as well as horizontally and can expose the emitter-base junction at the surface of shallow (high speed) transistors.

The very first planar post-alloy diffused transistors, fabricated by IBM in 1965, were plagued by two problems. During alloying, the molten metal attacked the oxide mask, making it impossible to control the horizontal spreading of the emitter. In addition, the vertical dimensions of the alloyed emitter varied from device to device, preventing reproducible fabrication. Nevertheless, hybrid circuits incorporating these germanium devices had a delay of 600 picoseconds—well ahead of the silicon state of the art.

Holding action

But major improvements have since been made. In 1966, IBM researchers developed techniques for protecting the oxide from the molten alloy, thereby permitting horizontal control of the emitter shape. Soon after, the company introduced a method of confining the alloy vertically through the use of intersecting 111 crystal planes. Under this method, devices are fabricated on a 110 crystal surface. During the heating cycle, the 111 planes take longest to dissolve and confine the emitter to a wedge shape as the germanium recrystallizes.

Using devices fabricated by this method, J. J. DeCillo of IBM's Watson Research Center reported on emitter-follower current switch circuits with 0.1-mil transistor emitters separated from the bases by 0.15 mils. Circuit switching delay is the aforementioned 150 psec.

Somewhat longer delays per stage—265 psec—have been reported by IBM's F. H. Dill and H. N. Yu for germanium planar IC's made with double diffusion techniques. This work was done at an earlier stage in the planar germanium technology.

The basic logic circuit resulting from either the post-alloy or double diffusion process consists of six transistors and three resistors; it has a fan-in of three and a fan-out of five. Four such circuits have been fabricated on a 35- by 35-mil germanium chip.

Lab workers have tried building this kind of circuit on semi-insulating gallium-arsenide substrates to cut down on junction isolation capacitance. Here again, germanium has an edge on silicon because its crystal lattice constant—5.6575 angstroms—closely matches that of semi-insulating GaAs—5.6533 Å—from below room temperature to about 350°C. IBM researchers have formed islands of germanium by epitaxially growing the material on this type of GaAs and then etching through to the substrate and filling the holes with GaAs of the same crystal structure.

Because the ratio of lateral to vertical diffusion during device isolation is about the same as that of the etchant, it's possible to pack circuits as densely as with junction-isolated techniques. For the same reason, the same masks can be used for both isolation processes.

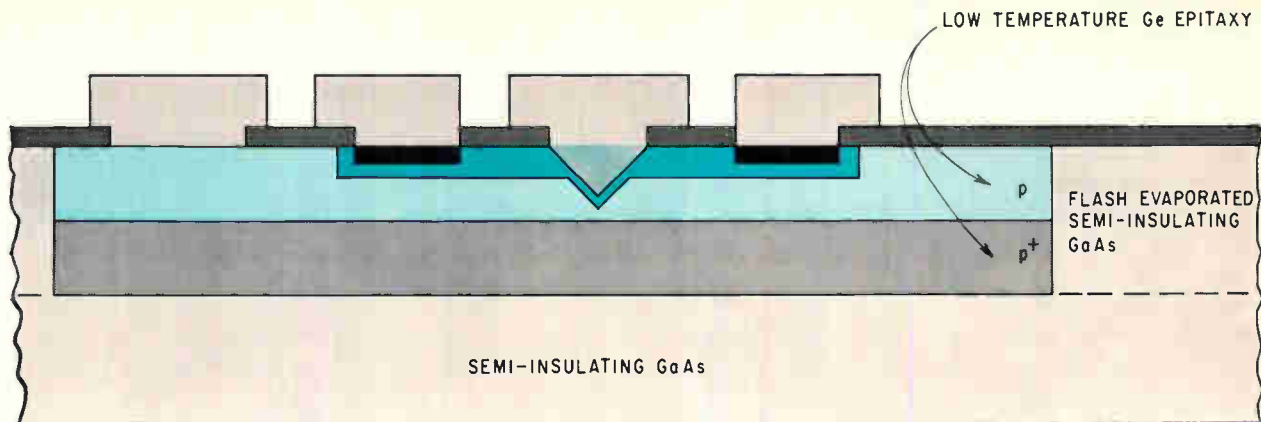

Fabrication technique. In post-alloy diffusion, metal doped with n- and p-type impurities is alloyed into germanium. The impurities diffuse out at different rates, forming base and emitter. In the first transistors of this type, emitter shape couldn't be controlled. New technique uses crystal planes to achieve wedge-shaped emitter. Experiments are under way to fabricate such circuits on semi-insulating gallium-arsenide substrates for lowest parasitics.

However, the performance of these gallium-arsenide isolated circuits is relatively poor, mainly because the epitaxial layer must be grown at low temperatures so that it won't react with the GaAs substrate. At these low temperatures, it's difficult to incorporate impurities in an electrically active state.

Still, this process holds great potential for very fast logic circuits because it offers a way of lowering parasitics without creating other problems at the same time. In dielectric isolation techniques using silicon dioxide, on the other hand, semiconductor material is wasted during etching, and mechanical stresses are set up in the crystal. As noted before, etching proceeds laterally as well as vertically. The stresses build up because the structures of crystal and dielectric are very different.

Filmland

Along with these advances in active-device technology have come improvements in the fabrication of thin-film resistors and capacitors.

IBM researchers have developed a sputtering process for making thin-film nichrome resistors as small as 1 mil wide and with tolerances of $\pm 5\%$. The film's sheet resistivity varies less than $\pm 1\%$ and is the same as bulk nichrome's. The resistivity of nichrome film fabricated by conventional means usually exceeds that of the bulk material, making tolerance control difficult.

The close tolerances of the sputtered resistors makes trimming unnecessary—an important advantage in picosecond circuits with many densely packed components. Films with resistivities of up to 40 ohms per square can be made with the process.

Thin films also give best results when used to fabricate capacitors for power-supply decoupling in the picosecond circuits. One of the most promising materials—strontium titanate—has excellent characteristics well into the high gigahertz range and can be fabricated into devices with capaci-

tances per square mil of 5 to 7 picofarads.

For all these advances, however, efforts to narrow the delay time of high-performance germanium IC's are useless if chip and module interconnections delay signals excessively. Packaging problems—usually treated as an afterthought—become particularly formidable in the context of high-speed logic systems.

Consider that circuits in present-day high-speed computers might be packed seven per square inch on the average and that the average worst-case path per stage—the distance between two circuits in a data flow path—is about 10 inches. Signals take 2 nanoseconds to travel this distance. (Propagation velocity in a microstrip line equals the velocity of light divided by the square root of the dielectric constant—in the case of silicon dioxide, four.) Thus, even if it were possible to design circuits with no delay at all, total system delay would still be 2 nsec, an unacceptable figure for the high-speed computers envisioned.

Shortcuts

Shortening the worst-case per stage path to 1 inch to reduce wire delay to 0.2 nsec, however, requires about a 10^2 increase in circuit packing density. Therefore, to improve wiring delay by a factor of 10 would thus entail an increase in packing density to 700 circuits per square inch. For a hypothetical picosecond computer with circuits having a 200-psec delay, a fan-in of three, a fan-out of five, and a loading delay of 15 psec, the worst-case path delay shouldn't exceed 500 psec.

The graph on page 92 showing system delay per stage as a function of packing density indicates that within the current state of the art—with circuits packed 100,000 per square inch—the total wiring delay per stage is around 100 psec. As lens design and photolithographic techniques improve, device dimensions will shrink and packing densities rise.

Then, too, present two-dimensional packaging may eventually give way to three-dimensional meth-

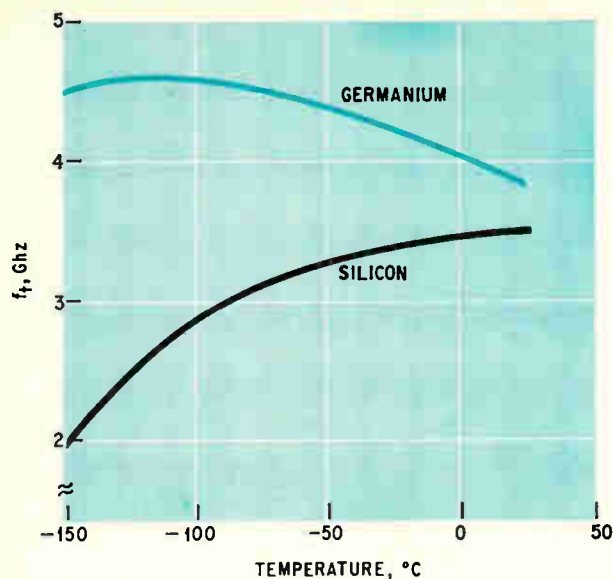

Some like it cold. Below room temperature—down to -150°C —germanium's high-frequency performance keeps improving while silicon's gets worse.

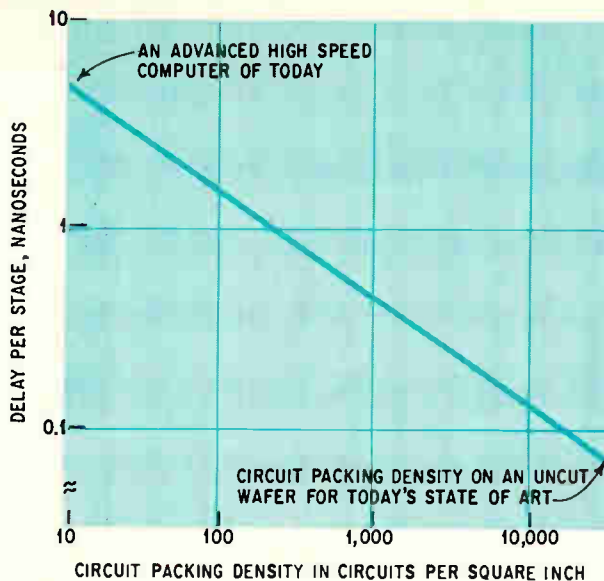

Making time. To reduce worst-case delay in a computer by a factor of 10 it's necessary to increase circuit packing density a hundredfold.

ods that will reduce delay. In present-day computers, several chips are mounted on modules and interconnected, and a number of these modules are mounted on cards. It's been estimated that 90% of the worst-case path delay involves signals traveling from a module on one card to a module on another; such signals often have to travel around the periphery of a card to get to the output pins. IBM's Watson Research Center is now trying to develop ways to areally connect modules on different cards.

Whittling the chips

Confining a worst-case path to a few chips in order to perform one type of operation creates new worst-case paths for handling other types of operations. The net result is that the same circuits must be interconnected differently in different portions of the computer, thereby raising the parts number count—the number of different chips required.

For this reason, future computers using, say, 50 different types of circuits could require several hundred kinds of chips—each with different circuit interconnections. Mask costs, let alone yield problems, would be frightening.

Keeping the number of circuits per chip at a minimum and having a large number of chips per module seems one solution. After all, it's the number of circuits per square inch that counts, not the number of circuits per chip. The latter is just a means of achieving the former.

For example, 100 chips per square inch with seven circuits to a chip would give the 700-circuit-per-square-inch density required for the operation of a picosecond system. Of course, as chip-module interconnections increase, so does the chance of a contact failure. On the other hand, though, the many levels or interconnections required on a

multi-circuit chip would also be a hazard to reliability and yield.

But there's another argument for keeping chip size down: signals propagating on microstrip lines interconnecting IC's can travel at speeds as slow as a 50th that of light. This phenomenon is a result of the way integrated circuits are structured. Following land and chip adhesion metalizations, IC's essentially become strip lines consisting of two dielectric layers. The first, silicon dioxide, is several thousand angstroms thick and has an almost infinite resistance. The second, the semiconductor chip, is several times thicker and has a resistivity ranging from more than 10 ohm/centimeters to below 0.01 ohm/cm.

Model study

In the normal range of IC resistivities, signal velocity is primarily determined by the semiconductor, not the oxide. When Henry Guckel and P.A. Brennen of the Watson Research Center analyzed IC strip lines using a parallel-plate waveguide model, they found that if semiconductor resistivity is intermediate—as it is in most IC's—the transverse electromagnetic propagation mode changes to the slower transverse magnetic mode.

However, measurements proved delays were as much as 50% smaller than calculated—about 2.5 psec per mil. Initial calculations hadn't taken into account the effect of the air dielectric on the borders of the strip line. Isolating junctions would also help, probably paring delays to 1 or 2 psec per mil. Nevertheless, a 100-mil chip with land lengths of 200 mils would still hold up signals as much as 400 psec. With fast circuits that respond in less than 100 psec, delays due to interconnections would be the principal limit on system performance.

Guckel and Brennen have also shown that delay could be reduced by optimizing strip lines. On a semiconductor with a resistivity of 0.1 ohm/cm, for instance, the optimum line width is 1 mil.

Against the tide

Certainly at this point in the technology it seems reasonable to keep chip size small. While this seems to go against what's now an accepted fact of life in the semiconductor industry, it may represent the best tradeoff. LSI is, after all, primarily directed at cutting costs, not increasing circuit speed.

The limits on chip size could be lifted, however, if such techniques as depositing ground planes on the oxide or upper metalization levels are perfected. And future packaging schemes using areal interconnections could also affect size.

Let's assume, then, a future computer with four to 10 circuits per chip and module packing densities of 700 to 1,000 circuits per square inch. Such a machine might require 1-mil-wide microstrip line interconnections with a characteristic impedance of 50 ohms and a 10% tolerance or better. Using copper signal and ground planes, the dielectric and lines would have to be 7 microns thick and would vary no more than 5%.

Interconnecting the modules in this type computer presents a problem. There's little space available for lateral spreading, so the holes through which the interconnections are made must be of extremely small diameter.

Then there's also the difficulty of bonding many chips to modules simultaneously. Present multiple bonding techniques apply only to interconnections at the chip periphery. Techniques for making areal interconnections could be most easily adapted to flip chipping, but such a design would raise positioning problems.

Some of the problems of picosecond computer operation cited here vanish, or at least diminish,

at low temperatures. Operating germanium-based computers at temperatures down to -100°C would reduce undesirable physical and chemical effects by orders of magnitude.

For example, current densities in the type of circuits discussed here could be as high as 10^6 amps per cm^2 in device contacts and interconnections. And in the devices themselves, junction current densities reach 5×10^4 amps. At such densities, electromigration—the diffusion of atoms into unwanted regions—becomes increasingly probable and reliability suffers. But a reduction in temperature from $+100^{\circ}\text{C}$ to -100°C cuts electromigration by a factor of a million or more.

At -100°C , the conductivity of metal interconnections is two or three times better than it is at 50°C , an important factor in tightly packed systems where d-c loss due to resistance in interconnections can become prohibitive. Equally important is the fact that metals with established technologies—such as aluminum—can perform as well or better at low temperatures than can less familiar materials at high temperatures.

Another important plus at low temperatures is that the spread in the forward characteristic of the emitter-base junction, V_{be} , for different devices decreases. In addition, the band gap becomes larger. These two factors make it easier to design the circuits and eliminate the necessity for a voltage translation stage to prevent the circuits from operating in a saturated mode.

Opposite reactions

The performance of germanium circuits is some 30% better at -100°C than at room temperature. With silicon, on the other hand, performance deteriorates by about the same percentage at -100°C . W.P. Dumke of the Watson Research Center attributes this behavior to the different binding energies of the two semiconductors; he notes that trapped minority carriers in silicon increase as the temperature is lowered, sharply reducing f_T , the frequency at which common-emitter current gain falls to unity. In germanium, such trapping mounts at much lower temperatures.

Of course, the cooling of computers will create its own problems. For example, it might cause mechanical stresses in semiconductor circuits, complicate maintenance, make it difficult to change the functions of a system, and raise the cost of removing power.

On the other hand, refrigeration techniques are probably advanced enough today to cope with heat-dissipation and temperature-control problems. And no matter what temperature the computer operates at, the relative difficulty of making engineering changes or replacing components will depend primarily upon the packing density. It's not inconceivable that 1,000 circuits might have to be removed just to replace one. And that's perhaps the strongest argument for cooling: the low temperatures can boost reliability to the point where such repairs are minimal. ■

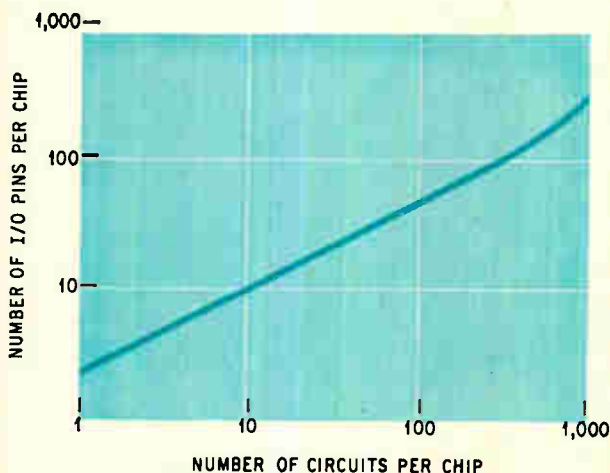

Pin count. There are good reasons for keeping the number of circuits on a chip to a minimum, but there's the disadvantage of an increased number of input-output connections.

Designer's casebook

19 op-amp gains are switched without offset

By Robert Guyton

Mississippi State University, State College, Miss.

Changing the gain of operational amplifiers built with integrated circuits usually requires a readjustment each time of the offset voltage at the output, because changing the gain varies the resistance from pin 2 to ground of the amplifier. This resistance change in turn varies the small constant input current that is needed to bias the input base. With the switching scheme shown in the diagram, the

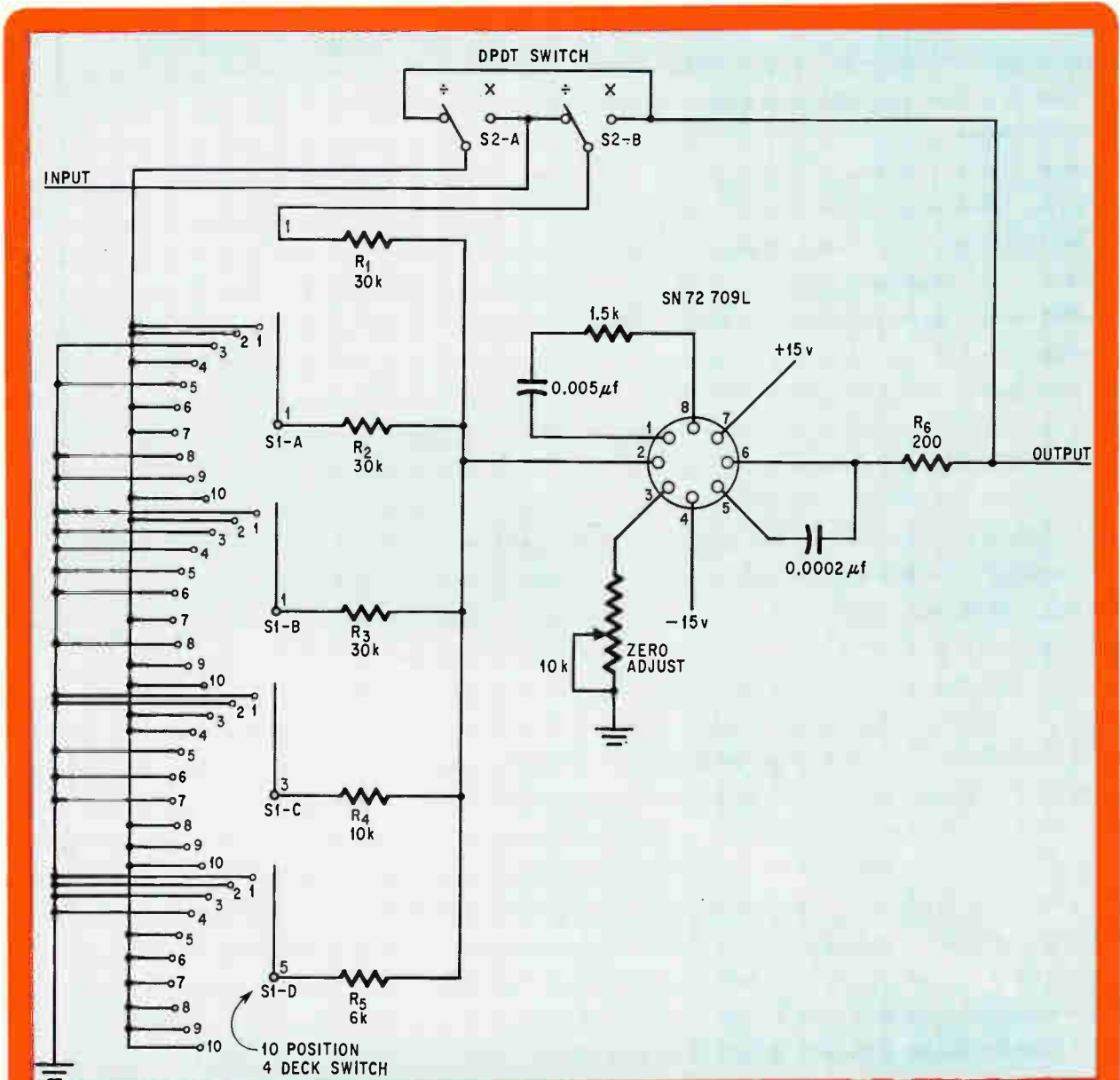

No readjustment. Switch S_1 is set for the desired integral value and switch S_2 selects the operation of multiplication or division by this integer. The resistance from pin 2 to ground of the amplifier stays the same regardless of which gain is selected—eliminating readjustment of offset for each gain.

designer can select as many as 19 different gains while the resistance from pin 2 to ground remains the same without further adjustment. This feature improves the drift and offset characteristics of the circuit.

The gains are selected by two switches. The first switch, S_1 , which is a 10-position, four-deck

switch, picks the integral value, and the second, S_2 , a double-pole, double-throw, decides on multiplication or division by this integer.

R_6 guards against short circuits while still retaining low output resistance. The 10-kilohm potentiometer nulls the output when the input is zero, and needs to be adjusted only once.

MOS FET prevents loading by a pulse stretcher

By John Holland

Government Communications Headquarters,
Gloucester, England

Unless a metal oxide semiconductor field effect transistor is used, circuits designed to stretch narrow pulses by large factors can load the preceding stage. With the field effect transistor, however, the circuit's input impedance is several megohms and therefore prevents this loading.

The stretching circuit consists of R_1 , R_2 , C_1 , and D_1 . R_1 and R_2 provide a small forward bias to the diode, making possible low-amplitude input pulses. R_1 also acts as a good match to the input. C_1 charges

through the forward resistance of the diode and discharges through the parallel combination of R_2 , the diode's back resistance, and the FET's input resistance. Since the FET's input resistance and the diode's back resistance are larger than R_2 , the stretching factor can be controlled by R_2 . The best output waveform with maximum stretching is obtained for $C=t/1.25R$, where t is the input pulse width in seconds, R is the diode's forward resistance and the source resistance in ohms, and C is in farads.

The stretched output from the field effect transistor is further amplified by the two pnp transistors. The circuit will provide a stretching factor of about 2,000 times to a 2.5-nanosecond negative-going pulse having a peak amplitude of at least 0.5 volt.

For very narrow pulses, the charging rate of C_1 becomes important, and therefore a diode having a low forward resistance with a fast response time should be used.

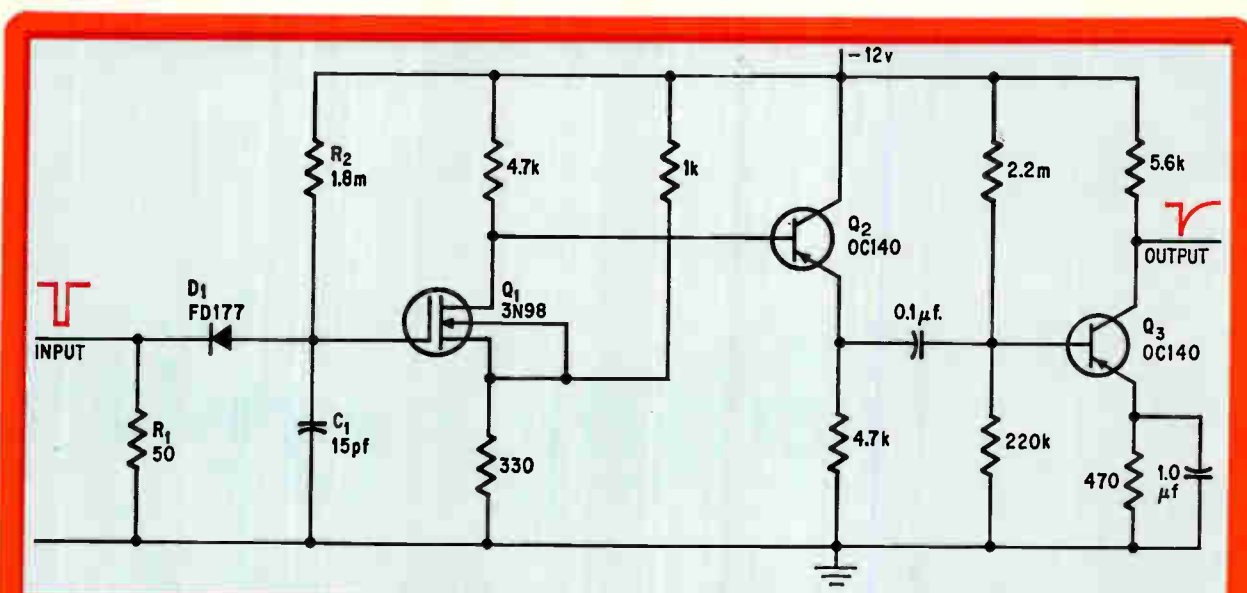

Wider. The MOS FET's high input impedance prevents loading of the preceding stage. Since both the FET's input resistance and the diode's back resistance are larger than R_2 , the stretching factor can be controlled by R_2 . Narrow pulses require a diode with low forward resistance and a fast response time in the circuit.

Sweep circuit triggers on only 200 millivolts

By Edwin Feuer

Army Electronics Command, Philadelphia

This sweep circuit will trigger on as little as 200 millivolts from d-c to over 10 megahertz. Like many other devices these days, it's made mostly with integrated circuits, which makes it cheap to build and easy to assemble.

The input stage has a low input impedance, which can be raised with an additional circuit such as an emitter follower. The stage serves as a preamplifier and phase inverter, allowing selection of positive- or negative-slope triggering. The second stage is a Schmitt trigger, which supplies a fast-rising positive pulse to an R-S flip-flop—making up the third stage—when an incoming signal of sufficient amplitude arrives.

The fourth stage acts as a buffer and drives Q_1 at input frequencies above 1 Mhz. This sets the flip-flop's output high and the buffer's output low. Q_1 turns off, reverse-biasing D_5 , and C begins to

charge through R from the constant-current source, Q_2 . The resultant sawtooth output waveform has very good linearity, and its sweep length can be adjusted for speeds as fast as 0.5 microsecond (with C equaling 100 picofarads and R equaling 3 kilohms).

When the sawtooth amplitude reaches a peak of 10 volts, the zener diode breaks down and delivers a pulse to emitter follower Q_3 . Q_3 's output restores the flip-flop to its original low state and turns Q_1 on again via the buffer stage. C rapidly discharges through the diode, and this causes the sweep to retrace.

Q_3 also triggers the fifth stage—a monostable—which supplies a positive pulse of a certain width to the flip-flop. This inhibits incoming signals from retrigging the third stage before C has fully discharged. The entire cycle repeats itself at the next input.

"Lock-up" cannot occur in this circuit, because as soon as the charge on C exceeds 10 volts, Q_3 resets the flip-flop's output low, which therefore arms the circuit for the arrival of the next incoming pulse.

The 10-volt sawtooth amplitude can be set at a different threshold by using a different zener diode. A positive square wave at Q_1 's collector can be used for cathode-ray tube unblanking. Connecting a 10-

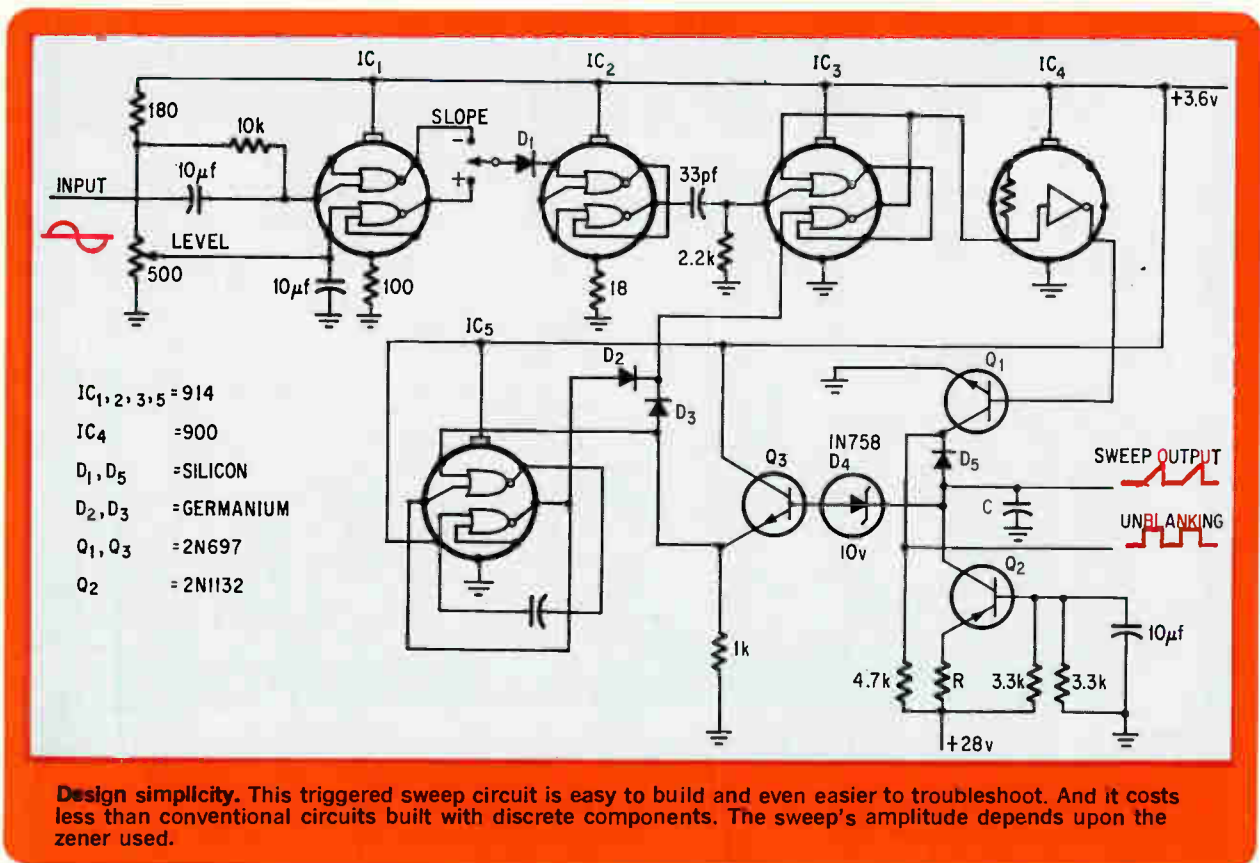

kilohm variable resistor from pin 2 to the supply of the third stage adjusts the sweep for "free run."

The capacitor in the output circuit of IC₅ adjusts the monostable's pulse width.

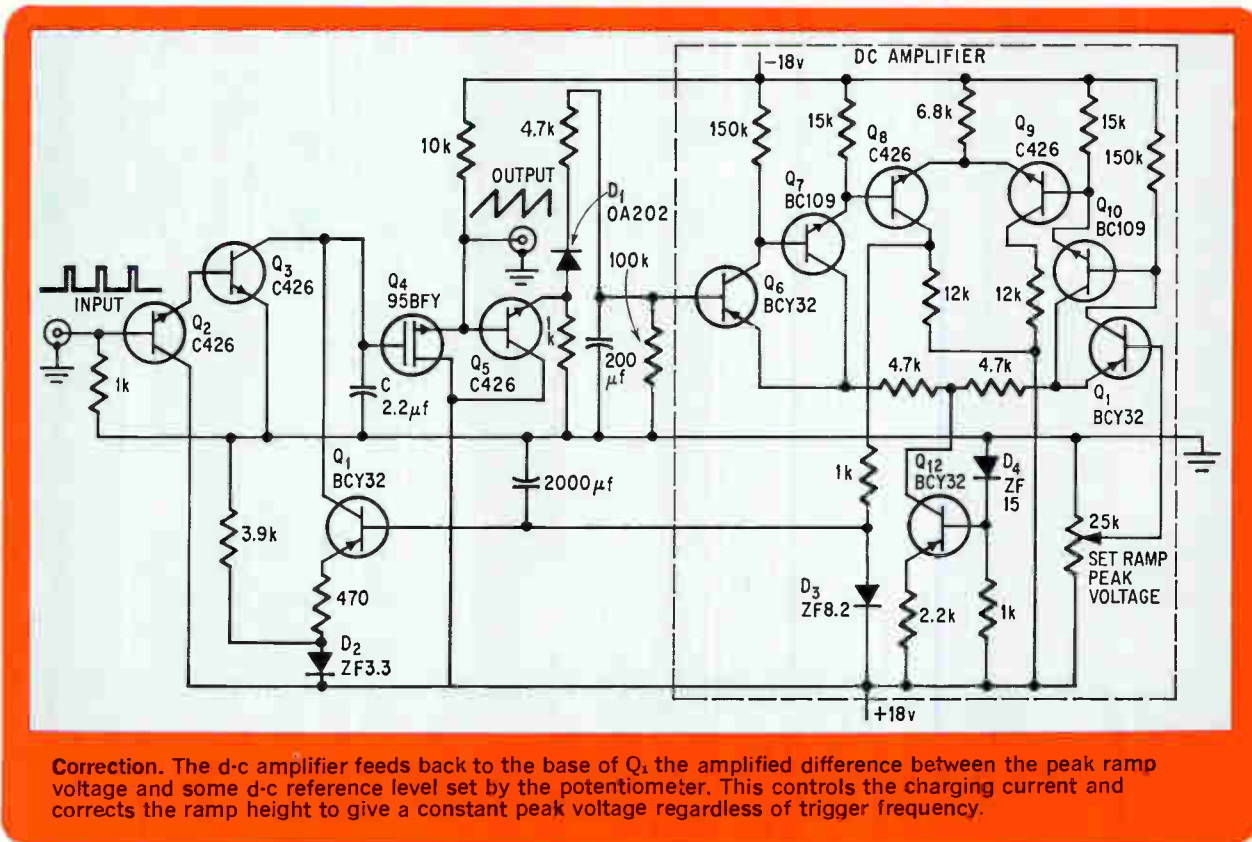

Sawtooth generator delivers constant peak voltage

By Paul R. Adby

University of Sussex, England

Some circuits that generate sawtooth waveforms might not deliver constant amplitudes if the trigger frequency should vary. With the addition of a feedback amplifier that compares the ramp's peak voltage with some reference and uses the error to control the charging current, the ramp's height can be kept at a constant peak voltage regardless of variations in the trigger frequency.

The constant current source, Q₁, charges capacitor C, which periodically discharges through Q₃ to ground. The circuit's output is taken from the ca-

pacitor via field effect transistor Q₄, which acts as a source follower. The d-c amplifier consisting of transistor Q₆ through Q₁₂ and shown boxed in the circuit diagram, takes the signal from the peak detector, amplifies it, and feeds back the difference between the peak ramp voltage and the d-c level set by the potentiometer to Q₁'s base to control the charging current.

The input that discharges C is a positive 5-volt, 20-microsecond pulse delivered from a 5-kilohm source impedance. With the capacitors shown, the circuit is limited in its frequency range to 10 hertz to 1 kilohertz over which the output voltage is constant to within ±5%. At lower frequencies, the circuit will tend to oscillate, and at higher frequencies there will not be sufficient current from Q₁ to charge C.

When combined with a comparator that is set between 0 and 100% of the ramp amplitude, this circuit can be used as a frequency compensated phase delay.

Instruments win top billing with more IC's and digital designs

Trends away from analog indicators and toward circuit integration, evident at earlier IEEE exhibitions, have really taken hold—as has the industry's move toward modular construction

By Owen Doyle

Assistant editor

A visitor to the 1969 IEEE exhibit may at times get the feeling that he's at an instrumentation show, because most of the products on display are from instrument makers. And the kind of products these firms are bringing to New York indicate that the trends discernible at earlier IEEE Shows have entered the mainstream of the industry.

Most companies are switching to integrated circuits, for instance, to boost performance and lower prices. Also, the visitor to IEEE will see more digital machines than ever before as more companies abandon higher-priced analog displays. And the growing number of modular instruments and plug-ins indicate that instrument designers are considering not only what their instrument is supposed to measure, but with what other instruments, handling devices, and controllers it's supposed to interface.

Instrument firms producing digital displays generally plan to expand their lines. Weston Instruments and Datascan, among others, plan to introduce digital panel meters, and Data Technology and the Cimron division of Lear Siegler are just two of the firms showing digital voltmeters at IEEE.

And some holdouts will be jumping on the digital bandwagon. Keithley Instruments will unveil a three-digit picoammeter, and Triplet Electrical Instruments will probably have its first digital meter ready by March 24.

Most makers say analog meters are safe in the \$100-and-under price range, but they agree with Fred Katzmann, director of Monsanto Electronic Instruments, who says, "There's always going to be a place for analog meters, but the days of the high-precision—1% and better—device are over."

More volume, improved production techniques,

and some technical advances have combined to push the prices of digital meters steadily downward. Before the year is over, three-digit multi-meters will be selling for under \$200, and panel meters, in 100-unit lots, for \$150. But 1969 may also be the year that prices start leveling off as designers run into major technical roadblocks.

"Performance of many instruments is being held back by the limitations of linear IC's," explains one engineer. And Delbert Johnson, chief engineer at Cimron, points out that the response time of digital meters is still high. "It takes 300 microseconds for the input amplifiers on digital voltmeters to settle. In the microvolt ranges, the settling time is hundreds of milliseconds, although solid state choppers are improving this speed." Johnson says this problem won't be solved soon.

The big factor in the price of digital meters is the cost of displays. Just about all digital instruments use cold-cathode tubes, which require voltages far above the voltage levels in the rest of the instrument.

Says Johnson: "Nixie tubes are fast and reliable, but they take a lot of voltage. So I think there'll be a lot of interest in phosphor-type displays such as those Tung-Sol is making [*Electronics*, Oct. 28, 1968, p. 160], which are compatible with MOS FET logic levels. Within two years, I think all logic will be on one MOS chip."

All the instrument makers are looking for less expensive display techniques. "No matter what we do with IC's, the bottom level of the price is always limited by the cost of traditional displays," says Ken Petersen, marketing vice president at Hickok Electrical Instruments. "We need something cheaper, and it doesn't necessarily have to be all



It counts; it figures. Hewlett-Packard's newest entrant in the counter timer race is the 5360A which, is both a fast and accurate counter and a calculator.

electronic. I don't rule out the possibility of an electromechanical system. But I don't see anything coming soon; all the proposed replacements for Nixies are hard to make and require expensive logic circuits."

One who does see a change coming soon is Monsanto's Katzmann. He predicts that within a year his company will be selling instruments with displays made from its light-emitting diodes.

As for IC's, more of the instruments at this year's show will have more of their insides made with integrated circuitry. "What would have been a huge blob without IC's," says Robert Boole, marketing research manager at General Radio, "is a small, cheap, reliable instrument with them."

As an example, Boole points to his company's model 1822 dvm calibrator, which will be introduced at the show. Light enough to be hand-carried, the 1822 can check out a d-c dvm in minutes, stepping through voltages from 100 microvolts to 1,000 volts, checking the meter's divider network, exercising every digit in the display, and testing the meter's response to various loads.

Home or away?

But with their increasing use of IC's the instrument companies have to decide not only whether they will buy or make the circuits they need, but if they will use custom-made IC's that fit their designs or design their circuits to fit IC's available off-the-self.

Many of the larger companies make most of the IC's they use, particularly the specialized hybrid

and microwave circuits. For example, Hewlett-Packard engineers designed and made the microwave IC's in the firm's new 8554L r-f section, a plug-in for a spectrum analyzer [*Electronics*, Jan. 6, p. 196]. Among the IC's in the 8554L are a 13-pole Tchebycheff filter and a 2.0-to-2.3-megahertz oscillator that delivers 20 milliwatts.

However, Stephen Lipsky, a vice president of Polorad Electronics, another maker of spectrum analyzers, questions the wisdom of making IC's in-house. "We can make microwave IC's too," says Lipsky, "but if you invest heavily in fabrication equipment, it's expensive to change designs if better components become available." Besides, he adds, no matter how much you pretest an instrument, things can start going wrong when it's in a customer's hands, and it's a lot easier to modify an instrument's design in the field when you're not committed to a specific IC.

Monsanto's Katzmann expects his company to increase the number of IC types it produces, but he predicts that the ratio of store-bought to home-mades will stay at about its present level because the total number of IC's Monsanto uses is on the rise. Katzmann also notes that Monsanto only buys IC's that are available from more than one supplier. "We don't want to be at the mercy of any one company," he explains.

Hickok's Petersen says that "regardless of who is making them, there's a swing towards custom IC's. It's more economical in the long run to design your IC's to fit an instrument design. Big companies like H-P and Tektronix can afford, in fact, have to develop their own IC capability because it's so expensive to buy customized units. But smaller firms like us just don't have the broad product base to support an IC capability. There's a real market for inexpensive customized IC's."

Block after block

Another thing that will be apparent to the IEEE visitor is the industry's swing to modular types of instruments—instruments that can be controlled by a computer, that can easily interface with other instruments, that have binary-coded-decimal inputs and outputs, and that can accept plug-ins.

The last few years have seen many companies go the modular route. Hickok, for a long time a maker of portable work-alone instruments, started making what the company calls semisophisticated measuring systems about four years ago. It first introduced a mainframe with a three-digit display, which now sells for \$375, and a plug-in for measuring d-c voltage. It has added four plug-ins since then, and at the IEEE Show will unveil four more: a d-c microvoltmeter, an a-c voltmeter, an 80-megahertz counter, and a time-interval meter.

One company that's just decided to make the switch is Ballantine Laboratories, which notes that a lot of its customers, particularly General Radio, insist that instruments be designed with the building-block concept in mind. So Ballantine is starting a line of modular instruments with outputs and

remote programming capabilities, and hopes to have its first ready for IEEE.

The trend towards modular instruments is paralleled by moves towards programable instruments, like the John Fluke Mfg. Co.'s 3330A calibrator, and completely automatic systems, like the linear-IC tester that Teradyne hopes to ready for IEEE.

The Teradyne system, including a PDP 8I computer, is priced at around \$80,000. Similar in design to the company's J259 digital-IC tester, the new system measures, among other parameters, input bias current, output offset voltage, output voltage swing and common-mode rejection.

Alexander D'Arbeloff, a Teradyne vice president, says: "One finds input-output jacks on the backs of more and more instruments these days as manufacturers find that their gear is likely to find its way into an automated setup. I'm told that some larger firms, rather than equipping a lab with the usual scope, digital voltmeters, and standards, now buy a computer-based system and add to suit their needs.

"If anything particularly identifies this trend, D'Arbeloff continues, it's the use of software as a means of improving performance without obsoleting one's hardware."

Bob Brunner H-P's group director of marketing, feels the move to computerized systems is inevitable and says he welcomes it. But Brunner warns that computer control isn't an unmixed blessing. The buyer is faced with the fact that "any hard-wired digital process can be done 10 times faster than it can be on a digital computer so the user might need a special-purpose instrument instead. As for the maker, Brunner goes on, if sales of systems don't affect the amount of dollars available, system sales may cut into instrument sales.

Both maker and user have an interface problem, too, Brunner observes. "We don't really have interface standards. TTL circuitry is becoming the de facto component, but no Government agency, company, or trade association is tackling the problem of standardization."

One product area that will generate some excitement at this year's show is the field of counter/timers. Hewlett-Packard has been dominating the medium-price (around \$3,000) market with its 5245L, but at least three companies—Beckman Instruments, Nanosecond Systems, and Systron-Donner—are coming to New York intent on knocking the king off that mountain.

Counter insurgency

Meanwhile, however, the king is climbing another mountain. Probably the most technically significant instrument at the show will be H-P's new 5360A computing counter. Priced near \$7,000, the 5360 has 1-nanosecond accuracy and 100-picosecond resolution. The measuring range of the basic instrument is 0.01 hertz to 320 Mhz, but plug-ins can push it up to 18 gigahertz.

The 5360 can automatically measure a short burst of an r-f carrier and display the frequency,

can calculate phase information from time-interval measurements and display the information, and can directly measure and display the ratio of frequency change to frequency.

On command from a keyboard—a \$1,000 option—the 5360 will, among other things, make differential measurements, take square roots and calculate standard deviations.

One instrument due for technical improvements is the oscilloscope. A couple of makers claim they're close to building 500-Mhz real-time scopes, but they won't be displaying any at this year's show. One of the fastest of the scopes slated for the show will be on the SS-211, a 200-Mhz unit from E-H Research Laboratories.

A scope likely to get a lot of attention is almost an old-timer—Tektronix 576 curve tracer [*Electronics*, Oct. 28, 1968, p. 149]. This unit, introduced last fall, uses fiber optics to display horizontal and vertical scales, increments of input current, and transistor gain.

Back for its second debut at IEEE will be Boonton Electronics' Q bridge. According to Raymond Lafferty, a Boonton vice president, after displaying a mockup of the bridge last year the company received more than 35 orders. Boonton ran into some technical problems, however, but Lafferty says the firm is ready to start deliveries this year.

The bridge can directly measure the Q of a capacitor over a range from 5 to 10,000 and with an accuracy of better than 15%, the executive says. "That's a lot better than you can do with a Q meter," he adds, "and there's no calculating needed." The bridge also measures capacitance from 20 to 1,000 picofarads with better than 1% accuracy, and has a frequency range of 100 kilohertz to 50 Mhz.

On the make

There'll be no big-name dropouts this year, but spokesmen for large established firms continue to feel that it's the new or small companies that derive the most benefit from the show.

Says Teradyne's D'Arbeloff: "For new companies, IEEE is great. One gets good market penetration per dollar and sees the people one needs to see. For example, when Teradyne was new, IEEE enabled us to reach the production people who were our real customers.

"But for a mature company, IEEE's usefulness declines. If one knows one's customers and is known by them, the show becomes only a convenient place to chat with old friends and to do a little pulse-taking."

But no matter who's the big gainer, at these shows many participants feel that the spotlight is shifting away from technical improvements in instruments and focusing more on marketing efforts.

H-P's Brunner believes that for most types of instruments, the parameters that people have been fussing about—frequency, speed, size—have reached useful levels. "The question now is not so much what we can do, but what we can do profitably."

Small counter aims high

A giant-killer: that's the way Systron-Donner sees one of the two frequency- and time-measuring instruments it's unveiling. The company has designed this unit to challenge Hewlett-Packard's pre-eminence in the field of small, lightweight counter/timers, the most used instruments of all.

The job of the 13-pound model 7035 universal counter/timer will be to grab some of the large market now dominated by H-P's 5245L counter and assorted plug-ins, its 5253B heterodyne frequency converter, and its 5262A time-interval plug-in.

The seven-digit 7035 measures frequencies up to 500 megahertz without a plug-in heterodyne; Systron-Donner has used an internal divide-by-four prescaler with a range of 10 Mhz to 500 Mhz to reach that level. Gate time is 0.1 microsecond to 100 seconds in decade steps.

The device's 1-Mhz crystal frequency changes at a rate of only $\pm 5 \times 10^{-9}$ per day after 45 days of dynamic aging. Time-interval measurements range from 0.1 μ sec to 10^9 seconds, with frequency counted from 10 Mhz to 0.01 hertz in decade steps; resolution is 100 nanoseconds. Time intervals are displayed in microseconds, milliseconds, seconds, and kiloseconds with positioned decimal points.

The instrument's weight is less than half that of the 30-pound Hewlett-Packard 5245L without plug-ins, says Charles Rice, sales manager at Systron-Donner's Measurements division. And at 5¼

by 15 by 10¼ inches, the 7035 is only half as large as previous counter/timers.

The divide-by-four prescaler is a major factor in these size and weight reductions. Richard Hall, the firm's manager for frequency counters, says that with transistor-transistor-logic circuits, tunnel diodes, and other circuit refinements, the prescaler takes up but one 3-by-4-inch printed-circuit card. TTL circuits are used extensively.

According to Rice, devices measuring levels below 500 Mhz account for 80% of the counter/timer market. And he says most frequency-counter applications don't require an instrument with the kind of versatility afforded by a variety of optional plug-ins. Any job previously requiring a counter and two plug-ins, he says, can be handled by the 7035. Price is \$2,275 and delivery time is 60 days.

Others in this same new family of Systron-Donner instruments are the model 7038, which is essentially the same as the 7035 but has no prescaler and measures to only 125 Mhz, and the model 7034, which measures to 20 Mhz. The 7038 costs \$1,825 and the 7034 \$1,075.

The second product Systron-Donner is introducing is the model 153 microwave counter, an instrument that operates from 300 Mhz to 3 Ghz, again without a heterodyne plug-in.

Because its operation is simple, this counter should find a place on production lines employing



Checkout. Portable counter/timer 7035 is shown on a test bench, making a frequency measurement in the 500 Mhz band. In the foreground is one of the plug-in boards that combines the decimal count chains with the digital indicators. The board shows the extensive use of integrated circuitry that is characteristic of the instrument line.

unskilled workers. After an input signal is connected to its front panel, the counter provides a six-digit, readout that requires no offsets. Two wide-band sampling mixers are employed here, one to phase-lock the internal oscillator to the input, the other to detect the harmonic number of the

local oscillator. Computing circuitry corrects the time base by multiplying it by the harmonic number. The 153 is priced at \$1,350; delivery time is 60 days. IEEE Booth No. 2B41.

Systron-Donner Corp., Systron Drive, Concord, Calif. 94520 [511]

Fast scope aims at computer market

When you're No. 3, you have to do more than try harder; you have to provide something different. "We don't want to fight the big companies on the basis of copied products," says William Bosboom of E-H Research Laboratories Inc. "That's a losing game." E-H, a maker of sophisticated test equipment, also handles U.S. marketing for the Iwatsu Electric Co. a Tokyo concern that claims to be the third largest oscilloscope maker in Japan.

Says Bosboom: "We will concentrate on the Iwatsu products that advance the state of the art."

E-H will market 100-megahertz and 200-Mhz real-time scopes, both with the extremely fast writing time of 1 nanosecond per centimeter, and an 18-gigahertz sampling scope that triggers automatically at the 18-Ghz rate.

"One of the biggest opportunities for cracking the oscilloscope market is in the computer field," says Robert H. Ragsdale, marketing manager for Automated Measurements Corp., the E-H subsidiary that handles the scopes. "It used to be that only makers of test equipment wanted fast oscilloscopes; now it's IBM and Control Data that demand them. They have to watch a hundred thousand 0's go by and then trigger when a 1 appears, so the

scopes must respond at the computer clock rate. Also, the 1 comes only once, so the scope must have a fast write rate with good visibility."

The high writing speed is provided by an off-the-shelf cathode-ray tube made by Philips' Gloeilampenfabrieken of the Netherlands.

Some of the vertical amplification techniques in the Iwatsu SS-112 (the 100-Mhz instrument) and the SS-211 (200-Mhz) were provided by E-H. The scopes use a distributed deflection system with special transistors that were built to an E-H house number by Motorola's Semiconductor Products division. The transistors provide an improved ratio of transconductance to capacitance (G_m/pf). Rise times are 3.5 nanoseconds for the SS-112 and 1.75 nsec for the SS-211. The 100-Mhz scope has a sensitivity of 5 millivolts per centimeter to 12.5 volts per cm, and an input impedance of 1 megohm; the 200-Mhz scope has sensitivity of 10 mv/cm to 1 volt/cm, and an input impedance of 50 ohms.

Prices haven't been set but will be about \$5,000 for the 18-Ghz scope, \$3,000 for the SS-211, and \$2,500 for the SS-112. IEEE Booth No. 2C29.

E-H Research Laboratories Inc., 515 Eleventh St., Oakland, Calif. 94607 [512]



Fast, faster. The bandwidth of this sampling oscilloscope is either 7 GHz or 18 GHz, depending on the choice of plug-in. The scope is also fast along the horizontal, with speeds up to 10 picoseconds per centimeter.

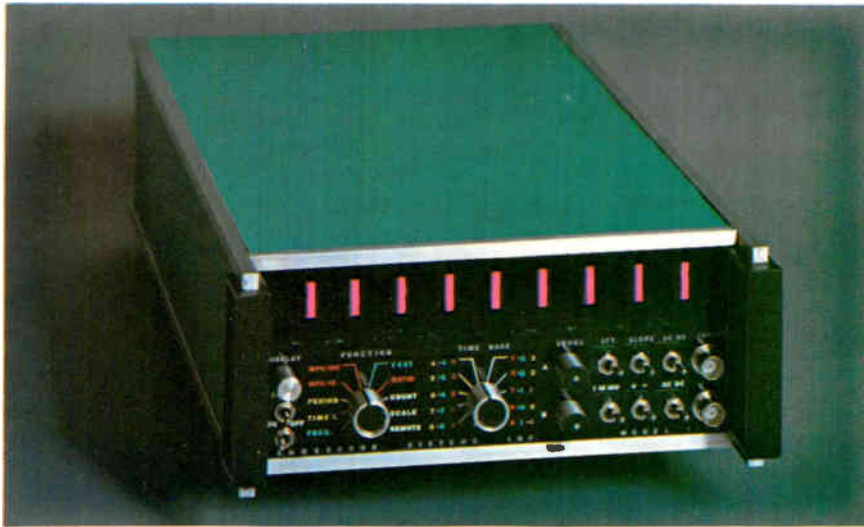

Programmable. A remote programming feature is optional with the 1714. By insertion of circuit cards, the function, time base, trigger level, attenuation slope, and other parameters can be controlled automatically. To program, three eight-bit words have to be provided in sequence at the remote programming jack.

The 'compleat' counter—without plug-ins

Measurement of frequency, period, multiple-period average, ratio and multiple-ratio average of two input frequencies, time interval, and event accumulation can be accomplished by several versatile counters on the market. But Nanosecond Systems Inc. calls its model 1714 the first counter that does it all without plug-ins. The counter has a resolution of 10 nanoseconds.

The model 1714 measures frequency over a range of 0 to 125 megahertz with error no greater than ± 1 count \pm the time-base error. It can measure single periods over the range of 10 nsec to 10^{10} seconds with maximum error of ± 1 count \pm the time base error \pm the trigger error. For multiple periods, the range is 8 nsec to 10^3 sec. This low error is possible because the instrument measures directly, instead of by heterodyning.

It can measure the ratio of frequency A to frequency B over a range of 0 to 125 Mhz on both channels.

The numeric read-out has nine digits; it automatically positions the decimal point and displays the units of measurement.

The oscillator is temperature controlled to maintain a stability of 3 parts in 10^9 per day over an external environment temperature range of 0 to 50°C. The instrument can be used as an external frequency standard, with the output adjustable in decade steps from 0.1 hertz to 100 Mhz.

The 1714 is 3.5 by 8.5 by 14 inches and weighs 12 pounds. The price is \$2,750. IEEE Booth No. 3A48.

Nanosecond Systems Inc., 176 Linwood Ave., Fairfield, Conn. 06430 [513]

A trio of testers

One's for the fast, one's for the thrifty, and one's for the bench.

Engineers at the John Fluke Mfg. Co. have designed a trio of d-c calibrators, each intended for a different type of user. The 3330A is a programable voltage or current calibrator intended for use in automatic and semiautomatic test and calibration systems.

The 343A is a voltage calibrator that Fluke says has the lowest price—\$1,700—and the lowest silhouette—3½ inches high—of any such instrument with the 343A's capabilities. Its place is in

the standards laboratory as a precision reference.

In contrast, the 341A is a voltage calibrator for the laboratory workbench. The price is \$1,000 and the 0.01% accuracy is good enough for calibrating most voltmeters. This calibrator doesn't need a temperature-controlled room to live in; its accuracy stays within 0.01% bounds for temperature swings as wide as 10°C.

The 3330A, which costs \$3,000, is for calibrating meters and analog-to-digital converters and for testing precision components and gyros. Whether it's in its constant-current or constant-voltage mode,



Steady I or V. The 3330A calibrator provides a programmable constant current or constant voltage and operates in automatic systems.

the instrument's output and current-limiting, crowbar, and standby-operate functions can be remotely controlled.

The 3330A has three voltage ranges—10, 100, and 1,000 volts—and an accuracy of 0.005%. The temperature coefficient from 0°C to 50°C is the sum of 0.001% of the setting, 0.00001% of the range, and 2 microvolts expressed per degree centigrade. Stability is 25 parts per million per month.

The output current can go up to 100 milliamps for the lower ranges, and up to 50 ma for the 1,000 range. For constant-current work, the 3330A has ranges of 1, 10, and 100 ma. Accuracy is 0.01%, temperature coefficient is 6 ppm.

When the 3330A is set to one of the lower current

ranges, the output voltages will go as high as 1,000 volts to keep the current constant; in the 100-ma range, the output can go to 500 volts.

Both the 343A and the 341A have three ranges: 10, 100, and 1,000 volts. The 343A has an accuracy of 0.003%, a temperature coefficient of about 0.0005%/°C, and stability of 0.00015% per month. The coefficient of the 341A is 0.001%/°C and stability is 0.004% per month. Both instruments measure 3½ by 19 by 18 inches.

Delivery time is two to three months for the 341A and 343A, and three to four months for 3330A. IEEE Booth No. 2C02.

John Fluke Mfg. Co., P.O. Box 7429, Seattle, Wash. 98133 [514]

An in-between source

The road to success with test instruments is paved with holes. Rather than meet bigger companies head-on, young firms prefer to make units that fill holes in the big boys' product lines.

For example, there was once a gap in the signal-source market. "If money was the problem, you

bought a signal generator for \$1,500 or less," says Robert Hesselberth, sales manager for RF Communications Inc. "If purity was the thing, you put out \$5,000 to \$10,000 for a frequency synthesizer. There was nothing in between."

Now the hole is starting to fill. LogiMetrics



Locked in. The 808 uses an indirect technique—phase locking—to generate its output frequencies, which run from 50 khz to 80 Mhz.

brought out a radio-frequency generator late last year [*Electronics*, Dec. 23, 1968, p. 110], and now Hesselberth's company is ready with its in-between source.

The RF-808 signal generator is a \$3,000 instrument with a range of 50 kilohertz to 80 megahertz. It can put 2 watts into a 50-ohm load, and sweep is either manual or automatic.

The output's purity and linearity, according to Hesselberth, are "just a little bit under what you get from a synthesizer." Harmonics in the output are at least 30 decibels below the selected frequency. RF hasn't set the spurious-signal specification, but Hesselberth predicts it will be 70 db.

An internal 400- or 1,000-hertz signal or an external signal up to 100 khz can modulate the output. For a-m operation, the output's amplitude can be varied by as much as 100%; for changes up to 70%, linearity is better than 1%.

When the output is frequency-modulated, maximum deviation of 5, 15, 75, or 375 khz can be selected; linearity is within 1% when the deviation is 75 khz.

The 808 is 17 by 5 by 15 inches and weighs 40 pounds. RF will start making deliveries in July. IEEE Booth No. 2C01.

RF Communications Inc., 1680 University Ave., Rochester, N.Y. 14610 [515]



Four-plus. The DT 350 has a four digit-plus-overrange readout, and four ranges from 1 to 1,000 volts. Accuracy of the dvm is 0.01%, and it has a 1-microvolt resolution.

Add IC's, subtract cost

It would be hard to name a more competitive market in the instrumentation field than the one for digital voltmeters. But the Data Technology Corp. is planning to gain some ground in that market in the simplest way possible—by offering a basic unit priced considerably lower than the competition.

The series 350 dvm costs a rock-bottom \$695; purchase of the plug-in options that give it the functions of a full multimeter—measuring a-c voltage, millivolts, and ohms—boosts the price of the equipment to \$1,380.

The instrument's designer, Takashi Mori, says that he has replaced at least half the discrete components of earlier versions with IC's. And this cut-back in discretes has allowed Mori to dispense with half the printed-circuit-board area required in the older instruments. The result, of course, has been reduced manufacturing costs.

The 350 employs dual-slope integration, which Mori says is cheaper than other analog-to-digital conversion techniques and eliminates many of the problems associated with them. Since the base line (reference level) of the integrator voltage doesn't have to be stable, according to Mori, integration can begin from a different level at each measurement. The designer notes that in the dual-slope integration method, the only reactive passive circuit element of importance is the integrating capacitor. And the technique doesn't require an accurate, drift-free clock. Transistor-transistor logic is used in the 350.

The meter is sold in a half-rack package measuring 3½ by 14 by 8⅞ inches. Delivery: 30-60 days.

Data Technology Corp., 1050 East Meadow Circle, Palo Alto, Calif. 94303. [516]

MAGNETICS BY ARNOLD

RUB-A-DUB-DUB... GOODBYE!

So who wants the hand crank on the washer and wringer?

On today's automatics you push the button and you're in business. Of course the timer requires an Arnold hard ferrite unit and so does the motor. But they get the job done with much less scrub. And a good many other appliances around the home lean on Arnold to get *their* job done.

Forward-looking manufacturers always look to Arnold for high-quality magnetic materials, design, technology and components. Magnetic cores. Powder cores. Laminations. You ask. We'll supply. The best in magnetic materials.



ARNOLD
SPECIALISTS IN MAGNETIC MATERIALS



The Arnold Engineering Company, Main Office: Marengo, Ill.
Branch Offices and Representatives in Principal Cities

Write for your free guide to the only complete line of magnetic materials.

Other Arnold products can also fit easily into the appliance industry: MPP and powdered iron cores Tape and Bobbin Cores Alnico and Arnox® permanent magnets Supermendur transformer cores.

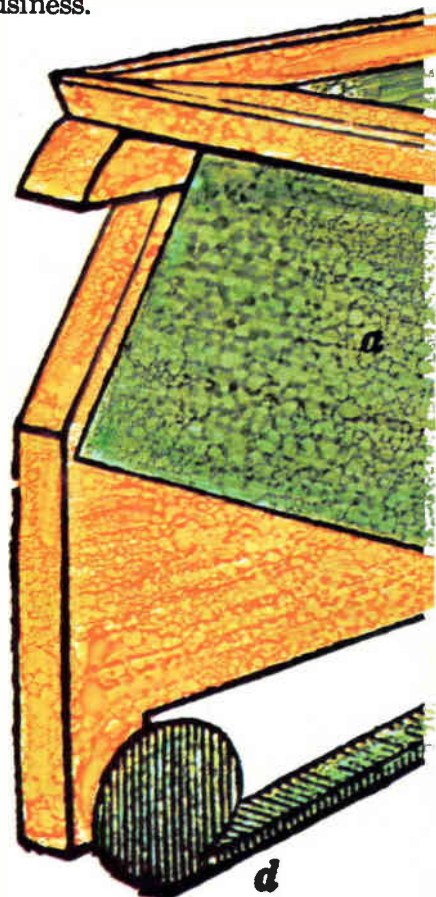

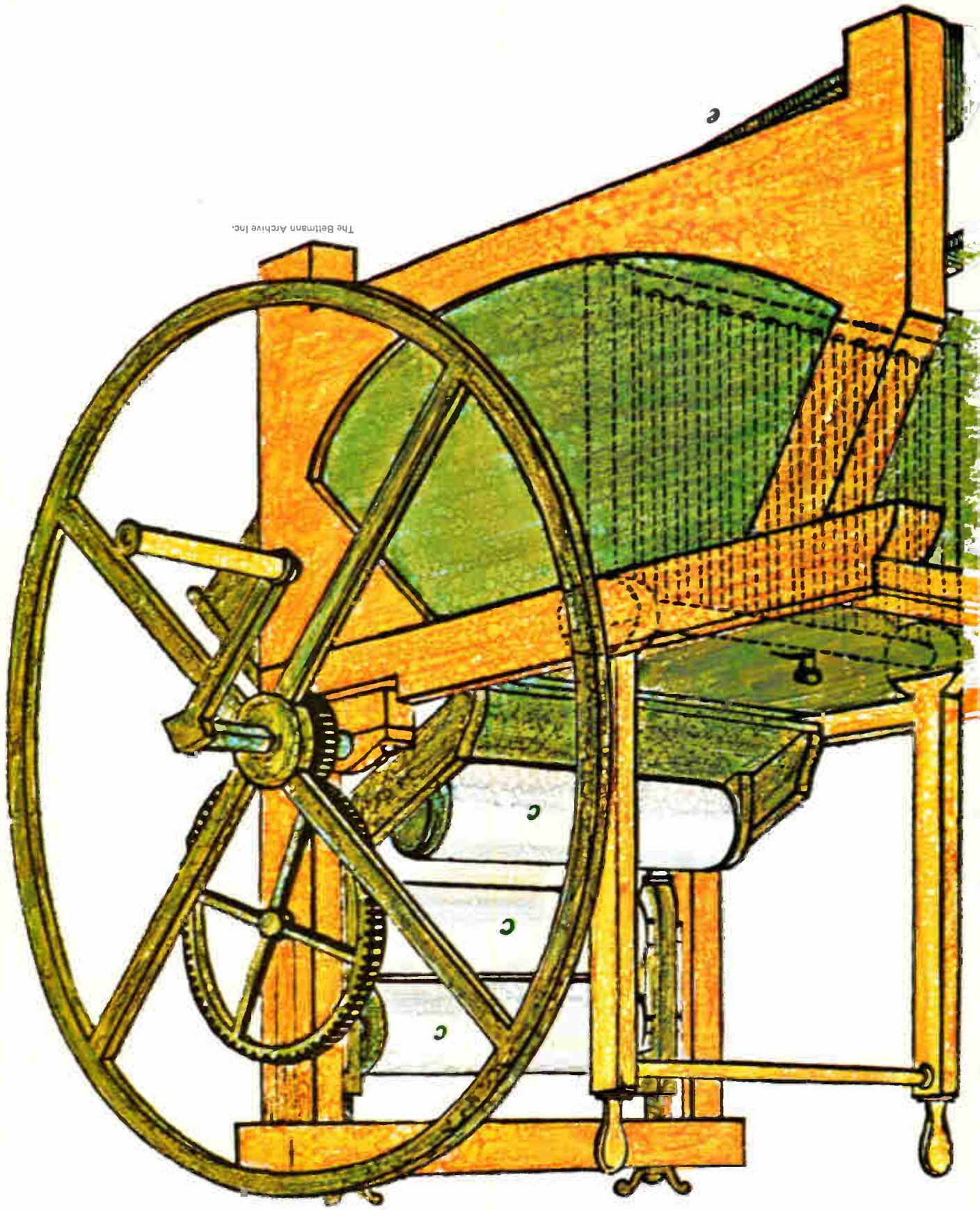

The Bettmann Archive Inc.



Optical techniques light the way to mass-storage media

By M.D. Blue and D. Chen

Honeywell Research Center, Hopkins, Minn.

Optical techniques, though still in an early stage of development, offer a number of advantages in mass-storage applications. In fact, beam-alterable, beam-addressable mass memories are a definite possibility within the foreseeable future.

Optical methods permit information-packing densities greater than those possible with magnetic recording, which provides a different approach to problems of power consumption, weight, and mechanical complexity. In the meantime, of course, computer systems and applications are evolving to the point where ever greater storage capacities are required.

Given the present rate of growth in data processing, 10-billion-bit memories are conceivable. With optical techniques, such a memory could be contained in less than a square foot of surface. Magnetic techniques on the other hand would require at least 100 times as much area.

Researchers in their approaches to optical memories take advantage of all the latest tricks of the trade—such as holography, high-resolution photographic emulsions, and photochromism. They use lasers to vaporize material or to heat it above some critical temperature, where it can be affected by external magnetic or electric fields.

An optical beam, for example, can be focused to a diffraction-limited spot size whose diameter is approximately equal to the light wavelength. Thus when the wavelength is 1 micron (near infrared) the potential density of resolvable focused spots is more than 100 million per square inch. Visible light wavelengths are about half a micron, which makes the potential density of stored information even greater.

By contrast, magnetic recording—on drums, disks, cards, and tapes—currently offers densities of about 100,000 bits per square inch. Improved materials and techniques might conceivably increase density to a million or so, but it's limited by signal amplitude and noise, in turn determined by tradeoffs in track width, track spacing, and surface-to-head distance.

This is the sixth installment in *Electronics'* continuing series on memory technology, which began in the October 28, 1968, issue.

Given these available densities, therefore, a memory of ten billion bits requires 10,000 square inches of magnetic recording surface, or an area eight feet square. This is obviously too large to be addressed directly in a single module; if divided into smaller areas, problems of mechanical motion in access arise.

The performance of various types of computer memories plotted on a storage capacity-access time plane [see opposite page], illustrates the general tradeoff between capacity and access time. Viewed in this way, the projected performance of optical mass memories can include a larger capacity, a shorter access time, or both.

A typical optical memory, diagramed on page 110, uses a laser as a light source. It is thus distinguished from an optoelectronic memory, whose light is internal to the element [see following article]. Almost all proposed optical memories use lasers to get light of high power density (very bright), spatial coherence (waves in phase), or both. The light-beam modulator is a high-speed switch. The beam-deflection system directs the modulated beam to the recorded information, either mechanically—with a scanning prism arrangement, for example—or electrically, using electro-optic or acoustic techniques. The light beam emerges from the deflection system and passes through the storage plane, whose information content alters the beam's character—that is, its intensity, its phase, or its polarization. It then is focused onto a detector, whose signal fluctuations can be interpreted as binary 1's and 0's.

This mode of operation in an optical mass memory system imposes several general requirements on the storage medium:

- It must be readable by the beam, and changeable except in special applications requiring a very

How optical memories compare with other mass-storage units

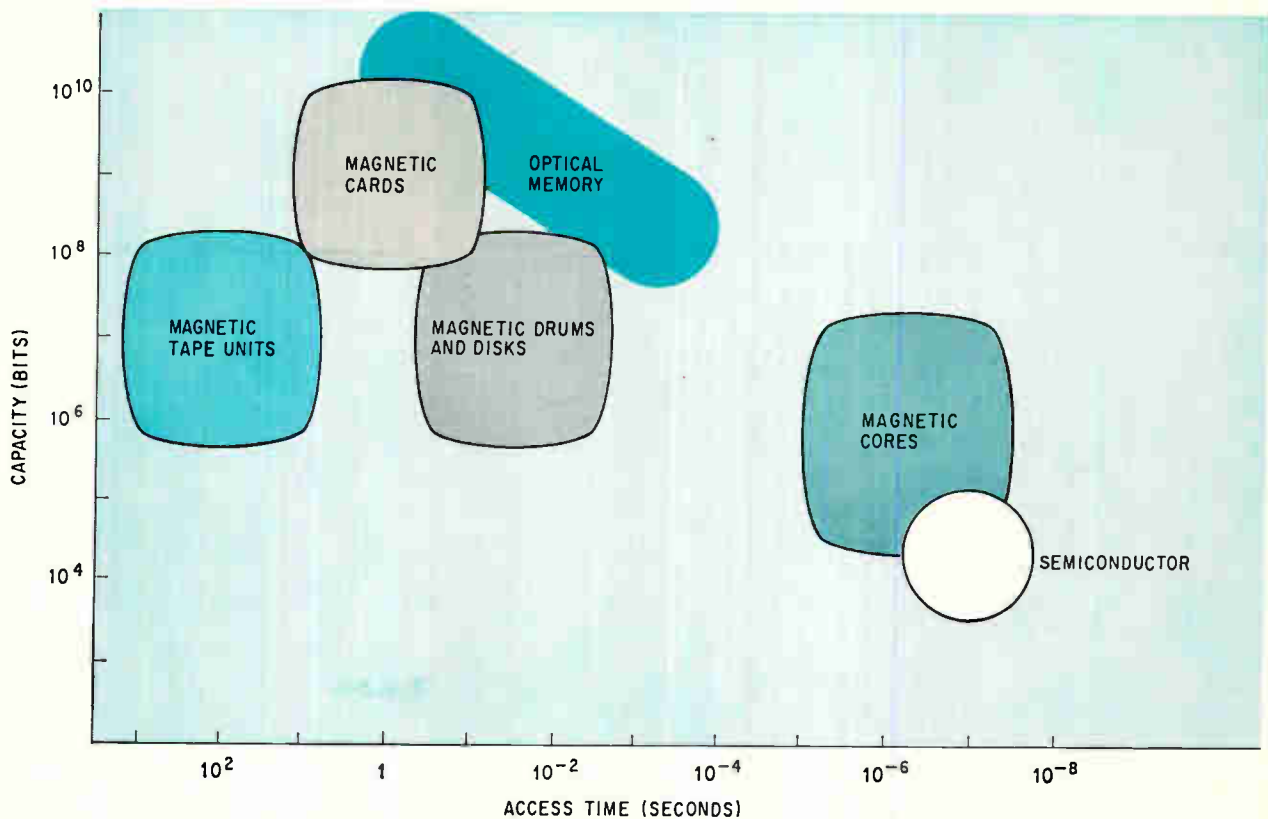

Big and fast. Optical memories hold the promise of capacities larger than presently available units, yet significantly faster than today's big ones.

large permanent memory.

- It must require a reasonable beam intensity.
- It should operate at a reasonable temperature—preferably room temperature.
- Its intensity threshold must permit repeated reading and tolerate scattered beam intensities without affecting the stored information.
- It must be stable over extended periods of time.
- It must be effectively grainless to permit recording information at high densities.

Permanent storage

A novel approach to optical read-only memories, studied at Bell Telephone Laboratories, stores information in a rectangular array of holograms, each of which contains a page of information.^{1,2} The holograms are recorded on a high-resolution photographic plate; thus the information cannot be altered. Each page, or individual hologram, is read by illuminating it with a laser beam, which reconstructs the image—an array of light and dark spots corresponding to 1's and 0's. These are detected by an array of photodiodes. Each hologram can produce a reconstruction at the same location at the readout plane, and as a result, the same array of photodetectors can monitor the entire surface of

the hologram array.

The Bell Labs group, using the holographic technique, demonstrated a system with a capacity of about 4 million bits, and now suggests extending this technology into a system with 100 times the capacity and an access time of less than 10 microseconds.

To erase old and store new information in this system, an alterable material that can record holograms is needed. A photochromic material may turn the trick; such materials are described later in this article.

Photographic emulsions are generally more sensitive than photochromic and other direct recording approaches. The chemical processing of photographic emulsions after exposure effectively amplifies the latent image. However, the advantage of amplification is offset by the delay that the chemical processing requires. Because of the time lag, the information isn't available for reading immediately after writing.

High-resolution photographic emulsions are also permanent. However, they fill the bill for applications that require high information storage density in a fixed form using optical techniques. Recording densities greater than 10⁹ bits per square inch have been achieved,³ and various coating methods are

possible. Writing schemes that use diffraction techniques reduce sensitivity to dust and dirt; these schemes are somewhat analogous to the holographic approach.

Standing waves within the thickness of the photographic emulsion offer another approach toward increasing information storage density. This standing wave occurs when a light beam exposing the film to store a 1 reflects off the substrate below the emulsion and interferes with itself. In doing so the beam sets up a periodic layer structure in the developed silver image, and has a spacing related to the light's wavelength, or color. Light is masked out of areas where 0's are stored, so that these spots remain unexposed. When a beam of light reflects from the developed emulsion, it reproduces the information stored by the light that originally exposed the emulsion. In principle, by using a number of light sources of different colors, many bits could be stored and retrieved at each location in the memory.⁴

Laser on tape

Several proposed laser writing schemes are based on material removal or vaporization by laser beam bombardment. For example, the Precision Instrument Co. has an experimental digital-tape recording system called the Unicon [Electronics, Feb. 3, p. 52]. The system uses a one-watt argon laser, controlled by an electro-optic modulator, which vaporizes 1.5-micron holes in an opaque coating on a clear polyester tape. The tape itself is not damaged. This system records data at several megabits per second, with information densities above 10 million bits per square inch. A lower-power laser, too weak to alter the opaque coating, reads the information from the tape. The stored information is permanent.

Scientists at the National Cash Register Co. report laser beam recordings on evaporated metallic

films⁵ 500 to 1,000 angstroms thick, and on organic coatings several microns thick. In this technique a helium-neon gas laser with a maximum power of 38 milliwatts, focused to a spot 1.8 micron in diameter, records more than a million spots per second. A two-dimensional scanner permits direct facsimile recordings of capital letters approximately 30 microns high.

Itek has studied an optical memory system which uses a laser to write on 10-inch-diameter storage disks coated with photographic emulsion. Data is recorded on five-micron-wide tracks within a 1-inch band at the outer edge of the disks. A store of 650 disks, each holding 200 million bits of data, gives on-line random access to approximately one trillion bits of data.

Beam-alterable memory

A photochromic-holographic optical memory overcomes some of the disadvantages of photographic emulsions, and has some advantages of its own. Photochromism⁶—a characteristic of many organic dyes and other organic or inorganic compounds—is a reversible change in a compound's absorption spectrum when it's irradiated with a specific wavelength of light. In general, short wavelengths cause the spectrum to shift toward the red; longer wavelengths shift it back toward the blue. Thus, a photochromic material that is transparent to visible light can be darkened by ultraviolet irradiation and bleached by visible or infrared light. Alkali halides, such as potassium iodide and potassium bromide, are examples of these crystals. Other materials are transparent only to infrared light; they can be "darkened" by visible light and "bleached" by infrared. The darkened crystal absorbs radiation of a specific wavelength, and continues to transmit other radiation. For example, a material might appear to the eye to change color from yellow-orange to blue-gray, because the red component of white

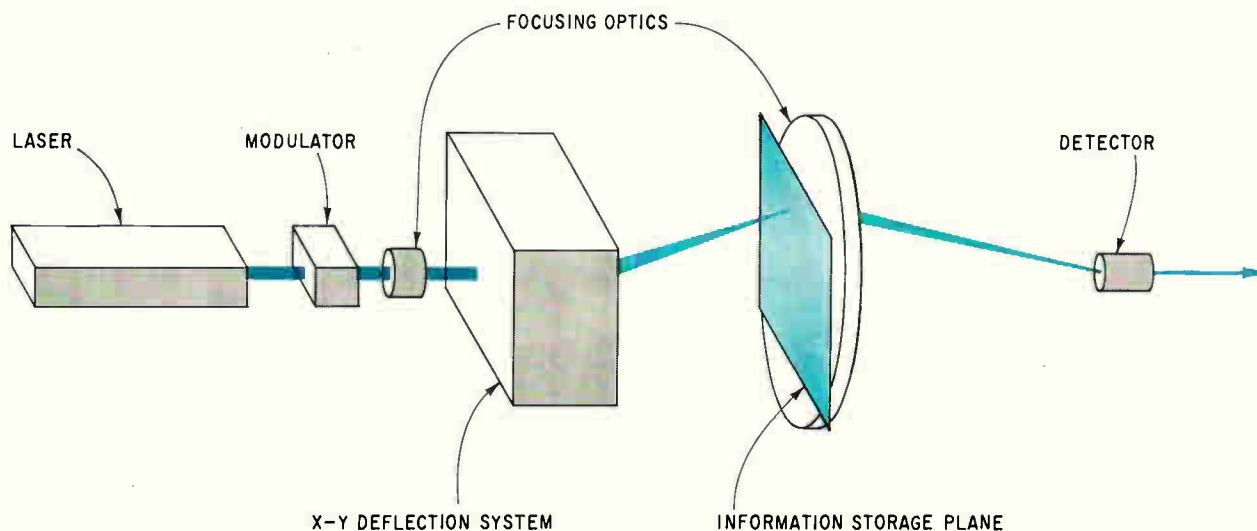

Components. All optical memories require these basic parts, most of which can be implemented in various ways. Common to most of them is the laser, which is both bright and coherent.

light would be absorbed.

Carson Laboratories Inc. took the photochromic approach, and built a system in which the same laser beam bleaches and subsequently reads the alkali halide crystal. The crystal must be heated to approximately 80°C during recording and cooled to 0°C during readout. Its operation requires a high energy level, in terms of much power or a long time; it takes 100 seconds of bleaching to produce a 5% density change when the helium-neon laser's flux density is 50 megawatts per square centimeter and its wavelength is 6,328 angstroms.

Other companies studying photochromic techniques for computer memory applications include RCA, the Univac division of the Sperry Rand Corp., the International Business Machines Corp., NCR, the Control Data Corp., and Itek.

These memories have some unique advantages. Since information can be stored three-dimensionally, the volume instead of the area of the medium is available for storage. Using holography in combination with photochromism, information about each bit is distributed over the entire area of the hologram, so that the memory isn't sensitive to dust particles or mechanical damage. The light deflector's specifications are simpler and the illumination need not be uniform over the hologram area. Photochromic media employ molecular or atomic phenomena and are therefore virtually grainless. Other properties of holograms permit a memory system to be organized in a variety of ways.

But present photochromic media are subject to fatigue after repeated operation, long-time instability, lack of a well-defined threshold of intensity—that is, the media are too nearly linear—and sensitivity to scattered light. Research is under way to solve many of these problems.

Lights and magnets

Magnetic materials when combined with optical systems lead to several novel approaches for reversible storage media. Now that high-power lasers and materials that have improved magneto-optical properties have been developed, the laser can induce usable changes in the magnetic storage medium. Typically, a focusing system concentrates the laser energy on a small region of the material. Information is written in the material with a thermomagnetic effect.

Honeywell Inc. is currently studying how to store information in thin magnetic film of a manganese-bismuth alloy.⁷ This material, in thin-film form, can be magnetized perpendicularly to the film plane, with two stable magnetic states; in both of these it exhibits the magneto-optic Faraday effect. In one stable state, the magnetic field is directed upward through the film. In the other state, the field is directed downward. Regions in the film magnetized up or down correspond to binary 1's and 0's.

The films are first saturated magnetically so that all regions are in the same state. To write information, a laser beam is focused onto a small region, whose temperature rises rapidly. At a temperature

of 360°C—the alloy's Curie temperature—this region loses its magnetization. As the region cools, the magnetic flux from an external field or from the surrounding region aligns the magnetization in the desired direction. This localized region now stores a bit of information. This is called a Curie-point writing technique.

Stored information is retrieved using the magneto-optic Faraday effect. A beam of plane-polarized light from a beam deflector passes through the desired region of the film. Because the film is magnetized, it rotates the plane of polarization of the transmitted beam, one way for a stored 1, the other for a 0. If an analyzer has been set to extinguish light from a 0 bit, then a region magnetized the other way will rotate the beam in the opposite direction, so that it is partially transmitted by the analyzer. A photodetector reads the stored information.

New twist

This readout technique requires a medium, such as MnBi, that has a high Faraday rotation. This rotation is about half a million degrees per centimeter of the material's thickness; but since the thickness in this case is measured in angstroms, the actual rotation is only a few degrees.

The Curie-point writing technique would seem to be inherently slow, depending as it does upon heating a localized region. However, typical laser pulses as short as 0.1 microsecond have been used successfully. After all, spot sizes are only one or two microns in diameter; as a result the amount of material to be heated is very small.

These tiny spots, spaced from 5 to 10 microns apart, can have a density of from six to 24 million bits per square inch.

This writing technique is also applicable to other ferromagnetic materials, notably europium selenide and europium oxide. IBM has been actively engaged in using these materials to demonstrate a technique for an optical memory.⁸ These media have a very large Faraday rotations, but their Curie temperatures are very low—4.2°K for EuSe and 60°K for EuO—so that they must be operated in a cryogenic environment.

Multilayer films whose components have different Curie-temperatures, can also store data using the Curie-point writing technique.⁹ Heating a spot in the multilayer film to a temperature above the Curie point of one of the component films reduces the coercive force of all the layers as a whole to a lower level. An external field slightly above this level then writes data in that spot without affecting the rest of the film.

Garnet adds up

Single crystal garnet materials for magneto-optic memories have been investigated at Bell Labs and at Univac. Gadolinium iron garnet (GdIG), for example, has some very interesting magnetic properties.^{10,11} This material's total magnetization is attributed to two opposing sublattice magnetiza-

Optical mass memory performance

Material	Writing technique	Writing speed, bits/sec	Readout technique	Readout speed, bits/sec	Erasure	Packing density, bits/cm ²	Stability
Manganese bismuth	Thermomagnetic Curie-point writing using 10-mw laser beam; magnetization determined by field near Curie point (350° C)	10 ⁶	Magneto-optic effect	10 ⁸	Applied magnetic field and coincidence laser heating	4 × 10 ⁶	Good below 340° C
Alkali halide	Photochromic process; illumination by ultraviolet or blue beam causes absorption spectrum of bits to shift toward red	10 ⁶	Absorption of light	10 ⁶	Near infrared laser or heat	10 ⁶	Poor
Europium oxide	Thermomagnetic Curie-point writing using low-power laser beam; magnetization determined by field near Curie temperature (−190° C)	10 ⁷	Magneto-optic effect	10 ⁸	Applied magnetic field and coincidence laser heating	10 ⁶	Must be below −190° C
Garnet	Thermomagnetic compensation-point writing using low-power laser beam; magnetization determined by field near compensation temperature (15° C ± 3° C)	10 ⁴	Magneto-optic effect	10 ⁸	Applied magnetic field and coincidence laser heating	10 ⁵	Must be at compensation temp.
Ferroelectric	Combination of photoconductivity and ferroelectric effect. Light beam reduces resistance of photoconductive layer, allowing the applied field to affect ferroelectric polarization.	10 ⁴	Discharge current sensing	10 ⁸	Destructive read only	10 ⁴	Good

tions. At a certain temperature, called the compensation temperature, the two magnetizations cancel in a way that results in a very large increase in the coercive force over its normal value. This compensation temperature can be near room temperature—usually slightly below.

Wafers of this material have only two stable magnetic states, similar to those of manganese-bismuth films. With the crystal magnetically saturated in one state, switching localized regions into the other state stores information in those regions. They can be switched by locally raising the temperature from the compensation level with a focused laser beam, and simultaneously applying an external magnetic field exceeding the coercive force. A small temperature rise—approximately 3°C in GdIG—sharply reduces the coercive force which is the magnetic field required to reverse the local magnetization. Therefore the applied field can switch the heated region, but will not affect the unheated region, which remains at the compensation temperature.

The smallest regions that can be switched on a smooth wafer of GdIG are approximately 100 mi-

crons in diameter, corresponding to about 64,000 bits per square inch. Smaller regions have been obtained by scribing the material into squares. Using this approach, information packing densities approaching a million bits per square inch have been achieved.

Scientists at IBM have recently succeeded in preparing thin films of GdIG chemically. This thin film medium can support a packing density of 10 million bits per square inch, but it requires a higher magnetic field to write, and a larger temperature rise.¹²

Ceramic sandwich

Ferroelectric material, like ferromagnetic material, can have two stable polarization states. Applying an electric field switches the material from one state to the other, just as magnetic fields cause a switch of magnetization in ferromagnetic materials. These basic properties make ferroelectric materials such as barium titanate and triglycine sulfate appear suitable for an alterable medium.

The "ferrotron" scheme suggested by the Marquardt Corp. is an interesting application of ferro-



Optoelectronic memories: light to read out by

By Richard D. Stewart

General Electric Co., Syracuse, N.Y.

electrics to optical memory.¹¹ This device consists of a photoconductive and a ferroelectric layer sandwiched between two electrodes; the electrode next to the photoconductive layer is transparent. When the photoconductive layer is dark, it prevents the electric field applied at the electrodes from reaching the ferroelectric layer. But a light beam focused on a particular spot of this device reduces the photoconductive layer's resistivity at that spot. Consequently, the external field reaches the ferroelectric layer at a localized region and orients its polarization accordingly.

The written information is read out by discharging the ferroelectric medium when the beam addresses it. The direction of the discharge current indicates the direction of the polarization, and thus indicates that a 1 or 0 had been stored.

The readout is destructive because it removes the stored electric charge. A nondestructive readout in the ferroelectric would be possible using the electro-optic effect, which would alter the character of a polarized light beam as mentioned previously. But the development of a ferroelectric optical memory lags other techniques. The main difficulties are in the material preparation and in the lack of well-defined switching thresholds in many practical ferroelectric materials. Recent studies in polycrystalline electric ceramics suggest these difficulties eventually will be resolved.

The major approaches to optical memories are summarized in the table opposite. The performance figures are estimates, based on material limitations and in some instances on preliminary experimental results. ■

References

1. F.H. Smits and L.E. Gallaher, "Design considerations for a semipermanent optical memory," *Bell System Technical Journal*, July-August, 1967, p. 1,267.
2. L.K. Anderson, "Holographic optical memory for bulk data storage," *Bell Laboratories Record*, Nov. 1968, p. 319.
3. J.A. Altman and H.J. Zweig, "Effect of spread function on the storage of information on photographic emulsions," *Photographic Science & Engineering*, May-June, 1963, p. 173.
4. H. Fleisher, P. Pengelly, J. Reynolds, R. Schools, and G. Sincerbox, "An optically accessed memory using the Lippmann process for information storage," *Optical and Electro-Optical Information Processing*, MIT Press, Cambridge, Mass., 1965, p. 1.
5. C.O. Carlson, E. Stone, R.L. Burstein, W.K. Tomita, and W.C. Myers, "Helium-neon laser: thermal high-resolution recording," *Science*, Dec. 23, 1966, p. 1,550.
6. A. Reich and G.H. Dorion, "Photochromic high-speed large-capacity semi-random access memory," *Optical and Electro-Optical Information Processing*, MIT Press, Cambridge, 1965, p. 567.
7. D. Chen, J.F. Ready, R.L. Aagard, and E. Bernal G., "Laser-addressable manganese-bismuth film: key element in a high-density optical memory," *Laser Focus*, March, 1968, p. 18.
8. G.Y. Fan and J.H. Greiner, "Low-temperature beam-addressable memory," *Journal of Applied Physics*, Feb. 1, 1968, p. 1,216.
9. D. deBouard, "Feasibility study of a large-capacity magnetic-film optical memory," *IEEE Journal of Quantum Electronics*, May, 1968, p. 378.
10. J.T. Chang, J.F. Dillon, Jr., and U.F. Gianola, "Magneto-optical variable memory based on the properties of a transparent ferrimagnetic garnet at its compensation temperature," *Journal of Applied Physics*, March, 1965, p. 1,111.
11. Norman Goldberg, "A high-density magneto-optic memory," *IEEE Transactions of Magnetics*, Dec. 1967, p. 605.
12. R.E. MacDonald and J.W. Beck, "Magneto-optical recording," 14th Annual Conference on Magnetics and Magnetic Materials, Nov. 18-21, 1968.
13. S.C. Requa and J.M.N. Hanlet, "Externally sensitive solid-state image storer," *Space/Aeronautics*, August, 1964, p. 87.

Optoelectronic memories have two unique features: First, their electrically bistable, light-emitting storage elements are completely independent of their detectors, which read out the stored information. Second, partly as a result of this isolation, much intermediate processing can be done during readout—in fact, almost as a part of it.

Optoelectronic memory technology, however, has a long way to go. The big problem is system design; even though some remarkable devices have been invented, such as the light-emitting switch and the electroluminescent-photoconductor cell, few advances have been incorporated into practical systems.

The isolation means that there's no limit to the number of detectors that can be operated simultaneously, in any kind of sequence or pattern. Readout can be serial, parallel, or by block. If the application warrants it, even reading and writing can be simultaneous—although not in the same element, of course. And the light emitters and detectors can operate with different ground references without interference.

By contrast, most other forms of storage elements are built into a linear array that permits reading or writing in only one element at a time, so they are intrinsically serial. Some configurations permit reading or writing in an entire row or column at a time, but this is the closest approach to true parallel operation of nonoptoelectronic arrays, short of operating several small arrays at once, and it's very expensive. Designers must take care to eliminate ground loops and other paths for spurious signals.

While the data is being read out, intermediate processing can be done with an opaque mask, a filter, or a Kerr cell. Thus, with optoelectronics, an associative memory, for example, could be built; or a correlation function could be applied to the data as it is being read out. For example, if an optoelectronic memory contained the digital equivalent of a pictorial image, correlation would permit the image to be separated from a noisy background, or would establish the existence of certain characteristics in the image. This technique has already been used successfully in a fingerprint identification experiment.

The General Electric electronics laboratory is currently developing new ways to fabricate high-density arrays of optoelectronic elements, not only

for memories as such but also for memories with optical readout—that is, for displays. In another current program, the British Ministry of Technology is evaluating optical mass memory storage techniques. International Computers Ltd. is building an optical read-only memory, based on a cathode-ray tube scanner, photographic data store, and a photomultiplier readout. The system is designed to store 65,536 words of 69 bits each. This program's results will indicate the capability of an optoelectronic system based on well-established optical components.

The difference between optoelectronic and electro-optical memories should be kept carefully in mind. Optoelectronic memories contain an array of electrically bistable light-emitting elements, any of which can be turned on or off, so binary data can be stored. Because each bit requires a separate electrically switchable element accessible from the array's exterior, optoelectronics is most suitable for small, fast memories, such as scratchpads.

Electro-optical memories, on the other hand, store data in some kind of mask that transmits or obstructs a beam of light [see preceding article].

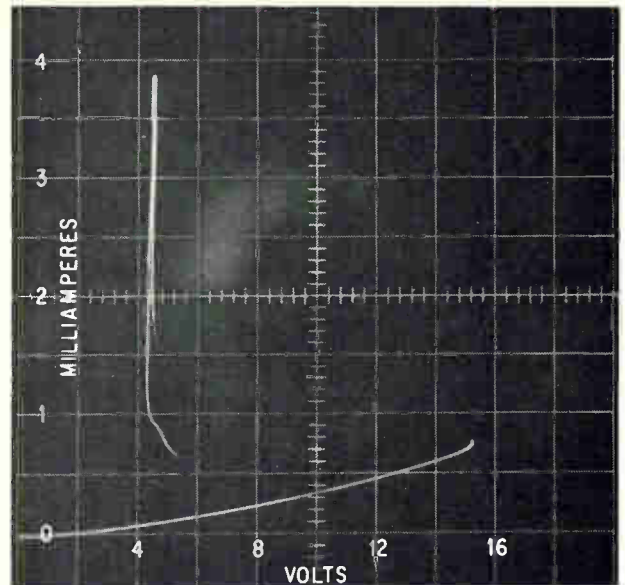

Threshold. Voltage-current characteristic of light-emitting switch shows threshold, where gradually increasing current suddenly begins to climb steeply as voltage drops back. Curve is also discontinuous with decreasing current.

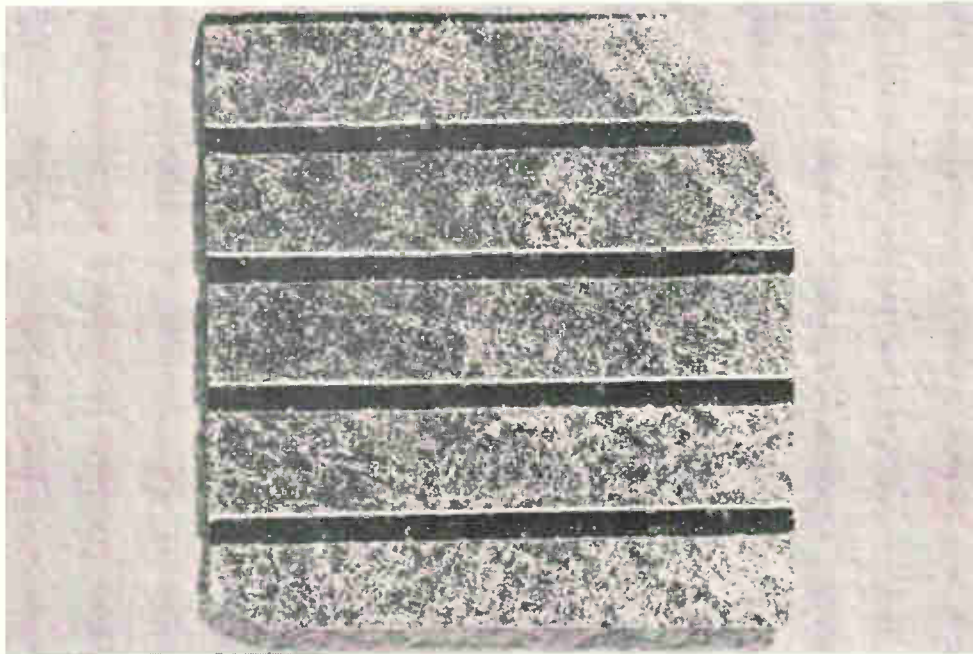

Etching. Black stripes are semi-insulating substrate, showing through where p-type material (gray) has been etched away to isolate the columns in a memory array about $\frac{1}{4}$ -inch square. Continuous gray material connects the anodes of a column of diodes. The bottom photograph shows the reverse side of a $\frac{1}{2}$ -by-1 inch wafer that, except for size, is similar to the one above. Each white dot is a spot of n-type material. A memory array would be made from this wafer by evaporating a thin-film resistor beside each dot, then connecting the resistors in rows perpendicular to the columns, as shown on page 116.

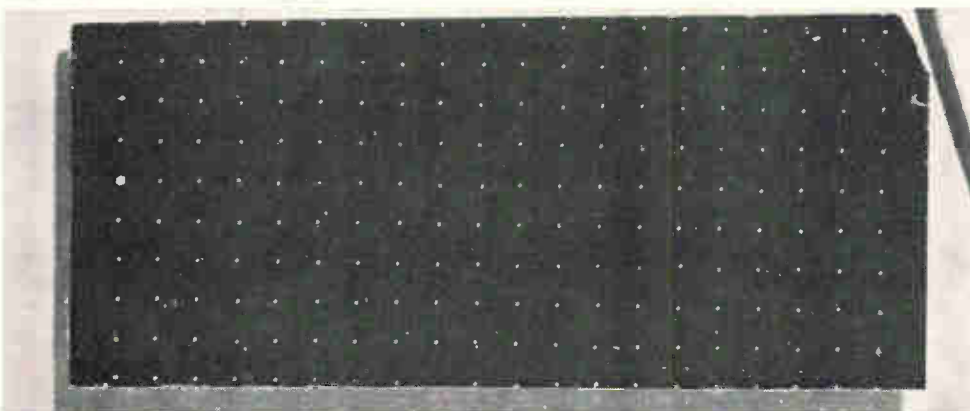

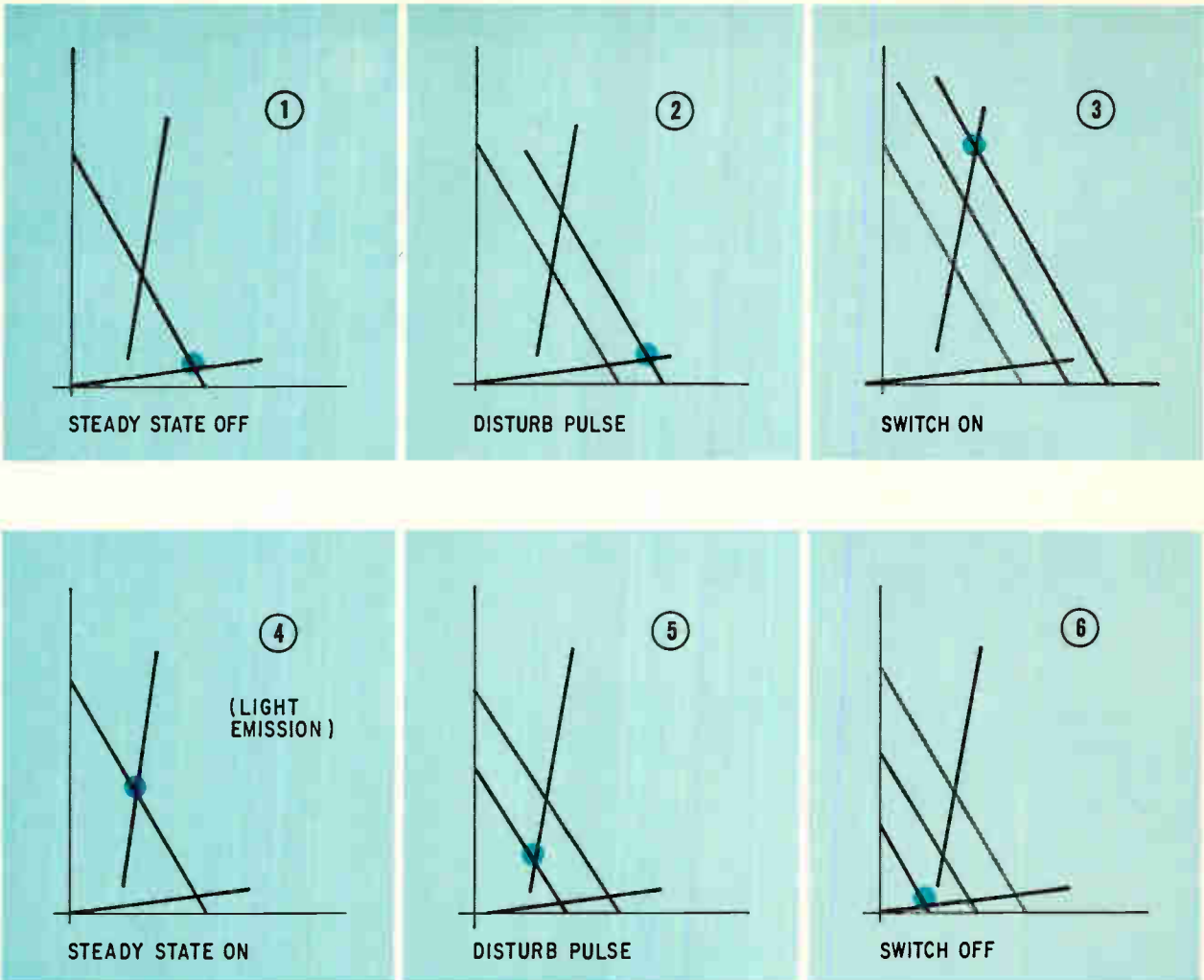

Disturbance. In the matrix on the next page, a single disturb pulse at either end of a diode has no effect on it, but pulsing both ends of the same diode can change its state. These six diagrams trace the sequence of events.

Since the mask can be large and the data densely packed, the electro-optical memory is suitable for bulk storage. Also, because often the data in the mask cannot be changed easily or at all, most electro-optical units are either read-only or updatable memories, that is, data can be added but not removed.

Optical feedback

Several kinds of devices or combinations of devices meet the requirements of an optoelectronic memory. One simple combination is the photoconductor and neon bulb; a similar unit is the electroluminescent-photoconductor (EL-PC) cell. These devices are connected as a series circuit, with optical feedback to establish bistability. Once the bulb or EL device begins to emit, its light reduces the photoconductor's resistance, ensuring that the emission continues. In addition, the emitted light indicates the storage cell's state. It's turned on by applying a momentary overvoltage to the series circuit, or by shining an external light source on the PC element; it's turned off by removing the power

momentarily.

The combination, however, is larger than monolithic circuitry. A much smaller cell is a combination of a silicon integrated flip-flop and a light-emitting diode. The silicon IC provides the three-state and storage action. In this configuration the light emission is solely for external detection; it doesn't enter into the circuit function.

A light-emitting switch developed by GE embodies the concept of an optoelectronic memory element in a single device.* It's essentially the only unit now being developed. Unlike a light-emitting p-n diode, the LES contains a layer of semi-insulating material between the p and n regions. This material's resistivity—generally between 10^5 and 10^6 ohm-centimeters—is considerably higher than that of the usual doped semiconductor, which is about 0.01 to 1 ohm-cm, yet isn't quite as high as that of an ideally pure, or intrinsic, semiconductor—about 10^8 . (The classic insulating materials, such

* The LES device was investigated for memory and display applications under military contracts AF30(602)-3615 and DA28(043)-01486(E), respectively.

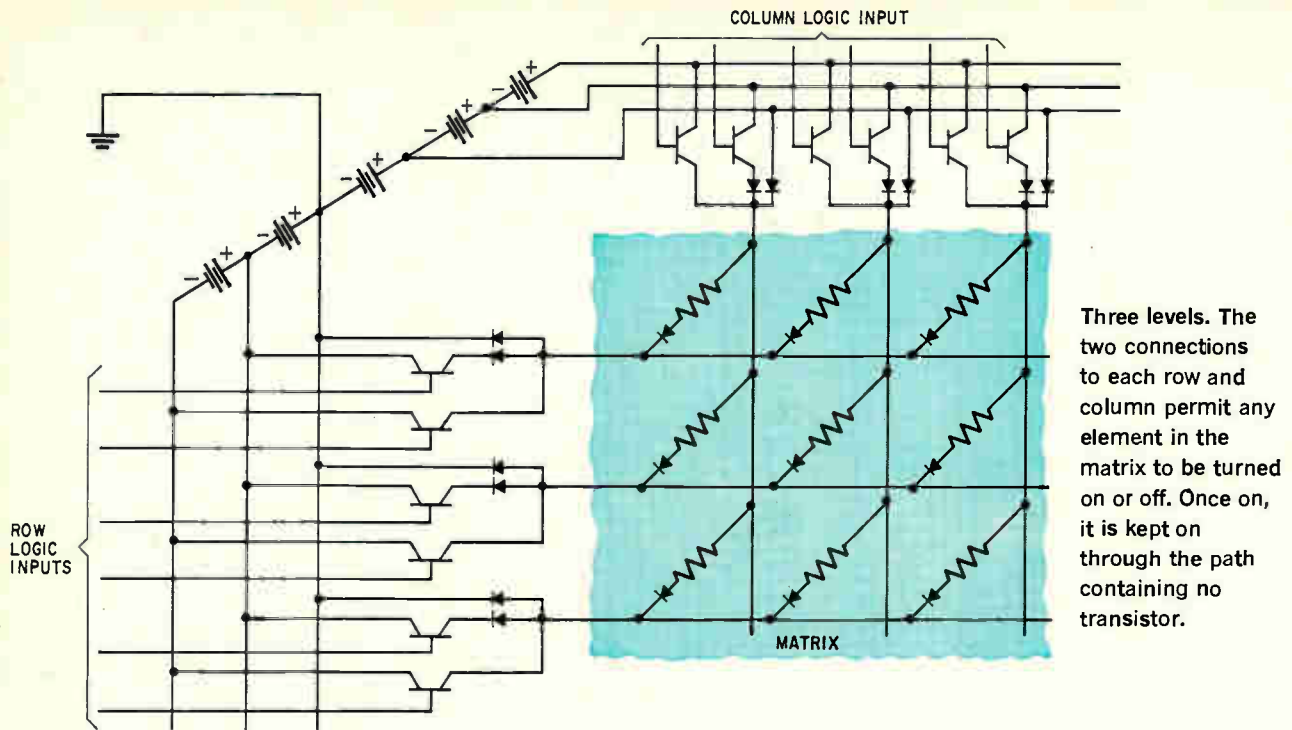

as rubber or porcelain, have resistivities of about 10^{15} ; copper is about 2×10^{-6} .) This material also distinguishes the LES from the superficially similar p-i-n diode, whose interposed layer's resistivity closely approximates that of intrinsic material.

The LES, when properly biased, will maintain a steady state with either high or low impedance. Its voltage-current characteristic curve, shown on page 114, and the diagrams on page 115 show how it does this. In the low-impedance, or "on" state, the LES emits radiation characteristic of its bandgap. For a gallium arsenide structure this radiation occurs near 8,800 angstroms, similar to the GaAs p-n emitter. Since the LES emits no radiation in the high-impedance mode, its state can be interrogated by sensing its optical output.

To use any optoelectronic device in a practical memory, many units must be integrated into a high-density array. The LES structure is well suited to this array fabrication, because the individual device element consists of a p region and an n region formed on opposite faces of a high-resistivity wafer. The isolation between adjacent devices depends on the starting wafer's bulk resistivity; since this is on the order of 10^6 ohm-cm, several tens of megohms are easily achieved.

To apply an optoelectronic storage element as a memory, appropriate signals must be presented to each element in the array so that it can be switched independently from the high-impedance or "off" state to the low-impedance or "on" state, or vice versa. These can be obtained from three-level drivers connected to the rows and columns of the array, as shown above. Writing a 1 into a particular element in the matrix requires each of

the two drivers that control the element's row and column to apply half the selection voltage. This increases the voltage applied to the element above its threshold level, switching it to the low-impedance state. Writing a 0 is similar; the applied voltage is reduced below its lower stable level.

Because data retrieval is optical, it's independent of the switching electronics. The read part of the memory consists of an image sensor system that can sample each of the storage locations. This can be done serially, in parallel, or in a combination of both. The most basic detector system is an array of photodetector elements—one for each of the emitters. Several kinds of solid state arrays of photoconductors, photodiodes, or phototransistors are available for this function.

Another type of detector can be made from a vidicon sensitive to near-infrared light. One difficulty in this approach is aligning the electron beam to a particular location on the photo-cathode corresponding to a specific storage element. A potential solution entails a discrete diode array for the vidicon cathode, so that a unique correspondence exists between each emitter and detector. Similar photodiode vidicons have been successfully operated at Bell Telephone Laboratories at densities of about a million per square inch. ■

Bibliography

- E.I. Gordon, "Beam-scanned vidicon," Bell Laboratories Record, June 1967, p. 175.
- G.C. Gerhard and H.A. Jensen, "Visible light-emitting switch," Applied Physics Letters, June 15, 1967, p. 333.
- A.M. Barnett and H.A. Jensen, "Observation of current filaments in semi-insulating GaAs," Applied Physics Letters, May 15, 1968, p. 341.
- "Electro-optical mass memory," Data Processing Magazine, July 1968, p. 23.

RIGHT NOW

This North American
LSI Test Console is

- AVAILABLE VERSATILE
- ECONOMICAL RELIABLE

... and it's PROVEN!

Available now . . . not "soon." (Normal delivery is within 60 days.) Reliable now . . . proved in regular use by several of the largest producers and users of arrays. (Names on request.) Economical now . . . costs far less than computer-driven testers or building your own black box. Versatile now . . . can be programmed in 15 minutes to test almost any array or IC (LSI—MSI—MOS) without punched cards, paper tape or magnetic tape. Building block concept permits special panels that aren't special. This right now LSI Tester is fast becoming the standard of the industry. Write or phone for complete information right now.

The N.A.E.S. mobile LSI Test Console features:

- a word generator capable of 40 words, each 100 bits long, bit rates from DC to 2.5 MHz;
- a four channel clock generator with adjustable frequency, sequencing, positioning, inhibiting, and leveling of clock pulses;
- a 16 channel comparator with adjustable bit time strobe, 1 and 0 level windows, don't care inhibits and error overrides;

- a 40 channel converter with every word adjustable for 1 and 0 levels;
- a work area with quick connect fasteners for different array socket carriers, array loading and treeing tie points and four adjustable power supplies;
- word toggling capability for words up to 800 bits.

for further information, write or call:



North American Electronic Systems

DIVISION OF EDUCATIONAL COMPUTER CORPORATION

Sicklerville, New Jersey 08081

Telephone: 609-629-4141



Charting a simpler course to the design of yig filters

Multiresonator devices can be put together quickly on paper through the use of charts to determine input, output, and interstage coupling networks; the technique is much faster than trial-and-error work on the bench

By Walter Venator

Airtron Division, Litton Industries Inc., Morris Plains, N.J.

The increasing use of multioctave yig-tuned filters as fast scanning preselectors in commercial and military equipment makes a quick and accurate design procedure invaluable. The usual procedure for multiresonator yttrium iron garnet filters—trial and error to determine coupling-loop parameters and the spacing between resonators—is no longer adequate.

The empirical method was used simply because most of the literature treated the response characteristics of single-section filters only. Now, however, electronically tunable multiresonator yig filters can be designed using only two conventional filter tables and some new coupling-bandwidth design charts. These charts detail the input, output, and interstage coupling requirements as a function of the sphere's diameter and its saturation magnetization.

When using yig spheres as filter resonators, three basic techniques can be used to couple r-f energy from one sphere to another: one or more full turns, semiloop coupling, or sphere-to-sphere coupling.

The full-turn loop is usually used for the lower-frequency filters—below 2 gigahertz. For example, to determine the coupling-loop parameters for two ferrimagnetic spheres, assume that they're centered in identical coupling loops, have the same diameter and saturation magnetization, experience the same magnetic field, and are separated by a metallic wall so that the coupling is due only to the loops. Now, the coupling bandwidth, BW_{coupling} , in megahertz, can be calculated

$$BW_{\text{coupling}} = \frac{2}{3\pi} \left(\frac{d_s}{d_1} \right)^3 \omega_m$$

where d_s = sphere diameter
 d_1 = mean coupling-loop diameter

$$\omega_m = \gamma 4\pi M_s = (2.8) 4\pi M_s$$

This equation, an extension of Comstock's work,¹ shows that the coupling bandwidth depends on the ratio of the loop and sphere diameters and the saturation magnetization, $4\pi M_s$, of the resonator material.

To find the coupling-loop dimensions, the coupling bandwidth of each resonator must be calculated from the 3-db bandwidth of the filter multiplied by the normalized coupling coefficients. The exact values of the coefficients depend on whether a flat (Butterworth) or ripple (Tchebycheff) passband is desired. These coefficients are listed for up to an eight-pole filter in many reference texts.² Multiplying each coefficient by the 3-db filter bandwidth gives the coupling bandwidth for the input, output, and interstage coupling loops.

The last parameter that must be determined before using the design chart to find the ratio of the coupling loop and sphere diameters is the maximum value of saturation magnetization. This value, which depends on the lowest frequency at which the filter must operate without limiting the r-f signal, is found using the chart shown on page 121. It is equal to the saturation magnetization just below the intersection of the filter's lowest operating frequency and the f_2 curve. Now, using this value of saturation magnetization, the ratio of the coupling-loop and sphere diameters that satisfies each coupling bandwidth is determined from the appropriate design charts. The chart for the full-loop coupling, for instance, is shown on page 122. Once this ratio, the loop-wire thickness, and the

Anatomy of a yig filter

When a d-c magnetic field is applied to yttrium iron garnet, the material exhibits a high-Q resonance at a frequency proportional to the strength of the field. Called the gyromagnetic resonance frequency, this can be changed simply by changing the strength of the field.

The basic electronically tunable yig filter uses a yig sphere—highly polished for lower loss—placed in the center of two coupling loops whose axes are perpendicular to each other and to the direction of the field, H_{d-c} . With no external field, there is little input-to-output coupling through the unmagnetized yig sphere, since the coupling loops are at right angles to each other.

However, in a d-c magnetic field, the yig material's magnetic properties change and coupling from the input to the output can occur even though the coupling loops are at right angles. The amount of coupling depends on the r-f signal frequency and the magnetic-field strength. R-f energy at the gyromagnetic resonance frequency, $f_0 = 2.8 H_{d-c}$, will be coupled with little attenuation, but at other frequencies the attenuation becomes quite high.

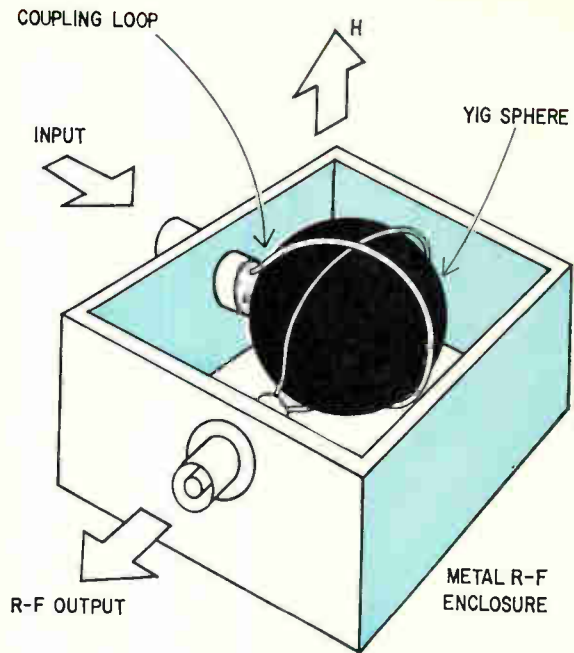

sphere size are determined, the loop diameter is easily found. This same basic design procedure is also used for semiloop or sphere-to-sphere coupling.

Suppose a filter with the following specifications was required.

- Tuning range 1-2 Ghz
- Selectivity -60 db at $f_0 \pm 85$ Mhz
- Passband response maximally flat
- 3-db bandwidth 25 ± 5 Mhz
- Insertion loss 4 db maximum
- Off-band isolation 80 db minimum
- Limiting level 0 dbm at 1 Ghz

From the design chart shown on page 121, we find that 535 gauss is the maximum value of saturation magnetization that can be used before the filter starts to limit the input signal within its passband. To satisfy the selectivity and off-band isolation requirements, a four-section filter, similar to the one shown on page 120, must be used. The normalized coupling coefficients for a maximally flat four-pole filter are²

$$q_1 \text{ and } q_4 = 0.766$$

$$k_{12} \text{ and } k_{34} = 0.840$$

$$k_{23} = 0.542$$

The required coupling bandwidth for each filter section is found by multiplying these coefficients by 25 Mhz—the over-all 3-db filter bandwidth. The coupling bandwidths are

- 19.1 Mhz between the input and the first sphere, and the fourth sphere and the output
 - 21 Mhz between the first and second, and the third and the fourth, spheres
 - 13.5 Mhz between the second and third spheres
- Using the design chart on page 122, the ratio of

the loop and sphere diameters, d_l/d_s , can be determined for each of the coupling bandwidths for the interstages. The coupling bandwidths are used directly as calculated, but the input and output coupling bandwidths must be doubled. This must be done because the input and output coupling uses only one sphere and one loop, whereas the chart was based on two loops and two spheres. If a sphere diameter of 0.03 inch and a coupling-loop wire size of 0.005 inch are used, then each coupling-loop diameter is found simply by multiplying d_l/d_s by 0.03 inch.

$$k_{12} \text{ and the } k_{34} \text{ loop} = 0.075 - 0.005 = 0.070 \text{ inch}$$

$$k_{23} \text{ loop} = 0.087 - 0.005 = 0.082 \text{ inch}$$

$$q_1 \text{ and } q_4 \text{ loop} = 0.063 - 0.005 = 0.058 \text{ inch}$$

Insertion loss

The midband insertion loss of a yig filter depends on several factors: the 3-db bandwidth, the normalized low-pass element values, g_k , and the unloaded Q, Q_{uk} , of the resonator material. The low-pass element values depend on the desired shape, and the unloaded Q depends on the resonator's linewidth. And usually, the higher the saturation magnetization, the lower the linewidth, and the lower the insertion loss. The insertion loss, IL, in db, can be expressed as³

$$IL = 4.34 \frac{f_0}{\Delta f} \sum_{k=1}^N \frac{g_k}{Q_{uk}}$$

where g_k low-pass element value, Δf = 3-db filter bandwidth, Q_{uk} = unloaded resonator Q, f_0 =

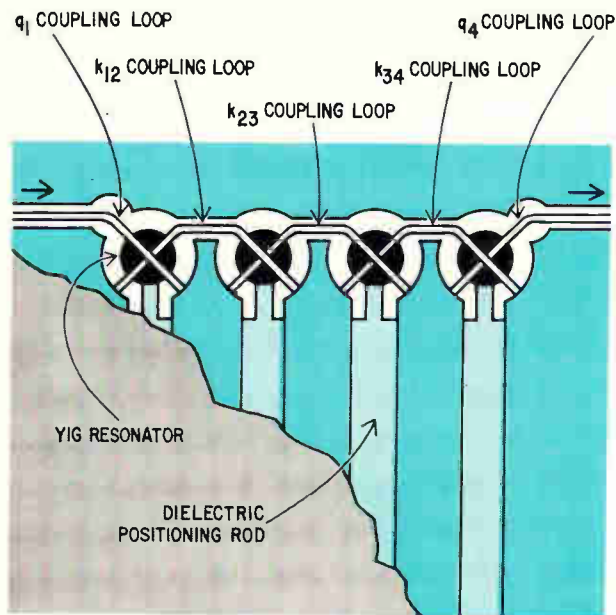

Typical filter. The cutoff section that houses the yig resonators and full-turn coupling loops of the L-band filter is smaller than the r-f connectors.

resonant frequency of the filter, and N = number of filter sections.

The unloaded Q of a yig resonator can be expressed as the ratio of the applied magnetic field, H_0 , and the linewidth, ΔH . Multiplying both terms by γ , the gyromagnetic ratio of the ferrite material, we have

$$Q_u = \frac{\gamma H_0}{\gamma \Delta H}$$

And since the resonance frequency, f_0 , is equal to γH_0 , the unloaded Q can be expressed as $f_0/\gamma \Delta H$, where $\gamma \Delta H$ can be considered the unloaded bandwidth of the yig sphere. Now if we assume that the unloaded Q of each section is the same, then the insertion loss, in db, for a yig filter becomes

$$IL = 4.34 \frac{\gamma \Delta H}{\Delta f} \sum_{k=1}^N g_k$$

L-band filter performance

Frequency (Ghz)	Bandwidth 3-db (Mhz)	IL (db)	Off-band isolation (db)
1.0	22	3.0	80
1.2	25	3.0	80
1.4	25	2.8	80
1.6	24	2.5	80
1.8	24	2.5	80
2.0	26	2.5	80

The low-pass element values are⁴

$$g_1 \text{ and } g_4 = 0.7654$$

$$g_2 \text{ and } g_3 = 1.848$$

And the sum of these values is 5.22.

The last parameter required before the insertion loss can be calculated is the material's linewidth. According to the manufacturer's data, the material selected has a linewidth of 1.0 ± 0.2 oersted.

Inserting all these terms and $\gamma = 2.8$ for yig into the previous equation, the insertion loss is 2 db for a ΔH of 0.8 oersted, and 3 db for a ΔH of 1.2 oersteds.

An L-band four-section filter was built using the calculated loop sizes and 0.030-inch-diameter yig spheres with a saturation magnetization of 530 gauss and a linewidth of 1.0 oersted. The resulting filter performance, tabulated at the lower left, either met or exceeded the initial specifications.

Bandwidth limitations

Wide-bandwidth filters do pose a greater problem of spurious responses, which are similar to those found in a conventional microwave cavity when a mode other than the desired one is allowed to propagate.

Narrow-bandwidth yig filters exhibit out-of-band spurious responses that are typically 15 db below the main response for each filter section—or 60 db of rejection in a four-section filter. For a given value of saturation magnetization a wider bandwidth requires tighter coupling, and this can cause non-uniform r-f magnetic fields that increase the in-band spurious responses.

Yig filters are inherently narrow-bandwidth devices (3% or less); however, bandwidths up to 300 Mhz at X band can be obtained with pure yig as the resonating element. Saturation magnetization less than that of pure yig—1,750 gauss—considerably reduces the maximum attainable bandwidth. This is because the r-f coupling properties of a material vary directly with the value of saturation magnetization. Also, the requirement of a loop-to-sphere ratio greater than 1.5:1 to minimize spurious responses, and the smaller coupling-loop inductance necessary to prevent self-resonances, make it particularly difficult to obtain wide-bandwidth filters below 1.0 Ghz.

To prevent in-band limiting at 500 Mhz, the resonator material's saturation magnetization should be no greater than 260 gauss. However, with this low a value it's difficult to obtain a wide bandwidth with just a single full-turn coupling loop, and multiturn loops cause additional problems. A two-section maximally flat filter, using 260-gauss material, requires a normalized input loop coupling coefficient, q_1 , of 1.414. The coupling bandwidth required of the filter for a 1.5 ratio of loop-to-sphere diameter is found to be 46 Mhz from the chart on page 122. But since the coupling is due to only one sphere and one coupling loop, the 3-db bandwidth must be halved. The maximum 3-db bandwidth is found simply by dividing the coupling bandwidth by the coupling coefficient.

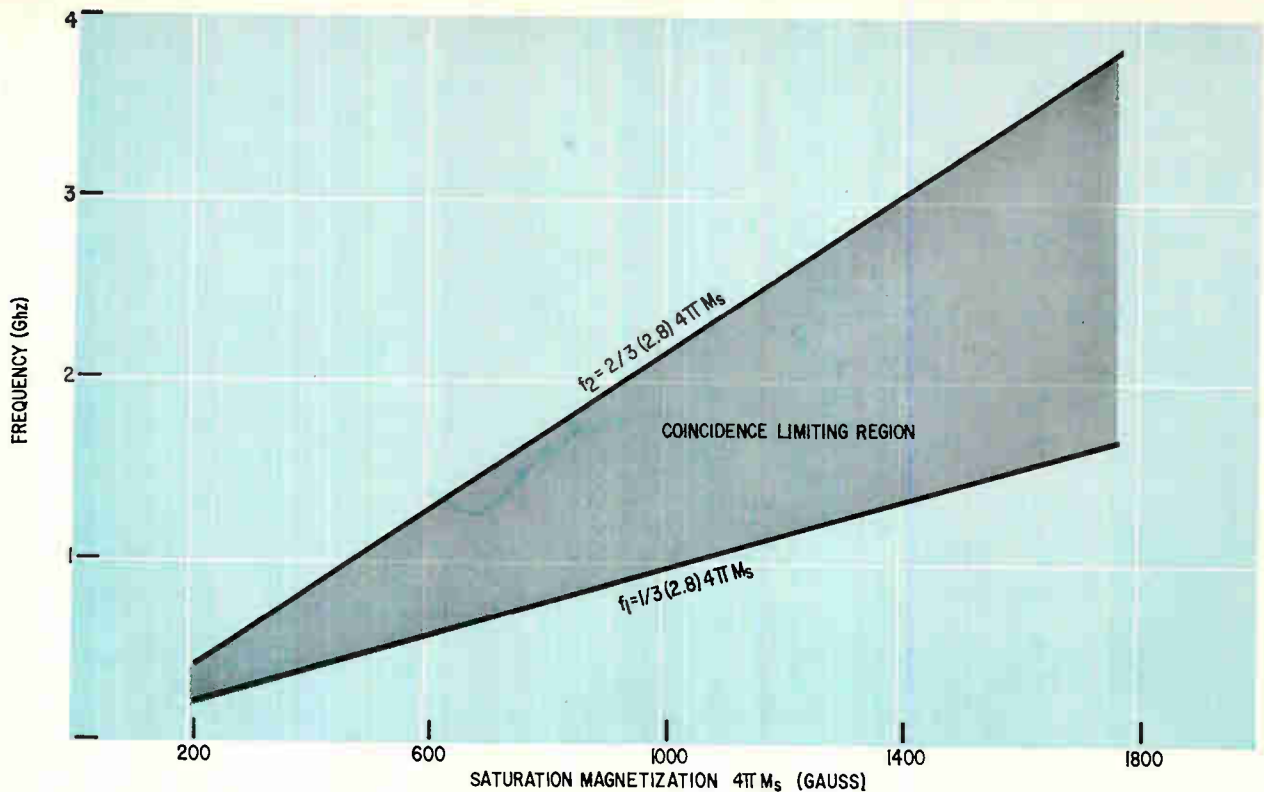

No coincidence. The region enclosed by f_2 and f_1 where a ferrite exhibits coincidence limiting depends primarily on its saturation magnetization, $4\pi M_s$.

$$BW_{3\text{-db}} = \frac{46}{(2) 1.414} = 16 \text{ Mhz}$$

If still wider bandwidths than can be obtained using a single-turn loop are required, double- or triple-turn loops can be tried. Of course, this increases the loop inductance, which will most likely decrease the off-band isolation and increase the spurious resonances.

To find the loop diameter for the double-turn case, halve the required coupling bandwidth and proceed as for the single-turn configuration. Coupling increases as the number of loops increase until the self-resonances caused by the loop inductance and the interloop capacitance become intolerable. If the coupling-loop diameters are kept small enough, triple loops can be used up to 1 Ghz; double loops from 1 Ghz to 2 Ghz; single loops from 2 Ghz to 4 Ghz, and semiloops from 4 to 12 Ghz.

Another technique that is often employed to increase the bandwidth and avoid the self-resonance problem makes use of low-pass filter transformers. This technique reduces the impedance seen by the input filter resonator, increasing the Q-bandwidth product by the amount of impedance reduction. The output impedance of the filter is then transformed back up to match the impedance that the filter must work into.

Suppose a wide-bandwidth filter with the following characteristics was required

- Tuning range 4 to 5 Ghz

- Number of sections 4
- 3-db bandwidth: 100 Mhz
- Response shape: 0.1-db ripple
- Insertion loss: 1.0 db
- Limiting level: >0 dbm at 4.0 Ghz

According to the design chart above, for a limiting level of 0 dbm at 4.0 Ghz, pure yig material, with a saturation magnetization of 1,750 gauss, can be used. Pure yig should be used whenever possible because it has the lowest line-width—highest unloaded Q—of most ferrite materials.

The normalized coupling coefficients for a four-section filter with a passband ripple, (V_p/V_r) , of 0.1 db are

$$q_1 \text{ and } q_4 = 1.05$$

$$k_{12} \text{ and } k_{34} = 0.737$$

$$k_{23} = 0.541$$

The coupling bandwidths are found by simply multiplying the 3-db bandwidth of 100 Mhz by each of the coupling coefficients. The coupling bandwidths are

- 105 Mhz between the input and the first sphere, and the fourth sphere and the output
- 73.7 Mhz between the first and second, and the third and fourth, spheres
- 54.1 Mhz between the second and third spheres

The required ratio of the loop and sphere diameters can be found using the design chart shown on page 122 for a saturation magnetization of 1,750 gauss. Since a 0.020-inch sphere diameter and a wire thickness of 0.005 inch are used, the coupling-

4-to-5-GHz wideband filter performance

Frequency (Ghz)	Bandwidth 3-db (Mhz)	IL (db)	Off-band isolation (db)
3.4	98	0.6	95
4.0	100	0.6	94
5.0	102	0.8	85

loop diameters can now be determined. They are: k_{12} and $k_{34} = 0.041$ inch; $k_{23} = 0.053$ inch; and q_1 and $q_4 = 0.030$ inch.

Such a filter was built, and its performance, tabulated above, was well within the specified tolerance.

One of the unique features of yig-tuned filters is the multioctave tuning range. Although the yig material imposes no restrictions on the filter's maximum operating frequency, other factors do. The size and the type of coupling, for instance, restrict the tuning range, bandwidth, out-of-band isolation, and, to some extent, the limiting level.

The sphere should be made small to minimize

the semiloop diameters, which is necessary to prevent any self-resonance of the coupling loops. But doing this would limit the maximum 3-db bandwidth. For a workable sphere size, the tuning range and bandwidth must be compromised.

The bandwidth increases as the filter is tuned to higher frequencies. It would double for a 12-to-1 tuning range. This is due to unwanted magnetic and electrostatic coupling that occurs between the input and output as well as between the inter-stages. Usually a 2-to-1 bandwidth spread is tolerable for many system applications, such as pre-selectors for spectrum analyzers or broad-band intercept receivers. However, if greater off-band isolation is required, two filters, in tandem, with some isolation between them, should provide about the selectivity of a four-section filter. A multioctave, two-section yig filter that tunes from 1.0 GHz to 12.4 GHz was designed and built using .020-inch-diameter spheres of 535-gauss material. The results of a two-section filter that tunes from 1.0 to 12.4 GHz are tabulated on page 123.

The maximum number of sections for a yig filter depends primarily on the maximum tolerable insertion loss and physical size. The greater the number of sections, the more the insertion loss; the

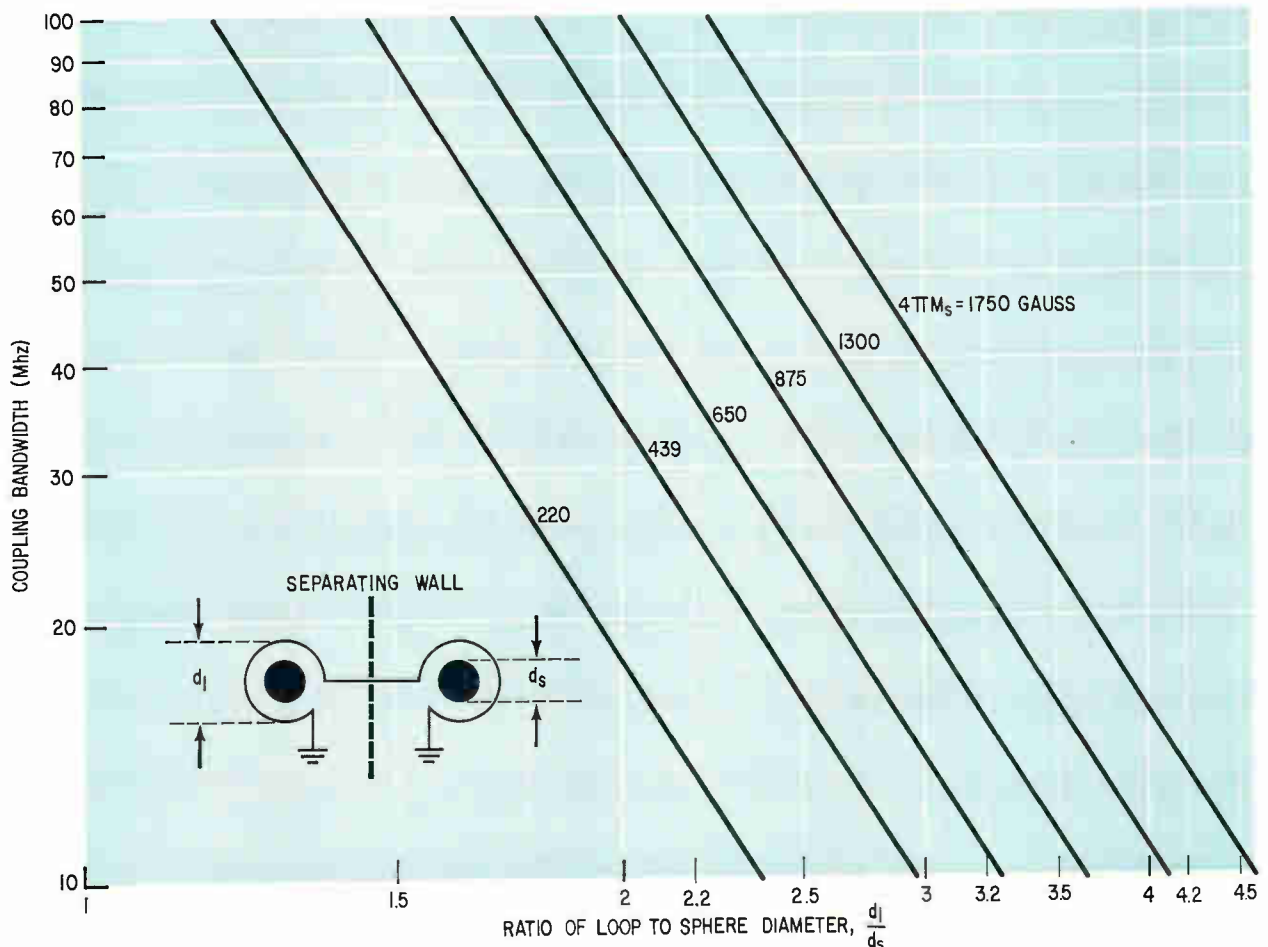

Full-loop coupling. Saturation magnetization and coupling bandwidth determine the coupling-loop diameter.

Multi-octave filter performance

Frequency (Ghz)	Bandwidth 3-db (Mhz)	IL (db)	Off-band isolation (db)
1.0	20	3.75	60
2.0	21	2.75	60
3.0	22	3.0	60
4.0	23	3.0	60
5.0	23	2.5	60
6.0	25	2.75	60
7.0	26	3.0	60
8.0	30	3.0	55
9.0	31	3.25	55
10.0	36	3.0	55
11.0	43	3.0	55
12.0	47	3.5	50
12.4	51	3.5	50

larger the magnet's pole face area must be to ensure a uniform magnetic field across the sphere, and the larger the over-all size.

It would be better, if possible, to minimize the number of sections used and to design the coupling loops to give the desired response function.

Greater selectivity can be obtained using sphere-to-sphere coupling because the technique allows greater flexibility in achieving the required bandwidth. For filters above 4 Ghz, all coupling-loop inductances should be eliminated, and it is possible, using this technique, to do this on all but the input and output coupling loops.

Such a filter design would consist of a coaxial TEM-mode launcher that terminates into a .005-inch semiloop coupler. The launcher couples r-f energy to the input coupling loop, which, in turn, couples it to the first yig resonator. At the gyromagnetic resonance frequency of the yig resonator, the magnetic component of the r-f field is rotated by 90° and then coupled to the second sphere. The r-f output from the last sphere is again rotated 90° and coupled to the output loop.

The input and output semiloop coupling still depends on d_1/d_s , the ratio of the loop and sphere diameters. The coupling bandwidth is plotted for different values of saturation magnetization as a function of d_1/d_s on the design chart on page 124. The interstage sphere-to-sphere coupling, however, depends on the ratio of the center-to-center spacing between spheres, r , and the sphere diameter, d_s , as shown on page 126.

The spheres are placed in an appropriate r-f structure and covered with a metal plate. The complete assembly then forms a waveguide-beyond-cutoff structure that provides the filter's off-band isolation. The amount of off-band isolation that can be achieved is, at best, a compromise, and depends on the 3-db bandwidth, the number of resonator sections, and the sphere's diameter and saturation magnetization.

The coupling between two ferrimagnetic spheres in free space can be determined.⁵ This method can also be used for spheres in a cutoff waveguide if the waveguide walls are far enough away from the sphere.

The coupling bandwidth of a sphere-to-sphere system is given by

$$BW_{\text{coupling}} = 5.32 \times 10^{-2} \left(\frac{d_s}{r} \right)^3 \omega_m$$

where d_s = sphere diameter; r = sphere center-to-center separation; and $\omega_m = (2.8) 4\pi M_s$.

Suppose a filter with a passband ripple of 0.1 db were required that had the following characteristics

- Tuning range 4 to 6 Ghz
- Number of sections 4
- 3-db bandwidth 15 ± 1 Mhz
- Insertion loss 2 db
- Off-band isolation 70 db

Since limiting will not occur above 4 Ghz using a material with a saturation magnetization of 1,750 gauss, 0.030-inch pure yig spheres were chosen.

To determine the center-to-center spacings between the spheres, the coupling bandwidths, which depend on the normalized coupling coefficients, must be determined. For a four-pole response shape with a passband ripple of 0.1 db, they are

$$k_{12} \text{ and } k_{34} = 0.84$$

$$k_{23} = 0.542$$

The required coupling bandwidth between the first and second and the third and fourth spheres is 12.6 Mhz, and the coupling bandwidth between the second and the third spheres is 8.2 Mhz.

Now, using the design chart on page 126, the ratio of the sphere spacing to sphere diameter, r/d_s , can be found.

The sphere separation is found by simply multiplying this ratio by the sphere diameter.

For a flat response, the separation between the first and second and the third and fourth spheres is 0.0825 inch and that between the second and third spheres is 0.096 inch. To prevent an under-coupled response due to tolerance dimensions from degrading the filter performance, the sphere separation tolerances should be carefully chosen. The final response shape would then fall somewhere between the flat and the 0.1-db ripple case. Using the same procedure as for the flat response shape, the center-to-center spacing for a 0.1-db passband ripple is found. The separation between the first and second and third and fourth spheres is now 0.088 inch, and that between the second and third spheres is 0.096 inch.

The maximum and minimum separation figures for the first and second and third and fourth spheres that are necessary so that the bandpass response remains within flat and 0.1-db ripple are 0.0825 and 0.088. Choosing a value of 0.085 ± 0.002 inch should ensure the required response, allowing for normal machining tolerances. Since the separa-

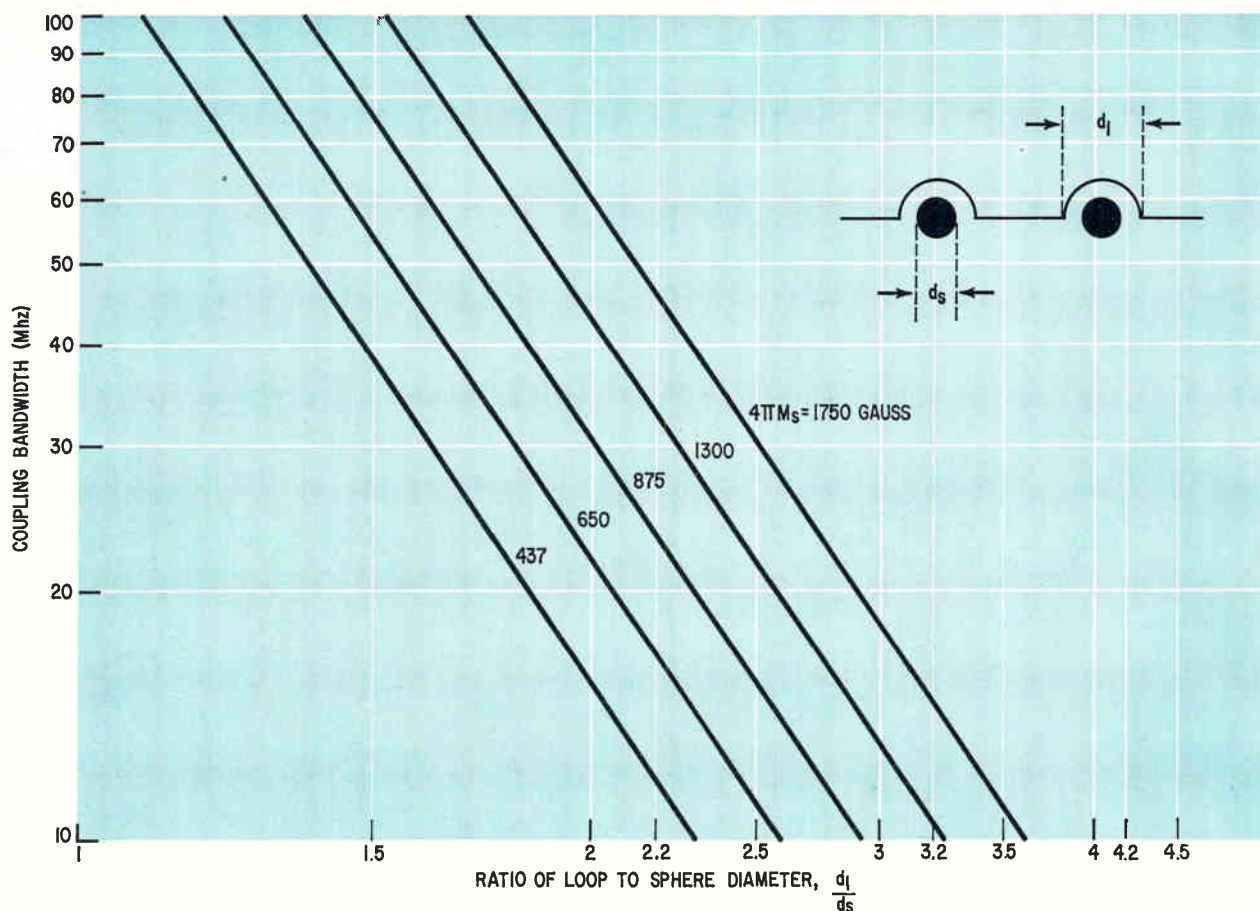

Semiloop coupling. The coupling-loop diameter depends on the coupling bandwidth and saturation magnetization.

tion between the second and third spheres is the same for either response shape, its actual value is more critical and should be held to tighter tolerances. The semiloop coupling bandwidths that are required for the input and output coupling dimensions are also determined by multiplying the 3-db bandwidth and the appropriate normalized coupling coefficients. Once the coupling bandwidth is determined, the ratio of the loop and sphere diameters can be found from the design chart shown above. Multiplying this ratio by the sphere diameter results in a diameter of 0.050 inch for the 0.1-db ripple response shape, and 0.055 inch for the maximally flat case. The 0.050-inch loop size was selected because it provided the greater selectivity.

The calculated midband insertion loss for this filter, using a yig sphere with a linewidth of 0.4 oersted, was 1.7 db.

For this type of filter the cutoff length depends on the distance between the input and output coupling loops, so that for a specified 3-db bandwidth the maximum off-band isolation is limited to the cutoff attenuation obtainable in that distance.

The off-band isolation is inversely proportional to the 3-db bandwidth and depends on the sphere diameter, since this dimension determines the length of the cutoff section.

Using the 0.136-inch spacing between the center of the end spheres as the length, l , and 0.093 inch as the diameter of the cutoff section, the off-band isolation, in db, for a sphere-to-sphere coupled filter with a 3-db bandwidth of 15 Mhz is approximately

$$L \cong 60 \frac{l}{d} = 60 \left(\frac{0.136}{0.093} \right) = 87 \text{ db}$$

Such a filter was built using these calculated values for the sphere separations and loop sizes. The filter was then tested; the results are tabulated on the top of page 125.

Using sphere-to-sphere coupling reduces the fabrication time of the filter, since the inter-stage coupling loops have been eliminated. However, the maximum bandwidth using this coupling method is only one-fourth that which could be realized using full-loop coupling if $d_l/d_s = r/d_s$.

Beyond X band

Suppose an engineer wants to know what insertion loss and off-band isolation he can expect from a four-section waveguide filter that tunes from 12 to 18 Ghz and has a 3-db bandwidth of 100 Mhz. Since the waveguide dimensions deter-

mine the off-band isolation loss, he should start here.

The design of the impedance-matching transformers—using a WR-62 waveguide, which covers this frequency range is straightforward.⁶ If the waveguide wall-to-sphere diameter is held at about 1.5, then if the smaller dimension of the reduced waveguide section is about 0.078 inch, a 0.050-inch diameter sphere will suffer little loss in its Q.

The sphere-to-sphere coupling bandwidth is again determined by multiplying the 3-db bandwidth by the normalized coupling coefficients for a four-section filter. Now, once the coupling bandwidths and the sphere diameters are known, the ratio of the sphere spacing to the sphere diameter is found using the design chart on page 126.

Multiplying these ratios by the sphere diameter gives the required center-to-center sphere separations. The separation between the first and second, and the third and the fourth, spheres is 0.073 inch, and the separation between the second and the third spheres is 0.084 inch.

The input and output yig spheres are placed in the propagating region of the waveguide and the two interstage spheres placed in the cutoff section. The off-band isolation depends on the attenuation characteristics of the cutoff guide. Its value, in db, is given by

$$L = 54.5 \frac{d}{\lambda_c} \left[1 - \left(\frac{\lambda_c}{\lambda_o} \right)^2 \right]^{1/2}$$

where d = length of the cutoff section
 λ_c = cutoff wavelength

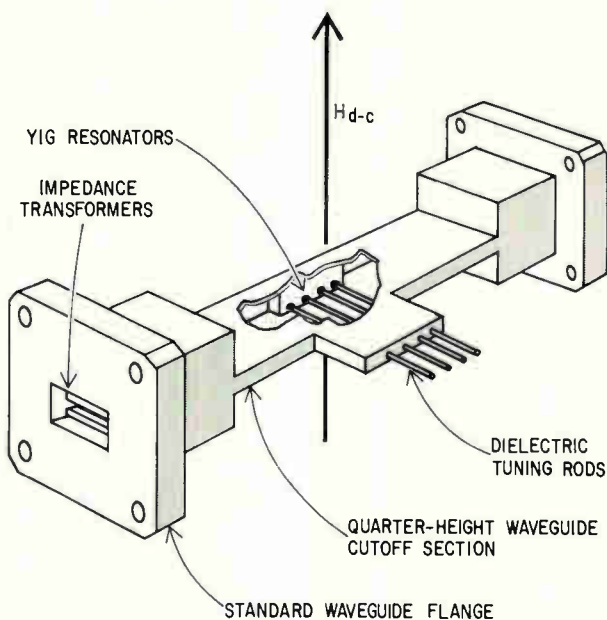

Reduced dimensions. The four yig resonators are placed in the quarter-height cutoff section of the waveguide bandpass filter.

4-to-6-Ghz filter performance

Frequency (Ghz)	Bandwidth 3-db (Mhz)	IL (db)	Off-band isolation (db)
3.4	13.5	2	75
4.4	14	2	75
6.0	16	1.8	73

When $\lambda_o \gg \lambda_c$, then

$$L \cong 54.5 \frac{d}{\lambda_c}$$

The length of the cutoff section for the previous filter example is 0.084 inch; therefore, the off-band isolation is calculated as 23 db. However, the off-band isolation can be improved for a given bandwidth by using the largest possible sphere diameter for a fixed waveguide dimension. Increasing the sphere diameter increases the separation between the spheres, which also increases the length of the waveguide cutoff section. This, of course, also increases the off-band isolation. Since the sphere diameter has increased, the waveguide wall thickness must be reduced to keep the same wall-to-sphere ratio; otherwise the insertion loss will also increase.

The use of higher-saturation magnetization materials increases the coupling properties, and this allows a greater separation between spheres for the same bandwidth and hence greater off-band isolation.

For example, if lithium ferrite spheres, which have about twice the saturation magnetization of yig—3,640 gauss—were used, the distance between the spheres could have been doubled, which would double the off-band isolation.

Once the response characteristics of the filter are determined, the insertion loss depends mainly on the material's linewidth. The linewidth of the yig material used for the filter resonators measured 1.2 to 1.5 oersteds at 18 Ghz. Now, assuming a worst-case linewidth, the midband insertion loss, in db, is found by

12-to-18-Ghz filter performance

Frequency (Ghz)	Bandwidth 3-db (Mhz)	IL (db)	Off-band isolation (db)
12	90	1.8	28
14	95	2.0	28
16	95	2.0	27
18	95	2.0	25

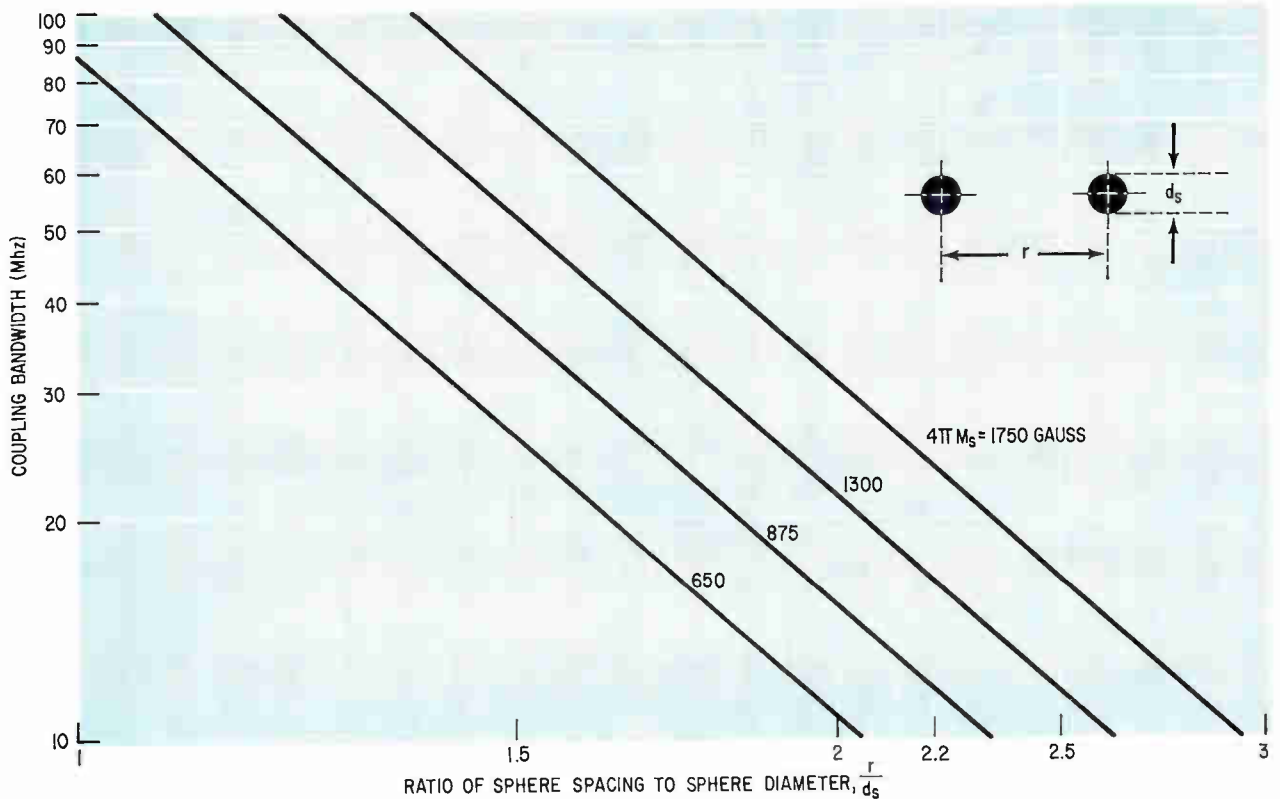

Sphere spacings. The ratio of the sphere spacing to sphere diameter can be found for various values of saturation magnetization and the coupling bandwidth.

$$IL = 4.34 \frac{(2.8)(1.5)}{100} 5.22 = 0.96 \text{ db}$$

This value neglects any reduction in unloaded Q due to the nearness of the waveguide walls, or the increased losses due to mismatching at the cutoff section. However, 1 db is about typical for these filters; therefore, the total insertion loss should be close to 2 db at 18 Ghz.

A filter was built and tested over the 12-to-18-Ghz band. Its performance is tabulated on the bottom of page 125.

How wide a bandwidth is possible in waveguide yig filters depends on many factors, but particularly on the amount of insertion loss that can be tolerated. For example, if the filter in the previous example used 0.060-inch-diameter spheres instead

of 0.050 inch, a longer cutoff could have been used. This would have increased both the off-band isolation and the 3-db bandwidth.

The test results of the increased-bandwidth four-section yig filter, using the 0.060-inch spheres, are tabulated below.

Yig filters are inherently narrowband devices. It is not only difficult to obtain a wide bandwidth, but the achievable bandwidth shrinks as the operating frequency increases. For instance, suppose we must design a four-section, 300-Mhz, 3-db bandwidth filter that tunes from 18 to 26 Ghz. Then, to achieve that bandwidth using 0.020-inch yig spheres, a sphere separation of 0.021 inch between the first and second, and the third and fourth, spheres, and 0.024 inch between the second and third spheres, would be required. With these dimensions the length of the cutoff section would be approximately 0.023 inch. This, unfortunately, would only give about 10 db of off-band isolation. ■

12-to-18-Ghz wideband filter performance

Frequency (Ghz)	Bandwidth 3-db (Mhz)	IL (db)	Off-band isolation (db)
12	300	4.0	60
14	330	3.5	58
16	270	3.5	57
18	250	5.0	52

References

1. R.L. Comstock, "Synthesis of Filter-Limiters Using Ferrimagnetic Resonators," *Trans. on Microwave Theory and Techniques*, November 1964, pp. 599-607.
2. Reference Data for Radio Engineers, 5th ed., section 8-26.
3. S.B. Cohn, "Dissipation Loss in Multiple-Coupled-Resonator Filters," *Proc. IRE*, Vol. 47, August 1959, pp. 1,342-1,348.
4. *The Microwave Engineers Handbook and Buyers Guide*, 1968, p. 104.
5. A.L. Mikaelyan and V. Ya. Anton'yants, "Phenomena of Mutual Coupling in a System of Magnetized Ferrite Specimens," *Radio Engineering and Electronic Physics*, May 1962, pp. 586-593.
6. G.L. Matthaei, et al, "Microwave Filters, Impedance-Matching Networks, and Coupling Structures," McGraw-Hill Book Co., 1964.

Speed costs

particularly when you don't need it.

COST/PERFORMANCE — UTILOGIC II vs "THE OTHERS"

DECISION FACTOR	UTILOGIC II	930 DTL	MC800 RTL	7400 TTL	MC830 DTL	SUHL I TTL	SUHL II TTL
D. C. NOISE MARGIN (mv)							
"0" Level	800	450	300	400	450	650	550
"1" Level	1100	450	300	400	500	600	600
FAN OUT	16	8	5	10	8	6	6
SPEED (ns typical)	25	25	25	13	25	10	6
PRICE (100-up)							
Quad Gates	\$1.07	\$1.55	\$1.25	\$1.55	\$1.55	\$2.40	\$2.65
Dual Binaries	\$1.99	\$4.75	\$2.30	\$3.85	\$4.75	\$5.95	\$6.60

What the chart says is simply this: except where TTL speed is essential, Utilogic II is the best buy in both performance and cost. Utilogic II not only provides fan out up to 16 and noise immunity up to 1.1V (nearly twice what you get in other IC families) but is available in reliable silicone DIPs. In addition, it is the only logic family that allows you to implement functions any way you choose — with AND, OR, NAND or NOR elements. Last thing. Check the prices below.

Now, wasn't that fast?

UTILOGIC ELEMENTS (+10°C to +55°C) IN 14-LEAD DUAL IN-LINE PAK (100-UP)

LU300A	Dual 3-Input Gate Expander	\$0.83
LU301A	Diode Expander	0.83
LU305A	6-Input AND Gate	0.83
LU306A	Dual 3-Input AND Gate	0.83
LU314A	7-Input NOR Gate	0.83
LU317A	Dual 4-Input NOR Gate	0.89
LU321A	Dual J-K Binary	1.65
LU322B	Dual J-K Binary	1.83
LU333A	Dual 3-Input OR Gate	0.89
LU334A	Dual 4-Input OR Gate	0.94
LU337A	Dual 4-Input Expandable NAND Gate	0.94
LU356A	Dual 4-Input Line Driver	1.15
LU370A	Triple 3-Input NOR Gate	0.89
LU374A	Triple 3-Input OR Gate	0.94
LU375A	Triple 2-Input OR Gate	0.94
LU377A	Triple 3-Input NAND Gate	0.94
LU380A	Quad 2-Input NOR Gate	0.89
LU384A	Quad 2-Input OR Gate	0.94
LU387A	Quad 2-Input NAND Gate	0.94

For more information call your nearest Signetics sales office or distributor.

Signetics Integrated Circuits

A SUBSIDIARY OF CORNING GLASS WORKS
811 East Arques Ave., Sunnyvale, California 94086



See us at IEEE, booth number 3A01 to 3A04

Pick the
BEST IC
for the job

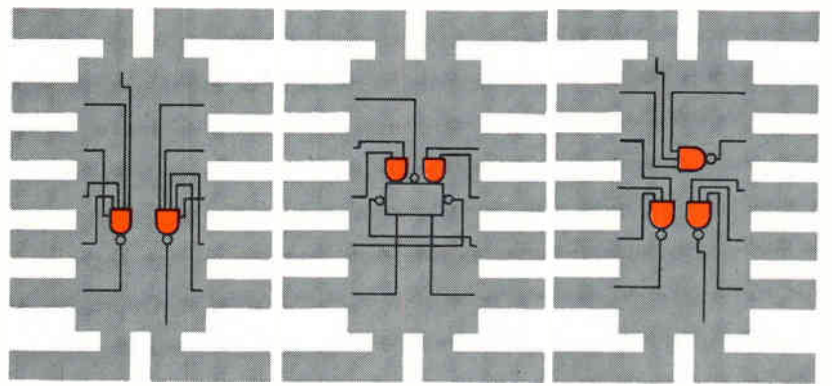

Best line of defense against

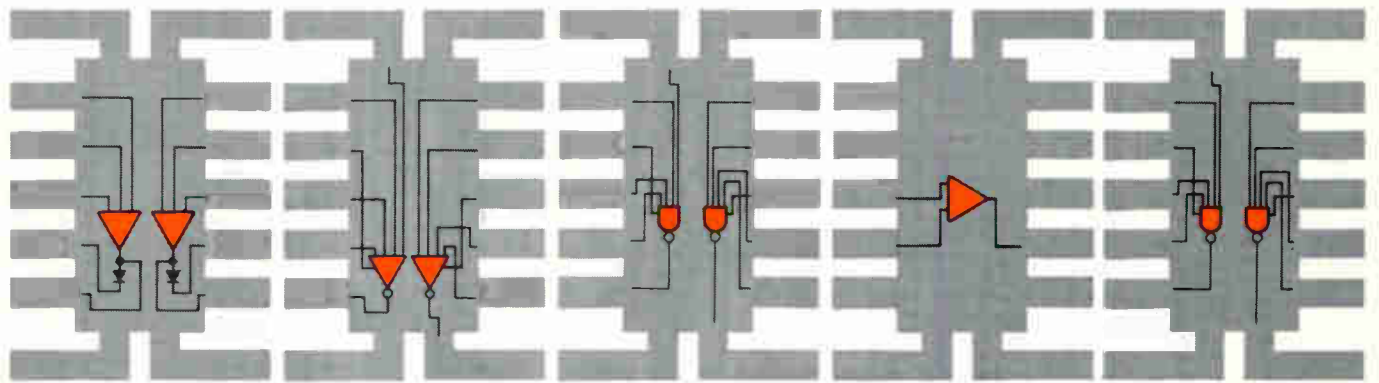

radiation environment

Radiation offers the circuit designer two orders of magnitude improvement in hardening levels over conventional PN junction devices. This is accomplished by dielectric isolation, thin-film resistors over oxide, small-device geometries, shallow diffusions and other special design techniques. So when you pick the Best IC for a radiation environment application, doesn't it make sense to come to the leader in hardened circuit technology?

Our line of defense consists of 930 series DTL, a level shifter, a line driver and a linear 709. These are not prototype circuits. We can deliver Dual 4 Input; Dual 4 Input Power or Triple 3 Input Gates; Clocked Flip-Flop; Dual 4 Input Buffer; Dual Level Shifter; Dual Line Driver and 709 Operational Amplifiers. With the exception of the Dual Level Shifter and Dual Line Driver, all are plug-in replacements for their non-hardened 930 Series and 709 counterparts. The Hardened Dual Line Driver is a pin-for-pin replacement for Radiation's standard RD 209 Line Driver.

Want more information? Contact your nearest Radiation Sales Representative. He'll give you complete details and help you pick the Best IC for the Job.

WE MAKE THE **BEST IC** FOR THE JOB

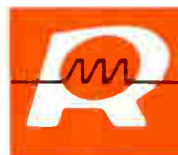

See these circuits at IEEE Booth 4-H 19-21

RADIATION
INCORPORATED
SUBSIDIARY OF HARRIS-INTERTYPE CORPORATION
MICROELECTRONICS DIVISION

RADIATION SALES OFFICES: P. O. Box 476, Lexington, Mass. 02173, (617) 862-1055 • 600 Old Country Road, Garden City, N.Y. 11530, (516) 747-3730 • 2600 Virginia Ave. N.W., Washington, D.C. 20037, (202) 337-4914 • 6151 W. Century Blvd., Los Angeles, Calif. 90045, (213) 670-5432 • Saratoga, Calif., (408) 253-5058 • P. O. Box 37, Melbourne, Fla. 32901, (305) 727-5430 • International Sales: Marketing Department, P. O. Box 37, Melbourne, Fla. 32901, (305) 727-5412

Low-cost motion control is here...

and PMI has the precision motor!



When your motion needs accurate controlling, call your PMI Applications Specialist. Our experience in fast response actuators has helped us to design a new low cost version with the best performance per dollar in the industry. The same proven reliability found in our standard line is built into these lower cost motors.

The U9M4F is the first of the new servo series which will be used for low cost EDP peripheral equipment, fast stop-start applications for industrial use and low cost video and tape recorders.

This motor will also be available with our new integral tachometer.

Motion control is our prime concern... a field in which we are constantly innovating. This new DC servo motor is another example of our interest in helping you solve your precision control problems. We have a broad line of fast response actuators and an extensive free application assistance program to help you with your special requirements. Write or call us (212-676-8000) for all the details.



PRINTED MOTORS, INC. GLEN COVE, NEW YORK 11542

Engineering, Manufacturing and Sales by: PHOTOCIRCUITS CORPORATION, Glen Cove, New York 11542

CROWBAR...?

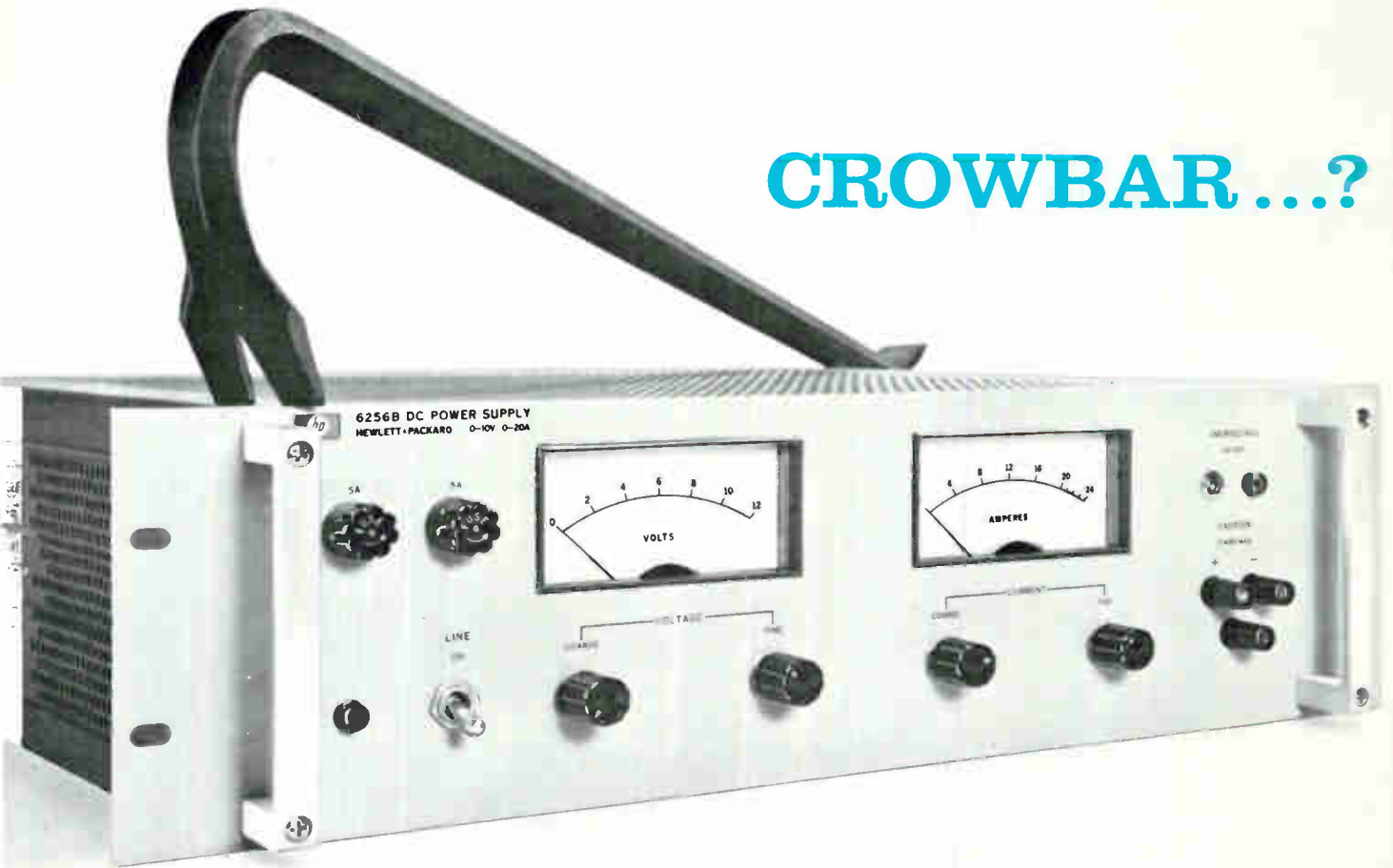

The One Inside is FREE

Not so many years ago, the prudent transmitter engineer discharged a high voltage capacitor bank by dropping a shorting "crowbar" across its terminals. Today's "crowbar" is a protective overvoltage circuit found on DC power supplies — usually at extra cost. Now HP includes a crowbar as standard on its recently updated series of low-voltage rack supplies . . . at no change in price.

Long established as preferred system supplies for component aging production testing and special applications, these supplies have now been redesigned and expanded to meet the stringent demands of today's power supply user. Advantages include low ripple (peak-to-peak as well as rms), well-regulated constant voltage/constant current DC with outputs to 60 volts and 100 amps.

Where loads are critical and expensive, the extra pro-

tection — say, against inadvertent knob-twiddling — from a crowbar is invaluable. On all internal crowbars in this series, the trip voltage margin is set by screwdriver at the front-panel.

Pertinent specifications are: triggering margins are settable at 1V plus 7% of operating level; voltage ripple and noise is 200 μ V rms/10mV peak-to-peak (DC to 20 MHz); current ripple is 5 mA rms or less depending on output rating; voltage regulation is 0.01%; resolution, 0.25% or better; remote programming, RFI conformance to MIL-I-6181D.

Prices start from \$350. For complete specifications and prices, contact your local HP Sales Office or write: Hewlett-Packard, New Jersey Division, 100 Locust Avenue, Berkeley Heights, New Jersey 07922 or call (201) 464-1234 . . . In Europe, 1217 Meyrin, Geneva.

Additional data sheets
available upon request

HEWLETT *hp* PACKARD
POWER SUPPLIES

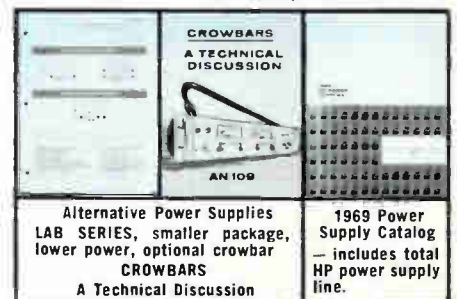

Alternative Power Supplies
LAB SERIES, smaller package,
lower power, optional crowbar
CROWBARS
A Technical Discussion

1969 Power
Supply Catalog
— includes total
HP power supply
line.

NEW PRODUCT NO. 72

NPN/PNP COMPLEMENTARY POWER TRANSISTORS

Fairchild's newest complementary power transistors handle more power than any other comparable devices.

They're rated at collector currents of 2, 5 and 10 amps, but current doesn't tell the power story. In the Fairchild series, power dissipation is 30W-100W at 40V (50°C case temperature). That's five to ten times the power handling capacity of similar transistors on the market.

We haven't traded power for performance, either. The transistors are all designed to minimize mismatch and crossover distortion in Class B and complementary symmetry audio amplifiers. f_r is a minimum of 40MHz, and the beta-linearity shows it. Your amplifier power output is linear over an extremely wide frequency range.

These same characteristics make the devices the best choice available for servo amplifiers and high-speed switching applications (such as military dc-dc converters).

The operating range for all devices is from -65°C to +200°C, and there's a variety of packages available to suit specific applications. Write for our spec sheets and applications information.

Collector / Maximum Power Current / Dissipation*	NPN Part No.	PNP Complement Part No.	NPN Price (1-99)	PNP Price (1-99)
2A/30W	2N4998	2N4999	\$22.50	\$28.50
	2N5000	2N5001	27.00	33.00
	2N5002	2N5003	30.00	36.00
5A/50W	2N5004	2N5005	45.00	54.00
	2N5284	2N5286	52.50	60.00
	2N5285	2N5287	60.00	75.00
	2N5006	2N5007	60.00	90.00
10A/100W	2N5008	2N5009	75.00	112.50
	2N5288	2N5290	90.00	135.00
	2N5289	2N5291	105.00	157.50

*50°C case temperature

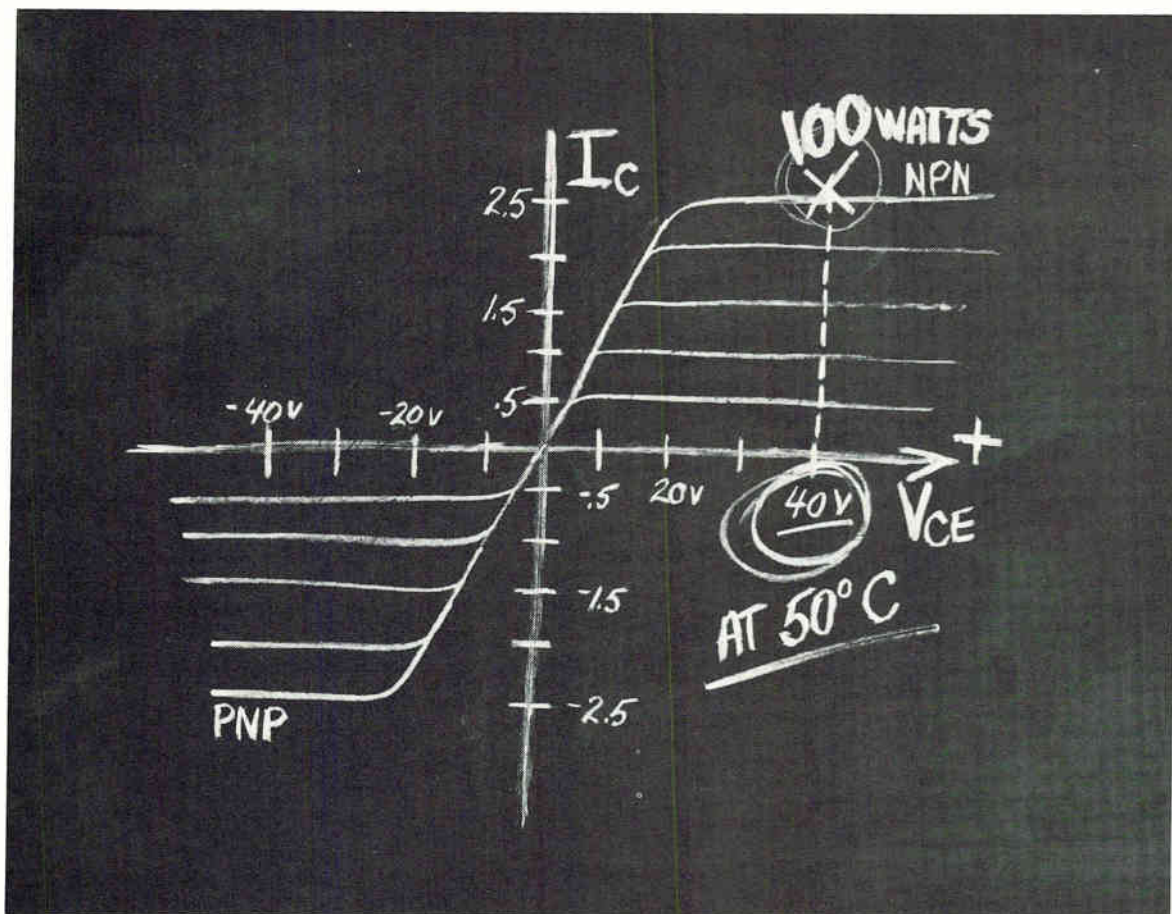

FAIRCHILD
SEMICONDUCTOR

FAIRCHILD SEMICONDUCTOR A Division of Fairchild Camera and Instrument Corporation Mountain View, California 94040, (415) 962-5011 TWX: 910-379-6435



Flight Companion

417—the lightweight recorder you carry on the plane

It's the one data recorder you don't have to waste time crating and shipping, or possibly having damaged by baggage-style handling. The compact 417 flies with you, safely under the seat, ready to work when you step off the plane.

Only 6"x14"x15", the rugged 417 weighs just 28 pounds—50 pounds less than any comparable recorder. Works in any position, under roughest vibration conditions, for dependable data gathering in plants, labs, on and under the seas, or out in the wilds.

Maintenance-free mechanism has exclusive low-mass differential capstan drive for precision opera-



LOCKHEED ELECTRONICS COMPANY
A Division of Lockheed Aircraft Corporation.

tion. Phaselock servo for precise speed control, with accuracy matching large rack machines. Records on 7 channels, IRIG compatible. Runs on 110/220v AC/DC or internal battery. Power consumption as low as 10w. Frequency response: 100 kc direct, 10 kc FM.



Priced as low as \$7,000.

Send for our catalog containing full details on the 417, one of a family of precision data recorders for land, ocean, air and space applications. Write: Boyd McKnight, Dept. E-3F, Lockheed Electronics Company, Plainfield, New Jersey.

Have questions on data recording? Call us at (201) 757-1600.

5 fast, effective ways to stop EMI:

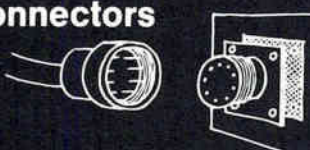
If you want to shield...

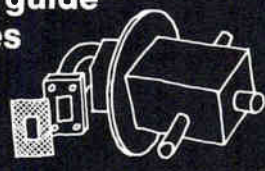
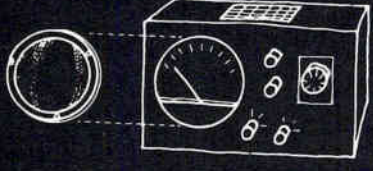
<p>Electrical connectors</p> 	<p>use Metex Porcupine Metalastic™ Its many contact points make this an ideal gasket for RFI/EMI. Silicone rubber provides a pressure and moisture barrier.</p>
<p>Switches/ push buttons (also keep out moisture)</p> 	<p>use Metex Flex-Shield shielded rubber boots. Metal mesh, molded in flexible rubber, gives maximum reliability against RFI-EMI.</p>
<p>Electronic equipment (and vent it, too)</p> 	<p>use Metex Shield-Cell honeycomb panels. It's designed to meet specific attenuation requirements over specified frequency ranges. Many standard sizes and materials are available.</p>
<p>Wave guide flanges</p> 	<p>use Metex Feltex™ material. Designed for wave guides, specifically provided for either pressurized or non-pressurized systems.</p>
<p>Viewing windows</p> 	<p>use Shield-Vu™ Metex Your choice of monel, low carbon steel or etched metal laminated in plexiglass. Any color, size, or shape.</p>
<p>QUICKLY</p>	<p>call (201) 287-0800 for design engineering service (for your rush rush requirements)</p>

For technical assistance on your particular requirements—write:

M

METEX CORPORATION

970 New Durham Road
Edison, New Jersey 08817
(201) 287-0800 • TWX 710-998-0578

West Coast: Cal-Metex Corp., 509 Hindry Ave., Inglewood, Calif. 90301 • (213) 674-0650 • TWX 910-328-6100

From the Millimeter Men at TRG...

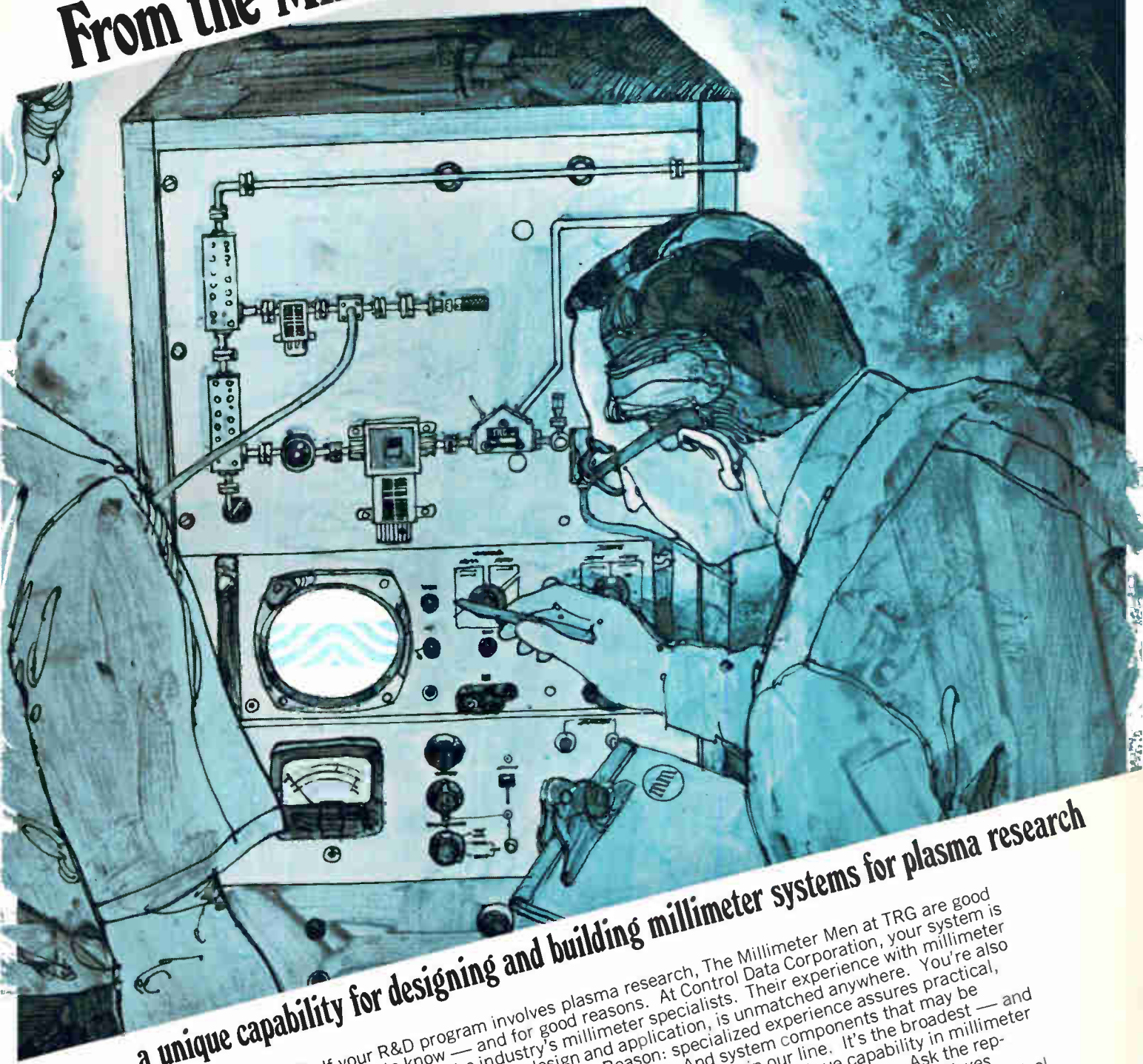

...a unique capability for designing and building millimeter systems for plasma research

If your R&D program involves plasma research, The Millimeter Men at TRG are good people to know — and for good reasons. At Control Data Corporation, your system is engineered by the industry's millimeter specialists. Their experience with millimeter technology, and system design and application, is unmatched anywhere. You're also likely to save time. And money. Reason: specialized experience assures practical, time-saving solutions to design problems. And system components that may be "specials" elsewhere are apt to be standard items in our line. It's the broadest — and most advanced — millimeter line in the industry. For unique capability in millimeter wave systems for plasma research, look to Control Data Corporation. Ask the representative in your area for a copy of *Plasma Diagnostics with Millimeter Waves* describing Control Data systems built for others. Or write The Millimeter Men, Control Data Corporation, Boston Space and Defense Systems Operation, 400 Border Street, East Boston, Mass. 02128. Tel: 617-569-2110.

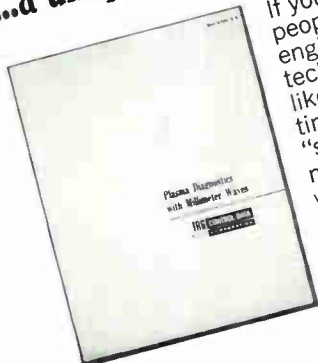

We're introducing a new Millimeter Swept Measuring System at the IEEE Show. See us at booth #3K18

CONTROL DATA
CORPORATION
SPACE AND DEFENSE SYSTEMS

Circle 135 on reader service card

TEFLON: all by itself the most thoroughly proven, high-reliability insulation

Now, look at the extras you get with TEFLON plus polyvinylidene fluorides

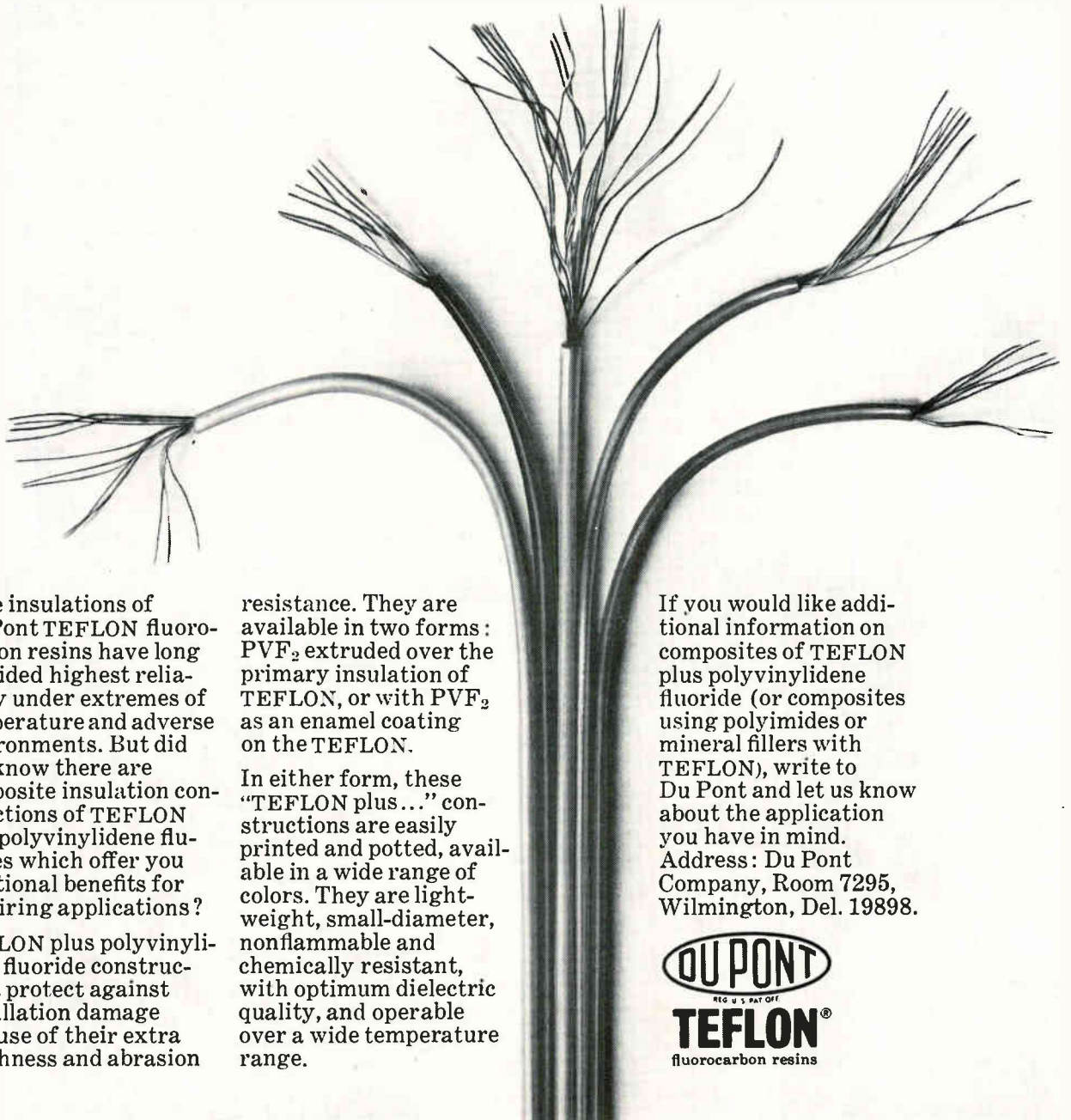

Wire insulations of Du Pont TEFLON fluorocarbon resins have long provided highest reliability under extremes of temperature and adverse environments. But did you know there are composite insulation constructions of TEFLON plus polyvinylidene fluorides which offer you additional benefits for all wiring applications?

TEFLON plus polyvinylidene fluoride constructions protect against installation damage because of their extra toughness and abrasion

resistance. They are available in two forms: PVF₂ extruded over the primary insulation of TEFLON, or with PVF₂ as an enamel coating on the TEFLON.

In either form, these "TEFLON plus..." constructions are easily printed and potted, available in a wide range of colors. They are lightweight, small-diameter, nonflammable and chemically resistant, with optimum dielectric quality, and operable over a wide temperature range.

If you would like additional information on composites of TEFLON plus polyvinylidene fluoride (or composites using polyimides or mineral fillers with TEFLON), write to Du Pont and let us know about the application you have in mind. Address: Du Pont Company, Room 7295, Wilmington, Del. 19898.

DU PONT
REG. U. S. PAT. OFF.
TEFLON[®]
fluorocarbon resins

Let us throw you a curve

If you've problems with LC circuits, Magnetics' new Iso-Q contour curves speed ferrite pot core selection.

No more squinting at tangles of curves on log paper to find the ferrite pot core size you need. Magnetics' new Iso-Q contour curves let you zero in on your target size in seconds. We've plotted over 100 of these time-savers to handle more than 90% of normal design

requirements. They're all contained in our new Ferrite Cores Catalog, first of its kind in the industry.

Magnetics' high purity ferrites cover frequencies up to 2 megahertz. Linear temperature coefficients on 750, 1400 and 2000 permeability materials are guaranteed from -30° to $+70^{\circ}\text{C}$. Flat temperature coefficient on 2300 perm material is guaranteed from $+20^{\circ}$ to $+70^{\circ}\text{C}$.

Magnetics' wide selection of ferrites comprises eight international standard sizes and five additional sizes—175 part numbers for design freedom. We can give you quick

delivery from our large inventory that includes both gapped and un-gapped cores in your most asked-for sizes. Of course, we provide one-piece clamping hardware for most sizes. Finally, we offer you a complete choice of tuning assemblies, bobbins and shapes—toroid, E, U and I.



Get your set of our new Iso-Q Curves. You'll like their curvilinearity. Magnetics Inc., Butler, Pa. 16001

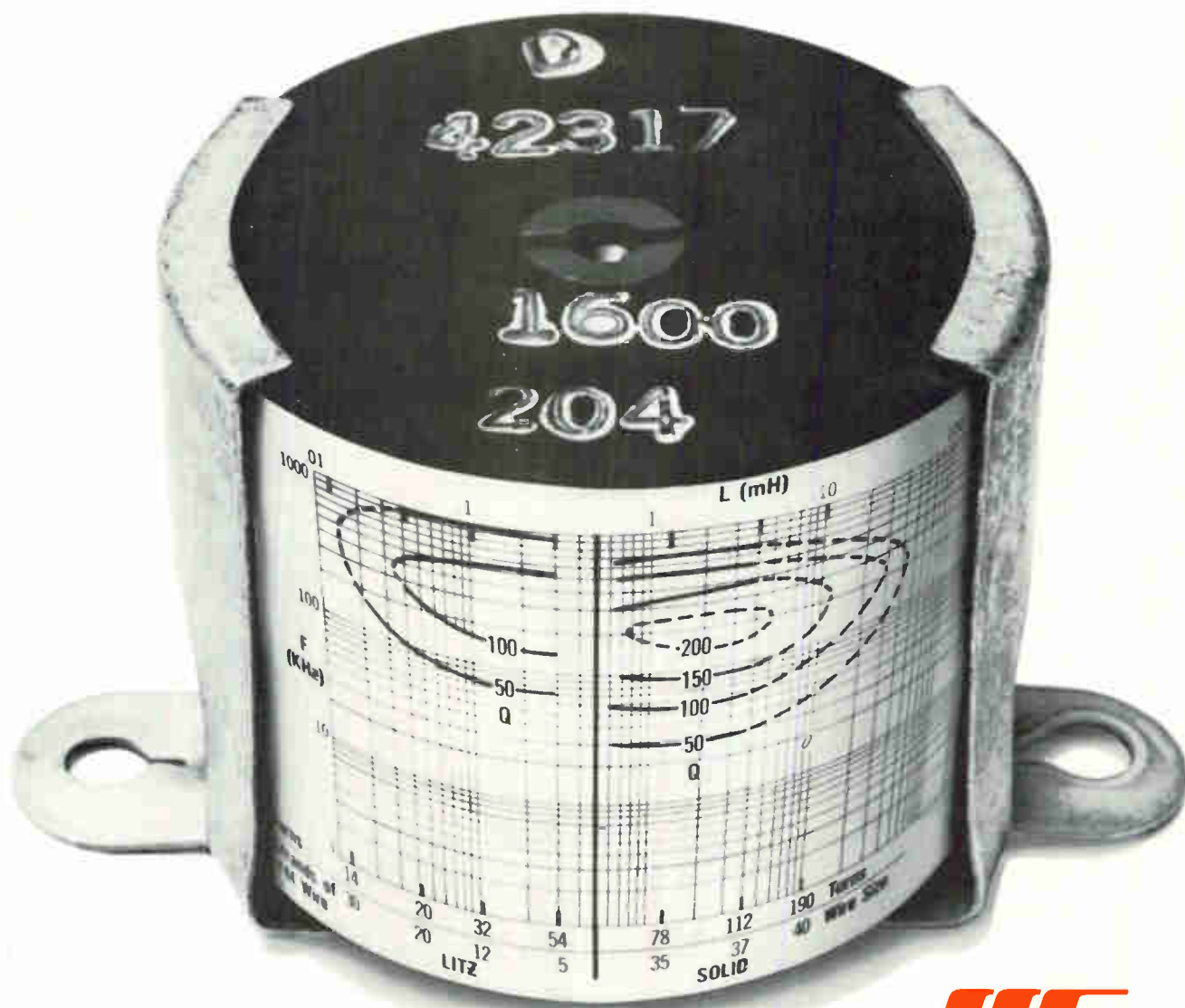

MAGNETICS inc.
®

Today...the switch is to TECH LABS

For high quality, precision switches designed for long service life, industry turns to Tech Labs. All Tech Lab switches are manufactured for rugged service and exacting performance. They meet all applicable Military Specifications and are available in a wide range of sizes and types to fit your most demanding designs.

THUMBWHEEL SWITCHES

A compact, molded, printed-circuit wafer switch for limited space and in line readout. Modular type for either front or back of panel mounting: Modules $\frac{1}{2}$ " between center lines, height 2". Single or double pole, 10 position, binary or complementary codes, standard. Other codes available on request. Available with adjustable stops.

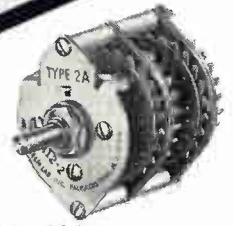

Type 2A: An instrument control switch of the highest quality possible with a reasonable price. This switch is a must for all applications where the rating and requirements are high. Rating 5 amp carrying. Size $1\frac{3}{4}$ " by $2\frac{1}{4}$ ". Available in all combinations with up to 26 decks and 2 to 26 positions. Has adjustable stop. Solenoid operated if required.

Type 3A: A molded miniature switch used in military and commercial applications where space is a premium and a superior switch is required. Can be furnished with up to 8 decks, 12 positions per deck single pole, or 6 positions double pole, adjustable stop. Rating is 5 amps carrying and it can be solenoid operated and hermetically sealed. Only $1\frac{1}{4}$ " diameter.

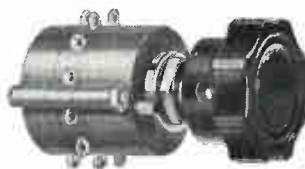

TAP SWITCHES

ATTENUATORS

We also manufacture a complete line of attenuators, both audio and RF. These include potentiometers, ladders, T-pads, H-pads, etc., in many varieties of sizes. Our attenuators are approved by the most particular users in this country.



STEPPING SWITCHES

All our switches can be fitted with a stepping mechanism and can be furnished HERMETICALLY SEALED, EXPLOSION PROOF, if desired. We have built stepping switches with 500 positions per deck.

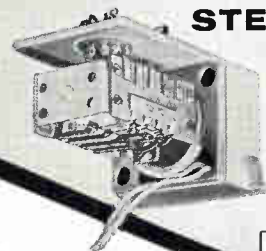

HEAVY DUTY CONTROL SWITCHES

We manufacture a line of heavy duty control switches in various sizes, which are extremely flexible in the combinations available. These switches are particularly useful where a large number of poles are required.



SPECIAL SWITCHES

When standard switches will not meet the requirement, we design and manufacture special switches to order. Send us your specs.

Telephone: 201-944-2221 • TWX: 201-947-4730

TECH LABORATORIES, INC., Palisades Park, N.J.



FREE!
Send today for our 24 page Switch Catalog

Most analog tape system users don't get the ultimate in time base accuracy

KNOW WHAT YOU'RE PAYING FOR

There are specs and there are specs. Especially with analog tape recorders. Some are realistic statements of recording/reproducing efficiency. Others are "ultimates" that can be achieved only under ideal conditions.

Take Time Base Error (TBE), for example. There's not much point in paying for a TBE of 1 or 2 microseconds, if the servo reference "Limit of Error" is greater than several parts in 10^6 . Although the IRIG 106-66 Document method of measuring this specification may indicate a TBE of 1 or 2 microseconds, it does not take into consideration manufacturing tolerances or aging and environmental changes.

Instead of talking about TBE as measured according to the IRIG 106-66 Document, it makes better sense to talk about "Absolute Time Base Error" (ATBE). Or a reproduced time base that is within 0.01% of the recorded time base.

The Hewlett-Packard 3950 Analog Tape Recorder is a dependable all-round workhorse for lab or field usage that offers an "ATBE" specification as stated above. It also offers a direct Signal-to-Noise ratio better than 30 db at 120 ips over a passband 400 Hz to 1.5 MHz or 23 db at 120 ips over a passband 600 Hz to 2.0 MHz. Chance of operator error is greatly reduced by the elimination of complicated

tape paths that involve vacuum systems and reel servos. Best of all, the Hewlett-Packard Model 3950 is reasonably priced. For example, a one-inch tape system, including 14 channels of record and reproduce amplifiers with a phase-lock tape speed servo is less than \$22,000.

Why specify "TBE" when "ATBE" is more practical? Why specify lower Signal-to-Noise ratios? Why take chances on losing valuable data because of operator errors? Call your HP field engineer for the simplest solution to your recording problems. Or write Hewlett-Packard, Palo Alto, California 94304; Europe: 1217 Meyrin-Geneva, Switzerland.

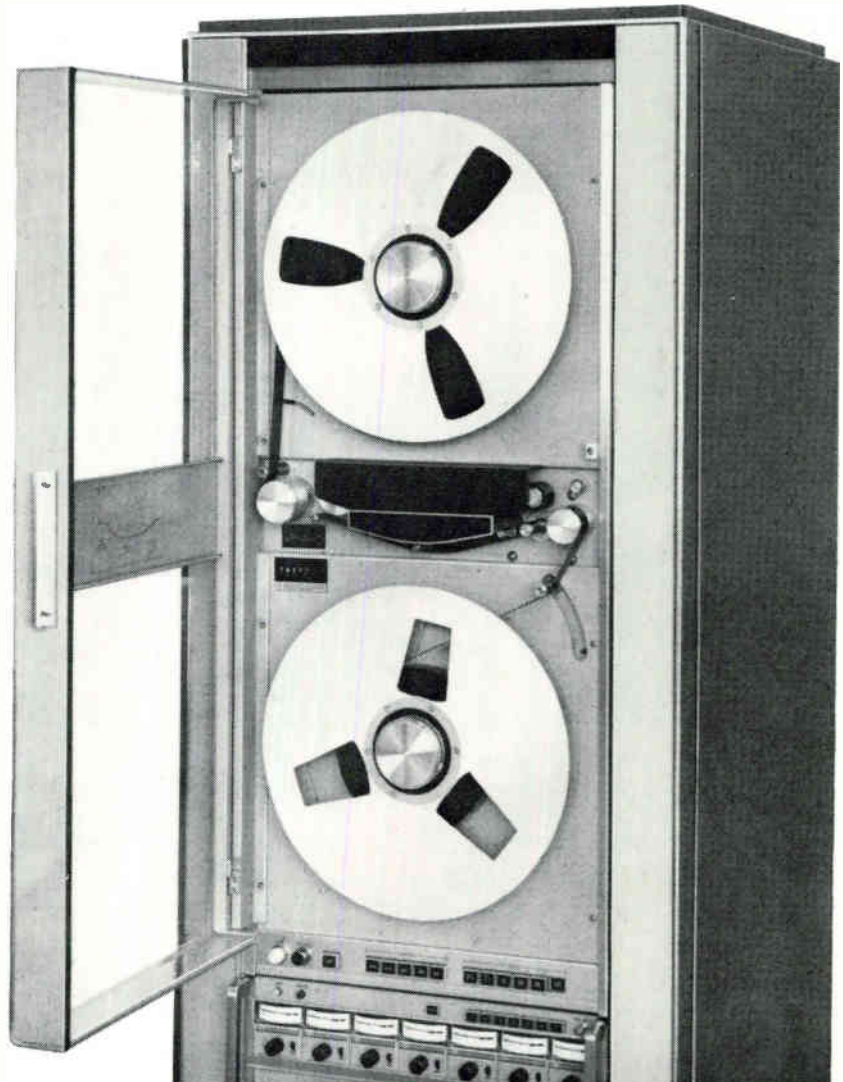

HEWLETT  **PACKARD**
MAGNETIC RECORDERS

Tips on cooling off hot transistors

See how circuit designers use IERC heat dissipators to protect semiconductors...improve circuit performance and life.

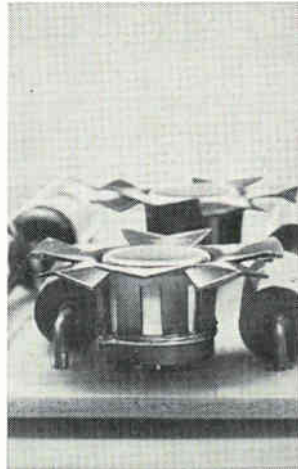
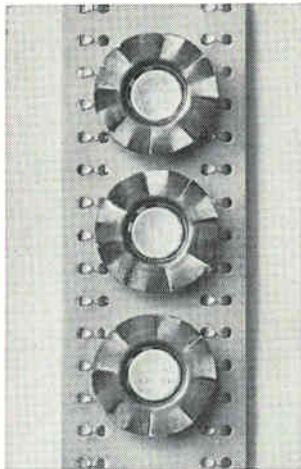

Fan-top dissipators for TO-5 and TO-18 cases drop temperatures dramatically; cost just pennies. T-shape adds almost nothing to board height; allows components to snuggle close to transistors. Spring fingers provide fast, press-on installation.

To cool off low-to-medium power transistors in TO-5 and TO-18 cases, use IERC's efficient LP's. Patented, staggered-finger design maximizes radiation and convection efficiency, radiates heat directly to ambient. Available in single or dual mounting for thermal mating of matched transistors.

IERC Thermo-Link Retainers provide efficient thermal links between transistors and chassis or heat sinks. (Also, excellent dissipation when used on p-c boards.) Integral BeO washers reduce capacitance up to 2/3. Fast, no-snap installation; transistors are firmly held.

New! Dissipators and retainers for plastic and epoxy transistors. 3 new series for RO-97A, RO-97 and X-20's. Permit a jump of 10% to 33% in operating power.

Free 8-page short form catalog discusses IERC's complete line of dissipators, retainers and tube shields. Gives specifications, prices, how to order. Send for your copy today.

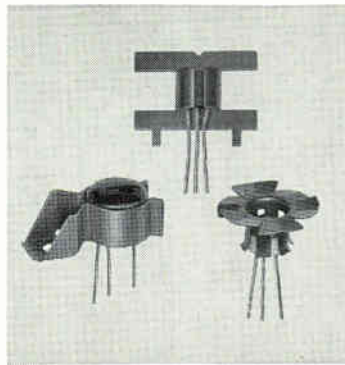

Special insulating coating — Insulube 448, a special non-hygroscopic finish developed by IERC, combines excellent dielectric properties, 50 K megs insulation resistance, and high heat emissivity. Also protects against salt spray, fungus, etc.

Tough heat dissipating problem? IERC engineers welcome your letter-head inquiry for specific information or assistance in selecting heat dissipators.

See us at the IEEE Show Booth #4F 16-18

ierc
SEMICONDUCTOR
HEAT DISSIPATORS

INTERNATIONAL ELECTRONIC RESEARCH CORPORATION • A corporate division of Dynamics Corporation of America  135 West Magnolia Ave. • Burbank, Calif. 91502



product report
curve tracer

New Type 576 Curve Tracer

Advanced Measurement Features for Semiconductor Testing



Expanded Viewing Area—combines a 10 cm x 12 cm graticule with fiber-optic readout of scale factors, step amplitude, and Beta/div or g_m /div

Swept or DC Collector Supply to 1500 V

Leakage Measurements to 1 nA/div

Multi-function Switching—direct-reading power limits, polarity tracking, auto positioning, mode changes

Calibrated Display Offset—improved accuracy ($\pm 2\%$), increased resolution

Step Generator Range to 2 A or 40 V

Calibrated Step Offset—aid or oppose

Pulsed Base Operation

Kelvin Sensing for high-current tests

Interlock Operator Protection

Provision for Future Expansion

please turn page for additional information 

Making the Measurement . . . with the unique performance features of the Tektronix Type 576 Curve Tracer

EXPANDED VIEWING AREA—The large display area (10 cm x 10 cm, 12 cm usable horizontal), internal illuminated graticule, and bright trace bear directly on viewing ease, resolution, and readability.

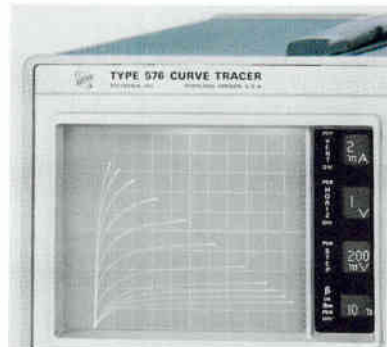

Scale-factor readout effectively labels the display parameters near the CRT for convenient reference during setup and testing. The simple, but bothersome, correction for magnifiers or multipliers is computed and displayed, as is the often used value of Beta/div or gm/div. Calibration data recording during photography is a prime convenience factor.

SETUP VERSATILITY FOR DIODES, TRANSISTORS, AND FET's—Multi-function switching makes test set-up faster and more understandable. By combining and pre-programming compatible functions, a single switch movement can select several normally-used conditions.

Examples:

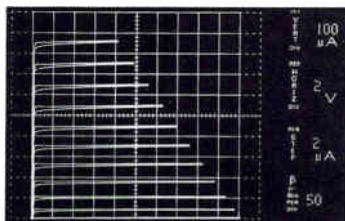

Other than the normal display functions, the NPN transistor waveform (above) required selection of collector range and percent, power limit, polarity and step amplitude. Step generator polarity and positioning is combined with the polarity switch; series resistance is determined by the voltage range and power limit switch.

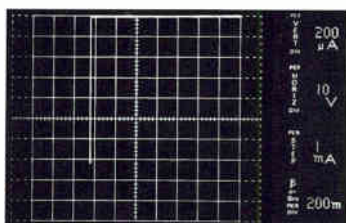

This Zener diode display required settings for collector volts, power limit, and polarity. The negative polarity selection positioned the trace-start to the upper right-hand corner. If desired, the display could be inverted with a single pushbutton. The Zener voltage at 1 mA is 72 V, accurate within 3%.

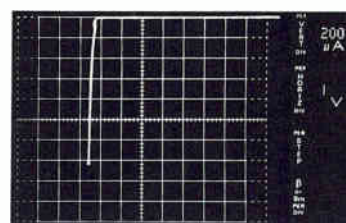

The display above is the same 72 V Zener diode test previously discussed except the display offset and magnifier are used to improve resolution and accuracy. The centerline value is now 70 V but the horizontal deflection factor is 1 V/div. The Zener voltage can now be resolved as 72.6 V within 2%, a X10 increase in resolution and improvement from 3% in absolute accuracy.

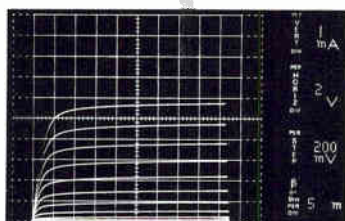

This MOSFET drain family test set-up is the same as for transistors except the step polarity was inverted for operation in the depletion region. The DC step offset could be used to view both enhancement and depletion characteristics by positioning the step-start below the zero bias level.

RESOLUTION AND CONTROL is enhanced in the Type 576 by the concept of calibrated offset. The DISPLAY OFFSET is a precision positioning control and X10 magnifier which calibrates the graticule effective measurement axis to 100 cm rather than 10 cm.

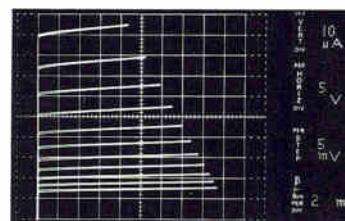

The display above shows a transistor test with voltage drive to the base. The DC STEP OFFSET permits positioning of the small voltage steps within the active region of the transistor base.

ADAPTABILITY—Connecting the many types of semiconductors to the instrument requires a wide range of adapters. A new line of adapters has been designed for the Type 576 which includes a universal unit for single and bipolar FET's and transistors, guiding long-lead adapters for untrimmed units, high-current adapters with KELVIN sensing, and clip or magnetic axial-lead diode holders.

Your Tektronix Field Engineer will conduct a comprehensive demonstration of the Type 576 on request.

For additional information, contact your local Tektronix Field Office, circle the Reader Service Number, or write Tektronix, Inc., P. O. Box 500, Beaverton, Oregon 97005.

TYPE 576 CURVE TRACER \$2125
U.S. Sales Price FOB Beaverton, Oregon

Measurement Concepts

SEMICONDUCTOR DEVICE MEASUREMENTS

This new concepts book is available through Tektronix Field Offices.





Tektronix, Inc.

committed to progress in waveform measurement

Wall Street hunts for systems to keep up with volume growth

Brokers, banks, exchanges agree that electronics can do it, but they have yet to decide on how and when

By Peter J. Schuyten

Staff writer

In desperation, the financial community, meaning the two major stock exchanges, the brokerage houses, and the major banks, last month hired the Rand Corp. and North American Rockwell to devise means of keeping up with the constant increase in stock trading. As the New York Stock Exchange tells it, the contracts are part of a pro-

gram "to revolutionize the securities trading system."

The current crisis really got going more than a year ago. The ever-increasing volume of trading at both the New York and American exchanges, as well as in over-the-counter securities, has been causing massive confusion and in some cases total breakdowns in the back-

office paperwork at most brokerage houses, and the situation isn't improving. Last year, for example, daily trading volume on the New York Stock Exchange, which accounts for something over three-fourths of all activity in listed securities, was just under 13 million shares; in 1965, average daily volume was less than 7 million. By



A day in the life. It's business as usual on the floor of the stock exchange, where rising volume has created an avalanche of paperwork that threatens to bury member firms' back offices. Brokers look to electronic systems to clear up the chaos.

HELL TO HEAVEN & between

SAICOR REAL TIME SPECTRUM ANALYZERS MAKE SENSE!

Devour and analyze data fast — subsurface or space; natural or man-made; esoteric or explosive — with no sacrifice of resolution. Engineered for instant action, simple operation, continuous and transient analysis in real time with almost any output format — digital or analog. Solid-state, MOS FET shift register memory for non-spurious data. Options to fit any application: 1/3 octave, frequency tracking, translator, etc.



Don't buy more resolution than you can use.

5 standard models, each designed for the resolution required. SAI-21 (above) was developed for applications requiring 200 point resolution. Only SAICOR makes such a unit; priced at the lowest cost anywhere for the finest real time spectrum analyzer. Lighter weight, smaller size, portability, make it ideal for field and laboratory.

SAICOR DIGITAL INTEGRATORS FOR PSD PLOTS: NO LOOPS, TIME 1/30

For hard-copy records including PSD, no tape loops are needed; time is reduced from up to 30 minutes per plot to less than 1 minute. Digital-integrated value may be observed during and after integration. Used with the analyzers, the compatible SAICOR Integrators effect important economies. They may also be used independently.

For literature, write or call Dept. E, Signal Analysis Industries Corp.
12 Di Tomas Court, Copiague, N. Y. 11726
Phone: 516/691-8080

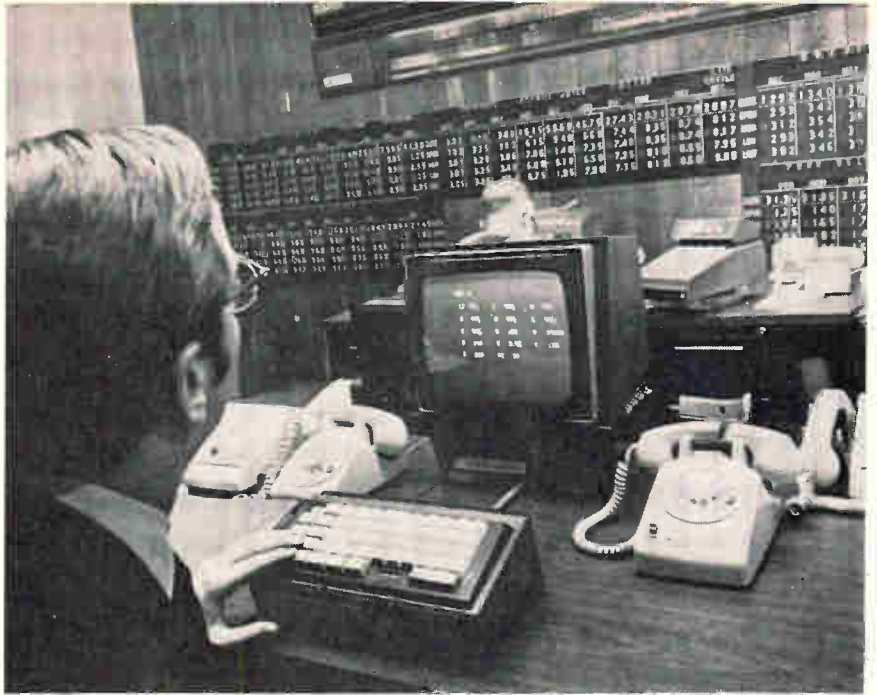

Mea culpa. At least part of the blame for the volume and paperwork crisis belongs to the registered representatives, who, it is maintained, spend their money on desktop terminals for the front office—where customers see them.

1975, predicts exchange economist William Freund, daily volume will be at least 23 million.

Not surprisingly, the Securities and Exchange Commission is anything but sympathetic. In fact, a source close to the commission says that the SEC is a bit piqued at the brokers for spending their money on fancy automatic wall displays and desktop terminals for the front office—where the customers see them—and leaving the back office, where the paper is handled, to the methods of the Nineteenth Century. "But," says the same source, "the brokers are paying for it now, and in the worst way."

Accusing finger

Indeed, the brokerage houses, in order to keep pace with their paperwork, have had to turn away customers, close branch offices, and pay huge amounts of overtime to back-office workers. Worse still, some of the bigger firms have been hurt financially; because they can't deliver and don't receive traded securities on time, the brokerage houses are living with an erratic cash flow. And the bottom could, according to some, fall out anytime.

The accusing finger, however, is not pointed solely at the stock brokers. The banks have come in

for their share of criticism. In fact, the brokers claim that the banks, because they act as transfer agents as well as traders, have their own back-office problems.

Up to now, fines and penalties imposed by the exchanges have done little to reduce the problem. Instead, say some Wall Street observers, studies like those by Rand and North American Rockwell appear to be the best solution.

For its part, the Rand Corp., one of the original think tanks, will make a year-long survey of the securities industry that is expected to provide a base for developing systems and methods to restructure present ways of processing paper. The North American Rockwell study, on the other hand, is aimed at providing more immediate relief by improving existing operations.

Hope stirs. But these are not the only recent developments that give rise, if not to optimism, then at least to a feeling of hope on Wall Street. For example, the New York Stock Exchange has established a Central Certificate Service (CCS) where brokers can deposit stock certificates. "In fact," says CCS head Charles Lynch, "it's very like your checking account. Brokers make their deposits—in this case, the certificates—with us. Our com-

puter complex keeps a record of all the stock held in the central depository for each firm." When instructed to deliver shares, the computer subtracts the number of shares from the account of the delivering firm and adds the same number of shares to the account of the receiving firm. Title to the shares is changed by computerized bookkeeping entries.

Formerly, Lynch explains, some 50,000 envelopes containing stock certificates were hand-delivered daily to the clearinghouse from about 300 brokers. "With CCS, at least we eliminate the physical handling of the certificates."

At the heart of the system is an IBM 360/50 computer. Complementing the computer are 10 tape drives, two printers, IBM 2314 and 2311 disk drives, and two IBM 1418 optical scanners, each driven by a 360/30 computer. Input is by any of 20 remote terminals or the two scanners, which read mark-sense data or already printed material. Although some of the data is

The order of orders

Typically, a stock transaction works this way. The order, be it round-lot, odd-lot, limit, buy, or sell, comes from the customer to the brokerage house. The customer's man, after making out a receipt, writes five copies of the order, one of which he keeps. The rest go to the order room, or the back office. Then one of the copies goes to the purchase and sales department where bookkeeping is done, two go into files, and the last is kept by a clerk, who either telephones or wires it to his counterpart on the floor of the exchange.

The exchange clerk makes out still other copies of the order and gives one to the specialist on the floor, who makes the trade. Once the trade is made the clerk sends a floor report detailing the disposition of the order to the back office, where duplicates are made and then matched with the original five copies of the order ticket. Finally, if all has worked, the broker issues a confirmation to his customer, as well as an updated statement of the customer's account.

Circle 145 on reader service card→

SUPERPOT



The Nearly Indestructible Conductive Plastic Potentiometer

Beneath that mild looking exterior, the Farite infinite resolution potentiometer is really rugged. Whether in the frigid depths of cryogenic cold...or in temperatures to 150°C...or in 100% humidity... the Farite Superpot keeps right on doing its job. And it can survive the

most fiendish tortures ever devised by reliability engineers: 15 G vibrations at 2000 Hz...50 G's of shock and acceleration...even neutron bombardment and gamma radiation. We have information that fully describes the amazing characteristics of the Farite Superpot. Why not call or write for your copy today. If the Superpot can't solve your environment problem — then **nothing** will.

FAIRCHILD

CONTROLS

A DIVISION OF FAIRCHILD CAMERA AND INSTRUMENT CORPORATION
225 PARK AVENUE, HICKSVILLE, L. I., NEW YORK
TELEPHONE: (516) 938-5600 • TWX: (510) 221-1854
CABLE: FAIRCON-HICKSVILLE, NEW YORK, U. S. A.

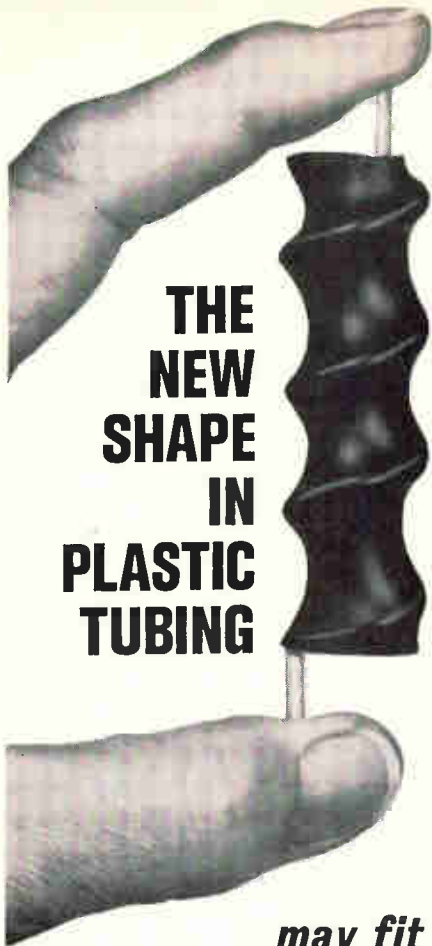

THE NEW SHAPE IN PLASTIC TUBING

*may fit
your problem
exactly*

FLEXITE *Shrinkdown* Plastic Tubing shrinks 50% in diameter upon application of moderate heat to form a tight-fitting sheath around objects of irregular shape. It's being used to solve many different problems . . . like insulating electrical connections; protecting delicate components; strengthening assemblies; binding things together; resisting corrosion, heat or moisture; preventing wear, vibration and noise. What problems do you have that a tight sheath of tough plastic might solve? Markel offers *Shrinkdown* in three distinct types to meet a broad range of needs. Your call or letterhead request will bring samples and data.



L. FRANK MARKEL & SONS, INC.
Norristown, Pa. 19404 • Phone: 215/272-8960
INSULATING TUBINGS AND SLEEVINGS
HIGH TEMPERATURE WIRE AND CABLE

entered on line, most of it is batch processed. However, the input and retrieval equipment is being redesigned, and Lynch hopes the new system will provide for more teleprocessing and less batching.

Amex next

By the end of the month CCS will have almost 15% of all NYSE certificates on file, "enough to account for about 75% of all the trading done on the floor," says Lynch. Once the Big Board issues are in the system, CCS will start phasing in Amex certificates, probably this summer. Ultimately, the service will be expanded to include over-the-counter issues. "Of course," Lynch hastens to add, "CCS—even when fully operational—can clear up only a small bit of the over-all paperwork problem."

Automation of odd-lot, stop, and limit orders is yet another program currently being implemented at the two exchanges. Odd-lot purchases—fewer than 100 shares—account for about 30% of all trades and paperwork, but only about 7% of the total volume. These systems would, when completed in two or three years, take odd-lot, limit, and stop orders and switch them directly into a computer complex. And because the price of an odd-lot trade is determined by the price of the last round-lot trade, the com-

puter will automatically execute the order at the latest price and send the broker a confirmation.

Getting started. At the Amex, for example, the first stage of this program is already under way. There, by the end of the year, a computerized message-switching center will transmit odd-lot orders directly from member firms to trading posts on the floor. "The rest of the sale will be handled as before," says Martin S. Weinman, assistant vice president for systems and development at the Amex. "Right now we're picking hardware for the system. Tentatively, we'll be getting either three IBM 360/50's or two 360/65's, along with some external devices like a large core memory. However, we're still trying to determine how much processing capacity we'll need.

"We're also desperately looking for a small, inexpensive terminal that smaller brokerage houses could afford to buy and we've got to have it in about two years." Small brokers make up more than 50% of the American exchange's floor members. Weinman says that such a terminal, which will be used to send orders to the computer, must have a keyboard format that virtually anyone can use, as well as a receive mode for verification of an order.

Currently his staff is looking at



In the cards. Ornate, hard-to-handle stock certificates may soon be replaced by more functional punch-card versions.

three types of terminals: a key set with a video or hardcopy output, a card-reader type, and a Touchtone-type terminal with an audio reply. Ten vendors have been consulted, but so far none has been able to quote a price.

Like the American Exchange, the Big Board has its own staff of systems people who are constantly on the lookout for new hardware. Edward De Laura, head of the NYSE's systems development group, explains that his department spends a lot of time prodding vendors to develop new hardware designs. Sometimes, De Laura says, the systems he'd like to implement must wait for the technology to catch up with them. For example he would like to see hand-held crt displays that would replace the floor specialist's book, as well as order-entry-devices and remote optical scanners to input the display.

One incentive for the vendor who can develop some of these devices, De Laura points out, "is that when we opt for a new piece of equipment, say a new scanner, the brokers, when they hear about it, are going to be just as interested as we are; this makes for a rather large market, and our vendors know it."

Two roads. There are two ways to work with a vendor to develop a piece of hardware. De Laura explains. "We can pay the whole cost or go into partnership with the developer and let him get his money back later."

Currently, the NYSE systems group is looking into a radio-paging system for brokers on the floor as well as a new type of ticker tape that is eight times faster and has an easier reading format than the present 900-character-per-minute ticker. The 900, as it's called, was installed only 5 years ago with the express purpose of eliminating lags between tape and transaction; now the 900 must be replaced because it can't keep up with the trading volume.

While solutions to the New York and American exchanges' problems are at least on the horizon—however far away—there is little relief in sight for the large over-the-counter market. With market makers—brokers who act as agents for individual issues—and transfer agents scattered all over the country, it's difficult to clear OTC trans-

it's true!



StereoZoom® 7, just added to the matchless line of Bausch & Lomb Stereomicroscopes, now takes pictures. That's right, takes pictures.

There's an integrated camera system, which allows you to use a 35mm or 4" x 5" film; or 3 1/4" x 4 1/4" or 4" x 5" *Polaroid camera, and start shooting. You might call it the StereoZoom 7 Triocular Photomicrographic System, because that's what it is.

It's also a multiplex system, because visual and photographic functions in no way interfere with each other. You can look while you shoot. And you know how important that is.

This photographic potential plus the widest zoom range, clearest viewing, highest magnification, and a sufficient variety of models make StereoZoom 7 the one you surely should find out about.

Write today for Catalog 31-2185 and for our free demonstration offer. Bausch & Lomb, Scientific Instrument Division, 61415 Bausch Street, Rochester, New York 14602.

*Reg. Polaroid Corp.

BAUSCH & LOMB

SCIENTIFIC INSTRUMENT DIVISION

See the Bausch & Lomb lines demonstrated at IEEE, Booths 2C07-09.

Circle 147 on reader service card→

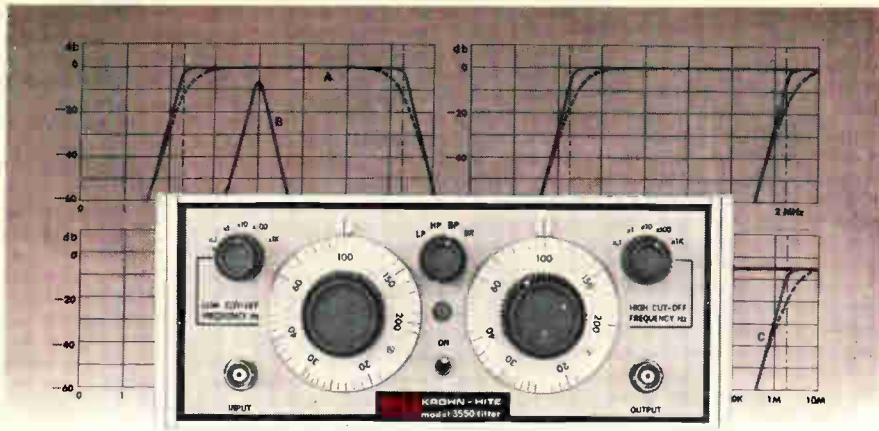

New, low priced all solid-state variable filters

cover 2 Hz to 200 KHz

MODEL 3550 — a new, all solid-state multifunction variable filter covering the 2 Hz to 200 KHz frequency range. Functions include band-pass, high-pass, band-reject and low-pass with 24-db-per octave attenuation slopes extending greater than 60 db. Frequency response can be switched from Butterworth to Low Q (transient free). Low hum and noise (200 μ v rms). Dynamic range of greater than 80 db. Insertion loss 0 db. Bench model: 8 $\frac{5}{8}$ " wide x 3 $\frac{1}{2}$ " high x 13 $\frac{1}{2}$ " deep. Rack model: 19" wide x 3 $\frac{1}{2}$ " high x 13 $\frac{1}{2}$ " deep. Price: \$525

MODEL 3500 — a new all solid-state variable band-pass filter covering the 20 Hz to 200 KHz range. Switches from Butterworth to Low Q. Attenuation slopes: 24-db-per octave extending to greater than 60 db. Hum and noise: 200 μ v rms. Dynamic range greater than 80 db. Insertion loss 0 db. Size: same as above. Price: \$395

SEE THEM AT IEEE — Booth No. 2H30-32. See for yourself why these new Krohn-Hite solid-state variable filters make "do-it-yourself" filter design a relic of the past.

OVERSEAS SALES OFFICES: BELGIUM, C. N. Rood s. a. DENMARK, SC Metric A/S; FRANCE, Antares; GERMANY, Nucletron Vertriebs-GMBH; HOLLAND, C. N. Rood n. v.; ITALY, Dott. Ing. Mario Vianello; SWEDEN, Teleinstrument; ISRAEL, R.D.T. Elect. Eng. Ltd.; JAPAN, Shoshin Shoji Kaisha, Ltd.; AUSTRALIA, Sample Electronics (Vic.) Pty., Ltd.; G. B., B & K Inst. Ltd.

KH KROHN-HITE CORPORATION

580 Massachusetts Ave., Cambridge, Mass. 02139, U.S.A.
Phone: (617) 491-3211 TWX: 710-320-6583

actions within the five-day limit. Thus it's not surprising that both the Amex and the NYSE estimate that most of the failures to fulfill order commitments at their member firms involve OTC transactions.

Indeed, the OTC problem is so critical that last fall the two exchanges required all their clearing brokers who deal in unlisted securities to join the National Over-The-Counter Clearing Corp., which operates off the Amex computers.

Far off. More significant, but hardly around the corner, is an ambitious plan to build an automated quotations system for the OTC market. For this, the National Association of Securities Dealers, which regulates the unlisted securities market, contracted with the Bunker-Ramo Corp. to build what is estimated to be a \$12 million system that will initially provide instant quotations on some 1,500 unlisted securities—in effect, an OTC ticker. Eventually, NASDAQ, as the system is called, will be expanded to include as many as 20,000 issues. And although Bunker-Ramo has already broken ground in Trumbull, Conn., for the NASDAQ computer center, it will be two years before the system is operating.

In the meantime, the National Security Traders Association, an organization of OTC traders, is implementing what to some looks like an interim step to NASDAQ. Called STAQ, for security trader automated quotations, this system will supply hourly quotations to the three major suppliers of computerized market information: Bunker-Ramo, Scantlin Electronics, and the Ultronic Systems division of Sylvania Electric Products.

Some 30 to 50 market makers will send OTC bid and asked prices by Teletype to both the Bunker-Ramo and Scantlin computer centers; Ultronic Systems will get data from Bunker-Ramo. When received, the data will be processed and transmitted to subscribers' displays.

Hollow victory. But stock market officials have mixed feelings about STAQ and NASDAQ. They say that these systems will speed up OTC trading and therefore create just that much more paperwork. But A.A. Freda, assistant director of Bunker-Ramo's Business and Industry division, feels that although STAQ may do this, NASDAQ, when

fully operative, will provide an excellent data base for other OTC services.

Punch-card, or machine-readable, stock certificates, in the view of many brokers, may provide another partial answer to the paperwork problem. Such cards, were they to be authorized by the New York and American Exchanges, would be much simpler to print, process, and store. With this in mind, at least one company, Lewis Business Forms Inc. of Jacksonville, Fla., is manufacturing a certificate that can be issued over a high-speed computer. Called Contin-u-Card, this certificate is currently being used by several OTC firms. And, says Barney Fishman, the company's special products manager, Lewis has 60 other jobs in the works.

Still, in the eyes of most observers of the financial scene, punch-card certificates, OTC instant quotations, odd-lot automation, and CCS will go only so far in relieving the mess that Wall Street finds itself in. "For these things to be completely meaningful," says one officer of the New York Stock Exchange, "the individual brokerage house must begin to straighten out the real source of the problem, his back office."

Although most of the big brokerage houses long ago installed computers to help them with their bookkeeping, the fact remains that these computers are doing little to relieve the paperwork glut. Each trade requires that literally a small suitcase of accompanying forms and receipts be processed. Under ideal conditions, at least 10 pieces of paper result from each order. When complications set in, that figure often triples.

Solutions may be found during the course of the several studies currently being conducted by a number of electronics firms for the brokerage industry, including one by Autonetics for Merrill Lynch, Pierce, Fenner & Smith and another by Ultronic Systems for Paine, Webber, Jackson & Curtis. What these studies will find and what type of hardware will be proposed is, at this point, anybody's guess. Wall Streeters expect that the changes recommended will be sweeping. "They'll have to be," says one market analyst. "Otherwise we'll all drown." ■

Solve all Resistor problems fast...

TALK TO THE SPECIALIST... LECTROHM



With LECTROHM's entire production facilities devoted to the manufacture of quality power, wire-wound resistors, we are in the unique position to provide quick, economical solutions to all resistor problems. As specialists in the field, LECTROHM knows resistors.

Whether your products require "standard" or "custom" styles — fixed or adjustable types, vitreous enamel or silicone coated — there is a LECTROHM resistor to match those needs precisely. To meet your production schedules, large stocks of standard styles in popular values are always available for immediate shipment, with special facilities geared to fast delivery on small orders of special values.

Whatever your resistor problems entail, you will do better talking to the specialist — talk to LECTROHM. You'll be time and money ahead, everytime.



Vitreous Enameled Fixed Resistors



Vitreous Enameled Adjustable Resistors



Type FP Resistors



FREE!

Full line LECTROHM catalog.

Send for your copy today!

Lectrohm, Inc.

A subsidiary of



COOK ELECTRIC

5562 Northwest Highway, Chicago, Ill. 60630

NEW...!

FROM TRACOR/GTC,
the most experienced producers of
RUBIDIUM FREQUENCY STANDARDS
THE NEW MODEL 304-D

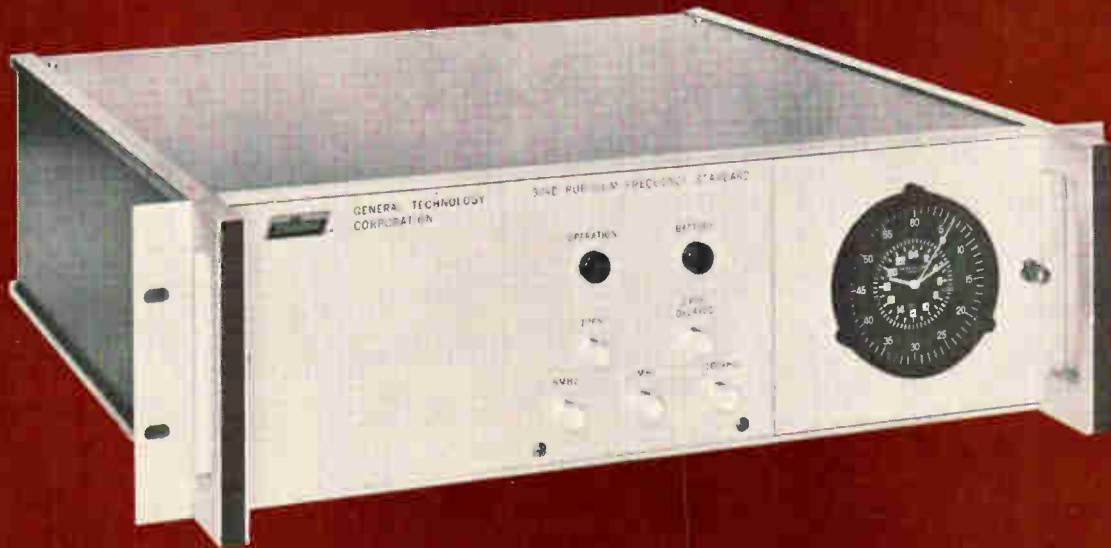

Developed from space environment designs at the General Technology Corporation, this new Atomic Standard combines state of the art circuitry with GTC's unmatched Rubidium Frequency Standard technology.

- Superior Long Term Stability
- Internal Standby Battery†
- Internal Clock system†
- \$7,300.00* with internal time scale selector.

Write for specifications on the new 304-D to
TRACOR
INDUSTRIAL INSTRUMENTS
6500 Tracor Lane, Austin, Texas 78721
AC 512/926-2800

*FOB Los Angeles †optional

**SEE IT AT THE IEEE, Booth
#2J-05, OR ASK YOUR
LOCAL TRACOR
REPRESENTATIVE FOR A
DEMONSTRATION.**

Specialized instruments to meet your specific needs

TRACOR[™]

IA-124

Climate friendly in Mexican border zone

Cheap and plentiful labor, eagerness of officials to help lure assembly operations across Rio Grande; Yankees find a little bribery makes path smoother

By Marvin Reid

Dallas news bureau



Putting it all together. Mexican employees at Electronic Control Corp.'s Matamoros plant assemble control devices. The company operates in a building it has leased for 10 years; it credits the border operation with helping to keep it in the black.

When a small Dallas-based electronics firm recently won a contract to supply 1.5 million semiconductor control components to a large Japanese manufacturer, it underbid two Japanese suppliers. The company, the Electronic Control Corp., was able to do that because its Mexican plant just over the Texas border turns out the devices for 22% to 35% less than is possible in the United States.

This is one of the more dramatic examples of the economic impact that the U.S.-Mexican border industrialization program is beginning to have in some electronics markets here and abroad.

Launched in mid-1965, the joint project is aimed primarily at relieving Mexico's chronic unemployment. Electronics firms—particularly fabricators of inexpensive

items such as home-appliance control devices—are finding that the setup puts them squarely in the ballgame with all price competition in most areas.

Come on over

The most important feature of the border development program is a duty-free zone for foreign manufacturers, a 12½-mile-wide strip extending along the entire boundary on the Mexican side. Foreign companies may operate manufacturing plants within the zone, importing raw materials and equipment on a duty-free basis. Output must be exported from Mexico, and the U.S. charges duty on a complicated “value-added” basis only.

While there are unique problems and business procedures, most Americans now involved say the



Going back. Assembled devices clearing Customs at the border.

TRYGON HAS THE POWER



to deliver new Liberator slot range systems power in rack-mount and modular units..from \$105

Now the Liberator wide-slot line is even wider. We've added new LVS low-power modules in voltage ranges from 2.5-5.5V to 115-161V, and up to 2.1 amps, at prices as low as \$105. Optional rear mounting OV protection module. Plus new low-price LHS half-rack power supplies with ratings to 115-161V and up to 25A; and up to 70A with the L3R/L5R Liberator Rack series.

- All silicon design—precision performance
- 0.01% regulation—high stability
- Low noise for IC and systems applications
- ¼ and ½ rack; full rack; modular and metered models
- Adjustable current limiting and foldback protection—OV protection option
- Integral meter and control options
- Convection cooling—no temperature derating to 60° C
- Remote sensing and programming

Liberators offer the ultimate in systems versatility when combined in any of TRYGON'S five mix-n-match rack adapters. Up to 7 DC outputs—more performance versatility—combine any of these with TRYGON'S famous Series I Module Power Supplies.

For full details on these and many more, write today for your free copy of Trygon's brand-new Liberator Power Supply Brochure.

TRYGON POWER SUPPLIES

111 Pleasant Avenue, Roosevelt, L.I., N.Y. 11575
Trygon GmbH 8 Munchen 60, Haidelweg 20, Germany
Write for Trygon 1969 Power Supply Handbook.
Prices slightly higher in Europe.



Picking up business. A new employee at one of the Mexican border plants undergoing training. Her supervisor is a graduate EE. Some companies send American engineers to serve as supervisors.

advantages gained by utilizing inexpensive Mexican labor outweigh any disadvantages.

Growing. Twelve or so electronics firms are among an estimated 65 U.S. companies with plants along the strip. Many are small companies specializing in control devices and such; however, big names—such as Transitron and Fairchild—are represented. RCA has also been negotiating for a site. But big or small, the main attraction is inexpensive—and plentiful—labor.

Some estimates place the available labor pool at 15 million with unemployment running from 30% to 40%. Minimum wages are as low as \$2.55 a day. Electronics assemblers are getting \$3.20 a day or slightly better, with fringes and other "indirect" costs pushing the figure to \$3.50 to \$4.

Professional help is also plentiful at relatively low cost. Typical pay for Mexican EE's along the strip runs about \$350 a month. Several American firms there employ them as supervisory line foremen.

To evaluate the benefits and spotlight the pitfalls of Mexican border operations, the activity around Matamoros can be taken as typical of what's happening in the other cities involved—Tijuana, Nuevo Laredo, and Ciudad Juarez.

Plants in Matamoros include those of the Electronic Control Corp., Varo, Hunt Electronics, the CTS Corp., and Electro-assemblies Inc. In each case, they have assembly-type operations with piece parts shipped in for partial or total assembly. The firms employ about 1,100 Mexicans.

Electronic Control was one of the first to establish in Matamoros. It now has about 225 employees assembling its devices. The payoff, says president Ed Kile, is big.

In the black. "Our labor savings at the Matamoros plant represented our profits last year," says Kile. "Without the low-cost labor, we would have lost some business and may have had to operate at an over-all loss."

Harry Hoff, the firm's vice-president, says that about 85% of the labor involved in making the company's products is performed at the Matamoros plant. He estimates the unit-hour cost of making the products in Matamoros runs 56 cents compared to \$3.60 in the headquarters plant near Dallas.

Varo, whose power-conversion product line competes with Electronic Control's, estimates that its total labor costs in Matamoros run 47 cents an hour compared to \$2.20 in Dallas.

TRW METALLIZED POLYCARBONATE CAPACITORS



... small enough to fit!

TRW 50-volt Metallized Polycarbonate Capacitors are made to squeeze into tight places. Imagine 10 microfarads measuring .547" x 1¼" long... the smallest wound capacitor on the market!

Short on size and long on reliability, the X463UW series meets all requirements of MIL-C-27287.
VOLTAGE—50V, 100V, 200V, 400V
CAPACITANCE—.001 through 10 mfd
TOLERANCE—available to $\pm 1\%$.

For data, write TRW Capacitor Div., Ogallala, Neb. Phone (308) 284-3611. TWX 910-620-0321.

TRW®

Report from

**BELL
LABORATORIES**

A New Use for the Sun

Radio frequencies in the range of 10 to 40 GHz are of interest for satellite communications. But signals at these frequencies—including millimeter wavelengths at 30 to 40 GHz—are attenuated by rain, snow, fog, and other weather conditions. To study these effects, we needed a source of millimeter waves in the sky. What could we use?

Putting up a research satellite would be difficult and expensive. But fortunately a millimeter-wave transmitter in the sky already exists ... the sun. By tracking the sun and

correlating the signal losses with atmospheric effects, we are gaining valuable insight into the problems and possibilities of maintaining reliable communications at millimeter-wave frequencies in all kinds of weather.

Our apparatus includes a steerable, plane metal mirror that reflects solar energy into a stationary horn-reflector antenna (photo). The signals are processed and recorded in a temperature-controlled equipment house. The system automatically follows the sun on its daily

path across the sky by a clock mechanism which can be set for a full week's automatic observation.

The sun emits radio signals at a great many frequencies, but the sun-tracker is tuned only to signals at 16 and 30 GHz. The received energy has two significant components: one due to the sun and one due to the atmosphere (which attenuates solar energy but also radiates energy of its own). To allow for the atmospheric component, we tilt our mirror away from the sun once each second, thus getting a sky-only reading. We subtract this from the sun/sky total and plot the difference. The equipment responds to and records signal changes as rapid as 30 dB in 15 seconds.

The graphs (left) indicate that there are periods when rain will attenuate the received signal by 30 to 40 dB. Such attenuation would seriously impair communications signals from satellites. The problem can be solved by spacing several ground terminals far enough apart that at least one of them would always have a clear path to the satellite. This would be done at both receiving and transmitting terminals.

Data from the sun-tracking experiments will help us determine how many terminals might be needed for communication systems operating at high frequencies, and how these terminals might be spaced to achieve maximum efficiency and economy.

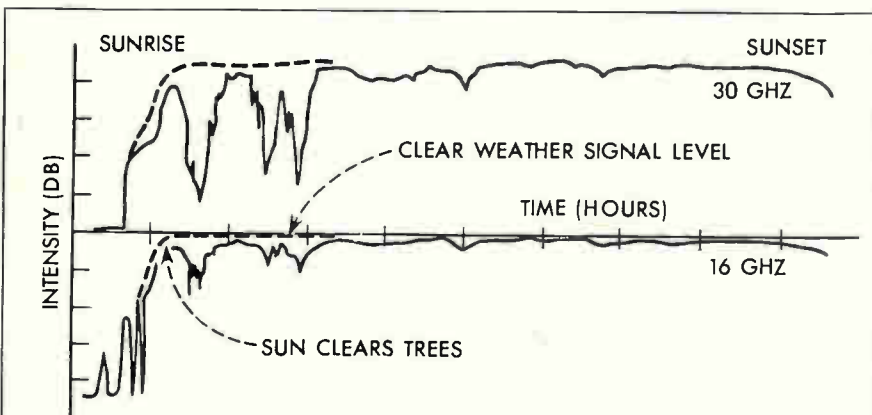

Intensity of solar radiation at two frequencies, recently observed at Bell Laboratories' installation at Holmdel, N.J. Graphs show one 9-hour period out of months of study. Note attenuation due to rain early in the day.

Bell Laboratories' station for studying atmospheric effects on solar radio energy. The flat mirror has two axes. One is parallel to the earth's polar axis—for daily rotation. The other is perpendicular—for seasonal variation. Experiment designer R. W. Wilson checks the horn antenna into which signals are reflected.



Bell Telephone Laboratories
Research and Development Unit of the Bell System

Electro-semblies has come up with a new wrinkle in its Matamoros facility: manual assembly of products for customers who furnish the parts. It estimates assembly charges will be between \$2.50 and \$3 per worker hour.

But labor economies aren't the only lure. The Americans also are impressed by the supply and quality of Mexican workers.

Vox pop. "When we started hiring, we had block-long lines of applicants," says Bernie Cunningham, manager of Varo's Matamoros operations. "It beat anything we had seen in a long time."

The vast numbers of people seeking work enable the Americans to screen for top quality. The result is a work force better than what some managers had expected. "We have been extremely pleased," says Kile of Electronic Control. "We learned that the old mañana stuff doesn't exist with the younger generation in Mexico. These people are really dedicated and they have a great deal of pride in their performance."

Girls averaging 18½ years old are generally hired for the assembly lines. Most have the equivalent

of a high-school education; company training usually takes six weeks or less. After training, says Electronic Control's Hoff, "They will outperform what we normally expect from our lines in Dallas."

While the quality of help available is good, Electronic Control and Varo people report differing experiences on working long-distance with engineering in Dallas and manufacturing in Matamoros. One reason, possibly, lies in the approach each took.

Local talent. Electronic Control says it has experienced no difficulty. It sent two handpicked manufacturing men from Dallas to set up and operate its plant. They are still the only Americans in it. The firm views the operation as "a Mexican plant for Mexicans," says Kile. Mexican EE's do all supervisory work.

This approach may take more training initially, but the long-range benefits apparently are good. Jim McCoy, manager of the Matamoros plant, says the Mexican EE's do not have the electronics background of U.S. graduates "but they learn fast." Hoff claims that after a few months, "we learn solutions to

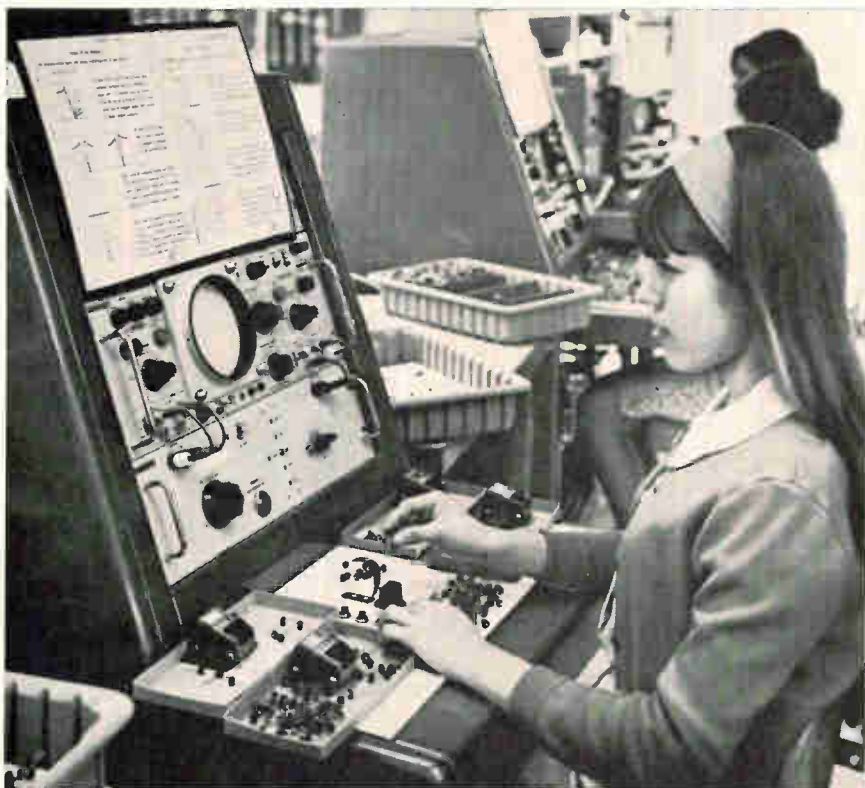

Meter readers. Girls at Electronic Control Corp.'s installation testing components packaged there. The typical assembly-line worker is a high-school graduate who receives six weeks' work training.

invaluable

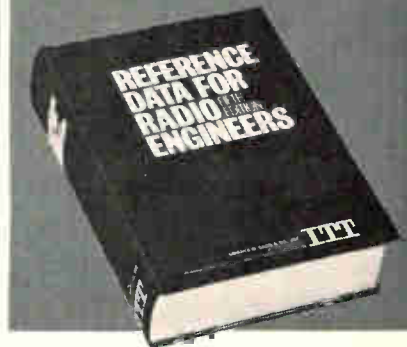

NEW 5TH EDITION OF THE WORLD-FAMOUS Reference Data for Radio Engineers

Now contains 50% MORE DATA to include major information developed over the past 12 years. Prepared by an outstanding group of practicing engineers, professors, and industry and government experts, under the direction of the International Telephone and Telegraph Corporation staff.

OVER 160,000 COPIES SOLD
IN THE FOURTH EDITION

The new FIFTH EDITION of this widely used reference work has been completely revised and updated. It provides in a single volume comprehensive data on all basic phases of electronics, including tables, formulas, standards, and circuit information—PLUS—all-new data on microminiature electronics, space communications, navigation aids, reliability and life testing, international telecommunication recommendations, switching networks and traffic concepts, and quantum electronics. 45 data-packed chapters provide invaluable information for practicing radio and electronics engineers. Includes over 1300 charts, nomographs, diagrams, tables, and illustrations. 1155 pages, plus 41-page index.

10-Day Free Examination

Howard W. Sams & Co., Inc. Dept. EL-3
A Subsidiary of International Telephone and Telegraph Corp.
4300 W. 62nd St., Indianapolis, Ind. 46268

Send me REFERENCE DATA FOR RADIO ENGINEERS for 10-day examination, without cost or obligation.

If I decide to keep the volume, I will send:
 \$20.00 (plus postage), or \$7.00 (plus postage) in 10 days, and \$6.50 per month for 2 months. Otherwise, I will return the book postpaid within 10 days.

\$20 payment enclosed. Send my copy postpaid with full 10-day return privilege. (Include sales tax where applicable.)

Name _____

Company _____

Address _____

City _____ State _____ Zip _____



Best readability among small DPM's

API's new digital panel meters are the only ones of their size with seven-bar segmented digits, $\frac{7}{8}$ " high, all on one plane, readable from 40 feet at angles of ± 70 degrees. They need only $1\frac{1}{2}$ " behind the panel when the detachable power supply is mounted remotely.

- 3 and $3\frac{1}{2}$ digit models.
- Accuracy $\pm 1\%$ of reading, ± 1 digit.
- BCD output.
- Auto-polarity.
- 1000 megohms input impedance.
- Front or rear panel mounting.

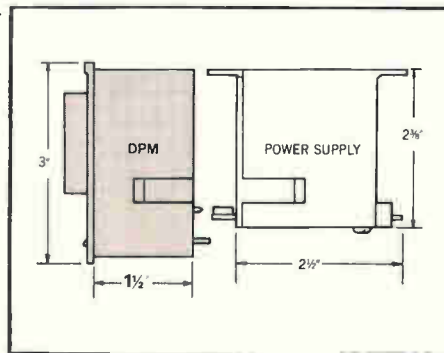

Priced to compete with high accuracy analog meters in OEM quantities.

Ask for Bulletin DP-1 ■ IEEE Booth No. 2G-34

api INSTRUMENTS CO.

Chesterland, Ohio 44026 | (216) 729-1611

some problems from these people."

Varo, on the other hand, has tried to handle all engineering with its own people. As a result, admits Cunningham, it has found "too big a physical separation" between its engineering in Dallas and manufacturing in Matamoros. "We haven't been too successful in getting our engineering people to move to Brownsville (across from Matamoros in Texas) but we will have to move some of them. We have had some problems and we attribute them primarily to this separation."

Mordido

To take advantage of the relatively inexpensive and plentiful Mexican labor, American firms must learn what channels to do business through and be prepared for the country's well-entrenched bribe system. It's known as "mordido," which means, literally,

Whether they approve of mordido or not, the Americans learn they can't bypass it. "We know some companies that tried," says one source. "They found nothing would move, neither the processing of operation permits nor materials and equipment through customs. There are certain procedures and channels you follow over here."

Some of the companies take the philosophical attitude that this system is just part of doing business in Mexico. "You get used to it," says one executive. "We pay our mordido to the people we're told should get it. We don't know how much this amounts to at times nor do we know how it is split up. We really don't care. It is just another operating cost to us."

Whites and reds. There are two major labor union groups in Mexico. Americans label them the "whites" and "reds." The latter group is considered Communist-oriented, and, says one Texan: "You certainly don't want any part of it."

Most of the American firms affiliate with the whites—the Confederacion de Trabajadores Mexicanos. It has local chapters, and relations depend on the local leaders. For the most part, however, American management finds them much easier to deal with than their U.S. counterparts.

Interior monologue

Motorola Semiconductor, which has a Mexican border-zone plant in Nogales, has built a second plant—in the interior—at Guadalajara. The company is quick to point out that its decision to build deeper inside Mexico does not indicate any unhappiness with its border operation. As a matter of fact, a spokesman points out, the border plant is being expanded to 15,000 square feet from 5,000. However, says Motorola, it sees three advantages in building at Guadalajara:

- Motorola's policy is to own its facilities, which is impossible under the border-development program.

- Nogales is small—pop. 50,000—while Guadalajara's metropolitan area is home to 1.3 million. This gives Motorola a huge labor market, while it would have trouble staffing a second, or greatly enlarged, Nogales plant.

- The border-development program requires products made in the zone to be shipped back to the U.S. before going to foreign customers.

"By having executives follow the right procedures, if you know what I mean, the Mexican union works for management," says one American. "They become your representative to the workers instead of the reverse." The "right" relations can also help get around a general rule that employees are eligible to receive three months' severance pay if they are discharged after completing a 29-day training period.

Serious labor trouble, however, can make a strike in the U.S. look like a church social. "When the black flag goes up over there signaling a strike," says Kile, "there is no question about continuing operations. No one goes in or out of a struck plant. There can be machineguns and that type of thing."

Dual operations

Some companies that operate manufacturing plants on the Mexican strip find it advantageous to locate warehousing facilities or allied plants on the American side.

WITH INSERTS, THE SAVINGS ARE IN THE HOLE

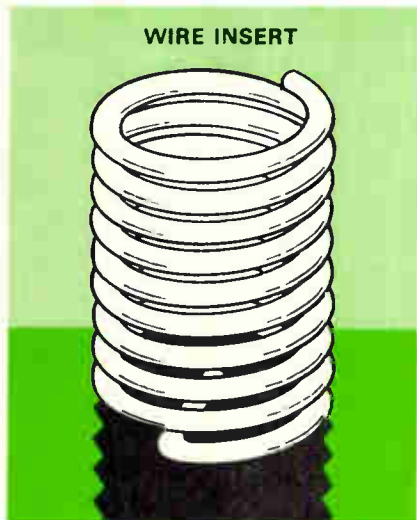

WIRE INSERT

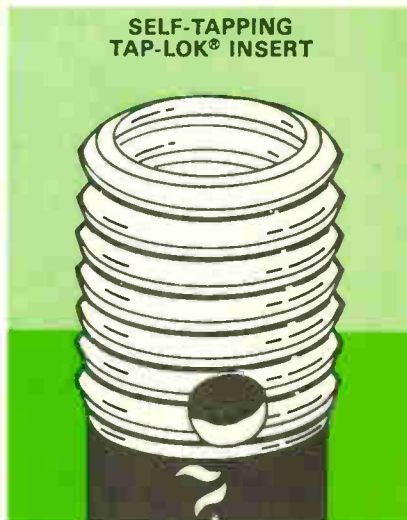

SELF-TAPPING
TAP-LOK® INSERT

For the real bargain in inserts, look into the hole. You'll get a new view of what really counts — final installed costs. Check these approximate installation figures:

(Estimated Costs*)

Wire-Type Inserts

Insert Cost	5¢
Drill Hole	5¢
Tap Hole	7¢
Gage Hole	3¢
Install Insert	8¢
Remove Tang	5¢
Per Finished Hole	33¢

Do Our Costs Agree With Yours?
If Not, Fill in Your Own

(Estimated Costs*)

Self-Tapping Tap-Lok® Inserts

Insert Cost	4.4¢
Drill Hole	5.0¢
Tap Hole (Not Req.)	—
Gage Hole (Not Req.)	—
Install Insert	8.0¢
Remove Tang (Not Req.)	—
Per Finished Hole	17.4¢

*Estimated cost for wire-type 4-40, .224" long, 25,000 quantity;

Tap-Lok 4-40, .234" long, case-hardened steel, 25,000 quantity.

Estimated average costs will vary with user, equipment, overhead, and labor rates.

You can see that Tap-Lok eliminates three operations which alone amount to about triple the cost of the insert itself. There are other savings, too. With Tap-Lok inserts you need only one inexpensive installation tool. Wire inserts require special taps, gages, and a tool to remove the tang, in addition to the installation tool. With Tap-Lok inserts, rework on the production line is almost nil, and field repairs are a rarity. Solid Tap-Lok inserts cut their own threads in the parent metal, offering greater strength, and improved reliability . . . and they conform to MS 35914 — 101 through 166.

Don't be misled by original cost-per-insert. Look into the hole. That's where the savings are.

Write for more information on Tap-Lok inserts. Groov-Pin Corporation, 1121 Hendricks Causeway, Ridgefield, New Jersey 07657. Telephone: (201) WH-5-6780.

FASTENER DIVISION

GROOV-PIN CORP.

CALL YOUR LOCAL INDUCTOR CENTER

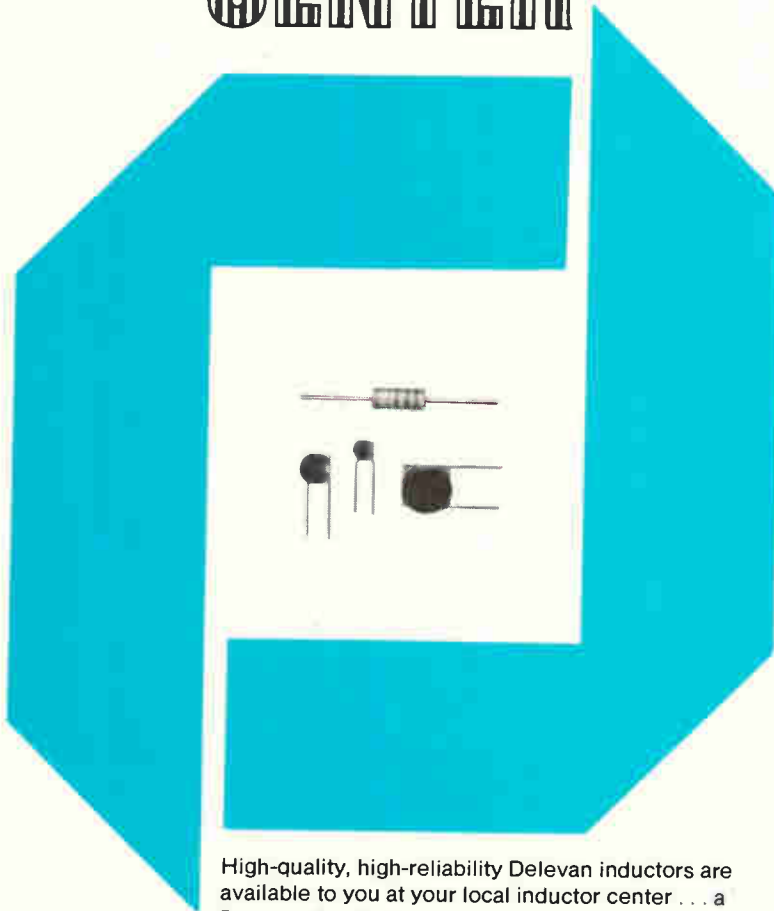

High-quality, high-reliability Delevan inductors are available to you at your local inductor center . . . a Delevan distributor. He's part of our world-wide distributor organization, each maintaining a well-balanced inventory of our standard series inductors. There's a Delevan distributor near you. You'll find his name on page 1102 of the 1969 Electronics Buyers' Guide and on page 2850 of EEM. Call him soon.

Delevan Electronics
Division



AMERICAN
PRECISION
INDUSTRIES INC.

270 QUAKER ROAD EAST AURORA, NEW YORK 14052 716 652-3600

OTHER DIVISIONS OF AMERICAN PRECISION INDUSTRIES INC. BASCO • DUSTEX • ELECTRO-MECHANICAL PRODUCTS • MOELLER INSTRUMENT CO. • OXFORD CORP. • TRUCK EQUIPMENT CO.

Chamber of Commerce people in such Texas towns as Brownsville are pushing the idea of support plants. And in some cases, the American border towns offer almost as lucrative a labor market as those on the Mexican side.

Cameron County, which includes Brownsville and other Lower Rio Grande valley towns, has a nagging unemployment problem: the rate has been at least 6% for several years. It is estimated that 61% of the county's residents earn less than \$5,000 a year.

Its leaders want the electronics firms to establish support facilities on the Brownsville side; they claim to have commitments from a half-dozen or so. The Cameron County people also envision allied support companies coming in to work with the electronics activities.

The future. American border town leaders see the industrial buildup on the Mexican strip as the greatest thing ever. But some of the companies are less enthusiastic about the long-range picture.

Electronic Control's Kile, for example, expects the buildup on the Mexican strip to increase at the rate of 6% to 10% annually over the next five to seven years. After that, the pickings may not be too good, in his opinion. He thinks it will take about that long for "animosity to build up" among the people involved; as a result, companies may find operating conditions not nearly as good as they are now.

Border woes. Customs problems may become more difficult, too. Already, some companies have hit snags on importing products back to the U.S. One company building tv cabinets in Matamoros, for example, found recently that it had to pay 10% duty to U.S. Customs because it had "changed the identity of wood" it had sent to its Mexican plant. This duty was not anticipated and swallowed the expected profit.

U.S. Customs now charges duty based on whether a company assembles, manufactures, or processes goods from raw materials imported from U.S. Those doing business in the Mexican strip say these regulations are so complicated that a company has to get customs brokers on both sides of the border to advise them. ■

AU!

Where do you get yours?

Prospecting was once the only source for gold. Not so today! The most modern production techniques, the latest refining methods and the best equipped research laboratories make Williams your one best source for all

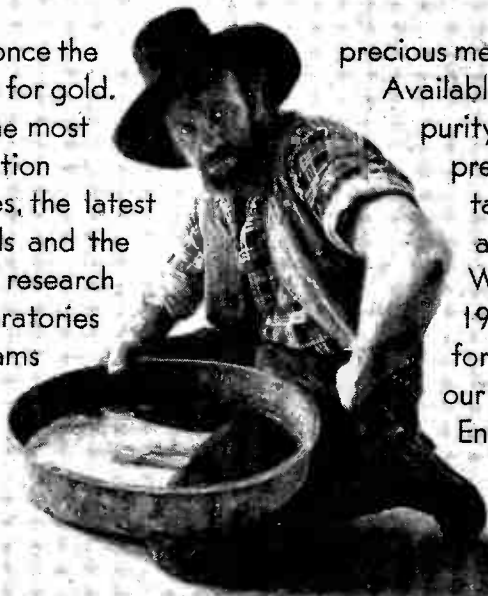

precious metals and their alloys. Available in ultra-high purity sputtering discs, preforms, foil, ribbon, tape, wire, sheet and other forms. Write for our 1969 catalog and for information on our "Instant Engineering" kit.



Discrete Semiconductors.

As of January 31, you
had 67,866* standard types
to choose from



*World-wide figure courtesy D.A.T.A. Inc.

It's high time somebody made your choice easier and safer

Somebody has.

Let's face it: there are just too many types of semiconductor devices to choose from today...and that can make your choice both difficult and hazardous.

Many "standards" no longer are. Many are in limited production and, consequently, are high-priced — you may settle on a \$3.00 device when a 30¢ one would do. Many are not readily available — understandable, with 67,866 types involved, but small consolation when you have to accept slow delivery. Many have been made obsolete by newer, low-cost devices with better performance characteristics.

To give you a lot more assurance in your device choices, we've come up with a bold, new concept. We call it our *Preferred Semiconductor* line, and it will pay off for you in simplified selection, faster delivery, lower costs, less inventory and reduced testing.

By *preferred* we mean *customer preferred*. After months of computerized demand analysis, we've zeroed in on 285 highly popular types that meet the vast majority of semiconductor requirements. These are the workhorses.

- All are in wide use today, known and proven.
- All are in volume production, and that spells low prices.
- All are readily available from TI distributors and factory stocks, so you can count on prompt delivery.
- All are recommended for either present or new designs.

These advantages make it worth your while to consider TI Preferred Semiconductors *first* for your new designs or system redesigns. You may still decide that you need a tailor-made device, or a more obscure standard. If so, we already make over 1500 other standard

types and some 13,000 specials which may meet your needs. If not, we'll make more. But the place to *start* is TI's Preferred line.

We've made it easy for you with a new Preferred Semiconductor and Components catalog. It contains detailed specs on all 285 types — small signal and power transistors, both germanium and silicon; diodes, thyristors, rectifiers, regulators, light sensors and resistors. All are indexed by both type number and application. There's a numerical listing to our full line of 1800-plus standards and an extensive cross-reference guide to products of other manufacturers. Application ideas are included, too. This could prove to be the most helpful semiconductor catalog you've ever used.

You can get a copy simply by asking. Ask your TI sales engineer. Ask your TI distributor. Or write us on your company letterhead or on the back of your business card: Texas Instruments, PO Box 5012, MS 308, Dallas, Texas 75222. Or, if you prefer, just circle 106 on the Reader Service card. It's high time.



TEXAS INSTRUMENTS
INCORPORATED

Panasonic invites you to a preview of tomorrow.

Including our pocket-size TV with 1½" screen.*

*measured diagonally.

See "tomorrow" happen today at the Panasonic booth at the IEEE Show. Electronic components with a "years ahead" concept, design and performance. Panasonic—building a reputation with components of the highest quality for myriad applications.

ELECTRONIC TUNERS Exceptionally long life is assured due to direct voltage control, which eliminates the need for mechanical contacts. These tuners offer TV reception in the VHF-UHF range with channel tuning through the use of variable capacitance diodes, band switching through switching diodes.

Micro-miniature tuners, although sub-miniaturized and of greatly reduced weight, deliver performances fully compatible with conventional, large size tuners.

Miniature tuners mount directly on printed wiring boards rendering the assembly of TV sets unusually easy. These tuners also simplify remote and program controlling.

PANASONIC FLAT SCREEN DISPLAY PANEL An electro-luminescent panel is divided into 50,900 picture elements. Only 1½" thick, it offers a variety of military and industrial applications. It is the forerunner of wall TV screens for the future.

MICRO-PROCESSOR CAMERA Instantly reproduces and reduces to projection slide size all printed matter (charts, maps, letters, documents, etc.). Process is done electronically and instantly within 10 seconds with no developing time required. The resulting slide can be used for permanent storage or projection onto a screen. Simplicity of design, ease of operation and compact size permit lower original monetary outlay, lower operating costs and reduced maintenance costs.

See these and many of the other exciting developments from Panasonic, such as Semi-Conductors for television and computer applications, N-P-N Silicon Transistors and our exclusive PCM ceramic material for compact solid state circuitry—all at the IEEE Show.

Complete information on the above components is available. Write to our Applications Engineering Division now.

VISIT US AT THE IEEE SHOW. BOOTHS 4J12-14, 4K11-13.



PANASONIC **IC** INTEGRATED CIRCUIT

These Micro-Miniature VHF and UHF Tuners made possible our ultra-compact 1½" diagonal screen TV (TR-001) now available in limited quantities.

PANASONIC[®]
Electronic Components and Devices

Matsushita Electric Industrial Co., Ltd., Osaka, Japan.
Matsushita Electric Corporation of America, 200 Park Avenue, New York, N. Y. 10017.
(212) 973-5700

The Engineering World Is Full Of Great Ideas, But...

What you do with your ideas is a measure of your progress. Getting an idea is not always easy. Transforming that idea into reality — and proving it — that's where the work really begins!

At HP, we're using the best of our ideas and years of experience in design and production of measurement instrumentation to make the job of turning your ideas into realities easier and faster.

Take the HP 180 Scope System as a case-in-point. It now has a sampling system that allows you to see 12.4 GHz. This sampling system circuitry contains step recovery diodes which produce nanosecond rise times with high power. Dr. Frank Boff was using the first practical gigahertz sampling scope—the HP 185—to analyze the effects of different combinations of "p" and "n" material when he dis-



covered the step recovery diode. Other research by Hewlett-Packard Associates produced the hot carrier diode that made the 12.4 GHz system practical, provided an extremely fast sampling gate, simplified circuitry and gave greater reliability.

The engineering world has been plagued for years with inaccuracies caused by capacitance when measuring high frequencies and nanosecond rise times. We fought this

problem, also. HP Microwave Division's experience with high frequency 50 Ω transmission systems led to development of the 50 Ω input system for the 100 MHz 180 scope, so you have a near-perfect termination — regardless of your signal frequencies.

A few years back, to design connectors, circuits, antennas, strip lines, and similar component parts, you had to measure all around the problem. Then to get where you needed to be—to find out what, where, and how much, you had to interpolate or extrapolate to find your answer. Now all you need for a direct measurement is the 180 and the TDR plug-in—another HP idea that came from experimentation with microwave circuitry.

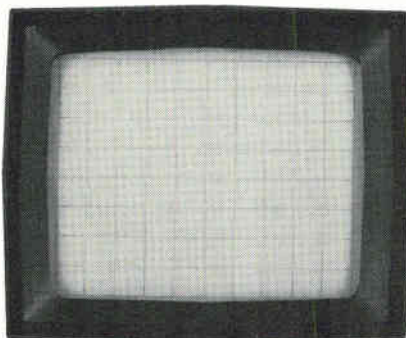

CRT size is another example. Early scopes—and even some of the modern scopes—had CRT's that were so small you had to squint to see them. We took the post-accelerator technique and the mesh dome technique ideas and combined them to produce larger, easier-to-read and more accurate CRT's. This combination requires lower driving potentials so the CRT can be driven directly by the plug-in. Driving the CRT from the plug-in gives you a mainframe that is not limited by its internal components and allows a choice of 50 MHz, 100 MHz, four channels, differential offset...

Vacuum tube scopes have a difficult time settling down to the point where accurate measurements can be made consistently — time after time. Signals often drift all over the face of the CRT! All-solid-state com-

ponents (which reach operating level almost immediately) and field effect transistors in the 180 scope system amplifier plug-ins virtually eliminate drift in both ac and dc measurements!

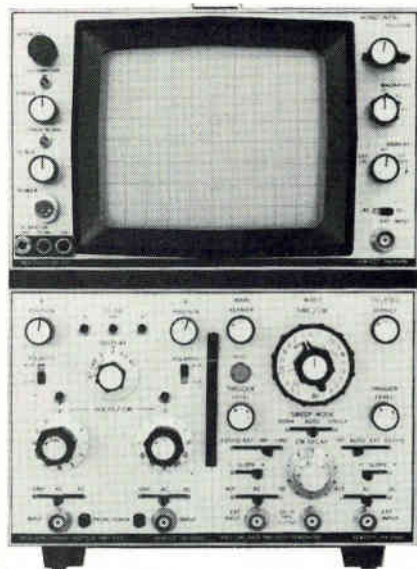

Speed your great ideas into realities. Step forward with the state-of-the-art new-idea-packed 180 scope system! It's no johnny-come-lately. It's been proven by more than two years in the field.

Consult your Hewlett-Packard Instrumentation Catalog for specifications and prices on the 180 Scope System mainframes and plug-ins, then contact your nearest HP field engineer. (He's an instrumentation specialist who can furnish information on a *complete* measurement system using the HP 180 as the core.) Or, write to Hewlett-Packard, Palo Alto, California 94304. Europe: 1217 Meyrin-Geneva, Switzerland.

089/3

STEP FORWARD

HEWLETT  PACKARD

OSCILLOSCOPE SYSTEMS

If the communications system
doesn't track after the big move,
you know who's going to hear about it.

You might receive a few communications that would be banned in Boston (or anywhere else) if the sensitive electronic components go on the blink.

So maybe you'd better communicate with a highly-professional mover who knows how to do the job—Allied Van Lines.

Our Electronic Vans are just as good as our personnel. They have a special bracing that keeps your equipment from slipping . . . an air suspension system that soaks up jolts and bumps along the way.

Call the highly-trained Allied Agent in your area.



We make the kind of moves
you never hear about

Circle 165 on reader service card

Of all DVM's, only
 Honeywell Digitest gives
 you five functions (DC Voltage,
 AC Voltage,
 DC Current,
 AC Current,
 Resistance),
 a choice of two models, and

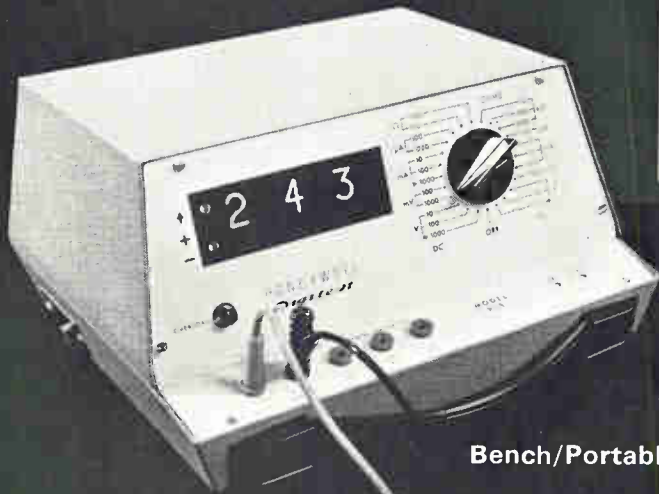

Bench/Portable, Model 333



Bench/Rack, Model 333R

a price tag of only \$395!

With $\pm 0.5\%$ accuracy, $100\mu\text{V}$ resolution, absolutely clear $3\frac{1}{2}$ -digit readout, and simple, foolproof operation, the tough, compact little Digitest makes other low-cost DVM's look overpriced and under-engineered. We won't even mention a comparison with conventional meter-movement instruments.

Both models share the same specs, but Model 333 is completely portable thanks to built-in rechargeable ni-cad battery operation. It operates on AC as well. Both instruments give you $3\frac{1}{2}$ -digit readout, with Model 333R providing an overrange digit while Model 333 employs an overrange indicator.

Compare features, specs, and prices — you'll see that Digitest is your best DVM value. That \$395 price, by the way, is *complete*. There are no shunts or plug-ins to buy, and even leads are furnished. The only option is a set of ni-cad batteries for the portable model at \$33. **Order yours today!** Call Don Anderson (collect) at (303) 771-4700, or send your purchase order to Don at Mail Station 222, Honeywell, Test Instruments Division, P.O. Box 5227, Denver, Colorado 80217. Both models are in stock for immediate delivery, so order now!

Honeywell

Honeywell engineers sell solutions

See us at the IEEE Show — New York Coliseum, March 24-29. Booths 2G39 to 2G43.

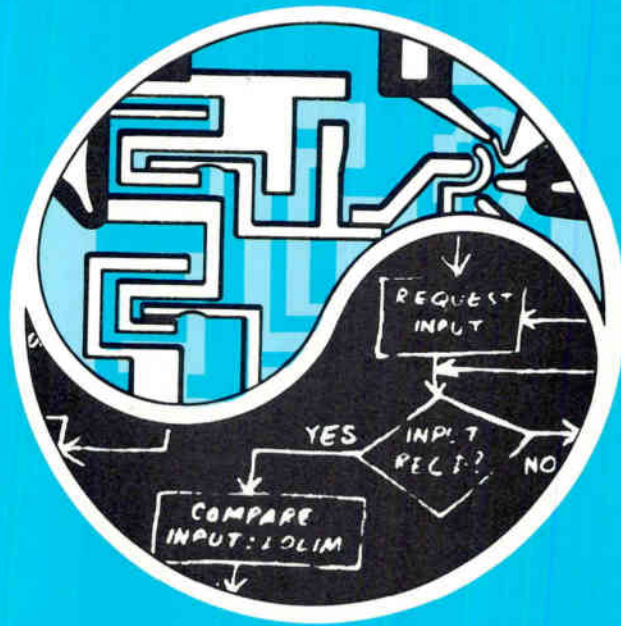

THE CHANGING INTERFACE

An IC/Systems Seminar

MARCH 28, 1969, PARK SHERATON HOTEL, NEW YORK, 9:00 AM—5:00 PM
Presented by the Electronics/Management Center

Program

Implications Of LSI On The Electronics Market: Glenn E. Penisten, Vice President, Components Group, Texas Instruments Inc., Dallas.

The Rationale For An In-House IC Capability: Alvin B. Phillips, Assistant to the President, Autonetics Division, North American Rockwell Corp., Anaheim, Calif.

The Component Maker's Responsibility In The System/Component Interface: Robert M. Walker, Supervising Engineer, Array Systems Engineering, Fairchild Semiconductor, Mountain View, Calif.

The System Builder's Responsibility In The System/Component Interface: Richard Stokes, Manager of Planning, Electronic Systems Organization, Burroughs Corp., Paoli, Pa.

The Mask And Computer-Aided Design As Interface: Wally Raisanen, Operations Manager for MOS and IC Memories, Motorola Semiconductor Products, Phoenix, Ariz.

The Testing Interface: William Dunn, Engineer-in-charge, Custom LSI, Sylvania Semiconductor Div., Woburn, Mass.

The Integrated Circuit Design Interface In Bell Laboratories: James M. Early, Director, Semiconductor Device Laboratory, Bell Telephone Laboratories, Allentown, Pa.

How IBM Deals With The Interface Problem: Paul Low, Manager of Logic Products, IBM, East Fishkill Facility, Hopewell Junction, N.Y.

Controversies And Future Trends In LSI: Donald Farina, President, ICST, Inc., Sunnyvale, Calif.

Panel Discussion

Moderator: Orville Baker, Vice President, Signetics Inc., Sunnyvale, Calif. Speakers and invited guests will join in an open forum discussion of interface problems, and will answer questions submitted from the audience.

ADVANCE REGISTRATION

"The Changing Interface" — March 28, 1969 — Park Sheraton Hotel, 7th Avenue & 56th Street, New York, N.Y.

NAME _____

TITLE _____

COMPANY _____

ADDRESS _____

CITY _____ STATE _____ ZONE _____

Registration Fee: \$65 (Fee includes all sessions, refreshments, luncheon, and a copy of the proceedings when published.)

Note: Attendance will be limited and applications will be handled on a first-come, first-served basis.

Mail registration and make checks payable to: Electronics/Management Center, An Information Service of McGraw-Hill, Inc., 330 West 42nd Street, New York, New York 10036

ITS...another mo



Positive new way to avoid the growing complexities of aircraft wiring. ITS—here today from Deutsch!

ITS...the abbreviated way to say "Integrated Termination System"...which is the fastest, simplest, most standardized method ever devised to approach electrical interconnection problems in aircraft, missiles, space vehicles and ground support equipment.

Deutsch thought up the ITS idea. And perfected it to the point where one single tool, and one standard working procedure is all that's required to complete every termination—miniature and sub-miniature connectors, junctions, feedthrus, switches, relays and a wide range of component devices—in exactly the same way.

ITS helps you save time...space...weight...money. You decrease downtime and virtually eliminate all chances of error. You get increased reliability with less inventory and far less trouble.



DEUTSCH ELECTRONIC COMPONENTS DIVISION

Municipal Airport • Banning, California 92220 • Telephone: Area Code 714 • 849-6701

COPYRIGHT, 1969 DEUTSCH ELECTRONIC COMPONENTS DIVISION

e into the future!

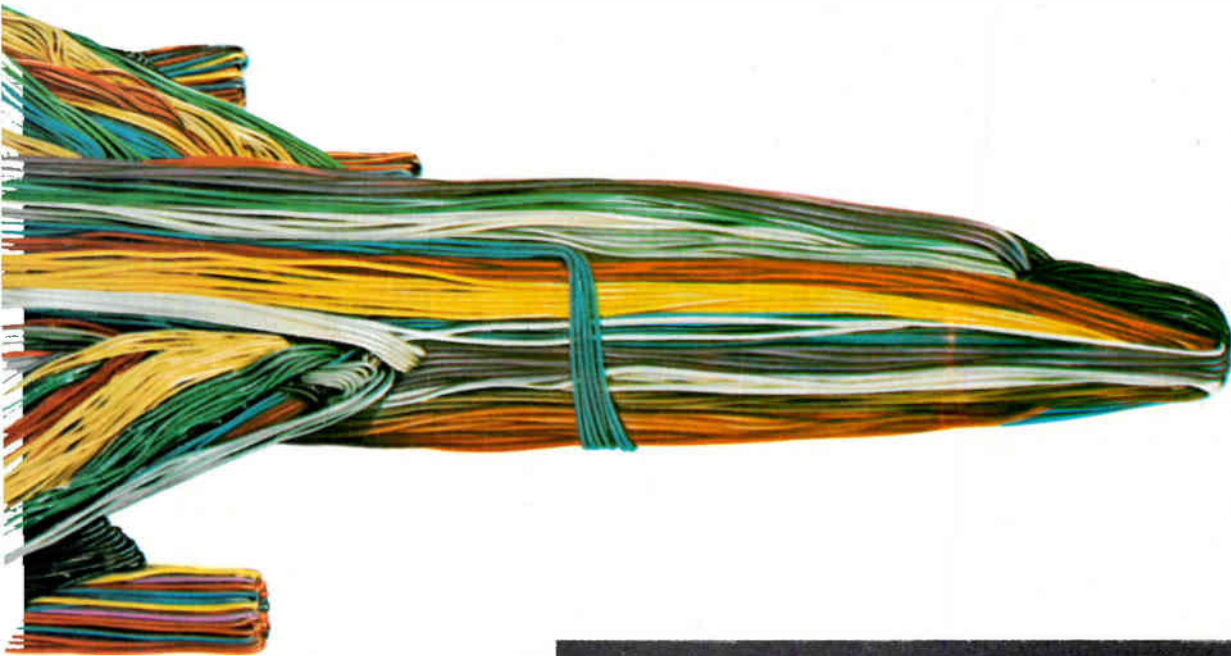

Deutsch gives you fast, individualized, world-wide servicing. And—if that's not enough, consider that ITS can be taken in easily integrated stages. A good starting place is shown at your right. Your local Deutschman has many other noteworthy suggestions. Call him today. Or write.

But you don't have to wonder why the Deutsch RSM is the most-wanted of all sub-miniature push-pull connectors. No other unit handles more wires in less space. Or treats them so gently while still maintaining excellent electrical engagement. Push-pull, quick-disconnect coupling. And—quick delivery! Call your local Deutschman for more details. This "small wonder" is another component of ITS... the Deutsch Integrated Termination System.



DEUTSCH

ELECTRONIC COMPONENTS DIVISION

Municipal Airport • Banning, California 92220 • Telephone: Area Code 714 • 849-6701

COPYRIGHT, 1969 DEUTSCH ELECTRONIC COMPONENTS DIVISION

Two for the Show

Applied Materials unveils vertical epitaxial reactor for silane deposition, while Hugel introduces barrel reactor with induction coil inside susceptor

A vertical epitaxial reactor system for silane deposition and a barrel reactor embodying a radically new design will be displayed by neighboring California companies at the IEEE Show. Applied Materials Technology Inc. of Santa Clara will show its model AMV-800, in which gas flow is directed so as to pre-mix and preheat incoming silane and deposit it under conditions of chemical near-equilibrium. Hugel Industries, situated a few miles up the Bayshore Freeway in Sunnyvale, will unveil a barrel reactor that has its induction coil inside an unusual graphite cylinder to ease and speed the loading of silicon wafers.

The Hugel reactor was dubbed "Epi Grand" by the late Frances B. Hugel, whose last design it was. The graphite cylinder, called susceptor, is 10 inches in diameter, 16 inches high. Its outer surface is dimpled so that the wafers can sit vertically around it. Capacity is 50 two-inch wafers, very high for a bell-jar type of reactor. The susceptor can also be dimpled for 1½-inch or even 1-inch wafers, but it's a high-production unit and the company believes that most of its customers will use the larger size.

Working out. "It was Fran's idea to put the coil inside the susceptor," says Donald G. Pedrotti, Hugel's engineering vice president. "The theory was that you couldn't get good coupling to the susceptor that way. But although we were told to expect losses of up to 40%, they turned out to be less than 10%.

Putting the coils inside permitted use of a water-cooled stainless-steel bell jar instead of the expensive and fragile quartz, since all stray flux is coupled to the susceptor and not to the jar. The steel

reflects heat and helps keep temperature variation within 5°C over the whole surface. The chief benefit of the inside coils, of course, is in the loading. Previous barrel systems with coils wrapped around the susceptor have proved extremely tricky to load.

Gas flows horizontally around both sides of the susceptor from a tube on one side to a partial vacuum tube on the other, and the

susceptor itself is rotated 12 to 18 times a minute so that each slice sees gas flow in both directions.

Two at a time. Because the system takes a long time to cool down, Hugel suggests a double-barreled arrangement, with one chamber cooling and one in use. With two control units, such a system could also be used simultaneously for epitaxial growth and ni-

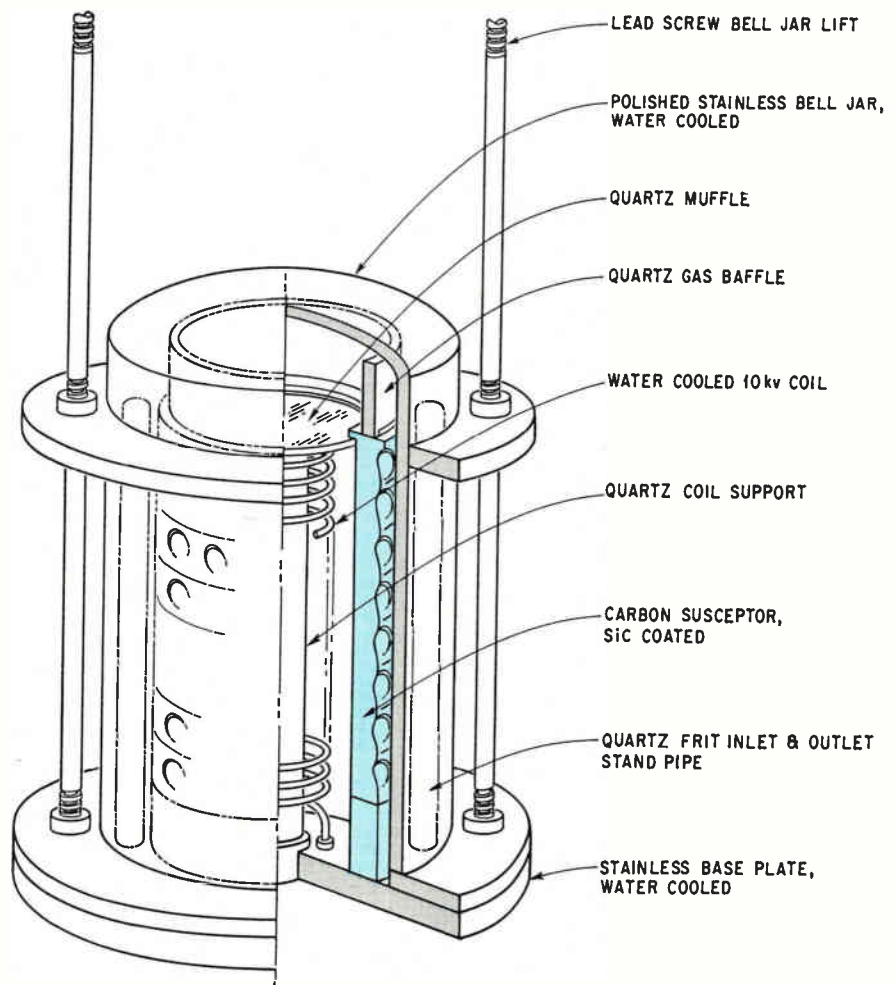

Slot machine. The outer surface of Hugel's new carbon susceptor is dimpled so that up to 50 two-inch wafers can be placed around it.

tride or oxide passivation.

The control unit is the company's standard PCD 10 x 30 process controller, an automated system that's programed by inserting pins through a plastic program card into a matrix.

As for the other reactor, Applied Materials has devoted considerable time to studying the nature of silane and silane epitaxy; it will even supply the gas to its customers. Since SiH_4 decomposes rapidly at temperatures over 600°C , it can be used as a silicon source for epitaxial growth at temperatures lower than those necessary with silicon chloride, the other commonly used gas. Walter C. Benzing, a physical chemist and the firm's director of technology, notes that the lower temperature reduces the diffusion of impurities from the substrate into the deposited film, and minimizes the liberation of impurities from the susceptor.

The design of the AMV-800 is such that the gas enters the bell jar through the hole in a doughnut-shaped susceptor and is mixed with the recirculating gas already in the jar before passing over the wafers. It's heated by the recirculating gas during its toroidal flow, and it decomposes into silicon and hydrogen in a process that has a very weak reverse reaction. The gases are thus close to chemical equilibrium when they pass over the wafers. Benzing says the crystalline layers formed in this fashion are more nearly perfect than those formed by a strong chemical driving force (gases far from equilibrium).

Horizontal gas systems require gases with strong chemical forces, Benzing observes; otherwise they'll produce wafers that vary in resistivity according to their position from front to back in the reactor. (In a horizontal reactor, a wave of gas is passed down a quartz tube, so that each wafer sees the gas at a different point in time.)

Mechanically, the AMV-800 uses a flat susceptor with an 8-inch outside diameter and a 1.5-inch hole in the middle. A $2\frac{1}{2}$ -inch track permits the loading of eight 2-inch wafers or 12 of $1\frac{1}{2}$ inches. The susceptor revolves to insure wafer uniformity. The company claims that it can get about $\pm 5\%$ uniformity in a batch.

THE PARKER TWINs

**3½" EDGEWISE
INDICATORS & CONTROLLERS**



ER-35

CONTROLLING



E-35

NON-CONTROLLING

The Parker edgewise twins give total flexibility in design approach plus uniformity of panel appearance.

ER35

A control meter available with 1 or 2 set points giving a choice of 4 possible switching configurations. Standard switching power ranges from 50 MW up to 7.5 Amperes at 115 volts. Completely independent controlling and indicating functions.

E35

An edgewise indicator matching the Model ER35 control meter in dimensions and appearance. Like the ER35, it offers 3 standard Pointer/scale configurations and is available with electroluminescent lighting.



PARKER INSTRUMENT CORPORATION

200 HARVARD AVENUE, STAMFORD, CONNECTICUT 06904, (203) 325-4361, TWIX-710 474-2277

Circle 257 on reader service card

QUICK



SLICK

PERFECT FIT!

Here's the perfect way to reduce instrumentation downtime. Deutsch spherically-oriented rack and panel connectors mate or release—instantly. Even when misaligned, plug and receptacles compensate automatically, and you get perfect "cork-in-bottle" environmental seals. They're vibration-dampened. Spring loaded. Unaffected by pressure. Available in a full range of miniature and subminiature sizes and insert arrangements. Get the facts now from Deutsch, the "live-wire" leaders in Integrated Termination Systems.



DEUTSCH

ELECTRONIC COMPONENTS DIVISION

Municipal Airport • Banning, California 92220 • Telephone: Area Code 714 • 849-6701

COPYRIGHT, 1969 DEUTSCH ELECTRONIC COMPONENTS DIVISION

Monolithic crystal filter vaults to eight poles

Two-step electrode deposition process is the key to building circuit designed for single-sideband and other communications applications

A **monolithic multipole** crystal filter poses a severe problem for the manufacturer: how to get an accurate center frequency. Electrode geometry is the clue to accuracy. The crystal products group of Tyco Laboratories solves the problem by a two-step electrode deposition process and a special way of measuring the geometry.

First, the silver electrode is elec-

troplated on the quartz with a mass that will give a center frequency slightly higher than the design value. Then, as the filter output is continuously monitored, the electrode is exposed to iodine vapor, which combines with the silver and increases the mass. The reaction is terminated at precisely the desired center frequency.

Tyco is now offering the mono-

lithic filter, available in up to eight poles, at a price that is competitive with discrete filters—about \$1.50 per pole. However, the company hopes to reduce the price to about \$1.00 per pole in six months.

The new monolithics are designed for industrial and military single-sideband and radio communications applications. The present center-frequency range of the mono-

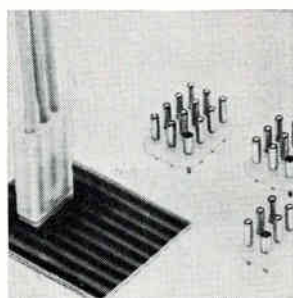

Designed for p-c applications, the Wafercon connector is a series of nylon wafer receptacles supplied with preassembled terminals and ready for press-fitting to a p-c board or for fountain or wave soldering. Positive polarity is guaranteed by intermixing male and female terminals in wafer receptacle and mating plug. Molex Products Co., 5224 Katrina Ave., Downers Grove, Ill. [341]

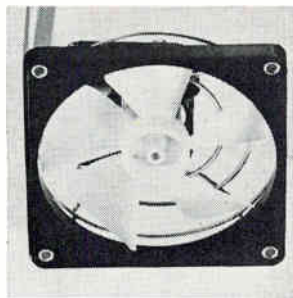

Miniature axial fan SK4251 features blades molded of Celcon, a high strength acetal resin, coupled with an impedance protected motor. With a free air delivery of 115 cfm, the unit can run continuously for a minimum of 5 years without maintenance, when operated at maximum ambient temperatures of 125° F in clear atmosphere. Ripley Co., Middletown, Conn. 06457. [342]

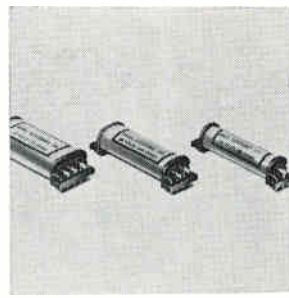

Universal mount reed relays have a contact life rated at 20 million operations (resistive) at rated load and 100 million operations at 7 va. They can operate within 2 msec and release within 1 msec over a temperature range of -65° to 125° C. Prices range from \$4.75 to \$1.65; discounts are available for production lots. James Electronics Inc., 4050 N. Rockwell St., Chicago. [343]

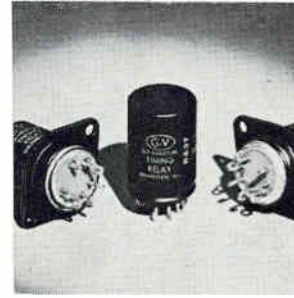

Thermal timing relay series LT is for time delay use where weight and size are of prime importance. Height above mounting panel is 1 1/8 in.; weight, 0.65 to 0.8 oz. Units can withstand 10 g 1,000 hz vibration and 50 g 11 msec shock without damage or false contact operation. They operate over a range of -65° to +125° C. G-V Controls Inc., Okner Parkway, Livingston, N.J. [344]

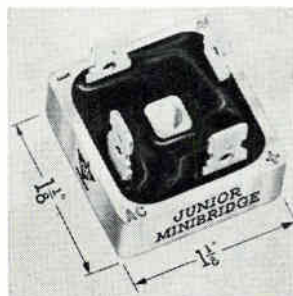

Silicon rectifier bridge designated the Junior MinibrIDGE offers an output of 8 amps at 55° C case temperature with a piv range of 50 to 1,000 v. It replaces 4 stud rectifiers and related heatsinks in such applications as computers, digital and analog instrumentation, automation equipment, and motor controls. Electronic Devices Inc., 21 Gray Oaks Ave., Yonkers, N.Y. 10710. [345]

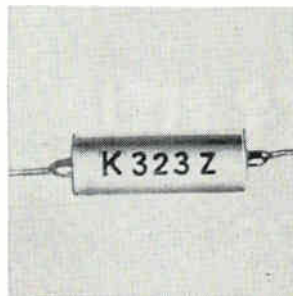

Metalized polycarbonate capacitors K123Z and K323Z offer size and weight savings over paper capacitors in the lower voltage ratings. Dissipation factor at room temperature does not exceed 0.5% with capacitances up to 1 µf at 1,000 hz and over 1 µf at 60 hz. Units with 0.235-in. diameter have max. dissipation factor of 0.75%. Aerovox Corp., New Bedford, Mass. [346]



A-c null sensing relays combine solid state input circuitry with dry reed load contacts. The hybrid modules can often replace more complicated, costly components commonly used for transducer sensing, servo positioning, or sensing and regulating motion displacement in control systems. Price (1-24) is from \$21.75. Sensitak Instrument Corp., 531 Front St., Manchester, N.H. [347]



Double-pole, double-throw push-button switch B7070 is a snap-action device that measures 3/8 x 1 1/8 in. including terminals and pushbutton. Designed to meet the needs of data processing and industrial control, the unit has a minimum life of 50,000 operations at loads of 1 amp resistive or inductive at 28 v d-c or 115 v a-c. Controls Co. of America, Delmar Dr., Folcroft, Pa. [348]



Multipole. Design of filters is keyed to communications jobs.

ololithics is 5 to 22 megahertz with fractional bandwidths of 0.01% to 0.4%. However, the majority of the filters will be under 0.1% fractional bandwidth.

"Computer-aided design," said Robert A. Crawford, vice president of the division, "has made it possible to evaluate all of the thousands of network parameters and possible performance factors to evolve this family of monolithics. The new monolithics will be a key to improved economy, reliability, and miniaturization for designers."

For one design, the company offers two six-pole packages used in tandem to provide 12-pole performance. A typical eight-pole monolithic filter at 10.7 Mhz center frequency with 7 kilohertz range will meet 2:1 shape factors at 60 to 6 decibels. Stop-band rejection is over 100 db and spurious responses are down at least 90 db.

Other specifications are: 6 db bandwidth range is 2 khz to 15 khz; 60 db to 6 db bandwidth ratio is 2.1 maximum; 100 db to 6 db bandwidth ratio is 2.5 typical, 2.7 maximum; midband insertion loss is 0.25 db typical, 1 db maximum; in-band ripple is 0.25 typical, 1 db maximum; operating temperature range is -55°C to $+90^{\circ}\text{C}$.

Units are available on a 30- to 60-day basis. IEEE Booth No. 3E11.

C-F Networks division of Tyco Laboratories Inc. Bear Hill Rd., Waltham, Mass. 02154 [349]

Unlocking the Future

Electrical Electronics Engineering



Monday through Thursday

4 FLOORS OF EXHIBITS
NEW YORK COLISEUM
48 TECHNICAL SESSIONS
NEW YORK HILTON

- 48 TECHNICAL SESSIONS at the New York Hilton. Hours: 10:00-12:30; 2:00-4:30.
- FOUR FLOORS OF EXHIBITS at the N. Y. Coliseum including over 600 firms. Hours: 10 a.m.-8 p.m. 4 Days.
- GALA ANNUAL BANQUET—Wednesday 7:15 p.m. N. Y. Hilton Grand Ballroom — \$18.00.
- FREE SHUTTLE BUSES between the Hilton and the Coliseum — every few minutes.
- REGISTRATION — Good all days — Technical Sessions and exhibits. In and out privileges. — IEEE Members \$3.00. Non-members \$6.00. Ladies \$1.00. High School Students \$3.00 if accompanied by an adult — One student per adult: Thursday only — limit of 3 students per adult.
- REG-IDENT CARD speeds request for exhibitors' literature. Ask for one when registering.
- ESCALATORS/EXPRESS ELEVATORS to the Fourth Floor.

IEEE '69

INTERNATIONAL
CONVENTION & EXHIBITION
MARCH 24-27, 1969

Circle 258 on reader service card



OUT OF SIGHT! A Deutsch DBA 70 connector may be operating away from your line of vision, but you don't have to see it to connect or disconnect properly. There's nothing to turn, twist or thread. Just push to engage; pull to disconnect. Mating is grope-free, **trouble-free!** Environmentally-sealed, the DBA 70 stands up under temperatures ranging from -67° to 392°F . It meets all the performance and reliability requirements of NAS 1599 and works in absolute harmony with the rest of our Integrated Termination System. Out of sight? Maybe! Out of reach? Never! Just pick up the phone and call your friendly Deutschman.



DEUTSCH ELECTRONIC COMPONENTS DIVISION

Municipal Airport • Banning, California 92220 • Telephone: Area Code 714 • 849-6701
COPYRIGHT, 1969 DEUTSCH ELECTRONIC COMPONENTS DIVISION

Well?

Gas discharge tube



Power Supply 150 V

Digivac S/G



Power Supply 25V and 1.6V

450 MW

**TOTAL
POWER**

120 MW

(Typical Operation)

How's this for saving power?

The low-voltage/low-power drain of Digivac S/G readouts contributes substantial advantages in both economy of installation and reliability of operation. In addition to minimizing heat in multiple displays, the low voltage permits use of Digivac S/G readouts in battery operated equipment. The up-front single-plane display is consistent and highly-legible, even from oblique angles. Blue-green color of the display provides optimum contrast free of interior wire glow. Digivac S/G can be used in "time sharing" circuits. Write for literature describing all of the features of Digivac S/G readouts.

TUNG-SOL DIVISION / WAGNER ELECTRIC CORPORATION

ONE SUMMER AVENUE, NEWARK, NEW JERSEY 07104

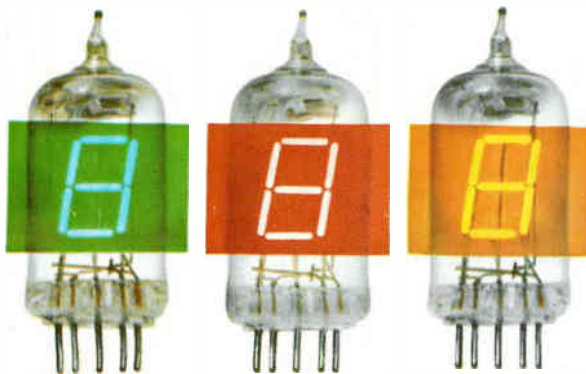

CHOICE OF COLOR WITH FILTERS

Simple filtering provides an almost unlimited choice of colors for identifying individual readout arrays.

TUNG-SOL[®]
DIGIVAC S/G[™]

...the newest state
of the readout art

Exhibit Area 3E15-3E17 IEEE Show, New York Coliseum

New components

Differential unit compares well

Comparator's impedance is 100,000 megohms, voltage swing ± 30 volts

The largest differential input-voltage swing available may be the ± 30 volts maximum of the model 350 voltage comparator from Analog Devices Inc. The device also offers what is probably the highest input impedance available in solid state comparators—100,000 megohms—and what may be the lowest input bias current: 50 picoamperes.

Analog's market researchers found that most comparators were of the integrated-circuit 710 or 711 type. And of these, at least a third were preceded by a 709-type op

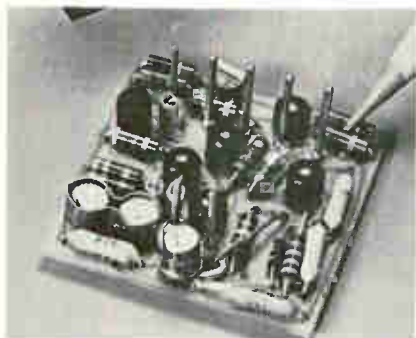

Low-down. The input offset bias of this solid state comparator is 50 picoamps.

amp; because the 710's input bias current often reaches 20 microamperes, the 709 is needed for buffering.

Although Analog's model 350 costs \$10 to \$12 more than a 709-710 combination, the input bias current is nearly 10 times better.

Another potential drawback to the 709-710 combination is its low output current. Many comparators must drive DTL or TTL, which require 5 milliamperes or more at ± 5 volts for fastest turn-on. The 709-710 combination, however, can go as low as 2 milliamps. Analog's

How'd you like to drill carbon plates 6 times faster? Pinpoint accuracy—even for unskilled operators with the new multi-spindle

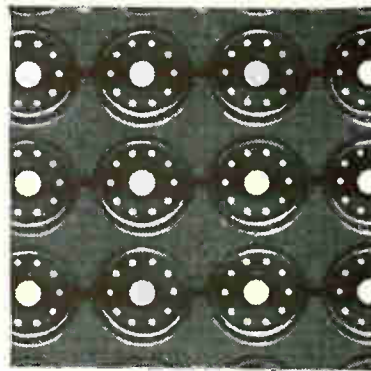

Engravograph[®]

Speed transistor mounting! Now anyone can drill six carbon plates in one operation from one template with registration and depth of hole controlled to a plus-or-minus .001" tolerance.

Drill up to 1600 holes per minute. Save time, labor... and especially costs.

For details write: Dept. 175.

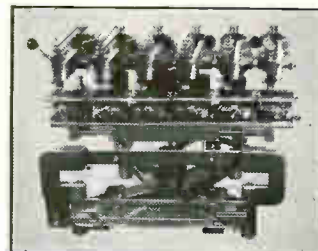

new hermes engraving machine corp.

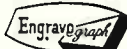

20 Cooper Sq., N.Y., N.Y. 10003 • Chicago, Atlanta, Los Angeles, Dallas, Montreal, Toronto, Mexico City

SEE US AT BOOTH IJ12 AT THE COLISEUM

Circle 259 on reader service card

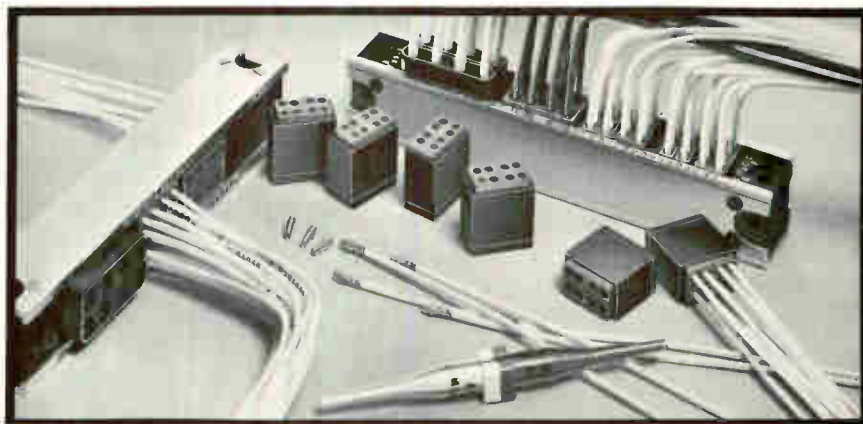

KING OF THE COMMONERS!

A termination device that requires only one common assembly procedure and one common tool and that's compatible with a common integrated system makes a lot of sense. In this regard, the Deutsch Terminal Junction is the king! It's your best means of commoning, busing together, or joining two or more circuits. And look at the cost saving... almost two-thirds less. And look at the efficiency and versatility. No splicing, soldering, wrapping or lugging. If you want to add on, you just **do** it. Extra plugs-ins are ready and waiting. You can turn Deutsch Terminal Junctions upside down, sidewise, or what have you. Hail to the King! Still another component of ITS... the Deutsch Integrated Termination System.



DEUTSCH

ELECTRONIC COMPONENTS DIVISION

Municipal Airport • Banning, California 92220 • Telephone: Area Code 714 • 849-6701

COPYRIGHT, 1969 DEUTSCH ELECTRONIC COMPONENTS DIVISION

When E-H announces a whole bundle of totally new products...

they're not just giving you a line.

E-H is introducing a whole lineup of eight totally new products. And if you're just expecting a new line of pulsers, guess again.

Among the eight new products are three new E-H digitally programmable system modules. Model 1223 is a programmable 6-channel delay unit covering 10 ns to 1 ms at up to 50 MHz clock rate. Model 1422 is a dual timing unit featuring program control of frequency from 1 kHz to 50 MHz and dual width and delays of 5 ns to 100 μ s. Model 6601, however, is a programmable source-sink which marks a new field of endeavor for E-H.

It features fast response time (20 μ s), extreme accuracy of voltage or current programming and unsurpassable isolation of output lines.

Also included in E-H's bundle are three new high frequency oscilloscopes. Model SS-211, 200 MHz bandwidth at 10mV/cm, and Model SS-112, 100 MHz bandwidth at 5mV/cm, both feature 6 cm x 10 cm

display and high writing speed. Model 5009B is a sampling oscilloscope which features 7 GHz bandwidth with the type V9-B vertical plug-in unit and 18 GHz bandwidth with the V9-F.

And, to complete the new lineup, E-H introduces two totally new pulsers featuring dramatic advances in repetition rate, output voltage and parameters under digital program control. Model 129 features rep rates from 10 kHz to 500 MHz by internal clock, and an output voltage specified at ± 2 V at a rise time of 450 picoseconds, with DC offset of ± 1 V available. Model 134 yields ± 100 V at a duty factor of 40% with rep rates up to 5 MHz, and rise and fall times of 12 ns.

So if you're looking for something completely new to tie up with your present system, contact your E-H representative for more information.

They won't just hand you a line. And that's a promise.

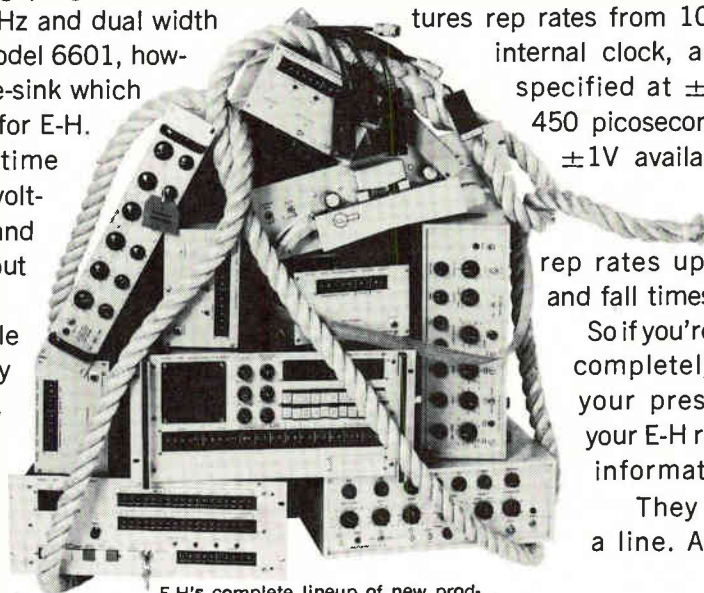

E-H's complete lineup of new products will be shown for the first time at the IEEE. Visit Booth #2C 29-35.

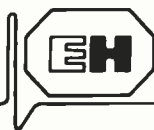

E-H RESEARCH LABORATORIES, INC.

515 Eleventh Street • Box 1289, Oakland, California 94604 • Phone: (415) 834-3030 • TWX 910-366-7258
In Europe: E-H Research Laboratories (Ned) N.V., Box 1018, Eindhoven, The Netherlands, Telex 51116
In Japan: Iwatsu Electric Company, Limited, No. 710, 2-Chome Kugayama Sugunami-Ku, Tokyo, Japan

350 has a 7-milliamp minimum.

This high output current and the 350's high input-voltage and impedance specs make the new comparator a natural for working directly with transducers, according to Ray Stata, senior vice president. "Because of the 350's field effect transistor input, its performance is equivalent to that of similar comparators built with vacuum tubes," he says. The 350 is only 1.5 inches square and 0.4 inch high. Power supply requirements are ± 15 to 16 volts, and quiescent current is only about 3.5 milliamperes.

The 350 comes in three models, A, B, and C; they have the same specs except for offset-voltage and bias-current drift. These get tighter as the price goes up. The highest-priced model, the 350-C, has an offset-voltage drift versus temperature of ± 25 microvolts per degree Centigrade.

Analog's applications data suggests uses in level detectors, square-wave and pulse sources, one-shot multivibrators, voltage-to-frequency converters, and pulse-width modulators.

Prices range from \$38 for a 350-A in quantities of 10 to 24 to \$70 for the 350-C in single units. Delivery is from stock. IEEE Booth No. 4E26.

Analog Devices Inc., 221 Fifth St., Cambridge, Mass. 02142 [350]

New components

Reed with a twist has longer life

Sliding action

cuts bounce time

of switch to 70 μ sec

Letting things slide is the way engineers at the Gordos Corp. boost the life and cut the bounce time of their reed switches.

Reeds are usually flat, and when a magnetic field pulls them together the reeds flap off each other for as long as 1 millisecond before making firm contact.

In the new switch from Gordos,

COMPACT Hoyt METERS

Designer's Choice for size, performance

No. 685 Moving Coil pancake edge-wise meters, without barrel projection, may be mounted together for comparison reading applications. 30% larger dial area for better readability. Shielded high torque movement for all ranges 50 UA up to 750 volts. VU meters, and AC rectifier type voltmeters.

No. 2015 Custom 1 1/2" Panel Meter. Hoyt proven high torque movements, quick response, fine damping. Linear design cases with optional color variations. No. 2015/B distinguishes panels with die cast metal bezel for mounting meter behind panel. Small, compact and unique in design. Available in all DC, VU and rectifier type movements. Visit booth 2H17 at IEEE Show.



No. 685 Meter (without bezel)
2 1/4" x 7/8"

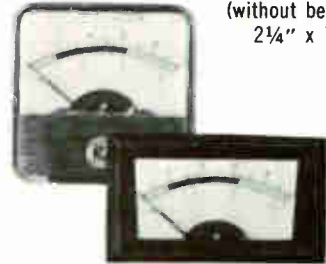

No. 2015, 1 3/4" square;
No. 2015/B (with bezel)

Hoyt

HOYT ELECTRICAL INSTRUMENT WORKS, INC.
BURTON-ROGERS COMPANY / Sales Division
46 Carleton St., Cambridge, Mass. 02142 (617) 491-7400

Circle 260 on reader service card

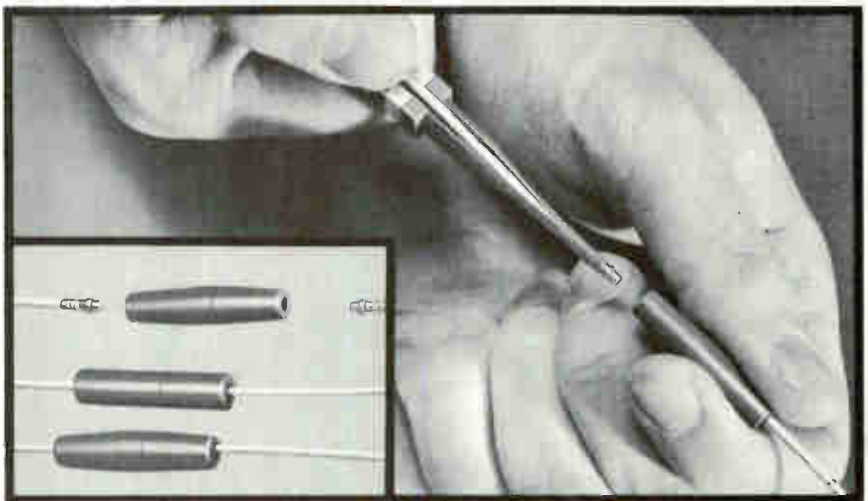

Nicer than Splice!

We know you aren't out to win any beauty contests when making wire-to-wire connections. But you'd get the prize anyhow with Deutsch Jiffy Junctions! Their soft, form-fitting, wire-hugging rubber cylinders flex, insulate, seal. Better than the wires themselves? Snap your wires in place and forget all about them. They won't shake loose, pull apart or turn brittle. Jiffy Junctions make one-to-one unions. Multi-Junctions for three-to-one combinations. As important members of your Integrated Termination System (ITS) they're Deutsch little sisters — both nicer than splice!



DEUTSCH

ELECTRONIC COMPONENTS DIVISION

Municipal Airport • Banning, California 92220 • Telephone: Area Code 714 • 849-6701

COPYRIGHT, 1969 DEUTSCH ELECTRONIC COMPONENTS DIVISION

Indispensable—MCL's NEW, **HIGH POWER PULSE MODULATOR**

Model 10299



featuring these Much Wanted Specs:

- Continuously adjustable output voltage: 0 to 3.0 KV @ 3.0 amperes, peak.
- Peak output voltage readout.
- Pulse characteristics: Width, 0.5 to 10 microseconds, adjustable. Pulse droop, 5%, maximum at 10 microseconds' pulse width. Rise and fall time: < .4 microsecond into 1000-ohm load.
- Adjustable pulse repetition rate: 150 Hz to 10 kHz.
- Duty cycle readout: .001 to .01.
- Adjustable overload cut-off.

ADDITIONAL FEATURES, SPECIFICATIONS

- Modifications available, facilitating output voltages to 6.0 KV at average power levels to 100 watts
- Positive or negative, output pulse polarity
- Internal or external triggering (external: + 2.0 V into 75 ohms)
- Input power: 115 VAC, 50/60 Hz @ 300 watts
- Dimensions: 11" x 11" x 10"
- Weight: 45 lbs., approx.

Write for descriptive brochure. Also ask for MCL's new catalog describing "Dynamic Disciplines" products.

MICROWAVE CAVITY Laboratories, Inc.



10 North Beach Avenue
La Grange, Illinois 60525
Phone: (312)—354-4350
Western Union Telex: 25-3608

Producers of quality, high power RF, CW and pulse amplifier systems-subsystems; klystron amplifiers; solid state components; test equipment; accessories.



Slider. Twisted reeds slide along each other, keep contacts clean.

the reeds are twisted so that when they come together, they tend to slide along each other rather than bounce. Called the Tiny Twister, the switch has a bounce time of 70 microseconds.

The device also lives longer than standard reed switches. According to Gordos, during the life of a switch, resistive films grow at the ends of the reeds. The thicker the films become, the hotter the contact point gets when current passes through the switch. Eventually the heat burns out the switch.

The sliding action of the reeds in the new switch wipes off some of the film as it forms, so it takes longer for a thick layer to build up. Gordos rates the unit at 500 million operations, a lifetime that the company says is two and a half times that of reed switches with similar power ratings.

The contacts can pass 10 watts at 150 volts d-c. Initial contact resistance is 100 milliohms, operate time is 500 μ sec, and release time is 50 μ sec.

Priced at \$1.25, the switch has sensitivities between 20 and 70 ampere-turns.

Gordos expects production quantities to be ready by late March. IEEE Booth No. 4K 31.

Gordos Corp., 250 Glenwood Ave., Bloomfield, N.J. 07003 [351]



Cimron's new Word Generator gives you up to 16,320 bits—and you pay only by the word!

The message is simple: this all-IC Word Generator is the last word in pushbutton programming flexibility—but plug-in design insures that you don't have to buy a bit more than you can use. Up to nine plug-ins, each providing a serial word of data from 1 to 16 bits are available—and up to four repeat controls. These can be installed in combination to give you the precise output you want—fast, slow, or very complex. With four repeat controls, this word generator can deliver up to 16,320 bits—repeatable up to

255 times on a bit by bit, single word or continuous basis as selected. Digital period control has a range of 0.2 Hz to 5 MHz, continuously variable. RZ or NRZ modes; 10 ns rise and fall, 10 ns to 100 ms delay and width. By cascading repeat controls, repeats of up to 1,020 times can be achieved. As always, Cimron's *customer concern* gives you what you need at the lowest possible price. For details on Model 3903, write Cimron, Dept. C-129, 1152 Morena, San Diego, California 92110.



LEAR SIEGLER, INC.

CIMRON DIVISION



AIRPAX

MULTIPOLE PROTECTOR with SINGLE TOGGLE ACTUATION

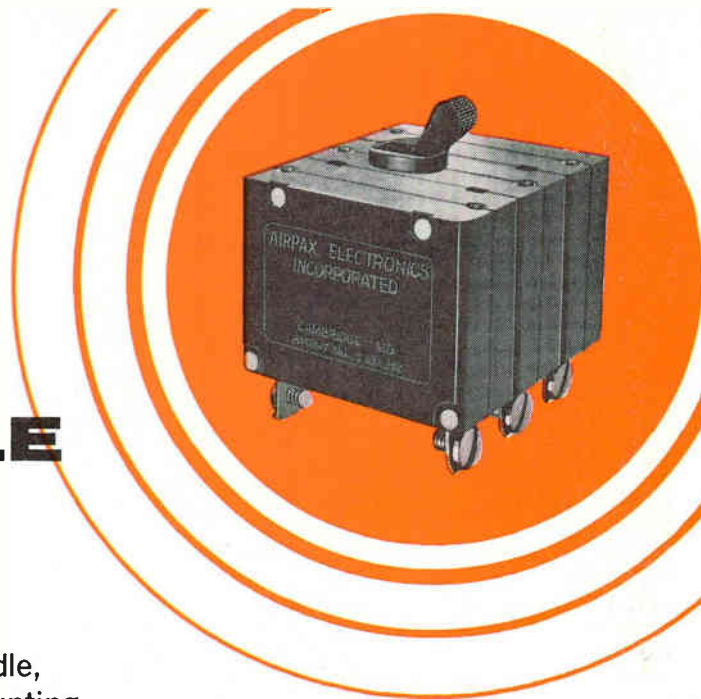

Airpax multipole APG magnetic circuit protectors operate with a single toggle handle, a feature which greatly simplifies panel mounting and provides a lower cost, compact unit with high operating dependability. Internal coupling assures instant action of all protectors should an overload occur in any protected circuit.

FEATURES

- Current ratings from 20 mA to 30A.
- Voltage ratings to 250 volts, 60 and 400 Hz and to 50 volts dc.
- Series, shunt and relay types, auxiliary switch available on series type.
- Choice of trip delays; trip free operation.
- Individual poles need not have identical characteristics.
- Quick connect or machine screw terminals.
- Available with 1, 2 or 3 poles.
- Electromagnetic operation with magnetic-hydraulic delay.

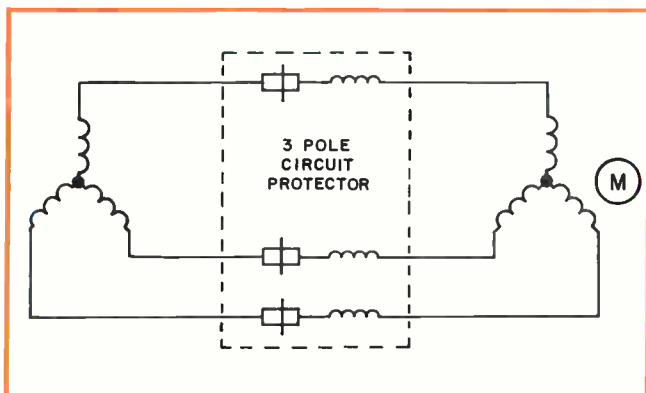

THREE PHASE MOTOR PROTECTION

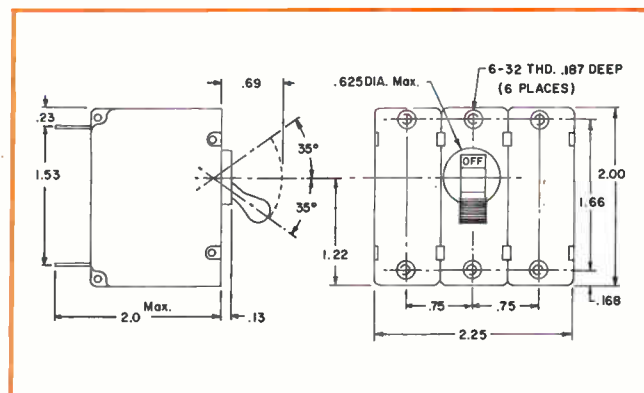

DIMENSIONAL DRAWING

AIRPAX ELECTRONICS

CAMBRIDGE DIVISION, CAMBRIDGE, MARYLAND 21613

PHONE (301) 228-4600

TELEX 8-7715

TWX 710 865-9655

An extra card, and dvm measures low resistance

Extensive use of IC's allows meter to measure 1 ohm to 100 megohms; sealed construction, conductive cooling built in for industrial jobs

A low-ohms measurement on a digital voltmeter is hard to find these days. Most provide the normal 1,000 ohms to 10 megohms full scale in five ranges. Usually the low-ohms extra is worked into an optional package outside the basic dvm. But engineers at the Cimron division of Lear Siegler Inc., through extensive use of integrated circuit logic in their model 6853-

dvm, allow the low-ohms option to be joined to the basic 19- by 5 by-19-inch machine by the addition of a plug-in card.

This range extender gives the model 6853 the ability to measure from 2 ohms full scale to 100,000 ohms full scale. These are true four-wire measurements, adds Robert Goerlitz, the design engineer. An extension of Cimron's recently in-

troduced model 6753, the new instrument is intended for more hostile environments than its predecessor. Instead of a fan cooling the internal components, the 6853 uses conductive cooling in a sealed construction that will make it useful in industrial plants, says Delbert Johnson, chief engineer.

"An oil refinery is a good example," he notes. "There are a lot of



Scope pack model P-TEK improves the performance of oscilloscopes and crt devices. It provides 50 db filtering to 1 Mhz and 0.25% regulation. Scope problems such as pretriggering, jumping off scale, false signals, jitter, and erroneous readings caused by line disturbances are virtually eliminated. Price is \$325. Wanlass Instruments, 1540 E. Edinger Ave., Santa Ana, Calif. [361]



Dual slope volt/multimeters series 9200 feature $\pm 0.01\%$ accuracy. They combine the best features of integration with provision for selectable input filtering to achieve a noise rejection of 80 db at 60 hz. The four-digit series also features automatic ranging and polarity, sampling speed to 6/sec and 20% overranging. Systron-Donner Corp., 888 Galindo St., Concord, Calif. [362]



Reversible 2-channel counter model 106A has a 5 hz to 5 Mhz counting rate for each channel. Versatility is provided by the rapid counting rate, combined with averaging capability as well as measuring sum and differences. The unit measures $4\frac{3}{4} \times 7\frac{1}{2} \times 9$ in., weighs 5.6 lbs. Price is \$895; delivery, 4 weeks. Monsanto Electronic Instruments, 620 Passaic Ave., West Caldwell, N.J. [363]

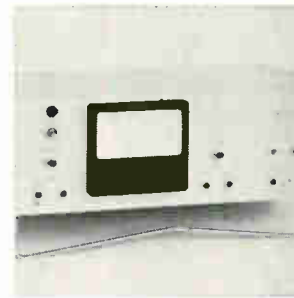

Transmission test set model 9271 checks telephone lines that will be used for digital transmissions or for facsimile work. It also tests and aligns equalizers. Group delay errors and circuit noise effects on the test signal are measured as the reduction in peak-to-average ratio of the received test signal. Wiltron Co., 930 East Meadow Drive, Palo Alto, Calif. 94303. [364]



Exciter-demodulator model 7001, for use with all types of a-c operated electromechanical transducers, provides direct readout. Accuracy is 1.5% on any full-scale range; frequency response is from d-c to 100 hz with 1 khz carrier. Prices range from \$450 to \$650 and delivery is 4 weeks or less. Columbia Research Laboratories Inc., MacDade Blvd. & Bullens Lane, Woodlyn, Pa. [365]



A-c/d-c transfer standard model ATS converts rms to d-c at 0.01% accuracy in 15 seconds. It converts a d-c digital voltmeter, potentiometer, or any d-c measuring system to a true rms measuring system. Its rated accuracy covers the range of 0.25 to 1,000 v and 5 khz to 20 khz. Price is \$3,500; availability, from stock. Singer Co., 915 Pembroke St., Bridgeport, Conn. 06608. [366]



Secondary frequency standard 300R can be used in the receive mode for calibrating oscillators directly without the use of an oscilloscope or other indicating device. Stability is 0.005% (5 hz at 10 khz, 0.01 hz at 200 hz). A switch selects up to 3 standard frequencies. Price is \$169.50; availability, 4 weeks. Pioneer Electronics, 738 Pacific St., San Luis Obispo, Calif. [367]



Digital panel meters 200, 210, 220 and 230 measure d-c voltage, d-c current, a-c voltage and a-c current, respectively, with full-scale display of 1,999 counts. Currents are measured from 1 na to 200 ma, and voltages from 10 μ v to 200 v. Thirty-one different models and 13 options permit a variety of applications. Newport Laboratories Inc., 630 E. Young St., Santa Ana, Calif. [368]

SPERRY GaAs LASER DIODES AND ARRAYS NOW AT NEW LOW PRICES



Increased demand and greater production capacity now permit reductions of up to 60%.

Here is a laser that's the solution to many of today's IR source problems in intrusion, communications, navigation and station keeping, fusing, optical radar, tracking and guidance, braking and docking, and anti-collision. And the Electro-Optics Group of the Sperry Gyroscope Division has made it available for immediate delivery in a full range of diodes and arrays (with compatible modulators), all now available at new low prices. For example, our 10 watt array is now \$20 per unit in quantities of 100.

These units:

- provide peak power up to 2 watts/mil (equivalent to 4Mw/cm²)
- emit into 0.1 steradian angle (f/3 lens collects all radiation)
- radiate at approximately 9160 Å, with a half-power width ± 50 Å
- operate at room temperature
- are small, compact and simple to operate
- are available off the shelf

The line of lasers ranges from a 10 watt peak power diode through an 800 watt array. The triangular-package diodes are available in 10, 14, 18 and 30 watt peak power outputs.

Three arrays are available, providing 200, 400 and 800 watts peak. The 200 watt array has a diameter smaller than a dime and is less than 1/2" high. These uncooled units emit invisible infrared (9160 Å) radiation into a 20° cone angle.

For additional information write to the *Electro-Optics Group, Sperry Gyroscope Division, Great Neck, New York 11020.* (Telephone: 516-574-2292)

SPERRY
GYROSCOPE DIVISION
GREAT NECK, NEW YORK 11020

 **SPERRY RAND**

chemicals present in vapor form that could condense on the circuit boards of an unsealed instrument if a cooling fan carried them into the machine."

Essentially, the model 6853 is a five-digit machine, with a sixth digit to accommodate a 10% over-range. It will measure d-c voltages in four ranges—1.09999, 10.0999, 100.099, and 1,099.99. An optional converter lets it measure a-c volts in the same four ranges.

In addition, a second ohms-measurement option gives two-wire measurements from 1,000 ohms full scale to 100 megohms full scale. Goerlitz says this option in most dvm's extends only from 1,000 ohms to 10 megohms full scale.

Inside reference. The a-c converter option also allows the user to perform a-c to a-c ratio measurements. Johnson says that for this function, the internal voltage reference is replaced with an external reference, and an optional a-c to d-c converter inside serves as the ref-



Wide-ranging. The 6853 measures resistances over a 100-megohm range.

erence for the machine. "Some instruments take a measurement of the input a-c and store it," Johnson explains, "Then they do their ratio, but this doesn't give you a real-time ratio. With a separate a-c to d-c converter for the input and for the reference, the model 6853 does give a real-time ratio."

The 6853 is a tracking logic machine rather than a successive approximation machine, and also offers automatic desensitizing. In a tracking logic instrument, the internal reference is continuously compared to the unknown input signal. The display remains unchanged as long as the input signal stays constant. "When you reach the true absolute null of the output, you get one reading of its absolute value," Goerlitz observes. He adds that in a successive approximation machine, periodic readings of the input signal are taken—possibly as

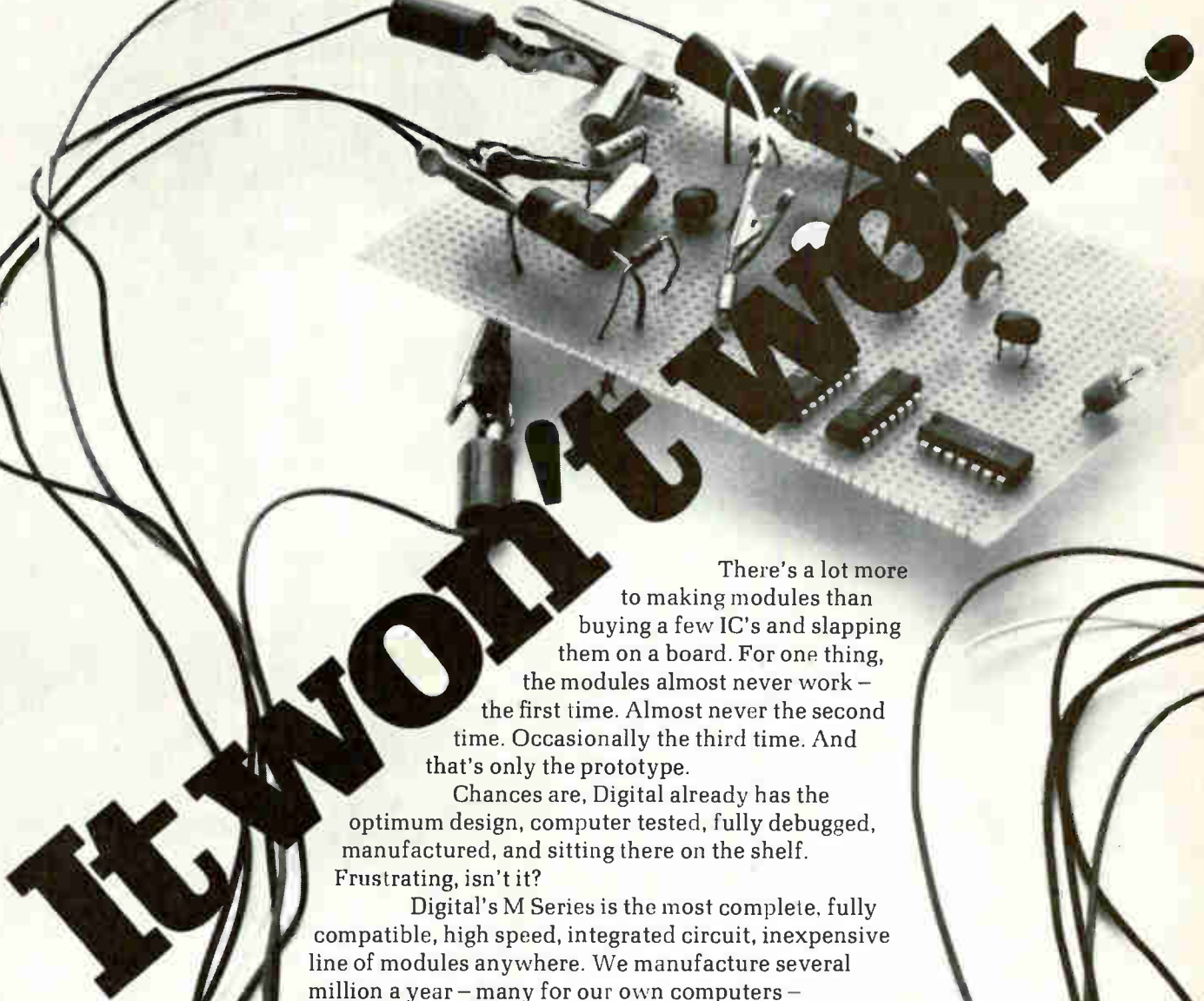

It won't work!

There's a lot more to making modules than buying a few IC's and slapping them on a board. For one thing, the modules almost never work – the first time. Almost never the second time. Occasionally the third time. And that's only the prototype.

Chances are, Digital already has the optimum design, computer tested, fully debugged, manufactured, and sitting there on the shelf. Frustrating, isn't it?

Digital's M Series is the most complete, fully compatible, high speed, integrated circuit, inexpensive line of modules anywhere. We manufacture several million a year – many for our own computers – and know how.

Send for our new Logic Handbook. It tells you what, why, and how to build logic systems from modules. But, alas, not how to build the modules themselves.

DIGITAL EQUIPMENT CORPORATION, Maynard, Massachusetts 01754. Telephone: (617) 897-5111 / Cambridge, Mass. / New Haven / Washington, D.C. / Parsippany, Palisades Park, N.J. / Princeton, N.J. / Rochester, N.Y. / Long Island, N.Y. / Philadelphia / Pittsburgh / Cleveland / Dayton / Huntsville / Cocoa, Fla. / Chicago / Denver / Ann Arbor / Salt Lake City / Houston / Albuquerque / Los Angeles / Palo Alto / Seattle. INTERNATIONAL, Carleton Place and Toronto, Ont. / Montreal, Quebec / Edmonton, Alberta, Canada / Reading and Manchester, England / Paris, France / Munich and Cologne, Germany / Oslo, Norway / Stockholm, Sweden / Sydney and West Perth, Australia.

digital
MODULES • COMPUTERS



... logic designed to cut component count ...

many as five—before a final reading of the signal's absolute value is displayed.

The automatic desensitizing feature results in the instrument going to the next most significant decade if it can't get a null for the input signal of the least significant decade because of noise. This procedure is repeated for each of three decades until either a null is reached, or if the noise is too great, a printout is produced showing how far the instrument had to desensitize and how much noise there is in the system. Goerlitz says desensitizing is important for unattended operations in systems applications, and Johnson believes Cimron's is the only dvm with this feature.

In the d-c ratio mode, the 6853 accommodates 1 to 10 volts, positive or negative, with an option that allows the user to go to ± 100 volts.

The external reference input impedance for the model 6853 is 10,000 megohms. "So for ratios," Goerlitz explains, "we'll have an external reference looking into 10,000 megohms, which limits you to a source impedance on the outside world."

He says a great deal of the logic in the new machine has been designed to reduce component count, which, in turn lessens heat in the instrument and permits conductive cooling instead of convective cooling. For example, all power supplies use operational amplifiers—both monolithic and hybrid integrated-circuit types. In this manner, Goerlitz says, five or six transistors can be replaced with a monolithic op amp, reducing heat-producing current. The basic logic in the instrument is series 930 diode-transistor logic.

Johnson says the closest competitive voltmeter is Dana Laboratories' model 5700, which sells for \$4,100 but doesn't have the low-ohms measurement option or the a-c to a-c ratio measuring capability. Johnson says the price of the model 6853 will be "competitive with the other Cadillacs in the industry."

Cimron division, Lear Siegler Inc., 1152 Morena Blvd., San Diego, Calif. 92110 [369]

Chassis-Trak Slides ... where it really counts!

See you at
the IEEE
Booth 1F02

Hard, cold-rolled steel makes Chassis-Trak Slides extra strong and cadmium-plating gives them protection against corrosion. Poxylube 75 dry-film lubricant continues to give smooth slide operation even after years of use ... no matter what climate, what conditions.

Chassis-Trak Slides are instantly removable and interchangeable for in-

spection or emergency replacement when it really counts. Three basic slide designs—tilt, non-tilt, and tilt-detent—support up to 1,000 lbs., and permit thorough flexibility of use and application.

These are just some of the reasons Chassis-Trak is specified for military applications throughout the world ... where it really counts. Why don't you find out why!



A package for every Major Missile Project from ...
525 South Webster Ave., Indianapolis, Indiana

The Standard of Excellence



Bracelets by J. E. Caldwell Co., Philadelphia—\$13,200

Amplifiers by Clifton

Clifton care and know-how combine to make a line of amplifiers which offer you superb quality and reliability—and at a price you can afford!

In Clifton amplifiers, all soldering and welding meet or exceed the requirements of NASA NPC 200-4 and SP-5011. All amplifier components meet the

requirements of MIL-S-19500. Rigid quality control in-line and final inspection assure top workmanship. Extensive temperature testing is performed to verify end product performance. In addition, our over all quality program meets MIL-Q-9858.

The result is predictable! Clifton servo amps, booster re-

solver amps and electronic modules make your system look good!

Call your Local Clifton Sales Office or 215 622-1000 for prompt service.

Why not buy the best?

CLIFTON 
DIVISION OF LITTON INDUSTRIES

To turn off rejects of 3rd generation circuits:

Turn on Barnstead's New Micro-Cleaner

There's no better way to make micro-circuits come clean!

Barnstead's new microelectronic cleaning station provides an ultra-pure final rinse — in a totally clean environment — at minimum cost.

Write for Bulletin 211, describing this 3rd generation cleaning station.



225 Rivermoor St.
Boston, Massachusetts 02132



Positive-pressure hood keeps work area free of airborne contaminants, with absolute air filter; quiet, spark-free blower. Meets or exceeds applicable MIL SPECS.

Five hot, cascading pure water rinses in tinlined monel tanks do a thorough cleaning job. Final rinse, measuring 18 megohms/cm @ 25°C and free of organics, gases, biologicals — is much purer than demineralized water.

Purity meter checks quality of rinse water, both "upstream" and "downstream" from final rinse.

To make a few gallons do the work of thousands, water is continuously recirculated, repurified. System includes . . .

Demineralizer. Automatic still. Organic removal bed. 0.1 micron particle filter. Sump, protected by ultraviolet unit, Ventgard® air filter. Regenerative heat exchanger. Cuts electrical load by more than 50%

New instruments

Holdout joins digital crowd

Picoammeter, at \$1,000, has three-digit display with 100% over-ranging

That old analog gang is almost gone. Now, one of the last holdouts has joined the digital crowd. Keithley Instruments Inc., known for products that measure low values with a high accuracy, is introducing its first digital meter, the 440 picoammeter.

This \$1,000 instrument has a three-digit display with 100% over-ranging. Its nine scales go from 10 picoamperes to 10 milliamperes full-scale. Accuracy is 0.5% on the



Two slopes. The 440's analog-to-digital converter employs a dual-slope integrating circuit.

lower scales and 0.2% on the higher ones. The display rate is adjustable between 24 readings per second and two per minute, and the long-term stability is 0.5% of full scale per week.

According to the manufacturer, the 440 brings digital convenience to engineers measuring the leakage currents of semiconductor devices and to scientists measuring the low-level outputs of such analytical devices as spectrometers, chromatographs, ion chambers, and beta gages.

The 440's input is an MOS field effect transistor, which keeps the offset current under 0.1 picoamp. Subsequent stages use bipolars.

The 440 draws 40 watts, measures 5¼ by 19 by 10 inches, and weighs 12 pounds. IEEE Booth No. 2H19.

Keithley Instruments Inc., 28775 Aurora Rd., Cleveland 44139 [370]

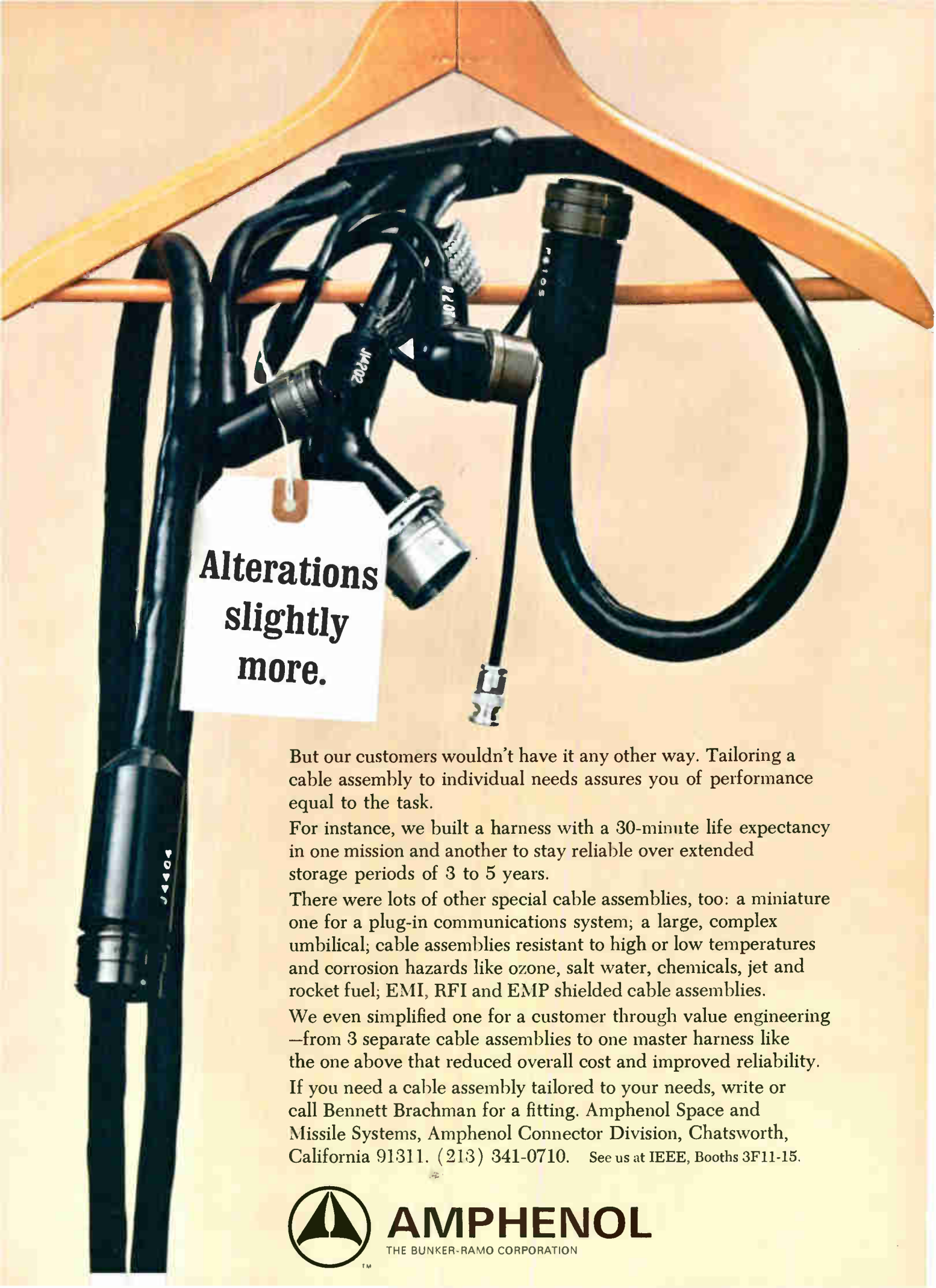

**Alterations
slightly
more.**

But our customers wouldn't have it any other way. Tailoring a cable assembly to individual needs assures you of performance equal to the task.

For instance, we built a harness with a 30-minute life expectancy in one mission and another to stay reliable over extended storage periods of 3 to 5 years.

There were lots of other special cable assemblies, too: a miniature one for a plug-in communications system; a large, complex umbilical; cable assemblies resistant to high or low temperatures and corrosion hazards like ozone, salt water, chemicals, jet and rocket fuel; EMI, RFI and EMP shielded cable assemblies.

We even simplified one for a customer through value engineering—from 3 separate cable assemblies to one master harness like the one above that reduced overall cost and improved reliability.

If you need a cable assembly tailored to your needs, write or call Bennett Brachman for a fitting. Amphenol Space and Missile Systems, Amphenol Connector Division, Chatsworth, California 91311. (213) 341-0710. See us at IEEE, Booths 3F11-15.



AMPHENOL
THE BUNKER-RAMO CORPORATION

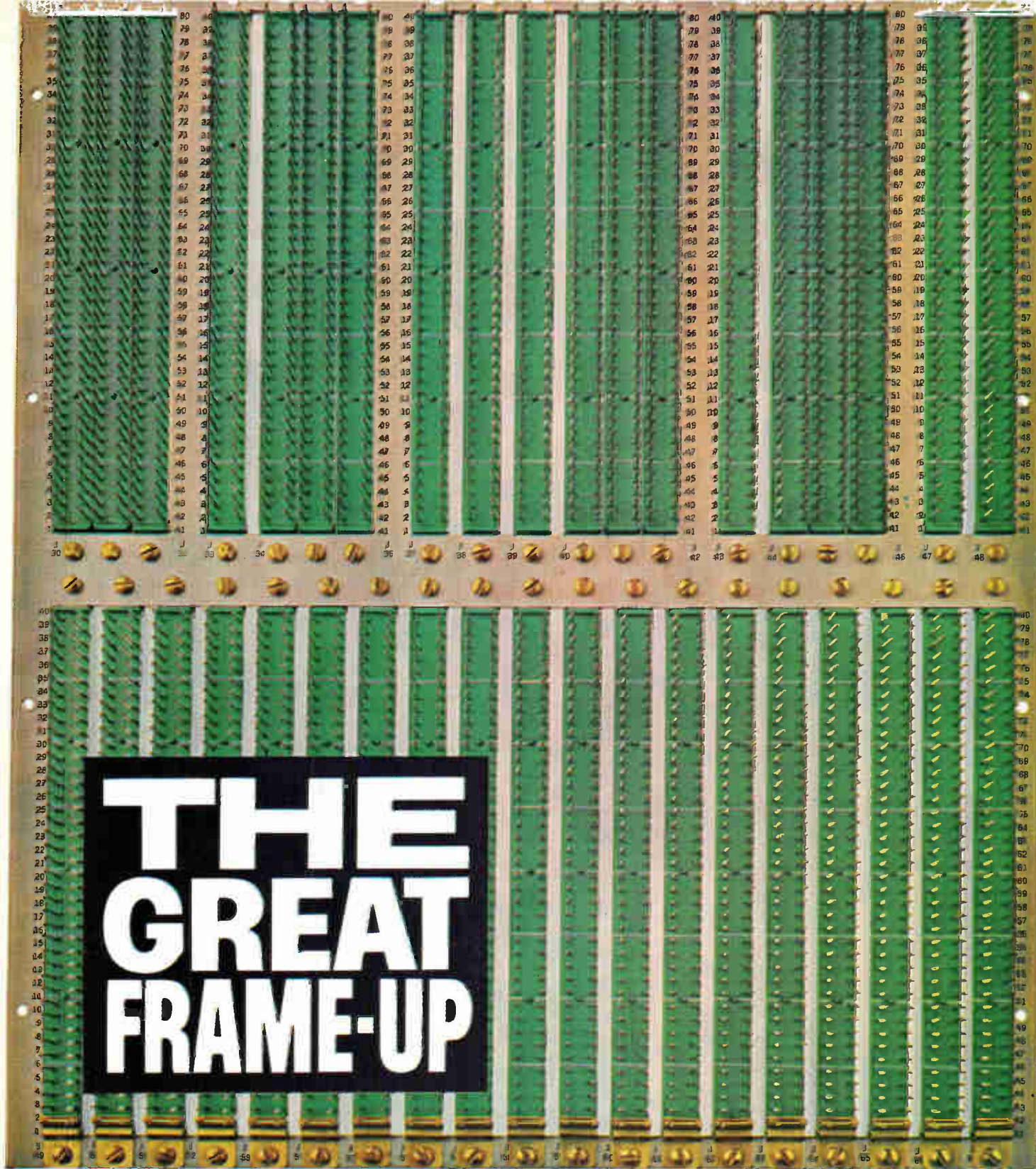

We call it AccurFrame. And it can save you more than 1¢ per contact.

Our new AccurFrame takes the fuss and bother out of wire-wrapping. It's easy, fast and error-free. And very simple to use.

Here's why. Our HW Series Wire-Wrap* connectors have two polarized alignment holes in the card insertion side of the block. These fit over accurately positioned pins on the alignment tool. There's no chance of a connector being placed wrong-end-to.

With connectors in perfect position, our frame is placed over the assembly; connectors are quickly attached with machine screws. The frame and connectors lift off — ready for automatic wire-wrapping.

Winchester's long experience has made the whole thing so sure, simple and *fast* that most users are saving 1¢ per contact over other methods. And those pennies add up.

You'll like our Wire-Wrap connectors, too. They're available in sizes ranging from 22 to 50 contact positions. Designed for automatic equipment, high-strip force retention, bifurcated spring contacts for superior interfacing. We integral-mold them in diallyl phthalate SDG-F. Contacts are easily removed. Retained by a 90° twist.

Get all the profitable facts about the Great Frame-Up from your District Sales Office. Or from Winchester Electronics, Main Street & Hillside Avenue, Oakville, Connecticut 06779.

WINCHESTER ELECTRONICS 
LITTON INDUSTRIES

*Trademark-Gardner Denver Company

Getting out of the gate, fast

Hybrid FET switch turns on in only 50 nanoseconds and can be driven directly by DTL and TTL circuits

Vital parameters of a semiconductor switch include its turn-on and turn-off times. Crystalonics has introduced a hybrid field effect transistor switch that, according to Joel Cohen, director of engineering, "is faster by about 30 times than anything else around. Other gates switch in about 1.5 microsecond, but ours takes only 50 nanoseconds to turn on."

The switch, designed for analog gating functions in multiplexers and store-and-hold circuits, is available in three versions. The CAG10 has a maximum on resistance of 30 ohms and is rated at ± 5 volts; the CAG10A is also rated at ± 5 volts but has a maximum on resistance of 6 ohms, and the CAG10B has a maximum on resistance of 50 ohms and is rated for 10-volt operation.

The gates are designed to be driven directly from DTL or TTL.

Thin-film techniques are used in the hybrid integrated circuit, and all the semiconductor chips are military grade. To ensure reliable operation over the full military temperature range, all the active semiconductors have been preconditioned.

"If you take devices off the

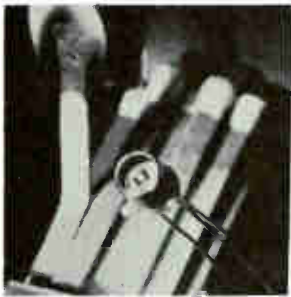
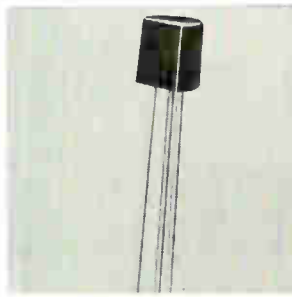
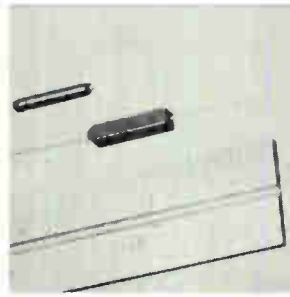

Photo-SCR'S series RTPC0501 are for operation over the military temperature range (-55° to $+125^{\circ}$ C). They feature light sensitivity of 20 footcandles typical without need for a focusing lens. Five types are offered with peak off-state voltages ranging from 15 to 200 v. All handle up to 300 ma of d-c current. Transistron Electronic Corp., 168 Albion St., Wakefield, Mass. [436]



Epoxy encapsulated transistors designated GET'S come in a package with T0-18 lead configuration. They are for use in switching and amplifier applications and are of the npn and pnp types. Features include these reliability characteristics: 85° C at 85% relative humidity; thermal shock of -65° to $+150^{\circ}$ C. General Electric Co., 1 River Road, Schenectady, N.Y. 12305. [437]



High-voltage, fast recovery, silicon rectifiers series FR are hermetically sealed devices that have a recovery time of 300 nsec and are rated at 3 ma continuous current at voltages from 7,500 to 50,000 v. They are for voltage multiplier assemblies, crt and electrostatic power supply use. Atlantic Semiconductor, Div. of Aerological Research, Mattison Ave., Asbury Park, N.J. 07712. [438]



Gallium arsenide varactor diodes offer a 400 GHz cut-off. Operating at all frequencies from uhf through Ku band, the units provide high gain bandwidth and low noise figures. Minimum reverse breakdown voltage is 6 v. Maximum power dissipation is 250 mw. Operating temperature is $+10^{\circ}$ K to $+175^{\circ}$ C. Varian Solid State Operation, Salem Road, Beverly, Mass. 01915. [439]

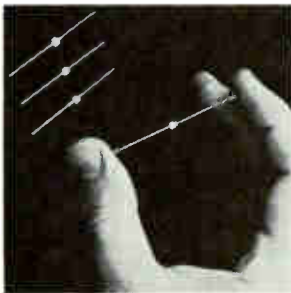

Microminiature, 3-amp, fast recovery rectifiers, designated types 1N5185, -6, -7, and -8, are available in peak reverse working voltages of 50, 100, 200, and 400 v. Features include reverse current of less than 5μ a and recovery time of less than 300 nsec. Price is \$2.50 each at the 999 piece order level. Centralab Semiconductor, 4501 North Arden Dr., El Monte, Calif. 91734. [440]



Optically coupled isolators XL102 and 103 can replace low-power relays and transformers. They provide electrical isolation of ± 100 v, internal resistance greater than 10^{12} ohms, and a capacitance of 4 pf, all enhancing signal-to-noise performance. Typical over-all current gains are 0.6 for the 102 and 1.4 for the 103. Texas Instruments, P.O. Box 5012, Dallas 75222. [441]

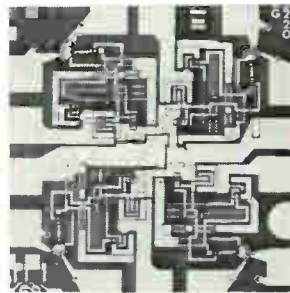

Transistor-transistor-logic IC's known as RAYIII come in 19 basic circuit types including NAND gates, AND gates, AND-OR-INVERT gates, a hex inverter, and single and dual flip-flops. Maximum propagation delay for NAND gates is 5.5 nsec and power dissipation is typically 22 mw per gate. Logic levels are typically 3.5 and 0.3 v. Raytheon Co., 350 Ellis St., Mtn. View, Calif. [442]



Silicon Schottky barrier photo-diodes models QD80, -80A, -20, and -20A are for near infrared applications. Key features include: highest detectivity at 0.85μ of 9×10^{12} cm hz $^{1/2}$ /w; fast rise-times of 5×10^{-9} sec; active diameters up to 10 mm; dark currents as low as 5×10^{-7} amps. Prices range from \$30 to \$95. Nuclear Diodes Inc., P.O. Box 135, Prairie View, Ill. 60069. [443]

**DEMODULATES
AMPLIFIES
RECEIVES**



**AM, FM, SSB, CW, MCW, FSK
Signals From 1 to 1600 kHz**

W-J's new Type DMS-105 Demodulator tunes from 1 kHz to 600 kHz and 540 kHz to 1600 kHz in two bands. Four IF bandwidths are available for reception of upper or lower sideband signals: 2.5, 3.5, 4 and 8 kHz. For other operating modes, bandwidths of 150 Hz, 1, 5, 7, 8 and 16 kHz are provided.

A digital automatic frequency control circuit provides high stability by locking the tuner's local oscillator to the electronic counter circuits. In addition to providing high local oscillator stability, the DAFC circuit acts as a frequency synthesizer, providing the equivalent of 160,000 crystal-controlled frequencies. The frequency to which the DMS-105 is tuned is shown on a 5-digit Nixie tube display reading to the nearest 100 Hz. A decimal shift mode displays the tuned frequency to the nearest 10 Hz. The DMS-105 thus can be locked to a frequency whether or not a signal is present. The unit is standard 19-inch rack size, 5.25 inches high.

CEI DIVISION



WATKINS-JOHNSON

6006 Executive Boulevard, Washington Science Center
Rockville, Maryland 20852 (301) 881-3300

See us at our applications engineering suite at the Barbizon Plaza during IEEE week.

World's largest selection of receiving equipment for surveillance, direction finding and countermeasures.

**... the integrated circuit
is reliability stressed ...**

slice," says Cohen, "and plunk them into a hybrid circuit, they've never been burned in, and they won't be because the hybrid circuit has been derated, so in the end there's no stress on the components at all. But we use chips that are premounted, tested, and burned in—just as in a discrete-component circuit—so the IC is reliability stressed. As far as I know, we're the only ones doing this."

There are monolithic devices that perform the same function, but they're metal oxide semiconductor units, usually with three or four gates in a package. The problem with these, according to Cohen, is that "they have an on

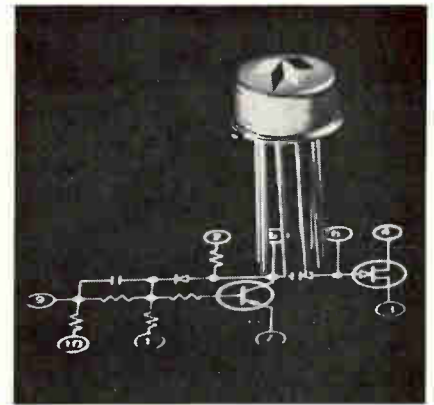

Quick switch. Hybrid FET gate turns on in only 50 nanoseconds.

resistance of several hundred ohms and they're slow, about 50 times slower." The density is roughly as good as that of a monolithic device. The Crystalonics units come in low-profile TO-5 cans.

The basic circuit for the FET gate was designed by Frank Slater of Sanders Associates in Nashua, N.H., and was modified for hybrid construction by Crystalonics. This is becoming a more common experience with IC manufacturers—a customer has a circuit that he wants integrated, and it later becomes an off-the-shelf item.

The unit price of the switch in quantities up to 99 is \$42; in quantities up to 999 they're \$28 apiece.

Crystalonics, a Teledyne Division, 147 Sherman St., Cambridge, Mass 02139 [444]

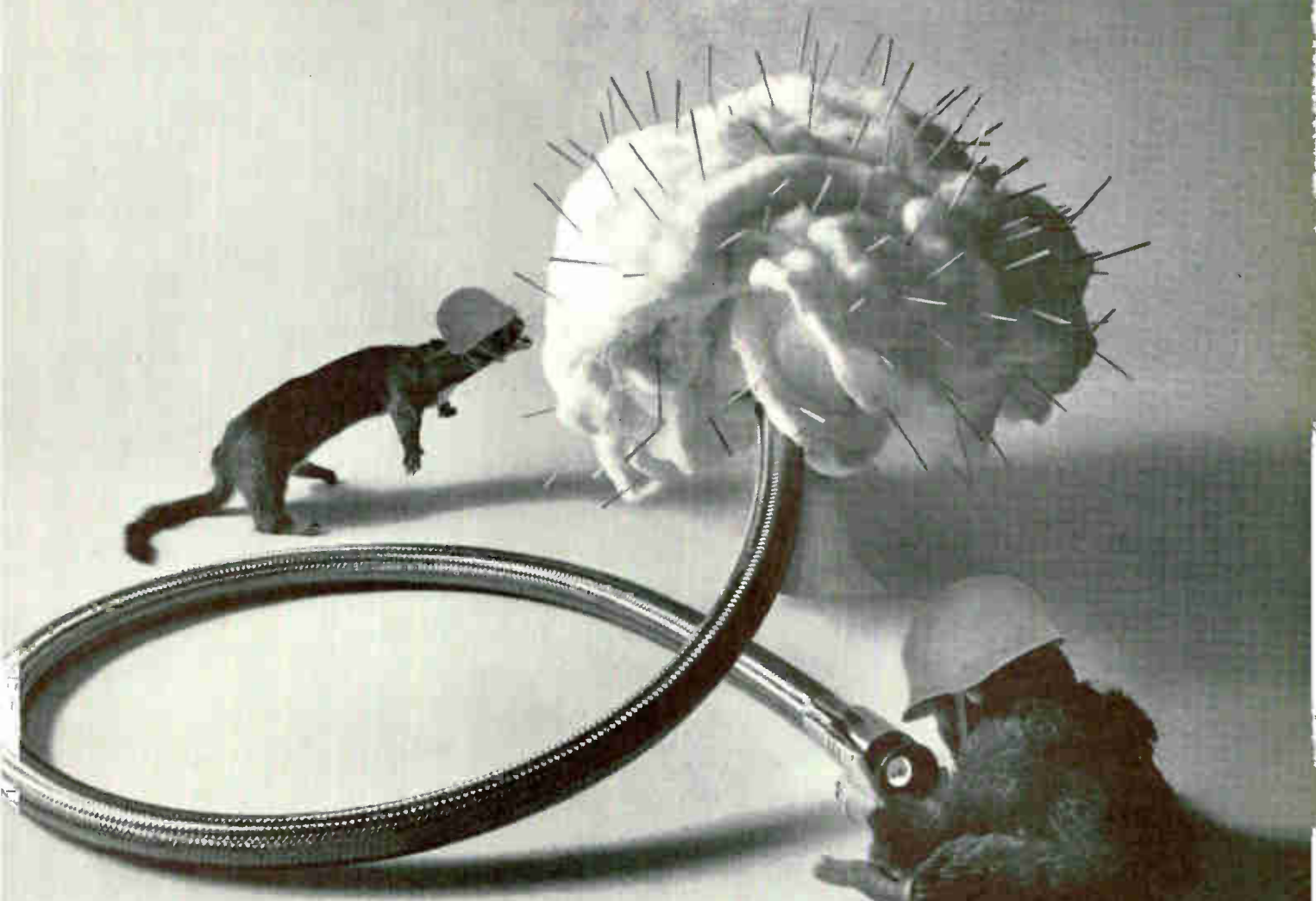

What does the monkey of today use to track the elusive weasel all around the prickly mulberry bush?

A flexible Bendix imagescope. An image transfer device that monitors remote events and inspects otherwise inaccessible areas. It doesn't beat around the bush. But beats into it . . . and under it . . . and over it. In fact, the Imagescope can bend, twist, and "weasel" its way into many hard-to-see places. And because it can be optically coupled to an image intensifier device, it can bring a picture right into the cockpit of a tank, or a helicopter, or a fighter plane. This rugged, but flexible, device can carry a picture of what's there to any lengths because it consists of a coherent bundle of glass fibers. The Imagescope breaks up an image into thousands of minute parts, conducts each separately within the individual fiber, and then reassembles them at the other end. There you can attach it to any photo-optical system: Vidicon or still camera. The Bendix Imagescope has so many uses that it can "pop" into any mulberry bush to identify any weasel.

For more information about the Bendix weasel-tracking Imagescope, call or write: Mosaic Fabrications Division, The Bendix Corporation, Galileo Park, Sturbridge, Mass. 01518 • (617) 347-9191

Bendix  **Electronics**

CIRCLE 191 ON READER SERVICE CARD

**ETCH YOUR OWN
P C BOARDS
AUTOMATICALLY**
(in less than 5 minutes)

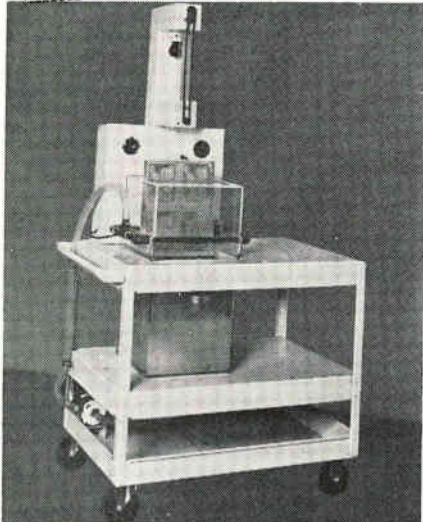

Model No. 201 (illus.), etches two 11' x 14" one-sided boards or one 11" x 14" two-sided board: **\$795**
Pat. applied for

from this →
to 11" x 14"
Shown Actual Size

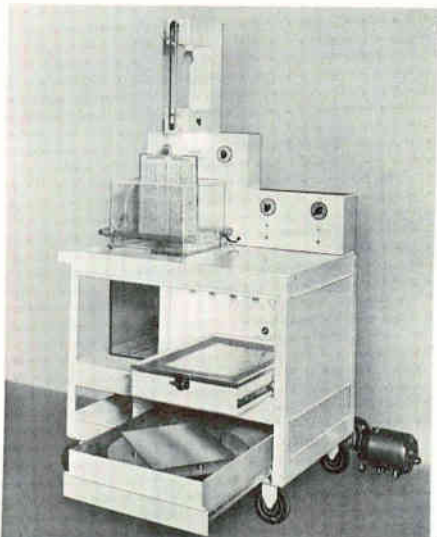

Model No. 205 (illus.) Portable Photo-Etch Lab on Wheels **\$1495**
Pat. applied for

Includes etcher, whirler, infra-red drying oven, vacuum frame and pump, ultra-violet exposure—all assembled into 24"x36" mobile cart. Complete photo processing instructions. \$1495

Model No. 204 Photo-Lab without Etcher (not shown) \$750

CYCLO-TRONICS, INC.

3858 N. CICERO — CHICAGO, ILL. 60641
TELEPHONE: (312)-282-6141

Visit us at IEEE Booth No. 1G01

New semiconductors

Core drivers are IC-compatible

Six multiple transistors feature fast switching, high current, low capacitance

Many functions can't be handled properly by integrated circuits, and one of them is driving a core memory. But Motorola Semiconductor Products has introduced six multiple core-driver transistors specifically designed to work with IC's. And, to make automatic assembly easier, the multiple transistors are also compatible with IC's in size and construction. The compactness not only saves space on printed-circuit boards, but also allows shorter leads to be used, and this is especially important in fast high-current core drivers. The transistors can also be used as r-f drivers at up to 200 megahertz.

The devices are multiple versions of the 2N3762 and 2N3467 high-speed, high-current pnp switches. Like the single transistors, the new devices have a high current capability, low saturation voltage, a capacitance of only about 11 picofarads, and fast switching—about 22 nanoseconds turn-on and 46 nsec turn-off at rated current. They have a voltage rating of 40 volts.

Half an amp. The MD3467 dual transistor is packaged in a TO-5 can; the MD3467F dual transistor, in a six-pin ceramic flatpack; and the MQ3467 quad, in a standard 14-pin ceramic flatpack; all are rated at 0.5 amp. The TO-5-can dissipates a total of 600 milliwatts at an ambient temperature of 25°C. The small flatpack is rated at 350 mw total, and the 14-pin flatpacks have a rating of 500 mw. These three units are pnp types; the other three in the series are npn complementary transistors.

Prices range from \$7.50 to \$31.75 in quantities of 100 to 1,000, depending on the package.

Motorola Semiconductor Products Inc.,
Box 20924, Phoenix, Ariz. 85036 [445]

The Material
of Unlimited Uses...

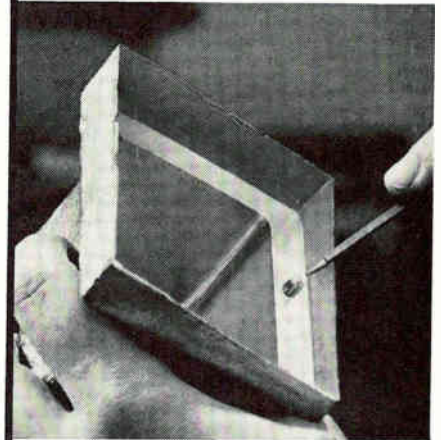

INSTANT DIP-A-MOLD

In seconds, you can make perfect molds, like this one, for potting any encapsulation, and make them economically, with low-melting CERRO® Alloys. Just dip the master in molten alloy. A thin coating of alloy clings to the pattern. Withdraw the pattern, and you have a perfect high fidelity mold. When the encapsulating plastic cures, simply remove the CERRO Alloy. Use it over and over again, almost without limit.

This particular alloy—CERROTRU®—does not shrink, slips easily from the pattern without parting or contaminating compounds or coatings. Because of its low melting point, it is safe and easy to handle.

You can reproduce such unusual details as positioning lugs for transformer cases, as shown above, without the use of cores, inserts or secondary operations.

Instant molding is just one of the many uses for CERRO Alloys. To find out more, contact Cerro Copper & Brass Co., Cerro Alloy Dept., Stamford, Conn. 06907... R. S. Darnell (203) 327-0550. In Europe, contact Mining & Chemical Products Ltd., Alperton, Wembley, Middlesex, England.

CERRO®

The Single Source For Reliable Protection For Every Type Of Electronic And Electrical Circuit And Device

BUSS QUALITY

SMALL DIMENSION FUSES AND FUSEHOLDERS

Include dual-element "slow-blowing" fuses, single-element "quick-acting" fuses and signal or visual indicating type fuses . . . in sizes from 1/500 amp. up . . . PLUS: a companion line of fuseholders.

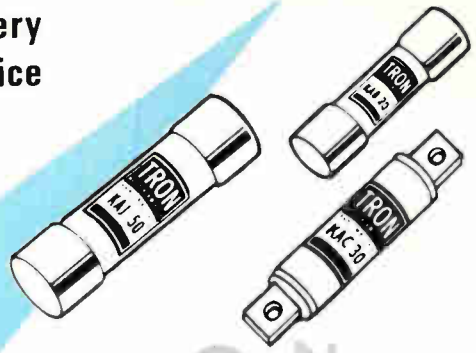

TRON Rectifier Fuses
For the Safe Protection of Solid State Devices
Provide extremely fast opening on overload and fault currents, with a high degree of restriction of let-thru current. Many types and sizes available. Ampere ratings from 1/2 to 1000 in voltages up to 1500.

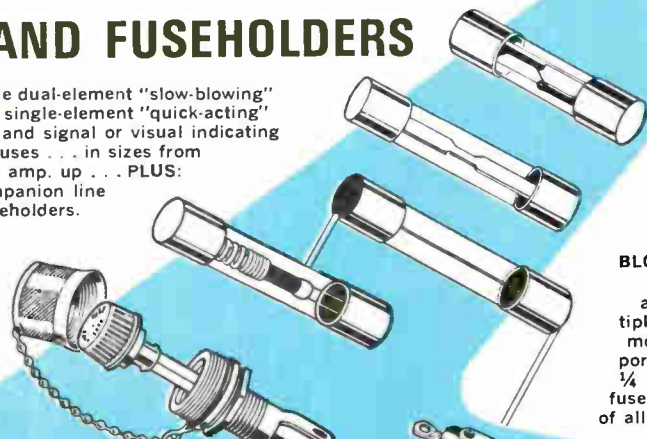

BLOCKS FOR BUSS FUSES
All types available for every application. Single pole, multiple pole, small base, full base, molded base, laminated base, porcelain base for fuses from 1/4 x 5/8 inches up. Also signal fuse blocks and special blocks of all types.

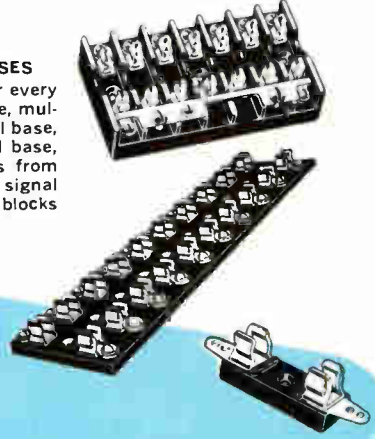

HMR RF shielded fuseholder for 1/4 x 1/4 in. fuses.

HKA lamp-indicating, signal activating fuseholder.

HKP panel mounted fuseholder for 1/4 x 1/4 in. fuses.

THE COMPLETE LINE OF SIGNAL-INDICATING ALARM-ACTIVATING FUSES

For use on computers, microwave units, communication equipment, all electronic circuitry.



BUSS GLD-1/4 x 1/4 in. Visual-Indicating, Alarm-Activating.

BUSS GBA-1/4 x 1/4 in. Visual-Indicating.



BUSS Grasshopper Fuse, Visual-Indicating, Alarm-Activating.



BUSS MIN-13/32 x 1 1/2 in. Visual-Indicating.

BUSS MIC-13/32 x 1 1/2 in. Visual-Indicating, Alarm-Activating.



BUSS ACH Aircraft Limiter, Visual-Indicating.



FNA FUSETRON Fuse 13 32 x 1 1/2 in. slow-blowing, Visual-Indicating, Alarm-Activating. (Also useful for protection of small motors, solenoids, transformers in machine tool industry.)

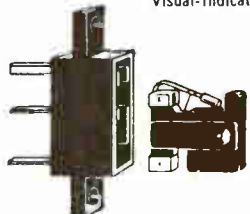

BUSS GMT and HLT holder, Visual-Indicating, Alarm-Activating.

SUB-MINIATURE FUSES

Ideal for space tight applications, light weight, vibration and shock resistant. For use as part of miniaturized integrated circuit, large multi-circuit electronic systems, computers, printed circuit boards, all electronic circuitry.

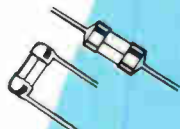

TRON Sub-Miniature Pigtail Fuses—Body size only .145 x .300 inches. Glass tube construction permits visual inspection of element. Hermetically sealed. Twenty-three ampere sizes from 1/100 thru 15.

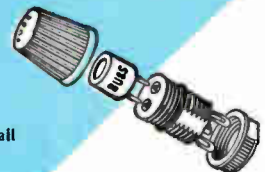

BUSS Sub-Miniature GMW Fuse and HWA Fuseholder. Fuse size only .270 x .250 inches. Fuse has window for visual inspection of element. Fuse may be used with or without holder. 1/200 to 5 amp. Fuses and holders meet Military Specifications.

FOR MORE INFORMATION ON THE COMPLETE BUSS LINE, WRITE FOR BUSS FORM SFB
BUSSMANN MFG. DIVISION, McGraw-Edison Co., St. Louis, Missouri 63107

SUPPLIED THE ECONOMICAL WAY . . . THRU DISTRIBUTORS

BUSS QUALITY

FUSES

FOR FUSES AND FUSEHOLDERS OF UNQUESTIONED HIGH QUALITY FOR EVERY PROTECTION NEED INSIST ON . . .

"SEE US AT IEEE SHOW BOOTH 3B24"

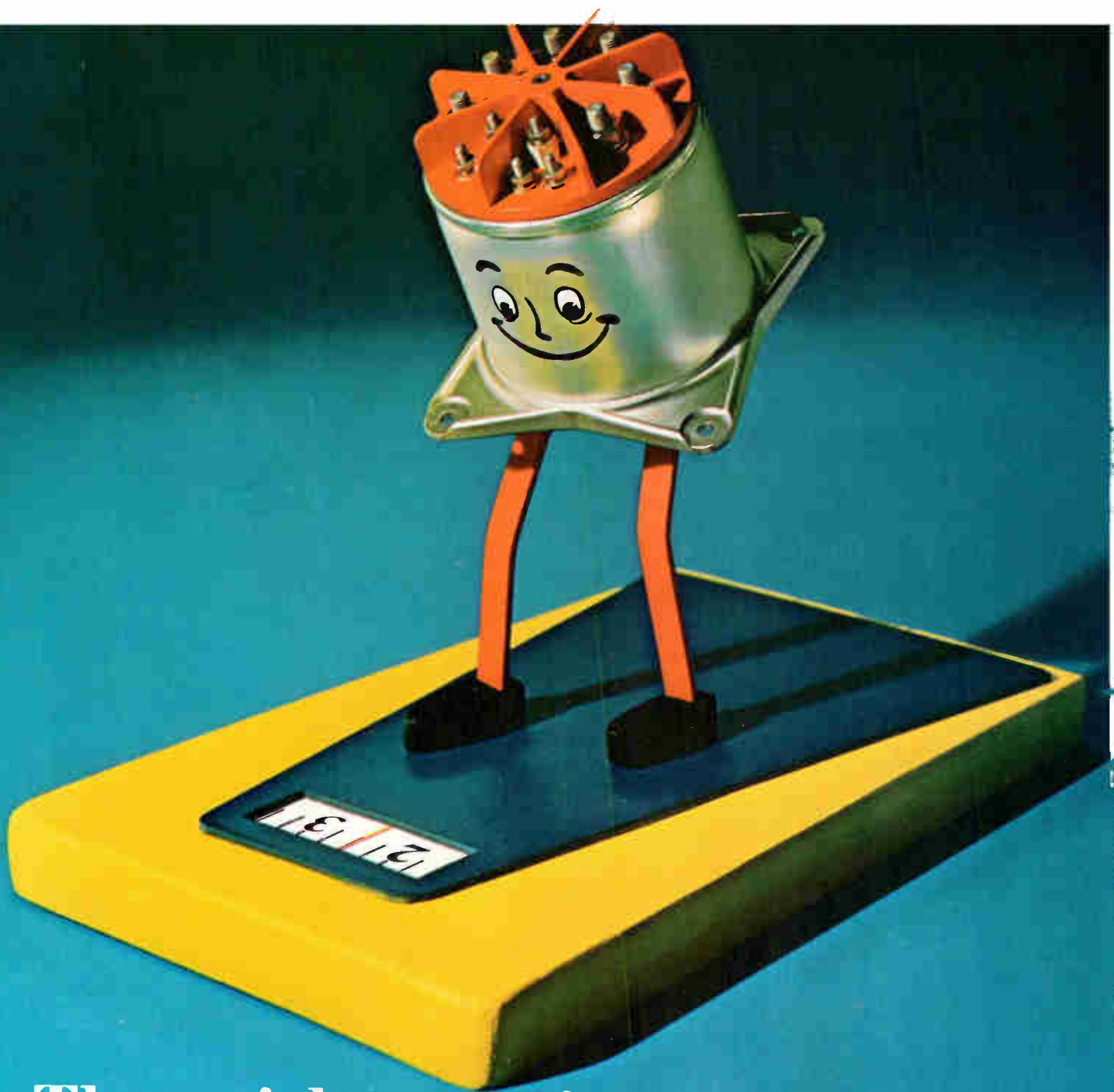

The weight-conscious contactor...

(for heavy-amp applications)

Twenty-two percent lighter for 150 amp applications than any existing 100 amp contactor: 3 lb. max. to be exact. That's right, the new Guardian 150 amp Series 4400 Contactor is 22% lighter and 16% smaller in volume than any existing 100 amp contactor.

Unique? You bet. And there's more. The 4400's design features internal as well as external phase isolation. It's unique—again—in offering a hermetically-sealed coil to prevent contact contamination, plus a hermetically-sealed unit outer cover.

Available 3 PSTNO normally open with 10 amp (*not* 5 amp) auxiliary contacts, the 4400 is designed for 240/416 VAC, 400 Hz systems of the future as well as 115/200 VAC, 400 Hz and 28/30 VDC systems of today.

A new 75 amp contactor, the Series 4500, offers the same basic design advances. For complete specifications and test reports on these two new weight-conscious contactors that let you do more with less, write for Bulletin D3.



**GUARDIAN[®]
ELECTRIC**

MANUFACTURING COMPANY 1550 W. Carroll Ave., Chicago, Illinois 60607

Circle 194 on reader service card

R-f connector extends upper frequency range

Removing plating from right-angled connector improves electrical performance in gigahertz region

By bending the center conductor and its insulation, a right angle can be formed in conventional r-f connectors. To do so decreases the impedance at the bend and creates a discontinuity in the line. To compensate, the Sealectro Corp. surrounds the single center conductor with a cylindrical insulator. The insulator is coated with a metallic plating or conductive epoxy to

provide a continuous outer current path.

Tests show this construction increases the usable upper frequency range of type N and similar connectors while retaining relatively uniform and low voltage standing-wave ratio characteristics at frequencies up to 12.4 gigahertz. Until recently, angular connectors had inferior vswr characteristics over a

limited frequency range. With the new design, the limitation of the right-angled connector is overcome.

The initial design of the improved right-angled connector consisted of a single contact surrounded by a TFE dielectric that formed a 90° bend and terminated in two mating faces. The outer diameter of the dielectric was 0.306



Standing wave detector type 2219K measures vswr and angle of reflection coefficient over a frequency range of 10 to 2,300 MHz at a sensitivity of 5 mw. It eliminates heavy slotted sections and features adapters to all standard coaxial transmission lines. Detector components are now available in a kit form. PRD Electronics Inc., 1200 Prospect Ave., Westbury, N.Y. [401]



Ultraminiature balanced mixer model MI8010-5 covers a frequency range of 8.4 to 9.7 Ghz. Noise figure is 7.5 db max. Vswr is 1.75 max. Local oscillator-signal isolation is 15 db minimum. Package measures 1/2 x 3/4 x 1/2 inch. Price in 1-9 lots is \$250 each. Delivery of prototypes is 2-3 weeks. G-L Microwave Corp., 825 Black Oak Ridge Rd., Wayne, N.J. 07470. [402]



Bulk effect microwave oscillator SX-1 is a Gunn effect oscillator that can deliver more than 25 mw at any preset frequency in the 8 to 12.4 Ghz range. It is frequency and power stable over a temperature range of -30° to +71°C. The unit can be mechanically tuned ±500 Mhz from center frequency. Melabs, 3300 Hillview Ave., Stanford Industrial Park, Palo Alto, Calif. [403]



Microwave spectrum analyzer model SPA-100 offers full 100 Mhz dispersion throughout its 10 Mhz to 40 Ghz range. It has built-in i-f marker for self-calibration, and provides calibrated 60-db on-screen log display with 1 Mhz bandwidth for maximum dynamic range. Singer Co., 915 Pembroke St., Bridgeport, Conn. [404]



Coaxial, thin-film thermoelectric power heads models N420C, -21C, -22C and -23 operate from 2 Mhz to 12.4 Ghz. Vswr is a maximum of 1.5 over the entire operating range. They can be used with all the manufacturer's power meters. Each meter is capable of direct-reading power measurements from 30 nw to 3 w. General Microwave Corp., 155 Marine St., Farmingdale, N.Y. [405]



Rotary attenuator RA-100 covers 0 to 100 db in 10-db steps. It covers the frequency range of d-c to 1.2 Ghz with a 1.2:1 maximum vswr at 1 Ghz, with impedance of 50 ohms. The unit measures 1 7/8 x 2 1/8 in. Connectors available include the BNC, TNC, type N and STM. Price is \$140 each with delivery in 2 weeks. Texscan Corp., 2446 Shadeland Ave., Indianapolis 46219. [406]



Thirty miniature diode switches, which occupy less than 3/4 cu. in. (excluding connectors) and operate over frequency ranges from 50 to 12,000 Mhz, are available. They provide switching speeds of 10 nsec from 2 to 12 Ghz, with power handling capability of 100 w peak and 1 w average. Typical dimensions are 1 3/4 x 1 3/4 x 1/2 in. Kevlin Mfg. Co., 26 Conn St., Woburn, Mass. 01801. [407]

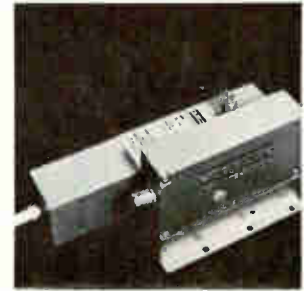

Phase-locked fundamental oscillator MO (L)-100XE is for use in tropospheric scatter or line-of-sight radio relay use. It operates at 685 to 1,055 Mhz with a minimum power out of 80 mw over a temperature range of -30 to +60° C. F-m noise is 6 hz in a 3 khz bandwidth. Price (1-9) is \$535 each. Fairchild Microwave Products, 2513 Charleston Rd., Mtn. View, Calif. [408]

more
display channels
per dollar

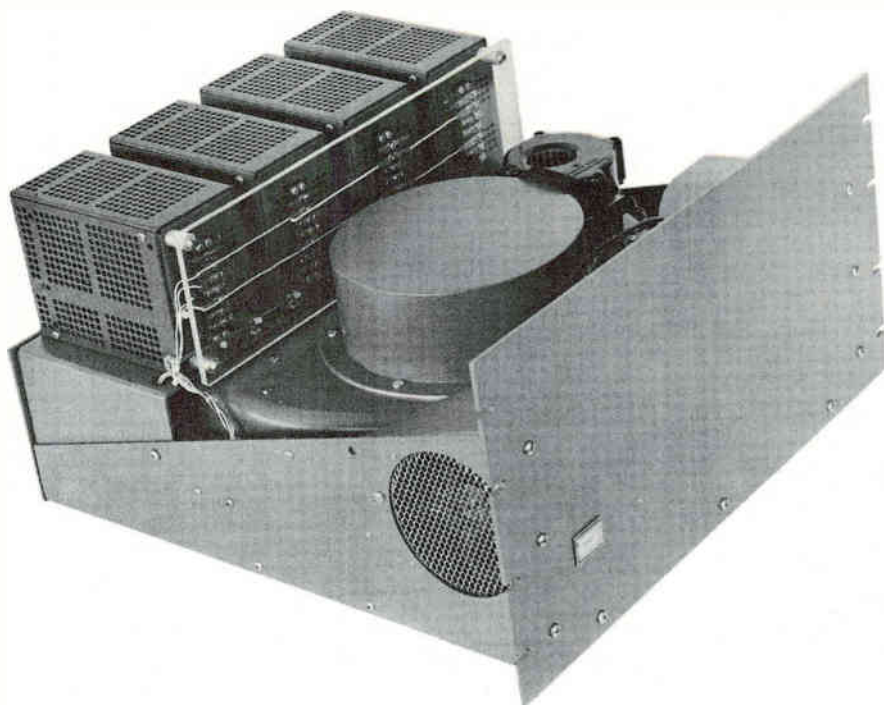

Data Disc's new digital/video disc memory opens a whole new world of display possibilities. Think about how you can use up to 72 completely independent tracks — each with its own head and read/write/clock electronics — to store up to 100,000 bits per track — accessible at a 3 megabit/second rate.

Because the data is clocked in and out, using TTL logic, track-combining techniques can provide up to 7.2-megabit capacity at up to 216 megabits/second. Write on any track without disturbing the displays being read from adjacent tracks.

Applications include X-Y CRT and TV-monitor refreshment, digital-television storage, and high-speed parallel buffer memory.

Price for the FPD? \$4,870 plus \$300 per track. Delivery? 30 days! Application and interface details? Call Bill Stevens at (415) 326-7602 or write:

Data Disc, Inc., Display Division,
1275 California Ave., Palo Alto, Calif. 94304

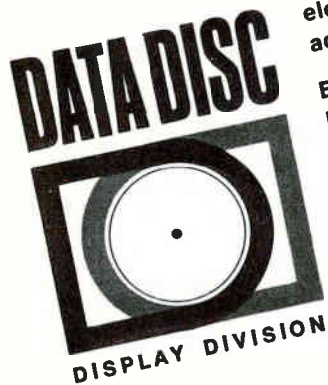

inch bent around a radius of 0.125 inch. A metallic insert was machined to surround the apex of the bend, and all remaining cavities were filled with fine metallic particles. The metallic particles improved the performance of the connector considerably; consequently, the insert was discarded in favor of the metal particles. While dropping the insert improved the electrical characteristics of the connector, it was mechanically unfeasible to distribute the particles efficiently to completely surround the dielectric.

Silver's the thing. The scarcity of epoxies with high electrical conductivity placed limits on their use. Plating the dielectric with silver provides a continuous outer coating and solves the problems. But mechanical and electrical tests indicated that a low-impedance section still existed in the region of the bend. For an optimum con-

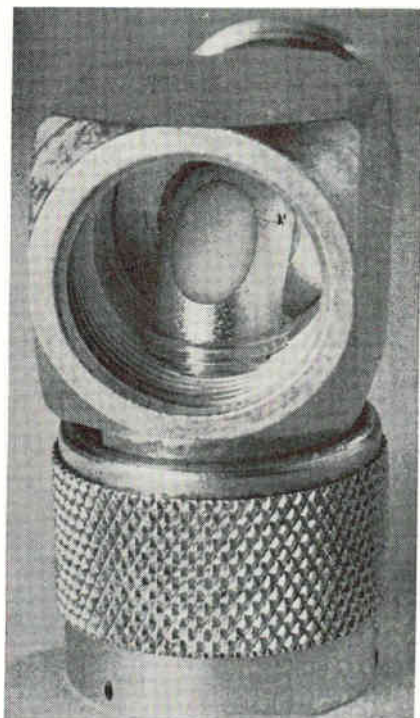

A pinch. Connector's 90° bend reduces impedance, causing discontinuity. Removal of plating overcomes the loss.

figuration the elbow should have the center conductor equidistant from the outer surface of the dielectric at all planes that are perpendicular to the axis of the bent assembly. However, due to the sharpness of the bend and the



Monotherm® homes in.

An infantryman has only one shot at an enemy plane with the Army's infrared homing missile, the Redeye. So he expects 100% reliability. Every time. And he gets it.

One reason is that General Dynamics specified a Riegel Monotherm® flexible laminate of copper and Type H Kapton® for the Redeye's three rugged printed circuits.

This Monotherm laminate withstands 550°F soldering without delaminating or circuit swimming. It won't support combustion, being non-

flammable and self-extinguishing. It is unaffected by repeated soldering (30 re-soldering operations per connection on the Redeye).

It can be bent 360 degrees in any direction. It can be subjected to high pressure multi-layering and the circuit won't swim or rupture. Yet for all its strength, its weight is one-third that of conventional wire circuits and it requires a third of the space—a great advantage in the world's smallest guided missile.

In 2½ years of Army use, The Riegel

Monotherm laminate used in the Redeye has proven to be 100% reliable.

For more information, mail the coupon today.

.....
 TAYLOR CORPORATION
 Valley Forge, Pennsylvania 19481
 Please send me Kapton®/copper data sheets
 and the Conductor and Dielectric Guide for
 Riegel Monotherm®.

 Name

 Company

 Street City

 State Zip

Monotherm® - registered trademark of Riegel Paper Corporation for its laminations of conductive and dielectric materials.
 Kapton® - registered DuPont trademark.



EXCLUSIVE U.S. DISTRIBUTOR OF RIEGEL MONOTHERM IN SHEETS AND ROLLS.

WHERE ACCURACY COUNTS!

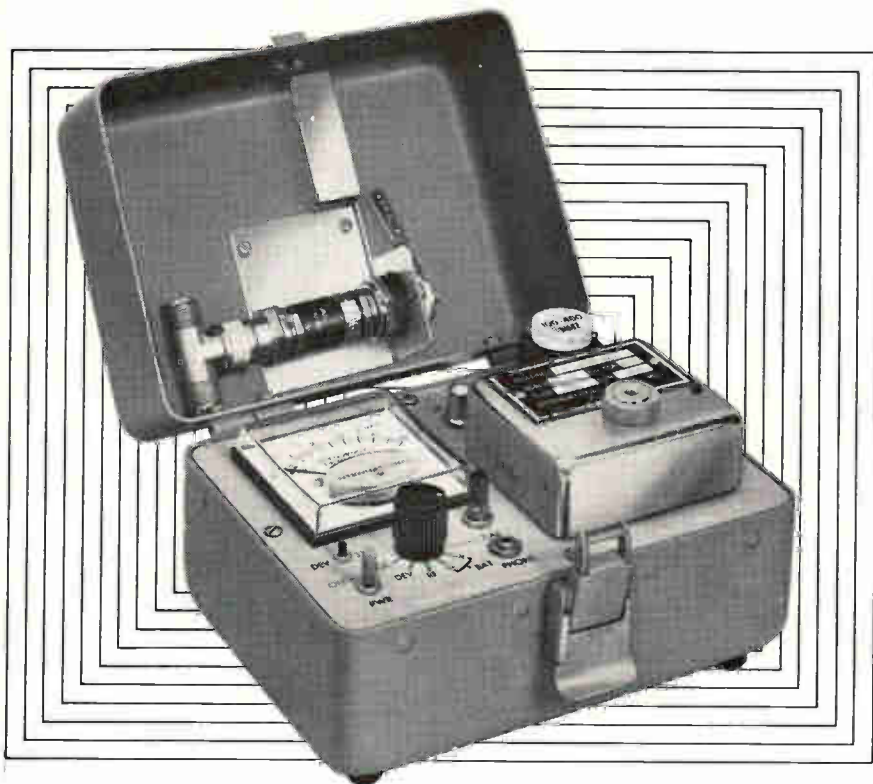

INTERNATIONAL MODEL 6000 FREQUENCY METER
measures frequencies 10 khz to 600 mhz with accuracy as close as .000125%

The Model 6000 Modular Frequency Meter will measure frequencies 10 KHz to 600 MHz with .000125% accuracy. The wide variety of plug-in oscillator accessories and range modules makes the Model 6000 adaptable to a number of jobs in the field and in the laboratory. Portable, battery operated with rechargeable batteries.

Model 6000 with 601A charger, less plug-in modules.....\$195.00



RANGE MODULES (Mixers)
\$25.00 to \$45.00 each

OSCILLATOR MODULES
(Crystal Controlled For Frequency Measurement)
\$30.00 to \$90.00 each

... For complete information
write International today.



INTERNATIONAL
CRYSTAL MFG. CO., INC.
10 NO. LEE • OKLA. CITY, OKLA. 73102

... technique applicable
to other types ...

physical properties of the materials, this condition does not exist.

Instead, when the assembly is bent, the dielectric stretches and the center conductor tends to move radially outward at the apex of the bend. This results in a lower cross-sectional area at the elbow and, thus, when the assembly is plated or surrounded by conductive particles, the impedance at the section is decreased. To achieve satisfactory electrical performance,

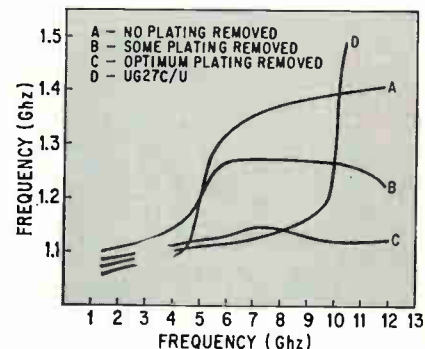

Test results. The removal of some plating from the apex lowers the vswr in the range from 4 to 12.4 Ghz.

compensation for the impedance discontinuity is required.

This compensation is accomplished in either of two ways—a reduction of the center conductor or an increase of the outer conductor. By removing the conductive material at the apex of the elbow, the company was able to simulate an increased outer conductor. A reduced center conductor didn't change performance.

Where plating was not removed, the vswr is higher than exhibited by the UG-27C connector, but the usable frequency range is extended from 10.5 gigahertz to 12.4 Ghz. The optimum degree of compensation results in a vswr of less than 1.15 from 1 to 12.4 Ghz. This design is not limited to the type N series of connectors. This new method of compensation may be applicable to semirigid bent-cable assemblies or to performance parameters in excess of 12.4 Ghz. IEEE Booth No. 4E03.

Selectro Corp., 225 Hoyt St., Mamaroneck, N.Y. 10543 [409]

IMMEDIATELY AVAILABLE!

12.5V

RF KITS

from  **Solitron**

Solitron's silicon RF power kits are now available in power ranges from 12 to 40 Watts in TO-5, TO-60 and plastic stripline cases. These kits are designed to operate on 12.5V mobile supply at a frequency of 175 MHz. They are directly interchangeable with popular interdigitated structure devices currently in use.

175 MHz - 12.5 VOLT SUPPLY

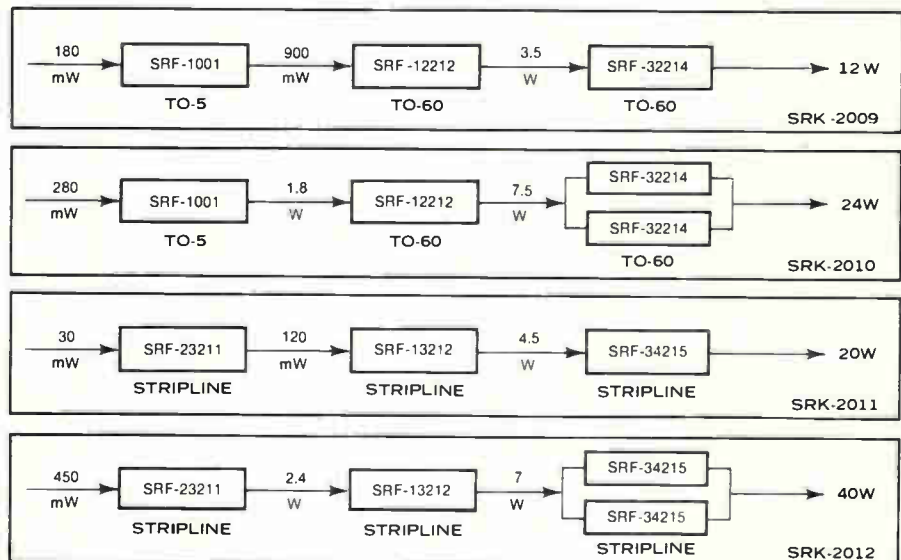

Also immediately available from Solitron are the 2N3375, 2N3632, 2N3733, 2N4040, 2N4041, 2N4440, 2N5090 and 2N5108. Other discrete RF transistors are available in varying package configurations for operation at frequencies up to 1 GHz. Contact us today for complete information.

Dial 1-800-327-3243 for a "No Charge" telephone call and further information

Solitron DEVICES, INC.

1177 BLUE HERON BLVD. / RIVIERA BEACH, FLORIDA / (305) 848-4311 / TWX: (510) 952-6676

The phenomenal ferrite bead:

Stackpole's simple solution to noise and filter problems.



Ceramag® ferrite beads offer a simple, inexpensive, yet effective means of obtaining RF decoupling, shielding, and parasitic suppression without sacrificing low frequency power or signal level.

Unlike conventional RF chokes, beads are compact, have no DC losses, and will not couple to stray capacity and introduce detuning or spurious oscillations. Ceramag® beads offer an impedance which varies from quite low at low frequencies to quite high at noise frequencies. Beads need not be grounded; however, chassis contact is permissible when desired, as beads possess sufficiently high resistivity to preclude grounding.

Installation of Stackpole

beads is easy. Simply slip one (or several) over appropriate conductor(s) for the desired noise suppression or high frequency isolation. Beads are available in sleeve form in a range of sizes starting at .025 ID, .060 OD, and .400 long. For special compact filtering applications such as cable connectors, beads can be supplied to tight mechanical tolerances.

Several ferrite grades provide a variety of attenuation characteristics. Inductance tolerance is normally $\pm 30\%$ as measured on an LC meter. The performance of a Ceramag® 7D bead as a parasitic suppressor is shown in Figure 1.

Other applications might include: decoupling in "B" circuitry; noise suppression; RF isolation in filament circuits;

use in combination with capacitors to form "L" networks.

FIGURE 1

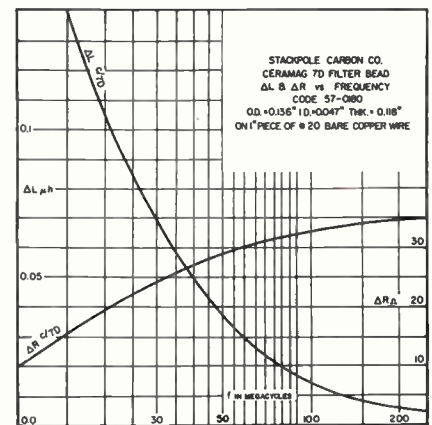

Sample quantities of Ceramag® beads and beads with leads are available without charge upon request. Send your requirements to Stackpole Carbon Company, Electronic Components Division, St. Marys, Pennsylvania 15857. Phone: 814-781-8521. TWX: 510-693-4511.



Now available...Ceramag® beads with leads

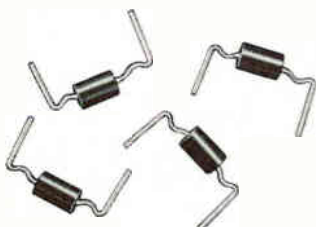

Additional savings in production time and labor costs are now possible by utilizing automatic insertion equipment to install Ceramag® ferrite beads in printed circuit boards.

Data generator logically copes with MSI

ECL and TDL give the machine either very high or very low speeds; synchronized clock signal permits testing of clock-gated logic

"MSI is too complex and logic too fast for the test techniques now available," says Yohan Cho, president of Tau-tron Inc. But Tau-tron, a newly formed company, may have an answer to this problem in a new programmable data generator.

As IC's grow larger, functions that once were spread over several printed-circuit boards are being

collected on single chips. This is fine from the standpoint of economics and miniaturization, but not from the standpoint of present static and dynamic testing gear. Not only are there medium-scale integrated devices too complex for the testers now available, but they are too small—perhaps by a factor of 10, says Cho—to make economical use of computer diagnostics.

Users generally wind up working with modified pulse generators, or with data generators. But Cho maintains that pulse generators can't simulate the conditions an array will encounter, and that the data generators available aren't fast enough (about 30-40 megabits per second appears to be tops) to exercise high-speed emitter-coupled logic or even top-line tran-



Wavedipper WD-4-HT "RR" solders at temperatures up to 850° F. It is for such applications as soldering relay coil bobbins using polyurethane insulated wire. Special treatment of its tank and pump prevents intermolecular migration between tin-lead solders and stainless steel parts that usually occur at higher temperatures. Electrovert Inc., Hartford Ave., Mt. Vernon, N.Y. [421]



Paste power stirrer CM-6 handles emulsions, resins, and other thixotropic materials used in electronic fabrication. It features high torque and low speed. Continuously variable (between 0 and 1,000 rpm), the unit permits reproducible and uniform treatments to be applied to inks used in print and fire processes. Starnetics Co., 10639 Riverside Dr., N. Hollywood, Calif. [422]

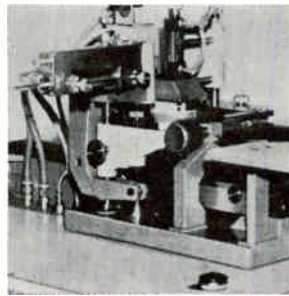

Semiautomatic screen printer model 350 is for use on TO-5 and TO-8 substrates, and parts up to 2 in. square by 1/2 in. thick. It provides superior pattern definition because the screen or etched mask can be separated from the substrate by a stripping motion. A micrometer adjustment accurate to 0.001 in. permits precise height adjustment. Precision Systems Co., Somerville, N.J. [423]



Portable ultrasonic cleaner model SP-100 measures 10 5/8 x 8 1/2 x 6 3/4 in. and incorporates a stainless steel tank with a capacity of 1 3/8 quarts. Its 100-watt average output results in high intensity uniform action and efficient cleaning in the removal of grease or contaminants. The unit's only control is an off-on switch. Blackstone Ultrasonics Inc., Sheffield, Pa. 16347. [424]



Free-abrasive machinery tool is for semiautomatic controlled-temperature polishing of memory disks used in the computer field. Designed to polish 4 disks simultaneously, the machine features automatic timing, a vacuum system that holds the memory disk to the chuck, and a continuously rotating polishing wheel. Speed-Fam Corp., 509 N. Third Ave., Des Plaines, Ill. 60016. [425]



High vacuum system for thin film r-f sputtering has a failsafe automatic push-button controller that is fully protected from operator error in both the automatic and manual mode. Any type of material may be deposited. The system features a fast pumping speed by virtue of a valve and LN trap combination. Davis and Wilder Inc., 717 Stierlin Road, Mountain View, Calif. 94040. [426]



Semiconductor output is boosted by precision beam lead bonder model 573. Bonding is achieved by a thermocompression wobble tool and is readily adaptable to semiautomatic setups. A reflex optical system gives the operator a clear view of the device pattern superimposed directly on the workpiece pattern. Kulicke and Soffa Industries Inc., Fort Washington, Pa. 19034. [427]

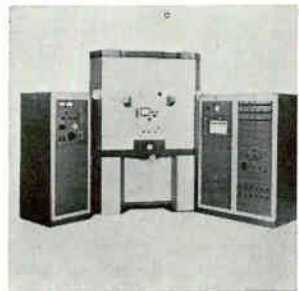

Production spectrometer model VPXQ analyzes up to 22 elements (from fluorine through the periodic table) simultaneously with a high-power X-ray tube. It may be used either as an air or vacuum system. The air system analyzes elements heavier than chromium. The vacuum version is used for elements lighter than manganese. Applied Research Laboratories, Box 129, Sunland, Calif. [428]

NEW

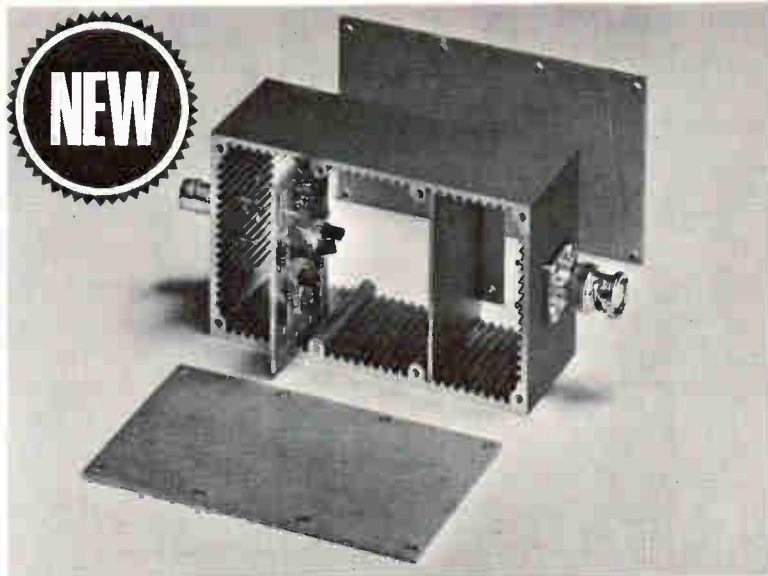

SHIELDED BOXES with CARD GUIDES

Rugged die-cast aluminum boxes, slotted to accept $\frac{1}{8}$ " circuit boards and shielding dividers. Excellent for packaging electronic circuitry. Boxes have removable top and bottom covers. Useable inside space: 4"x2"x1 $\frac{1}{2}$ ". Several models with various connectors.

Featured at IEEE booth 4H27



POMONA ELECTRONICS CO., INC.
1500 E. Ninth Street, Pomona, California 91766

Circle 262 on reader service card

Build this magnificent Schober Theatre Organ for only \$1550!*



*Includes finished walnut console. Amplifier, speaker system, optional accessories extra. Only \$1150.50 if you build your own console.

You couldn't touch an organ like this in a store for less than \$3500—and there hasn't been a musical instrument with this vast variety of genuine Theatre Organ voices since the days of the silent movies! Haunting tibias, biting strings, blaring reeds—the whole A to Z gamut of real pipe sounds that make the simplest playing a thrilling experience and give the professional organist everything he needs. If you've dreamed of the grandeur of authentic big-organ sound in your own home, you won't find a more satisfying instrument anywhere—kit or no kit.

You can learn to play it. And you can build it, from Schober Kits, world famous for ease of assembly without the slightest knowledge of electronics or music, for design and parts quality from the ground up, and—above all—for the highest praise from musicians everywhere.

Send right now for your copy of the full-color Schober catalog, containing specifications of the five Schober Organ models, beginning at \$599.50. No charge, no obligation—but lots of food for a healthy musical appetite!

The Schober Organ Corp., Dept. EL-13
43 West 61st Street, New York, N.Y. 10023

- Please send me Schober Organ Catalog and free 7-inch "sample" record.
- Enclosed please find \$1.00 for 12-inch L.P. record of Schober Organ music.

NAME _____

ADDRESS _____

CITY _____ STATE _____ ZIP _____

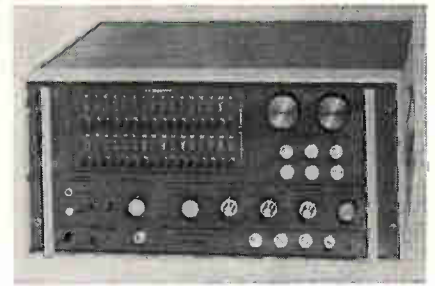

sistor-transistor logic. Nor, he says, do present data generators offer a wide enough range of data speeds or word lengths.

No reservation. Tau-tron's answer to these awkward-sized, ultra-fast arrays (and circuit board sub-assemblies, too), is the WG-100, which the firm flatly describes as the world's fastest data generator, and the one with the widest range of data rates.

At top speed, the WG-100 is capable of spewing out 32 bit words at 125 megabits per second. Throttled down, bit rates of lower than one per second are possible, and the speed is infinitely variable between these extremes.

Shorter words are selectable. On the standard model, lengths of 16 as well as 32 bits are available, and even shorter lengths can be had with minor adjustment. And for such jobs as testing pulse-code modulation equipment—where long words are used to approximate a pcm bit stream—a modified form of the WG-100 will provide 100-bit-long words.

In all cases, the binary 0's and 1's forming the words can be arranged arbitrarily with a switch panel on the front of the generator, or can be programmed through a binary-coded-decimal input at the rear. This latter feature could make the WG-100 a prime candidate for computer-controlled dynamic testing systems.

Logical complements of each word are produced as the words themselves are produced and both return-to-zero and nonreturn-to-zero formats appear at dual front-panel jacks simultaneously and automatically. So does a synchronized clock signal that permits the testing of clock-gated logic.

It took a special kind of logic to make the WG-100 possible, one developed by Cho and Tau-tron's vice president, John B. Connolly,

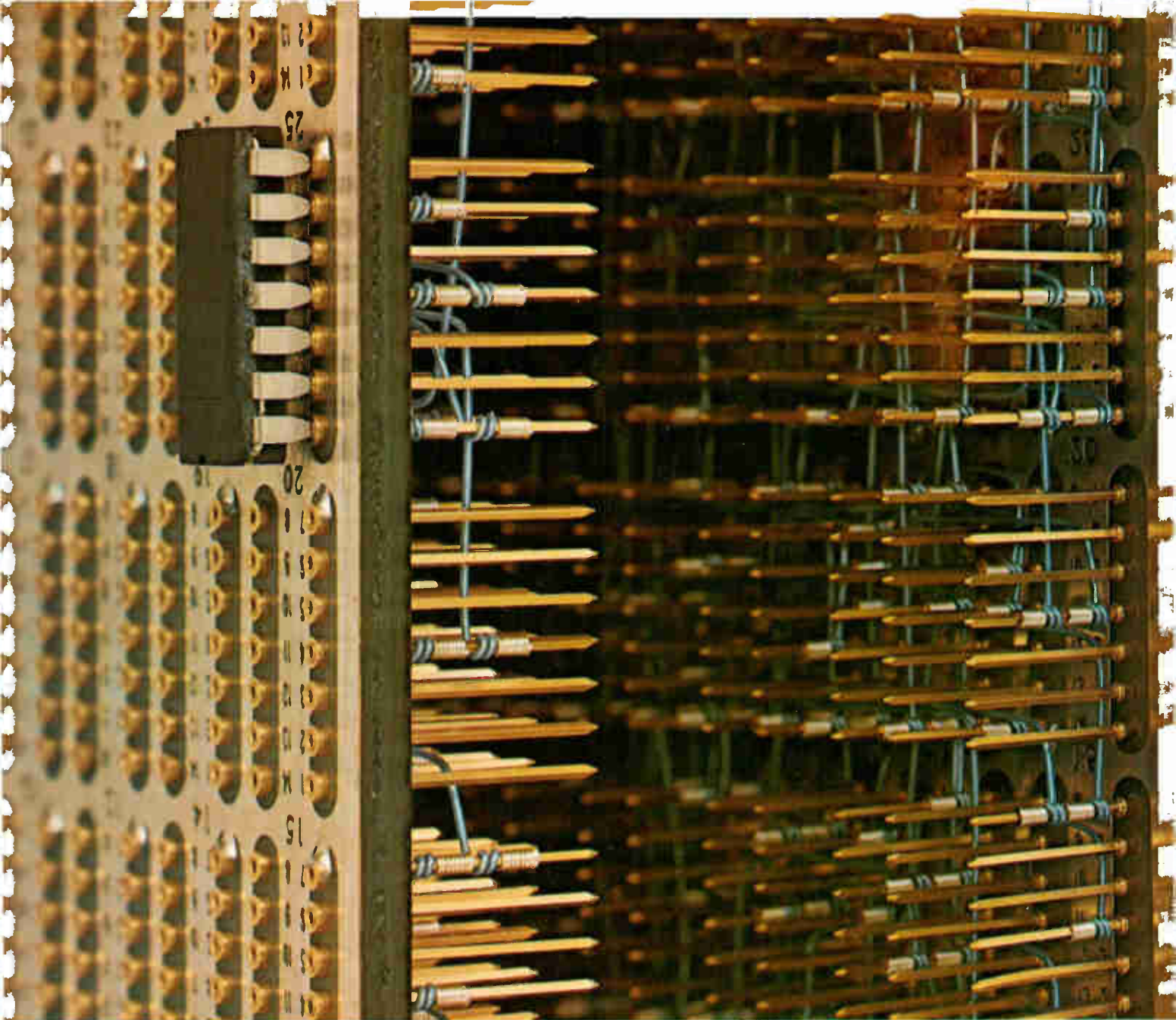

The ultimate in complete wire wrapped panels...from one source

Augat and **Raytheon** Now Combine their Capabilities
To Provide New Economies and Faster Turn Around Time.

An alliance of leaders.

Augat, long recognized for its innovations in
IC packaging panels and the quality of its products.

Raytheon, offering the largest, most versatile of wire wrapping service facilities.

Together, we're now producing packaged panels unmatched
in reliability, flexibility and fast turn around time.

Let us wrap up your IC and interconnection requirements efficiently and economically.

Contact: Augat Inc., 33 Perry Ave., Attleboro, Mass. 02703, (617) 222-2202.

AUGAT_{INC.}

BOOTH 4H 12-14 IEEE

Circle 203 on reader service card

BUS BARS

...FOR PC CARDS

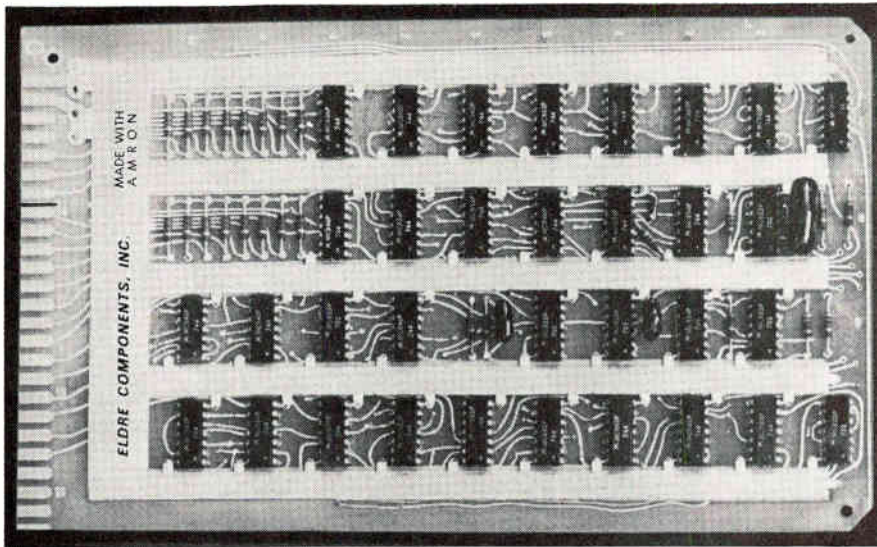

A laminated bus bar with distributed capacitance on a printed circuit card for power and ground distribution, eliminating the need for a multilayer card.



COMPONENTS, INC.
1239 University Ave.
Rochester, N. Y. 14607

Circle 263 on reader service card

ELGENCO 602A-1390 NOISE GENERATOR \$330

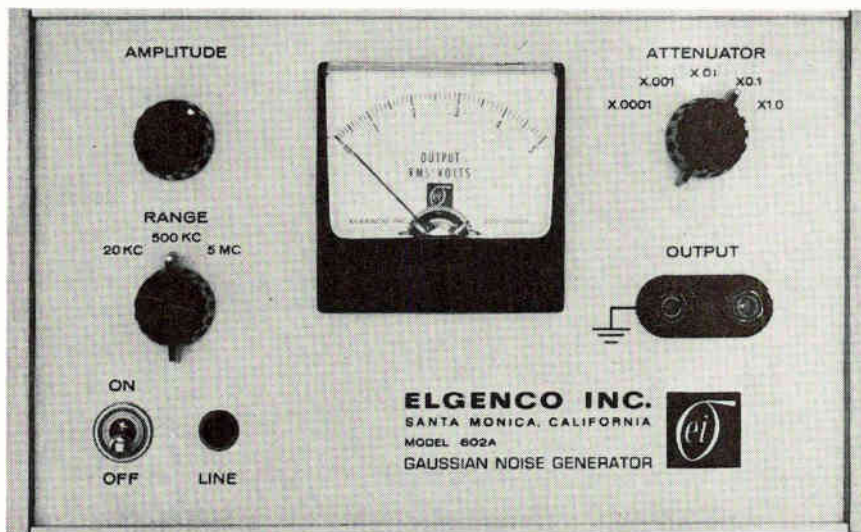

Many obsolete vacuum tube noise generators can be directly replaced/updated with this solid state 5 Hz to 20 kHz/500 kHz/5 mHz Random Noise Generator at low cost and with improved characteristics. Delivery from stock. Other Noise Generators covering the range of DC to 30 mHz and Demonstrator Models are available. For name of nearest Sales Rep see EEM or contact Elgenco, Inc., 1550 Euclid, Santa Monica, Calif. 90404, Ph. 213-451-1635.

204 Circle 204 on reader service card

... switching elements
recreate clean pulse ...

in their work at the Mitre Corp. and at MIT's Lincoln Laboratory over the past seven years [*Electronics*, Feb. 17, p. 56]. Called "Univer," Tau-tron's logic combines ECL and tunnel-diode logic to get both the isolation of transistor devices and the switching speed and excellent transfer characteristics of tunnel diodes.

Out of sight. Cho and Connolly state that Univer logic can clock at more than 250 megahertz and toggle with ease at speeds higher than 500 Mhz—rates just about impossible for even the fastest ECL. The Univer logic used in the WG-100 had to be derated to operate at the machine's relatively slow 125-Mhz peak rate. Even derated, though, the logic is so fast that a sync delay circuit in the generator has to employ high-speed logic IC's as delay lines.

Cho likes to point out that the Fairchild logic used for sync delay has a bad effect on transfer characteristics. The Univer elements have rise and fall times well below a nanosecond, he complains, but the "delay lines" are as much as five or 10 times slower and add a good deal of hash to the waveshape. However, the Univer tunnel-diode switching elements don't need a quick, clean waveshape to trigger. On the contrary, they steer current to recreate a clean, ring-free pulse each time they switch. For that reason, whether sync pulses are delayed 20 milliseconds or not at all, each output pulse is as clean as every other one.

Tau-tron claims clean pulses with steep rise and fall profiles, pulses with widths variable from 2 nanoseconds to 20 msec. Baseline offset is ± 3 volts to accommodate various logic types and circuit applications, and output amplitude is up to 5 volts at about 200 milliamperes with the final output level controlled by dual coaxial microwave attenuators.

The generator costs \$11,950 in its standard 32-bit word configuration; delivery time is one month.

Tau-tron Inc., 685 Lawrence St., Lowell, Mass. 01852 [429]

Circle 205 on reader service card →

SEMPER PARATUS

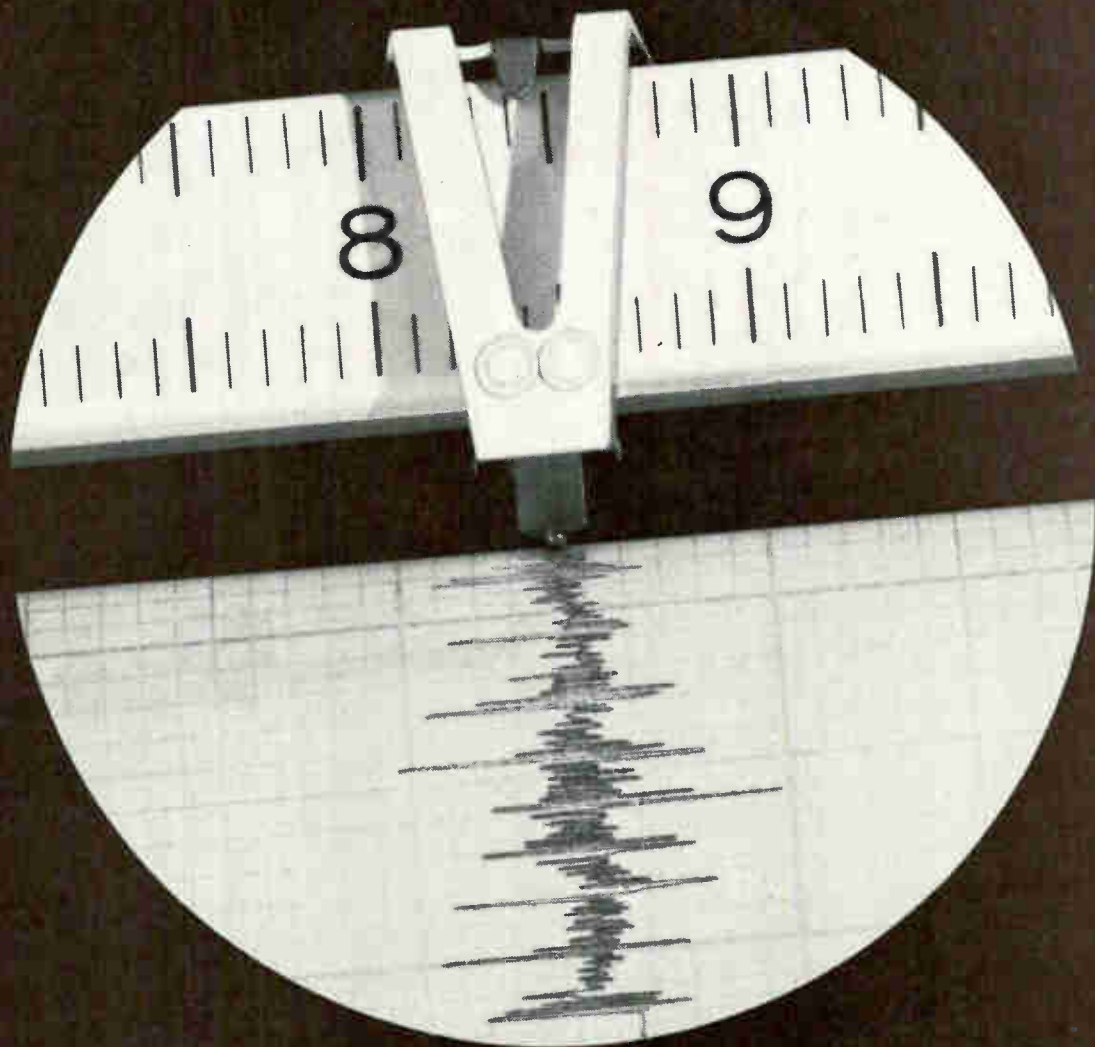

There are times when electric writing is best. Lots of times. Like when you can't get around to check your ink supply. When you've got an unattended station in a remote area. When your recorder may be on standby for long periods, yet must start and stop instantly to catch a one-shot event. When you have to be certain your records will be permanent. When environmental conditions may threaten the readability of your traces. Or, to put it more simply, when the odds are against a standard pen stylus.

HP's electric writing option

offers a degree of dependability to data gathering operations around the world. The technique uses special electro-sensitive paper and a low-voltage writing stylus. It gives you records that are impervious to heat, pressure or light. Altitude and vibration can be tolerated; no priming is necessary before operation. With very low chart speeds you can record data 24 hours a day, seven days a week, for extended periods of time. Yet it costs only \$75 to add this option when you buy either the HP 680 five-inch recorder or the 7100 series ten-inch recorder.

Find out more about this remarkably sim-

ple way to make certain your records will be there even if you're not. Just call your local HP field engineer. Or write Hewlett-Packard, Palo Alto, Calif. 94304; Europe, 1217 Meyrin-Geneva, Switzerland. We'll send you a sample of electric writing.

HEWLETT  **PACKARD**
GRAPHIC RECORDER



KEPCO

TRACKED VOLTAGES DUAL, PLUS / MINUS VOLTAGE SUPPLIES

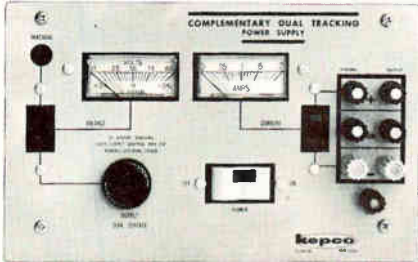

Model CDT 100-0.2 M

Kepco's new series of CDT Dual Power Supplies offer tracked voltages from 0-±15V to 0-±100V. Each supply is fully regulated: <0.01%; with low ripple: <0.25 mV rms; and an excellent temperature coefficient: <0.01% per °C.

The two sections function with a common reference and a single voltage control (with locking feature). They may be loaded separately, or in series for double output voltage. Metering includes (2) recessed taut band meters, measuring the current drawn from each section, and their output voltage. A unique differential metering function enables the voltmeter to monitor the voltage difference between the two sections.

Three instruments are available:

CDT 15-1.5 M	+15 V @ +1.5 A -15 V @ -1.5 A
CDT 40-0.5 M	+40 V @ +0.5 A -40 V @ -0.5 A
CDT 100-0.2 M	+100 V @ +0.2 A -100 V @ -0.2 A

CDT models are ideal for powering operational amplifiers, servoamps, position transducers, and balanced or differential circuits requiring maintenance of a common center point.

For complete Specifications and Applications Notes - Write Dept. AQ-14



131-38 SANFORD AVE. • FLUSHING, N.Y. 11352
(212) 461-7000 • TWX # 710-582-2631

Visit us at IEEE Show — Booths 2E-56 & 57

206 Circle 206 on reader service card

Production equipment

Sorter handles 5,000 IC's an hour

Dual in-line packages
slide from cartridges
to test stations

Integrated circuits in dual in-line packages cost less when delivered in cartridges or magazines, but they are harder to test and sort that way than when individually packaged. A DIP sorter developed by the Daymarc Corp. was designed to handle magazines and help test IC's at a rate of better than 5,000 circuits per hour.

When coupled with d-c or dynamic test equipment (such as the Teradyne J259 tester of Tektronix S-3130) the sorter can take IC's from a magazine, probe them, and divide them according to their characteristics among three other magazines. The d-c probe station has 32 Kelvin terminal connections (for 16-lead DIP's) and the dynamic probe has contacts short enough for subnanosecond measurements.

The IC's slide one by one from the magazine onto the eight stations of a rotating table that carries the IC to the probe. After testing, one of three arms behind each station is set magnetically; when the IC is rotated to the magazines, the arm trips a mechanism which unloads the IC into the proper bin. A terminal at the magazine erases the magnetic-mechanical memory.

Once the memory is set, nothing affects it; the machine can be turned off, and when turned on again will still send the IC to the proper bin, says A.H. MacQuarrie, applications engineer. "If we'd used a shift register we not only would have had problems synchronizing with the table's mechanical motion, but also would have risked 'electronic amnesia' during power failures."

With a test time of 300 milliseconds, the 852 can sort 5,600 DIP's per hour, and its speed can be adjusted to other test times.

Price is approximately \$13,000. Daymarc Corp., 140 Bear Hill Rd., Waltham, Mass. [430]

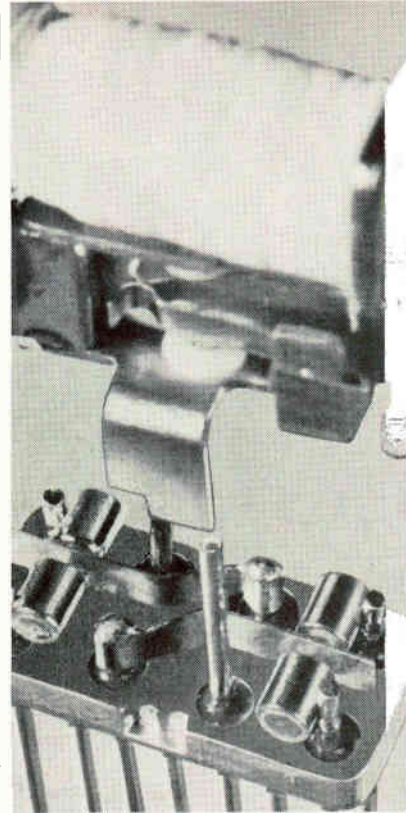

mite-size relays with macro-size contacts

Couch 2X relays are true 1/2-size, yet their contacts are as large or larger than many full and half-size crystal can units.

Couch 2X relays meet MIL-R-5757D/and/30 specs in 1/25th of a cu. in. Design simplicity and oversize contacts assure the ultimate in performance. Each relay is fully tested. Ideal for missile and aerospace switching applications or wherever reliability in small space of prime importance. Available in many terminal styles and a wide choice of mountings.



Write for Data Sheets No. 10 and No. 10 today.

	2X (DPDT)	1X (SPD)
Size	0.2" x 0.4" x 0.5"	same
Weight	0.1 oz. max.	same
Coil		
Operating Power	100 mw or 150 mw	70 mw or 100
Coil		
Resistance	60 to 4000 ohms	125 to 4000
Temperature	-65°C to 125°C	same
Vibration	20G	same
Shock	75G	same

RUGGED ROTARY RELAYS  Dynamically and Statically Balanced



S. H. COUCH DIVISION
ESB CORPORATION
3 Arlington St., North Quincy, Mass.

Circle 265 on reader service card

Low noise for hi-fi (stereo).

Build your stereo preamps with the Fairchild μ A739 Dual Low-Noise High-Gain Op Amp and you've got performance that's as good as any currently available discrete system. Besides getting both amplifiers on a single chip (and at a single chip price), you get channel separation 15dB better than most discrete designs, an output swing high enough to drive the most demanding power amplifier and a power supply rejection ratio so high that you can cut costs even further by relaxing your power supply specs. And check what the high common mode rejection ratio does for distortion.

That's our Second Generation Linear technology in action — proud performance, humble pricing. The μ A739 was specifically tailored for improved performance in any application that requires two high-gain amplifiers. Try it now in your modulators, voltage-to-frequency converters, instrumentation amplifiers or integrators and take advantage of its low noise, non-latching and unity gain crossover frequency of 20MHz. And for more flexible low power operation in military and industrial applications, we'll have it available (second quarter of calendar 1969) as our μ A749 without the internal output stage collector resistors. The μ A739 is available in a DIP; the μ A749 will come in a ceramic DIP, a flat-pak or a TO-5 metal can. Information on both is in our data sheets.

Write for them and our application notes now. Or, just check with your stocking Fairchild distributor.

To order the μ A739, ask for:

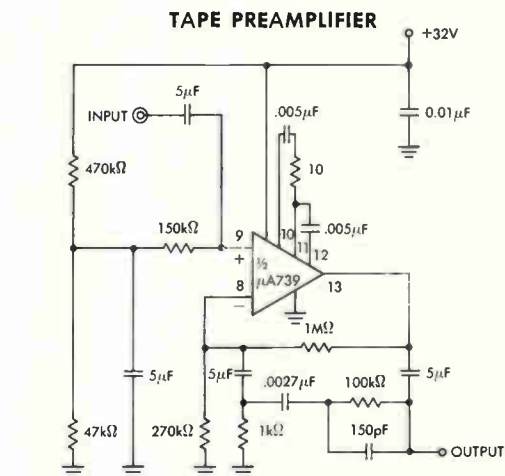

ELECTRICAL CHARACTERISTICS

Large Signal Open Loop Voltage Gain:	80 dB
Signal to Noise Ratio:	68 dB
Bandwidth:	20 to 20,000 Hz
Output Swing:	10 V _{rms}
Power Consumption:	250 mW
Input Impedance:	50 KΩ
Power Supply Rejection:	75 dB
Channel Separation:	60 dB
Distortion:	0.025 %

*For complete specifications, see data sheets.

PART NUMBER	PACKAGE	TEMPERATURE RANGE	PRICES		
			1-24	25-99	100-999
U6E7739393	DIP	0°C to +70°C	\$4.85	\$3.90	\$3.25

FAIRCHILD
SEMICONDUCTOR

For electrical contacts, as in medicine,

It pays to go to a specialist

A black and white illustration of three surgeons in an operating room. They are wearing masks and caps. One surgeon in the foreground is using forceps on a patient. In the background, another surgeon is visible. To the right of the surgeons is a piece of medical equipment with two gauges and a hose. The style is a high-contrast, graphic illustration.

A major operation requires a whole team of specialists. So too, it takes a team of specialists to design contacts. Configuration, materials, electrical performance, contact design and manufacture is complex. That's why Deringer believes it takes 100% concentrated effort to give our customers the best in electrical contacts, contact sub-assemblies and assemblies. Let Deringer be the doctor. Contact us today. We'll send one of our contact specialists right away.

D E R I N G E R

METALLURGICAL CORPORATION

1250 Town Line Road (Rt. 60) Mundelein, Illinois 60060

Circle 208 on reader service card

Computer display is a speedy writer

Low-cost unit for scientific processors can flash new data
8 microseconds after an excursion of 10 inches is called for

Its bread-and-butter product line is precision a-c calibration equipment, so Optimization Inc. concentrated on that until a few months ago. But now, having developed a taste for a little jam, the company has sold its first computer output display and intends to seek more business in this fast-growing market of peripheral equipment.

The CDO 6100, a 21-inch cath-

ode-ray tube with a usable display area that's 13 by 14 inches, is making its debut not long after engineering manager William Lockshaw came to Optimization from ITT's Aerospace-Optical division. The X-Y terminal will be shown for the first time at the IEEE show. The ITT division also makes computer output displays, but Lockshaw says he knows of no other

that delivers comparable performance at the price of the Optimization device—\$3,990. (The ITT unit sells in the \$4,000 range.) Lockshaw says Optimization got the price down through "clever engineering and the use of simple electronics."

The 6100 is not a storage display. It doesn't have its own formatting electronics because it's designed for makers of scientific com-



Antenna couplers series CRM-108 are for coupling the signal from one antenna to one to eight receiver outputs. The solid state devices feature a constant gain of 4 db with a ± 1 db frequency deviation over the entire operating range of 1.5 to 50 Mhz. Maximum noise figure is 6 db; typical dynamic range 130 db. Price is \$2,125. Comdel Inc., Beverly Airport, Beverly, Mass. 01915. [381]



Constant voltage, constant current lab power supply QAD50-1 has 0.01% regulation. It is designed for applications such as computer controlled lab testing requiring programing either up or down at a rate of 10 mv/ μ sec. Ripple is less than 0.5 mv rms or 2 mv peak-to-peak with excellent stability. Price is \$99. Todd Products Corp., 28 Laurel St., Hicksville, N.Y. 11801. [382]

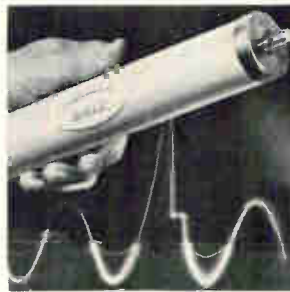

Transient voltage suppressor LA-27 used in h-v power supplies protects solid state rectifiers against punch-through and prevents dielectric failure in transformer windings. It can be factory adjusted for peak arc-over voltages in a range from 60 kv to 110 kv. The unit comes in a hermetically-sealed ceramic tube 1.5 x 9.5 inches. Dale Electronics Inc., Columbus, Neb. [383]



Voltage regulator model LM500 has a peak input voltage of 40 v and peak current of 4 amps. Load regulation with an input voltage of 12 v is typically better than 0.01% from no load to 3 amps full load. Dimensions are 1.2 x 0.65 x 0.25 in. Price for quantities of 100 to 999 is \$49 each. International Circuit Technology Corp., 18225 Euclid St., Fountain Valley, Calif. [384]



Inverter model MT-1 is for testing and evaluation of fractional h-p, instrumentation motors, and has provisions for driving center-tapped or full winding motor loads. By taking the product of the two front panel meter readings, the a-c power delivered to the load is given without requiring the usual corrections for power factor. Kintron Co., 29 S. Pasadena Ave., Pasadena, Calif. [385]



High accuracy and versatility are featured in model 101 analog multiplier/divider. Without requiring any balance or trim adjustments, the combined error from all sources is less than 0.2% of full scale. The unit can perform multiplication, division, squaring, and square-rooting. Hybrid Systems Corp., 95 Terrace Hall Ave., Burlington, Mass. [386]



Power source model 1579 is for high voltage crt display systems. Specifications include: maximum output current of 1 ma; 0.0025% regulation for line or load variations; less than 250 mv ripple peak-to-peak; output voltage drift less than 100 ppm/hr and 300 ppm/24 hrs; and repeatability of 100 ppm. Price is \$2,250. Power Designs Inc., 1700 Shames Drive, Westbury, N.Y. [387]



High-voltage d-c power supplies series H come in 55 models with voltmeter and ammeter hand calibrated to $\pm 2\%$. Units have voltage outputs up to 250 kv and are air or oil insulated. Other features include a load regulation of 7.5 to 15-25%, and capability of withstanding a continuous ambient temperature range from 0 to 40°C. NJE Corp., 20 Boright Ave., Kenilworth, N.J. [388]

50 YEARS OF INSTRUMENT KNOW-HOW...

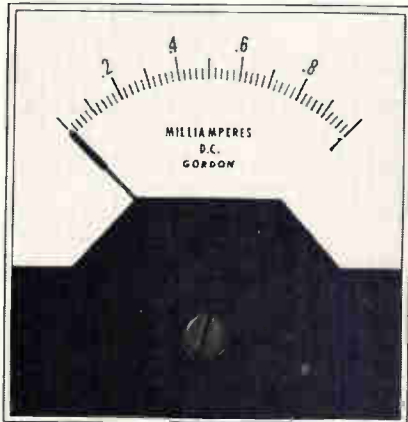

PACKED IN A 2½" CASE!

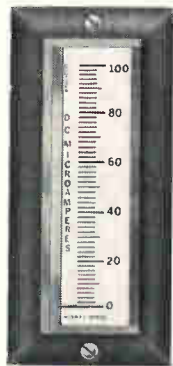

ALL-NEW SERIES 8000

GORDON METERS

Since 1914 we've furnished top quality instruments to science . . . to industry.

Now—our latest entry! Series 8000 GORDON PANEL METERS in popular 2½", 3½" and 4½" sizes.

50 years of know-how you can heft in your hand—or hook up to your panel displays, instruments or machinery.

Strikingly modern designs in sparkling clear high-visibility G.E. Lexan®.

Classic D'Arsonval movements with one-piece bridge construction, high-coercive Alnico core magnets, and spring-backed sapphire bearings standard on all models.

PLUS customizing, if you wish.

Hook up with a GORDON METER first chance you get. Order from your Gordon Sales Engineer TODAY!

FREE GORDON PANEL METERS BULLETIN 1-800



Write Today

PDC GORDON
A SUBSIDIARY OF
PNEUMO DYNAMICS CORPORATION
5710 KENOSHA ST. RICHMOND, ILL. 60071

... no cross coupling between X and Y axes ...

puters; users of these machines usually want displays of vectors rather than alphanumeric. Character and vector information is generated by the computer. The main advantage besides low price, Lockshaw says, is speed.

In using the terminal with scientific processors or computers driving training tools, such as aircraft simulators, the ability to quickly jump-scan from one point to another on the screen is important. Lockshaw says the large-step or long-excursion speed of the CDO 6100's major axis is 8 microseconds. This means that new data can be written 8 μ sec after an excursion of 10 inches is called for; with ITT's KM-105, said to be the closest competitor, the large-step response is 12 μ sec, according to Lockshaw. The small-step response of the Optimization terminal is 1.25 μ sec, meaning that new information can be displayed that soon after a move of 1 to 2 centimeters. He believes this is about twice as fast as the comparable ITT display.

Catching up. However, ITT is improving the speed of the KM-105 in a newer version designated the KM-125, soon to be introduced. The settling time for a large-step response on the major axis will be cut to 7 or 8 μ sec, putting the display in the same ballpark as the Optimization unit.

Amplifier characteristics influence the unit's speed, Lockshaw explains. On the major axis, the amplifiers give a large-signal response of 50 kilohertz over the specified 12-by-12-inch viewing area; the small-signal response is 300 khz for a 1-inch deflection on that axis. The unit is also designed to accept a minor deflection axis with a large-signal response of 500 khz for a 1.25-cm deflection, and a small-signal response of 1 megahertz or more for a 0.5-cm deflection.

Another feature Lockshaw believes is important—though not unique—is that there's no cross-coupling between the X and Y axes. "When you're writing large, fast vectors," he says, "and you want to draw two parallel lines close together, the lines won't be

Buying Power?

ERA
POWER SUPPLY CATALOG

Here's the new, single source for all your power needs.

- Mil Spec DC Modules
- Wide Range DC Modules
- Slot Voltage DC Modules
- Full-Range Lab Supplies
- Inverters, Frequency Changers
- High-Voltage Supplies
- AC Regulators
- Full Technical Data
- Full Specifications
- Mechanical Data
- Model Types
- Prices & Availability

Ask for Your Free Catalog #154 Today!



ELECTRONIC RESEARCH ASSOCIATES, INC.

67 Sand Park Road, Cedar Grove, N. J. 07009

(201) 239-3000

SUBSIDIARIES:

ERA Acoustics Corp. • ERA Dynamics Corp.
ERA Pacific, Inc. • Astrocom, Inc.



the new smoothies

Centralab's substrates in 95% and 99.6% alumina, provide unexcelled surface finish and reliability for hybrid microcircuits

Available in sizes and shapes to meet any design requirement, these materials are available as fired, glazed or metallized. (Glazed units are available only in 99.6% alumina.) They have high mechanical strength and good dimensional tolerance control.

Bodies	Surface Finish (μ in.)		
	As Fired	Ground	Glazed
95% Alumina	40	10*	(not available in 95% Al.)
99.6% Alumina	10-20	2-5*	1 max.

*Lapped, diamond polished.

Exclusive processing

These precision substrate materials are produced by an exclusive thin sheet process in specialized alumina kilns. They meet demanding design criteria of thick-film and thin-film hybrid circuit manufacturers and have been used in all types of circuit deposition: brushing, screening, dipping, spraying, vapor deposition, evaporation, tapes, decalomania, solution metallizing and printing.

Glazed substrates have a 1 $\frac{1}{2}$ mil maximum glaze thickness. Edge meniscus is negligible. Metallized units are available with up to 200 or more terminals, and can be brazed with kovar, nickel, copper or brass hardware.

All in all, for performance, variety and application, your design is in for smooth sailing when you specify substrates and ScoreStratesTM from Centralab.

TM-Scored substrates for multiple processing



CENTRALAB

Electronics Division
GLOBE-UNION INC.

5757 NORTH GREEN BAY AVENUE
MILWAUKEE, WISCONSIN 53201

M-6902

For more information and/or design assistance on substrates and ScoreStrates, contact Centralab Application Engineering.



By George... Captor sure makes small EMC Filters!

Captor subminiature EMC filters are the industry's smallest . . . 25% to 37% more compact than other popular miniatures. Volumes and weights are correspondingly reduced . . . as light as 4.9 grams for many units. Captor EMC filters maintain high published performance over full temperature range to 125° C. Their performance is equal to or better than the competition's, yet they truthfully cost less! Let Captor bid on your next EMC filter or filter assembly requirement, by George! Write for Catalog F-104 and prices today.

Captor Corporation manufactures miniature filters . . . communications and security filters... custom-design filters, and other electronic components.

CAPTOR CORPORATION
APPLICATION ENGINEERING DEPT.
5040 Dixie Highway, Tipp City, Ohio 45371

straight if you've got cross-coupling. Or if you want to draw a diagonal line quickly and the phase response of the amplifier on one axis isn't the same as that on the other, the line won't be straight.

"You want good bandwidth for small excursions because you want high speed to permit formats of either short, chain-linked vectors or dots that will cover the screen without using an inordinate amount of computer time."

No jitter. Optimization accomplishes the zero coupling between axes by using completely separate electronics for each axis. Lockshaw points out that this feature, like many others in the CDO 6100, is usually found in displays that cost as much as \$10,000.

Among those other features he lists good brightness, small spot size, good linearity and repeatability, and elimination of spot motion and jitter. Brightness has been calculated at 50 foot-lamberts; company officials say this is more than that of some of the more sophisticated storage display devices on the market.

The 6100 has a specified spot size of 20 mils in diameter in a 9-inch-diameter circle and 30 mils in a 12-by-12 inch area. Geometric and electrical linearity are within 1%, specified on the major axis; Lockshaw says this results in no perceptible nonlinearity.

Optimization is quoting 60 to 90 days for delivery. IEEE Booth No. 2H10.

Optimization Inc., 9421 Telfair Ave., Sun Valley, Calif. 91352 [389]

New subassemblies

Amplifier with 2-decade range

Transistorized device has
+20 dbm output capability
and 6-db noise figure

At the front end of a communications receiver, a low noise figure over a broad band of frequencies plus at least a medium level of

Now Cover the ULTRASONIC SPECTRUM

with the new
MULTISONS® series
of **BROAD BAND**
POWER GENERATORS



Bandwidth 10 KHz to 1 MHz
Average standard power outputs
available: 100, 250 and 500 Watts
(within 3 db)

Choice of four impedances: between
18 and 2400 ohms

Push-pull low harmonic distortion
driver and output stages

Standard parts used exclusively

All power circuits fuse protected

Maximum accessibility to all sections
for ease of servicing tubes

Variable D.C. bias for magnetostrictive
transducers

Plug in 60 min. timer for automatic
programming

Write for Bulletin 105

MACROSONICS CORPORATION
PIONEERS IN
APPLIED SONICS AND ULTRASONICS

MACROSONICS CORPORATION

880 Elston St., Rahway, N.J. 07065

FRENCH REPRESENTATIVE:
Societe Luziesca, 70 Rue J.P. Timbaud, 75 Paris XI
Tel: 023 · 48 · 22

SCIENCE/SCOPE

Apollo 8 voice and television communications depended heavily on Hughes-built equipment:

...the 20-watt microwave traveling wave tube that sent Apollo 8's signals earthward (one of the more than 100 flight-quality TWTs built for NASA since 1962 and used on the Syncom, Early Bird, Intelsat 2, and ATS satellites and the Pioneer, Mariner, Lunar Orbiter, and Surveyor spacecraft);

...the antenna-feed subsystems aboard three special vessels stationed on the high seas around the globe to receive and relay Apollo 8's signals;

...the ATS satellite used in support of the Apollo 8 splashdown; it relayed TV from USS Yorktown to Brewster Flats, Wash., for commercial distribution.

The first European-built equipment for NADGE -- the \$300-million air defense system that will guard NATO nations from Norway to Turkey -- is now undergoing integration testing at Hughes in Fullerton, Calif. The data display console built by Selenia S.p.A. of Italy and the video extractor by N.V. Hollandse-Signaalapparaten of The Netherlands are linked with a general-purpose computer and other equipment built by Hughes.

ENGINEERS: Hughes is on the grow! New development programs offer immediate opportunities for Systems, Circuits, Radar, Communications, Electro-optical, Display, Sonar, Electronics Packaging, Test Equipment, and Solid State Microwave engineers. Engineering degree, at least two years of related experience, and U.S. citizenship required. Please send your resume to Mr. J. C. Cox, Hughes Aircraft Co., P.O.Box 90515, Los Angeles 90009. An equal opportunity employer.

An infrared night sight for the Army's Cheyenne helicopter, now being built by Hughes under contract with Lockheed-California, will give the gunner a picture of ground targets nearly as clear as he would see in daylight. The PINE (for Passive Infrared Night Equipment) system enables him to locate targets and fire automatic guns, rockets, grenades, machine guns, or Hughes-built TOW wire-guided anti-tank missiles.

A new method of detecting flaws in metals was presented at the eighth Symposium of Physics and Nondestructive Testing in Chicago recently by a University of Arizona professor and a Hughes engineer. Their method sends ultrasonic Lamb waves throughout a solid material to find defects, much like a submarine sends out sonar waves. Engineers can pinpoint the location and size of flaws by noting the magnitude of the echo signals and the time they take to return.

An orbiting "windowshade" of solar cells, which will capture enough of the sun's energy to produce 1500 watts of power, is being built by Hughes under contract to the Aero Propulsion Laboratories of the U.S. Air Force. Designed to supply future satellites with electricity, it consists of two flat sheets of solar cells (called arrays), each 5½ x 16 feet long, which will unroll into space from a drum. Space testing of the system is scheduled for late 1970.

Creating a new world with electronics



Circle 213 on reader service card



The things we do to stay in front!



Because we're No. 1 in control knobs . . .



and because we're Rogan

Our reputation means a lot to us. So much in fact that the knobs we make are quality knobs . . . knobs that are "out in front" with "real design appeal" —yet priced right to fit your budget. Write today for free New color catalog or see us in Sweets or Thomas Micro catalogs.

Rogan
BROTHERS, INC.

8031 N. MONTICELLO AVE.
SKOKIE, ILLINOIS 60076

Visit Booth 1C19 IEEE Show

Circle 214 on reader service card

YOUR POSTMASTER SUGGESTS :

Make Those ~~FASTER~~ Connections

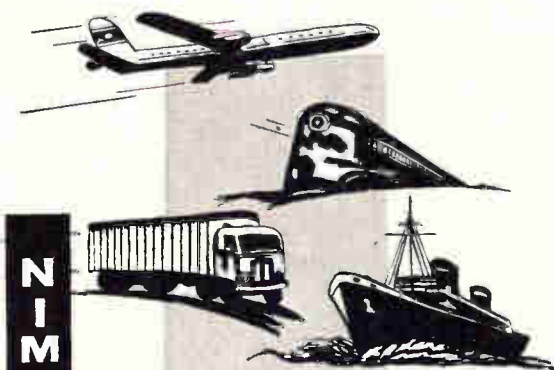

**N
I
M
S**

MAIL EARLY IN THE DAY!

linear output power make an effective combination.

These features are designed into an amplifier developed by AvanteK Inc. for military airborne and surface systems. The transistor amplifier, designated the AWP-1000T, provides a noise figure of 6 db over a wide frequency range, 10 to 1,000 megahertz. It maintains a gain of 30 db within ± 1 db and provides up to ± 20 dbm output before a gain compression of 1 db is reached.

The input power required to drive the complete amplifier is 24 volts d-c at 300 milliamps.

The intercept point for intermodulation products is ± 32 dbm for 3rd-order products and ± 40 dbm for 2nd-order. The voltage-standing wave ratio for both input and output is no more than 2.



Quiet. Transistor amplifier provides 6-db noise figure over the range from 10 to 1,000 Mhz.

Its low noise figure, two decades of operating range, and linear output power make the AWP-1000T suitable for countermeasures systems. In addition, says AvanteK's marketing director Arnie Acker, it can be used for driving both multi-coupler and multiplier chains.

The AWP-1000T is AvanteK's latest addition to a line of broadband microwave transistor amplifiers that operate through S band. It complements the model AV-4, a 1-watt device that covers 0.02 to 300 Mhz. Both multioctave amplifiers operate Class A for maximum linear performance.

The AWP-1000T is 6.2 inches long, 1.9 inches wide, and 1.3 inches high. It weighs 10 ounces.

Price of the device will be between \$1,000 and \$1,200, depending on quantity of the order and on special requirements for each application.

AvanteK Inc., 2981 Cooper Rd., Santa Clara, Calif. 95051 [390]

IRRAVINTM

INSULATED WIRE

Designer's new wire that production can't complain about.

Ever had to re-design because production is having problems and calling for your head as the solution? That's why we've come up with IRRAVINTM irradiation cross-linked PVC hook-up wires. You release the design knowing that wire complaints are stopped before they start.

IRRAVIN insulated hook-up wire continuously withstands temperatures up to 115°C, and higher for short periods of time. So there's no shrink back from hot solder-iron contact. Production doesn't waste time replacing wire just installed. Advantage: use higher density packaging without fear of accidental solder iron damage. And, you can specify IRRAVIN hook-up wire for applications where only costly high-temperature insulations were used before.

Consider crush and abrasion resistance. Our IRRAVIN insulation has four times the crush resistance of that other high temperature stuff. You eliminate lacing cut through, assembly damage, future



Unretouched photo of design engineer being greeted by production engineer after specifying IRRAVIN insulated hook-up wire.

breakdown from undetected cuts and other production grumbles.

Couple this with 5,000 foot lengths, pre-tinned conductors, and you can see why IRRAVIN insulated hook-up wire can be worked fast and safely through automatic processing equipment.

Or we could mention the advantage of having 27 striped and solid colors in stock. Or the 600, 1000 and 3000-volt rated wires con-

forming to MIL-W-16878 and carrying Underwriters' Laboratories, Inc. listings.

Most important, though, IRRAVIN hook-up wire costs less than half that of the other higher temperature wire. Unless you really need the additional degrees why put up with the additional price?

So, be a hero. Get a sample of IRRAVIN insulated hook-up wire and try it. Of course, it's free. Contact ITT Wire and Cable Division, Surprenant Products, International Telephone and Telegraph Corporation, Pawtucket, R.I. 02862.

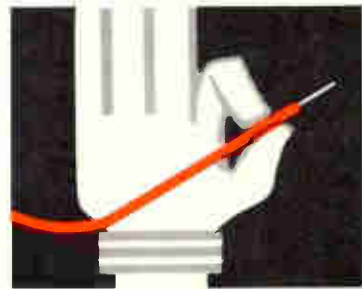

IRRAVIN—the wire
that stops the grumbles.

WIRE AND CABLE **ITT**

a Custom Meter Design by **BEEDE** for

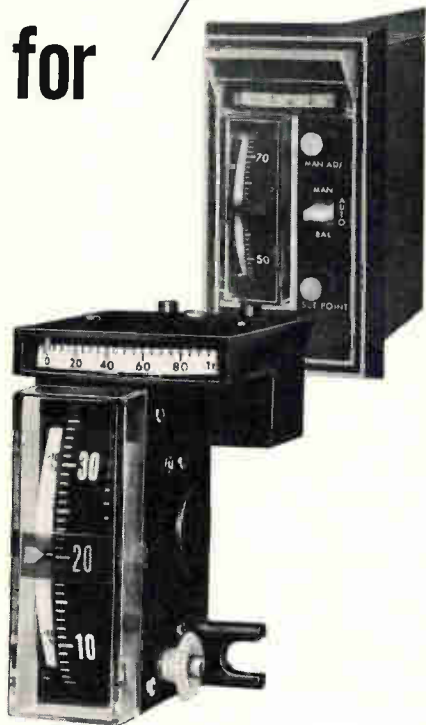

Robertshaw 

Beede designed the special meter movements installed in this new, solid-state Robertshaw Model 323 Process Controller. Robertshaw's demanding meter requirements were met by close engineering cooperation and Beede's experience in the panel meter instrument field. Beede worked with Robertshaw in the design of the special meter case. Robertshaw ships these cases to Beede for installation of the large taut band and smaller pivot-and-jewel meter movements.

Beede has the capability to solve your meter problems, as we did for the Robertshaw Controls Company. Call or write us about your custom meter requirements . . . or send for our Catalog of standard panel meter cases and meter movements.

BEEDE
ELECTRICAL INSTRUMENT CO., INC.
PENACOOK, NEW HAMPSHIRE
Area Code: 603-753-6362

BUY VALUE / BUY BEEDE

New Books

A refresher

Basic Network Theory
Paul M. Chirlian
McGraw-Hill Book Co.
624 pp., \$13.50

Today's electrical engineer who works with computers to design integrated circuits will find a refresher course in the fundamental principles outlined in this new book by Paul M. Chirlian. With a computer at his disposal, the electrical engineer now must have at his fingertips as many techniques as possible to analyze and design increasingly sophisticated circuits and systems.

Aimed primarily at the undergraduate, the text also offers the practicing engineer a detailed description of the analysis of nonlinear and time-varying systems as well as linear time-invariant systems. Most basic circuit courses taken by the engineer who graduated 10 years ago did not contrast time-domain analysis from the standpoints of Laplace transforms and state variables. In this book the author compares these two techniques and includes the classical method as well. The state variables technique is especially important for nonlinear and time-varying circuits and for analysis performed on a computer.

These techniques can help solve a wide variety of problems. For example, network theory and integrated circuits should be analyzed by Laplace transforms. State variables should be used to solve nonlinear electronic and control systems problems; designing integrated circuits requires a firm understanding of distributed-parameter systems.

A few reservations

Handbook of Transistors,
Semiconductors, Instruments and
Microelectronics
Harry E. Thomas
Prentice-Hall Inc.
453 pp., \$20

It must first be said that this book does manage to cover an extremely wide range of subjects in a practical and generally useful way. It

FASTER THAN A HOLE A SECOND!

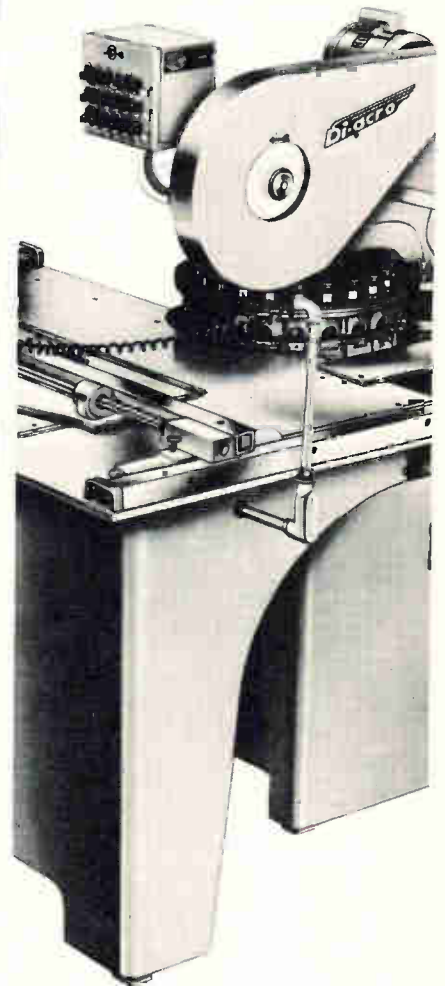

This is an 18 station turret punch press. Electrically linked to a floating stylus. Trace the template, touch the button—punch your holes.

The feather-touch stylus floats on recirculating ball bearings. Accurate within .005" of the template. Eighteen punch and die sets always ready, always perfectly aligned. Change setups fast as you can drop in a new template.

Capacity: up to 2" dia. hole in 14 ga. steel blank up to 19" x 24". Over 500 standard and "special" punches and dies from stock. Custom shapes to your order.

Call your Di-Acro distributor for the big 44-page Punching Catalog.



di-acro **DI-ACRO** division of
433 EIGHTH AVENUE
LAKE CITY, MINNESOTA 55041 

In hope of doing each other some good

Filters for the infrared

A small manufacturing operation in Rochester, N.Y. known from the trademark "Kodak" produces various kinds of filters for the infrared region of the electromagnetic spectrum. Though the trademark is generally associated with photography, these filters have little to do with photography. Direct photographic sensitivity ceases above 1.2μ in wavelength, whereas the booklet "Special Filters from Kodak for Technical Applications" describes mostly filters that start transmitting at this point or longer wavelengths.

Several of the polycrystalline KODAK IRTRAN Infrared Optical Materials make excellent substrates for interference filters to shape spectral distribution of infrared energy. That's one reason for us to be in the filter business. Another reason is to lend a hand in meeting filter requirements that companies bigger in the business may be too busy to fill.

The booklet also gives curves for our "hot mirrors" (filters that transmit in the visible and reflect in the near infrared), "cold mirrors" (vice versa, often

used behind a light source in a projection system), filters on AgCl substrate (strange, soft stuff) that open up at a choice of wavelengths from 1 to 6μ and remain open to 30μ (not interference filters), filters with conductive coatings, and interference filters on substrates other than Irtran materials.

Request Pamphlet U-73 from Special Products Sales, Kodak Apparatus Division, Eastman Kodak Company, Rochester, N.Y. 14650.

A \$300 investment

The Kodak School of Industrial Radiography limits classes to 16 students. Current location is near Atlanta, Ga. Expansion to other regions will soon occur. Tuition is \$300 for 80 hours of organized instruction. This includes over 25 hours of practical laboratory work. The 80 hours do not include overnight study assignments. Books and laboratory supplies are furnished.

Academic requirements for admission are minimal. For example, the inverse square law of illumination in-

tensity is not assumed to be something the student brings with him in his head but something he works out for himself. Visible light and ultraviolet simulate the hard stuff until the student reaches the point in the fortnight where he is ready for the real thing. Students don't all do the same laboratory exercises; doing different ones gives them the benefit of explaining their findings to each other. This school is up to date in more than physical facilities.

The final exam is a serious matter, comfortable as the surroundings may

be. It prepares for a subsequent examination, administered by an employer, by which is earned formal qualification as a Level I or Level II radiographer under the Recommended Practice of the American Society for Nondestructive Testing, Supplement A (Radiography).

Curriculum:

The radiographic process; characteristics of radiation; geometric principles; absorption and scatter; films and processing; sensitometry; image quality; penetrameters; codes and specifications; principles of welding; weld radiography; principles of casting; casting radiography; equipment selection; technique selection; electronic component radiography; radiation safety; film interpretation.

For list of dates write to Eastman Kodak Company, Department 741, Rochester, N.Y. 14650.



Let us gather the clan once again

On May 19 and 20 in Philadelphia we'll hold the Fifth Annual Kodak Photoresist Seminar. The year's developments in microelectronics fabrication technique with photoresists and high-resolution photography will be re-

viewed by our people and by speakers from other organizations. More of the latter than of the former. Candor, as in past sessions, will be the order of the day. Without it your travel expense to come would be harder to justify.

If you want to attend, drop a line to Frank Beuckman, Industrial Photo Methods, Eastman Kodak Company, Rochester, N.Y. 14650. If you wish he had notified you of the previous years' seminars, demand that he at least send you the notes on what you missed.

LOWEST COST . . . FULL WAVE BRIDGE RECTIFIERS & ASSEMBLIES

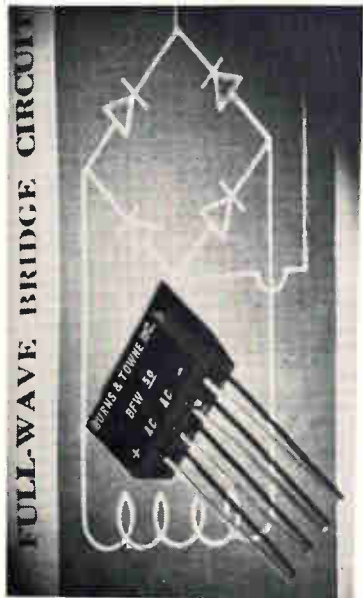

Burns & Towne pre-packaged rectifier circuits represent a significant cost savings over individual components used in multi-rectifier units. Yet, you are always assured of quality and reliability. The low cost BFW family of single phase full wave bridges . . . features high current capability of up to 2.0 amps.

Part No.	Max. PRV (volts)
BFW-50	50
BFW-100	100
BFW-200	200
BFW-300	300
BFW-400	400
BFW-500	500
BFW-600	600
BFW-800	800
BFW-1000	1000

Call or write for full specifications and price data.

BURNS & TOWNE INC.
SYSTEMS DIVISION 18-36 Granite St.
Haverhill, Mass. 01830, Tel (617) 373-1333

New Books

must also be noted, though, that details in some areas are on the technician level, and that some of the very latest techniques and developments aren't covered.

The first two chapters provide a standard treatment of semiconductor and transistor physics, closely following, in fact, the approach taken in the Army's 1959 technical manual on basic transistor theory. The next chapter, however, gives a brief but solid survey of semiconductor materials and junction formations. Also, a table introduces the novice to transistor geometry, and includes a cross-sectional view of a junction and a resistivity profile for 13 fabrication processes.

The section on "special" diodes describes tunnel, zener, and varactor types in some detail, but it hardly mentions step-recovery, Schottky, backward, noise, and avalanche transit-time devices. Gunn and LSA-mode diodes are left to a later chapter—but then are treated only briefly.

Again, in discussing transistor measurements, the author concentrates on the y-parameter and admittance-bridge techniques but ignores the newer method of scattering parameters. And some of the figures given for transistor ratings and characteristics don't come close to the values available today.

It's only fair to say, however, that many of these small criticisms stem from the very breadth of material covered and from the rapid pace of technological advance. For example, the chapter on microwave, photo, and thermal devices attempts to chart the gain, output power, and noise figures for microwave transistors versus frequency, but in this rapidly changing field it is just that—an attempt.

Certainly on the plus side is the book's treatment of large-signal and power amplifiers and its discussion of the design of high-frequency and wideband amplifiers. It covers parametric amplification in some detail and Hall generators thoroughly. Also, the book guides the uninitiated reader through the processing of alloyed, diffused, and

NEW SOLID STATE POWER PACKS

for
regulated
low voltage
applications
from

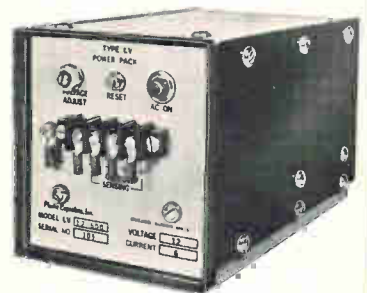

Plastic Capacitor's new LV Series Power Packs, ranging from 12 to 100 volts DC, offer an improved solution to today's system requirements. Models available with DC output voltages of 12, 24, 28, 36, 48, and 100 volts with power ratings of approximately 25, 50, 100 & 150 watts.

FEATURES INCLUDE:

- 0.01% LINE REGULATION
- 0.05% LOAD REGULATION
- 3MV PEAK TO PEAK RIPPLE AND NOISE
- NEGATIVE 0.015%/°C TEMPERATURE COEFFICIENT
- LESS THAN 0.2 OHMS OUTPUT IMPEDANCE
- TEMPERATURE OPERATING RANGE OF 0°C TO 55°C

For positive proof that good things come in small packages . . . check your power pack needs with Plastic Capacitors. Write for full engineering data today.

Plastic Capacitors INC.

2620 N. Clybourn Chicago, Ill. 60614
Tel: (312) 348 3735

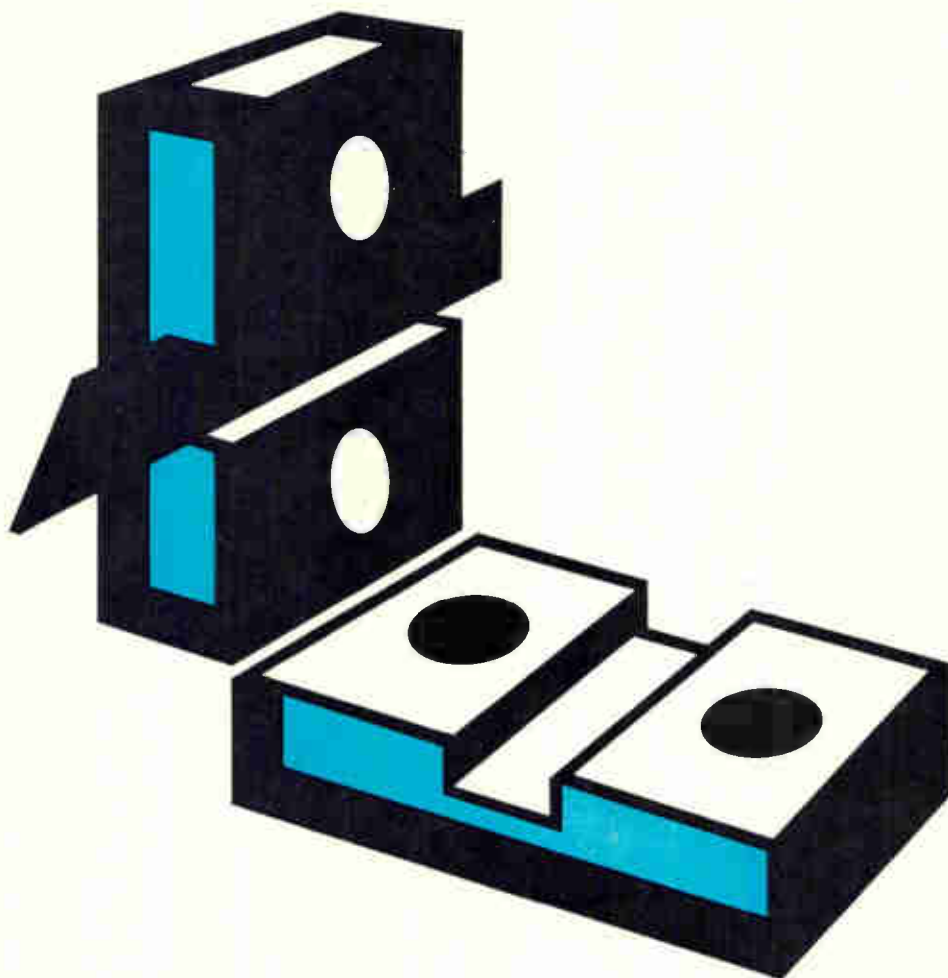

Kingpin

When it comes to controlling and conditioning signals in microwave and UHF systems, the HP Stripline PIN diode is far superior to glass and double-stud ceramic packages. Stripline techniques have the familiar advantages of small size, low weight and low cost, besides fewer parasitics and wider frequency range.

Hybrid integrated, this skinny diode has 20 dB isolation with only 0.5 dB insertion loss from 0.5 to 12.4 GHz—without additional matching structures or other compensating components. As usual, the exact amount of attenuation is controlled by the bias current. Without bias, or with reverse bias, it appears as just another part of the 50-ohm transmission line.

You can use this new PIN diode to limit, attenuate or modulate microwave power up to 18 GHz, at a price of \$25 each in small quantities. Ask your HP field engineer for detailed specs and quantity price quotations on the HP 5082-3040. Or write Hewlett-Packard, Palo Alto, Calif. 94304; Europe: 1217 Meyrin-Geneva, Switzerland.

HEWLETT  PACKARD

SOLID STATE DEVICES

01817A



the newest shape in receiving antennae

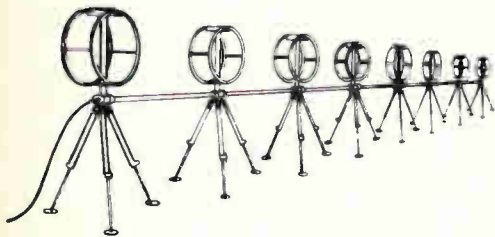

Aperiodic Loop Antennae... in an array composed of eight one-metre diameter untuned balanced loops spaced 13 feet apart... is the newest concept in "active" h.f. receiving arrays developed by E.M.I.

Each loop is fitted with a transistor pre-amplifier in its base, making possible a broad band (2 to 32 MHz) directional array much like a long-periodic or rhombic antenna. The system is only 30 metres long and a few feet wide. As it occupies but fraction of the space required for conventional passive fixed arrays, it is ideal for applications in areas of restricted space or when quick and simple set-up is important.

The new model 8E13 Aperiodic Loop Antenna Array has us rather excited. We would welcome the opportunity to tell you all about it in detail.

E.M.I. ELECTRONICS CANADA, LIMITED

Dartmouth, Nova Scotia, Canada

Mail: P.O. Box 1005

Phone (902) 466-7491

Cables: EMI CAN

New Books

mesa semiconductor types, and provides a chronological listing of transistor developments.

The chapter on integrated circuits isn't intended as an in-depth review of today's technology, but it does give the circuit-oriented engineer some insight into the design fundamentals.

And the appendix includes, along with the usual items, a list of laser types, the terminology of photo-optical measurements, and a rather complete glossary of semiconductor terms and definitions.

Recently published

Designing with Linear Integrated Circuits, Edited by Jerry Eimbinder, John Wiley & Sons Inc., 301 pp., \$10.95

Aimed at the design engineer, the book contains application information on a wide range of linear integrated circuits including operational amplifiers, power amplifiers voltage regulators, and r-f and i-f stages. Each section of the book is written by an expert.

Broadcast Station Operating Guide, Sol Robinson Tab Books Inc., 256 pp., \$12.95

This handbook explains in nontechnical terms how to set up a radio station. Information is provided on programing, accounting, advertising, and other matters concerning station managers and executives.

Micropower Circuits, James D. Meindl, John Wiley & Sons Inc., 260 pp., \$10.95

Written for the practicing engineer, this book deals with the problem of achieving a given electronic circuit function with a minimum expenditure of energy. Techniques for reducing the power drain of most types of transistor and integrated circuits by an order of magnitude are explained, and novel micropower design techniques are discussed.

Handbook of Transistors, Semiconductors, Instruments, and Microelectronics, Harry E. Thomas, Prentice-Hall Inc., 435 pp., \$20

This handbook describes the physics of operation, circuitry, and applications for almost every type of semiconductor device. The ratings and characteristics of components and devices are heavily emphasized because these are more frequently used by design engineers.

Phase-Space Dynamics of Particles, Allan J. Lichtenberg, John Wiley & Sons Inc., 331 pp., \$16

This monograph reviews phase-space concepts for beams, accelerators, and confined particles, together with descriptions of their relationship to basic theory.

Random Signal Analysis, Dwight F. Mix, Addison-Wesley Publishing Co. Inc., 271 pp., \$11.75

This book for the undergraduate or recent graduate aims to expand their basic knowledge of circuits to a comprehension of random signals. Fourier transform theory, probability, stochastic processes, and mean-square estimation and Wiener filter theory are covered.

MAKE WAVES



50 PPM/YEAR FREQUENCY STABILITY

The new μ Model 1705 Fixed Frequency Square Wave Oscillator offers 50 PPM/year, 10 PPM/°C frequency stability in a compact (3 in. H x 6 in. W x 9 in. D) package designed for use as a general purpose modulation source, or as a clock. The Model 1705 features 1000 Hz*, DC-coupled, symmetrical square wave, with current-limited output to minimize grounding loop transients and allow shunt clipping. Output level is variable, 0 to $\pm 12V$ at 12mA. Solid state and integrated circuitry is used throughout. Price? Only \$ 245, making μ standards-lab performance available to cost-conscious systems designers.

*Other frequencies available on special order.

See this and other Weinschel products at Booths 2L01, 2L02, IEEE Show, New York, March 24-27 and at Aisle 19, Booth 50, Salon International des Composants Electroniques, Paris, France, March 28-April 2.

For complete specifications, contact your μ representative, or write:

Designers and
Manufacturers of Precision
Microwave Equipment
WEINSCHTEL
ENGINEERING
Gaithersburg, Md. 20760
Tel: (301) 948-3434
TWX: 710-828-9705

If you think Iowa is just a cornfield... think again.

For a number of important reasons, Iowa's factories produce even more than her fields . . . reasons you should know. For information concerning Iowa's quiet industrial explosion, send the coupon.

(Confidential Reply Coupon)
IOWA DEVELOPMENT COMMISSION
Dept. E-3, 250 Jewett Building
Des Moines, Iowa 50309

Name _____

Firm _____

Address _____

City _____

State _____

Zip _____

Iowa Development Commission

250 Jewett Building - Des Moines, Iowa - Phone: (515) 282-0231

Ferrite Shielded Air Core Yoke C5380. Designed for high speed precision character displays (nanosecond writing speeds). Undesirable magnetic coupling and stray fields eliminated by unique shield design.



DESIGN DEVELOPMENT FROM *syntronic* THE YOKE SPECIALISTS

Syntronic engineers and manufactures the most extensive line of deflection yokes available . . . and continually develops new designs to satisfy the ever increasing requirements of the display industry. For large production or custom applications get the engineering control and production experience that only SYNTRONIC, the yoke specialists, can provide.



syntronic

INSTRUMENTS, INC.
100 Industrial Rd., Addison, Ill. 60101
phone 312-543-6444

Circle 271 on reader service card

Our Ultrasonic FACE Down Bonder welds semiconductor elements directly onto the substrates. With a minimum of time and utmost efficiency.

A cam-actuated horn fitted with a ball guide to assure precise welding and smooth chucking.

A vacuum substrate holder large enough for a 40mm x 40mm plate.

A half-mirror chip-dish to view the padded chip surface and the substrate pattern in the same scope field for simple and accurate positioning.



1969 IEEE Show Booth No. 3A06

You'll have a chance to examine this model, as well as other KEC products: Miniture FM Radiophone, Pocket Paging Receiver, Automatic Transistor Classifier, and etc.

Hope to see you.



KEC
KOKUSAI ELECTRIC CO., LTD.

9 NISHIKUBO-SAKURAGAWA-CHO, MINATO-KU
TOKYO-105, JAPAN

CABLE ADDRESS "SINESHIBA" TOKYO
TELEX: TOKYO 222-3277
PHONES: (03) 503-2211

Technical Abstracts

To agree

Environmental testing—the key to high reliability
R.L. Vander Hamm
Collins Radio Co.
Cedar Rapids, Iowa

Work with the MIL-STD-781 testing procedures (sometimes called Agree testing) for the past ten years, indicates that the Agree philosophy should be increasingly used not only by military contractors but also by commercial manufacturers. Besides improving product reliability, this test has shown that it reduces a manufacturer's development, production and support cost; furthermore it shrinks a customer's life-cycle costs.

The acronym stems from the Advisory Group on Reliability of Electronic Equipment, whose 1957 report was the basis of MIL-STD-781. Agree testing involves a new approach that demonstrates reliability to a statistical confidence under severe environmental conditions.

In a typical Agree test, the ambient temperature suddenly goes from the minimum rated value for the device under test to the maximum rated temperature, and then back down to the minimum where it's held for three hours. During this portion of the cycle, the device being tested is turned off. After three hours, the temperature goes to a maximum and stays there for five hours. During this time, the device is turned on and subjected to solid-mount vibration for 10 minutes every hour. The eight-hour cycle is repeated as often as 2,000 times. The device is accepted or rejected on the basis of a statistical evaluation of the number of failures and of on-time data.

Some questioned the severity of the test procedure when the military started writing Agree testing into military contracts in 1958. But the test procedure has won most skeptics over; the continual cycling of temperature, it appears, is a speeded-up simulation of actual field conditions. Inherent weaknesses in circuit design, material and workmanship show up quickly. The result is an increased predic-

JAPAN ELECTRONICS SHOW → '69,'70

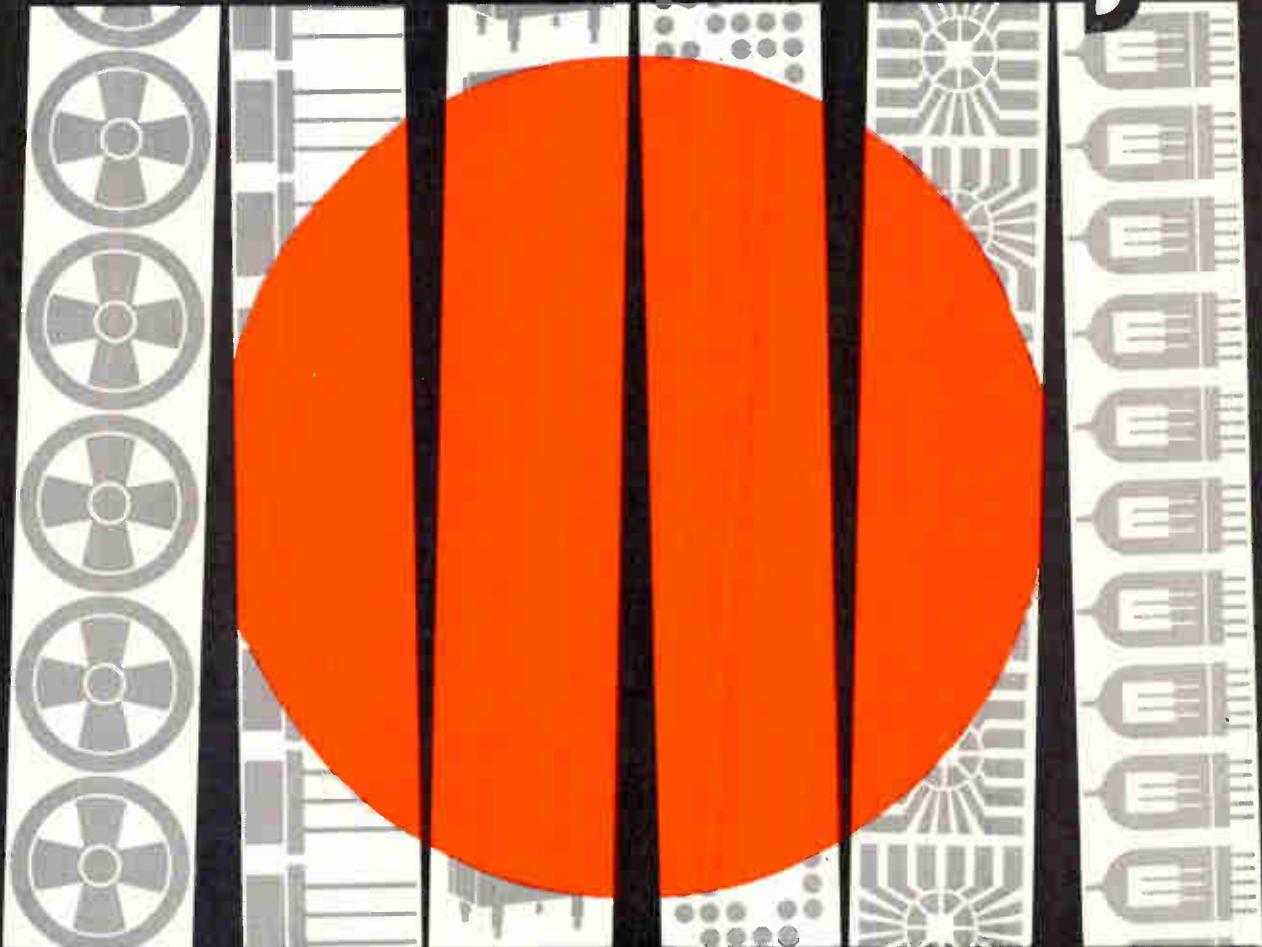

NOW JOT DOWN TWO DATES

Of special interest to you.

The dates for the next two forthcoming Japan Electronics Shows (popularly known as the J.E.S.) are: October 1-7, 1969 in Osaka, and early April, 1970, in Tokyo.

People in electronics all over the world now know that J.E.S. is the place where they can see the latest in electronic consumer and industrial products—as well as components.

We have become truly international...with an increasing number of foreign participants in our show, and an ever increasing number of visitors from abroad, each and every year since 1962.

This is an excellent opportunity for you to keep abreast of the constantly developing achievements in the field of electronics. Don't miss your J.E.S.

■ ELECTRONIC INDUSTRIES ASSOCIATION OF JAPAN

■ JAPAN ELECTRONICS SHOW ASSOCIATION
Tocho Bldg., 3-14, Marunouchi, Chiyoda-ku, Tokyo, Japan

■ Electronic Sec.,

JAPAN LIGHT MACHINERY INFORMATION CENTER
437, 5th Avenue, New York, N.Y.



Founder of a New Generation.. Sharp



CS-32C



As the world's first maker of IC calculators our claim is justified. Also being the largest producer we can offer a complete line of them. Any one will handle your time-consuming calculations in a fraction of the time you now take. Select the most suitable model.

Sharp's CS-32C, the 'Everything' calculator for scientific and business use. Silently calculates up to 16 digits and 8 decimal places. Has two memory banks for wide calculation versatility. Carries out square root extraction, exponent and mixed calculations instantly. Automatic successive multiplication and division by a constant. Fully automatic decimal system, automatic round off and credit balance. Only 14.5 lbs.



CS-17C

Adds, subtracts, multiplies and divides in milliseconds. Successive multiplication and division by a constant. Automatic decimal system. Two registers. 12 digit 6 decimal place capacity. Easy-to-read display panel. Only 8.8 lbs.



CS-22C

Fourteen digit 6 decimal place capacity. Automatic decimal and half-cent round off system. Credit balance. Two working registers plus a memory bank. Memory indicator, over-capacity error light. Silent, versatile and very elegant. Just 8.8 lbs.

Call on us; IEEE Booth 4F-20

SHARP

HAYAKAWA ELECTRIC CO., LTD. Osaka, Japan

U.S. Subsidiary: SHARP ELECTRONICS CORP. 178 Commerce Road Carlstadt, New Jersey

When Only Excellent is Adequate **TURN** to Grayhill

for **TOTALLY ENCLOSED ROTARY SWITCHES.**
TEMPERATURE TO 125°C. MULTI-POLE.
30°, 36°, 45°, 60°, and 90° ANGLE OF
THROW. 100,000 OPERATIONS.

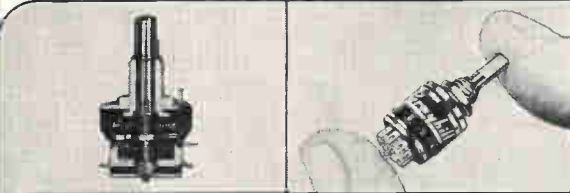

... the Difference Between
Excellent and Adequate

Typical Specifications

- Explosion Proof
- Contact Resistance 10 Milliohms
- Make or Break ¼ Amp. to 15 Amps., 115 VAC Resistive
- 1 to 6 Poles per Deck
- 2 to 12 Positions per Pole
- 1 to 12 Decks

Send for Engineering Catalog G-304-A



523 Hillgrove Avenue
LaGrange, Illinois 60525
Area Code 312, Phone 354-1040

"PIONEERS IN MINIATURIZATION"

Circle 272 on reader service card

When Only Excellent is Adequate **TURN** to Grayhill

for **MINIATURE
PUSH BUTTON SWITCHES**

- WIPING, SNAP ACTION and BUTT CONTACTS.
- SPST, SPDT, DPST, DPDT.
- PUSH-PULL — LIGHTED.
- 25,000 to 1,000,000 OPERATIONS.



... the Difference Between
Excellent and Adequate

Select Materials

- Contacts — Fine Silver
- Springs — Tinned Music Wire
- Housing — Molded Phenolic per MIL-M-14
- Shorting Bar & Terminals — Fine Silver or Silver Plated Copper Alloy

Typical Specifications:

- ¼ Amp. to 10 Amps., 115 VAC Resistive
- Contact Resistance 10 Milliohms
- Insulation Resistance — 25,000 to 900,000 Megohms

All fully described in Engineering Catalog G-304-A
Write



523 Hillgrove Avenue
LaGrange, Illinois 60525
Area Code 312, Phone 354-1040

"PIONEERS IN MINIATURIZATION"

**T.C. of $\pm 20\text{ppm}/^\circ\text{C}$,
std. tolerance of 1%**
in new models of DIPLOHMATIC
POWER RESISTORS
with welded terminations

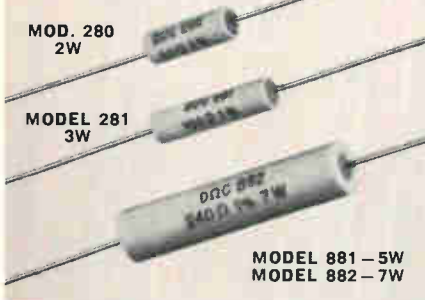

PRECISION WOUND on ceramic cores, with welded terminations. Ceramic sleeves, zircon sand filled. Values from 1Ω . Available in standard tolerances of $\pm 1\%$ to 0.1% . Production delivery 2 to 4 weeks. Price from 36¢ in 100 quantity.

FREE 12-PAGE CATALOG shows full line of wire-wound Diplohmic resistors, 1 to 40W, also trimming potentiometers. Representatives in principal cities. Write Diplohmic Division—

HARRY LEVINSON CO.

1211 E. Denny Way, Seattle, Wash. 98122
Tel. (206) 323-5100 TWX 910-444-2154

Circle 264 on reader service card

MICO

Pneumatic Controlled Drill Press Assembly

**MANUAL CONTROLLED
MODELS ALSO
AVAILABLE**

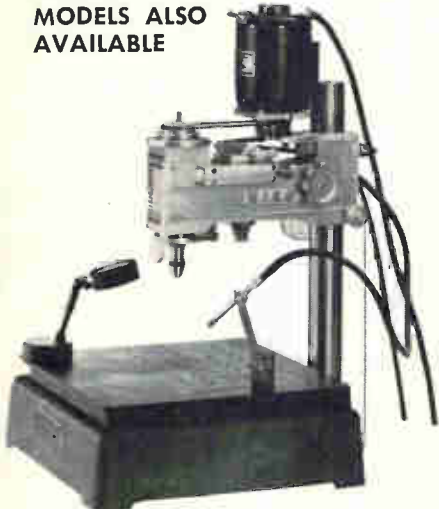

FEATURES OF PRECISION DRILL PRESS

- | | |
|-------------------|------------------------|
| Sensitive | Quick Spindle Response |
| Accurate | Only 50-75 lb. Air |
| Wide Range | Needed |
| Keyless Chuck | 7500 to 10,000 r.p.m. |
| Dual Air Controls | Motor |
| Sturdy | Air-Mist System |
| Easily Adjusted | Available |

Send for Illustrated Catalogs

MICO INSTRUMENT CO.

77 Trowbridge St. Cambridge, Mass. 02138

Technical Abstracts

tion of mean-time-between-failures for electronic equipment, from 25% to 50% over older standards, at the time the equipment is introduced to the field.

To give two examples, military uhf airborne transceivers were cycled between -54°C and $+71^\circ\text{C}$ and received a mean of 50 hours; Agree testing then pointed to material and design weaknesses that were corrected. In a second series using this test procedure, the prediction was 420 hours.

Before Agree came into being, commercial airlines using certain vhf transceivers reported failures averaged 200 hours. Production units then underwent Agree testing. All four failed during the first cycle. Redesign has boosted its life to 2,000 hours.

After ten years of Agree, the following general statements can be made about failure analysis. Well designed parts and materials can withstand Agree testing. Some types of parts are more susceptible to Agree failure than others; fine wires and miniature parts using ultrasonic and thermocompression bonding are the most susceptible. New part types should be Agree tested before being put into production equipment.

Agree cycling also serves as a burn-in technique. Besides boosting reliability, Agree burning immediately detects the occasional bad lot of vendor parts.

Presented at the Symposium on Reliability, Chicago, Jan. 21-23.

Long live beam leads

Reliability of beam-lead, sealed-junction devices

D.S. Peck
Bell Telephone Laboratories
Allentown, Pa.

The life spans of npn transistors and bipolar integrated circuits aren't shortened by the use of beam leads and junctions sealed with silicon nitride. Quite the contrary: accelerated life tests show that the failure rate of 0.001% per 1,000 hours possible with conventional planar units can be achieved with beam leaded devices, without

**LOW
COST
AUTOMATION
takes
many
forms**



Our famous plug-in Cycl-Flex® electromechanical and solid state time and count controls cut down-time... are replaceable in 5 seconds or less.

Get the facts on these and 560 other forms of low-cost automation. Send for Catalog 15.

GW Eagle Signal Division
E.W. Bliss Company
Davenport, Iowa 52803
A GULF + WESTERN COMPANY

**Service-In-Depth...
Local Engineering, Stock, Repair**

Circle 274 on reader service card

Circle 225 on reader service card

225

CARBON COMPOSITION AND WIRE-WOUND POTENTIOMETERS

Other LESA products
for electrical industries:

- Fractional HP Electric Motors
- Record Players and Record Changers
- Phonographic Piezo-electric Cartridges

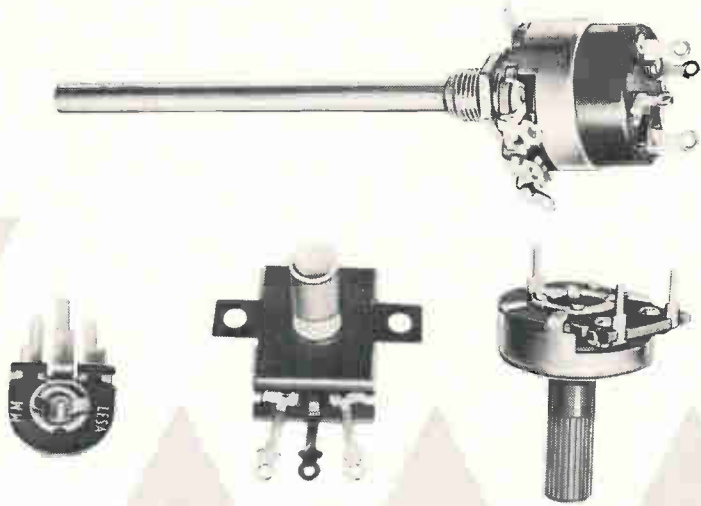

LESA

LESA OF AMERICA CORP. - 521 Fifth Avenue - NEW YORK, N.Y. 10017 (U.S.A.) - Tel. 212 697-5838
 LESA COSTRUZIONI ELETTROMECCANICHE S.p.A. - Via Bergamo, 21 - MILANO (Italia) - Tel. 554.341
 LESA DEUTSCHLAND GMBH - Wiesentalstrasse, 10 - 78 FREIBURG i/Br. (Deutschland) - Tel. (0761) 44 0 10
 LESA ELECTRA S.A. - Viale Portone, 27 - 6500 BELLINZONA (Svizzera) - Tel. (092) 5 53 02
 LESA FRANCE S.A.R.L. - 19, Rue Duhamel - 69 LYON 2 (France) - Tel. (78) 42 45 10

Circle 275 on reader service card

How good are your contacts?



Everybody knows that dirty contacts on relays, connectors and module board edges cause erratic operation. But what to do about it? Spray them clean—in seconds—with MS-230 Contact Re-Nu.

MS-230 Contact Re-Nu restores full electrical continuity instantly on all types of contacts. You can't keep dirt, grease and erosion dust from forming on contacts, but you can flush them away quickly and safely with this specially formulated solvent. Many telephone companies, airlines and a major broadcasting network prescribe MS-230 Contact Re-Nu for regular preventive maintenance.

Write on company letterhead for free 16-oz. sample. For literature only, use bingo card.

ms miller-stephenson
chemical co., inc.

ROUTE 7, DANBURY, CONNECTICUT
*U.S. and foreign patents pending

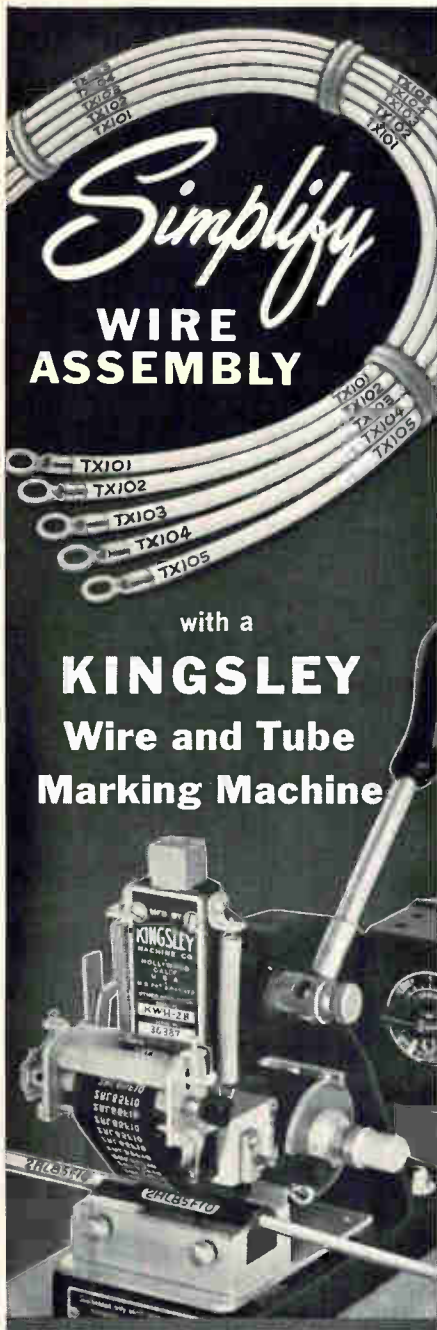

Simplify
**WIRE
 ASSEMBLY**

with a
KINGSLEY
Wire and Tube
Marking Machine

Now you can mark each wire or piece of plastic tubing with its own circuit number... quickly... economically, right in your own plant.

You reduce wire inventories because you need only one color of wire for as many circuits as necessary.

Simplify your assembly methods and speed production with the same machine that has proven so successful in the aircraft and missile field. Write for details.

KINGSLEY MACHINES
 850 Cahuenga • Hollywood 38, Calif.

Technical Abstracts

the need for expensive encapsulation or relatively low junction temperatures.

With the beam-lead technique only recently applied to IC's, transistors, and diodes the sensitive silicon surface isn't sealed from the atmosphere by vacuum-tight encapsulation. Instead, a silicon nitride layer is laid over the planar silicon oxide and over a multi-layer contact of platinum silicide, titanium, platinum, and gold. This contact provides the base for the plated gold leads and extend beyond the edge of the separated silicon chip to bond the chip to thin-film circuitry. Both the junction seal and the electrical and mechanical interconnections can be made by inexpensive batch processing.

The transistor and IC's tested had median lives of about 10,000 hours at a junction temperature of 300°C under power or with reverse bias. The failure mechanism was generally a penetration of the silicon by platinum from the contact, shorting the junction. This process has an activation energy of 1.8 electron-volts, higher than the 1.1-electron-volt energy of the mobile-ion-generated surface degradation common to conventional transistors.

In the tests, surface degradation didn't appear at 10,000 hours in tests down at 250°C, indicating that the beam-lead units can be appreciably more than even high-quality conventional devices.

Annual Symposium on Reliability, Chicago, Jan. 21-23.

POC makes its mark

Physics of control of electronic devices
 C.Y. Ang, P.H. Eisenberg and H.C. Mattraw
 Autonetics, Anaheim, Calif.

Everybody knows that reliability can't be built into an integrated circuit or transistor; it has to be tested in. Unfortunately, many system manufacturers still rely primarily on massive statistical programs and postmortem analyses. Autonetics, however, has attempted

**LOW
 COST
 AUTOMATION
 takes
 many
 forms**



New plug-in Cycl-Flex 2 & 3 digit totally solid state I/C counters. 100% accurate. Up to 1200 counts per minute. Available in higher count rates. Easy-to-set thumb wheels.

Get Catalog 15, describing these and 560 other forms of low-cost automation.

GW Eagle Signal Division
 E.W. Bliss Company
 Davenport, Iowa 52803
 A GULF + WESTERN COMPANY

**Service-In-Depth ...
 Local Engineering, Stock, Repair**



UNIVERSAL AD-YU AUTOMATIC PHASEMETER

TYPE 406

**ANALOG OUTPUT FOR
AUTOMATION . . .**

**INDEPENDENT OF INPUT
FLUCTUATIONS . . .**

IEEE SHOW BOOTHS 2J41-2J43

- **ABSOLUTE ACCURACY LESS THAN 1°**
- **1/4° RELATIVE ACCURACY**
- **SENSITIVITY 0.05V FOR 406/L**

- **406H 8 Hz - 500 KHz**
- **406L 1 Hz - 100 KHz**

DESIGNERS AND MANUFACTURERS OF PRECISION PHASEMETERS, PHASE STANDARDS, PHASE DETECTORS
FROM AUDIO TO GHz; DELAY LINES AND ACCESSORIES

UNIVERSAL AD-YU ELECTRONICS, INC., PASSAIC, N. J. 07055

249 TERHUNE AVENUE

PHONE (201) - 472-5622

CABLE: ADYU PASSAIC

A SUBSIDIARY OF UNIVERSAL TELEPHONE, INC.

Circle 280 on reader service card



Perfect your CCTV system with **COSMICAR®** lenses

Shown are a few selected at random from COSMICAR lenses ranging from 8.5mm to 1,000mm and zooms.

COSMICAR is also prepared to custom-make lenses of any specifications.

Please write today to:



COSMICAR OPTICAL CO., LTD.

(Former name: ICHIZUKA OPTICAL CO., LTD.)

568, Shimoochiai, 2-chome, Shinjuku-ku, Tokyo Cable Address: "MOVIEKINO TOKYO"

ECONOMICAL Thin Film!

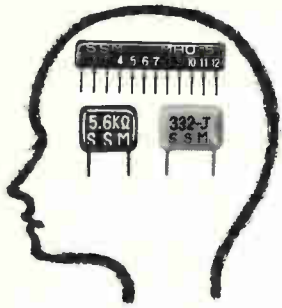

What's needed for memory system is everlasting high accuracy. SSM's components are the very ones satisfying superior reliability.

- Plate-ohm: evaporated metal film resistor
- Pla-module: thin film modulated C-R circuit
- Pla-con: organic thin film capacitor by plasma reaction

SUSUMU INDUSTRIAL CO., LTD.

Minami Bldg. 1-12 Ebisuminami
Shibuya-ku, Tokyo, Japan
TEL: Tokyo (03) 712-5990
TELEX: No. 246-6270

Circle 277 on reader service card

Technical Abstracts

to give more than lip service to the concept of built-in reliability by conducting a "physics of control" (POC) program with these goals:

- Characterizing, in depth, the good, qualified parts.
- Establishing relationships between the chemical, physical, and electrical properties.
- Determining allowable ranges for the various parameters.
- Recommending corrective action.

The over-all purpose of the POC program, of course, is determining and controlling product homogeneity within a lot, from lot to lot, and among the suppliers of the same device. It's chiefly *an priori* endeavor aimed at producing results during the period in which the supplier and its products are being qualified. After the device has been qualified and while it's being procured and assembled in the system, the POC program becomes a small sustaining effort of a "policing" nature.

In the preliminary Autonetics POC program, hundreds of units of 15 device types were studied; these included conventional IC's, dual, signal, and power transistors, and microdiodes. All units had passed established quality-control tests and were accepted as good production parts for system assembly. Histograms were constructed from test data for all specification parameters, and these revealed a degree of inhomogeneity that could lead to degradation and eventual failure of the devices in the field. Comparisons between manufacturers of the same device could also be made from the histograms.

It was even possible to use the histograms to correlate some of the anomalies—electrical, physical, chemical, or metallurgical. The statistical analysis made it possible to set allowable ranges of critical parameters for specifications and to decide on corrective action.

The test procedures used to evaluate the devices electrically were standard ones. Similarly, the destructive tests were conventional—metallography, surface topography, microplasma observation, microprobe analysis, electron micro-

LOW COST AUTOMATION takes many forms

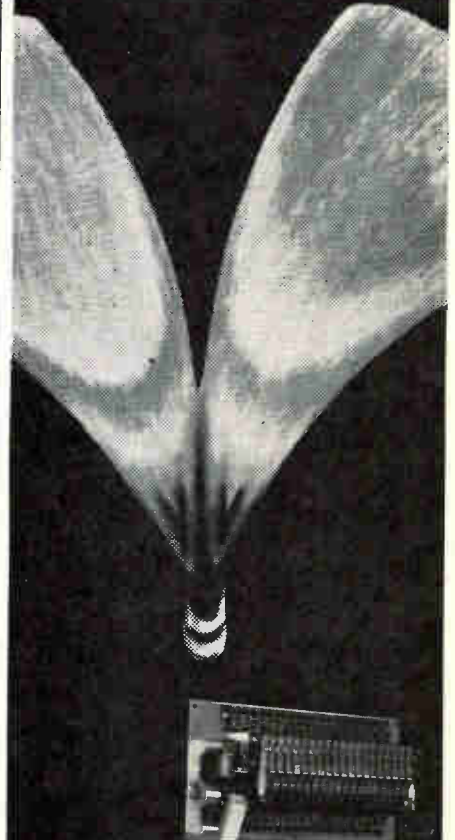

With this super-simple MT Sequence Programmer you control up to 19 independent 10 amp load circuits in a predetermined sequence with random inputs. The MT isolates... interlocks... remembers... it's almost a computer. Should be the beginning of every control circuit design... eliminates many costly components.

Send for new Bulletin 910

GW Eagle Signal Division
E.W. Bliss Company
Davenport, Iowa 52803
A GULF • WESTERN COMPANY

Service-In-Depth...
Local Engineering, Stock, Repair

NOW! APPLY KODAK PHOTO RESISTS this new AEROSOL way



QUICK
CONVENIENT
ECONOMICAL

Three types to suit all your etching needs now available at local industrial photo dealers

TYPE-P containing Kodak KPR* —for copper, copper-clad laminates, other metals. 16 oz. \$5.95

TYPE-M containing Kodak KMER* —for aluminum, stainless steel, titanium, other metals. 16 oz. \$5.95

TYPE-T containing Kodak KTRF* —for high resolution etching of thin films. 16 oz. \$6.95

*KPR, KMER, KTRF are products of Eastman Kodak Co.

INDUSTRIAL CHEMICAL SPECIALTIES CORPORATION
75 Hillside Rd., Fairfield, Conn. 06430

Please rush me more information on Spray Resist products and, also, name of nearest dealer:

NAME _____
COMPANY _____
CITY _____ STATE _____

Circle 278 on reader service card

Circle 229 on reader service card

229

Discover the Japanese Exhibits at the IEEE Show



And visit us October 1-7
in Osaka, Japan
for the Japan Electronics Show.

ELECTRONIC INDUSTRIES ASSOCIATION OF JAPAN

Write for our free 172 page Guide to recent Japan Electronics Show product listings.
Electronics Division—Japan Light Machinery Information Center
437 5th Ave., New York, N.Y. 10016 • (212) MU 6-0731

Circle 279 on reader service card

Will you be in New York for the IEEE Show?

*Let's talk over a rewarding
career in Connecticut.*

Call Hamilton Standard's
representative in New York
at 212-765-9104
Monday through Friday,
March 24 through 28.



APPLICATIONS ENGINEERS **SYSTEMS ENGINEERS**
LOGIC DESIGNERS **TEST ENGINEERS**
CIRCUIT DESIGNERS **RELIABILITY / MAINTAIN-
ABILITY ENGINEERS**
PACKAGING, Electronic **SYSTEMS DESIGN AND**
Design Engineers **ANALYSIS (software)**

Airborne Integrated Data Systems Digital Flight Controls Airborne Environmental Control Systems
Aircraft Signal Multiplexers Electronic Engine Controls Special Purpose Computers, Airborne Sensors
and Indicators Inertial Gyros • Biomedical Products Guidance and Control Systems Graphic Display
Systems Special Purpose Automatic Check-Out Equipment

Take this convenient opportunity to investigate the personal growth potential at this dynamic, expanding multi-product company. We are seeking creative, aggressive, responsibility-minded individuals who want to put their career in high gear. Have you experience or interest in one of the following product areas?

An Equal Opportunity Employer

If you are unable to interview with us now, please forward your resume, stating present salary, to Mr. R. S. Wellington, Personnel Department, Hamilton Standard, Windsor Locks, Connecticut 06096.

**Hamilton
Standard**

**U
A®**
DIVISION OF UNITED AIRCRAFT CORPORATION

Technical Abstracts

scopy, and analysis of ambient gases.

However, several novel testing schemes were developed during the investigation. In leak detection, for example, an experimental setup using inoculants such as sulphur hexafluoride or pentane was found to be a promising analytical method. In the study of cracks in semiconductor chips, a strain-gage technique was developed for tracing the stress history during the production of small semiconductor devices. A laser orientation system for precision-angle-positioning of devices for sectioning, angle-lapping and metallography was developed; this system should be useful in solid state materials research as well as in failure analysis.

Although the Autonetics task force had fairly clear ideas of what to look for and what scientific capabilities to use, it did not foresee the organizational problems that cropped up when the multitude of technical disciplines at the Aerospace Systems Group were pooled. Developing a practicable organization proved to be a major hurdle.

One important conclusion was the need for reducing product inhomogeneity in many electronic devices. But there is much to be done before this problem can be pursued further and corrected; diagnostic tools such as electrical dynamic displays, isolation electrical probing, and microplasma observation have to be further developed.

Some of the group's work has already produced practical results. Even with small samples, the insight obtained by studying ambient-gas compositions and package design, and by static and dynamic radiography, has been used to correct production procedures.

Although the researchers observed some correlation between materials characterization and electrical parameters, they feel that more data is needed before the correlation can be used to control product homogeneity. They regard their studies of diffusion profiles, lattice imperfections, and surface effect as preliminary.

Presented at 1969 Symposium on Reliability, Chicago, Jan. 21-23.

a double gun 15 MHz Scope for \$774*

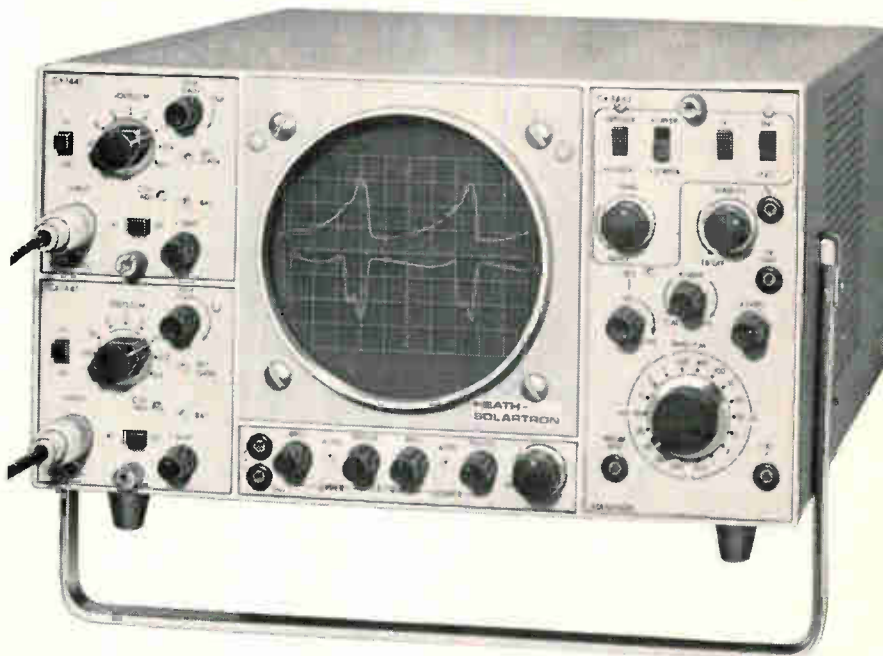

Heath/Solartron CD-1400 Series

Main Frame \$450*

Plug-Ins \$91* up

The Heath/Solartron CD-1400 is more than a portable, general-purpose, true dual-beam oscilloscope: it is a fully modular system of vertical amplifiers and time bases to fill your measuring requirements with unmatched flexibility. The 5" CRT, coated with P31 phosphor, operates at 4 kV to give you high resolution and bright displays. Viewing area of the graticule is 8 by 10 cm. Separate gun assemblies, positioned vertically to minimize geometric distortion, have separate focus and brilliance controls. Available in factory assembled and tested form only.

The CD-1400 shown above with two CX-1441 Wide-Band Amplifiers and a CX-1443 General Time Base and X Amplifier features:

- DC to 15 MHz bandwidth
- 24 ns rise time
- 9 sensitivity ranges from 100 mV/cm to 50 V/cm (10mV/cm, DC to 750 kHz with switched x10 gain)
- 18 calibrated sweep ranges from 0.5 us/cm to 200 ms/cm in a 5, 2, 1 sequence (a continuous uncalibrated coverage up to 500 ms/cm gives a 5 s sweep)

- $\pm 5\%$ accuracy
- x1 to x5 expansion
- Int, Ext, +, -, Normal, Auto, HF Sync Trigger Modes . . . all for just \$774

A sensitivity of 100 uV/cm is available up to 20 kHz, increasing to 1 mV/cm up to 75 kHz by plugging in the CX-1442 High Gain Differential Amplifier.

High frequency low level signals in the presence of large in-phase signals can be displayed with the CX-1449 Wide Band Differential Amplifier featuring 10 mV/cm sensitivity on the DC-10 MHz bandwidth.

Variable sweep delay to 100 ms is provided on the CX-1444 Sweep Delay Time Base.

DC external trigger, DC coupled X input and Single Shot are available on the CX-1448 Wide Range Time Base which has 20 ranges from 0.5 us/cm to 1 s/cm extendable to a 25 s sweep.

The modular design of the CD-1400 system protects it against obsolescence and gives greater measurement capability customized to your needs at an unassuming price: the main frame costs only \$450, plug-ins start at \$91.

For more information send for the NEW HEATH Scientific Instrumentation Catalog



HEATH COMPANY, Dept. 520-28
Benton Harbor, Michigan 49022

Please Send Free New Scientific Instrumentation Catalog

Name _____

Company _____

City _____ State _____ Zip _____

Prices & specifications subject to change without notice.

*Mail order prices; F.O.B. factory.

TE-196

Communications & industry vote NEC microwave diodes & transistors tops in the semiconductor field.

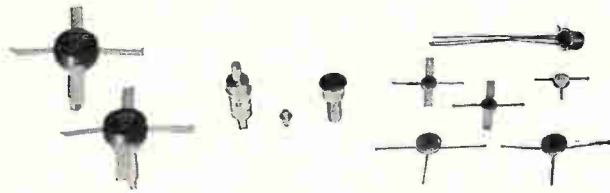

High Power Microwave Transistors

Gunn Diodes and Impatt Diode

Small Signal Microwave Transistors

Naturally. Since these NEC components prove their high reliability in actual performance in hyper-high frequency oscillators and extreme low-noise broadband amplifiers.

Microwave Diodes

Classification	Type No.	Applications and Remarks
GUNN DIODE	GD408A~E	Local Oscillator in Microwave
	GD411A~E	Communication Systems, Portable
	GD508A~D	Radars, Microwave Measuring
	GD511A~E	Instruments, and many advanced uses,
	GD514A~E	replacing Low Power Klystrons and
	GD518A~C	Harmonic Generator Chains.
IMPATT DIODE	AD611A~C	Switching voltage ratio: 25 (typ.) Po: 30 mW min.~200 mW min. Operating Freq.: 6~21 GHz. γ : 2.0% (typ.)
		Local Oscillator in Microwave and Space Communication Systems. Po: 300 mW min.~500 mW min. Operating Freq.: 8~13 GHz. γ : 4.0% (typ.)

Microwave Transistors

Classification	Type No.	Applications and Remarks	
Small Signal	2SC800	RF Amplifier in L-Band fr: 800 MHz.(Standard) Low-Noise, NF: 5.0 dB at 900 MHz.	
	2SC985	RF Amplifier and Oscillator in L~S-Bands. Extremely High Gain Bandwidth Product, fr: 3.2 GHz.	
	2SC986	Gp: 9.5 dB, NF: 5.3 dB at 2 GHz. High Signal Level Amplifier and Oscillator in Industrial and Communication Services. Gp: 5 dB at 2 GHz.	
	2SC987	Posc.: 300 mW at 2.0 GHz. fr: 2.5 GHz. Low Noise Amplifier and Oscillator in S-Band. Extremely High Gain Bandwidth Product, fr: 4.5 GHz.	
	2SC988 2SC988A 2SC988B	Gp: 5 dB, NF: 9 dB at 4 GHz. Low-Noise Applications for L-Band in Industrial and Communication Services	
	2SC989	fr: 3.5 GHz. Gp: 25 dB at 500 MHz. NF: 2.5 dB, 2.0 dB, 1.5 dB (Depending on Suffix) at 500 MHz. Ultra-High Speed Current Mode Switching Applications in Industrial and Communication Services. fr: 3.2 GHz. Switching Turn-on Time, ton: 0.8 ns. Switching Turn-off Time, toff: 0.9 ns.	
	High Power	V575	High Power Amplifier for 2 GHz-Band in Industrial and Communication Services. Po: 1.4 W, Gp: 3.5 dB at 2.3 GHz. Rth: 20 °C/W
		V643	High Power Amplifier for 2 GHz-Band in Industrial and Communication Services. Po: 800 mW, Gp: 5.0 dB at 2.3 GHz. Rth: 40 °C/W

Please visit us at the IEEE Show, Booth #3B-01, 02

Sales Engineers and Stocking Representatives in U.S.A. & Canada:

CALIFORNIA EASTERN LABORATORIES, INC.

1540 Gilbreth Road, Burlingame, Calif. 94010
Tel: (415) 697-6670 Telex: 03-4282

87 Terrace Hall Avenue, Burlington, Mass. 01803
Tel: (617) 272-2300

Sole Agent in West Germany:

FIRMENGRUPPE ROEDERSTEIN

DITRATHERM TÜRK & CO. KG.

8300 Landshut/Bay. Ludmillstr 23/25

Telegramme: DITRATHERM Landshut/Bayern

Telefon: Sammelnummer 3085 (Ortskennzahl 0871)

Telex: Nr. 058 246 (Erola)

Products for today—
Innovations for tomorrow

NEC
Nippon Electric Co., Ltd.

P.O. Box 1, Takanawa,
Tokyo, Japan

Measure phase easily, directly, and accurately

ACCURACY $\pm 1^\circ$ WITH LARGE SIGNAL-TO-REFERENCE RATIOS ... $\pm 0.5^\circ$ WITH SMALL SIGNAL-TO-REFERENCE RATIOS ■ CONTINUOUS 0° TO 360° READINGS ■ EXPANDED SCALES FOR ACCURATE AND EASY READING ■ ACCURACY INDEPENDENT OF ANGLE ■ DIGITAL RATIO-METRIC READOUT AVAILABLE ■ ACTON LABS' 329B PHASE METER.

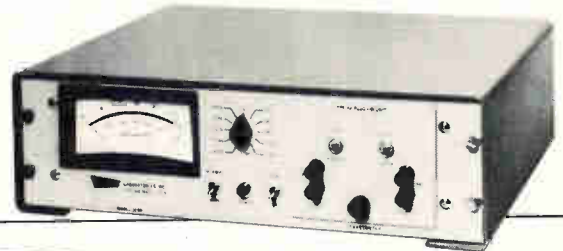

BOWMAR

ACTON LABORATORIES, INC.

A Subsidiary of Bowmar Instrument Corporation

531 Main Street • Acton, Mass. 01720 • (617) 263-7756

Circle 281 on reader service card

di/dt capability
10 times industry's best
EVEN WITH LOW POWER GATE DRIVE

NATIONAL® INVENTS THE REGENERATIVE GATE® SCR



NATIONAL ELECTRONICS, INC. regenerative gate SCR is the only SCR that will give 600 amps/ μ sec. when tested according to JEDEC SUGGESTED STANDARD NO. 7 Section 5.1.2.4. This is a di/dt rating at three times the peak on-state current and 1/2 the switching loss of any SCR now on the market. No sacrifice is required in gate drive, turn-on time, turn-off time or any other characteristic. Now available in 55 and 110 amps. *Patent Pending

NATIONAL
ELECTRONICS, INC.

REQUEST BULLETIN

a varian subsidiary

PHONE: (312) 232-4300 • GENEVA, ILLINOIS 60134

New Literature

Coldweld crystals. CTS Knights Inc., Sandwich, Ill. 60548. Data sheet 014-1002-0 covers three basic types of precision coldweld crystals. Circle 446 on reader service card.

Modular cabinetry. Apparatus Controls Division, Honeywell Inc., 2727 S. Fourth Ave., Minneapolis 55408, has issued a 28-page catalog on the series 40 Modu-Mount modular cabinetry designed for rack-mounting electronic, radar, and other sensitive equipment. [447]

Computing system. Electronic Associates Inc., West Long Branch, N.J. 07764, has available bulletin 852519 describing and illustrating the 7800 analog-hybrid computing system. [448]

Phototransistors. Motorola Semiconductor Products Inc., P.O. Box 20924, Phoenix 85036. Application note AN-440 is a 12-page introduction to the theory and characteristics of phototransistors. [449]

Alternator winder. Adamatic Inc., 6169 Industrial Court, Greendale, Wis. 53129, has released a catalog page describing the model AW-101 alternator winder that features 90-per-hour production. [450]

Induction heating. Cycle-Dyne Inc., 134-20 Jamaica Ave., Jamaica, N.Y. 11418, has issued an illustrated brochure on various induction heating applications. [451]

Modular pcm systems. Radix Telemetry Corp., 184 E. Liberty Ave., Anaheim, Calif. 92801, has published an eight-page brochure containing a complete description of its modular pulse code modulation telemetry systems. [452]

Power supplies. Velonex Division of Pulse Engineering Inc., 560 Robert Ave., Santa Clara, Calif. 95050. Twelve-page bulletin V-50 covers a complete line of rugged and compact d-c to d-c power supplies [453]

Photometric accuracy calibrator. Beckman Instruments Inc., 2500 Harbor Blvd., Fullerton, Calif. 92634. Bulletin 7141 covers a photometric accuracy calibrator for use with the company's IR-4, IR-9, and IR-12 spectrophotometers. [454]

Ordinate holding switch. Cunningham Corp., Honeoye Falls, N.Y. 14472. Bulletin 604 describes the capabilities, operational characteristics and applications of the ordinate holding switch. [455]

Air trimmer capacitors. Voltronics Corp., West St., Hanover, N.J. 07036. Information and data vital to users of air dielectric trimmer capacitors are



Pfizer Research advances the science of sound and image recording.

The phenomenon of magnetism, which occurs naturally in some minerals, was known to the Greeks six centuries before Christ. Yet it remains perhaps the least understood of all forces.

For example, how *can* a thin coating of special iron oxides—on any of many base materials—reproduce with high fidelity almost the entire range of sound and visual communications?

Pfizer probably knows as much about this mystery as anyone, since we've pioneered in magnetic recording for over 20 years. Not in making tapes, drums, and discs except for test purposes . . . but rather in the iron oxides they require. Oxides possessing exceptional performance characteristics.

Pfizer has learned a lot about the subject, and is continuing to learn more, from our extensive research, development, and pilot plant manufacturing. If you make any of the products concerned, for consumer sales or industrial use, our advanced knowledge may help you.

Your technical inquiries will receive immediate attention.



Pfizer

**MINERALS
PIGMENTS
& METALS
DIVISION**

Dept., 9E3 235 East 42nd Street
New York, New York 10017

Photo Caption:

GOETHITE— $\text{Fe}_2\text{O}_3 \cdot \text{H}_2\text{O}$, hydrated ferric oxide. Named after poet J. W. von Goethe. Specimen from Gömör, Hungary and reproduced in scale of 4.3:1 reduction. High purity grades of synthetic Goethite are among the major sources of Pfizer's wide range of oxides for magnetic recording purposes.

Send your electrical contact requirements to—

NEY

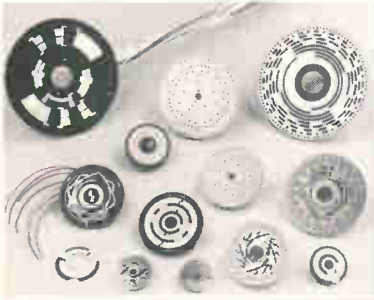

**NEYETCH
COMMUTATORS
AND SLIP RINGS**



WIRE FORMS



HEADED CONTACTS

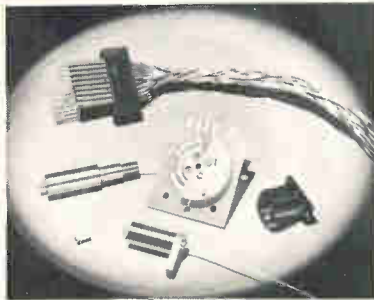

**ASSEMBLED
COMPONENTS**



**STAMPED AND
FORMED CONTACTS**



**WELDED AND
STAKED ASSEMBLIES**

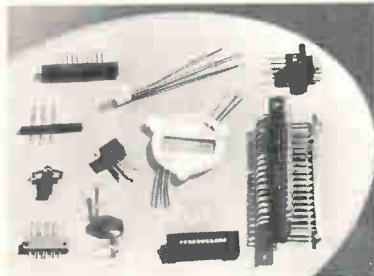

**MOLDED
CONTACT
ASSEMBLIES**

PALINEY®, NEYORO® ALLOYS

48 PAGE CATALOG ON REQUEST

THE J. M. NEY COMPANY
Maplewood Ave., Bloomfield, Conn.
TEL. HARTFORD 242-2281 (area 203)

NEY



Designers Choice

What's best for your logic system design? CAMBION's Logic Manual tells you all you need to know about CAMBION DTL, TTL, HTL circuits, full MIL capability, complex functions, all types of cards for use in industrial controls, computers, A-to-D converters; interfacing instrumentation, and automatic check-out systems.

CAMBION's new Wire-Wrap* Products and Service Brochure covers our prototype and production wire-wrap activity . . . plus sockets, cards, files and racks for the designer developing his own cards. Get these two free catalogs today. Cambridge Thermionic Corporation, 457 Concord Avenue, Cambridge, Massachusetts 02138. Phone: (617) 491-5400. In Los Angeles, 8703 La Tijera Boulevard 90045. Phone: (213) 776-0472.

*Registered Trademark of Gardner-Denver Co.

Standardize on

CAMBION®

The Guaranteed Electronic Components

Circle 283 on reader service card

Now
**For The
First Time**

You can completely design,
layout, construct and test
your most intricate new
circuitry with the dynamic

elite 1

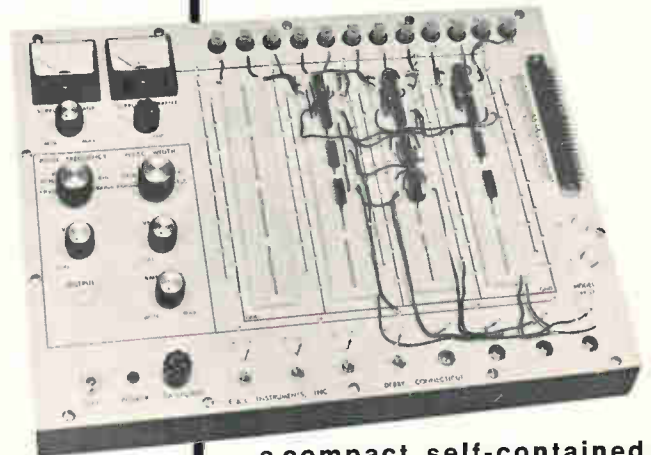

... a compact, self-contained,
general-purpose Electronic
Testing Laboratory for **\$650.00**



EL Instruments Incorporated

61 First Street, Derby, Connecticut 06418 Telephone 203-735-8774

New Literature

printed in a guide for design engineers in the latest issue of Trimmer Topics, a two-page newsletter [456]

R-f power transistors. ITT Semiconductor, 3301 Electronics Way, West Palm Beach, Fla. 33407. A folder and wall chart combination lists key parameters for 24 of the company's r-f power transistors. [457]

Second generation LIC's. Fairchild Semiconductor, P.O. Box 1058, Mountain View, Calif. 94040, has published a 28-page brochure to help engineers solve complex design problems by use of second generation linear integrated circuits. [458]

Magnetic amplifiers. Airpax Electronics, P.O. Box 8488, Fort Lauderdale, Fla. 33310. Bulletin M-62 describes high sensitivity d-c magnetic amplifiers with gains up to 10,000 and drift as low as $1\mu\text{V}$. [459]

Indicator lights. Industrial Devices Inc., Edgewater, N.J. 07020, has available a bulletin describing the Glo-Dot series 2900 one-piece lens-body type indicator lights. [460]

FET selector guide. Motorola Semiconductor Products Inc., P.O. Box 20924, Phoenix 85036. Six-page selector guide and cross reference chart SG-15, covering a complete line of field-effect transistors, may be obtained by writing on company letterhead.

Visual image processing. Information International, 11161 West Pico Blvd., Los Angeles 90064. A 12-page color brochure describes and illustrates visual image processing via the company's computer-based optical systems. [461]

Video distribution. Dynair Electronics Inc., 6360 Federal Blvd., San Diego, Calif. 92114, has published an informative, 51-page book called "Video Transmission Techniques." [462]

Computer system. Foxboro Co., Neponset Ave., Foxboro, Mass. 02035. Bulletin L-19A titled "PCP88" summarizes the features of a multi-computer system for direct digital control of industrial processes. [463]

Aerospace motors. Kearfott Products Division, Singer-General Precision Inc., 12690 Elmwood Ave., N.W., Cleveland 44111. Compact aerospace induction motors for specialized applications in aircraft, missiles, ground support, and industrial applications are described in bulletin A-5138. [464]

R-f components. Relcom, 2329 Charleston Road, Mountain View, Calif. 94040. A six-page catalog contains specifications and application material on dou-

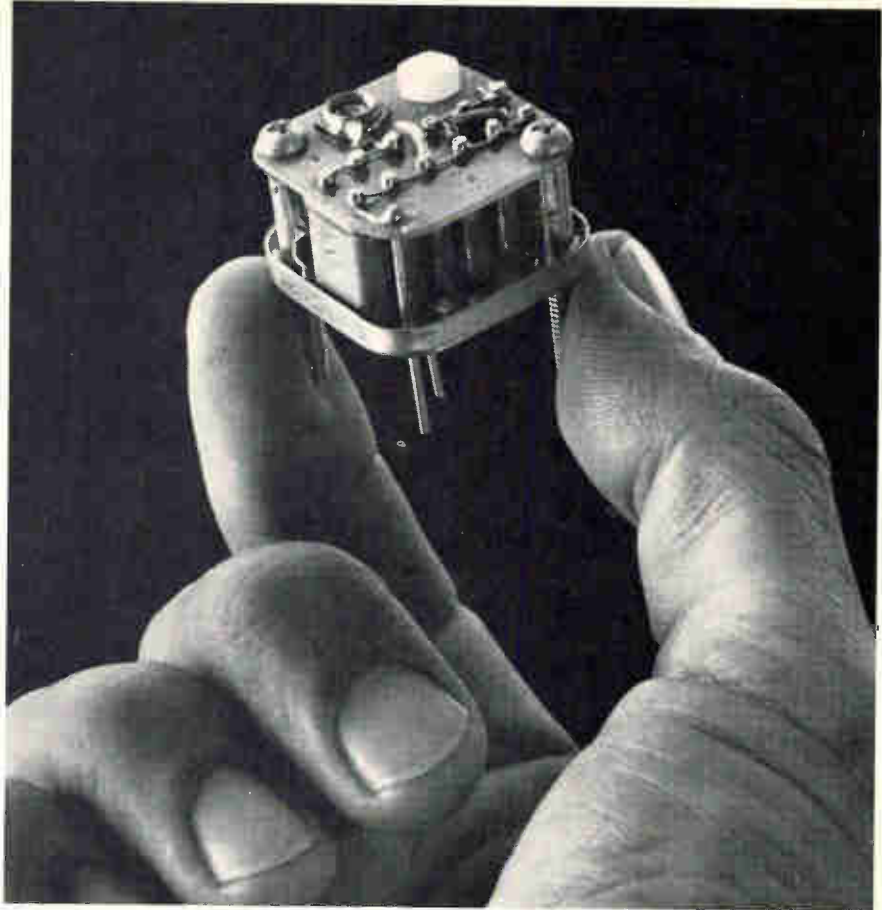

How do you get prototype, special or short-order crystal filters fast?

Listen to Sherold's pitch.

We're right on target with the top-quality crystal technology that assures you of prototypes and short-order specials with the speed and accuracy you need. And the facilities to put your prototypes into low-cost quantity production when the time comes. That's why Sherold is the largest single independent source for both crystal filters and discriminators. And why we've built more PRC and VRC filters than any other supplier. Sherold has the widest range of filter designs in production and the technology to develop and put yours into production, too. From computer-designed monolithic filters to extra-rugged MIL-spec models. Send us the details of your frequency selection problem and we'll listen to your pitch. Write Sherold Crystal Products Group, Tyco Laboratories, Inc., 1510 McGee Trafficway, Kansas City, Mo. 64108. Or phone (816) 842-9792. TWX 910-771-2181.

TYCO

EG&G SILICON DIFFUSED PHOTODIODE

- HIGH QUANTUM EFFICIENCY
- WIDE SPECTRAL RANGE • FAST RESPONSE TIME • LOW NOISE

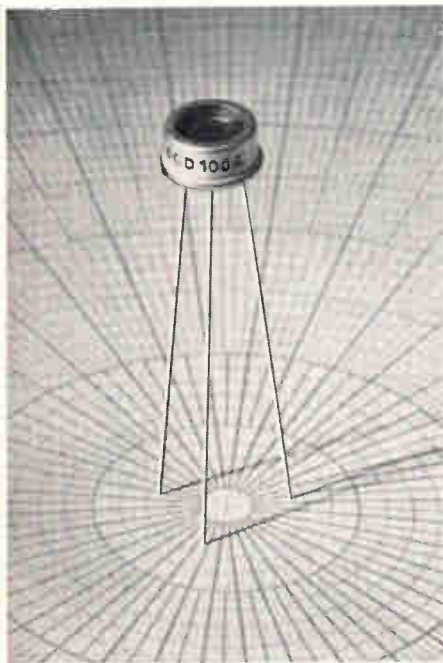

SGD-100A PHOTODIODE

The SGD-100A Silicon Photodiode provides a unique combination of wide spectral range, high sensitivity, fast speed of response, and low noise. Utilizing a planar diffused, oxide passivated, guard ring construction, the SGD-100A is suitable for applications requiring a high degree of electrical, optical, and mechanical reliability. The SGD-100A is hermetically sealed in a TO-5 package.

Sensitivity $0.5 \mu\text{A}/\mu\text{W}$ at 0.9 microns
(70% quantum efficiency)

Spectral Range 0.35 to 1.13 microns

Capacitance 7 picofarads at 90v

Rise Time 4 nanoseconds

Leakage $0.2 \mu\text{A}$ at 90v

NEP ($0.9 \mu\text{m}$, 10³, 1) 7.9×10^{-13} watts

Linearity of Response over 7 decades

Applications include CW, pulsed light and laser detection and measurement, star tracking, optical navigation, communication and guidance, and range-finding systems. The new SGD-100A, also available in calibrated versions, is in quantity production for fast delivery at low price.

For information, write: EG&G Inc., 166 Brookline Avenue, Boston, Massachusetts 02215. Telephone: 617-267-9700. TWX: 617-262-9317. On west coast, telephone: 213-464-2800.



ELECTRONIC PRODUCTS DIVISION

New Literature

ble-balanced mixers, hybrids, power dividers, single-balanced mixers, switches, and balanced transformers. [465]

Frequency components. Motorola Communications and Electronics Inc., 1301 E. Algonquin Rd., Schaumburg, Ill. 60172. Brochure TIC-3401 describes the company's capability in the frequency control field and the component devices now available. [466]

Magnetic pickups. Dynalog Corp., 4107 N.E. Sixth Ave., Fort Lauderdale, Fla. 33308. A bulletin designated Dynaform 100 provides a technical description of a line of magnetic pickups used in rpm detection, motion studies, counting, and positioning applications. [467]

D-c power supplies. Sola Basic Industries, 1717 Busse Rd., Elk Grove Village, Ill. 60007. Bulletin 540 describes a line of scr regulated d-c power supplies. [468]

Lock-in amplifiers. Princeton Applied Research Corp., P.O. Box 565, Princeton, N.J. 08540. Engineering applications and theory of operation of lock-in amplifiers are given in application note T-192A. [469]

Telephone signal converters. Quindar Electronics Inc., 60 Fadem Road, Springfield, N.J. 07081, offers product data sheet PDS-2-3 on the QTC series telephone signal converters. [470]

Trigger program generator. Datapulse Division, Systron-Donner Corp., 10150 W. Jefferson Blvd., Culver City, Calif. 90230. A six-channel trigger program generator is described in technical bulletin 206. [471]

Production screening. Aremco Products Inc., P.O. Box 145, Briarcliff Manor, N.Y. 10510. Product bulletin 3200 is a two-page data sheet describing the Mech-Pak 3200, a screen printer mechanization system permitting production screening at the rate of 2,500 parts per hour. [472]

Servo recorders. Esterline Angus, Division of Esterline Corp., Box 24000, Indianapolis 46224, offers a 16-page catalog SRC 1088 that describes a full line of servo recorders. [473]

Condensed keyboard guide. Micro Switch, a division of Honeywell Inc., 11 W. Spring St., Freeport, Ill. 61032, has available a condensed keyboard guide that allows potential customers to review the major features of the division's new wired and encoded solid state keyboards. [474]

Pushbutton switches. C&K Components Inc., 103 Morse St., Watertown, Mass.,

FM Stereo Engineers!

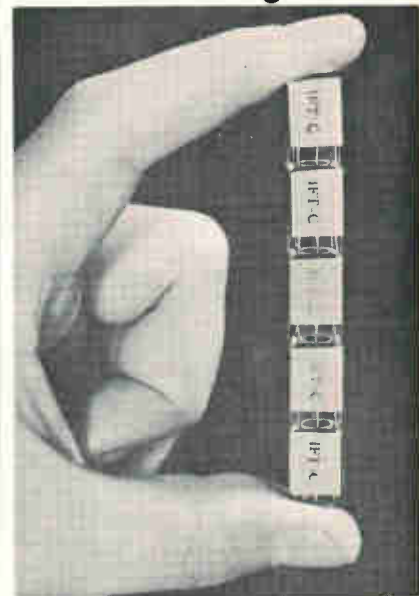

Replace
5 IFTs
with the
new
Murata
**CERAFIL
BLACK**



Now, it is the new ceramic filter for FM stereo receiver.

Murata introduces remarkable new ceramic filter "Black"—Model CFP-10.7MA. It replaces five conventional IFTs. Not three or four.

We repeat the new Black replaces five IFTs. You don't believe it?

Then sent for the latest technical bulletin for complete specifications and selectivity curve.

In addition, the new Black is fixed tuned and need no alignment as other Murata ceramic filters are. There is no mechanical coupling between the square plates but wholly electrical.

Improve your next FM stereo radio with the new Black—the Model CFP-10.7MA.

muRata

Murata Manufacturing Co.
Nagaoka, Kyoto, Japan
Telex: 5422-317 KYO

Cable Address: MURATAKYOTO

Murata Corp. of America
2 Westchester Plaza, Elmsford,
New York 10523

Telex: MURATA EMFD 137332
Phone 914-592-9180

See us at IEEE Booth 3H08

We are able to manufacture more ferromagnetic pot cores than anybody else . . .



because . . .

1. No one can match the variety of materials at our disposal—many unique because we developed them ourselves. (Our F series 2001~4 demonstrate drastically improved temperature coefficient for this reason.)
2. We use the most modern technology in the world, both domestic and imported.
3. Our factories are second to none in scale and up-to-dateness.
4. Our 3,000 highly skilled employees, advanced research laboratory, and 30 years' experience back up every product.

If your telecommunications equipment calls for high-performance pot cores of guaranteed uniformity, send us your specs. We'll do the rest. Also, we'll be happy to send you detailed technical literature on request.



Tohoku Metal Industries, Ltd.

4, 7-chome, Ginza-Higashi, Chuo-ku, Tokyo, Japan
 Telephone: Tokyo 542-6171 Cable Address: TOHOKUMETAL TOKYO

Main Products: Ferrite Cores, Memory Cores, Memory Matrices, Ferrite Magnetostrictive Vibrators, Pulse Transformers, Permanent Magnets (Cast, Ferrite), Tape Wound Cores, Bobbin Cores, Magnetic Laminations, Fe-Co Alloys, Sendust Cores

Circle 286 on reader service card

**PROVEN RELIABILITY—
 SOLID-STATE POWER INVERTERS,
 over 260,000 logged operational hours—
 voltage-regulated, frequency-controlled,
 for missile, telemeter, ground support,
 135°C all-silicon units available now—**

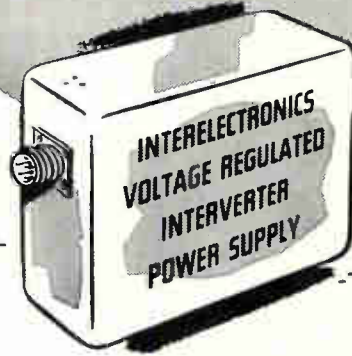

Interelectronics all-silicon thyatron-like gating elements and cubic-grain toroidal magnetic components convert DC to any desired number of AC or DC outputs from 1 to 10,000 watts.



Ultra-reliable in operation (over 260,000 logged hours), no moving parts, unharmed by shorting output or reversing input polarity. High conversion efficiency (to 92%, including voltage regulation by Interelectronics patented reflex high-efficiency magnetic amplifier circuitry.)



Light weight (to 6 watts/oz.), compact (to 8 watts/cu. in.), low ripple (to 0.01 mv. p-p), excellent voltage regulation (to 0.1%), precise frequency control (to 0.2% with Interelectronics extreme environment magnetostrictive standards or to 0.0001% with fork or piezoelectric standards.)

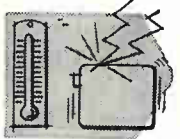

Complies with MIL specs. for shock (100G 11 mlsc.), acceleration (100G 15 min.), vibration (100G 5 to 5,000 cps.), temperature (to 150 degrees C), RF noise (I-26600).



AC single and polyphase units supply sine waveform output (to 2% harmonics), will deliver up to ten times rated line current into a short circuit or actuate MIL type magnetic circuit breakers or fuses, will start gyros and motors with starting current surges up to ten times normal operating line current.

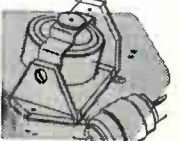

Now in use in major missiles, powering telemeter transmitters, radar beacons, electronic equipment. Single and polyphase units now power airborne and marine missile gyros, synchros, servos, magnetic amplifiers.

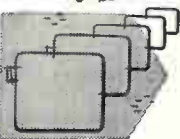

Interelectronics—first and most experienced in the solid-state power supply field produces its own all-silicon solid-state gating elements, all high flux density magnetic components, high temperature ultra-reliable film capacitors and components, has complete facilities and know how—has designed and delivered more working KVA than any other firm!

For complete engineering data, write Interelectronics today, or call 914 Elmwood 8-8000.

INTERELECTRONICS CORP.

700 U. S. Route 303 Congers, New York 10920

Circle 237 on reader service card

Bliley IS Unique

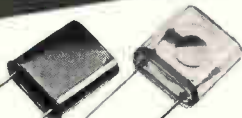

BLILEY offers you a unique combination of top crystal technology and state-of-the-art oscillator design capability

When you need precision crystals or crystal oscillators you can count on BLILEY expertise backed by 38 years of experience in frequency control.

CCO

Crystal Controlled Oscillators

TCCO

Temperature Compensated Crystal Oscillators

VCCO

Voltage Controlled Crystal Oscillators

Call or write us today with your specification requirements.

Bliley If you buy quality

BLILEY ELECTRIC COMPANY

2545 West Grandview Boulevard
Erie, Pennsylvania 16512

New Literature

02172. A two-page data sheet describes four momentary snap action, subminiature pushbutton switches. [475]

Test jacks. Star-Tronics Inc., Moulton St., Georgetown, Mass. 01830, has released an engineering data sheet describing the characteristics of its single terminal test jacks. [476]

Serial printer. Adtrol Electronics Inc., 116 N. Seventh St., Philadelphia 19106, offers a data sheet giving full information on the model SCP-6A serial character printer. [477]

Tunable tone transformers. Sangamo Electric Co., P.O. Box 359, Springfield, Ill. 62705. Four-page bulletin 5113 describes a line of tunable, multifrequency tone transformers. [478]

Rotary switches. RCL Electronics Inc., 700 S. 21st St., Irvington, N.J. 07111. An expanded catalog gives complete technical specifications on six new series of miniature rotary switches. [479]

Temperature controllers. Research Inc., P.O. Box 6164, Minneapolis 55424. A booklet on proportional temperature controllers presents the basic fundamentals in a technically simplified manner and shows how to apply these concepts to the reader's own applications. [480]

Vibration control mountings. Lord Mfg. Co., 1635 W. 12th St., Erie, Pa. 16512, offers a bulletin covering a family of compact, lightweight vibration, shock and noise control mountings. [481]

H-v power supplies. Venus Scientific Inc., 399 Smith St., Farmingdale, N.Y. 11735, has issued a combination catalog and file folder on miniaturized high-voltage power supplies and related products. [482]

Connectors. U.S. Components Inc., 1320 Zerega Ave., Bronx, N.Y. 10462. An eight-page catalog features a qualification-tested series of interchangeable miniature connectors. [483]

Cast mica capacitors. Sprague Electric Co., 35 Marshall St., North Adams, Mass. 01247. Engineering bulletin 1240A contains data on cylindrical-body cast mica capacitors for operation up to 125°C. [484]

Analog function modules. Intronics Inc., 57 Chapel St., Newton, Mass. 02158. Engineering technical notes describe four important types of analog function modules for analog data processing applications [485]

Temperature controller. Electronic Control Systems Inc., Midland Park, N.J., offers literature describing the Alpha 1 temperature controller. [486]

STABILITY & QUALITY

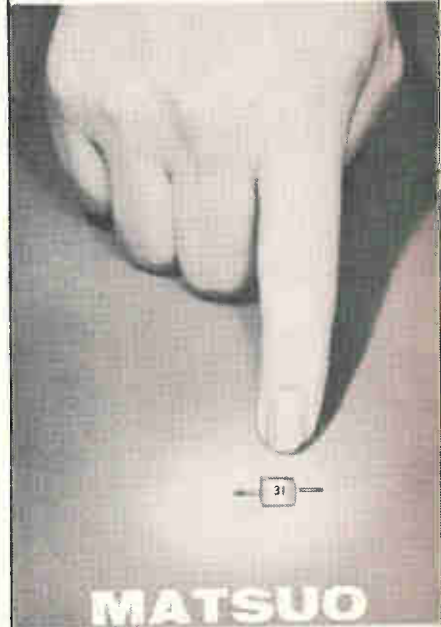

SOLID TANTALUM CAPACITORS FOR HYBRID ICs - "MICROCAP".

Capacitance exceeding 10,000 picofarads obtained despite miniature size. "MICROCAP" features excellent heat resistance, solderability and mechanical strength comparable to conventional discrete components, for easy use in hybrid integrated circuits.

Specifications:

Operating Temperature Range: -55°C to +85°C
Standard Voltage Rating: 6.3, 10, 16, 20, 25, 35 VDC
Standard Capacitance Value: .001 to 22MFD (E6 series)
Standard Capacitance Tolerance: ±20% (M)

MATSUO'S other capacitors include:

Metallized Polyester Film Capacitor:

Type FNX-H mylar wrapped.

Solid Tantalum Capacitors:

Type TAX hermetically sealed in metallic case, Type TSX encased in metallic case and sealed with epoxy resin, Type TSL encased in metallic case and sealed with epoxy resin.

Polyester Film Capacitors:

Type MFL epoxy dipped, Type MFK epoxy dipped, non inductive, Type MXT encased in plastic tube, non inductive.

For further information, please write to:

MATSUO ELECTRIC CO., LTD.

Head Office: 3-5, 3-chome, Sennari-cho, Toyonaka-shi, Osaka, Japan

Cable: "NCOMATSUO" OSAKA Telex: 523-4164 OSA

Tokyo Office: 7, 3-chome, Nishi-Gotanda, Shinagawa-ku, Tokyo

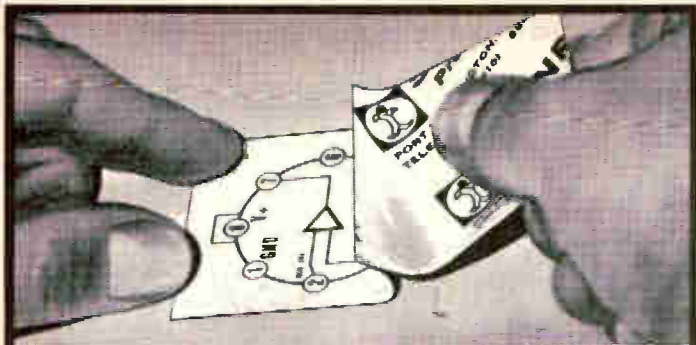

STANPAT GIVES SHARP, CRISP REPRODUCTION EVERY TIME!

STANPATS are made specifically for use on drawings. Inferior imitations create endless problems. STANPAT will preprint your own repetitive items for instant drafting. Every sheet is guaranteed to meet your exact requirements. Adhesion is instant . . . reproduction is always perfect. Unbelievable? Send today for free samples — judge for yourself. Be sure to enclose a sample of your own repetitive details and we'll send you a quote. Use quick-reply coupon.

Telephone: 516 883-8400

faithfully serving the architect and engineer for over 25 years



STANPAT PRODUCTS INC.

Dept. J3, 366 Main St., Port Washington, N.Y. 11050

Send free samples and literature. Quote on my attached art.

Name _____ Title _____

Company _____

Address _____

City, State, Zip Code _____

Circle 288 on reader service card

HERE'S HELP FOR YOUR COST-REDUCTION PROGRAM

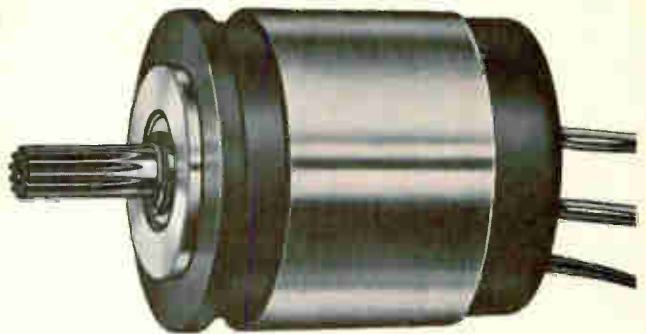

Cedar's new **JETLINE** Servo Motor

With Cedar's traditional high quality and performance but at far less cost than conventional motors

The new Jetline motors are a family of standard motors available from stock for quick delivery. Modifications and special designs on request. Size 8, 10 and 11 servo motors and Size 8 and 10 motor-tachs are available for both 26-volt and 115-volt applications.

These new motors are an extension of Cedar's more than 10 years experience in the transfer-molding of stators. Molded plastic replaces the case and end cap resulting in fewer parts. Efficiency is maximized through the use of larger stator laminations. The larger flanged bearings fit against the molded plastic, run cooler and provide greater reliability.

Thorough testing of these motors has proven them to meet traditional Cedar quality standards. Our normal warranty applies. Jetline motors have, however, demonstrated over 3500 hours at 100°C ambient.

The important difference to you when you specify Cedar's Jetline motors is that they cost less. For example, a standard Size 10 Servo Motor costs only \$16.50 in quantities up to 1000. To get all the facts on how Cedar's new Jetline servo motors can help in your cost-reduction efforts, write or call today.

CEDAR CONTROL DATA
DIVISION CORPORATION

5806 West 36th Street, Minneapolis, Minnesota 55416
Phone: 612/929-1681

Circle 239 on reader service card

239

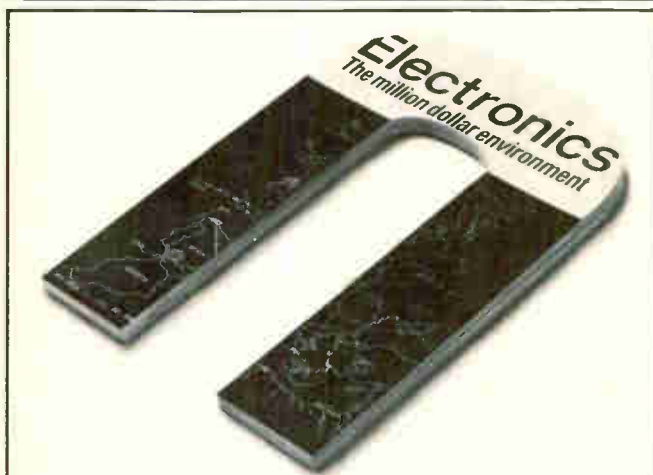

Every year, ELECTRONICS attracts requests for over 125,000 editorial reprints.

They're like interest payments on our million-dollars-a-year editorial principles.

That's how much we spend annually to produce timely, authentic, and useful articles like those listed on the reader service card as reprints currently available.

Investment and interest make both ELECTRONICS and its readers more meaningful to its advertisers.



Educating electronics personnel is too big a problem to have only one solution.



Of course, you're sold on the importance of providing continuing education for your electronics personnel. So rapidly do new developments take place in electronics that knowledge begins to lose its value almost as soon as it is acquired. Valuable men can become outmoded and unproductive almost overnight. And the shortage of technical manpower at both the professional and supporting levels makes it imperative that you utilize fully every man you have.

Perhaps your company conducts in-plant programs of instruction. Or pays all or part of the cost

of evening classes in nearby technical institutes, colleges and universities. Whatever your educational program, we believe it will be more flexible and more effective if you supplement it with CREI Home Study Programs in Electronics.

We've prepared a brochure that tells how CREI Programs can help you update, upgrade and reorient electronics personnel. Use coupon below to send for a copy today.

Founded 1927



Accredited Member of the National Home Study Council

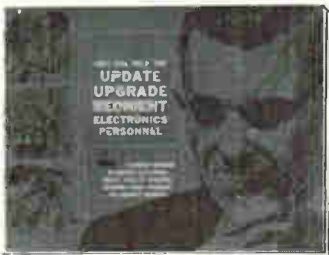

CREI, Home Study Division, McGraw-Hill Book Company

Dept. WTC-04, 3224 Sixteenth Street, N.W.
Washington, D.C. 20010

I want more information on CREI Programs in Electronics and how they can supplement our educational program for electronics personnel. Please send me, without obligation, your descriptive brochure.

Name _____

Title _____

Firm Name _____

Address _____

City _____ State _____ Zip _____

Looking for a better job?

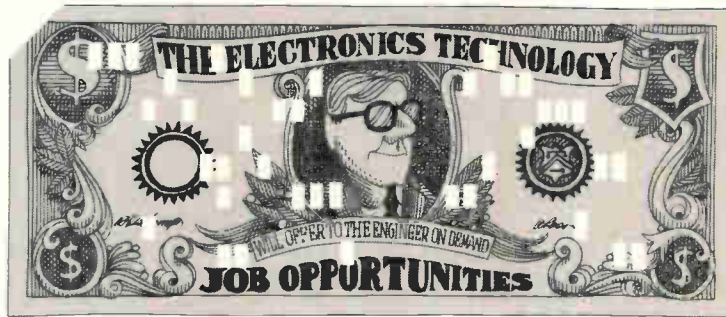

Ask Electronics' computer all about it

Electronics magazine feels an obligation to help its readers find positions in the electronics technology which will make the greatest contribution to their profession and to society — jobs in which electronics men themselves will be happiest.

Electronics has joined with a nation-wide talent search company—National Manpower Register, Inc.—to form the computerized Electronics Manpower Register. Your qualifications and job requirements will be pro-

grammed into a GE 265 computer, direct-linked to the Manpower Register's offices in New York. The computer, once your resume form (bottom of page and following page) is received, will continuously compare all your data with the specific manpower needs of electronics companies. When a match is made, you will be contacted directly or through an affiliated agency. The company and you will be brought together on a confidential basis.

Continued on next page

Electronics Manpower Register

It is important that your information be complete and that you type or print legibly

IDENTITY

Name	Date	PRESENT OR MOST RECENT EMPLOYER	
Home address		Parent company	
City	State	Zip	Your division or subsidiary
Home phone		Location (City/State)	

Do you subscribe to Electronics or see a library or pass-along copy

GEOGRAPHICAL PREFERENCE (Check appropriate boxes and complete all blanks)

I will NOT relocate I will consider opportunities in: North East Mid Atlantic South Midwest Southwest Calif. Northwest

Prefer: Metro. area Medium town Rural area Other: _____

EDUCATION

Degree	Major field	Year	College or University

EMPLOYMENT INFORMATION

Position desired	FOR OFFICE USE ONLY		
Present <input type="checkbox"/> or most recent <input type="checkbox"/> position	From	To	Title
Duties and accomplishments			

--	--	--	--	--	--	--	--	--	--

REGISTRATION NUMBER

INITIAL OF LAST NAME

HAVE YOU REGISTERED WITH THIS SYSTEM PREVIOUSLY? Yes No

CONTINUED ON OTHER SIDE

What can Norden mean to you?

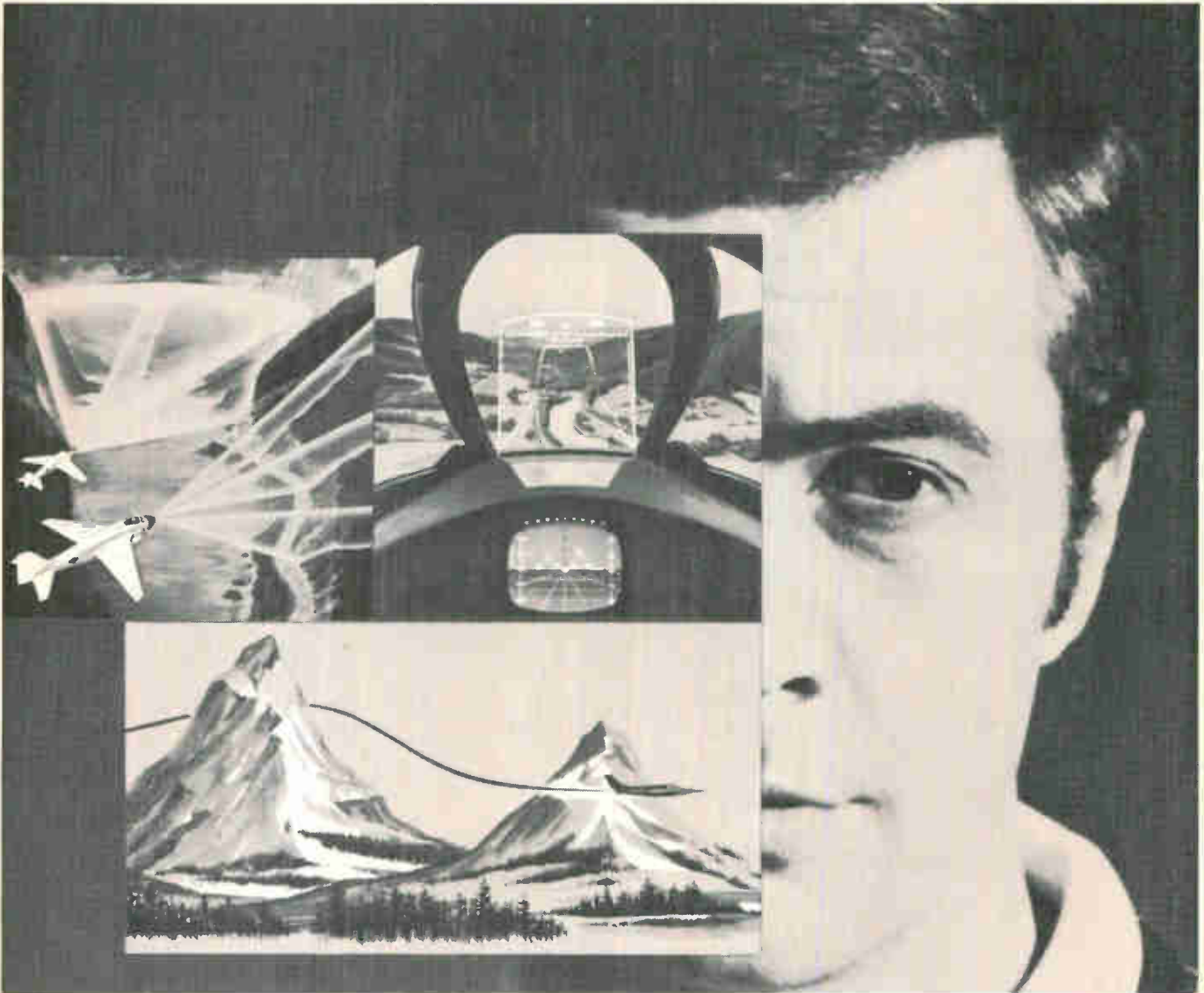

advanced systems concepts

At Norden, systems sophistication is a lot more than just a generality. It's fact—both conceptually and in terms of hardware.

If radar is your specialty, consider the multi-function phased-interferometry techniques we've evolved. A whole new generation of fixed-wing and VTOL tactical aircraft will use the resultant systems as their all-weather 'eyes' for ultra-low-level terrain-following approaches. Or, if you prefer displays, consider our work in developing practical pilot display systems that provide "head-up" display of aircraft situation in all flight modes, from takeoff to landing.

This same systems approach characterizes our work on a broad spectrum of problems in ground support equipment, optical devices, computer technology and electro-mechanical technology for aerospace, marine and industrial applications.

If you want to develop advanced systems/components concepts, we'll match your abilities with some advanced

ideas about responsibility and growth. Interested? Why not investigate one of our openings in the following areas:

RADAR—Radar & Antenna Systems • Microwave • Receiver & Circuit Design—**QUALITY ASSURANCE**—Systems Reliability • Reliability Analysis • Maintainability • Environmental Test • AGE Data—**PILOT DISPLAYS**—Video Systems • Data Processing & Display • Circuit Design—**ADVANCED COMPUTATION**—Computer Applications • Systems Simulation—**MECHANICAL DESIGN**—Electromechanical & Analytical Design • Electronics Packaging.

Please forward your resume to Mr. James E. Fitzgerald, 308 Helen Street, Norwalk, Connecticut 06852.

Be sure to visit us during the IEEE Show
March 24 through March 27.

Norden DIVISION OF **United Aircraft**

An Equal Opportunity Employer (m/f)

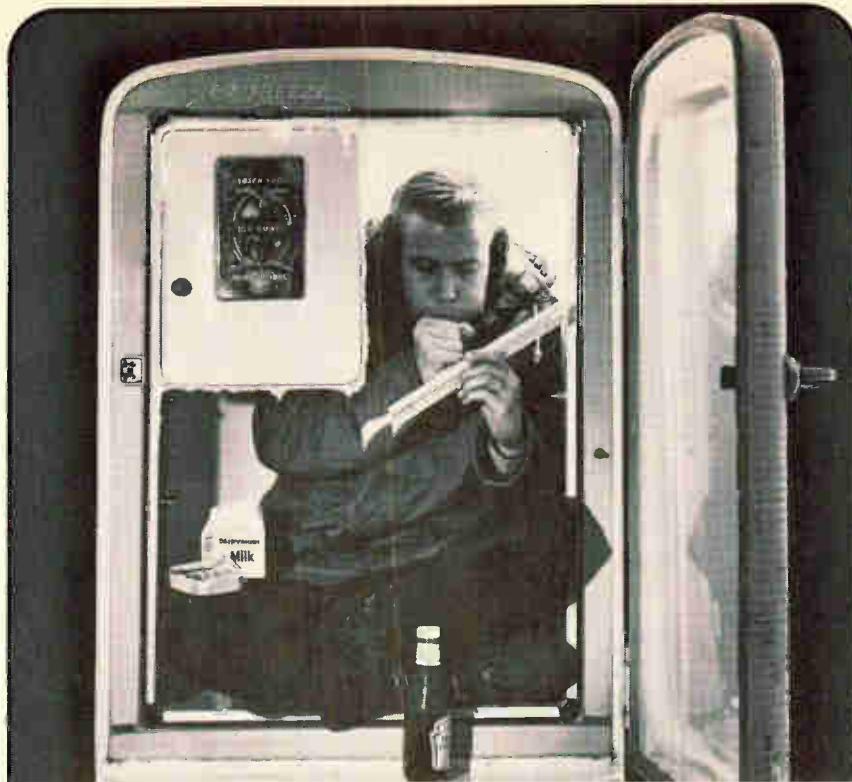

frigid air is for leftovers!

Is that what you are? . . . Left over from the great American population shift to the Southwest sun country? Why not warm up in Phoenix, the sun-fun capital of the world where the whole year is for fishing, golf, tennis or most any other sport.

Why buy overcoats and snow shovels when you could spend your money for a new rod and reel? Motorola in Phoenix provides a warm climate and a long growing season for engineers and scientists. Forty years of leadership in electronics systems engineering and unmatched technical facilities can be your place in the sun. If you provide the brainpower, nearby Arizona State University will provide the ticket for that unfinished Master's or PhD.

Make one more trip into the frigid air and mail us your resume . . . and while you're out, take a look at a new spinning reel; it costs just about the same as a new snow shovel.

Specific opportunities are:

Space Communications ■ Radar Systems ■ Tracking & Telemetry ■ Fuzing Digital Data Transmission ■ Guidance & Navigation ■ Radar Transponders ECM & Elint ■ Coherent Transponders ■ Integrated Electronics ■ Antennas & Propagation ■ Advanced RF & Microwave Techniques ■ Ground Support Equipment ■ UHF/VHF Communications Equipment ■ Display ■ Digital Multiplex ■ Troposcatter ■ Readout ■ Undersea ■ Mechanical Design ■ Reliability & Components

in PHOENIX  **MOTOROLA**

Government Electronics Division

Write: Paul Ahler, Recruitment Mgr., Dept. 65, Box 1417, Scottsdale, Arizona

AN EQUAL OPPORTUNITY EMPLOYER

ADDRESS BOX NO. REPLIES TO: Box No.
Classified Adv. Dept. of this publication.
Send to office nearest you.
NEW YORK, N. Y. 10036: P. O. Box 12
CHICAGO, Ill. 60611: 645 N. Michigan Ave.
SAN FRANCISCO, Cal. 94111: 255 California St.

EMPLOYMENT SERVICES

Florida/Nationwide EEs, MEs, IEs . . . Electronic, Aerospace, Industrial, Sales & Mfg. \$9-18,000. Tech Div Brodeur Personnel Service, Inc., 3947 Blvd., Center Drive, Jacksonville, Fla. 32207.

FOR INFORMATION

*about
classified advertising,
contact the McGraw-Hill
office nearest you*

ATLANTA, 30309
1375 Peachtree St., N.E.
404-875-0523

BOSTON, 02116
607 Boylston St.
617-262-1160

CHICAGO, 60611
645 No. Michigan Avenue
312-664-5800

CLEVELAND, 44113
55 Public Square
216-781-7000

DALLAS, 75201
1800 Republic Nat'l, Bank
Tower
214-747-9721

DENVER, 80202
1700 Broadway, Tower Bldg
303-255-5483

DETROIT, 48226
856 Penobscot Building
313-962-1793

HOUSTON, 77002
2270 Humble Bldg.
713-224-8381

LOS ANGELES, 90017
1125 West Sixth Street
213-482-5450

NEW YORK, 10036
500 Fifth Avenue
212-971-3594

PHILADELPHIA, 19103
Six Penn Center Plaza
215-568-6161

PITTSBURGH, 15222
4 Gateway Center
412-391-1314

ST. LOUIS, 63105
7751 Carondelet Avenue
314-725-7285

SAN FRANCISCO, 94111
255 California Street
415-362-4600

CIRCLE 967 ON READER SERVICE CARD

ENGINEER LIBRASCOPE

in Glendale, California offers exceptional opportunities in Advanced Development Projects in

ASW SYSTEMS

Systems Analysis, Simulation, Evaluation & Preliminary Design.

- ANALYSIS and Preliminary Design of ASW WEAPON CONTROL and Data Acquisition systems.
- PROJECT engineering responsibilities involving requirements analysis, error analysis, cost effectiveness analysis, systems integration and preliminary design.
- BS or MS in engineering, math or physics required, with 2 or more years directly applicable experience in ASW engineering.

Call or send resume to:

R. D. MACUMBER
EMPLOYMENT MANAGER
(213) 245-8711. Ext. 1246
808 Western Avenue
Glendale, California 91201

SINGER LIBRASCOPE

Equal Opportunity Employer, M/F

Your Used,
Surplus and
Rebuilt Equipment
Advertising here
in the
Searchlight
Section
will impress
key buyers . . .

Buyers regularly turn to these pages for their used equipment needs . . . You can reach these buyers quickly and economically with your advertising in this "meeting place" of used mining equipment buyers and sellers.

For more information, please contact:

Electronics

Classified Advertising Dept.
P. O. Box 12, New York, N. Y. 10036
Area Code 212, 971-6586



SEARCHLIGHT SECTION

- CLASSIFIED ADVERTISING • BUSINESS OPPORTUNITIES
- USED OR SURPLUS EQUIPMENT

AUTOTRACK MOUNT

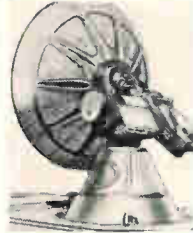

360 degree azimuth, 210 degree elevation sweep with better than 1 mil. accuracy. Missile velocity acceleration and slewing rates. Amplidyne and servo control. Will handle up to 20 ft. dish. Supplied complete with control chassis. In stock—immediate delivery. Used world over by NASA. (SAF, MP-6) B. Type SCR 584. Nike Ajax mounts also in stock.

PULSE MODULATORS

MIT MODEL 9 PULSER 1 MW—HARD TUBE
Output 25kv 40 amp, 30kv 40 amp, max. Duty cycle .002, .25 to 2 microsec. Also 5 to 5 microsec. and .1 to .5 microsec. Uses 6C21 Input 115v 60 cycle AC. Mfg. GE Complete with driver and high voltage power supply. Ref: MIT Rad Lab. Series, Vol. 5, p. 152.

2 MEGAWATT PULSER
Output 30 kv at 70 amp. Duty cycle .001. Rep rates. 1 microsec 600 pps. 1 or 2 msec 300 pps. Uses 5948 hydrogen thyratron. Input 120/208 VAC 60 cycle. Mfr. GE. Complete with high voltage power supply.

250 KW HARD TUBE PULSER
Output 16 kv 18 amp. Duty cycle .002. Pulses can be coded. Uses 5D21, 715C or 4Pr60A. Input 115 v 60 cy AC \$1200 ea.

18 MEGAWATT PULSER
Output 150KV at 120 amps. Rep rate: 50-500 PPS. Pulse length: 5 msec. 15KV 120 amp. into pulse transformer. Rise time 1.5 msec. Filament supply 5V 80 amp. Incl. 17 5KV 1.5 amp DC power supply. Input: 220V 60 cy AC.

INDICATOR CONSOLES

AN/SPA 4A, PPI 10", range to 300 ml.
VJ-1 PPI 12", Range to 200 ml.
VL-1 RH1 12" to 200 ml. 60K ft.

SCR 584 AUTOTRACK RADARS

Our 584s in like new condition ready to go, and in stock for immediate delivery. Ideal for telemetry research and development, missile tracking, satellite tracking. Fully Desc. MIT Rad. Lab. Series, Vol. 1, pps. 207-210, 228, 284-286. Comp. Inst. Bk available \$25.00 each

40 KW TRANSMITTER

4 to 21 MHz, 40 kw Telegraphy, 30 kw Voice, can be SSB. New condition. Two systems in stock. Excellent rf source, broadcast or point-to-point.

ANTI-AIRCRAFT GUN MOUNT

Will handle 6,000 lbs. rapid slew through 360° azimuth, 180° elevation. Mobile.

MICROWAVE SYSTEMS

200-2400 mc. RF PKG

Continuous coverage, 30 Watts Cw nominal output. Uses 2C3BA. Price \$375.

L BAND RF PKG.

20 KW peak 990 to 1040 MC. Pulse width .7 to 1.2 micro sec. Rep. rate 180 to 420 pps. Input 115 vac incl. Receiver \$1200

200-225 mc RADAR SYSTEM

1 Megawatt output, 200 nautical mile range for long range detection of medium and high altitude jet aircraft as well as general search. AN/TPS 28

SURVEILLANCE DRONE RADAR SYSTEM

X-Band tracking system with plotting boards. Type AN/MPQ-29. Drone also in stock.

5 MEGAWATT C-BAND

Klystron RF package delivering nominal 5 megawatt pulse RF. Complete with pulser and power supply.

500 KW L BAND RADAR

500 kw 1220-1359 msc. 160 nautical mile search range P.R.I. and A scopes. MTI thyratron mod 5326 magnetron. Complete system.

AN/GPG-1 SKY-SWEEP TRACKER

3 cm. automatic tracking radar system. Complete package with indicator system. Full target acquisition and automatic tracking. Input 115 volts 60 cycle New. In stock for immediate delivery. Entire System 6' long, 3' wide, 10" high. Ideal for Infrared Tracker, Drone Tracker, Missile Tracker, R. & D.



C Band Autotrack

1 Megawatt 10 ft. Parabola. Sperry.

RADAR SYSTEMS GROUND AND AIRBORNE, AUTOMATIC TRACKING ANTENNA SYSTEMS, NIKE AJAX, NIKE HERCULES, M-33, MSO-1A, MPS-19, MPS-9, SCR 584, TPS-1D, TPS-28, FAA-ASR-2, AIRBORNE SYSTEMS, APN-84, APN-102, APS-20, APS-27, APS-45, DPN-19, DIGITAL COMPUTERS, IBM 650, IBM 704.

LARGEST INVENTORY OF RADAR AND MICROWAVE EQUIPMENT IN THE WORLD.
RADIO RESEARCH INSTRUMENT CO.
45 WEST 45TH ST. N. Y. 10036 212-JU 6-4691

CIRCLE 968 ON READER SERVICE CARD

ELECTRON TUBES

KLYSTRONS • ATR & TR • MAGNETRONS
SUBMINIATURES • C.R.T. • T.V.T. • 5000-
6000 SERIES
• SEND FOR NEW CATALOG A2 •
A & A ELECTRONICS CORP.
1063 PERRY ANNEX
WHITTIER, CALIF.
696-7644

CIRCLE 969 ON READER SERVICE CARD

SURPLUS IBM EQUIPMENT

FREE catalog of powers supplies, light & switch panels, semiconductors, test equipment, IC's, optics, etc.

GADGETEERS SURPLUS ELECTRONICS, Inc.
5300 Vine St. Cincinnati, Ohio 45217

CIRCLE 970 ON READER SERVICE CARD

Minifluid DISPENSER
AIR OPERATED
for miniature potting and encapsulating

Available in 3 sizes
6cc - 12cc - 30cc

\$34.00 up

PHILIP FISHMAN COMPANY
7 CAMERON ST., WELLESLEY, MASSACHUSETTS 02181

CIRCLE 971 ON READER SERVICE CARD

Remember . . .
MAIL MOVES THE COUNTRY
but . . .
ZIP CODE MOVES THE MAIL

Somebody—
Somewhere,

needs your idle equipment!
Reach that buyer quickly and economically thru the

"SEARCHLIGHT SECTION"

The meeting place of Used
Equipment Buyers and Sellers

General Electric introduces a faster, more convenient and less costly technique for production line encapsulating and potting. And the RTV's used in the process are as tough as any previously available.

Called the RTV-800 series, the new liquid silicone rubbers do not need a catalyst to activate them, so no premixing is needed.

They cure at temperatures ranging from 200°F to 450°F, so pot life is far longer than is customary with RTV's. A typical deep section cure would be one hour at 300°F. For really rapid cure, components can be preheated and dipped into the RTV.

These three new products are supplied in both opaque and clear grades, with viscosities ranging from very pourable to pourable. They can be blended with one another to suit your particular encapsulating job.

For more information about these new encapsulating RTV silicones (they also make good short-run molding-

materials), write Section 300, Silicone Products Dept., General Electric Company, Waterford, N.Y. 12188.

TYPICAL PROPERTIES

Uncured	RTV-815	RTV-830	RTV-835
Color	Clear	Beige	Beige
Consistency	Easily pourable	Pourable	Easily pourable
Viscosity, cps	3500	200,000	8000
Specific Gravity	1.02	1.28	1.18
Solids, %	100	100	100
Shelf Life, months	4	4	4
Cured, ± 1 hr. @ 150°C	RTV-815	RTV-830	RTV-835
Hardness, Shore A durometer	35	50	35
Tensile Strength, psi	700	800	500
Elongation, %	150	250	200
Tear Strength, lb/in.	15	100	20

GENERAL  ELECTRIC

Now. Heat-curing,
no-mixing, high-strength
RTV silicones.

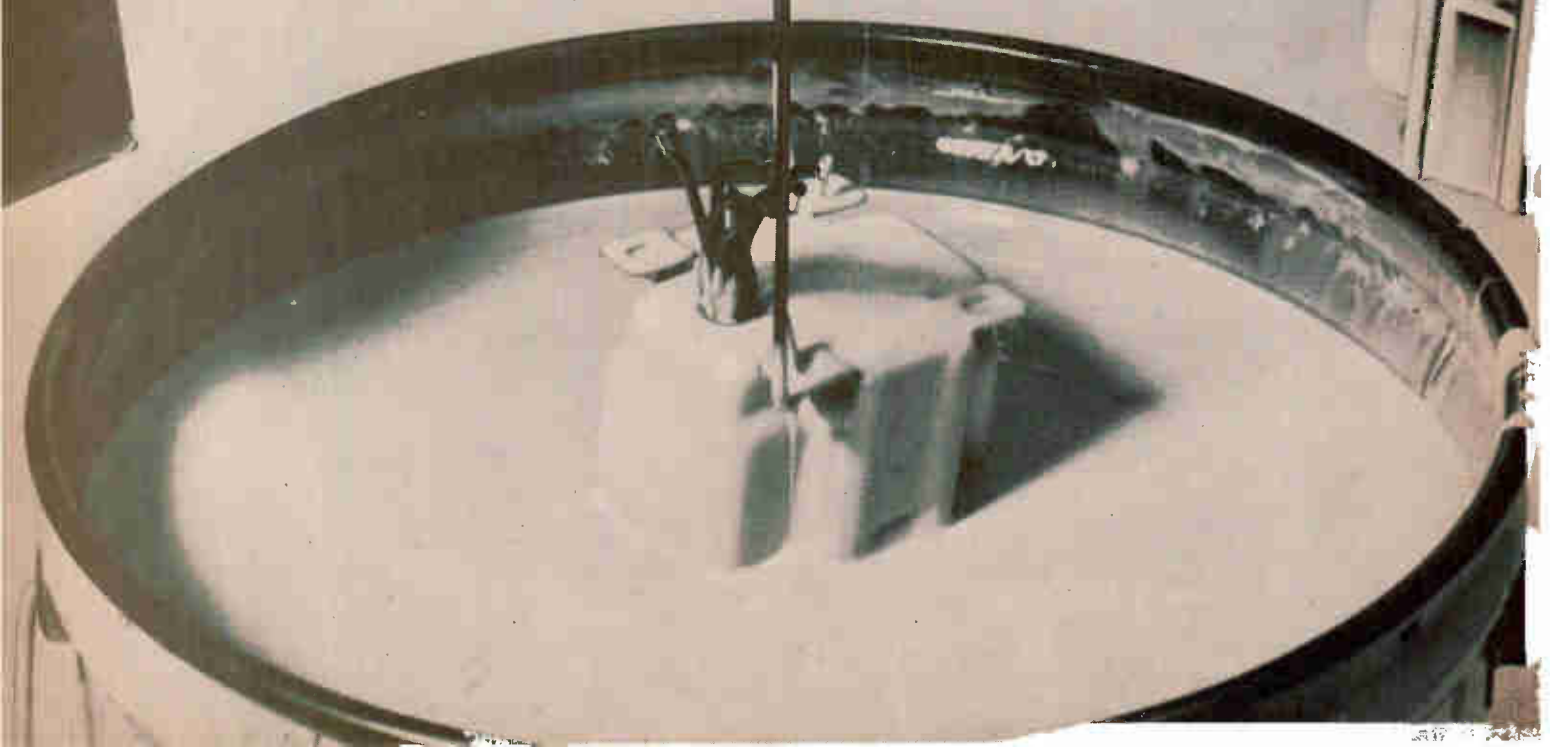

International Newsletter

March 3, 1969

Sony power: 18-watt IC

The Sony Corp. has logged a stunning new high in power output from a monolithic integrated circuit—18 watts continuous rms. That's more than triple the power levels obtainable with the highest rated consumer-product IC amplifiers now on the market.

Sony says its new IC will start turning up in its own consumer products this fall. The first applications: stereo hi-fi sets, tape recorders, radios, and tv sets. In addition to performing as an audio-output amplifier, the IC can serve in a tv set's vertical deflection circuit.

Underlying the high power output, Sony says, is a process that lets the company grow single-crystal and polycrystalline silicon precisely on the chip to get low-resistance connections to buried collectors and still have a high breakdown voltage. The maximum supply voltage for the new IC is 40 volts, and the maximum current rating is 4 amps peak-to-peak.

The circuit packs two power transistors, four other transistors, a diode, and six resistors on a chip 1.5 by 1.75 millimeters. For high-power applications, Sony has a special flat package built around a strap-style heat sink. For outputs of several watts, there's a version in a TO-5 can.

Soviet mass market for color-tv sets 2 or 3 years off

Russia's communist consumers apparently are acting much like their capitalist counterparts in the West when it comes to color television. They're not rushing to buy sets.

Color-set production last year reached 200,000 units, says Leonid S. Maksakov, vice-chairman of the Soviet State Committee on Radio and Television. The figure far exceeds estimates by Western observers, who so far have tagged Russian color-set production as minimal. Less surprising is Maksakov's assessment of the market, "It's easier for us to produce these sets than to sell them," he maintains.

To get their color boom started, Soviet officials plan to follow much the same strategy as West European producers and broadcasters. They'll cut down color-set production this year. At the same time, retail prices will be whacked down 25% and credit terms eased. The price cut will bring the ticket on a 23-inch set down to \$950. That's about three times the price of a black-and-white set and the same color-monochrome ratio found in Western Europe.

Just as important as price cuts on sets is the Soviet strategy to vastly step up color programing. Right now, there's a scant seven hours a week of color broadcasting by stations in Moscow, Kiev, Tbilisi, and Leningrad. By the end of the year, the capitals of 15 Soviet Republics should have colorcasting facilities, and there'll be from 12 to 20 hours of color programs weekly. The boom in color program production—and in set sales—won't come for another two years or so, though.

Europeans to form Comsat counterpart

In a move to counter U.S. dominance in Intelsat, more than 40 large companies in eight European countries have grouped informally as the first step toward forming a consortium to set up and operate satellite communications systems.

The group, mostly aerospace and electronics companies, calls itself Eurosat. It hopes to be to the Conference Europeenne de Telecommuni-

International Newsletter

cations par Satellite (CETS), the association of European telecommunications authorities, what Comsat is to Intelsat.

As the Europeans see it, Eurosat will not compete head on with Comsat. Instead of global communications, the new consortium will try its hand—if CETS so wishes—at things like satellite navigation services and regional communications networks. Although its main customers would be CETS member states, Eurosat would go after likely non-European customers too.

U.K. 19" color sets get Japanese tubes

It now looks as if Japanese picture-tube producers will wind up with the British market for 19-inch color tubes.

Some set makers have already started using imported tubes in their sets. Rather than try to match Japanese prices—which are 15% to 20% lower than their own—the three U.K. tube producers apparently will phase out 19-inch production and concentrate on 22- and 25-inch sizes.

The gradual shift to imported 19-inch tubes was triggered mainly by a sluggish market for color sets and U.K. producers' worries that a wave of small Japanese color sets will turn up in Britain next fall when color transmission is extended from one network to all three. By building sets with imported tubes, U.K. producers can shave from \$30 to \$40 off the retail price of a \$700 set.

Germans will supply Diamant B test gear

France will turn to West Germany for the instrument package it needs to test its Diamant B rocket, slated to be flown for the first time in February 1970.

French space authorities had originally worked out a deal to get the test package from the European Launcher Development Organization (ELDO). The French had agreed to use the Diamant B to test the perigee-apogee system of ELDO's Europa II rocket if ELDO included rocket-test instrumentation in its package. ELDO's perigee-apogee satellite experiment has now been canceled so France has signed on West Germany as a partner in the project, called Dial.

In exchange for the instrumentation, the Germans will get a Diamant B launch for a scientific satellite that will measure electron energy and density in the earth's magnetic field.

France to form aerospace giant

The de Gaulle government has decided to consolidate its three biggest aerospace firms. With total sales of some \$500 million and with 40,500 employees, the merged company would be by far the largest in France. But it will rank well behind the British giant in the field, Hawker Siddeley, in total revenue.

The companies that will be combined are Sud-Aviation, maker of the Caravelle and Concorde airliners, Nord-Aviation, and Societe pour l'Etude et la Realisation d'Engins Balistiques. The merger, which will become effective next year, will give France a better bargaining position when contracts are let for multinational aerospace projects.

Addendum

A consortium of European electronics firms led by West Germany's Standard Elektrik Lorenz AG has won the \$25 million contract to build a NATO-wide network of 12 ground stations for satellite communications [*Electronics*, June 10, 1968, p. 245].

Prospects bright in U.K. for glow-diode displays

One British group produces arrays by bundling gallium-phosphide diodes; another builds gallium arsenide-phosphide diodes directly on substrates

There's little doubt—except perhaps among indicator-tube makers—that the solid state display will hold sway as the standard readout for instruments within five or 10 years.

Already, the Hewlett-Packard Co. has put on the market a display based on an array of 28 light-emitting gallium arsenide-phosphide diodes. And just about every major semiconductor maker in the world has something in the way of a solid state readout in the works.

A good fix on how bright the prospects are for light-emitting diodes in Britain will come next week at the annual Physics Exhibition in London. There, two groups that have government research contracts will show what they've done in gallium phosphide and gallium arsenide-phosphide displays.

The GaP group is working at the behest of the Ministry of Defense and bands together the Services Electronics Research Laboratory (SERL), Ferranti Ltd., and the Plessey Co. Handling the Ga(As,P) side of the government's solid state display effort is Standard Telecommunications Ltd., a British subsidiary of ITT.

Lots of pull. The SERL group has based its display-fabrication technique on a crystal-pulling method developed at the Royal Radar Establishment [*Electronics*, June 13, 1966, p. 258]. By covering the melt with a layer of boric oxide, single GaP crystals about 1-inch in diameter can be had. This gives SERL the possibility of laying down many diodes with similar characteristics on one wafer.

SERL fabricates the diodes by

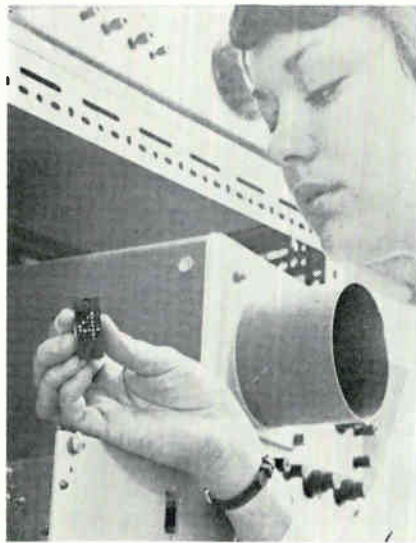

Number's up. Gallium phosphide diodes in SERL array glow with a brightness of 500 foot-lamberts. The array measures $\frac{1}{2}$ by $\frac{3}{4}$ inch.

growing an epitaxial layer on the GaP substrate. The wafer then is diced up into pieces about 0.040-inch square. Part of the p layer is etched away so that the back of the n layer can be fitted with an ohmic contact. A second contact is made to the p layer; then the diode is encapsulated in transparent plastic and mounted—n layer outwards—in a plastic cylinder.

These individual diodes become building blocks for 7-by-5 arrays that measure $\frac{1}{2}$ by $\frac{3}{4}$ inch. Even though all the diodes in an array usually come from the same substrate wafer, their characteristics vary and so SERL grades and matches them before assembly. Yield is a secret, but SERL says that it gets enough light-emitting diodes with an external quantum

efficiency of at least 0.5%—a performance suitable for readable displays—to warrant production.

At the 0.5% level, SERL's diodes glow at about 500 foot-lamberts when powered at 2 volts and 10 milliamperes. But Mike Rowland, who's in charge of the GaP development, sees 1000 foot-lambert diodes as feasible. Colin Gooch, who heads the device-fabrication side of the effort, thinks a 35-diode array could be manufactured for as little as \$12 in volume production.

Seeing red. SERL's array shines a bright red since its peak output is at 6,900 angstroms. The spectrum, though, ranges from the infrared on up to near-yellow, and a peak can be had at 5,500 angstroms—a bright green. Green-emitting diodes now are being developed.

Standard Telecommunications (STL), though, is seeing red exclusively. Its Ga(As,P) diodes peak at 6,600 angstroms and the half-peak width is a mere 200 angstroms. Like SERL, STL is working with a 5-by-7 array. But STL's is considerably smaller—only 0.3 by 0.4 inch; arrays half this size look possible to Jack Peters, who's in charge of device construction. This is because STL fabricates the array of diodes all at once on a substrate rather than bundling together individual devices.

To make an array, a selenium-doped Ga(As,P) layer 100 to 200 microns thick is grown on a GaAs substrate. Growing this layer evenly on the substrate is a tricky process; it took STL three years to develop a satisfactory one. Clive Stewart, who is in charge of materials development, says that

about half the STL output is now of even composition, uniformly doped with selenium, and sufficiently smooth.

Layout by laser. The diode junction is obtained by diffusing in zinc vapor through a passivating layer of silicon dioxide deposited over the Ga(As,P). Windows that locate the diodes in the array are etched through the passivating layer using a mask cut by STL's laser-machining technique. Contact strips around the diodes are deposited using a similar mask.

Peters says that the planar process used to put in the diodes plus the peripheral contact strips results in an even current distribution among the 35 diodes. Their dynamic resistance, he says, is only 1.5 to 2 ohms, so that the dissipation of the display is quite low and uniform from diode to diode on an array.

With an input of 50 ma at 1.7 volts, the STL array develops an output of 250 foot-lamberts. The external quantum efficiency is 0.07%, much lower than that claimed by SERL. But STL points out that the values can't be compared directly. The 0.5% figure for the GaP array includes invisible radiation. STL's 0.07% covers only visible radiation, since that's the only kind the array puts out.

Backward-wave advance

The advent of commercially available Gunn diodes with power outputs that are flat over a 2-to-1 range of frequencies in the X band gave engineers at Microwave & Electronic Systems Ltd. an idea. Why not, they wondered, employ these diodes in a solid state replacement for the backward-wave oscillator tube? The new device, they reasoned, could be compact, light, and reliable enough for military airborne applications—electronic countermeasures, for instance.

Thus was conceived in Newbridge, Scotland, a Gunn-yig oscillator capable of sweeping a range of 7 to 12.4 gigahertz with an average power of 5 milliwatts ± 3 decibels.

The prototype has a volume of

10 cubic inches, but Mike Jinman, who directed the project, says the production versions expected later this year will be about 5 cubic inches—30% smaller than conventional bwo tubes. More important, the Gunn-yig device requires a drive of only 6 to 8 volts and a power supply of 6 to 12 volts, 1 or 2 amperes for tuning. Typical bwo tubes need upwards of 2,000 volts, and thus a bulky power supply.

Jinman concedes that the solid state bwo cannot sweep as fast as a tube. And he admits there are some unsolved problems, too. For one thing, although the yig sphere is an almost ideal microwave resonator, "it's very difficult to couple it to an external circuit closely enough to control the oscillation frequency properly without, at the same time, exciting spurious magnetostatic resonance modes," he says.

Hot item. The proximity of heat-generating components (the Gunn diode and the magnetic circuit) and heat-sensitive components (the sphere and diode chips) is unavoidable in the tiny physical structure demanded by large bandwidths at X band. The main problem here, Jinman notes, is the heat generated by the magnetic circuit. He feels that the solution lies in a thinner microwave package and a reduced magnet gap.

Like most oscillators, the Gunn-yig combination is sensitive to output loading. However, Jinman's group has developed a miniature

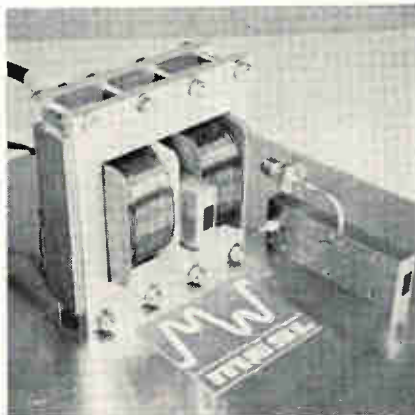

In the wings. Gunn-yig combination is a candidate to supplant larger backward-wave oscillator tubes.

broadband ferrite isolator that takes care of this. Other improvements will include higher output powers—up to 100 milliwatts—as well as C- and K-band versions of the unit.

The oscillator, which according to Jinman's estimates should cost less than half the price of a bwo tube, will be on display at the Physics Exhibition in London and at the IEEE Show in New York later this month.

West Germany

Traced in a trice

Just about any draftsman will tell you that much of his work is drudgery. His complaints are getting less plaintive, though. Digital processing systems are gradually taking over such time-consuming jobs as evaluating drawings and sketches.

One of the latest systems to hit the market is AEG-Telefunken's graphics-input equipment, which transforms the scribbles of a sketch into x-y coordinate data a computer can handle; at the same time, it provides for the feeding of alphanumeric information to the computer to define the sketch in more detail or serve as instructions.

At first glance, Telefunken's new hardware might be dismissed as just another graphics input system that's reasonably priced—\$20,000 in West Germany. But a closer look reveals a real advance. Instead of a special stylus or a high-frequency probe, an ordinary ballpoint pen or a sharp pencil is all that's needed to write on the "tracing pad" of the new equipment.

Direct-writing input pads aren't new. IBM, for one, developed a small pad more than two years ago [*Electronics*, Nov. 14, 1966, p. 43]; but Telefunken appears to be the first to put a large one into production equipment. The first delivery—to the company's semiconductor research facility at Heilbronn—will be made soon.

Layers. The input pad, a whopping 18 by 24 inches, is composed of two layers of 0.1-millimeter-thick



Quick on the draw. Telefunken's graphics-input terminal converts sketches to digital data that a computer can process. An ordinary ballpoint pen or sharp pencil will work on the 18-by-24-inch input pad.

fiberglass. One sheet has 121 copper-clad conductors laid out vertically, the other has 91 conductors arranged horizontally. The spacing between conductors in each case is 5 mm. The conductors in the two layers, in other words, form a grid with 11,011 intersections. And between the layers lies a thin polyester film with a small hole for each intersection.

Covering this fiberglass-polyester sandwich is a white polyvinylchloride sheet with a 5-by-5-mm grid etched into its surface. Sketches to be analyzed are taped onto the pvc and simply traced. As the pen or pencil point moves over intersections, the horizontal and vertical conductors make contact through the associated holes in the polyester film, provoking a voltage change that's converted into a coded digital signal. A coded address is added to the signal and both are fed to a buffer store that feeds, in turn, either a computer or a tape-punching unit.

The pad is designed so that one and only one pressure-sensing area can feed information into the buffer at any one time. If the person tracing a drawing hits the pad with his hand, therefore, the system won't record the accident.

Extras. The alphanumeric information that defines the drawing in more detail or that instructs the

computer is fed in through four keyboards.

One, with 25 keys, lets the tracer define points on the drawing that are closer together than the 5-mm spacing of the grid—down to 1 mm. On a second keyboard, the first and last x-y coordinates of a line can be marked and the system will generate the line without getting all the intermediate x-y points.

Then there's a 100-keyboard for "symbol inputs." They include two-digit markings for oft-occurring drawing elements—resistors, transistors, diodes, and the like. Finally, there's a keyboard for program instructions.

Improving the iron

Engineers with a penchant for breadboarding should soon have a new tool to work with—an inexpensive soldering iron that holds a constant temperature.

The new iron does with a tiny bit of ceramic material in its tip what other irons do with a resistance element coupled to a fairly expensive ferromagnetic switch or an electronic control. Although he can't cite actual prices, Ekkehard Andrich, its inventor, says the iron will probably cost much less than conventional temperature-regulated irons with the same power rating.

Andrich works at the Philips' Gloeilampenfabrieken research facility at Aachen and expects one of the Philips companies in Europe to put his tool into production soon.

The application of just the right amount of heat keeps power consumption down. The tip stays clean and solder applied to it doesn't roll off or oxidize. On transistor circuit boards, particularly, overheated irons can be instruments of destruction.

Positive. The ceramic heating element tucked into the iron's copper tip is a sintered mixture of barium titanate and lead titanate. It has a positive temperature coefficient: its resistance shoots up as much as a hundredfold when it's heated to its Curie temperature. Thus the ceramic cuts down the current drawn by the iron should its temperature rise above the Curie level; conversely, the current rises automatically when the iron cools down again a few degrees.

The Curie temperature for the barium-lead titanate depends on the mixture that's sintered. With equal amounts of barium titanate and lead titanate, the value is 350°C. The resistance change, in turn, depends on the sintering temperature.

The sintered material is shaped into plates 1 x 5 x 16 millimeters to fit into the tips.

So far, experimental versions of the iron have been made with power ratings from 6 watts to about 100 watts. The iron warms up in about 10 seconds and operates off a power supply from 6 to 20 volts.

The operating life of the ceramic element is between 3,000 and 6,000 hours.

Japan

Doctor's helper

Medical men have realized for a long time that computers could carry much of the routine load of diagnosis and analysis of tests. Trouble is, doctors aren't programmers. Besides, it takes an expensive general-purpose computer to do the

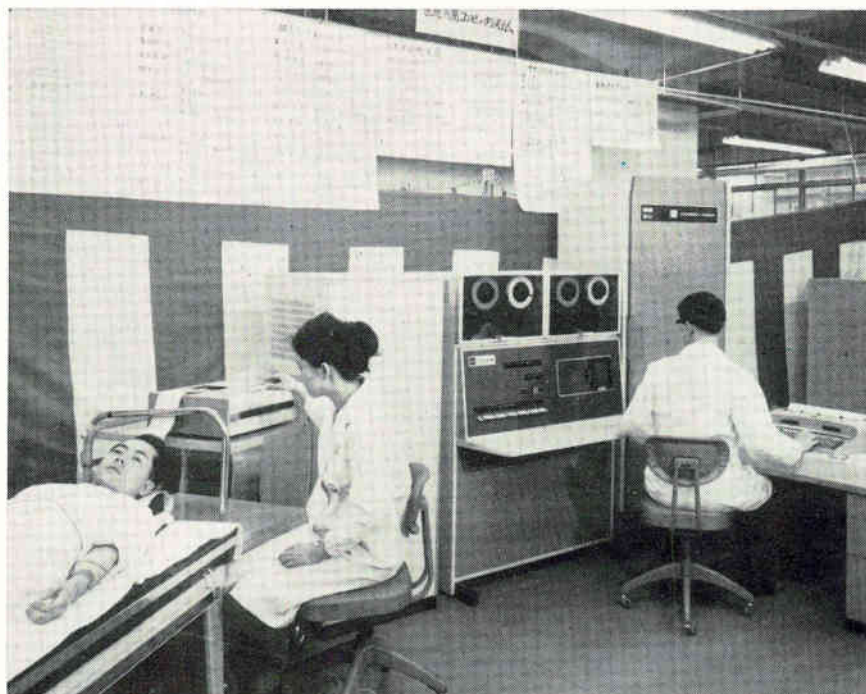

EDP practitioner. Toshiba's special medical computer can handle many routine diagnostic tasks like analyzing electrocardiograms.

job in an acceptable fashion.

Spotting a likely market, the Tokyo Shibaura Electric Co. has put together a special medical version of its Tosbac 3000 scientific and control computer. The company expects to start deliveries in about a year.

The T-3000/M, as Toshiba calls the special version, isn't something a general practitioner might buy for his office. The machine will sell for from \$80,000 to \$111,000, depending on the number of peripherals. But the machine will be within financial reach of hospitals.

Toshiba designed the computer with doctors in mind. The console includes easy-to-operate tape storage units, a cathode-ray-tube display, and analog-to-digital converters that interface between the computer and medical instrumentation.

Better still, Toshiba will have available a software package extensive enough to allow doctors themselves to work directly with the machine. There'll be 100 basic programs and 10 applications programs, all on magnetic tape. The package will include, for example, programs for automatic analysis of electrocardiograms, for tests of

respiratory functions, and for monitoring of patients with serious coronary troubles. For real-time uses, there's priority interrupt.

One special program provides for topological electrocardiograms. It gives a plot of equipotential regions at the same instant during several heart cycles.

France

Getting baudier

When it comes to data processing, France is little different from her North European neighbors. There's a data-transmission explosion building in the country, and the government-run telephone system will be hard put to keep up with the demand for lines to link remote computer users to central processors.

But where there's a Gallic will there's usually a Gallic way—as General de Gaulle so often has shown. And despite an overloaded, largely obsolete phone system, French communications officials expect to find a way to cope with the demand. They'll either set up a temporary service within the ex-

isting phone network or go ahead with a new, independent system for data transmission.

World parley. The decision will come in June. The Finance Ministry will have a major say about what's built since it rides herd on an austerity budget. But the Ministry of Posts and Telecommunications (P&T) will make its choice knowing it's had the thinking of some 1,200 experts in the field without having had to pay a centime of consulting fees. It's behind the first international conference on data transmission by phone lines. Officially sponsored by the 5,000-member Société Française des Electroniciens and Radioelectriciens—the French equivalent of the IEEE—the conference will be held in Paris, March 24-28.

No matter what they decide to do, French telephone officials will be hard pressed to meet the demand for lines. They estimate that the number of remote data processing terminals in France—there are 1,000 at the moment—will double every year for the next four years. Virtually every user of a computer worth more than \$200,000, they expect, will eventually want transmission lines for remote terminals.

As it is now, phone subscribers can send data at 200, 600, or 1,200 bauds—a snail's pace. On leased lines the figure goes up to 4,800 bauds.

Looking to pcm. Telex subscribers will be able to send data over their lines at 200 bauds before the end of 1969. A year or so after that, there may be 2,400-baud lines available for phone subscribers. That's one of the two schemes the P&T has in mind, according to Gilbert Dennerly, who's in charge of data transmission services.

The other scheme, more ambitious, calls for a special network with lines good enough to handle computer-to-computer conversations at rates of perhaps 1 million bauds. The system would be based on pulse-code modulation. Trouble is, it would be 1975 before the network could be operating. By then, the phone system itself will be well along in its transition to pcm, and its data-transmission capability will have improved considerably.

□ Morgan Group, The \$17
Scientific Advertising & Marketing Ltd.
Mosaic Fabrications Div. of
Bendix Corporation 191
Van Christo Associates Inc.
Motorola Semiconductor Products
Incorporated 45
■ Murata Mfg. Co. Ltd. 236
Dentsu Advertising Ltd.

■ National Electronics Incorporated 232
Connor-Sager Associates
National Semiconductor Corporation 76-77
Hall Butler Blatherwick Inc.
New Hermes Engraving Machine
Corporation 175
Lester Harrison Adv. Inc. 234
■ Ney & Company, J.M. 234
Peck-Adams Inc. 232
■ Nippon Electric Co., Inc. 232
Hakuhodo Inc.
North American Electronic Systems,
Div., Educational Computer Corp. 117
George Moll Advertising Inc.

Oak Manufacturing Co., Div. of
Oak Electro/Netics Corp. 71 to 74
Buchen Advertising Inc.

■ Parker Instrument Corporation 171
□ Pechiney St Gobain 3E-4E
PEMA
■ Pfizer & Company Chas.,
MPM Division 233
Newmark, Posner & Mitchell Incorporated
□ Phillips N.V. Pit/EMA Division S3-2E
Marsteller International S.A.
Photocircuits Corporation 130
Duncan Brooks Inc.
■ Plastic Capacitors Inc. 218
Sander Rodkin Adv. Agency Ltd.
■ Pomona Electronics Company 202
Buxton Advertising Agency
Princeton Applied Research Corporation 46
Mort Barish Associates Inc.

Radiation Inc. 128-129
W.M. Zemp & Associates Inc.
Radio Corporation of America
4th Cover, 80-81
Al Paul Lefton Company
■ Rogan Brothers Inc. 214
Christopher Advertising Inc.
□ Rohde & Schwarz 10E

□ Schlumberger Ltd. EMD \$7
□ Schneider R.T. 13E
Noircerc Publicite
Schober Organ Corporation 202
Harry C. Waterston Inc.
□ SDSA \$1-S2
Public Service, Neuilly
■ Semtech Corporation 53
Burruss Advertising
□ SGS \$18
Bonner Hodgson & Partners Ltd.
Signal Analysis Industries Corp. 144
Robin Advertising Service Inc.
Signetics Corp. Sub.
Corning Glass Works 127
Cunningham & Walsh Inc. 7
Siliconix Inc.
Graphics West
Solitron Devices Inc. 199
Transistor Division
Haselmire Pearson Advertising Inc.
■ Sorensen Operation Raytheon Company 67
Urrutia & Hayes Inc.
□ Souriau & Cie \$6
Ariane Publicite
□ S. P. Elettronica 6E-7E
Studio Sergio Rosata
Sperry Gyroscope Company, Division of
Sperry Rand Corporation 182
Basford Inc.
Sperry Rand Corporation, Sperry
Microwave Electronics Division
Neals & Hickok Inc. 64
Sprague Electric Company, The 5-9
Harry P. Bridge Company
Stackpole Carbon Company,
Electronic Components Division
Meek & Thomas Inc. 200
Stanpat Products Inc. 239
Morton Advertising Inc.
■ Susumu Industrial Co. Ltd. 229
Sanko Sha Advertising Agency Co. Ltd.
■ Syntronic Instruments Inc. 222
Burton Browne Advertising



Tateisi Electronics Company Ltd. 24-25
Dai-ichi International Inc.
Taylor Corporation 197
Gray & Rogers Inc.
■ Tech Laboratories Inc. 138
Lewis Advertising Agency
□ Technique et Produits 14E
Ste de Publicite de Films et de
Documentaires
■ Tektronix Inc. 141-142
Dawson, Turner & Jenkins Inc.
Teradyne Inc. 12-13
Quinn & Johnson Advertising Inc.
Test Equipment Corporation 14
Dean & Bain Advertising Inc.
■ Texas Instruments Incorporated, 160-161
Components Group
Don L. Baxter, Div. of Albert Frank-
Guenther Law, Inc.
■ Tohoku Metal Industries Ltd. 237
Hakuhodo Inc.
Todd Products Corp. 60
J.R. Bloome Company
■ Tractor Inc. Industrial Instruments Div. 150
Winn-McLaine Associates Inc.
Triplett Electrical Instrument Company 63
Burton Browne Advertising
TRW Electronics, Capacitors Division
Fuller & Smith & Ross Inc. 153
■ Trygon Electronics Inc. 152
Kameny Associates Inc.
■ Tung-Sol Division, 174
Wagner Electric Corporation
Feeley & Wheeler Inc.
Tycos Laboratories Inc.,
Sherold Crystal Products Group 235
Kenyon & Eckhardt Inc. Adv.

■ United Transformer Company, 2nd Cover
Division of TRW Inc.
Fuller & Smith & Ross Inc.
■ Unitrode Corporation 61
Silton Brothers Inc.

■ Weinschel Engineering Company 220
E.G. White Advertising Inc.
Williams Precious Metals Div.,
Williams Gold Refining Co. Inc. 159
Stahlka, Faller & Klen Inc.

Classified & Employment Advertising

F.J. Eberle, Manager
212-971-2557
EMPLOYMENT OPPORTUNITIES . . . 241-243
Motorola 244
United Aircraft Corp., Norden Div. 243
EQUIPMENT
(Used or Surplus New)
For Sale
Fishman, Philip 244
Gadgets Surplus Electronics Inc. 244
Radio Research Instrument Co. 244

■ For more information on complete product
line see advertisement in the latest Elec-
tronics Buyer's Guide
□ Advertisers in Electronics International

Electronics Buyers' Guide

George F. Werner, General Manager
[212] 971-2310
Robert M. Denmead,
Midwest Regional Manager
[312] MO 4-5800
William A. Capuzzi,
New York, New England District Manager
[212] 971-3793
Regina Hera, Directory Manager
[212] 971-2544
Thomas M. Egan, Production Manager
[212] 971-3140

Circulation Department

Isaaca Siegel, Manager [212] 971-6057

Research Department

David Strassler, Manager [212] 971-6058

Advertising Sales Staff

Frank E. LeBeau [212] 971-6464
Advertising Sales Manager

Wallis Clarke [212] 971-2187
Assistant to sales manager
Donald J. Austermann [212] 971-3139
Promotion Manager

Warren H. Gardner [215] LO 8-6161
Eastern Advertising Sales Manager

Atlanta, Ga. 30309: Michael H. Miller, 1375
Peachtree St., N.E.
[404] 892-2868

Boston, Mass. 02116: William S. Hodgkinson
McGraw-Hill Building, Copley Square
[617] CO 2-1160

Cleveland, Ohio 44113: William J. Boyle, 55
Public Square, [216] SU 1-7000

New York, N.Y. 10036
500 Fifth Avenue
James R. Pierce [212] 971-3615
John A. Garland [212] 971-3617
Michael J. Stoller [212] 971-3616

Philadelphia, Pa. 19103:
Jeffrey M. Preston
Warren H. Gardner,
6 Penn Center Plaza,
[215] LO 8-6161

Pittsburgh, Pa. 15222: Warren H. Gardner,
4 Gateway Center, [412] 391-1314

Rochester, N.Y. 14534: William J. Boyle,
9 Greylock Ridge, Pittsford, N.Y.
[716] 586-5040

Donald R. Furth (312) MO 4-5800
Midwest Advertising Sales Manager

Chicago, Ill. 60611: Kenneth E. Nicklas
Ralph Hanning, 645 North Michigan Avenue,
[312] MO 4-5800

Dallas, Texas 75201: Richard P. Poole, 1800
Republic National Bank Tower,
[214] RI 7-9721

Houston, Texas 77002: Robert Wallin,
2270 Humble Bldg. [713] CA 4-8381

Detroit, Michigan 48226: Ralph Hanning,
856 Penobscot Building
[313] 962-1793

Minneapolis, Minn. 55402: 1104 Northstar
Center [612] 332-7425

St. Louis, Mo. 63105: Kenneth E. Nicklas,
The Clayton Tower, 7751 Carondelet Ave.
[314] PA 5-7285

James T. Hauptli [415] DO 2-4600
Western Advertising Sales Manager

Denver, Colo. 80202: Joseph C. Paqe, David
M. Watson, Tower Bldg., 1700 Broadway
[303] 255-5484

Los Angeles, Calif. 90017: Ian C. Hill,
John G. Zisch, 1125 W. 6th St.,
[213] HU 2-5450

Portland, Ore. 97204: James T. Hautli,
Thomas McElhinny, 218 Mohawk Building,
222 S.W. Morrison Street,
Phone [503] 223-5118

San Francisco, Calif. 94111: James T. Hauptli,
Thomas McElhinny, 255 California Street,
[415] DO 2-4600

Pierre Braude Tel: 225 85 88: Paris
European Director

Paris: Denis Jacob
88-90 Avenue Des Champs-Elysees, Paris 8

United Kingdom and Scandinavia
London: Oliver Ball, Tel: Hyde Park 1451
34 Dover Street, London W1

Milan: Robert Saege
1 via Baracchini Phone 86-90-656

Brussels: F.I.H. Huntjens
27 Rue Ducale Tel: 136503

Frankfurt/Main: Hans Haller
Elsa-Brandstroem Str. 2
Phone 72 01 81

Geneva: Denis Jacob
1. rue du Temple Phone: 31 95 60
Tokyo: Takeji Kinoshita, McGraw-Hill
Publications Overseas Corporation,
1 Kotohiracho, Shiba, Minato-ku, Tokyo, Japan
Osaka: Akihiko Kamesaka, McGraw-Hill
Publications Overseas Corporation, Kondo
Bldg., 163, Umegee-cho Kita-ku [362] 8771

Business Department

Stephen R. Weiss, Production Manager
[212] 971-2044

Thomas M. Egan,
Assistant Production Manager [212] 971-3140

Dorothy Carmesin, Contracts and Billings
[212] 971-2908

Frances Vallone, Reader Service Manager
[212] 971-2865

NEW PRODUCT NO. 71

MSA 8506 RF POWER TRANSISTOR

The MSA 8506 is Fairchild's first new discrete device for 1969. It provides a combination of power output, frequency and price that can't be matched by any competitive transistor.

The new RF device features 25W output at 175MHz. It's resistor-stabilized and comes in the largest strip line package on the market. (Package size contributes to improved power dissipation.)

The MSA 8506 is designed for final power amplifier applications in communications systems such as AM and FM radio; Mobile, marine radio, and portable radios.

Typical specifications for the 12V device include V_{ce0} of 18, BV_{ces} of 36 and 25W P_{out} . It's radiation hardened and will operate over the entire temperature range from -55°C to $+125^{\circ}\text{C}$. Write for complete specs. Your Fairchild distributor has this device in stock now. Prices are \$36.00 each for 1 to 99, \$29.00 each for 100 to 999.

25W@175MHz

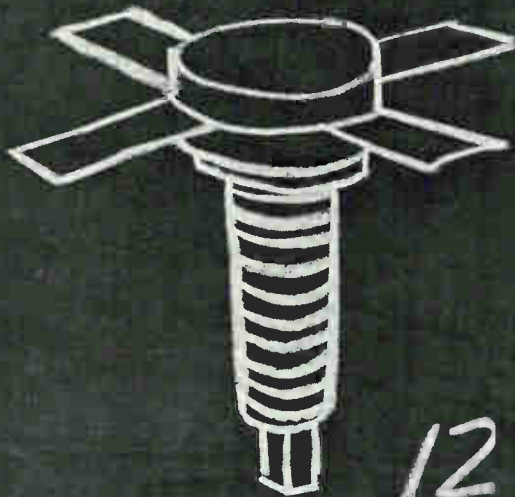

12V.

(LARGEST AVAILABLE)

FAIRCHILD
SEMICONDUCTOR

FAIRCHILD SEMICONDUCTOR A Division of Fairchild Camera and Instrument Corporation Mountain View, California 94040, (415) 962-5011 TWX: 910-379-6435

How our VariplateTM connecting system keeps your fifty-cent IC's from becoming four-dollar headaches.

IC's don't cost much. Until you use them. You can buy, say 20,000 IC's for the innards of a compact computer, packed in the transistor cans, flat packs, or Dual-in-Line (DIP) packages, for a unit cost of less than fifty cents.

Great.

But then you have to connect them.

Not so great.

Because those 20,000 IC's have anywhere from 200,000 to 280,000 leads waiting to be connected. Fine leads. Closely spaced. And, of course, you want to pack the IC's as densely as possible. So it's really no surprise that your *in-place* cost of an IC can climb to \$4.00.

Fortunately, we have a system that can keep your in-place cost down: the Variplate interconnection system.

With the Variplate system, you can pack those IC's—and all the pc boards and other components you have—as densely as the application demands. You can do it on automated equipment—and we'll even do the wiring for you.

All the components you need.

The system begins with the base plate, a self-supporting structural member. It carries the insulated contact modules, accommodates secondary components and hardware, and provides for mounting to support framework.

The plate can be a single metal sheet that provides a ground plane, or it can be a sandwich that provides both volt-

age and ground planes for common bussing.

For the next layer in your electronic sandwich, we have all the header plates, card-edge receptacles and guides, and bushings you're likely to require. (For unlikely requirements, we'll come up with something new.)

And the connectors. Of course. Our own respected VarimateTM, VariconTM, and VarilokTM connectors, or standard fork-and-blade, terminal stud, card-edge, or bus strip contacts. Your choice.

No holes barred.

We put all these components together in any size, any shape, and almost any density of package you require. Plates can be any size. Contacts can be spaced on .100", .125", .150", or .200" centers, in square or offset grids—on non-standard configurations where you need them.

What you get is a solid electrical and mechanical foundation for your electronic network, so precisely made that any automated assembly equipment can take over from there.

However.

You'll save time and money if you let us go one step further and wire your network for you. Our

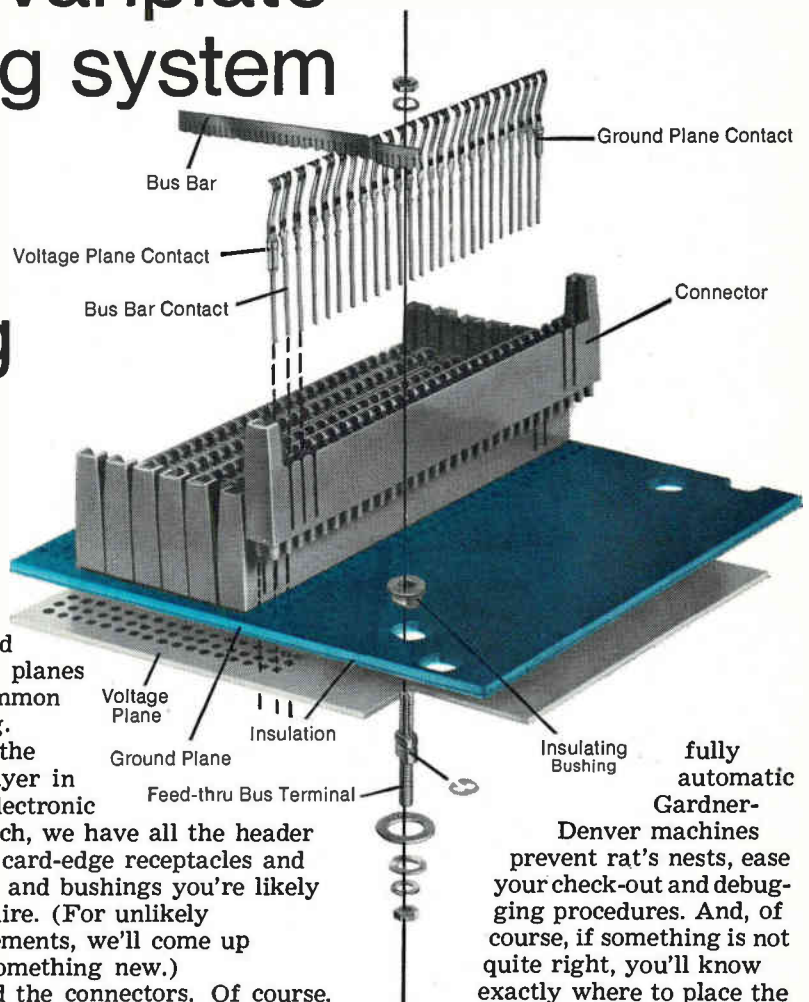

fully automatic Gardner-Denver machines prevent rat's nests, ease your check-out and debugging procedures. And, of course, if something is not quite right, you'll know exactly where to place the responsibility.

Altogether, it's quite a system. And worth all the work we've put into it. Because if we can save you just a nickel on the cost of installing each of your 20,000 IC's you can add a thousand dollars to

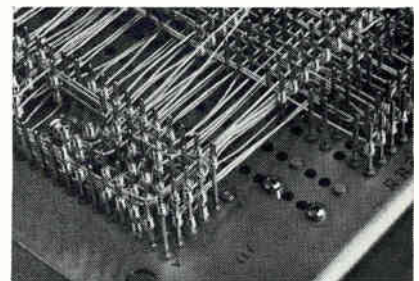

your company's profits.

We're sure we can save you that nickel, and more. For more information, write, wire, call, or TWX us for our Variplate interconnecting systems catalog. Elco Corporation, 155 Commerce Drive, Fort Washington, Pa. 19034. 215-646-7420; TWX 510-661-0



ELCO Variplate Connectors

Electronics reader service

Warning: The Post Office now requires your ZIP CODE on all mail. Please include your ZIP CODE number when filling out your reply card.

Use these handy post cards for more detailed information on: products advertised, new products, new literature.

Circle the number on the Reader Service post card that corresponds to the number at the bottom of the advertisement, new product item, or new literature in which you are interested.

Please print clearly. All written information must be legible to be efficiently processed.

If someone has beaten you to the post cards, you may obtain the needed information by writing directly to the manufacturer, or by sending your name and address, plus the Reader Service number, to Electronics Reader Service department.

All inquiries from outside the U.S. that cannot reach Electronics before the expiration dates noted on the Reader Service post card, must be mailed directly to the manufacturer. The manufacturer assumes all responsibilities for responding to inquiries. Electronics merely provides and clears requests for information from inquirer to manufacturer.

Correct amount of postage must be affixed for all mailings from outside the U.S.

To subscribe to or to renew Electronics

Fill in the "For Subscriptions" area on the card if you desire to subscribe to or renew your present subscription to Electronics. Send no money. Electronics will bill you at the address indicated on the Reader Service post card.

Multi-product advertisements

For information on specific items in multi-product advertisements which do not have a specific Reader Service number indicated write directly to manufacturer for information on precise product in which you are interested.

5 *For employment inquiries fill in home address. March 3, 1969 Card Expires May 3, 1969 14

Name _____ title _____ For Subscriptions
 new renewal
 3 years \$16.00
 1 year \$8.00

Company* _____

Address _____

City _____ State _____ Zip Code _____

1	20	39	58	77	96	115	134	153	172	191	210	229	248	267	286	305	324	343	362	381	400	419	438	457	476	495	514	962
2	21	40	59	78	97	116	135	154	173	192	211	230	249	268	287	306	325	344	363	382	401	420	439	458	477	496	515	963
3	22	41	60	79	98	117	136	155	174	193	212	231	250	269	288	307	326	345	364	383	402	421	440	459	478	497	516	964
4	23	42	61	80	99	118	137	156	175	194	213	232	251	270	289	308	327	346	365	384	403	422	441	460	479	498	517	965
5	24	43	62	81	100	119	138	157	176	195	214	233	252	271	290	309	328	347	366	385	404	423	442	461	480	499	518	966
6	25	44	63	82	101	120	139	158	177	196	215	234	253	272	291	310	329	348	367	386	405	424	443	462	481	500	900	967
7	26	45	64	83	102	121	140	159	178	197	216	235	254	273	292	311	330	349	368	387	406	425	444	463	482	501	901	968
8	27	46	65	84	103	122	141	160	179	198	217	236	255	274	293	312	331	350	369	388	407	426	445	464	483	502	902	969
9	28	47	66	85	104	123	142	161	180	199	218	237	256	275	294	313	332	351	370	389	408	427	446	465	484	503	951	970
10	29	48	67	86	105	124	143	162	181	200	219	238	257	276	295	314	333	352	371	390	409	428	447	466	485	504	952	971
11	30	49	68	87	106	125	144	163	182	201	220	239	258	277	296	315	334	353	372	391	410	429	448	467	486	505	953	972
12	31	50	69	88	107	126	145	164	183	202	221	240	259	278	297	316	335	354	373	392	411	430	449	468	487	506	954	973
13	32	51	70	89	108	127	146	165	184	203	222	241	260	279	298	317	336	355	374	393	412	431	450	469	488	507	955	974
14	33	52	71	90	109	128	147	166	185	204	223	242	261	280	299	318	337	356	375	394	413	432	451	470	489	508	956	975
15	34	53	72	91	110	129	148	167	186	205	224	243	262	281	300	319	338	357	376	395	414	433	452	471	490	509	957	976
16	35	54	73	92	111	130	149	168	187	206	225	244	263	282	301	320	339	358	377	396	415	434	453	472	491	510	958	977
17	36	55	74	93	112	131	150	169	188	207	226	245	264	283	302	321	340	359	378	397	416	435	454	473	492	511	959	978
18	37	56	75	94	113	132	151	170	189	208	227	246	265	284	303	322	341	360	379	398	417	436	455	474	493	512	960	979
19	38	57	76	95	114	133	152	171	190	209	228	247	266	285	304	323	342	361	380	399	418	437	456	475	494	513	961	980

5 *For employment inquiries fill in home address. March 3, 1969 Card Expires May 3, 1969 14

Name _____ title _____ For Subscriptions
 new renewal
 3 years \$16.00
 1 year \$8.00

Company* _____

Address _____

City _____ State _____ Zip Code _____

1	20	39	58	77	96	115	134	153	172	191	210	229	248	267	286	305	324	343	362	381	400	419	438	457	476	495	514	962
2	21	40	59	78	97	116	135	154	173	192	211	230	249	268	287	306	325	344	363	382	401	420	439	458	477	496	515	963
3	22	41	60	79	98	117	136	155	174	193	212	231	250	269	288	307	326	345	364	383	402	421	440	459	478	497	516	964
4	23	42	61	80	99	118	137	156	175	194	213	232	251	270	289	308	327	346	365	384	403	422	441	460	479	498	517	965
5	24	43	62	81	100	119	138	157	176	195	214	233	252	271	290	309	328	347	366	385	404	423	442	461	480	499	518	966
6	25	44	63	82	101	120	139	158	177	196	215	234	253	272	291	310	329	348	367	386	405	424	443	462	481	500	900	967
7	26	45	64	83	102	121	140	159	178	197	216	235	254	273	292	311	330	349	368	387	406	425	444	463	482	501	901	968
8	27	46	65	84	103	122	141	160	179	198	217	236	255	274	293	312	331	350	369	388	407	426	445	464	483	502	902	969
9	28	47	66	85	104	123	142	161	180	199	218	237	256	275	294	313	332	351	370	389	408	427	446	465	484	503	951	970
10	29	48	67	86	105	124	143	162	181	200	219	238	257	276	295	314	333	352	371	390	409	428	447	466	485	504	952	971
11	30	49	68	87	106	125	144	163	182	201	220	239	258	277	296	315	334	353	372	391	410	429	448	467	486	505	953	972
12	31	50	69	88	107	126	145	164	183	202	221	240	259	278	297	316	335	354	373	392	411	430	449	468	487	506	954	973
13	32	51	70	89	108	127	146	165	184	203	222	241	260	279	298	317	336	355	374	393	412	431	450	469	488	507	955	974
14	33	52	71	90	109	128	147	166	185	204	223	242	261	280	299	318	337	356	375	394	413	432	451	470	489	508	956	975
15	34	53	72	91	110	129	148	167	186	205	224	243	262	281	300	319	338	357	376	395	414	433	452	471	490	509	957	976
16	35	54	73	92	111	130	149	168	187	206	225	244	263	282	301	320	339	358	377	396	415	434	453	472	491	510	958	977
17	36	55	74	93	112	131	150	169	188	207	226	245	264	283	302	321	340	359	378	397	416	435	454	473	492	511	959	978
18	37	56	75	94	113	132	151	170	189	208	227	246	265	284	303	322	341	360	379	398	417	436	455	474	493	512	960	979
19	38	57	76	95	114	133	152	171	190	209	228	247	266	285	304	323	342	361	380	399	418	437	456	475	494	513	961	980

5 *For employment inquiries fill in home address. March 3, 1969 Card Expires May 3, 1969 14

Name _____ title _____ For Subscriptions
 new renewal
 3 years \$16.00
 1 year \$8.00

Company* _____

Address _____

City _____ State _____ Zip Code _____

1	20	39	58	77	96	115	134	153	172	191	210	229	248	267	286	305	324	343	362	381	400	419	438	457	476	495	514	962
2	21	40	59	78	97	116	135	154	173	192	211	230	249	268	287	306	325	344	363	382	401	420	439	458	477	496	515	963
3	22	41	60	79	98	117	136	155	174	193	212	231	250	269	288	307	326	345	364	383	402	421	440	459	478	497	516	964
4	23	42	61	80	99	118	137	156	175	194	213	232	251	270	289	308	327	346	365	384	403	422	441	460	479	498	517	965
5	24	43	62	81	100	119	138	157	176	195	214	233	252	271	290	309	328	347	366	385	404	423	442	461	480	499	518	966
6	25	44	63	82	101	120	139	158	177	196	215	234	253	272	291	310	329	348	367	386	405	424	443	462	481	500	900	967
7	26	45	64	83	102	121	140	159	178	197	216	235	254	273	292	311	330	349	368	387	406	425	444	463	482	501	901	968
8	27	46	65	84	103	122	141	160	179	198	217	236	255	274	293	312	331	350	369	388	407	426	445	464	483	502	902	969
9	28	47	66	85	104	123	142	161	180	199	218	237	256	275	294	313	332	351	370	389	408	427	446	465	484	503	951	970
10	29	48	67	86	105	124	143	162	181	200	219	238	257	276	295	314	333	352	371	390	409	428	447	466	485	504	952	971

Reprint service

All Electronics editorial matter available in reprint form:

For reprints of special reports and feature articles see list on right side of this page. Send your order to Electronics Reprint Department at the address indicated. To expedite mailing of your order for single reprints please send cash, check or money order with your order. Allow 3-4 weeks for delivery.

Bulk reprints of editorial matter can be ordered from current or past issues. The minimum quantity is 100 copies. Prices quoted on request: call 212-971-2274, or write to address below.

Warning: The Post Office now requires your ZIP CODE on all mail. Please include your ZIP CODE number when filling out your reply card.

3

Business reply mail

No postage stamp necessary if mailed in the United States

Postage will be paid by

Electronics
Reader service department
Box 444
Hightstown, N. J. 08520

First class
Permit no. 42
Hightstown, N. J.



2

Business reply mail

No postage stamp necessary if mailed in the United States

Postage will be paid by

Electronics
Reader service department
Box 444
Hightstown, N.J. 08520

First class
Permit no. 42
Hightstown, N. J.



1

Business reply mail

No postage stamp necessary if mailed in the United States

Postage will be paid by

Electronics
Reader service department
Box 444
Hightstown, N.J. 08520

First class
Permit no. 42
Hightstown, N. J.



To order reprints or for further information, please write to: Electronics Reprint Department, 330 West 42nd Street, New York, N.Y. 10036.

You may order any of the below listed reprints by key number. Discounts on quantities over 10.

- Key no. R-01 Computer-aided Design: Part I, The Man-machine Merger. 16 pages. \$1.25.
- Key no. R-04 Multilayer Circuit Boards: Sharpening An Imperfect Art. 7 pages. 50¢.
- Key no. R-05 Topology Cuts Design Drudgery. 12 pages. 50¢.
- Key no. R-06 Report on Japanese Technology: Sony. 20 pages. 50¢.
- Key no. R-010 Special Report on Large Scale Integration. 54 pages. \$1.50.
- Key no. R-011 Medical Electronics (1967). 8 part series, 44 pages. \$1.25.
- Key no. R-012 Special Report on Gallium Arsenide 17 parts. 32 pages. \$2.00
- Key no. R-016 Special Report on The Transistor: Two Decades of Progress. 48 pages. \$1.50.
- Key no. R-017 Special Report on Ferrites. 16 pages. \$1.00.
- Key no. R-018 European Electronics Markets 1969 20 page forecast report with a 6 page foldout. \$1.00
- Key no. R-019 U.S. Electronics Markets 1969 32 page forecast report with 4 page foldout. \$1.00
- Key no. R-020 1968 Electronics Index to Technical Articles and Authors Free.
- Key no. R-021 Infrared Detector Characteristics. 23 x 11 inch fold-out chart. 50¢
- Key no. R-87a The Packaging Revolution in Microelectronics, Parts I through VI. 64 pages. \$2.00.
- Key no. R-79 MOS Integrated Circuits. 12 pages. 50¢.
- Key no. R-78 The Overlay Transistor. 15 pages. 50¢.
- Key no. R-75 Biotelemetry. 2 part series, 16 pages. 50¢.
- Key no. R-64 Field Effect Transistors. Parts I, II, and III. 64 pages. \$1.00.

General Railway
Signal Company
uses both silicone
and vitreous coated
Dale Resistors



Now...rugged Dale Wirewounds with your choice of coatings!

Coating makes a difference in the performance of industrial power wirewounds. That's why it's easier to call Dale when you're not sure what's best for your application. We make both silicone (HL) and vitreous (VL) coated models. Before coating they're identical. HL models receive multi-layer coatings of a special silicone formulation. This low-temperature process has less effect on resistor windings—and we sell more HL resistors where customers are primarily concerned with maintenance of tolerance and low TC. Our vitreous enamel coating is baked on to provide maximum resistance to moisture and chemical action—and VL sales are highest where these conditions are a factor. Today many companies—like General Railway Signal—make good use of Dale's single-source capability for power resistors. You can, too.

12 Different Silicone (HL) and Vitreous (VL) Models

	HL/VL 3-225 watts, .1 ohm to 1.3 Meg., $\pm 5\%$ tol.*		HLT/VLT 11-225 watts, .1 ohm to 1.1 Meg., $\pm 5\%$ tol.
	HLW/VLW 3-20 watts, .1 ohm to 80K ohms, $\pm 5\%$ tol.*		HLZ 40-375 watts, .13 ohm to 25 ohms, $\pm 10\%$ tol.
	HL/VL Flat 24-95 watts, .1 ohm to 150K ohms, $\pm 5\%$ tol.*		MIL. SPEC. All HL and VL models meet or exceed the requirements of MIL-R-26 and MIL-R-19365C where applicable.
	HLM/VLM 10-20 watts, .1 ohm to 51K ohms, $\pm 5\%$ tol.		* $\pm 10\%$ below 1 ohm
	HLA 10-225 watts, 1 ohm to 100K ohms, $\pm 5\%$ tol.		

For fast price and
delivery information,
phone 402-564-3131.

DALE ELECTRONICS, INC.
1300 28th Ave., Columbus, Nebr. 68601
In Canada: Dale Electronics Canada, Ltd.

Circle 901 on reader service card



55 MHz Video Amplifier

RCA-CA3040 now opens a new era in monolithic device design for high-gain, wideband performance. This new linear integrated circuit offers high input impedance, emitter-follower output, and exceptional stability over the full -55°C to $+125^{\circ}\text{C}$ operating temperature range. Check these significant CA3040 performance highlights:

- 37 dB typ. differential push-pull voltage gain
- 31 dB typ. single-ended voltage gain
- 55 MHz typ. -3 dB bandwidth
- useful gain to 200 MHz
- two bias options for temperature compensation
 - constant DC output voltage
 - constant differential voltage gain
- 150 k Ω typ. input resistance
- 0.5 V_{RMS} typ. output swing voltage

Look into CA3040 now for performance and economy in video amplifiers, Schmitt triggers, modulators, IF amplifiers, high-speed sense amplifiers, product detectors, and instrumentation amplifiers.

For details, contact your local RCA Representative or your RCA Distributor. For technical data, write RCA Electronic Components, Commercial Engineering, Section ICN-3-1, Harrison, N. J. 07029.

... and Check These RCA Wideband Amplifiers

CA3001	For video, IF, and DC 29 MHz typ. -3 dB BW	\$3.35 (1,000 units)
CA3002	IF and video ampl 11 MHz typ. -3 dB BW	\$2.25 (1,000 units)
CA3021	4 mW power drain @ 6 V 2.4 MHz typ. -3 dB BW	\$1.90 (1,000 units)
CA3022	12.5 mW power drain @ 6 V 7.5 MHz typ. -3 dB BW	\$1.60 (1,000 units)
CA3023	35 mW power drain @ 6 V 16 MHz typ. -3 dB BW	\$1.55 (1,000 units)
CA3020	$\frac{1}{2}$ -watt "Universal" ampl 8 MHz typ. -3 dB BW	\$1.55 (1,000 units)
CA3020A	1-watt "Universal" ampl 8 MHz typ. -3 dB BW	\$1.98 (1,000 units)

RCA

Integrated Circuits

RCA-CA3040 in 12-lead TO-5 style package
\$2.95 (1000 units)

