

# Electronics®

Ferrite circulators for vhf: page 84

Producing circuits faster, cheaper: page 88

Controversy over LSI testing: page 99

November 25, 1968

\$1.00

A McGraw-Hill Publication

Below: Spider bonding  
boosts reliability, page 72

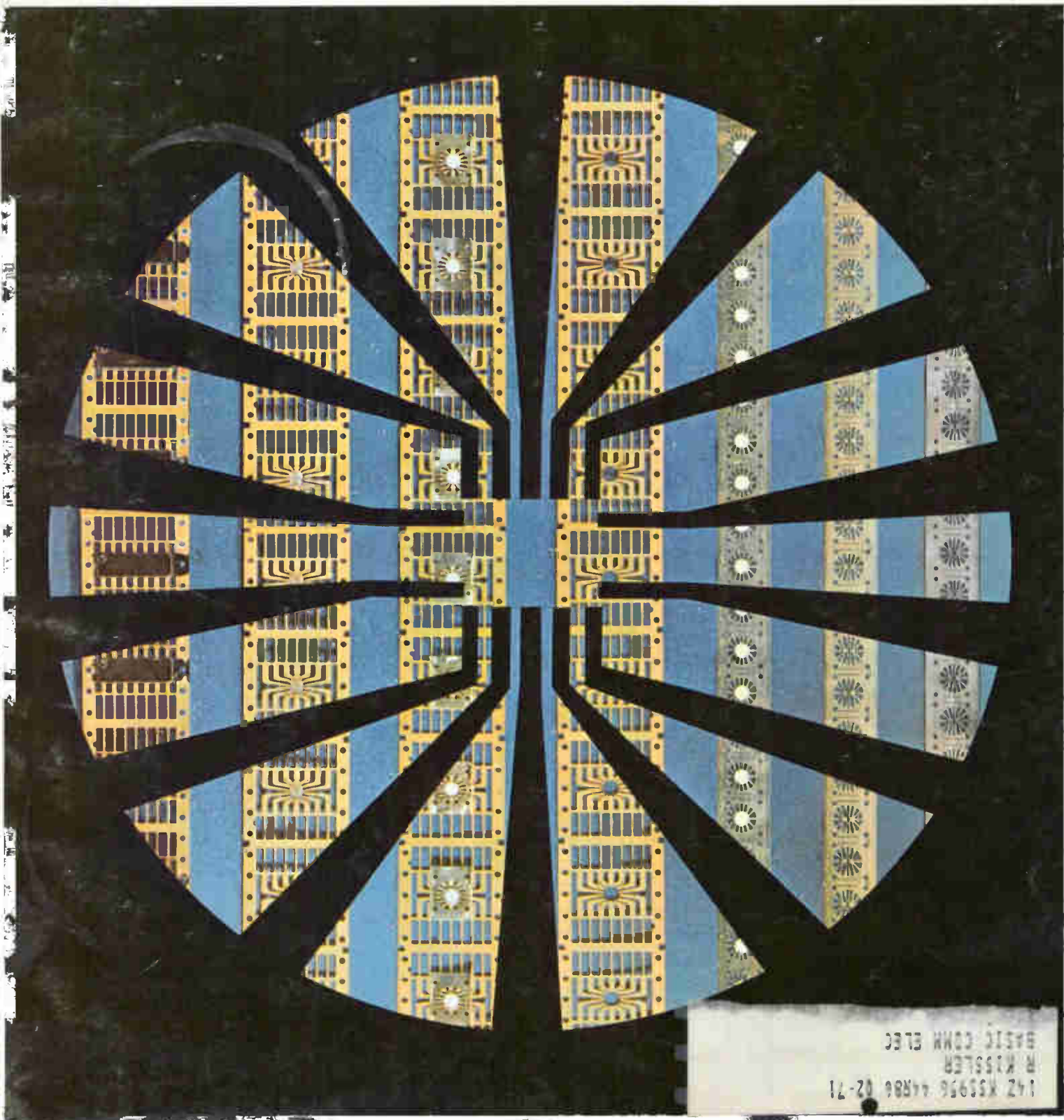

142 K58956 4R86 02-71  
R KISSLER  
BASIC COMM ELEC



At \$2995, this signal generator costs less than those costing half as much.

Not everyone needs the performance of our 1003 Standard-Signal Generator. But those who do need it lose money if they settle for anything less. Why? Because the stability, accuracy, and resolution of the 1003 are as much as an order of magnitude better than those of any other instrument in the 67 kHz-to-80 MHz frequency range. It has motorized tuning, programmability, convenient 2-to-1 range switching, fast settability, and limited sweep capability, to name a few operating conveniences. These are all features that enable you to make better measurements faster. In applications where hundreds of measurements are made daily, the cost of measurement time saved with a 1003 mounts rapidly. That's why the initial cost of the 1003 becomes less significant as you take a closer look at the "big picture."

Here are a few specific examples of how the 1003 can produce real savings:

- The motorized tuning and programmable frequency selection of the 1003 can cut measurement time in half. On a one-shift, production-line basis (at a \$3 per-hour wage) this amounts to savings of \$12 per day . . . \$60 per week . . . over \$3000 per year.
- The high resolution and stability (1 ppm per 10 min., typically) in the face of range switching, rf level adjustments, and load variations mean you don't have to buy a counter to set and monitor frequency. If you're already using a \$2500 counter, the 1003 frees it for use elsewhere.

- The 1003 is virtually unaffected by power-line fluctuations; frequency will vary less than 1 ppm as a result of  $\pm 10\%$  line-voltage changes. You don't have to buy a voltage regulator, so you save money.
- All solid-state circuitry means a cool-running instrument that consumes little power and is not as likely to break down as a tube-type instrument. Low downtime means you save money.
- Warmup drift is low and of short duration, so the instrument is usable at 8:15, not 9:00 A.M. You waste little time, so you save money.

We could go on and on with how and why this instrument performs the way it does, but you have to put the 1003 through its paces yourself to appreciate fully its convenience and performance. So why not do just that? Write or call the GR Sales Office nearest you for the loan of a demonstrator and evaluate the 1003 yourself. There's no cost or obligation. For more information on the 1003, write or call General Radio Company, W. Concord, Massachusetts 01781; telephone (617) 369-4400. In Europe: Postfach 124, CH 8034, Zurich 34, Switzerland.

**GENERAL RADIO**

Circle 900 on reader service card



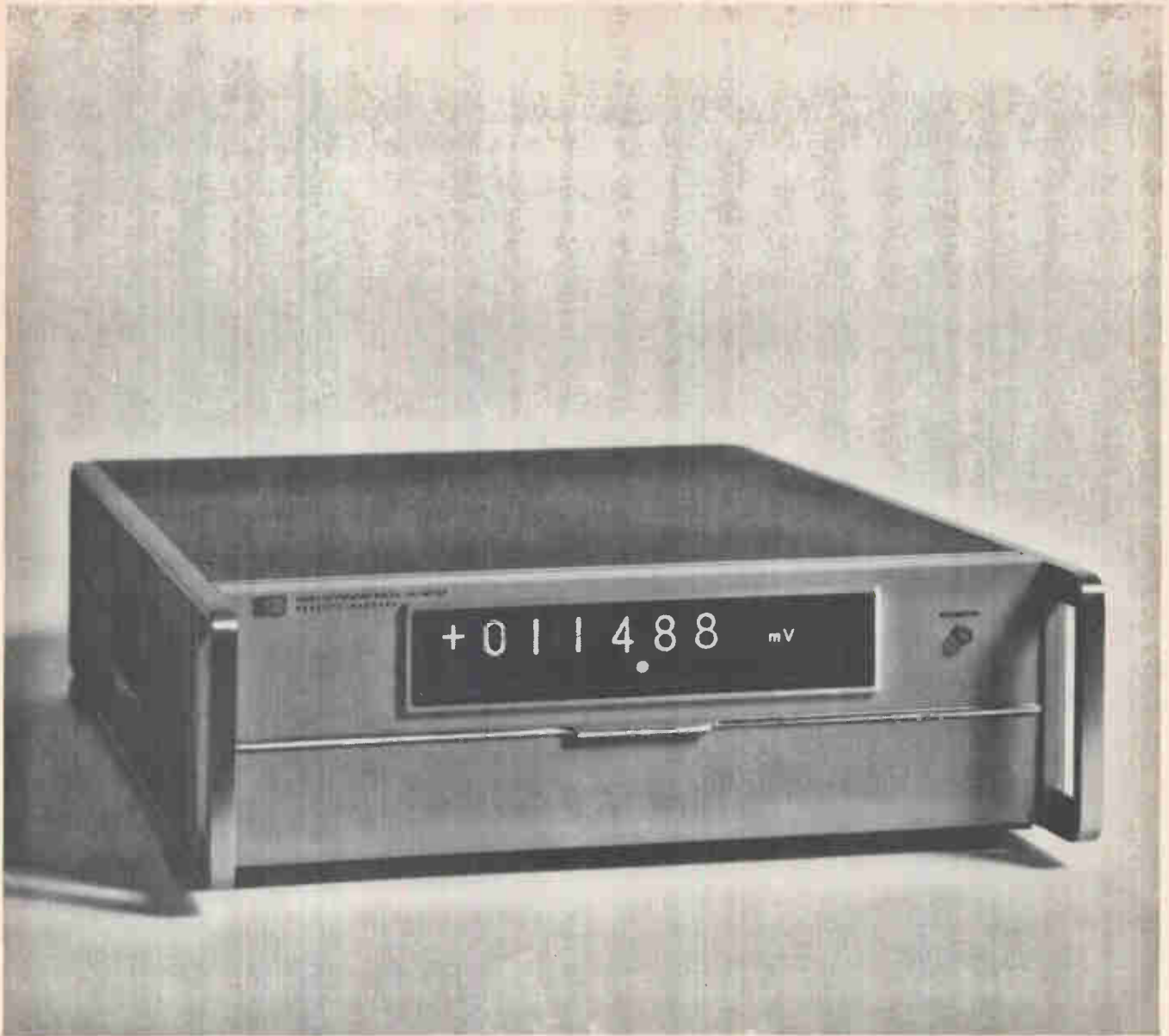

## Systems Specialist

A lot of noise in your system won't faze the Hewlett-Packard 2402A Integrating DVM. It measures low-level signals buried in noise without even slowing down. No more sacrificing speed for accuracy, no more tolerating preamp errors and delays.

The 2402A is an unequalled combination of speed, accuracy and noise immunity in a single package. With it, you can make 5-digit measurements 43 times a second, resolving down to a microvolt with full-

speed accuracy of 0.01%. That's lab accuracy at system speed, even in noise that would slow active-filter DVM's to a virtual halt. BCD output and full programming are standard, and AC, ohms and frequency are plug-in options.

For complete details on how to get both accuracy and speed in the same system, call your local HP field engineer. Or write Hewlett-Packard, Palo Alto, Calif. 94304; Europe: 1217 Meyrin-Geneva, Switzerland.

HEWLETT  PACKARD  
DIGITAL VOLTMETERS

# Looking for Fast, High Volume AC and DC Calibration Capability?

Whenever and wherever you need precision, high volume calibration capability for your calibration laboratory, production line, maintenance testing shop — Hewlett-Packard has an instrument that specifically meets your requirements.

Two of these instruments—designed specifically to meet high accuracy and high volume calibration needs—are the hp 740B for DC and the hp 745A for AC. With either instrument, you press a button, turn a dial and you have an instant voltage reference!

**High Resolution DC Calibration.** The hp 740B DC Standard/Differential Voltmeter delivers output voltage to 1000 V with six digit resolution in discrete steps of 1 ppm of range. Accuracy of  $\pm(0.002\%$  of setting  $+0.0004\%$  of range) extends over 30 days.

As a differential voltmeter, the 740B measures voltage to 1000 Vdc with an input resistance of  $>10^{10}\Omega$ , independent of null condition. Accuracy is  $\pm(0.005\%$  of reading  $+0.0004\%$  of range  $+1\mu\text{V}$ ).

The 740B is also a precision dc amplifier and high impedance voltmeter, and can be used to drive a recorder.

**Fast, Accurate AC Calibration—**Cut your ac calibration time in half with the state-of-the-art hp 745A AC Calibrator—an excellent choice for pro-

duction line calibration and maintenance testing.

The 745A has a calibrated output voltage with  $\pm 0.02\%$  accuracy. It also has a six-digit readout, pushbutton ranging and a continuously adjustable frequency from 10 Hz to 110 kHz.

Eliminate tedious error calculations with the exclusive 745A direct reading percent error scale.

Get full specifications on these and other calibration instruments from your hp field engineer. Or, write to Hewlett-Packard, Palo Alto, California 94304. Europe: 54 Route des Acacias, Geneva. Price, 740B, \$2350; 745A, \$4500.

098/18 2

HEWLETT  PACKARD

WORKING STANDARDS





## News Features

### Probing the News

- 99 **Integrated electronics:** Large-scale problems in LSI testing
- 105 **Space electronics:** Ground-station market flies high

### Electronics Review

- 49 **Companies:** Ovonic switch
- 50 **Industrial electronics:** The computer and the election
- 50 **Displays:** Color panel
- 51 **Advanced technology:** Recombination radiation
- 52 **Avionics:** Guidance computer for \$2,000
- 58 **Communications:** Task force report

### Electronics International

- 145 **Great Britain:** Lighter, smaller solar cells; credit curbs hit color tv makers in their backlogs
- 146 **West Germany:** Taking the pistons' temperature; cutting labor and mistakes in big wiring jobs
- 147 **Japan:** Hybrid IC amplifier for S band; desk-calculator components by Toshiba introduced in race for big future market
- 148 **Around the world**

### New Products

- 111 **IC audio amp puts out 5 watts**
- 115 **Components review**
- 115 **IC op amp in a flatpack**
- 120 **Fuse blows in a millisecond**
- 123 **Instruments review**
- 123 **Battery-powered pulse generator**
- 126 **Proportional control for ovens**
- 131 **Semiconductor review**
- 131 **180-volt transistor turns on fast**

Title R registered U.S. Patent Office; © copyright 1968 by McGraw-Hill Inc. All rights reserved, including the right to reproduce the contents of this publication in whole or in part.

## Technical Articles

- Solid state** 72 **In search of a lasting bond**  
Beam leads and flip chips have their advocates, but many firms continue to weigh the cost and reliability advantages of the two techniques; meanwhile, another company has put forward a third: spider bonding  
Lawrence Curran, Los Angeles bureau manager

- Circuit design** 81 **Designer's casebook**
- Analog gate's output is cleaned up by FET
  - Darlington transistors widen multivibrator's range
  - Fast discharge reduces multivibrator's rise time
  - UJT protects op amp from voltage transients

- Advanced components** 84 **Ferrites: part 2**  
**Circulators for vhf and uhf**  
Once considered purely microwave devices, these versatile components are now coming into wider use for applications at the lower frequency ranges  
Vernon E. Dunn, Melabs

- Manufacturing** 88 **Automating all along the line**  
Computer- and tape-controlled machines assemble circuits with little human help, and are faster and more reliable than semiautomatic setups  
Thomas J. Thomas, Kearfott Products Division, Singer-General Precision Inc.

## Departments

- |    |                          |     |                          |
|----|--------------------------|-----|--------------------------|
| 4  | Readers Comment          | 33  | Electronics Newsletter   |
| 8  | Who's Who in this issue  | 65  | Washington Newsletter    |
| 14 | Who's Who in electronics | 135 | New Books                |
| 22 | Meetings                 | 137 | Technical Abstracts      |
| 31 | Editorial Comment        | 138 | New Literature           |
|    |                          | 143 | International Newsletter |

# Electronics

Editor-in-Chief: Donald Christiansen

## Associate managing editors

Technical: Stephen E. Scrupski  
News: Robert Henkel  
Copy: Sally Powell

## Senior associate editors

Joseph Mittleman, Harry R. Karp

## Department editors

Avionics & Space: Alfred Rosenblatt  
Computers: Wallace B. Riley  
Communications: William Buccini  
Components: George Watson  
Consumer electronics: John D. Drummond  
Design theory: Joseph Mittleman  
Industrial electronics: Harry R. Karp  
Military electronics: Richard Gundlach  
Special projects: Raphael Kestenbaum

## Domestic bureaus

Boston: James Brinton, manager  
Chicago: Frederick Corey, manager  
Los Angeles: Lawrence Curran, manager  
New York: Howard Wolff, manager  
San Francisco: Walter Barney, manager; Peter Vogel  
Washington: Robert Skole, manager; Paul Dickson, William F. Arnold

## Foreign bureaus

Bonn: John Gosch  
London: Michael Payne  
Tokyo: Charles Cohen

## Copy editors

James Chang, Larry Miller

## Graphic design

Art director: Gerald Ferguson  
Assistant art directors: Valerie Betz, Susan Hurlburt  
Production editor: Arthur C. Miller

Editorial secretaries: Lorraine Longo, Claire Goodlin,  
Patricia Gardner, Barbara Razulis

## McGraw-Hill News Service

Director: Arthur L. Moore; Atlanta: Fran Ridgway; Chicago: Robert E. Lee  
Cleveland: Arthur Zimmerman; Dallas: Marvin Reid  
Detroit: James Wargo; Houston: Barbara LaRoux  
Los Angeles: Michael Murphy; Pittsburgh: Louis Gomolak  
San Francisco: Margaret Drossel  
Seattle: Ray Bloomberg; Washington: Charles Gardner, Daniel B. Moskowitz,  
Herbert W. Cheshire, Seth Payne, Warren Burkett, William Small, William D. Hickman

## McGraw-Hill World News Service

Bonn: Robert Dorang; Brussels: James Smith; Hong Kong: Wes Perry;  
London: John Shinn; Mexico City: Gerald Parkinson; Milan: Ronald Taggiasco, Jack Star;  
Moscow: Jack Winkler; Paris: Robert E. Farrell, Stewart Toy  
Rio de Janeiro: Leslie Warren; Tokyo: Marvin Petal

Reprints: Susan Nugent

Circulation: Isaaca Siegel

## Publisher: Gordon Jones

Electronics: November 25, 1968, Vol. 41, No. 24

Published every other Monday by McGraw-Hill, Inc. Founder: James H. McGraw 1860-1948.

Publication office 99 North Broadway, Albany, N.Y. 12202; second class postage paid at Albany, N.Y.

Executive, editorial, circulation and advertising addresses: McGraw-Hill Building, 330 W. 42nd Street  
New York, N.Y. 10036. Telephone (212) 971-3333. Teletype TWX N.Y. 710-581-4235. Cable address:  
MCGRAWHILL N.Y.

Subscriptions solicited only from those professionally engaged in electronics technology. Subscription rates:  
qualified subscribers in the United States and possessions and Canada, \$8.00 one year, \$12.00 two years,  
\$16.00 three years; all other countries \$25.00 one year. Non-qualified subscribers in the U.S. and  
possessions and Canada, \$25.00 one year; all other countries \$50.00. Air freight service to Japan \$50.00  
one year. Single copies: United States and possessions and Canada, \$1.00; all other countries, \$1.75.

Officers of McGraw-Hill Publications: Joseph H. Allen, President; J. Elton Tuohig, Executive Vice President;  
David J. McGrath, Senior Vice President-Operations; Vice Presidents: John R. Callahan, Editorial; Paul F. Cowie,  
Circulation; John R. Emery, Administration; John M. Holden, Marketing; David G. Jensen, Manufacturing;  
Jerome D. Lutz, Planning & Development; Robert M. Wilhelmy, Controller.

Officers of the Corporation: Shelton Fisher, President and Chief Executive Officer; John L. McGraw, Chairman;  
Robert E. Slaughter, Executive Vice President; Daniel F. Crowley, Donald C. McGraw, Jr., Bayard E. Sawyer, Senior  
Vice Presidents; John J. Cooke, Vice President & Secretary; Gordon W. McKinley, Vice President & Treasurer.

Title registered in U.S. Patent Office; © Copyright 1968 by McGraw-Hill, Inc. All rights reserved. The contents  
of this publication may not be reproduced either in whole or in part without the consent of copyright owner.

Subscribers: The publisher, upon written request to our New York office from any subscriber,  
agrees to refund that part of the subscription price applying to copies not yet mailed.  
Please send change of address notices or complaints to Fulfillment Manager; subscription  
orders to Circulation Manager, Electronics at address below. Change of address notices  
should provide old as well as new address, including postal zip code number. If possible,  
attach address label from recent issue. Allow one month for change to become effective.

Postmaster: Please send form 3579 to Fulfillment Manager, Electronics,  
P.O. Box 430, Hightstown, New Jersey 08520

## Readers Comment

### Only half the picture

To the Editor:

The article "Waiting for a home vtr? Don't hold your breath" [Sept. 30, p. 102] provided an excellent roundup on today's video tape recorders. Seemingly, however, the author held out little hope that the future would see a cheap home set.

Since I am involved with tape recorders only as a hobby, I have no ax to grind. My remarks reflect my personal reactions to the article.

At first glance, it seemed all Dostoyevskian gloom with no hope in sight. But when I finished the article I realized that the comments pertained mostly to color vtr's. Since an acceptable bandwidth is now possible with black-and-white sets, wouldn't the greatest need now be compatibility among the manufacturers—a standard of, say, 7.5 ips of half-inch tape running past a fixed head?

As a home entertainment medium, people were happy for years with black-and-white home movies. Why not with monochrome vtr's? As to the idea of a camera costing \$15,000 to \$70,000, that is as inappropriate as using the most expensive condenser mike for a seven-transistor tape recorder.

George deLucenay Leon  
Los Angeles

### Easier said than done

To the Editor:

The letter "Voicing the case for ssb" [Sept. 2, p. 4] urges "that both a-m and f-m be phased out for all person-to-person voice transmission."

However, the land mobile section of the Electronics Industries Association, in an effort to determine what modulation methods make optimum use of the electromagnetic spectrum allocated for voice communications, has investigated and rejected single sideband as a means of better utilization.

The EIA report observes that "suppressing the carrier and transmitting only one sideband has long been a favored method of reducing

# Something *New* Has Been Added!

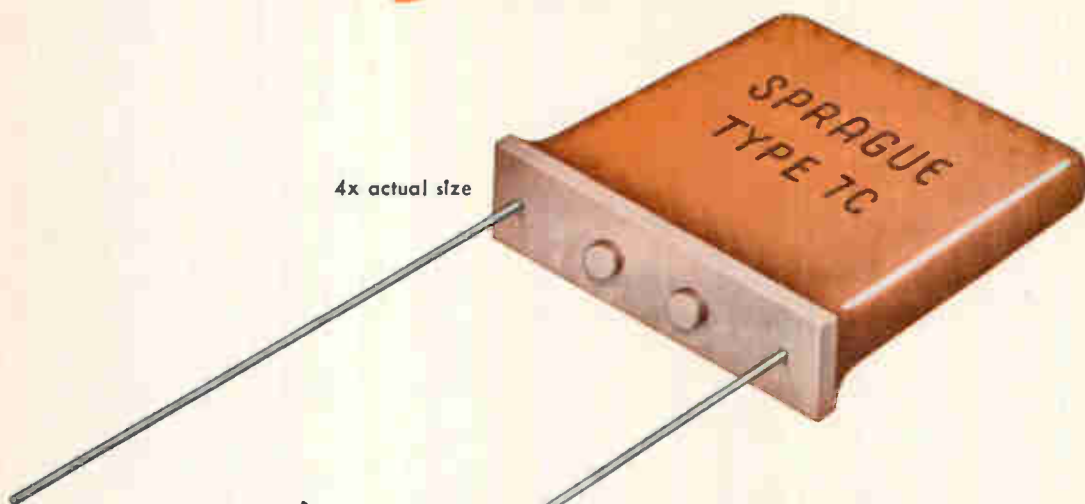

## *Improved* SPRAGUE MONOLYTHIC<sup>®</sup> CERAMIC CAPACITORS

now have a phenolic terminal base

Type 7C Radial-lead Capacitors are made with alternate layers of sprayed ceramic dielectric material and screened metallic electrodes, fired into a solid homogeneous block and coated with a tough phenolic resin. Their new bossed terminal base construction provides these advantages: (1) No resin run-down on leads. (2) Uniform lead spacing is automatically maintained. (3) No dirt and moisture entrapment; degreasing fluid flows freely between capacitor and board.

Body Code	EIA Characteristic	Operating Temperature Range	Maximum Cap. Change over Temp. Range	WVDC	Capacitance Range	Capacitance Tolerance
082	N030	-55 C to +125 C	-30ppm/°C, ±30ppm/°C	50 100 200	51 pF to .024 μF	±20% ±10% ±5% ±2%
075	N750	+25 C to +85 C	Meets MIL-C-20 Char. UJ	50 100 200	.001 μF to .082 μF	±20% ±10% ±5% ±2%
		-55 C to +125 C	-750ppm/°C, ±120ppm/°C			
067	W5R	-55 C to +125 C	±15%	50 100	.0018 μF to 1.5 μF	±20% ±10%
023	Z5U	+10 C to +85 C	+22%, -56%	50	.01 μF to 3.3 μF	+80, -20% ±20%



Also made with axial leads, Monolythic<sup>®</sup> Ceramic Capacitors are available in four body formulations, including a newly-developed 075 ceramic material, as described in the adjacent chart.

For complete technical data write for engineering bulletins on Monolythic Ceramic Capacitors to: Technical Literature Service, Sprague Electric Co., 35 Marshall St., North Adams, Mass. 01247.

### SPRAGUE COMPONENTS

- |                         |                        |                                      |
|-------------------------|------------------------|--------------------------------------|
| CAPACITORS              | PULSE TRANSFORMERS     | CERAMIC-BASE PRINTED NETWORKS        |
| TRANSISTORS             | INTERFERENCE FILTERS   | PACKAGED COMPONENT ASSEMBLIES        |
| RESISTORS               | PULSE-FORMING NETWORKS | BOBBIN and TAPE WOUND MAGNETIC CORES |
| INTEGRATED CIRCUITS     | TOROIDAL INDUCTORS     | SILICON RECTIFIER GATE CONTROLS      |
| THIN-FILM MICROCIRCUITS | ELECTRIC WAVE FILTERS  | FUNCTIONAL DIGITAL CIRCUITS          |

48C-8107



\*Sprague\* and \*®\* are registered trademarks of the Sprague Electric Co.



# We've got a plan for speeding up delivery on Heinemann Circuit Breakers.

Read the fine print:

## AUTHORIZED HEINEMANN STOCKING DISTRIBUTORS

**Alabama**  
Electro-Tech, Inc.  
Huntsville  
(205) 539-1250

**Arizona**  
Kierulff Electronics, Inc.  
Phoenix  
(602) 273-7331

**California**  
Wesco Electronics  
Los Angeles  
(213) 685-9525

**Wesco Electronics**  
Palo Alto  
(415) 968-3475

**Wesco Electronics**  
San Diego  
(714) 279-3471

**Colorado**  
Kierulff Electronics, Inc.  
Denver  
(303) 343-7090

**Connecticut**  
MarLe Company  
Stamford  
(203) 348-2645

**Grand Light & Supply Co.**  
New Haven  
(203) 777-5781

**Florida**  
McDonald Distributors  
of Florida Inc.  
Fort Lauderdale  
(305) 563-1255

**Industrial Electronics**  
Associates, Inc.  
West Palm Beach  
(305) 848-8686

**Parts Service Corp.**  
Winter Park  
(305) 647-5343

**Georgia**  
Electro-Tech, Inc.  
Hapeville  
(404) 758-7205

**Illinois**  
Electric Supply Corp.  
Chicago  
(312) 263-5225

**Hall-Mark Electronics**  
Rosemont  
(312) 299-6602

**Kansas**  
Hall-Mark Electronics  
Kansas City  
(913) 236-4343

**Kentucky**  
E & H Electric Supply Co.  
Louisville  
(502) 587-0991

**Marine Electric Co.**  
Louisville  
(502) 587-6511

**Louisiana**  
Poulan's Electrical Co.  
Monroe  
(318) 323-7701

**Hall-Mark Electronics**  
New Orleans  
(504) 242-7581

**Maine**  
Stanley J. Leen Co., Inc.  
Portland  
(207) 774-6266

**Maryland**  
Lee Electric Co.  
Baltimore  
(301) 752-4080

**Pyttronic Industries, Inc.**  
Baltimore  
(301) 727-5100

**Massachusetts**  
Apparatus Service Co.  
Allston  
(617) 787-1300

**Electrical Supply Corp.**  
Cambridge  
(617) 491-3300

**T. F. Cushing, Inc.**  
Springfield  
(413) 788-7341

**Mississippi**  
Ellington Electronic  
Supply, Inc.  
Jackson  
(601) 355-0561

**New Jersey**  
Valley/Hamilton Electro  
Sales  
Cherry Hill  
(609) 662-9337

**Federated Purchaser, Inc.**  
Springfield  
(201) 376-8900

**New Mexico**  
Kierulff Electronics, Inc.  
Albuquerque  
(505) 268-3901

**New York**  
Federal Electronics Inc.  
Vestal  
(607) 748-8211

**F-J-R Electronics, Inc.**  
Hicksville, L.I.  
(516) 433-5530

**North Carolina**  
Electro-Tech, Inc.  
Charlotte  
(704) 392-7451

**Ohio**  
Midwest Equipment Co.  
Cincinnati  
(513) 821-1687

**Radio & Electronic Parts**  
Cleveland  
(216) 881-6060

**Oklahoma**  
Hall-Mark Electronics  
Tulsa  
(918) 835-8458

**Oregon**  
Platt Electric Supply  
Portland  
(503) 222-9633

**Pennsylvania**  
West Chester Electric  
Supply Co.  
West Chester  
(215) 696-7500

**Rhode Island**  
William Dandreta & Co.  
Providence  
(401) 861-2800

**Texas**  
Cummins Supply Co.  
Amarillo  
(806) 373-5379

**G. E. Jones Electric Co.**  
Amarillo  
(806) 372-5505

**Priester-Mell Co.**  
Austin  
(512) 452-7634

**Warren Electric Co.**  
Beaumont  
(713) 833-9405

**Hall-Mark Electronics**  
Dallas  
(214) 231-6111

**Nelson Electric Supply**  
Dallas  
(214) 741-6341

**Hall-Mark Electronics**  
Houston  
(713) 781-0011

**Warren Electric Co.**  
Houston  
(713) 225-0971

**Messner Electric Supply**  
Longview  
(214) 753-4484

**The Perry Shankle Co.**  
San Antonio  
(512) 223-1801

**Virginia**  
Dominion Electric Supply  
Arlington  
(703) 536-4400

**Washington**  
Kierulff Electronics, Inc.  
Seattle  
(206) 725-1550

HEINEMANN ELECTRIC COMPANY



Trenton, New Jersey 08602

## Readers Comment

bandwidth in point-to-point services and where impulse noise is seldomly encountered." It's the point-to-point and impulse-noise parameters that are significant in that statement. Give an operator a "clarifier" to fine-tune the receiver and the articulation index will improve; but imagine a busy dispatcher fine-tuning every mobile-to-base transmission, or a police officer fine-tuning during a chase to compensate for Doppler shift.

The tests performed by the EIA show that when impulse noise is introduced, ssb covers less than half the range that can be covered by the equivalent primary-power narrowband f-m (NBFM) system, meaning that more or higher-power ssb transmitters would be required to cover the equivalent NBFM area. It goes without saying that ssb receivers would require noise blankers as standard equipment for vehicular communication. The EIA also showed that ssb systems experience adjacent-channel interference at greater distances than do NBFM systems. In other words, ssb systems require greater geographic spacing than NBFM systems for the same frequency spacing—a factor in direct contradiction with the need for more ssb transmitters to overcome the impulse-noise problem.

For these primary reasons, it is highly unlikely that both a-m and f-m will be phased out for all person-to-person voice transmission.

R.T. Buesing

General Electric Co.  
Lynchburg, Va.

### Vested altruism

To the Editor:

Certainly the electronic component manufacturers that have established facilities in the Far East [July 22, p. 31 and Sept. 30, p. 31] were drawn to the area primarily by the abundance and low cost of local labor. And it's true that the hourly figures for workers are 13 cents in Taiwan and 20 cents in Hong Kong. But these figures are "unloaded" and carry the unfortunate connotation that American industry is internationally exploitive. Loading not only makes the costs involved more realistic, but brings to light something frequently overlooked. For lack of a better phrase, I call it "vested altruism."

As an example, the girls on Fairchild Semiconductor's Hong Kong assembly line receive an excellent luncheon as part of their compensation. I recall hearing the marketing director at Fairchild say, "The meal was so good and their work environment so much better than their home conditions that a significant problem was getting the workers to leave after their shift."

I think an informal survey of the Hong Kong facilities of other U.S. corporations would yield further support for my belief that companies operating overseas are not easily categorized as latter-day Simon Legrees. Further, I believe that our vested altruism is sincere and will most probably increase.

Ricardo J. Alfaro II

Vice president  
Ness Industries Inc.  
Palo Alto, Calif.

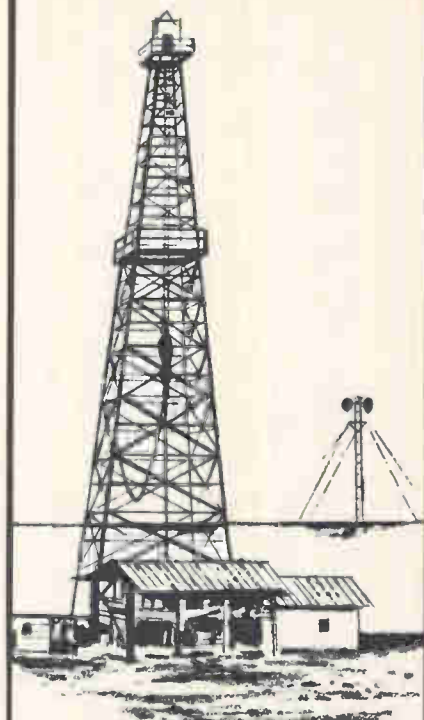

## The Coastal States Gas Producing Co. of Texas

uses Farinon microwave systems for reliable communications

So do three oil companies in Africa, four more in Venezuela, nine major US oil producers, 43 major US telephone companies, 16 US government agencies, and five railroads . . . among 223 others.

They appreciate Farinon's skill at combining high performance and reliability with economy.

Write for our catalog of radio, microwave and multiplex equipment, accessories and services.

# Farinon

Farinon Electric, 935 Washington St., San Carlos, Cal. 94070

### SUBSCRIPTION SERVICE

Please include an Electronics Magazine address label to insure prompt service whenever you write us about your subscription.

Mail to: Fulfillment Manager  
Electronics  
P.O. Box 430  
Hightstown, N.J. 08520

To subscribe mail this form with your payment and check  new subscription  renew my present subscription

Subscription rates: qualified subscribers in the U.S.: 1 year \$8; two years, \$12; three years, \$16. Non-qualified: 1 year \$25. Subscription rates for foreign countries available on request.

### CHANGE OF ADDRESS

ATTACH LABEL HERE

If you are moving, please let us know five weeks before changing your address. Place magazine address label here, print your new address below.

name \_\_\_\_\_

address \_\_\_\_\_

city \_\_\_\_\_

state \_\_\_\_\_

zip code \_\_\_\_\_

# Is Your Budget Too Tight For Your Bandwidth?

**\$284**

○ Low Cost

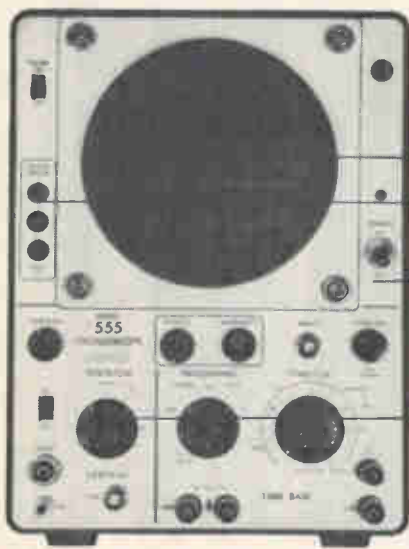

○ 8 cm x 10 cm Viewing Area

○ Voltage Calibrator

○ Solid State Reliability

○ 7 MHz Bandwidth

Try this one for size—Data Instruments Model 555. For any application, Production Line, Field or Laboratory, this scope is a perfect fit. Look at what it offers: (1) Performance. A 7 MHz bandwidth, and an extremely linear time base with variable controls over 19 calibrated ranges and a variety of triggering modes. (2) Display. A 5 inch Braun type tube with an edge lit, removable graticule provide highly precise and legible traces on an 8 x 10 centimeter viewing area. (3) Reliability. All attenuators are solid state and fully compensated. Backing up this solid state reliability is a full year's warranty and complete field and factory service.

Examine the specifications.

VERTICAL AMPLIFIER					
BANDWIDTH DC-7 MHz	SENSITIVITY/CM 20mv	ATTENUATOR 9 position	RISE TIME .05 $\mu$ s	ACCURACY $\pm$ 5%	IMPEDANCE 1M $\Omega$ + 33pf
TIME BASE			CRT	PHYSICAL	
SWEEP/CM	TRIGGER	HORIZONTAL AMP.	DIA.	DIM. & WT.	
1 $\mu$ s-1 sec. (19 ranges)	20Hz-7MHz (20mv)	Exp. X5 2Hz-200KHz	5" (1600V)	8" x 10.5" x 16" 22 lbs.	

Look at the scope in action. Drop us a note and we'll arrange a demonstration in your plant. You'll find the 555 fits your bandwidth requirements comfortably. At \$284 its very comfortable indeed.

Data Instruments Division • 7300 Crescent Blvd. • Pennsauken, N.J. 08110

## Who's Who in this issue



Dunn

**First impressions** of microwaves for Vernon E. Dunn came when he worked with radom installations as an ROTC man at Wright-Patterson Air Force Base. These impressions must have been strong; they led eventually to a Ph.D. dissertation at Stanford University on microwave pulse-compression filters. Dunn, author of the circulator article on page 84, also earned his BSEE and MSEE at Stanford and worked in the systems techniques lab there. He's been at Melabs since 1962, working in several microwave areas, and now heads the microwave advanced development group. A major interest at the moment is the application of thin-film techniques to the fabrication of ferrite devices. He sees thin-film microstrip circuitry as the wave of the future in the production of ferrite devices. Dunn, the father of three children, turns to photography for relaxation.





Thomas

Airplanes, not corridors, take Thomas J. Thomas from one "office" to another. Thomas probably spends almost as much time flying from one coast to another as he does behind a desk; he splits his time between his headquarters in Little Falls, N.J., and his company's manufacturing facility in San Marcos, Calif. He's still spending a great deal of time on the automated production line he describes in the article on page 88.

Thomas is senior vice president for avionics of the Kearfott Products division of Singer-General Precision Inc. He's been with Kearfott since 1951, and as a design engineer has worked on such projects as navigational computer systems, precision-stable platforms, analog-to-digital converters, and navigational display instruments. He holds a BS from Pennsylvania State University and an MS from Stevens Institute of Technology.

The special report on face-down bonding techniques on page 72 was put together by Lawrence Curran, Electronics' Los Angeles bureau manager. Inputs came from Walter Barney and Peter Vogel in San Francisco, James Brinton in Boston, William Arnold in Washington, and William Bucci and George Watson in New York. Curran, who has chalked up nearly two years in Southern California for Electronics, began his investigation of bonding methods in August.

# Your custom pulse transformer is a standard DST\* transformer

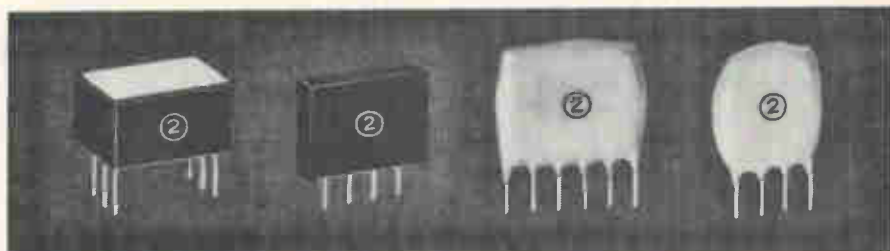

Some of the case styles in which Sprague DST Pulse Transformers are available. Note the in-line leads.

**You can select** the transformer design you need from the new Sprague DST Family, a fully-characterized series of Designer Specified Transformers which Sprague Electric has pioneered. It's easy. Start with the two basic parameters dictated by your circuit requirements: primary (magnetizing) inductance and volt-second capacity.

New Sprague engineering data gives basic information from which all nominal sine wave parameters are derived. This data allows you to specify the one transformer from thousands of possibilities which will optimize performance in your application.

**Design Style A** minimizes magnetizing inductance change as a function of temperature. Typically it's  $< \pm 10\%$  change from 0 to 60 C;  $< \pm 30\%$  from -55 to +85 C.

**Design Style B and C** give you broad bandpass characteristics, and still keep magnetizing inductance change  $< \pm 15\%$  from 0 to 60 C.

**Design Style D is fast.** Associated leakage inductance and coupling capacitance are kept at a minimum. This style is just what you need for interstage and coupling devices in computer drive circuits.

*The Sprague DST Series packs a lot of transformer into minimum volume packages — epoxy dipped for minimum cost, or pre-molded. The 100 mil in-line lead spacing is compatible with integrated circuit mounting dimensions on printed wiring boards.*

**To solve your pulse transformer design, start now. Write for Engineering Bulletin 40,350 to the Technical Literature Service, Sprague Electric Company, 35 Marshall St., North Adams, Mass. 01247.**

\*Trademark

## SPRAGUE COMPONENTS

PULSE TRANSFORMERS  
CAPACITORS  
TRANSISTORS  
RESISTORS  
THIN-FILM MICROCIRCUITS  
INTEGRATED CIRCUITS

INTERFERENCE FILTERS  
PACKAGED COMPONENT ASSEMBLIES  
FUNCTIONAL DIGITAL CIRCUITS  
MAGNETIC COMPONENTS  
CERAMIC-BASE PRINTED NETWORKS  
PULSE-FORMING NETWORKS



Sprague and ® are registered trademarks of the Sprague Electric Co.

488C-8122

# microtopics

product news from Philco-Ford Microelectronics

## Our Hybrid Hunters are looking for you!



**W. Peter Dean:** Department Manager, Hybrid Circuits. More than 10 years' semiconductor and hybrid circuit experience.



**Mal Gilbert:** Engineering Supervisor, Circuit Design, Hybrid Circuits. 10 years' system design and hybrid circuit experience.



**Hal Molyneux:** Engineering Supervisor, Prototype Group, Hybrid Circuits. More than 10 years' semiconductor and hybrid experience.



**Shawki Ibrahim:** Circuit Design Engineer, Hybrid Circuits. More than three years' circuit design experience.



**Bob Simon:** Marketing Manager, Hybrid Circuits. Approximately 10 years' experience in semiconductors and hybrid circuits.

CIRCLE 507 ON READER SERVICE CARD

Are you a design engineer looking for a fast, low cost way to miniaturize circuits now made of discrete components? Can't afford the time, tooling costs and operational limitations of monolithics? Willing to pay about the same price as discrete construction?

If you fit this description, you're the man our traveling Hybrid Hunters are looking for. We're ready to come to your plant, sit down with you and talk about your circuits. We'll analyze your requirements. In four weeks, we'll deliver a hybrid prototype. In six weeks, we can get your circuit in volume production, at rates of 2500 or more per month.

We know we can do the job, because we've been doing it for years for hundreds of customers. Just call 215-948-8400 and ask for a Hybrid Hunter. Or check the number below on the Reader Service Card.

## Lockheed Awards Philco-Ford Contract for Poseidon IC's

A letter contract which it is anticipated will result in a multi-million dollar agreement calling for manufacture of seven types of integrated circuits (IC's), for use in the United States Navy's Poseidon program, has been awarded to Philco-Ford Corporation's Microelectronics Division by the Lockheed Missiles and Space Company, Sunnyvale, California.

"The contract's value is expected to

exceed \$5 million over an 18-month period," said Howard T. Steller, Microelectronics Division General Manager, in announcing the award.

Poseidon is the newest missile being developed for the United States Navy Fleet Ballistics Missile System. Lockheed is prime contractor.

The seven types of IC devices Philco-Ford will supply are five IC's with diode-transistor logic (DTL), a

Model 709 operational amplifier, and a Lockheed-designed IC.

Mr. Steller pointed out that this award, expected to exceed \$5 million, is the second major order recently received by the Microelectronics Division. The Division was selected to be one of three firms to share in a Burroughs Corporation order for IC's, believed to be the largest order ever placed in the semiconductor industry for standard devices.



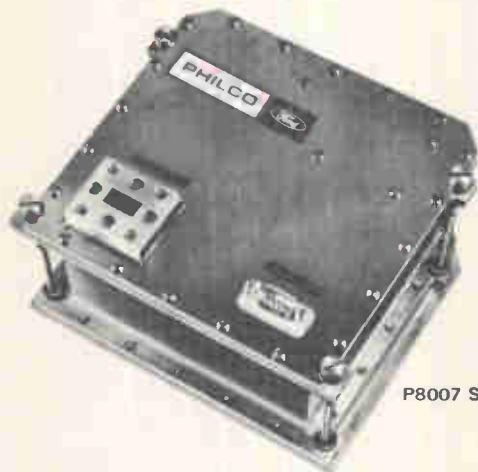

P8007 Solid-State Power Source

## Take the solid-state route to >1 watt CW output in K<sub>u</sub> band!

Cash in on the simplicity and compact size of the Philco P8007 Solid-State Power Source. It delivers more than 1 watt of spectrally clean, stable CW power at 13.8 GHz.

What's the secret of its success? Philco L8500 Series Silicon Integrated Varactors do the job of frequency multiplication. Their unique design, using series-connected silicon varactor chips bonded to a high thermal conductivity substrate, produces power handling capability nearly an order of magnitude greater than conventional varactors.

Supplied in standard microwave packages, they only need heat sinking at one end. Use of the single substrate technique results in the lowest thermal resistance values available in the industry. Cutoff frequencies up to 300 GHz can be provided.

We can supply proven Silicon Integrated Varactors to assemble into your own microwave power source. Or, we can take on the entire job and deliver the best high-power, solid-state power source you've ever seen.

CIRCLE 508 ON READER SERVICE CARD



Package Style 4



Package Style 5

Philco Integrated Varactors

### Capability of Philco Silicon Integrated Varactors:

Type	Band	CW Watts Output
L8505	L	35
L8504	S	25
L8503	C	12
L8512	X	3
L8513	Ku	1.5

### Spectral Characteristics of Philco P8007

Frequency stability: ±10 ppm long term  
 Spurious outputs: more than 40 db below carrier  
 AM noise: -120 db typical at 1 KHz (100 Hz bw)  
 FM noise: 6 Hz at 10 KHz (100 Hz bw)

## Dielectrically Isolated IC's Now Available

The conventional technique for isolating components of an integrated circuit—reverse biased P-N junctions—has some inherent shortcomings, one of which is high sensitivity to transient radiation.

The urgent need for radiation tolerant systems has spurred development of dielectrically isolated integrated circuits in recent years. Philco-Ford is a leader in this technology. We have developed a reliable process for making IC's in which isolation is obtained by fabricating each component in a "tub" of silicon dioxide. Radiation-induced currents of catastrophic magnitude are thereby prevented from flowing throughout the die.

We are currently in position to supply prototype quantities of a selection of dielectrically isolated DTL devices, including gates, buffers and flip-flops. We're ready to consult with you on your specific application.

CIRCLE 509 ON READER SERVICE CARD

## Industrial Cerdip DTL with MIL hermeticity... at new low prices

Performance. Economy. Immediate delivery. These are good reasons to put Philco-Ford Cerdip DTL to work in your equipment.

If you're using flat packs now, consider this: Cerdips are far more convenient to stock, handle and connect. They're ideally suited for automatic insertion and soldering techniques.

And when you buy from Philco-Ford, you can be confident that quality and reliability are proved by exhaustive qualification testing, and assured by the most painstakingly thorough inspection procedures in the IC business.

If you've looked on Cerdip as the high-priced package, turn your thinking around. Our industrial Cerdips carry new low price tags. They're immediately available for quantity shipments.

And they're ideal for MIL breadboards.

CIRCLE 510 ON READER SERVICE CARD



# New Computing Expressway

DIRECT ACCESS TO ALL AREAS  
OF SCIENTIFIC AND ENGINEERING CALCULATION  
VIA THE 9100A COMPUTING CALCULATOR

No more delays  
waiting to get on the big computers.  
No more bogging down  
on stop-and-go side street calculators.  
No more detours  
converting your problem into computer language.

Now you can go from *data* to *information* in milliseconds...  
10 to 50 times faster than previously possible!  
And our extensive, growing program library  
helps speed you to virtually any computational destination  
via such express routes as  
second order differential equations...  
analysis of variance... Chi-square tests  
for goodness of fit... moments of inertia...  
real and complex polynomial evaluation...  
coordinate geometry... regression analysis...  
three dimensional vectors...  
numerical integration, and many more.  
Also, the 9100A remembers the way!  
You can store your programs on  
credit-card size magnetic cards that  
instantly program the calculator for repeat trips.

Single key strokes perform  
all log, trig and math functions...  
convert from fixed to floating decimal point...  
from rectangular to polar coordinates!

All this—and more—computing capability  
is packed into one silent, 40 lb desk top package!  
A phone call to any of the 135 worldwide  
Hewlett-Packard Sales and Service offices  
will expose you to a comprehensive demonstration,  
after which you'll probably want  
to go the full route!  
The one-time toll of \$4900 will put you  
on the 9100A Computing Expressway.  
Write for your 22-page brochure.  
Hewlett-Packard, Box 301,  
Loveland, Colorado 80537  
Europe: 54 Route des Acacias,  
Geneva.

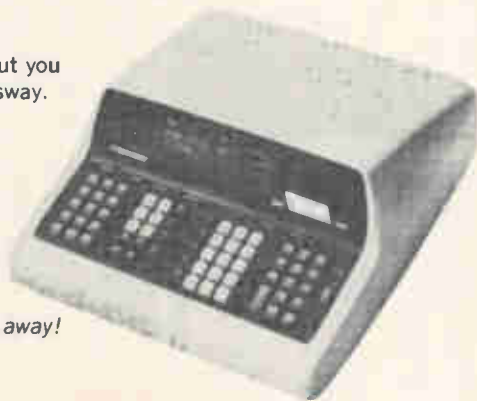

9100A puts answers just a touch away!

HEWLETT  PACKARD

764 8387 z temporary  
8.338 845 816 05 y accumulate  
33.80 x keyboard

Dynamic range  $10^{-99}$  to  
 $10^{99}$ , nearly 200 dec-  
ades. Observation of  
math operations on 3 displayed registers.  
Up to 16 more registers for data storage.



Complex and vector arithmetic  
simplified with coordinate trans-  
formation keys, rectangular-to-  
polar and vice-versa, in milliseconds.



Trig functions covering all quad-  
rants and any size angle in  
degrees or radians.



**Branching and looping flexibility** provided by "IF" keys expands programming capability.



**Edit programs easily.** Single-step through programs to check and de-bug. Address an individual step and make corrections without re-entering the entire program.



**Program from the keyboard.** Record and store 196-step programs on credit-card-size magnetic cards for repeated use.

**Designed for expansion.** Printer, plotter, electrical data input/output will become available.

**LOW-COST**  
**POWER**  
**SUPPLIES**  
**FOR LAMPS AND RELAYS**



THIS POWER SUPPLY WAS SHIPPED WITHIN  
**3 DAYS** AFTER RECEIPT OF ORDER  
*Acopian*

Acopian offers 62,000 different AC to DC plug-in power supplies, all available for shipment in three days, including these low-cost unregulated models specially designed for powering DC relays and lamps:

MODEL	RELAY VOLTAGE	OUTPUT CURRENT (AMPS.)	VOLTS (NL TO FL)	RIPPLE (VOLTS, RMS)	PRICE
US6	6	2.0	7.7 to 4.8	2.0	\$35.00
U6	6	5.0	8.0 to 5.0	2.5	65.00
US12	12	1.5	14.9 to 10.9	2.5	35.00
U12	12	5.0	15.3 to 10.0	3.0	65.00
US24	24	1.5	26.2 to 20.2	2.5	35.00
U24	24	3.5 5.0	26.6 to 21.0 26.6 to 20.0	3.0 3.2	65.00
US28	28	1.0	30.6 to 25.5	2.0	35.00
U28	28	3.0 5.0	31.9 to 26.0 31.9 to 23.6	2.7 3.4	65.00

For your copy of the Acopian catalog listing all 62,000 models, write Acopian Corp., Easton, Pa. 18042 or call (215) 258-5441.

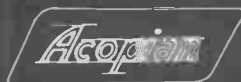

**Who's who in electronics**



Vanzetti

"They all laughed at Christopher Columbus" could well be Riccardo Vanzetti's favorite song after three jobs and nearly 15 years of trying to get his ideas on infrared component testing accepted. Far from getting discouraged, however, Vanzetti has founded his own firm, Vanzetti Infrared & Computer Systems Inc., to do the work nobody else seemed interested in.

Vanzetti became interested in i-r during his mid-50's work at the Fisher Radio Co. in New York when he saw a technician checking resistors with a wet finger. "This fellow said he could adjust bias on electron tubes just by feeling hot resistors; if he could do that, I thought, I should be able to take infrared photos to detect overheating components," he says.

It turned out that he could, but Fisher didn't take the idea seriously, so Vanzetti went to the American Bosch Arma Corp. (now called Ambac Industries), which was then developing control and guidance computers.

**Two systems.** Though Vanzetti had some thoughts about spotting flaws by placing i-r-sensitive overlays on computer circuit boards, his ideas struck out at Bosch, just as they had at Fisher. So he surveyed the industry "for the best deal I could get. Finally, I picked Raytheon."

Some of his effort as Raytheon's manager of i-r techniques and systems was used in the development of Compare, an automated system for making i-r profiles of circuit

boards, and in an i-r profile method of testing integrated circuits [Electronics, April 3, 1967, p. 100].

He left Raytheon, he says, because "I wanted to work on recombination radiation." Recombination radiation, in the near i-r spectrum, is a very faint emission caused as current moves through a semiconductor. "I had first written a paper on it in 1962 and had followed this with proposal after proposal—they were all turned down because no one thought such radiation could be detected. But I thought it could be detected and that it could be used to look inside semiconductors and spot modes of operation and failure."

During his last year at Raytheon, Vanzetti finally succeeded in getting a NASA contract on "transient radiation in semiconductor materials." "They called it transient radiation because recombination radiation couldn't be detected and 'everybody' knew it. Nobody would have approved a study on recombination." But Vanzetti detected it (see story on p. 51) late last spring before leaving Raytheon.

"Raytheon's management didn't want to invest in an infrared instrumentation line," he says. "For them it would have been small potatoes—only about \$12 million or so by 1973 or 1974."

**Sweet sorrow.** So Vanzetti and Raytheon parted friends. "For a while, they were even looking for a firm to employ me and let me work full time on infrared, but on Oct. 1, I struck out on my own."

"Recombination is going to be as important to the development of solid state devices as the oscilloscope was to tube technology," he says. "Now for the first time we can study the behavior of carriers in, say, a small part of a junction—this is a very intimate tool."

He notes, "And I'm happy finally to have an employer who will let me work full time on i-r."

The large structure that will house IBM's newest center, the Communications and Engineering Sciences



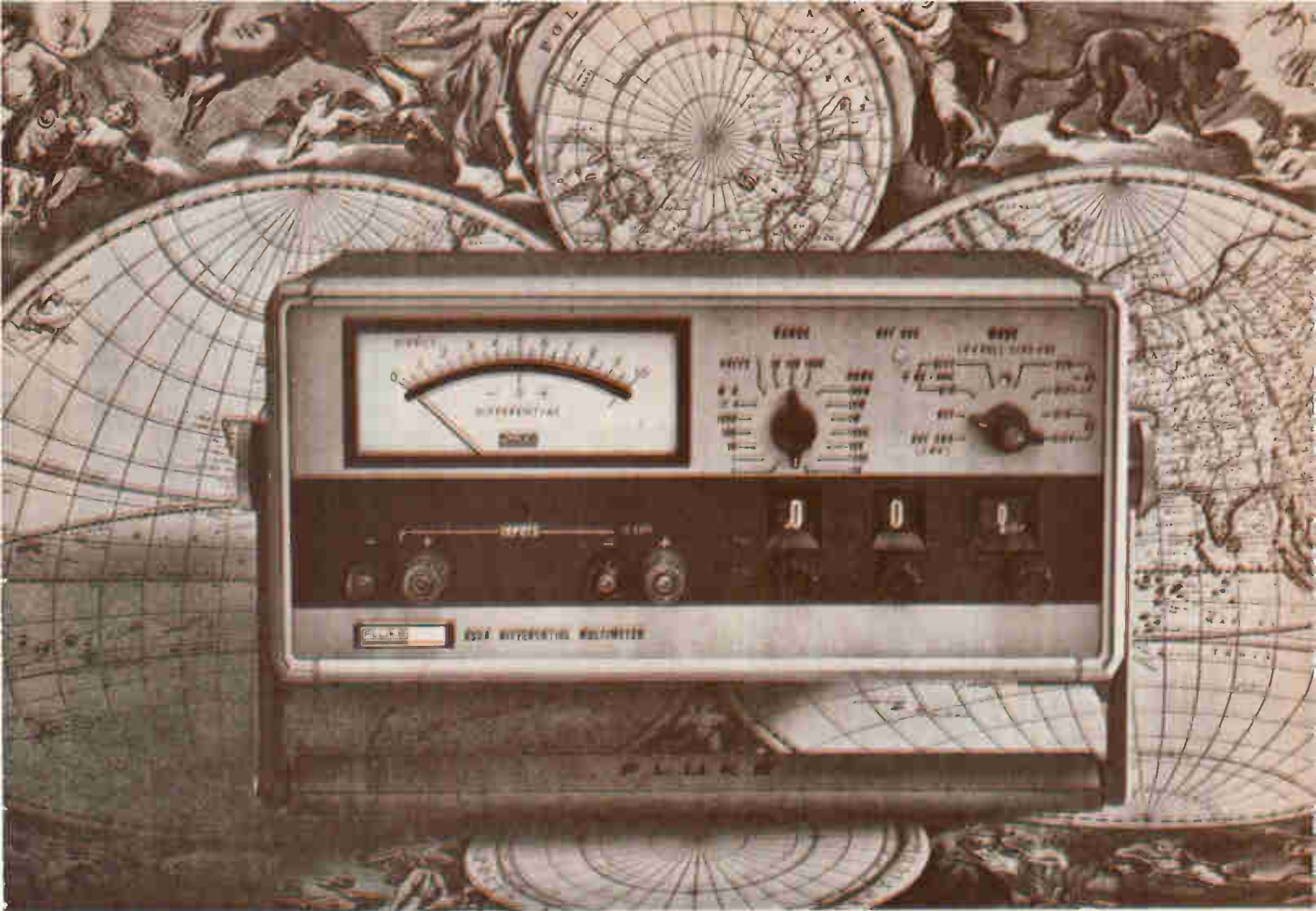

## The most accurate multimeter in the world: try one free for ten days.

The Fluke 853A is the most accurate multimeter in the world and the most reliable. Once you've tried the 853A, we're willing to bet you won't let it go. Laying it on the line, try the 853A free for ten days with absolutely no obligation.

Here are the key specs and features. DC volts, 0.2%. AC volts, 0.5%. Range, 0 to 1.1 KV. DC amps, 0.2%. AC amps, 0.5%. Range, 0 to 11 amps. Ohms, 0.2%. Range, 0 to 110 megohms. All of these specifications are

guaranteed to hold for one full year without recalibration. Complete overload protection is featured. And the price is only \$445.

*Available from local stock for fast delivery.*

The Fluke 853A is now available off the shelf in major cities throughout the country. To painlessly arrange a free trial, simply call the nearest Fluke sales-engineering office (listed below) or, if you wish, drop us a line and we'll take care of all the details.

*Call the number nearest you for a free trial.*

Huntsville, Ala. (205) 534-1648  
 Phoenix, Ariz. (602) 959-2115  
 Los Angeles, Cal. (213) 245-9404  
 San Diego, Cal. (714) 232-2017  
 San Francisco, Cal. (408) 244-1505  
 Denver, Colo. (303) 934-5505  
 Hartford, Conn. (203) 633-0777  
 Orlando, Fla. (305) 425-2764  
 Honolulu, Hawaii (808) 506-095

Chicago, Ill. (312) 825-1144  
 Indianapolis, Ind. (317) 244-2456  
 Baltimore, Md. (301) 744-7700  
 Boston, Mass. (617) 646-1034  
 Detroit, Mich. (313) 838-7324  
 Minneapolis, Minn. (612) 920-1022  
 St. Louis, Mo. (314) 423-1234  
 Newark, N.J. (201) 687-8737  
 Albuquerque, N.M. (505) 265-7766

Long Island, N.Y. (516) 433-1421  
 New York, N.Y. (914) 769-1811  
 Rochester, N.Y. (716) 381-8330  
 Syracuse, N.Y. (315) 454-9377  
 Greensboro, N.C. (919) 273-1918  
 Cleveland, Ohio (216) 734-0960  
 Dayton, Ohio (513) 298-9964  
 Portland, Ore. (206) 767-4260  
 Philadelphia, Pa. (215) 279-0377

Pittsburgh, Pa. (412) 371-1231  
 Dallas, Tex. (214) AD 1-2573  
 Houston, Tex. (713) NA 1-0040  
 Seattle, Wash. (206) 767-4260  
 Washington, D.C. (301) 946-0300  
 Vancouver, B.C. (604) 291-7161  
 Ottawa, Ont. (613) 725-1288  
 Toronto, Ont. (416) 636-4910  
 Montreal, Que. (514) 747-9849

Fluke, Box 7428, Seattle, Washington 98133. Phone: (206) 744-2211. TWX: 910-449-2850. In Europe, address Fluke Nederland (N.V.), P.O. Box 5053, Tilburg, Holland. Telex: 844-50237. In the U.K., address Fluke International Corp., P.O. Box 102, Watford Herts, England. Telex: 851-934-583.



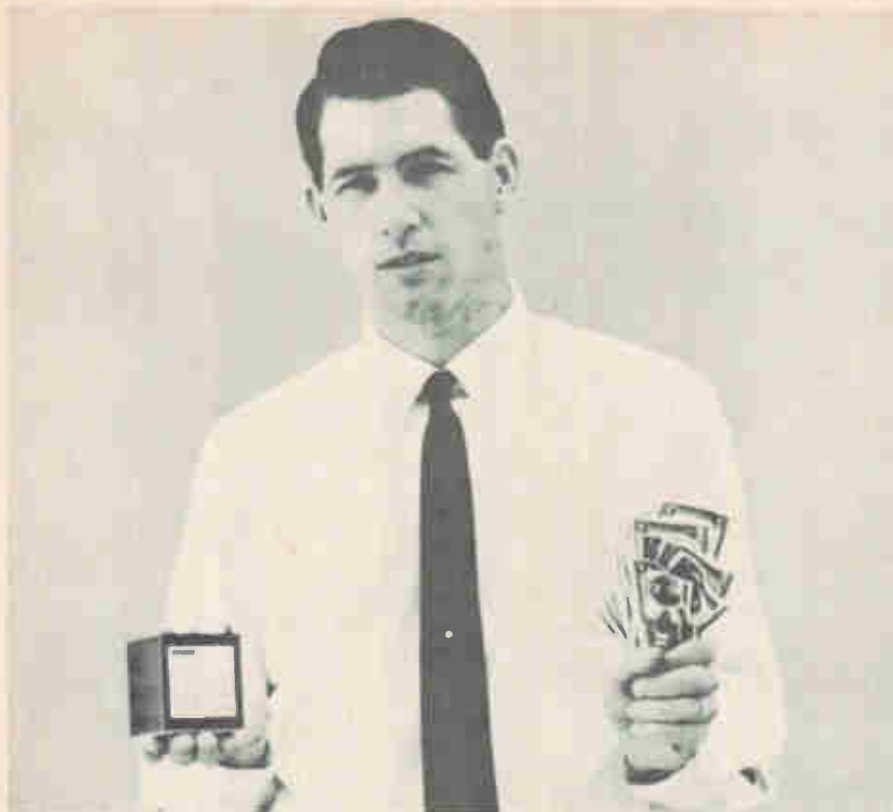

## How to Buy a Good Power Supply Without Spending a Bundle . . .

Take a long look at the Abbott line of over three thousand standard models *with their prices listed*. The unit shown above, for instance, is the Abbott Model AL6D-27.6A, a DC to DC converter which puts out 28 volts of regulated DC at two amps and sells for only \$220.00. Other power outputs from 5 to 240 watts are available with *any output voltage from 5 volts to 10,000 volts*, all listed as standard models in our catalog. These converters feature close regulation, short circuit protection, and hermetic sealing for rugged application found in military environment.

If you really want to save money in buying your power supply, why spend many hours writing a complicated specification? And why order a special custom-built unit which will cost a bundle — and may

Please write for your FREE copy of this new catalog or see EEM (1968-69 ELECTRONIC ENGINEERS MASTER Directory), Pages 1727 to 1740.

**abbott transistor**

LABORATORIES INCORPORATED

5200 W. Jefferson Blvd./ Los Angeles 90016  
(213) WEBster 6-8185 Cable ABTLABS

bring a bundle of headaches. As soon as your power requirements are firmed up, check the Abbott Catalog or EEM (see below) and you may be pleasantly surprised to find that Abbott already has standard power supplies to meet your requirements — *and the prices are listed*. Merely phone, wire, or write to Abbott for an immediate delivery quotation. Many units are carried in stock.

Abbott manufactures a wide variety of different types of power supply modules including:

- 60 $\infty$  to DC, Regulated
- 400 $\infty$  to DC, Regulated
- 28 VDC to DC, Regulated
- 28 VDC to 400 $\infty$ , 1 $\phi$  or 3 $\phi$
- 60 $\infty$  to 400 $\infty$ , 1 $\phi$  or 3 $\phi$

TO: Abbott Transistor Labs., Inc., Dept. 87  
5200 West Jefferson Blvd.  
Los Angeles, California 90016

Sir:

Please send me your latest catalog on power supply modules:

NAME \_\_\_\_\_ DEPT. \_\_\_\_\_

COMPANY \_\_\_\_\_

ADDRESS \_\_\_\_\_

CITY & STATE \_\_\_\_\_

## Who's Who in electronics



Jennette

Center, is now taking shape in Gaithersburg, Md. The managerial structure is also taking shape. The most recent appointment: Joseph E. Jennette Jr., 36, who will be the assistant general manager at the center.

Jennette, an electrical engineer, has the reputation at IBM of being one of its top men in contracts and marketing. At the Electronics Systems Center in Owego, N.Y., Jennette handled the business side of the highly successful 4-pi airborne digital computer. Under his direction the 4-pi was picked for major military systems, including the Manned Orbiting Lab and the Mark 2 avionics system.

**Lasers, too.** Jennette, who will be guiding staff operations, says the center will develop communications devices that are not part of computer systems. "We plan to introduce a fair number of new devices next year," he says.

He points out that some of the devices will be "stand alone" items that will operate with computers but can be marketed independently, while others will be tied to the IBM product line. Among the items of interest: input-output devices for information systems, displays, devices to transform input from sensors into computer formats, and, in general, items to help in the establishment of digital computer communications networks.

The center will also do a lot of laser work. Jennette says, "We are interested in a host of applications for the laser—for ranging as well as detection."



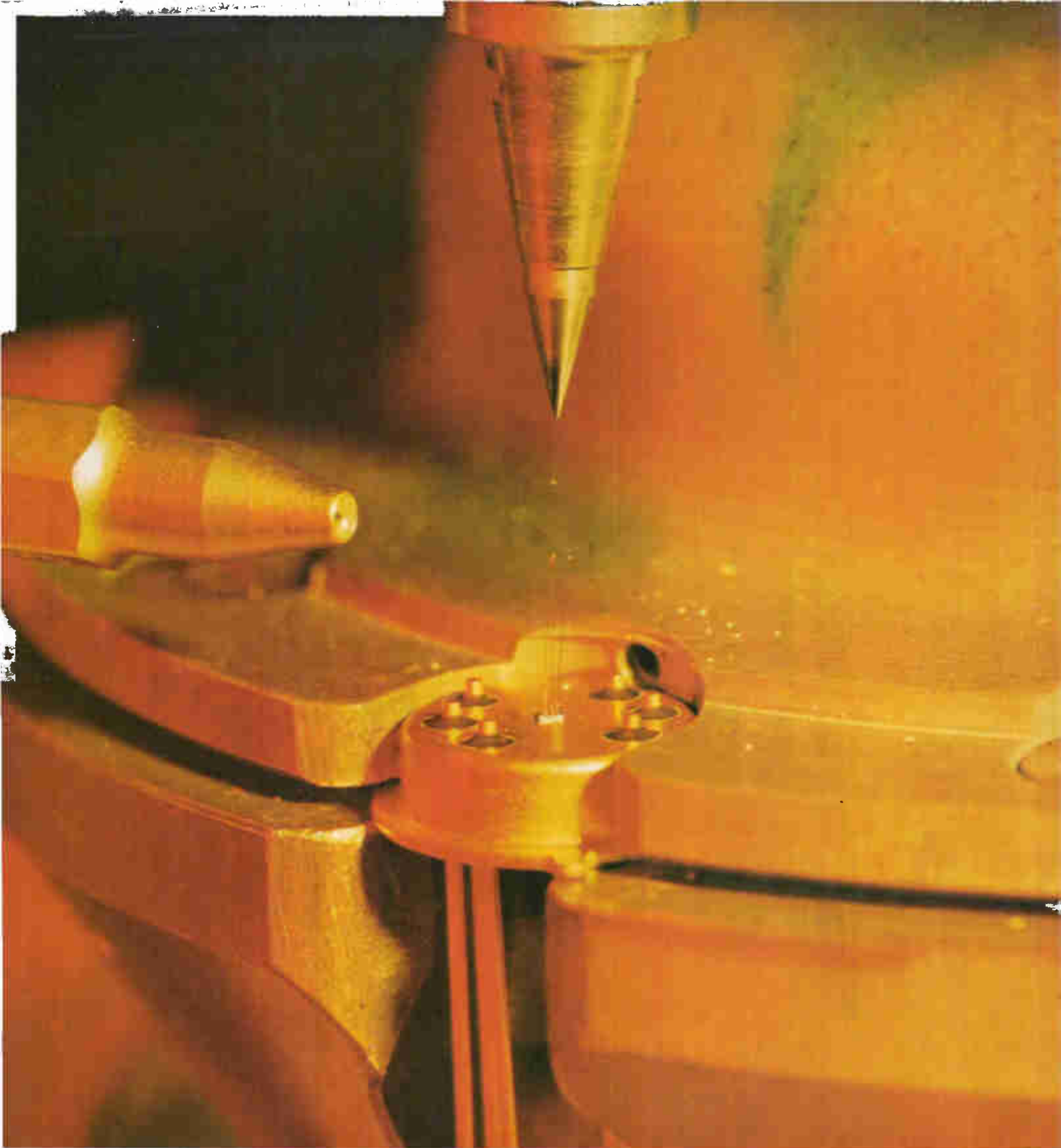

## Ball .002" dia., Iteration $\pm 5\%$

TEMPRESS HYDROGEN FLAME-OFF TORCHES FOR LEAD-BONDING MACHINES ARE STAINLESS STEEL, WITH SAPPHIRE ORIFICE INSERTS that maintain size and shape accuracy of the 2166°C hydrogen flame. The highly polished inner surface of the sapphire insert assures this by eliminating gas turbulence and a resultant distortion of the flame. The end result is essentially identical gold balls on every lead, from start to finish of a production run. 14X magnification of operation shows flame-off torch at left, with orifice partially visible. Gold wire, with perfectly formed ball, protrudes from Tempress tungsten

carbide capillary tube, ready for next bonding cycle. This extreme precision symbolizes the Tempress approach to every project... explains why it requires 11 months to train an operator for many Tempress production operations. Other Tempress products include automatic scribing machines, diamond scribes, diamond lapping points, and tungsten carbide probe contact needles.

*Lead-bonding, Model DTN-1, at Union Carbide Electronics.*



# TEMPRESS

Tempress Research Co., 566 San Xavier Ave., Sunnyvale, Calif.



# Pick a number...

## Only Amphenol lets you pick from all four PC connector families

No matter which printed circuit connector family you choose, Amphenol produces it. In hundreds of thousands of combinations. No one else gives you this choice.

*Expect to save.* While gold, copper and labor costs go up, we keep modernizing production methods. Enough to maintain prices, even reduce them. We can show you how to save with all four families.

Check the PC connector families below. Then call your Amphenol Sales Office or Distributor. The connector you need is probably on the shelf. If it's a special we can help you design it. Write today for new PC Connector Catalog PC-5. Amphenol Industrial Division, The Bunker-Ramo Corp., 1830 S. 54th Avenue, Chicago, Ill. 60650.

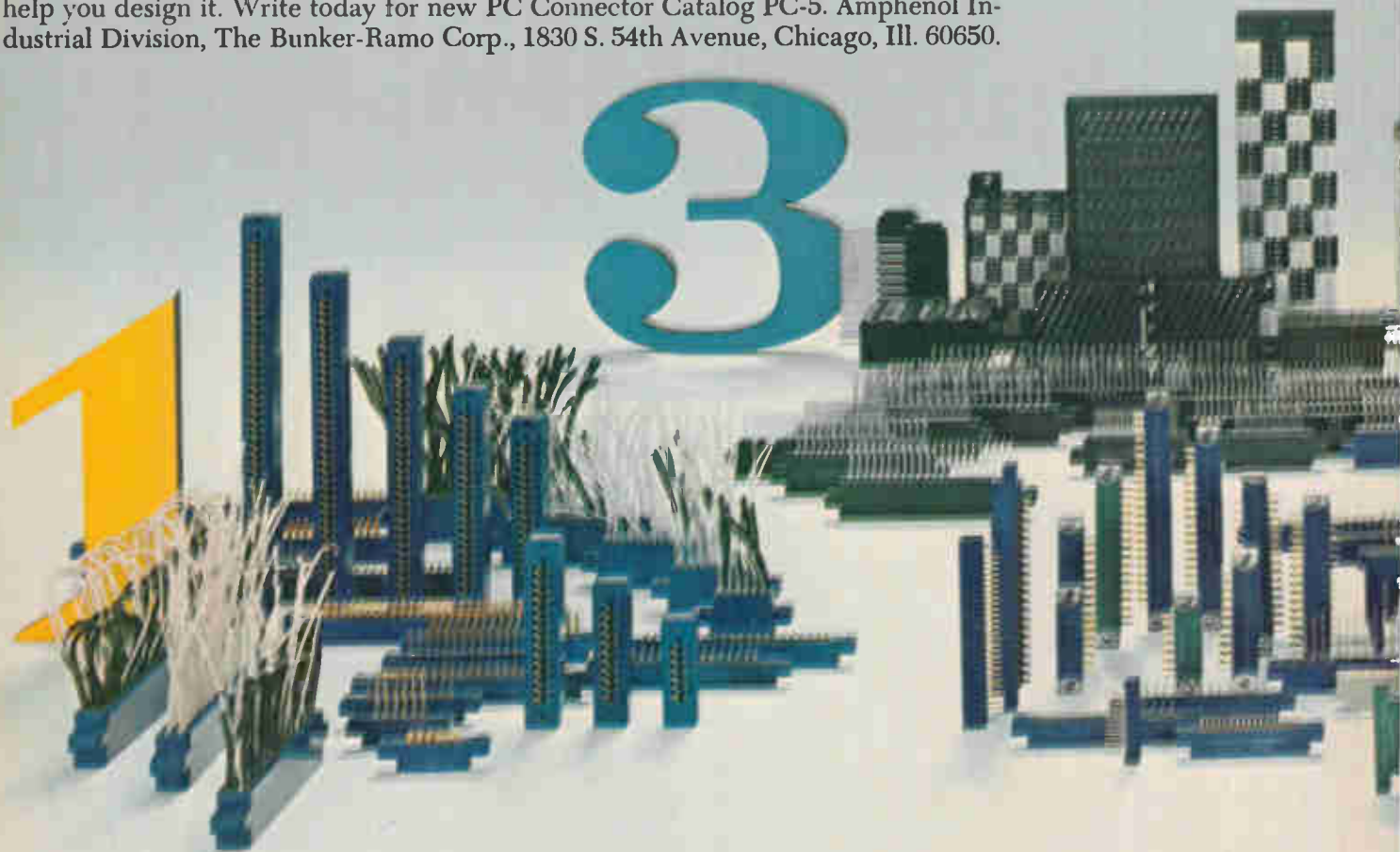

**1** **BIFURCATED BELLOWS CONTACTS** For smooth, positive mating action—that's easy on your PC board surface—pick Amphenol's 225 Series. Bifurcation provides 2 points of contact, even on irregular surfaces. Bellows action exerts positive pressure, even under extreme vibration. Gives you thousands of insertions and withdrawals without failure. Nine sizes, ten tail styles, four mounting configurations, two contact platings, and solder, taper pin or Crimp Poke-Home® terminations. Exceeds MIL-C-21097B.

**2** **TUNING FORK CONTACTS** For the lowest contact resistance in the industry today—even with PC boards at the extremes of tolerance in thickness—pick Amphenol's 143 Series. Amphenol's tuning fork contacts provide excellent current-carrying capability with uniform tine pressure and positive wiping action. For non-direct card entry applications, the 143 Series receptacle can be mated with a 133 Series plug. Nine tail styles, eight sizes and choice of solder or solderless wrap terminations. Series 233/243 exceeds MIL-C-21097B.

**3** **PRELOADED CANTILEVER CONTACTS** For a low cost, high performance connector—designed especially for automatic wire wrapping—pick Amphenol's 261 Series. Cantilever contacts are confined in the dielectric to a predetermined load force. This gives you uniform pressure and positive mating action. Contacting surfaces have a minimum of 50 microinches of gold over phosphor bronze. Wire wrap capability on .100", .125", .150", .156" and .200" centers. Also, high contact density multi-board connectors for your special applications.



**4 MODULAR PLATE ASSEMBLIES** For custom designed specials at production line prices—with up to 36,000 contacts—pick Amphenol's 230 Series Snap-Wrap® or 240 Series Mini-Wrap® connectors.

Design your own interconnection system using Amphenol's building block concept. The contacts you need are inserted into nylon insulators and mounted into aluminum plates. These plates can be drilled, formed or notched to your specifications. Snap-Wrap 230 Series: 7 contact styles, 12 color-coded insulators with plate sizes up to 22" x 45". Mini-Wrap 240 Series: 4 contact styles, 12 color-coded insulators, .100", .125" or .150" centers with plate sizes up to 21" x 24". The same modular concept is now available for direct card entry applications with our 250 Series.

®Registered trademarks of The Bunker-Ramo Corporation



**AMPHENOL**

THE BUNKER-RAMO CORPORATION

Circle 19 on reader service card



The accuracy is a "first" in DVM design. 0.0025%. Stability is too. .0065% for a full year over a temperature range of +12° to +40°C. Nor do the "firsts" stop here.

There's a speed you've never seen. 18 milliseconds for dc, and 45 milliseconds for ac.

There's no other unit more of a stranger to noise. It has the now famous "3-pole, active filter." This outshines an integrator or a notch filter anytime. You can even choose the amount of noise rejection by either programming or manually selecting the filter position.

And since the unit is a box-within-a-box, it's immune from common mode noise.

There's a flexibility you've never heard of before. Four dc, four ac, and four dc/dc ratio ranges, three dc millivolt ranges, and five kilohm ranges.



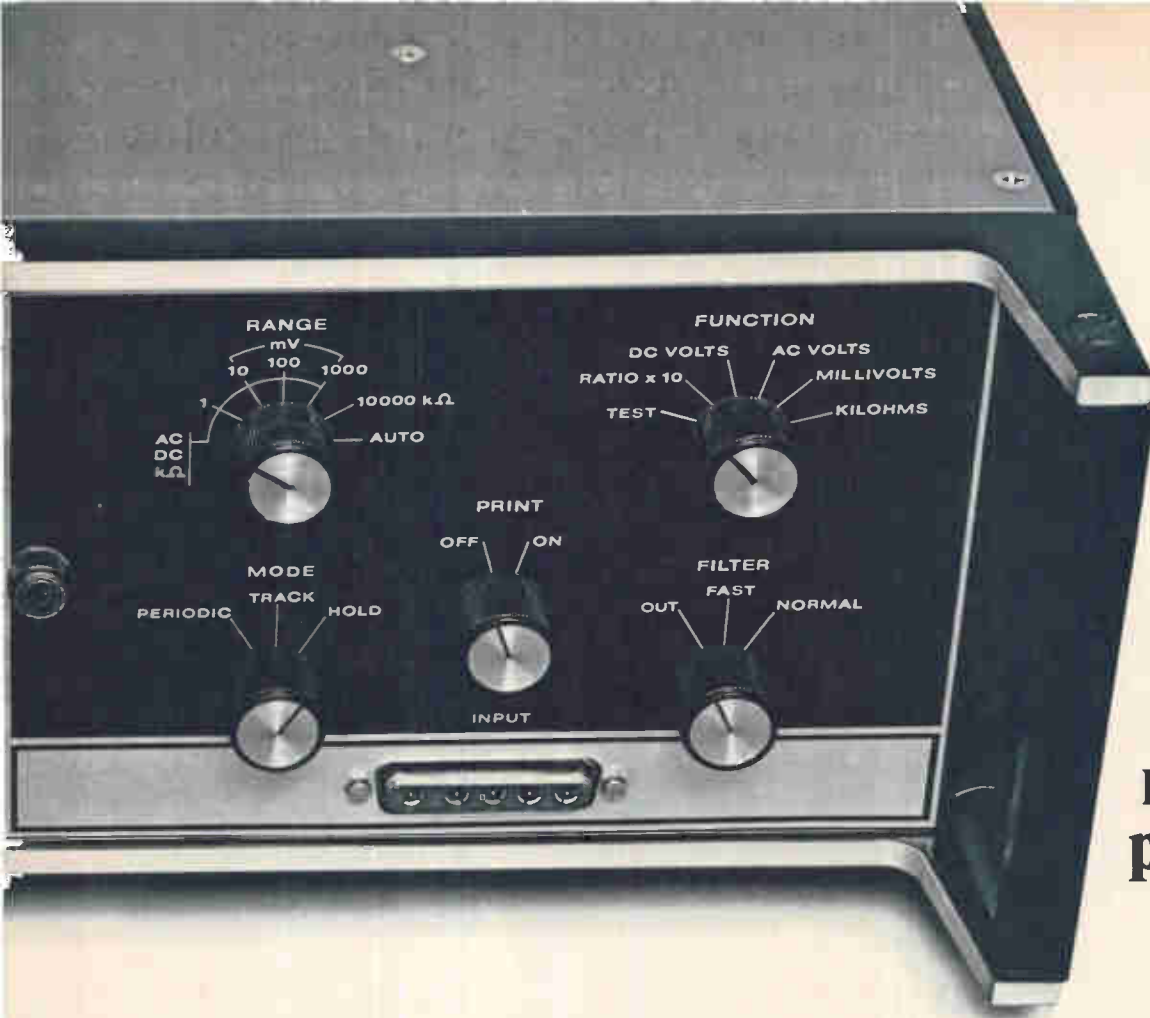

**The Dana  
5700 DVM is  
not just another  
pretty face.**

There's no instrument more compatible.

Both the digital output and programming are completely isolated. No grounding problems.

There's nothing easier to calibrate. No adjustments, just a single point calibration. Once a year.

There's nothing easier to maintain. All the plug-in boards can be slipped in and out from the front.

Which brings us to that pretty face business. If you're the finest DVM in the world, you've got to have more to offer than just good looks.

*Speaking of handsome, we have a brand new brochure with all the specs on the 5700 and every other Dana instrument. Own one. Write Dana Laboratories, Inc., 2401 Campus Drive, Irvine, Calif. 92664.*

**DANA**

Circle 21 on reader service card

# PROGRAM VOLTAGE OR PROGRAM CURRENT WITH KEPCO AUTO-CROSSOVER POWER SUPPLIES

by PROGRAM, we mean the exercise of intentional control over the output of your power supply — a regulated supply that remains quiescent — unmoving, stable until it receives your command signal.



Model KS 18-15M voltage/current regulator showing Kepco's exclusive mode indicator lights — VIX®. This 5 1/4" x 19" rack mounting power supply delivers 0-18V@0-15A.

You can signal with analog voltage or current or resistance or conductance. Or, you can get fancy and use digital control. Kepco's 20 KS models offer complete control over both voltage (0-8V to 0-120V) and current (0-1A to 0-100A) in four basic panel heights — 3 1/2", 5 1/4", 7" and 8 3/4". Write Dept. K-14 and we'll tell you about the 16 programming terminals available on all models.

**with KEPCO  
IT'S CONTROL!**



131-38 SANFORD AVE. • FLUSHING, N.Y. 11352  
(212) 461-7000 • TWX # 710-582-2631

## Meetings

### Superficial input, superficial output

As usual, the Fall Joint Computer Conference, which will be held this year in San Francisco, Dec. 9 to 11, is supposed to be all things to all people, and therefore lacks the depth that many computer engineers might like.

The meeting's scope is illustrated by two sessions entitled, "The computer field: what was promised, what we have, what we need." One concentrates on software, the other on hardware. Unfortunately for hardware-oriented engineers, the latter is on the third day of the conference, whereas the software session is bright and early the first day. Attendance at conferences usually drops off sharply on the last day as almost everybody

scurries to get started for home ahead of the rush.

Three sessions will deal with robots. One, on vision and speech, is largely software-oriented. A discussion of intelligent robots will describe primitive robot-like machines. The third, on human augmentation, is apparently intended to answer the question, what good are robots?

An exception to the usual kind of discussion is a one-man session at which Douglas Engelbart of the Stanford Research Institute will expound on his ideas for expanding human intellectual processes with computers.

For more information write AFIPS, 210 Summit Ave., Montvale, N.J. 07645

### Down from the ivory tower

By their very nature, conferences on circuit theory have an ivory-tower quality about them, stressing mathematics and pure science but ignoring practical applications. They generally attract local college professors and researchers—not circuit designers. But their image may be changing. The 1968 IEEE International Symposium on Circuit Theory—Dec. 4 to 6 in Miami Beach—will pay as much attention to the practical as to the theoretical and will be attended by representatives of both industry and universities around the world.

Heavy emphasis has been given to selecting papers that offer either solutions to problems or at least a means of attacking them. Computer-aided design of circuits and systems will be investigated, for example, and two panel discussions on the subject are planned. The conference will look into the shortcomings of current computer programs and offer suggestions about the direction future CAD programs should take.

The problems of optimizing large-circuit designs and distributing electrical power will receive

similar treatment, as will the area of communications, particularly digital. For instance, A.G. Constantinides of the City University, London, will present a paper on digital filters with equiripple passbands—devices of particular interest because they can be built with inexpensive, mass-produced digital gates.

**Filter tips.** Several of the scheduled papers will be devoted to active-filter design. One of them, "Synthesis of Microstrip Transmission Networks Utilizing Semiconductor Dielectrics," by A.W. Cuilwik of Bell Labs and J.H. Mullan of New York University, will describe how to build a distributed IC network that can operate at high frequencies. Also, Dan Hilberman of Bell Labs will discuss active network synthesis using nonzero-gain amplifiers, and C.K. Kuo and K.L. Su of the Georgia Institute of Technology will offer a paper on the synthesis of negative-impedance converters and negative-resistance networks.

All the papers in the active-filter field will concentrate on achieving  
(Continued on p. 24)

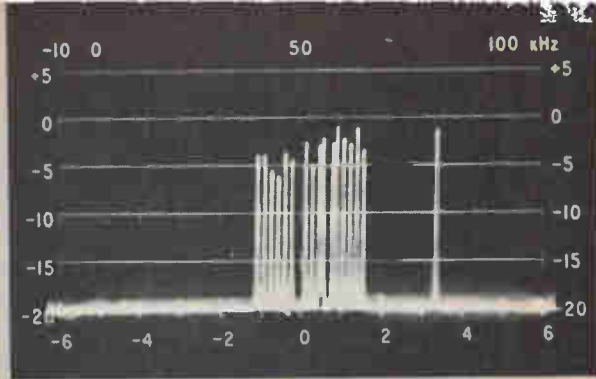

Three 4-kHz channels of L3 carrier multiplex system. Center channel has teletype subcarriers. Model 360A is in 12-kHz sweep width mode, sweeping from 6.780 to 6.792 MHz.



Switch-selected meter modes, normal or expanded scale, provide level measurement resolution of 0.05 dB. Signal generator level increments as fine as 0.01 dB can be readily resolved.



Frequency resolution to nearest 10 Hz in phase-locked tuning mode is displayed on flat-plane, high-brightness readouts. Alternative continuous tuning mode presents frequency resolved to nearest 100 kHz.

## A Communications System Test Set (VLF to HF)...

From Sierra comes the most thoroughly human-engineered instrument for HF-radio and telephone-carrier applications in today's knob-and-meter-ridden world: The Model 305/360 Communications System Test Set.

Model 305/360 gives you ultra-bright, unambiguous electronic digital readouts of frequency. Built-in counter automatically totals outputs of both the coarse and fine tuning oscillators, reads out tuned frequency with 10-Hz resolution. Attenuator levels appear in three-digit displays, with unique logic and switching circuits combining the levels of the 10-dB and 1-dB per step attenuators. Rear-projection meters with luminous pointers permit parallax-free viewing from any angle with easy resolution of fine-level increments.

Performance features include phase-locked tuning circuits, a single continuous tuning range covering voice frequencies through 32 MHz, and selective bandwidths of 250 and 3100 Hz. You can resolve signals separated by as little as 35-Hz.

Model 305/360 does everything humanly possible to keep foibles from fouling your readings. For the brochure, write Sierra, 3885 Bohannon Drive, Menlo Park, California 94025.

\*Average to Very Bright

engineered for  
humans (A to VB\*)



PHILCO-FORD CORPORATION  
Sierra Electronic Operation  
Menlo Park, California • 94025

Circle 23 on reader service card



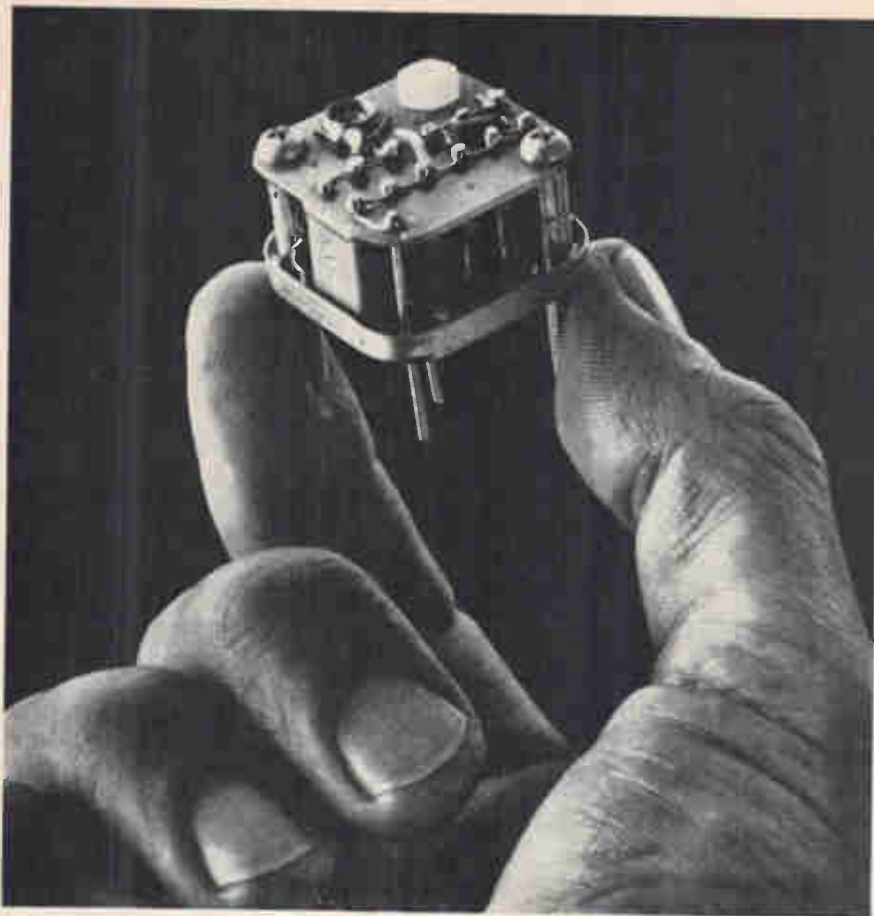

## How do you get prototype, special or short-order crystal filters fast?

### Listen to Sherold's pitch.

We're right on target with the top-quality crystal technology that assures you of prototypes and short-order specials with the speed and accuracy you need. And the facilities to put your prototypes into low-cost quantity production when the time comes. That's why Sherold is the largest single independent source for both crystal filters and discriminators. And why we've built more PRC and VRC filters than any other supplier. Sherold has the widest range of filter designs in production and the technology to develop and put yours into production, too. From computer-designed monolithic filters to extra-rugged MIL-spec models. Send us the details of your frequency selection problem and we'll listen to your pitch. Write Sherold Crystal Products Group, Tyco Laboratories, Inc., 1510 McGee Trafficway, Kansas City, Mo. 64108. Or phone (816) 842-9792. TWX 910-771-2181.

# TYCO

## Meetings

(Continued from p. 22)

high  $Q$ 's from RC active networks by eliminating the large, lossy inductor usually needed at low frequencies.

For more information write M.S. Ghausi, New York University, University Heights, Bronx, N.Y.

## Calendar

Winter Annual Meeting & Energy Systems Exposition, American Society of Mechanical Engineers; Hilton Hotel, New York, Dec. 1-5.

Conference on Applications of Simulation, Association for Computing Machinery, IEEE; Hotel Roosevelt, New York, Dec. 2-3.

Reliability Physics Symposium, IEEE; Hilton Hotel, Washington, Dec. 2-4.

Vehicular Technology Conference, IEEE; Hilton Hotel, San Francisco, Dec. 3-4.

Entry Vehicle Systems and Technology Meeting, American Institute of Aeronautics and Astronautics; Williamsburg, Va., Dec. 3-5.

Circuit Theory Symposium, IEEE; Hilton Plaza Hotel, Miami Beach, Fla., Dec. 4-6.

Symposium on Theory & Measurement of Atmospheric Turbulence & Diffusion in the Planetary Boundary Layer, Sandia Corp. and the Atmospheric Sciences Laboratory of the Army Electronics Command; Albuquerque, N.M., Dec. 5-7.

Vehicular Technical Group Conference, IEEE; Hilton Hotel, New York, Dec. 6-8.

Electrical Insulation Conference, IEEE; Biltmore Hotel, Los Angeles, Dec. 8-12.

National Electronics Conference, IEEE; Conrad Hilton Hotel, Chicago, Dec. 9-11.

Fall Joint Computer Conference, IEEE; Hilton Hotel and Civic Center, San Francisco, Dec. 9-11.

Consumer Electronics Symposium, Conrad Hilton Hotel, Chicago, Dec. 9-10.

Symposium on Adaptive Processes, IEEE and UCLA; University of California at Los Angeles, Dec. 16-18.

Winter Institute in Computer and

(Continued on p. 26)

# IC Testing?



## MicroTest has canned it!

Revolutionary?

We don't know what else to call it!

A fast, accurate Universal Digital IC Tester with a built-in film strip projector. The IC circuit diagram, the test specifications, and even the logic levels on each pin for the 16 functional test sequences performed, are projected on the large front panel screen!

Operator-oriented? You bet! Just dial in the data on any of 15 ICs stored on the film strip. Read the specified voltages for each pin. Then set the voltages precisely, using the concealed front panel controls and the built-in digital voltmeter.

Now push the "go" button and zip through the automatically programmed functional tests in less than 16 milliseconds.

A test failure? That's where the Microtest 100-D really shines! The failure shows up as a light superimposed on the projected display.

Your operator instantly knows which test has failed, and on what pin the failure has occurred!

Write for our new, colorful Brochure.

MicroTest Corporation

9000 Winnetka Avenue



Northridge, Calif. 91324 Telephone (213) 341-0080

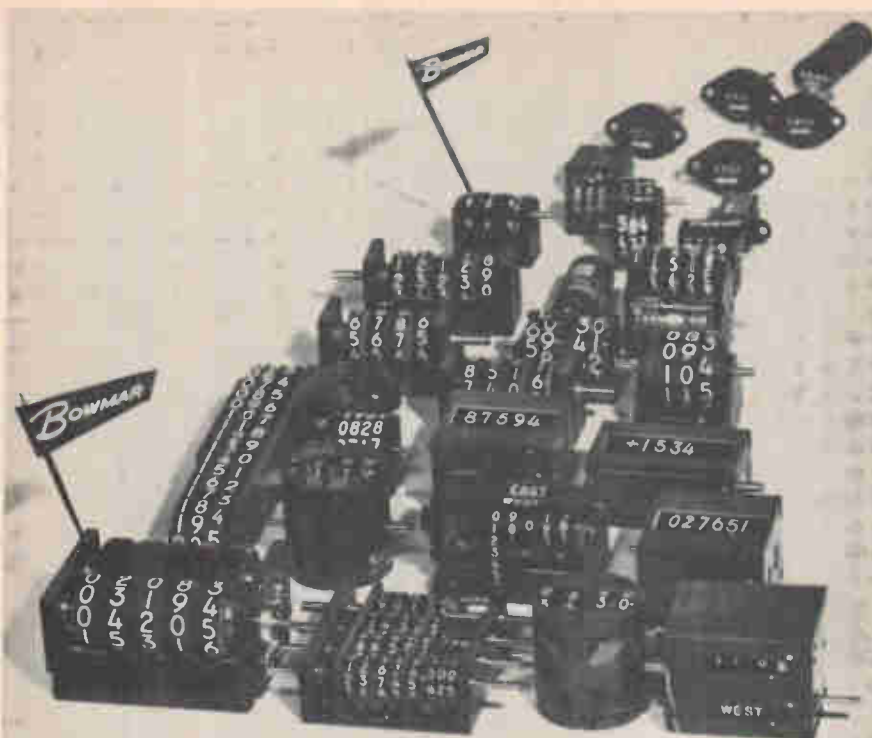

**In the name of design freedom  
...join Bowmar's  
counter revolution!**

While others have been trumpeting the merits of standards, we've spent the past 18 years quietly meeting the mechanical counter needs of the world's 100 toughest customers. Now, with thousands of field-proven configurations in our B-line™ design library, we can't stay quiet any longer.

**WE'RE STARTING A  
COUNTER REVOLUTION!**

Bowmar's B-line™ design library, which includes all popular counter configurations, enables us to compare favorably in price and delivery with many "off the shelf" counters. B-line also offers you unique design freedom. You don't have to design

around our counters; we'll design around your *requirements* quickly and economically. If you want complete design *liberation*, simply give us the inputs and outputs, and we'll supply your entire counter/display package.

Our B-line™ counters and display assemblies have met the toughest reliability and life demands of military, NASA, commercial aviation, and heavy industry.

Be a counter-revolutionary! Strike a blow for design freedom by adding Bowmar to your qualified bidder list.



**The shortest distance between  
output and display  
is the Bowmar B-line\***

\* Call (219) 747-3121 for engineering assistance



**INSTRUMENT CORPORATION**  
8000 BLUFFTON ROAD □ FORT WAYNE, INDIANA 46809

**Meetings**

(Continued from p. 24)

Information Sciences, University of Florida; Gainesville, Dec. 17-21.

American Association for the Advancement of Sciences; Dallas, Dec. 26-31.

Symposium on Reliability, IEEE; Palmer House, Chicago, Jan. 21-23.

Second Hawaii International Conference, Department of Electrical Engineering, University of Hawaii, Honolulu, Jan. 22-24.

Winter Power Meeting, IEEE; New York, Jan. 26-31.

International Symposium on Information Theory, IEEE; Nevele Country Club, Ellenville, N.Y., Jan. 28-31.

**Short courses**

ECAP Workshop (Electronic Circuit Analysis Program), University of Wisconsin, Madison, Jan. 27-28; \$70 fee.

Theory and Design of Reliable (Fault-Tolerant) Computers: Protective Redundancy, Diagnosis, Self-Repair Engineering, University of California, Los Angeles, Jan. 6-17; \$375 fee.

Computer Aided Circuit Design, George Washington University, Washington, Jan. 6-10; no fee.

**Call for papers**

Biomedical Sciences Instrumentation Symposium, ISA and the University of Michigan; Chrysler Center, University of Michigan, Ann Arbor, May 19-21. Dec. 15 is deadline for submission of abstracts to 1969 BSIS Technical Program Committee, c/o Ernest E. Sellers, host chairman, Box 618, Ann Arbor, Mich. 48107

Conference on Electric Fields in the Magnetosphere, American Geophysical Union and Rice University; Rice University, Houston, March 10-13. Jan. 6 is deadline for submission of abstracts to Prof. J.W. Freeman Jr., Department of Space Science, Rice University, P.O. Box 1892, Houston.

Nuclear Electronics Symposium, IEEE; Ispra, Italy, May 6-8. Jan. 10 is deadline for submission of abstracts to Prof. Luciano Stanchi, C.C.R. Euratom, 21020 Ispra.



# Cermet

AND THE

## Model 3262

POTENTIOMETER

Meets requirements MIL-R-22097, Style RJ-26  
TC 150PPM/°C\* over entire resistance range 10Ω to 1 Meg.



Designed to not only meet requirements, but beat requirements! A ¼ inch square potentiometer of the highest quality available — in the tradition of excellence of design and workmanship you have come to expect from Bourns . . . the leaders in the industry. Write or call the factory, your local field office or representative today for technical data.

\* 100PPM/°C AVAILABLE



BOURNS, INC., TRIMPOT PRODUCTS DIVISION • 1200 COLUMBIA AVE., RIVERSIDE, CALIF. 92507



START

MOTOR 4



# Pushbuttons?

## Why not go where you have the whole spectrum to choose from!

With panel design continually increasing in sophistication, pushbutton specifications are becoming more and more exacting. Whatever the case—whether your needs call for the simple or the complex—your best bet is to call MICRO SWITCH. The reason is plain. No one can match our pushbutton line in breadth of selection.

What's more, your MICRO SWITCH Distributor can offer you literally thousands of pushbutton varieties *right off the shelf*. For example, he stocks hundreds of interchangeable operator and switch modules that combine into thousands of different assemblies—allowing

you to economically customize your panel with unlimited design freedom.

Special problems? MICRO SWITCH also puts the broadest field engineering service at your beck and call. These pushbutton specialists, backed up by the largest manufacturing and design facilities in the industry, can come up with the right solutions fast.

Just a sampling from our spectrum of pushbuttons is shown at left and described below. For more details, call a Branch Office or an Authorized Distributor (Yellow Pages, "Switches, Electric"). Ask for Catalog 51.

**1. Unlighted Pushbutton Switches.** Bushing or bracket mounted. Available in 1-, 2-, 3- or 4-pole double-throw circuitry, momentary or alternate action. Black, red and green buttons in various diameters. Sealed designs available. Wide range of electrical power-handling capabilities.

**2. Series 2C200 Modular Lighted Pushbutton Switches.** Rectangular display lighted by projected or transmitted 4-lamp color. Can be relamped without tools. 1, 2, 3 and 4 section split-display screens. Maintained, momentary or magnetic hold-in operation. Switch modules with silver or gold contacts, multiple circuits and broad choice of contact arrangements and electrical capacities. Also reed switch module.

**3. PT Heavy-duty and CMC Pilot-duty Industrial Manual Controls.** Oiltight pushbuttons, selectors and indicators with the modern square look. Lighted or unlighted. Large easy-reading legends. Multi-circuit control with up to 32 circuits per unit.

**4. KB Switch/Display Matrix.** New keyboard building block concept consisting of pushbuttons and pushbars (lighted and unlighted), switches, indicators, mechanical interlock units, and modular hardware for mounting and wiring. En-

tire KB matrix can be bench assembled. Switches can be pre-wired and plugged in like a radio tube. Milliamp-rated "encoding" switch produces a coded output for data entry, exclusive of separate circuit packages. "Power" switch with 5 amp. 115 vac rating has lighted display option.

**5. 50PB Bushing Mounted Pushbutton Switches.** One-lamp indication. Choice of button sizes, shape and colors. Long- and short-stroke and turn-to-hold momentary action; one- and two-level alternate-action. 1-4 pole double-throw and two-circuit double-break contact arrangement.

**6. DM Pushbutton Switches:** Attractive, rugged snap-in panel mount. SPDT or

DPDT circuitry. Three snap-on button styles, 1/2" to 1" diameter, red or black. Also 1/32" diameter integral momentary-action and push-pull alternate action buttons. Rating: 10 amps, 125 or 250 vac; 1/3 hp, 125 or 250 vac.

**7. 302PB Miniature Pushbutton Switches.** One- or two-section two-lamp display. Momentary and alternate-action operation of two SPDT switches. Spacing barriers and panel seals available.

**8. Series 2N Modular Lighted Pushbutton Switches.** Relampable without tools, these switches feature spring-lock mounting. Molded color housings, in gray, white or black, can be supplied with terminals for two or four lamps. Modularity provides a number of circuit, operation and display possibilities paralleling the 2C200 options. Spacing barriers and hold-in coil modules are available.

**9. Series 2M Round Display Modular Lighted Pushbutton Switches.** Colored guard rings encircle display screen, prevent accidental operation, code control function. Broad choice of circuitry through switch modules used with Series 2N. Many choices of transmitted and projected display colors. Panel mount in 1/16" to 3/16" thick panels.

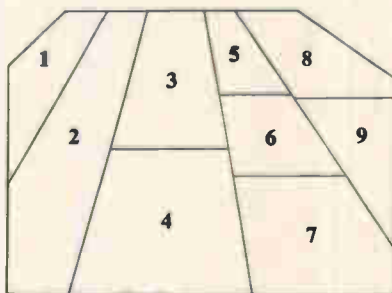

## MICRO SWITCH

FREEPORT, ILLINOIS 61032

A DIVISION OF HONEYWELL



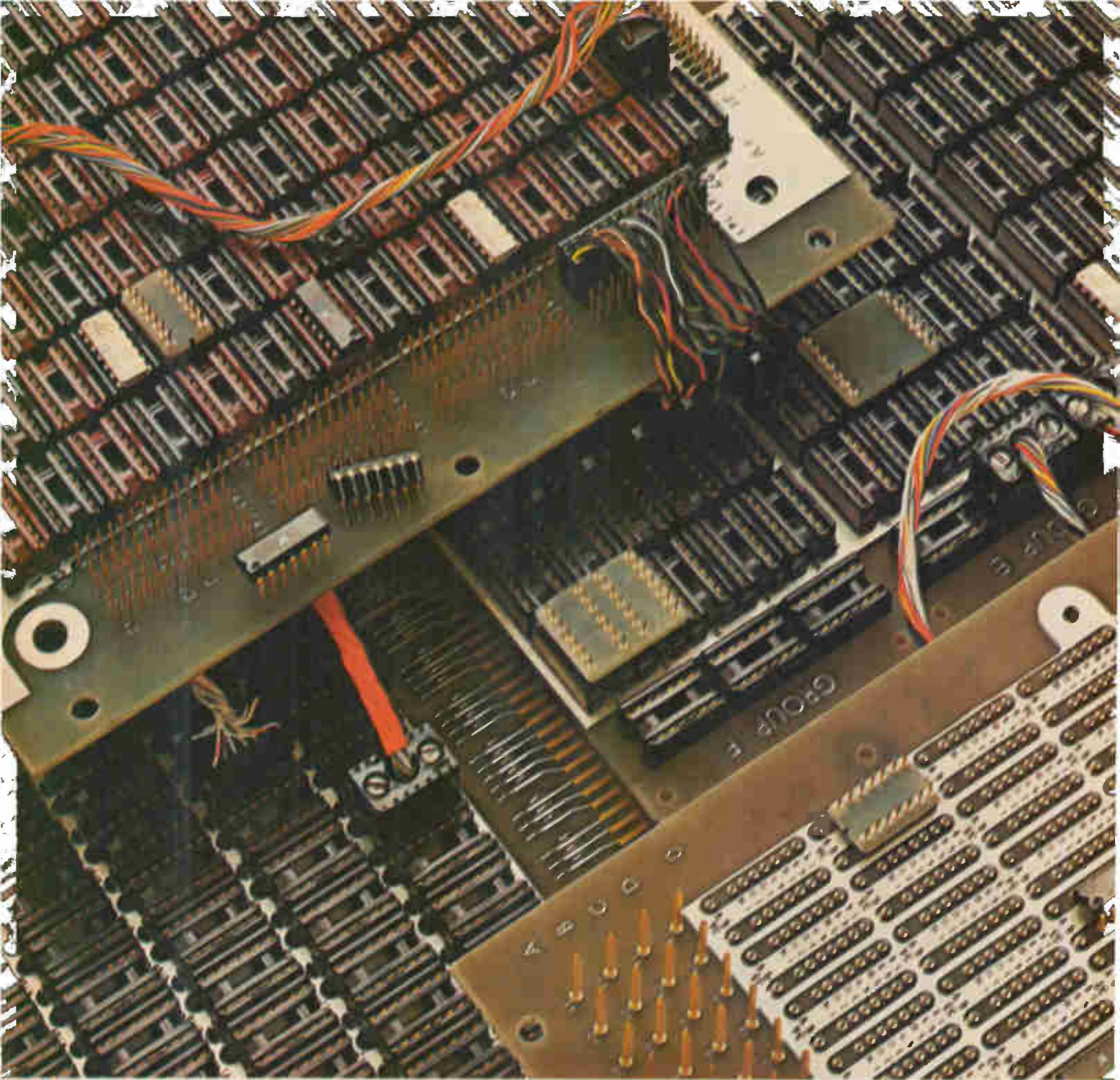

## Innovation in IC packaging panels

Let Augat provide flexibility, reliability and fast turn around time you need

You can have increased flexibility — and save time, space and money — with Augat's unique 2-dimensional approach of packaging IC's on a point-to-point basis. And regardless of the size of package, Augat can design and produce the panels and peripheral hardware to solve your most difficult packaging problem. In addition to standard panels, modifications can be made to your specification without premium charge: Standard sockets and connectors, providing excellent lead retention, low contact resistance, and long life reliability are used on all panels.

Illustrated are four methods of input-output connections. These are available on virtually any size or shape panel required to fit your existing cabinets, racks and drawers. Variations in contacts and materials permit unusual pricing flexibility.

Why wait. Call Augat for fast proposal and delivery.

Tel: 617/222-2202 or write

for our complete IC folder. Augat, Inc.,

30 Perry Ave., Attleboro, Mass. 02703.

**AUGAT**<sub>INC.</sub>



---

**Editorial comment**

---

## Enhancing the voice of the people

**Fast vote tabulation** is the least of the Election Day benefits electronics can confer. Greater participation in the democratic process—and, as a consequence, a better-informed electorate—can result from the wise application of technology to the election process.

The trend to electronics is already under way. Some 60 counties in 15 states used the IBM Votomatic (punched card) system in last month's Presidential election. In some isolated cases, the tests fell short of expectations. In Dallas County, Texas, for example, some of the ballot cards were improperly punched due both to voter error and machine misadjustment.

In Los Angeles County, 33,000 Votomatic recorders were used in the June primaries and again in November. Transporting the cards from the 7,000 precincts to check-in and tabulating centers proved a problem in June, though the operation went smoothly in November.

But in spite of occasional troubles, such trials can be regarded as the first step toward a streamlined, nationwide voting system based on advanced data-transmission techniques.

The challenge cries out for a systems engineering approach. And it's clear that when this approach is applied, the telephone will be considered for a role in the voting process, a role that will permit citizens to cast their ballots without stirring from homes or jobs. One possibility would be a phone set into which the voter could insert an identification card that would connect him to a central computer. If conventional telephones were used, the voter might be identified by his voice print. Although voice prints might be counterfeited, there seems little likelihood of fraud on a large scale.

Robert Stiefel, president of Infotran Inc., told a recent meeting of the Association for Computing Machinery that the best kind of automatic electronic voting system would be one that accepts a variety of inputs—voting-machine cards, mailed ballots, or telephoned votes. Such a system might encompass:

**Automatic voting booths.** Candidates and issues could be displayed on electronic readouts. The voter would have a personal voting card to validate his right to vote, connect him to a central computer, and permit him to cast his ballot.

**Machine-readable ballots.** Unit data cards such as punched cards would be mailed to eligible voters (presumably they would be prepunched to

certify the individual voter's identity). The voter would mark his card and mail or carry it to a local voting center where a machine would read and count it.

**Special telephones.** A modification of the subscriber's regular phone could permit the reading of his voter identification card. Automatic checking gear such as magnetic disk files would validate the voter's card and give him a "proceed to vote" signal. He would then dial a predetermined code to register each of his choices on candidates or issues.

**Conventional telephones.** Voice validation would be the logical choice in this case; voice prints have the advantage of being easily transmitted by narrow band. The prints would be accompanied by a dialed voter code.

Stiefel envisions a nationwide network of such inputs connected directly to local voting centers. These, in turn, would be connected to county, state, and Federal centers by data-transmission links. Besides encouraging wider participation at election time, the same system could be used to feed back public opinion on key issues to legislators.

Admittedly there are hazards in setting up such a system. Above all, it would have to be tamper-proof. And it would have to ensure accurate and reliable data transmission and storage, and protect the privacy of the voter. A skillful technician might be able to alter the accumulators of electronic registers without leaving a trace. Stiefel suggests such countermeasures as encrypting data at the major centers.

That accumulators can go haywire was vividly demonstrated during the Presidential election when the computer-based system serving the major television networks and wire services began to report wildly inflated counts and percentages (see "A night to forget" in *Electronics Review*). To avoid a recurrence, gross errors could be detected by comparing the accumulated vote with the maximum possible vote or, better yet, with the projected vote. And error detection could be carried out on a continuous basis using error coding schemes.

We agree with those observers who feel a large-scale electronic voting system is not only technically feasible, but inevitable in the very near future. One wonders which electronics firm will tackle the challenge and thereby share in a potentially lucrative market—the market for voting machines alone is estimated at \$500 million. ■ ■

# The standard of excellence

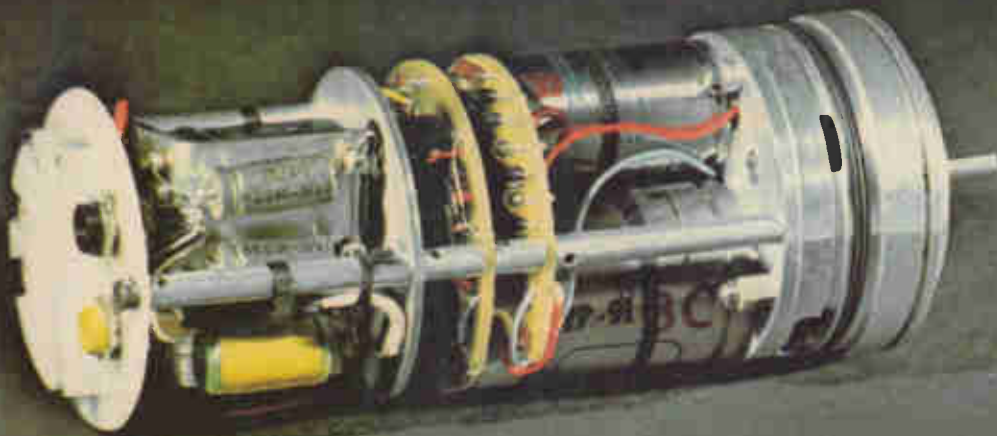

Diamond by J. E. Caldwell Co., Philadelphia—\$60,000

## in servo packages.

Important ingredients of every Clifton module are Clifton engineering, Clifton rotating components, Clifton gear trains. True "single source" responsibility.

The really priceless ingredient, however, is Quality. Quality borne of many years of meeting the most demanding standards of excellence—for both customers and ourselves.

A good example of Clifton excel-

lence and packaging is the Servo Repeater shown above. It can replace a size 23 torque receiver and improve accuracy by an order of magnitude. Here are some of the parameters:

- Velocity constant ( $K_v$ ) adjustable to  $300 \text{ sec}^{-1}$ .
- Slew speed capability greater than 216 degrees per second.
- Stall torque 10 oz-in/ $^\circ$  min.
- Torque gradient 10 oz-in/ $^\circ$  min.
- Input voltage 115 vac  $\pm 10\%$ ,

- 400Hz  $\pm 5\%$ .
- Synchro input 11.8 or 90 vac, 400Hz.
- Weight 18 ounces.

You expect Clifton to be better. When you select Clifton, you're getting the best.

Call your local Clifton Sales Office, or telephone (215) 622-1000 for prompt service.

**CLIFTON**   
DIVISION OF LITTON INDUSTRIES



---

# Electronics Newsletter

---

November 25, 1968

## Laser tv display fails military test . . .

The military has become disenchanted with laser television displays, believing that the technology is still too crude. Instead, scientists in the three services plan to push simpler laser display technologies that can't generate moving pictures.

The disenchantment stems from nearly two years of experiments with a feasibility system developed by Texas Instruments. That system, costing about \$87,000, has suffered from one failure after another, a civilian Air Force scientist concedes. The problems have been with the two lasers (ion-argon and helium-neon types) and the modulation/deflection scheme.

"Let's face it, it'll be years before a really reliable high-power laser that gives us the colors we want can be built," the scientist says. "And the electromechanical modulator/scanner design is a headache."

## . . . and search begins for new recruits

Air Force scientists say informal discussions with colleagues from the other services have led to agreement that they must start searching for other technologies to produce large displays.

The search appears to be turning to screens that produce images by either reflecting light or letting it pass. One possibility would be photochromic materials whose transparency or opacity depends on whether they've been scanned with a laser. The laser beam could be used much like a light pen, drawing the image on the screen; the display would then be completed by back-lighting the screen. Because the screen could store the patterns, relatively few passes of the beam would be necessary to build up an image. The Air Force will soon begin material-development research for the screen.

Such a system could use a weaker laser and slower scanning than laser tv, which requires about 30 watts of c-w power and a raster that scans as quickly as the electron beam in a cathode-ray tube. Both kinds of laser systems can produce wall-size displays that can be viewed in a normally lighted room.

Several firms, apparently seeking industrial customers now that the military market has dried up, are working hard to prepare laser tv systems that have been under development for the past few years. GT&E just introduced a laser system that takes pictures directly from a tv set. A civilian Air Force engineer familiar with the system concedes that it's an improvement over the Texas Instruments design but says, "It suffers from the same general technical problems."

## IBM thinks small in experimental unit

Even the giant of the computer industry appears to be developing some interest in the exploding minicomputer market, if a paper to be presented at the Fall Joint Computer Conference (see page 22), is any indication. So far IBM's smallest computer has been the 1130, which sells for about \$24,000 and up. But three researchers have built a purely experimental computer on a single 8-by-12-inch multilayer board—the same kind used by the dozens in most of the company's computers and peripheral equipment.

The computer has only three instructions—fetch, store, and conditional branch. The designers' aim was to build a computer with a minimum of hardware and a maximum of program. Everything is done with a table

---

# Electronics Newsletter

---

look-up procedure; the tables and all information for timing and data manipulating, as well as the instruction stream itself, are kept in the memory. And the memory's capacity is only 512 bytes. It's mounted directly on the board and takes up about a third of the space on it.

Standard hybrid microcircuit cards plug into the rest of the board; they can process data four bits at a time at a 3-microsecond rate. The complete unit, excluding input/output controls and a power supply, is only 3 by 15 by 18 inches and weighs 24 pounds.

## Solid state color tv in works at Zenith

Zenith is reportedly working feverishly to produce its first all-solid state color television set. Motorola started the trend two years ago, and RCA began shipping its first solid state color sets to dealers earlier this month.

In a related move, an industry source says Zenith will introduce a chassis with removable printed-circuit boards similar to Motorola's scheme [Electronics, July 10, 1967, p. 45]. The company has traditionally used the costlier hand-wired chassis. Zenith will use more printed circuits—all socket-mounted for easy replacement—than any of its competitors.

## Picturephone ready for trials next year

It now appears that AT&T may be far enough along in its development of the Picturephone to introduce it commercially on a limited basis some time next year. Company sources indicate that the service will cost \$100 a month.

However, before going to the marketplace, the Bell System in February will conduct trials of the device—a combination telephone and two-way television viewing system—between the New York and Pittsburgh offices of Westinghouse Electric. Some 40 sets will be used in the test.

## Laser helps driver in Ford experiment

Practical applications are still a long way off, but for the past year Ford engineers have been experimenting with a laser range finder that controls a car's throttle and braking systems. A driver is still required for steering. The system, mounted in a Thunderbird, will be demonstrated next month. It's composed of a gallium arsenide diode laser that emits a 60-milliwatt continuous-wave signal, a conventional infrared detector, and a computer to interpret the return signal, calculating range and range rate.

## Air Force to test relaxed procedure for documentation

The Air Force Systems Command has decided to give its streamlined systems engineering management procedure [Electronics, Sept. 16, p. 153] a try, even though it's still classified as a test document. The new format, devised after complaints that the Air Force's 375-5 procedure was restrictive and generated too much paperwork, will first be applied in the contract definition stage of the FX tactical fighter program. Projects being considered for the new approach include the AX attack aircraft and the Light Intertheater Transport, and there's an outside chance that it might be used for the Airborne Warning and Control System.

Testing of the new format, which will be the basis for an eventual Defense Department standard, has been held up by Pentagon, Army, and Navy reviews. This is why the new procedure won't be used in the initial source selection of the FX program. The tri-service plan in effect during contract definition, however, will be "basically the same document as the relaxed one," says a command spokesman, "but the Defense Department, the Army, and the Navy may change or clarify it."





## MOS ANALOG FUNCTION GENERATOR

Complex analog functions, like that in Figure 1, can be digitally generated as fast as 125,000 analog levels a second. The generator fits on a small printed-circuit board, because the function is stored as binary bits in an MOS read-only memory and is read out through an integrated-circuit digital-to-analog converter. In the past, slow and bulky electromechanical equipments, such as photoelectric mask scanners and machined-cam followers, were used to generate signals as unusual as these.

The initial application of the MOS generator is drawing special test patterns on a CRT screen. An operator can compare the generated function with the signal produced by systems or transducers excited by programmed test stimuli. This substitutes a quick go-no-go curve-matching test for a laborious measuring and plotting procedure. It takes little imagination to see many non-display applications. Coders and decoders for secure communications, analog computers and simulators, and automatic control of processes are a few probabilities.

The memory circuits are 256-bit MM520's, which are frequently used as character generators (Figure 2). Programmed metallization masks are used to store code words during chip manufacture. Connections are made or not made at each storage node in the chip, depending on whether the code calls for a binary "1" or "0" at that node.

Figure 3 represents the operating model that produced the scope photos in Figure 1. Coding of the analog levels is somewhat like pulse-code modulation. The number, N, of bits in each binary-coded word determines the waveform resolution:

$$\% \text{ Resolution at full scale} = 100/2^N$$

For the model, 6-1/4 percent was ample, so each word is four bits long and each MM520 thus stores 64 distinct, quantized levels.

The bits are read out serially when a logic "1" signal triggers the start input of the first MM520. The end-of-sequence pulse from the first MM520 triggers the next, and so on through the string. Flip-flops A and B (MM583 JK binaries) generate the trigger pulse and also divide the clock by four, so that the MM508 serial-in/parallel-out register will separate the serial bit stream into the four-bit code words.

© 1968 NATIONAL SEMICONDUCTOR CORP.

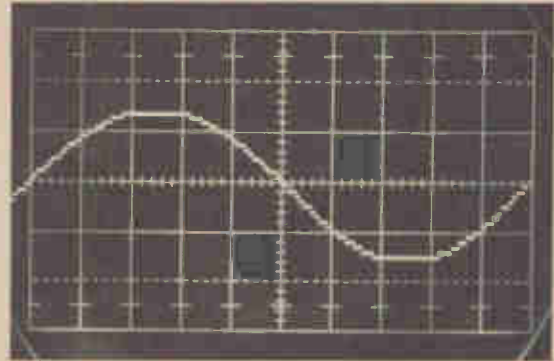
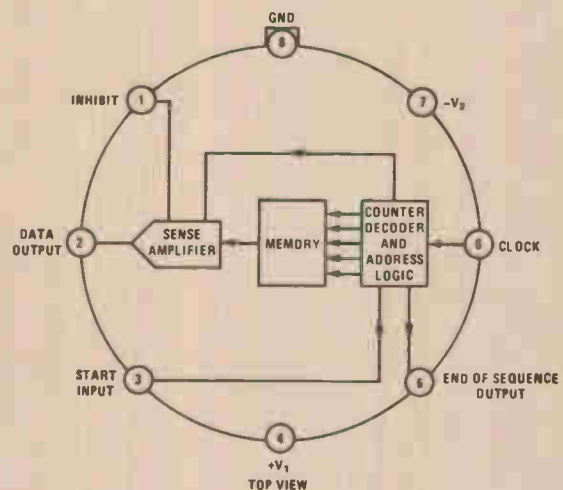

FIGURE 1. Typical Scope Trace Produced by MOS Memory.



NOTE: Pin 4 connected to case

FIGURE 2. MM520 Read-only Memory and Character Generator Contains 256 Bits of Storage, Addressing and Control Logic in a Single Chip of Silicon.

Four more MM583 flip-flops and four MM580 dual NOR gates operate as buffered registers to hold the four bits of each word and drive the A/D converter. The converter is a four-rung resistor ladder and an MM551 multiplexer used as a series switch. Errors in the analog output are detected and nulled in the ladder via the feedback loop of the LM201 operational amplifier. Full-scale voltage adjustment is provided in the feedback loop by potentiometer R1. All analog levels appearing at the output are equally spaced in time, since the system is synchronous.



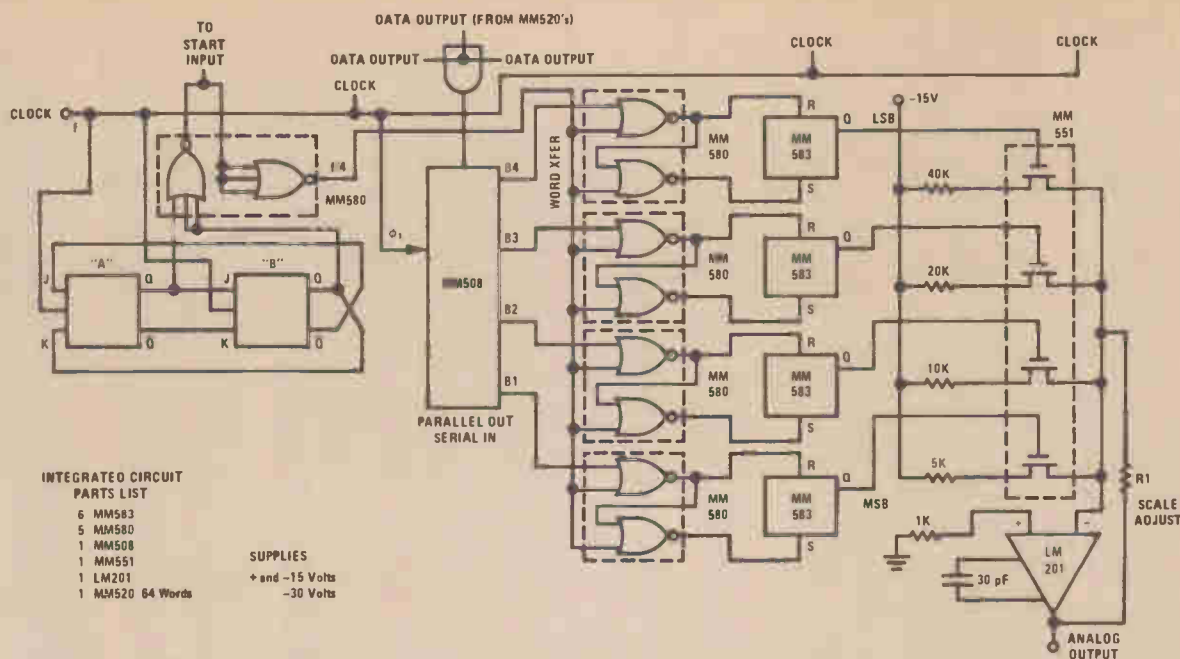

FIGURE 3. Working Model of Analog Function Generator Uses Four Bits in Each Digital Word to Define Analog Levels. Any Number of MM520's Could Be Used.

If greater resolution than 6-1/4 percent is desired, the words can be made longer, of course, by merely extending the clock divider and converter logic circuits. One operational amplifier will still suffice. In fact, this portion of the system can easily be time-shared by several function generators if a programmed selector switch is added. Or the operator can change functions by manual switching or plug-in replacement of the MM520 strings.

Some applications require a periodic function—for example, a complex sine wave. The auxiliary circuit in Figure 4 makes it unnecessary to store both positive and negative halves of the function. In the working model, the ripple counter produces a sign-reversal pulse at 64-word intervals. Delivered to the MM550 analog switch, the pulse periodically connects the function-generator output to the positive or negative side of the operational amplifier. Here again, the number of circuits used can easily be changed to fit the function-generation requirement.

Stored code words can also be used to divide an oscilloscope's sweep into regular angular incre-

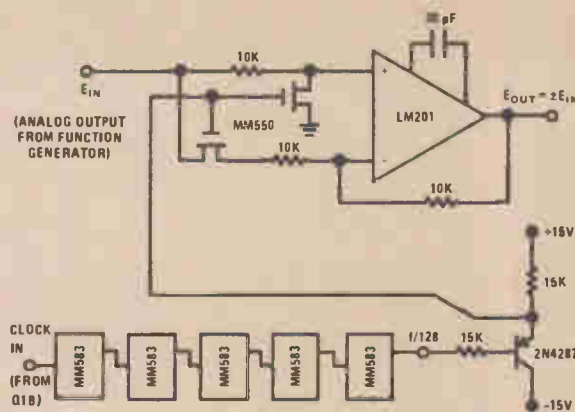

FIGURE 4. Analog Inverter Reverses Polarity of Periodic Functions.

ments, or to produce other special traces that may be required in analysis work. Since the words are digital, they can also be used to compute automatically the sine, tangent or other mathematical functions of the analog signals that are displayed.

Complete data sheets and additional applications information on all the MOS devices are available upon request.

## National Semiconductor Corporation

2975 San Ysidro Way, Santa Clara, California 95051  
(408) 245-4320/TWX (910) 339-9240



There's something here for everybody.

Could this  
microcircuit  
package sealant  
be what you're  
looking for?

This particular material seals at 450° C. Reheats to 525°. It's a high strength, crystallizable glass package sealant recommended for Kovar®-alumina packages. With a wide vitreous range, it permits preglazing of parts without crystallization.

Our growing family of new glass materials for microelectronics is comprised of two basic groups; one for package sealants, the other for substrate glazes and insulating films. All tailored formulations with a range of properties and characteristics keyed to a specific need.

Discovered and developed at the Owens-Illinois Research Center where glass-ceramics experience is unequaled, these versatile materials have been customized in dry mixture form. They come packaged in one-, five-, and twenty-pound containers, and are offered in three different grinds.

← Circle 36 on reader service card

Two new brochures, free on request, give complete descriptions, specifications, packaging and price information.



**OWENS-ILLINOIS, INC. • Commercial Development**  
P. O. Box 1035 • Toledo, Ohio 43601

Please send brochures on Package Sealants and Substrate Glazes/Insulating Films

Name \_\_\_\_\_ Title \_\_\_\_\_  
Firm \_\_\_\_\_  
Address \_\_\_\_\_  
City \_\_\_\_\_ State \_\_\_\_\_ Zip \_\_\_\_\_

**OWENS-ILLINOIS**   
Toledo, Ohio 43601

Circle 37 on reader service card

37





## Aluminum Foil for Electronics

### PLAIN FOIL

Republic has three types of standard purity (99.45% aluminum) capacitor foil available for the manufacture of paper and film wound capacitors.

**ELECTRO-DRY®**—A foil that has negligible organic and inorganic residues on the surface. This type can be used for high reliability and standard units. Electro-Dry is a superior dry foil.

**SILWYND®**—A foil that has a controlled lubricated surface made by a patented process. Silwynd is used for a free unwind and where a slight lubricant is essential to winding. The slip coating is a high grade silicone which makes Silwynd particularly suited to silicone impregnated capacitors.

**ELECTRO-SLIK®**—A foil that has a controlled residue produced from the rolling lubricant. The slight residue facilitates unwinding.

**ELECTROGAGE®**—Super-thin foil .00015" and .00017" features guaranteed gage for critical capacitor requirements. Available in Electro-Dry, Silwynd, and Electro-Slik.

**Widths** — Republic manufactures all commercial widths from 1/16" in .00015" thru .00035" gages, from 1/8" in .0004" thru .0007" gages, and from 1/4" in .00075" thru .005" gages.

**Alloys** — Plain capacitor foil is available in commercial alloys 1145, 1180, 1188, 1199 and 0191 (99.45%, 99.80%, 99.88%, 99.99% and 99.93% minimum aluminum content, respectively.)

### HIGH PURITY FOIL FOR ETCHING

The following high purity alloys and gages are produced in commercial quantities at Republic:

Alloy	Gage in Inches
1180	.00040 — .0050
1188	.00065 — .0050
1199	.0010 — .0050
0191	.00065 — .0050

**Widths** — Widths are available in some alloys from 1/8".

### FOIL FOR COIL WINDING

Republic supplies both precision slit\* and edge contoured\* aluminum strip conductor for coil winding.

Gages - up to .040" — Widths - from 1" Outside Diameters - up to 42" — Alloy - EC  
\* Depends on width and gage.

### ETCHED ALUMINUM FOIL

Republic Foil produces a complete line of etched foils including high voltage, mid-range, low voltage and cathode. These foils are custom made to customer specifications and are available in several different alloys.

Gages — Etched foil is available in the following gages.

Cathode — .0011" thru .002"  
Anode — .002" thru .0035"

Widths — Etched foil is available in all commercial widths from 1/8".

The consistent high quality of Republic's standard and high purity aluminum foils is maintained through the utilization of advanced test methods and meticulous inspection procedures.

Republic Foil Inc. is one of the world's leading producers of aluminum foils for the electronics industry and has the most complete line available from any one source. Experienced engineers are available to offer technical assistance and to tailor foil requirements to fill the most critical customer specifications.



## REPUBLIC FOIL INC.

GENERAL OFFICES, OANBURY, CONN. 06810: TEL. 203-743-2731

BRANCH SALES OFFICES: Chicago, Ill. 312-545-2142 • Salisbury, N. C. 704-633-6020 • Cleveland, Ohio 216-871-6268  
WEST COAST - Electrical Specialty Co., 213 E. Harris Ave., So. San Francisco, Cal.; 2820 E. 12th St., Los Angeles, Cal.

PLANTS - Oanbury, Conn. - Salisbury, N. Carolina - Somerville, Mass.





Allen-Bradley's experience in resistor production reaches...

to the moon and back!

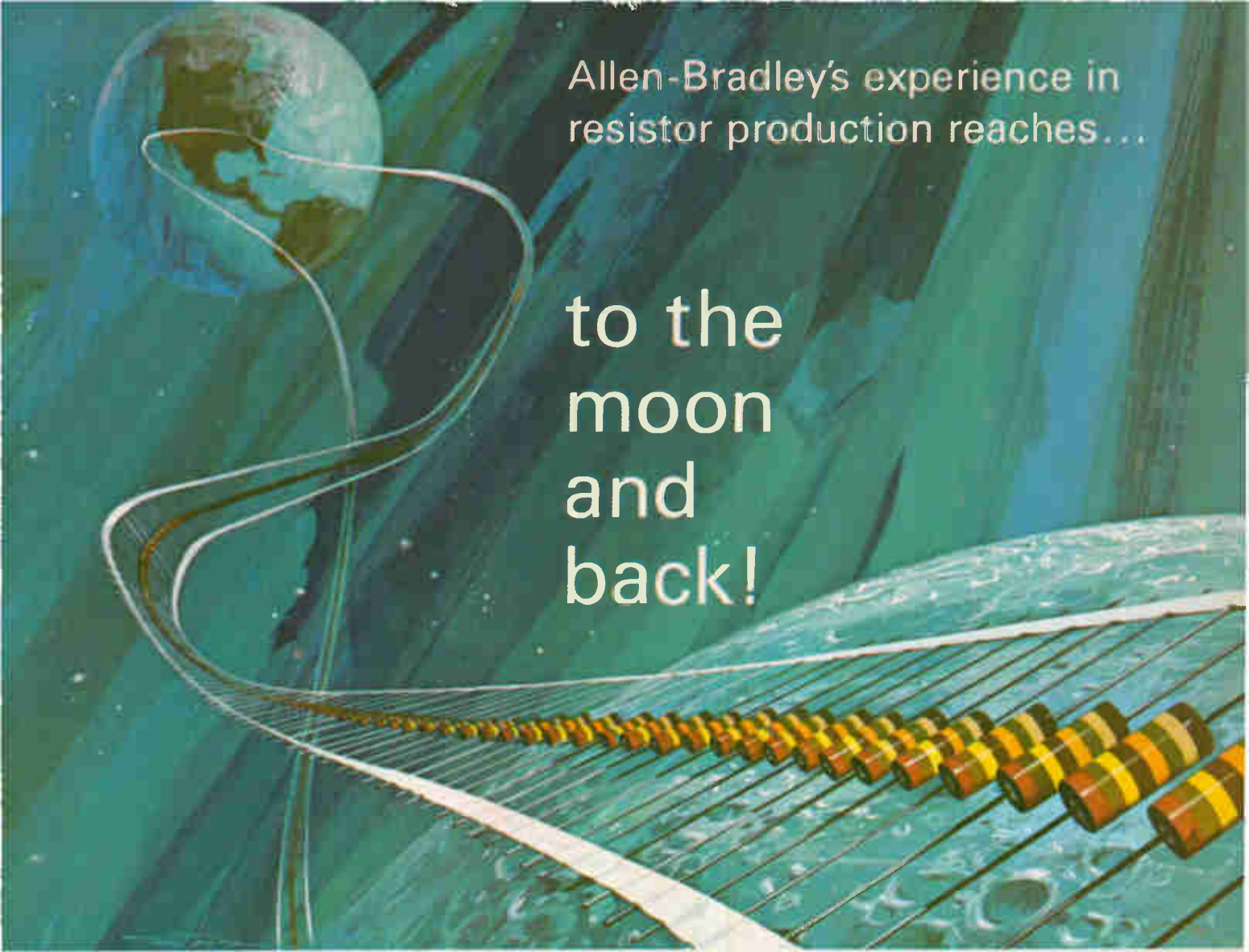

TYPE BB 1/8 WATT

TYPE EB 1/2 WATT

TYPE HB 2 WATTS

TYPE CB 1/4 WATT

TYPE GB 1 WATT

A-B hot-molded fixed resistors are available in all standard resistance values and tolerances, plus values above and below standard limits. A-B hot-molded resistors meet or exceed all applicable military specifications including the new Established Reliability Specification at the S level. Shown actual size.

After more than three decades and untold billions of hot-molded resistors, Allen-Bradley has accumulated manufacturing "know-how" which cannot be approached by anyone else. The fact that the resistors made by A-B over the years—if placed side by side—would more than reach to the moon and back, may be impressive. But "how" they are made is the key.

Allen-Bradley resistors are produced by an exclusive hot-molding technique—developed by A-B. They're made by completely automatic machines—also developed, built, and used only by Allen-Bradley. The human element of error is removed. Uniformity is so precise from one resistor to the next—year in and year out—that long-term resistor performance can be closely predicted.

And there has been no known incident of catastrophic failure of an A-B hot-molded resistor.

The reputation for quality and performance established by Allen-Bradley hot-molded resistors is reflected in the fact that they have been an integral part of virtually every U.S. space probe. And they are "on" the moon. No other resistor applications demand a higher measure of reliability.

For detailed specifications on this superior line of hot-molded resistors, please write Henry G. Rosenkranz and request a copy of Technical Bulletin 5000: Allen-Bradley Co., 1201 South Second Street, Milwaukee, Wisconsin 53204. Export Office: 630 Third Ave., New York, N.Y., U.S.A. 10017. In Canada: Allen-Bradley Canada Limited.

EC 6815

QUALITY ELECTRONIC COMPONENTS



ALLEN - BRADLEY



# Now...increased efficiency with higher reliability

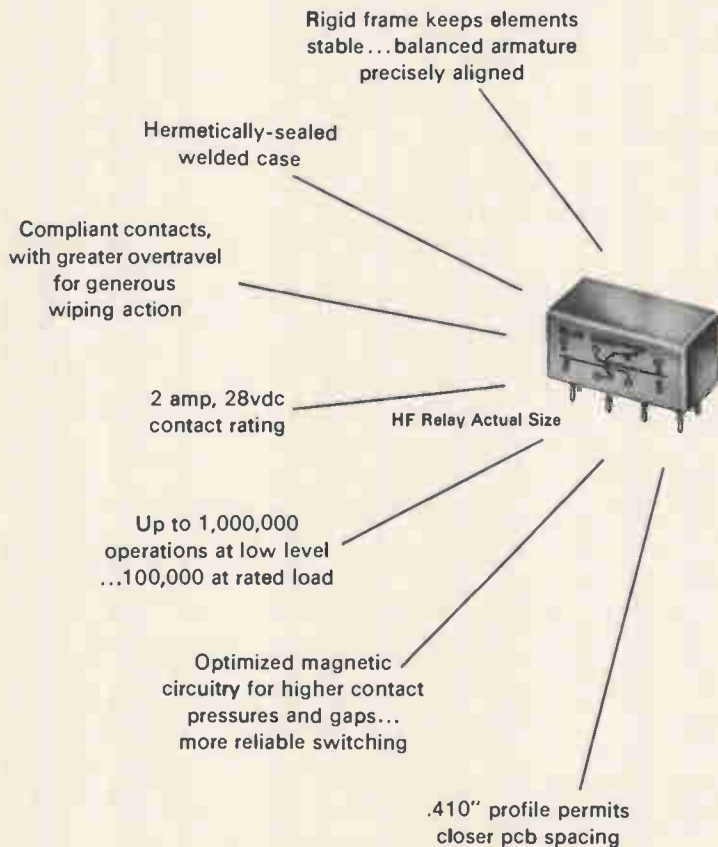

## Clare HF Military Type Relays

Utilize Clare's continuing advancements to give you improved magnetic circuitry and higher contact reliability... a real step ahead in over-all switching efficiency!

Important new magnetic design improvements add to the Clare HF's versatility and long life in demanding environments. This half-size relay meets military, industrial and commercial switching requirements over temperatures of  $-65^{\circ}\text{C}$  to  $+125^{\circ}\text{C}$ ... shock to 65G... vibration to 30G—without false operation. Variety of mounting styles (see below) extends application flexibility.

For complete data, circle Reader Service Number, or ask Clare for Manual 701. Write Group 11N7

C. P. Clare & Co., Chicago, Ill. 60645  
...and worldwide



a GENERAL INSTRUMENT company

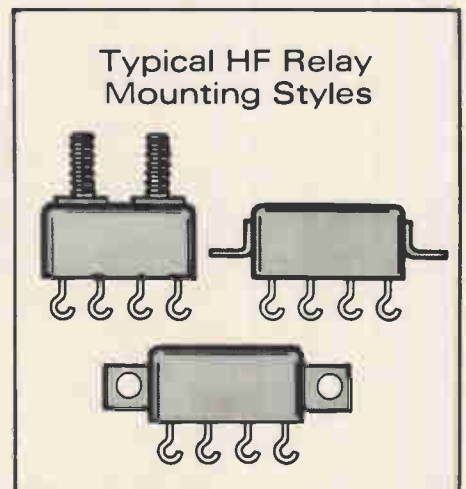
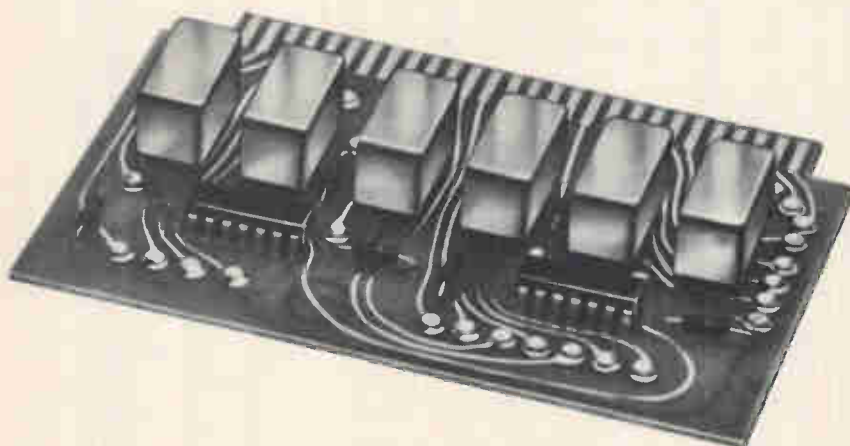

**CLARE TYPE HF MILITARY TYPE RELAY**  
for airborne, aerospace and ground support equipment,  
communications, industrial and commercial control systems

# Just when we thought we had every FET in the book...

Device Number	Function	Polarity	Type	$I_{DSS}$ (mA)	$V_{GS}$ (V)	$C_{iss}$ (pF)	Price (100's)
2N5265	Depletion Mode (Type A) General Purpose Amplifiers	P	JFET	0.5-1.0	80	2.0	\$5.40
2N5266	(Type A) General Purpose Amplifiers	P	JFET	0.8-1.6	60	2.0	5.10
2N5267	Purpose Amplifiers	P	JFET	1.5-3.0	60	2.0	4.80
2N5268		P	JFET	2.5-5.0	60	2.0	4.50
2N5269		P	JFET	4.0-8.0	80	2.0	4.80
2N5270		P	JFET	7.0-14	80	2.0	8.10
2N4091	Depletion Mode (Type A) Chopper & High Speed Switch	N	JFET	30 (min)	40	5.0	6.10
2N4092	(Type A) Chopper & High Speed Switch	N	JFET	15 (min)	40	5.0	3.70
2N4093		N	JFET	8 (min)	60	5.0	2.75
2N5358	Depletion Mode (Type A) General Purpose Amplifiers	N	JFET	0.5-1.0	40	2.0	4.00
2N5359	(Type A) General Purpose Amplifiers	N	JFET	0.8-1.6	40	2.0	3.60
2N5360		N	JFET	1.5-3.0	40	2.0	3.30
2N5361		N	JFET	2.5-5.0	40	2.0	3.00
2N5362		N	JFET	4.0-8.0	40	2.0	3.30
2N5363		N	JFET	7.0-14	40	2.0	3.60
2N5364		N	JFET	9.0-18	60	2.0	4.00
2N5457	Depletion Mode (Type A) General Purpose Audio & Switching	N	JFET	1.0-5.0	-25	3.0	.60
2N5458	(Type A) General Purpose Audio & Switching	N	JFET	2.0-9.0	-25	3.0	.55
2N5459		N	JFET	4.0-16	-25	3.0	.60
2N5460	Depletion Mode (Type A) General Purpose Amplifiers	P	JFET	1.0-5.0	40	2.0	.67
2N5461	(Type A) General Purpose Amplifiers	P	JFET	2.0-9.0	40	2.0	.50
2N5462		P	JFET	4.0-16	40	2.0	.67
2N5463		P	JFET	1.0-5.0	60	2.0	1.00
2N5464		P	JFET	2.0-9.0	60	2.0	.80
2N5465		P	JFET	4.0-16	60	2.0	1.00
2N5471	Depletion Mode (Type A) General Purpose Amplifiers and Switches	P	JFET	-0.02 to -0.06	40	1.0	7.00
2N5472	(Type A) General Purpose Amplifiers and Switches	P	JFET	-0.05 to -0.12	40	1.0	8.80
2N5473		P	JFET	-0.10 to -0.28	40	1.0	6.25
2N5474		P	JFET	-0.20 to -0.50	40	1.0	3.25
2N5475		P	JFET	-0.40 to -1.0	40	1.0	2.25
2N5476		P	JFET	-0.80 to -2.0	40	1.0	3.25
3N155	Enhancement Mode (Type C) Chopper & Switch	P	MOSFET	-1.0 (max) NA	-35	1.3	5.00
3N155A	(Type C) Chopper & Switch	P	MOSFET	-0.25 (max) NA	-35	1.3	5.00
3N156		P	MOSFET	-1.0 (max) NA	-35	1.3	5.00
3N156A		P	MOSFET	-0.25 (max) NA	-35	1.3	5.00
3N157	Enhancement Mode (Type C) Amplifier and Switch	P	MOSFET	-1.0 (max) NA	-35	1.3	5.00
3N157A	(Type C) Amplifier and Switch	P	MOSFET	-0.25 (max) NA	-35	1.3	5.00
3N158		P	MOSFET	-1.0 (max) NA	-35	1.3	5.00
3N158A		P	MOSFET	-0.25 (max) NA	-35	1.3	5.00

## Here's 39 more!

Now there really is a Motorola FET for *your* application! The list above includes MOS and junction FET types for enhancement and depletion operating modes - in both P and N channel polarities - for amplifier, switch and chopper applications.

It's easy to see why Motorola supplies *one* out of every *four* FETs used in industry today. If you would like to try one of these new EIA-registered types ask your nearest Motorola representative for an evaluation unit. Check the specs in the chart for the type that best fits your FET application requirement.

For a complete data sheet on one or all of the above types, write Motorola Semiconductor Products Inc., Technical Information Center, Box 20912, Phoenix, Arizona 85036. We'll have them in the mail within hours.

*P.S.* Your nearby Motorola Semiconductor distributor has all of these types "on the shelf." Call him.

- where the priceless ingredient is care!



## MOTOROLA Field-Effect Transistors

MOTOROLA SEMICONDUCTOR PRODUCTS INC. / P.O. BOX 20912 / PHOENIX, ARIZONA / 85036



They can. Our CK8754, for example, costs much less...the lowest price available for any side-view type. You can save \$450 per thousand or more! Call us to find out.

This price reduction...with tubes made only in the U.S.A.... has been achieved without sacrificing quality. All tubes are EIA rated...produced for 200,000 hours of reliable operation. Datavue Tubes also feature:

- Straight, stiff leads for fast insertion in sockets. There's no

need to waste production time aligning and straightening leads.

- Full 5/8" characters for quick, accurate reading from distances up to 30'.

- High brightness, in-line characters...rated for strobing operation.

Datavue Indicator Tubes are promptly available in a wide range of alphanumeric, decimals, and special characters. Fast turn-around service on all custom designs is also assured.

**For prices and data, call these Raytheon sales offices:**  
Dallas, Texas 214-631-3745  
Dayton, Ohio 513-223-8128  
Des Plaines, Illinois 312-296-6677  
Englewood, N.J. 201-567-4911  
(In Manhattan, call 947-6400)  
Glen Burnie, Md. 301-761-0450  
Inglewood, Calif. 213-757-0251  
Quincy, Mass. 617-479-5300  
San Carlos, Calif. 415-593-1021  
Minneapolis, Minn. 612-927-9923

**RAYTHEON**

## **If imported indicator tubes cost \$3.95 each, can U.S.-made Datavue<sup>\*</sup> Tubes cost much less?**

(To find out, call your Raytheon regional office.)

\*Trademark of Raytheon Company

**Goldilox built-in protection system gives you Mil. Spec. reliability in commercial TTLs.**

**And that's no fairy tale.**

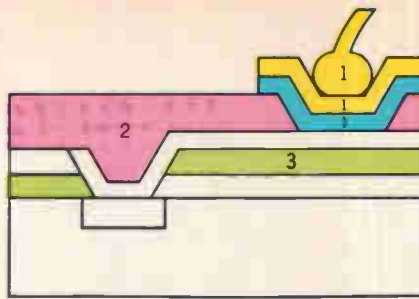

- Only Westinghouse offers you TTLs with:
1. Titanium-Gold bonding at interconnects for heat stability—to eliminate purple plague.
  2. Glass-over interconnects make chip surface impervious to corrosion, surface damage.
  3. Silicon nitride passivation retards ion

migration, eliminates inversion and leakage.

Reliable? Without packaging, Goldilox devices have operated under water for over an hour!

The Westinghouse 600 TTL series give you all of the SUHL characteristics. A pin-for-pin replacement. And we offer a complete line of military and commercial devices to meet your requirements. Our TTLs come in the 14-pin plastic dual-in-line, ceramic dual-in-line, and flat packages.

For Goldilox TTL products, call your local Westinghouse sales office or Westinghouse Molecular Electronics Division, Elkridge, Maryland, (301) 796-3666

J-09149

You can be sure... if it's

**Westinghouse**



# Goldilox, The IC Protector.



# The product improvers.

Improved N-channel FET choppers from TI feature lower capacitances for reduced feedthrough plus faster chopping and switching.

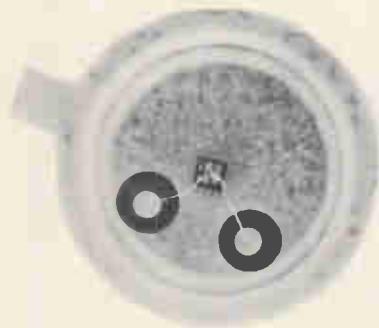

Here's the new look in FET chopper transistors from TI. A new design gives significantly lower  $C_{ISS}$  and  $C_{RSS}$ .

These lower capacitances reduce feedthrough of the input signal into the output line. Faster chopping and switching are other results.

In addition to the improved 2N4856A-61A series, this family now includes 2N3970-72, 2N4091-93, and 2N4391-93 FETs, as well.

Use of any or all of these FET "product improvers" will mean big dividends for you...in upgraded performance and reduced costs.

You won't have to wait, either, because production quantities are immediately available.

So don't put off evaluation any longer. Call your TI sales engineer or distributor now. Or, for data sheets, write on your company letterhead to Texas Instruments Incorporated, P.O. Box 5012, MS 980-B Dallas, Texas 75222.

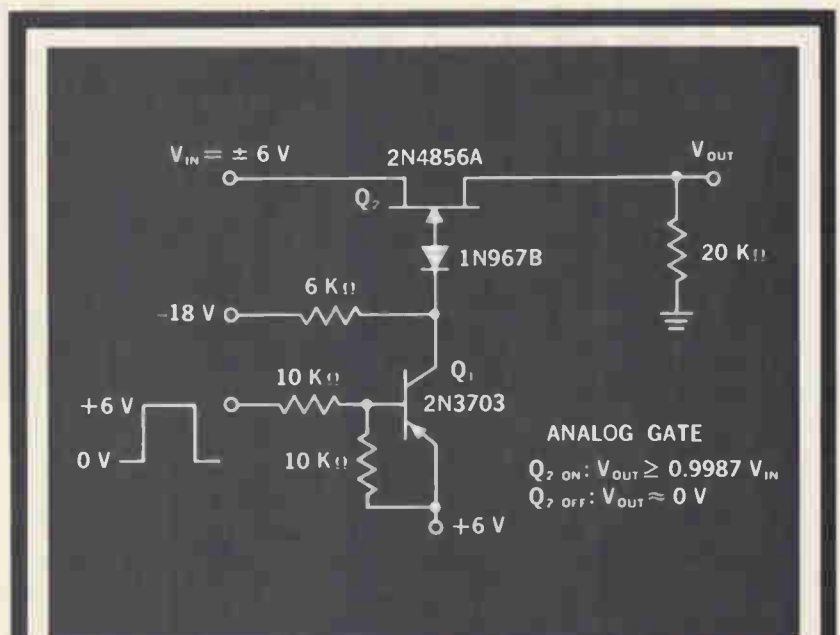

These two circuit applications demonstrate performance advantages of 2N4856A FET.

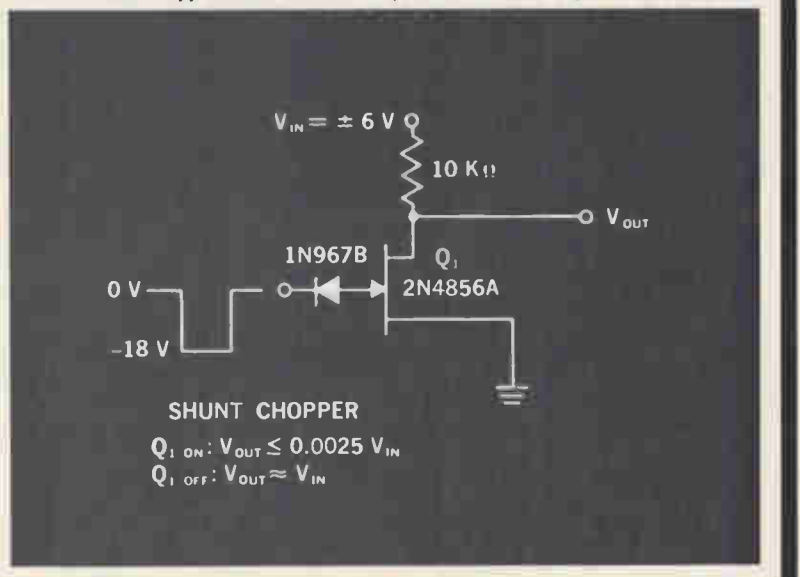



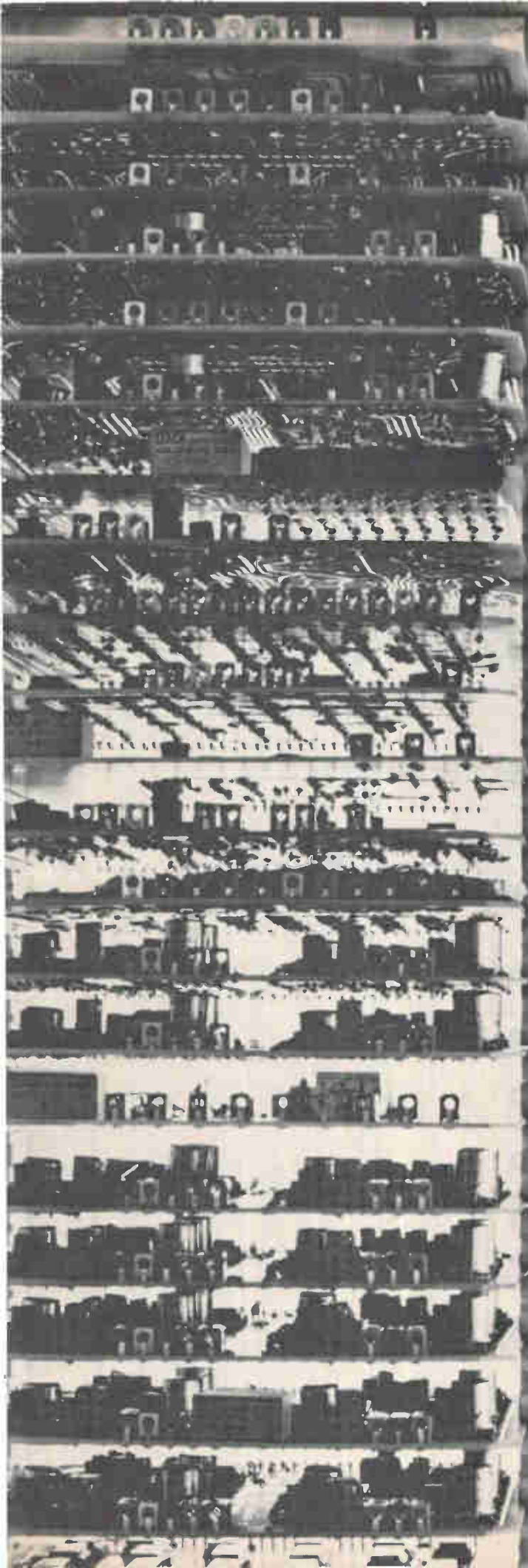

ACTUAL SIZE

Our new 150 Grid, Series G relays are only 0.32" high. You can stack more PC boards in a given height and increase the packing density of components. The Series G is a sealed, mil-spec, 2 amp, 2 pdt unit—54% smaller and 52% lighter than 1/2 size crystal can relays. Complete details are in our new Bulletin 3200. Write for it. Leach Corporation Relay Division, Dept. A, 5915 Avalon Blvd.,

**LEACH** Los Angeles, Calif. 90003.  
(213) 232-8221

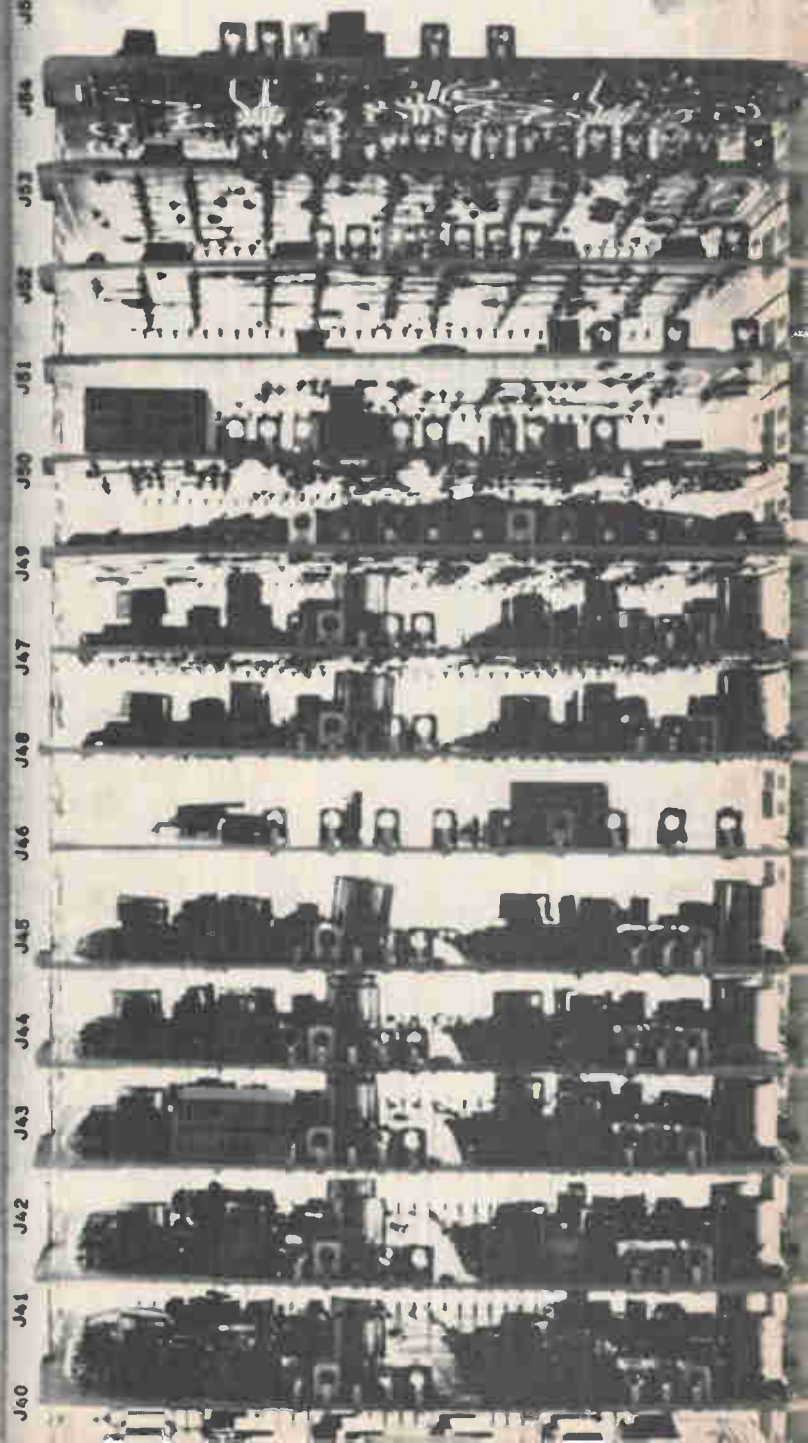

# The phenomenal ferrite bead:

## Stackpole's simple solution to noise and filter problems.

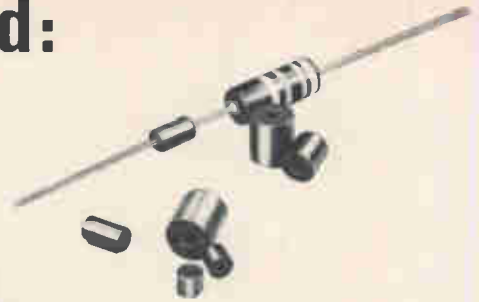

Ceramag® ferrite beads offer a simple, inexpensive, yet effective means of obtaining RF decoupling, shielding, and parasitic suppression without sacrificing low frequency power or signal level.

Unlike conventional RF chokes, beads are compact, have no DC losses, and will not couple to stray capacity and introduce detuning or spurious oscillations. Ceramag® beads offer an impedance which varies from quite low at low frequencies to quite high at noise frequencies. Beads need not be grounded; however, chassis contact is permissible when desired, as beads possess sufficiently high resistivity to preclude grounding.

Installation of Stackpole

beads is easy. Simply slip one (or several) over appropriate conductor(s) for the desired noise suppression or high frequency isolation. Beads are available in sleeve form in a range of sizes starting at .025 ID, .060 OD, and .400 long. For special compact filtering applications such as cable connectors, beads can be supplied to tight mechanical tolerances.

Several ferrite grades provide a variety of attenuation characteristics. Inductance tolerance is normally  $\pm 30\%$  as measured on an LC meter. The performance of a Ceramag® 7D bead as a parasitic suppressor is shown in Figure 1.

Other applications might include: decoupling in "B" circuitry; noise suppression; RF isolation in filament circuits;

use in combination with capacitors to form "L" networks.

FIGURE 1

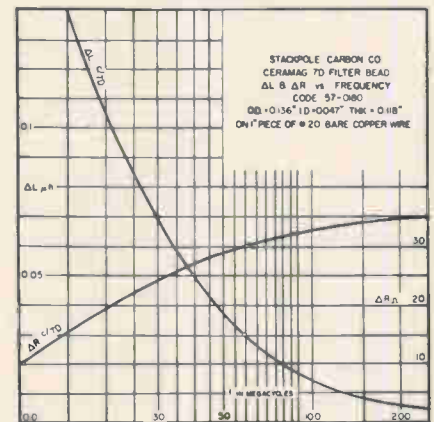

Sample quantities of Ceramag® beads and beads with leads are available without charge upon request. Send your requirements to Stackpole Carbon Company, Electronic Components Division, St. Marys, Pennsylvania 15857. Phone: 814-781-8521. TWX: 510-693-4511.



## Now available...Ceramag® beads with leads

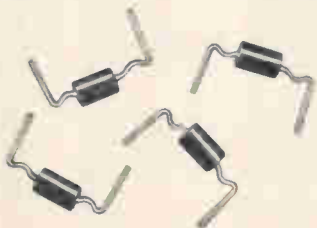

Additional savings in production time and labor costs are now possible by utilizing automatic insertion equipment to install Ceramag® ferrite beads in printed circuit boards.



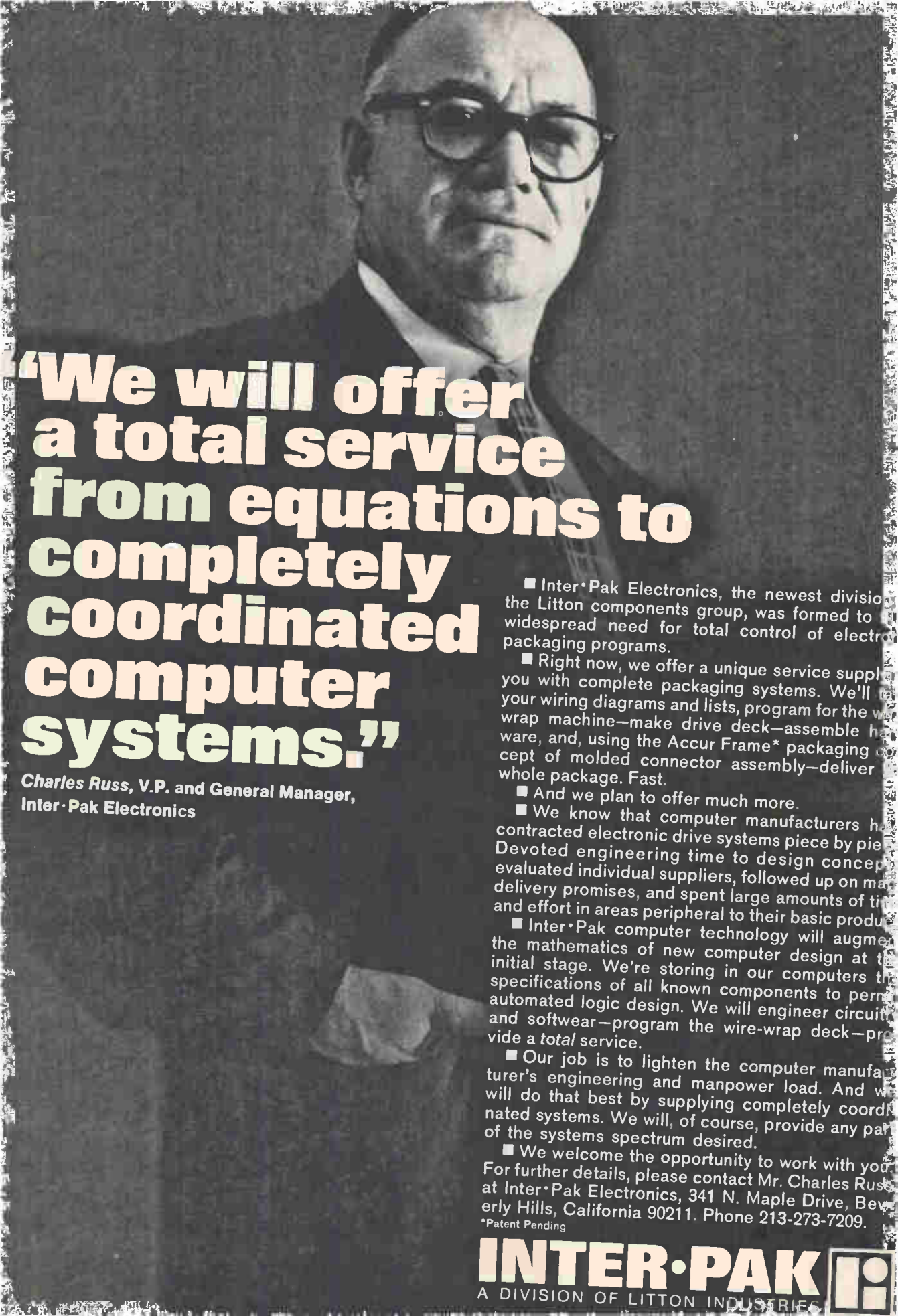

**"We will offer  
a total service  
from equations to  
completely  
coordinated  
computer  
systems."**

**Charles Russ, V.P. and General Manager,  
Inter-Pak Electronics**

■ Inter-Pak Electronics, the newest division of the Litton components group, was formed to meet the widespread need for total control of electronic packaging programs.

■ Right now, we offer a unique service supplied to you with complete packaging systems. We'll take your wiring diagrams and lists, program for the wire-wrap machine—make drive deck—assemble hardware, and, using the Accur Frame\* packaging concept of molded connector assembly—deliver the whole package. Fast.

■ And we plan to offer much more.

■ We know that computer manufacturers have contracted electronic drive systems piece by piece. Devoted engineering time to design concepts, evaluated individual suppliers, followed up on manufacturing delivery promises, and spent large amounts of time and effort in areas peripheral to their basic products.

■ Inter-Pak computer technology will augment the mathematics of new computer design at the initial stage. We're storing in our computers the specifications of all known components to permit automated logic design. We will engineer circuitry and software—program the wire-wrap deck—provide a total service.

■ Our job is to lighten the computer manufacturer's engineering and manpower load. And we will do that best by supplying completely coordinated systems. We will, of course, provide any part of the systems spectrum desired.

■ We welcome the opportunity to work with you. For further details, please contact Mr. Charles Russ at Inter-Pak Electronics, 341 N. Maple Drive, Beverly Hills, California 90211. Phone 213-273-7209.

\*Patent Pending

**INTER-PAK**   
A DIVISION OF LITTON INDUSTRIES



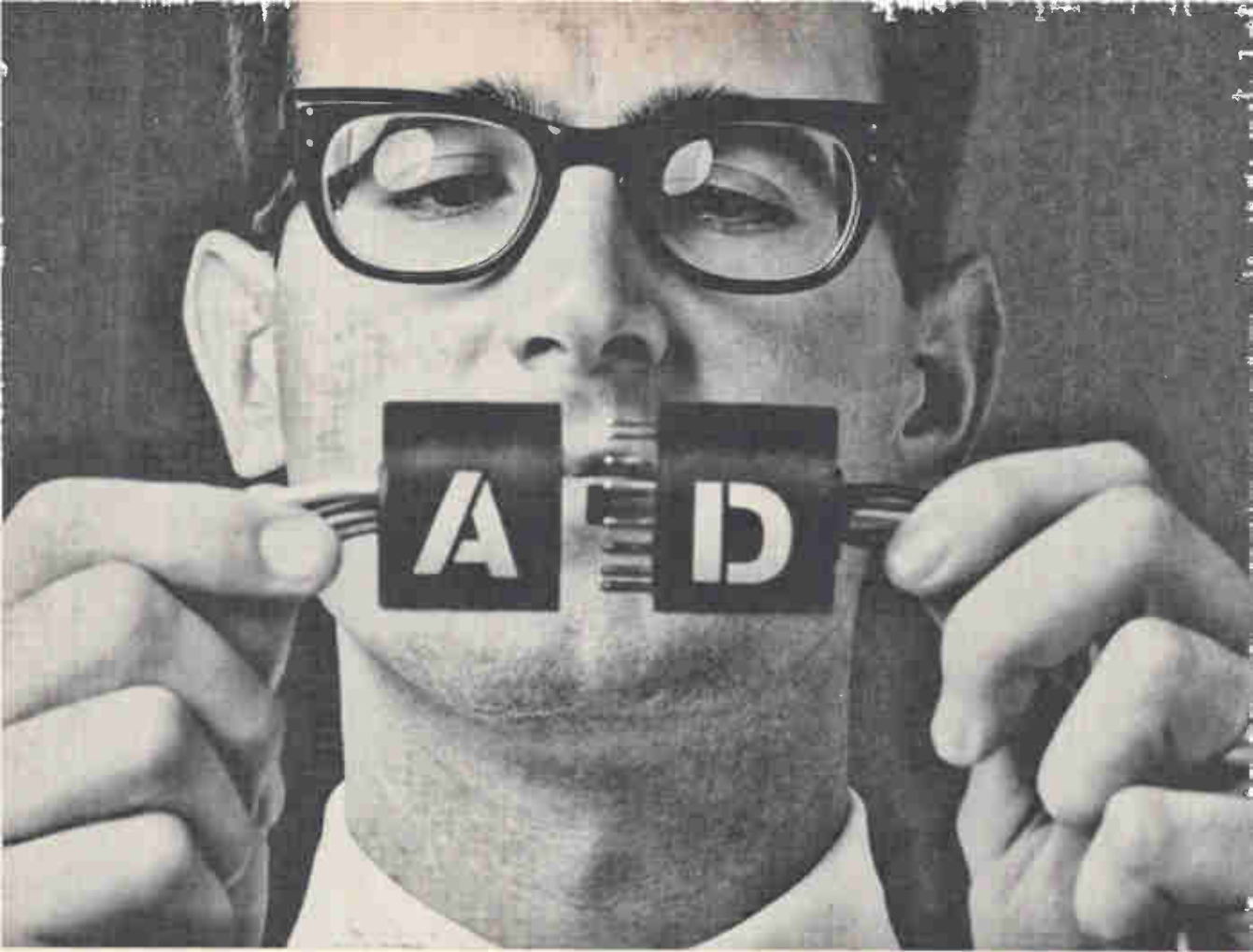

## Even a digital engineer can interface our new analog instruments.

Analog engineers design analog instruments for analog engineers. Digital engineers aren't usually analog engineers. This leads to problems.

Because we're involved with both D and A, we developed a group of instruments everyone can understand and use.

Before they were put on the market, our systems engineers demanded that analog signals get in and out of digital equipment with blinding speed and stunning accuracy. As a result, we are bold statements about our new line: **Our new instruments are:** A. As fast and more accurate than . . . B. Faster and more accurate than . . . C. Almost as fast and just as accurate as anyone else's. Whether A, B, or C applies depends on the instrument you choose.

Here are some of the new ways to get from analog to digital and back again.

### Multi-channel digitizers

Multi-channel high-level multiplexers with sample and hold amp, and a 15-bit A-D converter in the same chassis. Accuracy: 0.1%. The MD51 has a sample and conversion time of 10  $\mu$ sec for \$8,250 plus \$200 for each eight channels. If you can afford another 20  $\mu$ sec, you'll save \$3,050 with the MD41.

### Single channel digitizers

put word rate of 100 KHz for \$5,400. The AD41, though only costs \$4,000, isn't a slowpoke. Throughput is 33  $\mu$ sec.

### Digital to analog conversion

The DA40 is a 10-bit, 16 channel D-A converter. If you need more channels, up to 16 DA40's can be ganged together for 256 analog outputs. Each includes address decode and channel controls, plus a power supply. \$375 per channel.

### One of the world's fanciest op-amps

Variations on a theme called the HT58 universal operational amplifier include a single-ended op-amp, differential amplifier, unity gain buffer and a buffer with gain, all for use with "T" and "J" series modules. Input impedance of  $10^8$  ohms,  $\pm 40$  ma. output current over a voltage range of  $\pm 10$ V. Accuracy: 0.01%. Settling time: 5  $\mu$ sec. You can adjust the gain, zero offset, and the input offset voltage temperature coefficient. \$170.

Our spec sheets meet the same requirements as our instruments: they're understandable by digital engineers, analog engineers, and anyone else who can understand the specs above. For a complete set of spec sheets contact us digitally, or

**SDS**

# Electronics Review

Volume 41

Number 24

## Companies

### Making it

Stanford R. Ovshinsky, a 46-year-old inventor who proudly tells visitors that he never made it beyond high school, called a press conference earlier this month to announce that the prestigious *Physical Review Letters* was about to publish his technical paper "Reversible Electrical Switching Phenomena in Disordered Structures"—a description of an a-c switch made of a homogenous film containing no rectifying junctions.

Generally, announcements of such a narrowly technical nature are received with something less than enthusiasm by the public press. But this conference, held in Ovshinsky's small office in Troy, Mich., was attended by reporters from such national newspapers as the *New York Times* and the *Wall Street Journal*. The *Times* subsequently front-paged the story under the headline, "Glassy Electronic Device May Surpass Transistor."

**Overnight fame.** The impact of this publicity was immediate: the price of stock in Ovshinsky's small research company, Energy Conversion Devices, tripled, and Ovshinsky's phone began to ring incessantly. Stockbrokers, investors, and executives of electronics companies deluged his office with questions, requests for licenses, and even offers to put money into the firm.

The reaction was understandable. The newspapers, apparently basing their reports strictly on the information they received at the news conference, heralded Ovshinsky's device as the eventual key to such long-sought developments as the complex, low-cost desk-top computer, the flat, tubeless televi-

sion receiver, and the missile-guidance system that's impervious to high radiation.

**What's new?** What the newspapers didn't note was that Ovshinsky's invention (he calls it an Ovonic device) was reported years ago by the technical press [*Electronics*, Sept. 19, 1966, p. 191, for instance]. In fact, Ovshinsky long ago licensed the device to several U.S. firms—ITT among them—and to Danfoss AS of Denmark and L.M. Ericsson of Sweden. And sample quantities of the Ovonic device have been sold to research firms for tests over the past few years.

Also, initial press reports didn't point out that Ovshinsky isn't the only claimant to the technology. Bell Telephone Laboratories reported the development of a memory device made of an elemental glass in 1962, and received a patent on the material on March 15, 1966. Ovshinsky was granted a patent on his device on Sept. 6, 1966.



Stanford Ovshinsky

Bell says it doesn't want to be drawn into a controversy at this point, but it does add: "We are of the opinion that nothing new has been disclosed in [Ovshinsky's] paper."

**Mixed reviews.** However, any dispute on this score may be academic. Despite the years of research that have gone into Ovonic devices, apparently no one has been able to go beyond building more than workable laboratory models. ITT, for example, is understood to have made a few Ovonic devices that worked in a system. But the company now appears cool to the development and hints that no work is being done on it. Many other electronics firms have indicated similar disenchantment.

In fact, some semiconductor industry executives questioned about Ovshinsky's device deride it as "a crackpot scheme" or "a fraud." Ovshinsky, an ebullient man, brushes off such comments. He confesses that he's delighted, but hardly awed, by the sudden publicity.

And certainly not everyone in the electronics field is ready to write off his work. A random sampling of researchers indicates that the scientific community tends to take a wait-and-see position.

**Phenomenon.** Just what are the properties claimed for the glassy substances in Ovonic devices? The materials—mixtures of tellurium or arsenic or both with other elements in the III, IV, and VI groups—have a resistance in the megohm region as long as the voltage across them is below some level, which can be selected by adjusting the mix. When the voltage reaches this threshold, the materials switch to the conducting state. Some of them stay in this low-resistance state even after the voltage is removed, while others switch back when the



current falls below some minimum.

No one questions the existence of this switching effect, but many doubt that it can be applied in a mass-produced device.

Until recently, Energy Conversion Devices made only discrete switches, but it's now concentrating on developing a thin-film process. Ovshinsky says that he can put 2,500 switches on a 1-inch-square substrate and that his firm can crank out 60 of the substrates—with 150,000 switches—in one batch.

But the process isn't completely refined, and all the thin-film devices are fed back into the company's in-house testing program. How well this program is going is a moot point because Ovshinsky won't supply information on the repeatability and reliability of his thin-film devices.

The company says the thin-film switches will never be sold off the shelf but will be used in systems designed by Energy Conversion Devices engineers. The company is unwilling to predict when the first commercial system will appear.

Until these systems are ready, the company will continue to sell sample quantities of the discrete switch to selected companies and to seek contract work. Energy Conversion Devices now has a few contracts, one of them with the Avionics Laboratory at Wright-Patterson Air Force Base.

---

### Industrial electronics

---

#### A night to forget

As if the drama of election night wasn't enough, there was a subplot that might have been entitled "Man versus Machine," with IBM being miscast in the role of the villain.

The News Election Service (NES), set up by the two national wire services and three major television networks to ensure fast, accurate tallies, began to lose its poise at the height of the vote counting. Not only did the system's central computers—two IBM

360/40's—start to spew out some obviously inflated vote totals around 10 p.m., but at one point they pegged the percentage of ballots cast in one state at 177%.

**Needling.** So while IBM representatives twitched and tv commentators waxed sarcastic about the computer industry, NES workers rushed about frantically trying to find out what was going wrong. They finally agreed to take the central machine off line and rely on their backup system of seven regional 360/30 computers—slowing the tallying process somewhat.

But the problem, it was later discovered, was not in the hardware at all, Huntley and Brinkley to the contrary. It was, according to NES director J. Richard Eimers, "solely due to software. I have no complaint with the hardware."

Eimers also points out that the regional centers were able to carry the load efficiently from about 2 a.m. Wednesday until midmorning, when the primary system was put back on line.

NES was set up to receive precinct results at its regional centers from 118,000 reporters via telephone, and tallies from the 50,000 precincts that use automatic vote-counting equipment via Data-Phone. The raw data was put into a format at the regional centers and fed simultaneously to the two primary computers at NES headquarters in New York and the seven backup machines. Both the central and regional computers were to tally the votes, but only the central system was to transmit the tabulated results to the service's five members and 11 subscribers.

**Snowballing.** But things didn't quite work out that way. Actually, the errors involved only 10 or so counties, but in some cases they were gross enough errors to possibly affect state results and therefore Electoral College totals.

The question that puzzles many is why the backup system worked when the central system didn't, especially since both used programs supplied by the same firm, Programming Methods Inc. of New York. "The answer," explains a PMI spokesman, "is that the program for the backup system had

been thoroughly debugged and tested in the primary contests." Also, each backup computer was responsible only for the votes in its region. In the case of the central system, one computer (with the other acting as a fail safe) handled data from all seven regions. The program used at headquarters was infinitely more complex and, more important, it was untested.

---

### Displays

---

#### See-through view

Designers of displays—whether for computers or wall-size projections—have concentrated on two basic technologies: vacuum tubes, such as cathode-ray and Nixie tubes, and solid state devices, such as light-emitting diodes and electroluminescent panels. Researchers at the Sandia Laboratories, however, have taken a different view: the see-through approach.

Instead of having the material light up itself, they've developed a ferroelectric ceramic that takes white light and, with electronic switching, blocks out all but the wavelength desired. The result: a panel, illuminated by ordinary light from the rear, can produce a full-color display as big and as bright as you please.

Crucial to the Sandia approach is the ferroelectric ceramic lead zirconate titanate, discovered only a dozen or so years ago. Sandia's scientists found that the material has two very interesting properties. It exhibits hysteresis—that is, having been polarized with a voltage pulse, it retains the polarized state without being continuously addressed. And it can be selectively polarized: its degree of polarization depends on the amplitude of the applied voltage pulse. The material's birefringence, together with the selective polarization, provides the varying colors.

**Making a rainbow.** The Sandia scientists—Cecil E. Land and Donald G. Schueler—found that they could pack the ceramic cells tightly



Advanced technology

New way to look at it

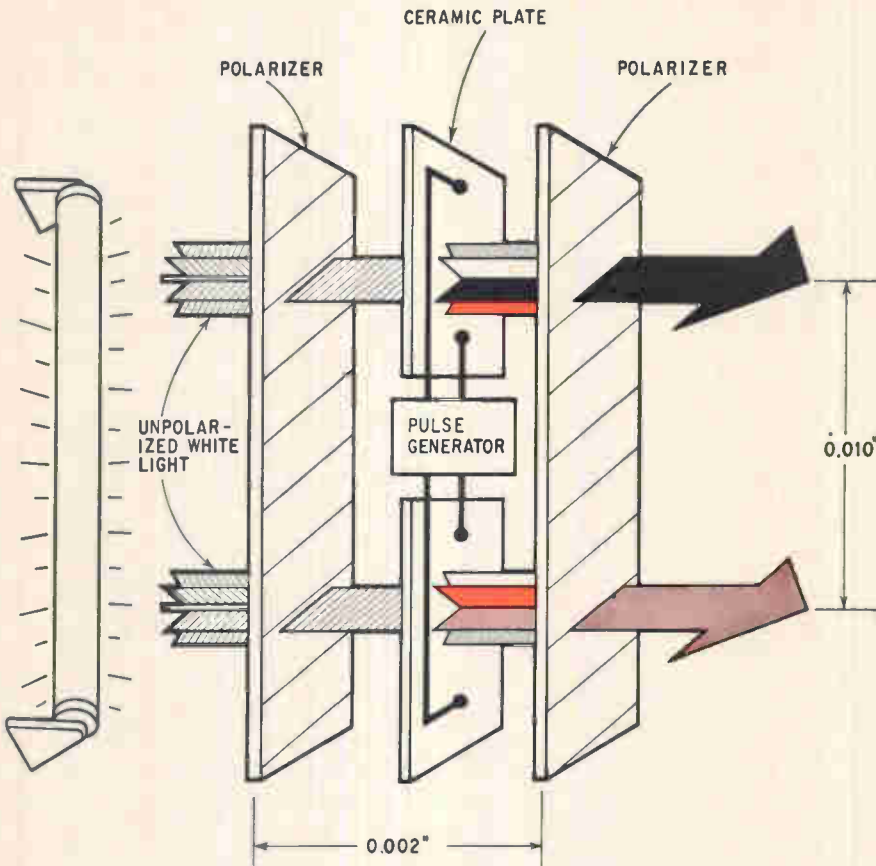

As current is pulsed across the junction of a semiconductor, electrons take on energy, jump out of valence positions on one atom, and move to the valence ring of another. When an electron drops out of its excited "carrier" state and recombines with an atom, it emits a small amount of energy called recombination radiation. If detected and measured, recombination radiation could be a useful tool for engineers, since its intensity is proportional to current density. Even if the detection scheme yielded only a qualitative yes or no indication, it would still be useful in spotting overloaded components and nonoperating junctions.

But recombination radiation is only about  $10^{-5}$  as intense as the infrared emission caused by thermal effects in the chip. Virtually all the energy of recombination is soaked up in phonon generation rather than more easily detected photon radiation.

**Serious effort.** Thus, while discussions of recombination radiation are nearly 10 years old, nobody seems to have made a serious effort to detect it until NASA's Electronic Research Center in Cambridge, Mass., funded the work of Riccardo Vanzetti, former manager of the Raytheon infrared techniques and systems department, Wayland, Mass., (see page 14).

"Theoreticians had decided that recombination radiation was too weak to detect," says Vanzetti. "I proposed study after study on recombination, and each proposal was turned down—once or twice because those in authority were trying to save me from making a fool of myself, I think."

Vanzetti finally got the money he needed about a year ago under a contract entitled "Transient infrared radiation in semiconductors." "We couldn't have called it 'recombination radiation' and still gotten funds," he says. "All the experts 'knew' it was undetectable."

Vanzetti himself had a few anx-

enough to produce a picture with good resolution. A panel that's now being made contains 100 cells in an area 130 by 65 mils. The package is 2 mils thick.

A voltage applied to the ceramic rearranges dipoles throughout the material. So, when a white, polarized beam enters the birefringent material, the wavelengths are split apart and each is shifted in polarity by a different amount. Out the other end, then, appears a rainbow, with each color having its own plane of polarity.

To apply this effect, the Sandia scientists put together a surprisingly simple package. The ceramic color cell is sandwiched between two sheets of polarizing material, and electrodes, attached to both sides of the cell, are connected to a pulse generator. The only other item needed is the external light source.

**Singing the blues.** In operation, then, a white, unpolarized beam hits the ceramic and gets broken into its component wavelengths. After that the beam hits the final

polarizer, and only the component that's polarized in the same direction gets through—producing one dot in the display. To switch the color, the operator need only send a new voltage pulse to the ceramic; such a switch takes but 100 microseconds.

The design does have weak spots. For one, the blues and blacks are very weak. To help step up the blues, the developers are considering using a bright blue light as the source. The design also suffers from some crosstalk problems, but the Sandia researchers believe that by improving the fabricating techniques they can solve them.

Although displays may be the development's broadest application, another possibility is an erasable color slide.

Several private firms already have the development under review for commercial applications and have applied for a license, which Sandia—an Atomic Energy Commission prime contractor—provides free.

Stainless steel shaft with nickel silver bushing and Teflon rotor plus ceramic stator, gold-plated solid silver contacts and cadmium-plated housing.

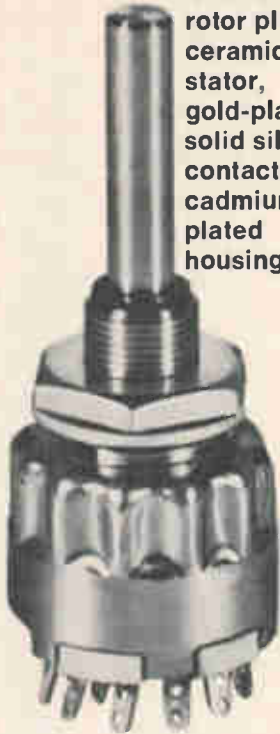

## How's that for a switch?

Look at these specifications for our heavy-duty JSR-170 switch: 2 to 12 positions; 1 to 6 pole; 30° angle of throw; 1/8" diameter shaft; 20,000-cycle load life; 350 ma rated switched current; 2.5 amp maximum current carried.

Vibration resistance to withstand the requirements of MIL-S-3786 and breakdown voltage ratings of over 1000 volts AC.

Size: just 3/4" long and .63" diameter. Ceramic wafer provides 10<sup>12</sup> ohms insulation resistance for high frequency use.

For complete information, write ITT Jennings, a division of International Telephone and Telegraph Corporation, 970 McLaughlin Avenue, San Jose, California 95108.



JENNINGS **ITT**

## Electronics Review

ious months until he first detected the weak emissions last February. "We picked a solid state diode and pushed it way outside its rated current densities. Finally, it emitted enough radiation for us to spot and show on a scope," he says.

The detector has been made more sensitive since then, allowing him to study integrated circuits operating within and below their ratings. Vanzetti's detector is a cryogenically cooled avalanche photodiode adapted from laser communications experiments. The photodiode is most sensitive to wavelengths of about 1.06 micron, putting it in the middle of the band of interest; silicon emits recombination radiation at about 1.1 to 1.2 microns, while germanium emits at 1.8.

**Won't detail.** Even with a sensitive detector, Vanzetti found it necessary to add signal-processing electronics and a specialized optical pickup. The processor—a so-called waveform extractor — is a digital signal-averaging device; further details are under wraps as Vanzetti applies for a patent on it. The optical pickup is straightforward, however, consisting of a single optical fiber.

Trying large fiber optic bundles, Vanzetti found them too large to allow him to view IC's in the detail he wanted. With the single fiber pickup, though, he can view areas as small as a part of a junction.

"The fiber also acts as an optical bandpass filter," he adds, "discriminating against unwanted wavelengths which would otherwise add to noise and make the signal we want to view hard to spot."

By improving the pickup and signal-processing electronics, Vanzetti has been able to boost the signal-to-noise ratio of the detector to about 20 times the level of early experiments. "Where formerly the pulse was barely discernible, now it rises cleanly above the noise shown on the scope trace," he says.

Since detecting recombination radiation, Vanzetti has left Raytheon to form his own firm, Vanzetti Infrared & Computer Systems in Dedham, Mass., and his detection scheme is going to be his stock in trade. He says that it will "let engineers check how pulses flow

through IC's. For the first time, designers will be able to detect crosstalk, proximity effects, pulse distortion—and study designs, not just through their input-output characteristics, but by looking within the circuit."

**Spotting failures.** "Quality assurance engineers would not only be able to spot failure, but also to determine exactly what transistor or diode is failing. Buyers could check vendor process control by noting chip-to-chip variations in junction performance within lots of IC's—vendors with small variations would have good control and vice versa," he says.

Vanzetti's detection scheme may be important to development of dependable large-scale integrated circuits, too. He feels that "the output of an LSI device doesn't have very much information content relative to the number of active elements in the chip; one wave-shape looks much like another. But with recombination radiation detection, an engineer could look at two devices with identical outputs and spot differences in the performance of individual components, possibly finding potential failure points before making final design decisions."

Vanzetti plans to make the detector available as a commercial product, perhaps by mid-1969. But for the immediate future, he notes that there is still work to be done in relating oscilloscope displays of detected radiation to specific failure or operating modes. Vanzetti feels that the technique needs a body of statistics to support its worth.

"Without such figures, engineers might not take the idea seriously," he says with a grin. "After all, recombination radiation is 'known' to be undetectable."

## Avionics

### Guidance for \$2,000

Building a \$2,000 computer to guide an air-to-surface missile is a tall order, but two firms have



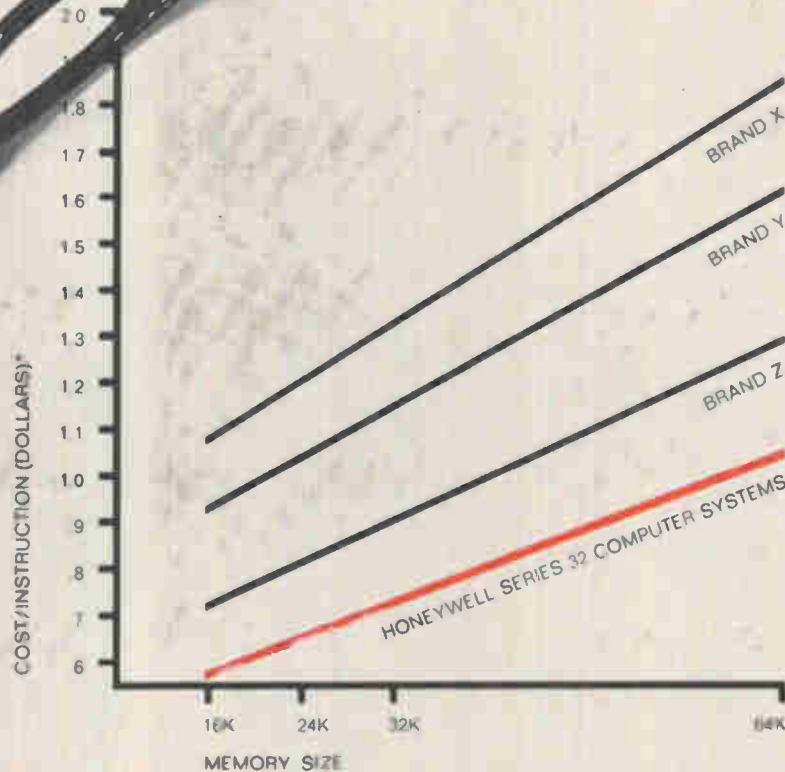

## Now...for all the other reasons why you should go with Series 32 Computer Systems

When a real-time systems man like you looks for a computer, you want the most performance for the fewest dollars. And H632 — *first* member in the Honeywell Series 32 family of medium-scale computer systems — has the others beaten by anywhere from 15 to 50%.

But you want a lot more, too.

You want software tools for easy program development. H632 software package includes a basic operating system, powerful macro assembler, extended USASI FORTRAN IV compiler, and many more.

You want expandability. H632 memory can grow from 8K to 132K words using plug-in modules. There can be as many as four central and four I/O processors in a single system. Floating-point hardware is available.

You want reliability. H632 is a compact I/C computer — the fifth I/C line we've built. Calculated MTBF is 1,740 hours.

You want a complete line of peripherals and subsystems. H632 offers everything from discs to displays, communications subsystems, and analog-digital I/O systems.

You want fast delivery. We're quoting typical systems as six months A.R.O.

You want full support services. We offer them all . . . world-wide.

Series 32 systems offer an advanced concept of modular integration and coordination which permits special processor capabilities in multiprocessor configurations. By being able to work with various-size data elements, Series 32 systems make optimum use of available memory

space. They also provide a systems-oriented instruction set, including an extensive set of bit, boolean, and halfword operations.

Whatever your requirements for real-time applications, check into Series 32 computer systems. They give you all you could ever want . . . at the lowest cost. Our new Series 32 summary brochure is yours for the asking.

Honeywell, Computer Control Division, Old Connecticut Path, Framingham, Mass. 01701.

*\*System cost ÷ instructions per second using a modified Gibson mix.*

*Come see the H632 system at the Fall Joint Computer Conference.*

# Honeywell

COMPUTER CONTROL  
DIVISION



# Let TI Supply Your Pulses.

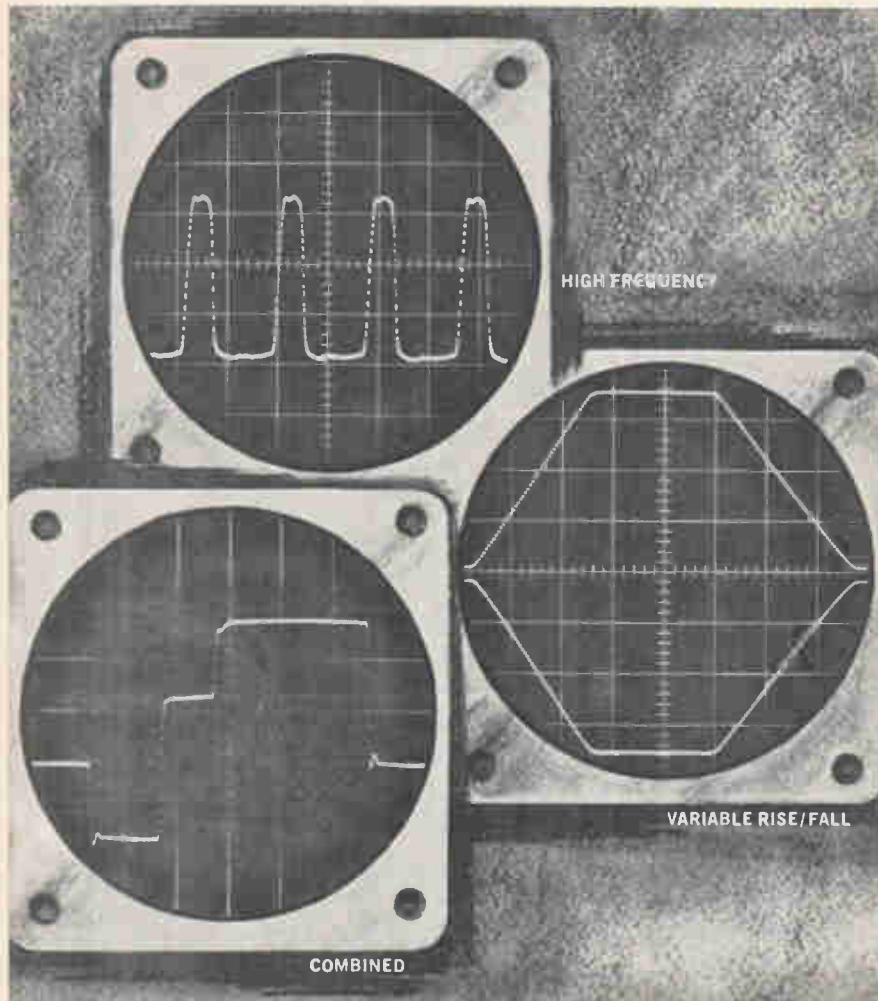

Texas Instruments pulse generator line offers you a wide choice in test pulses. There are rep rates to 100 MHz, positive or negative outputs to 50v, rise times less than 1 nanosecond and variable pulse widths, delays, amplitudes, and rise/fall times.

Select the pulse generator that best suits your needs, and be assured of TI quality and performance. Choose a high-voltage model for evaluation of core and thin magnetic film memory arrays, high-frequency types for state-of-the-art circuit design and TDR studies or units for

general-purpose testing.

And when you have special pulse generator requirements, build your own pulse generator from TI's complete modular line. These all-solid-state "building blocks" assure you custom performance and versatility.



But the best way to get the whole story is with TI's pulse generator data file. Write the Industrial Products Division, P.O. Box 66027, Houston, Texas 77006 (713-349-2171).



**TEXAS INSTRUMENTS**  
INCORPORATED

## Electronics Review

been funded by the Avionics Laboratory at Wright-Patterson Air Force Base to do just that. Both Litton Industries and Bunker-Ramo are making their developmental models predominantly with metal oxide semiconductor technology, with Litton using unpackaged large-scale integrated wafers [Electronics, June 24, p. 47] and Bunker-Ramo medium-scale integration.

Litton uses a form of discretionary wiring outside the wafer to connect good devices on wafers with as many as 20,000 MOS transistors. After the wafers are probed, a functional unit that fails is programmed out of the loop.

Albert Goldstein, manager of the data equipment department in Bunker-Ramo's Defense Systems division, thinks the company has a better idea, using what he calls MSI packaged chips in a "bit-slice" form of organization.

**Featherweight.** The associated bits of five different registers—plus the associated logic or gating to transfer signals between these register bits—are all put on one chip. "This is a functional approach to component design that reduces backplane wiring or interconnections between components," Goldstein says.

The development model will prove out the four kinds of MOS chips designed by Bunker-Ramo and built by General Instrument. The initial computer will weigh about 4½ pounds and take up 145 cubic inches. Goldstein says, however, that a production version using leadless ceramic multichip packages (instead of the one-chip, 44-lead metal flatpacks in the development model) will reduce the weight to 2.15 pounds and the size to 43 cubic inches.

A production version of the computer would consume about 22 watts, Goldstein says, and have a generalized input/output system and a memory with 2,000 words of 16 bits each. The Air Force has asked Burroughs to develop the electrically alterable nondestructive read-out memory, which contains a planar film. It will have 1-microsecond read and write cycles.

The four basic chips Bunker-Ramo engineers have designed are

**New TRW  
Crystal Manual  
tells all...**



**"5 Parts in  $10^{-8}$ /week stability"**

Long term stability is only one of the subjects covered in the new TRW Crystal Manual. There's helpful information covering the whole field of crystal technology.

You can read about special applications, optimum frequency control, and how to make the most of design trade-

offs... also complete specifications on TRW crystals.

TRW manufactures the "AT" fundamental through 9th overtone, "TRW," "CT," "WT," "DT," "X," "Y," "MT," and  $+5^\circ$  X quartz crystal resonators. Frequency range 15 kHz to 200 MHz.

Send for your copy of the new, 20-

page TRW Crystal Manual today. Write to: TRW Crystal Plant/Capacitor Division, 2303 W. 8th Street, Loveland, Colorado 80537. TWX: 910-930-9022, or Phone: (303) 667-2261.

**TRW**<sup>®</sup>



**NEW  
production  
techniques  
enable  
Reeves-  
Hoffman  
to REDUCE  
CRYSTAL  
PRICES**



When you need production quantities of, for example, the 100 kHz crystal specified below, write. With our new technical developments in producing crystals, you can buy Reeves-Hoffman quality at lower prices, in quantity. Challenge us! Send us your specs.

Frequency . . . . .	100 kHz
R <sub>1</sub> , ohms . . . . .	1,800
L <sub>1</sub> , henries . . . . .	67
C <sub>1</sub> , picofarads . . . . .	0.037
C <sub>0</sub> , picofarads . . . . .	5.78
Q . . . . .	24,000
Holder (1.526 x .757 x .352 in.) . .	HC-13

5° X crystal for filter or oscillator applications, fundamental extensional mode.



**REEVES-HOFFMAN**

DIVISION, DYNAMICS CORPORATION OF AMERICA  
400 WEST NORTH ST., CARLISLE, PENNSYLVANIA 17013 • 717/243-5929

**QUARTZ CRYSTALS  
CRYSTAL FILTERS  
OSCILLATORS  
COMPONENT OVENS**

a register chip having one bit of each of the five registers, an adder that performs the function of a full adder, a carry chip, and a central chip to provide all the general functions needed in the central part of the processor to interpret the instruction logic. Each chip measures 80 by 90 mils and contains 300 to 500 MOS field effect transistors; the register chip has the equivalent of 170 gates, including five flip-flops.

Goldstein feels the MSI approach is more flexible and will give better yields than the Litton approach. Dan Reed, project engineer in the Air Force's Avionics Lab computer group, says the Litton design carries a higher risk because the unpackaged LSI wafer is stretching the state of the art, but he also notes that the elimination of dicing and packaging cuts costs. He maintains, however, that both firms will come close to the \$2,000 goal, based on a large production run.

**Broad application.** Both computers, Reed says, are applicable to navigation problems, but the Bunker-Ramo design could be used for almost any kind of aerospace computation. The big advantage of the Bunker-Ramo system, in Reed's opinion, is that fewer types of chips are needed to build the computer. Increasing the word length, for example, simply means more chips have to be used, so that the unit could handle the more complex problems of an aircraft navigational computer. But Reed also notes that the Litton design can be adapted for other kinds of navigational computation by linking more wafers in parallel.

Reed says Bunker-Ramo's effort is on schedule. Litton's schedule, however, has had to be revised, with delivery of a developmental model now set for mid-1970. Reed explains that the Litton approach, because it is stretching the state of the art, requires more development time.

With an eye toward a production contract, Bunker-Ramo engineers have designed the version of the computer using the leadless flat-packs, which are 7 inches long, 2 3/8 inches high, and 3 1/2 inches deep. This model would have two



Mount in free air as is, or with a heat radiator. In any case, all you do is drop an RCA all-diffused, three-lead TO-5 SCR package into the circuit board. Current rating for circuit board mounting in free air at 25°C is 1.5 amperes. It's 3.5 A rms at 180° conduction angle with the radiator.

SCR's 40654 and 40655 (free air types) complemented by types 40658 and 40659 (with radiator) are designed for use in 120 and 240 volt lines at 50 or 60 cycles, and in pulse operation from dc supplies. Applications run the

gamut from lamp controls, motor speed controls and power switching, to ignition systems for automobiles, boats or lawn mowers.

Added advantages: high surge current (80 A single cycle) and pulse current (100 A peak repetitive at 0.1% duty factor) ratings; high di/dt and dv/dt capability; and high forward and reverse gate capability. Plus the inherent reliability you can expect from all RCA Thyristors... the broadest line of SCR's, Triacs, and Diacs the industry has to offer.

See your RCA Field Representative or your RCA Distributor for further information. For technical data, write RCA Electronic Components, Commercial Engineering, Sec. R-N-11-2, Harrison, New Jersey 07029.

**This RCA SCR drops right into  
a circuit board  
like this...or this...**



**for a wide variety of applications**

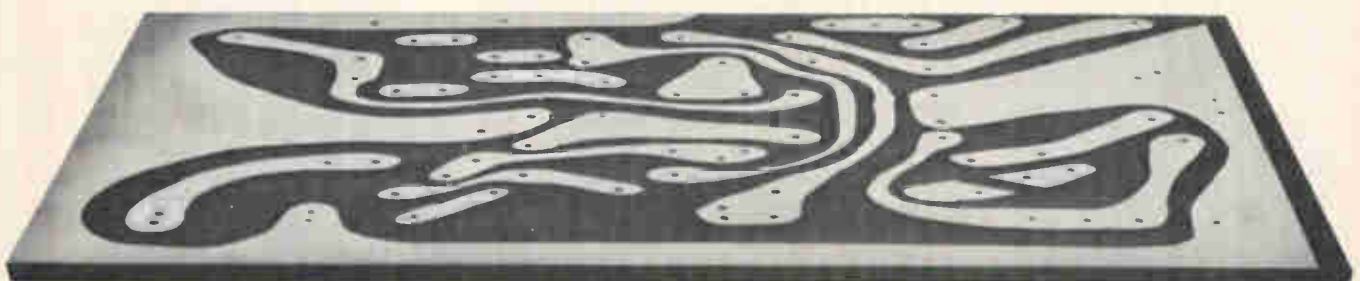

Now, three standard LOGICATOR models give you new flexibility in designing your logic indicators. The basic DA-3305 electromagnetically positions the readout drum directly from computer-level voltages. The companion DA-3306 contains built-in drive. The DA-3307 contains both drive and memory to store computer data at microsecond speed, freeing the computer for other work between reading changes. Only LOGICATOR displays provide this versatility.

The LOGICATOR display is also the only indicator with excellent readability under all light conditions . . . combining printed-drum legibility with exclusive back-lighting . . . ideal for airborne instrumentation requiring Mil-E-5400 Class 2 performance. Features such as 1 million cycle life, fast response, 1 watt power consumption, and inherent magnetic memory make LOGICATOR displays your logical choice in computer indicators. Make a B-line\* for Bowmar.

## Only LOGICATOR<sup>®</sup> computer displays solve your readability, drive, and memory problems.

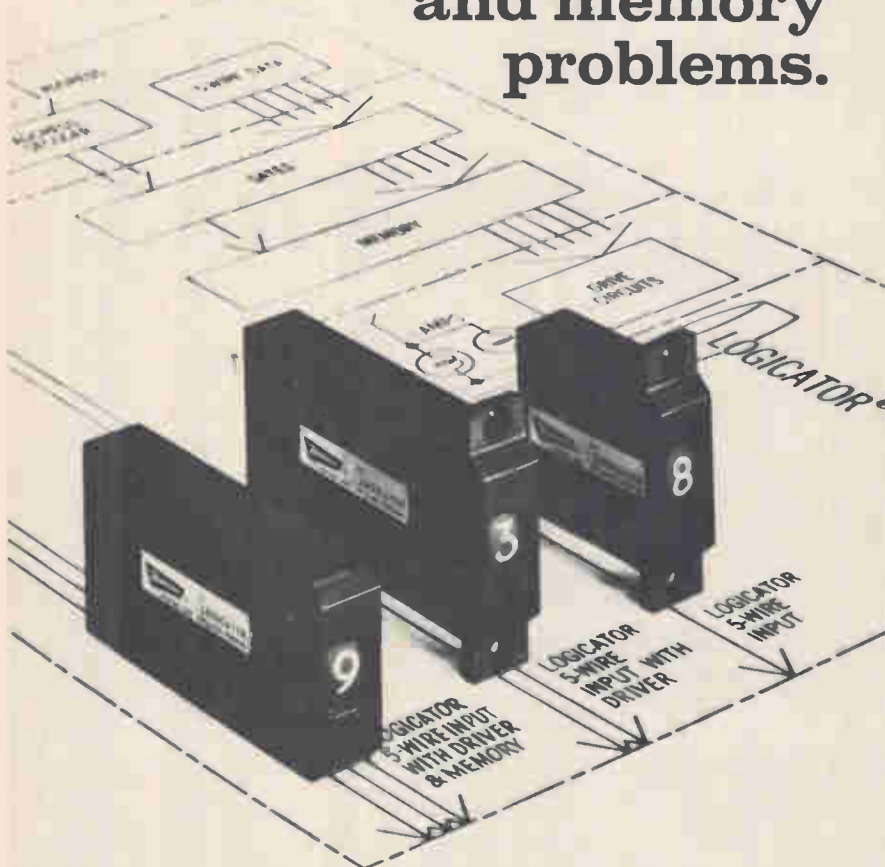

**The shortest distance between computer and display is the Bowmar B-line\***

\*Call (219) 747-3121 for engineering assistance



**INSTRUMENT CORPORATION**  
8000 BLUFFTON ROAD □ FORT WAYNE, INDIANA 46809

processor modules, two basic input/output modules, and a memory module.

The Bunker-Ramo development model will have four double-sided circuit-board modules; a programmable data processor module with 54 IC flatpacks plus 25 14-lead bipolar IC's to interface with the outside world; hybrid thin-film clock oscillators and drivers; an input/output module, and a memory interface module to be used in testing with a memory other than the Burroughs planar-film type being developed.

### Communications

#### A single voice

The Presidential Task Force on Telecommunications is planning to suggest that Comsat serve as the nucleus of a new company that would take over the international transmission facilities of all existing U.S. carriers. In a nearly final working paper, the task force says the monopoly would end what it calls the inefficiencies of competition between satellites and cables.

Comsat has about \$160 million in cash reserves; it's estimated that the proposed new company would have assets of \$500 million. International carriers, in addition to Comsat, include AT&T, IIT World Communications, RCA Global Communications, and Western Union International, which was separated from the domestic Western Union in 1962.

**Hot potato.** The recommendation seems certain to be the most controversial in the task force report, which is due to be released in late November after 16 months of work. The private carriers will probably complain bitterly about the plan.

The recommendations are so sweeping that even the Administration may treat the report like a hot potato. And chances are that the new Republican Administration will be even less eager to ask Congress to enact all the recommendations. But the problems that led the task force to the study in the

# E-H leads in pulse technology by solving tomorrow's problems...



## today.

If you decide to buy a pulser just because it costs less and it solves your immediate problems, your problems may have just begun. Before you know it, that pulser has become obsolete and you're out shopping for another one. Need a better solution? E-H offers it.

Every E-H instrument is designed to give you the most advanced solution to your problems today. And to take care of tomorrow's problems, each instrument has a built-in margin of performance you never see in the written specs. That's the extra that makes an E-H pulser extra useful in years to come.

Here, for example, is one of our newest problem

solvers — the **E-H Model 137**. This all solid-state pulser has rep rates of 10 Hz to **100 MHz**, pulse amplitude of up to **±5V** into 50 ohms (**±10V** open circuit), DC offset of up to **±5V** into 50 ohms (**±10V** open circuit), transition times of **<2ns** to 200  $\mu$ s, leading and trailing edges independently variable up to ratio of **10:1**, external drive requirements **1.2V pos or neg**. Price, **\$1,950**. f.o.b. Oakland.

Call your E-H representative for a demonstration now. And if our new Model 137 doesn't quite fit your needs, ask about E-H's eighteen other advanced problem solvers.



**E-H RESEARCH LABORATORIES, INC.**

515 11th Street • Box 1289, Oakland, California 94604 • (415) 834-3030 • TWX 910-366-7258

In Europe: E-H Research Laboratories (Ned) N.V., Box 1018, Eindhoven, The Netherlands, Telex 51116

In Japan: Iwatsu Electric Co., Ltd., No. 710, 2-Chome Kugayama Suginami-Ku, Tokyo, Japan



Making a ceramic tower base insulator to 9,000,000 lbs. ultimate strength isn't easy . . .

# Lapp specializes in tough jobs.



That was one of our toughest. But, Lapp has designed and built hundreds of tower insulators. They range downward to 80,000 lbs. ultimate strength. In fact, Lapp insulators support most of the world's larger radio towers, both self-supporting and guyed masts.

Lapp has over 50 years of "know-how" and experience that won't cost you a cent when you bring your insulating problem to us. From drawing board to delivery you can count on Lapp to handle your tough tower . . . and antenna . . . insulating jobs.

Can we help? Lapp Insulator Co., Inc. LeRoy, N.Y. 14482.

## Lapp

## Electronics Review

first place are so acute that they'll have to be faced somehow.

The task force feels that economy and coordination are impossible in the present situation, because the private carriers are economically tied to cables and the FCC is caught in the middle between the two technologies as it tries to work out formulas for parceling out the business.

The task force is critical of the FCC. The panel thinks the agency erred in letting cable carriers build new facilities and protecting them from Comsat competition by directing that cables and satellites be used equally.

The plan for granting Comsat a new charter may conflict with another section of the task force report that calls for granting Comsat authority to build and operate a "pilot" domestic satellite system. In the section on international carriers the task force says that no company with an interest in domestic communications should have a part in the new entity. This conflict could mean the task force has concluded that Comsat should not be given more than interim responsibilities for domestic service.

The domestic restriction also means, of course, that the carriers would have to sell their holdings in Comsat, which total 41%.

**Old idea.** The report doesn't work out wording for the legislation, but does suggest that the new entity be closely monitored by the FCC, make procurements competitive, not be connected in any way with the manufacture of communications equipment, and have no terminal-connection functions. The new entity could deal directly with users needing no more than raw bandwidth.

The single entity, the task force believes, would provide a united front for U.S. interests overseas, be easier to regulate, help the Government in its foreign dealings, and ultimately cut transmission rates.

The suggestion isn't new—several groups, including Congressional committees, have urged such an entity—but the task force is the first to suggest even the basic mechanics for creating one and to propose Comsat as its nucleus.

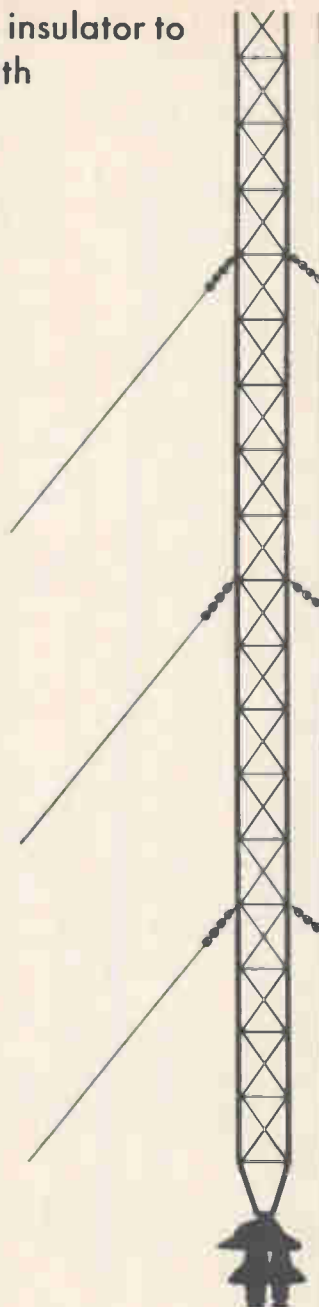

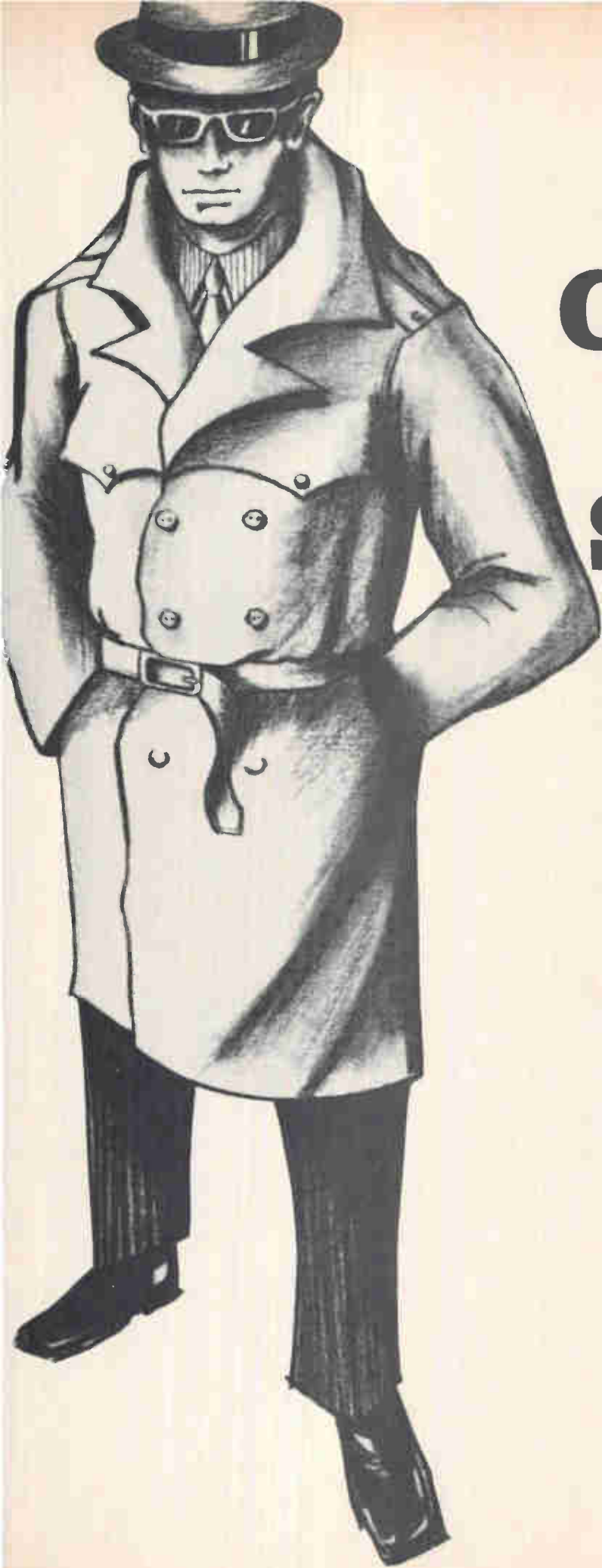

# IS YOUR CONTACT MAN A SPECIAL AGENT ?

He is if he's backed by 100% concentrated effort. This is why Deringer specializes instead of trying to be all things to all people. All our effort is concentrated on providing our customers with the best in electrical contacts, contact sub-assemblies and assemblies. Our entire engineering and manufacturing attention centers on helping contact users solve their contact problems with the optimum contact for each particular application. Contact Deringer. We'll send one of our special agents right away.

**D E R I N G E R**

**METALLURGICAL CORPORATION**

1250 Town Line Road (Rt. 60) Mundelein, Illinois 60060

Circle 61 on reader service card

# THE COUNTER REVOLUTION GOES ON AT HP

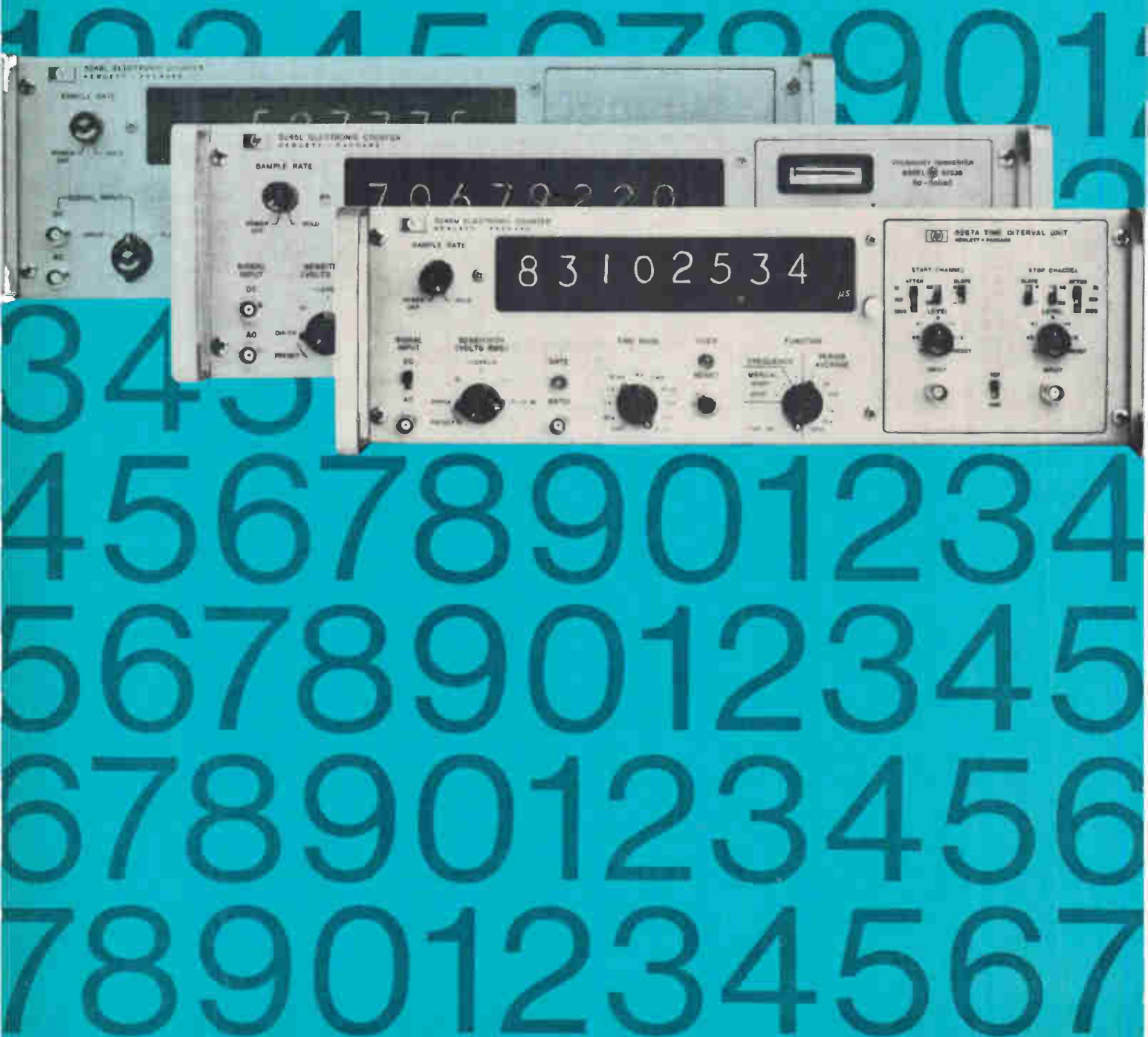



# it's a family tradition

Ever since 1954. That's when the Hewlett-Packard 524A Electronic Counter first set the industry standard for quality and versatility. And since then the entire counter family has gotten into the act—consistently offering revolutionary values.

The tradition continues—giving you the ideal combination of accuracy, versatility and reliability... at the right price!

Look the current 5245 series family over. And join the Counter Revolution.

**THE 5248L/M COUNTER.** The newest, "jet set" member of the family, this high-speed counter extends your frequency range to 135 MHz and, with the 5267A plug-in, gives you time interval resolution to 10 ns. Has all the features of the 5245L and accepts all the plug-ins. ("M" version gives you rapid warm-up and even greater time base stability.) Great for high-speed applications such as wind-tunnel testing, computer switching, pulse delay, as well as general-purpose counting. Price: \$2900. (5248M version, \$3300.)

**THE 5245L COUNTER.** Patriarch of the family, this highly versatile precision instrument measures frequency from 0 to 50 MHz, period, multiple period average and frequency ratio. It has  $<3 \times 10^{-7}$ /day time-base aging rate *together* with excellent short-term stability of  $2 \times 10^{-10}$  rms (1 second averaging). Input impedance is high and constant at 1 megohm/25 pF on *all* input attenuator ranges, and dc input coupling is usable over the entire frequency range. Display storage and BCD output are *standard*, instead of extra-cost options. It accepts all HP plug-in accessories. Price: \$2480.

**THE 5245M COUNTER.** The respected "uncle," this counter is nearly identical to the 5245L, except it has the most stable and spectrally pure time-base oscillator ever built into an off-the-shelf counter. Aging rate is  $5 \times 10^{-10}$ /day and short term stability is  $5 \times 10^{-11}$  rms (1 second averaging). With rapid warm-up, this crystal oscillator is an excellent secondary frequency standard, whose S/N ratio is typically  $>87$  dB. Price: \$3100.

**THE M54-5245L COUNTER.** The family "hero"—the military ruggedized version of the 5245L. Meets MIL STD-108D section on moisture-proof enclosures, and MIL specs for shock, vibration, humidity, temperature and electromagnetic compatibility. Still basically the 5245L. Price: \$2850.

**THE 5246L COUNTER.** A stripped-down economy version of the 5245L, this "cousin" has a 6-digit readout and a time-base aging rate of  $<2$  parts in  $10^7$ /month. Options available are 8-digit read-

out, BCD output, and 5245L time base. It also uses all the 5245L plug-ins. Price: \$1800.

**THE 5247M COUNTER.** This "cousin" is for rapid but accurate "hands-off" measurement of an extremely wide range of signals. It measures frequency only, directly to 135 MHz (to 18 GHz with a plug-in frequency extender), and accepts any input voltage between 100 mV and 10 V without trigger level adjustment. It's similar to the 5245M in ultra-stable, rapid warm-up characteristics. Price: \$3150.

**THE 5244L COUNTER.** This member of the family is the "basic frame" counter. It doesn't accept plug-ins, but sports the frequency, ratio and period measurement versatility of the 5245L. Frequency range is to 50 MHz, with standard 7-digit readout and BCD output. Time-base aging rate is  $<2$  parts in  $10^7$ /month. Price: \$1900.

And, of course, the "family appliances"—HP's extensive line of plug-ins and other accessories to make the 5245 family of electronic counters the most flexible line of counters available in the industry.



#### PLUG-INS TO USE WITH THESE COUNTERS:

5256A	Heterodyne Converter, 8 GHz to 18 GHz (and 1 to 200 MHz), \$1950.
5255A	Heterodyne Converter, 3 GHz to 12.4 GHz (and 1 to 200 MHz), \$1850.
5252A	Prescaler, DC to 350 MHz, \$685.
5253B	Plug-in Converter, 50 to 512 MHz, \$500.
5254B	Plug-in Converter, 0.2 to 3 GHz, \$825.
5257A	Transfer Oscillator, 50 MHz to 18 GHz, \$2100.
5258A	Prescaler, 1 to 200 MHz, 1 mV, \$900.
5261A	Video Amplifier, 1 mV RMS, 10 Hz to 50 MHz, \$325.
5262A	Time Interval Plug-in, 100 ns resolution, \$250.
5264A	Preset Unit for normalized measurements, \$650.
5265A	Digital Voltmeter, 6-digit presentation of 10, 100 and 1000V full scale, \$625.
5267A	Time Interval Plug-in, 10 ns resolution, \$400.

Nice thing about this family of counters: spare parts and service are available almost everywhere. So, join forces with the HP family, and revolutionize your own counting capabilities.

For complete information on any or all of these counters, call your local HP field engineer or write Hewlett-Packard, Palo Alto, California 94304; Europe: 54 Route des Acacias, Geneva.

HEWLETT  PACKARD  
ELECTRONIC COUNTERS

ANDREW

*Lower attenuation...*  
**new HELIAX®**

1/4", 3/8", 1/2" flexible  
coaxial cables for

- Military
- Broadcast
- CATV
- Mobile Radio
- Data Processing and  
Instrumentation Systems

These new air and foam cables offer lower attenuation in small physical sizes. Type FH1, 1/4" Foam HELIAX Cable has 30% lower attenuation, 60% smaller size and 50% less weight than RG8/U. The copper inner and outer conductors assure optimum electrical performance with long life reliability. Available in long splice free lengths with or without polyethylene jacket.

For additional information on HELIAX Cable, contact your regional Andrew sales engineer or write Andrew Corporation, 10500 W. 153rd St., Orland Park, Illinois 60462.

6-65A

IN EUROPE: Andrew Antenna Systems, Lochgelly, Fife, Great Britain

*Andrew*  
CORPORATION

31 YEARS OF ENGINEERING INTEGRITY

---

# Washington Newsletter

---

November 25, 1968

**NASA okays ATS-E tests of L band . . .**

The space agency has finally given a go-ahead for work on hardware for the first tests of aircraft-to-ground communications via satellite relay at 1,540 to 1,660 megahertz. After much deliberation, NASA decided to include an L-band transponder on its fifth Applications Technology Satellite, an addition proposed by the FAA. But the late change in equipment will delay the ATS-E launch from May to August [Electronics, Sept. 2, p. 54].

There isn't time enough now to design from scratch an L-band transponder for the spacecraft, so the ATS project office will have Hughes—the satellite builder—convert existing C-band equipment.

The transponder won't be the perfect one for the job, concedes Don Fordyce, ATS project manager, but it will be the best possible with the time and money available. NASA is now developing specifications for the transponder and Hughes should have it ready to go by June.

**. . . and FAA plans to make the most of its opportunity**

The FAA—prime mover in getting NASA to fly the L-band transponder—plans to conduct as many experiments with the equipment as its funds will allow. The FAA is now negotiating with manufacturers to line up aircraft and ground equipment for voice communications tests, and the first contracts covering this phase of L-band utilization should be awarded in about a month.

Other experiments the agency is considering include air-to-ground ranging trials and the feeding of the ranging data to experimental air traffic control displays. All of this would be expensive, but an FAA communications expert says: "We are committed to the voice experiments and I think that R&D funds will be made available for the rest of the proposed experiments. We've been waiting a long time for a crack at L band, and we hope to take full advantage now that we have it."

**Future ATS craft to get L-band gear**

Though a month ago it appeared that an L-band satellite transponder might be a long way off, it now looks as if there'll be several of them soon. In addition to the ATS-E, the follow-on ATS-F and probably the ATS-G craft will carry L-band gear to support a new program in which the Goddard Space Flight Center will try to demonstrate the feasibility of L-band communications, position locating, and ranging. Place—for position location and communications experiment—will initially employ the ATS-E L-band equipment in conjunction with the Navy's Omega navigation system.

When ATS-F is launched, the Omega portion will be dropped and a sophisticated dual-satellite ranging system put into operation. Goddard already has been told unofficially that an L-band transponder will be approved for the ATS-F.

**Schriever seems likely NASA head**

The man most mentioned in Washington as Richard Nixon's choice to head NASA is retired Gen. Bernard Schriever, former head of the Air Force Systems Command. Schriever campaigned for Nixon and wrote some speeches on space for him. His appointment would probably lead to moves to combine military and civilian space activities. Schriever currently heads his own consulting firm [Electronics, Aug. 19, p. 59].



---

# Washington Newsletter

---

## NIH fears outlay may be cut by Nixon

The National Institutes of Health is slated for a healthy increase in biomedical research spending this year, but its officials are increasingly uneasy over the possibility that the new Administration may cut back these funds. In fact, one NIH official flatly predicts that the outlay will be reduced after Nixon takes over.

The Department of Health, Education, and Welfare has approved fiscal 1969 expenditures of \$30 million for the research, up from \$20 million in fiscal 1968. The money would cover work on medical applications for instrumentation, lasers, and computers, among other things.

## Air Force negotiates computer contract

The Air Force is currently negotiating with several companies for the development of an advanced airborne computer for its FX fighter and the AX attack planes. The Air Force won't say with whom it's negotiating, but four of the several companies believed to be in the running for the important award are Burroughs, IBM, Raytheon, and TI.

If selected, Burroughs would be building its first airborne computer. The company is understood to be designing a machine with complex integrated circuits containing between 100 and 200 gates.

## Profit inquiry likely on defense gear that's below specs

The General Accounting Office may look into profits made by contractors on military electronic equipment that doesn't meet performance specifications. This is one of the tasks that Sen. William Proxmire (D., Wis.) will probably include in his proposal for an investigation of defense profits.

Proxmire is particularly angry over a Budget Bureau study reporting that "performance has little correlation with profit" in the case of military electronics gear. There is a "high incidence of delivered electronic systems with degraded performance," but contractors aren't penalized because of "the current special partnership that exists between Government and the aerospace industry," the report said.

Although the Pentagon won't openly oppose Proxmire's proposal, it feels that its own studies of profits from noncompetitive and negotiated contracts are sufficient.

## Army readies RFP's on missile controller

The Army Missile Command expects to select a contractor this spring to develop a prototype missile fire-control system to succeed the Hughes-built AN/TSQ-51. Designed for the Nike-Hercules system, the TSQ-51 Missile Mentor has been operational for only two years. The new TSQ-73 will be designed to handle the Hawk, SAM-D, and Sentinel missile systems in addition to the Nike-Hercules.

Requests for bids on the R&D contract will soon be issued to selected companies, with answers expected within three months.

The TSQ-73 will feature "as great a miniaturization as we can get," says one military source. "But it will be MSI," he adds, "since LSI isn't proven yet." The computers will be built of throwaway modules and will have a self-testing capability.

## Addendum

A contractor will be named shortly to build a prototype airborne solid state teletypewriter with a cathode-ray-tube display. The Air Force is now evaluating bids from 18 companies; the prototype will be due a year after work begins on the contract. The service wants a compact terminal with a variable speed (75 to 2,400 bits per second).

Sorensen's QRE Series, available from stock, will limit overvoltage excursions to 250mV under any condition — then reduce the output voltage to 0 within 10 $\mu$  sec.



Model QRE 7.5-10



Model QRE 10-3.7

## Sorensen QRE Series for IC's:

- 10 $\mu$  sec adjustable "Crowbar" over-voltage protection
- Voltage Regulation:  $\pm 0.01\%$  for maximum line and load changes combined
- Voltage Ripple: 300 $\mu$ V r.m.s. (3mV peak-peak) max!
- No turn-on/turn-off overshoots
- Remote Programming
- Remote Sensing
- Ambient Temperature:  $-20$  to  $+71^{\circ}\text{C}$

Model Number	Output Voltage Range	Output Current Range @ Ambient			Size (inches)			Price
		@ 40 $^{\circ}\text{C}$	@ 50 $^{\circ}\text{C}$	@ 71 $^{\circ}\text{C}$	h	w	d	
QRE 10-2.2	0-10Vdc	0-2.40	0-2.20	0-1.50	3 $\frac{3}{8}$	5 $\frac{1}{8}$	8 $\frac{1}{4}$	\$135
QRE 10-3.7	0-10	0-4.10	0-3.70	0-2.50	3 $\frac{3}{8}$	5 $\frac{1}{8}$	11 $\frac{1}{4}$	\$155
QRE 7.5-10	0-7.5	0-10.0	0-10.0	0-6.60	3 $\frac{1}{2}$	19	13 $\frac{1}{4}$	\$295
QRE 7.5-20	0-7.5	0-20.0	0-20.0	0-13.0	5 $\frac{1}{4}$	19	13	\$465
QRE 7.5-50	0-7.5	0-50.0	0-50.0	0-33.0	5 $\frac{1}{4}$	19	15 $\frac{1}{4}$	\$645

Contact your local Sorensen representative or: Raytheon Company, Sorensen Operation, Richards Ave., Norwalk, Connecticut 06856. TWX 710-468-2940.



for more data on this versatile instrument . . . **Call Sorensen: 203-838-6571**



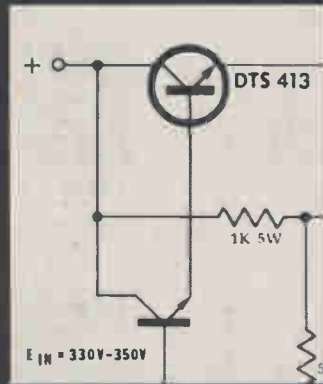

# The Kokomoans'



Power semiconductors. And that knowledge can help you solve your most intricate problems in power. Our applications experience began the moment the power industry was born. Grew with it. And comes to you in Delco applications engineers stationed in nearby offices throughout the country. Engineers who've worked with people in everything from TV to space technology. Engineers who'll work with you to help take your pro-

gram from concept into production. Help you simplify circuits, lower costs or take care of most anything that might be short-circuiting your operation.

Prompt delivery's no problem because the Delco Radio organization is keyed 100% to mass production: mass production of components to meet customer production schedules. And mass production of our own end products—car radios and automatic temperature control systems. StereoTape systems. Portable military communications equipment.

When a company is geared like this, you know you'll get your parts on time. You'll find that Delco devices come with conservative specs. Plus the uniform high quality and reliability gained through our precision high-volume production. So you can design with confidence.

When a company is geared like this, you know you'll get your parts on time. You'll find that Delco devices come with conservative specs. Plus the uniform high quality and reliability gained through our precision high-volume production. So you can design with confidence.

When a company is geared like this, you know you'll get your parts on time. You'll find that Delco devices come with conservative specs. Plus the uniform high quality and reliability gained through our precision high-volume production. So you can design with confidence.

When a company is geared like this, you know you'll get your parts on time. You'll find that Delco devices come with conservative specs. Plus the uniform high quality and reliability gained through our precision high-volume production. So you can design with confidence.

**SEMICONDUCTOR DISTRIBUTORS: EAST**—BALTIMORE, MD. 21201, Radio Electric Service Co., 5 North Howard Street, (301)-539-3835 BINGHAMTON, N.Y. 13902, Federal Electronics, Inc., P. O. Box 1208, (607)-748-8211 CLIFTON, N.J. 07015, Eastern Radio Corporation, 312 Clifton Avenue, (201)-471-6600 NEWTON, MASS. 02195, The Greene Shaw Co., Inc., 341-347 Watertown St., (617)-969-8900 NEW YORK, NEW YORK 10036, Harvey Radio Co., Inc., 2 West 45th St., (212)-582-2590 PHILADELPHIA, PENN. 19123, Almo Industrial Electronics, Inc., 412 North 6th Street, (215)-922-5918 PITTSBURGH, PENN. 15206, Radio Parts Company, Inc., 6401 Penn Ave., (412)-361-4600 WOODBURY, L. I., N.Y. 11797, Harvey Radio Company, Inc., 60 Crossways Park West, (516)-921-8700 **SOUTH**—BIRMINGHAM, ALA. 35233, Forbes Distributing Company, Inc., 1416 Fourth Ave., South, (205)-251-4104 MIAMI, FLORIDA 33142, Mountain Electronics, Division of Mountain National Co., 3730 Northwest 36th St., (305)-634-4556 RICHMOND, VA. 23220, Meridian Electronics, Inc., 1001 West Broad Street, (703)-353-6648 WEST PALM BEACH, FLA. 33402, Mountain Electronics, Division of Mountain National Co., 1000 N. Dixie Highway, (305)-833-5701 **MIDWEST**—CINCINNATI, OHIO 45237, United Radio, Inc., 7713 Reinhold Drive, (513)-761-4030 CLEVELAND, OHIO 44125, The W. M. Pattison Supply Co., Industrial Electronics Division, 4550 Willow Parkway, (216)-441-3000 INDIANAPOLIS, IND. 46225, Graham Electronics Supply, Inc., 122 South Senate Avenue, (317)-634-8486 KALAMAZOO, MICH. 49005, Electronic Supply Corp., P. O. Box 831, (616)-381-4626 KANSAS CITY, MO. 64111, Walters Radio Supply, Inc., 3635 Main



# knowledge is power.

You'll find that detailed Delco data sheets and applications notes are written especially for engineers in a standard, easy-to-analyze form.

And you'll find that often we can recommend suitable devices at a lower cost than those originally applicable. Once you get what you need, you get follow-up service to make sure each device works where it's supposed to.

For more information on what's in Delco power semiconductors for you, contact your local Delco distributor or Delco sales office. See why the Kokomoans' power is knowledge.

#### FIELD SALES OFFICES

Union, New Jersey\* 07083  
Box 1018 Chestnut Station  
(201) 687-3770

Chicago, Illinois\* 60656  
5151 N. Harlem Avenue  
(312) 775-5411

Syracuse, New York 13203  
1054 James Street  
(315) 472-2668

Santa Monica, Calif.\* 90401  
726 Santa Monica Blvd.  
(213) 870-8807

Detroit, Michigan 48202  
57 Harper Avenue  
(313) 873-6560

Kokomo, Ind. 46901  
700 E. Firmin  
(317) 459-2175 Home Office

\*Office includes field lab and resident engineer for application assistance.



**DELCO RADIO**  
DIVISION OF GENERAL MOTORS  
**KOKOMO, INDIANA**

Street, (816)-531-7015 MINNEAPOLIS, MINNESOTA 55401, Stark Electronics Supply Co., 112 3rd Ave., North, (612)-332-1325 SKOKIE, ILL. 60076, Merquip Electronics, Inc 7701 N. Austin Ave., (312)-282-5400 ST. LOUIS, MO. 63144, Electronic Components for Industry Co., 2605 South Hanley Road, (314)-647-5505 WEST—ALBUQUERQUE N. M. 87103, Sterling Electronics, Inc., 1712 Lomas Blvd., N. E., (505)-247-2486 DALLAS, TEXAS 75201, Adleta Electronics Company, 1907 McKinney Ave., (214)-742-8257 DENVER, COLO. 80219, L. B. Walker Radio Company, 300 Bryant Street, (303)-935-2406 HOUSTON, TEXAS 77001, Harrison Equipment Co., Inc., 1422 San Jacinto Street, (713) 224-9131 LOS ANGELES, CAL. 90015, Radio Products Sales, Inc., 1501 South Hill Street, (213)-748-1271 LOS ANGELES, CAL. 90022, Kierulff Electronics, Inc., 2585 Commerce Way, (213)-685-5511 OKLAHOMA CITY, OKLAHOMA 73102, Radio, Inc., 903 North Hudson, (405)-235-1551 PALO ALTO, CAL. 94303, Kierulff Electronics, Inc., 3969 East Bayshore Road, (415)-968-6292 PHOENIX, ARIZ. 85005, Sterling Electronics, Inc., 1930 North 22nd Ave., (602)-258-4531 SAN DIEGO, CAL. 92101, Milo of California, Inc., 2060 India Street, Box 2710, (714)-232-8951 SEATTLE, WASH. 98108, Kierulff Electronics, Inc., 5940 6th Ave., South, (206)-763-1550 TACOMA, WASH. 98402, C & G Electronics Company, 2502 Jefferson Ave., (206)-272-3181 TULSA, OKLAHOMA 74119, Radio, Inc., 1000 South Main Street, (918)-587-9124 CANADA—SCARBOROUGH, ONTARIO, Lake Engineering Co., Ltd., 123 Manville Rd., (416)-751-5980

# Boost IC op amp power with Helipot's miniature hybrid amplifiers.

## Here's how they perform:

- 5 watt peak output power
- 30 MHz bandwidth
- $\pm 16V$  voltage swing
- less than  $90^\circ$  phase shift
- $-55$  to  $+125^\circ C$  operation
- foldback short circuit immunity
- protects op amp and power supply from overload reflections

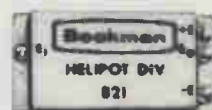
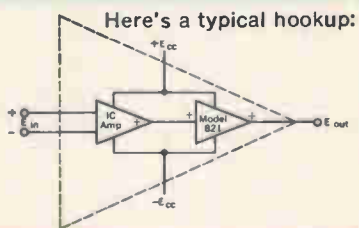

Actual Size

## Here are the prices:

(1 to 9 quantity)

Model 821: \$35.00

Model 822: \$40.00

Delivery from local stock.



Models 821 and 822 are hybrid, cermet thick film power amplifiers that can drive load resistances as small as 50 ohms to within 4 volts of the supply voltage. Their combination of unity voltage gain and wide bandwidth (d-c to 30 MHz) permits boosting the power of an IC amplifier without affecting its other performance capabilities. In addition, the Power Amplifiers' ability to block all overload reflections results in the prevention of heat generated errors in the op amp and allows immediate recovery upon overload removal.

Completely self-contained, these fully sealed units are only 0.170" high, occupy just 0.5 sq. inches of board space, and are compatible with both flat pack and dual in-line IC packages.

Ask your local Helipot sales representative for complete information on Models 821 and 822.

**Beckman**

INSTRUMENTS, INC.  
HELIPOT DIVISION  
FULLERTON, CALIFORNIA • 92634

INTERNATIONAL SUBSIDIARIES: GENEVA; MUNICH; GLENROTHES, SCOTLAND; TOKYO; PARIS; CAPE TOWN; LONDON; MEXICO CITY; STOCKHOLM; VIENNA

# Technical Articles

---

**Pros and cons of face-down bonding technologies**  
page 72



The growing complexity of integrated circuits spotlights a serious drawback of semiconductor devices: the unreliability of wire bonds. And the advent of medium- and large-scale integration has increased the need to automate the bonding process. As an answer to both the problem and the need, some manufacturers are going with flip chips, some with beam leads. Still others are investigating both methods, and one maker, Motorola, has reached the production line with a third technique—the spider bonding shown on the cover. This survey, the first article in a two-part series, covers the cost and reliability aspects of competing techniques.

**Circulators for vhf and up**  
page 84

Circulators and isolators are solving some of the worst isolation problems that have frustrated designers of vhf through microwave circuits and systems. Although the solutions still involve tradeoffs, these ferrite devices, among other tasks, isolate a transistor oscillator or amplifier from a varying-load impedance with little loss in the usable output.

**P-c card assembly is untouched by human hands**  
page 88

To put an engineer's schematic in one end of an automated production line and get a completely assembled printed-circuit card at the other is the goal of a manufacturing system being set up by Kearfott Products. A few human operators are still needed, but the combination of new machines and tape and computer control brings completely automatic circuit manufacturing a giant step closer.

---

## Coming

**The mini-est minicomputer**

Detailed design information on the Nova, the third generation's first small computer, will cover its architecture, its multiple accumulators, and its unusual read-only memory.



## In search of a lasting bond

Beam leads and flip chips have their advocates, but many firms continue to weigh the cost and reliability advantages of the two techniques; meanwhile, Motorola has put forward a third: spider bonding

By Lawrence Curran

Los Angeles bureau manager

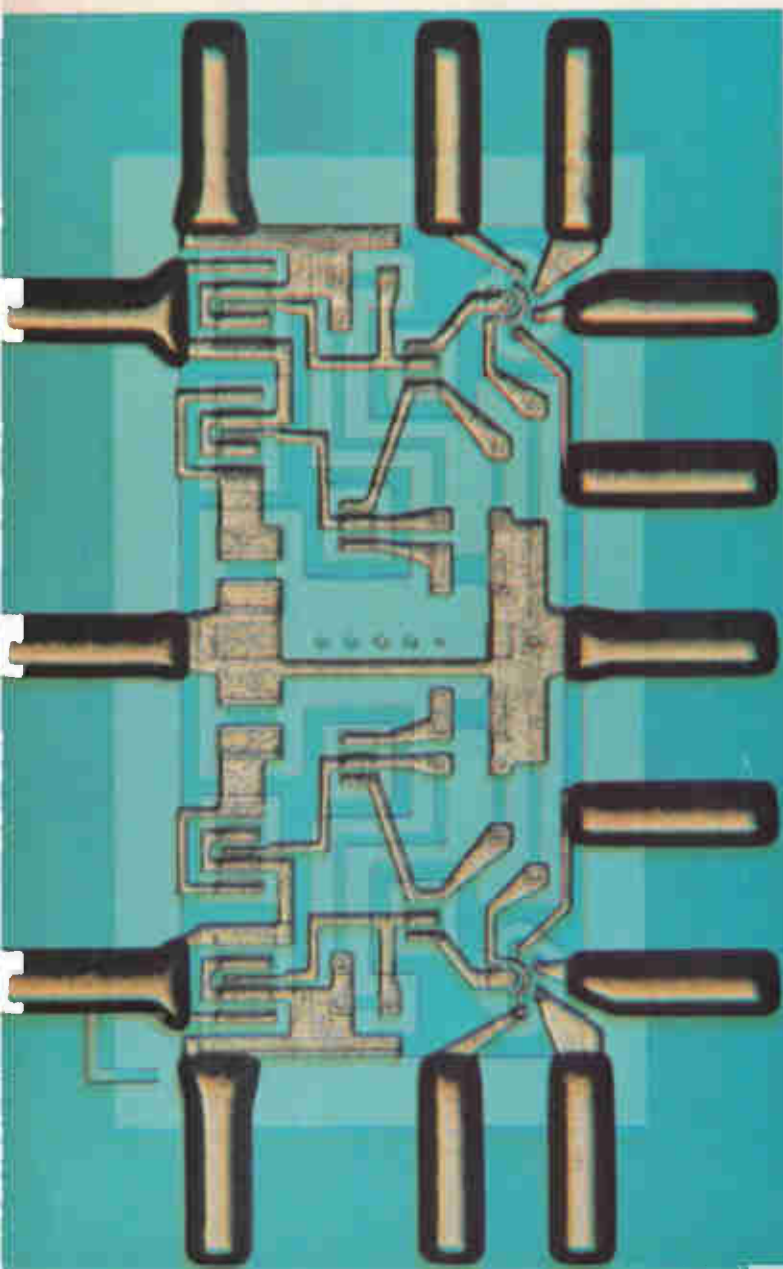

Ask any engineer concerned with semiconductor reliability what his biggest headache is, and the odds are he'll tell you it's faulty wire bonds. The wires pull away from contact pads on the dice or they separate from package lead frames under stress.

The logical way to solve the problem is to eliminate wire connections altogether. In doing so, the semiconductor manufacturer can not only improve device reliability but reap some labor savings by eliminating the 28 manual bonds required in fabricating the typical 14-lead integrated circuit. And as the industry moves into the realm of medium- and large-scale integration, the need to automate bonding becomes more pressing.

Several ways to eliminate both wires and manual connecting processes have emerged in the past few years—flip chips, beam leads, and spider bonding. Many of the larger semiconductor manufacturers and users are examining all these possibilities before they commit themselves. Others have come out solidly for either flip chips or beam leads, and one maker is offering spider-bonded circuits.

There does appear to be a trend at semiconductor houses toward flip chips because they're easier to make than beam-lead devices. But there are also indications that beam leads will be the way to go to achieve the highly reliable devices required by the military services.

In the flip-chip method, which has been in use

The hard way. Sprague Electric chose a small-geometry device for its entry into the beam-lead field, a dual four-input NAND gate.

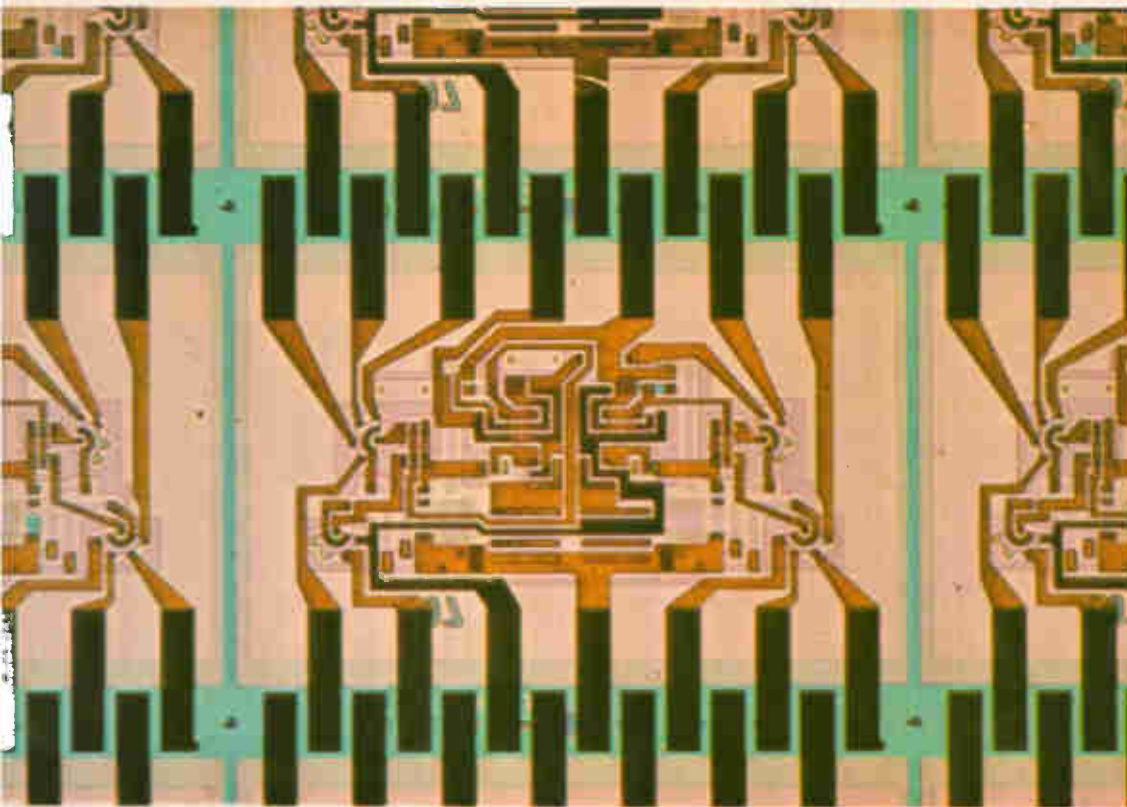

Beamed flip-flop. Typical of Sylvania's efforts is a beam-lead two-phase clocked device with a 20-Mhz toggle frequency.

for about six years, metal bumps or balls are applied to the contact pads on the die in place of wires; the bumps are bonded with the die face down in a one-shot or reflow solder operation.

The International Business Machines Corp. is applying a modified flip-chip technique called solid logic technology (SLT) to its 360 computer line. Here, one or two transistors are bonded face down to a hybrid thick-film substrate on which stencil-screened land patterns and passive components have been deposited. Bonds are made to solder-covered copper balls, which contact the emitter, base, and collector. Solder on the balls flows when the chips are heated, forming the bond. IBM passivates its active devices with phosphorous silicate and uses a can that isn't hermetically sealed. The can's function is simply to protect the devices against mechanical damage in handling.

IBM officials say the company is turning out hundreds of thousands of SLT circuits a day, plus like amounts of slightly more complicated devices called solid logic dense (SLD) in a fully automated setup. The SLT circuits are said to have a bond failure rate of 0.00004% per 1,000 hours and an electrical failure rate of 0.0002% per 1,000 hours.

The firm has also announced a new process that appears intended for use in bonding IC's containing many elements to substrates [Electronics, Oct. 28, p. 50]. Called "controlled collapse," this technique dispenses with the copper balls employed in SLT to keep the chip above the substrate so it doesn't short out. In controlled collapse, molten solder holds the chip off the substrate. A large

portion of the lands is coated with glass to protect it from the effect of bonding heat. Heated solder can thus flow only over the tiny uncovered portion of the lands, and there isn't enough of this solder to short the circuit.

The General Electric Co. has developed a wire-less bonding method called semiconductor on thermoplastic on dielectric (STD) [Electronics, Jan. 8, p. 45], but the Commerce Department has clamped a lid of secrecy on the project at the behest of the Pentagon. However, though the Government now deems the technique vital to the nation's security, some general details were published before the program was put under wraps.

It's known that under the STD process, the IC is nestled among copper projections or mesas on a substrate. The circuit is embedded in a clear, heat-resistance plastic that's flush with the mesa tops, and it's linked to the outside world by metal interconnection paths deposited on the plastic.

Versatility appears to be one big advantage of STD. The technique can be applied to discrete devices on up through large-scale integrated circuits, and can be used with thick- or thin-film compo-

This is a first of a two-part series on methods of eliminating wire bonds. The second article will cover such aspects as commercial availability and automatic handling and testing.



**Mosaic.** A control logic circuit with 47 logic gates and seven flip-flops is among the most complex beam-lead chips yet built. The beams on this Bell Labs circuit are 2 mils wide and 7 mils long.

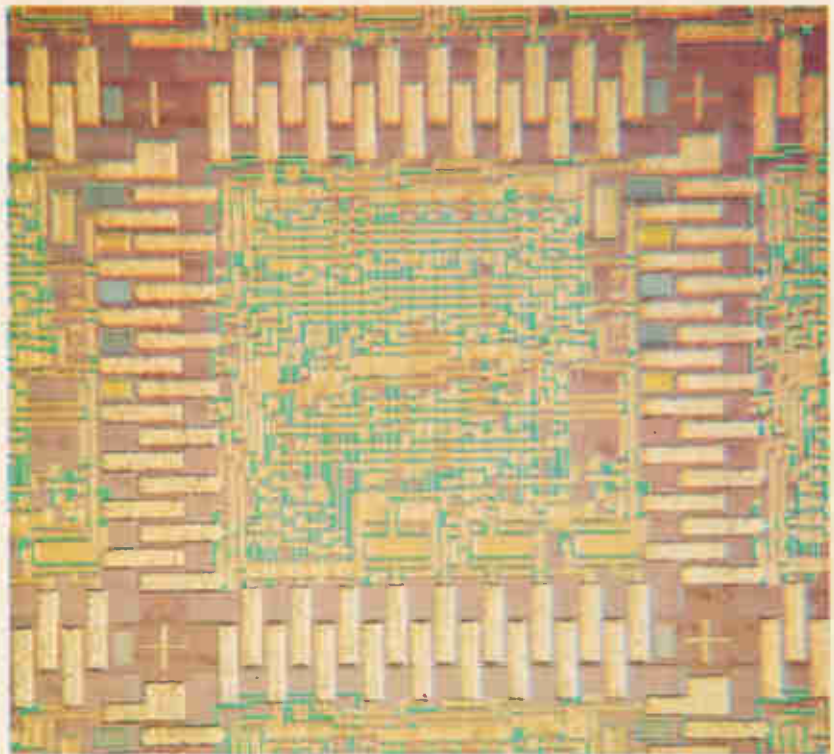

**Over the edge.** A 40-gate, beam-leaded TTL chip built by the Raytheon Missile Systems division has interconnection lines in the center channels for the various circuits along each side.

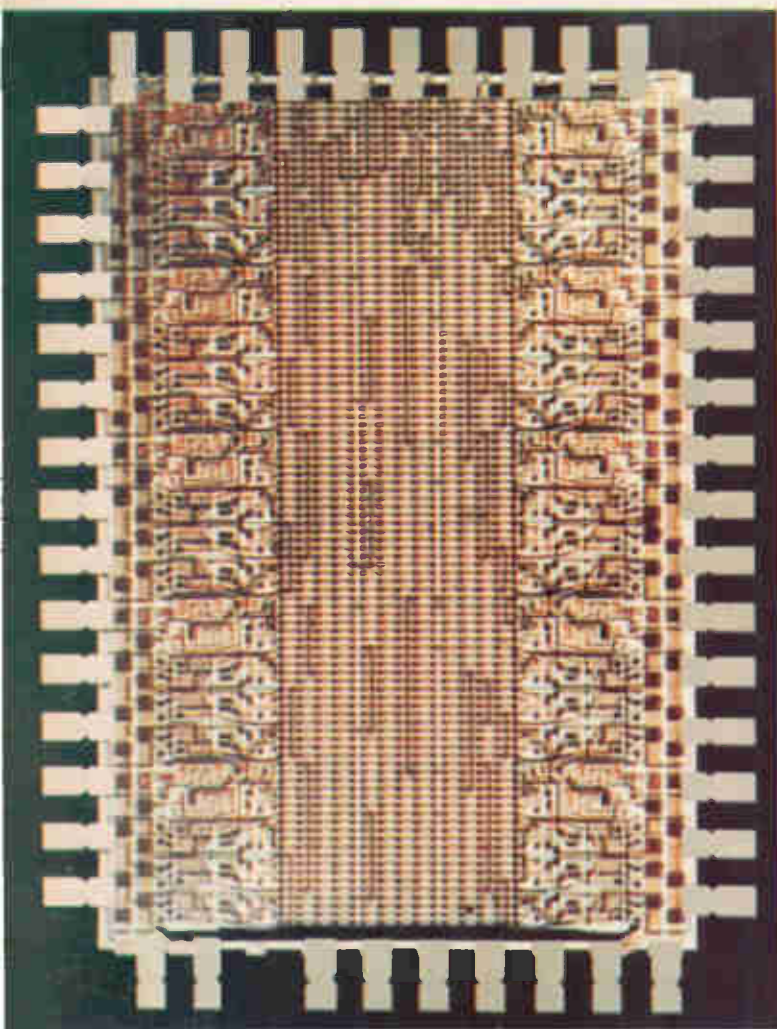

nents or any combination of them. Besides these benefits, STD offers a way around the alignment difficulties of the flip-chip approach. Also, because the chip is face up in a clear plastic, it can be visually inspected.

#### **Delicate operation**

In the beam-lead method, which was pioneered by the Bell Telephone Laboratories, a gold metallization system not only interconnects individual components of an IC but provides a way to join the circuit to the outside world. The gold beam lead is relatively thick (12 microns) and extends beyond the boundaries of the silicon circuit, like a cantilevered beam, to contact the circuit-board pads.

Exposed terminal points are interconnected by electroplated gold leads placed on top of successive layers of platinum silicide, titanium, and platinum. The platinum silicide offers a good low-resistance ohmic contact to the silicon at the terminals, titanium bonds the platinum layer that goes on top of it to the nitride in the contacts' overlay portion, and the platinum protects the underlying layers from gold migration.

Separating the individual devices is a ticklish proposition since ordinary dicing obviously would damage the beam leads. At Bell Labs, the wafer is coated with wax and mounted, with the beam leads down, on a flat sapphire disk about 0.09 centimeter thick. The back of the wafer is lapped to a thickness of about 0.005 cm, and a coat of emulsion is applied to the wafer. The connection grid pattern required to separate the chips is defined by a mask that's aligned with the aid of infrared light, and



## New ballgame

IBM was the first to mass produce flip chips. In the solid logic technology process it uses to form modules (upper right) for the 360 computers, the basic substrate has screened resistors and conductors with pads that contact the three transistor terminals. Each transistor has three solder-coated copper balls. When heated and placed on the pads, these bond the transistor to the substrate, make the electrical contact, and keep the device from collapsing onto the substrate and shorting the circuit.

In a newer method, shown at the lower right, the copper balls are replaced by solder balls, and another step is added. A nonsolderable glass deposited over a small part of the lands near the chip end acts as a dam, blocking the flow of molten solder down the lands during the bonding process. The surface tension of the molten solder then holds the chip off the substrate until the solder hardens. This new "controlled collapse" technique offers the advantage of greater compliancy—a must when multielement chips are to be bonded to a substrate.

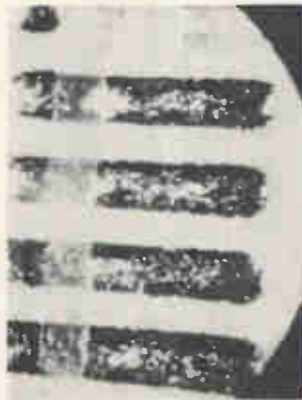

the wafer is then etched through with an acid solution. After separation, the individual devices remain fixed in their wafer orientation by the wax on the sapphire disk; they're tested automatically at this stage.

After testing, the devices are cemented to a wire mesh screen in the transfer fixture. The mounting disk is heated to remove the wax, and is then itself removed from the wafer.

Once the devices have been cleaned of any wax residue, the chips, wafer, and a resin-coated disc are clamped in a fixture and dipped in acetone to dissolve the cellulose nitrate used to hold the devices to the screen. The fixture is opened, leaving the chips clinging to the silicone resin, from which they can be easily removed by a vacuum pickup needle.

The Western Electric Co., manufacturing arm of the Bell System, claims that beam-lead devices they've made show a mechanical yield of better than 99%; electrical yield is expected to top 90%.

The spider bonding process recently unveiled by Motorola [Electronics, Sept. 16, p. 58] is an especially promising entry in the automation derby. The firm's Semiconductor Products division has gone to this technique for all its dual in-line, 14-lead plastic-packaged transistor-transistor logic circuits, and it can deliver these IC's today.

One machine at Motorola ultrasonically bonds

semiconductor dice to spider-like leads stamped out of a continuous strip of metal, and another automatically welds the spider-bonded dice and leads to a header strip. Both operations are one-shot jobs, and the over-all process is said to be 20 times faster than manual wire bonding.

The availability of the company's spider-bonded IC's must be heartening to potential users, as flip-chip and beam-lead devices are still largely under developmental wraps.

### Missile booster

Probably the greatest single boost beam-lead technology has gotten was the selection of beam-lead devices for the Army's Sentinel antiballistic missile system. Western Electric, prime contractor for Sentinel, has awarded initial contracts of \$5 million each to Motorola's Semiconductor Products division, Texas Instruments, and RCA for these devices.

Also, the Raytheon Co.'s semiconductor operation, which showed air-isolated devices at last August's Wescon Show, has a contract to deliver both IC's and discrete transistors and diodes in beam-lead form to the North American Rockwell Corp.'s Autonetics division; it should be in production early next year [Electronics, April 29, p. 25]. Raytheon also has ambitious plans to apply beam leads to its entire commercial IC line.

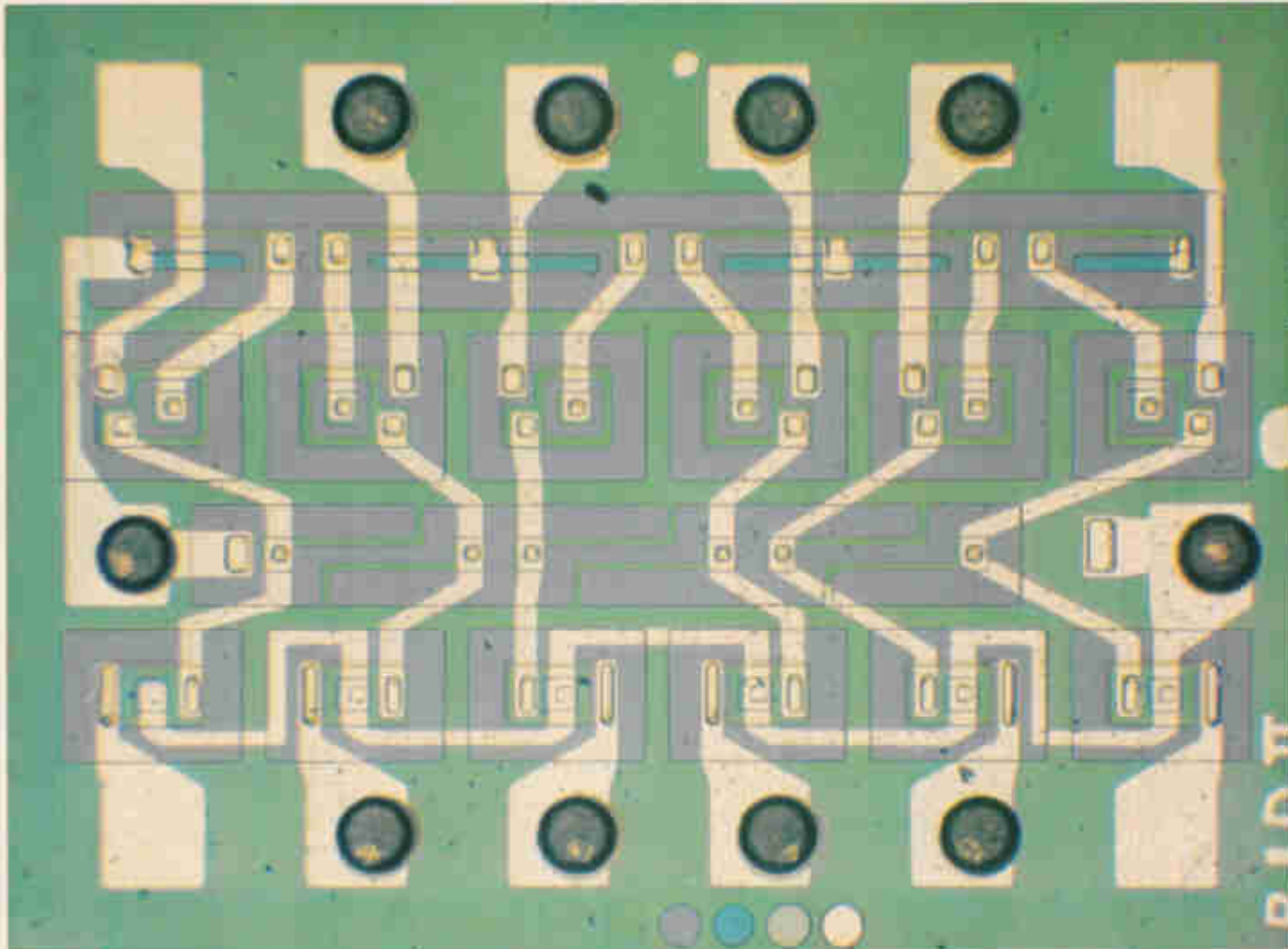

**Bumpy drive.** Bipolar IC with solder bumps is a six-channel driver for a MOS-FET switch. This circuit, built by Siliconix, has only four channels bumped for input and output; the other two bumps are for supply voltage and ground.

William Hugel, president of Hugel Industries, Sunnyvale, Calif., reflects the thinking of many in the semiconductor industry when he lists the following advantages of beam leads:

- They are visible under ordinary optics at the connection points.
- Several methods of die attachment can be used, including spot welding, soldering, thermo-compression bonding, and ultrasonic bonding.
- The expanded size of the leads makes interconnection-path tolerances somewhat less critical than they are in flip chips or chip-and-wire devices.
- Beam leads are perhaps less susceptible to long-term stress bond ruptures than are flip-chip or chip-and-wire devices.

Others in the industry would add these features to the list:

- Little or no heat or pressure gets to the active semiconductor area in beam-lead bonding.
- The leads are wider than their chip-and-wire counterparts and therefore more rugged—though still delicate.
- Uniformity and repeatability of device charac-

teristics permits preselection of devices—particularly discrete devices for microwave systems—after only a small sampling.

- Beam leads can be shaped to help control device inductance, something that can't be easily done with flip chips.
- The Bell Labs approach results in gold-to-gold bonds, which are more reliable than bonds involving dissimilar metals.

Generally, industry men reckon the disadvantages of beam leads thusly:

- To date, the leads and lead-chip interfaces are somewhat fragile.
- The gold and the added processing steps are costly.
- Beam-lead devices require a lot of silicon surface real estate because a large land area is needed to assure that the bonding tool is applied to the beam, not to the chip.
- Backside alignment is needed for the etch pattern to separate the chips from the wafer.
- There are few sources of supply.
- Beam leads have lower bond strengths than



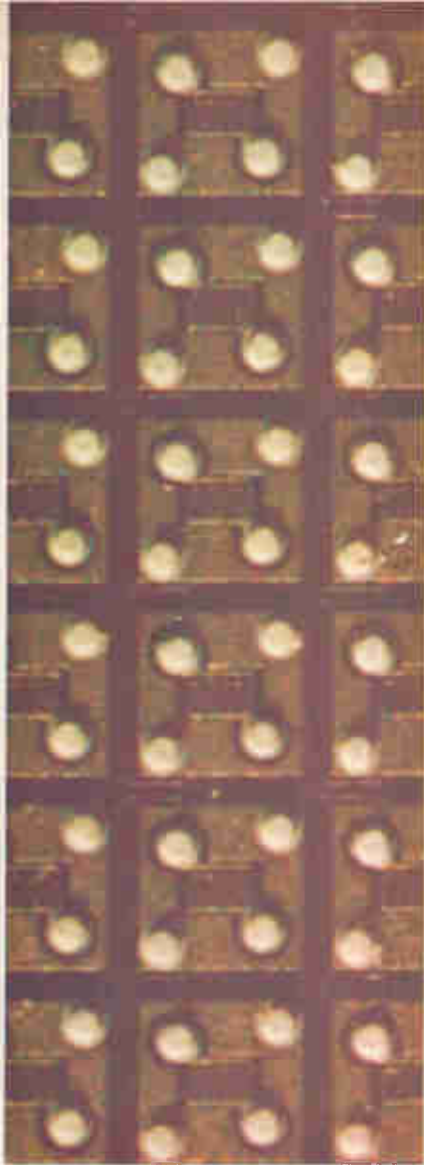

**A whole slew.**  
Portion  
of a Siliconix wafer  
carries flip-chip field-  
effect transistors on  
which solder bumps  
are formed.

do flip chips.

- The silicon chip used with beam leads is thin (2 to 5 mils against 10 mils or more for flip chips).

As for flip chips, Hugle points out the following advantageous features:

- Their processing is compatible with present IC production lines.

- They need less silicon surface than do beam leads.

- Once they are attached to the substrate, they're very rugged.

- Bonds are strong.

But here again there are drawbacks. Hugle notes the following ones:

- The bonds aren't visible after attachment except with infrared optics.

- Great precision is required in substrate conductor printing if maximum economy in chip size is to be realized;

- Flip chips aren't as easily repaired as beam leads. Hugle observes, however, that flip-chip makers are finding new ways to repair bad bonds.

Many semiconductor manufacturers are keeping

their options open by developing both technologies in house. This includes most of the big boys—Fairchild, Motorola, TI, and the Signetics Corp.

Signetics is evaluating flip chips and beam leads from the point of view of reliability and cost trade-offs. David Kleitman, director of research and development at the Sunnyvale, Calif., subsidiary of the Corning Glass Works, says: "In any application where cost is important, flip-chipping has an advantage. Beam leads certainly double, and may triple, chip costs, and they will for some time to come."

On the other hand, Donald Winstead, Signetics' product marketing manager, states: "We still haven't proved the reliability of the flip-chip process. Beam leads seem more attractive to the marketing and management segments of the company because they offer a bond with more integrity."

Regarding Bell Labs' beam-lead processing method, Winstead says, "platinum-titanium-platinum-gold-gold metalization is a tough proposition. We have a major metals study going on now and we expect results in February, so we can look for beam-lead products by the middle of next year."

Motorola is backing all three horses in the race. Richard Abraham, director of both advanced IC programs and Motorola's Sentinel program, says: "The beam-lead approach is intended essentially to improve reliability; spider bonding was developed to cut bonding costs. The two techniques will be aimed at different markets and it will be a long time before they meet head-on. Our beam-lead effort is aimed at the high-reliability market. Spider-bonded IC's are currently packaged in plastic for the commercial-industrial market.

"I don't think there will be a major cost reduction realized by using beam leads," Abraham continues, "but we look for a major reliability improvement. We can see and inspect each bond produced by the beam-lead approach, and results are excellent. We can't find a centrifuge that will pull the bonds apart." The official adds that the most stringent centrifuge test spins the devices at 100,000 g's.

### Secretive

The three firms funded by Western Electric to develop beam-lead devices for the Sentinel program aren't eager to talk about that effort. Motorola's Abraham is mum on the subject, as are officials at RCA. James Hubbard, manager of some of TI's advanced IC work, will say, however, that "there are some cost problems to be worked out with beam leads, but we see a need for them when we get into complex functions. They should complement discretionary wired medium-scale and large-scale integrated circuits. Although the bump approach might cut costs, the ultimate yield might dictate beam leads. These are questions we are trying to answer now with our studies of beam leads and flip chips."

Ross Schraeder, manager of IC package development at TI, has for two years headed the firm's



IC flip-chip development, an effort embracing both hermetically sealed and plastic dual in-line devices. TI appears to be closer to the market with the former, but Schraeder is more excited about the outlook for plastic-packaged flip chips. Several approaches are being examined, but Schraeder isn't willing to give details. He simply says: "We feel this will be the big market and it's the area in which we're putting our biggest effort. We are studying various techniques in an attempt to select the most reliable and producible flip-chip package."

Schraeder believes both flip chips and beam leads "have a place," but feels flip chips will win out for high-volume orders. For one thing, he says, flip chips allow greater device density on a slice at lower cost. For another, they can be densely packed on a hybrid substrate because there are no leads overhanging the silicon perimeter.

### Spider fancier

Fairchild's eventual route has become more difficult to predict since the arrival at the company of a flock of ex-Motorola executives. One of them, Eugene Blanchette, Fairchild's IC manager, was a big booster of spider bonding while at Motorola, maintaining that the degree of automation the process allows is imperative if semiconductor device costs were to be kept in line. He says Fairchild has lab notebooks that prove the firm was working on spider bonding as long ago as 1960, but he fails to explain why the process still hasn't made it to the production stage.

One of Blanchette's first actions upon moving to Fairchild was to stop production of the Fairpak, the flip-chip package that proved impervious to all cost-cutting attempts since the company introduced it nearly two years ago.

Blanchette had never been enchanted by the Fairpak; shortly after arriving at Fairchild he noted that "the metalized ceramic substrate puts it out of the ballpark for really low cost."

The main reason the package was dropped may have been the recent development of a radically new kind of aluminum beam-lead device that's produced by a technique far simpler than Bell Labs air-isolated, back-etched method for gold beam leads. Under the new technique, Blanchette explains, the dice aren't etched apart at all, despite the fact that they're formed on the wafer in an interdigitated geometry.

Devices have already been assembled by this process and are undergoing reliability tests. Blanchette is close-mouthed about how they're made or when they'll be introduced, but this aluminum beam-lead approach is the only one of four methods of one-shot bonding to which he has assigned a development task force. The others under study at Fairchild are gold beam leads, spider bonding for plastic-packaged flip-chips, and bumped chips for multichip packages.

The Westinghouse Electric Corp. is another firm that hasn't yet chosen between flip chips and beam leads. Both techniques are under study at the

firm's Molecular Electronics division in Elkridge, Md., and Stephen Guthman, manager of marketing services there, says one will be chosen next year. Guthman foresees 3% to 4% of the division's semiconductor production in face-down bonding of some type next year, 10% to 15% in 1970, and 100% by 1972.

### Opposing camps

Once you get past the companies that are still studying the options, you find a host of firms lining up in support of either flip chips or beam leads, and, unlike the fence-straddlers, these advocates are quite vocal. Siding with the Hughes Aircraft Co., a pioneer in flip chips, are Intersil Inc. and Amelco Semiconductor, a subsidiary of Teledyne Inc. And a large-volume user of flip chips is the Electronics division of the Aerojet-General Corp.

On the other side of the fence, the biggest pushers of beam leads outside Bell Labs appear to be Raytheon, the Semiconductor division of Sylvania Electric Products Inc., the Semiconductor division of the Sprague Electric Co., and Hewlett-Packard Associates. Some of the firms in the beam-lead camp, Sylvania and Raytheon in particular, have in-house users who are enthusiastic about beam leads, but possibly the most important "non-captive" user is Autonetics.

After customers mention the magic words "reliability" and "cost" in citing reasons for choosing one of the technologies, they usually ask, "Can I buy devices today?" Flip-chip device manufacturers can generally give an affirmative answer more readily than can producers of beam-leaded semiconductors.

The Newport Beach, Calif., operation of Hughes Aircraft has been turning out flip-chip devices on a production basis for about two years. Herbert Evander, assistant manager for microelectronics at Hughes, says beam-lead products will always cost more than flip-chip devices because of the metallurgical and processing complexity inherent in the Bell Labs process. He makes no direct comparisons on the score of reliability, however, explaining that beam leads haven't been around long enough. He is prepared to compare flip-chip and chip-and-wire techniques on the basis of bonding labor costs to the user. For a 14-lead IC, at a labor rate of \$8 an hour with standard chip-attachment techniques (ultrasonic bonding, reflow soldering), the labor content for a flip-chip device would be 3.2 cents, he says, against 11.6 cents for a comparable chip-and-wire device.

"At 250 devices per hour," says Evander, "that works out to a ratio of from 3 to 1 to 4 to 1 in favor of flip chips." And he adds that Hughes is shooting for bonding rates of up to 1,800 devices an hour with an automatic flip-chip bonder the company hopes to introduce in mid-1969.

The Hughes official also asserts that flip chips are anywhere from seven to 14 times as reliable as chip-and-wire devices. To support this contention, Evander cites an Air Force study of chip-and-wire

hybrids and face-bonded devices conducted at the Rome, N.Y., Air Development Center.

For chip-and-wire devices with three bonds—one connecting the wire to the contact pads, a second connecting the wire to the lead frame, and a third connecting the external lead to a circuit board—the failure rate was found to be about 0.00013% per 1,000 hours. A combination of flip-chip techniques and very close process controls yields an estimated failure rate of 0.00001% per 1,000 hours—at least as good as the rate for chip-and-wire devices with ultrasonically bonded aluminum wires and an order of magnitude better than the rate of failure for devices with thermocompression bonds using gold wires.

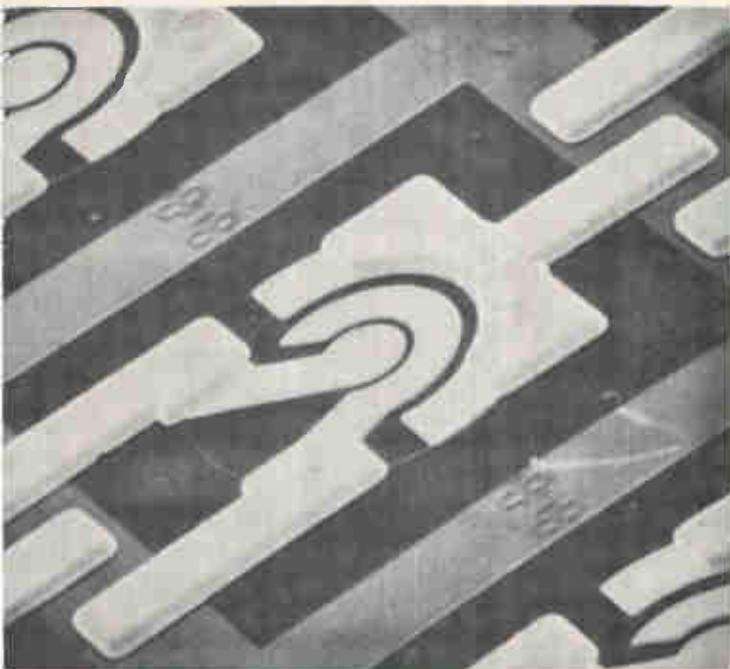

Close look. An electron-beam scanning microscope shows Texas Instruments' developmental beam-leaded npn transistors.

It should be noted, though, that the same Air Force study gives beam leads as good a rating as it does flip chips.

### Raising bumps

In "electroforming," the name given to the Hughes scheme for attaching bumps to semiconductor dice, a chrome-gold chip interconnection system is used with pure silver bumps, and a proprietary glass is r-f sputtered over the wafer along with silicon dioxide for passivation. The bumps are coated with a eutectic silver-tin alloy that has a melting temperature of 217°C.

"It's a relatively elaborate scheme," concedes Evander, "but it produces reliable devices and good bump geometry. With the silver-tin alloy, we haven't had a case of silver migration in any of

our tests. With the glass, we get a good seal to the bumps and the silicon dioxide. The devices readily pass standard military environmental tests, and you can drop them on the floor and still use them—if you can find them."

The Hughes system permits the use of either ultrasonic bonding or reflow soldering to a hybrid substrate, and it can be applied to just about any kind of semiconductor die, says Evander.

### Thick chips

Amelco's flip chips for the most part have aluminum bumps that are evaporation deposited through masks and then glass passivated. Roger Murray, a senior project engineer at the company, estimates that of the 30 to 40 devices in Amelco's TTL IC line, plus npn and pnp switching transistors and "a couple of junction field effect transistors," 20 are in flip-chip form.

He says Amelco's dice are much thicker than other flip chips—9 to 10 mils compared with 4 to 5 mils for conventional dice. This thickness has both quality-control and reliability implications. According to Murray, the die isn't as flexible as thinner ones under conditions of static loading. Also, there is less chance of cracking the chip because it has a higher resonant frequency than slimmer versions. "You don't decouple as much bonding energy through harmonic vibrations as you do with thinner chips," he explains.

The first products introduced by Intersil were flip chips; they made their debut about a year ago. Jean Hoerni, the firm's founder, is convinced that flip chips will become "the sustaining force of the semiconductor industry in the future."

The firm uses vacuum deposition through masks to form aluminum bumps about 1 mil high and 4 mils in diameter.

John Hall, a senior member of the technical staff, says Intersil has so far produced in flip-chip form a 20-bit, MOS p-channel shift register with a low threshold voltage, npn and pnp transistors, dual matched transistor chips, and n-channel junction FET's.

About 30% of Intersil's output is now in flip-chip form, and Hall says these devices cost from 10% to 30% more than their wire-bonded counterparts without bumps. But Intersil engineers contend that once a company is prepared to go with flip chips, the over-all cost of using them in hybrid circuits is substantially lower than that of conventional wire-bonded circuits. And the big bonus is reliability. Hall declares that the aluminum bumps give a bonding durability that far exceeds the normal requirements for ultrasonic bonding.

Because little reliability data on beam leads is available, many backers of that technology, and some neutral observers as well, fall back on intuitive feelings in contending that beam leads are potentially more reliable than flip chips. When pressed, they explain that the bonds can be seen—they can be visually checked. Flip-chip advocates, of course, find this argument meaningless.



The Big Daddy of the beam-lead team, Bell Labs, won't let skimpy reliability data squelch its enthusiasm. James Early, director of the labs' semiconductor device and electron tube facility in Allentown, Pa., says: "We don't have enough stuff in the field yet to make a definitive statement, but we've been evaluating beam-leaded circuits under a variety of conditions, and all indications are that these are the most reliable and stable semiconductor structures we've ever seen. Our evaluations indicate orders of magnitude decreases in degradation compared with vacuum-encapsulated circuits."

Probably the biggest beam-lead drumbeater outside the Bell System is Raytheon. The firm's semiconductor operation has what is probably the only contract outside the Bell organization to supply beam-lead circuits. The contract, worth \$285,000 and covering components for the attack and reconnaissance radars that will go aboard the Air Force's FB-111A and F-111D planes, was awarded by Autonetics earlier this year. It encompasses nine types of Series 100 diode-transistor-logic circuits, three kind of Series 800 TTL, and a number of RB709A linear differential amplifiers. Besides these integrated circuits, the order calls for four types of discrete diodes. The devices are being purchased in chip form (though oriented just as they were on the wafer by means of a special carrier) for use in thin-film multichip circuits.

Rudolph Thun, manager of microelectronics at Raytheon's radar and electronics laboratory, holds that gold will probably replace aluminum in high-reliability, low-radiation applications because "aluminum is estimated to be safe for only about 10 years at current densities of 200 to 300 kiloamperes per square centimeter of conductor cross-section; some less optimistic estimates drop this density to about 80 ka. Thus you can expect to see longer-lasting gold metalization to the exclusion of aluminum in long-life IC's, whether they have beam leads or not."

Regarding Raytheon's adoption of beam leads, Paul Sullivan, product manager for IC's, explains: "You can only go so far in improving wire bonding because of the heat and pressure applied to the chip, and cost limitations militate against any great improvements in hermetic packages. So we looked for another way."

### Some variation

The Bell Labs process appealed to Raytheon, but Sullivan says his firm didn't go all the way with it initially. "When we first started (a one-year development program undertaken early this year under the sponsorship of Autonetics and two potential in-house users), we weren't thinking about air isolation, so we chose the term 'flip-tab' for our process rather than calling it beam lead in the Bell Labs sense. We've given the engineer an ideal situation," Sullivan adds, "with a gold-to-gold metal system, no wires, and no heat or pressure on the chip."

Raytheon does manual lead bonding now, but

Sullivan says the process could be automated. He concedes that it's too early to make hard predictions about output rates, but he estimates that beam-lead production should be at least four times as fast as manual wire bonding.

Sullivan says a chip-to-ship ratio (number of chips made versus the number delivered) of 1½ to 1 isn't bad for conventional wire-bonded devices, but he believes beam leads will narrow that ratio to the ultimate 1 to 1. "With beam-lead circuits, a-c and d-c testing can be done at three temperatures at the wafer stage [Electronics, Oct. 14, p. 33], giving the user confidence that he's starting with a good chip. And because there's no chip damage in bonding, and because die attachment is eliminated, we visualize not only improved reliability but lower costs."

Historically, Raytheon has tried about everything. Thun says they've investigated face-down (flip-chip) bonding, a technique for dropping face-up IC's into cavities in a substrate and wire bonding, and even the application of an overlay of metalized plastic to complete circuits. Problems of reliability and alignment made these investigations "nightmarish," he says. "We looked at all these schemes and found that beam leads made the best tradeoffs possible because much of their assembly lends itself to batch processing and there are fewer restrictions on the number of pinouts."

### Open package

Brian Dale, chief engineer at Sylvania's semiconductor division, doubts that beam-lead IC's will be more expensive than conventional dice once the technology reaches the production line. "There might be some dollar premium at the chip level," he says, "but with silicon nitride and beam leads there should be none at the packaged level. Indeed, costs might fall a bit because the silicon nitride 'package' is batch processed."

Sylvania has thrown in its lot with beam leads after studying the technique for about four years. "We try beam leads on everything we build," Dale says. "Two potential advantages impressed us. One was the possibility of automation; the other was the reliability of the device's metalurgy, particularly with silicon nitride passivation. We're trying an open package—possibly with a hole in the lid or no lid at all. This would supply the necessary physical protection, and the silicon nitride would seal the chip from the environment."

Sprague Electric, another supporter of beam leads, agrees that batch fabrication will help keep costs in line. Robert Pepper, director of research, development, and engineering at the firm's Semiconductor division, states: "The production steps that differentiate beam-leaded IC's from ordinary monolithics are susceptible to batch work—nitriding, etch separation, and transfer. All are done at the wafer stage rather than at the chip stage. With semiautomatic bonding, I'd like to think that beam-leaded devices could offer the same functions as circuits with bonding pads, and at lower costs."



# Designer's casebook

## Analog gate's output is cleaned up by FET

By Thomas J. Davis

Pacific Northwest Laboratory, Richland, Wash.

Unwanted outputs of serious magnitude can arise in bidirectional analog gates during switching by control signals. These outputs—flat-topped pulses, differentiated spikes from the leading and trailing edges of the control pedestal, or spikes resulting from noncoincident switching of the gating elements—mean headaches for the circuit designer. But the voltage-controlled resistance of a field effect transistor can overcome these spurious, superimposed signals. The result: the gate delivers smooth, clean waveforms as it's rapidly switched by the FET.

The input signal is fed to both bases of differential amplifier  $Q_1$ - $Q_2$ , and is amplified by  $Q_4$ .

The differential amplifier, initially balanced by potentiometer  $R_2$ , is dynamically balanced by the drain resistance of field effect transistor  $Q_3$  when the input is transmitted. This resistance is several megohms at pinch-off gate voltage, but it drops to 90 ohms when  $Q_3$ 's gate is turned on. This drop provides  $Q_2$ 's emitter with an a-c bypass to ground through  $C_1$ , and thus unbalances the differential amplifier.  $Q_2$  conducts much more heavily than  $Q_1$ , and the relative over-all voltage gain "jumps" from -40 db to 0, allowing full signal transmission.

On-off transitions contain little pedestal injection by  $Q_3$  since this transistor behaves as a voltage-controlled resistor rather than a current sink.

The Miller capacitance of  $Q_3$  passes small, differential pedestal spikes through  $Q_2$  to the output, but  $C_2$  offsets them by feeding similar spikes to  $Q_1$ 's emitter for common-mode rejection. Spikes of only a few millivolts are then present at the output.

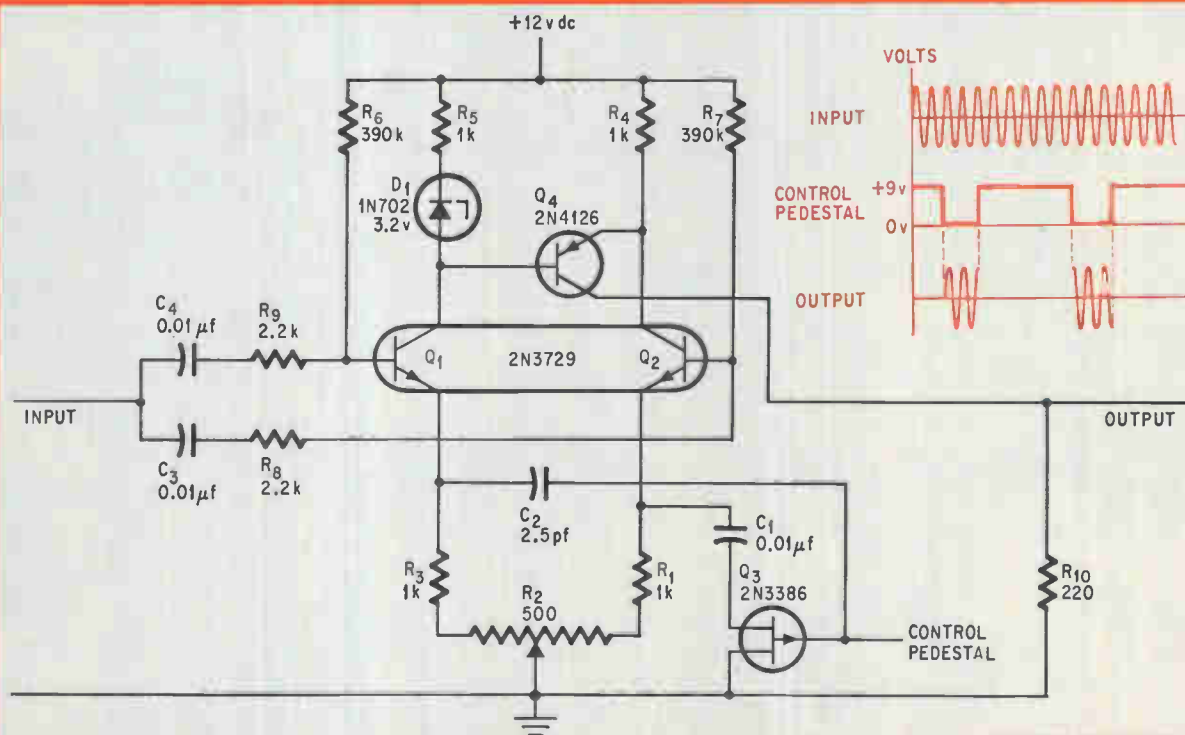

Suppression. Control-pedestal spikes at the output of the analog gate are minimized by the field effect transistor,  $Q_3$ . When the control signal switches between +9 volts and ground,  $Q_3$ 's drain resistance drops from several megohms to 90 ohms and cleanly gates the input signal out.

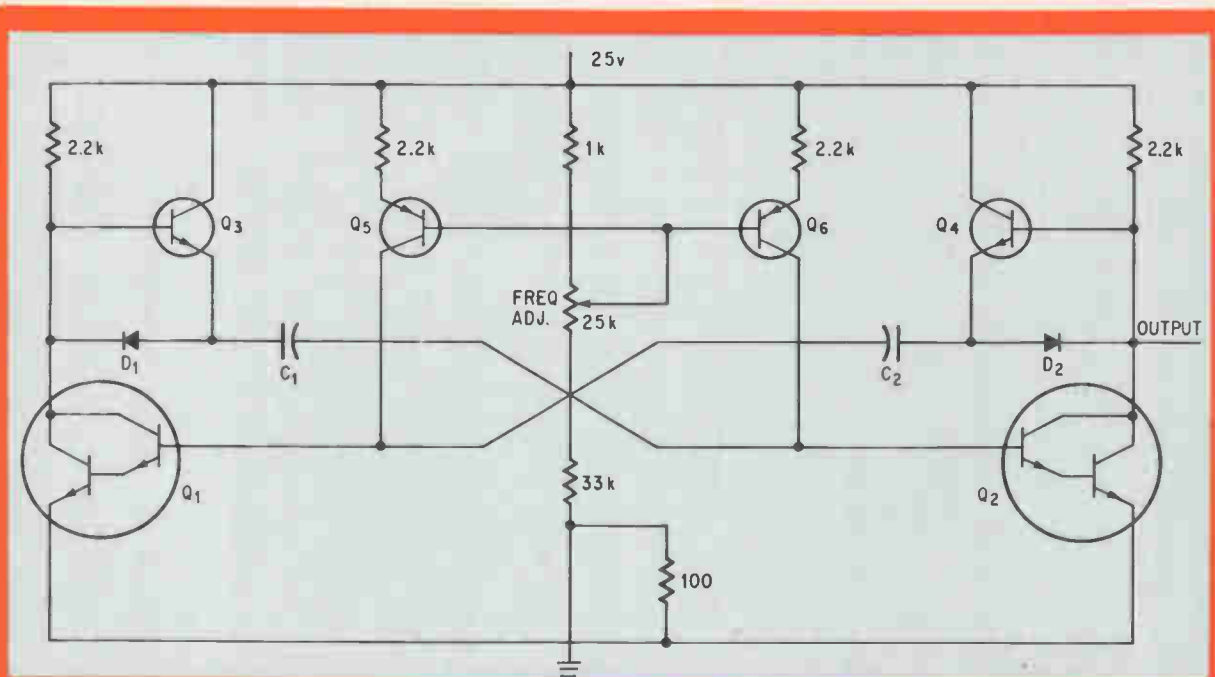

Improved multivibrator: Since  $Q_1$  and  $Q_2$  require less base current than ordinary transistors to turn on, and are therefore on longer, the lower limit of frequency is pushed down. The high gain of  $Q_3$  and  $Q_4$  provide high input impedance and stable performance.

## Darlington transistors widen multivibrator's range

By F.B. Golden

General Electric Co., Auburn, N.Y.

High-gain Darlington transistors and quick-acting emitter followers can broaden the frequency range of free-running multivibrators.

Less charging current is needed through the timing capacitors,  $C_1$  and  $C_2$ , to turn  $Q_1$  and  $Q_2$  on. The result: the Darlington stay on longer and push apart the frequency limits of the multivibrator.  $Q_3$  and  $Q_4$  ensure quicker discharge of  $C_1$  and  $C_2$  and, therefore, higher frequencies.  $Q_5$  and  $Q_6$  act as current sources making linear tuning possible.

The device can be continuously tuned over a range of 1,000 to 1 by the 25-kilohm potentiometer. If  $C_1 = C_2 = 250$  picofarads, the frequency range is 50 hertz to 100 kilohertz. The circuit can be used as a voltage-controlled oscillator by feeding the voltage directly to the bases of  $Q_5$  and  $Q_6$ .

## Fast discharge reduces multivibrator's rise time

By Larry V. Hendricks

Varian Data Machines, Newport Beach, Calif.

Fast removal of a stored charge keeps a single-shot multivibrator's rise and fall times down to about 10 nanoseconds. An emitter-follower action

and a strong current drive help narrow the pulses to as little as 20 nsec while maintaining stability during temperature and voltage changes.

In the quiescent state,  $Q_1$  and  $Q_3$  are saturated and the diode biases  $Q_2$  off. A negative trigger of 5 volts is coupled through  $C_1$  and turns  $Q_1$  off. The emitter-follower,  $Q_1$ , puts a negative voltage on  $Q_3$ 's base and enhances the removal of stored charge from  $Q_3$ . At the same time,  $Q_1$ 's collector delivers a positive voltage to  $Q_2$ 's base and turns it on. The current drive from  $Q_2$  quickens the rise time at the output.

Once the initial transient is coupled through  $C_1$

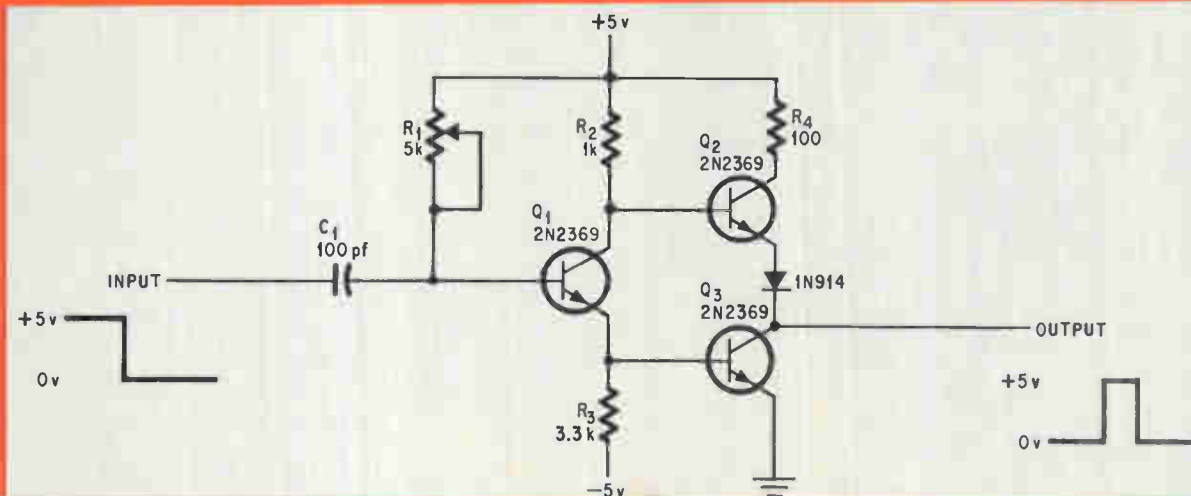

**Speedy response.** Pulses as narrow as 20 nanoseconds with rise and fall times of 10 nsec are generated by this single shot multivibrator. The 5-kilohm potentiometer produces delays that are greater than 100 nsec and are very stable during temperature and voltage changes.

and the input is held at ground,  $C_1$  will discharge through  $R_1$  with a time constant of  $R_1 C_1$ . Pulses as wide as 100 nsec are obtained by adjusting  $R_1$ .

When  $C_1$  has discharged to the cut-in voltage of

$Q_1$ ,  $Q_1$  and  $Q_3$  will again saturate and  $Q_2$  will turn off. The input must be held low for the duration of the desired delay, since a rise in input voltage at  $Q_1$ 's base would end the delay too soon.

## UJT protects op amp from voltage transients

By R. Chapman

National Research Council of Canada, Ottawa

Large voltage transients at the inputs of operational amplifiers can make them "latch on" if the input stage saturates or can even destroy them. Connecting a zener diode across the input will not solve the problem if a high input resistance is required. A unijunction transistor connected to the input, however, can both serve as a variable threshold limiter and maintain a resistance of about  $3 \times 10^9$  ohms.

The minimum threshold voltage of the circuit is determined by the ratio—typically 0.7—of the UJT's standoff ratio to its base-two voltage. If the base-two range is 3 to 35 volts, the threshold can be set from 2.1 to 24.5 volts. In the circuit shown, the UJT limits the input to 5 volts before firing. The UJT's emitter current is limited by the 100-ohm resistor.

The circuit shown limits positive-going transients

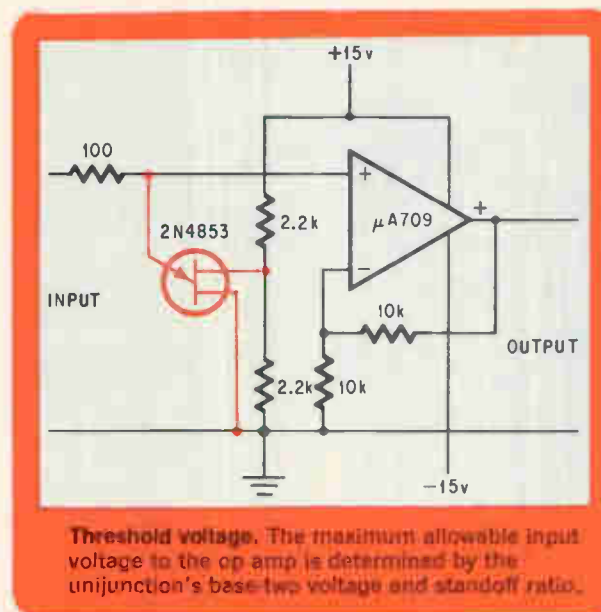

**Threshold voltage.** The maximum allowable input voltage to the op amp is determined by the unijunction's base-two voltage and standoff ratio.

only. A similar scheme, using the complementary UJT, can be used instead of or with this circuit to limit negative transients.



# Ferrites: part 2

## Circulators for vhf and up

Once considered purely microwave devices, these versatile components are now coming into wider use at the lower frequency ranges

By Vernon E. Dunn

Melabs, Palo Alto, Calif.

The circulator has been catching the fancy of more and more designers of r-f systems and circuits. Several years ago, many engineers considered circulators exclusively microwave devices, but today these versatile components are also offering solutions to many frustrating very- and ultrahigh frequency problems, such as an oscillator shifting frequency when connected to a load, or a transistor's amplifier stage breaking into oscillation during tuning.

These solutions still entail tradeoffs, of course, but with the circulator an engineer can trade less to get more. Without a circulator, the compromises were usually quite restrictive. For example, the amount of isolation required to buffer an oscillator from a load or to minimize the interaction of transistor stages had to be carefully weighed against the acceptable amount of insertion loss. And if no loss could be tolerated in the transistor amplifier or driver, the engineer could only fiddle with the tuning in hopes of getting the most out of the amplifier before a transistor was destroyed by oscillations. With the circulator, choices must still be weighed carefully, but are much less restricted.

### A disk and three coils

One of the typical types of circulators is the lumped-constant device, shown schematically on page 85. It's a symmetrical, nonreciprocal element consisting of three coils wound on the ferrite disk so that the magnetic field of each coil is rotated 120° with respect to the others. Additional disks, which provide a return path for the radio-frequency fields, are placed on the top and bottom of the main one. Finally, a d-c field that biases the ferrite near ferromagnetic resonance is applied normal to the plane of the disk. The ferromagnetic resonant frequency,  $\omega_0$ , is related to the bias field  $H_A$ , by

$$\omega_0 = \gamma H_A - 4\pi M_s$$

where  $\gamma$  is the gyromagnetic ratio, a constant usually taken as 2.8 megahertz per oersted and  $4\pi M_s$  is the saturation magnetization of the ferrite material in gauss.

Without the ferrite disk, a voltage applied to port 1 would induce equal voltages in coils 2 and 3 because of the circuit symmetry. The disk makes the magnetic coupling between the coils nonreciprocal; the coupling from coil 1 to coil 2 is no longer the same as that from coil 2 to coil 1. The nonreciprocity, then, provides isolation.

Analysis of the lumped-constant circulator shows that for ideal circulation at any one frequency,  $\omega$ , the following conditions must be satisfied

$$\frac{\omega L_0}{2} (\mu^+ - \mu^-) = \frac{R_0}{\sqrt{3}}$$

$$\frac{\omega L_0}{2} (\mu^+ + \mu^-) = \frac{1}{\omega C}$$

where  $R_0$  is the characteristic impedance,  $C$  is the capacitance in series with the coil,  $L_0$  is proportional to the inductance of one of the coils without the ferrite, and  $\mu^+$  and  $\mu^-$  are the effective scalar permeabilities of the ferrite for positive and negative circularly polarized fields. The typical behavior of the permeabilities plotted as a function of the bias field is shown on page 85.

These equations don't completely specify the design. For example, at a given frequency, the difference between  $\mu^+$  and  $\mu^-$  depends on where the ferrite is biased, which therefore determines how large a value of  $L_0$  is required. The choice of bias point is far from arbitrary, because the bandwidth and insertion loss of the circulator increase as the bias point gets closer to resonance. On the other hand, operating much below resonance increases insertion loss.

The equations, then, ensure good isolation at

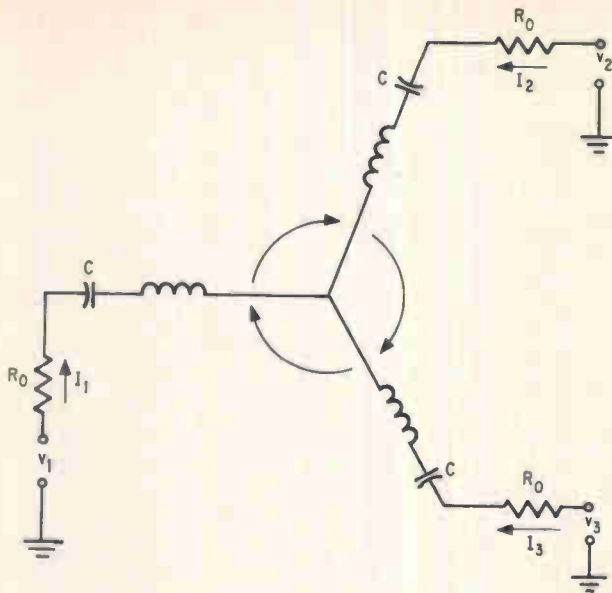

Equivalent circuit. A series capacitor resonates winding inductance of a lumped-constant circulator.

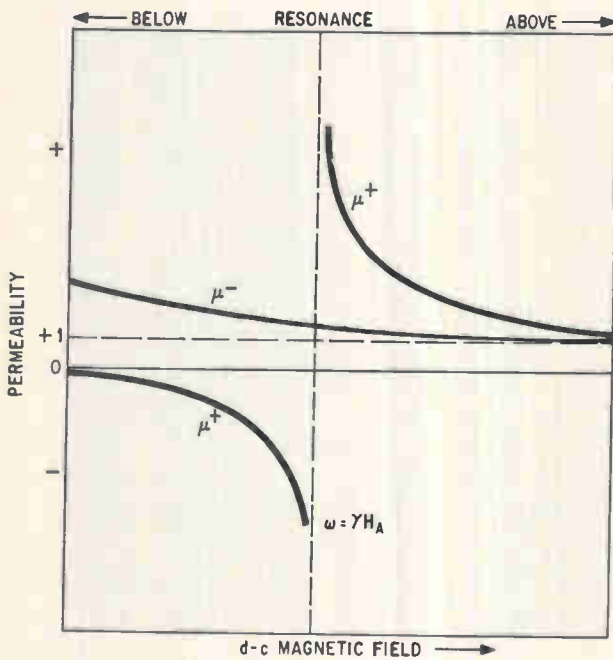

Biased. The value of the d-c field determines the isolation, insertion loss, and bandwidth of the circulator.

only one frequency; at other frequencies, the isolation decreases and the insertion loss increases. That bandwidth for which the isolation is greater than 20 decibels—usually considered the practical minimum—is given by

$$\frac{\Delta\omega_{20\text{db}}}{\omega} = 0.2 \sqrt{3} \left( \frac{\mu^+ - \mu^-}{\mu^+ + \mu^-} \right)$$

The minimum practical operating frequency can

be expressed in megahertz as

$$f_L \cong 2.8 \times 4\pi M_s$$

Materials that are commonly used have saturation magnetization that range from less than 100 gauss to about 5,000.

Operation in the vhf region, then, requires materials that have a low saturation magnetization; for example, a figure of less than 100 gauss is required for operation below 280 Mhz. Unfortunately, these materials tend to have rather poor temperature properties, and as a result, below-resonance operation is rarely used below 1 gigahertz. Above-resonance operation suffers from reduced bandwidths, and as the circulator is operated at higher frequencies, much larger magnetic bias fields are needed.

Lumped-constant circulators have been operated from uhf down to 35 Mhz with insertion losses that ranged from 0.3 db at 400 Mhz through 0.8 db at 100 Mhz to 2 db at 35 Mhz.

Good points for operation, then, are found slightly but not much below resonance. At these points isolation decreases, so does loss. The exact point chosen, of course, will depend on the user's specific requirements.

A nonreciprocal lumped-constant circulator, called an isoductor by Melabs, can give the circuit designer additional flexibility. Using suitable design circuitry, the isoductor can provide either isolation or circulation, but, unlike the conventional circulator, it can be tuned at any frequency from 100 to 600 Mhz, as well as for impedance levels other than 50 ohms. The performance data of a triple-tuned, above-resonance circulator is shown on page 86.

Junction circulators are closely related to lumped-constant types, much as a resonant cavity is akin to a lumped-constant resonant circuit. A stripline junction circulator is illustrated on page 86.

The ferrite disk acts as a dielectric resonator; the smaller its diameter, the higher the frequency. The relatively high dielectric constant of ferrite materials—12 to 15 times that of free space—makes it possible to build circulators that, for microwave frequencies, are reasonably small. Of course, in the vhf and uhf regions, lumped-constant circulators can be made smaller than the distributed-junction types because at the lower frequencies lumped elements are much smaller than resonant cavities or quarter-wavelength matching transformers.

The circulator's bandwidth is limited by ferrite material properties but can be increased by broadbanding techniques. A bandwidth of 15% for 20 db of isolation can be achieved in a circulator without broadbanding elements. However, if additional matching circuits are used to double- or triple-tune each port of the circulator, the bandwidth can be improved from two to five times. In any case, though, an octave bandwidth is about the best that can be achieved. Typical performance data for a double-tuned microstrip circulator is shown on page 87.

**Peaks and valleys.** As the vswr goes, so goes the isolation. The points of minimum vswr corresponds to the points of maximum isolation in the triple-tuned above-resonance lumped-constant circulator. Although the insertion loss can be kept below 0.5 db over most of the frequency range, it does increase at both ends.

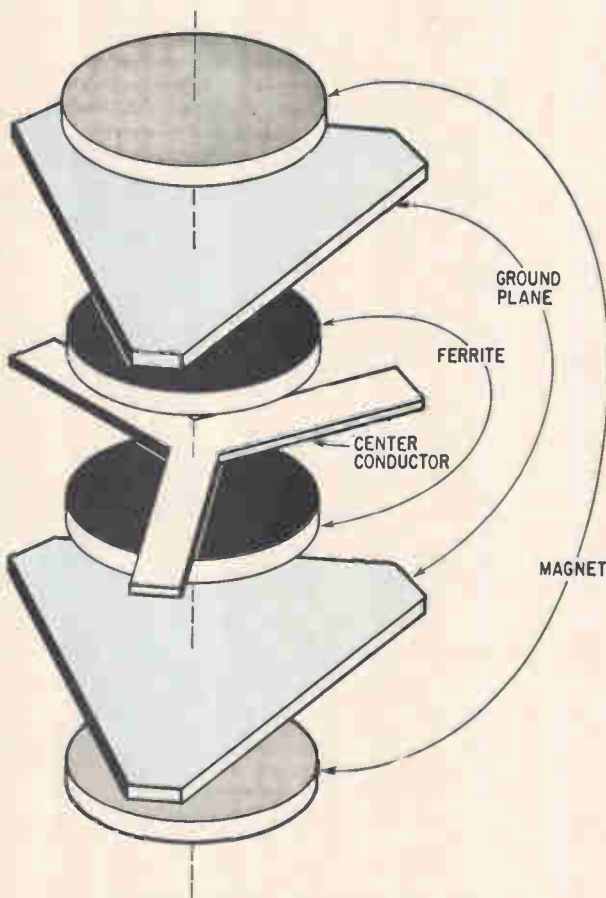
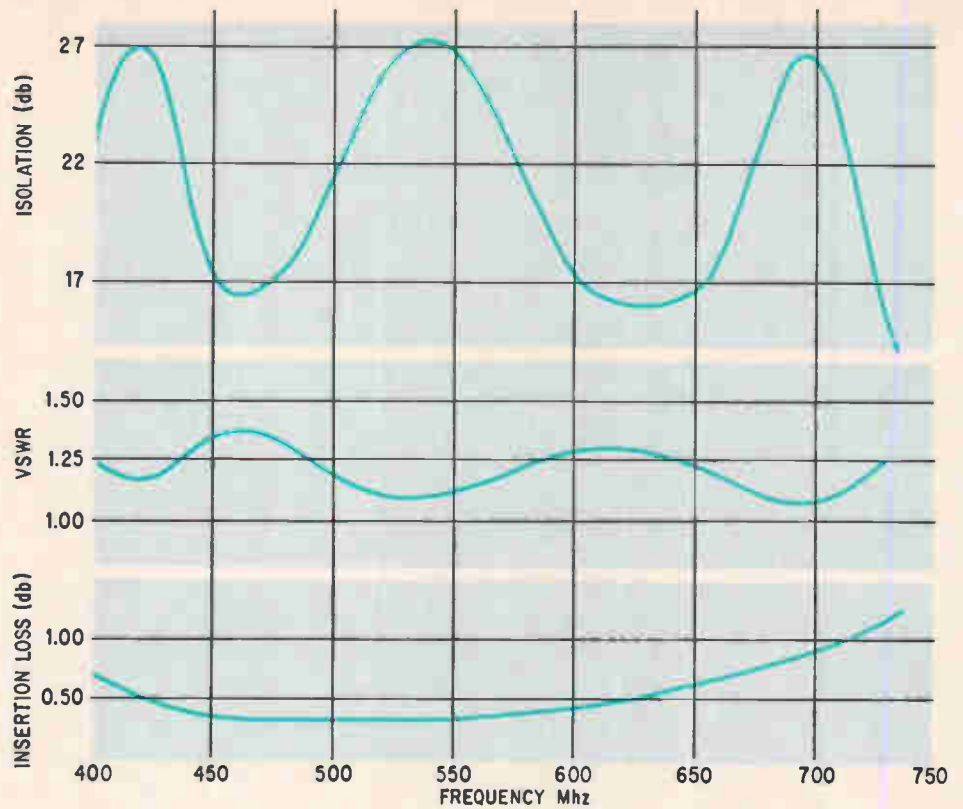

**Layers.** Two ferrite disks and the center conductor are sandwiched between the ground planes, and the two magnets bias the stripline junction circulator.

Junction circulators are built in stripline, waveguide, and microstrip configurations. They cover octave bandwidths at microwave frequencies, but are limited to about 40% at vhf and uhf. Of course, if a narrower bandwidth can be tolerated, improved performance, lower cost, and smaller size can be realized. At X band, a junction circulator using coaxial connectors has an insertion loss of 0.3 db, a voltage standing-wave ratio of less than 1.25, and an isolation of more than 20 db over a 15% bandwidth. The circulator, which is built into a half-inch cube, operates from  $-55^{\circ}\text{C}$  to  $+70^{\circ}\text{C}$ . Waveguide circulators offer lower loss and a better vswr than the coaxial type for the same isolation and bandwidth. For example, a vswr of 1.05 and an insertion loss of 0.1 db can be achieved over a 15% bandwidth. The waveguide type, however, at uhf and vhf is larger than an equivalent junction type.

**Same result, different method**

Another type, basically a transmission line loaded with ferrite, is called a resonance isolator. The ferrite is positioned so that a signal traveling in one direction does not interact with it and passes through relatively unimpeded; a signal traveling in the opposite direction does interact with the ferrite and is attenuated. In this type of isolator, the reverse signal power is dissipated in the ferrite. Still another type of circulator-isolator is the differential phase-shift circulator. It is a four-port device constructed from a combination of conventional microwave 3-db couplers and ferrite non-reciprocal phase shifters (lengths of ferrite-loaded



transmission line in which the amount of phase shift depends on the direction of propagation in the line).

Even though the differential phase-shift circulator is larger than the junction circulator, it is used for high-power duplexers.

Since the direction of circulation depends on the polarity of the magnetic bias field, a circulator can function as a single-pole, double-throw switch simply by controlling the bias field. This field is generated either by an electromagnet or by construction of the circulator so that the d-c magnetic flux has a closed return path through a magnetic material with a square hysteresis loop.

Circulators can be latched in either of two states and switched from one state to the other. This is done by controlling the polarity of the pulse passing through the control winding of the electromagnet switching the state of the ferrite material.

Many latched circulators provide a return flux path outside the microwave part of the structure, but some have been built with the return path inside the microwave part. Doing this minimizes switching time and energy and the ferrite volume, but performance isn't usually as good as that of devices with external flux paths.

### Workhorse

Another task handled by circulators is circulating energy from one port to the next with relatively little loss in the preferred direction while providing isolation in the reverse direction. Perhaps the most common application of this sort is a duplexer—a device that connects a transmitter and receiver to a common antenna. The circulator isolates the receiver from the transmitter energy and provides low-loss paths from the transmitter to the antenna and from the antenna to the receiver.

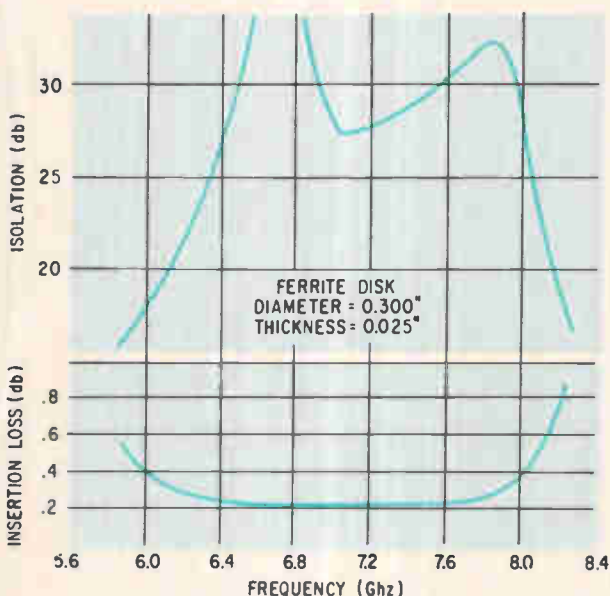

Wider. Double-tuned circuits broaden the bandwidth of an X-band microstrip circulator.

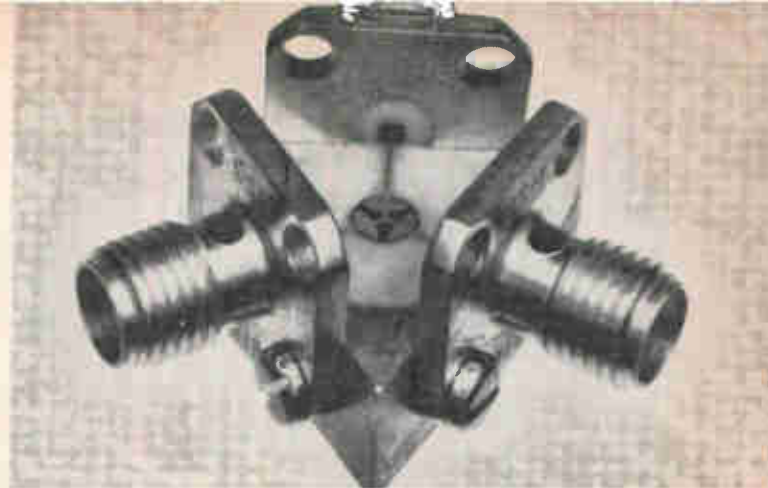

Microstrip circulator. The coaxial connectors dwarf the 1/8-inch-diameter X-band circulator element. The "Y" of the narrow center conductor provides tight inductive coupling to the ferrite, and the large tabs add the shunt capacitance.

Circulators also couple signals to the input of a negative resistance device, such as a tunnel diode or a parametric amplifier, and couple the resulting amplified signal to the output. Since the magnitude of the reflection coefficient at the end of a transmission line can be greater than unity, if a circulator separates incident and reflected signals and controls the direction of travel of each, a two-port amplifier is the result. Usually, isolators are placed on the amplifier's input and output to ensure stable operation even with changing load and source impedances.

In another application, terminated circulators can isolate two or more communications transmitters to reduce intermodulation distortion. Without this isolation, energy could be coupled from one transmitter to the other, thus producing undesirable third-order intermodulation products.

Circulators are also used as a convenient method of phase-locking a diode oscillator to an external signal. The oscillator is connected to one port of the circulator and a low-level reference signal to another port. The oscillator is then phase-locked to the reference signal and the output is taken from the third port.

The use of integrated-circuit fabrication techniques is now enabling producers to turn out large quantities of microstrip circulators. The process, which is more reliable and reproducible than conventional methods, makes these circulators more compatible with microwave IC's.

### Bibliography

- H. Bosma, "On Stripline Y Circulation at UHF," IEEE Transactions on Microwave Theory and Techniques, vol. MTT-12, No. 1, January 1964.
- C.E. Fay and R.L. Comstock, "Operation of the Ferrite Junction Circulator," IEEE Transactions on Microwave Theory and Techniques, vol. MTT-13, No. 1, January 1965.
- V.E. Dunn and R.W. Roberts, "New Design Techniques for Miniature vhf Circulators," 1965 G-MTT Symposium, Clearwater, Fla., May 1965.
- Y. Konishi, "Lumped Element Y Circulator," IEEE Trans. Microwave Theory and Techniques, vol. MTT-13, No. 6, November 1965.

# Automating all along the line

With very little human help, computer- and tape-controlled machines make circuit assemblies faster and more reliably than semiautomatic processes

By Thomas J. Thomas

Kearfott Products Division, Singer-General Precision Inc., Little Falls, N.J.

**Automation** of some steps in circuit production is far from new. It usually works fine as far as it goes, but the steps that remain unautomated are often time-consuming, and human error can result in an unreliable piece of hardware.

By almost completely replacing the human element with computer- and tape-controlled machines, the Kearfott Products division of Singer-General Precision Inc., has sharply increased output and reliability of its avionics production line. Kearfott has automated all operations except the loading of machines and a few other tasks. Because the tooling is in the paper tape that controls the machinery rather than in hard fixtures, the 75,000 square-foot facility can shift production from one kind of printed-circuit assembly to another by simply reprogramming. The line turns out more than 90 kinds of p-c assemblies.

## Vital element

There are three parts to Kearfott's automation: design, manufacturing, and testing of both the purchased components and the finished circuit boards. Perhaps the most important element in the system is the computer program that takes the engineer's schematic and works out the layout for the circuit boards. At the same time, the program produces some of the control tapes, develops lists of needed materials, and prints out requisition forms and purchase orders.

With few exceptions—when putting on trim components, for example—production-line workers don't touch the components, which are supplied in protective carriers or reels. They're removed by a machine only when they're to be fastened to a circuit board.

Most of the production machines were specially built for Kearfott by outside suppliers, who plan to offer similar units to the industry. These include:

- A sequencer that arranges discrete components

on a belt in the order in which they're to be inserted into the p-c boards. The unit can select components from as many as 18 storage bins.

- A component-insertion machine with a servoed, adjustable head that can handle any of the parts selected by the sequencing unit. In ordinary insertion machines, the head must be changed each time the size of the component changes. This means that a separate pass must be made over the p-c board each time a different type of component must be inserted. First the machine inserts the resistors, then the capacitors, and so on. The new machine, made by Universal Instruments Corp. of Binghamton, N.Y., handles any mix of components so that all parts can be inserted in a board in one pass. This saves not only time but also space on the production line, because a single machine can do the job of several. Components can be inserted at a rate of up to 1,800 per hour. At most, a standard circuit card—6 by 3.8 inches—has 75 components and 45 flatpacks on a side.

- An automatic reflow soldering machine that selects any of up to 14 different types of integrated circuits from feed bins, then fastens them automatically to a circuit board. The fastest conventional soldering machines are semiautomatic; an operator must position either the soldering head or the circuit board, transport each IC into place, and press a button to solder.

The cards are used in the analog-digital converters and control panels in the advanced avionics package for the F-111D fighter and FB-111 fighter-bomber, the navigational computer for the P-3C early warning aircraft, and the converter for the A-7D/E Corsair II attack aircraft.

## Two programs

The components on the engineer's schematic are fitted into a layout at Kearfott's Little Falls, N.J., facility by two computer programs. One, supplied





Tape by tv. An artwork master on tv is used to prepare a control tape for the drilling machine.

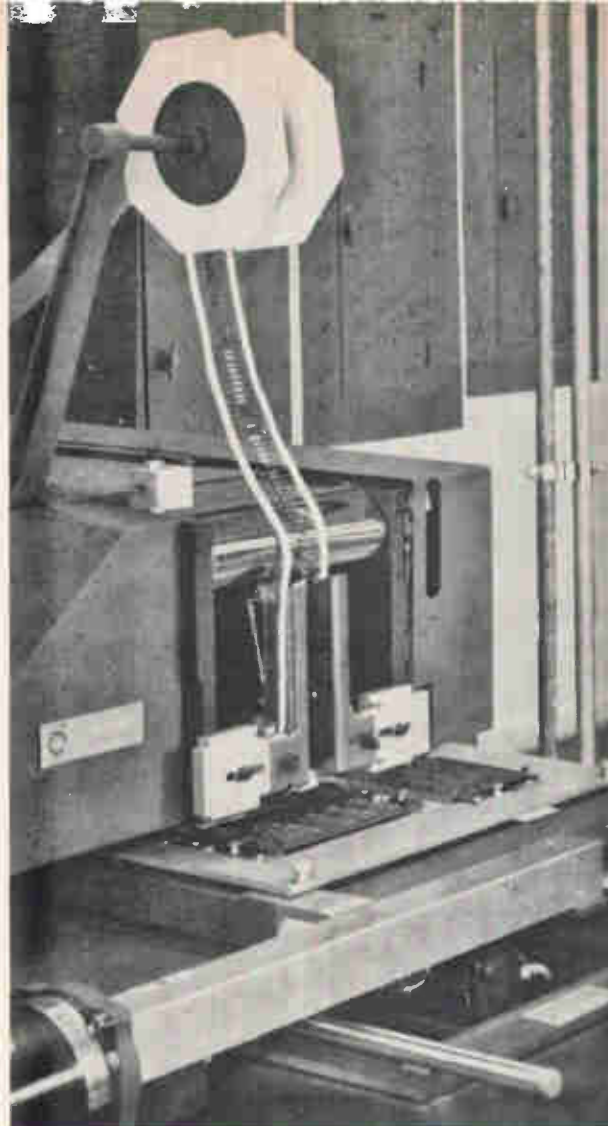

Size no object. The component inserter, above, can handle all parts as they come along because its servoed head adjusts, as seen in the multiple exposures below. A p-c board can be assembled in a single pass.

by ITT Data Services, Paramus, N.J., clusters the IC elements, such as gates and flip-flops, to minimize the number needed. Then the program decides in which IC's the elements should be placed.

The second program, developed by Singer's Friden unit in San Leandro, Calif., takes the clustering and placement information, with the rest of the circuit details, and routes the wiring. Interconnection crossovers are kept to a minimum and components are positioned—generally with their axes pointed in one direction—so they can be easily placed on the board by the automatic equipment.

Soon, both parts of this procedure will be brought together in a single program that will also minimize the number of plated-through holes in the circuit board. These holes are a potential source of unreliability because extra steps, such as plating and eyeletting, are required to produce them. Sharply reducing plated-through holes minimizes the chance that a manufacturing variable, such as hole-etching time, photo-exposure time, or humidity, may be inadequately controlled.

To make the boards even more reliable, Kearfott doesn't use a multilayer design. It uses a board with a 50-mil-thick aluminum core. The rigid core acts as a ground plane and heat conductor.

An engineer uses the Friden program by keying into the computer the types of components in his

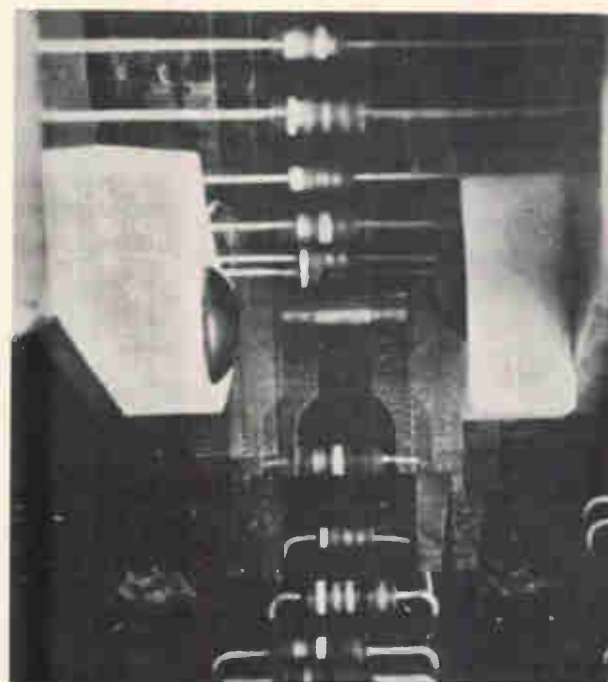



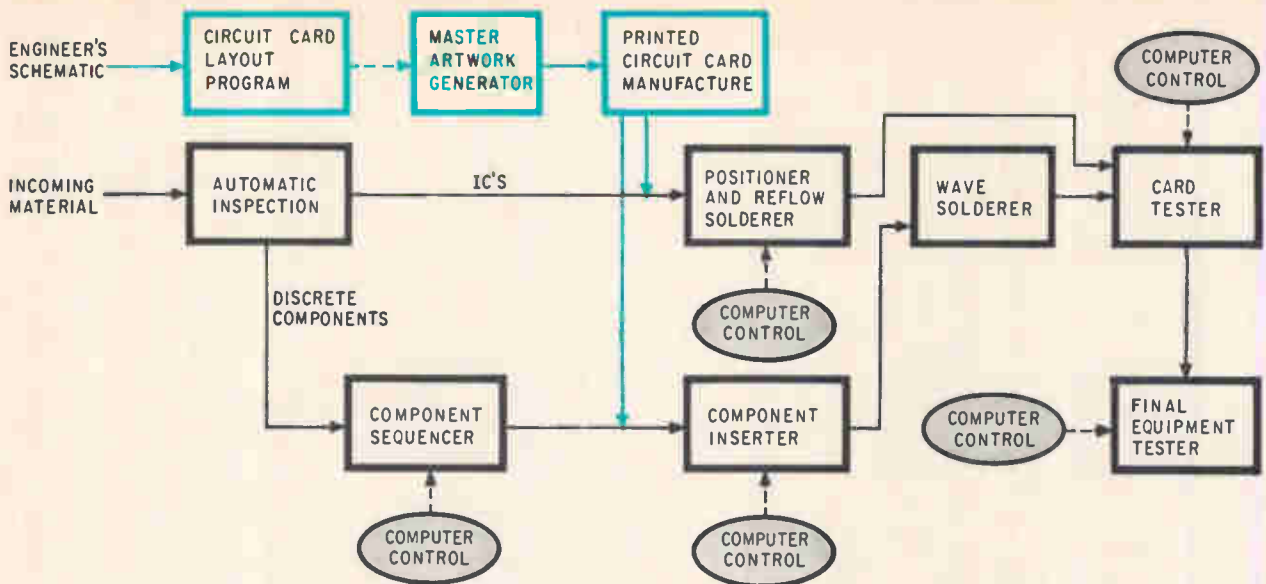

No hands. Computers and punched tapes produce artwork masters and control incoming and final inspection, component insertion and soldering, and almost all other steps in p-c board assembly.

schematic and how they're interconnected. The computer is also told the dimensions of the p-c card and the coordinates of areas where components and interconnections may not be placed. The computer program then does the rest, using standard widths for signal and power lines. Ten mils is a good width for signal lines, 30 mils for power lines.

### Film direction

The artwork for photoetching the patterns on the circuit boards is developed from the layout. Currently, this is done manually by an operator at an automatic drafting machine made by the Mergenthaler Linotype Co., a division of the Eltra Corp., N.Y. The rough layout from the computer is used as the basis for precisely locating lines and hole patterns. The operator selects the patterns from a library of slides within the machine, which then produces the layout pattern by photographically exposing a Mylar film. The artwork is completed by a technician, who very carefully puts down opaque black tape.

This machine, called a Diagrammer, and its operator will be replaced by an automatic machine developed by the Superior Electric Co., Bristol, Conn. Numerically controlled, the SNC100 Photo-optical Positioner System produces one-to-one artwork masters for the p-c boards. The base price of the positioner is \$26,000, from \$40,000 to \$170,000 less than numerically controlled drafting machines already on the market. The price is low because the machine is designed for generating artwork, not for general-purpose drafting.

The new machine consists of two basic parts: an off-the-shelf three-axis numerical controller that Superior sells for controlling tools such as drills and milling machines, and a precision x-y plotting

table with an optically focused light source. The table can travel over an 11-by-18-inch rectangle. This is a considerably smaller area than is usually covered by the general-purpose drafting machines, so the positioning and environmental controls are simpler.

Mylar film or a glass master is fastened to the table underneath the light source. In front of the light is a disk with 66 apertures shaped in straight lines, pads, or circles. Light shines onto the film through an aperture selected by the control tape, which comes from the layout program.

As the table moves, the film is exposed. Line widths ranging from 5 to 300 mils can be traced on the film to an accuracy of  $\pm 1$  mil. The control program also adjusts the intensity of the light to maintain line clarity as the table changes speed. Kearfott has produced photographic masters on 4- and 7-mil Mylar film and on glass.

### Drill instructor

The control tape that generates the artwork can also be used for drilling and eyeletting the boards. The tape formats for controlling the machines are the same. It's also possible to prepare by hand a tape for controlling the artwork generator; the input is obtained from a grid-paper layout of the p-c board.

Right now, drill tapes are produced by fastening the master artwork from the Mergenthaler Diagrammer onto a precise x-y positioning table and focusing a closed-circuit television camera on it. An operator, looking at a greatly enlarged part of the artwork in the tv monitor, positions a set of cross-hairs precisely in the center of each hole by moving the x-y table. He then presses a button, and the control tape for the drill is punched out.

A television system that can work in a fairly

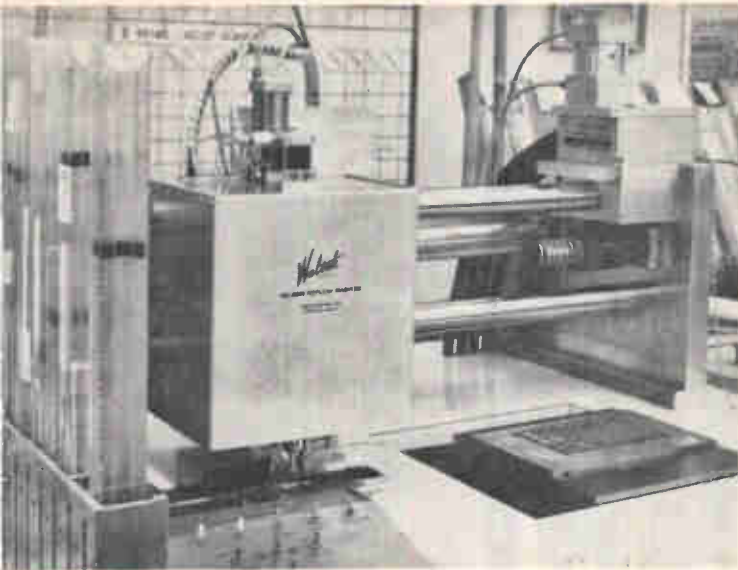

No bother. The automatic reflow solderer selects an IC from the feed bins and puts it on the p-c board.

low light level is used; a conventional optical reader's light could distort the Mylar artwork masters. Glass masters, which could withstand the heat, are 3 to 10 times as expensive.

With some additional information—such as the type and size of the components to be inserted in the hole—the drilling-machine tape is used to produce tapes that control the sequencing and insertion machines.

The sequencer puts the components on a reel in the order they're to be used; the reel is then fed into the insertion machine, where the program tape anticipates the size and shape of the component about to be put into the board. Automatically adjusting the size of the servoed insertion head, the tape commands the head to grasp the component and insert it. The machine also bends and crimps the leads, clipping them onto the back of the card.

Production is speeded if a circuit board has either all discrete components or all flatpacks. Every board with flatpacks, however, requires at least two resistor-capacitor networks for clipping line transients. The components are inserted first, the board is wave-soldered, and then the IC's are reflow-soldered in place.

### Six-second solder

The programmed reflow soldering machine, developed for Kearfott by the Weltek division of Wells Electronics Inc., South Bend, Ind., solders up to 14 leads on an IC flatpack in a single heat cycle. The IC's come from the supplier tinned and cut to size. Each IC comes in a special two-piece carrier that Kearfott, because it buys so many units, was able to design and insist on receiving.

This carrier, consisting of a holder and a small, pop-off cap, is compatible with the production-line

machines. The IC rests in the holder, secured by the cap. Two prongs coming up through the bottom of the carrier easily pop the cap off so that the IC can be lifted out by a vacuum head. The caps on most of the other carriers on the market were designed to be removed by hand.

In the soldering machine, IC's are arranged in as many as 14 different feed magazines. The p-c card on which the IC is to be soldered is held flat on an x-y table. A transport mechanism selects an IC from the bottom of a magazine and shuttles it to a pickup station, where the cap is popped off. The vacuum head lifts the flatpack out of the carrier and places it down onto the programed pads on the circuit board, which has been moved into position by the table. The reflow soldering head, made of a beryllium-copper alloy that retains little heat, holds the leads in position while the heat is automatically applied. A blast of air cools and hardens the solder quickly.

Until this machine was developed, production-line soldering devices were semiautomatic, requiring an operator to position the circuit card and initiate the soldering action. One type of IC was worked on at a time by hand. An experienced operator can solder one IC to a board in about 30 seconds, but the automatic machines take only six seconds.

Another different aspect of the new machine is that the flatpack leads aren't crimped before being soldered. (The crimp is made to help an operator solder the leads.) The leads are left straight and, on the finished board, have a slight bow. This bow, unlike a crimp, doesn't put any stress on the hermetic seal and allows for differential expansion of the seal and lead materials.

### Quick tests

All the discrete components are electrically tested while they're still in the reels they're supplied on. A reel handler feeds the components into a Fairchild 4000M programed component tester that handles up to 1,800 discrete devices per hour. Components that fail the tests are cut out of the reel automatically. A flatpack handler feeds the Fairchild tester with up to 400 IC's per hour.

The finished cards are tested on a programable automatic test console, PAT 202, built by Kearfott. Separate test programs are compiled for each type of card and put into the tester on punched tape. The cards are first tested, by a Digital Equipment Corp. PDP-8 computer, without trim components installed. The value of the trim component is then calculated by the computer; a printout provides the values required at the various trim positions. After the trim components are put on by hand, the card is run through the automatic tester for a final acceptance check.

A different version of the Kearfott tester, the PAT 302, checks out the completed avionics systems after cables and harnesses are first checked by a Hughes Aircraft Co. Flexible Automatic Circuit Tester (FACT 8) run from punched cards.

# SPST, DPDT, SPDT, DPST, 4PST...

What type of *Analog Switch* do you need?

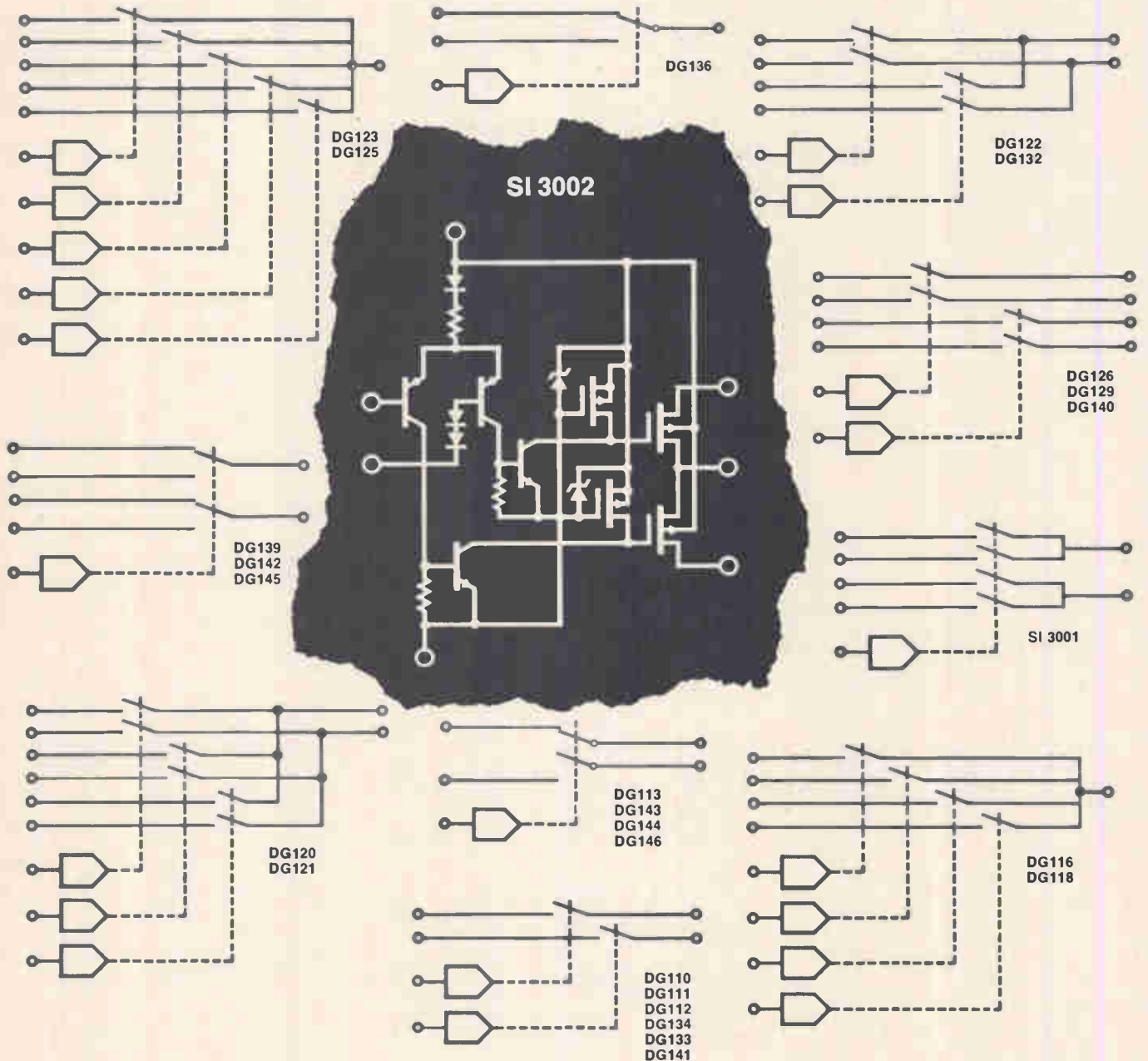

We offer 27 different integrated circuits to satisfy known driver-FET switch needs. Features include:

- MOS or junction FETs
- $r_{ds}$  as low as 10 ohms max
- Switch analog signals up to 20V
- Drive from standard 5V logic
- Up to 5 channels per package
- TO-86 or TO-100

Write for our FET Switch Data Packet or tell us your design problem.



**Siliconix incorporated**

1140 W. Evelyn Ave. • Sunnyvale, CA 94086  
Phone (408) 245-1000 • TWX: 910-339-9216



## HERE'S HOW...

THE ELECTRONIC INDUSTRY IS USING  
THESE FAMOUS ULANO FILMS IN  
ULTRAMINIATURE MASK TECHNOLOGY  
AND COMPLEX PRINTED CIRCUITRY

Cut a piece of the desired film large enough to cover area to be masked. Tape it down firmly at the top with dull-side up.

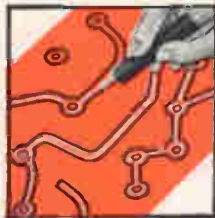
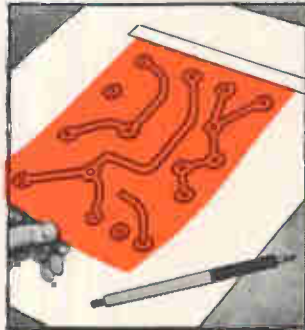

With sharp blade, outline the areas to be masked. Do not cut through the backing sheet. The Ulano Swivel Knife does the job quickly, easily.

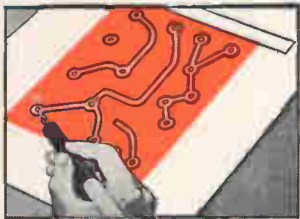

Using the tip of the blade, lift up a corner of the film thus separating it from the backing sheet.

Now carefully peel off the film as outlined leaving a completed mask, positive or negative, that corresponds exactly to the desired pattern.

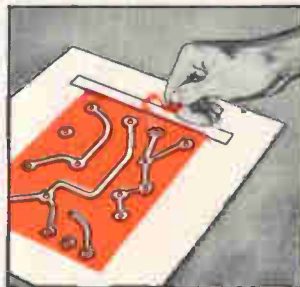

**Ulano**<sup>TM.</sup>  
**RUBYLITH**<sup>TM.</sup>  
**AMBERLITH**<sup>TM.</sup>

HAND CUT MASKING FILMS FOR THE GRAPHIC ARTS

ULANO RUBYLITH . . . a revolutionary knife cut red film is laminated to a stable transparent plastic backing sheet. The red film is "light safe" so that when contacted to a sensitized emulsion and exposed to a suitable light source, light passes through the cut-out portions only . . . not through the red film. ■ The polyester backing is absolutely stable . . . insures perfect register. ■ Special effects such as crayon tones, paste ups, benday sheets, and opaquing are easily combined with versatile ULANO RUBYLITH.

ULANO AMBERLITH . . . a companion to Rubyolith serves as a color separation medium used as the master on camera copy board to secure negatives or positives.

*A wide variety of Ulano films—  
in rolls and sheets—is readily available*

*Designed*  
**FOR YOUR PARTICULAR NEEDS**

Ulano offers the most versatile line of hand-cut masking films, including:

**.0075—RUBYLITH 75 DR\*** **.005—RUBYLITH 5 DR†**

**.005—AMBERLITH 5 DA†**

Where exact register assures a critical importance, you will find these new, thick, polyester based films the positive answer.

\* Available in sheets only, cut to your specifications

† Available in rolls and sheets



**WRITE TODAY**  
*on your letterhead for free  
special sample kit 1748*

"Ulano"—"Rubyolith"—"Amberlith" are registered trade marks of the Ulano Companies.

**ulano**

610 DEAN STREET, BROOKLYN, N.Y. 11238

In Europe: ULANO A.G., Untere, Hesiibachstrasse No. 22, Kusnacht, Zurich, Switzerland

# Speed reading for status seekers.\*

You've never seen an indicator quite like this before. Only the exclusive optical meter capability of Weston could offer it to you now. The new Weston Model 1316 Optical Ribbon Indicator lets you scan the status of many parameters at a quick glance. Parallax problems are eliminated by optical projection, and the unique design allows the flat scale to be changed as often as desired without expos-

ing the mechanism. It's ideal for displaying temperature, making inspection histograms, or gauging liquid or material levels. The flat, self-shielded mechanism also permits side-by-side mounting where group display is required. So you can use multiple units as a medical patient/station monitor, for example, or to monitor temperature profiles or a roomful of lathes. Accuracy is  $\pm 1\%$ , and the instru-

ment is available in all popular ranges—including suppressed zero for process control applications. Priced under \$60 in quantity. Write today for complete details on this latest Weston advance in optical meters. **WESTON INSTRUMENTS DIV.**, Weston Instruments, Inc., Newark, N.J. 07114, a Schlumberger company.

**WESTON**<sup>®</sup>

\*The Weston Optical Ribbon Indicator

PS.I. X10

.000"

GALS.

CU. FT.

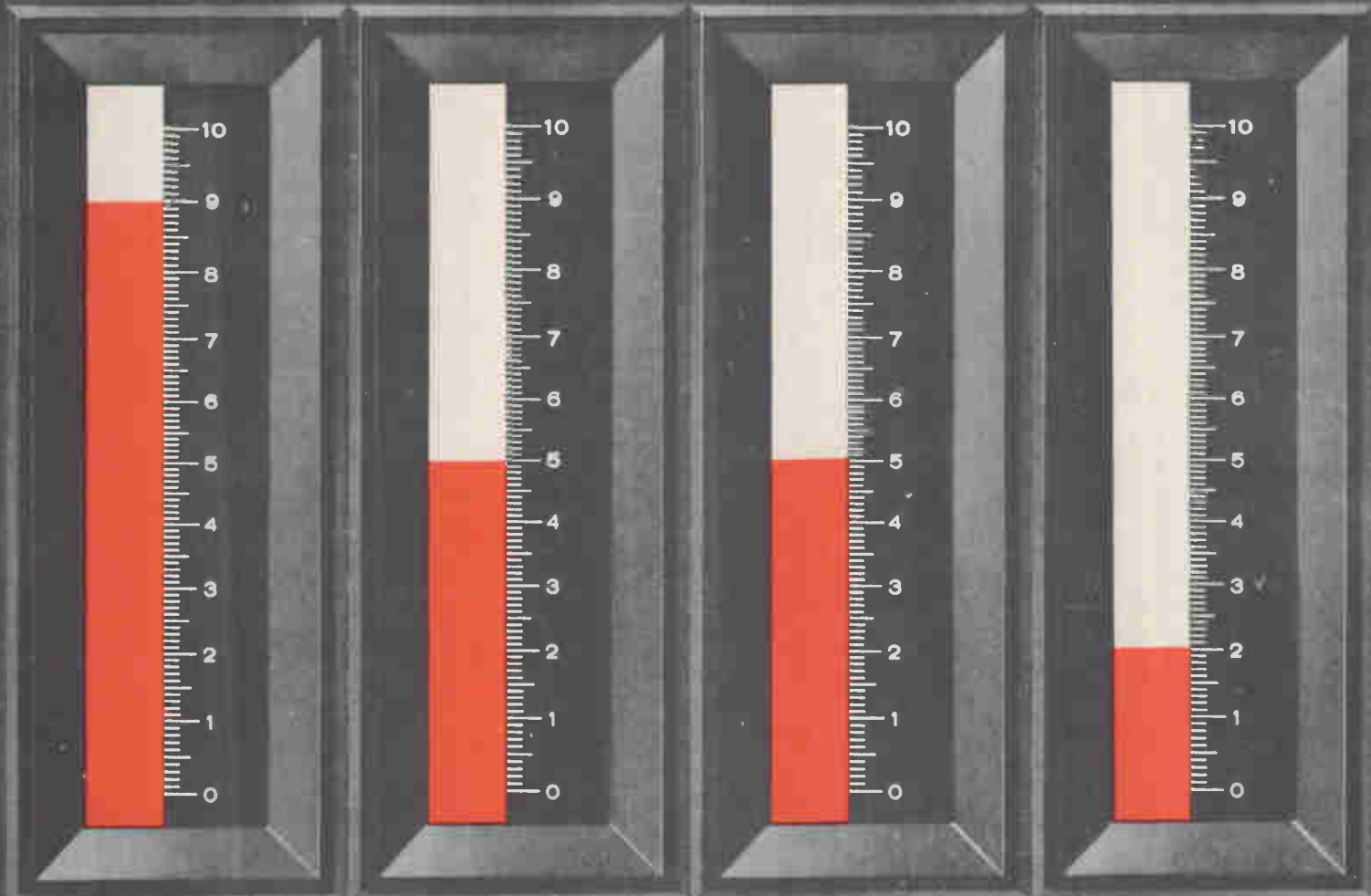

**“I wonder... so many facts point to expanding in Wisconsin, but what's it really like to live there?”**

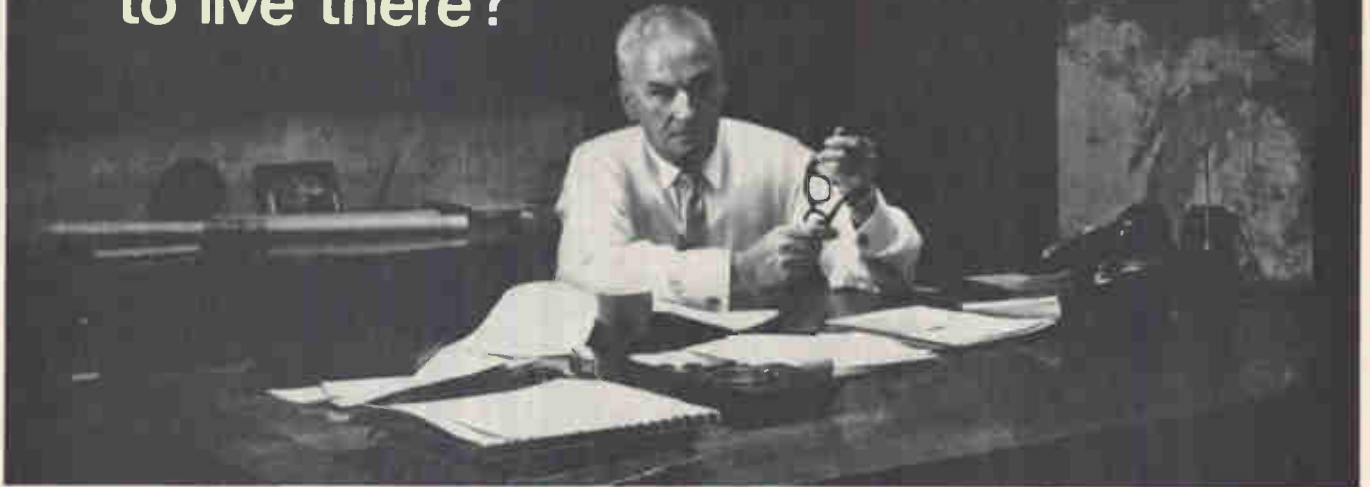

*two ways to get candid answers to this key question*

**1.** Talk to a Wisconsin business executive — off the record — at his office or at yours, or on the phone. We will help arrange this kind of get-together for you . . . through the Wisconsin Development Authority. This is a group of more than one hundred Wisconsin company presidents, many in the same business as yours.

These WDA members are knowledgeable, practical-minded executives who welcome *candid* man-to-man discussion with you. They will answer your questions frankly.

Write us on your executive letterhead, or return the coupon, and we'll arrange this kind of meeting for you. (In addition, we'll send you useful new booklets on Wisconsin's industrial advantages and opportunities.)

**2.** Just beginning to think about expansion in Wisconsin? A possible move to Wisconsin? See what it's really like to live here and do business here; “be our guest” in your home or office — *free* — through the pages of our newspapers! They reflect our lives — day after day, revealing everything from the price of eggs to the status of the labor market as portrayed in classified ads.

We'll gladly send to any *qualified business executive* a paper from a different Wisconsin community every day or two — a total of 30 issues in all. We'll also acknowledge your inquiry with a fact kit on Wisconsin. Write — using your company letterhead, or send the coupon below. (Sorry, neighbors. This invitation open to industrialists everywhere, except those living in Wisconsin.)



# Wisconsin

**8 Good TAX-REASONS Why “You'll Like It Here”**

- Wisconsin did not raise tax rates or add new taxes for fiscal 1967-69. All adjoining states raised taxes and/or altered tax systems.
- We have no capitalization tax.
- Corporate income tax provides for two-year net loss carry-forward . . . no “poor year” burden.
- Properly tax credit on inventories is up to 60%.
- Our average unemployment compensation tax rate was 1.5% . . . national average 2.0% (1966).
- Industry realizes an average of 22.7% relief on personal and real property tax.
- Per capita sales tax of median state among those having sales tax was \$42.35 . . . ours only \$22.14 (1966).
- Wisconsin returns 61% of its revenues to local governments.

**Division of Economic Development, 757 State Office Bldg., Madison, WI. 53702**

<p>NAME _____ TITLE _____</p> <p>FIRM NAME _____</p> <p>KIND OF BUSINESS _____</p> <p>ADDRESS _____</p> <p>CITY _____ STATE _____</p> <p>ZIP _____ PHONE NO. _____</p>	<p>1. I'm interested in speaking with your WDA business man <input type="checkbox"/></p> <p>2. Send the newspapers to my home <input type="checkbox"/> office <input type="checkbox"/></p> <p>HOME ADDRESS _____</p> <p>CITY _____</p> <p>STATE _____ ZIP _____</p>
--	---



# Electron gains > $10^8$ with background counts < 1 in 10s



... obtained from the Mullard range of 14 standard Channel Electron Multipliers. Specials built to order.

**Response** All these Multipliers respond to electrons, ions, short-wavelength ultraviolet radiation, and both soft and diagnostic-quality X-radiation.

**Ideal for rocket and satellite payloads** Because they are small and rugged, have a high electron gain, and require only minute operating power. Earth bound applications are in the fields of mass and ultraviolet spectroscopy.

**Important properties** \* windowless input \* high electron gain \* low background count rate \* narrow pulse-height distribution \* low power consumption.

**Features that count** \* performance independent of ambient pressure over a wide range \* compact, rugged and light \* freedom from contamination after long-term exposure to normal atmospheres \* simplicity of use.

Two series are available—high-resistance, with a particularly low power consumption, and low-resistance for high pulse-counting rates. There are open or closed output versions of all types for dc or pulse-counting operations.

The Mullard range of Channel Electron Multipliers has been developed from a specialised series of Electron Optical devices. These include channel plates, infrared image converters and cascade image intensifiers—all from Europe's largest image-device facility.

Every designer should have a copy of the Mullard book on C.E.Ms. It gives full information on their characteristics and principles of operation. Also ask to be put on the mailing list of the Mullard Bulletin—a regular publication which gives details of new components and applications . . . the result of extensive research and development programs in the Mullard laboratories in England. Mullard employ 1000 qualified scientists and engineers and have six major plants, with over 3 million square feet of floor space.

Write today for information on Mullard Channel Electron Multipliers, and name of your local representative.

Mullard Limited, Mullard House, Torrington Place, London WC1, England.

U.S.A. enquiries to Mullard Inc., 100 Finn Court, Farmingdale, Long Island, New York. 11735 U.S.A. Telephone: (516) 694-8989 Telex: 961455.

# Mullard

MOL50

# NEW

## HIGH GAIN PLANAR TRIODES

# 20 dB

FOR U. H. F.  
TELEVISION  
TRANSLATORS  
470 - 960 Mcs

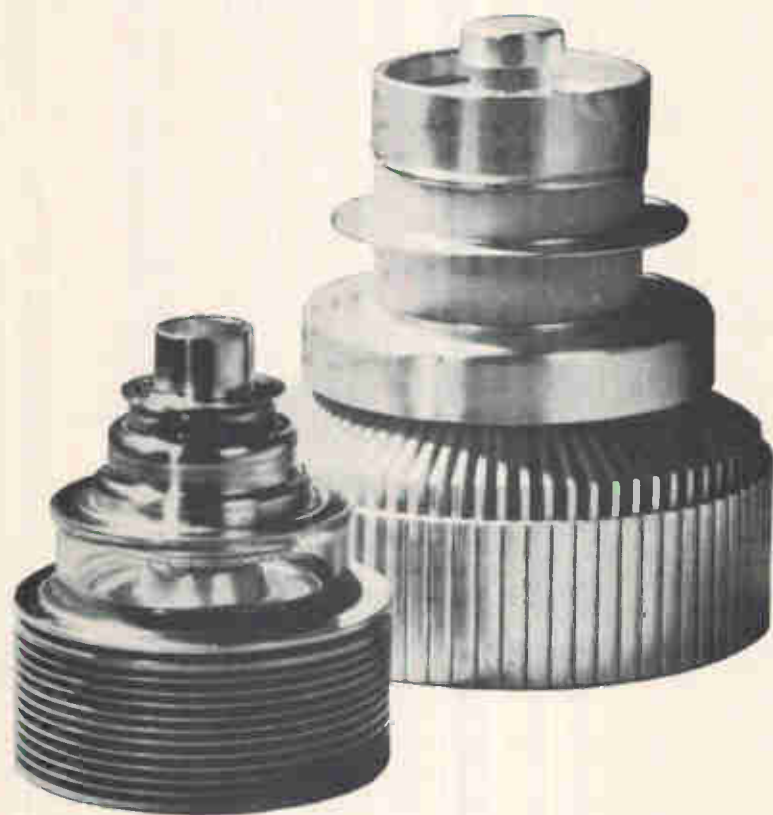

**THOMSON**  **HOUSTON**

*...a trusted name*

**LONG LIFE - HIGH RELIABILITY**

RATINGS		TH. 302	TH. 328
HEATER VOLTAGE	V	5	5
HEATER CURRENT	A	1,9	5
ANODE VOLTAGE	kV	1,6	2
ANODE CURRENT	mA	130	250
OUTPUT POWER	W	25 *	100 *
INTERMODULATION LEVEL (3 Tones Test)	dB	> 52	> 52

\* The Indicated output power corresponds to critical linear class A operation in U.H.F. Television translator handling both sound and vision signals and complying with C.C.I.R. - F.C.C. - O.I.R.T. specifications.

- \* THE MOST ADVANCED TECHNOLOGY
- \* THE LOWEST OPERATION COST

These tubes are designed for use in power amplifiers associated with solid-state drivers.

High gain U.H.F. Planar Triodes TH 302 and TH 328 are also recommended for use in Communication and Television Transmitters.

*We are ready to solve your problem. Please contact for specific information*

**THOMSON HOUSTON - HOTCHKISS BRANDT**

ELECTRON TUBE DIVISION - 8, RUE CHASSELOUP-LAUBAT - PARIS XV\* - FRANCE - TEL. : 566.70.04

THOMSON ELECTRIC Co INC. 50 ROCKEFELLER PLAZA · ROOM 916 NEW-YORK, 10020 N.Y. U.S.A. · Phone : 212 245 3900

**IN ATOMIC  
FREQUENCY  
STANDARDS**

*six points make the difference*

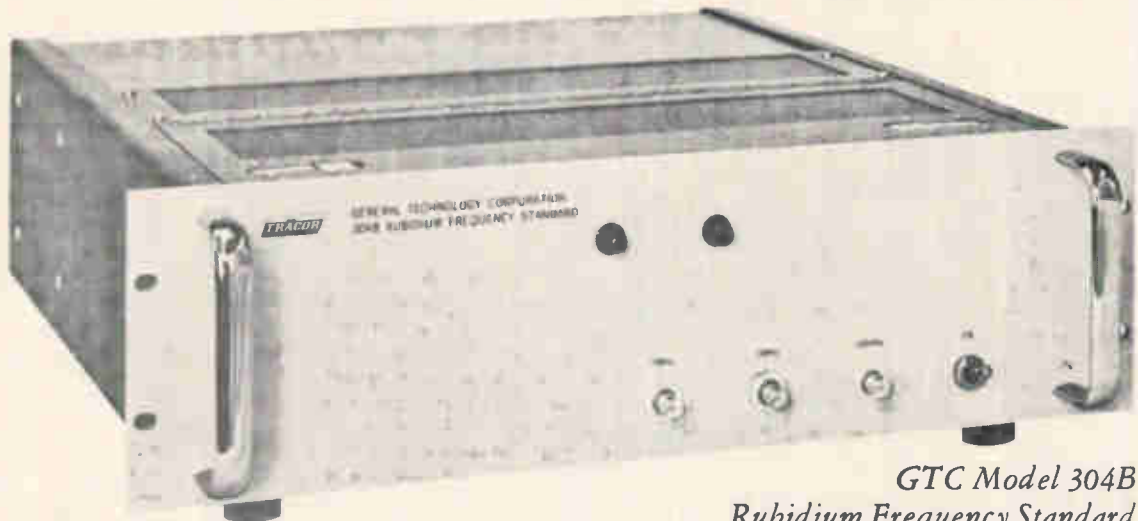

*GTC Model 304B  
Rubidium Frequency Standard*

1. LONG TERM STABILITY:  $5 \times 10^{-11}$  (Std. Dev.) per year
2. DRIFT RATE: Less than  $1 \times 10^{-11}$  per month
3. RELIABILITY: Five years proven performance, more than 24,000 hours MTBF.
4. WARM UP: The 304B will meet specs 30 minutes after turn on.
5. POWER REQUIREMENTS: 35 watts AC, 30 watts DC (using optional battery supply).
6. AVAILABILITY: Within 30 days.

*Write for complete technical and MTBF data on the GTC Model 304B Atomic Frequency Standard. TRACOR, Inc., 6500 Tracor Lane, Austin, Texas 78721, AC (512)—926-2800.*

**"SEE US AT BOOTH 1406, N.E.C."**

*Specialized instruments from **TRACOR** to meet your specific needs*



# Probing the News

Integrated electronics

## Large-scale problems in LSI testing

As arrays become increasingly complex and fast, producers and users scramble to develop and program computer-based systems that will make adequate checks

**At the moment**, companies involved in testing large-scale-integration devices agree on little beyond the fact they have problems. Among the biggest headaches: deciding what to test, programming computer-controlled systems, determining the validity of results, and achieving higher operating speeds. One observer—Al Schmitt, director of the computer laboratory at Litton Industries Inc.'s Guidance and Control Systems division—goes so far as to say: "There isn't yet enough knowledge about LSI testing to spot trends or even hold long-range opinions."

**Schools of thought.** While a majority of firms favor functional testing, there's at least one vocal and articulate advocate of one-shot checks: John C. Hubbs, president of E-II Research Laboratories Inc., Oakland, Calif. In one-shot testing, a pulse is applied to a single pin at a time, and its speed through the

device is measured; in functional checks, test systems put a pulse on every input and sense every output simultaneously.

Hubbs, whose firm makes pulse generators and other solid state test equipment and systems, says one-shot checks are the only practical way to pinpoint problems. "If a test reveals only that a device is no good without indicating which of its many gates has failed, then the production department's going to have a tough time discovering just where the process went wrong," he says. "From the standpoint of information, a functional test provides only a 1 or a 0, but a parameter test furnishes a much more valuable real number."

By way of example, Hubbs points out that if the turn-on time for a gate is 5.2 nanoseconds and the turn-off time 3.2 nsec, it's possible to say the threshold level is too far toward the 1 state. "The mili-

tary is vitally interested in this sort of testing," he says, "because it can tell something about devices' life expectancy."

### Majority views

Few, if any, experts in the testing field fully accept Hubbs' views. For instance, Gordon Padwick, applications manager at the Instrumentation division of the Fairchild Camera & Instrument Corp. in Sunnyvale, Calif., feels the technique's accuracy is open to question. The fast pulses used aren't actually measured; they are converted into voltage and stretched. "Small swings—on the order of 50 millivolts—are hard to measure through the 50-ohm impedance of a probe," says Padwick.

In any case, says Padwick, propagation delays are not always as critical as they are in, say, the central processing unit of a large computer. He's sold on functional

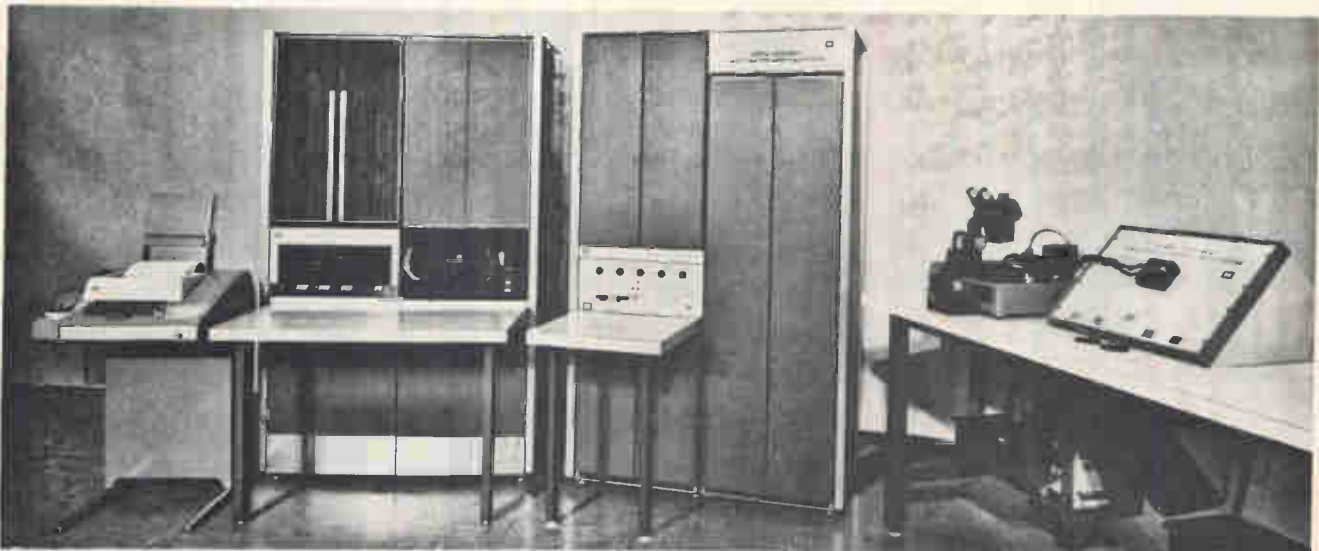

GI issue. General Instrument's LSI test system includes, from left to right, a teletypewriter, PDP-8 computer, company-built test set, probe station, and device-control unit; firm is working on a new version to up 2-Mhz speed.

# Now! TCXO's from Bulova!

Stability:  
 $\pm 0.5$  PPM



Now you can get Temperature Compensated Crystal Oscillators from Bulova, with all the quality and dependability that have made Bulova the leader in frequency control products. Our new Model TCXO-5 is just four-cubic-inches, consumes only 50 mW, and employs a computer-selected-and-optimized compensation network designed to maintain frequency stability over wide temperature ranges without the need for an oven ( $\pm 0.5$  PPM from  $-40^{\circ}\text{C}$  to  $+70^{\circ}\text{C}$ ). Perfect for aerospace and military applications where power, space and weight restrictions are severe.

## SPECIFICATIONS

Frequency Range:	2MHz to 5MHz
Frequency Stability:	$\pm 0.5$ PPM from $-40^{\circ}\text{C}$ to $+70^{\circ}\text{C}$
Output:	Sine Wave, 1VP-P into a 1000 OHM Resistive Load
Input:	50 mW
Size:	Just 4 cu. in.
Weight:	Only 5 oz.

Other frequencies, output wave shapes, output levels and load impedances can also be supplied.

Write today for more information about Bulova's new TCXO-5, or assistance with any Crystal Oscillator problem. Address: Dept. E-27.

# Try Bulova First!

## FREQUENCY CONTROL PRODUCTS

ELECTRONICS DIVISION  
OF BULOVA WATCH COMPANY, INC.

61-20 WOODSIDE AVENUE  
WOODSIDE, N.Y. 11377, (212) DE 5-6000

... at this stage, no one really knows  
what kind of LSI tester they want ...

testing: "It's the key sorting parameter now and will be even more so with LSI devices." Hubbs' rejoinder is that his company is building testers only slightly more expensive than those used to check 14-pin integrated circuits. "As the world moves toward medium-scale integration, it can do nothing but fall in our lap," he says.

The principal elements of E-H's test system for LSI are a strobing voltmeter, switching time converter, timing unit, and pulse driver. Hubbs concedes that his company faces "an uncomfortable squeeze" as devices get more complex and faster. There's a problem in getting from any of three pulse generators to any of 48 pins without going through a transport matrix, where bandwidth may be 20 nsec. Accordingly, the firm recently bought Automated Measuring Corp. to help develop elements for a new scanning system.

**Pragmatism.** Fairchild, along with Texas Instruments Incorporated and most other LSI makers, stresses testing of devices in the environments in which they are designed to operate. Dale Williams, who heads advanced development activities at Fairchild Instrumentation, points out that IC's that fail to meet a particular specification can be peddled to less demanding customers. "With LSI, each circuit will be different, and we won't be able to do this," he says.

As a result, Williams believes high-speed devices will have to be tested at speed. Fairchild already offers a tester, the 8000A, that can handle devices with up to 144 pins, but it operates at only 10 kilohertz. The company's Instrumentation and Semiconductor divisions are at work on prototype equipment that will improve on this rate. But Padwick says frankly: "It's very unlikely we're building the system everyone's waiting for. At this stage of the LSI game, we really don't know what it has to look like. All we can do now is make decisions and back them with money."

Other firms are in much the same position. In fact, when the General Instrument Corp. and

American Micro-Systems Inc. wanted to test assemblies at 2 megahertz, they had to undertake the building of their own equipment at costs in the hundreds of thousands of dollars.

## Smith brothers

GI, which is noted for its skills in MOS technology, turned the tester project over to twin brothers, K.D. and K.F. Smith, at its Research and Development Center in Salt Lake City. They designed and built a system that's now on line at the company's Hicksville, N.Y., plant, and have begun work on a second-generation configuration. The operational equipment consists of: a Digital Equipment Corp. PDP-8 computer; a company-built test set—in effect, another computer that administers the tests and determines whether a circuit is good—a probe station for wafer tests, and a device-control unit for packaged circuits. The system has 12 channels; it will test circuits with 12 inputs, 12 outputs, 4 clocks, 2 power supplies, and 1 reset, at a 2-Mhz rate. This is clearly neither big enough nor fast enough for true LSI devices, so the second-generation unit will be built around a PDP-9, which will permit testing more devices with more leads.

The operational tester runs a specific test pattern, loaded by the computer into a 320-bit shift register, and compares the actual and expected outputs, providing go/no-go evaluations. With a separate 320-bit test pattern, this routine is performed for every test. While this doesn't appear to be particularly tricky, GI had to decide just how many tests to run. It eventually settled for testing every gate at least once—but not necessarily every combination of gates. "I feel that there is an optimum set of frequencies, loads, and logic states to test," says K.D. Smith. "But this is purely intuitive."

**Range.** The operational model compares not only logic but also logic amplitude at the output; it can also make a number of static tests for leakage and current monitoring. K.D. Smith wants to make



more d-c tests in the new system now being built. For instance, he wants to know the on impedance for multiplexers; to this end, he will force current into the test device and measure the voltage across the switch.

He also wants to measure current down to 0.1 nanoamp—as against 100 na in the present version. There will also be a new technique for measuring threshold voltages; the present system uses a reference voltage. To measure thresholds at specified currents, he will use a current/voltage technique in which current can be sourced or sunk at any terminal and the corresponding voltage measured.

He anticipates a problem testing complex devices at speed. GI is already producing MOS devices that operate at 10 Mhz, he says. The four-phase logic they use has two bits of overlap between the clocks, a situation that requires six bits of information to strobe a four-clock system. This means the strobing circuitry must be operating at 60 Mhz. "MECL or the new SUHL might handle this," he says. "But it might be better to make most tests at slow speeds and then run a special speed test." Harold Vitale, an engineer working on LSI at Fairchild Semiconductor, agrees. He points out that a device can be given a special test for speed, in which all inputs are held at a certain state with a fast series of clock pulses being applied. After a given number of pulses, the outputs can be sensed to determine if they are in the proper state.

#### On and off line

The Semiconductor Products division of Motorola Inc., is also developing an LSI tester for its own use that will be in action before year's end. It is reportedly 100 to 1,000 times faster than available systems. The equipment, designated EC-34, can handle both bipolar and MOS arrays; it includes a Motorola-built central computer that uses MECL-2.

One of the key features of the EC-34 is the use of programable pulse generators rather than relay matrixes to speed testing. The unit will eventually be able to test devices with up to 120 pins, but at the outset 60 pins will be tops. George

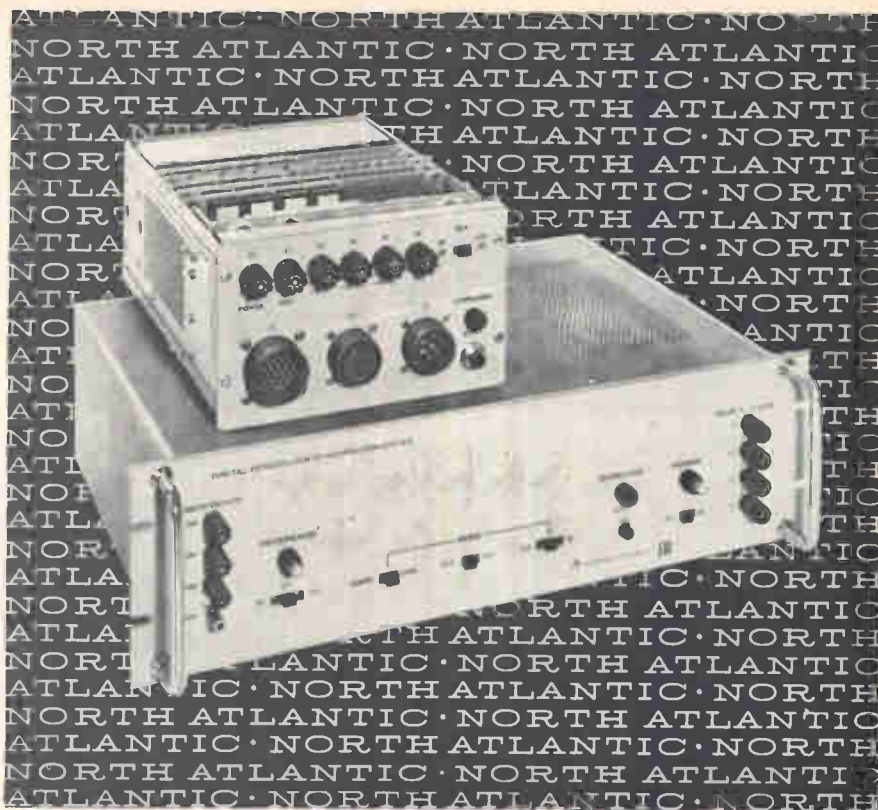

## digital to resolver/synchro converters ... here's the next generation!

North Atlantic now brings you a new generation of solid-state digital-to-analog converters. They offer major advances in resolver/synchro conversion accuracy along with drift-free and stable performance unobtainable with currently available resistor/amplifier devices.

Typical of these new instruments are the Model 536 D/R and Model 537 D/S "shoebox" converters (11-13 bit) and the Model 538 D/R-S converter (14-17 bit). Both models use solid-state switched trigonometric transformers and feature input data storage registers thereby saving computer time. Conversion speed exceeds 10 microseconds. Built-in overload and short circuit protection assures trouble-free system integration and reliable on-line performance.

Your North Atlantic representative (see EEM) has complete specifications and application information. He'll be glad to show you how these new converters can be the answer to critical interface problems.



**NORTH ATLANTIC** industries, inc.  
TERMINAL DRIVE, PLAINVIEW, NEW YORK 11803 • 516-681-8600



# EUROPE'S STRONGEST GROUP IN SOLID STATE DEVICES CAN DELIVER THESE IC'S RIGHT NOW



## TTL INTEGRATED CIRCUITS - FJ FAMILY

(compatible with the SN74N series)

With a stage delay of about 13 ns, and a dissipation of only 10 mW per gate, the FJ family is first choice for many high-speed instrumentation, computer, and telecommunications applications. Included in this versatile family are higher-order functions as well as NOR

and AND-OR-NOT gates. Circuits of the FJ family have a high fan-out (minimum = 10), plus the ability to drive large capacitive loads. Other features are: high logic swing, low output impedance, and inherent protection against output short-circuits.

### MAJOR CHARACTERISTICS

High noise margin	typ. 1 V
Average propagation delay with a fan-out of 10	typ. 13 ns
Very high fan-out over full temperature range	min. 10
Full industrial temperature range	0 °C - 70 °C
Popular package for easy mounting	dual-in-line

### WE OFFER FULL DIGITAL CAPABILITY !

- We also make an extensive range of IC's for medium and ultra-high-speed applications: the DTL FC family and the TTL FH family, which are compatible with the 200-series and SUHL II respectively.

- We design higher-order circuits for large-volume requirements, compatible with any one of these digital families.

- We can make ultra-high-speed current-mode logic in the 2 to 3 ns range to suit your needs; emitter-emitter coupled logic for example.

- We have a well-established process for making complex MOS circuits with excellent performance throughout life.

- We achieve high noise immunity with digital circuits. Our 12 V circuitry has a noise margin of 5 V, and a speed of several hundred ns.

### RANGE OF STANDARD CIRCUITS

DESIGNATION	TYPE NUMBER
single NAND gate	FJH101
dual NAND gate	FJH111
triple NAND gate	FJH121
quadruple NAND gate	FJH131
quadruple NOR gate	FJH221
quadruple two input NAND gate	FJH231
dual buffer NAND gate	FJH141
dual AND-OR-NOT gate	FJH151 FJH161
single expandable AND-OR-NOT gate	FJH171
single AND-OR-NOT gate	FJH181
single JK flip-flop	FJJ101
single JK master-slave flip-flop	FJJ111
dual JK master-slave flip-flop	FJJ121
dual latch flip-flop	FJJ131
single decade counter	FJJ141
quadruple latch flip-flop	FJJ181
dual JK master-slave flip-flop	FJJ191
dual gate expander	FJY101

# PHILIPS

PHILIPS ELECTRONIC COMPONENTS AND MATERIALS DIVISION - EINDHOVEN, THE NETHERLANDS

distributed and sold in the U.S. by: AMPEREX ELECTRONIC CORPORATION Providence Pike, SLATERSVILLE, Rhode Island  
230 Duffy Avenue, HICKSVILLE, New York 11802 • 801 E. Charleston Avenue, PALO ALTO, California 94303 • 360 E. North Avenue, NORTHLAKE, Illinois 60164.

## ... LSI test systems typically cost several hundred thousand dollars ...

Witsell, manager of IC equipment engineering, says Motorola is making parts now that go into 60-pin packages—full adders, parity trees, counters, and shift registers.

All compilation, logic simulation, specification generation, and test reduction are done off-line in the Motorola system. "This feature is important in LSI testing," Witsell says. "Otherwise, the test computer would be wasting a lot of time. We're determining off-line what we have to test—the minimum number of tests we have to make based on certain assumptions about how many are needed to determine if we have a good device or not. The computer reduces the total of tests to a reasonable number—maybe 10,000, although we haven't had to do that many yet."

The EC-34 tests only propagation delay among a-c parameters now; a future version will also measure rise and fall times. "We measure only go/no-go on propagation delay, but the ability to measure it at full test speed is unique," Witsell maintains. The machine, however, can data-log most d-c and a-c parameters by successive approximation at a slower speed, he says. "We can do d-c and a-c go/no-go testing at 8 microseconds per functional pattern. If we want to data-log a parameter, we have to slow down to 12-test cycles (96 nsec)."

### Artistry

Another sophisticated LSI tester is being readied for use by the Raytheon Co.'s Missile Systems division in Bedford, Mass. Dubbed RATS (for Raytheon Automated Test System), this setup, according to Richard Norman, senior engineer at the division, will be able to make a-c and d-c checks of bipolar arrays, as well as performance checks of hybrid circuits built from several MSI chips. Early next year, the system will have a wafer dynamic testing capacity—an attractive feature in view of the company's interest in beam leads.

Perhaps the most intriguing characteristic of RATS, however, is the integration of mask-making into the IC test program. "Our sys-

tem prints out actual values of circuit performance," says Norman. "It's not just a go/no-go device—but a flexible engineering tool useful in design as well as production control." Ironically, Raytheon was originally aiming for a comparatively simple system without a computer capability. "But it just grew like Topsy," says Norman.

**Best bet.** As for determining what to test and the validity of results, most producers exhibit varying degrees of resignation. For example, James McPhail, who designed the American Micro-Systems tester, says: "You can no longer probe into a (black) box. Your only access is the input/output pins, and you need as thorough a check as possible." The rub, of course, is what constitutes thorough in the face of the staggering number of possibilities for testing in LSI circuitry.

"We use the old WIW formula—will it work," says L.J. Sevin, MOS-product manager at TI. Computer programs are far enough along so that large logic arrays can be simulated to check validity, he says. Litton's Schmitt, however, pinpoints the development of diagnostic programs for testing large arrays as a major problem.

**The money goes.** Looking for the black cat in the dark room is costing LSI makers and instrumentation houses a nice piece of change. Except for E-H, which says it produces operational equipment for less than \$100,000, most systems makers' investments run into the hundreds of thousands of dollars. Says AMI's McPhail: "When we tried to get instrumentation companies to build test equipment, they really socked it to us with ridiculous bids. Prices ran up to \$75,000 for the word generator alone and were close to a half-million dollars for the whole tester." However, most observers agree "the ballpark" extends from \$150,000 to \$300,000.

And the consensus is that it will be hard to lower these figures appreciably. "When you order steak, you have to pay," says Texas Instruments' Sevin. "It costs more than hamburger."

...and Amperex  
your American source  
for Philips IC's  
has monolithic IC  
specialists  
as close to you  
as your telephone:

on the East Coast:

Phone Cranston, R.I.  
401-737-3200  
or  
Hicksville, N.Y.  
516-931-6200

in the Midwest:

Phone Northlake, Ill.  
312-261-7878

on the West Coast:

Phone Palo Alto, Cal.  
415-327-0461

**Amperex**  
TOMORROW'S THINKING IN TODAY'S PRODUCTS

For immediate action, data sheets, etc., write:  
AMPEREX ELECTRONIC CORPORATION  
SEMICONDUCTOR AND MICROCIRCUITS DIVISION  
SLATERSVILLE, RHODE ISLAND 02876

# Pulse Performance

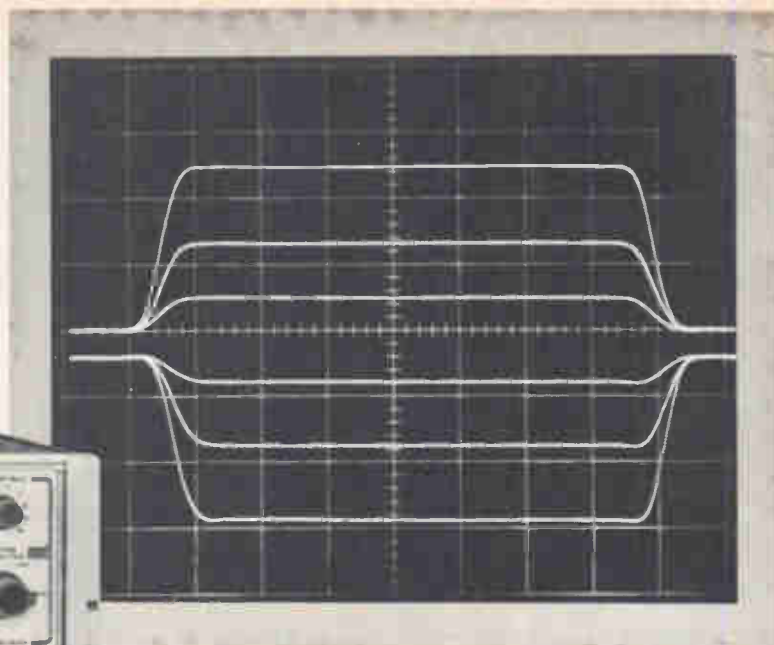

Multiple exposure showing typical waveform aberrations for positive and negative polarities at various amplitude settings. Notice the constant risetime and falltime with amplitude changes. 20 ns/cm sweep time and 4 V/cm deflection factor.

- REPETITION RATE 100 Hz to 10 MHz.
- VARIABLE RISE AND FALL TIME, 10 ns to 100  $\mu$ s.
- $\pm 10$  V into 50  $\Omega$ , with DC OFFSET.

## NEW TEKTRONIX TYPE 115 PULSE GENERATOR

This multi-purpose, solid-state generator produces exceptionally clean pulses with aberrations less than 3% P-P at  $\pm 10$  V into 50  $\Omega$ . Pulse risetime, falltime, width, delay, period, amplitude and baseline offset are separately variable, permitting precise waveform simulation. Five operating modes offer a variety of output configurations—undelayed pulses, delayed pulses, paired pulses, burst of pulses and gated pulses. Risetimes and falltimes are continuously variable from 10 ns to 100  $\mu$ s and periods variable from 100 ns to 10 ms. Pulse widths are variable from 50 ns to 500  $\mu$ s with duty factors to 75% (50 ns minimum pulse separation). A continuously variable DC offset feature permits positioning pulse baseline through a range of +5 volts to -5 volts. Triggering is selectable, internally or externally. A manual pushbutton provides a means to produce a single undelayed pulse, delayed pulse, pulse pair, or burst of pulses.

Your Tektronix Field Engineer will demonstrate the performance of the Type 115 in your application. Please call him, or write Tektronix, Inc., P.O. Box 500, Beaverton, Oregon 97005.

TYPE 115 PULSE GENERATOR . . . . \$825

U.S. Sales Price FOB Beaverton, Oregon

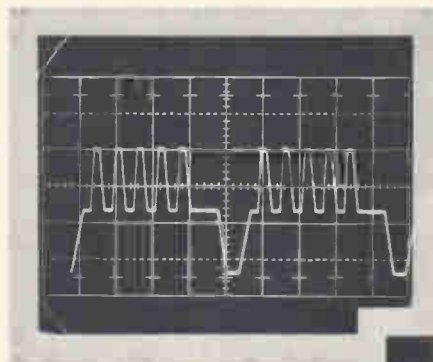

Single exposure showing combined outputs of two Type 115's. The burst of pulses on top of the positive pedestal was triggered by the + delayed trigger from the instrument generating the pedestal. 10  $\mu$ s/cm sweep time and 2 V/cm deflection factor.

Multiple exposure showing variable risetime and falltime. 500 ns/cm sweep time and 10 V/cm deflection factor.

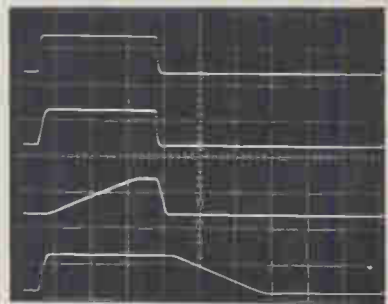

A detailed description of the Type 115 Pulse Generator is found in the August supplement to your Tektronix Catalog 27.



**Tektronix, Inc.**

*committed to progress in waveform measurement*



# Ground-station market flies high

Orders increase as prices and hardware needs decline; optimists expect demand to continue through 1975, but others see a crest coming up fast

By Paul A. Dickson

Washington regional editor

**Ground stations** for satellite communications are springing up around the world like mushrooms after a spring rain, and a brisk controversy over the size, shape, and staying power of the market is growing right along with them. Some observers believe demand for costly, large-scale installations is near a peak. Others, whose ranks include hopeful contractors of varying nationalities, anticipate a high level of demand for both big facilities and small, transportable setups through at least 1975.

No one can deny that business is booming at the moment. By year's end there will be 22 ground stations operating commercially around the globe. A dozen more are in various stages of construction, and contracts have been let for another four on which work will begin within the next few months. Using information gleaned from fellow members of the International Telecommunications Satellite Consortium, the Communications Satellite Corp. estimates that as many as 45 facilities will be on the air within the next year and a half. But as far as one Comsat official is concerned, the story ends right there. "We're witnessing the zenith of ground-station contracting and construction," he declares.

**Best teacher.** This source says the price tags on ground stations are coming way down as contracting agencies, as well as electronics firms and other suppliers, gain experience in the field. A few years ago, it took upwards of \$8 million to build a good-sized facility; the cost is now down to between \$4 million and \$5 million. And the next generation may go for around \$3.5 million.

"The satellites are better and

there's no longer a need to over-build," says the Comsat official. "We've learned, for example, that we don't need elaborate steering mechanisms for the antennas since the satellites are in synchronous orbits. In addition, we've eliminated sight towers, using the stars to calibrate the systems." The use of parametric amplifiers, rather than masers, with station receivers affords another significant cost saving, as does the use of more Spartan cooling systems. And since radiation feedback problems have proved less severe than originally anticipated, antenna dishes have been moved in close to the stations, eliminating up to a quarter mile of cabling, along with such associated electronic items as waveguide and amplifiers.

For all the cuts in prices and truncated shopping lists, a number of observers believe the market for ground stations and related hardware will wax rather than wane in the next few years. One such is D.N. Steel, sales manager for space and special projects at Page Communications Engineers Inc., a Washington-based subsidiary of the Northrop Corp. "Ground stations give a country—particularly an underdeveloped one—added political freedom," he says.

Steel points out that African communications still follow the old lines of colonial trade. Thus, for example a call from Lagos, Nigeria, to Nairobi, Kenya, must be routed through London. Similarly, calls between one-time French possessions go through Paris. "These countries and others like them want their own stations so they can cut these ties," Steel says.

**Orders and reorders.** A number of nations—Algeria, Israel, Sweden,

Switzerland, the United Arab Republic, and Turkey, among others—are scheduling their first ground stations for the 1970-72 period. In addition, Steel says, many countries already plan to supplement facilities that have yet to be built. For example, a request for proposals from the government of New Zealand is now making the rounds; it calls for the installation of antenna dishes and related hardware at four more cities after the island's first station goes on the air in 1970. And three East African nations that have contracted for a communal facility recently announced that they want another in 1972. "As

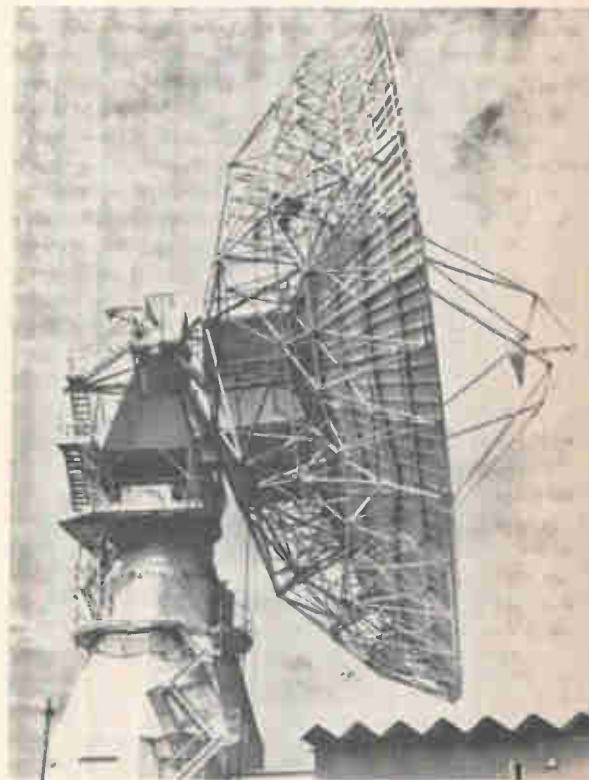

Profile. Ground station, built by Page in Panama, typifies current facilities.

# HICKOK CRO 5000 25 MHz Oscilloscope (all solid state)



**\$65000**

This high-precision laboratory oscilloscope equals the basic performance of higher priced, sophisticated 'scopes, yet meets the industry need for such performance in the \$600 price range. Emphasis has been placed mainly upon those characteristics most important in precise measurements, eliminating some of the more exotic and somewhat superfluous functions found in higher priced instruments. The result is an all-solid-state instrument in the medium price range with extraordinary stability, sensitivity, bandwidth, sweep-speed range, trigger capability, reliability, and ruggedness.

- 25MHz vertical bandwidth (to 3db down points)
- Usable to 50MHz
- All solid state for high stability and reliability
- 12 calibrated vertical attenuator ranges  
10 mv/div to 50 volts/div ( $\pm 3.0\%$  accuracy)
- 24 calibrated sweep ranges  
0.05 microseconds/div to 2 sec/div ( $\pm 3.0\%$  accuracy)
- Vertical delay line assures viewing of full leading edge of pulses
- "Sweep Delay" of up to 40 divisions
- Sweep speed continuously variable between ranges
- X-axis channel bandwidth DC — 5MHz
- 4" flat-faced CRT, 6 x 10 division graticule
- 3.8 kv HV provides sharp, bright trace
- Vertical amplifier will handle overloads, with negligible distortion of waveforms increased to 5 times screen height
- Internal 1.0% calibration squarewave
- Fast, convenient push-button selection of trigger modes
- Positive, solid triggering on all displays
- Small — 11 $\frac{1}{4}$ " W, 6 $\frac{7}{8}$ " H, 19" D; 24 pounds

HICKOK ELECTRICAL INSTRUMENT COMPANY, 10514 Dupont Ave., Cleveland, Ohio 44108



Furled. This GE antenna, shown folded, may be a forerunner of units for transportable ground stations.

primitive economies develop, requiring more and better communications services, there will be a greater demand for ground stations and related equipment," says Steel.

John Jenkins, assistant manager of Comsat's technical advisory department, agrees. "Early starters are now considering second systems," he says. "The ground-station market will continue to grow through 1975."

**Contenders.** The fact that there's a boom on in this field has not been lost upon the world's industrial giants. Jenkins, whose department furnishes technical advice to such lands as Chile, the Philippines, Peru, Jordan, Taiwan, Pakistan, Spain, Kuwait, and Venezuela, estimates that some 18 firms around the world are scrambling for a piece of the ground-station action. And new entries are crowding in, he says, pointing to Japan's Tokyo Shibaura Electric Co. and West Germany's AEG-Telefunken. Among the others who have been vying for orders are:

- Page, which has built stations for Comsat, the National Aeronautics and Space Administration, and the governments of Panama and Australia. The company recently won contracts for installations in Iran and Lebanon, and is after jobs in New Zealand and Pakistan.

- Canada's RCA Victor Ltd., which has just entered the field but is off to a good start with a contract for a station in India.

- The Hughes Aircraft Co., which, after a string of successes, stubbed its toe in Peru earlier this year [Electronics, March 4, p. 307].



▪ The General Telephone & Electronics Corp., which has been comparatively inactive during the last year after winning three straight prestige contracts.

▪ Japan's Nippon Electric Co., which has an edge in Asian outlets because of its proximity, technical competence, and access to financing.

In time, however, the number of firms in the field will shrink as the market matures. For one thing, the decline in the going rates for installations will make the business a survival-of-the-fittest proposition. For another, technological expertise is not the sole prerequisite of success. "A number of supplementary services are involved," says A.E. Sutter, vice president and senior director of marketing at Page. "Underdeveloped nations often need help in financing multi-million-dollar ground stations, and you've got to know your way around the international money markets to handle this sort of thing."

#### More for the money

"A traditional rule of thumb in communications is that once a system is operating, it's saturated," says Comsat's Jenkins. He contends this proposition will be particularly true in the case of satellite ground stations, with the start-up of one facility creating a need for more.

Installations for domestic satellite networks will, in Jenkins opinion, prove a huge market over the long run. He points out that the



Open. The GE antenna, unfurled here, is being checked out by NASA.

# Hickok

## DMS 3200 DIGITAL MEASURING SYSTEM (Fully solid state with IC's)



This all-solid-state precision measurement system offers unlimited expansion capability through plug-in additions, resulting in a specialized instrument for each type of measurement. New plug-ins now broaden the measurement capability of this field-proven unit. Over 10,000 are in use at present.

Scaling controls make possible resolution of up to seven digits on the three-digit display by utilizing the overrange capability of many of the plug-ins, thus providing high resolution and accuracy with minimum investment. Companion devices such as the PR 4900 Digital Printer and I050 Digital Set-Point Controller further extend the utility of the DMS 3200 System.



DC VOLTMETER PLUG-IN DP 100 **\$175**

00.1 mv to 999. volts  
± 0.1% rdg ± 1 digit

DC MICROVOLTMETER PLUG-IN DP 110 **\$450**

0.001 mv to 999.9 volts  
± 0.05% rdg ± 1 digit  
4-digit resolution

AC VOLTMETER PLUG-IN DP 130 **\$375**

0.01 mv to 999. volts  
± 0.1% rdg ± 1 digit  
22 Hz to 1.0 MHz

EVENT COUNTER/S�AVE PLUG-IN DP 140 **\$90**

Up to 1,000,000 counts/sec  
Cascade with second DMS to  
obtain 6-digit display

1 MHz COUNTER PLUG-IN DP 150A **\$230**

00.1 Hz to 999. kHz  
± 0.0005% rdg ± 1 digit  
7-digit resolution

80 MHz COUNTER PLUG-IN DP 160 **\$395**

00.1 Hz to 80.0 MHz  
± 0.00005% rdg ± 1 digit  
7-digit resolution

OHMMETER PLUG-IN DP 170 **\$275**

.001 ohm to 999. megohms  
± 0.1% rdg ± 1 digit  
Microamp test current

CAPACITY METER PLUG-IN DP 200 **\$275**

.001 picofarad to 9,999 mfd  
± 0.1% rdg ± 1 digit  
Low DC test voltage

TIME INTERVAL METER PLUG-IN DP 210 **\$230**

0.01 ms to 999. seconds  
± 0.0005% rdg ± 1 digit  
Period or time interval

DC CURRENT METER ADAPTER D 310 **\$90**

.0001 microamp to 9.99 amps  
± 0.15% rdg ± 1 digit

HICKOK ELECTRICAL INSTRUMENT COMPANY, 10514 Dupont Ave., Cleveland, Ohio 44108



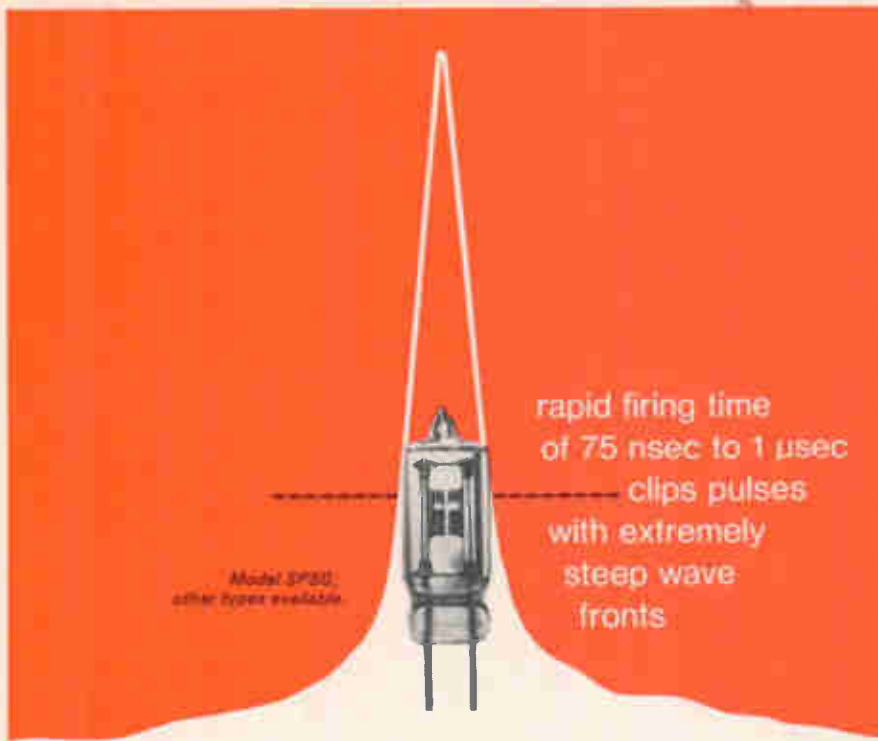

protect solid state  
circuits from  
catastrophic transient spikes  
with **VICTOREEN**  
**SPARK GAPS**

Extremely rapid firing time (as fast as 75 nsec, depending on circuit parameters) combined with excellent energy handling capabilities (100 joules for currents as high as 2000 amperes) anywhere in a broad range (85-5000 volts), including our new miniature version. And that's why they're providing sophisticated circuit designers with positive, economical protection for their solid state circuits.

Low interelectrode capacitance also makes them ideal for high frequency application where wave form must be preserved. In ignition applications, Victoreen Spark Gaps are used as hold-off devices to prevent current flow until circuit voltage reaches predetermined gap breakdown voltage. High repeatability and long service life enhance reliability of continuous duty systems in ambients from  $-65^{\circ}$  to  $125^{\circ}\text{F}$ . Shock resistance to 100g for 11 milliseconds, vibration resistance a full 10g from 55 to 2000 cps. For positive protection of exotic solid state circuits, call Applications Engineering Dept., (216) 795-8200, Ext. 306.

A-2732

**VICTOREEN INSTRUMENT DIVISION**  
10101 WOODLAND AVENUE • CLEVELAND, OHIO 44104  
IN EUROPE: GROVE HOUSE, LONDON RD., ISLEWORTH, MIDDLESEX, ENGLAND



proposed Canadian system [Electronics, Sept. 4, 1967, p. 131], which has just received Intelsat's blessing, will require 30 stations. And the on-again, off-again net proposed for the U.S. calls for 35. Ground stations for domestic systems will cost between \$250,000 and \$500,000 apiece—a far cry from even the bargain-priced facilities now being erected—but Jenkins notes that it's a volume market with plenty of growth potential.

Right now, Pakistan is as close as any country to implementing a domestic system; it plans two stations at either end of its divided territory to permit free communications. And Page's Steel reports that Brazil, India, and Australia, among other countries, are also interested in putting in domestic systems.

In for a penny. Sutter of Page reasons that the decline in the going rate for the biggest ground stations gives more nations a chance to buy them. Moreover, he believes initial installations will motivate governments to expand their communications horizons. "Once a nation has good international communications and realizes the backwardness of its local distribution, it's likely it will take steps to improve the setup in its own backyard," he says. "This will tend to encourage construction of domestic and regional systems, as well as second and third stations for the international net." His colleague Steel notes that the French have already been talking with a number of African countries about establishing a central system.

In the meantime, a number of companies are working on the development of low-cost, transportable ground stations. Prospective applications include provision of communications to and from remote construction sites, disaster areas, and the like. One of the concerns investigating such stations is the General Electric Co. Richard Hesselbacher, manager of communications systems at GE's Missile and Space Systems division in Valley Forge, Pa., says his organization is particularly interested in portable systems designed around antenna dishes as small as 10 feet in diameter.

From the ground up. Recently, the division was awarded a NASA

contract to study the possibilities of a direct broadcast system with the pint-sized dishes. At the same time, it's working on a potential television experiment for the space agency's Applications Technology Satellites F and G. This experiment would require the development of a low-cost ground station that could be assembled and put on the air by unskilled labor in a remote village in India to receive a tv signal from the satellites. The idea is to demonstrate that such systems are practical even in areas lacking in technological resources.

At the moment, NASA and GE are working with an umbrella-like antenna 15 feet in diameter and made of honeycomb Mylar. A version of this antenna was tested aboard the aircraft carrier Essex in connection with the Apollo 7 flight. Color pictures of the splashdown were transmitted from the ship via this unit.

**Hostile environment.** Transportable ground stations do, however, face some opposition. A couple of years ago, Intelsat published guidelines for its stations specifying that antenna dishes be 85 feet in diameter or larger. But even these giants fell short of the anticipated mark, and 95-foot dishes are now the norm. Enforcement comes down to a matter of economics; the consortium charges the proprietors of nonstandard systems more for satellite time. There's a certain rough justice in this procedure since, officials point out, a 42-foot dish, for example, requires 6.5 times more of the satellite's capacity than an 85-foot unit; a 30-foot installation requires 27 times as much. Charges are levied proportionately.

So far, nonstandard configurations have been used largely on a one-shot basis. A small station built by the Hughes Aircraft Co., for instance, was used to get Olympics coverage to the furthest reaches of the Pacific Northwest and Canada.

Intelsat is now looking into the question of which countries might require transportable ground stations and for what purposes. Officials hint that if there are sizable enough requirements, modifications may be made in future spacecraft to accommodate smaller ground antennas. However, no determination is expected before the end of next year.

# "The Infraredder" SSL lamps!



new from  
General Electric

If you're looking for SSL lamps with more infrared power output, look no further. Here are the SSL-5's, three new gallium arsenide solid state lamps with up to 7½ times the infrared output of our SSL-4.

Use them in readers, counters, controls and other photoelectric applications. They'll fit in anywhere you need a tiny infrared source capable of withstanding shock and vibration as specified in MIL STD-750.

Order your calibrated samples today. You'll soon discover how you can save space, improve performance and reduce maintenance costs in your product.

For more information on all GE infrared SSL lamps, ask for free technical bulletin 3-8268.

		
SSL-5A	SSL-5B	SSL-5C
POWER OUTPUT AT 100 MA		
.6mw	1.5mw	2.3mw

Please send me \_\_\_\_\_  
GE SSL-5A lamp(s) at \$9.10 each.

Please send me \_\_\_\_\_  
GE SSL-5B lamp(s) at \$14.56 each.

Please send me \_\_\_\_\_  
GE SSL-5C lamp(s) at \$18.20 each.

Name \_\_\_\_\_

Company \_\_\_\_\_

Address \_\_\_\_\_

City \_\_\_\_\_

State \_\_\_\_\_ Zip \_\_\_\_\_

To:  
General Electric Company  
Miniature Lamp Department  
P.O. Box 2422, Nela Park,  
Cleveland, Ohio 44112  
Attn: J. D. McMullin

MINIATURE LAMP DEPARTMENT

GENERAL  ELECTRIC

**MDS 2110R...  
THE LOW-COST PAPER TAPE  
PUNCH THAT DELIVERS  
HIGH-QUALITY SERVICE**



*MDS 2110R Paper Tape Punch—The low-cost Paper Tape Punch that makes no compromise with quality*

The 2110 is designed as simply as possible to accept coded electrical data serially by character and parallel by bit, for recording on tape, asynchronously, at speeds up to 30 characters per second.

Quiet, high-speed operation of the 2110R is assured by use of low-inertia parts and individually motor-driven supply and take-up reels. Front-loading of the tape, and a high-capacity, transparent chad cup, increase operating convenience. The punch and die assembly can be easily replaced, if necessary.

The MDS 2110R is designed for easy integration into a system... no critical pulse widths or regulated supply levels required. Connections are provided for error checking... backspacing of tape... and inhibition of punching in case of error.

With its standard MDS features... and the options available... the MDS 2110R Paper Tape Punch is the versatile, low-cost answer to your tape punch requirements.

Ask for: Complete folder-file on MDS 2110R Paper Tape Punch, with general specifications.

**FOR MORE—MEET YOUR MAN FROM MDS**

**MOHAWK<sup>MS</sup>**  
**DATA SCIENCES CORPORATION**  
**OEM MARKETING**

305 WEST GRAND AVENUE • MONTVALE, N. J. 07645  
Telephone 201/391-7000

Every MDS office is an OEM Marketing office

DIGITAL STRIP PRINTERS • BUFFERED TAPE UNITS  
HIGH-SPEED AND LOW-SPEED LINE PRINTERS  
CARD PUNCHES AND READERS  
PAPER TAPE PUNCHES AND READERS





# New Products

Consumer electronics

## IC audio amplifier puts out 5 watts

By raising the supply voltage and improving the thermal mounting, GE turns the trick in this monolithic device without increasing size

Raising the power output of an integrated circuit doesn't have to mean increasing the size of the IC, as device designers have demonstrated in a new power amplifier.

Retaining the basic plastic dual in-line package of previous 1-watt and 2-watt IC's (the PA234 and PA237), designers in the General Electric Co.'s Semiconductor Products department were able to provide the new PA246 audio amplifier with a power output capability of 5 watts continuous into a 16-ohm load with less than 5% total harmonic distortion.

They did it by increasing the maximum power supply voltage rating to 37 volts—thus boosting power without also boosting heat-generating current—and by modifying the thermal mounting to increase the power dissipation capability of the package. The chip is mounted directly on the lead frame, instead of being first mounted on the metal feed strip used in the earlier, lower-power versions. And the tab area (for mounting an external fin or other heat sink) has been increased. The net result is that the PA246's dissipation is rated at 5 watts with the tabs at 70°C. (At the 5-watt output level, it's dissipating about 3.5 watts.)

Elimination of the metal feed strip used in the lower-power IC's makes the automated fabrication process more complicated, since the chips now have to be fed individually instead of from a roll of strip. However, the presence of the extra layer of metal between the chip and the lead frame added too

much resistance to the thermal path from chip to heat sink, and would have prohibited the 5-watt dissipation rating. The chip assembly operation has been modified to provide vacuum pick-up of each chip, and automatic positioning of it on the lead frame. Almost simultaneously, the chip is welded to the lead frame.

GE engineers say that 5 watts output isn't the limit for the new thermal design. They believe that a family of IC's will evolve, with ratings up to 10 watts.

**Two markets.** The PA246 is the first monolithic IC that can produce this signal output power, according to GE. Sinclair Radionics Ltd. has advertised a similar IC in British publications at a retail price of \$7.15. But the Plessey Co., which will make the IC for Sinclair, has run into technical problems, and it will be several months before the circuit is in production [Electronics, Nov. 11, p. 306].

The Sinclair-Plessey IC has some specifications that are superior to those of the PA246. Its frequency response, for example, is 5 hertz to 100 kilohertz,  $\pm 1$  decibel, versus 30 hz to 100 khz,  $\pm 3$  db, for the PA246. With a sensitivity of 5 millivolts and power gain of 110 db, the British IC is a preamplifier as well as amplifier. However, the package is slightly larger (1 x 0.4 x 0.2 inch versus maximum dimensions of 0.770 x 0.280 x 0.160 inch), and the heat-sink tabs are considerably larger, thicker, and heavier.

GE expects the biggest market for

the IC to be in radio, phonograph, and tape recorder equipment, but also sees sizable industrial sales. The circuit can function as a servo amplifier, operational-amplifier booster, or relay driver, for example. The price is "under \$2 in volume quantities," notes Anthony Desiderio, sales planner for consumer microelectronic markets. In quantities of 100 to 999, the unit price is \$2.56. It's available in sample quantities in 30 days.

The plastic package has eight leads in a staggered arrangement to provide a mounting-hole spacing

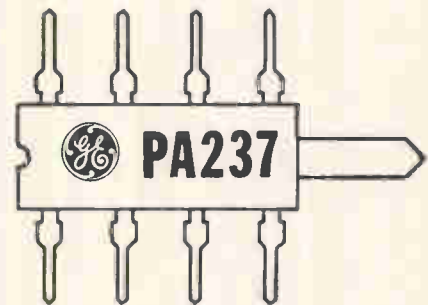

Same form. The package of the 5-watt amplifier is the same size as the 2-watt version (top). Two large heat-sink tabs replace the single sword-shaped one.

# We just took a great step backwards



## (with three new, forward-looking unitized DVMs)

Trymetrics' new 4243 Digital Multimeter with AC, DC and OHM readings—auto polarity—full four digit—0.1% (\$850) ... a tremendous step backwards. And so are the 4240 DVM (\$695) and 4230 DVM (\$595).

We started with our Model 4100: stored display—precision .01%, four-digit DVM and its full range of plug-ins for the price of an ordinary 3-digit job—just \$740 with the  $\pm 9.999v$  DC head; and eight other plug-ins to choose from. For an encore, the only way to go was down.

Down \$195 to \$850 for the versatile 4243 Digital Multimeter: DC-AC-OHMS .01% — auto polarity  $\pm 999.9mv$  to  $\pm 999.9v$ . Same 4-digit stored display—no plug-ins. Sorry—unless you don't need plug-ins.

Down again, \$155, to \$695, for the 4240 DVM. Same high accuracy, same stored display, same  $\pm 999.9mv$  DC to  $\pm 999.9v$  DC 4-digit measurements. But, no AC or OHMS—unless, of course you don't need AC or OHMS.

Once more, down, to \$595 for the Trymetrics 4230 DVM. Still the same precise 4-digit unit with readings  $\pm 9.999v$  DC to  $\pm 999.9v$  DC. Don't buy this one if you need to measure in the low millivolts.

You don't need true 4-digit readout with .01% accuracy at a 3-digit, .05% price? Sorry—but we can't keep backtracking forever. May we send you our new catalog that shows ALL our models, all our plug-in versatility, all our reasons for going backwards?

PRICES SLIGHTLY HIGHER IN EUROPE.

**TRYMETRICS**  
Corporation  
A SUBSIDIARY OF TRYCON ELECTRONICS, INC

204 Babylon Tpke., Roosevelt, L.I., N.Y.  
Phone 516-378-2800 11575

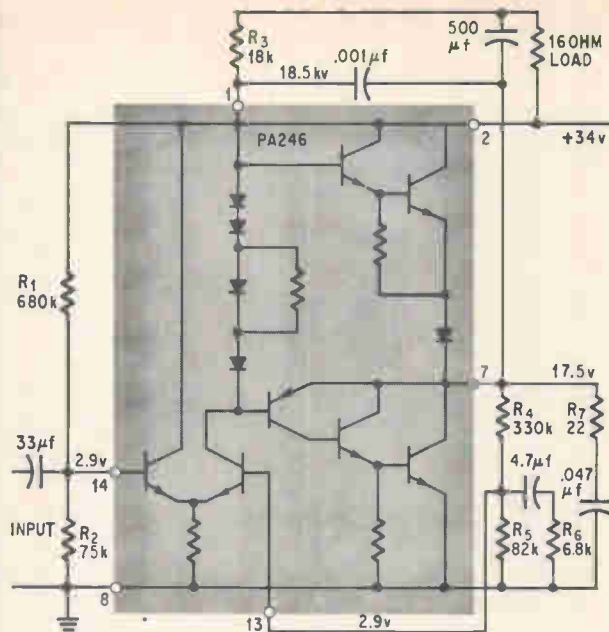

To test. The PA246 (shaded) has the specifications listed in the table when it's connected to these external components. The IC is in a 50 x 60 mil chip.

of 140 mils on the printed-circuit board. The two copper tabs extending from the package can be attached to an external heat sink when the circuit board is flow-soldered.

In a phonograph application, the PA246 accepts the approximately 1/2-volt signal from the pick-up. For external components, it requires two input resistors, one input capacitor, four output resistors, and two output capacitors. The IC chip itself is about 50 by 60 mils and contains seven transistors, five diodes, and four resistors.

The IC can operate from any supply voltage up to its maximum. Although it's designed for a 16-ohm load, other load impedances can be used with a slight drop in effi-

ciency. Frequency response extends from 30 hertz to 100 kilohertz, and noise output is typically -70 decibels relative to 5 watts. Input sensitivity is 180 millivolts and output harmonic distortion is less than 1% at the rated output.

### Specifications

(measured in test circuit illustrated)	
Supply voltage	37 volts max
Output current	1.25 amps max
Dissipation (tabs at 70°C)	5 watts max
Storage temperature	-65 to +150°C
Operating temperature	-55 to +125°C
Input voltage for $P_o=5$ watts	
$R_e = 0$	12 mv typical
$R_e = 6.8k$	180 mv typical
Efficiency for $P_o = 5$ watts	57%
Distortion at 1 khz, 5 watts $P_o$	0.7% typical
Output quiescent voltage at pin 7	17 v typical
Quiescent current	10 ma typical

Semiconductor Products department, General Electric Co., North Syracuse, N.Y. 13213 [338]

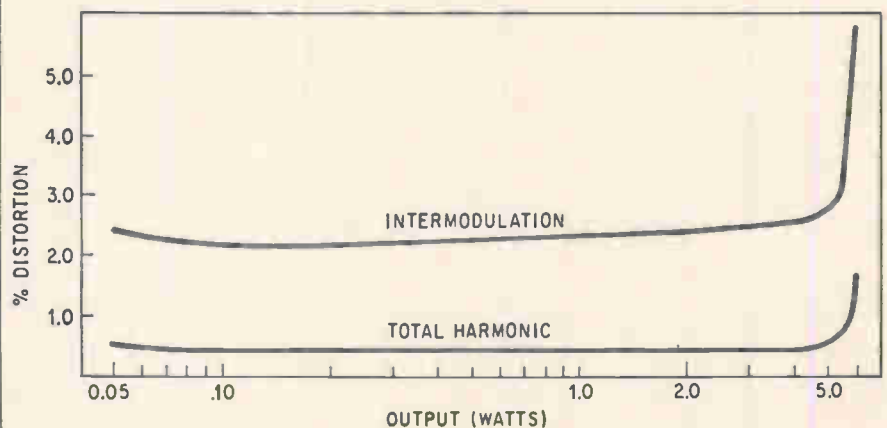

Flat. Intermodulation distortion is measured with 60-hertz and 6-kilohertz signals, mixed 4 to 1; total harmonic distortion is measured at 1 khz.



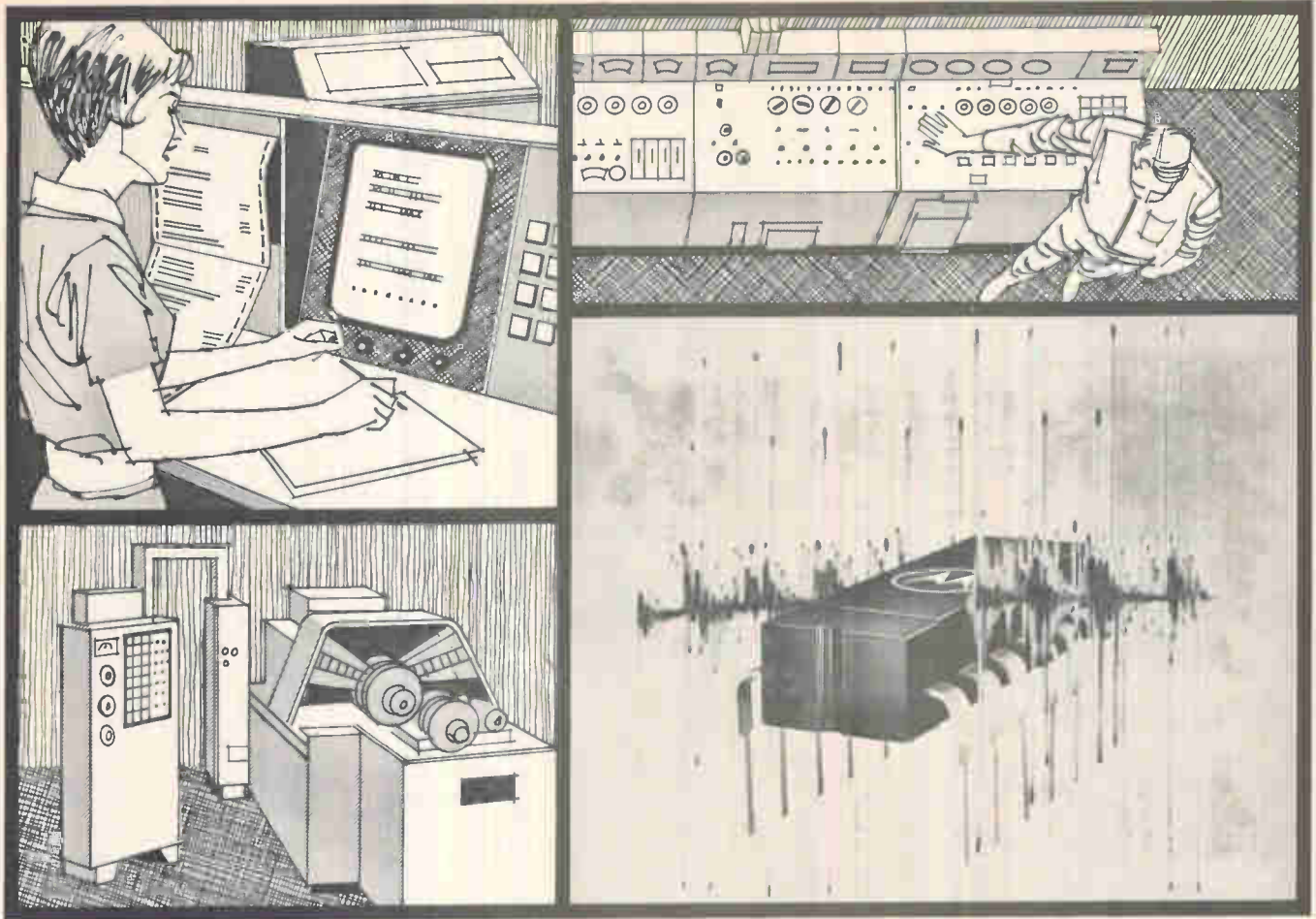

# If Noise Is Your I/C Problem... MHTL is The Economical Answer!

A recently-expanded line of integrated logic circuits that provides 6-volts (typ) noise immunity is now available in hermetically-sealed, dual in-line ceramic packages at the same price levels as previously-announced types in plastic.

It's called MHTL\*—for Motorola high-threshold logic. And, because of the six new circuits in the line — bringing the total to ten — the designer has much greater latitude in high noise-immunity system implementation.

MHTL is an ideal family for use in numerical control, supervisory control and computer-peripheral equipment. It's also valuable for interfacing with discrete components. In addition, MHTL offers a voltage swing of 13 V, over a wide operating temperature range ( $-30^{\circ}$  to  $+75^{\circ}\text{C}$ ), high fan-out and 30 mW power dissipation.

Here are the ten devices and functions:

TYPE	DESCRIPTION
<b>GATES</b>	
MC660L	Expandable Dual 4-Input Gate (active pullup)
MC661L	Expandable Dual 4-Input Gate (passive pullup)
MC670L	Triple 3-Input Gate (passive pullup)
MC671L	Triple 3-Input Gate (active pullup)
MC668L	Quad 2-Input Gate (passive pullup)
MC672L	Quad 2-Input Gate (active pullup)
<b>DRIVER</b>	
MC662L	Expandable Dual 4-Input Line Driver
<b>FLIP-FLOPS</b>	
MC663L	Dual J-K Flip-Flop
MC664L	Master-Slave R-S Flip-Flop
<b>EXPANDER</b>	
MC669L	Dual 4-Input Expander

Send for our new Perpetual Data Brochure which contains specifications, logic diagrams and operating characteristics for all ten MHTL circuits. We'll also send you two Application Notes to help you to better understand the use of these superior high-noise immunity circuits. **DO IT TODAY!**

\*Trademark of Motorola Inc.

— where the priceless ingredient is care!



**MOTOROLA Integrated Circuits**

MOTOROLA SEMICONDUCTOR PRODUCTS INC. / P.O. BOX 20912 / PHOENIX, ARIZONA 85036



# We reserve the right to make this ad obsolete without notice.

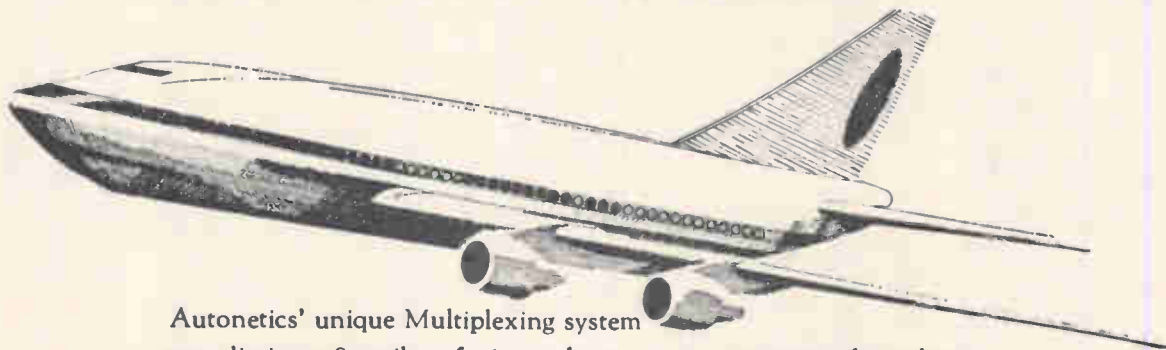

Autonetics' unique Multiplexing system can eliminate 80 miles of wire and save up to 1,500 pounds on large aircraft. Advanced microelectronic circuitry called MOS (metal oxide semiconductors) combined with other new techniques connect literally hundreds of aircraft subsystems through one coaxial cable.

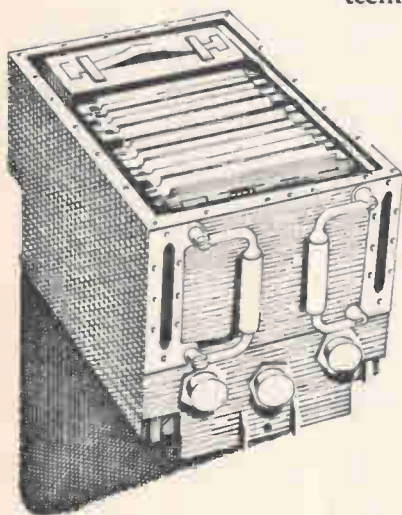

This advanced D26J computer uses commercially available integrated circuits and memories. It's flexible, fast, economical and reliable. Our delivery schedule is almost as fast.

This Autonetics MOS circuit contains more than 800 field effect transistors. It equals the performance of 100 integrated circuits. External or mechanical connections are reduced 30 to 1.

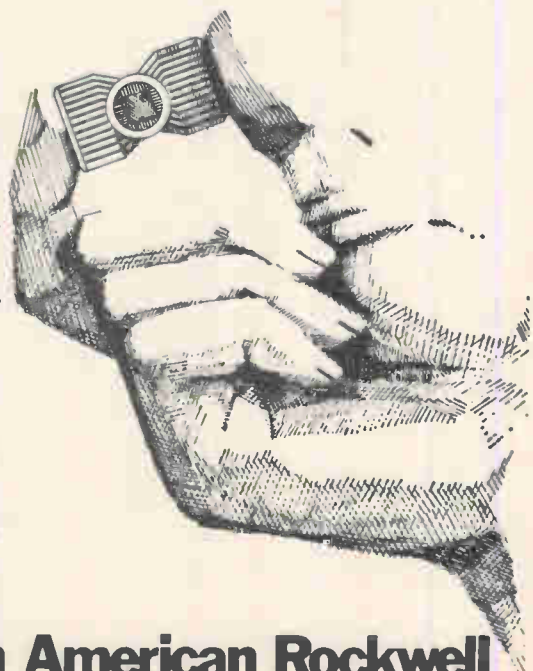

Someone is going to make these advanced Autonetics products obsolete some day. We intend to make sure it's us. For more information, write Department 080, 3370 Miraloma Avenue, Anaheim, California 92803.

## Autonetics Division of North American Rockwell

## New Components Review



Precision potentiometers model 140 (½ inch diameter, single-turn, wirewound) and model 162 (½ inch diameter, 10-turn, wirewound) feature a rear terminal design to accommodate maximum packaging density. Both have a power rating of 2 w at 40°C, derated to zero at 125°C. They meet MIL-R-12934. Spectrol Electronics Corp., E. Gale Ave., City of Industry, Calif. [341]



Four low-profile, circuit-board heat sinks series 2300 permit free circulation of air from all directions regardless of the mounting position. They have the same base size (1.81 inch square) and heat dissipating fin configuration but provide varying heights of ½, ¾, 1 and 1¼ in. Models are made of aluminum alloy. Astrodyne Inc., 207 Cambridge St., Burlington, Mass. [342]



Miniature d-c motors offer a range of sizes from 2 to 5 inches in length, and from 0.17 to 7 oz-inch torque. They operate without brushes, commutators, and rotor windings. The line offers instant reversibility and precise electronic speed control, even in the face of wide temperature, load, and voltage fluctuations. Siemens America Inc., 350 Fifth Ave., New York 10001. [343]



A-c sensitive relay model 1100 provides overcurrent protection. It features a solid state sensing logic and a self contained relay output housed in a sealed steel can. It operates directly from the line, or from a 5 amp secondary current transformer. The trip point is screwdriver adjustable from 1 amp to 5 amps. Wilmar Electronics Inc., 2103 Border Ave., Torrance, Calif. [344]



Trimming potentiometer model 325 measures 0.435 x 0.250 x 0.150 in., and weighs 0.5 gram, yet meets or exceeds MIL-R-27208. It has an operational temperature range of -65° to +200°C, and is rated at ½ w at 85°C. Wiper design assures constant positive contact with resistance windings, Atohm Electronics, 3030 Empire Blvd., Burbank, Calif. [345]

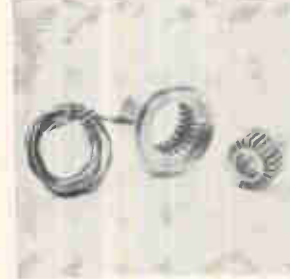

Rotary variable differential transformer 7149 has 48 null positions over a rotation angle of 360°. Carrier output voltage phase angle alternates between 0° and 180° from one null position to the other. Output voltage envelope is similar to a triangular function. All windings are in the stator, with no moving contacts. Pickering & Co., Sunnyside Blvd., Plainview, N.Y. [346]

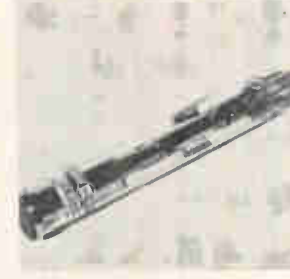

Character generator tube TH9503 is a fast generator of letters, figures, signs or symbols. While in monoscopes the signal corresponding to the complex picture is obtained by scanning the whole target at each frame, here the signal corresponding to the figure chosen is obtained by scanning 1 at a time among the 64 signs shown. Thomson Electric Co., 50 Rockefeller Plaza, N.Y. [347]



High voltage capacitors type CKM2 are packaged in rectangular CP70 cases with solder seal terminals that assure a true hermetic seal. They come in ratings from 600 to 50,000 v, and operate from -55° to +85°C without derating. Tolerance is ±20%. Dissipation factor does not exceed 0.8% at 1,000 Hz, ±25°C. Film Capacitors Inc., Eighth St., Passaic, N.J. [348]

### New components

## IC op amp compressed into flatpack

Double-substrate 'sandwich' construction of hybrid permits use of both thick- and thin-film resistors

The 14-lead flatpack is mowing down competing packages right and left. The blade began to swing with hermetics but picked up most of its force with the advent of integrated logic circuits in plastic packages. Now there's a booming business in circuit boards tailored

to fit 14- and even 16-lead flatpack elements.

With such emphasis on the small centipede-like flatpack, potential users look down on "cumbersome" packages as much as 1.12 inches square—especially when they'd like to save money by putting all their

components in flatpack-style circuit boards.

"So it's coming down to the problem of designing op amps to fit 14- or 16-lead IC flatpack sockets," says Robert S. Cook, a mechanical design engineer for Philbrick-Nexus Research, a Teledyne subsidiary.

The company's new model 1404 micropower op amp, though similar in many ways to its year-old Q-200, required some engineering hand-springs to get the circuitry—once housed in a 0.72-cubic-inch package—into the 0.07-cubic-inch flatpack.

The new op amp can be used where low quiescent current is re-



# RMC

## DISCAPS

### the complete Ceramic Disc line

Over the years Radio Materials Company has maintained its leadership in the production of ceramic disc capacitors. A complete line offering outstanding quality has been the key to continuing growth.

#### STANDARD

Type C, B, BA, JF, JL and JE

#### SUBMINIATURE

Type SM, BT, TA and Magnacaps

#### GREENCAPS

Type CG, JG, and BG

#### SPECIAL

U.L. Listed Discaps, T.C. High Voltage, High K High Voltage and Dual Section By Pass

#### SOLDER-IN T.C. DISCAPS

For application in equipment where lead inductance effects must be reduced to an absolute minimum.

#### U.L. LISTED T.C. DISCAPS

Should be specified when the use is an integral part of an antenna coupling network where compliance with Underwriters' Laboratories specifications are required

If your application requires special physical or electrical characteristics, contact RMC's Engineering Department.

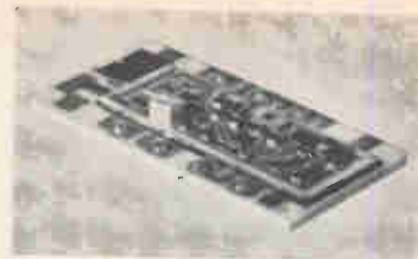

Tiered. Double layer widens resistance range of unit as well as saving space.

quired—in battery operation, for example, where little energy can be wasted. Remote, unattended seismic sensor systems may be one such application. A quiescent 1404 typically draws only 50 microamps.

To "compress" the op amp, Philbrick-Nexus used both thick- and thin-film hybrid technology, devising what may be one of the first "hybrid-hybrid" IC's.

A relatively large alumina substrate—0.46-by 0.75 inch—forms the base of the circuit. It has connections for the pins that will lead out of the package, a cermet thick-film resistor network, and chromium circuit interconnections.

**Epoxy on alumina.** A smaller alumina substrate is glued over the first one. It's placed atop the cermet resistor network and insulated from it by epoxy adhesive.

On this second layer of circuitry are the active components of the op amp, including 10 to 20 transistor chips, about 20 resistors, and three capacitors. Thin-film interconnections make a circuit out of these elements, and wire bonds like those used in IC packaging connect the upper and lower substrates.

Space and volume weren't the only reasons for going to a double-substrate system. According to senior engineer Arnold M. Liberman, it was impossible to get the wide range of resistors needed on a single substrate. "We needed from 27 ohms to 1.8 megohms. Originally we tried to realize the circuit in thick film alone but found it too bulky. And thin films couldn't give us some of the resistances we needed. So we combined the two techniques."

And David Ludwig, chief engineer, adds: "Use of both thick- and thin-films gives us the benefit of two realms of cost, accuracy, and resistance. Thin films allow precise but low resistances but at a

DISCAP  
CERAMIC  
CAPACITORS

RMC

RADIO MATERIALS COMPANY

A DIVISION OF P. R. MALLORY & CO., INC.  
GENERAL OFFICE: 4242 W. Bryn Mawr Ave., Chicago 46, Ill.  
Two RMC Plants Devoted Exclusively to Ceramic Capacitors  
FACTORIES AT CHICAGO, ILL. AND ATTICA, IND.



# Our private stock isn't private any more.



## Motorola's Frequency Control Products are now on the market.

They say that if you want a thing done right, you do it yourself. And so we did. For thirty years, we've been designing and manufacturing our own

frequency control components. Because they had to be good enough to use in our own products.

We've been selfish long enough. Now our precision crystals, oscillators, filters, and tone modules are available to designers and manufacturers throughout the electronics industry. And if the mile-long list of components

isn't long enough, our designers and engineers are ready to go to work on custom projects.

For additional information on existing products and design potentials, write to Motorola Communications & Electronics Inc., 4501 W. Augusta Boulevard, Chicago, Illinois 60651. Ask for Bulletin TIC-3401.



Circle 117 on reader service card

Choose from 44 styles  
of film capacitors...  
There's one to meet  
your exacting requirements

**HERMETICALLY-SEALED  
METAL CASE TUBULAR CAPACITORS**



**BARE METAL CASE**

Style LP8, metallized polycarbonate film  
Style LM8, metallized PETP-polyester film  
Style LS8, metallized polystyrene film  
Style AP8, polycarbonate film  
Style AM8, PETP-polyester film  
Style AS8, polystyrene film  
Style AF8, PTFE-fluorocarbon film

**METAL CASE WITH INSULATING SLEEVE**

Style LP9, metallized polycarbonate film  
Style LM9, metallized PETP-polyester film  
Style LS9, metallized polystyrene film  
Style AP9, polycarbonate film  
Style AM9, PETP-polyester film  
Style AS9, polystyrene film  
Style AF9, PTFE-fluorocarbon film

CIRCLE 511 READER SERVICE CARD

**EPOXY-CASE  
RECTANGULAR CAPACITORS**

**AXIAL-LEAD**



Style LP7A, metallized polycarbonate film  
Style LM7A, metallized PETP-polyester film  
Style LS7A, metallized polystyrene film  
Style AP7A, polycarbonate film  
Style AM7A, PETP-polyester film  
Style AS7A, polystyrene film

**RADIAL-LEAD**

Style LP7S, metallized polycarbonate film  
Style LM7S, metallized PETP-polyester film  
Style LS7S, metallized polystyrene film  
Style AP7S, polycarbonate film  
Style AM7S, PETP-polyester film  
Style AS7S, polystyrene film



CIRCLE 512 READER SERVICE CARD

**WRAP-AND-FILL  
ROUND TUBULAR CAPACITORS**



Style LP66, metallized polycarbonate film  
Style LM66, metallized PETP-polyester film  
Style LS66, metallized polystyrene film  
Style AP66, polycarbonate film  
Style AM66, PETP-polyester film  
Style AS66, polystyrene film

CIRCLE 513 READER SERVICE CARD

**WRAP-AND-FILL  
OVAL TUBULAR CAPACITORS**



Style LP77, metallized polycarbonate film  
Style LM77, metallized PETP-polyester film  
Style LS77, metallized polystyrene film  
Style AP77, polycarbonate film  
Style AM77, PETP-polyester film  
Style AS77, polystyrene film

CIRCLE 514 READER SERVICE CARD

**HERMETICALLY-SEALED  
METAL CASE RECTANGULAR CAPACITORS**



Style CML, high voltage paper/PETP-polyester film, inserted tab construction.

CIRCLE 515 READER SERVICE CARD

**HERMETICALLY-SEALED  
CERAMIC CASE TUBULAR CAPACITORS**



Style SML, high voltage paper/PETP-polyester film, inserted tab construction.  
Style SMLE, high voltage paper/PETP-polyester film, extended foil construction.

CIRCLE 516 READER SERVICE CARD

**HERMETICALLY-SEALED  
GLASS CASE TUBULAR CAPACITORS**



Style GML, high voltage paper/PETP-polyester film, 85 C  
Style GTL, high voltage paper/PETP-polyester film, 125 C

CIRCLE 517 READER SERVICE CARD

**EPOXY CASE  
RECTANGULAR CAPACITORS**



Style EFX, high voltage paper/PETP-polyester film.

CIRCLE 518 READER SERVICE CARD

For engineering bulletins on the capacitor styles  
in which you are interested, write to Dearborn  
Electronics, Inc., Box 530, Orlando, Fla. 32802.

**Dearborn Electronics, Inc.**  
(a subsidiary of the Sprague Electric Company)

FOREMOST IN FILM CAPACITORS

... three-layer hybrid  
may be tried next ...

higher price than thick films, which offer less precise but higher resistances."

Normally, Ludwig says, the 1404 would amplify or condition signals before transmitting them to an analog-to-digital converter. Its usable demand current of up to 3 milliamps is big enough to simplify the choice of an a-d converter.

Because of component matching, both at room temperature and (for critical transistors) over wide temperature ranges, the 1404 achieves a typical common-mode rejection of 90 decibels and a minimum of 75. This, says Ludwig, is easily within the range usually associated with discrete-component op amps.

For flexibility of operation with various power supplies, the 1404 can work with input voltages ranging from 2 to 15 volts, "and it could probably handle 17 or 18 without strain," according to Liberman.

Shake or break. How strong is a device in which a ceramic substrate doubles as a header? Very strong, according to Ludwig, who says the 1404 passes shock and vibration requirements of MIL-S-19500, "and these are pretty demanding specs."

"Certainly, the 1404 is tougher than other layered hybrid schemes now in the lab," says Ludwig. "In some of these the substrates would be separated by posts, so each could flex with respect to the other and possibly break. But by using epoxy as the center of our sandwich, we get two layers of alumina to reinforce one another, while the epoxy absorbs some minor stress in between.

"It's possible that we might try three-layer circuits of this type, but since bonding pads are needed at the edge of each successive layer, the topmost substrate soon gets pretty small—or the bottom one very large. In either case, it looks like three layers is near the point of diminishing returns."

Although no price has been set for the 1404, Philbrick-Nexus says sample lots will be available in a month.

Philbrick-Nexus Research, Allied Dr. at Rt. 128, Dedham, Mass. 02026 [349]



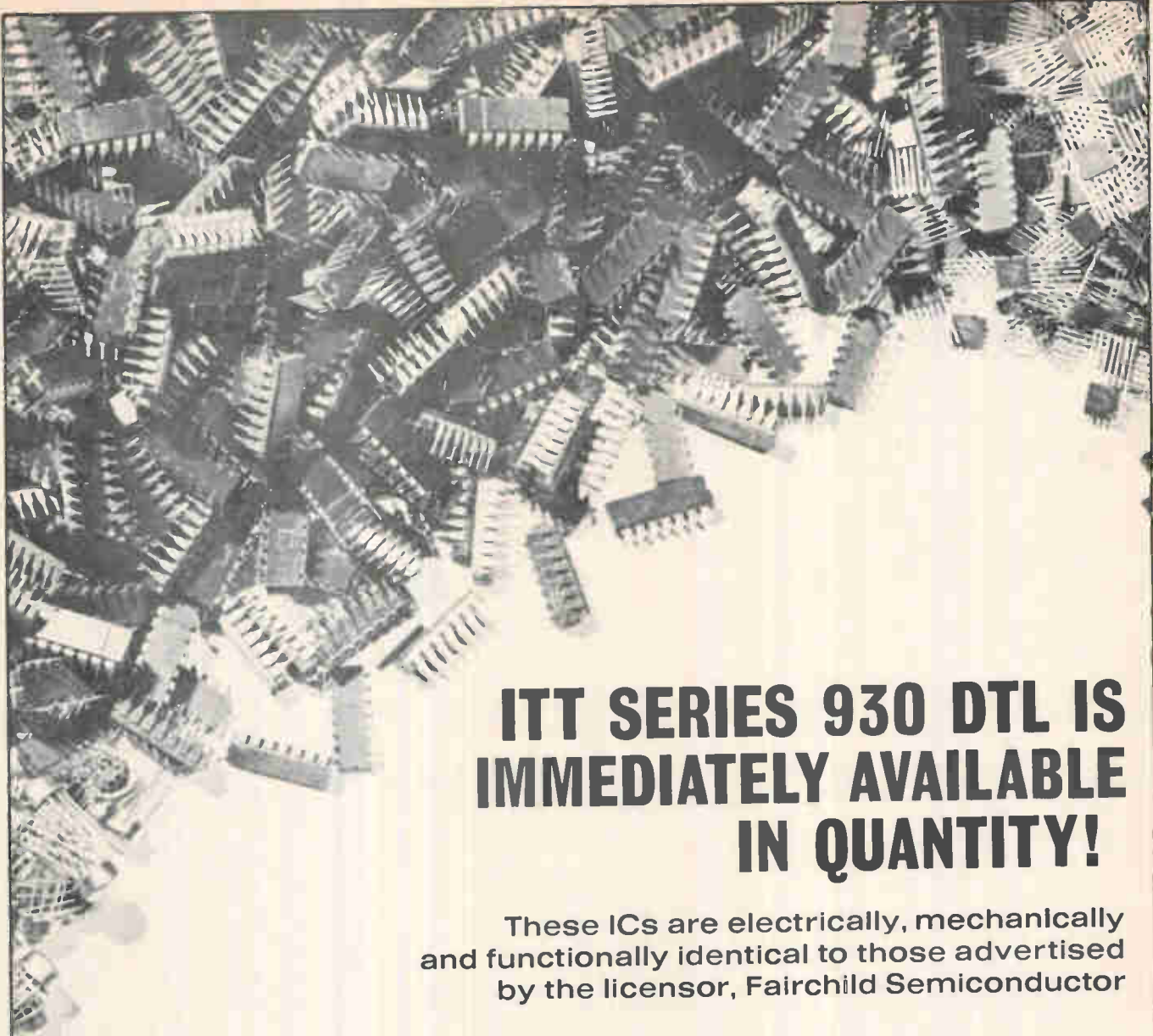

## ITT SERIES 930 DTL IS IMMEDIATELY AVAILABLE IN QUANTITY!

These ICs are electrically, mechanically  
and functionally identical to those advertised  
by the licensor, Fairchild Semiconductor

Buy them in ceramic dual in-line (or TO-5 and flat pack) from:

Phoenix, Arizona .....602/264-2778  
Long Beach, California...213/774-4820  
Palo Alto, California ....415/964-3400  
North Palm Beach,  
Florida† .....305/848-4617  
Altamonte Springs,  
Florida† .....305/831-1080  
Chicago, Illinois .....312/282-4777  
Towson, Maryland.....301/828-4616

Wakefield,  
Massachusetts .....617/245-8350  
Southfield, Michigan ...313/353-0880  
Minneapolis, Minnesota .612/920-2943  
Bloomfield, New Jersey..201/743-9613  
Poughkeepsie, N. Y. ....914/452-0800  
Syracuse, New York....315/463-6677  
Dayton, Ohio .....513/434-6121

Bala Cynwyd,  
Pennsylvania .....215/667-4596  
Seattle, Washington ...206/282-9150  
Pierrefonds, Quebec,  
Canada† .....514/626-6511  
Willowdale, Ontario,  
Canada† .....416/225-7494

OR Call Your Local  
ITT Stocking Distributor.

† ITT Representative

semiconductors **ITT**

ITT SEMICONDUCTORS IS A DIVISION OF INTERNATIONAL TELEPHONE AND TELEGRAPH CORPORATION, 3301 ELECTRONICS WAY, WEST PALM BEACH, FLORIDA 33407  
FACTORIES IN FLORIDA • CALIFORNIA • MASSACHUSETTS • ENGLAND • FRANCE • GERMANY • PORTUGAL • AUSTRALIA





# Counting Relay

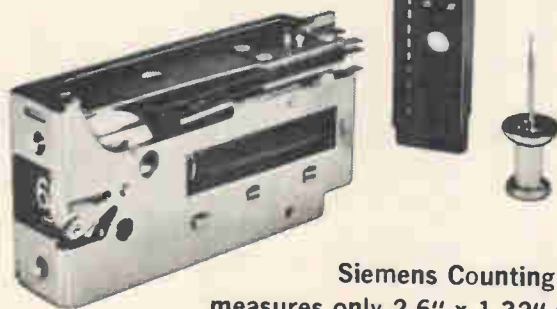

Siemens Counting Relay measures only 2.6" x 1.32" x .53"

- Static readout feature provides instantaneous electrical readout . . . can be used as decimal memory unit.
- Accessory contacts for logic function.
- Plug-in type.
- Low in price.
- Functions as a one digit indicator or part of a multiple counting module.
- Available in either forward or reverse counting direction.

Sample quantities available from New York stock

**SIEMENS AMERICA INCORPORATED**  
Telecommunications Division  
350 Fifth Ave., New York, N.Y. 10001 • Tel. (212) 564-7674

Circle 167 on reader service card

# Improve your system reliability by installing GE photoelectric tape readers



**PTR60 (Shown Above) and 70 Series:** reliable, compact, "through-the-tape" Readers of field-proven design. choice of reading speeds up to 500 characters per second.

**PTR80 (Shown Below) and 90 Series:** high performance readers designed for speeds up to 1000 characters per second. reflected light reading technique eliminates problems of variation in tape opacity and permits reading of both punched and printed tapes.



Install them and forget them. GE photoelectric tape readers give lasting service with minimum maintenance. Features include:

- no electrical adjustments
- unidirectional or bidirectional operation

- simple, complete controls
  - all solid state components
  - tape handlers available for entire reader line
- Numerous options are offered to meet your special requirements. Mail today for full details. 837-04A

Mail to Mr. R. S. Holmes, Printer-Reader Business Section, General Electric Co., 511 North Broad St., Philadelphia, Pa. 19123

NAME \_\_\_\_\_  
 ADDRESS \_\_\_\_\_  
 COMPANY \_\_\_\_\_  
 CITY \_\_\_\_\_ STATE \_\_\_\_\_ ZIP \_\_\_\_\_

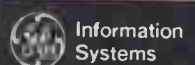

Printer-Reader Business Section



## New components

# Fuse blows in a millisecond

Fast unit can protect IC's, power transistors in digital microcircuits

They went shopping for fuses to go with a line of digital power components, but engineers in the microcircuit operation of Beckman Instruments Inc.'s Helipot division couldn't find devices that were fast enough.

The speediest 0.5-amp fuses took from 8 to 20 milliseconds to open a circuit, says George Smith, supervisor of product design, "and an 8-millisecond fuse isn't fast enough." So Beckman developed the 817 series, a line of fuses rated at 0.5, 0.75, and 1.5 amps. All three types blow in 1 millisecond. "This is with a small overload," says Smith. "It can get as fast as 50 nanoseconds with a 30-amp overload," which he says is not unusual.

**Power problem.** "The components we're worried about—the integrated circuits or power transistors—are downstream from the voltage regulator, but we're not too concerned about overvoltages," Smith notes. "It's power dissipation that's a problem. Power can produce destructive temperatures rapidly. The thermal time constant of one of our voltage regulators is 1 millisecond. This means that it reaches 63% of its final temperature in that time, and we need to shut down the system in 100 to 300 microseconds."

The new fuses, housed in TO-46 cans, consist basically of metal wires made of a high-temperature alloy and another proprietary material developed at Beckman. Operation is said to be stable at temperatures from -55°C to +125°C.

Prices for all three types range from 85 cents in quantities of 50 to 99, to \$1 for one to nine fuses. The fuses are guaranteed at 100% of their ratings for 1,000 hours.

Helipot Division, Beckman Instruments Inc., Fullerton, Calif. 92634 [350]

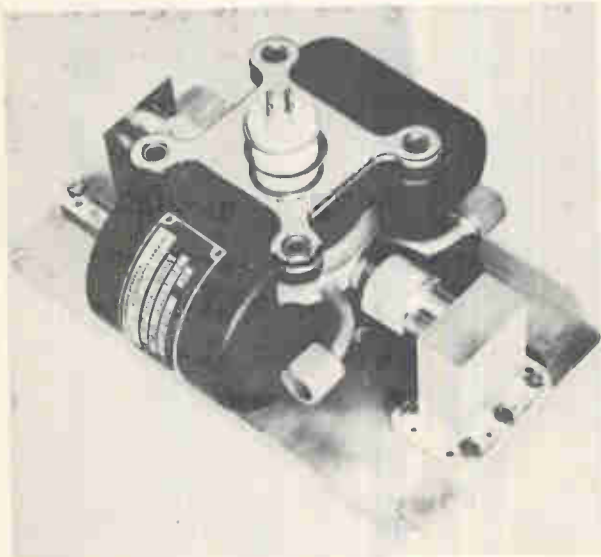

# CARPITRON

(Locked carcinotron)

The carpitron is an oscillator which can be locked by a drive signal in an electronically tunable band.

The range covered by the existing types is 500 to 18,000 MHz.

With output powers :  
2 kW to 100 Watts

**main features :**

- Small size
- Bulk structure
- High efficiency
- Low supply voltages
- Low noise performances

**applications :**

- Output tube for space telecommunications ground stations.
- Tropospheric scatters
- DOPPLER radars.

**examples**

**CMP 1115** (Developed for Intelsat ground station at Pleumeur-Bodou)

Frequency range .....	5925 - 6425 MHz
Output power .....	500 W
Instantaneous bandwidth .....	45 MHz
Equivalent gain .....	16 dB
Efficiency .....	35 %

**F 4190** (For KU band)

Frequency range .....	15 - 18 GHz
Output power .....	100 W
Instantaneous bandwidth .....	80 MHz
Equivalent gain .....	20 dB
Efficiency .....	15 - 20 %

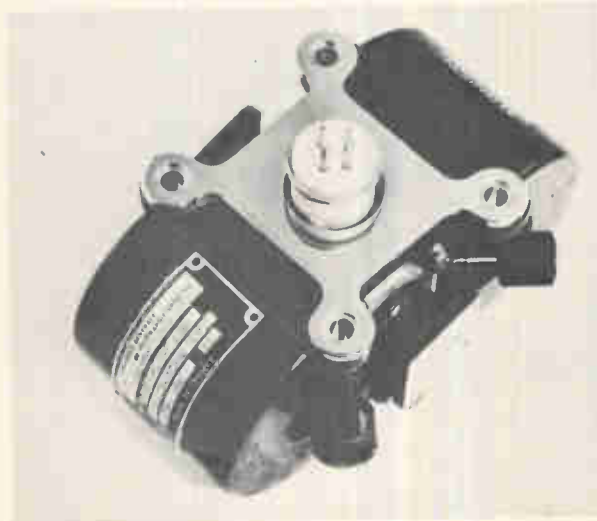

**CSF-COMPAGNIE GÉNÉRALE DE TÉLÉGRAPHIE SANS FIL**  
GROUPEMENT TUBES ÉLECTRONIQUES

55, RUE GREFFULHE - 92 - LEVALLOIS-PERRET-FRANCE. TEL. : 737.34.00

**U. S. Office : American Radio Company**

445 PARK AVENUE - NEW YORK, N. Y. 10022 (212) 753.5046

SPI.856

# You design RF circuits in terms of frequency domain.

# Now you can measure their performance that way, too.

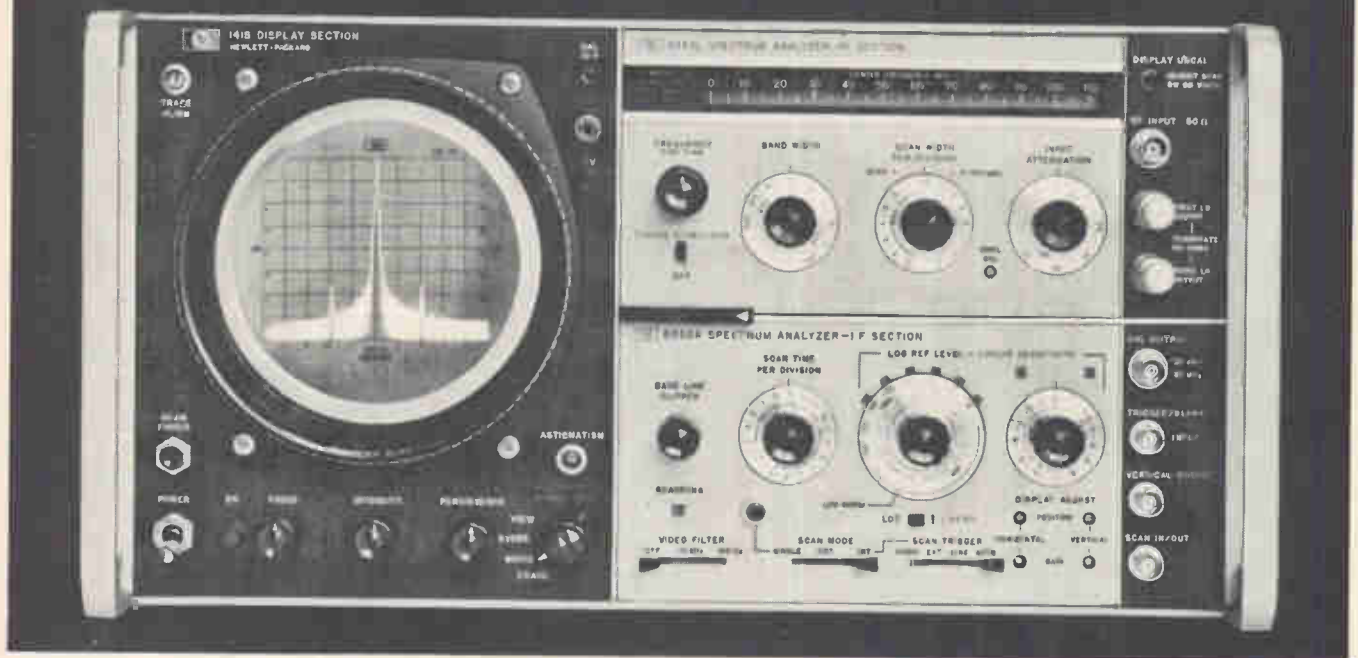

Forget all equipment limitations that used to plague signal analysis in the 1 kHz to 110 MHz range. The HP 8552A/8553L Spectrum Analyzer has all the characteristics—absolute calibration, high stability, freedom from internal distortion and spurious responses—that make it an indispensable tool for virtually every frequency domain measurement.

Absolute signal levels are displayed from  $-130$  dBm to  $+10$  dBm ( $0.07 \mu\text{V}$  to  $0.8 \text{ V}$ ). With the wide 100 MHz scan, you see the broad spectrum quickly, precisely. Reduce the scan width in calibrated steps (to as narrow as 2 kHz) for detailed examination of individual signals. With the analyzer's distortion-free 70 dB dynamic range and narrow 50 Hz resolution, you can characterize complex signals, even in the presence of other high-level signals.

Yours for the asking—a brochure describing how these

vital circuit performance characteristics are measured accurately and conveniently: *oscillator* spectral purity; *amplifier* response and distortion; *mixer* conversion efficiency; *modulation* index; *filter* response. Price of the full system—8553L RF section, 8552A IF section, 141S Variable Persistence Display section—\$5225.

Your HP field engineer can give you the details on how this remarkable new instrument can solve your frequency domain measurement problems, in circuit design lab or final system evaluation. Or write to Hewlett-Packard, Palo Alto, California 94304; Europe: 54 Route des Acacias, Geneva.

**HEWLETT**  **PACKARD**

**SPECTRUM ANALYZERS**

04807



## New Instruments Review



Direct-recording, light-beam oscillograph model LCR provides a complete analog recording system with built-in signal conditioning modules matched to single-unit galvo-magnet structures. Its servo drive system has 8 recording speeds ranging from 0.2 to 80 ips. The oscillograph features 3, 8 or 14 channels. Midwestern Instruments Inc., 6422 E. 41st St., Tulsa, Okla. [361]

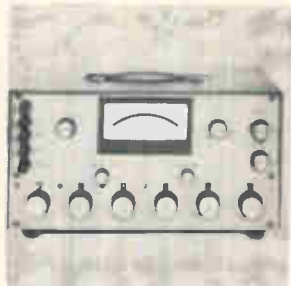

A-c/d-c voltmeter 1002 is a 5-in-1 instrument. As a differential voltmeter it is designed to provide d-c accuracy  $\pm 0.0025\%$  of reading and  $\pm 0.05\%$  a-c accuracy with a reference stability of 2 to 3 ppm. It can also be used as a decade voltage divider, ratiometer, calibrated reference source, and null detector. Precision Standards Corp., Box 8361, San Marino, Calif. [362]



Integrating digital multimeter DT-360 features 5 functions and 5 ranges, including a-c voltage and current. Zero and full scale calibration adjustments are made through the front of the meter; the pots are located behind the easily-removed identification strip. Unit price is \$450. Data Technology Instrument Co., 1050 East Meadow Circle, Palo Alto, Calif. 94303. [363]



A-c/d-c differential voltmeter model TDV-1000 offers 1 ppm linearity and resolution, d-c accuracy of  $\pm 0.0025\%$ , a-c accuracy of  $\pm 0.05\%$  and a stability of better than 0.0025% in 60 days. D-c range is 0.0000 to 1100.0 v; a-c is 0.001 to 1,000 v. Operating temperature range is 0° to 50°C. Price is \$1,585. Julie Research Laboratories Inc., 211 W. 61st St., New York [364]



A rear panel local oscillator output is now available as an option on all versions of interference analyzer model EMC-25, a solid state RFI/EMC swept receiver covering 14 khz to 1,000 Mhz. The I-O output spec is for a minimum of 100 mv into 50 ohms and levelled to within 25 mv for all bands up to 25 Mhz. Electro-Metrics Corp., 88 Church St., Amsterdam, N.Y. 12011 [365]

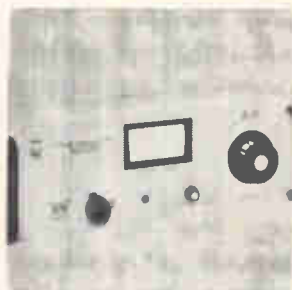

Ratiometer model C/KT4070 will accurately measure carrier level to noise power density ratio to within 0.1 db. Wide measurement bandwidth (40 Mhz centered at 70 Mhz) is obtained by utilizing the differential precision of a waveguide beyond cut-off attenuator, and a true RMS detection system. FKS Communications Inc., 3 Delaware Drive, New Hyde Park, N.Y. 11040 [366]



Precision calibrator model 838A is for rapid and accurate calibration of telemetry f-m subcarrier discriminators. It internally generates all 21 of the 7½% narrow-band and all 8 of the 15% wide-band proportional IRIG f-m subcarrier channels as well as four selectable tape speed reference frequencies. Monitor Systems Inc., 401 Commerce Drive, Fort Washington, Pa. [367]



Pulse generator PG-22 is an all silicon instrument featuring rise and fall times better than 2 nsec, rep rates from 0.1 hz to 50 Mhz, and wide range control of pulse width (10 nsec to 1 sec) and delay (-10 nsec to +1 sec). Simultaneous positive and negative outputs are independently variable up to 5 v into 50 ohms. Lyons Instruments Ltd., Hoddesdon, Herts., England. [368]

## New instruments

### Pulse generator takes to the field

Battery-operated unit, the size of a six-pack, directly drives RTL, DTL, and TTL circuits

If an engineer buys a portable oscilloscope, chances are he also needs some portable test gear. So goes the reasoning behind International Contronics Inc.'s decision to build a battery-powered pulse generator.

"Tektronix realized the need for

an oscilloscope that could be used in the field and other places where a-c power requirements couldn't be met," says Contronics' president, Charles Chapin. "And it continues to amaze me that Tektronix doesn't provide a complementary d-c pulse generator."



Wide and fast. Both the pulse width and repetition rate are adjustable.



## New...a deposition thickness controller you can trust—always

Now, Airco Temescal has eliminated misleading readouts caused by elevated temperatures, sudden thermal shocks, electron beam sources, and close substrate-to-evaporant spacing. And, we have not added a cent to the sales price—\$1150. Available from stock. Airco Temescal manufactures a complete line of thickness con-

trollers, rate controllers, and accessories. For further information contact:

### AIRCO Temescal

A Division of Air Reduction Co., Inc.  
2850 7th St., Berkeley, Calif. 94710  
Telephone 415 841-5720

Reliability Through Research.

Circle 168 on reader service card

## Cut Circuit Costs

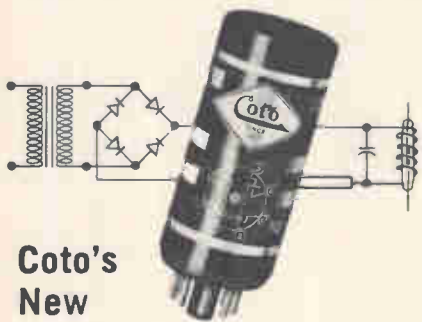

Coto's  
New

## A.C. Reed Relay

Replaces Costly AC/DC Circuits!

Contacts: Forms A or C with single or multiple poles.  
Ratings: to 3 amperes or up to 5000 volts D.C.  
Inputs: 60-800 Hz voltages available.

Physical: Available in 8 and 11 pin plug-in housings with electromagnetic shielding. Electrostatic shielding available on order.

Write for complete specifications. For special requirements, give complete details for quotation.

**Coto-Coil** COMPANY, INC.  
61 Pavilion Avenue  
Providence, R. I. 02905  
Phone (401) 941-3355

124

Circle 124 on reader service card

... select any frequency  
from 1 hz to 10 Mhz ...

Tektronix Inc. doesn't, so Contronics does. The Lochpulse generator weighs 6 pounds, is as big as a six-pack, and runs for 3½ hours off a 5-volt nickel-cadmium battery. It's the first product made by Contronics, a new company organized by a group of former Fairchild engineers.

Designed to work with the Tektronix 422 oscilloscope, the Lochpulse has two complementary, d-c-coupled outputs. Pulse amplitude is continuously adjustable up to 5 volts, as are pulse width, from 50 nanoseconds to 20 milliseconds, and repetition rate, from 1 hertz to 10 megahertz.

Rise and fall times are both typically 6 nsec when the instrument feeds a 50-ohm load. The maximum for both is 10 nsec.

The Lochpulse can feed almost any digital system; it directly drives resistor-transistor, diode-transistor, and transistor-transistor logic circuits.

No delay. Lochpulse, says Chapin, is the first portable pulse generator built with TTL integrated circuits. By using these IC's, Contronics engineers were able to give the instrument a 100% duty cycle without using delay lines.

TTL circuits are also used in the Lochpulse to generate repetition functions and to control width and output.

The company expects the generator to be used on ships, where the available a-c power is often too noisy for digital testing. Chapin also points out the commercial and military demand for equipment to test airborne navigational and data-handling systems.

There are three models of the Lochpulse. The 200-3 runs on a-c only and costs \$335. The 201-1 is a-c/d-c, but its pulses have constant amplitude; it sells for \$310. The 200-2 is a-c/d-c and has adjustable amplitude; it costs \$335.

When a Lochpulse runs off a-c power, it works with 105-to-125-volt signal at 50 to 400 hertz and draws up to 10 watts.

Delivery time for all models is one week.

International Contronics Inc., 106 Terra Bella Ave., Mountain View, Calif. [369]

750 V

**PRECISION SPARK GAPS\***

Oscilloscope of one of Joslyn's spark gap models — the 2001-28 made specifically for RCA—shows exact repeatability. All Joslyn spark gaps feature:

- Ultra-fast response (nanoseconds)
- Long life
- Wide dynamic range
- Stable operation
- Insensitive to light
- No isotope prompting
- Close tolerances
- Hermetically sealed
- Negligible voltage creep
- Lightning — EMP capability available

Ideal for protection of magnetron modulators, microwave stations, dc power systems, output of dc power supplies, all types of signal and data transmission lines, p.c. protectors, control circuits. Available from stock or custom designed.

Write today for new brochure JES-142. Joslyn Electronic Systems, Santa Barbara Research Park, P.O. Box 817, Goleta, California. Tel (805) 968-3551.

## JOSLYN

### ELECTRONIC SYSTEMS

\* Patented and Patent Pending 350

Circle 169 on reader service card

Electronics | November 25, 1968





## why should the only cargo that loads itself be toughest to ship?

Getting you to and fro has been a series of outright blunders, slow-dying half-measures, and scattered bits of good ideas.

The trend in surface commuting, for example, is for more and wider roads with more and fatter cars carrying fewer persons. The logical extension is an infinite number of empty cars, hub to hub and dent to dent, on a 15-mile circle of asphalt centered on each community.

We think system engineering can bring order to this chaos, and we intend to be there when it happens. What system engineers have done so far has

been merely practice for what lies ahead.

That's why we stress continuing education, offering graduate degree programs in our facilities and fellowships at nearby universities. We have found no substitute for formal training in the engineering of advanced systems.

Bringing system engineering disciplines to urban renewal, biomedical research and practice, safer streets, better nutrition, education, employment, international security, arms control — these are some of the real opportunities.

Tell us how you would take ad-

vantage of these opportunities in an atmosphere like this: engineering innovation as a way of life, systems the business of everyone, and the individual as contributor.

**WRITE TO** Mr. James L. Hackbush, Sanders Associates, Inc., Dept. 467E, 95 Canal St., Nashua, N. H. 03060.

**SYSTEM ENGINEERS • ECM ENGINEERS • ASW ENGINEERS • DIGITAL ENGINEERS • ANTENNA ENGINEERS • MICROWAVE ENGINEERS**

CREATING NEW DIRECTIONS IN ELECTRONICS

**SA**  **SANDERS ASSOCIATES, INC.**  
© 1968 SANDERS ASSOCIATES, INC.  
 An Equal Opportunity and Affirmative Action Employer M/F

NASHUA, N.H. □ MANCHESTER, N.H. □ BEDFORD, MASS. □ CAMBRIDGE, MASS. □ PORTLAND, ME. □ PLAINVIEW, L.I., N.Y. □ RESTON, VA.





With Tamron... on TV...  
the picture is getting brighter, all over the world



**Tamron Lenses**

No.	Focal Length	Aperture
1224	12.5-50mm	1 : 1.8
1624	16-64 mm	1 : 2.0
15210	15-150 mm	1 : 2.5
2024	20-80 mm	1 : 2.5
2524	25-100 mm	1 : 1.8
1214	12.5 mm	1 : 1.4
2514	25 mm	1 : 1.4
2519	25 mm	1 : 1.9
2911	29 mm	1 : 1.1
3611	36 mm	1 : 1.1
5014	50 mm	1 : 1.4
5019	50 mm	1 : 1.9
7514	75 mm	1 : 1.4
7519	75 mm	1 : 1.9

Tamron lenses for ITV at moderate cost for high quality and proven performance. Matching the most critical requirements of the world's leading TV camera makers and users, they are especially appreciated for high resolving power, freedom from aberration, superior radiation intensity, and no mechanical vignetting.

Manufactured by Taisei Kogaku, known particularly as the world's ZOOM specialist, Tamron lenses are generally designed to be equipped with manual, gear-driven and motor-driven systems.

Tamron CCTV lenses are members of the famous Tamron family of optics in the fields of X-ray, process, electrostatics copying, micro film, etc.

Tamron ITV lenses provide the full range from Super-Wide angle through 10:1 Zoom.



Circle 126 on reader service card

**New instruments**

**Steady heat for under \$100**

Proportional controller handles 15-20 amps; can be used for speed

Regulating an oven shouldn't be an off-and-on affair. It's inefficient to be continually shutting down and starting up an oven as the temperature jumps back and forth across a set point.

This is one reason makers of diffusion chambers, industrial furnaces, and other constant-temperature systems prefer proportional control—as temperature nears the set point, the voltage that controls the heating system changes in an attempt to stabilize the tempera-



Set up. The width of the proportioning band and the set point are fixed with knobs on the Mark III's front panel.

ture. Another reason is that proportional control permits more precise regulation.

Off-on systems cost less, of course, but PMF Electronics Inc. has built a proportional controller that sells for less than \$100. Thomas Richardson, president of the company, says similar devices cost at least \$250. He credits the low price to the use of circuitry produced for other PMF controllers and to the fact that the new device handles 15 to 20 amps, against about 600 amps for competing devices.

Called the Mark III-VP, the device is a meter-relay, and comes in ranges from 100°F to 2,500°F. The

Circle 127 on reader service card →

**FIGHT THEM ALL...**

**Heart Attack  
Stroke  
High Blood Pressure  
Rheumatic Fever**



**GIVE ...SO MORE WILL LIVE HEART FUND**

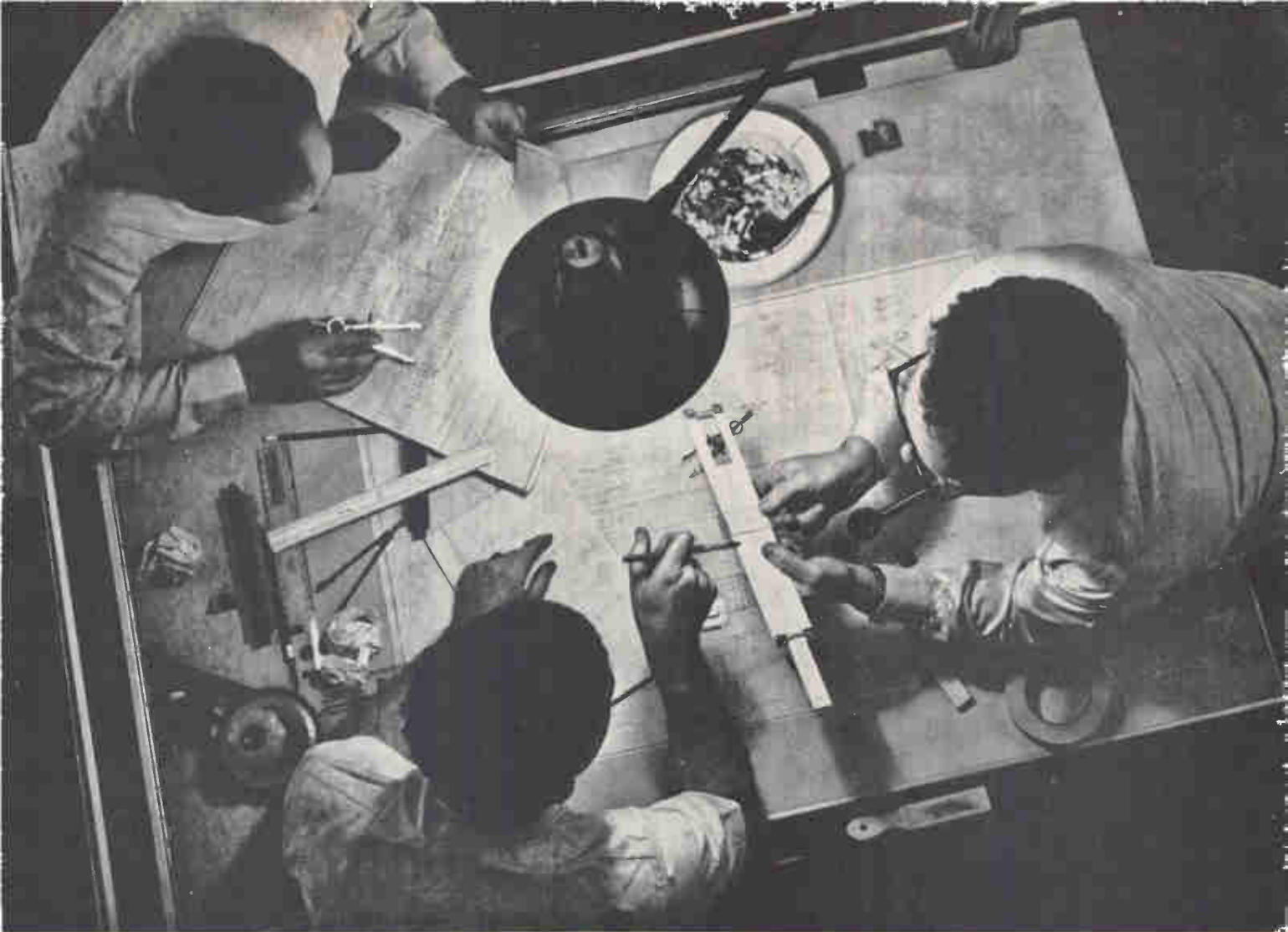

# We've been copying other people's designs for 17 years.

And they love us for it.

After all, we're custom fabricators. And if we didn't copy designs exactly, we wouldn't be doing our job.

We do it every day. On transistor leads, computer memory core frames, connectors, pen caps, aerosol spray tips, razor blade dispensers, integrated circuit frames.

You name it, we copy it. To your precise specifications.

Whether it's precise stamping of high-tolerance, miniature metal shapes.

Or precise molding of intricate plastic parts.

Or precise forming of wire for critical electronics.

Or precise combining of metals, plastics and wire into complex assemblies.

And we've got nine plants, the most advanced equipment, and the best engineers and diemakers around to do it.

We'll even help you design the part. Then we'll build the dies, produce the parts, and do the assembly. A perfect copy every time.

That means you get the parts you want, the way you want them, when you want them—probably at less cost than you could do it for yourself.

So the next time you come up with a great new design, give us a call and we'll copy it.

Sylvania Metals & Chemicals, Parts Division, Warren, Pa. 16365.

CUSTOM PARTS BY  
**SYLVANIA**  
A DIVISION OF  
GENERAL TELEPHONE & ELECTRONICS



## The Material of Unlimited Uses...



## DIP-MOLD PROCESS CUTS POTTING TIME 60%

Microtran Company, Inc., Valley Stream, N.Y., produces a wide variety of miniaturized and standard transformers, many specified with epoxy encapsulation. When dipping transformer bodies in epoxy proved slow and otherwise unsatisfactory, a shell-mold process was adopted, using Cerrotru® low-melting-point alloy. Here's how Microtran cut potting time, in some instances from 47 to 18½ minutes, and improved its product as part of the bargain: Cerrotru Alloy melts at a safe 281°F and expands (.0005"/inch) as it solidifies. A master pattern of polished aluminum, dipped into the molten alloy, yields almost instantaneously a shell mold of accurate dimensions and excellent surface finish. The transformer is placed in the shell; epoxy is poured in and air-cured. Such molds are used once and are broken off. The alloy can be reused indefinitely. Reverse curves and undercuts are readily accommodated by making the molds in matched halves. Shell molding is only one of many uses for Cerro low-melting alloys. For the full story on their versatility, call Cerro Alloy Dept., Cerro Copper & Brass Co., Rolling Place, Stamford, Conn. 06907. Telephone (203) 327-0550. In Europe, contact Mining and Chemical Products, Ltd., Alperton, Wembley, Middlesex, England.

# CERRO®

## ... if temperature goes up, Mark III's output goes down . .

set point is adjustable, and the proportioning band can go from 5% to 15% of full scale.

**Triac control.** Input to the Mark III comes from a thermocouple; the temperature-sensitive signal drives the voltmeter, which is scaled to read out in Fahrenheit or centigrade. Attached to the meter's needle is a plastic cylinder; as the needle moves, the cylinder rotates. Behind the meter are a lamp and a photocell. The rotating cylinder changes the amount of light reaching the cell, so the cell's resistance is proportional to the oven temperature.

The current in the cell controls a transistor that, in turn, determines the gating current of a triac. The triac's output, which is proportional to the gating current, flows back to the oven where it drives the heating system.

Because of the low current capability, Richardson expects makers of small ovens to be his first customers. He also feels that the Mark III has a place in process control systems, like those used for injection molding and die casting.

And the Mark III can also be made to keep temperature from falling too low. "We've already sold some of these for use in cryogenic surgery," says Richardson.

If a tachometer instead of a thermocouple feeds the Mark III, the device can be used to proportionally control speed.

**Dimmer display.** The Mark III runs off 115 volts a-c. Its front panel is 4 by 4½ inches, and its barrel is 5¼ inches long.

Besides the meter, there are two knobs and a lamp on the front panel. As the triac's output changes, the lamp brightens or dims. One of the knobs is used to fix the set point, and the other to set the width of the proportioning band. This second knob is attached to the shaft of a potentiometer that's in parallel with the photocell.

PMF can build in an integrated-circuit amplifier for the millivolt-range signals coming from the thermocouple.

PMF Electronics Inc., 124 E. Third St.,  
Dayton, Ohio 45402 [370]

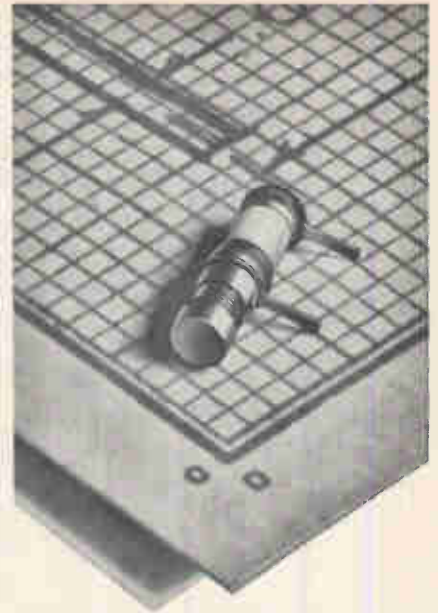

## Sub-Miniature Low-Inductance Capacitor

### High Q >1500 @ 500 mc

10:1 capacitance ratio in micro miniature size — extra fine tuning <.35 pF per turn. High Q, (greater than 1500 at 500 mc).

#### Specifications

Size: ⅛" diameter, ½" length  
Capacitance Range: 0.35 pF to 3.5 pF  
Working Voltage: 250 VDC  
(test voltage, 500 VDC)  
Q @ 100 mc: >5000; @ 250 mc, >2000  
Insulation Resistance: >10<sup>6</sup> Megohms  
Temperature Range: —55°C to 125°C  
Temperature Coefficient: 50  
± 50 ppm/°C

**Features 570° Solder. Prevents distortion. Not affected by conventional soldering temperatures.**

Call or write for complete information.

### MANUFACTURING CORPORATION

400 Rockaway Valley Road  
Boonton, N.J. 07005 • (201) 334-2676  
Electronic Accuracy Through Mechanical Precision



# can't get away for evening classes?



## here's a practical way to avoid technical obsolescence

Are irregular hours, travel and family obligations keeping you from attending classes—even though you worry about becoming technically obsolescent? Check into the Special Programs in Electronics for Engineers developed by CREI, the Home Study Division of the McGraw-Hill Book Company.

These are not simply courses, but comprehensive programs in advanced electronics offering major lectures in such fields as :

Communications Engineering, Aeronautical and Navigational, Television Engineering, Automatic Control Engineering, Missile and Spacecraft Guidance, Radar and Sonar Engineering, Nuclear Instrumentation and Control, Computers.

Industry-recognized CREI Programs make it possible for you to catch up on new developments in electronics through study in your own home, at your own pace,

your own schedule. Free book gives complete information and details of technical material covered. For your copy, mail coupon below or write : CREI, Home Study Division, McGraw-Hill Book Company, Dept. 1844G, 3224 Sixteenth St., N.W., Washington, D.C. 20010.



CREI, Home Study Division, McGraw-Hill Book Company  
Dept. 1844G, 3224 Sixteenth St., N.W.  
Washington, D.C. 20010

Send me free brochure describing CREI Programs in Electronics for Engineers.

NAME \_\_\_\_\_ AGE \_\_\_\_\_

ADDRESS \_\_\_\_\_

CITY \_\_\_\_\_ STATE \_\_\_\_\_ ZIP CODE \_\_\_\_\_

COMPANY \_\_\_\_\_

TITLE \_\_\_\_\_

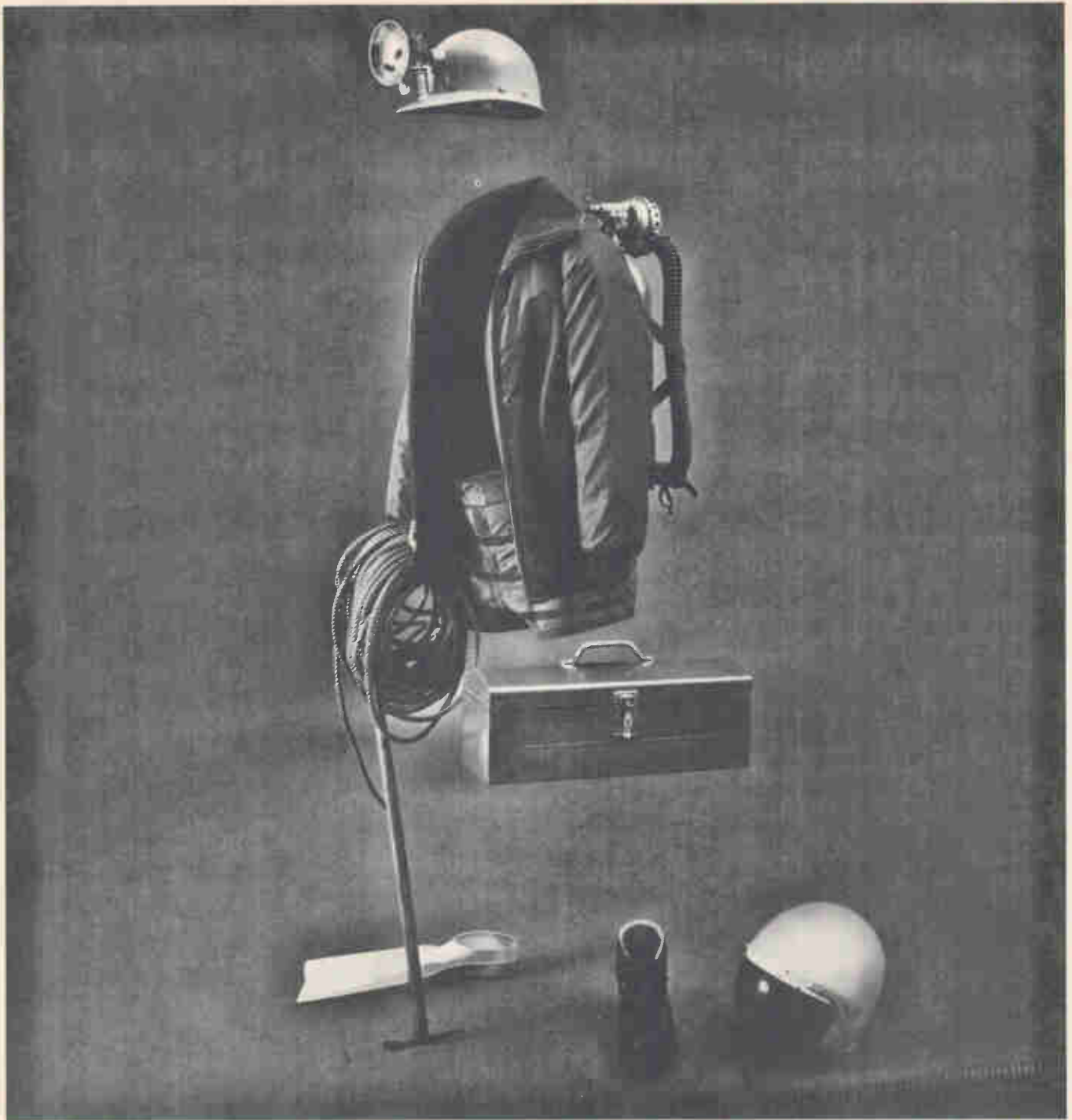

## If your equipment goes where a repairman can't,

Western Electric relies on Durez DAP to insulate telephone amplifiers submerged in several thousand feet of salt water.

Over 80 different parts molded from our DAP, an orlon-filled diallyl phthalate, insulate each amplifier.

Molding with DAP will give you precision tolerances without machining. DAP gives you average insulation resistance of  $1 \times 10^{11}$  ohms—tested for 96 hours at 60° C., 95% relative

humidity using ASTM test method D-257. DAP gives parts strength to withstand sudden shock or long term stress—remain dimensionally stable for over 20 years.

For extra-reliable units in outer space, aqua-space, underground, hot, cold, humid, or dry environments, specify Durez DAP. Write for complete information. Durez Div., Hooker Chemical Corp., 9011 Walck Road, North Tonawanda, N. Y. 14120.

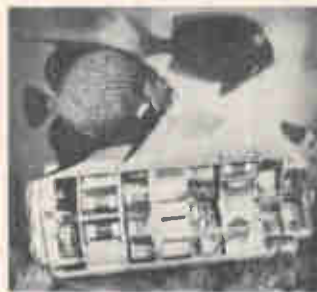

**mold with Durez DAP**

**hooker**  
durez DIVISION

## New Semiconductors Review

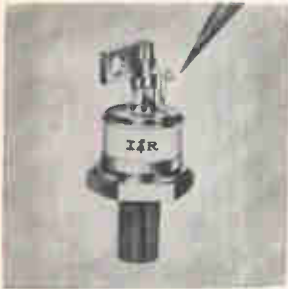

Fast-firing SCR's series 81RLA feature inrush currents of 800 amps/ $\mu$ sec. They can be turned on with 100 ma gate drive. The combination of epitaxial process, including contour groove and shorter emitter construction with accelerated cathode excitation, provides the ideal fast firing parameters. International Rectifier, 233 Kansas St., El Segundo, Calif. 90245. [436]

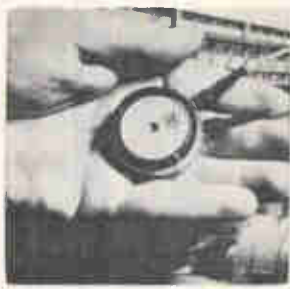

All-diffused thyristor called Power-Disc type 263 is designed for full capacity use. High surge current capability (1,600 amps) and high transient voltage capability (1,800 v, forward and reverse) permit the device to replace series SCR's in power supplies, motor controls, and primary controlled power systems. Westinghouse Semiconductor Division, Youngwood, Pa. [437]

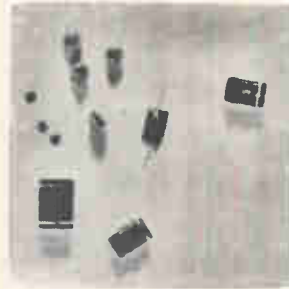

Varactor and p-i-n elements have been developed for use in microwave IC applications. An element consists of a chip mounted on a bonding pad, providing the circuit designer with greater flexibility. P-i-n elements are available for low power switching, phase shifting, limiting, duplexing, and modulation. Microwave Associates Inc., Northwest Industrial Park, Burlington, Mass. [438]

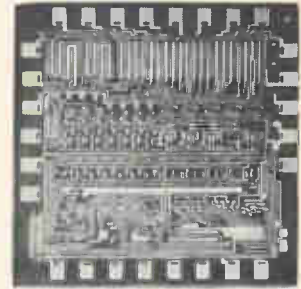

Advanced MOS/LSI 3751 is a 12-bit analog-to-digital converter containing all the logic and system timing circuitry needed for building a successive approximation type of A/D 36-pin dual in-line package. The design features parallel or serial output capability. Price in lots of 1 to 24 is \$144 each. Fairchild Semiconductor, 313 Fairchild Dr., Mtn. View, Calif. 94041. [439]



Single diffused, intermediate frequency silicon power transistors have current ranges from 3 to 30 amps. Features include capability to resist second breakdown, moderate frequency and power cut-off frequency beyond audio range. Applications include power supplies, audio power stages, series and shunt regulators. Solttron Devices Inc., Blue Heron Blvd., Riviera Beach, Fla. [440]



Ten n-channel dual FET's, 2N5515 through 2N5524, have ultra-low noise and tight matching for improved differential amplifier applications. They contribute less than the equivalent thermal noise of the signal source from 100 Hz to 10 kHz for generator resistance of 5 kilohms to 1 megohm. Units come in a 6-lead TO-18 package. Siliconix Inc., 1140 W. Evelyn Ave., Sunnyvale, Calif. [441]

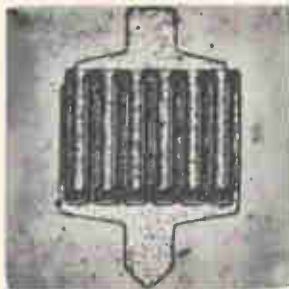

High frequency characteristics are specified and guaranteed for transistor chips series 35800 designed for microwave hybrid circuits. They are recommended for use in critical oscillator and amplifier applications. Typical  $f_T$ 's for the series are 3 to 4 GHz. Small quantity prices range from \$65 to \$80. Hewlett-Packard Co., 1501 Page Mill Road, Palo Alto, Calif. 94304. [442]

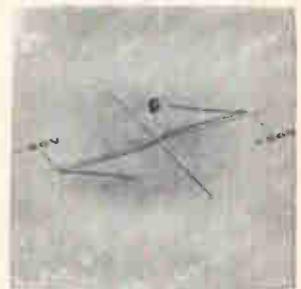

Low-voltage, silicon bilateral trigger device type MPT20 affords cooler thyristor device operation and increased reliability. By triggering earlier in the conduction cycle than higher voltage units, it reduces SCR and TRIAC power consumption, thereby minimizing switching losses and internal heating. Motorola Semiconductor Products Inc., Box 20912, Phoenix 85036. [443]

### New semiconductors

## High-voltage transistor switches fast

Rated at 180 volts, it turns on in 1.5 microseconds; device designed for airborne power-conversion jobs

Designers of airborne power supplies know that high voltages usually require sacrifices in transistor efficiency: higher saturation voltages and slower switching.

But engineers at TRW Semiconductors have developed a power transistor that is rated at 180 volts

at 80 megahertz and can handle peak surges of 50 amps yet has almost the same saturation voltage and switching speed as the 30-amp, 100-volt transistor TRW introduced last spring [Electronics, May 13, p. 159].

The 180-volt 2N5584 switches in

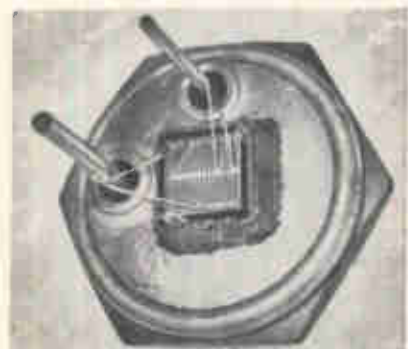

Fast operator. Transistor for avionics handles high voltages without sacrificing switching speed.



# WE MAY ALREADY HAVE DESIGNED THE SILICON RECTIFIER ASSEMBLY YOU WANT



Three phase bridge, up to 600 amps,  
D. C. protected against transients.

Tung-Sol packages a lot of performance into silicon rectifier stacks. Thorough experience in heat sink configuration, control of transients and the manufacture of solid state devices, assures highest efficiency in units that require only minimum space. Power capability is extremely broad.

Write for descriptive literature. Describe your requirements and we will offer specific suggestions. Tung-Sol Division, Wagner Electric Corporation, One Summer Ave., Newark, N.J. 07104.

Controlled avalanche assembly, to 150KV at 12 amps, single phase, half-wave rating.

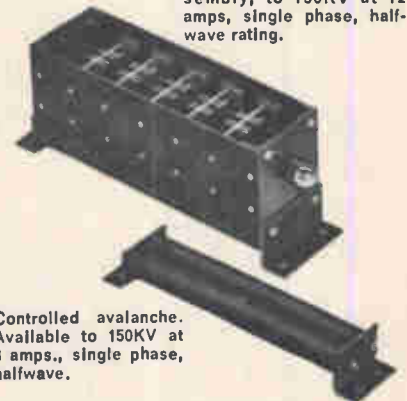

Controlled avalanche. Available to 150KV at 3 amps., single phase, halfwave.

## TUNG-SOL®

### SILICON RECTIFIER ASSEMBLIES

® REG. T. M. WAGNER ELECTRIC CORPORATION

... can be used with  
data-handling crt's ...

1.5 microseconds, and TRW will guarantee a saturation voltage of 0.4 volt at 10 amps. At 20 amps, the saturation level is 1.5 volts, and the device has usable gains to 50 amps. Robert Austin, assistant plant manager for power products, says other high-voltage transistors usually have a saturation voltage two to three times higher.

The trick, Austin says, was designing the emitter periphery of the interdigitated device in such a way as to sharply reduce the current per unit area. He adds that close control of diffusion techniques yielded the 80-Mhz cutoff frequency.

TRW says the new transistor is well suited for high-efficiency airborne power-conversion equipment, such as high-power inverters operating in the 50-kilohertz region, and for data-taking cathode-ray tubes in which switching speed is important.

**Helpful companion.** A 1N5409 high-speed, 40-amp rectifier will be sold as a companion device for the inverter applications. This 35-nanosecond rectifier is needed, Austin says, because the efficiency of a transistor in a high-frequency system is wasted if the rectifier is slower.

Like all TRW's power devices, the 2N5584 is designed for radiation resistance. "We're trying to become experts in power-conversion equipment," Austin says, "and radiation resistance is often a requirement, so the metalizing material we use doesn't have a high atomic mass and isn't affected by radiation." He adds that radiation hardening also strengthens reliability.

The transistor is designed to withstand the same high-temperature reverse-bias life testing—100-watt power and 100°C case temperature for 1,000 hours—as components that TRW supplies for strategic missile systems.

The 250-mil-square chip is housed in a TO-63 can, is available in distributor quantities, and costs \$105 for orders of one to 99.

TRW Semiconductors Inc., 14520 Aviation Blvd., Lawndale, Calif., 90260 [444]

# ORGANIZE!

**PLUGMOLD® MULTIOUTLET SYSTEMS** offer a versatile efficient way to organize electrical wiring and devices of all kinds. Build Plugmold into the products you design. Use it in lab and production areas.

Rugged, attractive Plugmold—in a variety of sizes—accommodates 14 to 2/0 AWG wire, devices to 60A, circuit breakers to 100A. U.L. listed. Send for bulletin.

YOUR OUTLETS AND  
WIRING, THAT IS!

1 9/32"  
3/4"

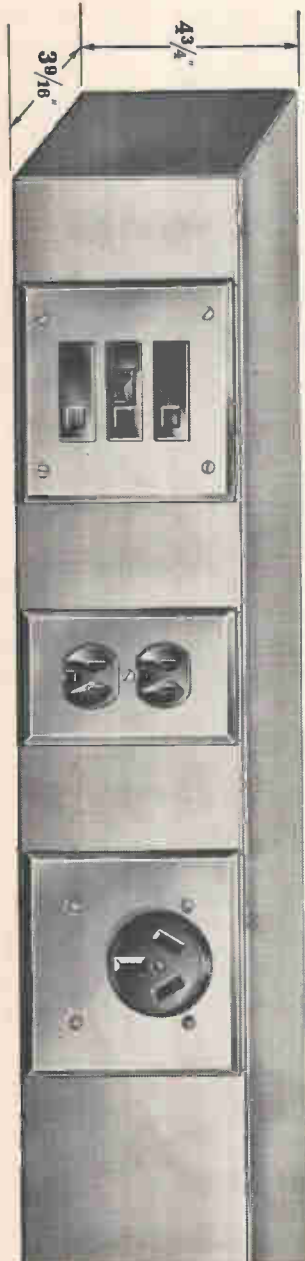

THE WIREMOLD COMPANY / HARTFORD, CONNECTICUT 06110

**WIREMOLD**

®

# SURE, HE'S MORE POWERFUL THAN A LOCOMOTIVE, BUT CAN HE DELIVER RCA DIGITAL I.C.'S?



© 1968 NATIONAL PERIODICAL PUBLICATIONS, INC.

## MILGRAY CAN

Superman's good for a lot of things, but Milgray's a lot better for RCA Digital Integrated Circuits Like Low-Power DTL (2.3mW/Gate), and Medium-Power DTL. Another thing we carry that he doesn't, RCA Ultra-High Speed ECCSL, Ultra-Low-Power COS/MOS. Call us. **RCA**



MILGRAY/NEW YORK  
180 VARICK ST., N.Y., N.Y. 10013  
212 YU 9-1800  
NEW JERSEY - 201 HE 2-4300  
TWX 710-381-3808, TELEFAX-PQF

MILGRAY/DELAWARE VALLEY  
232 N. BROAD ST., PHILA., PA. 19132  
215 BA 8-2000  
CAMDEN, N.J. 808-WO 8-7790  
TWX 710-870-5400

MILGRAY/CLEVELAND  
1021 EAST FORTIETH STREET  
CLEVELAND, OHIO 44108  
216 881-8800  
TWX 810-431-8878

MILGRAY/WASHINGTON  
5405 LAFAYETTE PLACE  
HYATTSVILLE, MARYLAND 20781  
301-864-1111  
9 a.m. 301-727-1870  
TWX 710-828-1127

MILGRAY/NEW ENGLAND  
75 TERRACE HALL AVENUE  
BURLINGTON, MASS 01803  
817-272-8000  
TWX 710-332-8508

MILGRAY/INTERNATIONAL  
180 VARICK ST.  
NEW YORK, N.Y. 10013  
TELEK RCA 223408  
ITT 429468  
CABLE-MILGRAY-NEW YORK



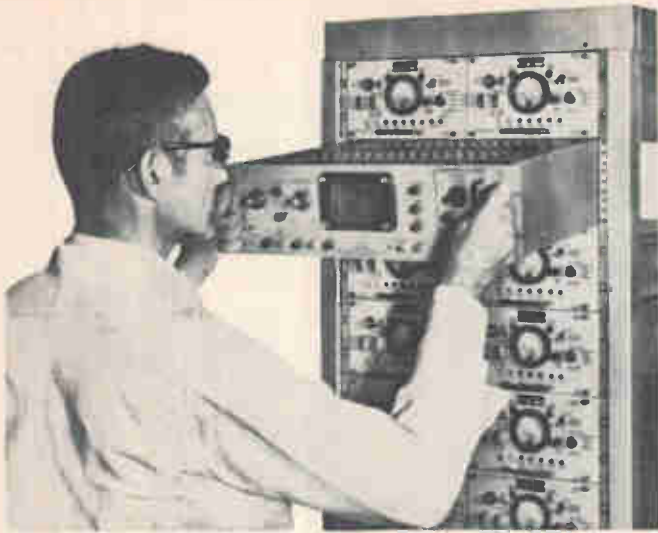

## JUST SLIDE IT IN AND TURN IT ON

**MIL Spec Scope K-106 (AN/USM-117)** a ready-made answer to military system display. Mil Spec requirements for scope ruggedization — performance — documentation — are all met in one 18 lb. fully transistorized oscilloscope. This is a stock instrument QPL'd and thoroughly job tested for more than 5 years by the Military.

Bandwidths range from 6 to 10 MHz. The cathode ray tubes are our own ETC brand, delivering the utmost clarity in data display. Accessories and plug-ins assure non-obsolescence.

For something a little special — wider bandwidths, unusual form factors, front panel variations, or somewhat different performance characteristics, let us know and we'll modify to your specs.

Facts, figures, specs, diagrams and photos—all the information you need to make the decision—are yours on call. Write Electronic Instrument Division, General Atronics, Phila., Pa. 19118, or phone (215) 248-3700.



**GENERAL ATRONICS**

**Boof  
air, gas  
and liquids  
out of  
your switches  
with a HEXSEAL®.**

The toughest enemies of push-button, toggle or rotary switches are air, gas and liquids. But Hexseal environmental boots seal them out so effectively that switches last longer... operate more reliably. So does the important equipment they activate. Just replace the mounting nut with a Hexseal, and you have a sealed switch. RFI/EMC shielding is available in all models. Color coding is available on request. Hexseals meet all applicable military specifications. (For less critical applications, Hexseals are available in commercial versions as well.)

For samples and data write to:  **APM-HEXSEAL CORP.**  
41 Honeck Street, Englewood, New Jersey 07631

Circle 173 on reader service card

## COMPACT • PORTABLE HIGH SENSITIVITY



**1.5MHz  
20mV/cm**

**MODEL  
536A**

Model 536A is a compact, portable, general purpose oscilloscope employing a 3 inch cathode ray tube and possessing superior electric characteristics and easy to operate.

This oscilloscope is a highly usable instrument, because the vertical axis is provided with a push-pull type DC amplifier of high sensitivity, wide band and good stability and phase characteristics, together with a time base oscillator of good linearity variable over a wide range.



**kikusui**

KIKUSUI ELECTRONICS CORP.

3-1175, SHINMARUKO-HIGASHI, KAWASAKI-CITY, KANAGAWA-PREF., JAPAN  
CABLE ADDRESS: "KIKUSUIDE" KAWASAKI.



0.5 $\mu$ V/ $^{\circ}$ C

**\$67**

(100 LOT)



MOSFET  
HYBRID  
CHOPPER  
STABILIZED  
OPERATIONAL  
AMPLIFIER

## ANALOG

221 FIFTH STREET  
CAMBRIDGE, MASS. 02142  
TEL: 617/492-6000  
TWX: 710/320-0326



## DEVICES

This ad is for the man who already knows that \$67 is a fantastically low price for a chopper stabilized op amp.

Model	J	K	L	Units
E <sub>os</sub>	0.5	0.25	0.1	$\mu$ V/ $^{\circ}$ C
I <sub>bias</sub>	1	0.5	0.5	pA/ $^{\circ}$ C
Price	\$67	\$82	\$105.	(100 Lot)

Make us prove it...the reader service card will bring comprehensive data sheets, or better yet, request a sample on your letterhead or business card. No obligation to buy, of course.

## New Books

### Wide appeal

Fundamentals of Integrated Circuits  
Lothar Stern  
Hayden Book Co., Inc.  
176 pages, \$8.95

This is one of those books that an engineer can recommend to his technician for a good background on the subject. Or, for those engineers who haven't become familiar with integrated circuits, this text will be a good start. And even those deeply involved in IC's might appreciate the chance to step back and get perspective on the whole forest.

Stern writes well, gets right to the point, and clearly outlines the tradeoffs and problems. The only fault that might be found is the lack of color in the drawings that explain the diffusion steps; the various schemes of cross-hatching don't clearly delineate the areas.

The book covers basic semiconductor theory, monolithic and film circuits, hybrid circuits, packaging, design, and layout principles, and ends with a discussion of large-scale integration that includes discretionary wiring and computer-aided design.

It also includes a good glossary —there's nothing more frustrating than coming upon an unfamiliar term and then trying to find where the author used it first to get his definition.

### Recently published

Magneto-hydrodynamic Energy Conversion, Richard U. Rosa, McGraw-Hill Book Co., 234 pp., \$17.50

A broad view of waves, instabilities, and other nonuniformities; magnet design as applied to MHD generators; design considerations; scaling laws; and space applications. This is both a reference and a text for engineers new to the field. Stressing practical applications of plasma physics, it includes discussions of the thermodynamics of power cycles and of the use of nuclear and chemically fueled MHD generators for electric power, for special scientific and military purposes, and for space propulsion.

Programming for Digital Computers, J.F. Davidson, Brandon/Systems Press, 214 pp., \$8.50

A guide to program writing, this book describes the scientific and technical applications of higher-level languages and their relation to commercial data processing. It also covers such peripherals as magnetic tape and disks, line printers, and card readers and punchers.

# NEW O.E.M.

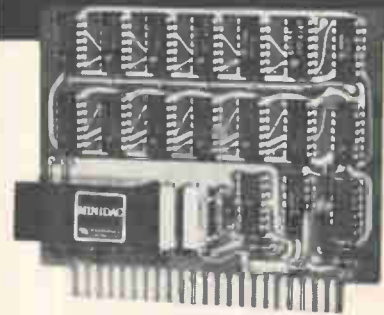

3 3/4" x 4 1/2" x 1/2"

## A-to-D Converter

Pastoriza offers the first utility converter for systems applications . . . priced for quantity sales.

Having first introduced the modular A-to-D and D-to-A converter, Pastoriza Electronics now offers an unprecedented innovation: A printed circuit card A-to-D converter featuring . . .

### High Performance

- 12 bits conversion in 8 microseconds.
- 10 bits conversion in 4 microseconds.
- 8 bits conversion in 2 microseconds.

### Low Cost

Priced competitively with any ADC available today, and designed for volume production.

### Open Book Concept

No black magic in the design — circuitry is accessible and repairable.

### User Confidence

Design and component information is supplied to insure ease and confidence in customer application.

This complete single-card A-to-D converter includes reference supply and comparison amplifier, using dual in-line integrated circuit logic with a MINIDAC D-to-A module. It accepts 0 to +10 volts input range, and provides up to 12 bits resolution.

Write for eye-opening facts on this newest modular A-to-D utility converter.

 **PASTORIZA**  
ELECTRONICS, INC.

385 Elliot St., Newton, Mass. 02164 • 617-332-2131

# Measure phase easily, directly, and accurately

ACCURACY  $\pm 1^\circ$  WITH LARGE SIGNAL-TO-REFERENCE RATIOS ...  $\pm 0.5^\circ$  WITH SMALL SIGNAL-TO-REFERENCE RATIOS ■ CONTINUOUS  $0^\circ$  TO  $360^\circ$  READINGS ■ EXPANDED SCALES FOR ACCURATE AND EASY READING ■ ACCURACY INDEPENDENT OF ANGLE ■ DIGITAL RATIO-METRIC READOUT AVAILABLE ■ ACTON LABS' 329B PHASE METER.



**BOWMAR** ACTON LABORATORIES, INC.  
A Subsidiary of Bowmar Instrument Corporation  
531 Main Street • Acton, Mass. 01720 • (617) 263-7756

Circle 175 on reader service card

# New, true dual-beam oscilloscope.



And only \$995\*

True dual-beam, portable oscilloscope features line or battery operation. Choice of 15 or 30 MHz bandwidth plug-in Y-amplifiers (23 and 12 nsec rise times).\*\* Solid state unit provides differential input, internal voltage calibrator, and both signal and time delay.

For complete data, write for Bulletin TIC 3318A to Motorola Communications & Electronics Inc., 4501 W. Augusta Blvd., Chicago, Ill. 60651.

\*Exclusive of options. \*\*15 MHz amplifier, \$395; 30 MHz amplifier, \$595.



**MOTOROLA**  
Precision Instrument Products

Circle 180 on reader service card

## SWITCH/INDICATORS

Unlimited Variety



Aren't these what you're looking for? Endless variety and options. Million-cycle reliability! Low, off-the-shelf prices. Compact design. TEC's got 'em... in switches matchmated with TEC-LITE Indicators to give your panel a more handsome design. For information about TEC's complete line of switch/indicators • readouts • display panels • data entry keyboards • CRT display terminals, call (612) 941-1100 or write:



Transistor  
Electronics  
Corporation

Box 6191 • Minneapolis, Minnesota 55424

136 Circle 136 on reader service card



One Gift Works Many Wonders  
**THE UNITED WAY**

Electronics | November 25, 1968



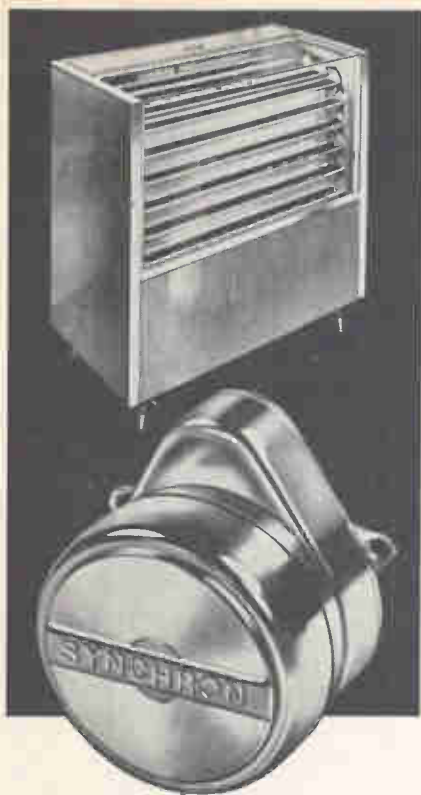

## HOW SYNCHRON® MOTORS time MOTION DISPLAY CASES

In revolving showcases like this, a SYNCHRON Motor controls the shaded pole motor that starts, stops, runs or reverses the moving trays, in a selection of motion speeds. SYNCHRON Motors can perform thousands of similar timing, control, switching and cycling operations. One of these motors may be ideal for your application, too. Find out—write or phone Hansen or your SYNCHRON representative, for brochure and all the facts.

**SYNCHRON timing and control motors; 168 different speeds. Right, left or reversible rotations. 8, 20 or 30 oz.-in. torques; 220, 110 or 24 volts; 60, 50 or 25 cycles.**

# HANSEN

Manufacturing Co., Inc., Princeton, Ind. 47570

HANSEN REPRESENTATIVES: CAREY & ASSOCIATES, Houston and Dallas, Texas; R. S. HOPKINS CO., Sherman Oaks, Calif.; MELCHIOR ASSOCIATES, INC., San Carlos, Calif.; THE FROMM CO., Elmwood Park, Ill.; JOHN ORR ASSOCIATES, Grand Rapids, Mich.; H. C. JOHNSON AGENCY, INC., Rochester, N.Y.; WINSLOW ELECTRIC CO., Essex, Conn.; Narberth, Pa., and New York, N.Y.  
EXPORT DEPARTMENT: 64-14 Woodside Ave., Woodside, N.Y.

Circle 177 on reader service card

## Technical Abstracts

### Under strain

A thin-film diode strain sensor  
Robert M. Moore and  
Charles J. Busanovich  
RCA Laboratories  
Princeton, N.J.

A strain sensor must be light and flexible enough to present a negligible mechanical load, yet sufficiently sensitive to reflect a small change in strain by a large change in output. These properties are realized in a thin-film, p-n heterojunction diode fabricated by vacuum-evaporation technology. This device also acts as a low-output-impedance voltage source—a big plus in most applications—and has a low-pass frequency response of up to 2 megahertz.

The sensor can be formed on a variety of substrates selected for their mechanical properties. Three that have been used are 0.001-inch-thick plastic, 0.005-inch aluminum, and 0.040-inch glass.

The typical heterojunction combination is n-type cadmium selenide deposited on p-type selenium, the whole being only 40 millionths of an inch thick including top and bottom electrodes.

In operation, the heterojunction diode is forward biased. Strain induces shifts in the forward current-voltage characteristic; tension makes the I-V curve rise more sharply and compression makes it rise more slowly.

The I-V characteristic resembles that of a vacuum triode, but the controlling parameter is mechanical strain rather than grid voltage. The sensor therefore acts as an electro-mechanical triode.

Voltage output of a typical sensor shifts 250 millivolts for an applied strain of  $5 \times 10^{-4}$ ; in other words, sensitivity is 500 volts per unit strain. This "typical" device has an active area of 2 by 6 millimeters and is operated at a bias of 10 milliamperes and 1.6 volts. The differential resistance at this bias point is 50 ohms, giving a gauge factor of 1,000—five times larger than that of single-crystal silicon piezoresistive devices.

Presented at the International Electron Devices Meeting, Washington, Oct. 23-25.

## A-to-D Converters

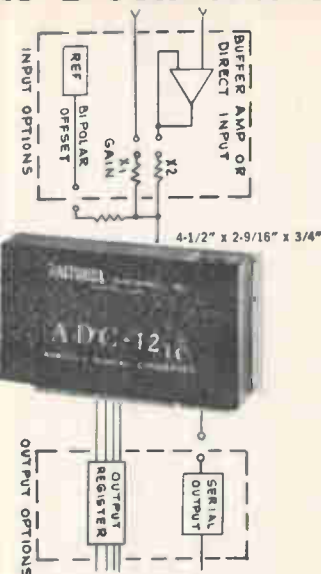

## with more options at less cost and delay

- High-frequency FET input amplifier.
- Bipolar or unipolar input signals of varying ranges.
- Parallel and serial outputs of binary or BCD codes.
- TTL logic for high speed and fanout drive capability.
- Resolution up to one part in 4096 (12 bits).
- Extended temperature capability.

The Model ADC-12c is a complete, general purpose, integrated circuit A-to-D converter that accepts input voltages on command and converts them to a 12-digit binary code in 25 microseconds. The single card contains an input amplifier, precision reference supply, logic, weighing network, switching, comparison, and internal clock. Only external DC power is needed.

The Model ADC-12c 12-bit converter is just one of Pastoriza's many competitively priced A-to-D and D-to-A converters. All are available with a variety of different input options, resolutions and output codes, usually in less than thirty days.

Write or call for more information  
on ADC TTL Series.

**PASTORIZA**  
ELECTRONICS, INC.

385 Elliot St., Newton, Mass. 02164 • 617-332-2131

Circle 137 on reader service card

137



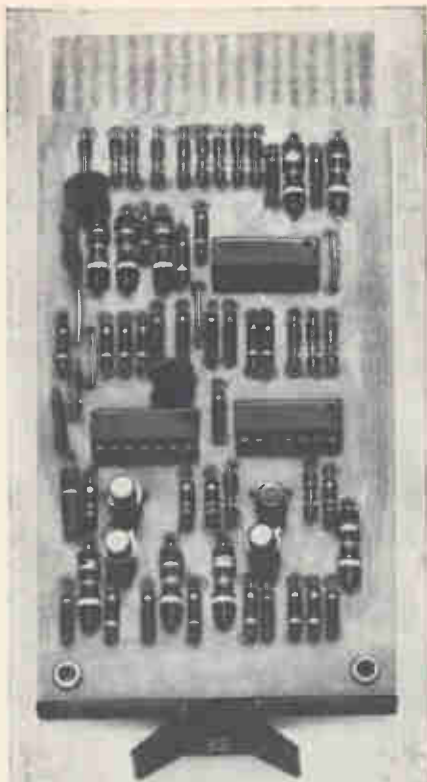

## K Series Modules are Built Tough—Used Easily!

K Series solid state modules are built for a tough environment.

A glass-epoxy board so strong it won't break even if you step on it.

No moving parts, of course, and all outputs are short-circuit proof.

And K Series modules are easy to use.

Only a few different module types do the vast majority of industrial or laboratory control functions. A lot of logic is on the circuit cards, and minimum wiring makes all the connections. In the K220, only two wires per decade are needed to interconnect into a BCD up/down counter. A companion module is available to display the contents of the register. K220 sells for \$52.00.

K Series modules have consistent pin assignments so that you don't have to look at the drawing all the time.

They're noise-immune, shielding becomes no problem; they work with 115 ac pilot circuits (indicator lights are on all AC pilot circuits). A test probe is available for troubleshooting and adjustment without a scope.

The hardware is designed to fit NEMA and standard 19" enclosures — and, of course, the modules plug in.

DIGITAL is the leading producer of modules for industrial and laboratory applications. These and other series are fully described in our Industrial Control and Logic Handbooks. Write for free copies.

**digital**

MODULES • COMPUTERS

Maynard, Mass. Tele: (617) 897-8821

## New Literature

Magnetic tape degausser. Ampex Corp., 401 Broadway, Redwood City, Calif. 94063. Description and specifications of the model SE-20 automatic magnetic tape degausser, designed for telemetry, radar, and other high-precision recording applications, are contained in data sheet D105. Circle 446 on reader service card.

Microwave multiplier diodes. Micro State Electronics, 152 Floral Ave., Murray Hill, N.J. 07974. Bulletin D-113 illustrates and describes the series MS-5000 microwave multiplier diodes. [447]

Miniature chart recorders. Rustrak Instrument division, Gulton Industries Inc., Municipal Airport, Manchester, N.H. 03103. Bulletin 16808 covers the 200 series of miniature strip-chart recording instruments. [448]

Zener diodes. Motorola Semiconductor Products Inc., P.O. Box 955, Phoenix, Ariz. 85001. Application note AN-437 contains comprehensive information on the characteristics, testing and reliability of temperature-compensated zener diodes. [449]

Straight cable plug. Sealectro Corp., 225 Hoyt St., Mamaroneck, N.Y. 10543. Product bulletin CX-119A describes the SRM straight cable plug for use with 0.141-inch-diameter semirigid coaxial cable. [450]

Pulse generator. Datapulse Inc., 10150 W. Jefferson Blvd., Culver City, Calif. 90230. Bulletin 100A describes a pulse generator with extended rep rate, width, and delay ranges. [451]

Chart papers. Houston Instrument division of Bausch & Lomb Inc., 4950 Terminal Ave., Bellaire, Texas 77401, has available a four-page bulletin describing the various 2-fold chart papers that can be used on the Complot digital plotters. [452]

High-vacuum facilities. Thermionics Laboratory Inc., 22864 Suro St., Hayward, Calif. 94544, offers an eight-page brochure describing its facilities for high-vacuum evaporative coatings, brazing, and leak detection services. [453]

Ultrasonic transducers. Phillips Mfg. Co., 7334 N. Clark St., Chicago 60626. Product bulletin 120 includes descriptions and specifications for both the end-fitting and bulkhead-fitting models of immersible ultrasonic transducers. [454]

Cable assemblies. Star-Tronics Inc., Moulton St., Georgetown, Mass. 01830, has released two engineering data sheets describing flexible and semirigid cable assemblies. [455]

## JOIN OUR PHOENIX PROFIT CLUB!

Most clubs take pride in their exclusiveness. But not ours. The only qualification for membership is a healthy profit-and-loss statement. And because we have a vigorous business climate, fast-growing markets, tax-free inventories, high worker productivity and low state income taxes, our membership is really zooming!

For our FREE 28-page brochure, "DYNAMIC PHOENIX," write Stanton Allen, Manager, Economic Development Dept., Room E-4, Chamber of Commerce, Phoenix, Arizona 85004

**dynamic**  
**Phoenix**

PROFIT CENTER OF THE SOUTHWEST

Circle 178 on reader service card

### EMPLOYMENT POSITION VACANT

Challenging Opportunity for E.E. with strong industrial experience to teach in a 2 year Associate Degree electronics technology program in a comprehensive community college. Attractive salary and fringe benefits. Graduate study available nearby. Write or call Mr. Leddu, Illinois Central College, P. O. Box 2400, East Peoria, Illinois 61611, phone 309-694-1421.

### EMPLOYMENT SERVICES

Florida/Nationwide EEs, MEs, IEs . . . Electronic, Aerospace, Industrial, Sales & Mfg. \$9-18,000. Tech Div Brodeur Personnel Service, Inc., 3947 Blvd., Center Drive, Jacksonville, Fla. 32207.

### SEARCHLIGHT

free catalog

POTTING APPLICATORS  
MANUAL AND DISPOSABLE

6cc 12cc 30cc

FOR POTTING, ENCAPSULATING, AND  
SEALING OF MINIATURE COMPONENTS

PHILIP FISHER COMPANY

7 CAMERON ST WELLESLEY 01 MASSACHUSETTS

CIRCLE 960 ON READER SERVICE CARD

### BUSINESS OPPORTUNITY

MANAGING DIRECTOR of progressive British Company visiting U.S.A. 1969 including Packaging Exhibitions Chicago April & Detroit October wishes to meet persons or companies who could sell a range of photo-electric and industrial controls or specific items from the range. We offer production to meet any demand from our new factory, ten years' know-how about industrial electronics and the right prices. Please write Hird-Brown Limited, Bolton, Lancashire, England.

CIRCLE 961 ON READER SERVICE CARD

RADAR SYSTEMS GROUND AND AIRBORNE AUTOMATIC TRACKING ANTENNA SYSTEMS NIKE AJAX NIKE HERCULES M33 M50 IA APS 19 MPS 9 SCR 58A IPS-1D IPS-2B IAA ASR 2 AIRBORNE SYSTEMS APN 85 APN-102 APS-73 APS-27 APS-45 DPN 19 DIGITAL COMPUTERS IBM 650 IBM 704

LARGEST INVENTORY OF RADAR AND MICROWAVE EQUIPMENT IN THE WORLD

**RADIO RESEARCH INSTRUMENT CO.**

45 WEST 45TH ST N Y 10036 212-JU 6-4691

CIRCLE 962 ON READER SERVICE CARD







## New Literature

High-power amplifiers. Radio Engineering Laboratories, 29-01 Borden Ave., Long Island City, N.Y. 11101. Three technical data sheets describe high-power amplifiers for satellite ground station subsystems. [456]

Incremental shaft encoders. Disc Instruments Inc., 2701 South Halladay St., Santa Ana, Calif. 92705. Five applications for Rotaswitch incremental shaft encoders are described in bulletin 456. [457]

Xenon arc lamps. Radiarc Inc., 526 N. Garfield Ave., Monterey Park, Calif. 91754. A four-page technical brochure describes xenon arc lamps. [458]

Semiconductor processing equipment. Fluoroware, Chaska, Minn. 55318, offers a catalog containing full information on a wide variety of products for handling substrates, wafers, and crystals. [459]

Microwave filters. DeMornay-Bonardi, division of Datapulse Inc., 1313 N. Lincoln Ave., Pasadena, Calif. 91103. New interdigital and combline microwave filters offering excellent electrical characteristics under severe environmental conditions are described in technical data sheet DB-358. [460]

Recorder/reproducer. RCA/Defense Electronic Products, Moorestown, N.J. 08057, has issued an eight-page brochure on the PT501 series of wide-band, 4-to-6-megahertz precision recorder/reproducer. [461]

Relays. Universal Relay Corp., 42 White St., New York 10013. Catalog 968 lists hundreds of types of microminiature, subminiature, telephone, aircraft, mercury wetted, differential, polar, sensitive, impulse, latching, vacuum, high-voltage, timing, sealed, resonant, stepping, and other relays. [462]

Resistor networks. Resistance Products Co., 914 S. 13th St., Harrisburg, Pa., 17104. A four-page brochure on precision resistor networks offers engineering information, temperature coefficient curves, temperature coefficient tracking, ratio matching and tracking data, stability, and tolerances for d-c and a-c networks. [463]

Proportioning control system. Blue M Electric Co., 138th & Chatham St., Blue Island, Ill. 60406. A four-page bulletin describes the company's Power-O-Matic 70 solid state control system and various units equipped with it. [464]

Laser data chart. Laser Nucleonics Inc., 123 Moody St., Waltham, Mass. 02154, has available a laser data compilation chart that measures 22 by 24 inches and folds so it can be put in a notebook. [465]



## UP-TO-DATE WORKS ON ELECTRICITY AND ELECTRONICS FROM MCGRAW-HILL

**1 STANDARD HANDBOOK FOR ELECTRICAL ENGINEERS.** 10th Ed. Edited by DONALD G. FINK and JOHN M. CARROLL. This new book continues the tradition of its preceding nine editions, providing in one volume the basic design data and application information relating to all components and systems employed in the generation, transmission, distribution, control, conversion and application of electricity. Primarily concerned with electric power, it includes Wire Communication, Electronic Data Processing and Industrial Electronics. New and sophisticated techniques for computer control of power generation and distribution appear along with conventional data on wiring sizes and switchgear.  
**2,506 pp., \$32.50**

**2 COMPUTER-AIDED INTEGRATED-CIRCUIT DESIGN.** By GERALD J. HERSKOWITZ. NEW. This book focuses on three broad areas vital to integrated circuit design: modeling procedures, including the determination of model parameters experimentally; network and system computer techniques to the design of integrated circuits; applications of modeling and computing techniques to realize specific integrated circuit designs with the aid of a computer.  
**423 pp., \$15.00**

**3 ADVANCED LINEAR PROGRAMMING COMPUTING TECHNIQUES.** By WILLIAM ORCHARD-HAYS NEW. Programmers, engineers, and designers will welcome this needed information on linear programming computing, and the mathematics of algorithms used in programming, debugging, basic documentation and other tasks. The book discusses actual computer methods for dealing with ill-conditioned matrices, considers questions on data formats for computer programs, and takes account of modern matrix and inversion techniques.  
**288 pp., \$12.50**

**4 ERROR DETECTING LOGIC FOR DIGITAL COMPUTERS.** By FREDERICK SELLERS, MU-YUE HSIAO and LEROY W. BEARNSON. NEW. This book provides engineers interested in problems of computer design, and specifically in logic design, with a number of error-detection systems, and provides a helpful reference for detecting errors in the areas of computer logic covered by the various chapters.  
**288 pp., \$15.00**

**5 MAGNETOHYDRODYNAMIC ENERGY CONVERSION.** By RICHARD J. ROSA. NEW. This timely reference avoids detailed derivations and explanations, yet gives, where possible, qualitative semi-physical arguments for those unfamiliar with plasma physics. It concentrates on a single practical application of plasma physics—MHD power generations—geared to engineering applications.  
**192 pp., \$17.50**

**6 CONTROL ENGINEERING.** By N. M. MORRIS. NEW. This book covers electrical, hydraulic, and pneumatic control systems and includes information on stabilizing techniques. It emphasizes the use of semiconductor devices, particularly the thyristor and its applications and limitations in industry.  
**240 pp., \$7.95**

**7 PRACTICAL SERVOMECHANISM DESIGN.** By HENRY S. BAECK. This work cuts through the complexities of useful servomechanism design in easy-to-follow steps. Designs are developed for a number of applications, providing experience typical of those encountered in practical servomechanism design. Applications are stressed. Hardware is described and mathematically modeled.  
**380 pp., \$15.00**

At your bookstore or direct from publisher for

**TEN DAYS FREE EXAMINATION**

McGraw-Hill Book Co., Dept. 23-L-1125

330 West 42nd Street, New York N.Y. 10036

Send me the book(s) circled below for 10 days on approval. In 10 days I will remit for book(s) I keep, plus a few cents for delivery costs, and return others postpaid. Include local sales tax if applicable.

1 20973-4      2 28395-2      3 47689-5      4 56204-1  
5 53605-2      6 94067-6      7 02985-0

Name (print) \_\_\_\_\_

Address \_\_\_\_\_

City \_\_\_\_\_ State \_\_\_\_\_ Zip Code \_\_\_\_\_

Offer good in U.S. and Canada only.

23-L-1125

Sales Engineers—EE or Physics:

## Six months ago, this engineer was bored.



He was stuck behind a desk every day. Doing routine work toward a routine future. He had no challenge. Nothing that required his analytical ability. No competition to bring some vitality into his work. The only time he left the office was to fight the commute traffic or run an errand.

Dull? You bet it was, but he did something about it.

He discovered that Hewlett-Packard needed him. Why? Because he understood the analytical problem. He had an EE or Physics degree. He had some marketing experience, or else was more than willing to acquire it. He liked getting out of the office and into the field. He liked meeting customers, putting personal contact into his job. He wanted to help them solve their problems—a variety of problems instead of the same old thing every day. He was aggressive, competitive. And he wanted his income to be in direct proportion to his ability. Most of all, he could sell digital analyzers for electronic, medical, chemical or nuclear applications. He had the analytical experience to prove it.

He's now an HP field engineer. He doesn't look bored, does he?

Send your resumé to Jim Sheldon, Hewlett-Packard, 1501 Page Mill Road, Palo Alto, California 94304. An Equal Opportunity Employer.

You may be in for a new career.

HEWLETT  PACKARD

# International Newsletter

November 25, 1968

## Space chiefs decide to keep ELDO alive

The bruised and battered European Launcher Development Organization, beset by financial troubles caused by Britain's defection, has gotten a new lease on life. Europe's space ministers meeting in Bonn have decided to stick with ELDO until 1971 when its current activities are to culminate with the launching of the Europa 1 and 2 rockets.

But the conferees cut out development of apogee motors in an attempt to stay within the program's new limits of \$626 million. They also called for studies of a post-1971 program to develop launchers for heavy stationary satellites.

Britain, which has announced its intention of dropping out of ELDO after 1971, came up with an alternate plan at Bonn. In exchange for an immediate release from its ELDO obligations, it offered to participate in a group combining the functions of ELDO and the European Space Research Organization. The proposed organization would build a television satellite and a big data-relay satellite, and also carry out long-range applied research. In other words, the British were saying that booster development is a waste and that the money should go to building satellites that could be launched by U.S. rockets. But the decision to go ahead with ELDO's program seems to make the British proposal academic.

## Ion implantation pushed in Japan

The Japanese government has earmarked nearly \$2 million to help its electronics industry catch up in the area of ion implantation. Both Toshiba and Hitachi Ltd. will receive \$900,000 contracts to develop, in Toshiba's case, ion-implanted transistors capable of operating up to 8 gigahertz, and in Hitachi's case, implantation techniques for the continuous fabrication of 30 transistor wafers an hour.

The subsidies will come from the Research and Development Corp. of Japan, a government-owned organization set up in 1962 to help the nation's industries attain their scientific and technological goals.

## Philips takes aim at computer sales

Philips Gloeilampenfabrieken, which only recently introduced its first commercial computer, is aiming to push computer sales to the point where they'll account for 10% of its total sales by 1973. Based on a predicted revenue of \$2.86 billion that year, this would amount to \$286 million of computer volume. Philips' 1968 total sales are estimated at about \$2 billion.

In announcing this goal, the huge Dutch firm insisted that it's not out to battle IBM head to head on the Continent.

## East Germans try advanced switching

The East German electronics industry, ranked right behind Russia's in the Eastern bloc, is apparently making big strides in telephone exchange technology. An experimental installation in East Berlin incorporates thin-film circuits in its control current loops and reed contacts for voice switching. The system, called ETS 700, was designed and developed by VEB Fernmelderwerk Arnstadt.

The installation is the country's second electronic exchange system. The first, turned over to postal authorities last year, was an international effort with East Germany as system manager. That project included the



---

# International Newsletter

---

Soviet Union, Poland, Hungary, Bulgaria, Czechoslovakia, and Rumania.

East Germany is so heavily engaged in the telephone exchange field because it is ideally situated to be a base for interface systems between electronic exchanges in the West and conventional ones in the East. That's why East Berlin, a major city fairly close to other big ones in the West, was chosen over Moscow or Warsaw as the site of the socialist bloc's first electronic exchange system.

## Toshiba sues Shiba in vtr patent case

Toshiba has tackled another opponent in its continuing battle with other Japanese makers of video tape recorders. The firm has filed a suit charging the Shiba Electric Co. with infringing on its helical-scan vtr patent. Besides seeking damages, Toshiba is asking that Shiba be barred from further production of the disputed recorder, a double-head model.

Toshiba's action is based on a 1959 patent issued specifically on a single-head recorder but also mentioning multiple-head designs. Whether it applies to recorders such as Shiba's, with two heads at 180° to each other, can only be settled by litigation.

To complicate matters, Shiba in 1963 asked Toshiba for a license under its patent. Before Toshiba could decide, Shiba broke off the negotiations, and said it would develop and sell a recorder that did not infringe on Toshiba's patent. Toshiba now not only claims infringement, but asserts that Shiba acted in an unprincipled manner in unilaterally ending the negotiations. Shiba denies both charges.

Meanwhile, on its other patent battlegrounds, Toshiba says it has reached an agreement with Sony and is holding talks with other manufacturers, including the Matsushita Electric Industrial Co. and Matsushita's subsidiary (and competitor) the Victor Co. of Japan.

## Intelsat 'cordial' to Canadian plan

It now appears that the proposed Canadian domestic satellite system will not run into any significant opposition from Intelsat. At a recent closed-door meeting of Intelsat's interim committee on satellite communications, the Canadians presented their plans for the system, which would be the first domestic satellite hookup.

According to one participant at the meeting, the proposal was "cordially" received by the delegates, although no formal vote was taken. Under existing Intelsat rules and in most of the proposed changes to them, a member nation needs Intelsat's blessing to start a commercial satellite communications system.

## Japan's spring tax bears autumn fruit

A change made last April in Japan's tax on television sets is now being reflected in steadily increasing production of 14-inch, monochrome transistorized sets. Until April, all transistor receivers were exempt from the country's tv excise tax—15% for screen sizes through 20 inches, 20% on sets with screens 21 inches and up—based on factory prices. The exemption was aimed at promoting solid state technology, which in Japan is without the benefit of any government-subsidized military or space projects.

The modified regulations still exempt transistorized sets with screens 14 inches and up, but impose a 5% levy on those with screens 12 inches and smaller; the government felt that the smaller solid state sets were competitive enough to get along with a narrower tax advantage. The result is that manufacturers now find they can sell a 14-inch tv for almost the same price as a 12-inch, so they're introducing more of them.

# Electronics International

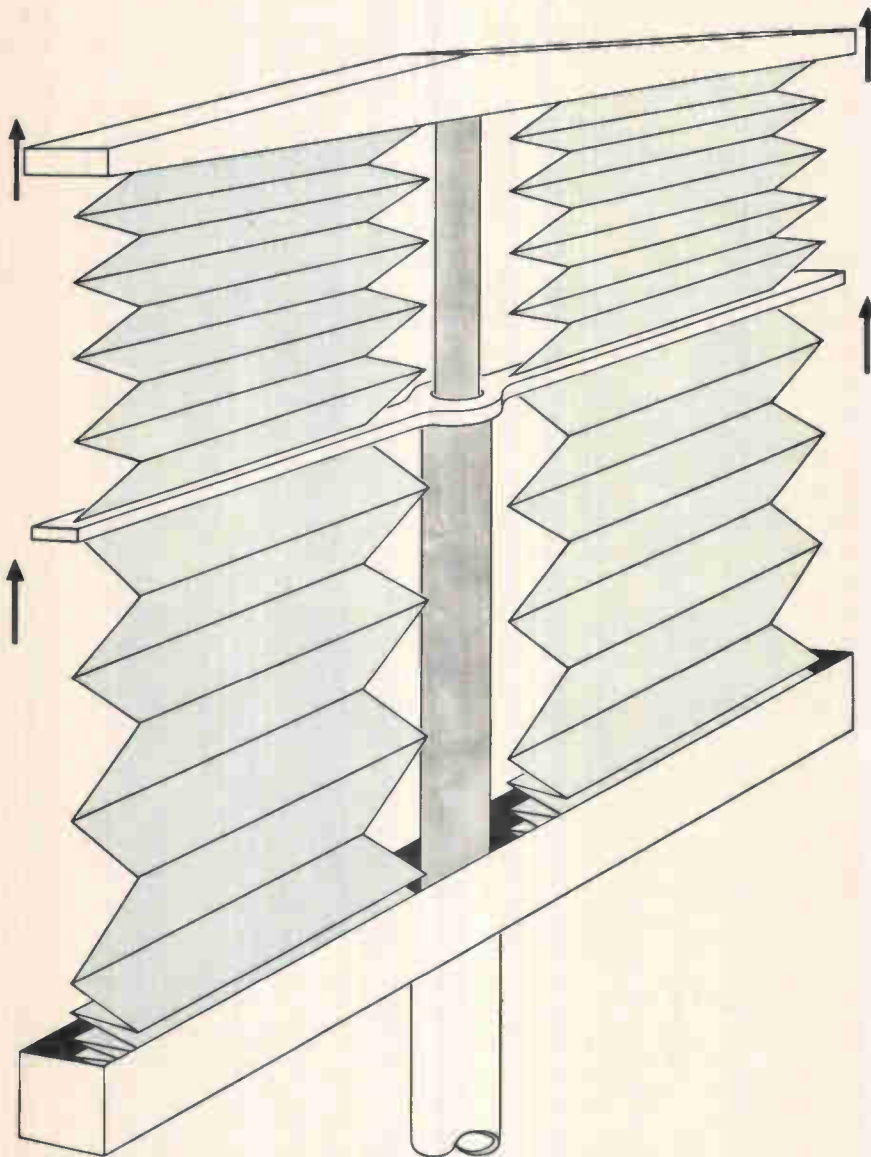

Setting sail. Thin solar cells, developed by the Royal Aircraft Establishment, are mounted accordion style. Arrays are shown in green.

## Great Britain

### Thin solar cells

As satellite power requirements soar, the additional size and weight of the solar-cell arrays needed to provide that power are becoming millstones around the designer's neck. Conventional configurations—rigid paddles that pop out after

launch, or cells mounted around the satellite's body—can no longer handle the additional power needs. Work is accelerating on both sides of the Atlantic in the search for lighter and more compact arrays.

The idea—being pursued in the U.S. by such aerospace companies as TRW Systems, Clevite, and Ryan—is to mount thinner cells on light, flexible systems that will fold or roll out of the way during launch.

U.S. work is aimed primarily at more power; the British at less size and weight—as in small satellites carrying one array weighing roughly 50 pounds and generating a kilowatt or more. Such an output would require about 140 pounds if the cells were paddle-mounted.

**Lower output.** Britain's work is being carried on at the Royal Aircraft Establishment. At last week's IEEE Photovoltaic Conference at Pasadena, Calif., the RAE's Roy Crabb and Fred Treble described a system of flexibly mounted thin silicon cells that has reached the ground-test model stage. Ferranti Ltd. has made about 1,000 of the cells and has approved yield and practicality even though thin cells cost more than thick ones.

The cells, 125 microns thick and 2 centimeters square, have lower electrical outputs than their thick cousins because photons at red and infrared wavelengths pass right through them. However, say Crabb and Treble, the power-weight ratio is about three times higher. What's more, they add, the output of both types is the same toward the end of their lives.

The thin cells use standard thick-cell n-on-p construction. The resistivity of the base is 10 ohm centimeters and the junction depth about 0.25 microns. Ferranti believes it will be able to get satisfactory yields with a top output of 12 milliwatts per square centimeter at 30°C, degrading to 11 mw after bombardment equivalent to  $10^{15}$  electrons per square centimeter at 1 megaelectron-volt. That, presumably, would be the condition of the cells after several years of orbit through the Van Allen Belt.

**Higher cost.** Made of oxygen-lean float-zone silicon, the cells are more expensive than those made of the high-oxygen silicon generally used in the U.S. However, say Crabb and Treble, they last longer, and a ceric-oxide coating keeps reflection losses down to 1%, com-



pared with 5% for the silicon monoxide used in the U.S. to cut reflection loss.

The sum of the two innovations, say the Britons, is maximum cell efficiency of about 9% at the mean solar constant of 140 mw per square centimeter. This would degrade, at the stated bombardment rate, to 8.2%. This compares to the 4% to 5% efficiency obtained by U.S. researchers working with thin-film polycrystalline cadmium sulfide and cadmium telluride cells.

The RAE-Ferranti cells are mounted on a light substrate of Du Pont's Kapton polyimide film 30 microns thick. The cells are in two parts, each folded accordion-fashion and attached to a telescoping mast. Each fold contains three rows of cells, which are protected during launch by interleaved thin plastic sheets that stay behind when the cells are freed.

### Reins damp tv outlook

As if British television-set makers didn't have enough problems with lagging color sales, they've now been hit by tighter credit regulations. The government has increased the minimum down payment and cut the maximum repayment period on all consumer goods.

The blow came at a particularly bad time. The color market has been in the doldrums, largely because the average receiver costs about \$700 and only one channel offers color programs. Since last summer, though, makers and renters have been stockpiling sets with an eye to increased winter sales. But it looks as though the stiffer credit rules will remain in force at least until next spring—the start of the slack season. What it all boils down to is that sales will probably crawl along at their present pace until next fall, when color transmission starts on Britain's other two channels.

The black-and-white picture is a bit brighter, however. Paradoxically, sales increased through the summer and most manufacturers have a backlog of orders.

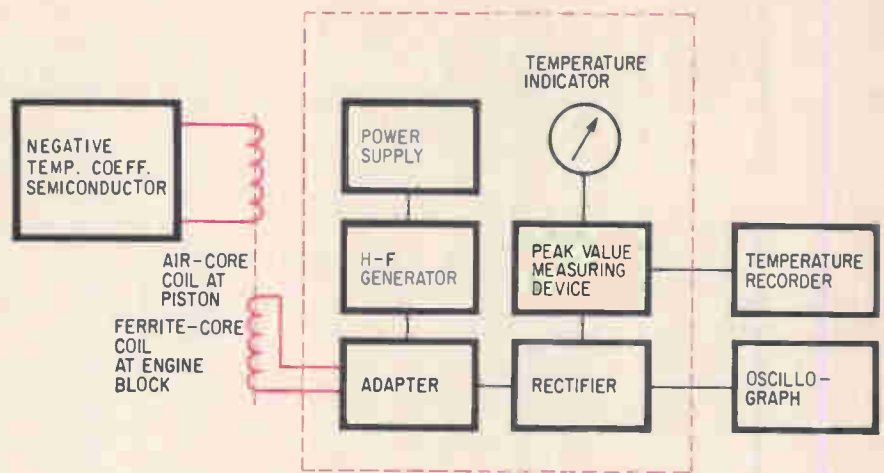

Hot rod. This system developed at the University of Aachen accurately measures the temperature of engine pistons.

## West Germany

### Feeling the heat

Automotive engineers seeking to improve engine designs must know the temperatures developed by the pistons. But methods used to date have been cumbersome, time consuming, and—most important—inaccurate. For instance, one technique calls for the insertion of metal plugs with different melting points in holes bored in the piston wall; the engine is then taken apart after each run to see which plugs have melted. The result is only a  $\pm 10^\circ\text{C}$  approximation of the temperatures.

The primitive state of this art prompted the Institute for Automotive Engineering at West Germany's University of Aachen to apply some familiar electronic principles to the problem. The result is a test system that's faster and more accurate than anything used up to now, and that eliminates any need to take the engine apart or to apply contacts while it's running.

**Warming up.** The technique employs negative-temperature-coefficient semiconductor elements as sensing devices, plus a set of coils. Circuit values that are a function of temperature are transmitted to a meter by the coils. Using the university's development, a piston manufacturer, Karl Schmidt GmbH,

has put together a system that can determine piston-wall temperatures to within  $1^\circ$  to  $2.5^\circ\text{C}$  and can handle inputs from as many as 10 spots around the piston simultaneously.

The elements are placed in small holes drilled into the piston's inner wall, with high-temperature paste insuring good contact between element tips and metal. The leads run along the inner wall to an air-core coil attached to the lower part of the piston. As the piston comes down to its dead point, the air-core coil caps a smaller ferrite-core coil fixed to the bottom of the engine block.

A 456-kilohertz voltage is applied across both a series resistance and the ferrite-core coil. When that coil meets the air-core coil, the negative-temperature-coefficient resistance causes temperature-dependent attenuation in the coils' circuits, changing both the current in the ferrite-core coil and the voltage across the series resistance.

**Option.** Since the resistance of the negative-temperature-coefficient element declines as temperature rises—causing attenuation to increase—the voltage across the series resistance rises. That voltage is picked off, rectified, and fed to a peak-value measuring device with a d-c amplifier. The amplified signal is then applied to a moving-coil temperature indicator; it can also be fed to a temperature



recorder for readings as a function of pre-ignition, or as a reflection of such things as knock, variations in gas-air mixture, and sparkplug defects.

The manufacturer says the setup has been used in test runs as long as 200 hours straight without any loss of accuracy. The price of a three-input system is \$2,500.

## On the spot

Any electronics production engineer knows that one of the most vexing and tedious jobs is wiring big patch panels, plug boards, and similar assemblies with a large number of terminals. Workers must look up terminal numbers on a drawing or wiring list, pinpoint the corresponding spots on the work piece, and then make the connection. That done, wires have to be "rung out" for continuity—and all too often reconnected because of errors.

Eliminating the drudgery in such work is what AEG-Telefunken has in mind with semiautomatic equipment it has just put on the market. In the equipment, slightly larger than a teletypewriter, an optical system produces a light dot that spots the correct terminal, thus telling the assembler where the connection must be made. The dot moves, according to information punched out on tape, and the lead is automatically checked out when the connection is made.

The equipment spells big savings in labor: three girls—one at the machine and two for preparing the leads—do the work of 14, a distinct advantage in West Germany's labor-short economy. What's more, the chance of wiring a lead to the wrong spot is less than one in about 14,000.

**No parallax.** Originally developed by Telefunken for its own use, the setup, called TAV, will be marketed by Amphenol-Tuchel Electronics GmbH, a subsidiary of the Amphenol Corp. It will sell for about \$30,000.

In a typical wiring job, the terminal board or frame is put into an adapter at the front end of



Light work. AEG-Telefunken's semiautomatic wiring equipment has connection tool that won't go on to next step if all isn't well.

the setup. The information for the equipment's control system comes from a reader that scans the terminal address punched out on eight-track paper or metallized plastic tape. After the address is stored the control unit stops the reader and triggers the optical indicating system. That system produces the light dot and steers it vertically and horizontally to the designated spot. The dot is produced in a glass panel installed above the terminal board; it is seen as a parallax-free reflection.

The connection tool also serves as a test probe. If the wire continuity test is positive, the control unit advances the punched tape so that the next terminal address can be read. If the test is negative the control unit fails to operate.

## Japan

### Steady gains

Designing hybrid integrated-circuit amplifiers for S-band operations is a ticklish proposition because the transistors must work in

a range close to  $f_t$ —the frequency at which input gain equals output gain in a common emitter. Gain at these frequencies falls at a rate of about 6 decibels per octave, making it difficult to maintain a constant gain value over a wide band.

The usual solution is to design the amplifier so that the transistors reflect some of the input power at the lower frequencies and are properly matched to circuits at the higher frequencies. But unless each stage is isolated, such matching can raise havoc with the circuits connected to the amplifier and thwart efforts to cascade several stages for increased gain.

**Another road.** Engineers at the Nippon Electric Co. rejected that method—and Bell Labs' use of two very closely matched transistors per stage—in building a simple i-f amplifier to be used in a receiver they've developed for a millimeter-wave pulse-code-modulation system [Electronics, Sept. 30, p. 209]. Their amplifier has transistors with a gain of about 4 db per stage over a frequency range of 3.5 to 4.3 gigahertz. It can be used as a substitute for low-power traveling-wave or triode amplifiers in a 4-GHz microwave relay station, as a pre-

amp in microwave test equipment, or as the i-f amplifier in wideband millimeter-wave communications systems.

Both the Nippon Electric and Bell amplifiers are built with strip-line having a 50-ohm impedance. But the Japanese technique eliminates transistor matching as well as any need for a three-dimensional coupler circuit within the 1/8-inch space between the triplate's two ground planes—another feature of the Bell scheme.

To keep the gain constant across the band (by increasing reflection at lower frequencies), the Japanese engineers paid a price they feel they can afford: the standing-wave ratio, especially at the input, increases as frequency decreases. This means that though the gain is constant, large ripples would be introduced into the gain's characteristic if several stages were cascaded.

**Follow the line.** One answer to the problem would be isolators between stages, but this method is costly and cumbersome. Instead, Nippon Electric researchers have inserted lengths of line between stages to introduce a phase shift that cancels the effects of reflections. The company claims that a quarter-wavelength line between the second and third stages of a three-stage amplifier does the trick.

There was yet another hurdle—the considerable variations in the standing-wave ratios between input at the first stage and output at the third. The solution: an isolator composed of yttrium iron garnet disks above and below the circuit. This isolator has a bandwidth exceeding 1 GHz in the 4-GHz band, and a unity standing-wave ratio of less than 1.2. Isolation is more than 20 db, and insertion loss is below 0.4 db.

### Calculating components

When electronic desk calculators become Japan's biggest market for integrated circuits—as they will within a few years—the marketplace will be crowded. The country's electronics giants have been busily designing such IC's for the



**Summing up.** This miniaturized experimental desk calculator was developed by Hayakawa and uses large-scale integration [Electronics, Nov. 11, p. 307]. It contains 11 MOS integrated circuits with 300 to 400 elements each, three bipolar hybrid IC's four bipolar transistors.

past several years. The latest to be announced are 64-bit and 60-bit shift registers and a full adder/subtractor with carry/borrow output, all from Toshiba.

The adder/subtractor uses metal oxide semiconductor exclusive-OR circuits for simplicity and better logic configuration. In fact, of the three current approaches to a full adder/subtractor for desk calculators, only the MOS IC needs just one package. By contrast, 64 devices are needed when only discrete components are used, and diode-transistor-logic IC's requires eight packages.

**Elementary.** Comparing the number of elements in each package reveals a similar pattern. The discrete contains 64 elements, the DTL 144, and Toshiba's new MOS version but 39. This simplicity is rooted in the exclusive-OR circuit, which requires only three MOS field effect transistors and correspondingly fewer elements throughout. Besides elements for the adder/subtractor, the die contains a flip-flop to generate a one-bit delayed carry. The die is approximately 1/16th inch square.

As to the shift registers, the 64-

bit version contains about 440 elements on one die.

One of the more important shift-register parameters for desk-calculator designers is the minimum operational clock frequency. Toshiba's units can operate at frequencies about 1/7th to 1/10th the minimums for similar circuits, or 22.5 hertz at 75°C. The reason: a lower leakage current and longer time constant.

### Around the world

**Central America.** The five member nations of the technical commission on telecommunications for Central America have agreed to study the plan for a regional two-satellite communications network proposed by Honduras [Electronics, March 18, p. 244]. The satellites would provide a link with the U.S. and Europe. The states—the other four are Costa Rica, Nicaragua, El Salvador, and Guatemala—also agreed to postpone from November 29 until January 15 the opening of bids on a regional non-satellite communications network.



## In hope of doing each other some good

### Rising tide of mesomorphics

Imaginative people get excited over liquid crystals. This category of people includes optical physicists, artists, analytical chemists, aerospace engineers, dermatologists, designers of integrated electronic circuits, contestants in science fairs, biophysicists, osmologists, welding engineers, and entrepreneurs who think it is still not too late to make a bundle by interesting the human female in body paint. Unimaginative people believe the word "fraught" is being overused. They may regret their attitude, or they may not.

Meanwhile, there must be almost as many laboratories either guarding or disclosing liquid crystal secrets as are working on holograms. With which the mesomorphic, or liquid crystal, state has no connection. Or does it?

A fraught statement enunciates the

liquid crystal principle and why we bring it up: The liquid crystal state is the opposite of the glassy state in the sense that glass is rigid but unordered, while the following become highly ordered even when soft as an unguent:

EASTMAN Mixture Solution No.	Cholesteric Solution No.	for temperature range
A10629		12-17 C
A10632		16-19
A10634		17-20
A10637		18-21
A10673		21-23
A10639		22-25
A10676		24-27
A10642		31-32
A10645		32-33
A10647		33-34
A10650		34-35
A9861		35-36
A10655		36-37
A10657		37-38
A10660		38-39
A10662		39-40
A10665		40-41
A10668		41-42
A10670		43-44

These believed of most immediate

practical application for thermographic mapping of a surface within each range indicated. With No. A10650, for example, you get no information about areas cooler than 34 C or warmer than 35 C, but you ought to be able to spot variations within that one-degree span from an iridescent blue appearance at 35 through a gamut of color to a red at 34. Order any of them at \$25 for 100 ml from Distillation Products Industries, Rochester, N.Y. 14603 (Division of Eastman Kodak Company). Blacken surface, spray on, let evaporate.

If no temperature range here listed fits proposed use, or if price seems discouraging for application from a big hose, inquire anyway. We pride ourselves on a practical outlook.

Price subject to change without notice.



Whatever else you see here, you are looking at a result of advanced technology with fibers.\* The garment and home-furnishings industries are not the only customers for fiber technology. To fabricators of artificial eyes we have been furnishing vein- and artery-like colored fibers. More complex projects seem even more exciting commercially. Papermakers ourselves for photographic applications, we have been talking and working a bit with other papermakers, who, as major users of fibers, have been attracted to KODEL Polyester Fiber. And aside from fibers themselves, the technology of fibers-handling seems to have some useful contributions to make to electrical-electronic technology in the matter of winding and insulating components.

Amos Griffin, Vice President/Fibers, Eastman Chemical Products, Inc. (Subsidiary of Eastman Kodak Company), Kingsport, Tenn. 37662 seeks new friends.

\*In this case with our VEREL Modacrylic Fiber—as put by North Bay into something a kind, animal-loving lady can appreciate. With the gifting season perilously close, there may still be time to get the list of labels to look for at the local shopping center by writing Knit Merchandising Department at Eastman Chemical Products, Inc., 260 Madison Avenue, New York City 10016.



### In contact with the film

Only modest skills in persuasion are needed to get an engineer to grant that photography on a continuous reel of film has attractive advantages in keeping watch on objects and scenes, in digital recording, or in recording analog signals with high-frequency components. Stronger talent is often needed to convince him that the advantages are worth the price in fuss, delay, and the need for expertise with solutions and the temperature thereof. Now the price has come down.

KODAK BIMAT Transfer Film, originally devised to process film unattended inside a satellite, is now available in four commercial forms. When this

film (which is not light-sensitive itself) is brought into proper contact with film on which your desired image has been exposed, the BIMAT Film turns within seconds into a high-quality positive and the original film into an even better-quality negative. They can be left in contact for minutes or hours with little visible difference in effect on results. Subsequent conventional treatment is necessary only if the negative or positive is to be kept for long periods of time. The system works with numerous taking films that have been on the market for some time. Also on the market—but not from us—is equipment, simple and compact, for bringing the films together and separating them. Equip-

ment manufacturers who furthermore think the market will reward good designs for continuous processing by this method can expect plenty of technical encouragement from us.

Let us be realistic, however. In order to give this thing the commercial viability it seems to deserve, we need to find people who can use the four existing kinds of KODAK BIMAT Transfer Film and to put those people in good contact with the product. A careful plan to achieve this has been thought out by K. T. Lassiter, Mail Code 942, Eastman Kodak Company, Rochester, N.Y. 14650, who eagerly awaits mail.

EASTMAN KODAK COMPANY  
An equal-opportunity employer



# Slowdown!

(and read about the world's fastest IC adder.)

Signetics announces a no-kidding leadership device: the 8260 Arithmetic Logic Element, latest addition to our DCL family.

The 8260, now available in volume, is a monolithic gate array incorporating four full adders structured in a look-ahead mode. The device may be used as four mutually independent Exclusive-NOR or AND gates by proper addressing of the inhibit lines. Here is a device which in typical application increases speed three to four times, greatly reduces package count and appreciably lowers over-all system costs.

As a four-bit adder, the 8260 permits parallel addition of four sets of data and features simultaneous (look ahead) carry on each bit within the package. Extension of the look-ahead feature for 16 bits or more is facilitated by the 8261 Fast Carry

Extender.

Access to the 8260 from previous stage(s) is provided through five OR-ed channels, and inhibition of carry-in-data and bit-to-bit carries is accomplished by a true (active high) logic level of  $C_{INH}$ .

The "carry-outs" available are: Internally Generated ( $\bar{C}_G$ ); Propagated ( $C_P$ ); and Ripple ( $\bar{C}_R$ ). This gives the 8260 complete flexibility when used in Ripple Carry or Anticipated Carry Adder systems.

The 8260 is available now in 24-lead flat pak,  $-55^\circ\text{C}$  to  $+125^\circ\text{C}$  and  $0^\circ\text{C}$  to  $+75^\circ\text{C}$ , and will soon be available in both full MIL and commercial DIPs.

For complete information on the world's fastest adder write Signetics, 811 East Arques Avenue, Sunnyvale, California 94086. Fast!

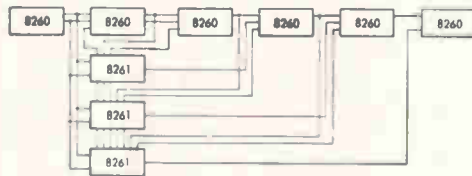

24-bit Fast Adder System; 9 packages; minimum external connections.

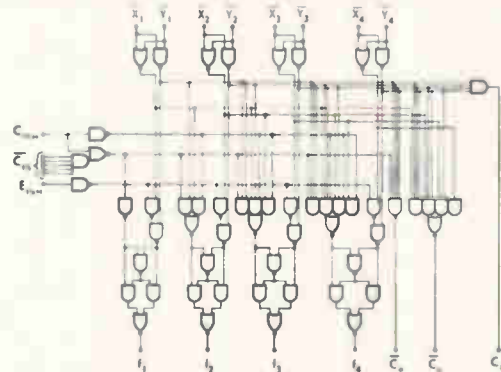

The 8260 Arithmetic Logic Element.

No. of Bits	Package Count			Addition Time per Bit (ns)	Total Addition Time Input to Output (ns)
	8260	8261	Quad 2-Input NAND Gates		
16	4	1	—	3.3	52
24	6	3	—	3.3	52
32	8	3	—	2.0	64
48	12	6	1	1.3	64
64	16	7	1	1.2	76

Increased speed and reduced package count far exceed what is attainable with any other IC family.

Signetics Integrated Circuits   
A SUBSIDIARY OF CORNING GLASS WORKS

**SIGNETICS SALES OFFICES:** Wakefield, Massachusetts (617) 245-8200; Trumbull, Connecticut (203) 268-8010; Poughkeepsie, New York (914) 471-3292; Syracuse, New York (315) 469-1072; Fort Lee, New Jersey (201) 947-9870; Radnor, Pennsylvania (215) 687-2660; Silver Spring, Maryland (301) 946-6030; Clearwater, Florida (813) 726-3734; Winter Park, Florida (305) 671-5350; Dayton, Ohio (513) 433-4133; Minneapolis, Minnesota (612) 920-3256; Rolling Meadows, Illinois (312) 259-8300; Richardson, Texas (214) 231-6344; Garden Grove, California (714) 636-4260; Burbank, California (213) 846-1020; Redwood City, California (415) 369-0333.

**DISTRIBUTORS:** Avnet Electronics Corp., Burlington, Mass. (617) 272-3060; Cescio Electronics, Ltd., Montreal, Quebec, Canada (514) 735-5511; Compar Corporation at the following locations: Huntsville, Alabama (205) 539-8476; Los Angeles, California (213) 245-1172; Burlingame, California (415) 347-8244; Hamden, Connecticut (203) 288-9276; Clearwater, Florida (813) 446-2991; Orlando, Florida (305) 855-3964; Park Ridge, Illinois (312) 692-4125; Baltimore, Maryland (301) 484-5400; Newton Highlands, Mass. (617) 969-7140; Minneapolis, Minnesota (612) 922-7011; St. Louis, Missouri (314) 542-3399; Albany, New York (518) 489-7408; Endwell, New York (607) 723-8743; Woodbury, New York (516) 921-9393; Fairport, New York (716) 271-2230; Syracuse, New York (315) 471-3356; Winston-Salem, North Carolina (919) 723-1002; Seattle, Washington (206) 763-1711; Hamilton Electro Sales, Culver City, Calif. (213) 870-7171; Hamilton Electro Sales, Cherry Hill, N. J. (609) 662-9337; Hammond Electronics, Orlando, Florida (305) 241-6601; Kierulff Electronics, Seattle, Wash. (206) 763-1550; G. S. Marshall, San Marino, Calif. (213) 684-1530; Milgray-Delaware Valley, Inc., Philadelphia, Pa. (215) 228-2000; Pioneer Standard Electronics, Rockville, Maryland (301) 427-3300; Schley Electronics, Watertown, Mass. (617) 926-0235; Semiconductor Specialists, Inc., Elmhurst, Illinois (312) 279-1000; Terminal Hudson Electronics, New York, New York (212) 243-5200; Universal Electronics, Inc., Houston, Texas (713) 781-0421; Wesco Electronics, Inc., Los Angeles, Calif. (213) 685-9525; Palo Alto, Calif. (405) 968-3475.

**DOMESTIC REPRESENTATIVES:** Compar Corporation at the following locations: Scottsdale, Arizona (602) 947-4336; Denver, Colorado (303) 781-0912; Southfield, Michigan (313) 357-5369; Haddonfield, New Jersey (609) 429-1526; Albuquerque, New Mexico (505) 265-1020; Albany, New York (518) 489-7408; Endwell, New York (607) 723-8743; Fairport, New York (716) 271-2230; Syracuse, New York (315) 471-3356; Rocky River, Ohio (216) 333-4120; Fairborn, Ohio (513) 878-2631; Dallas, Texas (214) 363-1526; Houston, Texas (713) 667-3420; Ozark Electronic Marketing, Inc., St. Louis, Missouri (314) 423-7200.

**INTERNATIONAL SALES:** France, Germany, Italy, Belgium, Holland, Luxemburg, Spain—Sovcor Electronique, 11, Chemin de Ronde, Le Vesinet, (S & O) France; United Kingdom, Ireland, Sweden, Denmark, Norway, Switzerland, Austria, Portugal—Electrosil Ltd., Lakeside Estate, Colnbrook-By-Pass Slough, Buckinghamshire, Great Britain; Australia—Corning, 1202 Plaza Building, Australia Square, Sydney, N.S.W. 27-4318; Canada—Corning Glass Works of Canada, Ltd., Leaside Plant, Ontario, Canada (416) 421-1500; Israel—Talviton, P.O. Box 3282, Tel Aviv, Israel 236-666; Japan—ASAHI Glass Co., Ltd., Corning Products Sales Dept. No. 14, 2 Chome Marunouchi, Chiyoda-ku, Tokyo, Japan 211-0411.

Abbott Transistor Labs, Inc. Technical Adv. Agcy.	16	Honeywell, Computer Control Division	53
■ Acopian Corp.	14	Cremer, Trowbridge, Case & Basford, Inc.	
■ Mort Barish Associates		Hooker Chemical Corp., Durez Div.	130
■ Acton Laboratories, Inc.	136	Rumrill-Hoyt, Inc.	
Impact Adv., Inc.		■ ITT Jennings Mfg. Co.	52
Allen-Bradley Co.	39	MacManus, John & Adams, Inc.	
Fensholt Adv. Agcy.		ITT Semiconductors Div.	119
■ Amperex Electronics Corp., Div. of North American Philips Co.	103	Neals & Hickok, Inc.	
Sam Groden, Inc.		■ Johanson Mfg. Co.	128
■ Amphenol Corp.	18, 19, 153	Josephson, Cuffari & Co.	
Marsteller, Inc.		Joslyn, Inc.	124
■ Analog Devices, Inc.	135	Chase Co.	
Kenen Associates		■ Kepco, Inc.	22
Andrew Corp.	64	Weiss Advertising	
Fensholt Adv., Inc.		Kikusui Electronics Corp.	134
APM-Hexseal Corp.	134	General Advertising Agency, Inc.	
Mohr & Co., Inc.		□ Laboratoire General de Telecommunications Publicite MAB	3E
■ Augat, Inc.	30	■ Lapp Insulator Co.	60
Horton, Church & Goff, Inc.		Wolf Associates	
■ Beckman Instruments, Inc., Helipot Div.	70	■ Leach Corp.	45
Hixson & Jorgensen, Inc.		Jay Chiat & Associates	
Bourns, Inc., Trimpot Div.	27	Litton Industries, Inc.	
Lester Co., The		Inter/Pak Electronics	47
■ Bowmar Instrument Corp.	26, 58	Mac Manus, John & Adams, Inc.	
Impact Adv., Inc.		□ LTT	9E
■ Bulova Watch Co., Electronics Div.	100	Promotion Vente Publicite	
Levy Adv. Assoc.		McGraw-Hill Professional and Reference Book Div.	141
Cerro Copper & Brass Co.	128	■ Micro Switch Division of Honeywell	28, 29
Feeley & Wheeler, Inc.		Batten, Barton, Durstine & Osborn, Inc.	
Clare & Co., C.P.	40	Microtest Corp.	25
Reinke, Meyer & Finn Adv., Inc.		Larry Courtney Co.	
■ Clifton Precision Products Co., Div. of Lifton Industries	32	■ Milgray Electronics	133
Ivey Adv., Inc.		Bliss/Gruenwald, Inc.	
Coto Coil Co., Inc.	124	Mohawk Data Sciences Corp./OEM Marketing	110
Williams Co., The		MacFarland Assoc., Inc.	
CREI, Home Study Div. of the McGraw-Hill Book Co.	129	Motorola Communications & Electronics, Inc.	117, 136
Henry J. Kaufman & Associates		The Griswold-Eshleman Co.	
□ C.S.F. GTE	4E, 121	Motorola Semiconductor Products, Inc.	41, 113
SPI Agency		Lane & Bird Adv., Inc.	
Cunningham Corp., Subsidiary Gleason Works	151	Mullard, Ltd.	96
Hutchins Adv. Co., Inc.		Parker-Rumrill International, Inc.	
Dana Laboratories, Inc.	20, 21	National Semiconductor Corp.	35, 36
Smith-Klitten, Inc.		Hall Butler Blatherwick, Inc.	
Data Instruments Division	8	North American Rockwell, Autonetics Div.	114
Technical Marketing		Campbell-Ewald Co.	
Data Products Corp.	154	■ North Atlantic Industries, Inc.	101
The G.M. Bronson Co., Inc.		Ross Roy of New York, Inc.	
Dearborn Electronics, Inc., Sprague Electric Co. Div.	118	■ Nortronics Co., Inc., OEM Div.	152
Harry P. Bridge Co.		Stral Adv. Co., Inc.	
Delco Radio, Div. of General Motors Corp.	68, 69	Owens-Illinois, Inc.	37
Campbell-Ewald Co.		Meldrum and Fewsmith, Inc.	
Deringer Metallurgical Corp.	61	Pastoriza Electronics Co.	135, 137
R.B. Advertising		L.K. Frank Co., Inc.	
Digital Equipment Corp.	138	Philco Ford Co., Microelectronics Div.	10, 11
Kalb & Schneider, Inc.		The Aitkin-Kynett Co., Inc.	
□ Dynamco, Ltd.	13E	Philco Ford Corp.	
Nicholas Daniels Associates		Sierra Electronics Operation	23
Eastman Kodak Co., Technical Corporate Adv.	149	Hal Lawrence, Inc.	
Rumrill-Hoyt, Inc.		Phillips Eindhoven, Nederland Media International	102
E-H Research Laboratories, Inc.	59	□ Phillips Eindhoven, N. V.	2E
Steedman, Cooper and Busse Adv.		T. A. G. De La Mar	
Farinon Electric	7	Phoenix Chamber of Commerce	138
Jack Herrick Adv., Inc.		Jennings & Thompson Advertising	
Fluke Mfg. Co., John Bonfield Associates	15	Radio Corporation of America	4th Cover, 57
General Atronics Corp.	134	Al Paul Lefton Co.	
Garceau Hallahan & McCullough, Inc.		Radio Materials Co., Div. of P. R. Mallory & Co.	116
■ General Electric Co., Miniature Lamp Div.	109	M. M. Fisher Assoc., Inc.	
Batten, Barton, Durstine & Osborn, Inc.		■ Raytheon Co., Components Div.	42
■ General Electric Co., Printer-Reader Business Section	120	Fuller & Smith & Ross, Inc.	
Robert S. Cragin, Inc.		■ Reeves Hoffman, Div. of Dynamics Corp. of America	56
□ G&E Bradley, Ltd.	148	Adams Assoc., Inc.	
Hyde and Partners, Ltd.		Republic Foil, Inc.	38
General Radio Co.	2nd Cover	The Graphic Group	
Horton, Church & Goff, Inc.		□ Rochar Electronique, Division of Schlumberger	7E
Hansen Mfg. Co.	137	Promotion Vente Publicite	
Keller-Crescent Co.		Sanders Assoc., Inc.	125
Heinemann Electric Co.	6	Harold Cabot & Co., Inc.	
Thomas R. Sundheim, Inc.		□ Schneider, R.T.	11E
■ Hewlett Packard, Colorado Springs Div.	3rd Cover	Noirclerc Publicite	
Tallant/Yates, Adv., Inc.		Scientific Data Systems	48
■ Hewlett Packard, Frequency & Time Div.	62, 63, 142	Doyle, Dane, Bernbach, Inc.	
Lennen & Newell, Inc.		SERNICE	145
■ Hewlett Packard, Loveland Div.	2, 12, 13	Publisher	
Tallant/Yates Adv., Inc.		■ Siemens America	120
■ Hewlett Packard, Microwave Div.	122	Clinton E. Frank, Inc.	
Lennen & Newell, Inc.		Signetics Corp. Sub. of Corning Glass Works	150
■ Hewlett Packard, Palo Alto Div.	1	Cunningham & Walsh, Inc.	
Lennen & Newell, Inc.		□ Silec Electronique	14E
■ Hickok Electrical Instrument Co.	106, 107	Publicite y Ch. Lambert	
Parsells Advertising Service			

# What do you expect from a high-performance matrix switch?

Probably perfection. And here's one that comes pretty close. The Cunningham general purpose, high-performance crossbar switch: **1. Versatile.** Covers the full range of data acquisition requirements. Handles voltages from 1 microvolt to 1000 volts—usable up to 30 MHz. **2. Reliable.** 20-million operations per crosspoint assured. Up to 100-million are common. **3. Readily Programmable.** By every control device from tape to direct computer input.

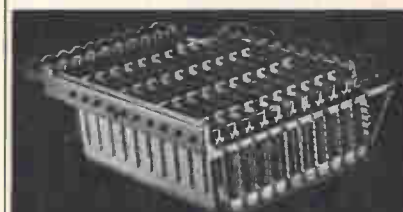

## The Cunningham Crossbar Switch

Switching systems problems?

Let our know-how in systems engineering work for you with: **Crossbar switches; McKee random access matrices** for high voltage and current; **reed matrix switches** for high frequencies; **Telefunken OHS (ordinate holding) switches** for low cost applications.

Free Design Data. Request new Data Sheet No. 601. Write or call Cunningham, Carriage St., Honeoye Falls, N. Y. 14472. Phone: (716) 624-2000.

**Cunningham**  
Subsidiary of Gleason Works  
Proven capability in engineered switch products and systems.





NEW / FROM  
NORTRONICS



HIGH  
PERFORMANCE  
PROFESSIONAL  
AUDIO  
TAPE HEADS

FOR 1/4" TAPE

20 Hz to 20 KHz Response

The new Nortronics PR Series tape heads provide a new standard of audio reproduction for broadcast equipment and other critical applications. Frequency response is within *one* DB from 20 Hz to 20 KHz in a mu-metal case. Even better response can be obtained with modified case shielding. In 7.5 and 15 ips playback applications the PR Series extends the usable low frequency response a full octave.

The PR Series is available in production quantities for full track and half track stereo, with other types supplied on special order. All heads feature the Nortronics deposited quartz gap

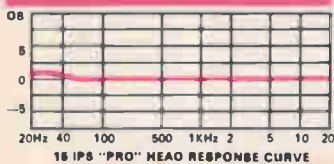

and laminated precision-lapped, low loss cores. They can be provided in a broad range of electrical specifications.

Standard "B" cases and terminal pin arrangements are used in the PR Series. Thus they are compatible with existing Nortronics mounting accessories and connector plugs.

*Complete technical data is available on request.*

**Nortronics**  
COMPANY, INC.

8101 Tenth Avenue North  
Minneapolis, Minnesota 55427



- Siliconix, Inc. 92
- Graphics West
- Sogle 146
- Etudes et Creations Publicitaire
- Sorensen Operation, Raytheon Co. 67
- Urrutia & Hayes, Inc.
- Sprague Electric Co., The 5, 9
- Harry P. Bridge Co.
- Stackpole Carbon Co., 46
- Electronic Components Div.
- Meek & Thomas, Inc.
- Sylvania Electric Products, Inc., 127
- Parts Div.
- Doyle, Dane, Bernbach, Inc.
- Taisei Kogaku Kogyo Co., Ltd. 126
- Asia Adv. Agcy., Inc.
- Technique et Produits 147
- Ste de Publicite de Films et de
- Cocumentaires
- Textronix, Inc. 104
- Dawson, Turner & Jenkins, Inc.
- Temescal, Div. of Aircro 124
- Allen & Dorward, Inc.
- Tempress Research Co., Inc. 17
- Hal Lawrence, Inc.
- Texas Instruments Incorporated 44
- Components Group
- Don L. Baxter, Div. of
- Albert Frank-Guenther Law, Inc.
- Texas Instruments Incorporated 54
- Industrial Products Group
- Robinson-Gerrard
- Thomson Electric Co., Inc. 97
- Tracor, Inc. 98
- Weekley & Valenti, Inc.
- Transistor Electronics Corp. 136
- Stevenson and Assoc., Inc.
- TRW Electronics, Crystal Div. 55
- Fuller & Smith & Ross, Inc.
- Trymetrics Corp. 112
- Kameny Assoc., Inc.
- Tung-Sol Division, 132
- Wagner Electric Corp.
- Feeley & Wheeler, Inc.
- Tyco Laboratories—Solor Systems Div. 24
- Kenyon & Eckhardt, Inc., Adv.
- Ulano Graphic Arts Supplies, Inc. 93
- Lory Roston Associates
- Victoreen Instrument Co. 108
- Palm & Peterson, Inc.
- Westinghouse/MED 43
- Pritchard Wood Assoc., Inc.
- Weston Instruments, Inc., Newark Div. 94
- Arndt, Preston, Chapin, Lamb & Keen,
- Inc.
- Wiremold Company, The 132
- The Charles Brunelle Co.
- Wisconsin, State of, Div. of
- Economic Development
- The Cramer-Krasselt Co. 95

**Classified Advertising**

F.J. Eberle, Manager

**EMPLOYMENT OPPORTUNITIES 138-140**

**EQUIPMENT**  
(Used or Surplus New)  
For Sale

- Fishman, P. Co. .... 138
- Hird-Brown Limited ..... 138
- Radio Research Instrument Co. .... 138

■ For more information on complete product line see advertisement in the latest Electronics Buyer's Guide

□ Advertisers in Electronics International

**Electronics Buyers' Guide**

- George F. Werner, General Manager [212] 971-2310
- Robert M. Denmead, Midwest Regional Manager [312] MO 4-5800
- Regina Hera, Directory Manager [212] 971-2544
- Thomas M. Egan, Production Manager [212] 971-3140

**Circulation Department**

Isaaca Siegel, Manager [212] 971-6057

**Research Department**

David Strassler, Manager [212] 971-6058

**Advertising Sales Staff**

- Frank E. LeBeau [212] 971-6464  
Advertising Sales Manager
- Wallis Clarke [212] 971-2187  
Assistant to sales manager
- Donald J. Austermann [212] 971-3139  
Promotion Manager
- Warren H. Gardner [215] LO 8-6161  
Eastern Advertising Sales Manager
- Atlanta, Ga. 30309: Michael H. Miller, 1375  
Peachtree St., N.E.  
[404] 892-2868
- Boston, Mass. 02116: William S. Hodgkinson  
McGraw-Hill Building, Copley Square  
[617] CO 2-1160
- Cleveland, Ohio 44113: William J. Boyle, 55  
Public Square, [216] SU 1-7000
- New York, N.Y. 10036  
500 Fifth Avenue  
James R. Pierce [212] 971-3615  
John A. Garland [212] 971-3617  
Michael J. Stoller [212] 971-3616
- Philadelphia, Pa. 19103:  
Jeffrey M. Preston  
Warren H. Gardner,  
6 Penn Center Plaza,  
[215] LO 8-6161
- Pittsburgh, Pa. 15222: Warren H. Gardner,  
4 Gateway Center, [412] 391-1314
- Rochester, N.Y. 14534: William J. Boyle,  
9 Greylock Ridge, Pittsford, N.Y.  
[716] 586-5040
- Donald R. Furth (312) MO 4-5800  
Midwest Advertising Sales Manager
- Chicago, Ill. 60611: Kenneth E. Nicklas  
Ralph Hanning, 645 North Michigan Avenue,  
[312] MO 4-5800
- Dallas, Texas 75201: Richard P. Poole, 1800  
Republic National Bank Tower,  
[214] RI 7-9721
- Houston, Texas 77002: Robert Wallin,  
2270 Humble Bldg. [713] CA 4-8381
- Detroit, Michigan 48226: Ralph Hanning,  
856 Penobscot Building  
[313] 962-1793
- Minneapolis, Minn. 55402: 1104 Northstar  
Center [612] 332-7425
- St. Louis, Mo. 63105: Kenneth E. Nicklas,  
The Clayton Tower, 7751 Carondelet Ave.  
[314] PA 5-7285
- James T. Hauptli [415] DO 2-4600  
Western Advertising Sales Manager
- Denver, Colo. 80202: Joseph C. Page, David  
M. Watson, Tower Bldg., 1700 Broadway  
[303] 255-5484
- Los Angeles, Calif. 90017: Ian C. Hill,  
John G. Zisch, 1125 W. 6th St.,  
[213] HU 2-5450
- Portland, Ore. 97204: James T. Hauptli,  
Thomas McElhinny, 218 Mohawk Building,  
222 S.W. Morrison Street,  
Phone [503] 223-5118
- San Francisco, Calif. 94111: James T. Hauptli,  
Thomas McElhinny, 255 California Street,  
[415] DO 2-4600
- Pierre Braude Tel: 225 85 88: Paris  
European Director
- Paris: Denis Jacob  
88-90 Avenue Des Champs-Elysees, Paris 8
- United Kingdom and Scandinavia  
London: Oliver Ball, Tel: Hyde Park 1451  
34 Dover Street, London W1
- Milan: Robert Saldel  
1 via Baracchini Phone 86-90-656
- Brussels: F.I.H. Huntjens  
27 Rue Ducale Tel: 136503
- Frankfurt/Main: Hans Haller  
Elsa-Brandstroem Str. 2  
Phone 72 01 81
- Geneva: Denis Jacob  
1, rue du Temple Phone: 31 95 60
- Tokyo: Takeji Kinoshita 1 Kotohiracho  
Shiba, Minato-Ku Tokyo [502] 0656
- Osaka: Ryoji Kobayashi 163, Umegae-cho  
Kita-ku [362] 8771
- Business Department**
- Wallace C. Carmichael, Manager [212] 971-3191
- Stephen R. Weiss, Production Manager [212] 971-2044
- Thomas M. Egan, Assistant Production Manager [212] 971-3140
- Dorothy Carmesin, Contracts and Billings [212] 971-2908
- Frances Vallone, Reader Service Manager [212] 971-2865



# The three basic elements of choosing trimmers.

Only Amphenol includes all three resistance elements—cermet, wire and metal film—in its trimmer line. We do this because each element has its own unique features:

**Wire Wound** Very low temperature coefficient of resistance; lowest and most stable contact resistance and the smallest change in resistance under maximum load and temperature.

**Cermet** For applications where infinite resolution is desired. Offers widest resistance range—up to 5 megohms.

**Metal Film** Infinite resolution with excellent low noise characteristics. This Amphenol patented element has a low TCR of less than 100 ppm/°C and is also available in low-ohm values, down to 10 ohms.

Tell your Amphenol sales engineer or distributor what trimmer features your application needs. Then ask for his recommendation. He's the only one who has all three.

Our full line of trimmers are available in commercial, military and industrial versions; square and rectangular sizes; humidity-proof and high temperature cases.

Amphenol Controls Division, Janesville, Wis.



**AMPHENOL**  
THE BUNKER-RAMO CORPORATION

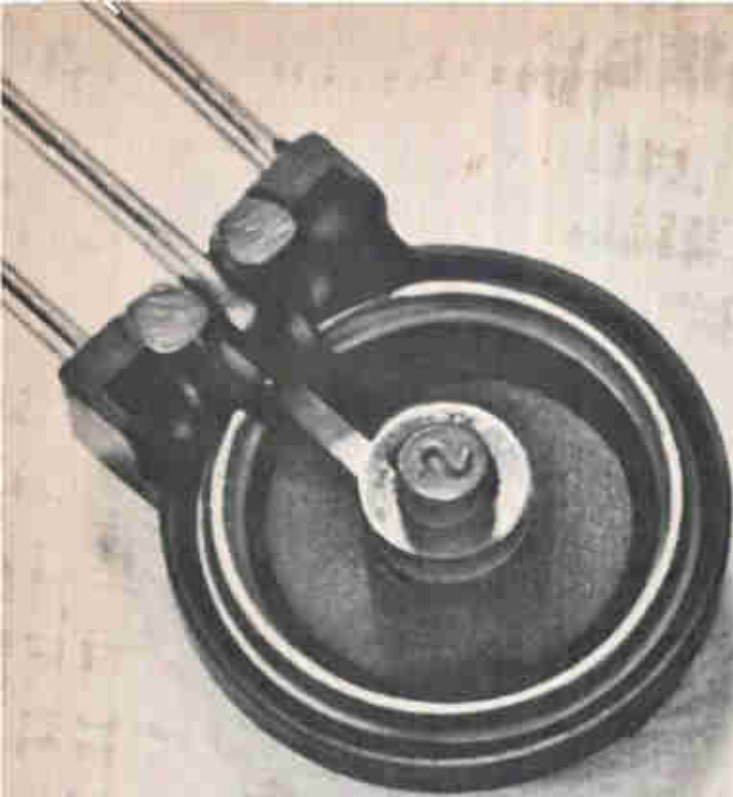

Wire

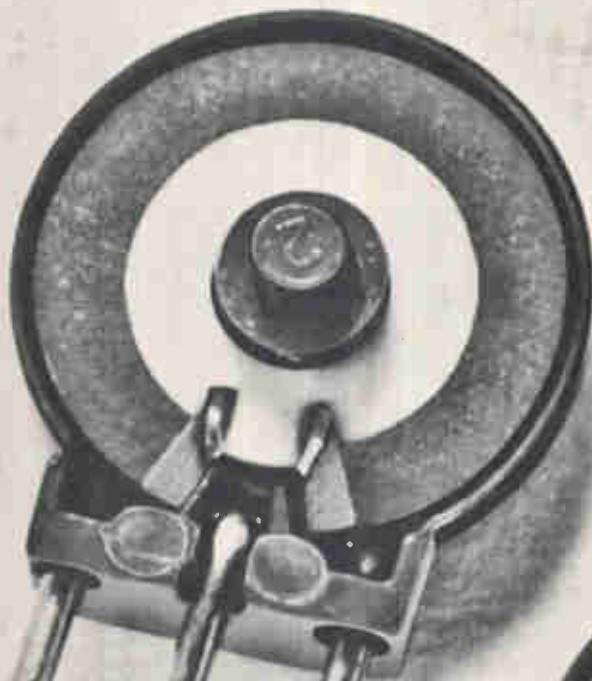

Cermet

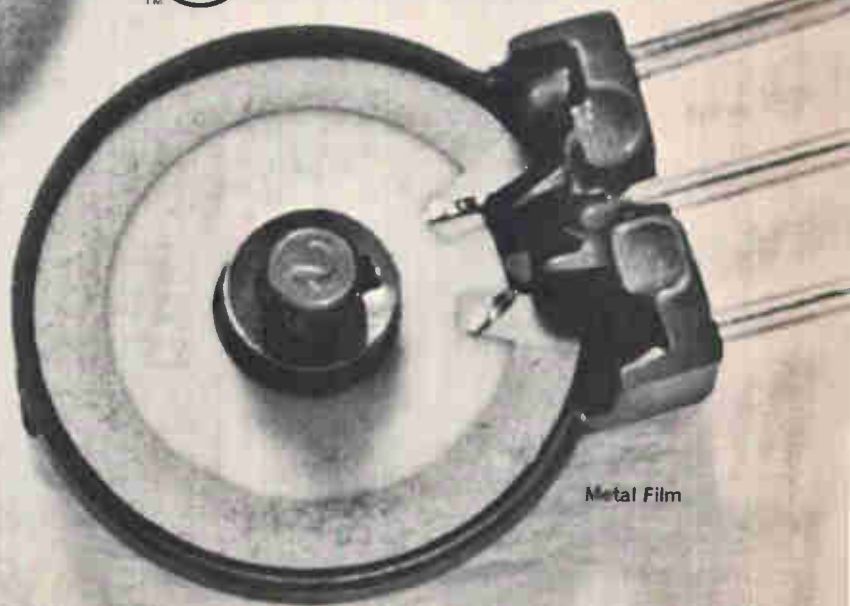

Metal Film

## A NEW TWIST IN MEMORY CORE MAKING...

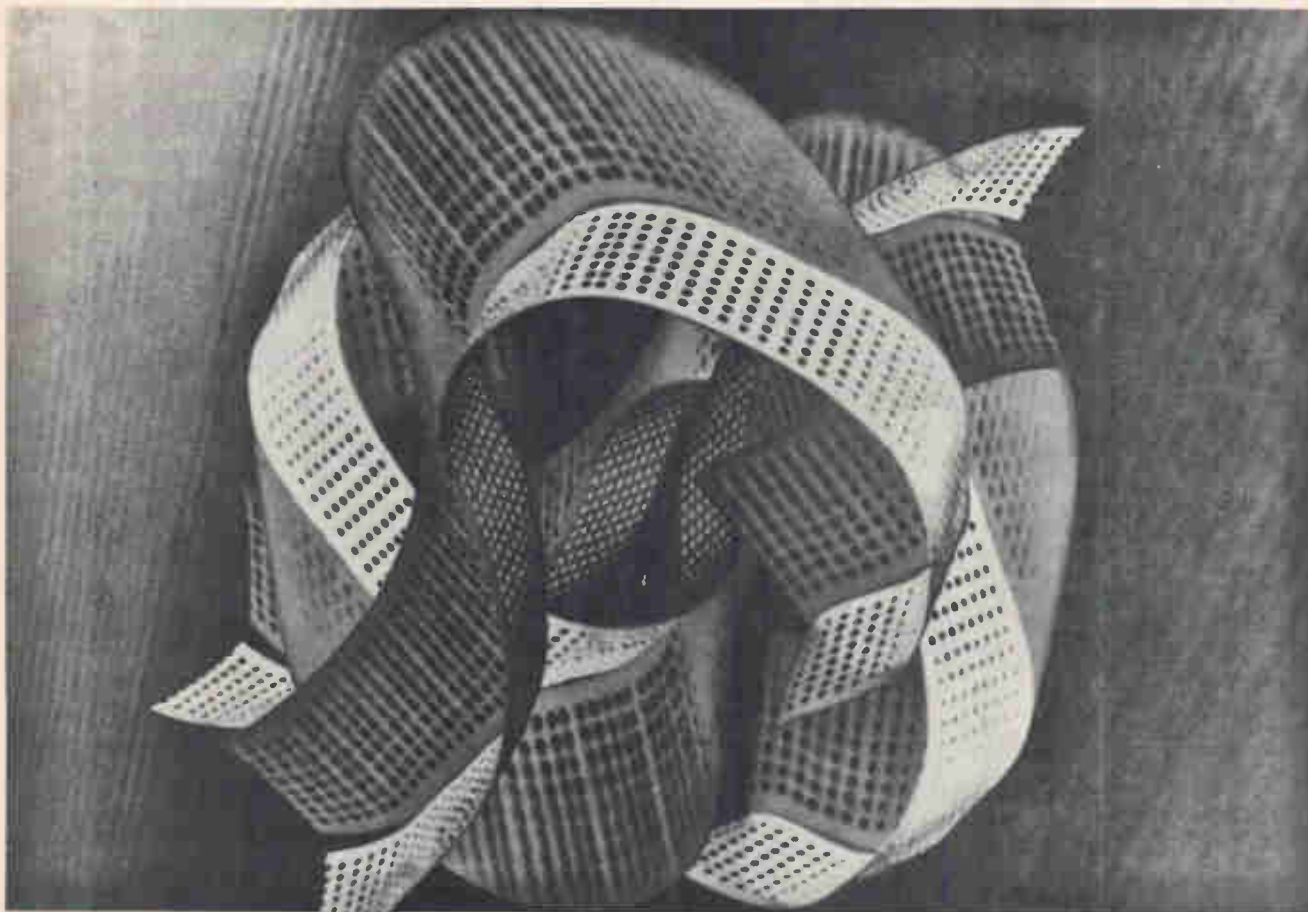

■ Cutting memory cores from tape instead of pressing them from powder...that's Core Memories\* new twist in core memory making. It lets us make cores with more uniform electrical characteristics and at higher production rates than ever before.

Most important to you, this new core making process allows us to build better planes, stacks, and complete core memory systems at lower cost.

For a reprint of the Inter Mag conference paper describing this new process and for literature on our ferrite cores, stacks and complete memory systems, write today to Data Products Corporation, 8535 Warner Drive, Culver City, California 90230.

Data Products manufactures LINE/PRINTERTM, DISCILEP, Core Memories, Off-Line Printer Systems, Card Readers & Punches

\*Core Memories, Incorporated is a subsidiary of Data Products Corporation.

***P*** data products

*"the peripheralists"*



# SEE MORE...DO MORE...

## For the first time there's Four-Channel Capability in a Portable, All-solid-state Scope—the hp 180 Scope System

Now—*whenever* and *wherever* you need four channels of high frequency information, the new hp 1804A Four Channel Vertical Amplifier plug-in provides more than twice the measurement capability of a two-channel scope. As a part of the lightweight 30-pound 180 scope system, the 1804A gives you 50 MHz, 20 mV/cm sensitivity, with four-channel capability in your lab, in the field, or in your production area.

Use the hp 1804A amplifier with 180A mainframe for making timing comparisons or measuring relationships of up to four inputs. Use the 1804A for designing computer logic circuitry, or for checking digital logic pulse trains. You'll save time

by comparing four inputs at one time!

Use the 1804A with 181A Variable Persistence and Storage mainframe to make measurements of four low rep rate pulses. Use variable persistence to eliminate annoying flicker. For time comparison of four channels of computer logic—which often are single shot phenomena—use the storage feature to capture and hold traces for accurate comparison.

The new hp 1804A amplifier offers a choice of selectable triggering or composite triggering. When set in SELECT mode, you can trigger on any one channel and see the time relationship with each of the other channels. For composite triggering, set the SYNC MODE switch to ABCD and each channel is triggered individually.

An UNCAL indicator lights when the CAL vernier setting on any channel is out of calibration. Channels are identifiable through use of the identification button next to the position controls.

The hp 1804A amplifier is another addition to the growing group of versatile plug-ins now available for use with the

hp 180 scope system. It is compatible with either the 1820A Time Base or the hp 1821A Time Base and Delay Generator. Other plug-ins available for use with the 180A conventional display scope and the 181A Variable Persistence and Storage scope are the 1801A 50 MHz 5 mV/cm Dual Channel Amplifier and the 1803A Differential/DC Offset Amplifier with its 40 MHz bandwidth and >0.5% accuracy.

Get the full story on the new hp 1804A Four-Channel Vertical Amplifier and the SEE MORE . . . DO MORE hp 180 Scope System. Contact your nearest hp field engineer. Or write to Hewlett-Packard, Palo Alto, California 94304. Europe: 54 Route des Acacias, Geneva. Price: hp 180A Oscilloscope, \$825; hp 181A Variable Persistence and Storage Oscilloscope, \$1850; hp 1804A Four Channel Vertical Amplifier, \$975; hp 1820A Time Base, \$475; hp 1821A Time Base and Delay Generator, \$800.

Circle 901 on reader service card

088/3

HEWLETT  PACKARD

OSCILLOSCOPE SYSTEMS

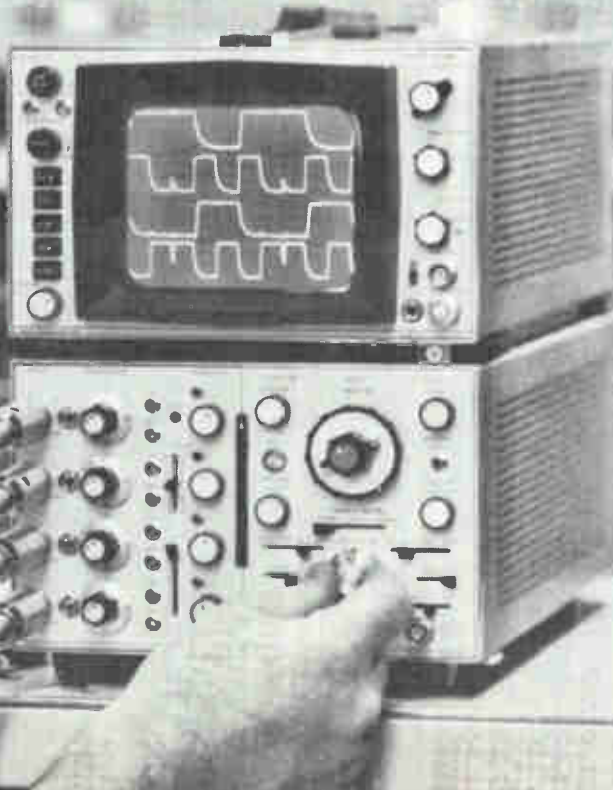



## 6 Independent Diodes for Design Flexibility —

**RCA-CA3039 @ 98¢ (1,000 units)**

RCA-CA3039 now gives designers six independent diodes for design flexibility. Use the array for bridge rectifiers, ring counters, mixers, modulators, balanced modulators, analog switches, diode gates for chopper-modulator applications, circuit protectors, diode voltage regulators, bias string regulators, customized logic circuits, level shifters, temperature compensation circuits. Use them in designs for telemetry, data-processing, instrumentation and communications equipment for service in the temperature range of  $-55^{\circ}$  to  $+125^{\circ}\text{C}$ .

Ask your RCA Representative for details or see your RCA Distributor for his price and delivery. Available in multi-unit quantities at multi-savings prices. For technical bulletin, write RCA Electronic Components, Commercial Engineering, Section No. 1C-N-11-2, Harrison, N. J. 07029.

Matched monolithic construction  $V_F$  matched within 5 mV  
Reverse recovery time 1 nsec (typ)  
Diode resistance ( $f = 1 \text{ KHz}$ ,  $I_F = 1 \text{ mA}$ )  $25 \Omega$  (min)  
Total device dissipation 600 mW (max)  
Low diode capacitance ( $V_R = -2\text{V}$ ,  $I_F = 0$ ) 0.65 pF (typ)  
DC forward current 25 mA (max)  
Peak recurrent forward current 100 mA (max)  
Reverse breakdown voltage (Diodes D1-D5) 5 V (min)

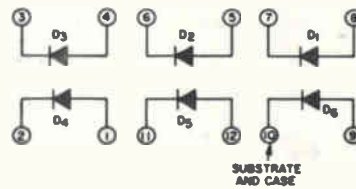

**RCA** Integrated  
Circuits

# The Handy "Six-Pack"

