

Electronics

®

Active filters need no inductors: page 109

Detecting bad IC's: page 120

Faster low-frequency measurements: page 123

May 27, 1968

\$1.00

A McGraw-Hill Publication

Below: Fourth dimension aids in
threshold logic design, page 94

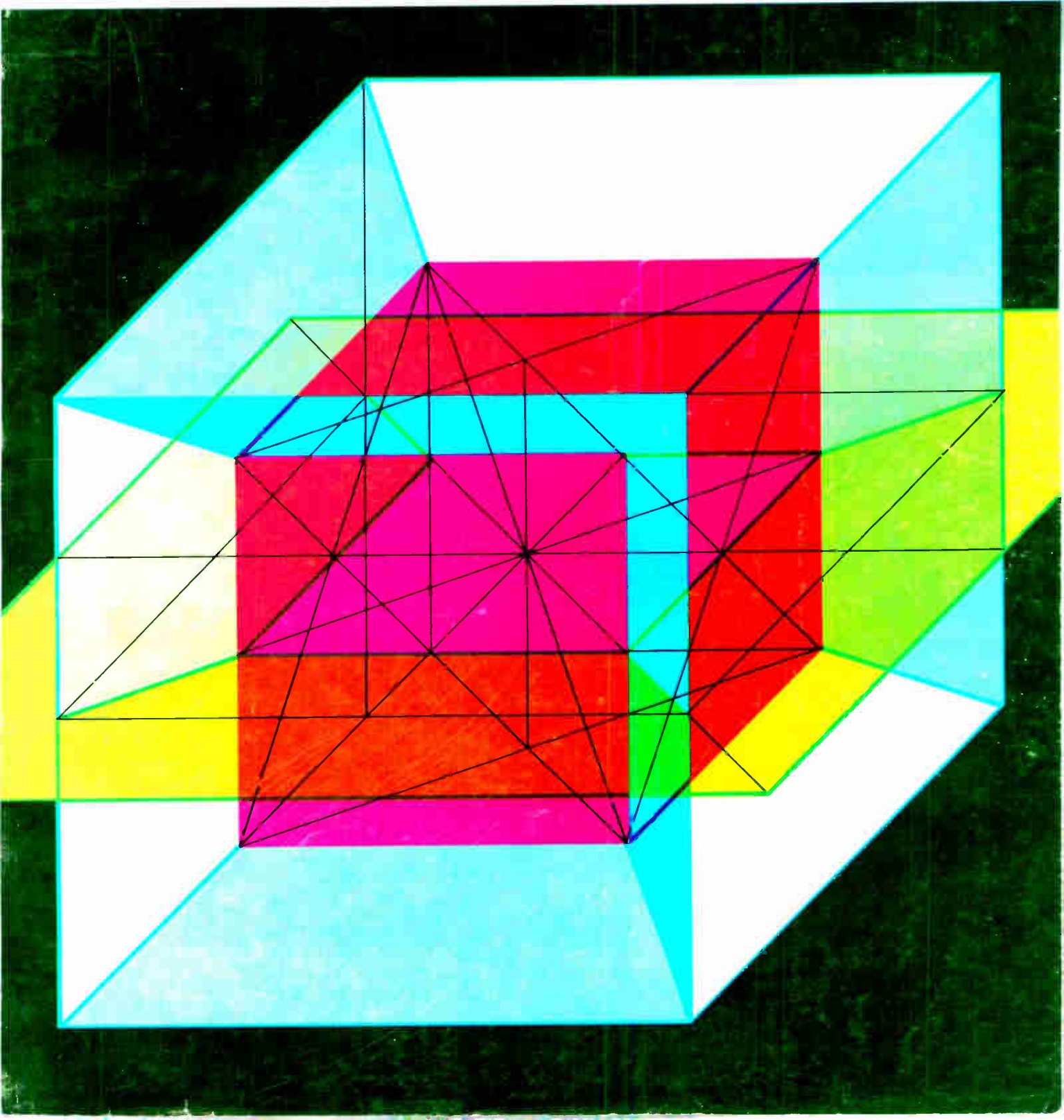



NEW BIT-250™ LINE

SMALLEST METAL-ENCASED TRANSFORMERS AVAILABLE!



BIT-250's achieve outstanding reliability, in a profile compatible with Flat Packs and IC's, while maintaining response and power levels found only in larger units. MIL-T-27B, Grade 4 completely ruggedized. Seventeen items immediately available from stock; plus specials to your requirements. Dimensions: .251" high x .250" diameter. Power to 80 mw. Patent applied to.

Write for descriptive brochure depicting ranges and capabilities.

UNITED TRANSFORMER CO. TRW
DIVISION OF TRW INC. • 150 VARICK STREET, NEW YORK, N. Y. 10013



No mystery to this plot!

*Not with the linearity and flatness of the new
hp 675A Sweeping Signal Generator!*

SWEEPER—You know the swept response you're getting is the true picture—because the hp 675A provides you with a linearity of 0.5%, output flatness of $.15\text{ dB}</math>, low residual FM of <math><70\text{ Hz}</math> peak, and a continuous range of $10\text{ kHz}</math> to $32\text{ MHz}</math>!$$$

The start-stop sweep has $\pm 1\%$ end point accuracy and the center frequency sweep has calibrated ΔF steps up to $10\text{ MHz}</math>. The low frequency drift of $<1\text{ kHz/hr.}</math> eliminates the need to individually calibrate each sweep setting. The $99\text{ dB}</math> calibrated output has $1\text{ dB}</math> step resolution.$$$$

If you need crystal marker accuracy in your display, you can get optional fixed frequency crystal and crystal controlled harmonic (comb) markers. The 675A has horizontal tilt and marker width and amplitude controls. With both external and internal detectors, markers are added after the signal has passed through the device under test.

Unique vertical blanking eliminates RF switching transients that could affect your device response.

SIGNAL GENERATOR (CW)—The 675A has CW dial accuracy of $\pm 0.5\%$ of full scale, $<60\text{ Hz rms}</math> spurious FM, $1\text{ kHz}</math> settable, calibrated output in 10 and $1\text{ dB}</math> steps, and an output monitor for an ideal signal generator. It can be amplitude mod-$$$

ulated internally or externally from 0 to 50% . External FM has a sensitivity of $1\text{ MHz/V}</math>.$

PROGRAMMABILITY—The external frequency control permits analog programming of discrete frequencies, swept frequencies and frequency modulation over the entire band. Amplitude can also be externally controlled over a $6\text{ dB}</math> range.$

Take the mystery out of your plots. Get the complete story on the new hp 675A Sweeping Signal Generator from your hp field engineer! Or, request a copy of our data sheet from Hewlett-Packard, Palo Alto, California 94304. Europe: 54 Route des Acacias, Geneva. Price: hp 675A, \$2250.00; markers and detectors optional.

097/16 A

HEWLETT  PACKARD

SIGNAL SOURCES

News Features

Probing the News

- 149 **Integrated electronics:** Putting the stress on IC reliability
158 **Instrumentation:** French firm enters U.S. market for nuclear instrumentation
165 **Advanced technology:** X rays can find wafer imperfections

Electronics Review

- 43 **Military electronics:** One step before the solid state radar; Modular air computer
45 **Companies:** Electronics in the ghettos
46 **Solid state:** Silicon-nitride passivation for MOS
48 **Avionics:** Pressure for aeronautical services satellite; Malfunction system
52 **Government:** Patent bill!
54 **Space electronics:** Tracking stars with an array; Weather watchers
60 **Computers:** Automated technician
62 **Communications:** Wireless mike
64 **For the Record**

Electronics Abroad

- 243 **Japan:** Pocket tv set; Elfin indicator tube
244 **West Germany:** Capacitors banished from tv circuits
245 **Great Britain:** Frequencies overlap in parametric amplifier pair; CdS oscillator powers experimental transmitter
246 **International:** Junketing experts lecture for NATO
246 **France:** Off-the-shelf Gunn oscillator
248 **Around the world**

New Products

- 177 **Six-pound scope developed**
181 **Components review**
181 Low-cost op amp has low drift
184 Full compensation added to op amps
188 Ladder switch for d-a converter
192 **Instruments review**
192 Two IC testers bow
197 **Semiconductors review**
197 Devices specified after radiation
200 Zener in plug-in package
203 **Microwave review**
203 50-milliwatt Gunn oscillator
209 **Production equipment review**
209 Position indicator uses IC's
215 **Subassemblies review**
215 Recorder has 512 pens

Title R registered U.S. Patent Office; © copyright 1968 by McGraw-Hill Inc. All rights reserved, including the right to reproduce the contents of this publication, in whole or in part.

Technical Articles

I. Design

- Computers** 94 **Threshold logic will cut costs, especially with boosts from LSI**
When the experimental threshold gates go into production, they'll reduce logic costs as much as 50%
Robert O. Winder, RCA Laboratories
- Circuit design** 104 **Designer's casebook**
▪ Sine-wave inverter prevents interference
▪ Gated semiconductors clean a-c switching
▪ Pulse generator is supply and temperature independent
- Design theory** 109 **Active filters: Part I**
The road to high Q's
Large inductors can be eliminated from low-frequency filters by using active filters
Joseph Mittleman, senior associate editor
- Design theory** 114 **Activating the passive RC network**
The characteristics of resistance-capacitance networks form the basis for active filter design
Arnold Meltzer, George Washington University

II. Application

- Instrumentation** 120 **Using a universal pulser for a-c checks of IC flip-flops**
Adapter adds dynamic test ability to automated d-c test equipment
Richard G. Parks and Luther J. Hintz, Honeywell Inc.
- Instrumentation** 123 **Two-step process speeds low-frequency measurements**
A counter circuit measures period first, then converts to frequency for fast, accurate measurements
James L. West, Weston Instruments Inc.
- Opinion** 129 **Industrial control computers solve some problems, but cause others**
A process-control expert says that computer manufacturers overlook too many important installation and service factors
Paul D. Griem Jr., Owens-Corning Fiberglas

Departments

- | | | | |
|----|------------------------|-----|------------------------|
| 4 | Readers Comment | 73 | Washington Newsletter |
| 8 | People | 221 | New Books |
| 14 | Meetings | 225 | Technical Abstracts |
| 23 | Editorial Comment | 230 | New Literature |
| 25 | Electronics Newsletter | 235 | Newsletter from Abroad |

Electronics

Editor-in-Chief: Donald Christiansen

Associate managing editors

Technical: Stephen E. Scrupski
News: Robert Henkel
Copy: Sally Powell

Senior associate editors

Joseph Mittleman, Harry R. Karp

Department editors

Avionics & Space: Alfred Rosenblatt
Computers: Wallace B. Riley
Communications: William Bucci
Consumer electronics: John D. Drummond
Design theory: Joseph Mittleman
Industrial electronics: Harry R. Karp
Instrumentation: Carl Moskowitz
Military electronics: Richard Gundlach
Solid state: Mark B. Leeds

Section editors

Electronics abroad: Arthur Erikson
Electronics review: Stanley Zarowin
New Products: H. Thomas Maguire,
William P. O'Brien
Probing the news: Eric Aiken

Assistant editors

Stephen Wm. Fields, Peter Schuyten,
James Kirby, Owen Doyle

Domestic bureaus

Boston: James Brinton, manager
Los Angeles: Lawrence Curran, manager; Burton Bell
New York: Howard Wolff, manager
San Francisco: Walter Barney, manager; Peter Vogel
Washington: Robert Skole, manager; Paul Dickson

Foreign bureaus

Bonn: John Gosch
London: Michael Payne
Tokyo: Charles Cohen

Copy editors

James Chang, Frederick Corey, Larry Miller

Graphic design

Art director: Saul Sussman
Assistant art directors: Ann Mella, Valerie Betz
Production editor: Arthur C. Miller

Editorial research: Kay Fontana

Editorial secretaries: Lorraine Longo, Claire Benell, Lynn Emery,
Patricia Gardner, Barbara Razulis, Frances Vacca

McGraw-Hill News Service

Director: Arthur L. Moore; **Atlanta:** Fran Ridgway; **Chicago:** Bruce Cross;
Cleveland: Arthur Zimmerman; **Dallas:** Marvin Reid;
Detroit: James Wargo; **Houston:** Robert E. Lee; **Los Angeles:** Michael Murphy
Pittsburgh: Louis Gomolak
San Francisco: William F. Arnold
Seattle: Ray Bloomberg; **Washington:** Charles Gardner, Daniel B. Moskowitz,
Herbert W. Cheshire, Seth Payne, Warren Burkett, William Small, William D. Hickman

McGraw-Hill World News Service

Bonn: Robert Dorang; **Brussels:** George Williamson; **Hong Kong:** Wes Perry;
London: John Shinn; **Mexico City:** Gerald Parkinson; **Milan:** Ronald Taggiasco, Jack Star;
Moscow: Howard Rausch; **Paris:** Robert E. Farrell, Peter Kilborn;
Rio de Janeiro: Leslie Warren; **Tokyo:** Marvin Petal

Reprints: Susan Nugent

Circulation: Isaaca Siegel

Publisher: Gordon Jones

Electronics: May 27, 1968, Vol. 41, No. 11

Published every other Monday by McGraw-Hill, Inc. Founder: James H. McGraw 1860-1948.

Printed at 99 North Broadway, Albany, N.Y. 12207; second class postage paid at Albany, N.Y.

Executive, editorial, circulation and advertising addresses: McGraw-Hill Building, 330 W. 42nd Street
New York, N.Y. 10036. Telephone (212) 971-3333. Teletype TWX N.Y. 710-581-4235. Cable address:
MCGRAWHILL N.Y.

Subscriptions solicited only from those professionally engaged in electronics technology. Subscription rates:
qualified subscribers in the United States and possessions and Canada, \$8.00 one year, \$12.00 two years,
\$16.00 three years; all other countries \$25.00 one year. Non-qualified subscribers in the U.S. and
possessions and Canada, \$25.00 one year; all other countries \$50.00. Air freight service to Japan \$50.00
one year. Single copies: United States and possessions and Canada, \$1.00; all other countries, \$1.75.

Officers of McGraw-Hill Publications: Joseph H. Allen, President; Bayard E. Sawyer, Executive Vice President;
J. Elton Tuohig, Senior Vice President-Operations; Vice Presidents: John R. Callahan, Editorial;
John M. Holden, Marketing; Paul F. Cowie, Circulation; Jerome D. Luntz, Planning & Development;
Robert M. Wilhelm, Controller.

Officers of the Corporation: Shelton Fisher, President and Chief Executive Officer; John L. McGraw, Chairman;
Daniel F. Crowley, Donald C. McGraw, Jr., R.E. Slaughter, Senior Vice Presidents; John J. Cooke,
Vice President & Secretary; Gordon W. McKinley, Vice President & Treasurer.

Title © registered in U.S. Patent Office; © Copyright 1968 by McGraw-Hill, Inc. All rights reserved. The contents
of this publication may not be reproduced either in whole or in part without the consent of copyright owner.

Subscribers: The publisher, upon written request to our New York office from any subscriber,
agrees to refund that part of the subscription price applying to copies not yet mailed.
Please send change of address notices or complaints to Fulfillment Manager; subscription
orders to Circulation Manager, Electronics at address below. Change of address notices
should provide old as well as new address, including postal zip code number. If possible,
attach address label from recent issue. Allow one month for change to become effective.

Postmaster: Please send form 3579 to Fulfillment Manager, Electronics,
P.O. Box 430, Hightstown, New Jersey 08520

Readers Comment

Outdated

To the Editor:

In the light of 1968 technology, the 1964 photograph that accompanied "Plastic IC's still 4-F" [April 15, p. 45] is an anachronism.

The circuit in the photograph had been covered with a silicone-polymer, Dow Corning 1400, due to introduction into the process at that time of a smaller-volume package, together with failure simultaneously to reduce the volume of polymer from that which had been used with the previous, larger package. As a result, the silicon wafer and part of the interconnection wires were covered with the DC 1400 polymer. Normally, the DC 1400 had been put around the bar and below it and used to coat the interconnection wires lightly. It had not normally encapsulated the wafer, nor had it submerged all or part of the interconnection wires.

This excessive amount of DC 1400 contracted during temperature-cycling of the device and snapped the interconnection wires. This was, and still is, a recognized characteristic of this silicone polymer varnish.

C. Gordon Peattie
Components Group
Texas Instruments Inc.
Dallas

Fast multiplier

To the Editor:

The general idea of our 500-Mhz coaxial line fast multiplier project has been reported correctly in your article "Pacing ultrahigh-speed computers," [March 4, 1968, p. 165]. However, two errors should be corrected:

An interface to an IBM computer has neither been constructed nor is it planned for the immediate future.

For a 50-bit digital memory, a high-quality coaxial line of 4 inches diameter would appear rather bulky and costly. In fact, the big cable shown to your reporter has been used for a totally different project; namely, temporary storage single-event waveforms for display

Only from Sprague Electric!

TYPE 137D TANTALEX[®] SINTERED-ANODE TANTALUM CAPACITORS

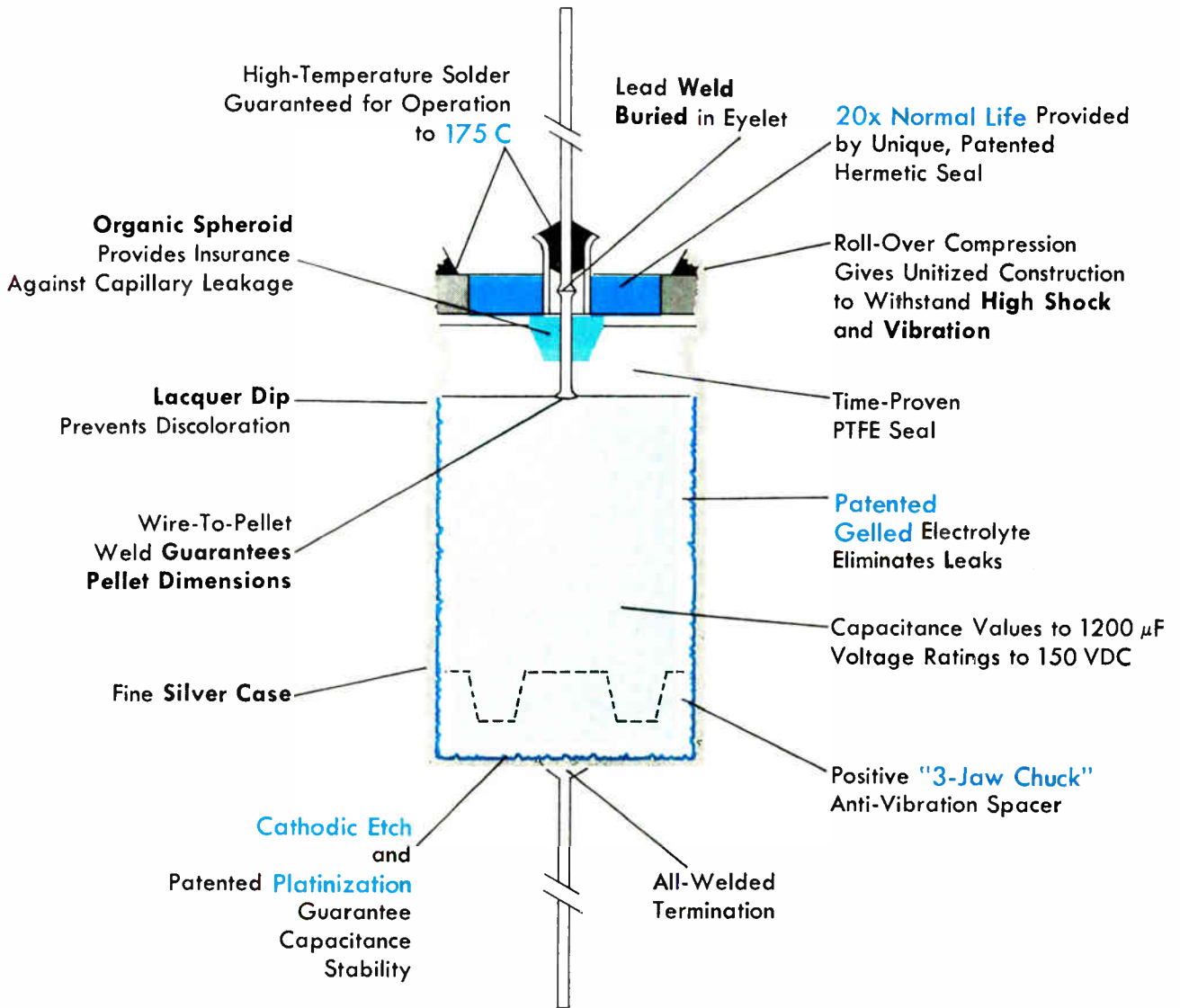

WHY SETTLE FOR LESS?

For complete technical data, write for Engineering Bulletin
3703A to Technical Literature Service, Sprague Electric Co.,
35 Marshall St., North Adams, Massachusetts 01247.

SPRAGUE COMPONENTS

CAPACITORS
TRANSISTORS
RESISTORS
INTEGRATED CIRCUITS
THIN-FILM MICROCIRCUITS

PULSE TRANSFORMERS
INTERFERENCE FILTERS
PULSE-FORMING NETWORKS
TOROIDAL INDUCTORS
ELECTRIC WAVE FILTERS

CERAMIC-BASE PRINTED NETWORKS
PACKAGED COMPONENT ASSEMBLIES
BOBBIN and TAPE WOUND MAGNETIC CORES
SILICON RECTIFIER GATE CONTROLS
FUNCTIONAL DIGITAL CIRCUITS



Sprague and ® are registered trademarks of the Sprague Electric Co.

LF MF HF

VHF UHF SHF

First counters to operate automatically across the VHF gap.

Until now you couldn't make simple, automatic frequency measurements from 100 to 300 MHz without a special VHF plug-in. The extra plug-in was clumsy in the lab. And when switching plug-ins was impossible—as in automatic console systems—the VHF gap was unavoidable. Now two self-contained Systron-Donner counters span the VHF gap, operating automatically from DC to the microwave region.

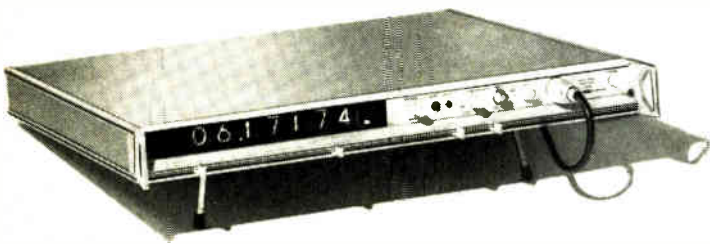

Non-stop DC to 12.4 GHz. The VHF gap is filled by a built-in prescaler in this new Thin Line counter. The instrument operates just like a simple frequency counter across the board from DC to 12.4 GHz. You merely connect the signal and read the final answer on the display. Built with IC's to take only 1-3/4" of rack space and operable by remote control, it is the ideal instrument for automatic systems.



Non-stop DC to 3 GHz. New ACTO® plug-in with built-in prescaler carries this counter across the VHF gap to 3 GHz with fully-automatic operation. The new broadband plug-in can be replaced by others to raise the frequency range to 40 GHz, to measure very noisy signals, to measure FM and pulsed RF, to read time interval, etc. This is the best available wide-range laboratory counter—the root of a system that can accomplish nearly everything possible with counter instrumentation.

**...two more reasons
to check with
Systron-Donner
before you buy.**



Send for Catalog.

Circle 6 on reader service card

SYSTRON  **DONNER**

888 Galindo Street, Concord, California 94520.

in a sampling oscilloscope.

Finally, it would be in order to acknowledge the valuable contribution of Gilbert Vuilleumier, a doctoral candidate at Geneva University, and to mention that funds for developing the demonstration model have been obtained from Eidgenössische Stiftung zur Förderung schweizerischer Volkswirtschaft durch wissenschaftliche Forschung.

Daniel Maeder

Professor
School of Physics
University of Geneva
Switzerland

Mission possible

To the Editor:

In a story on Litton Industries' Magna-Badge [April 15, p. 63] there's a statement that the identification card "would be difficult for even the gang from television's 'Mission Impossible' to forge."

I disagree. First, regardless of the magnetic recording media, the card could be reproduced without a great deal of difficulty. Second, the remanent polarization of the magnetic moments (1's and 0's) is easily identifiable, to which fact anyone versed in the art of magnetic recording will attest.

The distinct disadvantage of a magnetically coded card and the like, is in its very substance. It is well within the realm of possibility and probability that this type of device could find itself near a magnetic field of sufficient flux to either alter or destroy the information content, rendering the card useless.

On the other hand, the storage capability (130 to 800 bits) certainly is attractive, especially if the

mechanics of the system do not become a problem.

Carl A. Budde

President
Diginetics
Glendale, Calif.

▪ The story doesn't say it's impossible, just difficult and extremely costly. Moreover, it would take some zap to wipe out the information on the card!

Tire-testing computers

To the Editor:

This corporation has supplied 77 tire-uniformity testing computers within the past two years. Assuming some deliveries from other manufacturers it can safely be deduced that the total number of systems delivered in the last two years substantially exceeds the 100 referred to in your article "Sorting out the tires" [March 18, p. 125].

In the discussion of tire-uniformity correction, or tire grinding, that is on page 129 of the article, the authors say that this process is "now being developed." Actually, the process of correcting tire non-uniformities by grinding was developed by Clarence Hofelt and John Corl of General Tire & Rubber Co. and was announced in late 1967. The present instrumentation and control system for this process was designed and developed, and is now manufactured solely by IDC. The development of this control system was initiated by IDC some 18 months ago.

E.R. Raeder

Vice President
Information Development Corp.
Akron
Ohio

Application For

FET SWITCHES

PROBLEM: Switch high level signals with minimum drive voltage.

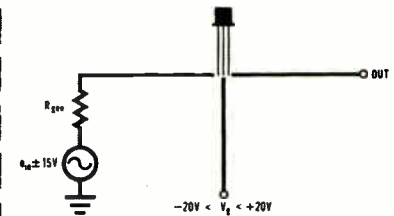

REQUIRED: Select FET to switch ± 15 V signals . . . maximum available drive voltage is ± 20 V. Use either a MOS or a junction type.

GIVEN: $e_{in} \dots \pm 20$ V
Available supply voltages . . . ± 20 V
Maximum $r_{ds(on)}$ allowed . . . 150Ω

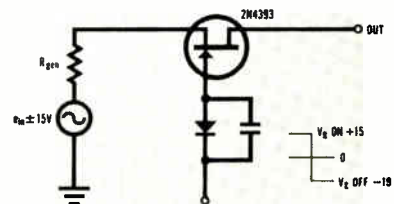

SOLUTION: Junction FETs are available in various ranges of V_P and $r_{ds(on)}$. This provides a trade-off between drive voltage and ON resistance. A good choice for this application is the 2N4393:

V_P max: -3 V
 $r_{ds(on)}$ max: 100Ω

The required drive voltages are:

$V_{G(OFF)} = -19$ V
 $V_{G(ON)} = +15$ V

Pinched to pick a FET? Contact us for applications help . . . and our FET switch data packet.



Siliconix incorporated

1140 W. Evelyn Ave. • Sunnyvale, CA 94086
Phone (408) 245 1000 • TWX: 910-339-9216

SUBSCRIPTION SERVICE

Please include an Electronics Magazine address label to insure prompt service whenever you write us about your subscription.

Mail to: Fulfillment Manager
Electronics
P.O. Box 430
Hightstown, N.J. 08520

To subscribe mail this form with your payment and check new subscription renew my present subscription

Subscription rates: qualified subscribers in the U.S.: 1 year \$8; two years, \$12; three years, \$16. Non-qualified: 1 year \$25. Subscription rates for foreign countries available on request.

CHANGE OF ADDRESS

ATTACH LABEL HERE

If you are moving, please let us know five weeks before changing your address. Place magazine address label here, print your new address below.

name

address

city

state

zip code

New from Sprague!

**5 Times the Resistance of
a Conventional Metal-Film Resistor
of Equal Size!**

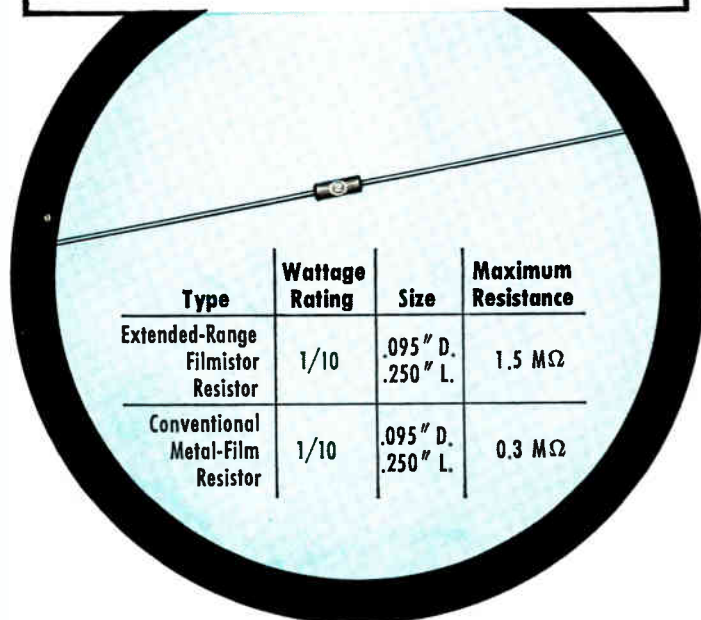

EXTENDED-RANGE FILMISTOR[®] METAL-FILM RESISTORS

**Substantial saving of space in all wattage ratings —
1/20, 1/10, 1/8, 1/4, 1/2, and 1 watt—with
absolutely NO SACRIFICE IN STABILITY!**

Extended-Range Filmistor Resistors now offer, in addition to accuracy . . . stability . . . reliability . . . resistance values in size reductions which were previously unobtainable. Size and weight advantages of Filmistor Resistors now make them ideal for applications in high-impedance circuits, field-effect transistor circuits, etc. Many designs which previously had to settle for the higher temperature coefficients of carbon-film resistors in order to obtain required resistance values can now utilize the low and controlled temperature coefficients of Filmistor Metal-Film Resistors.

Other key features are $\pm 1\%$ standard resistance tolerance, low inherent noise level, negligible voltage coefficient of resistance, and tough molded case for protection against mechanical damage and humidity.

For complete technical data, write for Engineering Bulletin 7025D to Technical Literature Service, Sprague Electric Co., 35 Marshall Street, North Adams, Massachusetts 01247.

SPRAGUE COMPONENTS

RESISTORS
CAPACITORS
TRANSISTORS
INTEGRATED CIRCUITS
THIN-FILM MICROCIRCUITS
INTERFERENCE FILTERS
45R-6139

PACKAGED COMPONENT ASSEMBLIES
FUNCTIONAL DIGITAL CIRCUITS
MAGNETIC COMPONENTS
PULSE TRANSFORMERS
CERAMIC-BASE PRINTED NETWORKS
PULSE-FORMING NETWORKS



Sprague and *®* are registered trademarks of the Sprague Electric Co.

People

Beam-lead metalization technology is under intensive development at Motorola, says Eugene Blanchette, the company's new director of integrated-circuit operations. The fine pattern definition needed for beam-lead metalization has to be demonstrated he adds, but if



Blanchette

Motorola chooses to use the technology it could be a production reality in eight months to a year.

New product development, according to Blanchette, is one of the reasons for the recent Motorola reorganization, which elevated him to his new position. Motorola is now producing 35 times as many IC's as it was in 1965, Blanchette says, "And we want to keep growing at that rate. But once you get larger, the rate of new product development begins to slow down. Management becomes too involved with current business. The question becomes one of how much should we produce next month, instead of what new products should be introduced."

Grouping talent. Some of the new product managers, who share Blanchette's former duties, have more than one of the division's lines, which encompass resistor-transistor, diode-transistor, transistor-transistor, and emitter-coupled logic, and linear circuits. Metal oxide semiconductor devices and memories have been split off from the other lines and linked for the first time. Under this kind of reorganization, much more of the available talent is brought together, he notes.

Blanchette, who was born in India and educated in Britain, succeeds Stephen Levy, a corporate vice president, who became assistant general manager of the Semiconductor division.

In the three years that George H. Didinger has been the Signetics

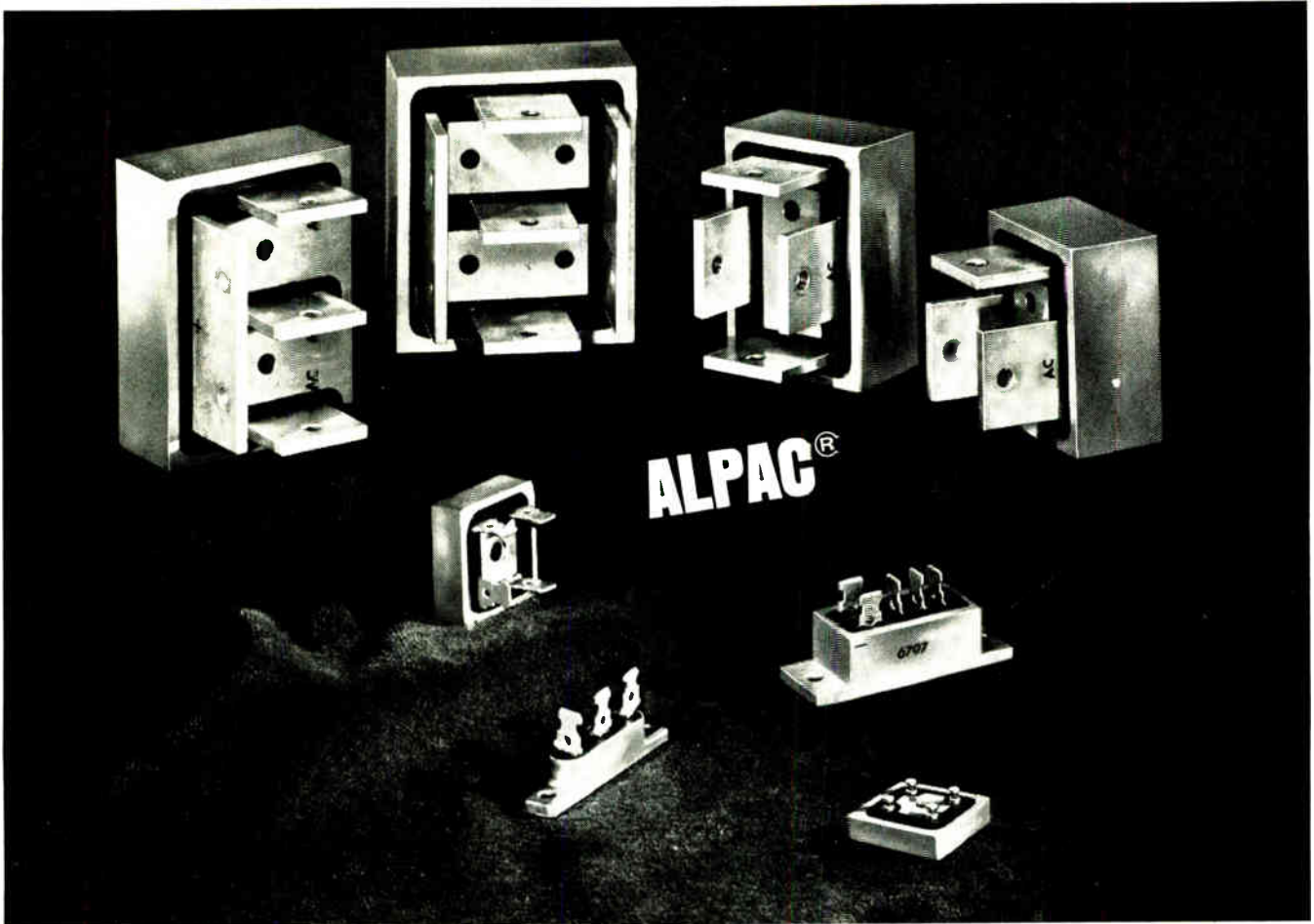

“Cool” Power Rectifiers

A Family of Bridges, Doublers and Center Taps.

The ALPAC Family is a complete line of silicon bridges, doublers and center taps. These power rectifiers offer PIV ratings from 50 to 600 volts, with an average output current from 5 to 250 amps.

All ALPAC devices offer the superior thermal characteristics of aluminum cases. TERMINALS ARE COMPLETELY INSULATED.

Internally, all ALPAC units utilize double Tungstaloïd pin rectifiers electrically and thermally bonded to the terminals.

ALPAC Family is economical, small and easy to mount.

The entire ALPAC Family is field tested and available for immediate delivery.

Introducing ALPAC “Jr.”

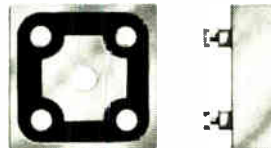

ACTUAL SIZE

The smallest silicon bridge rectifier in the family. Measuring only .750" square and .225" high. These devices are ideally suited to control circuits, converters, power supplies, etc.

ALPAC Jr. offers PIV ratings of 50 to 600 volts with an average output current of 5 amps. Thermal resistance is 5°C/watt, maximum.

San Francisco—941 E. Charleston, Suite 10, Palo Alto, California 94303
 (415) 328-8025
 Chicago — 140 N. La Grange Road, La Grange, Illinois 60525
 (312) 352-3227 / TWX: 910-683-1896
 Dallas — 402 Irving Bank Tower, Irving, Texas 75060 / (214) 253-7644
 New York — 116-55 Queens Blvd., Forest Hills, New York 11375
 (212) 263-3115 / TWX: 710-582-2959
 Boston — P.O. Box 264, Woburn, Massachusetts 01801
 (617) 935-5595
 European Sales — Bourns A. G. Alpenstrass 1, Zug, Switzerland
 (042) 4 82 72/73

SEMTECH™
 CORPORATION

652 Mitchell Road, Newbury Park, California 91320
 (805) 498-2111, (213) 628-5392 / TWX: 910-336-1264

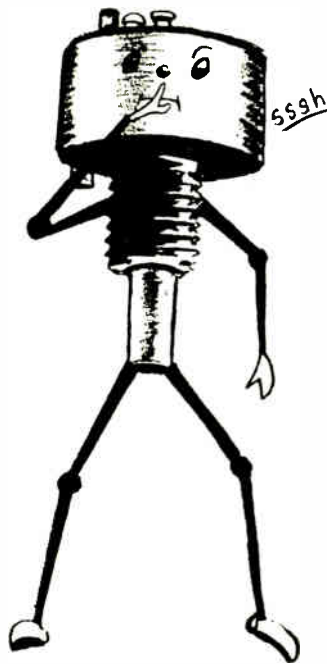

*Quiet
please . . .*

5 ohms

ENR

**at
work**

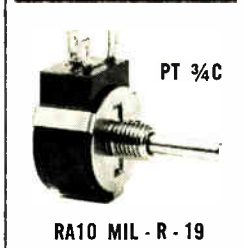
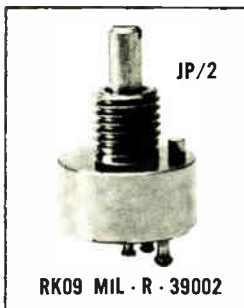

5 ohms Equivalent Noise Resistance is virtually unknown in a potentiometer. But Waters has a couple of pots in the JP/2 and PT 3/4C with maximum ENR of 5 very quiet ohms. Engineered to endure, they'll outlast just about any application they're specified for. And then show negligible degradation in end-of-life tests. They'll give greater plus-values in industrial applications over wide temperature ranges in all environments. Both conform to Military Specifications yet can be had in a hurry. Because we keep them in stock. Pricewise, they're as competitive as bread at the supermarket. A note will get you the entire story!

STANDARD SPECIFICATIONS	JP/2	PT 3/4C
Resistance Range	20 Ω to 20K	25 Ω to 20K
Standard Resistance Values	100, 200, 500, 1K, 2K, 5K, 10K	50, 100, 200, 500, 1K, 2K, 5K, 10K
Independent Linearity	$\pm 3\%$	$\pm 3\%$
Equivalent Noise Resistance	5 Ω Max.	5 Ω Max.
Temperature Range	-65 $^{\circ}$ to +150 $^{\circ}$ C	-65 $^{\circ}$ to +150 $^{\circ}$ C
Power Dissipation Rating	2 ω @ 85 $^{\circ}$ C derated to 0 at 150 $^{\circ}$ C	2 ω @ 85 $^{\circ}$ C derated to 0 at 150 $^{\circ}$ C

NEW CATALOG
Send for your copy today.
"RELIABLE POTENTIOMETERS & COMPONENTS"
A request on your company letterhead will bring you a copy of Waters new Potentiometer Catalog by return mail.



Waters Manufacturing, Inc., is a member of Electronics Industries Association.

People

Corp.'s marketing manager, he has seen the company's foreign sales climb steadily. "I would like to see it double in the next three years," he says. And expectedly so. Didinger has been named manager of the recently created Signetics International.



Didinger

The importance of Didinger's new assignment can best be weighed against the feeling among some company officials that Signetics is aiming for a foreign market that will account for 30% of its total sales. Last year, this subsidiary of Corning Glass Works rang up sales of about \$23 million—all in monolithic integrated circuits.

In the company's table of organization, Signetics International is on a par with the marketing, R&D, and operations departments. And like his counterparts, Didinger reports directly to James F. Riley, Signetics' president.

Build up. For the most part, the company's overseas sales have been handled by its representatives. One of Didinger's first jobs is to set up his own sales force. Also high on Didinger's list are manufacturing plants both in Europe and the Far East. The company already has an assembly plant in Seoul, Korea, but this plant isn't under Didinger's jurisdiction because its production is geared primarily for the United States market.

Despite Signetics' increasing foreign sales, the 43-year-old department chief believes the company hasn't been doing as well as it should. Riley agrees. "To do business, you must participate in the world market," says Signetics' president. "And to achieve growth in this area, you must make someone directly responsible for it," he says.

Adds Didinger wryly: "Since I did the most complaining, Jim gave that responsibility to me."

Looking for Fast, Easy AC and DC Calibration?

Simply press a button, turn a dial on one of these instruments, and you have convenient, fast and accurate ac and dc calibration. With the wide choice in total calibration capability offered by Hewlett-Packard, you can select the versatility and convenience best suited to your application. For complete specifications on these easy-to-use ac and dc calibration instruments and others in the hp line, see your Hewlett-Packard Instrumentation Catalog or call your nearest hp field engineer. Or, write to Hewlett-Packard, Palo Alto, California 94304. Europe: 54 Route des Acacias, Geneva.

The Most Accurate AC Voltmeter in the World! The hp 741B AC-DC Differential Voltmeter/DC Standard really is six instruments in one package—with 5-digit resolution. It is a dc standard, an ac differential voltmeter, a dc differential voltmeter, a floating dc voltmeter, an ac voltmeter—and a power amplifier. That is versatility! Price, \$1875.

0.002% Accuracy DC Standard—the 740B delivers highly stable accurate voltages to 1000 V with six-digit resolution in discrete steps as small as $1 \mu\text{V}$. It also is a differential voltmeter with $> 10^{10} \Omega$ input resistance, independent of null. Price, \$2350.

Instantly Available 0.02% AC Voltages make the hp 745A AC Calibrator an excellent choice for calibration and maintenance testing of

large volumes of ac instruments. The six-digit readout 745A also has push-button ranging with continuous frequency selection from 10 Hz to 110 kHz and calibrated output voltages from $100 \mu\text{V}$ to 110 V. For fast production checkout, the 745A has a direct reading percent error scale. Price, \$4500.

Complemental Instruments for DC Standards Use include the general purpose ± 2 ppm hp 735A DC Transfer Standard (\$375) and the battery-operated hp 419A DC Null Voltmeter (\$450).

098/17

HEWLETT  PACKARD

WORKING STANDARDS

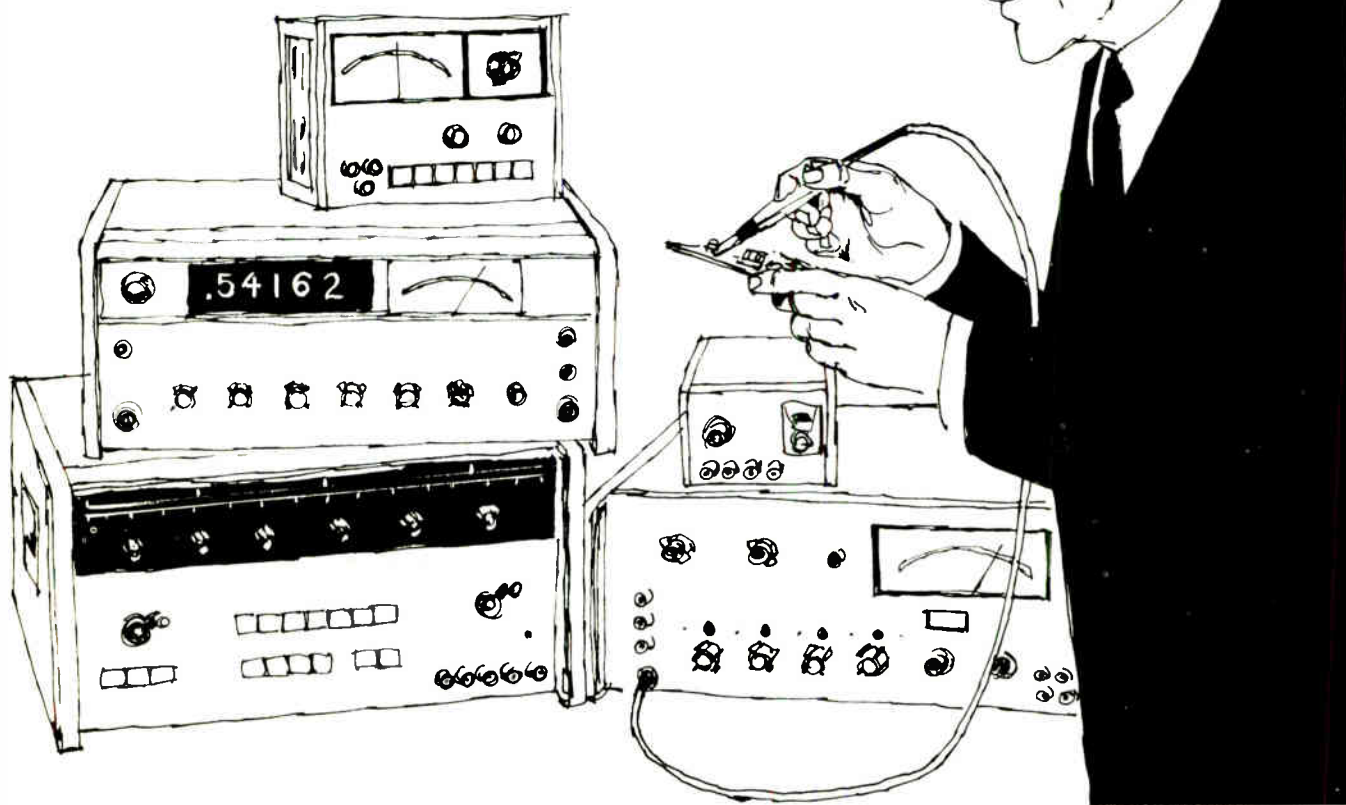

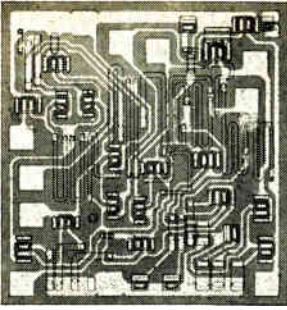

**One company
is developing the
top reputation for
integrated circuit
reliability
in the huge military
aerospace projects.**

**Any engineer
can tell you who.**

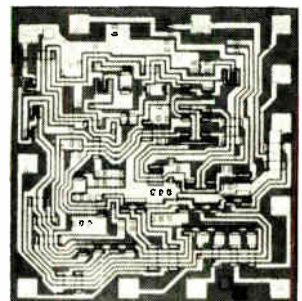

MOTOROLA SEMICONDUCTOR PRODUCTS INC.

**new automatic
tester speeds
production
checkout of
cables, connectors,
harnesses**

**this 40 lb. portable
high speed test set
checks continuity
or insulation at
up to 1200 tests
per minute**

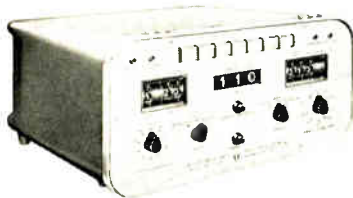

The AP-502 is a true lightweight automatic tester that saves time, cost and headaches of cable, connector and harness checkout. Its compact, yet rugged and reliable design makes it ideal for every test situation—incoming inspection, production, quality control, field site locations. The tester is powered by 110 volts or internal rechargeable battery. Automatic sequencing, direct readout of fault locations and simplified operation speed testing by unskilled personnel.



Teleproducts, Inc.

351 New Albany Rd., Moorestown, N.J. 08057
(609) 235-6227

Meetings

Communications agenda: a broad spectrum

The engineer attending the International Communications Conference will find it hard to decide which of the seven or so parallel sessions to attend. The meeting has a broad appeal to all segments of the communications industry—manager and engineer alike. However, only a few of the 166 papers being given are significant from a technical point of view. Instead, the main emphasis at this year's conference, in Philadelphia June 12 to 14, is on feasibility studies, economic approaches, surveys, and predictions about satellites, educational television, and electronic switching.

Carl A. Armstrong, deputy director of telecommunications management on the President's telecommunications taskforce, will describe the role of satellites in domestic and international communications, and James McCormack, chairman of the Communications Satellite Corp., will give his views on what satellites can do for educational systems. Paul A. Miller, an assistant secretary of Education in the Department of Health, Education, and Welfare, will present a paper on Government plans for electronic educational systems.

Foreign flavor. The conference has a lot more foreign contributions than usual. A leading Soviet space

expert, N.T. Petrovich of the Electrical Engineering Institute of Communications in Moscow, will discuss present and future Soviet efforts in deep space communications. Lester C. van Atta, NASA's assistant director of electromagnetic research, will then discuss probable U.S. deep-space communications efforts planned through the 1980's.

In a session on world switching systems, Georges Goudet, president of the Laboratoire Central de Télécommunications, and H. Benmussa, of the Compagnie Générale de Constructions Téléphoniques, will describe a fully automatic electronic data-switching system that receives, stores, analyzes, routes, or files incoming messages.

Erno Acs, a scientist at the Research Institute for Telecommunications in Budapest, will survey the use of pulse-code modulation behind the Iron Curtain. He will also describe a pcm address-code switching network in which a sample is characterized by a code and the terminal point by the time slot in which the code is transmitted. The address-code system is obtained by inverting the roles of the code and the time position.

For more information write R.S. Caruthers, ITT, 320 Park Ave., New York, N.Y. 10022

Calendar

Aerospace Instrumentation Symposium, Instrument Society of America; Statler Hilton Hotel, Boston, June 3-5.

Instrumentation Symposium, Instrument Society of America's Aerospace Division; Statler Hilton Hotel, Boston, June 3-5.

Product Assurance Conference and Technical Exhibit, American Society for Quality Control, IEEE, Standards Engineers Society; Hofstra University, Hempstead, L.I., June 7-8.

International Communications Conference, IEEE; University of Colorado, Boulder, June 9-11.

International Air Cargo Forum, American Institute of Aeronautics and

Astronautics; San Francisco, June 10-12.

Vacuum Metallurgy Conference, American Vacuum Society; Beverly Hilton Hotel, Beverly Hills, Calif., June 10-13.

International Conference on Communications, IEEE; Sheraton Hotel, Philadelphia, June 12-14.

American Society for Engineering Education Meeting; University of California, Los Angeles, June 17-20.

Electromagnetic Compatibility Symposium, IEEE; Berkeley Cartaret Hotel, Asbury Park, N.J., June 17-19

(Continued on p. 16)

The CONNECTOR Thing

A periodical periodical designed, quite frankly, to further the sales of Microdot connectors and cables. Published entirely in the interests of profit.

Announcing the interruption of an important commercial for an even importanter one.

Our cage door was rattled last week by a harassed engineer type who was sprouting cables and connectors and holding a large sampler that was sloppily stitched with

LOVE FOR SALE

We quoted him section 404.5 of the penal code just to be on the safe side, and invited him in.

He said he was from the cable assembly department. And we said whose? And he said Microdot's. And we said Hmmm. And he said there's a lot of people that don't think of Microdot as a cable assembly house and he'd like to do something about it like write an ad.

So we said fine, what would it be about and he brought out a fat stack of papers and said here, and we said forget it, but if you could tell it to us like it is in about twenty seconds we'd tape it. So he did. And we were so impressed, we thought we'd play it back to you. It's darned interesting. Ready? (And remember, he's not a professional and he talks fast, but we think the points came across.)

TAKE ONE—LOVE FOR SALE—SIDE ONE

"Not enough people have thought of Microdot as being in the cable assembly business. But we are, because we make cables and connectors. We're also very experienced in cable assemblies.

"And we'll assemble all sorts of funny combinations. Our cables, somebody else's connectors. Some of our connectors with someone else's. Mix and match!"

We turned off the recorder. "You mean we'll assemble competitive stuff?"

"Sure!"

"Does the Pres know?"

"Sure!"

"Okay!"



TAKE TWO—LOVE FOR SALE—SIDE ONE

"Where was I. Oh, I was saying

MICRODOT IS IN THE CABLE ASSEMBLY BUSINESS AND AT CUT RATE PRICES.

END OF TAPE

The idea is we can assemble cables for a lot less than people who try to do it themselves because we know what we're doing.

There are no set-up charges. And we'll even make up one assembly. And we can really save people a lot of money if they use our connectors.

"Another thing, people not only save money, but they can be sure their assemblies will be right. We figure why should they take a chance on their learning curve and build, say thirty assemblies, and have ten maybe turn out not so hot? Our way you order thirty, you get thirty that work!"

"You're running out of time!"

"Okay. Real quick. Hey out there. Why buy connectors one place, cable another, and assembly in a third? The cost in

paper work alone would drive your comptroller grayish. With us it's one P.O. One big savings. We've cut costs on cable assemblies not the performance just the cost. How's that?"

"Okay," we said, "but you didn't explain the Love for Sale bit. It was a sneaky way to get us interested in your pitch!"

"Oh, it truly is love for sale. We love our work!"

A guy with dedicated humor that crummy can't be all bad. We told him we'd see what we could do about spreading the word. So, to test if anyone is interested in low cost cable assemblies, we're running this microminiaturized RFQ. The whole idea seems to be worthy. If you agree, write in. We'll respond immediately.



MICRODOT INC.

MICROMIN RFQ FOR FAST FAST ACTION.

To Microdot Inc., 220 Pasadena Ave., So. Pasadena, Calif. 91030

Dear Pricecutters:

Please accept this abbreviated form as a gauntlet flung at you as a challenge, challenging your low, low assembly price claim.

Job to quote on, attached.

We have something in mind. You should get in touch.

Name _____

Company _____

Title _____ Phone _____

Address _____

City _____

State _____ Zip _____

SERIES
260
AND
265

1/8"
SHANK

SOLID CARBIDE CIRCUIT BOARD DRILLS

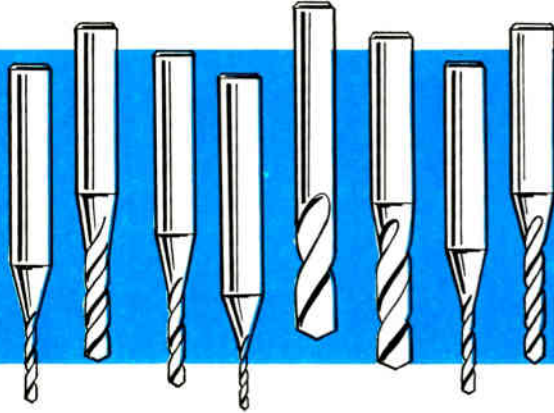

Choice of 58 drill sizes from No. 80 to 1/8"
ALL WITH COMMON 1/8" DIAMETER SHANKS



for precision drilling with every drill size!

You can now maintain location and hole size tolerances to extremely close limits . . . at drill feeds up to 15 feet per minute! The unequalled rigidity of solid carbide plus the added support of 1/8" shanks gives maximum deflection-free performance in drilling all diameter circuit board holes. All drills precision ground with unique four facet drill point configuration. Common 1/8" shank design eliminates need for collet and bushing inventory for each drill size. Your Metal Removal distributor provides vital sales and engineering liaison . . . call him or write for Catalog D67.



THE METAL REMOVAL COMPANY

1859 West Columbia Avenue • Chicago, Illinois 60626

Plants Located in CHICAGO/LOS ANGELES/SAN JUAN

MASTER TOOL AND WHEEL MAKERS FOR THE WORLD
END MILLS / DRILLS / REAMERS / BURS / SPECIAL TOOLING

Meetings

(Continued from p. 14)

Microelectronics Symposium, IEEE; Sheraton-Jefferson Hotel, St. Louis, June 17-19.

Meeting of the Institute of Navigation, King Hall, U.S. Naval Postgraduate School, Monterey, Calif., June 19-21.

International Symposium on Optimal Systems Planning, International Federation of Automatic Control; Case Institute of Technology, Cleveland, June 20-22.

Summer Power Meeting, IEEE; Sheraton Dallas Hotel, Dallas, June 22-27.

Consumer Electronics Show, Electronic Industries Association; Americana and New York Hilton Hotels, New York, June 23-26.

Short Courses

Silicon controlled rectifier control fundamentals, Milwaukee School of Engineering, June 10-14; \$150 fee.

Automatic manufacturing and the trends in numerical control, Purdue University's Schools of Engineering and Laboratory for Applied Industrial Control, Lafayette, Ind., June 10-14; \$150 fee.

Computer-aided circuit design, University of Michigan, Ann Arbor, June 10-14; \$200 fee.

Call for papers

Symposium on the Applications of Sea-Going Computers, Marine Technology Society and the Scripps Institution of Oceanography, La Jolla, Calif., Jan. 13-14, 1969. **Sept. 30** is deadline for submission of abstracts to Dr. John Mudie, Applications of Sea-Going Computers, Scripps Institution of Oceanography, P.O. Box 109, La Jolla, Calif. 92037

Symposium on Applications of Ferro-electrics, IEEE; Catholic University of America, Washington, Oct. 10-11. **July 1** is deadline for submission of abstracts to H. L. Stadler, Engineering and Research Staff, Ford Motor Co., P.O. Box 2053, Dearborn, Mich. 48121

Conference on Laser Engineering and Applications, IEEE; Washington Hilton Hotel, Washington, May 26-28, 1969. **Jan. 17** is deadline for submission of abstracts and summaries to William B. Bridges Sr., Hughes Research Laboratories, 3011 Malibu Canyon Rd., Malibu, Calif. 90265

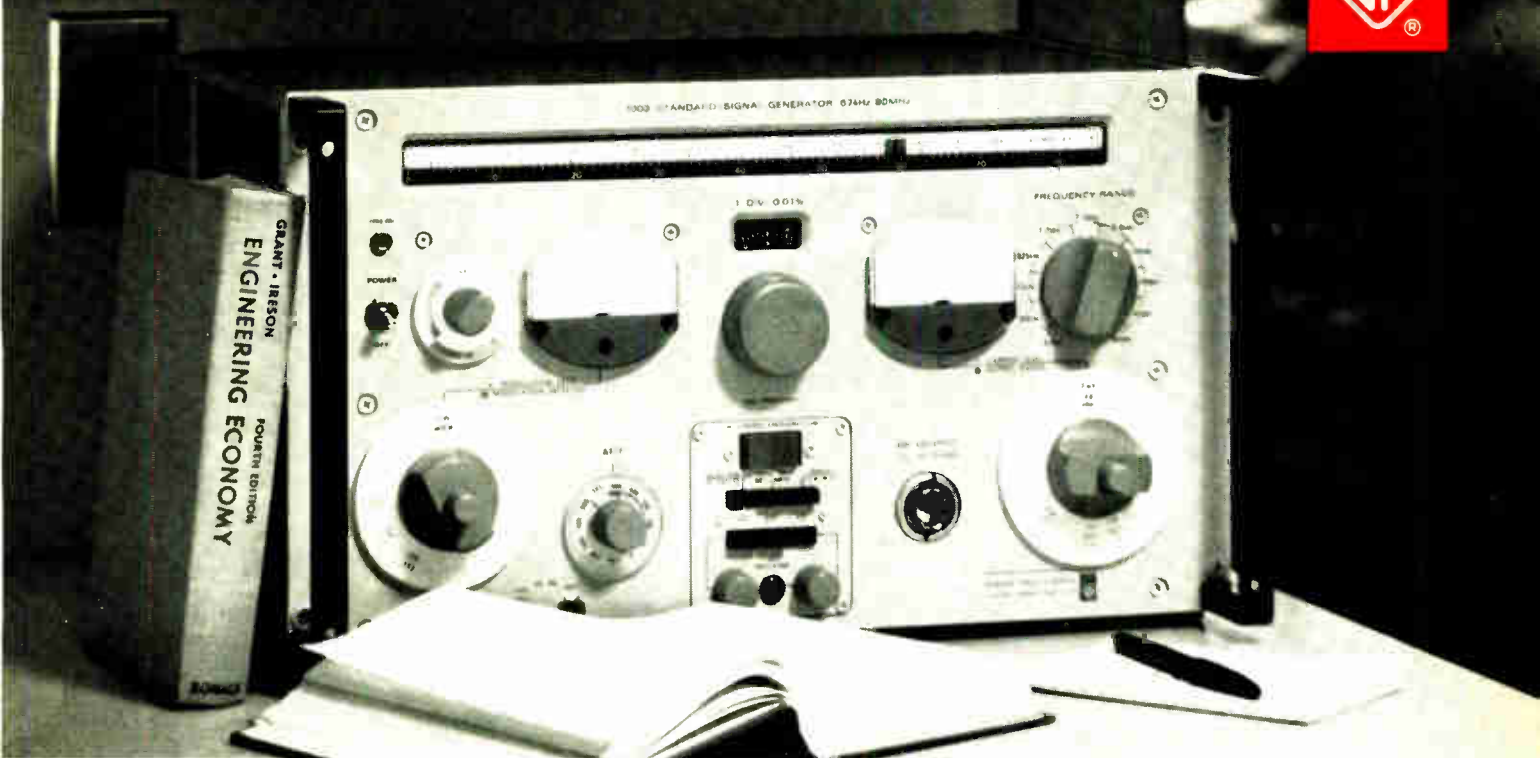

At \$2995, this signal generator costs less than those costing half as much.

Not everyone needs the performance of our 1003 Standard-Signal Generator. But those who do need it lose money if they settle for anything less. Why? Because the stability, accuracy, and resolution of the 1003 are as much as an order of magnitude better than those of any other instrument in the 67 kHz-to-80 MHz frequency range. It has motorized tuning, programmability, convenient 2-to-1 range switching, fast settlability, and limited sweep capability, to name a few operating conveniences. These are all features that enable you to make better measurements faster. In applications where hundreds of measurements are made daily, the cost of measurement time saved with a 1003 mounts rapidly. That's why the initial cost of the 1003 becomes less significant as you take a closer look at the "big picture."

Here are a few specific examples of how the 1003 can produce real savings:

- The motorized tuning and programmable frequency selection of the 1003 can cut measurement time in half. On a one-shift, production-line basis (at a \$3 per-hour wage) this amounts to savings of \$12 per day . . . \$60 per week . . . over \$3000 per year.
- The high resolution and stability (1 ppm per 10 min., typically) in the face of range switching, rf level adjustments, and load variations mean you don't have to buy a counter to set and monitor frequency. If you're already using a \$2500 counter, the 1003 frees it for use elsewhere.

- The 1003 is virtually unaffected by power-line fluctuations; frequency will vary less than 1 ppm as a result of $\pm 10\%$ line-voltage changes. You don't have to buy a voltage regulator, so you save money.
- All solid-state circuitry means a cool-running instrument that consumes little power and is not as likely to break down as a tube-type instrument. Low downtime means you save money.
- Warmup drift is low and of short duration, so the instrument is usable at 8:15, not 9:00 A.M. You waste little time, so you save money.

We could go on and on with how and why this instrument performs the way it does, but you have to put the 1003 through its paces yourself to appreciate fully its convenience and performance. So why not do just that? Write or call the GR Sales Office nearest you for the loan of a demonstrator and evaluate the 1003 yourself. There's no cost or obligation. For more information on the 1003, write or call General Radio Company, W. Concord, Massachusetts 01781; telephone (617) 369-4400. In Europe: Postfach 124, CH 8034, Zurich 34, Switzerland.

GENERAL RADIO

Circle 17 on reader service card

Do you want to go LSI now?

If you really want LSI now, grab the next plane to Mountain View. (It lands in San Francisco.) It's the quickest, least expensive way to get LSI into your system.

Plan to bring along your blueprints. And be ready to answer a lot of questions. We'll need to know what you have in mind for sub-systems, functions and specs. And, don't be surprised when we ask "why" a couple of times. It's all part of Fairchild's systems approach to complex circuitry.

We'll take your requirements and match them against our family of fundamental building blocks. We've got LSIs (and MSIs) that work in any digital logic system. The most advanced circuitry on the market. Offspring of computer-aided design and double-layer metal technology. And, they're all so versatile, we can probably give you a counter that has a dozen other applications in your system.

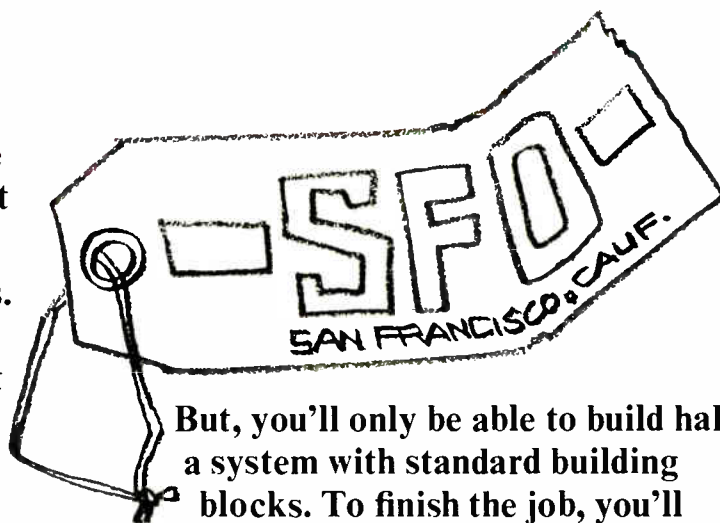

But, you'll only be able to build half a system with standard building blocks. To finish the job, you'll need interface devices to tie the whole thing together. And, here's where Fairchild can really save you time and money. We don't have to custom design each LSI interface circuit. We use Micromatrix™—a unique cellular array that's completed when we add your specific interconnection pattern. Your specs customize the entire array for your system.

Of course, there's a lot more to the story. But, you ought to hear it in person. Just call your Fairchild salesman. He knows the flight schedule to San Francisco.

Or do you want to think about it?

We've got an LSI design kit. It's based on our new 4500 Bipolar Micromatrix Array – the first device in a highly versatile LSI family. The 4500 is an eight-cell array that can be customized for virtually any function. All it needs is your interconnection pattern. You can determine the pattern by designing your own Micromatrix array with our kit. You can buy a kit from your Fairchild distributor for about \$100. And, in a couple of months, we'll see you in Mountain View.

FAIRCHILD
SEMICONDUCTOR

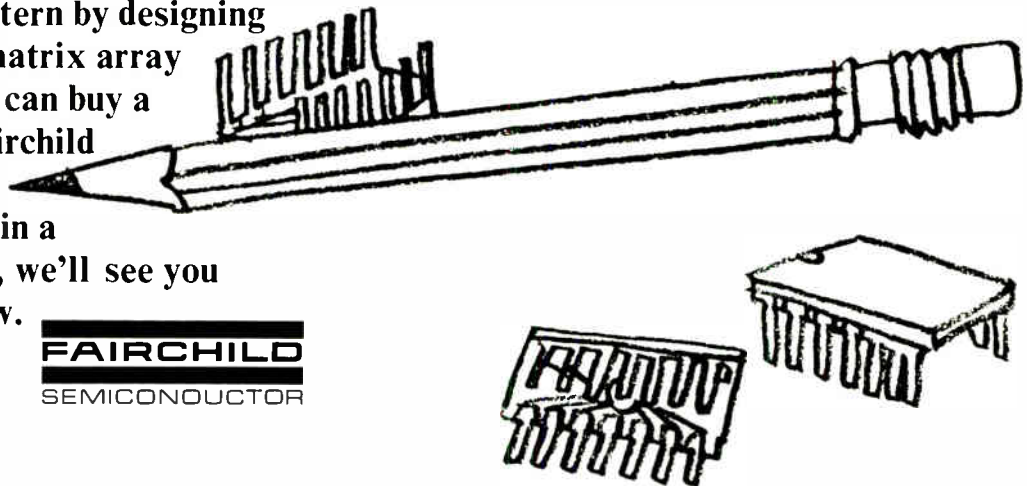

new ideas for
moving electrical energy

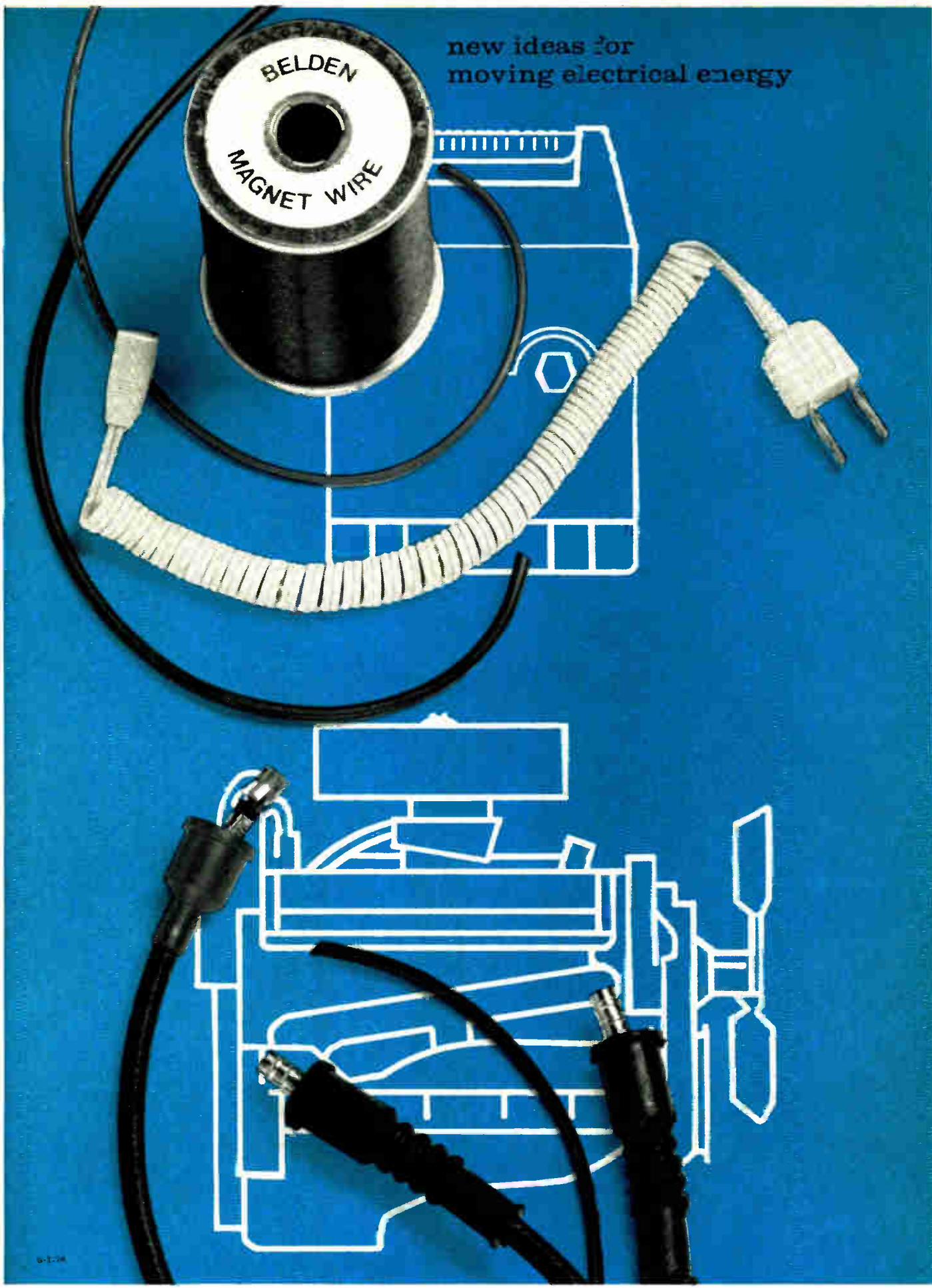

6-1-74

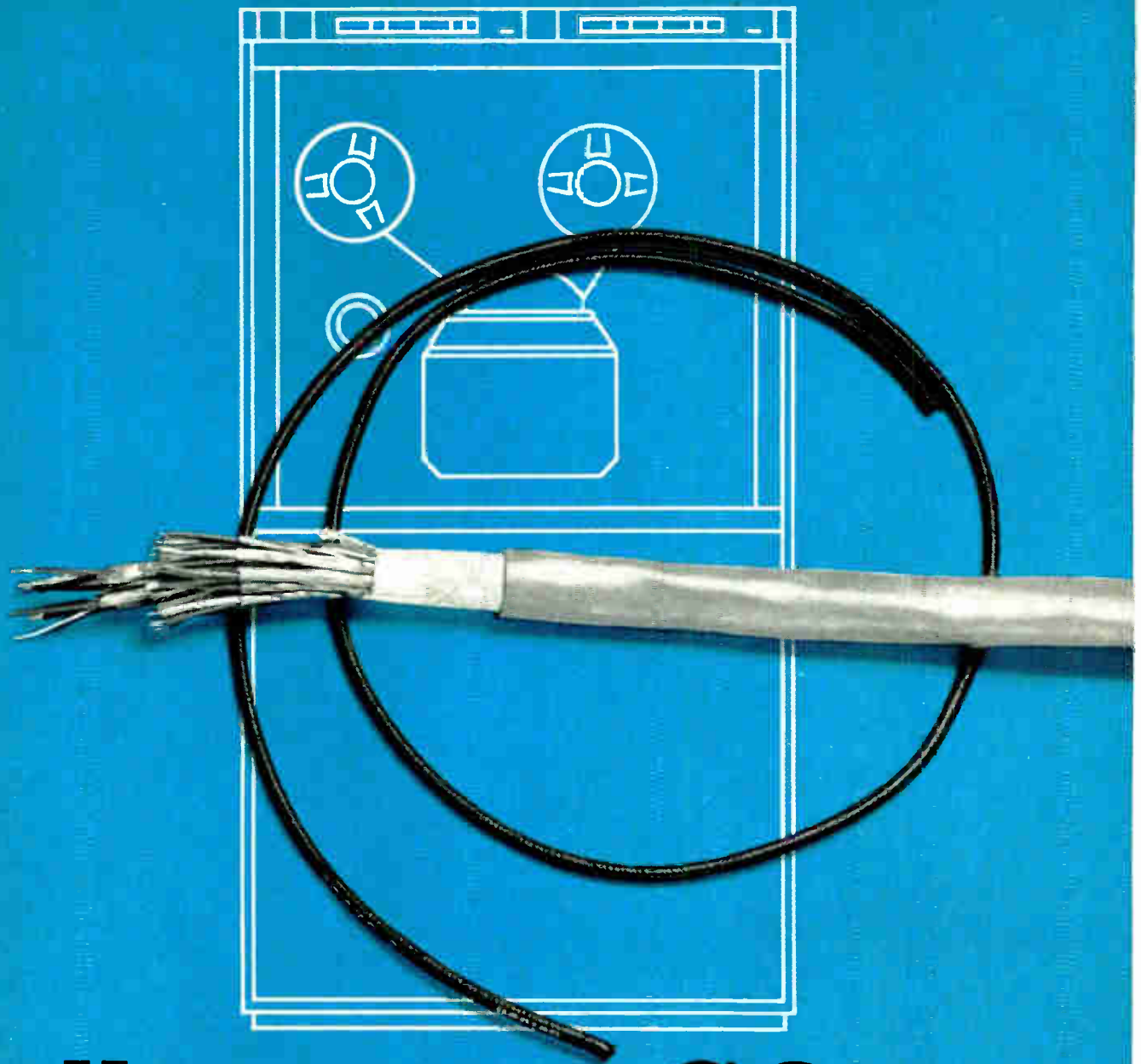

all systems GO

...when a Belden team of wire specialists shows you their dozen or so ways to wring out hidden values and costs. For example you can delve into design..maneuver with materials..analyze assembly..pry into processing..pick different packaging..or a host of others. But success takes a supplier who is really perceptive—one who makes all kinds of wire for all kinds of systems. Want to join us in wringing out values and costs? Just call us in...Belden Corporation **BELDEN** 
P.O. Box 5070-A, Chicago, Illinois 60680.

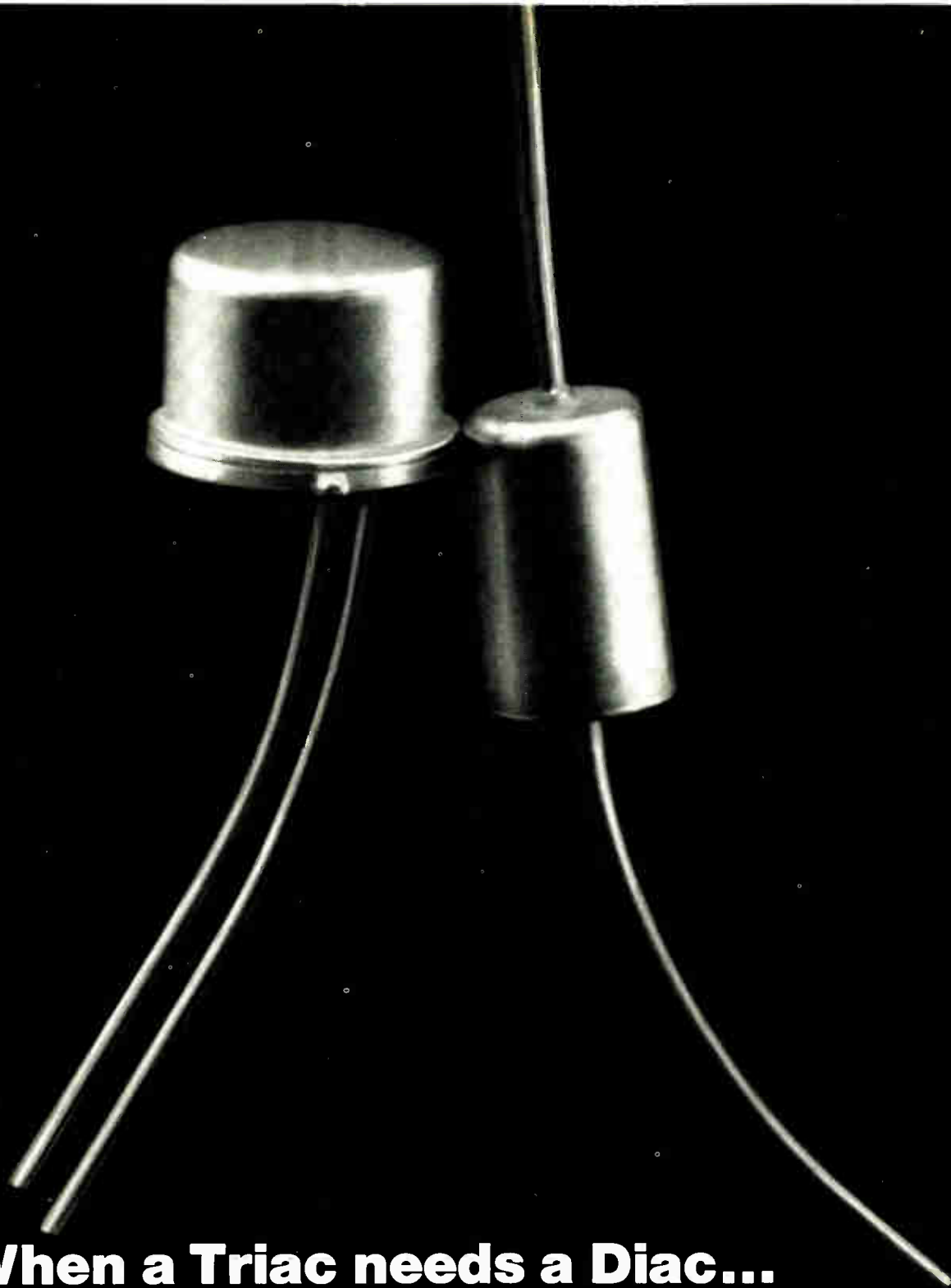

When a Triac needs a Diac...

Try your Triac Leader! You've asked for it... and we have it. To complement the largest Triac line in the industry, we've added the trigger diode. RCA's new silicon Diac (1N5411) is packaged in a hermetic DO-26 case. It has a typical break-over voltage of 32 volts, with a symmetry of ± 3 volts.

Manufactured by the same RCA assembly line that has produced millions of lead-mount rectifiers, our Diac is available right now in production quantities at attractive low prices. We think so much of the new 1N5411, we would like you to try one free in your AC-control circuits. Just mail in the coupon for your sample. Of course, there's no obligation.

RCA

Circle 22 on reader service card

RCA Electronic Components
Commercial Engineering Department
Section CN5-4
Harrison, N. J. 07029

FREE

Gentlemen:

I'd like to use an RCA Diac with my Triac. Please send me my free sample.

Name _____

Title _____

Application _____

Company _____

City _____ State _____ Zip _____

Editorial comment

Hard line on software

Designers and users of computers are trading accusations on who's responsible for the continuing inadequacy of software and debugging procedures. The users blame designers for not designing software along with the hardware, and for failure to build in debugging aids. The designers counter with the charge that users balk at paying for such refinements and won't wait the extra time required for their inclusion.

Both sides are in agreement, tacitly at least, that their common enemy is management. Designers and users hint that management, by pursuing unrealistic delivery schedules, is basically at fault—a charge that has considerable justification.

A consensus surfaced at the Spring Joint Computer Conference where heated, productive debate was the order of the day. There was agreement on the need for action by computer designers and implementers to eliminate the years-long debugging periods, to which users have become resigned. Among many proposals advanced at the meeting,

these seem most promising:

- The use of designed-in event recorders to provide a history of operation and make debugging easier.

- The ability to alter and expand a system while it is in operation, in effect permitting "live" debugging. This is not to be confused with on-line debugging as it is interpreted by some implementers—as providing simply a "programmer's testbench." Other experts continue to press for the wider use of diagnostic programs during the debugging period.

- A reappraisal of support systems. Too heavy emphasis on designed-in administrative or "manager" systems may lead to their use as a crutch.

- More rigorous simulation of a system before it is built. This is not a new idea and the question it raises has not yet been answered. Can a simulated system really be debugged?

The problems, admittedly complex, do not defy solution. In fact, we believe that the answers are standing in the wings just waiting for their cue.

An emerging solution

In the end it will be large-scale integration along with its handmaiden, computer-aided design, that will help solve many of the hardware and software problems now blocking computer developers. Both LSI and CAD have been underrated for the long term, if overrated for the short term.

In just a few years, arrays of as many as 500 gates and 1,000 bit shift registers will be commonplace. LSI will make possible the substitution of structured logic for random logic, by means of active read-only memories, and will permit greater use of buffer memories with input/output equipment. Furthermore, LSI may usurp the office business machines market as those machines become more complex, and it will simplify the application of error correction for digital communications.

But none of these exciting goals will be reached without growing pains. The design, layout, and checkout of LSI will become so complex that manual methods will be passé; the computer's assistance will be vital. Already one major IC manufacturing company, to expedite its entry into LSI, won't let

its development engineers use manual design techniques, although manual intervention is permitted while programs are in the experimental stage.

In some arrays, interconnections take up most of the surface, leaving as little as 15% for active devices. Multilayer arrays may cut down that imbalance. LSI designers sometimes face the problem of organizing a variety of different elements within one array to make them more universal in application, a challenge that encourages close liaison with system designers.

With LSI, semiconductor vendors encroach upon the digital subsystems business; they expect the new breed of engineer to use LSI subsystems as today's engineers use transistors. Because the design and organization of arrays is so closely linked to system design LSI customers will find it necessary and profitable to work hand in glove with the IC vendor. Indeed, the obstacles to a better generation of computers may be removed only when LSI designers, computer designers and implementers, and customers tackle the problems together.



IGC LAUNCHES A NEW ERA IN FERRITES

New shapes, new materials, and new processes are ready for engineers and designers who are bold enough to use them.

New techniques let us make shapes never possible before, providing you with virtually complete design freedom.

Our Pulse Rated Toroids are another IGC first. We've calculated toroid parameters like pulse inductance, pulse magnetizing current, and ET constant and listed them in black and white, for guaranteed per-

formance on each and every part.

We've stretched size limits in both directions to open new applications. From the world's smallest pot core (0.125" O.D., 0.035" thick), to ferrite plates as large as 1"x2"x6".

Products already using ferrites are being improved. And new ferrite applications are springing up all over. Success stories include: omnidirectional antennas, micro-miniature transformers, transistorized ignition

systems, fluorescent lighting, read-only memories. And more.

Discover it all. Our bulletins on ferrite materials, shapes and applications are a great place to start. If you have something specific in mind, send your requirements. Write Mr. K. S. Talbot, Manager of Sales, Indiana General Corporation, Electronics Division/Ferrites, Keasbey, New Jersey.



INDIANA GENERAL

Making Magnetics Work

Electronics Newsletter

May 27, 1968

Hughes unit to be IC second source

Watch for Hughes Semiconductors to become an important second source of bipolar integrated circuits in the next few weeks. The first step will be to introduce 27 circuits in Sylvania's SUHL 2 line of transistor-transistor logic.

The division, in Newport Beach, Calif., is stocking devices now and will probably follow the TTL line with diode-transistor-logic circuits similar to those of the Fairchild 930 series. On the linear side, popular operational amplifiers such as the Micro A709 will appear soon.

All this action, plus an ambitious new-product effort in the MOS FET line purchased from Raytheon last November, reflects Hughes' determination to turn from custom and engineering work to high-volume production.

NASA, Pentagon writing IC specs

Concerned over the reliability of their microelectronic purchases, the Pentagon and NASA are developing specifications specifically for integrated circuits. Until now, the mil specs have been nothing more than extensions of those for discrete semiconductors. The new documents are expected to cover bipolar and MOS monolithics as well as hybrids.

NASA is also initiating a program for assessing the way makers screen out defective or marginal IC's from their production lines.

Federal panel set up to study plastic IC's

An ad hoc committee composed of members of the three military services, NASA, and the Defense Electronics Supply Center will meet in mid-June to plan future programs for testing plastic-encapsulated IC's. The group will also lay the groundwork for permanent committees that will examine in detail the use, testing, and development of plastic-packaged devices.

The decision to form the panel came out of a closed-door meeting this month of Defense Department and NASA representatives [Electronics, April 15, p. 45]. The consensus among these officials was that plastic-encapsulated devices generally cannot be recommended for military or space use at this time, but that they hold promise for the future and that this is reason enough to coordinate Government agencies' testing and R&D efforts in this area.

One representative, C.E. Holland Jr. of the Naval Electronic Systems Command, said those present at the session felt there was no urgency about getting plastic-packaged circuits into military and space gear and that the major responsibility for devising an acceptable package rests with the electronics industry. The closed-door meeting followed a day of presentations by semiconductor manufacturers and users, including TI, Signetics, GE, Fairchild, Westinghouse, Motorola, Autonetics, IBM, and Hazeltine.

'Low-cost,' complex navigator is sought for Lockheed airbus

Lockheed-California has asked 12 avionics firms to quote prices on a "low-cost" inertial navigation system for its L-1011 airbus, but hasn't specified just how low the cost should be. The industry was generally surprised at Lockheed's request for more than a dozen outputs; the feeling was that because the system would be getting inputs from en route stations equipped with VOR (very-high-frequency omnirange receivers) and

Electronics Newsletter

distance-measuring gear, it could do its job by generating outputs for only pitch, roll, platform heading, and perhaps vertical reference.

A source at one of the companies contacted by Lockheed estimates that the inertial-navigation system might be priced anywhere from \$50,000 to \$70,000.

No IBM 1800 in 1969?

IBM's decision to move the production of its model 1800 process-control computer from San Jose, Calif., to Boca Raton, Fla., may well be its first step toward phasing out the 1800. Rumors in process-control circles indicate that IBM marketing strategists are considering ending the 1800 line.

The 1800 has enjoyed a respectable share of the market. Users, however, want systems that can be time-shared but still offer efficient software and memory utilization.

One computer-control specialist, who apparently became disenchanted with the IBM 1800 for his customer's direct digital-control application, predicted that IBM's next version of a control computer will be based on the 4 Pi computer [Electronics, March 6, 1967, p. 171] designed for military avionics use by IBM's Federal Systems division. He's concerned that the new computer, which he estimates will be available in late 1969, may not be software-compatible with the 1800. However, an IBM spokesman denied the company is now planning a new process computer.

Meanwhile, besides moving the 1800 operations to Boca Raton, IBM has transferred some process-control specialists to regional offices.

Hughes has designs on an Intelsat 4

The granddaddy of the communications satellite builders, Hughes Aircraft, is going all out to win the Comsat contract for Intelsat 4. Comsat is not yet committed to the Intelsat 4 program.

Hughes has proposed a synchronous spacecraft with two sets of antennas; two antennas would pack 3,000 watts of effective radiated power into their steerable "spotlight" beams for areas of heaviest communications traffic. The spot beams would be 4.5° wide and would use satellite antennas 8 feet in diameter. Hughes believes the high effective radiated power would allow quality reception with ground antennas as small as 30 feet in diameter. The other two planar arrays would serve areas not covered by the spot beams. The satellite could handle 6,000 two-way telephone conversations or 12 color-television channels.

The 12 linear broadband channels would have 40-megahertz beamwidths, and the spot beams would deliver 36 dbw effective isotropic radiated power; the earth-coverage beams would provide 24.3 dbw. The satellite would be spin-stabilized and weigh 2,430 pounds.

Fairchild unit chief gets long furlough

After a week of hemming and hawing, Fairchild's Instrumentation division finally announced that its top executive, Victor Grinich, is leaving the company for a teaching "sabbatical" of a year or so. But whoever replaces Grinich won't have a temporary job; Grinich, a research-oriented scientist and one of the founders of Fairchild Semiconductor, will not be head of the division when he returns.

He is the second Fairchild Instrumentation executive to leave this month. A week earlier, Charles Askanas resigned as head of the systems group, which makes integrated-circuit test equipment. Askanas is currently acting as a Fairchild consultant but is expected to join another company within weeks. He has been succeeded by Dean Mack.

No.1 in display



First with projected pointer meters

First with digital panel meters

First with projected scale meters

These panel meters represent the three most significant advances in meter design made in recent years. It is no coincidence that they are products of Weston, undisputed leader in display. Weston developed the projected moving pointer which did away with parallax and gave you full scale readings as low as 2 microamperes for the first time in an edgewise meter. Then

came the projected moving scale by Weston, offering 1% accuracy, hairline resolution and 8 inches of scale in a 2½-inch case. And in a slightly larger case, we offer the equivalent of a 30-inch scale with digital readout (analog motion). The latest Weston achievement is the all-electronic digital panel meter, providing unprecedented accuracy and solid-state reliability

in a compact OEM styled package. Such products reflect the kind of leadership that has earned Weston a reputation as "the number one innovator" in display technology.

WESTON INSTRUMENTS DIV.,
Weston Instruments, Inc., Newark,
N.J. 07114, a Schlumberger company.

WESTON®

Some companies are in the wire business.



**General Cable is in the magnet wire, lead wire, cordset,
coaxial cable, harness, hook-up wire,
Teflon* resin-coated wire, Teflon resin-coated fabric,
and audio and electronics wire business.**



For information on how General Cable's complete line of OEM products can help you, write:
General Cable Corporation, Section 700-01, 730 Third Avenue, New York, New York 10017.

GCC
GENERAL CABLE CORPORATION

*Teflon is DuPont's trademark for its fluorocarbon resins.

Scotchpar's producer uses more supporting players than any other big name film producer.

3M Company has the largest sales force—all engineers and insulation specialists calling exclusively on the electrical market—to make sure SCOTCHPAR® polyester film turns in a stellar performance for its customers. They're supporting a great film. It's thin, tough, transparent, flexible

and durable. It also has high dielectric strength, great temperature stability, and resistance to moisture and solvents.

Our men help capacitor manufacturers get the right kind of SCOTCHPAR film for their product—they can choose from a complete lineup of thin films down to .25 mils, plus SCOTCHPAK® film if they want heat sealable features.

They work equally hard for manufacturers who use SCOTCHPAR film as insulation in transformers, motors, wire and cable.

With all these men on the job, we still work harder than anybody else helping electrical men get the most out of polyester film.

All because we want our SCOTCHPAR film to win over a very critical audience. 3M Company, Film & Allied Products Division, 3M Center, St. Paul, Minnesota 55101.

Scotchpar 3M
BRAND POLYESTER FILM COMPANY

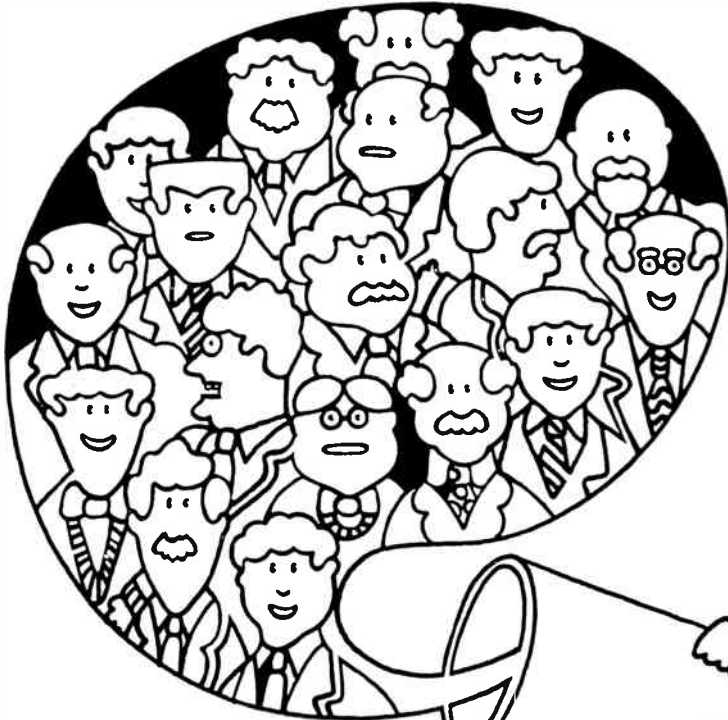



Ball .002" dia., Iteration $\pm 5\%$

TEMPRESS HYDROGEN FLAME-OFF TORCHES FOR LEAD-BONDING MACHINES ARE STAINLESS STEEL, WITH SAPPHIRE ORIFICE INSERTS that maintain size and shape accuracy of the 2166°C hydrogen flame. The highly polished inner surface of the sapphire insert assures this by eliminating gas turbulence and a resultant distortion of the flame. The end result is essentially identical gold balls on every lead, from start to finish of a production run. 14X magnification of operation shows flame-off torch at left, with orifice partially visible. Gold wire, with perfectly formed ball, protrudes from Tempress tungsten

carbide capillary tube, ready for next bonding cycle. This extreme precision symbolizes the Tempress approach to every project... explains why it requires 11 months to train an operator for many Tempress production operations. Other Tempress products include automatic scribing machines, diamond scribes, diamond lapping points, and tungsten carbide probe contact needles.

Lead-bonding, Model DTN-1, at Union Carbide Electronics.



TEMPRESS

Tempress Research Co., 566 San Xavier Ave., Sunnyvale, Calif.

Circle 31 on reader service card

This has to be the broadest wiring system

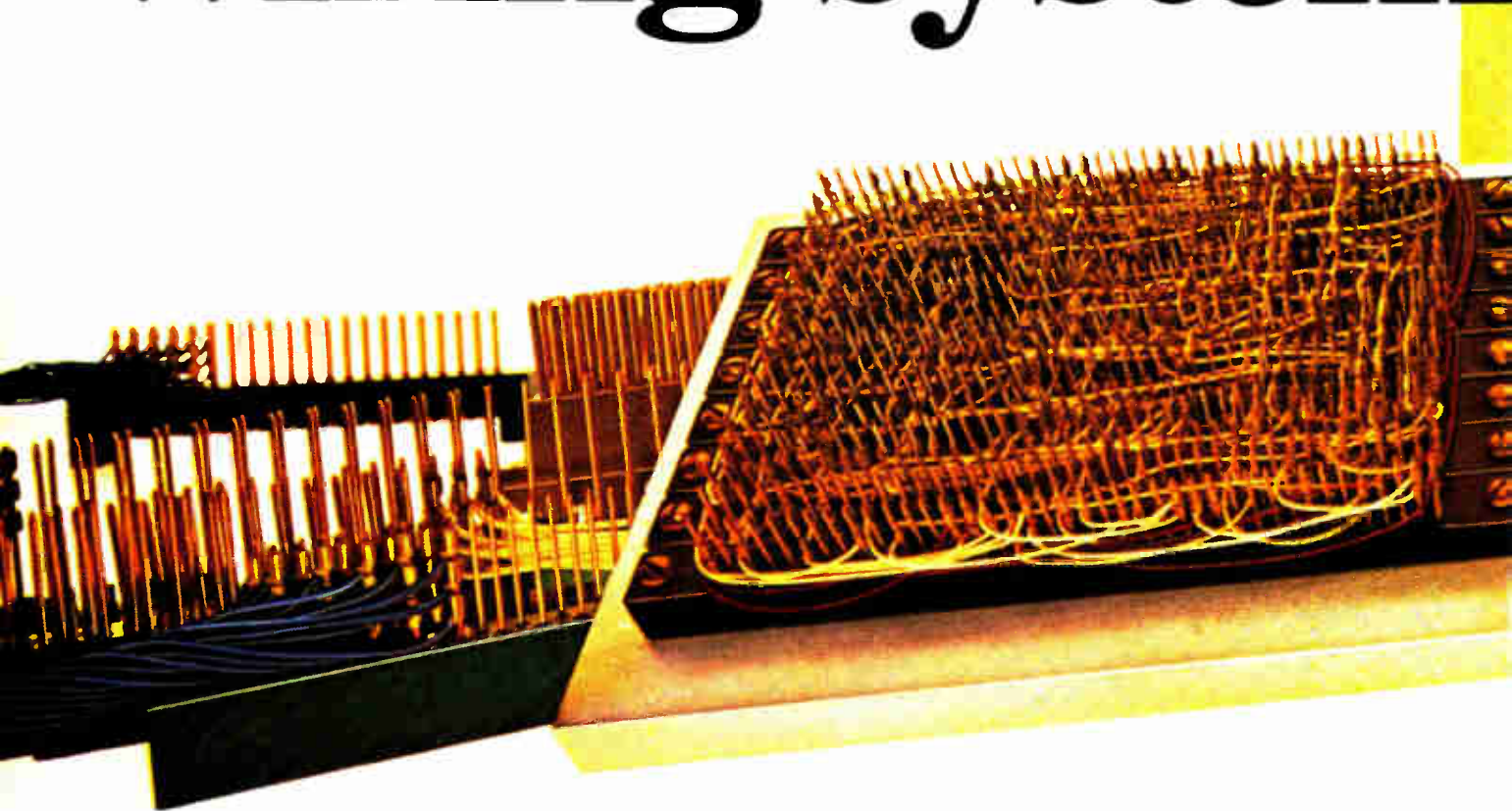

TERMI-POINT* Products: the most complete line ever designed for one termination technique. Includes flatpack receptacles, DIP headers, transition blocks, bus bars, modular interconnection systems, connectors, two-piece and one-piece printed circuit connectors of nearly every size and type. Uniform terminations save time, money. Heart of system: unique TERMI-POINT clip "irons"

*Trademark of AMP Incorporated

wire against post, provides insulation support, strain relief. Spring memory of clip resists vibration, shock. Gas-tight connection. Reliability second to none. Clips removed without electrically affecting any circuit. Non-destructive testing and easy servicing done with simple tools. Post densities to .100" on centers. Three standard post sizes. Posts used over and over. Many types of wire: stranded.

point-to-point in the world.

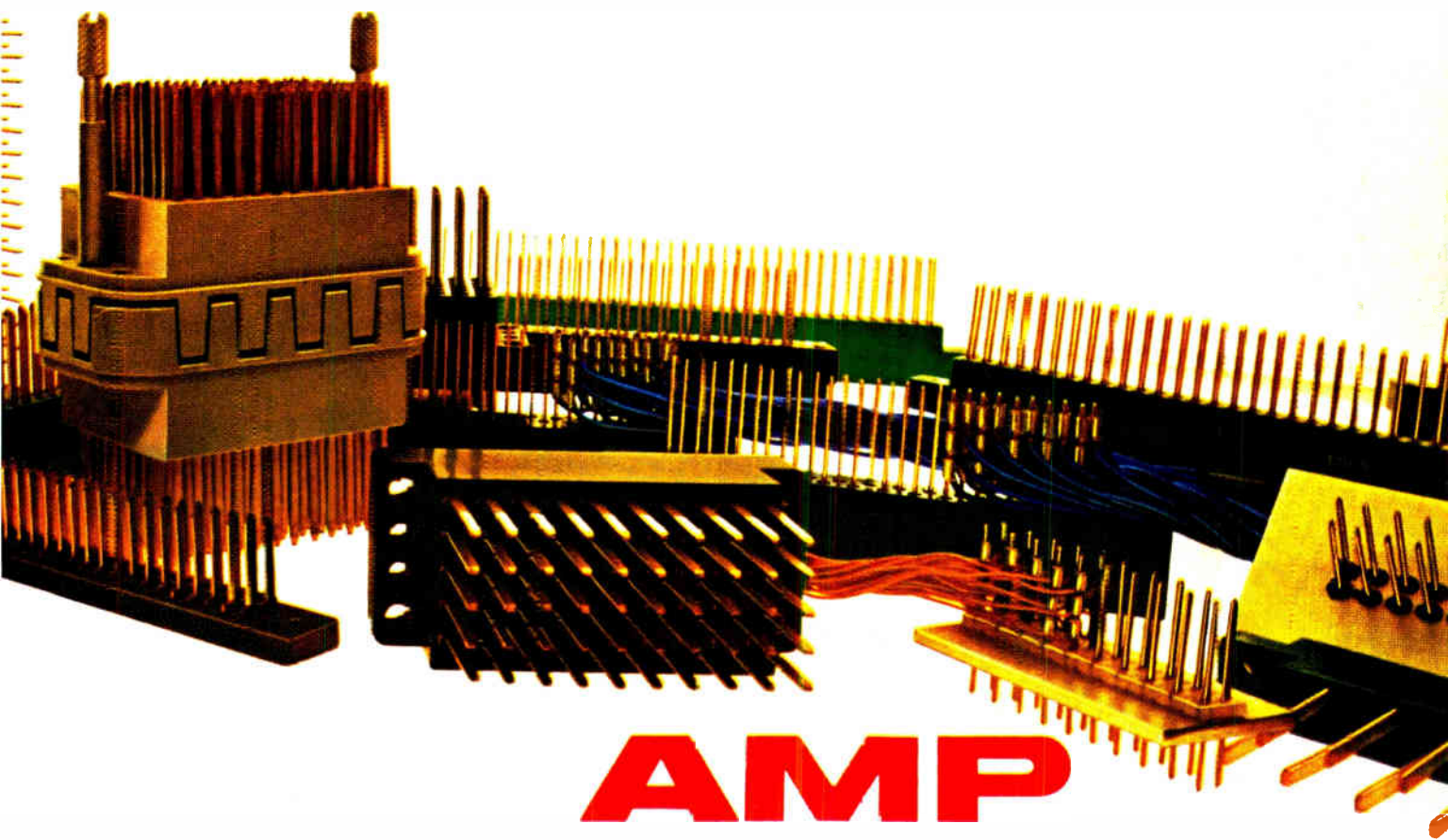

AMP

solid, flat cable, etc. (Sizes 30 thru 18 AWG.) Bulk wire plus very high speed application tooling equals lowest applied cost of any wiring system. For fastest means of wiring panels, AMP provides a TERMI-POINT Automatic Wiring Machine with speeds of over 1000 wires an hour (even on posts up to 35% off center)—plus equally reliable Hand Tools. Write AMP Incorporated, Harrisburg, Pa.

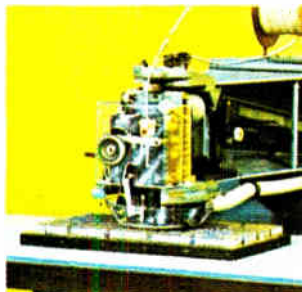

BELOW: Stomping herd of bull elephants in a futile attempt to crush the indestructible Type 04 Four Lite Illuminated Pushbutton Switch.

LICON'S
GREATEST
ADVENTURES
EPISODE
ONE



THE SWITCH



SEE
him handle
10 amps 30V.

TOM THUMB

and his Type 18 double break sub-subminiature switch. Tom Thumb is only 3 1/2 inches tall, but the switch is perfectly formed.

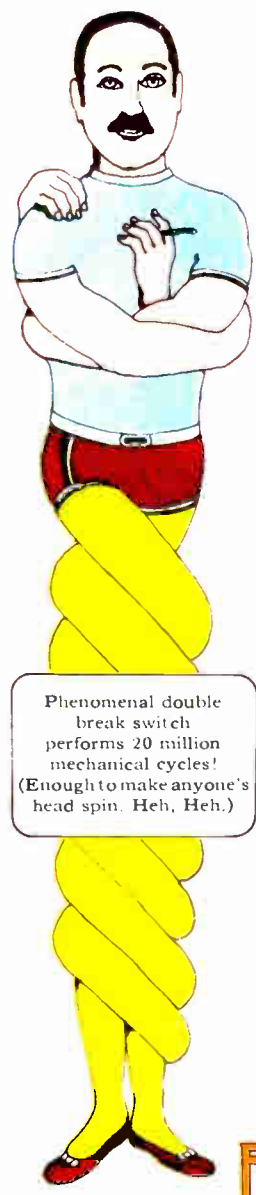

Phenomenal double break switch performs 20 million mechanical cycles! (Enough to make anyone's head spin. Heh, Heh.)

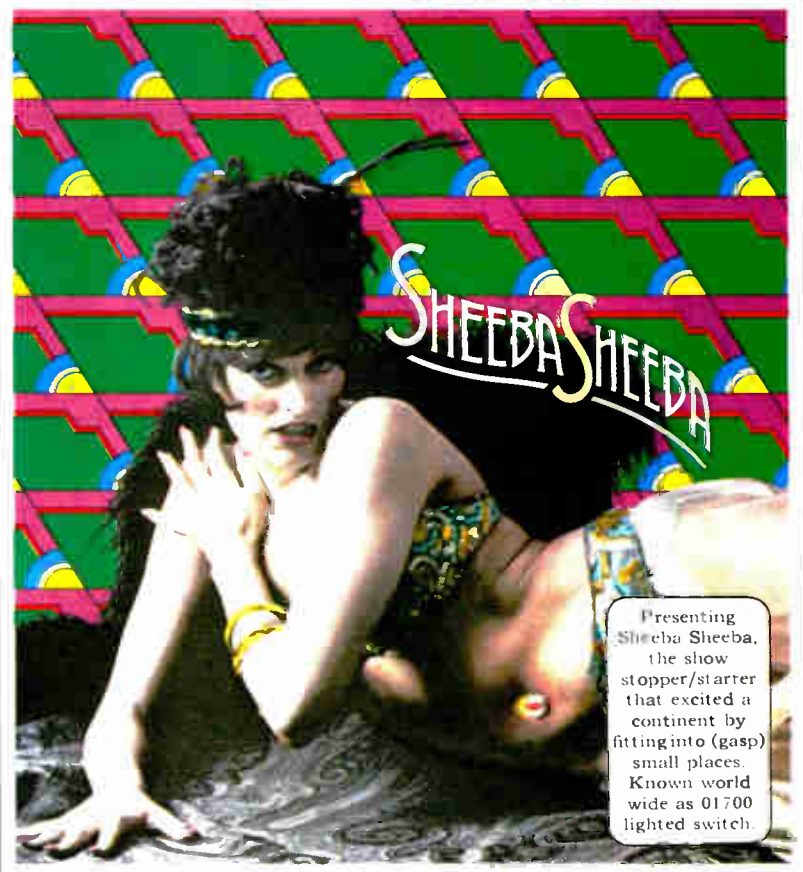

Presenting Sheeba Sheeba, the show stopper/starter that excited a continent by fitting into (gasp) small places. Known world wide as 01700 lighted switch.

FREE Giant color poster of Sheeba Sheeba in a dancing Egyptian container. To get your free life size color poster, write on your letterhead to: Licon Division, Illinois Tool Works Inc., 6615 W. Irving Park Rd., Chicago, Ill. 60634. Or circle no. 104 on the response card in the rear of this magazine.

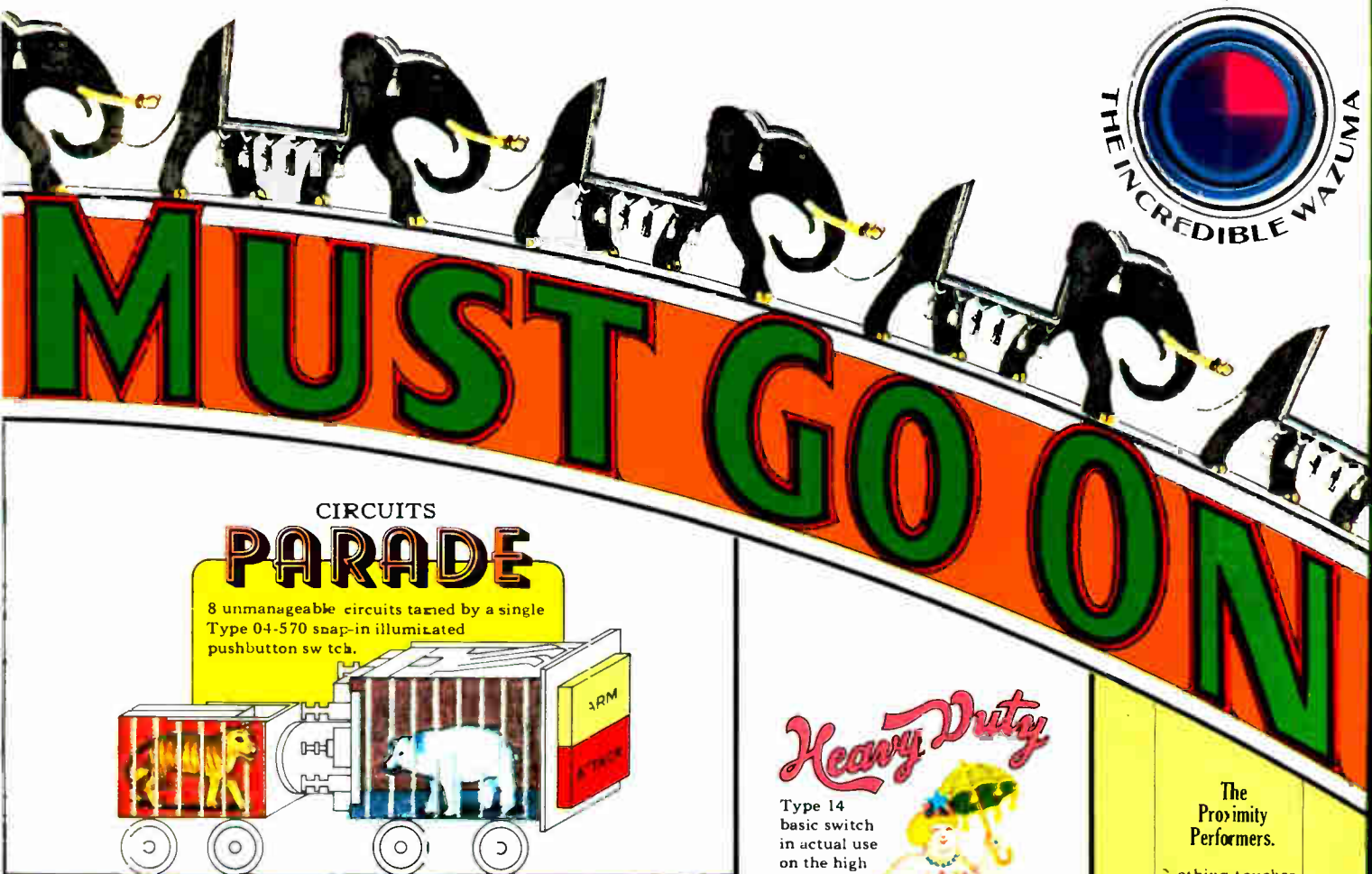

CIRCUITS PARADE

8 unmanageable circuits taxed by a single Type 04-570 snap-in illuminated pushbutton switch.

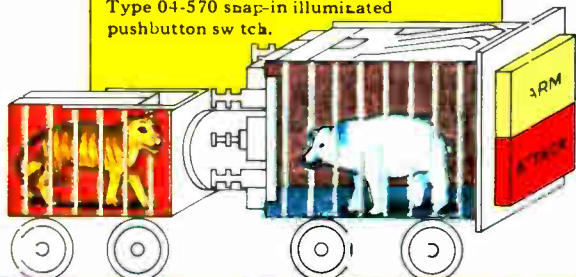

Heavy Duty

Type 14 basic switch in actual use on the high intensity wire.



The Proximity Performers.

Nothing touches their act. But nothing has to. They work anyway! Licon 70-700 Series. 1,000 cycles per minute activated by any ferrous or non ferrous metal coming within 1/2 inch.



King Licon

YOU'RE IN GOOD HANDS WITH LICON



NOW THERE'S A SWITCH

(Illustrating Licon's flexibility in engraving and hot stamping to meet everyone's desires).

i **t** **w** LICON
Division Illincis
Tool Works Inc.

We build connectors around filters, so you won't have to build filters around connectors.

Used to be, you had to build a filter around connectors to keep out EMI (electromagnetic interference.) Now Bendix is building its connectors around filters to settle the problem once and for all.

New Bendix® filter-connectors are an entirely new concept. Each pin is surrounded with its own miniature ferrite filter. The benefits of making the filter an integral part of the connector are obvious. You save space, weight and production costs. (A Bendix filter-connector costs about a third less than a filter-box setup.) You eliminate two out of three solder joints. And you wind up with a superior mechanical structure. That's important for improving the performance and reliability of today's highly complex electronic equipment.

Readily available filter-connectors include those intermatable with the Bendix Pygmy® Series (Mil-C-26482), Bendix JT Series and Bendix LJT Series (Mil-C-27599 and Mil-C-38999). Others are on the way. We'll design filter-connectors to meet your specific requirements, of course. For details, write: Electrical Components Division, The Bendix Corporation, Sidney, N.Y. 13838.

Bendix

Electronics

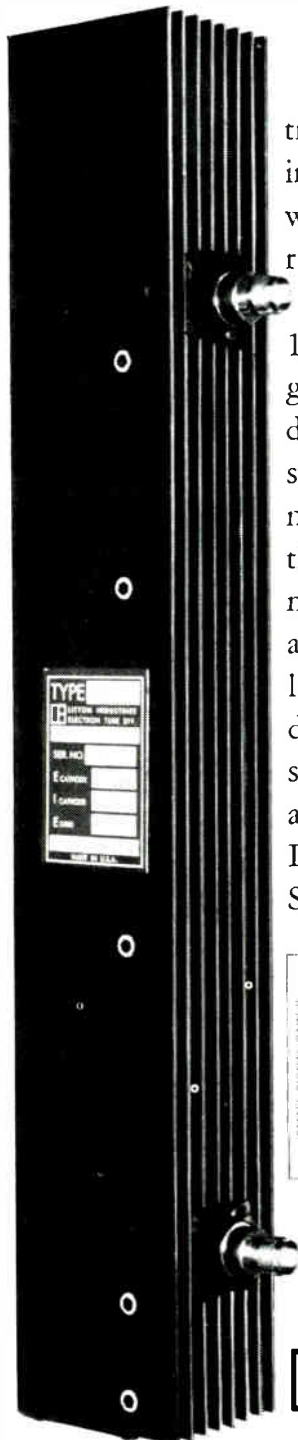

Your gain. One milliwatt to one kilowatt with a single TWT amplifier.



Length 15.69 inches.

Because of its high gain characteristics, Litton's new L-5126 traveling wave tube enables you to eliminate intermediate drivers in certain systems. Your additional gain? The reduction of the size, weight, cost and complexity of your system while improving reliability.

The L-5126 is a broadband traveling wave tube which provides 1.0 kilowatt minimum peak power output with 60 db minimum gain over the frequency range of 7.0 to 11.0 GHz. It may be driven to full power output by a standard signal generator, sweeper, or any conventional signal source. The L-5126 has a metal-ceramic vacuum envelope for reliable performance under the environmental extremes of MIL-E-5400, Class 2 environments, making it ideal for airborne and other similarly demanding applications. It is conduction cooled up to 1% duty and utilizes low cost Alnico periodic permanent magnet focusing. Its unique design and internal construction result in open and short-circuit stability. Tubes with comparable performance are also available at C-band. For additional information on the L-5126 and other Litton TWT's, write Electron Tube Division, 960 Industrial Road, San Carlos, California 94070 or call (415) 591-8411.

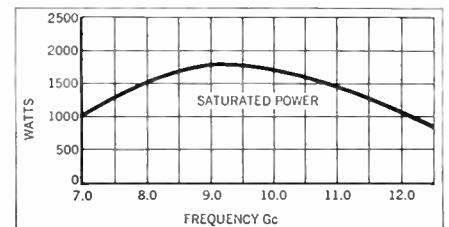
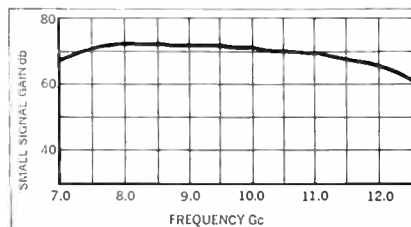

 **LITTON INDUSTRIES**
ELECTRON TUBE DIVISION

Who can make an active difference in your equipment?

We can. By supplying you with carbon composition resistors backed up by the most advanced Established Reliability program in the industry. Plus metal film resistors that are truly "second generation." Plus precision resistor networks custom-tailored to your precise needs. Plus variable resistors and trimmer pots

that are mechanically superior to any others on the market today. Plus inductors and capacitors that are equally significant. Plus something extra in the way of experienced technical service. If you have a passive component problem, tell us about it. Chances are, we've already solved it.



The passive innovators at Airco Speer.

AIRCO Speer Electronic Components include Speer resistors, Jeffers JC precision resistors, Jeffers JXP precision resistors and networks, Jeffers inductors and capacitors and PEC variable resistors and trimmer potentiometers. St. Marys, Pa. 15857 • Bradford, Pa. 16701 • DuBois, Pa. 15801 • Toronto 15, Ontario.



SYSTEMS TECHNOLOGY

Systems Technology is engaged in solving a wide variety of sophisticated technical problems related to advanced electronics, control and information systems, and electronic components at the rapidly expanding Fort Worth Division of General Dynamics. Within this department, effort is divided among several major areas of technology.

Radars and Navigation Systems. This area pertains to design, development and test of airborne radar, navigation, guidance, and fire control equipment. Research in fundamental electromagnetic propagation, transmission, and scattering is also conducted.

Electronics Systems. This activity is related to penetration aids equipment. It includes design and development of such systems as radar homing and warning, electronic counter-measures (ECM), IR detection, etc. Antenna design and fabrication is also a vital part of this work.

Information Processing and Sensor Technology. This covers technical fields and applications where the prime objective is acquisition and/or analysis of information. It includes displays and simulation, information processing, data analysis, and computer programming for both ground and airborne equipment.

Electronic Installation and System Design. This work includes design of electrical power generation, conversion, and distribution systems. Electrical wiring and installation of all avionics equipment is a part of this function.

Aerospace Ground Support Equipment (AGE). This work involves effort directed toward design and development of AGE which maintains and adjusts all avionics systems.

Aerosystems Laboratories. These laboratories provide support in such areas as electronic equipment design and fabrication, microelectronics design and development, F-111 avionic systems integration and testing, and flight test instrumentation design, development, and fabrication.

Find room for thought and career potential . . . and room for better living in smog-free Fort Worth, where the cost of living is low, and where metropolitan advantages exist alongside year-around outdoor recreational areas in a mild climate.

Call Collect — 817-732-4811, Extension 3551; or send a resume of your education and experience to Mr. J. B. Ellis, Industrial Relations Administrator-Engineering, General Dynamics, Fort Worth Division, P. O. Box 748E, Fort Worth, Texas 76101. An equal opportunity employer. U. S. citizenship required.

GENERAL DYNAMICS

Fort Worth Division

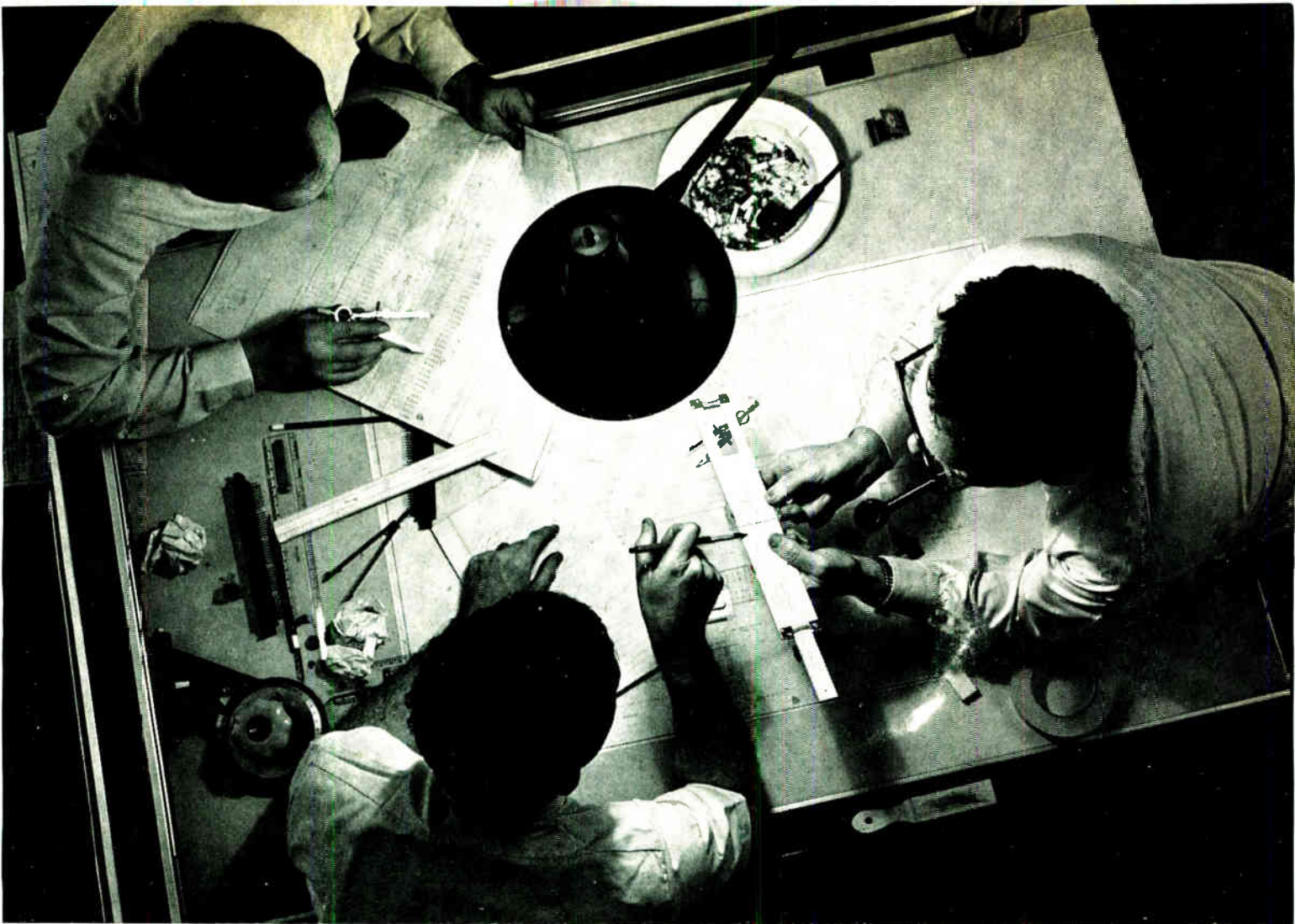

We've been copying other people's designs for 17 years.

And they love us for it.

After all, we're custom fabricators. And if we didn't copy designs exactly, we wouldn't be doing our job.

We do it every day. On transistor leads, computer memory core frames, connectors, pen caps, aerosol spray tips, razor blade dispensers, integrated circuit frames.

You name it, we copy it. To your precise specifications.

Whether it's precise stamping of high-tolerance, miniature metal shapes.

Or precise molding of intricate plastic parts.

Or precise forming of wire for critical electronics.

Or precise combining of metals, plastics and wire into complex assemblies.

And we've got nine plants, the most advanced equipment, and the best engineers and diemakers around to do it.

We'll even help you design the part. Then we'll build the dies, produce the parts, and do the assembly. A perfect copy every time.

That means you get the parts you want, the way you want them, when you want them—probably at less cost than you could do it for yourself.

So the next time you come up with a great new design, give us a call and we'll copy it.

Sylvania Metals & Chemicals, Parts Division, Warren, Pa. 16365.

CUSTOM PARTS BY
SYLVANIA
A DIVISION OF
GENERAL TELEPHONE & ELECTRONICS

Circle 41 on reader service card

Investigate Random or Periodic Processes with Correlation Function Computers

Correlation functions occupy a cardinal position in modern information theory and are basic to the analysis of random or periodic processes and the complex signals they produce. In many application areas, autocorrelation analysis allows noisy periodic or random signals to be defined, whereas crosscorrelation can determine the degree of conformity between two different noisy signals as a function of their mutual delay.

PAR™ Models 100 or 101 Correlation Function Computers simultaneously compute 100 points of the auto- or crosscorrelation function in real time over delay spans from 100 microseconds to 10 seconds. The Model 101 includes the capability for insertion of fixed delay increments ahead of the 100 computed points of the function, thereby providing greater resolution. The correlation function readout which may be obtained continuously as it is computed, is available at various rates consistent with the speed of the external readout device, e.g. oscilloscope or X-Y recorder.

Vibration analysis, radio astronomy, laser research, geophysics, radar, plasma physics, aero- and hydrodynamics, and biophysics are only a few of the fields where correlation techniques are useful.

Price of the Model 100 is \$8,500. The Model 101 is priced at \$9,500 to \$12,900. Export prices are approximately 5% higher (except Canada).

For additional information, write Princeton Applied Research Corporation, Box 565, Princeton, New Jersey 08540 or call 609-924-6835.

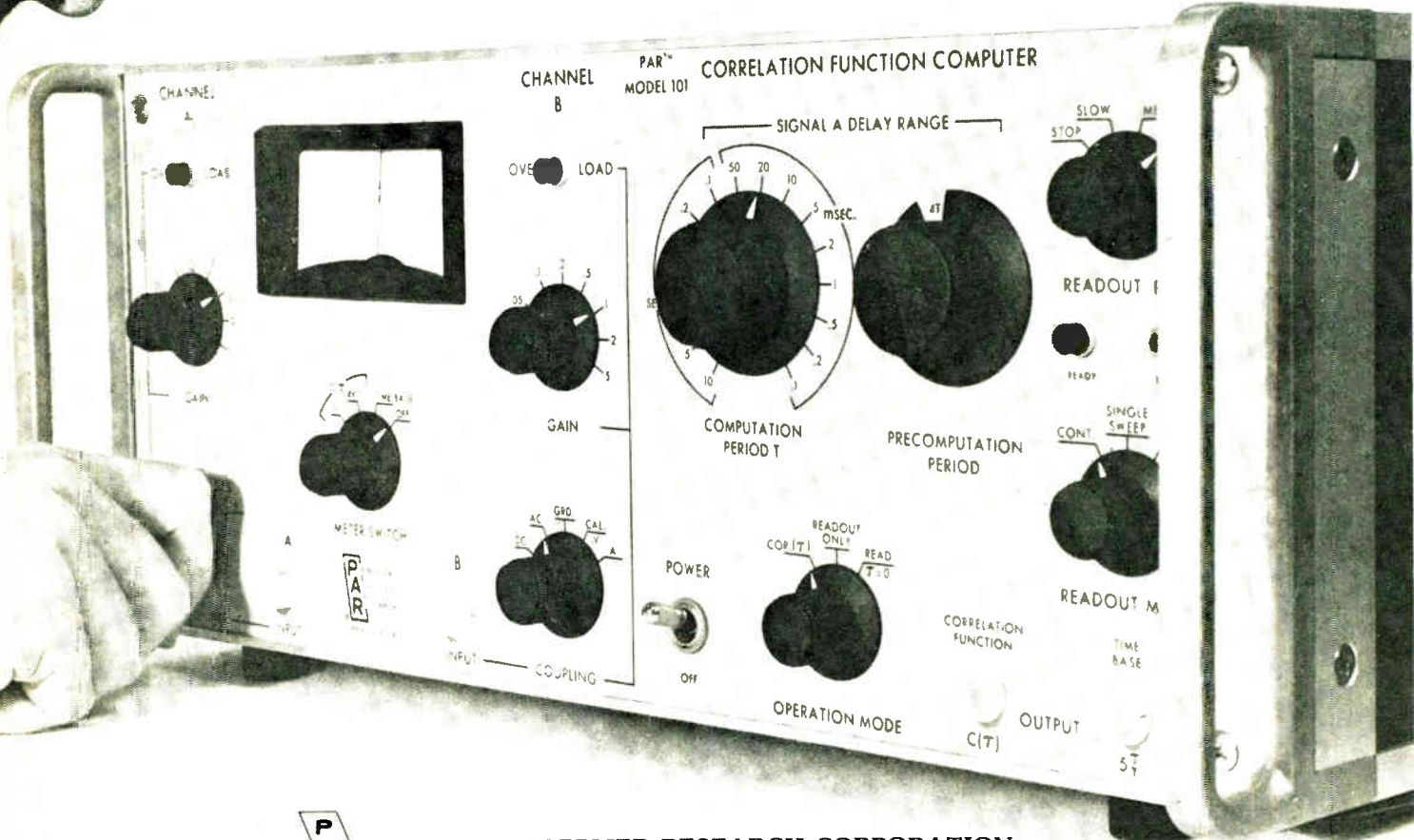

PRINCETON APPLIED RESEARCH CORPORATION

Military electronics

Half step

There's not much doubt now that the next big step in aircraft radar will be to replace mechanically scanning antennas with electronically phased arrays. But not everyone is convinced that a practical solid state source to drive the arrays is around the corner.

Several companies are hard at work on a half-step approach to a complete solid state radar driving an array with a conventional microwave tube. This is in contrast to Texas Instruments' approach in its Mera system, which uses a solid state driver and a ferrite phase shifter for each radiating element in the array.

TI's method appeals to the Air Force because of the space it would save in an aircraft—one radar could handle the work now being done by two or more. However, the Air Force also has contracts with the Raytheon Co. and the Emerson Electric Co., which are building phased-array flight hardware illuminated by a single-point source of microwave energy. Flight tests of the Ku-band sets may begin this year.

Rooftop tests. Meanwhile, the General Electric Co.'s Aerospace Electronics department in Utica, N.Y., is developing, with its own funds, a system it calls Masar (multimode airborne solid state array radar). Work started last year, and GE plans to begin rooftop tests on its X-band set early in 1969, with flight tests possibly later that year. Raytheon and Emerson will ground-test later this year, and TI is expected to deliver the first Mera set to the Air Force in the fall.

Emerson, Raytheon, and GE all

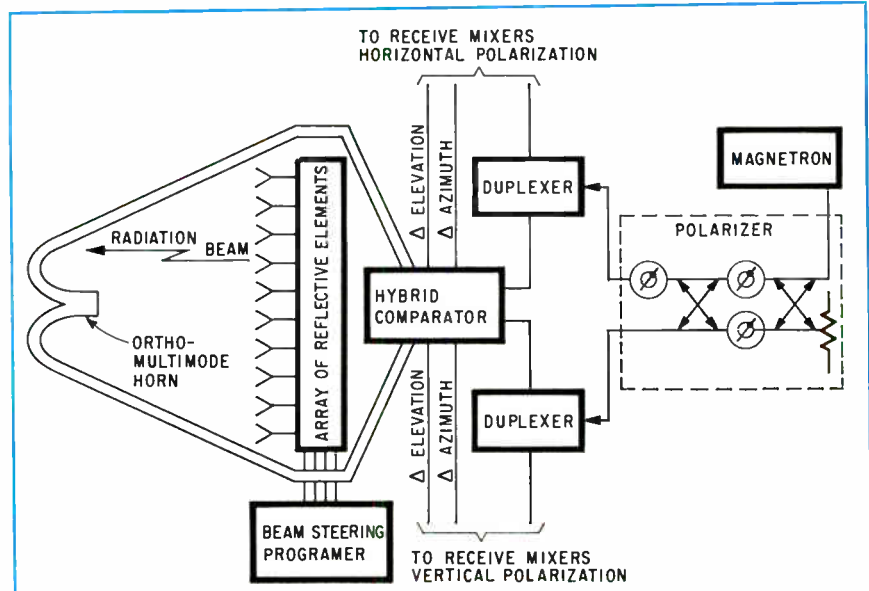

Demitask. Rather than go all the way with solid state, General Electric and others are using conventional microwave tubes to drive solid state elements in an electronically phased array radar system.

say that TI's Mera approach is limited by existing technology. Michael Briana, manager of Raytheon's phased-array program, feels that the multipliers TI is using to generate the X-band power have already been surpassed by Gunn and avalanche diodes that weren't available when the Mera program was started.

Along with TI, Emerson and Raytheon use ferrite phase shifters. GE, on the other hand, feels that ferrites should be avoided because of temperature instability; it's using digital diode shifters.

However, spokesmen for both Raytheon and Emerson say they have solved the temperature problems and have qualified their ferrite shifters over the wide temperature range required by the military specifications. O. B. Mitchell, project manager of Emerson's program, says he prefers ferrites to diodes because they are better understood, require less control power, and have proven power-handling capabilities

—particularly for the latching type ferrites.

Back to normal. Raytheon's Briana says his team has built four phased arrays—some using ferrite, some using diodes. They have found that the ferrites are more reliable: when they are overloaded they just saturate and return to normal. Diodes, on the other hand, burn out, he said.

All three systems produce more power than Mera, which has a peak of 600 watts. GE's system, says Robert L. Williams, the project engineer, generates a peak of 100 kilowatts, and the diode phase shifters can take 300 watts peak and 4 to 6 watts average.

Emerson says that its system also has a peak of 100 kw and that each element can handle 3 kw peak and 10 watts average.

Raytheon's system, points out Briana, can also generate 100 kw, but each element can handle up to 200 watts peak and 6 to 7 watts average. Briana says this is more

than adequate for the military's current needs.

Modular air computer

Designing an electronic intelligence or electronic warfare system with the airborne computers currently available is a tough job. The single processors limit what such a system can do, and the addition of special-purpose hardware to handle various applications boosts its complexity, cost, and weight.

One company that has had to face these problems in designing several large-scale electronic intelligence systems has undertaken a

major in-house effort to build a computer that will go a long way towards solving them. TRW Systems in Redondo Beach, Calif., is now proposing its EW 20/24 computer for many upcoming military programs. Though it won't identify any of these, it's known that the company is working on a jamming system that would be carried in light aircraft.

Businesslike. Electronic warfare systems have to handle large amounts of data in real time to find such emissions as continuous-wave radio and radar, classify the signals, pinpoint their origin, and jam their transmission. The job is closer to business data processing than

to the conventional tasks of avionics systems. Most airborne computers are designed for scientific or mathematical computations where complex equations are solved with only moderate data input. Their limited input/output capabilities and processing power just aren't suited to electronic warfare or intelligence requirements.

TRW proposes to build a modular digital computer that can be organized as a multiprocessor. Each of the system's basic building blocks—memory, central processor, and input/output processor—would be physically separate; the i/o processor could move large blocks of data in and out of the memory independent of the central processor, and the modules, TRW says, could be arranged to satisfy almost any computing requirement of a system.

"If you use the computer to get data in and out, you don't have much time to do analysis," explains Gerald E. Clark, an engineer at the company's guidance laboratory. "So we remove the input/output time load from the program," he adds.

In the works. The design has been completed, the memory built, and the arithmetic/control unit breadboarded. A prototype is expected to be ready in about six months for flight testing.

The computer is breadboarded with Texas Instruments' 5400 series transistor-transistor-logic integrated circuits, but TRW plans to go to large-scale integration, according to Clark. Just what LSI direction the company will take is to be decided in the next few weeks. "We may have to go through some intermediate step and use in-house facilities for the prototype," he says.

If TRW gets a contract that requires it to deliver by the end of the year, the system will have to use IC's, Clark notes. But he predicts that within two years the EW 20/24 will incorporate LSI. This would lower the cost of the logic, but wouldn't significantly affect the equipment's size, which is generally determined by connector requirements. And this system, with its modularity and organization, needs a lot of connections.

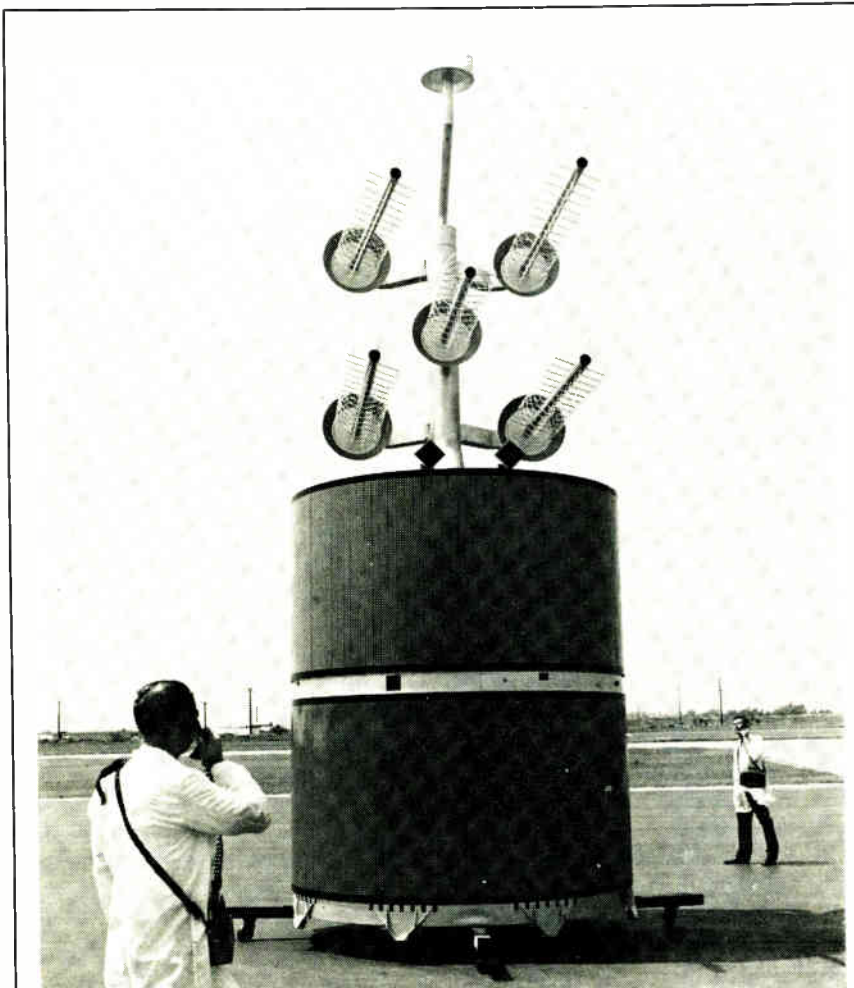

Big bird. Two-story experimental satellite, Tacsat, under construction by the Hughes Aircraft Co. for the Air Force, will provide the equivalent of 10,000 two-way telephone channels. The 1,600-pound, spin-stabilized tactical communications satellite is to be delivered late this year for launch into a 22,300-mile synchronous orbit. Tacsat will carry three antenna systems: five helical ultrahigh frequency antennas, two microwave horns for X band, and a bi-conical horn telemetry and command.

The smallest EW 20/24 system—one central processor, one input/output processor, and one memory module—would now fit in a standard rack 10½ inches wide, 17½ inches deep, and 7 inches high. It would weigh about 30 pounds and, using integrated circuits, consume 180 watts.

Four-bit differences. The central processor will be able to handle word lengths of either 20 or 24 bits—the difference being an 11-bit or 15-bit operand, or transfer address. Most entrance and return transfer orders will take 2 microseconds. Short instructions, such as add and subtract, will be done in 4 μsec, multiply in 29 μsec, and hardware divide in 55 μsec. A self-contained, 24-bit hardware interrupt register eliminates the need for additional interrupt processing software. Up to 22 different interrupts can be accepted by the processor.

The i/o processor is to be a small, simple unit that will be able to refresh a display with new computer-generated information, and digitally tune, scan, and extract information from an r-f receiver. It will have a parallel (24-bit) transfer rate of up to 70 kilohertz and serial transfer rate of up to 200 kilohertz.

The memory has a capacity of 8,192 words of 20 or 24 bits, a 0.7 μsec access time, and an effective over-all cycle time of 2 μsec. It uses 22-millimeter ferrite cores in a 2½-dimension arrangement. Since any processor's speed depends on how fast it can get instructions and data from the memory, TRW has divided the memory into small, self-contained modules that can be simultaneously accessed in parallel. Each processor could address any word in up to four memory units.

TRW is looking beyond electronic warfare and intelligence applications for the EW 20/24. Multiprocessors represent the next generation of airborne computers, Clark says, and the company is also aiming its system at such jobs as command and control, guidance and navigation, weapons fire control and delivery, antisubmarine warfare, air weather systems, and in-flight checkout.

Companies

Moving into ghettos

Despite pleas by political and civil rights leaders for industry to create more jobs in the urban ghettos, the response has thus far been disappointing. Among the few firms that have reacted favorably are two electronics companies—a small one that's barely getting started and two giants.

Armed with only \$57,000 in capital and a handful of guaranteed contracts from the nearby Hewlett-Packard Co., a recently formed electronics firm is rising in the slums of East Palo Alto, Calif. One of the large firms, North American Rockwell Corp., has formed a subsidiary that will concentrate on hiring people classified as unemployables from Los Angeles' Watts area. And across the continent, the International Business Machines Corp. is opening a plant in the squalid Bedford-Stuyvesant section of Brook-

lyn, New York.

Labor pool. The West Coast firm, East Palo Alto Electronics Inc., was formed by seven San Francisco engineers, six of whom are Negro. Thomas Turner, the firm's president, is recruiting workers from welfare rolls. Aside from using its 13,000-square-foot plant for manufacturing, the company will offer vocational training to neighborhood residents.

"There are many advantages in operating a business in the ghetto," says Turner. Not the least of which is rent. Outside the ghetto, the company would have had difficulty paying for 3,000 square feet. "These are new buildings," he says, "with \$20,000 worth of wiring and electrical work already in. There was another electronics firm located here, but the fear of the riots has driven many good businesses from the area."

The initial production staff consists of 15 women, most of whom have been trained by local vocational rehabilitation agencies, Turner explains.

"Some of them," says Turner, "even have prison records, and, as far as I know, we're the only ones who'll hire them."

The company's first contract followed an agreement initiated by David Packard, Hewlett-Packard's chairman. "There are a number of Hewlett-Packard instruments and modules that are produced only in small numbers," explains Turner; "we'll get them in kit form, assemble them, and test them to H-P standards."

Planning growth. Although the company is seeking all forms of electronics subcontract work, Palo Alto Electronics, according to Turner, hopes to start manufacturing its own devices and instruments within a year. Products will include compact voltage regulators, along with a line of standard, plug-in power supplies; solid state induction heating devices; seven-channel solid state monitor scopes, and a series of heavy-duty plating machines controlled by silicon controlled rectifiers.

North American Rockwell's new subsidiary, Nartrans, will train and employ up to 175 ghetto residents

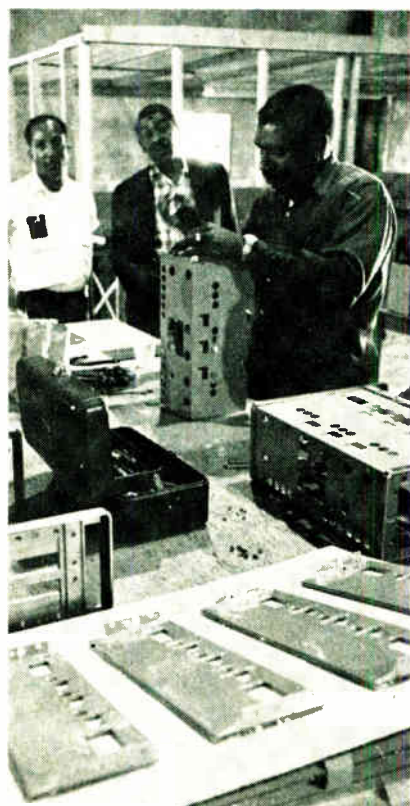

Training program. Negro-owned electronics plant offers jobs to ghetto residents.

from the Watts area. The subsidiary will run an 82,000-square-foot plant in the city's central district. Nartrans will teach its employees such skills as drawing, typing, drafting, and keypunching.

Meanwhile, IBM has leased an eight-story building for the production of computer cables and harnesses. The company expects to start production at the new plant within the month with a workforce of 100. By 1969, IBM hopes to employ at least 300 people at the Brooklyn plant.

Solid state

Si₃N₄ for MOS FET's

The inherent instabilities of metal oxide semiconductor field-effect transistors (MOS FET's) have kept them from winning as much acceptance among designers as junction FET's. But now the Semiconductor Products division of Motorola Inc. says it has overcome MOS FET instabilities by using silicon-nitride passivation. And the new technique carries a bonus: better yields.

Motorola officials think the development will increase MOS FET's share of the FET market to 40% or 50% in a few years from about 20% now.

The greater yields and volume from silicon-nitride (Si₃N₄) passivation will help cut MOS FET prices. A.E. Corwith, Motorola's product planner for radio-frequency devices, noting that the average price has dropped to about \$2.50 from \$3.75 last year, says the new technique should reduce the price to about 75 cents by 1970-71.

At least for now, however, the new devices will be priced the same as conventionally passivated MOS FET's. Robert Borawski, manager of high-frequency product operations, says the new technique has doubled yields at the test-probing stage of manufacturing.

Silicon-nitride passivation techniques for MOS FET's have been in development at Motorola for about two years. The Bell Telephone Lab-

oratories is credited with discovering that such passivation would work on MOS FET's, but Motorola spokesmen say it is the first to introduce it as a standard production technique for all discrete lines.

Borawski says that silicon-nitride passivation was first phased into production last November and that all Motorola's MOS lines are now using the technique. F.P. Huntsinger, product marketing group manager for r-f and FET devices, is replacing all MOS FET stocks of distributors with the new devices.

Unwelcome migrants. With MOS FET's, as with any MOS device, most of the electrical activity takes place within a few microns of the surface. Thus any surface contamination in the bulk silicon, especially sodium ions, changes the electrical characteristics. At high temperatures the ions can become highly mobile and migrate through both the usual silicon-dioxide passivation layer and the gate. The migrating ions invert p material to n material, causing undesirable conduction at zero bias.

Huntsinger notes that this usually occurs with a positive voltage on the gate, so the process can be reversed by putting a negative voltage on the gate.

Corwith points out that this instability has limited MOS FET's mainly to switching functions. "These are on-off circuits in which you don't have to worry about threshold voltages," he maintains. "Now, we can offer a MOS FET that operates over a broad temperature range, and the designer won't have to worry about shifts."

Storage temperatures for the devices have typically been from -65 to +175°C; the new passivation technique will extend the upper limit to 200°C. MOS FET's were formerly pretty touchy around 200°C because of the speed of sodium-ion migration, Huntsinger says, and military people want reliable operation at 200°C. Until now, he says, customers have been small-volume, sophisticated buyers who knew how to deal with the sensitivity of the transistors. Corwith says demand for cascode-type devices has increased, especially since RCA introduced the 3N140 MOS FET last year.

"This type of device with nitride passivation," he says, "would really go big for the front ends of television sets or f-m radios—or communications gear generally. You can apply automatic gain control to one gate and a signal to the other and get good dynamic range."

A secret. In discussing how silicon-nitride passivation is accomplished, Borawski will say only that the technique allows the use of all existing processes. How and when silicon nitride is applied is the key to the process and is proprietary, but silicon dioxide is still used on top of the bulk silicon, because silicon nitride would cause an excessive surface charge at the semiconductor-insulator interface.

The silicon dioxide also serves as a photo mask. A cross-section of one of the new MOS FET's before etching would show a bottom layer of bulk silicon covered with silicon dioxide. On top of that comes silicon nitride, and finally a top layer of silicon dioxide used as an etch resist, which is removed before metalization.

Silicon-nitride thickness is within the 1,000-angstroms range, Borawski says. The compound has twice the dielectric constant of silicon dioxide, according to Motorola engineers, so the silicon nitride is made thicker than the silicon-dioxide layer to preserve the device's capacitance characteristics. These are specified to be the same as those of a MOS FET passivated with silicon dioxide only.

Motorola engineers say silicon nitride gives a far more uniform passivation layer than silicon dioxide, whose thickness varies from a few hundred angstroms to whatever maximum is desired—possibly about 750 angstroms. Silicon nitride's uniformity allows Motorola to specify a gate-to-source breakdown of 50 volts for a typical device, compared with 15 volts for a MOS FET passivated with silicon dioxide.

Over Niagara. Some of the new components have completed 1,000-hour life tests. Roger Lohn, manager of silicon transistor reliability engineering, says n-channel and p-channel devices have been tested with both positive and negative bias

Flicker-Free CRT Storage

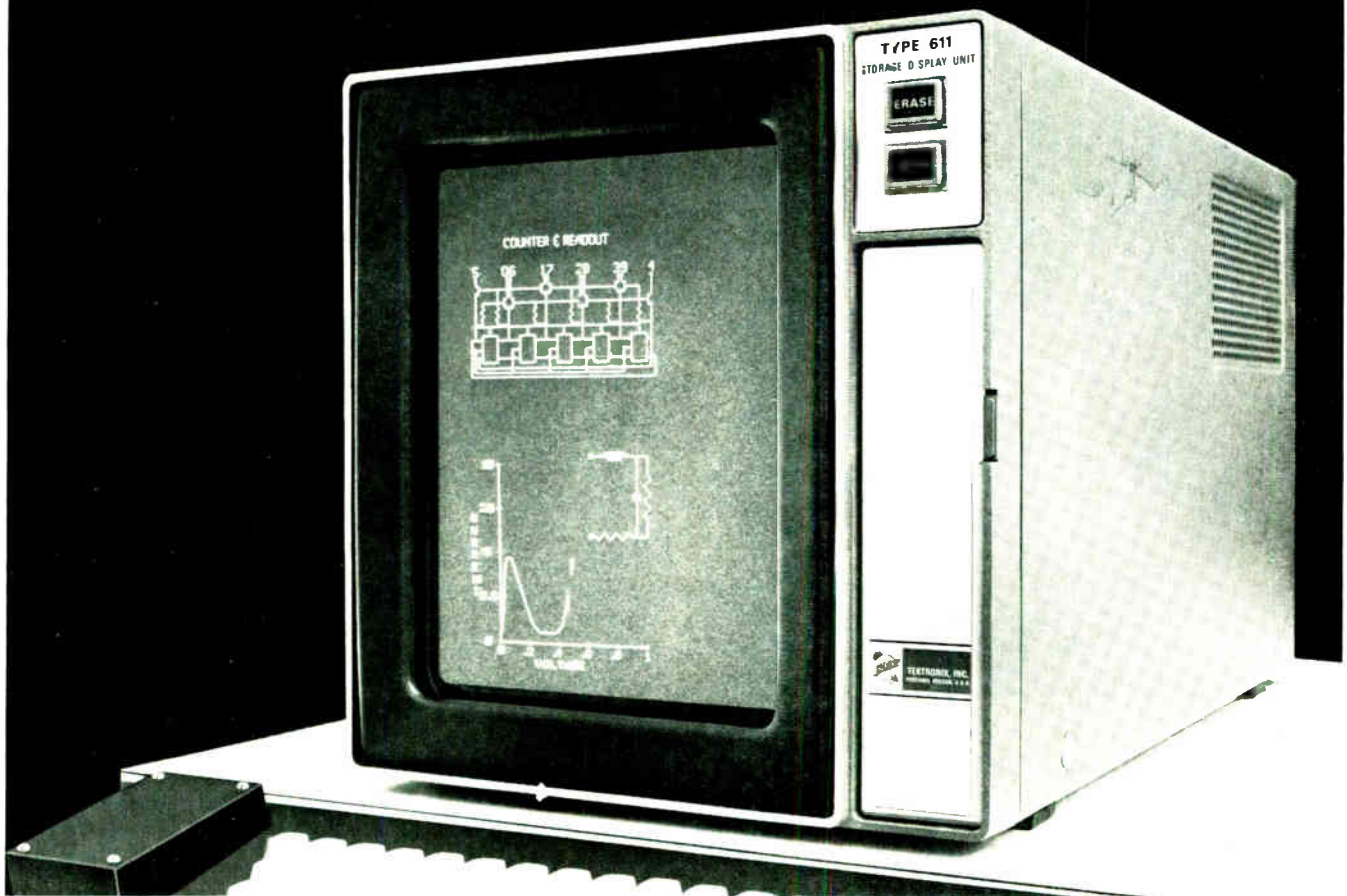

NEW Storage Display Unit from TEKTRONIX.

The Type 611 Storage Display Unit is designed to function as a computer console and remote terminal readout device. With X, Y, and Z inputs provided by peripheral equipment, this new instrument presents flicker-free displays of alphanumeric and graphic information without refreshing.

The Type 611 Storage Display Unit features an 11-inch, magnetically deflected, bistable storage display tube. This new storage tube offers high information density and excellent resolution on a 21-cm x 16.3-cm screen. 4000 characters, 90 x 70 mils in size, may be clearly displayed with good spacing. Resolution is equivalent to 400 stored line pairs along the vertical axis and 300 stored line pairs along the horizontal axis. Dot settling time is $3.5 \mu\text{s}/\text{cm} + 5 \mu\text{s}$ and dot writing time is $20 \mu\text{s}$. Time required to erase and return to ready-to-write status is 0.5 seconds. Operating functions are remotely programmable through a rear-panel connector. A "Write-Through" feature provides an index to the writing beam position without storing new information or altering previously stored information.

Type 611 Storage Display Unit \$2500

U.S. Sales Prices FOB Beaverton, Oregon

For a demonstration, contact your nearby Tektronix field engineer or write: Tektronix, Inc., P.O. Box 500, Beaverton, Oregon 97005.



Nearly half of our effort devoted to development and production of specialized components



... part of the Tektronix commitment to technical excellence

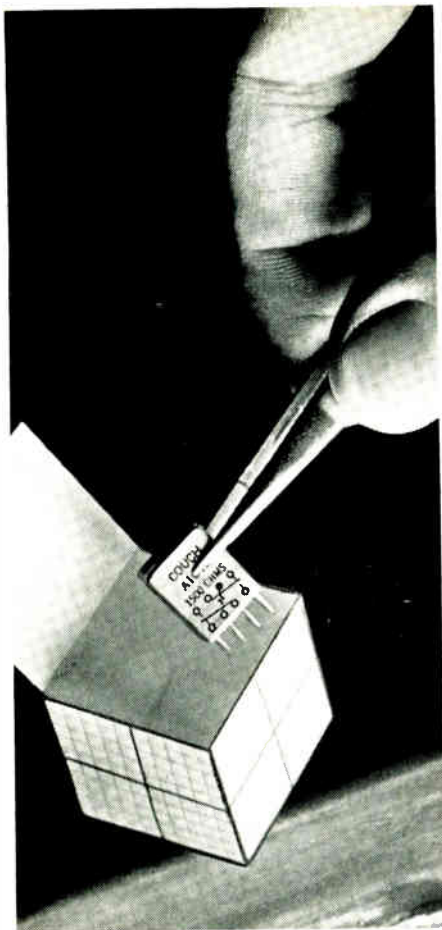

Couch 2X 1/7-size relays meet MIL-R-5757D/19 in 1/25th of a cubic inch

The new, third generation Couch 2X relays solve switching problems where space and weight are critical. Thoroughly field-proven in electronic and space applications. Relays are delivered *fully tested*. Additional screening tests available at your option.

	2X (DPDT)	1X (SPDT)
Size	0.2" x 0.4" x 0.5"	same
Weight	0.1 oz. max.	same
Contacts	0.5 amp @ 30 VDC	same
Coil		
Operating Power	100 mw 150 mw	70 mw 100 mw
Resistance	60 to 4000 ohms	125 to 4000 ohms
Temperature	-65°C to 125°C	same
Vibration	20 G to 2000 Hz	same
Shock	75 G, 11 Ms	same

Broad choice of terminals, coil resistances, mounting styles. Write for detailed data sheets.

RUGGED ROTARY RELAYS  Dynamically and Statically Balanced

Couch
1894

COUCH ORDNANCE INC.

3 Arlington St., North Quincy, Mass. 02171
Area Code 617 CYPRESS 8-4147
A subsidiary of S. H. COUCH COMPANY, INC.

conditions at greater than the rated gate voltage. Most of these tests are at high temperatures, 200°C for long-term reverse-bias tests and for short-term storage and gate-bias tests.

Corwith likens the reverse-bias test to "running a power boat over Niagara Falls." The Motorola engineers say that all conventionally passivated MOS FET's would probably fail the reverse-bias tests at high temperatures after 50 to 100 hours. The failures may not be catastrophic, but characteristics would drift as much as 20%, which can mean failure in a circuit.

A number of companies have been using silicon-nitride passivation of MOS FET's in the laboratory. Westinghouse Electric Corp., for example, uses it for integrated circuits in the Goldilox process. The Westinghouse Molecular Electronics division introduced the devices at the IEEE Show in March.

Besides silicon nitride, the Westinghouse IC's get a top layer of silane glass that is said to hermetically seal the device, and company officials think this development may help crack the military's resistance to plastic-packaged semiconductors.

Avionics

Breaking the logjam

Under heavy pressure from the airlines, which are impatient with the delays that have plagued the Aeronautical Services Satellite, Comsat is drawing up a new request for proposals (RFP). It will call for a very-high-frequency system for communications only, but the request could break the logjam that has delayed the program for four years.

Reasons for the delay were first technical, then financial, and finally political. Advances in the state of the art now make it possible for the power requirements to be achieved. And the airlines, in desperate need of satellite service, are reportedly ready to put up a sizable share of the satellite's development costs in advance. The only hang-ups that

remain are in the realm of international politics. But even these are likely to be overcome.

Report withdrawn. Airlines and airframe manufacturers are even now studying copies of a carefully leaked report on the satellite, prepared for Comsat by the Philco-Ford Corp.'s Space and Re-entry Systems division. A description of the report was scheduled to be delivered at the American Institute for Aeronautics and Astronautics' Communications Satellite Systems Conference in San Francisco in April, but was withdrawn at the last minute at Comsat's insistence.

Based on a nine-month study of transoceanic traffic density anticipated in the 1970's, plus communications and navigational requirements and technical forecasts, the report makes two main points:

- Within 10 years, it will be necessary to reduce the separation between aircraft lanes from the present 120 nautical miles to 60.

- It will take 10 years to get an L-band surveillance system operational. Vhf, the other proposed frequency range will not be accurate enough to maintain 60-mile separations.

Privately, Comsat is very happy with the report—even though Comsat's commitment to Intelsat, the international consortium of which it is the biggest member, dictated that the report be kept confidential. But the enthusiasm seems strange in view of the fact that the report cautions that if no immediate action is to be taken to develop such a satellite, the need for it would become acute before the equipment became available.

A risk. The fact that Comsat is now writing an RFP suggests that it is willing to let the airlines rush in where it fears to tread. Comsat, as a member of Intelsat, must consider foreign objections to a vhf system. The airlines can override those objections. But in so doing, they would run the risk of a French complaint to the International Telecommunications Union. France could argue that an Atlantic vhf satellite would violate its frequency rights.

The Comsat RFP will ask for four communications channels, each

The Raytheon 703 Computer finds its own faults. And you can fix them while you're having coffee.

The \$15,000 IC Systems Computer with \$1.50 spares. The 703 is the only small systems computer built like third-generation million dollar computers. The CPU is wire-wrapped with plug-in IC's on one motherboard. A unique CPU self-diagnosis solves its own circuit malfunctions. When necessary, you can simply plug in a new IC. Time: about 30 seconds. Cost: about \$1.50

The 703 is like larger computers in other ways. It's a 16-bit machine with 1.75 μ sec cycle time and is expandable from 4K to 32K. It has word and byte manipulation instructions, a real-time priority interrupt system and hardware multiply-divide option. Software includes an executive and real-time FORTRAN IV.

The 703 interfaces with all standard peripherals, including disk. Beyond this, Raytheon Computer offers extensive and compatible IC analog instrumentation like the MINIVERTE™ (multiplexer, sample-and-hold, and A/D converter) assembled from IC analog and digital modules. The complete line of modules and hardware is available for easy system design to your particular requirements. And you can even order your system wire-wrapped, to save you more time, money and sweat.

You'll find our sales engineers compatible too. Write or call today. Ask for Data File C-151. Raytheon Computer, 2700 South Fairview St., Santa Ana, Calif. 92704. Phone (714) 546-7160.

**Raytheon Computer...
the company that gives
you a break.**

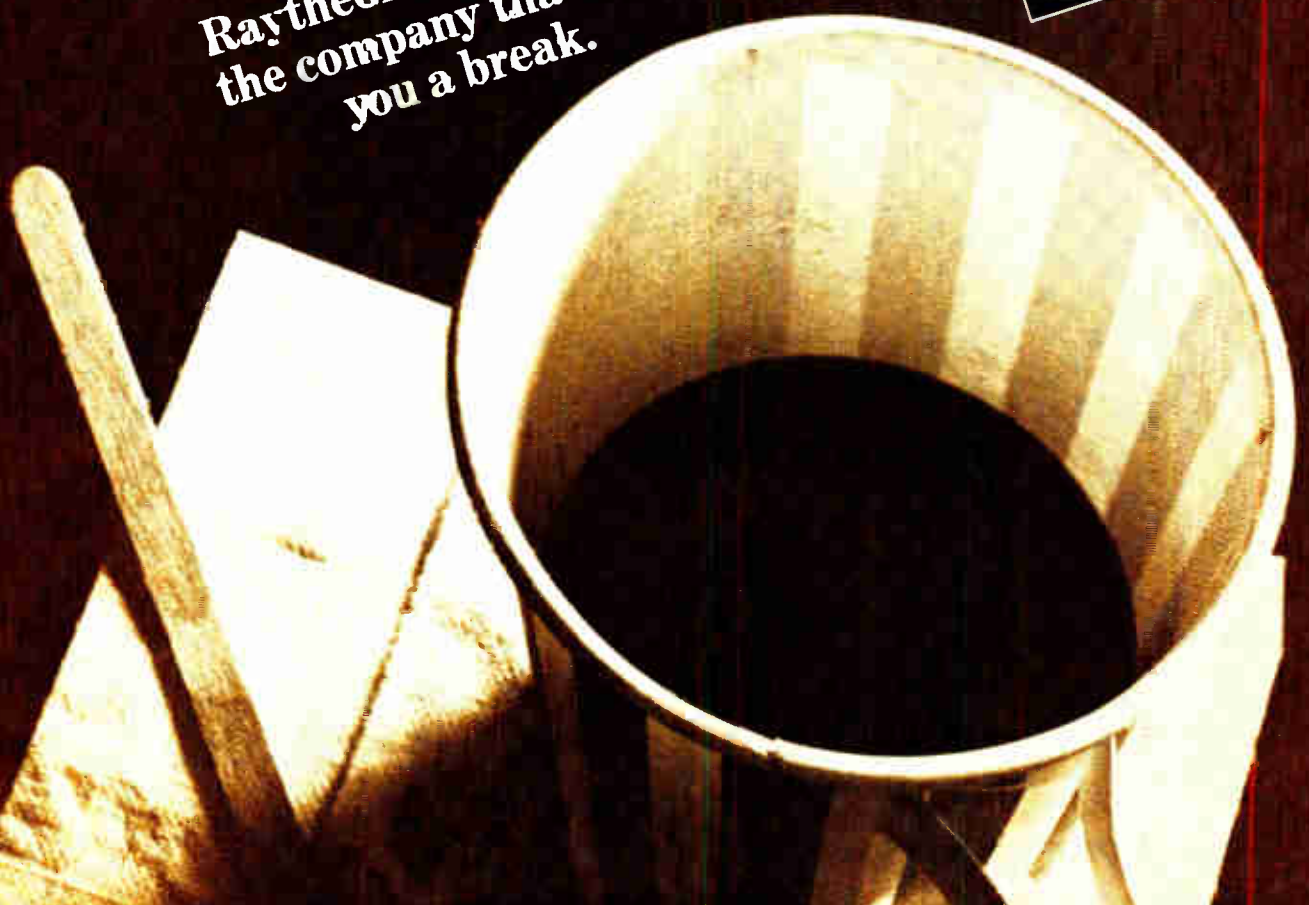

AMPERITE

Thermostatic DELAY RELAYS

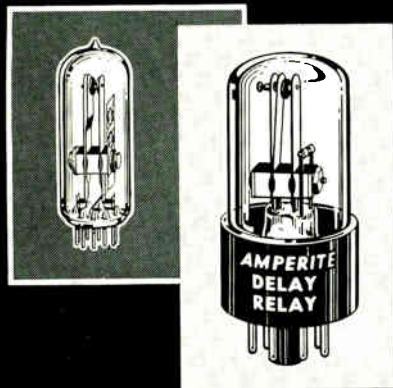

Only a glass seal offers true hermetic sealing
 ... assuring maximum stability and life!

Delays: 2 to 180 seconds . . . Actuated by a heater, they operate on A.C., D.C., or Pulsating Current . . . Being hermetically sealed, they are not affected by altitude, moisture, or climate changes . . . SPST only—normally open or normally closed . . . Compensated for ambient temperature changes from -55° to +80° C. . . Heaters consume approximately 2 W. and may be operated continuously . . . The units are rugged, explosion-proof, long-lived, and—inexpensive!

TYPES: Standard Radio Octal, and 9-Pin Miniature.
 List Price, \$4.00

PROBLEM? Send for Bulletin No. TR-81

AMPERITE

BALLAST REGULATORS

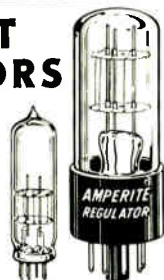
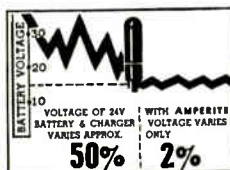

Hermetically sealed, they are not affected by changes in altitude, ambient temperature (-50° to +70° C.), or humidity . . . Rugged, light, compact, most inexpensive . . . List Price, \$3.00.

Write for 4-page Technical Bulletin No. AB-51

AMPERITE

600 PALISADE AVE., UNION CITY, N.J.

Telephone: 201 UNION 4-9503

In Canada: Atlas Radio Corp., Ltd.,

50 Wingold Ave., Toronto 10

with an effective radiated power of 200 watts. Presumably, it will be modeled on the Aeronautical Radio Inc. (Arinc) communications satellite specification that was to be approved at the May 22-24 Airline Electronic Engineering Committee meeting in Miami.

Arinc, the company that among other things handles transoceanic communications via high-frequency radio, reportedly suggested informally to Comsat that it issue the RFP now.

Two years ago, the requirement for four 200-watt channels in a 300-pound satellite (the Thor-Delta booster's weight limit), frightened away most satellite makers. One manufacturer likened the power-weight constraint to "putting an elephant in a Piper Cub." Since then, improvements in both solar cells and antenna design have boosted d-c power and antenna gain so that effective radiated power has been quadrupled.

Severe restraints. But mere technical ability to handle satellite communications isn't reason enough to put up a communications satellite. The guidelines set forth in the Philco study posed severe restraints on the nature of the service to be offered.

The guidelines: that two services be considered, communications only and communications plus surveillance; that two frequency bands be considered, vhf (118-136 megahertz) and L-band (1,540 to 1,660 Mhz); that a service, once initiated, be sustained for a period of 10 years or more to be applicable worldwide; that an operational surveillance system in either frequency band be limited to that band worldwide; that any system providing surveillance must also provide communications in that band (although it may also offer communications in the other band); that both vhf and L-band services are permissible in the same satellite, and that a communications-only system would not be worthwhile in L-band.

The guidelines led Philco engineers to suggest five possible types of service:

1. The vhf communications only.
2. Vhf communications with surveillance through Omega or iner-

tial navigation plus position determination from the communications satellite.

3. Vhf communications plus vhf surveillance.

4. Vhf communications plus L-band communications, with L-band surveillance.

5. L-band communications plus L-band surveillance.

The only compatible configurations for adjacent ocean areas are the first and second or the first and fourth, Philco indicates. The RFP now being written by Comsat is for the first service. A timetable drawn up by Philco indicates that the earliest possible date that a vhf-only communications service could begin operational evaluation would be early 1970, and that it would not be fully operational until mid-1971.

Deadline for the SST. Development of aircraft equipment, and installation on the world's airlines, would not permit the fourth service until mid-1977 to early 1979, the Philco report says. By that time, the supersonic transports, which will have even smaller separation requirements, will be in operation.

It was because of this time constraint that the airlines are pressuring Comsat for at least a start on the aeronautical satellite. The first satellite may cost from \$5 million to \$15 million, with replacements running from \$3 million to \$5 million each; and because of the political questions, the first bird may well go over the Pacific rather than over the more heavily traveled Atlantic. The Japanese and the Australians aren't as opposed to a vhf system as are the French.

The first system will reportedly drop the microwave link between ground station and satellite that had been a part of previous proposals, and use vhf for all links.

First AIDS

After spending several years studying various plans to install a complete malfunction system aboard aircraft, the Air Force finally got around this month to awarding a contract for a demonstration model.

A team led by the Garrett

FAST WARM UP IN A
PRECISION CRYSTAL
STANDARD IMPORTANT?

*Sulzer Labs' new 5C does 5 parts in 10¹⁰
within 12 hours!*

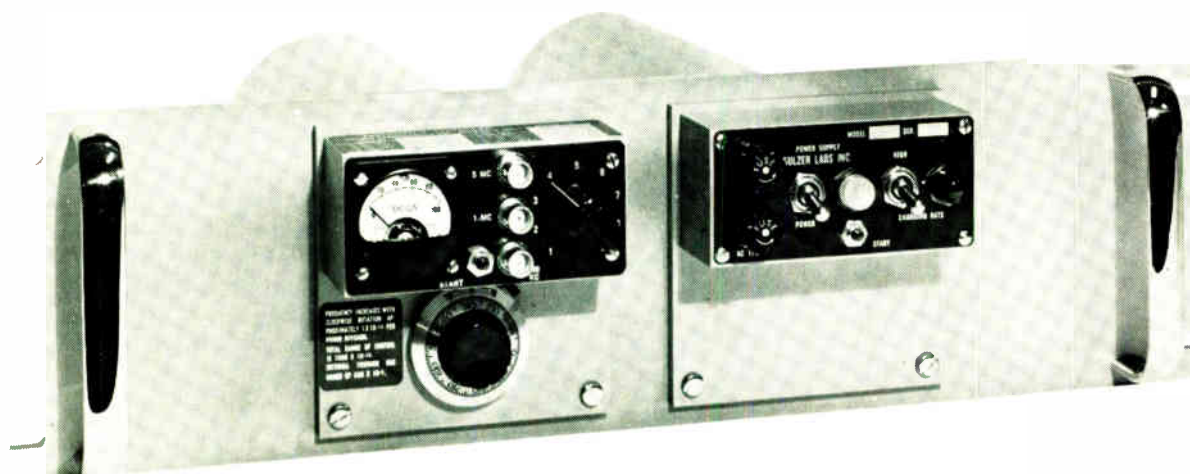

Temperature stability — better than
1 part in 10¹¹ per degree centigrade.

Typical ultimate aging rate — 1 part
in 10¹⁰.

. . . plus all of the features that you
need in a quality crystal standard.

*Write for additional information on
the Sulzer Labs 5C Crystal Standard.
TRACOR, Inc., 6500 Tracor Lane,
Austin, Texas 78721 • 512-926-2800.*

IA-116

Specialized instruments from **TRACOR** *to meet your specific needs*



Size 11
Resolver
State-of-
the-Art
is off
the shelf
at AEI

Series 11RP Compensated Computing Resolvers are designed for a variety of Aerospace, Military and Aircraft applications where size, weight and accuracy are critical parameters. Exceptional output accuracy has been achieved by unique design of compensator coils to null out effects of temperature and other operating variables.

TYPICAL SPECIFICATION
Computing Applications

- Functional accuracy $\pm 0.1\%$
- Perpendicularity of axis $\pm 5'$
- Transformation ratio balance $\pm 0.1\%$
- Total null voltage 1MV/V

Data Transmission Applications

- Angular accuracy $\pm 3'$
- Total null voltage 1MV/V

Complete literature is available by writing Instruments Group, American Electronics, Inc., 1600 East Valencia Drive, Fullerton, Calif. 92634, (714) 871-3020, TWX 910-592-1256

Instruments Group **AEI**
AMERICAN ELECTRONICS INC.

Please rush checked item(s)

- 22-Page Resolver Design Manual
- New 4-Page Resolver Technical Catalog

NAME _____

TITLE _____

COMPANY _____

ADDRESS _____

CITY _____ STATE _____ ZIP _____

Corp.'s AiResearch division and comprising Serendipity Associates for mathematical modeling and the McDonnell Douglas Corp. for air-frame modifications will begin a 26-month, \$1.93 million program to develop an Airborne Integrated Data System (AIDS) for bombers. The prototype will be tested on a B-52H.

The AIDS group, at Wright-Patterson Air Force Base in Ohio is aiming the development effort toward the retrofitting of B-52 and B-58 aircraft now flying as well as future bombers. The Advanced Manned Strategic Aircraft (AMSA), being pushed hard by the Air Force and some members of Congress, is a likely candidate, said one Air Force official in the AIDS group.

Red tape. The delay in going ahead with a prototype system stemmed partly from the current tightness in R&D funds. Also, according to an Air Force engineer, the program had to be looked at by just about everyone in the service.

AIDS will monitor all subsystems on the B-52H as well as the airframe. It will determine when a malfunction occurs and decide what unit must be replaced, thus reducing maintenance time.

The companies will spend \$500,000 for an initial 12-month study to sort out critical subsystems, identify line-replaceable units, and select the key parameters to monitor, according to Paul L. Ford, leader of the group. The companies will decide whether AIDS should use a central on-board computer or put the monitoring and decision-making elements at the equipment to be tested. They will also decide how to display and record the data.

After the Air Force approves the initial study phase, the Garrett team will begin designing the system.

AIDS vs. CITS? Once the Garrett system is designed, however, there may be some question whether it should go into the AMSA. For about three years, IBM and the Autonetics division of the North American Rockwell Corp. have been working on a Central Integrated Test Subsystem (CITS)

for the AMSA. [IBM's approach to this system, called automatic self-test, was described in *Electronics*, May 13, p. 78.]

Autonetics and IBM are also working on the avionics for the proposed bomber, but their CITS work includes the nonavionics subsystems. CIT's philosophy calls for doing as little system testing as possible, picking out the parameters to be tested that can give the most data.

Donald E. Pieratt, the AMSA project engineer in charge of monitoring the CITS work, says one study shows that CITS can reduce the number of test points on the hydraulics system by 30% to 70%. "We're testing functions, not black boxes," he said, adding that the idea is to "eliminate the brute-force approach of testing everything." Failure-mode effect analyses are now being run, he said.

Garrett is apparently working to integrate its system into the B-52H with equipment already on hand—an approach that could limit the system if it ever competes against CITS for AMSA.

Government

Patent bill not pending

The Federal budget squeeze and the President's decision not to seek a new term have killed patent reform legislation for this session of Congress.

Commerce Department lobbyists, acting for the Patent Office, have stopped pushing to get a bill voted before the new Congress is seated in January.

The budget-tightening steps will prohibit the hiring of the 60 examiners the Patent Office wanted. Many of the reforms advocated by the Patent Office depended on this increase to speed processing of patents. And the office may not even be able to replace any of its 1,200 examiners who may leave.

President Johnson's decision not to seek re-election is slowing patent reform because the top four officials at the Patent Office are Presidential

Precise control... high spectral efficiency...long life...

the reasons David W. Mann Co. chose EG&G Xenon Flashtubes for new IC photomask production system.

David W. Mann Co., a division of GCA Corporation and a leader in the production of precision IC photomask equipment, uses an EG&G pulsed Xenon Flashtube in their new Type 1480 Photorepeater. The EG&G Xenon Flashtube is the only one that meets the stringent operating requirements demanded by the Mann system. It provides precisely controlled variable intensity and flash duration needed for accurate exposure. It assures high spectral efficiency and energy balance to aid in razor-sharp edge definition. And, EG&G pulsed Xenon Flashtubes are designed to provide the longest, most reliable life.

EG&G specializes in the design and manufacture of complete pulsed Xenon Flashtubes for use in such diverse applications as laser stimulation, phototypesetting, flash photolysis, photocopying, stroboscopy, warning beacons, oscillograph recorders, and medical research. EG&G pulsed Xenon Flashtubes are available in linear, air and liquid cooled, helical, U-snaped, and coaxial type designs. Envelope materials are quartz, soft glass, or hard glass. Energy inputs range from 0.1 to 25,000 watt-seconds with operating voltages from 400 volts to 3.5 KV. Light output encompasses the entire visible spectrum and extends into UV and IR ranges.

EG&G also supplies chokes, trigger transformers, power supplies, and trigger modules. We'll even design any special flashtube circuitry your application may require.

If you'd like more information on EG&G pulsed Xenon Flashtube Systems, or for that matter on any of our products, such as thyratrons, krytrons, spark gaps, transformers, chokes, trigger modules, photodiodes, picoammeters, or light instrumentation, write: EG&G, Inc., 166 Brookline Avenue, Boston, Mass. 02215. Telephone: 617-267-9700. TWX: 617-262-9317.

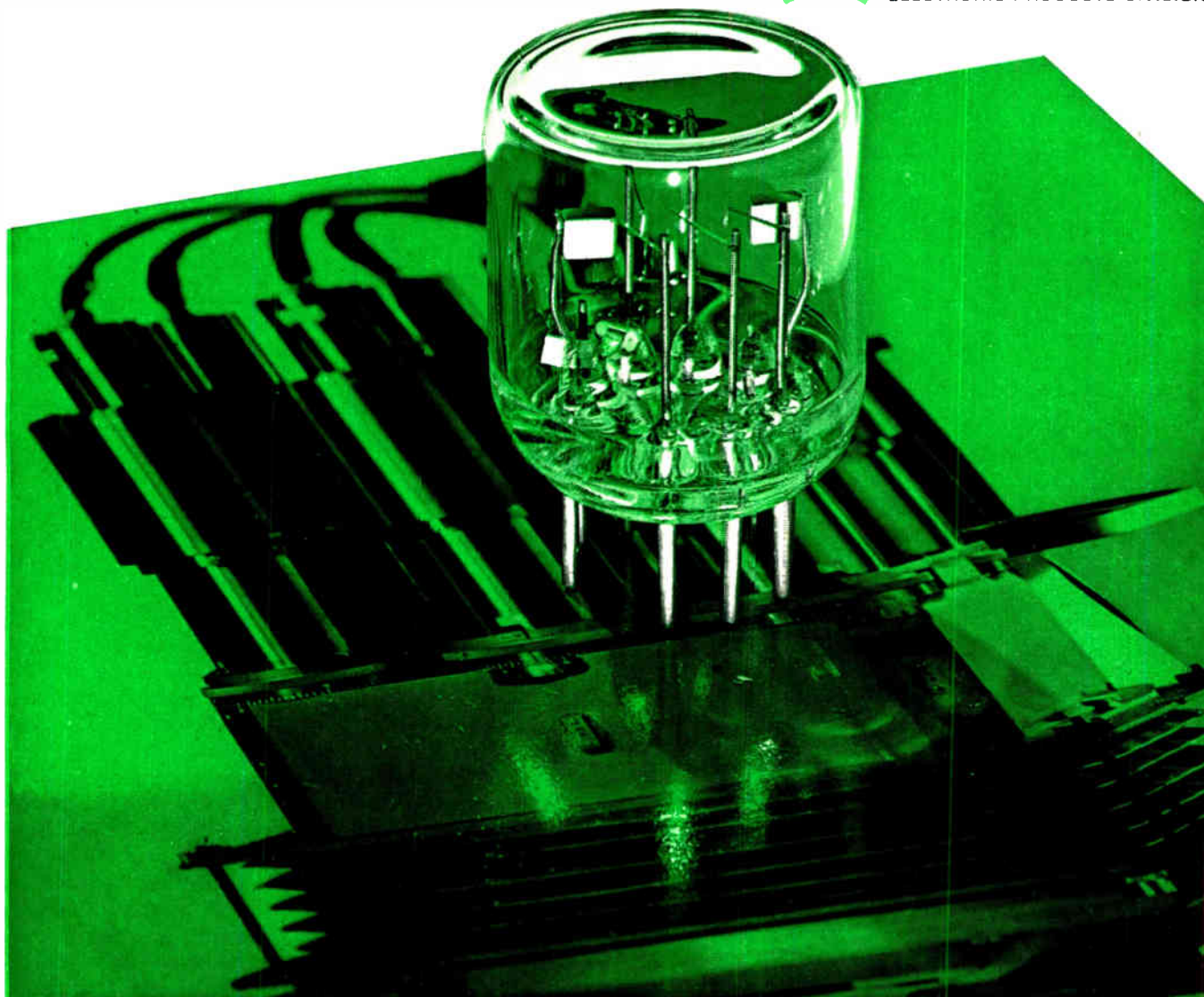

NO HOLES IN OUR LOGIC.

MicroVersaLOGIC is the complete and compatible line of IC logic cards for today's demanding applications. Designed by systems engineers for systems engineers, **µVL** is the practical line, easy to use, tested and proven in countless applications.

And MicroVersaLOGIC cards right now cost you no more than ordinary cards.

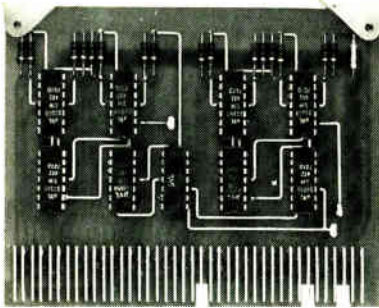

In addition to conservative 5 mHz rating, the complete MicroVersaLOGIC line gives you all the ready-made building blocks you need for anything from a register to an entire digital system, including plug-in power supplies and a broad line of system assemblies and accessories.

Let us send you our 40-page catalog, which will give you all the facts and possibilities of the MicroVersaLOGIC line. Just tell us who and where you are.

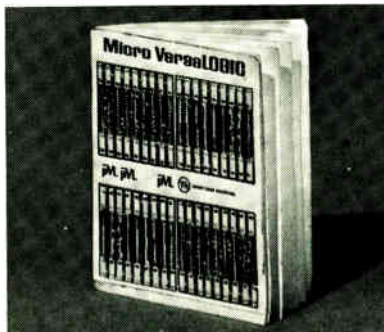

 **varian data machines**
a varian subsidiary
1590 Monrovia Ave., Newport Beach, Calif 92660
(714) 646-9371 TWX (910) 596-1358

appointees who are sure to change if a Republican President is elected and may change if another Democrat is elected.

Different ideas. A new commissioner and his lieutenants may have different ideas about patent legislation. The commissioner under a Republican administration, for instance, may be expected to favor the reform bill being offered by Sen. Everett M. Dirksen (R., Ill.) and the American Bar Association.

In view of the new developments, Sen. John L. McClellan (D., Ark.), chairman of the subcommittee on patents, trademarks, and copyrights, has decided to hold off pushing his compromise bill through the Senate. The McClellan bill, which now has Administration support, doesn't differ significantly from the Dirksen bill.

However, legislative experts now say it should be relatively easy to get Congressional action early in the new session.

While Congressional action on patent reform is held up for at least six months, the Patent Office is trying to streamline some of its operations.

Time savings. It's setting up a procedure that gives inventors some protection similar to a patent and avoids some of the cost and time associated with the issuance of patents.

To get protection under the new procedure, the inventor must waive all rights to royalties, but he's assured that no one else will be awarded a patent for the same thing.

Under this "protective publication," the inventor applies to the Patent Office just as though he was asking for a patent. An abstract of 200 words or less is printed in the Patent Office's Official Gazette, and drawings are inserted in the search files. The usual Patent Office examination isn't made, although examiners make sure that the abstract isn't advertising, frivolous, scandalous, against public policy or subject to national security controls.

Patent Office officials don't expect the defensive publications procedure to help individual inventors. Its value will be to large companies who have no desire to sell royalties,

but must be assured that no one else can ever be awarded a patent for their developments.

Open season. The effective date for the new procedure was May 1, but a six-month open season has been declared. Anyone with a patent application on file will have until Nov. 1 to decide if he would like to shift his application from the regular patent file to the defensive publication file, if the first action on the patent hasn't been taken.

For all new patent applications, the applicant will have eight months to decide if he wants to go after a patent or defensive publication. When an application is accepted for defensive publication, it will immediately become public, and the abstract will be published in the Official Gazette.

It now takes the Patent Office two to four years to process a patent application. Defensive publication can go into effect in weeks.

Patent Office officials predict that as many as 10% of the 90,000 applications it receives annually may be filed for defensive publication. This would significantly reduce the agency's work load.

Patent lawyers, however, predict that the procedure will be rarely used. Lawyers who profit from full patenting fees, are unlikely to advise its use. Two earlier attempts have been made to short-cut patent procedures, the lawyers point out, and both failed because they weren't used.

Space electronics

Starry-eyed mosaic

The tracker that locked onto the star Canopus to guide the Mariner spacecraft to Venus last year used an image-dissector tube as its photosensitive element. The tube weighed about 12 ounces and dissipated about 0.15 watt. Now researchers at the Autonetics division of the North American Rockwell Corp. have developed a solid state photomosaic device they believe can do the same job—but with sub-

Military and aerospace equipment demands proven reliability. That's why Dytronic specifies capacitors of MYLAR®

Dytronic Co., Inc., of Columbus, Ohio, makes Primary Phase Angle Standards that are used all over the world in all temperature extremes. Each precision unit uses 70 capacitors of MYLAR* polyester film. Why MYLAR? Here's what Paul Ryan, President, had to say: "Military and major aerospace facilities cannot afford equipment failure, and we must be sure of the

components we select. Hundreds of our Primary Phase Angle Standards are in military usage, and we are not aware of a single failure of capacitors of MYLAR...we feel that this is evidence of both the reliability and performance of MYLAR and we find that capacitors of MYLAR cost about the same as those made of paper."

MYLAR offers thermal stability from -70° to $+150^{\circ}$ C., plus excellent resistance to most chemicals and moisture.

MYLAR has high tensile and dielectric strength. Its unexcelled thinness has enabled manufacturers to reduce size and weight in capacitors.

Isn't that reason enough for you to consider capacitors of MYLAR in your designs? For additional information write to Du Pont, which offers the thinnest, most versatile range of capacitor dielectric materials available. Address: Du Pont Co., Room 5852B, Wilmington, Delaware 19898.

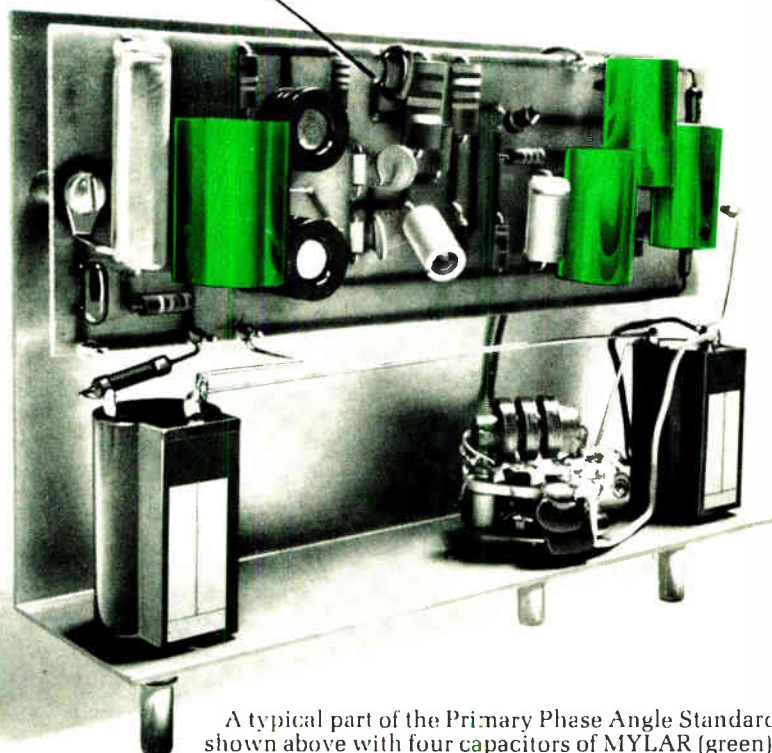
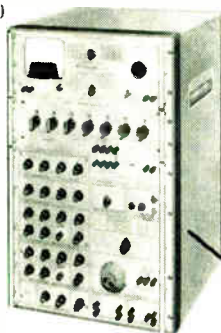

A typical part of the Primary Phase Angle Standard shown above with four capacitors of MYLAR (green).

Design Brochure Cable Assemblies & Coaxial Delay Lines



This 4-page brochure details specifications and multiple design possibilities of cable assemblies and coaxial delay lines. It also follows through with evaluation, production and test procedure info.

For your copy write or phone:
Times Wire & Cable, Wallingford,
Conn. (203) CO 9-3381

Circle 502 on reader service card

Seamless Metal Tube Sheathed Coaxial Cable



Times' new semiflexible coaxial cable with seamless aluminum tube sheath conductor is available in two standard versions:

1. ALUMIFOAM[®] — Foam polyethylene dielectric where pressurizing isn't practical.
2. ALUMISPLINE[®] — Air dielectric where pressurizing is practical. These cables offer more isolation—at 80 < db more than ordinary coax. Uniformity average — VSWR 1.1 or less. Stability — 10 times better. Lower loss — 30% less. Pulse reflection — less than 1%. Less distortion. Also avail. in solid dielectric and high temp. constructions.

For prices & data write or phone:
Times Wire & Cable, Wallingford,
Conn. (203) CO 9-3381

Circle 503 on reader service card

Connectors for Solid Sheathed Cable

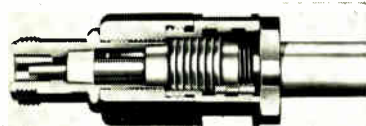

Only one step required to use the new one-piece TIMATCH[®] Connector with its own pat. CoilGrip[®] clamp—just unpack it. Its reusable and repeated assembly and disassembly does not impair either the RF or physical characteristics of the connector or the cable. Available in all popular sizes and fits all metal tube sheathed coaxial cables.

For prices & data write or phone:
Times Wire & Cable, Wallingford,
Conn. (203) CO 9-3381

Circle 504 on reader service card

Electronics Review

stantial savings in size, weight, and power.

The experimental device made by Autonetics' navigation systems division is 25 mils square, weighs about as little as a conventional integrated-circuit chip of that size, and dissipates only about 1 microwatt when a 1-volt bias is applied to the mosaic with light intensities of about 10 foot-candles per photosensitive element.

The device could perform other pattern-recognition tasks, says James Cross, a member of the technical staff in the electro-optics research group. But he notes that since the group's primary function is to support the navigation systems division, "we're pretty much star-tracker oriented" in thinking about applications. And Cross doesn't rule out the possibility that such a photosensitive mosaic could represent a step toward a solid state vidicon.

Better idea. Autonetics engineers decided four years ago that commercially available materials—particularly cadmium sulfide—weren't good enough to give them the solid state photomosaic they sought. Cross says cadmium-sulfide vacuum-deposition techniques had to be refined before the mosaic could be made.

Cadmium sulfide is the photosensitive material in the thin-film sandwich that has evolved as the latest version of the light sensor. The compound changes resistivity when light strikes it, and Cross calls it the ideal detector for visible light from 0.51 to 0.65 micron.

Most of the photoconductors used today have surface-effect detectors, as did those produced by Cross' group in the early stages. Such a device is made by vacuum-depositing a layer of cadmium sulfide 2 to 3 microns thick on a glass substrate, and then vacuum-depositing metal electrodes on top of the cadmium sulfide. The small areas between the electrodes in which the cadmium sulfide is exposed serve as the photoconductor.

Too small. "But because an electrode is needed on the device surface for each cadmium-sulfide detector," Cross explains, "we ended up with only tiny slits of

photoconductors. The detectors were good but the active areas were too small, so we switched from surface-effect detectors to volume-effect detectors."

The substrate is still glass. A layer of tin oxide about a half-micron thick is vapor-phase-deposited on it and photo-etched to form lines a half-mil wide, with half-mil spacing to yield electrode lines on 1-mil centers.

A layer of cadmium sulfide 2 to 3 microns thick is vacuum-deposited on the first electrode layer. Then comes a diffusion step in which gaseous impurities are used to give the cadmium sulfide its photosensitivity. After doping, a top layer of tin oxide a half-micron thick is vapor-phase-deposited and photo-etched to form electrode lines perpendicular to those in the bottom electrode layer.

Still slow. An active detector is formed at each intersection of electrodes, giving a much higher density of active regions than could be achieved with the surface effect. The narrowest center-to-center space for surface-effect detectors at Autonetics was about 3 mils. The latest mosaics have 25 electrode lines per side, for a total of 625 active light-sensing elements.

For one of the photomosaic devices, the typical current across the load resistor varies from three times 10^{-12} ampere when the detector is in the dark to three times 10^{-8} in bright light.

The device hasn't yet been tried in a system. But preliminary testing showed uniform sensitivity of about $\pm 10\%$ and a response time of about 100 milliseconds when illuminated with light intensity varying between 0.1 and 1 foot-candle. Cross says surface-effect detectors have response times in the tens of milliseconds, and he's confident that the Autonetics photomosaic sensor will reach the same levels.

Gain in gain. Photoconductor gain in the cadmium sulfide is far better than that possible with present junction devices used as light sensors, Cross maintains. Gains of 100 to 200 are being reported for junction devices; the solid state photomosaic could de-

Silicon Power PNP... of Age in '68



RCA PNP Type	NPN Complement	V _{CEO} (sus) V	I _C A	P _T W	H _{FE}		Pkg
					@ -50 mA	@ -500 mA	
2N5415	2N3440	-200	-1	10	30-150	--	TO-5
2N5416	2N3439	-300	-1	10	30-120	--	TO-5
2N5322	2N5321	-75	-2	10	--	30-130	TO-5
2N5323	2N5320	-50	-2	10	--	40-250	TO-5

Featuring high-voltage capability up to 300 volts. This is the year of PNP at RCA as the industry's silicon power leader sets up a program that successfully meets your product needs for complementary designs in commercial, industrial, and military applications.

For example, do your high-speed switching and linear amplifier designs need PNP power with 300-volt capability? Check RCA's new 2N5415 and 2N5416. If you're working with audio amplifier and industrial power switching circuits, try 2N5322 and 2N5323. They're "beefed-up" versions of the popular 2N4036.

There's more coming in '68. Look for low-cost silicon power PNP audio devices with gain up to 1.5 A, P_T of 5 W—at economy levels that really count. Watch, too, for types with I_C = 5 A and P_T = 45 W... and voltage handling capability up to 75 V. Details from your RCA Representative or your RCA Distributor.

Technical data from Commercial Engineering, Section CN5-4, RCA Electronic Components, Harrison, N.J. 07029.

RCA

RECORDERS

SINGLE AND MULTICHANNEL COMPACT ANALOG MODULES

These compact, one to six channel recorders offer the reliability and accuracy demanded by industrial and medical applications.

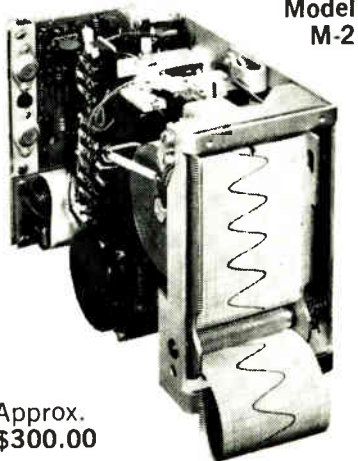

Model
M-2

Approx.
\$300.00

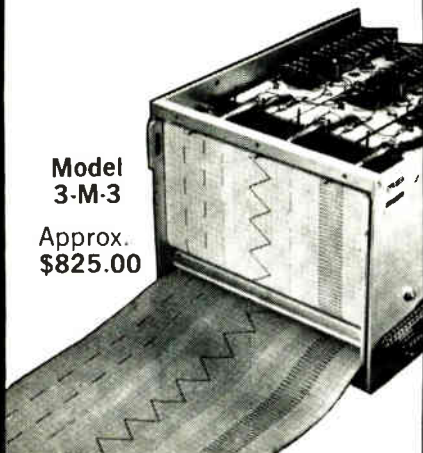

Model
3-M-3

Approx.
\$825.00

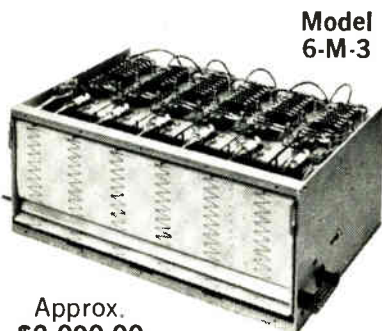

Model
6-M-3

Approx.
\$2,000.00

We offer you our unique capabilities in the custom recorder field. Write or telephone for complete information on the modules best suited to your needs.

MFE

MECHANICS FOR ELECTRONICS
Telephone (617) 864-8130
152 Sixth St., Cambridge, Mass. 02142

Electronics Review

liver a gain of a million.

Cross says his group might be able to produce prototype devices in six to eight months. Although no formal proposals have been made, Autonetics will be looking for Air Force or NASA sponsorship. The group hasn't spent much time on readout techniques, but in the earlier surface-effect work, an array of metal oxide semiconductor transistors was used as an amplifier in the detectors' package.

APT to grow

Ever since 1963, when the Tiros 8 satellite began automatically transmitting pictures of the earth's surface to ground stations, scientists have been using the pictures to predict weather, chart hurricanes, and perform meteorological research. The prime users have been NASA, the Air Force, and the Environmental Sciences Services Administration (ESSA).

But now, interest in Automatic Picture Transmission is booming in other quarters, and both the space agency and industry see a growing market—ranging from schools to local television stations—for APT equipment. And do-it-yourselfers in the U.S. and elsewhere have been building their own APT receiving stations for as little as \$400.

The major reason for the growing interest is NASA's long-term commitment to APT; the agency will definitely be using the system for at least another five years, and some officials say the period could lengthen to a decade or more. The system is used on all ESSA and Nimbus satellites. And NASA plans to relay APT pictures from future orbiting Nimbus satellites to Applications Technology Satellites so that a Nimbus on one side of the globe can pass pictures to the ATS on the other side. Right now, plans call for relaying Nimbus E pictures to the ATS-F satellite.

Hobby project. Several weeks ago, a publication entitled "Constructing Inexpensive Automatic Picture Transmission Ground Stations" was released by NASA's Of-

fice of Technology Utilization. The book details how an APT station can be put together for \$500. Charles H. Vermillion, the author and man in charge of ground-system development at the Goddard Space Flight Center, has already received dozens of inquiries on the book. The information-seekers have ranged all the way from firms considering production of APT equipment to a home for the aged that has already started work on its station. Vermillion points out that there are many jury-rigged APT stations already in operation.

One such station was built by John B. Tuke, a Scot, who made an APT receiver out of surplus parts. Another APT station has been built in Turkey, and a man in Princeton, N.J., put one together using a rolling pin for a picture drum.

John Stein, sales manager for Muirhead Instruments Inc., Mountainside, N.J., a commercial producer of APT equipment, says there's a hot market in surplus Navy AN/TXC-1 transceivers, which talented amateurs can convert into APT receivers.

Commercial APT equipment is also being produced by several other firms. The Electro-Mechanical Research Corp., College Park, Md., has begun selling sets for \$5,000, while others, including Muirhead, have been producing costlier equipment for the Air Force and NASA.

Vermillion says at least a half-dozen firms are readying APT equipment—ranging from kits for hobbyists to sophisticated \$5,000 to \$10,000 units—for the market. Muirhead's Stein says that the Navy is shopping for shipboard APT equipment and that colleges are starting to buy the equipment to train meteorologists. Muirhead delivered one system to the University of Miami and expects other college orders shortly.

Fishing market. Stein, who concedes that the competition will be getting tougher, says the market is large and includes tv networks, foreign governments, private research organizations, and fishing fleets.

Vermillion says, "Space photog-

You have probably replaced your High Voltage Rectifier Tubes for the last time.

New Silicon "Doorbell" Rectifier Modules just plug in, last almost forever, save you lots of money, and let your equipment keep its cool.

- Modules with current ratings from 0.67 amps to 6.6 amps, and PIV's from 2.5 KV to 15 KV just screw together to permanently replace over 50 different types of tubes. Ratings to over 100 KV.
- Reduce cabinet temperatures by 60°F to 100°F — prolong the life of your other components.
- Reduce power consumption by eliminating filament.
- Designed by high-voltage engineers who built in tremendous capacity to handle overload surges.
- Only void-free, whiskerless, controlled avalanche, individually fused-in-glass Unitrode diodes are used.

For fast action, call Fred Swymer COLLECT at (617) 926-0404



Send for Bulletin N-130A. It's 16 pages of really complete specs, diagrams, pictures, cutaway drawings, application dope, case histories, and direct replacement data. CHECK 315 ON INQUIRY CARD.

UNITRODE®

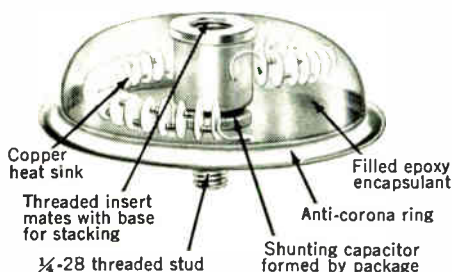



introducing a new versatile phase angle voltmeter for production test

North Atlantic now brings you a new group of solid-state Phase Angle Voltmeters for precision phase-sensitive nulling applications in production test and ground support equipment.

Designed for versatility, they feature measurement of the vector components (including phase) of complex AC signals at 4 discrete frequencies from 30Hz to 20KHz. Operating frequencies can be rapidly changed without calibration by direct plug-in replacement of frequency modules and harmonic rejection filters. Full operating performance is maintained over a bandwidth of $\pm 5\%$ and with 10X signal input overload.

The unit illustrated is the Model 214A. Also available are the Model 214B with reference isolation, and Model 214C with both signal and reference isolation.

North Atlantic's sales representative in your area (see EEM) can tell you all about these units as well as other Phase Angle Voltmeters and Phase Sensitive Converters.



NORTH ATLANTIC industries, inc.
TERMINAL DRIVE, PLAINVIEW, NEW YORK 11803 • 516-681-8600

raphy is here to stay and APT is the beginning. Nations will need APT equipment to train interpreters and meteorologists." He adds that when earth resources and other photographic satellite programs get off the ground, the APT system will have trained a whole generation of interpreters.

Currently, the Government of Mexico is using APT equipment on loan from NASA to establish a national meteorological system. The Mexicans plan to look at all the uses of APT and determine how pictures can be distributed nationally so that current data can be used by fishing fleets, airports, local weather stations, and scientists. According to Vermillion, the Mexican studies may be crucial in showing other countries the value of massive dissemination of space photography.

Computers

Automated technician

"Lab technicians are scarce, and engineers aren't willing to stand still for the sort of tedious, cautious, and often repetitious work we need in today's research," says Harold Posen. This is one reason why solid state physicist Posen has developed what he called an automated scientific laboratory at the Air Force Cambridge Research Laboratories, Hanscom Field, Mass.

An example of the sort of experimentation going on at his lab is Posen's own work on the atomic structure of materials. With the aid of X-ray diffraction, he is trying to come up with statistics showing the probability of a given element occurring in a given place in a molecule or crystal lattice.

Patient computer. But the method of diffraction analysis Posen is forced to use is one which takes a long time, extremely sensitive X-ray detectors, and a great deal of data reduction. Since computers have plenty of patience, are as accurate as their programs, and process data rapidly, Posen obviously opted for a computer to run the lab.

"This is one of the latest steps in the evolution of the computer as a scientific tool," he says. "At first, digital computers were treated like giant desk calculators; then as omnivorous data-collection devices. Now, we hope to develop what is almost a symbiotic relationship between the computer and the experiment."

The IBM series 1800 computer Posen is using is programmed to keep a running check on experimental results, to rectify errors in the experimental set up, and to signal when something unusual occurs. It controls nearly every facet of the experiment, and all the experimental equipment.

Time saver. As an example of how it might rectify an otherwise wasteful experimental error, Posen says that the computer could monitor the number of X-ray impacts at a scintillation counter and either add or subtract attenuation from the path of the X-ray beam to bring the count closer to predicted levels. Thus, much valuable experimental time could be saved.

In Posen's X-ray diffraction experiments, the experimental conditions are unchanged for times ranging from minutes to hours, leaving the computer little to do but note the counting rate from the X-ray detector. Thus, Posen is planning to add more experiments to his super-technician's workload as quickly as programming can be developed and proven.

Among Posen's candidates for automation are: Hall-effect measurements, mass spectrometry, electron-spin resonance, and crystal structure analysis in semiconductors.

Communications

Sound out of sight

Anyone who has watched a Barbra Streisand television special knows that she doesn't stand still for long. Her activity makes it tough to keep a microphone both close to her and out of the picture.

After a Streisand tv special about three years ago, the Columbia

The only thing this discriminator lacks is serious price competition

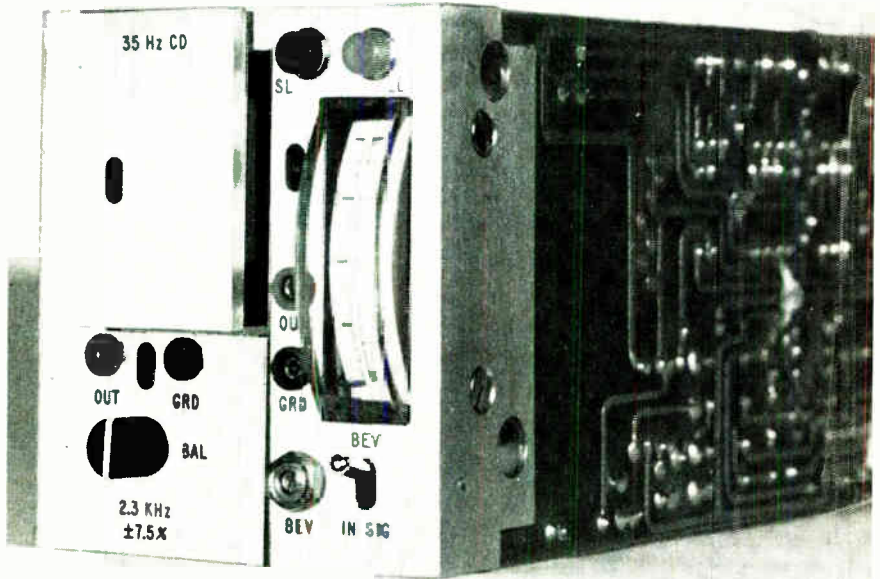

The SCD-5 phase lock loop discriminator represents the latest addition to the DEI F/M product line. Switchable loop filter bandwidths for operation within MI's of one and five are supplied as standard filters. Constant time delay input filter provides data distortion less than 0.3% at DR = 5.

The small size of the modules permits five discriminators to be installed in a standard 19-inch housing assembly with a panel height of only 3½ inches. Over 50 discriminators can be accommodated in a standard 72-inch rack.

Using all silicon transistor and IC circuitry, the SCD-5 is available with digital output and is priced under \$850.

For further information on what the SCD-5 has to offer, contact the DEI sales office nearest you.

Defense Electronics, Inc.

PRODUCERS OF
DEI AND NEMS-CLARKE
EQUIPMENT



DEI
RESEARCH
DEVELOPMENT
MANUFACTURING

ROCKVILLE, MARYLAND (301) 762-5700; TWX: 710-828-9783; TELEX: 089602 • LOS ANGELES, CALIFORNIA (213) 670-4815 • INTERNATIONAL: ROCKVILLE, MARYLAND • CABLE: DEIUSA; INTELX: 64102 • Sales Representatives: Rome, Italy • London, England • Madrid, Spain • Tel Aviv, Israel • Bromma, Sweden • Rijswijk, Holland • Köln, Germany • Paris, France • Zurich, Switzerland • Oslo, Norway

only
the ALL-NEW 620 & 640
BELL GAUSSMETERS
offer
you these combined features
for Increased Versatility



MODEL 620 GAUSSMETER
 All solid-state automatic battery take-over in case of line power failure. Available from stock.

MODEL 640 GAUSSMETER
 All solid-state—1000X scale expansion—5V AUX output standard.



1



PRECALIBRATED PROBES—new imaginative design permits changing probes without recalibration (probe and instrument are programmed).

- 2** Temperature Compensated Probes— with $\pm 0.005\%$ / °C temperature dependence make possible a stability not formerly available in medium priced gaussmeters.
- 3** High Accuracy— 0.5% FS to 10 kG and 1.0% FS to 30 kG (possible without reference to cal magnet).
- 4** True Zero & Field Polarity— measure direction as well as magnitude.
- 5** Probe Versatility— 15 standard transverse, axial & multi-axis probes.
- 6** Direct & Independent meter readout of ac and dc fields.
- 7** 1 V Calibrated Output at front panel output jacks.
- 8** 1000X Scale Expansion with automatic zero center meter reading in incremental mode (640 only).



All this and a Gold Seal Probe Guarantee, too!

"BELL PRODUCTS for PLANNED PROGRESS"



F. W. BELL
 F. W. Bell, Inc.
 1356 Norton Ave.
 Columbus, O. 43212
 Ph. 614-294-4906
 TWX: 810-482-1716

Broadcasting System—having spent more than it liked rehearsing boom-mike technicians without eliminating boom shadows in the picture—decided that it needed a better wireless lapel microphone.

Because those now available operate at about 27 megahertz, their signals are especially susceptible to interference from fluorescent lights, automobile ignitions, and other sources. Also, fidelity is poor because the mikes transmit only a part of the full audio bandwidth, making the relayed voice sound muffled or distorted.

Uhf and f-m. CBS brought the problem to Microwave Associates Inc., Burlington, Mass., which devised a relatively high-fidelity, broadband wireless transmitter, called Portamike, operating in the ultrahigh frequency range at 950 Mhz.

According to Jack Fackler, the project engineer, the Portamike is a miniature microwave broadcasting station with a range of about a quarter of a mile. It uses frequency modulation for freedom from interference and transmits almost the whole range of voice frequencies: 50 to 12,500 hertz, ± 0.5 decibels—a frequency-response curve flat enough to meet most hi-fi standards. Audio distortion is only about 1% at most.

The Portamike is all solid state, with discrete components, and runs for a minimum of six hours on its battery pack. Fackler's engineers have designed it to operate from 13 to only 8 volts to keep it on the air despite failing batteries.

Lowering the boom. The 10-ounce, 6-inch mike resembles a cigarette package with a couple of mike inputs and a radio-frequency output connector at one end.

Only a prototype has been delivered, but it has performed so well that CBS has ordered six more, and Donald W. Smith, sales engineering manager of Microwave Associates, sees a market in the making. "If the quantity materializes, we might well make them a regular part of our product line," he says.

Although there would be competition from the wireless mikes selling at \$500 to \$1,000, Smith fig-

These are the sketches

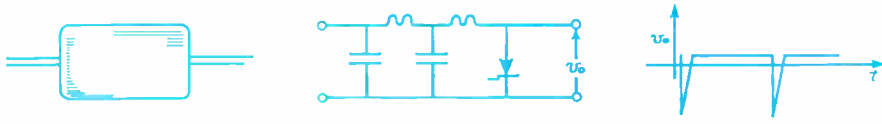

that solve the problems

that bug the designers

who are looking for

frequency multipliers.

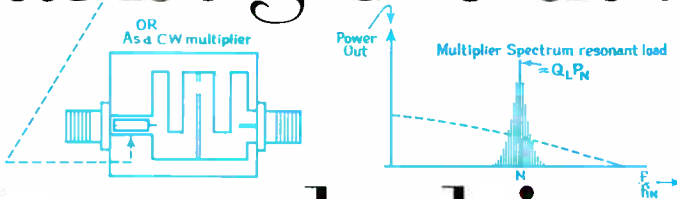
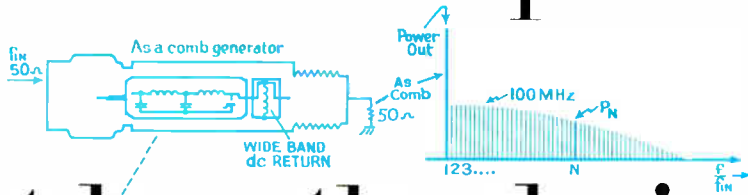

You don't have to buy individual diodes and spend valuable time fiddling with various configurations to get the performance you need in a CW multiplier. The new Hewlett-Packard SRD modules are easily and efficiently transformed into CW frequency multipliers when taken from a resistively terminated circuit and terminated in a resonant circuit. Simple, fast and economical. The sketches above tell the story.

At the top is HP's coaxial microwave comb generator module (50 ohm). The second line shows the module driven by an oscillator/amplifier of either 100, 250, 500 or 1000 MHz, resulting in a "comb" spectrum when terminated resistively. P_n is indicated in dark blue.

The bottom sketches show what happens when the SRD module is terminated in a resonant circuit. The P_n line simply becomes the original P_n increased by $\approx Q_L$. The resulting resonant spectrum is shown at the right.

Simple?

For receiver applications, testing systems, ECM, radar, airborne systems, surveillance systems—the versatility

of the HP 33002 family gives you new simplicity in a time-saving, money-saving module to meet your harmonic generation needs. Miniature size and rugged, all-solid-state construction gives reliable performance, at 4 input frequencies, with or without connectors.

Your local HP field engineer can provide you with additional technical details and specifications. Application Note No. 920, Frequency Multiplication With Step Recovery Diode Circuits, tells the whole story. Or write Hewlett-Packard, Palo Alto, California 94304; Europe: 54 Route des Acacias, Geneva.

01715



SOLID STATE DEVICES

Only the best
panel meters have
dual slope integration



actual size

API's new digital panel meter has it—which means the meter maintains its $\pm 0.1\%$ accuracy (DC voltage) over long periods of time. Erroneous signal transients are eliminated also.

There are other digital panel meters, but this one has an exceptional combination of attributes. It doesn't flicker annoyingly. It counts fast and it reads fast, so that you are always seeing an up-to-the-split-second signal.

API's digital meter not only looks pretty, but its required panel space is only 3 inches high and 4½ inches wide. It has no "iceberg" configuration behind the panel. Standard ranges begin at 0 to 20 microamperes DC and 0 to 200 millivolts DC.

List price: \$320.00

Bulletin 61 has full details

api
INSTRUMENTS CO.

CHESTERLAND, OHIO 44026 • (CLEVELAND - 216) 729-1611 • TWX: 810-427-9230
In Canada: Oshawa, Ontario • (416) 576-1541

Electronics Review

ures that Portamikes offer enough performance to warrant a higher price. How much higher will depend on the market. "We need to sell at least 200 to 300 of these devices to get our price down into the \$2,000-to-\$3,000 range," says Smith.

He's optimistic about such a market, having received many requests for information in the past month or so from broadcasters. In discussions with prospects, Smith says, he has found that the Portamike might allow studios to cut production costs by doing away with boom mikes entirely.

Smith isn't limiting his efforts to tv. Stage productions and possibly even films are also on his list.

For the record

Precursor. The first NASA test and training satellite (TTS-1) re-entered the atmosphere this month, ending its five-month mission. The tiny satellite gave NASA a chance to completely check out the manned spaceflight network for the forthcoming manned Apollo missions.

TTS-1 was used with the new unified S-band equipment for a series of complete simulations of manned missions. Another TTS will be launched shortly.

Stitched. The Singer Co. and the General Precision Equipment Corp. have signed a merger agreement and are awaiting the word from the stockholders.

Takeover. Pending stockholder approval, TRW Inc. will take control of Clevite Corp., Cleveland, a maker of electronic assemblies, instruments, and metal products.

Better late . . . Following the Mohawk Data Sciences Corp. and Honeywell Inc., the International Business Machines Corp. has come out with its own keyboard-to-magnetic-tape units [Electronics, April 15, p. 193]. The new units are the model 50 magnetic data inscriber and the model 2495 tape cartridge reader.

Philco-Ford puts logic in a box

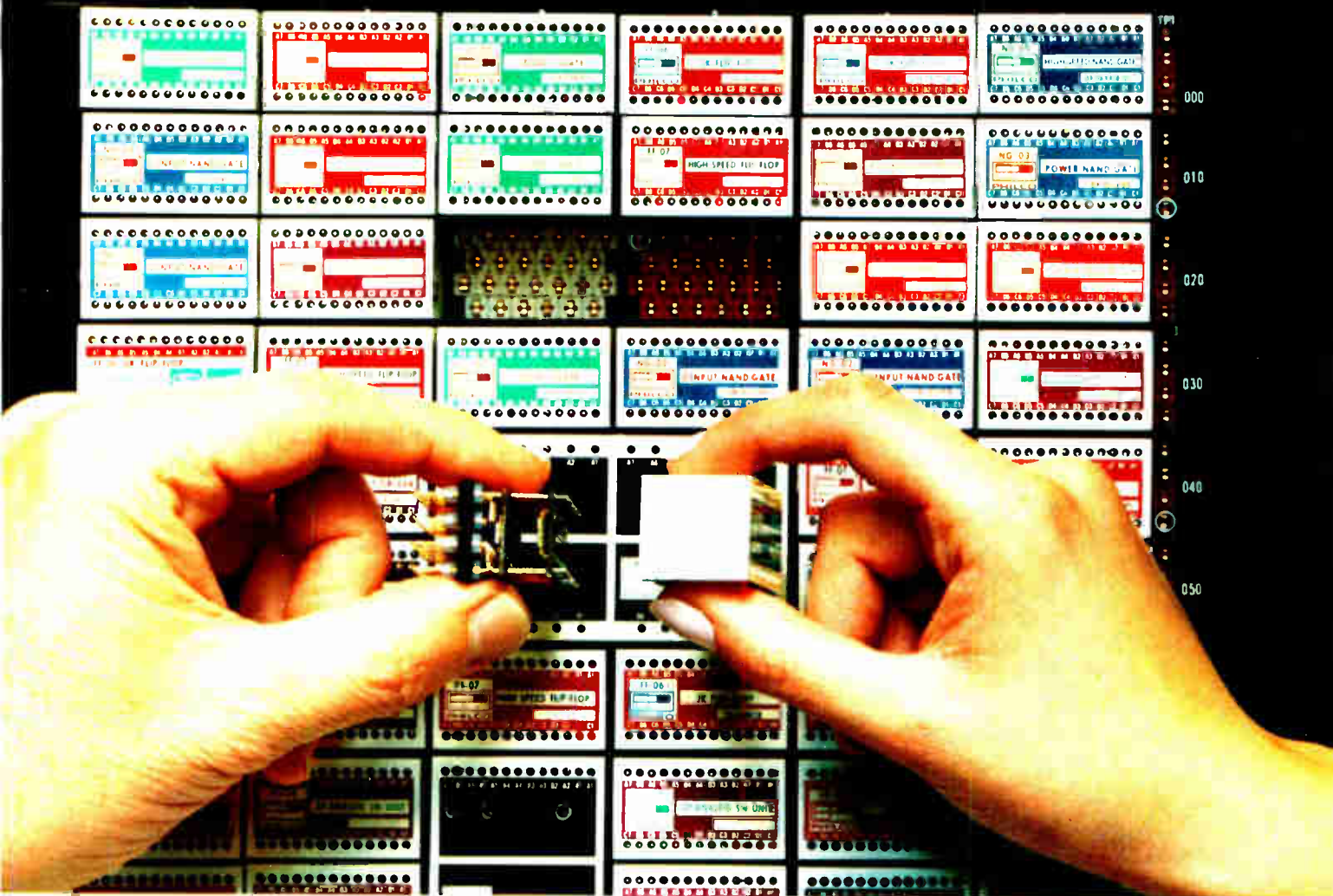

Creates a true micromodule for the IC Age

You may have worked with circuit modules before, but none like these. Unlike some others, micromodules from Philco-Ford's WDL Division make full use of advanced IC technology. They accept all existing monolithic ICs, using thin-film and discretes only where necessary. They embody functional circuits of great complexity, opening the way to far more effective systems packaging densities.

Digital and analog micromodules from WDL employ compatible logic up to 40 MHz in standard DTL, T²L and MOS circuits. They include some of the most sophisticated designs in today's state-of-the-art. Numbered among these are multiplexers, operational amplifiers, D-to-A and A-to-D circuits, and many computer interfaces. Over 200 types exist to meet your requirements.

You can service a micromodular system—from a single connector plate to complex rack-mounted arrays—with consummate ease. Clearance holes in the module cover provide front-panel access to all input/output terminals (no more trouble-shooting from the back). Color-coded labels identify logic families at a glance.

These same micromodules have performed with distinction in major military and space-support programs, notably at NASA's Manned Space Flight Center in Houston. They are proven!

For complete information, request Data File 151. Write Product Sales Manager, WDL Division, Philco-Ford Corp., Mail Station C-41, 3939 Fabian Way, Palo Alto, California 94303. Or call (415) 326-4350, extension 5981.

ADD (Automated Design and Documentation) This Philco-Ford computer-programming service generates system documentation at a cost significantly below that of hand-prepared equivalents. The computer program error checks design input data, optimizes the arrangement and sequence of wiring instructions, calculates wire lengths, provides wire lists sorted by length and by name, and maintenance lists. The program is available to all users of Philco-Ford micromodules.



PHILCO-FORD CORPORATION
WDL Division • 3939 Fabian Way
Palo Alto, California • 94303

Circle 65 on reader service card

Centralab "Little Giant" Microglass Zener Regulators

Centralab's Little Giant zeners thrive in tight spots. Their performance and competitive pricing have opened new product miniaturization possibilities in entertainment, industrial and high reliability military and aerospace applications.

Our 400 mW regulator has a zener voltage breakdown of 6.8 through 200 volts; the 1 watt from 6.8 through 200 volts; and the 1.5 watt from 6.2 through 200 volts. So the Little Giants do a big job in cramped quarters. What else? They're tough. So tough that gruelling tests of acceleration, mechanical and thermal shock, vibration, lead and body strength, temperature, humidity, salt spray and altitude leave them unscathed. Centralab's Little Giant zeners.

Real crowd pleasers.

FOR MORE INFORMATION ON DIODES,
SOLAR CELLS AND READOUT DEVICES,
WRITE CENTRALAB TODAY. THESE

CENTRALAB PRODUCTS ARE MARKETED
DIRECT TO MANUFACTURERS AND THROUGH
CENTRALAB SEMICONDUCTOR DISTRIBUTORS;
INTERNATIONALLY THROUGH GLOBE-UNION
INC. — INTERNATIONAL DIVISION.

FIT IN ANY CROWD



CENTRALAB

Electronics Division
GLOBE-UNION INC.

5757 NORTH GREEN BAY AVENUE
MILWAUKEE, WISCONSIN 53201

M-6822



*The more complex
the data system gets,
the simpler Cimron
can make it for you!*

Let's face it. You shouldn't have to be an electronics genius just to understand a system like the one shown here. You don't have to *design* the system to know what you want it to do—or to use it. That's where Cimron comes in. And the more complex the problem, the simpler Cimron can make it for you. That's what we're here for. To provide the expertise in this specialized field so you don't have to do it yourself.

The Model 1130 Production Test Applications System shown here monitors 100 channels of input signals, measures and records the data. It happens to employ a Cimron DVM with converters, a scanner, a serializer and a digital recorder. It could have been designed to solve your special problems as easily. For help, call Cimron collect at (714) 276-3200, or write Department B-112, 1152 Morena Boulevard, San Diego, California 92110.

CIMRON[®]
A Division of
Lear Siegler, Inc.



From idea to hardware in 50% less time, at 30% less cost, and with the highest degree of accuracy in the industry!

Completely eliminates heating problems associated with backplane wiring.

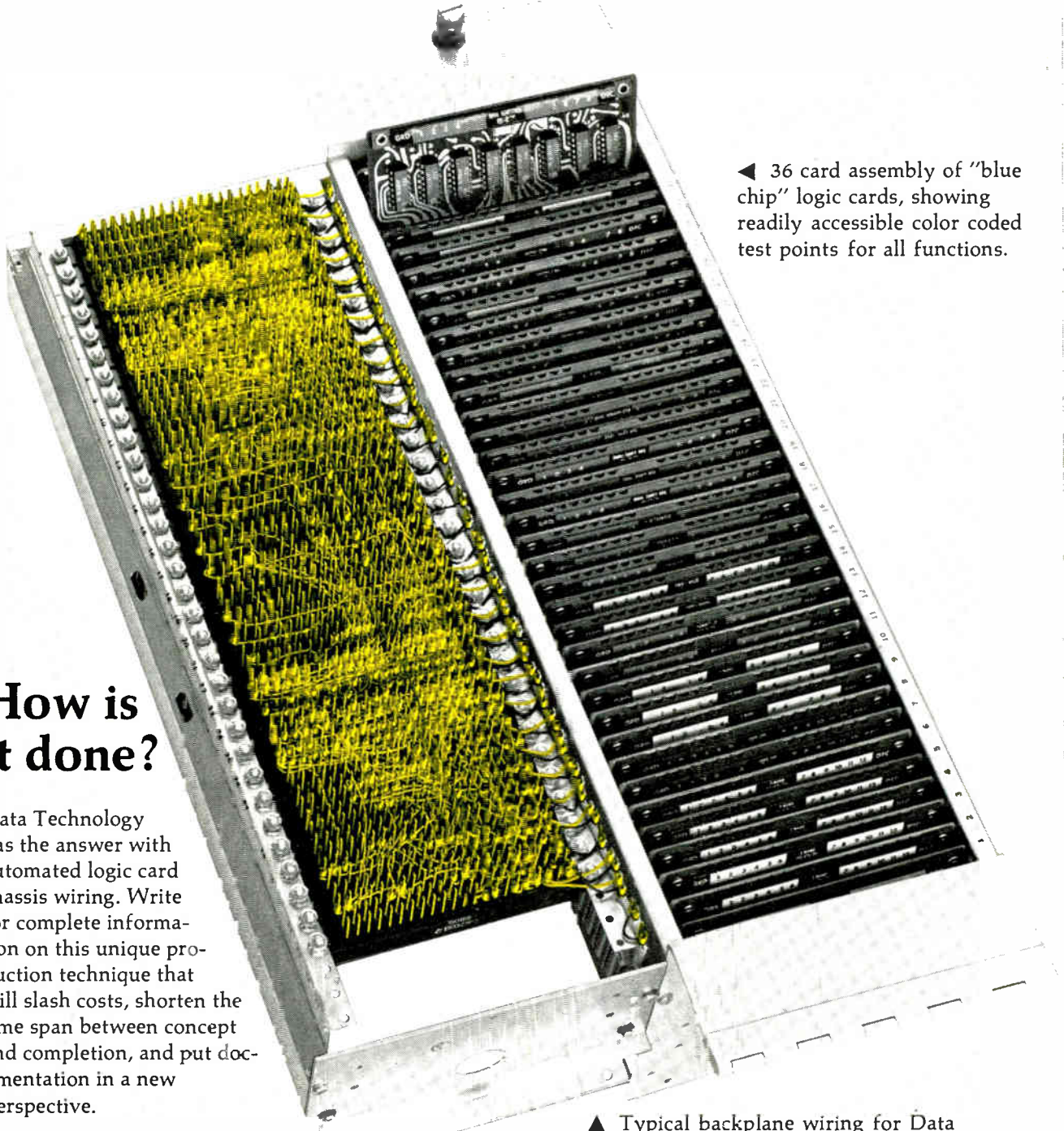

◀ 36 card assembly of "blue chip" logic cards, showing readily accessible color coded test points for all functions.

How is it done?

Data Technology has the answer with automated logic card chassis wiring. Write for complete information on this unique production technique that will slash costs, shorten the time span between concept and completion, and put documentation in a new perspective.



Automated logic card chassis wiring is another example of the total service package provided by Data Technology.

Data Technology Corporation, 2370 Charleston Road, Mountain View, California 94040. Phone (415) 964-2600, TWX (910) 379-6476.

▲ Typical backplane wiring for Data Technology's "blue chip" logic cards. Three card cages with up to 2,000 logic functions can be wired in one operation.

**From Monsanto:
130,000,000
discrete frequencies
with almost perfect purity.**



Computer-aided design and integrated-circuit construction in this new Frequency Synthesizer bring a new level of perfection to signal generation.

The new "4th generation" Model 3100A Digital Frequency Synthesizer obsoletes just about every current concept of general purpose signal sources. Pick your frequency from 0.01 Hz to 1.3 MHz in 0.01 Hz steps. The result—signal purity you can get only from Monsanto, with a stability of 1 part in 10^8 day. Other refinements include: internally supplied rapid or slow sweep and provision for

external sweep; dc coupled output permitting internally supplied offset; continuous control of output level over a 90 dB range; provision for amplitude modulation; and, in the remotely programmable version, switching time of less than 20 microseconds. Best of all, you can put this *better way* of signal generation to work for you for only \$3,950*. Call our field engineering representative in your area for full

technical details, or contact us directly at: Monsanto Electronics Technical Ctr., 620 Passaic Ave., W. Caldwell, N.J. 07006. Ph. (201) 228-3800; TWX 710-734-4334.

*U. S. Price, FOB West Caldwell, N. J.

Circle 69 on reader service card



ELECTRONICS



ARGUS NEEDED A BATTERY WITH MUSCLE ENOUGH TO ZOOM, DRIVE MOVIE FILM AND CUE PEOPLE IN— ALL AT THE SAME TIME.

MALLORY MADE IT.

WHAT CAN WE DO FOR YOU?

Argus needed a battery. A battery to take on three demanding jobs at once in the new Argus 816 automatic movie camera. A battery to drive thousands of feet of movie film at a constant rate. A battery to power a zoom lens in and out smoothly time after time. A battery that could keep a cue light burning brightly even as it was meeting these heavy current drains.

Mallory made it. The battery—a DURACELL® alkaline battery. It packs over 1800 milliamperehours of energy in its slim, "AA"-size steel container. It can maintain approximately 85% of that energy up to 2 years in storage. And it has the added advantage of being readily available at retail outlets throughout the world.

CONSTANT VOLTAGE

There's another battery in the Argus 816—

a Mallory mercury battery no larger than a dime. It wasn't that four jobs would have been too many for the hard-working alkaline battery, but that the mercury battery does the job so much better. The job: supplying steady voltage for the movie camera's electric eye system. As you can see from the graph, the mercury battery keeps the voltage steady, for two

continuous weeks under test conditions—actually, years in the operation of the camera.

OVER 1000 DIFFERENT TYPES

Chances are Mallory has the battery you need in production. Right now we're making over 1000 different types and sizes. And if we're not actually producing what you need, we'll be glad to sit down with you and design one to your specifications.

For more information, please write Technical Sales Department, Mallory Battery Company, a division of P.R. Mallory & Co. Inc., South Broadway, Tarrytown, New York 10591. Or phone us at 914-591-7000. (In Canada: Mallory Battery Company of Canada Limited, Sheridan Park, Ontario.)

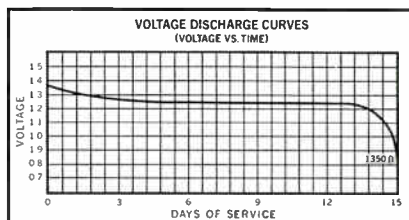

® Registered trademark of P.R. Mallory & Co. Inc.

MALLORY It's good business to do business with Mallory

Not all latching relays this small are reliable.



HL Latching Relay

This one is. Here's why.

First, the design. No other half crystal case latching relay, according to major users, can match its magnetic structure and its ability to meet the most stringent specifications.

Second, the meticulous production procedures we follow (our Intensified Control and Reliability Program) exceed industry standards. All assembly, adjusting and hermetic sealing are confined to our spacious clean room, replete with sophisticated air conditioning, laminar air flow work stations, ultrasonic cleaners, a Royco particle counter and a double air lock entrance.

Third, realistic verification of performance—including random vibration testing—is without duplication in the relay industry. For complete information, talk with your local P&B representative or call Potter & Brumfield Division of American Machine & Foundry Company, Princeton, Indiana.

HL SERIES ENGINEERING DATA

Description: Dual coil, polarized, magnetic latching (Single coil, polarized relays available on special order)

Contact Arrangement: DPDT (bifurcated, gold-plated silver-alloy)

Contact Rating: Dry circuit to 2 amperes @ 28V DC, resistive

Contact Resistance: 50 milliohms before life; 100 milliohms max. after 100,000 operations at maximum rated load

Expected life: 100,000 operations minimum at rated load

Pick-up: Dual coil—150 milliwatts (approx.)

Shock and vibration immunity:

Shock: 150g for 11 milliseconds

Vibration: .195" D.A. from 10 to 55 Hz.

30g, 55 to 3,000 Hz.

Random Vibration: In excess of .4g²/Hz.

20 to 2000 Hz.

No contact opening in either armature position



Partial view of clean room where HL relays are assembled, adjusted and sealed.



TIG (Tungsten inert gas) welding process is used to seal headers to cases.



Sealing in controlled atmosphere follows evacuation in vacuum ovens.



Hermetic seals of HL relays are verified with radio-active krypton 85.

AMF

POTTER & BRUMFIELD

Circle 71 on reader service card



MICROWAVE IC PROGRESS REPORT #2

PACT program circulators prove power handling ability up to 8.5 kW

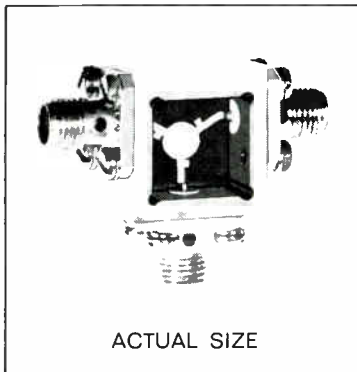

Sperry's PACT (Progress in Advanced Component Technology) program has achieved outstanding results in the development of microstrip ferrite circulators. PACT engineers report considerable progress in loss reduction, bandwidth, and power handling capability.

In the power area, laboratory work has already demonstrated Sperry circulators' ability to handle as much as 8.5 kW at X band. Improved power levels are achieved by doping the YIG substrate with small quantities (2%-5%) of dysprosium. While the higher power levels are achieved at the expense of somewhat higher insertion loss, PACT engineers feel that dysprosium doping offers great promise for high power applications.

Improvement in bandwidth/loss relationships has been equally gratify-

ing. Isolation of 20 db or better with insertion loss of .5 db or less has been achieved with a single device across a 40% (6.5-9.5 GHz) bandwidth.

PACT engineers feel that the reasons for such improvement are about

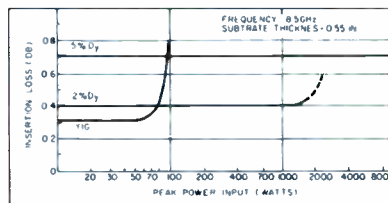

equally divided between selection and handling of substrate material and improved design of the microstrip conductors.

Substrate selection has been approached on a lowest possible loss basis; no other circuit parameters are considered at that stage. As a result, Sperry has learned that a thicker substrate is useful. Instead of the 25 mil substrate common in earlier microstrip work, PACT designers have gone to a 55 mil substrate and the added thickness contributes to demonstrably lower insertion loss.

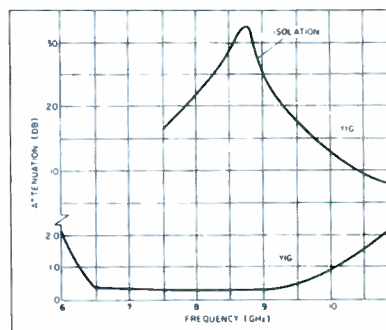

Bandwidth has been substantially increased by the addition of matching

stubs to the deposited microstrip structure. Considerable work has gone into determination of optimum size and location for the stubs, and these efforts have been extremely rewarding.

PACT efforts have resulted in a number of microstrip circulator designs which cover a combined frequency range from 1.5 to 13.0 GHz. All circulators in the group share the desirable bandwidth and low loss

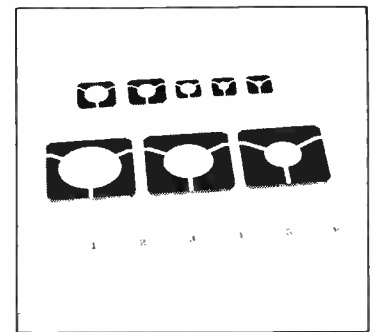

VARIOUS CIRCULATOR SIZES AND DESIGNS COVER 1.5 TO 13.0 GHz

characteristics described above. To date, PACT has concerned itself primarily with fixed bias devices, but recent technical evidence indicates that the program will shortly produce latching circulators with comparable capabilities.

If you would like more information about progress in microwave integrated circuit modules, contact your Cain & Co. representative or write Sperry Microwave Electronics Division, Sperry Rand Corporation, Clearwater, Florida.

*For faster microwave progress,
make a PACT with people
who know microwaves.*

SPERRY
MICROWAVE ELECTRONICS DIVISION
CLEARWATER, FLORIDA

Washington Newsletter

May 27, 1968

NASA buttons lip to preserve ERTS

The Earth Resources Technology Satellite (ERTS) program has taken on an air of mystery. NASA's assistant administrator for public affairs, Julian Scheer, has slapped an embargo on all news of the project, and neither NASA headquarters nor Goddard Space Flight Center (which will presumably manage the program) are talking.

A clue to the agency's reasoning may be found in the fate of the Interior Department's much-heralded Earth Resources Observation Satellite (Eros). Washington sources say Eros died of a case of bad public relations. Boasts about the craft's ability to determine the world's resources caused other countries to label it a spy satellite. Insiders say an alarmed State Department and the nation's intelligence agencies then exerted pressure to halt the project.

The final bell was sounded for the program last week when the House Appropriations Committee struck down the Interior Department's fiscal 1969 request for slightly over \$1 million to keep Eros alive. NASA undoubtedly has taken the lesson to heart. It doesn't want to make a false step with the ERTS program, for which a \$12 million outlay has been approved by the House Appropriations and Authorization Committees.

Dominick's round: bids on Army radios undercut RCA price

Sen. Peter Dominick (R., Colo.) has scored a coup in his campaign to end the awarding of military contracts on a noncompetitive basis. In his latest tilt with the Pentagon, Dominick discovered that the Army was buying AN/PRC-77 manpack radio transceivers and RT-841 transmitters from RCA at a noncompetitive price of about \$1,000 a unit. At the Senator's insistence, the embarrassed Army put the contract up for bids; the prices submitted were generally almost half the original cost, and even RCA cut its figure.

Among the lowest bidders was an Israeli firm, Tadiran Israel Electronic Industries. Tadiran has been producing radios almost identical to the U.S. equipment for Israeli use and for export to Europe.

Award of the order, which could run to about \$19 million over several years, will be delayed because of the political problems surrounding the presence of an Israeli company in the picture, and because one of the bidders is complaining that its competitors weren't qualified to submit proposals. Dominick estimates that the competitive bidding will save the taxpayer as much as \$15 million.

Air Force to expand its Mallard role . . .

The Air Force may wind up as one of the biggest partners in the Mallard project—the four-nation tactical field communications system for the 1970's. Originally launched as an Army program, Mallard soon attracted Air Force and Navy attention [Electronics, Oct. 30, 1967, p. 48]. And now, as result of Vietnam experience with interservice tactical communications, the Air Force is indicating an increased interest in the project. Col. F.J. Hickman, who's in charge of the Air Force's 407L tactical air control system, says, "Mallard will be our next major step; we aren't taking any piddling little steps any more."

This interservice borrowing is not a one-way arrangement. The Army now plans to obtain its own version of the Air Force's 407L. Bids are

Washington Newsletter

due early next month on the system, the heart of which will be 10 AN/TTC-30 electronic switching centers. The leading contender for the awards, which should amount to between \$5 million and \$10 million, is the North Electric Co., Galion, Ohio, supplier of electronic switching centers for the Air Force version.

The 407L will be used to link detection, tracking, and display facilities, and to control aircraft. Each of the centers built by North Electric under a \$25 million Air Force contract is housed in two shelters designed for transport by helicopter or plane, and provides fully automatic switching of up to 475 programable four-wire line and trunk terminals.

**... as common
switching specs near**

Agreement on common triservice specifications for electronic telecommunications switching gear is expected in about three months. Industry and the military believe that the move will speed the introduction of electronic switching centers for tactical communications. Heading the interservice negotiations is Army Maj. Gen. Paul A. Feyereisen, director of the Mallard program.

**Hughes proposes
'leftover' satellite**

The Hughes Aircraft Co. is proposing that NASA let it build an extra Applications Technology Satellite from parts left from the construction of the first ATS series. The spare would be called the "ATS-2B Prime" and could be readied, Hughes says, in 12 to 18 months. It would be primarily, a meteorological observation craft and could be mounted piggyback aboard an ATS launch vehicle. NASA headquarters and Goddard Space Flight Center are now looking into the Hughes proposal.

**War profit probe
seen unlikely ...**

Observers are betting that this session of Congress won't set up a special House committee to investigate Vietnam war profiteering. They further believe that the proposal by Rep. Henry Gonzalez (D., Texas) won't have much of a chance next year if a peace is negotiated. Gonzalez has been one of the few in Congress to raise the question of war profiteering. He and Wright Patman, another Texas Democrat, last week tacked onto the bill renewing the Defense Production Act an amendment directing the General Accounting Office to conduct a study of the advantages of uniform accounting by defense contractors. Although the move hasn't attracted much public attention, industry is sure to make an all-out effort to defeat it. Such a study might lead to a law requiring uniform accounting, a law that would make the detection of excess profits much simpler.

**... as softened
Renegotiation Act
leaves committee**

Industry can chalk up a major victory in the softened Renegotiation Act reported out of the House Ways and Means Committee last week. Although the panel extended the life of the Renegotiation Board to three years from its former two, it held out against efforts to expand the board's powers. Under the House bill, the board still can't review the profits of contractors doing less than \$1 million business annually; the committee rejected a move to drop the level to \$500,000. In addition, the committee ruled that a company has to sell 50% of product line commercially before an off-the-shelf price can be established. Previously, only a 35% share of commercial sales was needed.

Sorensen modular power supplies

$3\frac{5}{16}$ " x $3\frac{7}{8}$ " x 7", $\pm 0.005\%$ regulation

\$89⁰⁰

any questions?

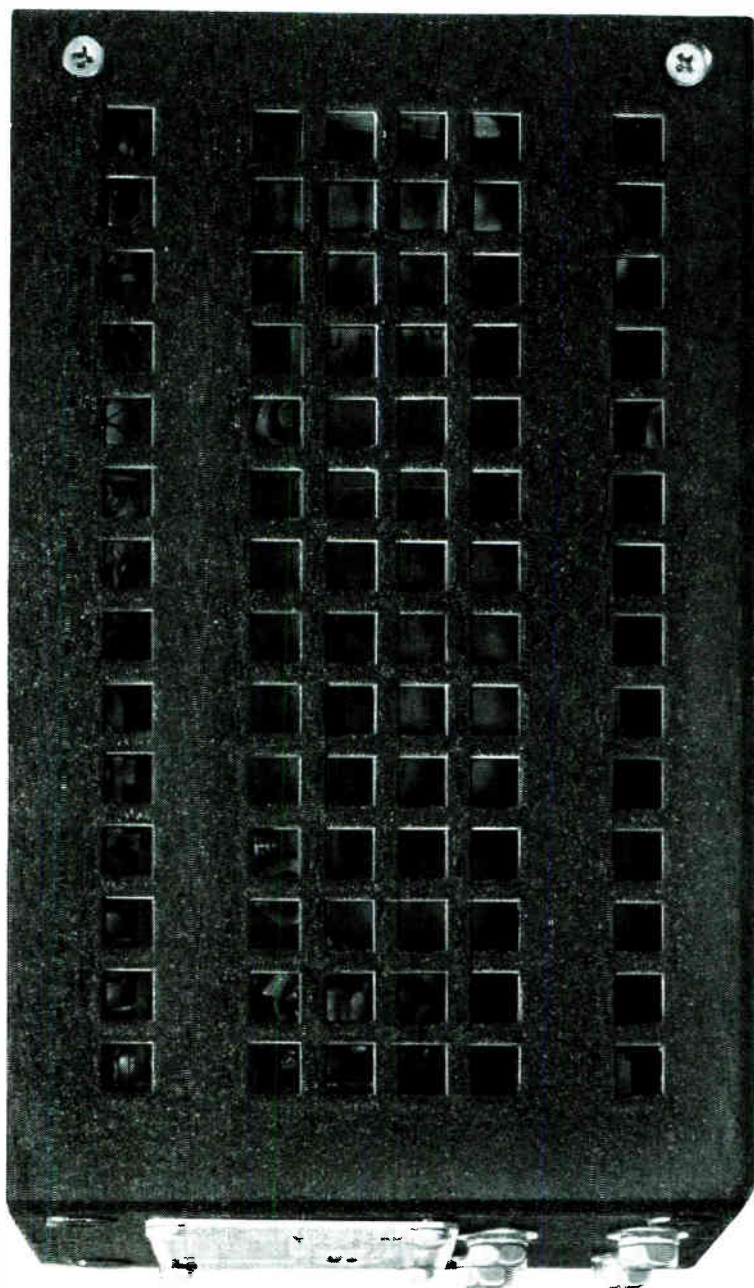

Model QSA48-.4 Power Supply, shown actual size, illustrates the compactness of the Sorensen QSA Series. New off-the-shelf models cover the range to 150 volts.

All silicon transistor design—convection cooled—operating temperatures up to 71°C.

Requires no external heat sink—mount in any position.

Lowest ripple of any modular supplies—300 μ V rms.

Best voltage regulation— $\pm 0.005\%$ line and load combined.

Lowest prices—\$89 to \$149.

Overload and short circuit protection.

20 μ s response time—no turn-on/turn-off overshoots.

Three sizes in each voltage range depending on power level—all are rack mountable with optional 3½" rack adapter.

Remote sensing and remote programming—capable of series/parallel operation.

Any further questions? For QSA details or for other standard/custom DC power supplies, AC line regulators or frequency changers contact your local Sorensen representative or: Raytheon Company, Sorensen Operation, Richards Avenue,



Norwalk, Connecticut 06856. Tel: 203-838-6571

Introducing the most versatile vidicon camera ever built – Cohu's new 3200 series!



IT'S A CCTV CAMERA – completely self-contained. Just add a single coaxial cable to any video monitor and it's ready to operate. Want high resolution? Plug in one of four optional integrated-circuit sync generator boards for 525-, 729-, 873-, or 945-line scan patterns.



IT'S A BROADCAST CAMERA, TOO! Add a "mounts-in-minutes" 5-inch viewfinder and the Cohu 3200 is ideal for studio, education, or remote applications. An optional film chain adapter further enhances its versatility and provides all necessary remote controls.

For prices, delivery and full details, contact Cohu engineering representatives in major cities throughout the United States and Canada.



Box 623
San Diego, California 92112
Phone: 714-277-6700

LOW PROFILE

hot-molded trimmer for
close circuit board stacking



Basic Type Y unit
shown actual size



With wheel for
side adjustment



With attachment for
horizontal mounting and
wheel for side adjustment



With attachment for
horizontal mounting

New Type Y single turn trimmer is especially designed for use on printed circuit boards. It has pin-type terminals for use on boards with a 1/10" pattern. And the new low profile easily fits within the commonly used 3/8" space between stacked printed circuit boards.

For greater operating convenience, the Type Y can be supplied with an optional thumb wheel for side adjustment, or an optional base for horizontal mounting, or both. The Type Y enclosure is splash-proof as well as dust-tight, and the metal case is isolated to prevent accidental grounding.

While featuring a new low profile, this new Type Y trimmer retains the popular Allen-Bradley solid resistance element, which is produced by A-B's exclusive hot-molding technique. With virtually infinite resolution, adjustment is smooth at all times. Being essentially noninductive, the Type Y can be used at frequencies where wirewound units are inadequate. The Type Y is rated 1/4 watt at 70°C and is available in resistance values from 100 ohms to 5.0 megohms. Standard and special tapers are available.

Let us send you complete specifications on this newest addition to the Allen-Bradley line of quality electronic components. Please write: Allen-Bradley Co., 110 W. Greenfield Ave., Milwaukee, Wis. 53204. In Canada: Allen-Bradley Canada Ltd. Export Office: 630 Third Ave., New York, N. Y., U.S.A. 10017.



New Type Y with handy
snap-in panel mount,
supplied with spacers for use
on panels up to 1/8" in thickness



ALLEN-BRADLEY
QUALITY ELECTRONIC COMPONENTS

How to use the Singer model SSB-50-1 Spectrum Analyzer to monitor tone level in a multiplexed communications system

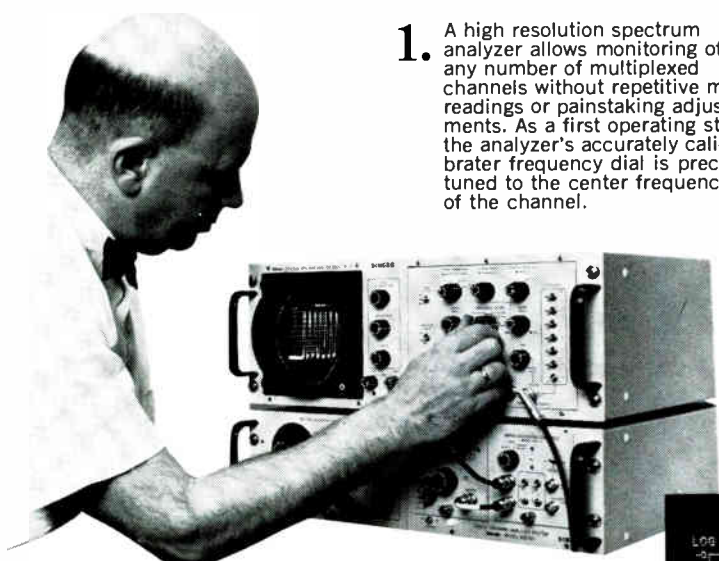

1. A high resolution spectrum analyzer allows monitoring of any number of multiplexed channels without repetitive meter readings or painstaking adjustments. As a first operating step, the analyzer's accurately calibrated frequency dial is precisely tuned to the center frequency of the channel.

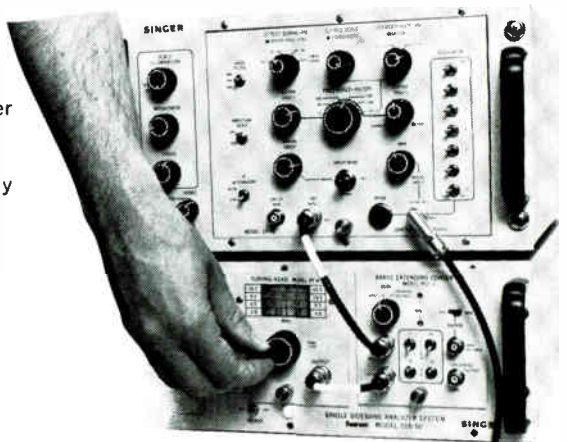

2. A selector knob sets the frequency scale in one of five settings from 15Hz/division to 1.4KHz/division. Interlocked circuit functions in the analyzer automatically optimize the display for any setting of the frequency scale.



3. The high resolution of the Singer Model SSB-50-1 provides this clear display of the multiplexed channel. The amplitude of each subcarrier is shown as a function of frequency. The display demonstrates complete operational readiness at a glance . . .

4. . . . but often a subcarrier level changes with a resulting communications malfunction. This display on the CRT shows that one subcarrier's level is down 12 db. Another is over the predetermined acceptable level.

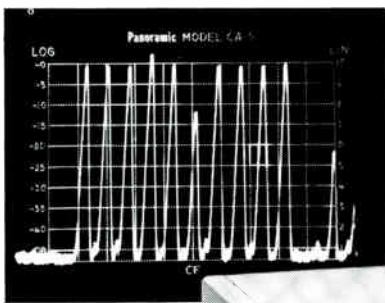

5.

Because the entire spectrum is continuously visible on the display, a lost channel shows up instantly . . . A frequency range of 10Hz to 40 MHz makes the Model SSB-50-1 an invaluable tool for this application and for general laboratory or field use.

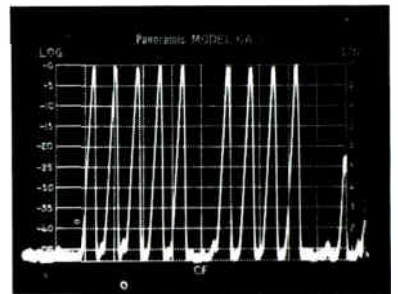

Model MF-5/CA-5-1 Spectrum Analyzer display section (features high resolution/low distortion and 70 db dynamic range)

Model TTG-3 Two-Tone Audio Generator 20-20,000 Hz frequency range and IM distortion of less than 70 db for testing single sideband transmitters

Model REC-2 Range Extending Converter (extends the tuning range down to 10 Hz)

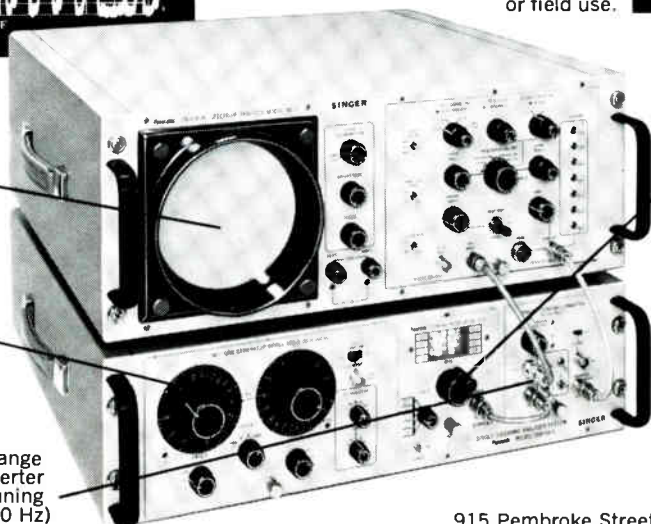

Model RF-8 Tuning Head (highly stable LO with coarse and vernier two speed tuning from 2 MHz to 40 MHz . . . usable to 200 MHz)



SINGER
INSTRUMENTATION

The Singer Company, Metrics Div.,

915 Pembroke Street, Bridgeport, Conn. 06608 (203) 366-3201



THE NEW IDEAS COME FROM GENERAL ELECTRIC

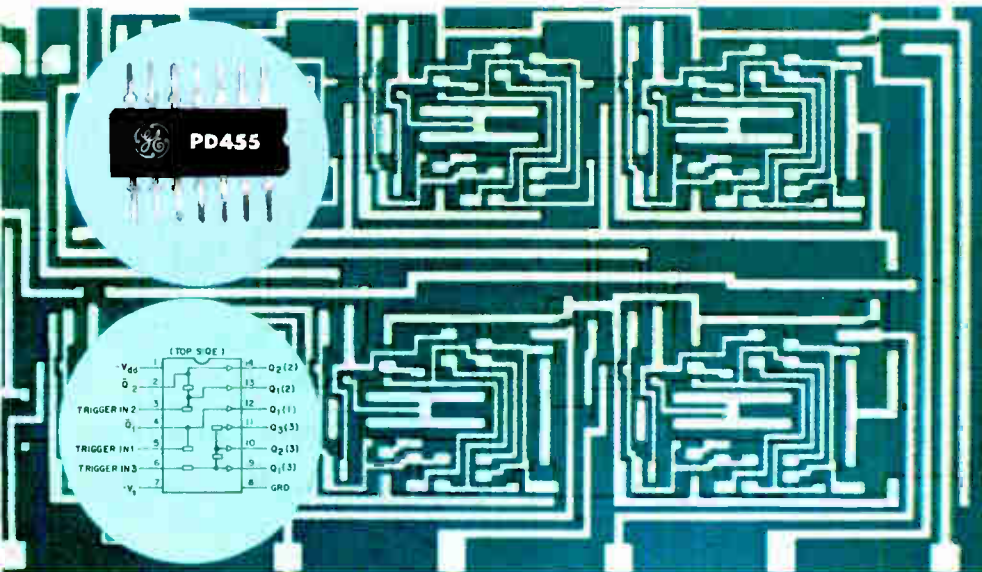

IN SEMICONDUCTORS. A 6-stage MOS-FET bi-stable frequency divider, PD455, is now available for consumer and industrial applications. The PD455 utilizes p-channel enhancement mode technology. It features stages internally connected in groups of 1-2-3 for design flexibility, short circuit protection, zener protected inputs and 0 to 1MHz toggle frequency. Typical applications include: musical instruments, long-term timing circuits and low frequency oscillators. Rely on General Electric for advanced MOS-FET circuits. Circle No. 90.



IN CAPACITORS. GE wet slugs offer lowest leakage current, smallest size per volt-mfd of any electrolytic capacitor. In applications with high volt-mfd requirements, GE wet slugs can often replace physically larger solid tantalums—without increasing cost! Circle No. 91.



IN TUBES. We've built thousands of separate planar tube designs for industrial and military applications. Each offers effective operation in oscillators to x-band (9.6gc) in extremely adverse environments such as artillery and missile fusing and other critical requirements. You expect such high performance and application flexibility from GE—world leader and innovator in planar tubes. And, you'll find similar extra values in every GE tube and allied product, including power tubes, compactrons, pressurized reed switches, photo cells, and display devices. Circle No. 92.

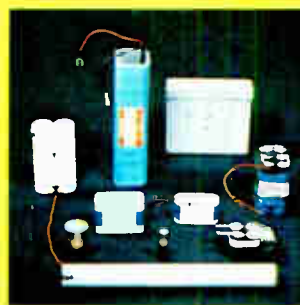

IN RECHARGEABLE BATTERIES. Top reliability of GE nickel-cadmium cells permits use for aircraft emergency lighting. High current discharge, vibration resistance are other features. GE sealed cells offer extra values in rechargeable portable power. Circle No. 93.



IN SEALED RELAYS. At GE, quality begins in research and continues through final assembly. Clean-room manufacturing, all-welded construction, test after test on parts and finished product—they're just part of our total effort to give you relays to rely on. Circle No. 94.

For the new ideas in electronics, look to General Electric—your best single source for electronic components 283-39

ELECTRONIC COMPONENTS SALES OPERATION

GENERAL  ELECTRIC

Oak's design engineers are impatient . . . nothing is ever quite good enough. They figure improved products today mean better circuits tomorrow. Take these: ♦ Oak-manufactured Rotary Solenoids and Selectors for multiple switching functions in limited space under severe operating and environmental conditions. ♦ Molded Pushbuttons designed specifically for computers, communications and other panel equipment. ♦ Rotary Switches with molded diallyl phthalate stators and rotors, Unidex™ indexing. ♦ Lever Switch with molded diallyl phthalate type "A" stator for miniaturization, versatility in a small area. Plus these—Rocker Thumbwheel, Pushbuttons, Lever and Slide Switches. Oak offers widest selectivity in quality switches for industrial, commercial or military requirements. In fact, Oak has more switches that meet MIL-S-3786 than all other manufacturers combined—over 24 switch products. The next switch manufacturer has six. In addition, Oak offers sub-assembly service to save you production time and costs. These are only highlights of a small part of the complete Oak line of components. Send today for Catalog 24.

**DESIGNED FOR TOMORROW'S
CIRCUITS!**

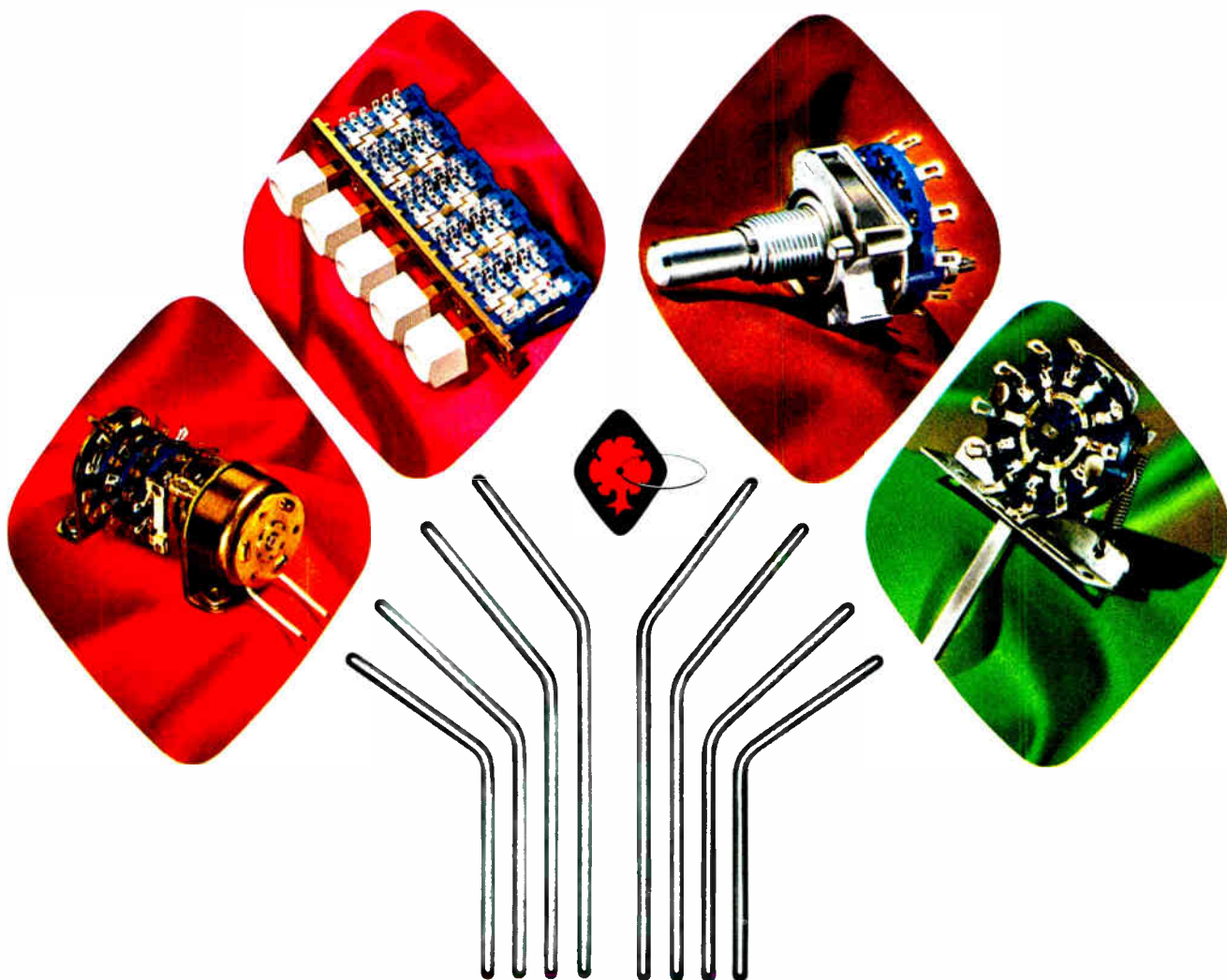

Ph: 815-459-5000 TWX: 910-634-3353

OAK

CABLE ADDRESS: OAKMANCO

MANUFACTURING CO.

A DIVISION OF OAK ELECTRO/NETICS CORP
CRYSTAL LAKE, ILLINOIS 60014

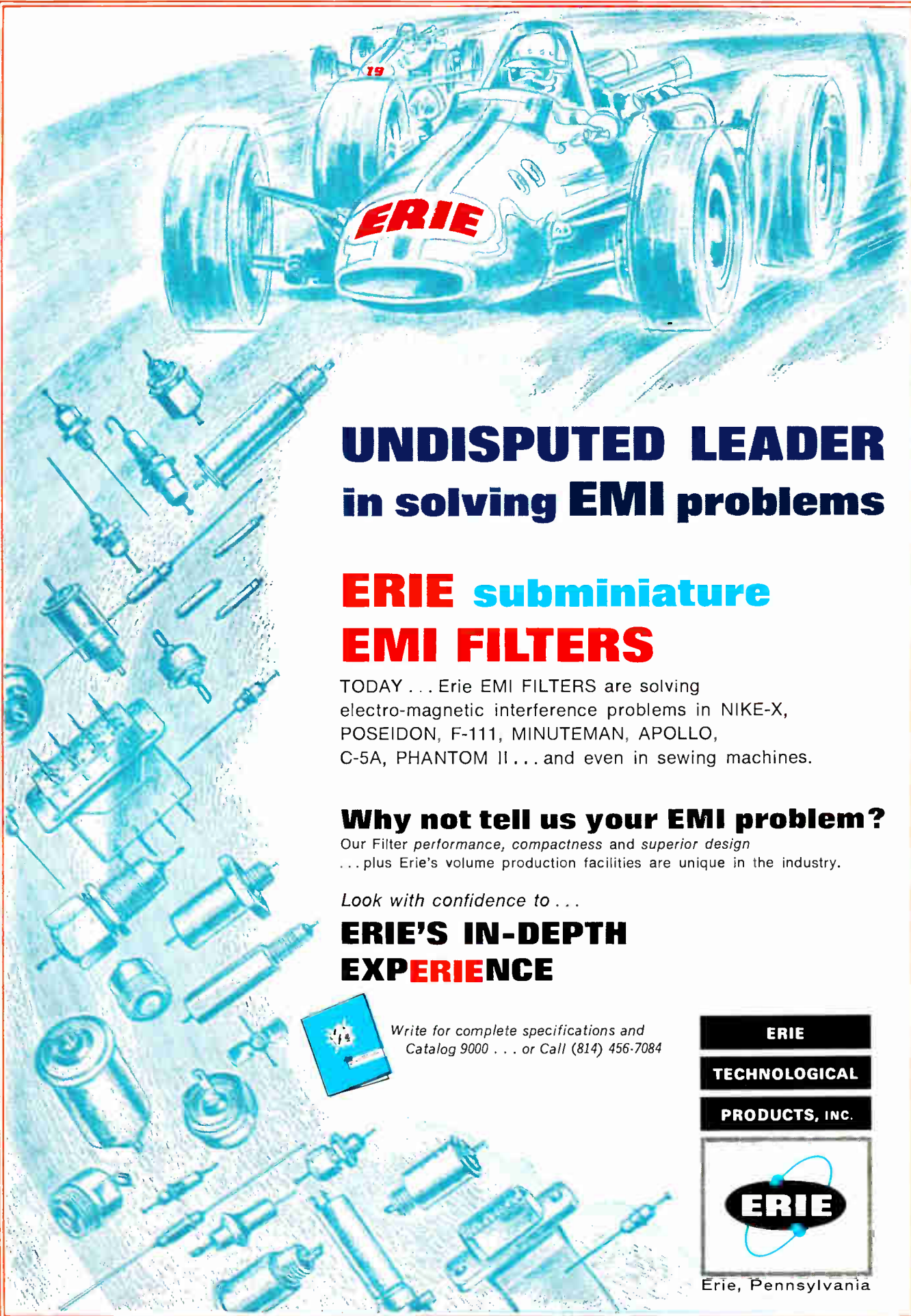

UNDISPUTED LEADER in solving **EMI** problems

ERIE subminiature **EMI FILTERS**

TODAY . . . Erie EMI FILTERS are solving electro-magnetic interference problems in NIKE-X, POSEIDON, F-111, MINUTEMAN, APOLLO, C-5A, PHANTOM II . . . and even in sewing machines.

Why not tell us your EMI problem?

Our Filter *performance, compactness and superior design* . . . plus Erie's volume production facilities are unique in the industry.

Look with confidence to . . .

ERIE'S IN-DEPTH EXPERIENCE



Write for complete specifications and
Catalog 9000 . . . or Call (814) 456-7084

ERIE
TECHNOLOGICAL
PRODUCTS, INC.

Erie, Pennsylvania



Burndy Vinylug™ The little cost saver.

The way it performs you'd never guess the price. This newly designed terminal puts a permanent crimp in your wire. And in your cost.

Engineered with all of Burndy's know-how, Vinylug delivers Burndy dependability in full measure. Tensile strength exceeds UL requirements and temperature rise is far below UL limits.

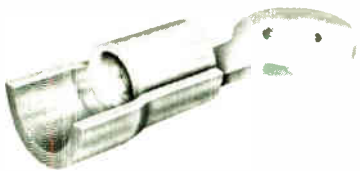

The vinyl insulation is color-coded for quick size identification, and the shroud is designed to provide a firm support for a wide range of cable diameters.

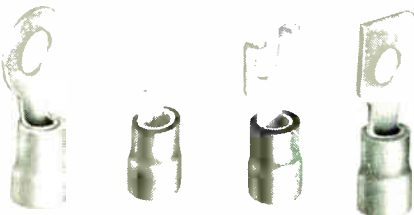

Vinylug one-piece body is constructed of high-conductivity copper, tin plated for lasting corrosion resistance. Chamfered edge permits easy entrance of stranded and solid wire into crimp area.

Four tongue styles: ring, fork, flanged fork and square are available in loose piece and continuous strip. Splices, too. Stud size: 1-3/8.

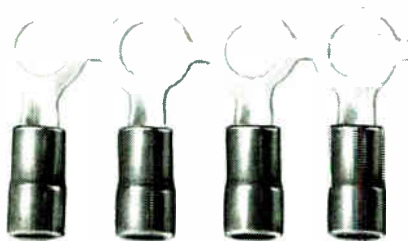

Burndy tooling is recommended as the quickest and easiest way to install Vinylug. Our plier and ratchet hand tools let you install all sizes and types without changing dies.

HYTOOL® Y10ME-4 Plier type tool featuring wire cutter, stripper, insulated and uninsulated crimp grooves to install terminals and splices. Excellent for hard to reach jobs.

HYTOOL MR8-89-1 Ratchet control production type hand tool of lightweight aluminum construction, designed to install full range of terminals and splices, wire range: 22-10. Crimp grooves designed to

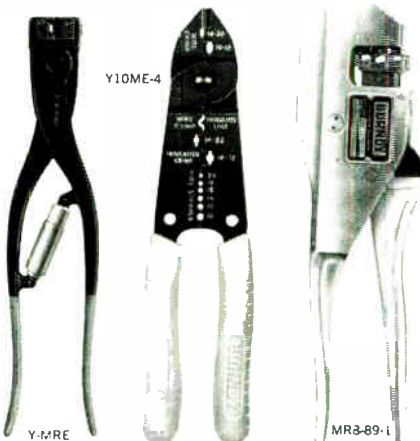

close insulation support at the same time it crimps.

Circle 83 on reader service card

HYTOOL Y-MRE Ratchet control type hand tool which installs terminals and splices covering a specific wire range. Designed for working in confined areas.

AVM2-1 for volume production, our Automatic Vinylug Machine installs up to 2,000 per hour.



We proudly offer to send you free samples of our new Vinylug. We're sure you'll like the finished look it adds to your product. We know you'll like the price.

FREE SAMPLE
BURNDY/Norwalk, Connecticut

I am curious about the little cost saver. Please send me a free Vinylug Sample Pack and the new Burndy Vinylug/Vinylink™ catalog.

Name & Title _____
Company _____
Address _____

BURNDY
Norwalk, Connecticut

INTERNATIONAL SALES HEADQUARTERS AND
MANUFACTURING FACILITIES: CANADA: Scarborough, Ontario
ENGLAND: St. Helens, Lancs. / MEXICO: Nahuatlpan de Jaurez
BELGIUM: Mechelen / BRAZIL: Sao Paulo
JAPAN: Tokyo / Sales Offices in Other Major Cities



THERE'S ONE MAIN REASON WHY THIS TEMPERATURE/ HUMIDITY CHAMBER IS BETTER THAN COMPETITION'S



(IT WORKS)

Don't laugh. If you've ever had to use a competitive temperature/humidity cabinet, you know we aren't joking.

Take controls, for example. With competition, you've probably run into out-moded on-off types. Not only is performance poor, but these systems also have a maze of complicated mechanical linkages between the programmer and recorder — wonderfully intricate nightmares that take an advanced degree (of education or experience) just to keep operating.

(Blue M uses the patented POWER-O-MATIC 60® Saturable Reactor Proportioning Control System which not only provides unmatched performance, but is a snap to operate. A child can do it.)

Then there's the compressor. Competitive systems slam on and cut off, causing a noticeable variation in chamber conditions every time. High maintenance, too.

(Blue M's compressor operates continuously for longer life, and performance is geared exactly to the operating temperature needs of the chamber at all times.)

Almost every chamber manufacturer has his own water

system: spray, steam injection, etc. While they do get water into the chamber, often it's in the form of mist or drops — hardly humidity. And they need constant attention.

(Blue M uses a reliable solid-state water leveling system and an exclusive vapor-pressure system. Efficient and no trouble.)

We could mention the cost-cutting construction you have probably run into. (We don't skimp. We even include an elapsed timer to record the actual number of hours the cabinet operates — something that might frighten competition.) And so on.

But the main point we want to make is simple: Blue M Temperature/Humidity Chambers do work as specified. They easily meet every current MIL Humidity Spec, for example. Everything about them has been designed to make sure they do . . . with a minimum of trouble and expense to you. And we're prepared to prove it to you with actual performance charts, data and demonstrations anytime you say.

Blue M builds the finest temperature/humidity chambers in the country. We challenge anyone to show us a better one.

SEND FOR FULL INFORMATION



BLUE M *Engineering Company*

A DIVISION OF BLUE M ELECTRIC COMPANY

Corporate Headquarters:

BLUE ISLAND, ILLINOIS 60406

Offices strategically located to serve you.

What in the world do Cherry Precision Switches do?

*what do you
want them
to do?*

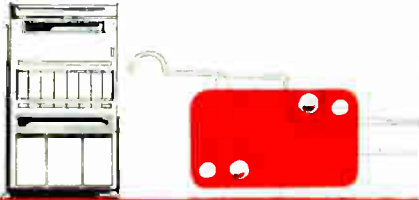

Operate a vending machine?
Select an E33-90H

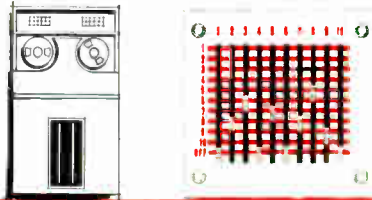

Program a computer?
Design with C10-20A

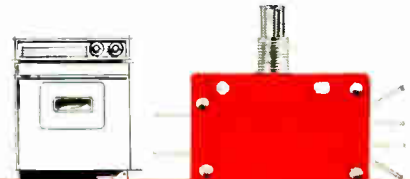

Start the clothes drying?
Incorporate an E19-00M

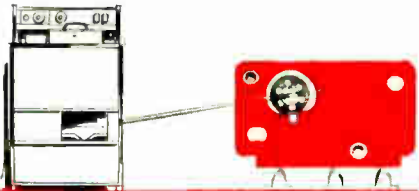

Start a photocopier?
Include an E51-00B

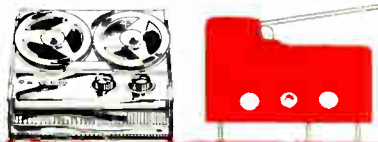

Begin recording?
Start with an E61-10H

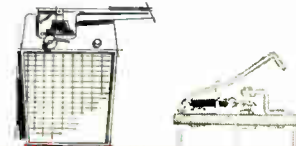

Turn on a can opener?
Choose an S30-00W

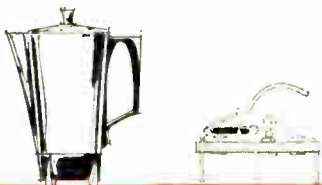

Start the coffee brewing?
Actuate an S30-20W

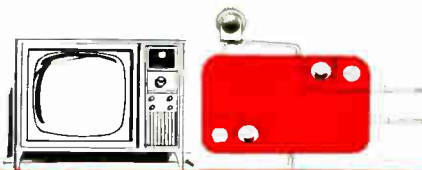

Tune a TV?
Use an E33-00K



Operate a projector?
Utilize an E13-00E

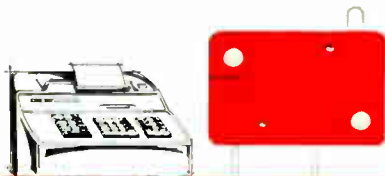

Check your figures?
Add an E16-00M



Trigger a typewriter?
Employ an E62-10A



Activate turn signals?
Specify S25-00T

If the project on your board incorporates a switch, the odds are about 7,582 to one that Cherry can give you the switch that will do the job **best**. We're awfully fussy about precision and reliability. And most people find that Cherry switches provide more value. Maybe that's why design engineers specify over 55,000 Cherry switches every working day.

Check our complete line.
Send for the new pocket-size
Cherry "Switch Selector Guide".

CHERRY 

CHERRY ELECTRICAL PRODUCTS CORP. • 1656 Old Deerfield Road • Highland Park, Illinois 60035

**DESIGN
ENGINEER'S
PRECISION
SWITCH
SELECTOR
GUIDE**

CHERRY

We have something for no-nonsense design engineers

who want to make
the best investment
in IC logic assemblies.

Design with CAMBION® IC Logic Assemblies. You get more for your money . . . more functions on every logic card . . . an exclusive 70-pin input/output that lets you bring more functions through to the outside world.

With this unique connector capability, we've developed both standard and those hard-to-find cards . . . grey code logic, arithmetic logic, counters, decoders, registers, comparators . . . all the odd-ball assemblies you need.

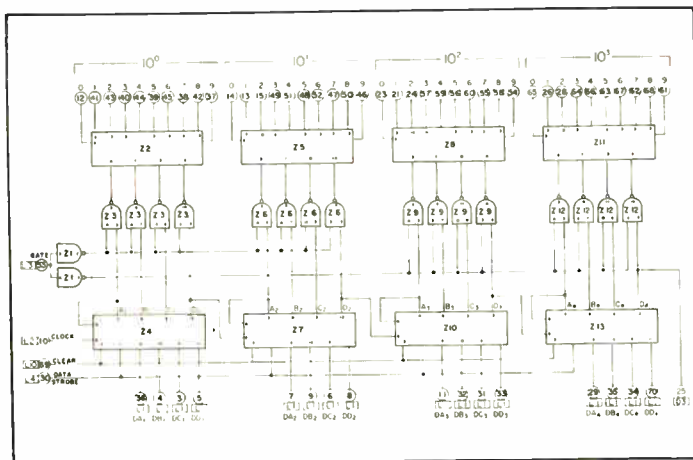
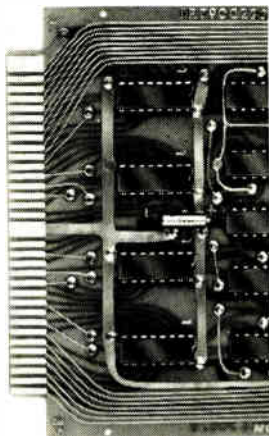

BCD counters with decoder/Nixie drivers

Look at these advantages:

SPEED — IC logic assemblies with speeds to 25 MHz.

NOISE — Exact component location with precision etched interconnections achieve "short-leads" and prevent signal cross-coupling. BCD counters with decoder/Nixie* drivers all on a single card are but one example.

PACKAGE DENSITIES — 70-pin input/output, plus a great array of complex functions and you've got what it takes for highest density packages. (You use fewer cards this way, too.)

VARIETY — Over 250 card types for difficult applications.

DELIVERY — Immediate . . . from stock . . . honestly.

DOCUMENTATION — CAMBION's new logic manual has the data, including application and helpful reference formulas.

NO-NONSENSE — Make the best investment in IC logic assemblies. Send for new manual. Cambridge Thermionic Corporation, 447 Concord Ave., Cambridge, Mass. 02138. Phone: (617) 491-5400. In Los Angeles, 8703 La Tijera Boulevard. Phone: (213) 776-0472.

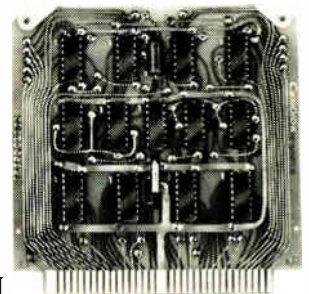

*Reg. U.S. Pat. Off.
*Trademark, Burroughs Corp.

CAMBRIDGE THERMIONIC CORPORATION
CAMBION®

Standardize on CAMBION . . . the guaranteed logic assemblies

Can you use a 0 ± 50 ppm TCC capacitor at $1/2$ the price and $1/2$ the size of an N.P.O. Ceramic?

The new KEMET® FKC $\pm 10\%$ Flat Kap is less than $1/2$ the size and $1/2$ the price of a $0.1 \mu\text{f}$ N.P.O. ceramic capacitor.

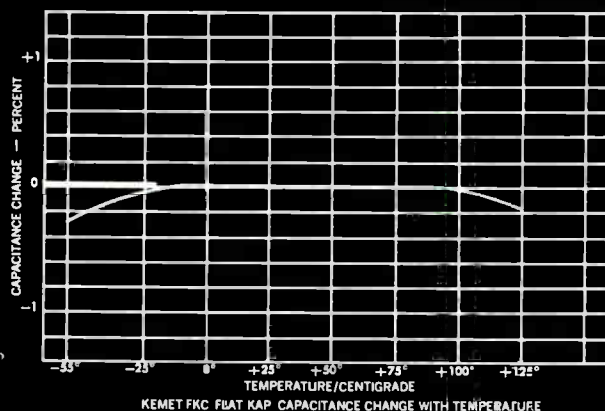

KEMET FKC FLAT KAP CAPACITANCE CHANGE WITH TEMPERATURE

For closer tolerances, the savings are even greater—the price adder for a 1% FKC is just $1/4$ of most N.P.O. ceramics.

This mini-sized KEMET Flat Kap is achieved through the use of parylene, the unique thin film plastic dielectric developed by Union Carbide.

The 0 ± 50 ppm TCC is built into the capacitor by using a temperature compensating solid impregnant which locks the capacitor together and improves stability. Aluminum foil is used for electrodes instead of high cost precious metals such as platinum.

KEMET Flat Kaps are available off-the-shelf (and there are no delivery problems) in compact rectangular epoxy cases.

Specifications are: Capacitance and Voltage, $.001 \mu\text{f}$ to $.1 \mu\text{f}$ at 50VDC—; Tolerance, 10%, 5%, 1% Standard—custom tolerances available on special order—; Retrace and Drift, 0.2% typical—; Operating Temperature Range, -55°C to $+125^\circ\text{C}$ —; IR, 100,000 megohms at 25°C —; D.F., 0.3% at 25°C 1KHz—; Humidity Test, Shock and Vibration, and Temperature and Immersion, per MIL-C-55514.

The new FKC Flat Kaps, from Union Carbide, The Discovery Company.

**UNION
 CARBIDE**
 ELECTRONICS

When your IC bugs out, chances are the heat's on!

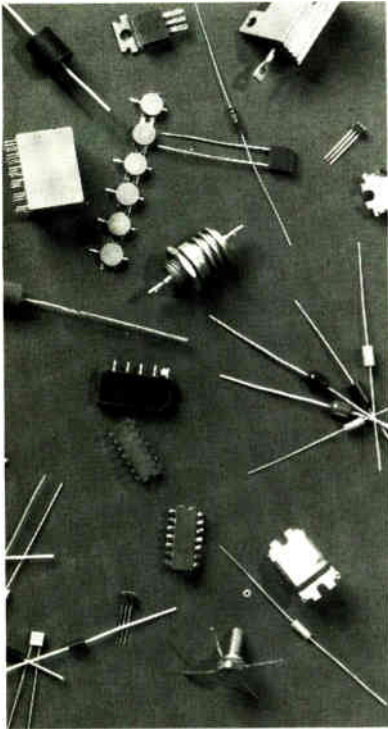

Devices packaged in Dow Corning® silicone molding compound are physically and electrically stable—even after long term exposure to both high heat and humidity. Derating, a practice common with organic packaging, is not necessary. In fact, you can design for high device and component density by using silicone molding compound. One manufacturer of glass package power diodes reduced the part to 1/30th of its former volume. Sizes from 1/5th to 1/3rd smaller can be obtained by using silicone molding compound in place of other plastics.

Little moisture absorption. Silicone molding compounds when exposed for 1000 hours to 93% RH at 70 C showed an average weight increase of 0.32% with the greatest increase being 0.5% and the least being 0.17%. Five organic plastics had average weight increases ranging from 1.0 to 2.1%—an average of nearly five times greater than silicone molding compounds under the same test conditions.

No cracking. Unlike other thermal setting plastics, Dow Corning silicone molding compounds are virtually unaffected by thermal shock. For example, a power resistor molded in Dow Corning® 307 compound was cycled repeatedly from -65 to 350 C without damaging the packaging material or the component.

Will not burn. Silicone molding compounds are

inherently nonburning. Thus, components and devices packaged in silicone molding compound do not constitute a fire hazard. No flame snuffers are used—a source of ionic contamination for devices packaged in organic materials.

Corrosion free. These silicone molding compounds are free of ionic contaminants which may contribute to metallic corrosion when operating in high humidity and influenced by voltage bias.

Competitive price. Costing only a fraction of a cent per device, Dow Corning silicone molding compounds enjoy a substantial price advantage over metal cans . . . glass packages.

Manufacturing economies. Transfer molding enables manufacturers to package devices and components with a minimum of manual labor and supervision. Good mold release and minimum flash assure high production rates . . . reduced deflashing costs. These manufacturing advantages make silicone molding compounds totally competitive with organic plastics.

So why be bugged by device failures because of a cheap plastic package? Specify Dow Corning® brand silicone molding compound, and get the best package protection in your electronic equipment . . . lets you keep your cool. For technical data, write: Dept. A-8472, Dow Corning Corporation, Midland, Michigan 48640.

DOW CORNING



GOOD

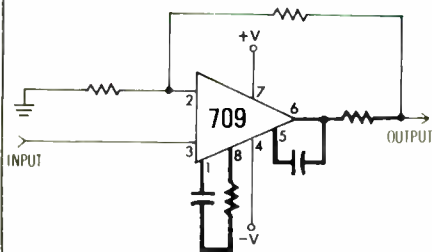

This buffer has a 10MΩ input . . .

BETTER

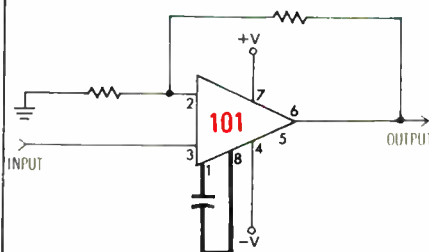

but the circuit can be improved

BEST

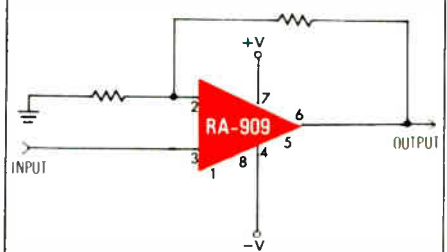

. . . or it can be optimized!

Now all 709 circuits can be optimized by using the NEW compensationless RA-909.

This pin-for-pin replacement eliminates extra components and offers performance better than the very latest versions of the 709.

It's possible to achieve an equivalent input impedance of 10MΩ or better and provide unity gain with a maximum error of .004% with the buffer illustrated on the left above. But why not get the same performance with less components? Use the new RA-909.

Design it in or use it as a replacement. Available in the popular eight pin TO-5 configuration and the TO-86 flatpack, both having blank pins where the 709 and 101 require compensation so that existing compensation networks will not affect the

RA-909. Eliminate possible failure sources and get better performance for a comparable price. You can expect improvements such as a slew rate of 5 volts per microsecond; power dissipation of only 52 milliwatts; transient response of 40 nanoseconds (10 to 90% points) with a 200 millivolt output into a 2KΩ, 100pF load in the worst-case unity gain configuration; and a maximum equivalent input noise of 5 microvolts rms. Yes, five microvolts!

Contact your nearest Radiation sales office for further information.



RADIATION
INCORPORATED

SUBSIDIARY OF HARRIS-INTERTYPE CORPORATION
MICROELECTRONICS DIVISION

Sales Offices: 600 Old Country Road, Garden City, N.Y. 11530. (516) 747-3730 — 2600 Virginia Avenue, N.W., Washington, D.C. 20037. (202) 337-4914 — 6151 W. Century Boulevard, Los Angeles, Calif. 90245. (213) 670-5432 — P.O. Box 37, Melbourne, Florida 32901. (305) 727-5430 — International Sales Marketing Department, P.O. Box 37, Melbourne, Florida 32901. (305) 727-5412

The end of the non-portable portable

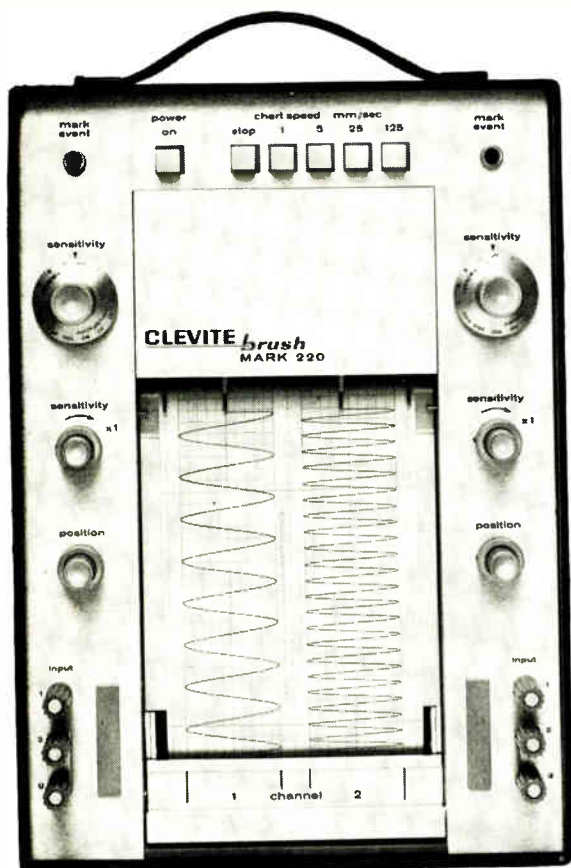

Dimensions: 13.06" x 9.12" x 7.56".

Mark 220 by Brush . . . a talented new-generation recorder with a 25,000-channel pedigree. Behaves like its famous grand-daddy, the Mark 200, but weighs only 25 pounds. Delivers traces that are unbelievably sharp, 99½ percent accurate. Solid state electronics provide position feedback pen control . . . no springs, no strings. The new Mark 220 has two channels for analog recording, two for events.

Maximum sensitivity is one millivolt per chart division, but the recorder is electrically

protected from overloads as high as 500 volts. Pressurized writing puts smudge-proof traces into paper, and there's enough ink in the throwaway cartridge to last for about

Throw-away ink cartridge—1000 mi. between changes.

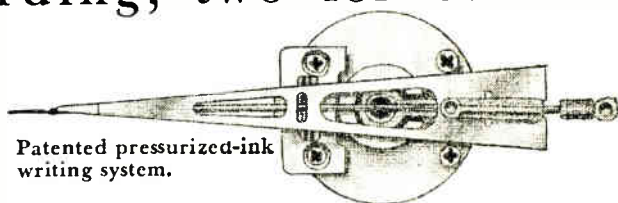
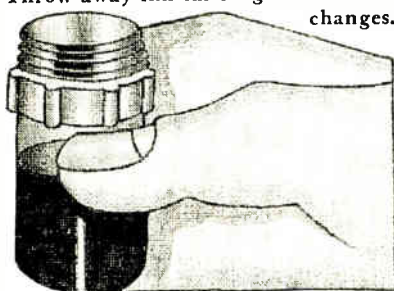

Patented pressurized-ink writing system.

a thousand miles. Less than \$1800 will put you in business with this fine instrument . . . and it's light enough to take anywhere. Call for a demonstration of the remarkable Mark 220 . . . and if you wish to keep the unit we'll swap it for a P.O. number. Clevite Corporation, Brush Instruments Div., 37th & Perkins, Cleveland, Ohio 44114.

Inputs.

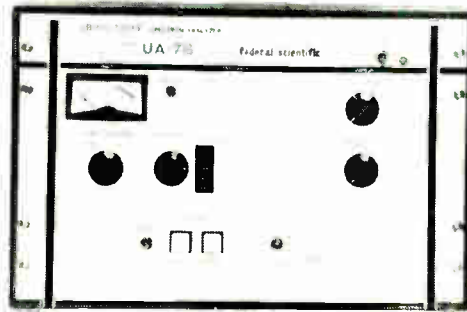
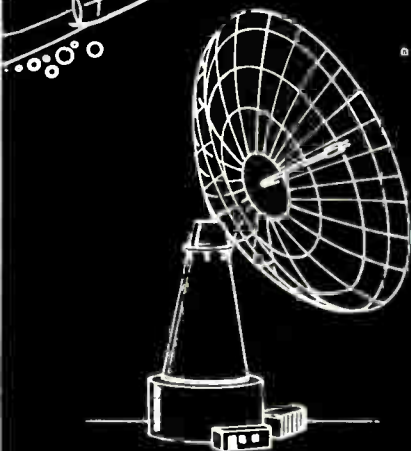
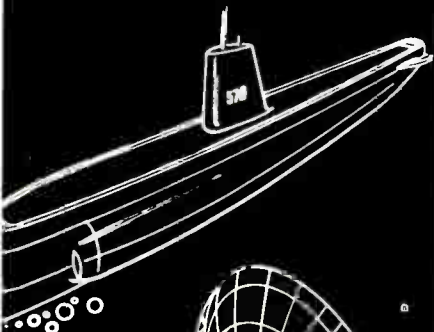
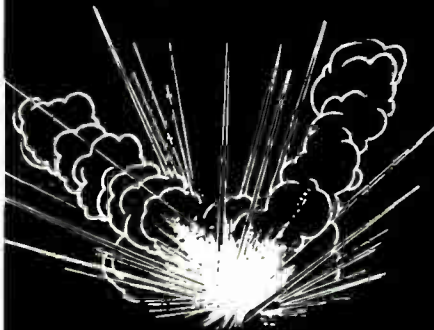
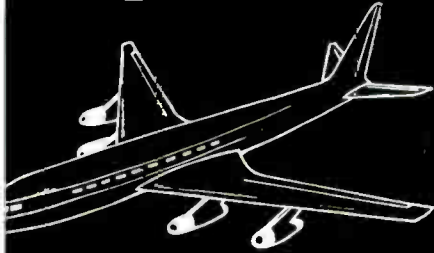

Our REAL-TIME Spectrum Analyzers are truly UBIQUITOUS®

... because there's a model for every use.

BASIC UA-6: Spectrum analysis in ranges of 0-10 Hz to 0-20 kHz with bandwidths of .02 Hz to 40 Hz (origin of range located to 1 mHz with options)

EXTENDED RANGE UA-8: Wide coverage spectrum analysis with ranges to 0-100 kHz

SPEECH ANALYZER UA-7/28: Spectrum analysis to 10 kHz with variable bandwidth for optimum processing by allowing tradeoff of frequency resolution for time resolution

DIGITAL PROCESSOR UA-7/51: Direct digital input and output for operation in all-digital systems

SHOCK ANALYZER UA-7/37: Shock spectrum analysis with capture of transients in non-destructive memory

ENGINE SIGNATURE UA-7/14: Engine order normalization for rotating machine signatures independent of RPM

PERCENTAGE BANDWIDTH UA-7/64: Percentage bandwidth analysis in addition to constant bandwidth in any of 10 octave ranges with percentage variable from 0.4% to 3.2%

CORRELATION UCA-7: Simultaneous correlation and spectrum analysis

NOISE OR VIBRATION PSD-7: Real time power spectral density without tape loops producing 2 years of PSD in one day

UNIVERSAL PROCESSOR UPS-7: Includes real time correlation, cross-power spectral density and transfer function analysis to 10 kHz

Federal Scientific Corporation, a subsidiary of T S T Industries, Inc., 615 West 131st Street, New York, N. Y. 10027. (212) 286-4400.

federal scientific

Originators of the Ubiquitous® Spectrum Analyzer

Outputs.

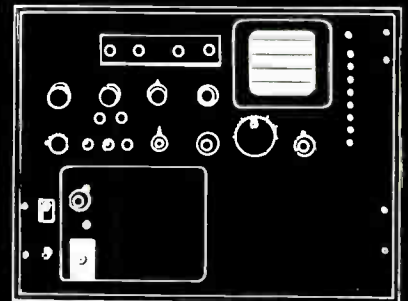
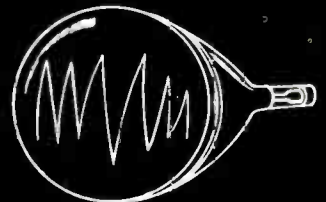
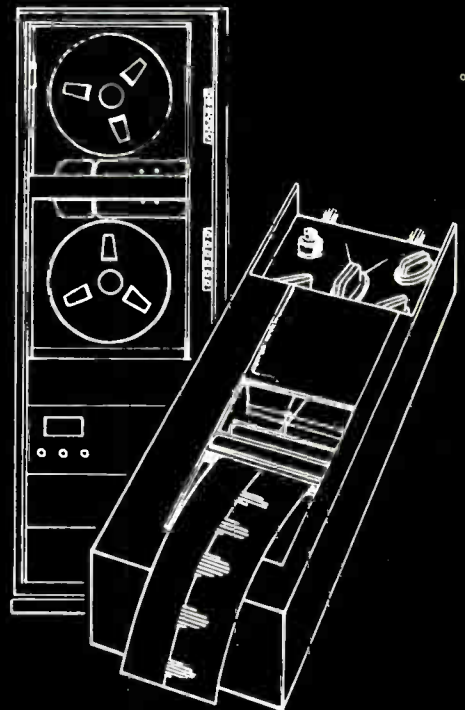
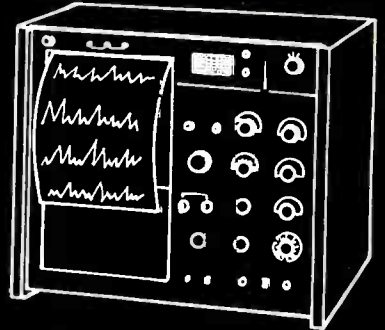
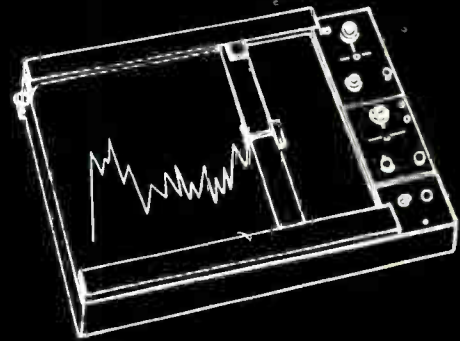

Leader in the World of Displays

BURROUGHS, THE LEADER, is continuously evaluating all types* of display devices and systems to provide the best possible displays for your application.

Whether your requirements are for present display devices or for displays not yet developed or conceived, come to the leader . . . Burroughs. We have been solving display problems for over a decade.

WHAT ARE YOUR DISPLAY REQUIREMENTS?

Call or write: *Burroughs Corporation, Electronic Components Division, P.O. Box 1226, Department A2, Plainfield, N.J. 07061 Tel: (201) 757-5000.*

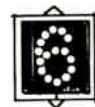
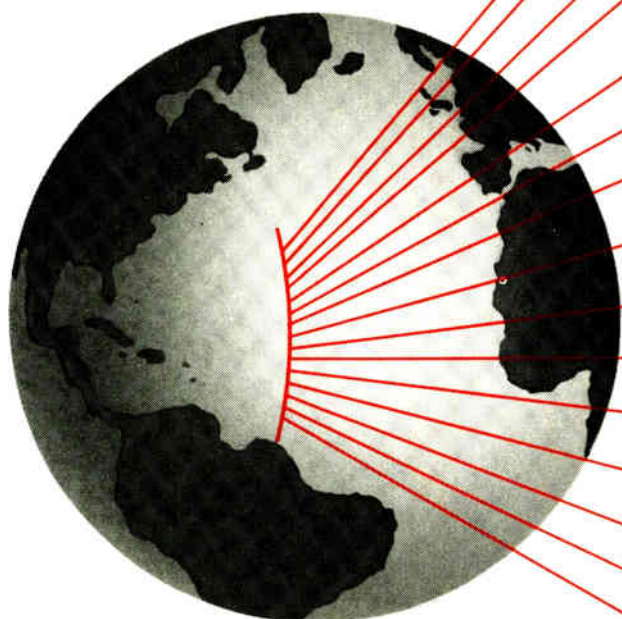

EDGE-LIGHT



COLD CATHODE



CRT'S



PLASMA

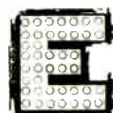

MAGNETO-OPTIC



SINGLE DIGIT CRT

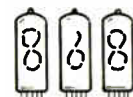

LOW VOLTAGE CATHODO-LUMINESCENCE



PROJECTED INCANDESCENT



DIRECT INCANDESCENT



ELECTRO-LUMINESCENCE



GLOW MODULATOR



REFLECTIVE ELECTRO-MECHANICAL



LENTICULAR

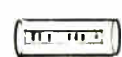

MULTI-ELEMENT COLD CATHODE REGISTER INDICATOR

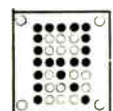

SOLID STATE DEVICES

Burroughs 

*Illustrated, for your information, are some present and future display devices. Some are of Burroughs manufacture while the rest are manufactured by other companies.

Technical Articles

**Threshold gates
cut logic costs**
page 94

Electronics



A computer's logic costs can be cut as much as 50% with threshold-logic gates. Engineers at RCA who devised an integrated threshold gate about a year ago have now gone further, combining the gates into large arrays. One of the fundamental tools of logic design, especially with threshold gates, is the four-dimensional hypercube, shown on the cover. The basis of earlier

Karnaugh and Veitch maps, the hypercube offers a technique to simplify logic functions.

**Avoiding inductors
in filter design**
page 109

Low Q's and bulky inductors are the major drawbacks of LC-filter circuits earmarked for low-frequency applications. But this isn't true for active filters. Greater values of Q are achieved with active filters in which transistors are used with the passive RC elements to simulate the inductor's characteristics. And since the active filters can be made in integrated-circuit form, they can be much smaller than conventional LC filters. In this article, the first of a series on active-filter design, three basic configurations are described: operational amplifier, gyrator, and negative-impedance converter.

**Low-cost pulse testing
for IC flip-flops**
page 120

Users of integrated-circuit flip-flops have trouble testing them. The devices come in such a variety of types and shapes that users are often faced with a choice between inadequate testing or huge outlays for automatic equipment. Engineers at Honeywell's Aerospace division got around the problem by designing an adapter that converts their d-c tester for pulse checks and costs only about \$1,500.

**Low-frequency counters
are needed, too**
page 123

Most recent counter developments have been directed toward higher frequencies. But accurate low-frequency measurements are often needed, too. And a high-frequency counter is just too slow to give the needed accuracy at low frequencies. New counter circuitry described in this article measures low frequencies in two steps: it first makes a conventional period measurement and then uses this information to convert the clock frequency to a high frequency that's proportional to the input frequency. The result is fast, high-resolution measurements of frequencies as low as 1 hertz.

**Misadventures in
computer control**
page 129

Computer designers may work at the state of the art of computer technology, but too many basic things continue to go wrong with industrial computer control. These problems can nullify all the sophisticated effort put into the process applications. An industrial control expert comments on some inadequacies of today's control computers and tells how small problems can have major effect on a system.

Coming

In the next issue we begin a series of articles on microwave integrated circuits with an examination of the entire field.

Threshold logic will cut costs, especially with boost from LSI

When experimental gates go into production they'll yield savings of as much as 50% over conventional Boolean and majority circuits; design can be tricky, but some configurations are quite straightforward

By Robert O. Winder

RCA Laboratories, Princeton, N.J.

Manufacturers of small parts learned long ago that weighing their output was faster and cheaper than counting each part. They pour parts onto one side of a balance that suddenly tips when the total weight exceeds a critical level just below a pre-determined threshold.

The same principle is used in threshold gates: they measure a total instead of counting its parts. Designers of logic systems will be able to cut costs as much as 50% by using such gates when they become available. However, the gates, unlike the small-parts balances, have two critical levels: above and below the threshold.

The day of commercial production has been brought closer by an interdivisional group at RCA. Last year the group developed the first integrated threshold gate that was compatible with conventional Boolean gates. Now they've devised a cell from which large threshold-gate arrays might be built. They've also developed networks for common logic functions that are simpler and more compact than the equivalent networks made from Boolean gates.

Individual threshold gates will cost more, but they'll produce savings because fewer will be needed for specific control, register, and processing

functions. This will make connections simpler. And, as noted, the devices can be incorporated in large integrated arrays.

A threshold gate produces an output only when its inputs exceed a prescribed value, or threshold. Each input may have a different value or weight—one unit, two units, and so on. The output is 1 when the sum of the input weights equals or exceeds the threshold and is 0 otherwise. The threshold gate is thus a generalization of the majority gate, whose inputs all have the same weight and whose threshold is half the number of inputs.

Cost and simplicity aren't the only advantages over conventional Boolean gates. For example, the designer can often make direct use of the characteristics of a function. If he's designing, say, a parity checker whose output is 1 when the number of inputs is odd, he need be concerned only with the total number of input pulses. If the designer used Boolean gates, he would have to determine which inputs were 1 and which 0 and include a Boolean gate for every possible odd combination of inputs. The parity checker, of course, is only an example; the output of many other functions depends only on the number of inputs, not which is which.

Theory of design

A sound basis for logic design with threshold gates has been established over the past eight or 10 years. At least three books, more than 100 papers, and many doctoral dissertations have been written, principally concerned with the following three areas:

- Determining what characteristics of a given function permit it to be realized with a single threshold gate, and what the best set of weights would be for a one-gate realization. Analogous

The author



Robert O. Winder is a member of the technical staff at RCA's David Sarnoff Research Laboratories near Princeton. He has a doctorate from Princeton University and has been with RCA since 1957.

studies in Boolean logic deal with minimization—removal of redundant terms from algebraic expressions.

- Determining how functions that aren't realizable with one gate can be best realized with several gates under various constraints—for example, using only gates with the same threshold, or limiting the number of inputs per gate.

- Investigating such aspects as the number of threshold functions, their characteristics, and tables of optimal weights.

Boolean to majority to threshold

Just as threshold logic is a more useful and general version of majority logic, majority gates are generalizations of the conventional Boolean gates that computer designers have been using for 20 years or more.

Any logic gate—Boolean, majority, or threshold—separates all possible input combinations into two classes, indicating one class by output 0, the other by 1.

For the familiar Boolean AND gate, one class consists of only a single combination—where all inputs are 1, and the output is 1—and the other class contains all other combinations. Similarly, an OR gate recognizes the single combination—all inputs 0—by providing a 0 output, and for all other input combinations provides a 1 output. These gates, together with the NOT or complementing gate, and including NOR and NAND, which produce the complemented outputs, are called Boolean gates because they correspond to the basic operations $+$ and \cdot of Boolean algebra.

While a Boolean gate separates one specific

Majority rule

		No. of 1's among w,x,y,z				
		0	1	2	3	4
(1)	OR	0	1	1	1	1
(2)	$a = b = c = 1$	0	1	1	1	1
(3)	$a = b = 1, c = 0$	0	0	1	1	1
(4)	$a = 1, b = c = 0$	0	0	0	1	1
(5)	$a = b = c = 0$	0	0	0	0	1

pattern from all others, the majority gate (MAJ) separates the input patterns into two classes containing several patterns. It generates a 1 when most of its inputs are 1, and 0 when most are 0. Of course, the gate must have an odd number of inputs to prevent an even split.

The majority gate can do more than a Boolean gate, in several respects. First, by considering some inputs to a MAJ gate as control inputs, the function performed by the gate on the remaining inputs can be varied electronically.

Capacity for logic

For example, compare a four-input OR gate with a MAJ gate having the same four inputs, W, X, Y, and Z, plus three control inputs, A, B, and C, as shown at the bottom of page 97. Various combinations of A, B, and C establish four different functions of W, X, Y, and Z, as in the table above. Adding control inputs to the OR gate doesn't provide such flex-

More logic, fewer gates

With Boolean gates, design is quite easy but requires several gates. For example, the parity function for three

variables is 1 when an odd number of the three inputs is 1. An AND gate recognizes each of the four cases in

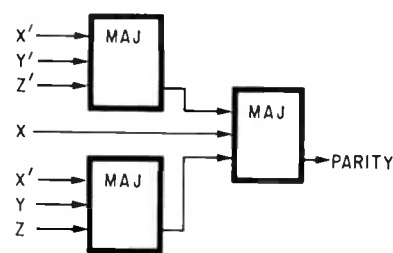
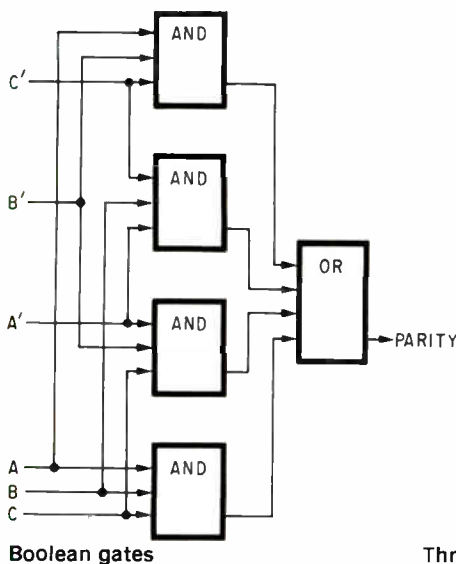

Majority gates

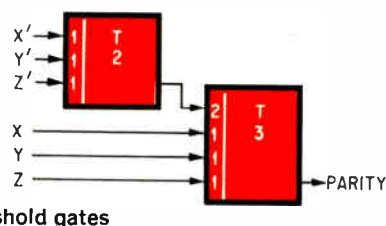

which the function is 1; the appropriate inputs represent 001, 010, 100, and 111, respectively. Then an OR gate produces 1 if one of the AND gates recognizes its assigned pattern.

Majority gates have more logical power than Boolean gates, but designing with them is usually more complex. The parity function requires three gates—one with the input-variable complements, one with a somewhat arbitrary choice of one complemented variable and two true, and one that mixes these with the remaining true variable.

Only two threshold gates are needed for the parity function. The simplest threshold gate, which has weights of 1 for each variable, won't work, regardless of the threshold level. What's needed is a way to change the main gate's threshold, depending on the number of input 1's. A three-input gate with a threshold of 2 does the job if it drives the main gate with a weight of 2 and a threshold of 3.

ibility. This greater logical capacity usually means that fewer gates are needed to realize any given computer function.

In the table, line 2 shows the effect of setting all three control variables equal to 1. With seven inputs in all, a majority is determined by four. Thus only one more 1 input produces an output of 1, so that the OR gate is duplicated. In the same way, line 5 represents the AND function. Lines 3 and 4 represent other useful functions.

One input of a logic gate permanently connected to a constant value may be assumed to reduce the capability of that gate. If such a permanent con-

nection is made to one of three inputs of a MAJ gate, it becomes a two-input AND gate. This doesn't work the other way; realizing a three-input MAJ function with Boolean logic requires four gates.

From the "voting" function of majority gates, the generalization to threshold gates is natural. Some inputs merely wield more power—more votes—than others. A threshold for an affirmative vote can be at any level—not necessarily at a simple majority. For example, the threshold may require a two-thirds majority.

The decision-making in a threshold gate consists of two parts: a summation of those weights that correspond to inputs with value 1, then a comparison of this sum with the gate's threshold.

Any real number—fractional, irrational, negative, or zero—can be used as a weight. However, only positive whole-number weights and thresholds need be considered. Zero-weighted inputs are the same as no input at all, and an arbitrary set of weights can always be transformed into an equivalent set of whole-number weights. Furthermore, negative weights can be eliminated by using the appropriate complemented input signals.

Integrating the gate

The integrated threshold-gate circuit developed last year by T.R. Mayhew of RCA Defense Electronic Products has five input switches, shown at left, each of which compares an input voltage with a reference voltage and routes current from one of two buses to an emitter resistor. A differential circuit connected between the two buses switches one way or the other depending on the relative voltage levels on the buses. The reference voltage originates in a voltage divider and is stabilized by an emitter-follower circuit. The same divider also controls two transistor clamps and two diode clamps that establish upper and lower voltage levels on the buses.

Early threshold-gate circuits added input voltages or currents directly through resistor inputs, following the appropriate Kirchhoff law. These circuits had several limitations that prevented them from being developed extensively:

- They required close tolerances on components and power supplies, to distinguish reliably between the various levels that could appear on the summation lines.

- They were relatively sensitive to noise on the signal lines, because it could cause the threshold to be exceeded at the crucial moment.

- They usually cost a lot more than contemporary Boolean gates, because of the close tolerances and the measures taken to suppress noise.

But monolithic silicon circuit technology has completely changed this situation. It overcomes the earlier difficulties in several ways:

- Component and power-supply tolerances are less important, because the current units generated by the various inputs are summed separately and the two results compared. As a result, although the circuit's operation is affected by base-to-emitter voltage differences in different transistors, it doesn't

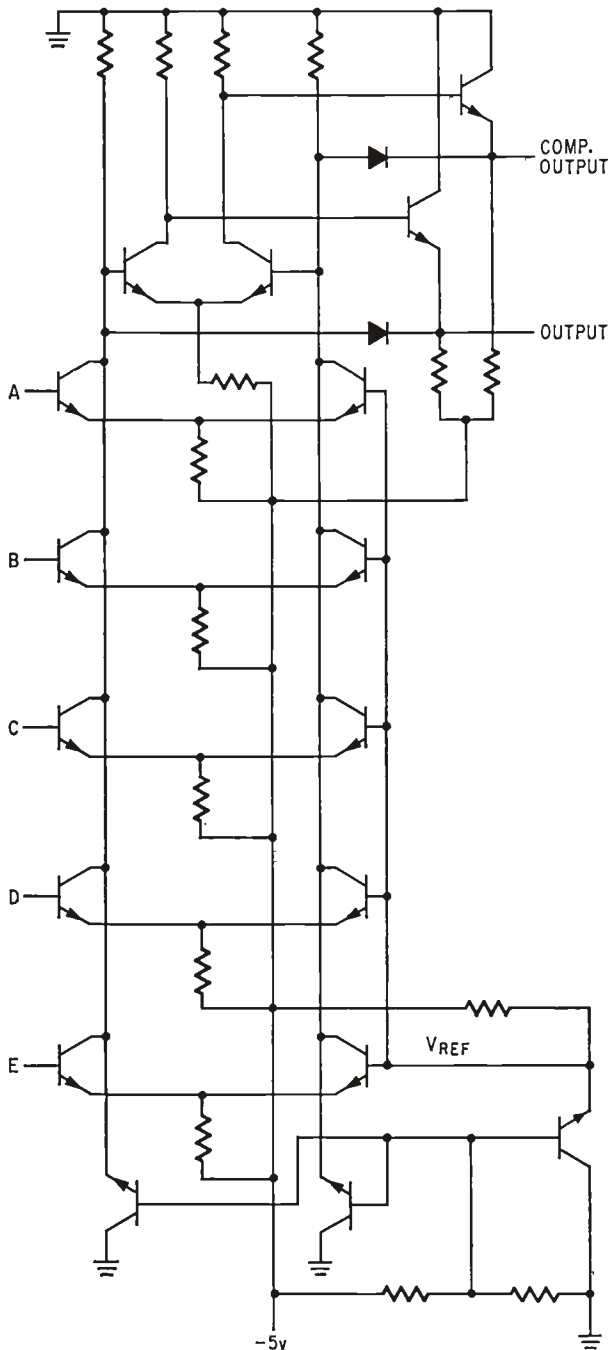

Threshold gate. Integrated circuit is first of its type competitive with Boolean logic.

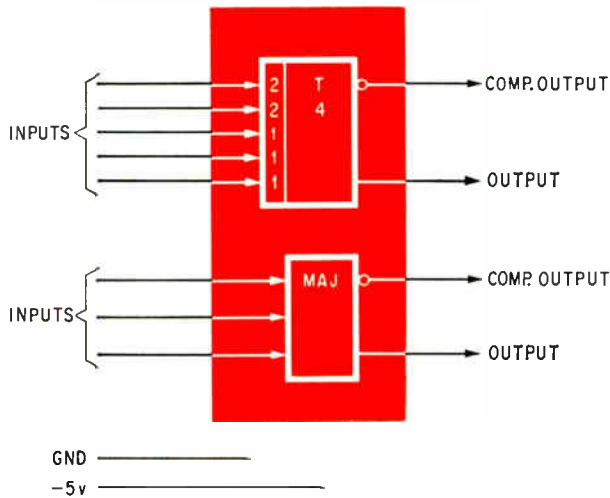

Two gates. A five-input threshold gate and a three-input majority gate fit in one dual in-line package.

depend critically on the actual values.

□ The units of current are developed through resistors whose ratios are more important than their absolute values. In integrated circuits, resistor ratios are easily held to $\pm 2\%$ or better; with this tolerance, four out of seven votes are easily distinguished from three of seven, and majorities of nine or 11 inputs are probably feasible.

□ Each input controls its own current switch; the quantity summed is an internally generated unit of current rather than the input voltage itself. This isolates the decision point from the inputs, establishing a very good noise immunity.

□ Threshold-gate circuits with monolithic silicon cost only slightly more than Boolean-gate circuits.

The integrated current-mode threshold-gate circuit has been made in small quantities at the Electronic Components and Devices division of RCA in Somerville, N.J. The gate's input weights are 2,2,1,1,1, and its threshold is 4. Thus the logic function performed by the gate is

$$AB + (A + B)(CD + CE + DE).$$

The two inputs with weights of 2 have emitter resistors half the value of the others, so the sum of all the weights is 7. The gate's detailed design has been previously reported.¹

Better noise immunity

The gate, like current-mode Boolean gates, requires a -5 -volt power supply and signal levels of -0.8 and -1.6 volts. Both true and complemented outputs are available. Compared with current-mode logic, power consumption is slightly greater and speed—15 nanoseconds worst-case delay with a 105-picofarad load—is slightly lower. Pilot production indicated that yields comparable to those of conventional current-mode circuits could be expected in full-scale production.

The noise immunity is better because the circuit has two stages of gain—the input switch and the decision switch. This results in a very steep transfer curve; for all but 85 millivolts of the 800-mv

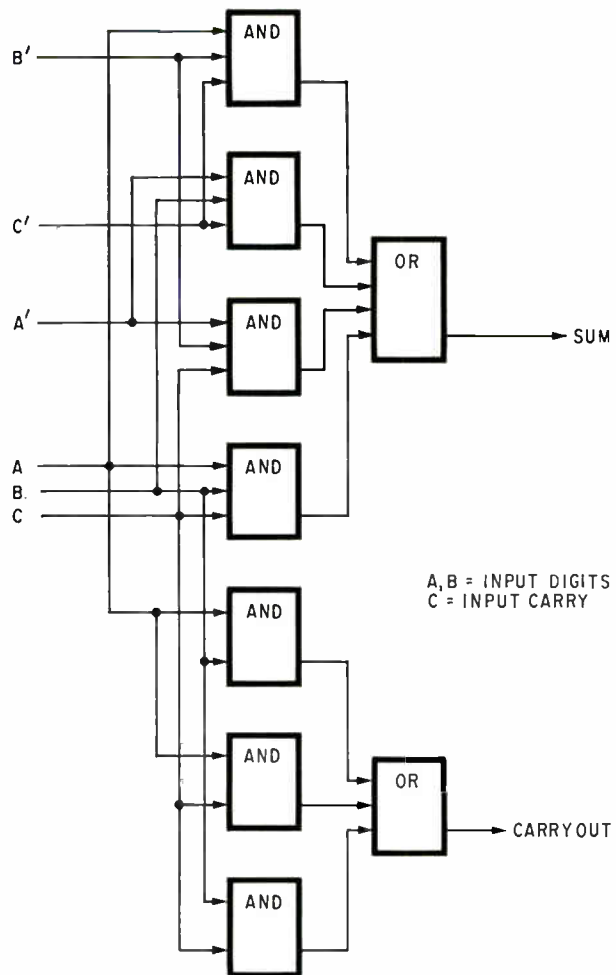

Boolean adder. Nine gates are required to realize a full one-bit adder in conventional logic.

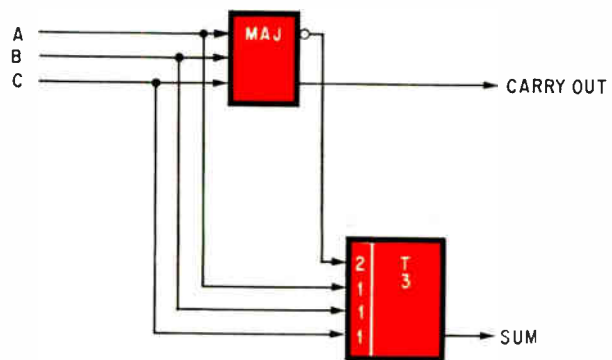

Threshold equivalent. A full adder requires only one threshold gate and one majority gate.

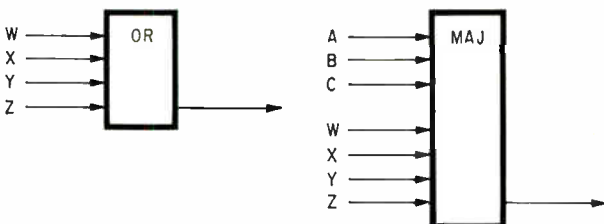

Variable function. The control inputs A, B, C alter the logic function performed on W, X, Y, Z electronically.

Hypercubes and threshold design

Geometric techniques make designing with threshold gates a lot easier, just as they do with Boolean gates. With a "map" of a function, the designer can easily recognize those functions that individual threshold gates can realize. Furthermore, as he builds up a network that realizes a designed function, the map technique shows him how to avoid intermediate functions that can't be realized by individual threshold gate circuits.

Most designers of Boolean logic are familiar with Karnaugh maps and Veitch diagrams—two related techniques that depict functions geometrically and show how they can be most economically built. Both techniques can be used with any number of variables, but their best-known form represents functions of four variables.

Fourth dimension. For these they use a four-by-four array of 16 cells corresponding, on the one hand, to the 16 possible combinations of four binary variables, and, on the other, to the 16 vertexes of a four-dimensional hypercube.

A hypercube can best be understood by generalizing from the more familiar two- and three-dimensional cases.

A square is a 2-D cube—four straight lines of equal length joined at right angles in a plane. The cube has four edges and four vertexes; its "faces" are undefined in 2-D.

A 2-D representation of the familiar 3-D cube, which has six faces, eight vertexes, and 12 edges, is simply two squares placed side by side, overlapped, or one inside the other, and four straight lines that join corresponding vertexes. The two

squares are two of the cube's six faces; the other four are formed by the joining lines, and are necessarily distorted because the 3-D figure is represented in two dimensions.

Cover story. In the same way, a 4-D hypercube can be represented as two 3-D cubes side by side, interlaced, or one inside the other. Eight straight lines join corresponding vertexes. These form six parallelepipeds or truncated pyramids (depending on the representation used), which represent six distorted 3-D cubes. These six and the two original cubes have a relationship to the 4-D hypercube that is the same as that of the six square faces to the 3-D cube.

A 2-D representation of a 3-D representation of a 4-D hypercube appears on the cover of this issue. The plane cutting the hypercube divides the vertexes representing 1 outputs from those representing 0 outputs.

No flats. The hypercube, or, in general, the n-dimensional cube, is also useful to designers of threshold logic. An n-dimensional cube has 2^n vertexes, which can be made to correspond to the 2^n combinations of n binary variables. The cube can be flattened into a 2-D plane in various ways. Boolean logic designers use one flattened representation as a Karnaugh map; threshold logic people prefer a different representation to preserve certain geometric properties that are lost in the Karnaugh map.

In the accompanying diagrams, 3- and 4-D cubes are shown relative to a set of coordinate axes parallel to the cube edges; these axes establish both the relationships between the variables and the edges and the orientation of 0 and 1 positions. For four variables, two 3-D cubes appear

input swing, the outputs are virtually certain to be within specifications—more than -850 mv or less than $-1,540$ mv. The comparable OR/NOR gate's outputs are ordinarily out of specification during 205 mv of the 800-mv signal swing.

This gate has been slightly improved recently and packaged with a three-input majority gate in a standard 14-pin dual in-line package. This two-gate circuit, in the block diagram at top left on page 97, is the basis for most examples in this article. Because the chip is bigger, this dual package costs about 25% more than the comparable dual current-mode OR/NOR gate.

Comparisons of Boolean and threshold gates in such computer parts as adders, registers, counters, and control units will be made here. Similar comparisons, using discrete circuits, have been made elsewhere.²

Nine Boolean gates, at top right on page 97, are required for a straightforward Boolean full adder, which has three inputs—two bits and a carry—a sum output, and a carry output. More sophisticated adders have been designed that use fewer Boolean

gates, but the designs are usually based on assumptions that offset the saving in gates.

Only two threshold gates (center, p. 97) are necessary for an equivalent full adder. In this case, using the integrated two-gate package, both true and complemented outputs are available, so the true inputs can be used in both blocks. Then the complementary output of the three-input gate drives the weight-2 input of the other gate.

Even though the actual gate has weights 2,2,1,1,1 and a threshold of 4, it can be used in the full adder, which calls for weights 2,1,1,1 and a threshold of 3. How this is done isn't as obvious as using only three inputs of a four-input OR gate. The technique (top left on p. 100), depends on the fact that different sets of weights can be used to realize any given threshold function. For example, a gate with weight 3,2,1,1 and threshold 4 is equivalent to one with weights 2,1,1,1 and threshold 3. In either case the function realized is

$$A(B + C + D) + BCD$$

as the reader can easily verify. Other convenient

side by side, with the fourth axis shown separately from the other three.

To represent a function on the diagram of a cube, the vertexes corresponding to those combinations of the variables for which the function is 0 are marked with a circle; vertexes corresponding to 1-values are marked with an X. For example, the three-variable parity function is at top right, and the four-variable function $A(B + C + D) + BCD$ is at center right. This is the function executed by the threshold gate shown on page 100, top left.

The importance of this representation can be stated in terms of a mathematical theorem:

If any four vertexes of an n-dimensional cube form a parallelogram in which one pair of diagonally opposite points is marked X and the other 0, then the function represented requires two or more threshold gates, regardless of the number of variables.

Conversely, if a function has a specified output for all combinations of its input variables and contains no such parallelogram when represented in a multi-dimensional cube, only one gate is necessary. This converse theorem holds true only if there are fewer than nine variables.

Proofs of these theorems, and extensive development of related ideas, appear elsewhere.⁷

Many such parallelograms appear, at least potentially, in a hypercube. They include the faces of the individual 3-D cubes, diagonal planes cutting pairs of opposed faces, and several other groupings.

No such parallelogram can be found in the diagram illustrating $A(B + C + D) + BCD$, indicating that a single gate can realize the func-

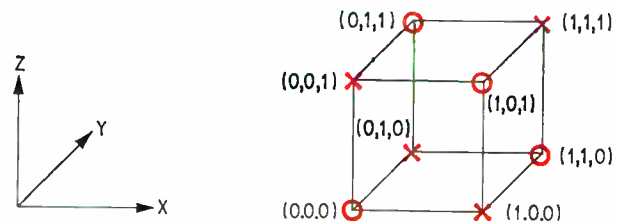

Parity function in three variables.

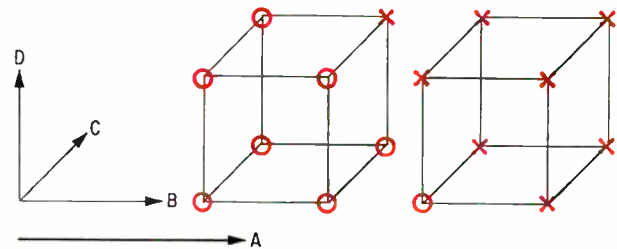

Typical one-gate function in four variables.

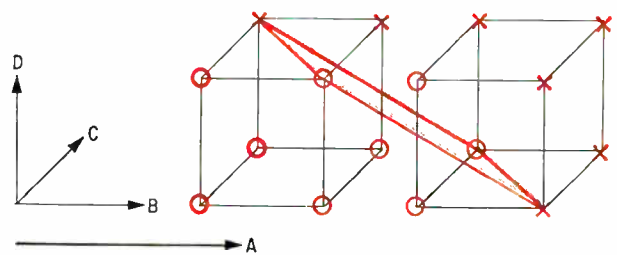

Parallelogram (shaded) shows this function needs two gates.

tion. But the parity function has many such parallelograms—for example, any face of the cube. The function $AB + CD$, directly above, has just one parallelogram, so it requires two gates.

equivalences are at top center and right, page 100. Equivalences between threshold gates have been thoroughly investigated and are described elsewhere.³

The ordinary full adders calculate each carry in terms of a preceding carry. Most fast computers use some type of carry look-ahead—a calculation of several carries in parallel. Any carry look-ahead function can theoretically be performed by a single threshold gate [see “Hypercubes and threshold design,” p. 98], but RCA’s 2,2,1,1,1 gate can look ahead only one bit position. However, a hierarchical arrangement using only 90 gates can add two 32-bit numbers, for example, in a total of five gate delays. The comparable Boolean gate look-ahead adder requires nine gate delays and uses 329 gates with as many as five inputs. These adders are too big to illustrate in detail.⁴

Registers

Direct feedback of a threshold gate’s output to one of its inputs allows the design of very efficient

storage circuits. In a Boolean circuit, such direct feedback would lock the gate permanently.

The simplest example is a single majority gate connected as a set-reset flip-flop. Two conventional interconnected NOR gates are necessary, as shown in color diagrams on the following page.

A gated flip-flop, however, is of more practical interest. This circuit, having first been reset, accepts data only when a control signal is present. The Boolean network requires an isolating gate to perform the extra function, but the threshold gate design simply incorporates additional inputs, as shown at the bottom of page 101.

In this circuit, when $R = S = 0$, $R' = 1$, so that the two 0’s and two 1’s cancel each other. Two of the three remaining inputs are fed back from the output, constituting a majority; they maintain the gate’s stable state, either 0 or 1. When R becomes 1, the four 0’s force the output unconditionally to 0—the gate is reset.

After R returns to 0, S becomes 1. This gives three 0’s, including the output fed back, that cancel

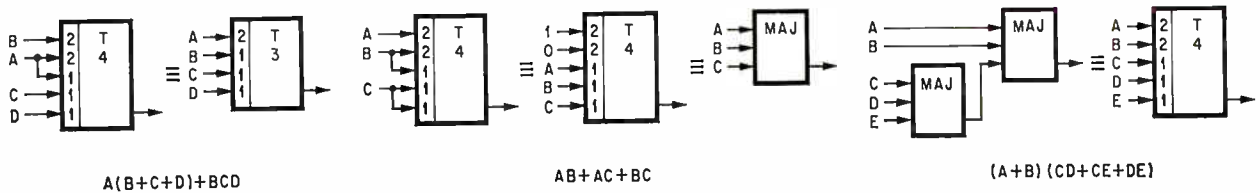

Equivalent networks. A given function often has two or more realizations in threshold logic, using the same or different gates. These are three examples of available choices. Many other equivalences exist.

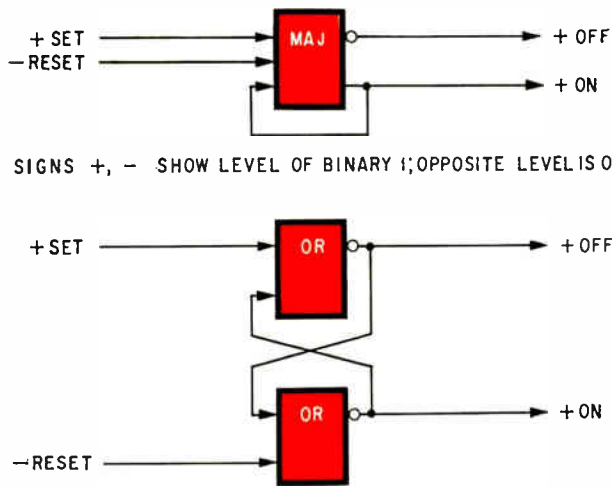

Flip-flop. One gate driving itself stores one bit, just as do two cross-connected Boolean gates.

three 1's, leaving the gate output to be determined by the signal on the bus. Finally, restoring S to 0 returns the gate to the stable state, where it maintains the same output regardless of subsequent changes on the bus. (Although the circuit calls for threshold gates, the diagram shows majority gates with the multiple-weight inputs tied together. These diagrams are generally easier to understand than if each block had little numbers representing weights on the inputs. The representation also appears in subsequent diagrams in this article.)

A third important class of flip-flop allows data to be set in without an initial reset. This operation is sometimes known as a "jam transfer." A Boolean network requires an isolation gate for this function and requires both true and complementary bus signals to be present. A threshold-gate equivalent de-

The hotter the better

In the threshold-gate cell being developed at RCA for large arrays, the output is independent of the base-to-emitter voltages of the cell's transistors, and the circuit's operation improves as the temperature increases. The following analysis shows why.

For convenience, let Δ stand for the base-to-emitter voltage and assume that all V_{BE} 's are equal. R_e represents the effective load resistance—the parallel combination of all the collector resistances on the reference side.

If n is the total weight of all the inputs, and if m of these are at the binary level 1, then the remaining $(n - m)$ are at 0 and $(n - m)$ units of current are delivered to the load resistance. The unit of current is

$$(-B - \Delta + 2B)/R = (B - \Delta)/R.$$

Thus the output voltage is

$$[-(n - m)R_e(B - \Delta)/R] - \Delta$$

If T is the threshold value and the critical cross-over value is equal to m , or $m = T - 1/2$, then the output should equal $-B$, the reference voltage:

$$[-(n - T + 1/2) R_e (B - \Delta)/R - \Delta = -B$$

Algebraic manipulation shows that:

$$R_e = R/(n - T + 1/2).$$

When $T = (n + 1)/2$, as in the majority gate, then $R_e = 2R/n$.

This value of R_e is independent of Δ —that is, at the output's critical transition point, the V_{BE} at the input switch is exactly compensated by the V_{BE} of the output emitter follower.

For the two worst cases $m = T$ and $m = T - 1$, giving outputs 1 and 0 respectively, the output values are:

$$\begin{aligned} & \left[-(n - T + \frac{1}{2} \neq \frac{1}{2}) \cdot \frac{R}{(n - T + \frac{1}{2})} \cdot \frac{B - \Delta}{R} \right] - \Delta \\ & = - (B - \Delta) \left[1 \neq \frac{1}{2n - 2T + 1} \right] - \Delta \\ & = -B = \frac{B - \Delta}{2n - 2T + 1} \end{aligned}$$

Thus the margin of the output—how much it differs from the reference $-B$ —increases with temperature, since Δ decreases. A circuit whose threshold and total weight were too close together would be unreliable without an ample margin. The margin is also less if the reference level is less, and is approximately inversely proportional to the difference between T and m . For example, with $B = 1.0v$, $\Delta = 0.7v$, for $n - T \leq 1$ we have a margin of $\approx 0.10v$.

With this margin the function $AB(C + D)$ can be easily realized in a single threshold gate. Its input weights would be 2, 2, 1, 1; the value of n is 6 and T is 5.

signed by K.R. Kaplan of RCA requires only one bus signal; however, like the Boolean network, it also requires another gate, either an AND or threshold gate. The basic configuration can be used in several other types of register systems.

A triggerable flip-flop is the basic unit in a binary counter—it changes state every other time its single input changes state. Realizing such a function without capacitors or inductors, to keep operation independent of input signal timing, requires six Boolean gates or three threshold gates.

Going through stages

Ring counters with an odd number of stages have a particularly straightforward threshold-gate realization. They require one threshold gate per stage or input cycle to be counted. For example, a three-stage counter shown at right can be made with three 3-input majority gates.⁵

At any given moment, alternate gate outputs are 0 and 1 respectively; of course, since the number of stages is odd, two adjacent gates somewhere along the line have the same outputs—00 if the input is 0, 11 if the input is 1. When the input changes, the right-hand member of the equal pair reverses value, thus becoming the left-hand member of the next pair. This shifting moves twice around the ring to complete one cycle.

In one design of an even-stage counter, one gate of an odd-stage counter is replaced by a five-input gate that looks ahead for the two equal outputs and reduces the cycle period by one trigger cycle. Other designs have also been worked out.⁶

Another family of ring counters uses a more natural counting system but requires gates with more inputs. Only one stage's output is 1 at a time when the clock input is 0. When the clock input becomes 1, the next stage to the right turns on; when the clock returns to 0, the original stage turns off. A four-stage counter using this principle requires threshold gates with weights 2,1,1,1,1 and therefore can't be built with the same package used in previous illustrations. Ring counters of any number of stages can be built following this design.

Shift registers

A double-bank shift register, in which one bank of flip-flops temporarily stores data while the other is being reset in preparation for a right or left shift, can be made with the gateable flip-flop stages shown below. The basic design requires four control lines—a set and reset line for each of the two

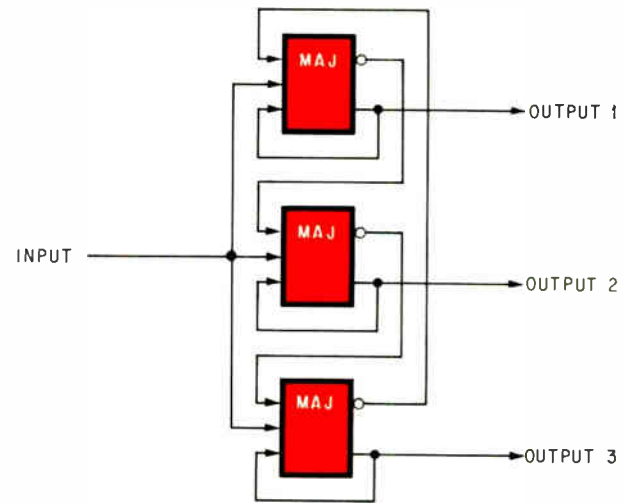

Simple ring. The pattern shown here can be repeated to make a ring counter of any odd number of stages.

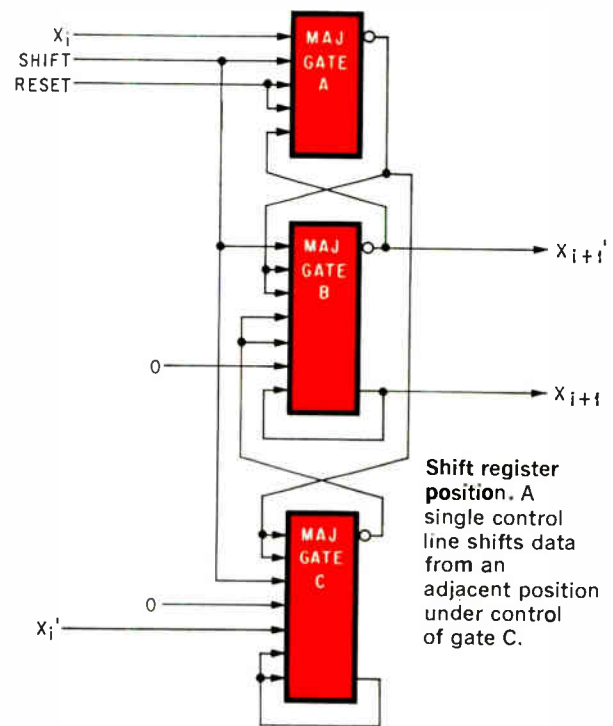

banks of flip-flops.

A simpler shift register with only one control line, shown above, has been designed by RCA's Kaplan, but it requires a third threshold gate in each bit position. When both reset and trigger lines are at 0, the register stores data normally. If two ad-

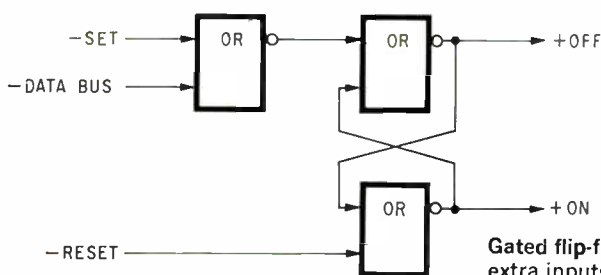

Gated flip-flop. Basic flip-flop, shown on page 100, requires only extra inputs to do what requires extra gates in Boolean design.

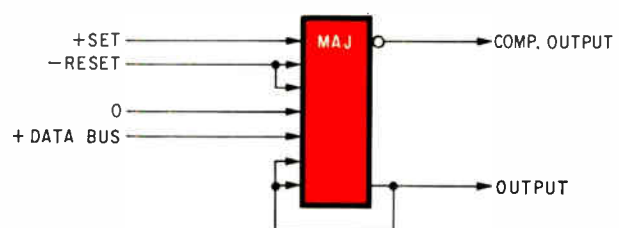

adjacent bit positions are equal, a signal on the trigger line has no effect. But if the bits are unequal, the rise of the trigger signal sets gate C to the complement of the adjacent position, and the signal's fall then sets B to the new complement of C—equal to the previous adjacent position. A signal on the reset line resets gate B to 1.

Control logic

A large part of the logic in any computer is control logic. However, because these systems are different for each machine and can't be described in general terms, the following example must be somewhat speculative.

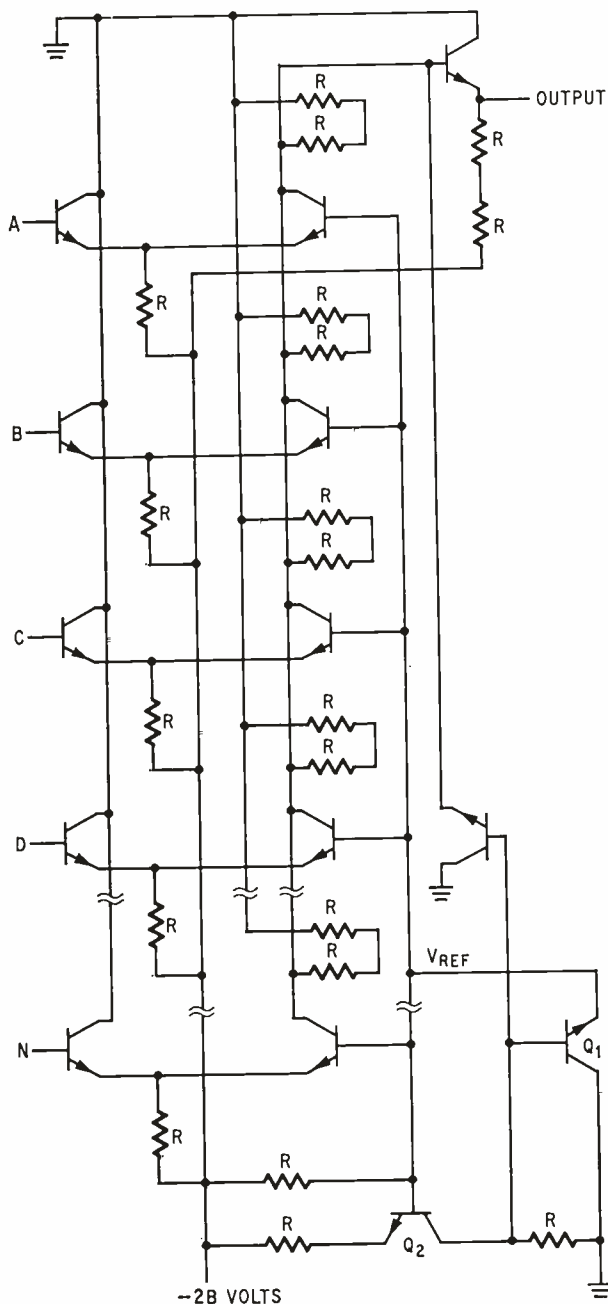

Cellular design. This threshold gate, derived from the earlier design, can be laid out as cells on a large chip.

A process involving several steps may be initiated by a signal shown at the top of the diagram on page 103. This signal locks gate A into the 1 state, which it maintains until turned off. Three timing pulses, TP_1 , TP_2 , and TP_3 , follow the initiation signal but have no effect unless the initiation has actually taken place. TP_1 sets gate B if a certain condition is met, producing a reset signal for the duration of TP_1 . TP_2 generates an unconditional proceed signal through gate C; TP_3 initiates a release signal at gate D, and feedback maintains the release signal. When the acknowledge-return signal arrives, gate E resets gates A and D, and the control system is ready to start over.

This example illustrates how threshold gates can realize, one-for-one, the various states of a control mechanism. Such a realization is expensive in a Boolean system because each state requires a flip-flop and gating circuitry. To reduce costs, Boolean control logic often relies on a smaller set of flip-flops—a control register—to store a set of binary numbers that encodes the set of all control states. Such a system requires decoders to recover the desired states and complicated AND/OR networks to drive the control register.

The simpler threshold-gate circuits are easier to design, easier to maintain, and probably easier to check for errors. But whether such circuits would be feasible in large control systems could be determined only by a complete computer design.

What about LSI?

Earlier threshold gates had to be redesigned for LSI, just as Boolean gates to be used in arrays must be modified to reduce power dissipation, simplify design, and reduce sensitivity to temperature and power-supply variations.

For example, the gate shown at left is much like that shown on page 96, but the threshold decision is made at the input switches of the next gate, instead of at a separate switch. This requires a redefinition of logic signals as voltage ranges instead of voltage levels.

Any voltage more than the basic reference supply, $-B$, is 1, and any voltage less than $-B$ is 0—maintaining a reliable margin of at least 100 mv, of course.

The critical transition point of the output is independent of transistor base-to-emitter voltage [see "The hotter the better," p. 100]. Also, all resistances in the circuit are the same value, making its fabrication considerably easier, and permitting the reference voltage to be established at half the power supply voltage and derived easily through a voltage divider. The equal resistors also account for the series-parallel combination forming the collector resistance $2R/n$. Therefore, wide swings in temperature—a bugaboo in large arrays—affect the circuits very little.

The reference voltage is obtained through a combination of a voltage divider and emitter follower—similar to the combination in the earlier version—and is further stabilized by the feedback con-

nection of the reference voltage to transistor Q_2 . These are important features, because on a large chip the voltages on the power and ground buses tend to vary as a result of the current drawn through the buses. However, as long as the two voltage drops are reasonably symmetrical, the voltage at the junction of a divider remains nearly constant regardless of where the divider is connected to the buses.

The emitter follower stabilizes the reference further by drawing more current through the transistor Q_1 if the reference tends to fall for any reason; the additional current through Q_1 's load resistor returns the reference toward its proper value. Small variations remaining in the reference control the transistor Q_2 , inserted in the voltage divider, and affect the voltage at the junction, which in turn controls the base of Q_1 and the clamping voltage on the bus.

This circuit has no complementary output. Threshold-gate logic needs fewer complemented signals than Boolean logic, but a separate complementing circuit is required. If the power supply is no more than about -2 volts, a simple differential amplifier driving two emitter followers will do. The circuit also requires a ground-to-collector diode to clamp the inverting transistor. For higher voltages, more complicated circuits may be necessary to avoid saturation.

A rare case

This basic circuit has great logical flexibility: extra input transistors can be added in parallel to any input switch, providing an input OR function just as in conventional emitter-coupled logic. Also, the effective load resistor on the summed input-switch currents can be changed to obtain any threshold value—the critical output value's independence of temperature isn't affected.

Interestingly, the more nearly the gate resembles an AND gate—that is, the higher the threshold—the easier the tolerance problems become, contrary to usual experience. This makes the circuit suitable for Boolean as well as threshold gates in LSI systems where the two are mixed. In particular, a load resistance high enough to make the circuit into an AND gate can combine with the input OR function to form a powerful circuit for Boolean design. Thus both kinds of gates can easily be put on the same chip.

As the number of inputs to a gate increases, its noise immunity declines. This allows a tradeoff in design of the logic and layout. A one-input gate has the largest guaranteed difference between output levels, and could be used as a driving circuit at the chip's output. It also requires the smallest input-signal tolerance, and can therefore accept signals from long transmission lines, or restandardize the outputs of threshold gates with many inputs.

An array of these gates could be conveniently fabricated from several cells, each containing, for example, two transistors and four identical resistors. An individual cell could be connected as an in-

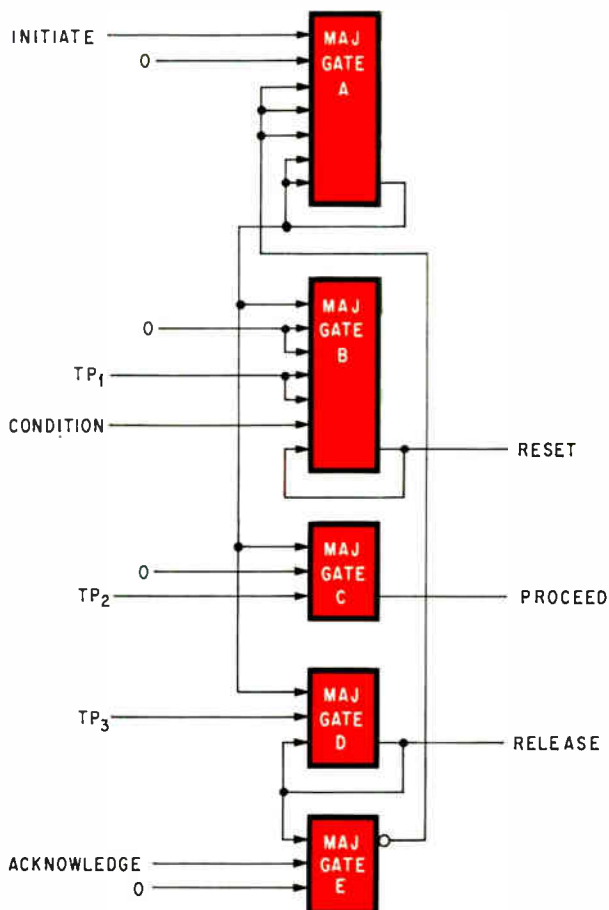

Control network. A chain of threshold gates can control a sequence of steps just as can Boolean gates.

put switch with a load, an output circuit with a clamp, or as half a pair of complementary circuits. The appropriate number of input cells could be used for each gate, without the waste that comes with standardization.

Bibliography

- Sze-tsen Hu, "Threshold Logic," University of California Press, Berkeley, 1965.
- P.M. Lewis II and C.L. Coates, "Threshold Logic," John Wiley & Sons Inc., New York, 1967.
- R.O. Winder, "The Status of Threshold Logic," First Annual Princeton Conference on Information Sciences and Systems, Princeton University, March 1967, p. 59.

References

- J.J. Amodei, D. Hampel, T.R. Mayhew, and R.O. Winder, "An Integrated Threshold Gate," Digest of the 1967 International Solid State Circuits Conference.
- C.L. Coates and P.M. Lewis II, "DONUT, a Threshold Gate Computer," IEEE Transactions on Electronic Computers, June 1964, p. 240.
- S. Cohen and R.O. Winder, "Threshold Gate Building Blocks," submitted to IEEE Transactions on Computers.
- R.O. Winder, "Logic Network for Realizing Associative Logic Functions," U.S. Patent No. 3,308,285, March 1967.
- J.E. Price, "Counting with Majority-Logic Networks," IEEE Transactions on Electronic Computers, April 1965, p. 256.
- Piotr Misiurewicz, "Comment on 'Counting with Majority-Logic Networks,'" IEEE Transactions on Electronic Computers, April 1966, p. 262.
- R.O. Winder, "Fundamentals of Threshold Logic," Air Force Cambridge Research Laboratories, AFCRL-68-0066, January 1968; to be included in "Applied Automata Theory," in preparation by Academic Press Inc., New York.

Designer's casebook

Sine-wave inverter prevents interference

By W.E. Osborne

Whittier, Calif.

Inverter transistors generate bursts of high-frequency, high-voltage noise as they switch on and off. When these bursts radiate to the sensing elements and high-gain amplifiers in battery-operated detection instruments, they blank out signals and cause inaccurate readings.

However, no switching noise is radiated when a sine-wave oscillator is used as the inverter's high-voltage source and an easily filtered d-c voltage results.

The coils L_1 and L_2 in the Colpitts oscillator should be tuned so that the oscillator's output voltage would be at its maximum when the resonant frequency reaches 100 kilohertz. If efficiency is of prime importance, high-Q toroidal coils should be used. In this circuit, L_1 and L_2 had Q's of 90. The oscillator's voltage is rectified by a bridge circuit

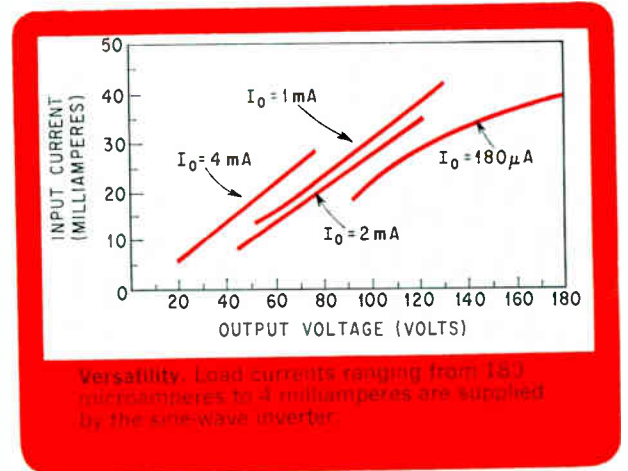

and then filtered by a 1-microfarad capacitor. A d-c voltage derived from a high frequency signal has a distinct advantage: ripple current remains infinitely small despite wide changes in load current.

A supply built for bias purposes in an infrared bolometer was contained in a copper shielded box whose total volume was less than 3 cubic inches. The two coils were shielded subminiature units having tunable slugs in ferrite cores. Output voltage

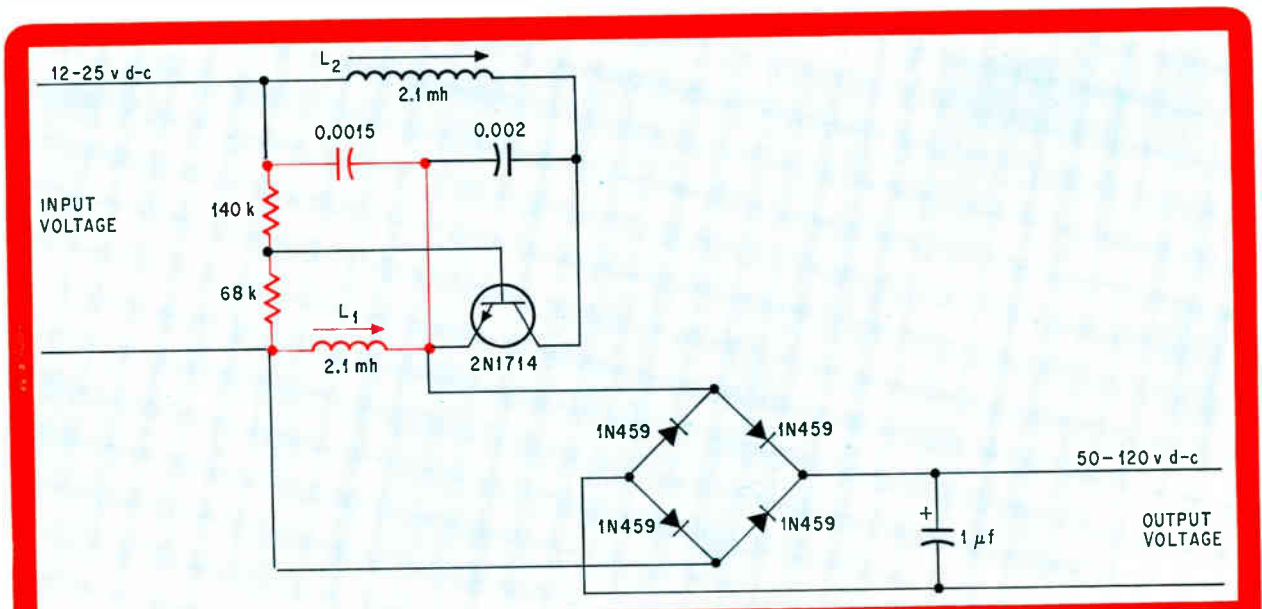

Unpretentious power. The pure sine wave at the output of the Colpitts oscillator has no high-current switching point like the square wave in a conventional inverter. Consequently, transients that radiate into other circuits aren't produced.

in this particular supply was 90 volts. To maintain this level, an additional 11 kilohm-5 μ f filter and a zener diode were placed at the bolometer's input.

If an inverter is designed to supply bolometer voltages in the 175-volt range, adjustments must be made in the oscillator circuit. Compensation must be made for bias changes that take place in the oscillator transistor when high voltage is being de-

veloped across L_1 . By placing a 1-kilohm potentiometer between Q_1 's emitter and L_1 , bias adjustments can easily be made. Inefficient operation of the inverter caused by a distorted sine wave is thereby prevented.

The negative side of either the input or output can be grounded. If both sides are grounded at the same time, the transistor will be destroyed.

Gated semiconductors clean a-c switching

By William B. Miles

Charles Bruning Co., Mt. Prospect, Ill.

An extra burst of high-frequency voltage is placed on a line when a load is switched on at a-c voltage peak or switched off when the load's a-c current is at its peak. These exponentially damped oscillations, known as radio-frequency interference, have voltages that can destroy transistors in line-operated equipment. Since it is difficult because of its high frequency, to remove rfi from the line, gate controlled a-c switches were used to prevent oscillations from starting. The two switches—one parallels the load and determines the trigger point on the other switch in series with the load—permit the voltage and currents to be switched only when their values are zero.

When the power switch is open, the a-c voltage coupled from the line through C_1 is able to bias

Triac₁ into conduction. The biasing alternates from positive to negative and since it is in phase with the line a-c keeps gated switch₁ as a permanent a-c short. The current drawn by this shunt path is 40 milliamperes and is kept at this level by the high resistance of R_2 .

As long as this gated semiconductor is in full conduction, its terminal 2—the point where diodes D_1 , D_3 and resistor R_2 are common—is at the same potential as terminal 1 at the gate end. The diode cannot be biased into conduction and, consequently, no current flows through R_3 . Since this gate voltage does not develop, the gated switch remains open, and consequently the load remains isolated from the 117 v supply by the triac's high resistance.

When the switch is closed, the a-c signal that was forward biasing this semiconductor switch is now shorted to ground. The half cycle, whether positive or negative, during which the switch is closed, completes and the operation stops at this zero point.

With Triac₁ shut off, the a-c signal is coupled through R_2 , the diodes (which depend on the a-c polarity), and across R_3 . A gate voltage is now developed for Triac₂ thus making it an a-c short be-

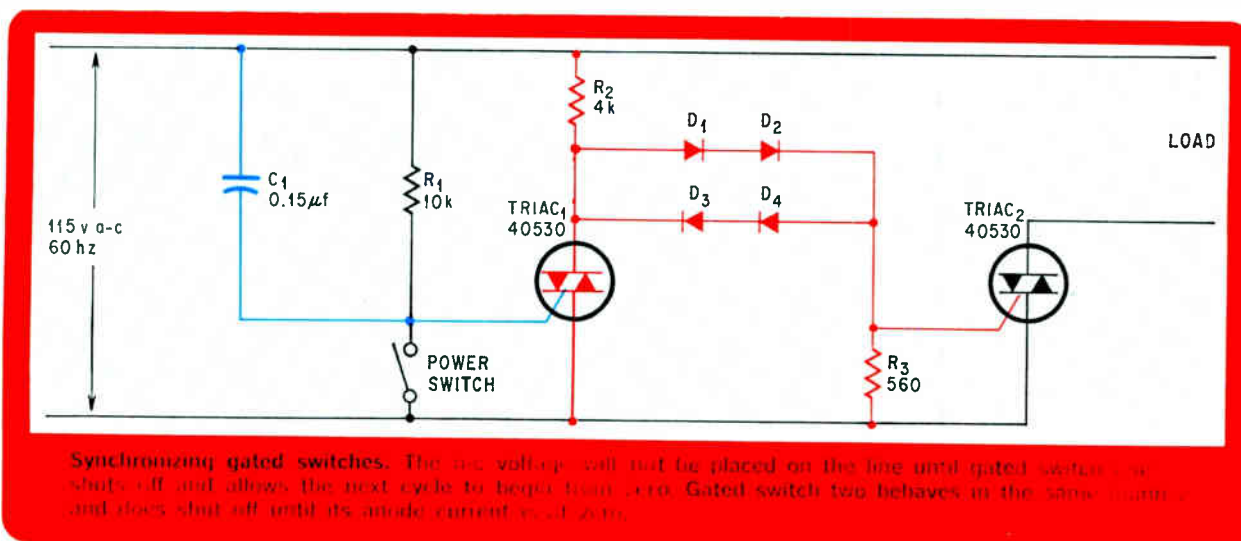

tween the line and the load.

At the reopening of the power switch, the first gated switch is biased into a-c conduction again, thus removing the second's gate voltage. Removing this does not cause an immediate stop in Triac₂'s

anode current. When the half cycle of a-c current is finished current stops and is unable to begin until Triac₁ is again gated into non-conduction.

Capacitor C₁ phase shifts line current so that the first gated switch starts before the second.

Pulse generator is supply and temperature independent

By Jack Kisslinger

Fabri-Tek Instruments Inc., Madison, Wis.

Because its charging rate can be nearly independent of temperature variations, the simple resistance-capacitance network is an ideal frequency source in a pulse generator. When used in conjunction with a differential amplifier and a multivibrator, the RC circuit takes on another desirable characteristic: its time constant is independent of supply-voltage variations.

The oscillator composed of these three circuits surpasses in stability the unijunction-transistor pulse generators now in use. With temperatures ranging from -25° to 100°C and supply-voltage variations of 30%, the oscillator's frequency will change less than 1%.

When the voltage on the charging C₁ becomes almost equal to the voltage across R₃, transistor Q₁ conducts. This moves the collector of Q₁ from +12 volts to approximately +6 volts. With the base of Q₃ at a much lower potential than its emitter, this transistor is biased strongly into saturation. In a few picoseconds the collector of Q₃ goes from the

ground to nearly 12 volts, thereby forming the leading edge of the output pulse.

The current through R₄ and R₅ when Q₃ is conducting develops voltage drops that bias Q₄ and Q₅ into saturation. The discharge of C₁ causes Q₁ to turn off while C₂ charges to 6 volts. Although the collector of Q₁ returns to 12 volts after Q₁ shuts off, Q₃ remains in conduction.

After C₂ completes its discharge through R₆, Q₃ turns off sharply, thus forming the falling edge of the pulse. Transistors Q₄ and Q₅ are returned to nonconduction and C₁ starts to recharge through R₁ in preparation for the following pulse.

The values of R₁ and C₁ must never become so low that the repetition rate of the pulse train nears the width of the pulse. If any changes are made in these values, they can be raised to 500 kilohms and .2 microfarads, C₂'s value must be also changed. Otherwise, a long pulse width won't allow enough time for C₁ to recharge.

The voltage divider—R₂ and R₃—that supplies the reference voltage at the base of Q₂ compensates for supply variations. Every variation in the supply changes the voltage to which C₁ charges. Fortunately, the reference voltage undergoes a corresponding change and the time interval necessary for the triggering of Q₁ remains constant.

Negative pulses injected at the base of Q₂ synchronize the oscillator. A varying d-c voltage at this point produces a voltage-controlled oscillator.

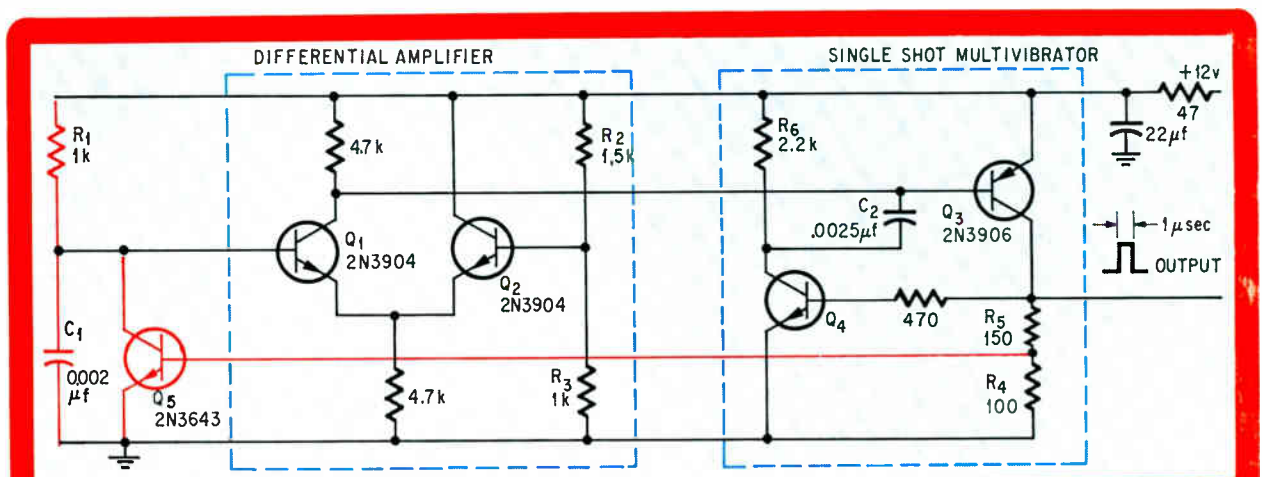

Protected stability. The time constant, RC, is unaffected by temperature and always triggers the differential amplifier at the same frequency. Compensating action by R₂ and R₃ prevents shifts in supply voltage from affecting the trigger point in the amplifier.

**5-AMP
10-AMP**

PNP

**Silicon
Power
Transistors**

from **Soliton**

In addition to 20-Amp devices, Soliton has now expanded its line of PNP Power Transistors with a 10-Amp and 5-Amp Series. Both Series have a voltage breakdown range of 40 to 120 Volts. All have direct complements available.

10-AMP SERIES



Type Number TO-61 Isolated	MAXIMUM RATINGS			PRIMARY ELECTRICAL CHARACTERISTICS ($T_C = 25^\circ\text{C}$)					
	V_{CEX} Volts	V_{CEO} Volts	V_{EBO} Volts	h_{FE}		$V_{CE(sat)}$ Volts	$V_{BE(sat)}$ Volts	I_{CEX} A	f_T MHz
				$I_C = 10A$ $V_{CE} = -5V$	$I_C = 5A$ $V_{CE} = -5V$				
				Min.	Range	Max.	Max.	Max.	Min.
SDT3105	40	-40	6	10	30-90	1.0	2.0	10	30
SDT3106	60	-60	6	10	30-90	1.0	-2.0	10	30
2N5316	80	-80	-6	10	30-90	1.0	2.0	10	30
2N5318	100	-100	-6	10	30-90	1.0	-2.0	10	30
SDT3109	120	-120	-6	10	30-90	1.0	-2.0	10	30

5-AMP SERIES



Type Number TO-5	Type Number TO-111 Isolated	MAXIMUM RATINGS			PRIMARY ELECTRICAL CHARACTERISTICS ($T_C = 25^\circ\text{C}$)					
		V_{CEX} Volts	V_{CEO} Volts	V_{EBO} Volts	h_{FE}		$V_{CE(sat)}$ Volts	$V_{BE(sat)}$ Volts	I_{CEX} A	f_T MHz
					$I_C = 5.0A$ $V_{CE} = -5V$	$I_C = 2.0A$ $V_{CE} = -5V$				
					Min.	Range	Max.	Max.	Max.	Min.
SDT3321	SDT3301	-40	-40	-6	10	40-120	-1.0	-2.2	10	40
SDT3322	SDT3302	-60	-60	-6	10	40-120	-1.0	-2.2	10	40
SDT3323	SDT3303	-80	-80	-6	10	40-120	-1.0	-2.2	10	40
SDT3324	SDT3304	-100	-100	-6	10	40-120	-1.0	-2.2	10	40
SDT3325	SDT3305	-40	-40	-6	5	20-60	-1.2	-2.5	10	40
SDT3326	SDT3306	-60	-60	-6	5	20-60	-1.2	-2.5	10	40
SDT3327	SDT3307	-80	-80	-6	5	20-60	-1.2	-2.5	10	40
SDT3328	SDT3308	-100	-100	-6	5	20-60	-1.2	-2.5	10	40
SDT3329	SDT3309	-120	-120	-6	5	20-60	-1.2	-2.5	10	40



Dial 1-800-327-3243 for a "No Charge" telephone call and further information

*When you think of semiconductors
...think Soliton!*

Soliton
DEVICES, INC.

1177 BLUE HERON BLVD. / RIVIERA BEACH, FLA. / TWX: (510) 952-6676

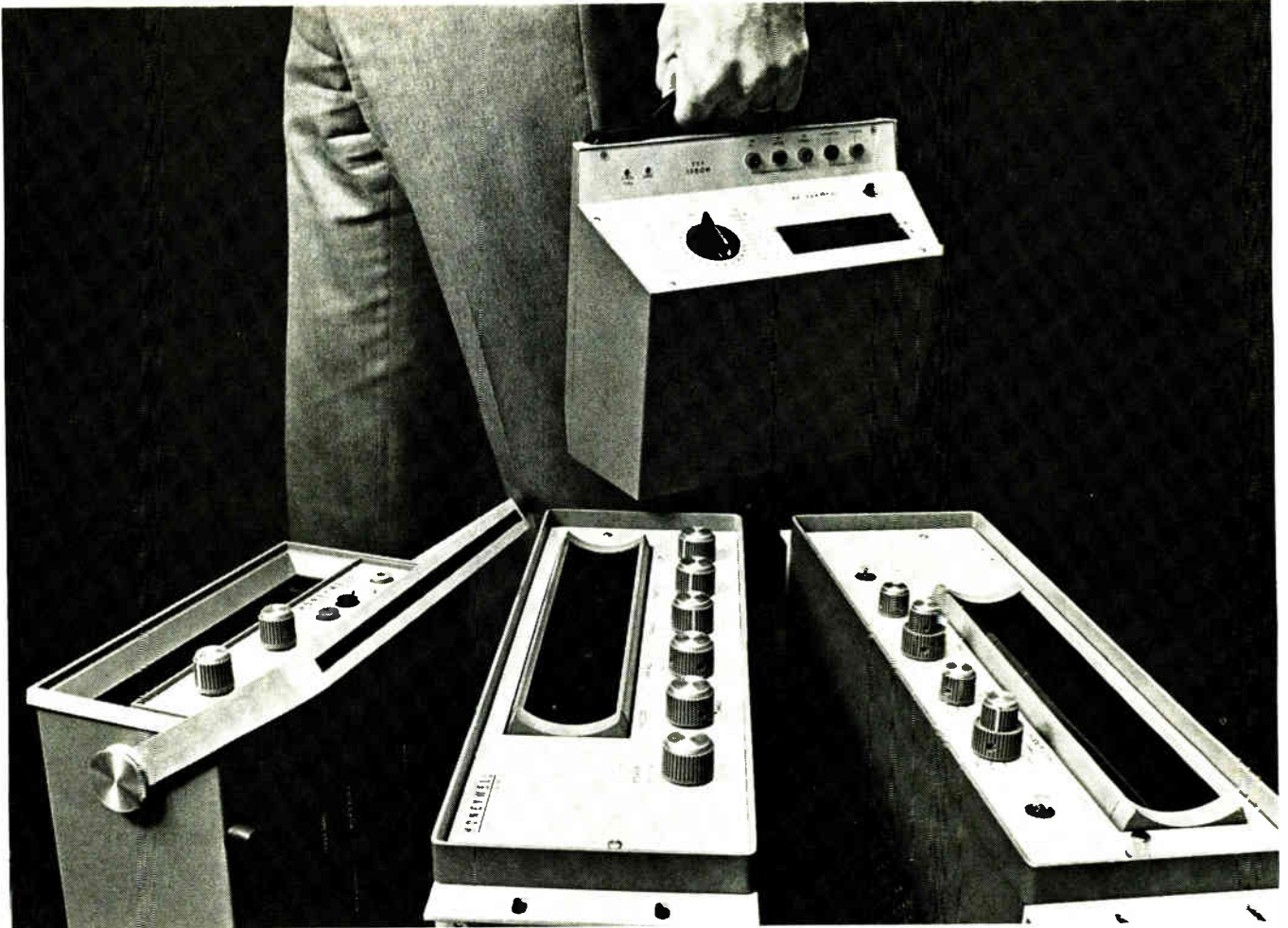

Being carried, the portable Digitest; other Honeywell DVM's (l. to r.): 620 Series; 630 Series; 85 Series.

You bet Honeywell makes DVM's -- here's our fifth generation!

Beginning in 1954 with our 4500 Series, we've been building good DVM's. We've refined them, improved their accuracy, and expanded their capabilities through four distinct generations — each better than the last. The family that makes up the present generation comprises a broad line of models in a wide price range. You can choose precisely what it takes to solve your measurement problems, buying no more — or no fewer — features than you really need. The table at right gives you a quick rundown on the fifth generation.

Send for the Honeywell DVM Solution Kit.

Get complete information on the entire Honeywell DVM line — learn how to select the instrument that will provide the precise solution to your measurement problems. Write: Honeywell, Test Instruments Div., P.O. Box 5227, 4800 E. Dry Creek Rd., Denver, Colo. 80217. Or, call your Honeywell Sales Engineer today!



Honeywell

	Price	Accuracy	Capability	Readout Speed
Digitest	\$395	.5%	DC/AC/I/Res.	2 sec.
Features: An extremely versatile solid-state instrument with total portability due to built-in, rechargeable batteries. High speed and accuracy make it a perfect all-around service tool, equally at home in the lab, on the production line, or in the field.				
620B Series	\$985	.01%	DC/AC/Res.	4 per sec.
Features: Portable, integrating units with exclusive "autoject" circuit providing higher noise rejection at any frequency than any other integrating DVM. Full 4 digits plus 5th for 20% overrange; automatic ranging and polarity; isolated differential inputs for over 140 db of common mode rejection of noise.				
630S Series	\$3595	.01%	DC/AC/Res.	10 per sec.
Features: Highly versatile without additional accessories, this integrating DVM/Counter series gives you 5 full digits plus 6th for 20% overrange; 5 DC ranges, with the most sensitive providing 1 μ v resolution; differential inputs and integrating logic for up to 140 db noise rejection, and remote programming of all functions and BCD outputs.				
85 Series	\$3800	.005%	DC/AC/Res.	100 per sec.
Features: Highly compatible with automatic data systems, these multimeters provide maximum measurement speed and accuracy. They offer ratemeter operation; basic 10 μ v resolution; full 5-digit measurements; automatic ranging and polarity, and up to 160 db common mode rejection of noise.				

Honeywell engineers sell solutions

Active filters: part 1

The road to high Q's

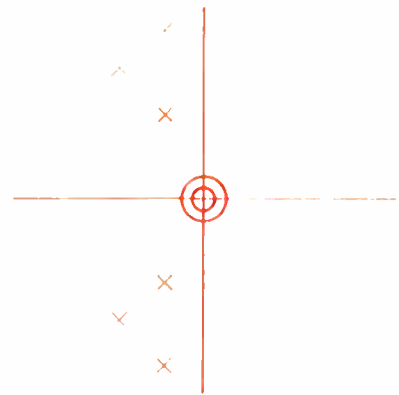

When it comes to low-frequency applications, passive LC networks have proven to be far from satisfactory because they require bulky inductors to achieve a maximum Q of 100; active filters, however, can be made in IC form and can achieve almost any desired value of Q

By Joseph Mittleman

Senior associate editor

Active filters are giving designers of bandpass amplifiers a shot in the arm—particularly when it comes to low-frequency applications. Instead of the familiar passive LC networks, designers can turn to a filter that is capable of achieving almost any value of Q. An active filter is merely a transistor coupled to a passive RC network to produce the frequency response of an LC filter.

Inductance-capacitance filters, though reliable at high frequencies and easy to design, are limited to a maximum Q of about 100 at low frequencies; higher Q's are physically impractical because it would necessitate a large, bulky inductor. This is true even for a value of 100 and has led to reliability problems because of thermal and vibrational stress stemming from the wiring's many turns. Attempts at reducing inductor size with high permeability materials and ferrite cores have had little success; inductor quality tended to deteriorate rapidly as the frequency was lowered.

Active filters, on the other hand, have a decided size advantage. Unlike the LC filter, the active unit can be fabricated in integrated-circuit form. Moreover, active filters need not be designed around a specific source or load impedance. Since this is required for passive filters, variations affect the electrical characteristics.

Another edge active filters have over passive ones: loss in signal strength between input and output is nonexistent.

Best suited for low- and medium-frequency applications calling for relatively high Q's, active

filters can be used in a variety of circuits. For example, they can be used as low-pass filters with cutoffs as low as 1 hertz and Q's well over 100, or in comb filters at 50 hz with a 0.5- to -1-hz bandwidth per spike. They can also be used in circuits that require wide bandwidths, small sizes, and low or zero midband insertion loss or even gain. Active filters can also be used in circuits that combine modulation, rectification, and filters, and in others where coils cannot be used because of inductive pickup.

The Scripps Institution in La Jolla, Calif., is using an active filter for ocean-wave analysis. The filter detects the build up of storm waves up to 2,000 miles away. And at the New Jersey Psychiatric Institute, active filters are being used in brain-wave analysis and encephalograms. Other actual applications include analog-to-digital conversion and noise suppression.

Texas Instruments is using active filters to prevent sampling errors that occur while converting the analog data to digital form in an a-d converter. Both the Leeds & Northrup Co. and the Cornell Aeronautical Laboratory are employing the active devices to reject noise. Leeds & Northrup has found the devices particularly effective while achieving a good attenuation and a quick response time in a process-control system.

And the aeronautical lab in Buffalo, N.Y., has found the filter successful in rejecting noise signals picked up in an aircraft.

Making it possible

Theoretical attractiveness is one thing, but putting theory into practice is altogether something else. Reliable fabrication of active filters proved

This is the first article in a continuing series of active filters. The editors welcome any contributions on this important subject.

far more difficult than what designers thought they would be. At first, there were these difficulties to solve:

- Achieving a low initial tolerance for the network elements;
- Minimizing the component temperature variations;
- Overcoming the long-term drift of the device's transistors and passive elements;
- Overcoming the prohibitive cost of building active filters;
- Stabilizing the filter's characteristics;
- Obtaining reliable capacitors on an IC chip that would be comparable to tantalums and polystyrenes.

Designers solved the element-tolerance problem by accurately designing and adjusting the elements, and compensating the parasitic effects that are always present. With lumped-element filters, the elements are fabricated to within a few percent and then trimmed to within a fraction of a percent. Since these filters are designed primarily for low-frequency applications, the parasitic effects are negligible and the engineer compensates for them by designing around them. These effects are particularly bothersome at high frequencies where the magnitudes are comparable to that of the designed network elements.

With present monolithic-IC fabrication techniques, designers must allow for initial tolerances of 25% to obtain reasonable yields. Thin-film depositions may, however, be made to tolerances of a few percent. Thus, monolithic active circuits can be coupled with passive thin films in feedback arrangements to obtain initial precision comparable to those of conventional, discrete-component filters. The IC is favored, however, below 400 hz because it is possible to get good integrated R's and C's. But above 400 hz the discrete R's and C's have much better tolerances than the IC's.

What is now desired is a technique for trimming the circuits to within a fraction of a percent. With IC's, the parasitic effects are due principally to the close proximity of components and the use of pn junctions to isolate the elements. Because these parasitics are unpredictable, they are difficult to control.

Since RC networks are capable of behaving like oscillators, temperature variation is extremely critical—far more so than in passive LC networks. Oscillation is most serious when high-Q poles are close to the right half of the complex frequency plane. The slightest change in pole position can cause oscillation, rendering the filter useless.

In conventional lumped-component filters, temperature compensation is usually accomplished by making the components as insensitive to temperature variation as possible and then choosing elements that vary in a complementary way. This technique can also be applied to thin-film components in IC's in which temperature-sensitive semiconductors can be troublesome. However, IC's do have a major temperature-compensation advantage

over discrete circuits. Because the IC's components are in close proximity, they tend to track temperature to a much greater degree. Moreover, their size makes it practical to stabilize the environment temperature with heaters.

Like temperature variations, the long-term drift of both the active and passive components must be minimized. The quality of thin-film resistors and capacitors is highly dependent on the process control and purity of the materials used. For example, the component characteristics may be changed by the migration of an impurity. But thanks to careful process and quality control, it is possible to fabricate thin-film resistors and capacitors comparable in quality to discrete components. There may be an initial period of change during burn-in time, but the components are quickly stabilized. In transistors, the leakage currents tend to increase with age and gains tend to decrease. However, their effects can be satisfactorily controlled with careful processing and burning-in.

Solving the problems

Many approaches have been taken to finding the solutions. One, favored by several designers, calls for starting with a basic IC active network, and then using a computer to select R and C values that are based on a customer's requirements.

Not only does this approach lead to quick turnarounds to customer inquiries, but it goes a long way towards lowering the design cost. Moreover, it combines two worlds—custom circuits with a standard network. Most manufacturers aren't quite sure for what frequencies they should stock filters, and at what point do they turn to customizing.

One firm—EG&G Inc. in Boston—believes it has hit upon a solution. Last year, the company introduced an active filter called the Minactor, for miniature active resonator [Electronics, Feb. 20, 1967, p. 221]. Measuring only 0.8 by 0.6 by 0.2 inch, the Minactor is a completely encapsulated hybrid-IC consisting of a thick-film resistor substrate, discrete capacitors for fixed frequency operation, and an amplifier with eight transistors. Seventy-five percent of the synthesis, in the form of a characteristic chart shipped with each unit, is already performed by the manufacturer. Each device provides an independent pair of complex conjugate poles and a tunable Q in its voltage transfer function. The resonant frequency can be tuned externally with optimum results from 0.7 to 1.4 times the nominal frequency. All the user need do is refer to the chart and select the proper resistor and capacitor—connected externally to the filter—that will give him the desired results.

The road to synthesis

Numerous synthesis techniques have been developed for fabricating active RC filters for any desired frequency or phase characteristic. But only three—the operational amplifier, the negative-impedance converter, and the gyrator—have become well known.

Computer-aided synthesis

With few exceptions, active filters are custom-made devices. And like most circuit designers, those working on filters are turning to computers for speedier results. Once a filter's specifications have been determined, a designer can employ a computer-aided synthesis technique to arrive at the optimum filter design and component values for the filter.

In one CAD approach, a customer's filter requirements—insertion

loss curve and phase shift or time delay—are fed into the computer. Based on this data, arbitrary pole-zero locations are established to start the computer's search pattern. The computer shifts the pole-zero locations, increasing their number if necessary, until the customer's specification is met. From this, the computer selects the most efficient structure and the required circuit values.

Not only does the machine print out these values, but it prints out

and plots the filter's insertion loss curve, phase shift, and time delay. Where all this could take a designer weeks to do, the computer can do the job in less than 48 hours—even on a time-shared basis.

After customer approval, the filter design is forwarded to prototype engineering, where microcircuit and filter engineers breadboard the circuit and test it to determine actual characteristics. Prototype performance data is usually available within two weeks.

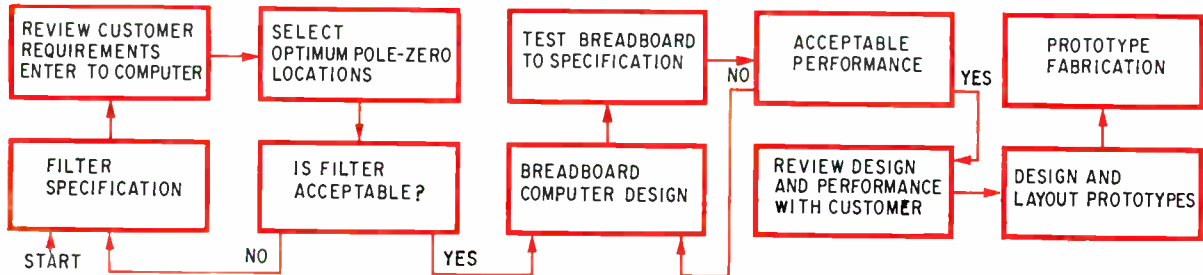

Design development cycle

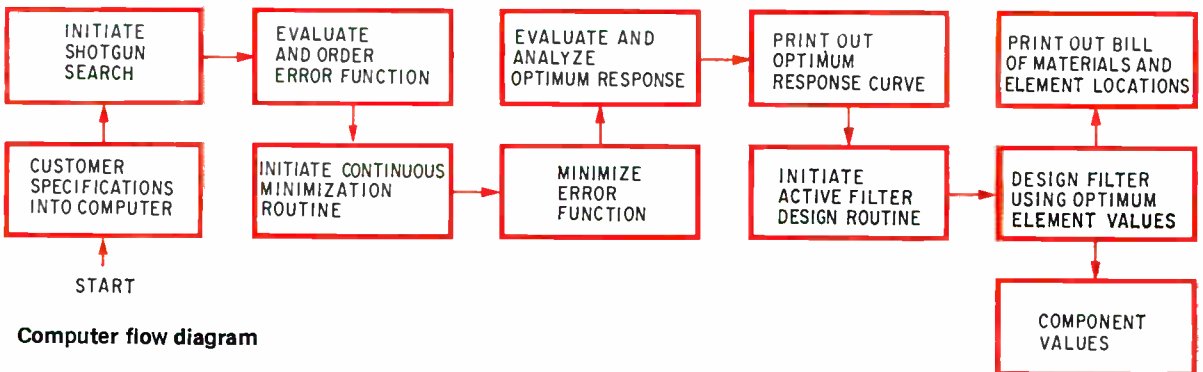

Computer flow diagram

All synthesis techniques, however, have one thing in common: the desired amplitude-phase characteristic is assumed specified as a ratio of polynomials and then factored into the product of second-order terms. Each factor is achieved independently by a network and then the networks are cascaded to yield the composite result.

In the approach for the operational amplifier, negative feedback is applied to the high-gain circuit to produce the required segments of the transfer functions. Illustrated by the bandpass structure on page 112, this technique has the advantage of being insensitive to changes in gain as long as the gain remains high. This scheme is good for high Q 's and needs only a low spread of network values. However, the op amp is difficult to adjust and requires many elements. A slightly different arrangement that is easy to adjust uses resistive clamping to obtain a bandpass filter from an oscil-

lator made with two operational amplifiers.

Moderate-gain amplifiers or controlled sources that are structurally similar to the infinite-gain op amp can also be used. These amplifiers may be single transistors in the case of a current-controlled current source or a field effect transistor in the case of a voltage-controlled current source. The controlled source can achieve moderate Q 's with a minimum number of elements and a minimum spread of values. High Q 's are out of reach at present because they require control of gain and element values that are far too precise.

Another scheme often used to produce the individual parts of the transistor function is the negative impedance converter, (NIC) a reciprocal, two-port device. When an impedance is connected across one set of terminals, the negative of this impedance appears across the other set. The major advantages here are ease of adjustment and few

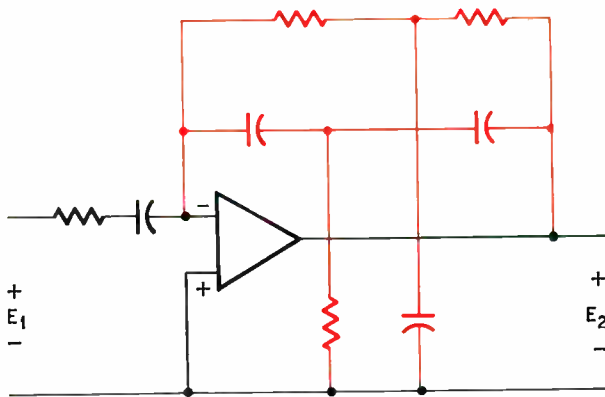

Bandpass filter. Very-high-gain amplifier with negative feedback produces desired transfer function. As long as the amplifier's gain remains high, filter will be insensitive to amplifier gain changes.

elements with low value spreads. But these are partially offset by the converter's instability and the need for special isolation.

Another technique for realizing a desired transfer function is the gyrator, a nonreciprocal two-port network. When an impedance is connected to one pair of terminals, it appears inverted at the other pair. Thus, a capacitor connected at one port appears as an inductor at the other port.

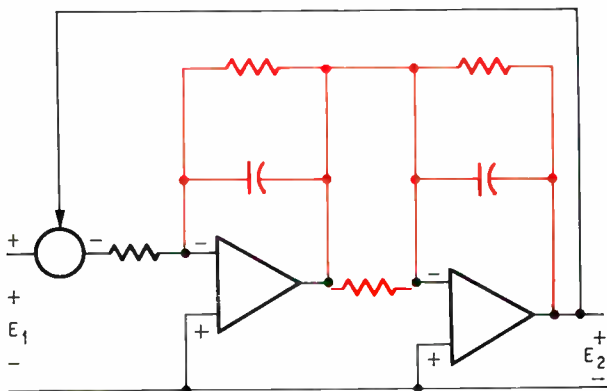

Damped oscillator. Resistive damping turns this oscillator, consisting of two op amps, into an active filter. Requiring only a few components, the filter is easily adjusted.

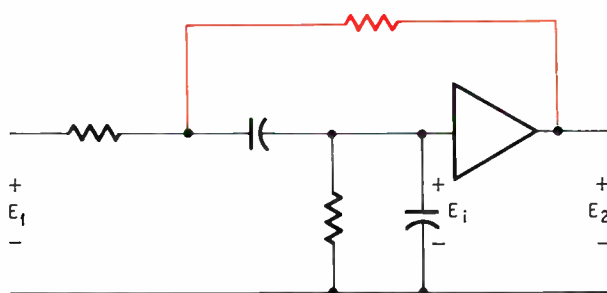

Controlled source. A single transistor incorporated into an op amp provides a current-controlled current source. A field effect transistor would produce a voltage-controlled current source. With either transistor, this circuit can achieve Q 's of about 1,000.

Although the concept was first introduced in 1948, the gyrator hasn't been a popular building block in practical circuits—primarily because it is usually constructed by using several negative-impedance converters, making it an extremely complicated structure. Recently, however, attempts have been made at using the gyrator to circumvent the sensitivity problem in active RC circuits. Instead of inductors, gyrator-capacitor combinations are used. But this places a great burden on the gyrator's design. With the gyrator, the designer gets better quality from the capacitor load than from a discrete inductor.

Defining the problem

Basically, filter synthesis means that a filter is constructed with a transistor characteristic that produces a specific variation with frequency.

The generalized transfer function for an active filter is given by

$$T(s) = \frac{E_{out}(s)}{E_{in}(s)} = \frac{a_m s^m + a_{m-1} s^{m-1} + \dots + a_1 s + a_0}{b_n s^n + b_{n-1} s^{n-1} + \dots + b_1 s + b_0}$$

where the a 's and b 's represent coefficients selected to give the desired shape of the transfer function, or insertion loss curve.

Consider, for the moment, a simple bandpass filter. The classic type of bandpass characteristic is the normalized resonance curve whose transfer function is described by

$$T(s) = \frac{E_{out}(s)}{E_{in}(s)} = \frac{Hs}{s^2 + \alpha s + 1}$$

where $b_0 = 1$, $\alpha = \frac{\omega_0}{Q}$, $H = \omega_0$ and H/α is the gain when $\omega = \omega_0 = 1$. The term ω_0 is the center frequency of the bandpass filter in radians per second, and Q is the center frequency divided by a 3-decibel bandwidth.

If the transfer function is evaluated at $s = j\omega_0$, then

$$T(j\omega_0) = \frac{\omega_0(j\omega_0)}{-\omega_0^2 + \frac{\omega_0}{Q}(j\omega_0) + \omega_0^2} = Q$$

Thus, instead of having an insertion loss at the center frequency as in a passive filter, the bandpass filter exhibits a voltage gain of Q at the center frequency. For good stability, the active circuit should be Q/ω_0 times as stable as the expected value of ω_0/Q to cancel any appreciable drift in the filter characteristic.

When an amplifier drives a capacitive branch of a network, the output impedance must be considerably smaller than any of the network's resistive elements. The attenuation achieved in regions well beyond cutoff frequencies falls short of

the theoretical value due to the finite impedance.

Since an active filter has high input and low output impedances, the insertion loss curve is essentially independent of the source and load impedances. This isn't true for passive filters.

Passive filters must be designed to a specific source and load impedance. If either the source or load impedance changes slightly, a marked difference may occur in the insertion loss curve. This also results from a temperature change—primarily due to the nature of the passive filter's inductor.

In the passive filter, the center frequency is determined by $1/\sqrt{LC}$, while the impedance level is determined by $\sqrt{L/C}$. When the temperature coefficient of L is chosen to track the capacitor, the impedance level stays constant but the center frequency changes. And when the temperature coefficient of L is the negative of C, the center frequency stays constant but the impedance level shifts. In either case, the response of the filter is adversely affected. The high input and low output impedances of an active filter prevents such characteristic changes.

Pole-zero plots

Another way of examining the transfer function is from a pole-zero plot of the roots of the polynomials. Thus,

$$T(s) = \frac{E_{out}(s)}{E_{in}(s)} = \frac{Hs}{s^2 + \alpha s + 1} = \frac{Hs}{(s + p_1)(s + p_2)}$$

where p_1 and p_2 are the poles and are expressed by

$$p_1, p_2 = -\frac{\alpha}{2} \pm \sqrt{\left(\frac{\alpha}{2}\right)^2 - 1}$$

When α is less than 2 a pair of complex conjugate poles result. For small values of α , resonance occurs at $\omega = \omega_0 = 1$.

The pole-zero diagram for small α is plotted in the complex frequency plane and shows the transfer function as roots of the numerator called the zeros and the denominator called the poles.

A passive RLC filter can have its zeros anywhere in the complex frequency plane while its poles are confined to the left half plane or on the $j\omega$ axis. Thus, the passive filter can be produced by almost any transfer function but at a sacrifice in gain.

The active RC filter can also have its zeros anywhere in the complex plane and its poles are also confined to the left half plane or on the $j\omega$ axis. Thus, it appears that the active RC filter can realize the same transfer functions as the passive RLC filter. However, the active filter can achieve higher gains, but it runs the risk of oscillation.

In active filters, the electrical properties of the passive RC networks are combined with the active properties of a transistor amplifier in a feedback

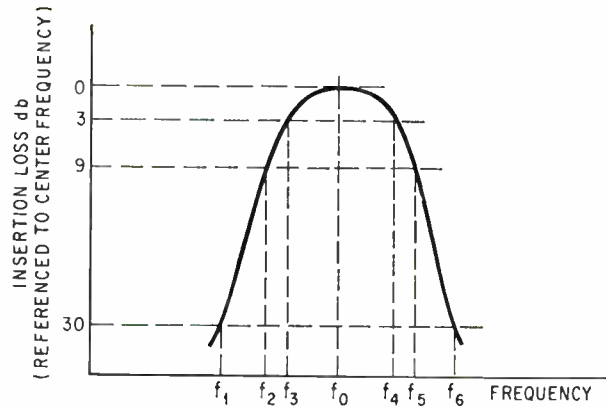

Computer-designed filter. Starting with the center frequency, f_0 , and six other points on the curve, the machine calculates the transfer function of a network capable of producing this response.

configuration, which results in the desired transfer function.

Computer-aided design

By simply cascading several filter sections more complex bandpass filters can be produced than with a single filter section. But this isn't as simple as it seems. Synthesis can be achieved far faster—if not better—with a computer than manually. The computer selects the number of stages required, and the electrical characteristics of each, to meet the desired requirements. Regardless of the filter's complexity, its over-all response is as stable as the single-tuned response. Any desired filter characteristic can be obtained without regard to conven-

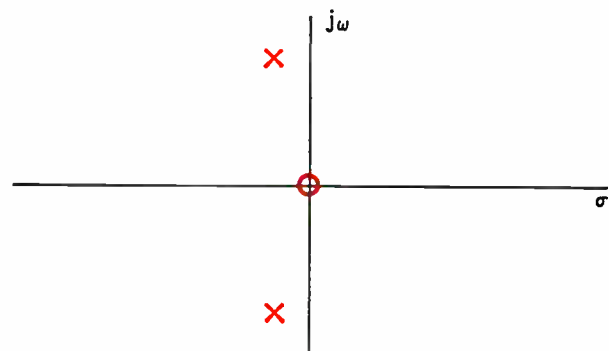
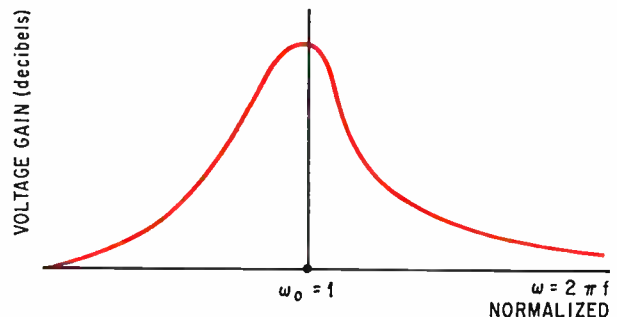

Bandpass response. Once a network's transfer function is established, a designer can plot the pole-zero position. From this, he can synthesize the network capable of producing the desired frequency response curve. Above is a typical response curve and its pole-zero plot.

Comparing the three techniques

Characteristics	Operational amplifier	NIC	Gyrator
Small number of network elements	fair	good	average
Stability of network	good	fair	average
Low output impedance	good	poor	poor
Produces all transfer functions	average	good	average
Ease of adjusting characteristics	fair	good	good
Produces active device	good	average	fair

tional well known filter types.

An example of computer-aided design is the filter characteristic at the top of page 113. In addition to the center frequency, six points of the insertion loss curve are usually specified. Starting from an arbitrary pole-zero location, the computer calculates the transfer function of the filter at each specified point. The difference between the computed decibel attenuation and the desired specification at a frequency, f_i , is called the residual, R_i .

If, for example, the attenuation at f_1 of the filter shown were 25 db instead of 30 db, the residual at f_1 would be 5 db. The residual at each frequency is computed, and the function $I = \sum f_i R_i^2$ is evaluated. The term I is never negative. When it is zero, the specification is exactly produced.

The computer moves the pole-zero locations to minimize I , increasing the number of poles and zeros, as required. When a computer run is finished, the designer obtains typical values of I of approximately 10^{-8} , well within the tolerances of the components used to assemble the filter. Element values are obtained directly from the computer program and when assembled, the filter characteristic is typically within 0.2 db of the insertion-loss curve predicted by the computer.

The choice of an active filter depends on the intended application. If weight and size pose no problem, then a passive filter may be best. However, if weight and size are of major importance, then an active filter should be considered since in many cases it can be fabricated in IC form.

Activating the passive RC network

By Arnold Meltzer

George Washington University, Washington

In **active filters**, the electrical properties of both passive RC networks and active semiconductors are combined. The passive RC configuration—usually a ladder, paralleled-ladder, bridged-T, twin-T, lattice, or any combination of these—has the poles of the transfer functions on the negative real axis of the complex frequency plane. The poles only occur once at any given point.

Zero locations, however, depend on the network's topology. Thus, a ladder network has its zeros—called transmission zeros—alternating with its poles on the negative real axis. The lattice network can have its zeros anywhere in the complex plane, and the other network types can have their zeros everywhere except on the positive real axis.

Ladder networks

One of the popular types of passive networks used in conjunction with active devices is the RC ladder network. Consisting of alternately connected series and parallel-elements—usually series resistors and parallel capacitors—ladder networks are often used in combination with operational amplifiers and negative-impedance converters to produce bandpass filter characteristics. The general transfer function

for a ladder network is given by

$$\frac{E_2(s)}{E_1(s)} = \frac{(s + z_1)(s + z_2) \dots (s + z_n)}{(s + p_1)(s + p_2) \dots (s + p_n)}$$

where the z 's are the zeros and the p 's are the poles of the transfer function. For a ladder network, the poles and zeros are real and negative numbers. By itself, the network doesn't have bandpass characteristics: the poles are on the negative real axis and do not occur as a complex pair near the $j\omega$ axis.

In a twin-T network, a pair of zeros on the $j\omega$ axis cannot develop an output voltage at that frequency. This transmission zero makes the RC twin-T network behave as a null network.

Because the twin-T is composed of resistors and capacitors, its poles are confined to the negative real axis of the complex frequency plane, but its zeros can occur on the $j\omega$ axis. A response curve for such a network, voltage gain as a function of frequency, has a null at the zero's frequency on the $j\omega$ axis. This network does not possess bandpass characteristics. In fact, it possesses band rejection characteristics because it rejects a band of frequencies about the transmission zero.

By adding an active device, such as an operational amplifier, to a passive RC filter, the designer is able to produce a bandpass response. As an example, consider two passive RC networks, denoted by a single and double prime, connected to the ideal op amp on page 116.

The passive networks can be described by their y-admittance parameters. Thus, for the single prime network,

$$\begin{aligned} I_1' &= y_{11}'E_1' + y_{12}'E_2' \\ I_2 &= y_{21}'E_1' + y_{22}'E_2' \end{aligned}$$

For the double prime network,

$$\begin{aligned} I_1'' &= y_{11}''E_1'' + y_{12}''E_2'' \\ I_2'' &= y_{21}''E_1'' + y_{22}''E_2'' \end{aligned}$$

Inserting these values into the over-all network relationship yields

$$\begin{aligned} I_1 &= I_1' = y_{11}'E_1' + y_{12}'E_A \\ I_2' &= y_{21}'E_1' + y_{22}'E_A \end{aligned}$$

and

$$\begin{aligned} I_1'' &= y_{11}''E_A + y_{12}''E_2'' \\ I_2 &= I_2'' = y_{21}''E_A + y_{22}''E_2 \end{aligned}$$

However, since this is an op amp, $E_A = 0$. Thus,

$$\begin{aligned} I_1' &= y_{11}'E_1' \\ I_2' &= y_{21}'E_1' \end{aligned}$$

and

$$\begin{aligned} I_1'' &= y_{12}''E_2'' \\ I_2'' &= y_{22}''E_2'' \end{aligned}$$

Also, an ideal op amp draws no current.

Hence $I_2'' = -I_1''$, which yields

$$I_2' = y_{21}'E_1' = -I_1'' = -y_{12}''E_2''$$

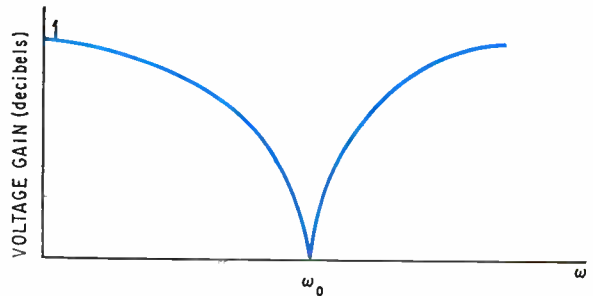
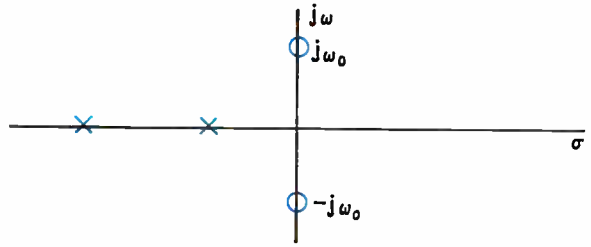
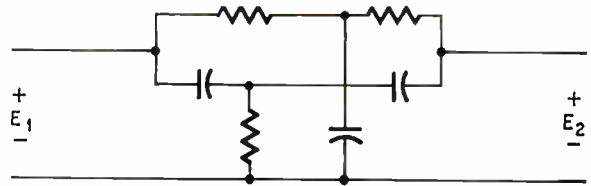

Twin-T network. Pole-zero pattern is for parallel arrangement of two T networks. Voltage gain is zero at ω_0 , indicated in the response curve

or

$$y_{12}'E_1 = -y_{12}''E_2$$

$$\frac{E_2}{E_1} = \frac{-y_{21}'}{y_{12}''}$$

Thus, the voltage transfer function for the entire feedback network is a function of the transfer admittance parameters of the RC passive network.

Consider a bandpass network of this structure

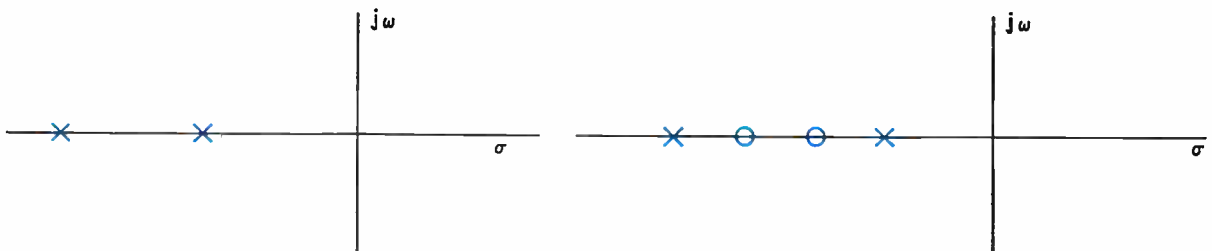
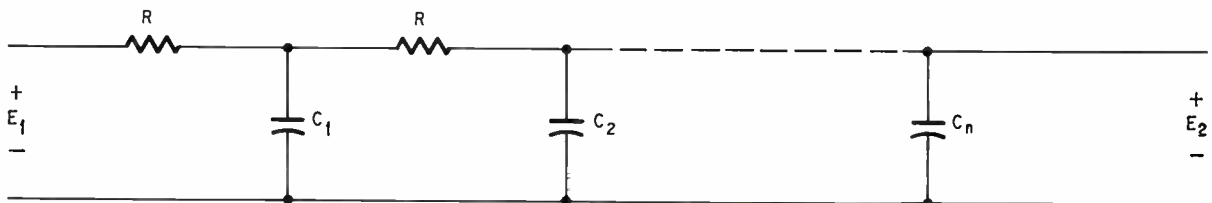

Ladder networks. RC ladder networks are used with semiconductors to form active filters. For such a network, the poles and zeros are on the negative real axis of the complex frequency plane. The pole-zero plots are typical for a single-section network, left, and a multisection filter, right.

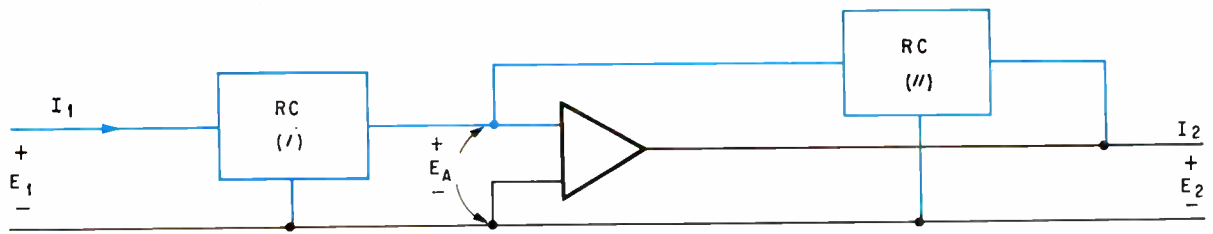

Synthesizing a filter. Two RC networks are coupled to an op amp . . .

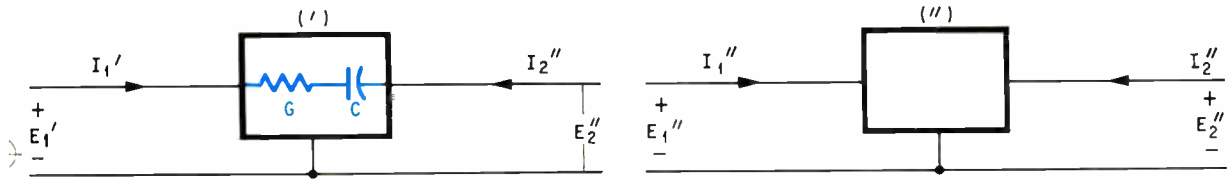

. . . one network is assumed to be a series-connected conductor and capacitor, and the designer uses the transfer function of the complete circuit to synthesize the other network . . .

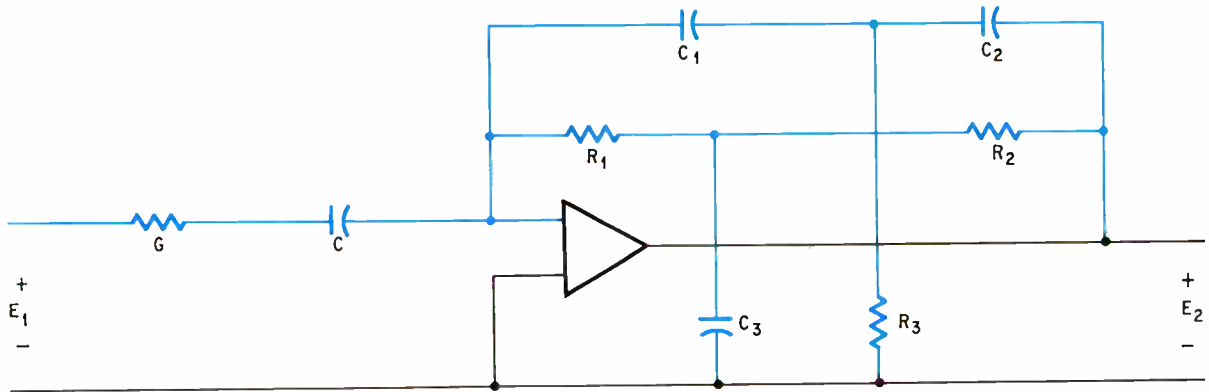

. . . the result is an active bandpass filter.

whose voltage transfer function is given by

$$\frac{E_2}{E_1} = \frac{Hs}{s^2 + \alpha s + 1}$$

where H is a positive gain constant. To obtain the denominator polynomial, assume a twin-T with a small value for α , common for most bandpass filter applications. Hence,

$$y_{12}'' = \frac{s^2 + \alpha s + 1}{s + 1}$$

Since

$$\frac{E_2}{E_1} = \frac{-y_{21}'}{y_{12}''} = \frac{\frac{Hs}{s+1}}{\frac{s^2 + \alpha s + 1}{s+1}}$$

Therefore, the single prime network should have a transfer function

$$-y_{21}' = \frac{Hs}{s+1}$$

This is the transfer function of a two-port network

with a conductance connected in series with a capacitor in one arm and a wire in the second arm.

Thus,

$$-y_{21}' = \frac{sG}{s + G/C}$$

with $G/C = 1$. The double-primed network is synthesized with a twin-T such as the one on page 115.

The completed network, directly above, has a low output impedance and is capable of driving successive stages. It features a summing point and good stability characteristics. But, it requires too many elements to cancel out the poles between the two passive RC networks. Moreover, adjusting the characteristics by a simple change of parameter variable is difficult.

Negative-impedance converters

A second approach to the design of active RC filters is the use of the negative-impedance converter. This two-port network converts an impedance at one of its ports to the negative of that impedance at the other port. However, the device has a serious disadvantage—it is open-circuit stable at one port and short-circuit stable at the other. Thus, the stability of the device is dependent upon the impedance level.

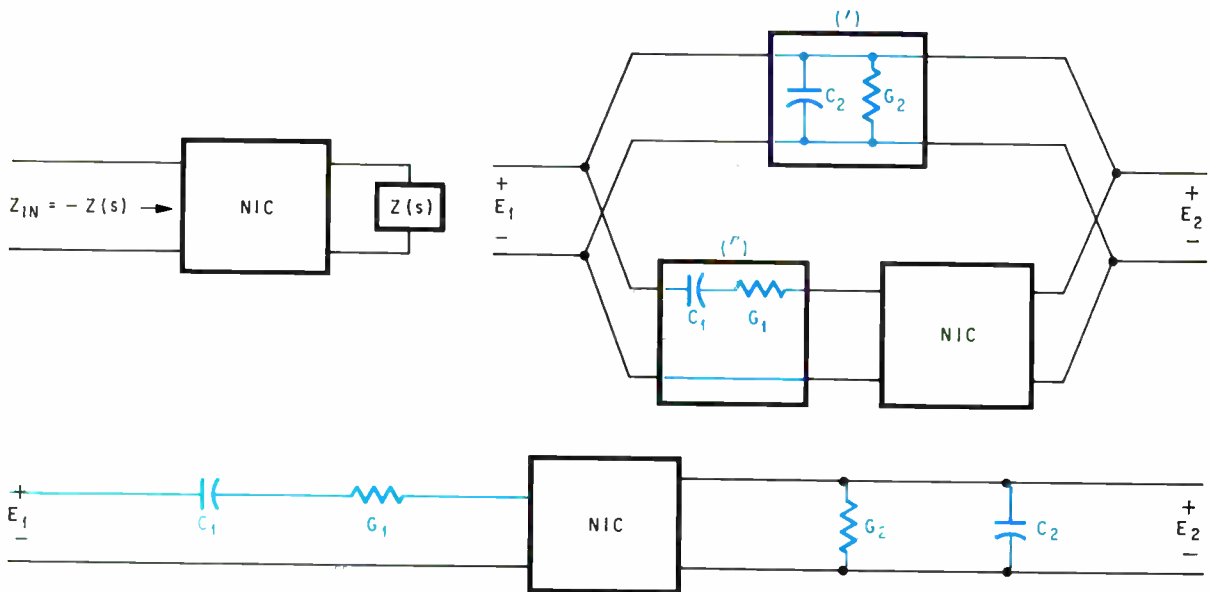

Negative-impedance converter. A parallel-parallel arrangement of two RC networks and an NIC is another approach to active-filter design. The negative impedance of a load appears at the input terminals of the converter, upper left. Final design is below.

One widely used synthesis technique for designing an NIC was developed by Yanagisawa.¹ His procedure uses two-port networks connected in parallel-parallel and cascade, two of these are usually ladder networks. The voltage transfer function for

the network is

$$\frac{E_2}{E_1} = \frac{-y_{12}' + ky_{12}''}{y_{22}' - ky_{22}''}$$

where the y 's are the two-port open-circuit param-

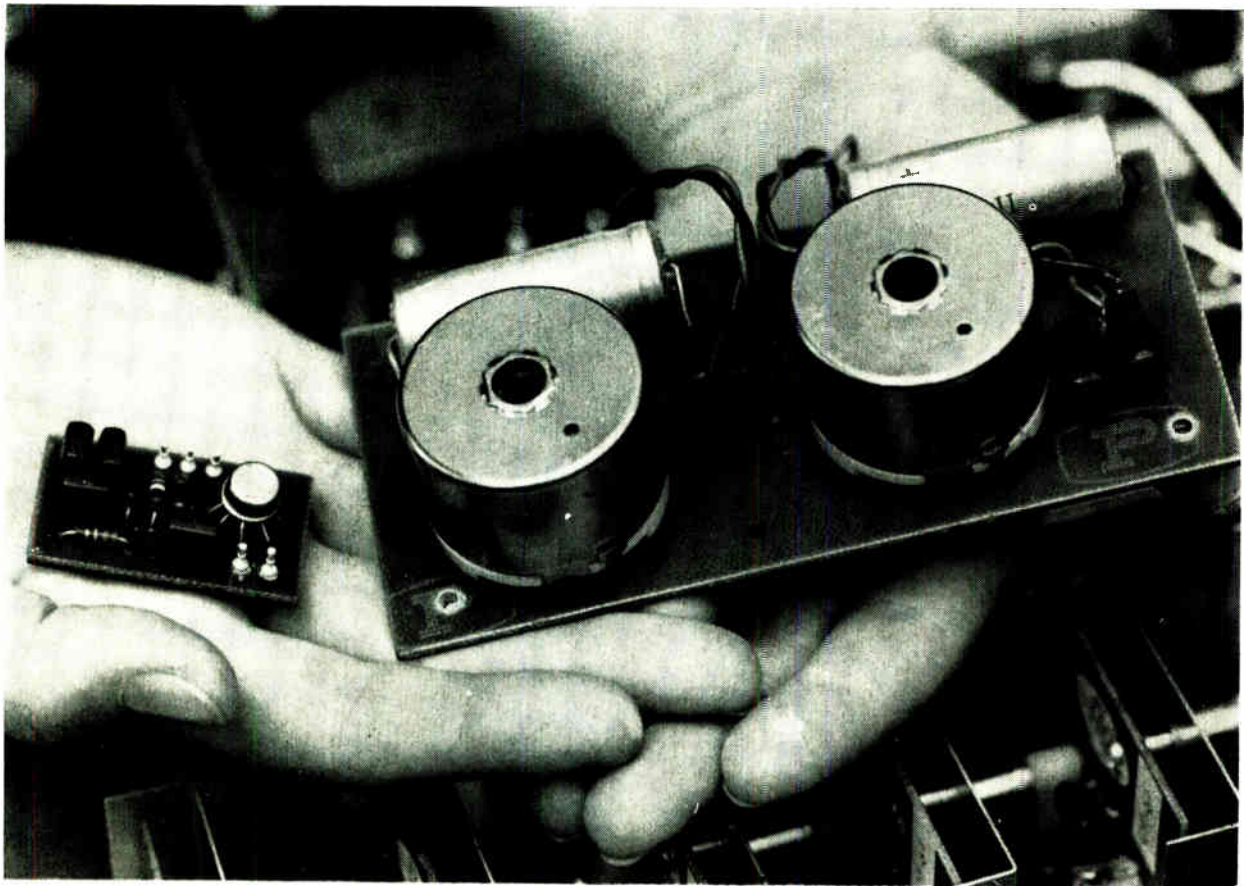

Bandpass amplifier. Passive element, 20-hz bandpass filter, right, has been reduced to ¼ ounce, a 40 to 1 savings in weight and volume from its predecessor. Redesigned active filter, left, uses an IC amplifier to attain equal performance but with a further reduction in size and weight.

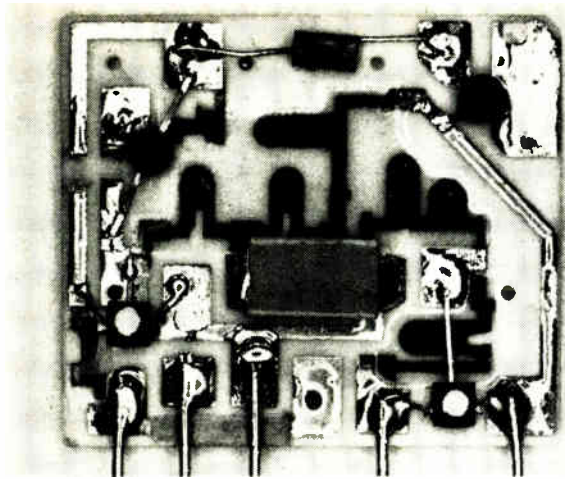

Low pass. Hybrid 6-kHz low-pass active filter was designed for telemetry and f-m multiplex application.

eters of a single- and double-prime networks and k is the conversion factor gain for the NIC.

Consider a bandpass filter, frequency normalized to 1 radian per second, whose transfer function is given by

$$\frac{E_2}{E_1} = \frac{-Hs}{s^2 + \alpha s + 1}$$

The prime network is assumed as a parallel RC network, the double-prime network is assumed as a series RC in one leg and a short circuit in the second leg.

Thus for the prime network,

$$y_{12}' = 0, \quad y_{22}' = sC_2 + G_2$$

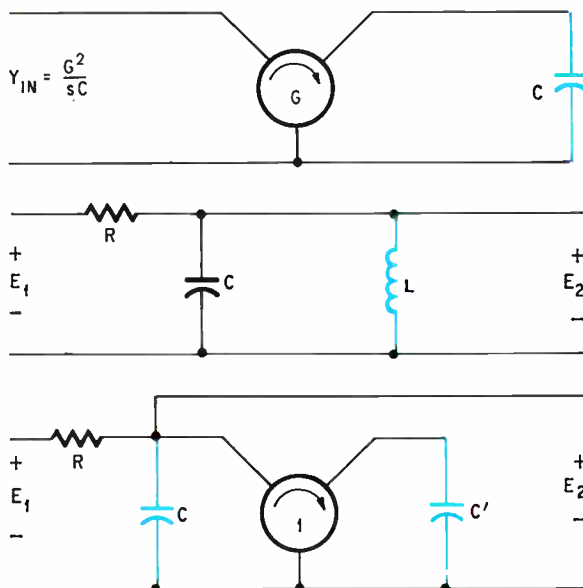

Gyrator. When a capacitor is used to load a gyrator, top, the admittance at the input has characteristics similar to that of an inductance. For the RLC circuit, center, C is loaded on the gyrator to produce the inductive effect. Thus, the need for an inductor is eliminated.

for the double primed network

$$y_{22}'' = -y_{22}' = \frac{sC_1G_1}{sC_1 + G_1}$$

Hence, the over-all network and its simplified version appear at the top of page 117, and the over-all transfer function is

$$\begin{aligned} \frac{E_2}{E_1} &= \frac{0 + k \left[\frac{-sC_1G_1}{sC_1 + G_1} \right]}{[sC_2 + G_2] - k \left[\frac{sC_1G_1}{sC_1G_1} \right]} \\ &= \frac{-skC_1G_1}{s^2C_1C_2 + s[C_1G_2 + G_1C_2 - kC_1G_1] + G_1G_2} \end{aligned}$$

Hence, there is an inversion in the output signal and the bandwidth is controlled by the NIC's gain.

Although the NIC bandpass filter has fewer elements than the op amp filter, its disadvantages are a nonzero output impedance and a loading effect on its characteristics. Thus, isolation must be used between successive stages of NIC filters.

A third popular circuit design technique for implementing an active filter is with a gyrator. The gyrator is a two-port device that can have as its input admittance the reciprocal of its load admittance. Thus, the gyrator can produce the characteristics of an inductance by connecting a capacitor as its load. The characteristic of the gyrator is represented by its gyrating conductance, G .

Fabricating a gyrator as an active filter is not as easy as either the op amp or NIC. Because a gyrator is usually constructed with NIC's, it is therefore a more complicated structure.

To understand the principal of gyrator operation as applied to building a bandpass filter, consider the passive RLC network at the left. The voltage transfer function is given by

$$\frac{E_2}{E_1} = \frac{s/RC}{s^2 + s/RC + \frac{1}{LC}}$$

Substituting a gyrator terminated in a capacitor, C' , for the inductor will yield the same transfer function. The combination of the gyrator and capacitor C' are needed to produce the inductor.

References

1. Takesi Yanagesawa, "RC Active Networks Using Current Inversion Type Negative Impedance Converters," IRE Transactions on Circuit Theory, Vol. CT-4, author of Tokyo Institute of Technology, Sept. 1957, pp. 140-144.

Bibliography

- J.G. Linvill, "RC Active Filters," Proceedings of the IRE, Vol. 42, March 1954, pp. 555-514.
 K.L. Su, "Active Network Synthesis," McGraw-Hill Book Co., 1965.
 "Handbook of Operational Amplifier Active RC Networks," Burr-Brown Corp., Tucson, Arizona, 1966

Model LAT-100

The \$6,000* Resistor Trimming System

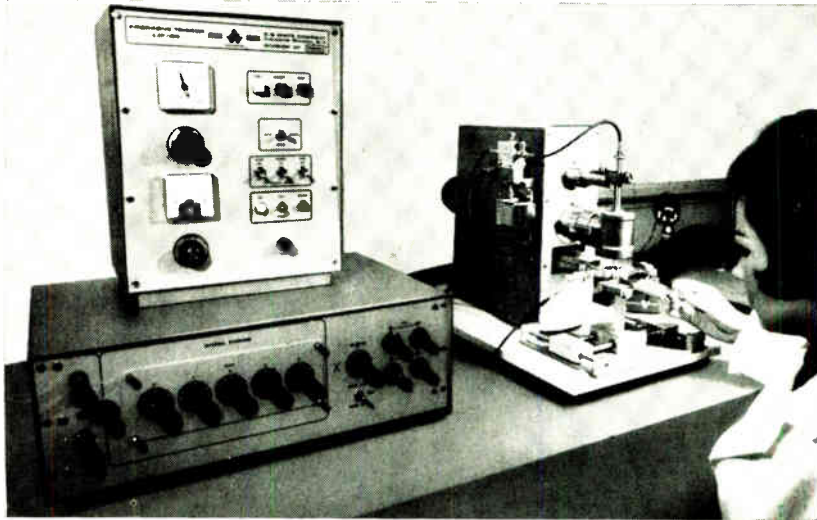

The number to call is 212-661-3320 for a demonstration like this—and you can bring your wife along if you like.

CALL us collect or write to arrange for a demonstration of S. S. White's new LAT-100, the complete, low-cost resistor trimming system for R & D and prototyping.

The LAT-100 automatically trims, monitors, and inspects PAF resistors to tolerances within 1%. That's guaranteed. In tests, 0.5% is often achieved. A precise 4-wire Kelvin bridge is integral to the system, which, with the optional plug-in decade box, permits the system to be programmed through five digits and three multipliers—from 0 to 10K and from 0 to 1M. Tolerances may be programmed from 0 to $\pm 11\%$. Panel controls permit operator to override the automatic cycle at will.

A holding fixture takes substrates up to 2x2 inches. A precise X-Y stage has 4"x4" movement. The trim slide has an automatic fast-return to place it exactly for the start of each trim. Tungsten carbide probes are mounted in a 14-position mounting ring. An efficient dust-removal system permits the LAT-100 to be operated in clean rooms. Installation requires a 110 VAC outlet and a level spot.

*Base price, \$5,950.00 each. With optional decade box, illuminator, foot-switch operation, \$6,350.00.

Without further detail, the LAT-100 does everything its bigger brothers the AT-701 and AT-704 do—a little less accurately, to be sure, and not nearly as fast—but what can you expect for a trifling \$6,000?

A step up from the LAT-100 is the AT-701, a no-nonsense production machine. The AT-701 can produce 600 trims per hour with guaranteed accuracy of 0.5% and attainable accuracy of 0.1% when



Model AT-701 garners accolades at IEEE show—top scientist says “Gee whiz.”

things are going your way. The AT-701 with a decent amount of employment (say 1000 hours per year) produces trims at about $\frac{1}{2}¢$ each—including labor, materials, maintenance, and amortization. How about *that*?

But say you're big. Really big. We've got our big Bertha model for you, otherwise called the AT-704, which produces 4,000 trims per hour with accuracy and cost similar to those of the AT-701.

S. S. White resistor trimming systems are based on the proven Airbrasive® concept, controlled by precision electronics. The Airbrasive method of removing resistance material produces neither heat nor shock. does not alter substrate—yields of 100% can be attained with any of the S. S. White resistor trimming systems at some sacrifice of speed and tolerance. Each of the systems trims and monitors simultaneously and inspects after each trim.

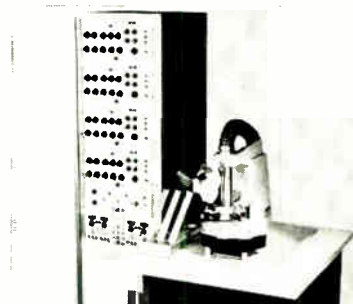

Big Bertha: Model AT 704 trims at 4,000/hour pace for high volume producers.

Up to now we've been able to offer fast delivery on all systems; however the enthusiasm we've encountered over the LAT-100 suggests that you'll be wise to place your order early for this model.

Call us or write to arrange for a demonstration of the LAT-100, the AT-701, or (if you're really big) the AT-704. Or ask for bulletin RT-14—it's great to read on planes.

Inquire, S.S. White Industrial, Dept. R. 201 East 42nd Street, New York, N.Y. 10017. Telephone 212-661-3320.

**SEE US BOOTH 522
NEPCON EAST SHOW**



S.S. WHITE
A DIVISION OF PENN. SALT CHEMICALS CORPORATION

Using a universal pulser for a-c checks of IC flip-flops

Adapter enables automated d-c equipment to check threshold values, accommodating the diversity of configurations and packages; it costs only \$1,500 and adds just 2 seconds to cycle

By Richard G. Parks and Luther J. Hintz

Honeywell Inc., Minneapolis

Diversity means difficulty when it comes to testing integrated-circuit flip-flops. The wide variety of electrical designs, packages, and lead configurations poses a dilemma: accept inadequate testing or spend huge sums for whole groups of test systems. And the flip-flop's versatility compounds the problem; the device can be used in so many ways that testing for all applications is almost impossible.

One solution has been devised by the Aerospace division of Honeywell Inc. The division had a Fairchild series 4000 d-c tester and wanted to perform a-c (dynamic) checks without buying or building another machine. So it designed and built a universal adapter that converts its d-c tester into a pulse checker for all types of IC flip-flops.

The adapter, in use for more than a year, applies

controlled clock pulses through short leads to test input threshold values. It adds just 2 seconds to the test cycle and costs only about \$1,500. Various applications can be checked without adjustment of the Fairchild machine, which for this kind of testing supplies only clock inputs and bias power if needed. A patch-cord matrix in the adapter enables it to accommodate all sorts of lead configurations, and interchangeable test sockets solve the package-diversity problem.

D-c tests by themselves aren't enough; for example, a flip-flop can pass all its d-c tests but fail dynamically because an output won't assume the correct state for a given input. Pulse tests can provide the missing ingredient for a good performance check.

Noise immunity

Input threshold tests are necessary to determine a flip-flop's degree of noise immunity. An input threshold test of a logic gate is relatively easy, because the gate's output directly indicates when the 0 or 1 threshold level is exceeded. Few IC vendors measure flip-flop threshold voltages on a 100% basis, and those that do generally don't check all the possible switch and hold conditions: the 0 to 1, 1 to 0, 0 to 0, and 1 to 1 states on the flip-flop's Q output before and after application of a clock pulse.

Flip-flops must be set to a known state before they can be tested for threshold value. A momentary high or low signal is used for this setting. Then a changing voltage edge—rising or falling depending on the type of flip-flop—is applied to the clock input while the J and K or R and S inputs are kept at the appropriate threshold condition.

The output is sensed to see if it's in the desired

The authors



Richard G. Parks is a micro-electronics specialist at Honeywell's Aerospace division. Currently, he's working on the problems of selecting, testing, and applying IC's. He has been with Honeywell for five years.



Electronic control is both specialty and avocation for Luther J. Hintz; he has built a lawn mower that works automatically by following a buried cable around his yard. His current task at Honeywell's Aerospace division involves the specification and application of IC's.

state after the clock pulse is applied. Crosstalk and distortion are common when fast rise-time pulses are sent through long wires in automatic testers, but the adapter overcomes this problem by bringing the device to the pulse source. Timing, however, is critical: the clock pulse must be applied after the momentary preset signal has ended but before the output sensing point is reached.

Two types

There are two basic types of flip-flops: those that require a clock-level input and those that require a clock-rate input. An example of the former is Texas Instruments Incorporated's 5472 transistor-transistor logic flip-flop. Clock levels determine whether a transistor conducts to pass information. An example of the latter is the Signetics Corp.'s SE 124 or 424, in which the input signal is a-c coupled to the device and the input's rate determines when information passes. The pulser (see schematic below) was designed to handle both types.

Testing level-type flip-flops for threshold requires an initial set signal, accurate threshold input voltages, and a variable-amplitude clock pulse. Rate-type flip-flops require all of these plus a variable-rate clock pulse. Because both types may be sensitive to capacitive loading on the outputs, provisions are made to decouple the outputs from the test-set wiring. Rate-type flip-flops are more susceptible to the effects of capacitive loading.

The pulser shown below is mounted at the test head of the automatic test station. When power is applied to the flip-flop, relay contacts K_1 open to allow capacitor C_1 to charge. The output of gate A remains in the 1 state until there is sufficient charge on C_1 to switch it. This provides the momentary low signal at the output of gate B—or momentary high signal at the collector of Q_1 —needed to set the flip-flop to a known state.

The signal is connected to the test station's external box and sent to the appropriate pin on the flip-flop. When the output of gate A switches to the 0 state, it triggers the adapter's binary-logic unit, causing the Q output to switch to the 1 state. When the Q output has been switched to this state, the capacitor C_2 is charged through R_5 until transistor Q_2 switches on to return the Q output to a 0 state, thus producing a clock pulse.

Rise and fall

This binary-pulse output is inverted by gate C and fed to two fast-switching transistors, Q_3 and Q_4 . Switch S_1 selects a high-going clock pulse for flip-flops with negative-edge triggering, or a low-going clock pulse for the positive-edge type. The voltage amplitudes for clock pulses A and B (CPA and CPB) are programed from the automatic test station. Selecting either CPA or CPB makes it possible to use clocks with well-defined amplitudes and rise and fall times for marginal-input threshold

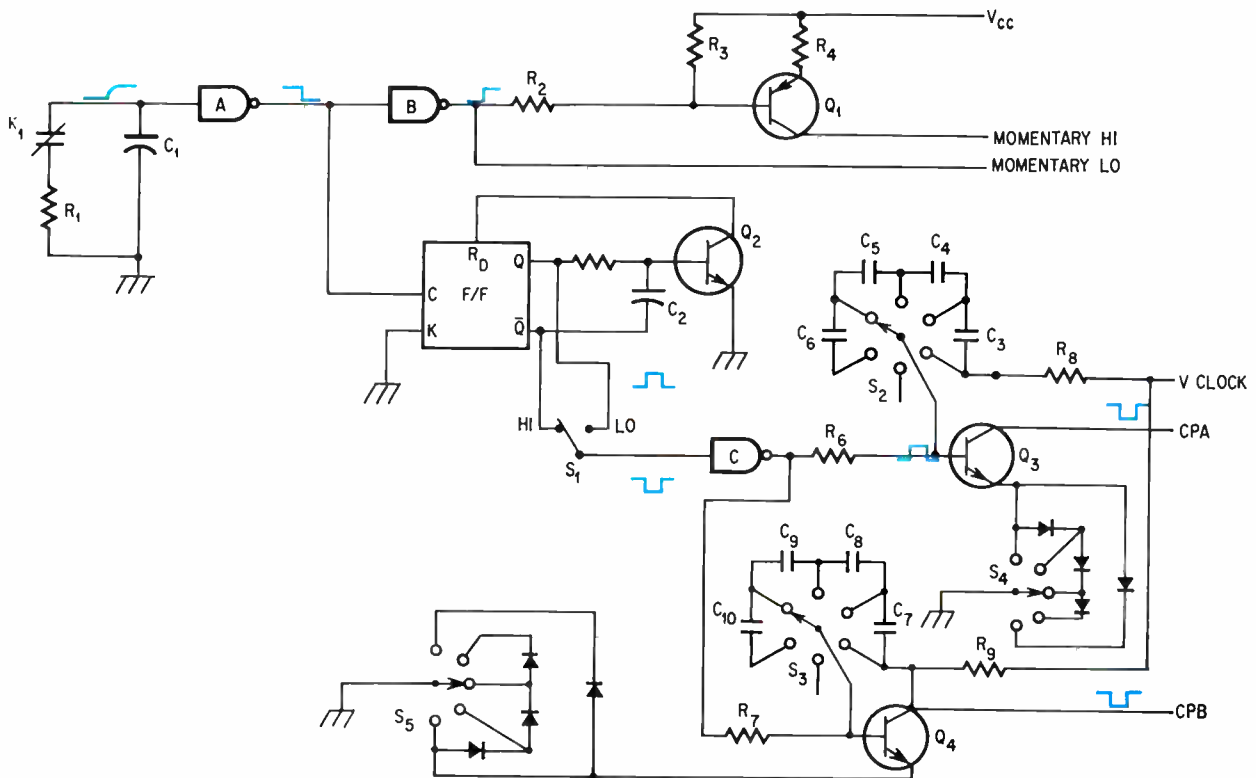

Charge it. When power is applied to the flip-flop, relay K_1 closes to charge capacitor C_1 . The output of gate A remains in the 1 state until C_1 is charged sufficiently to switch it and provide a momentary low signal at the output of gate B for the tester. A momentary high signal is available at the collector of transistor Q_1 .

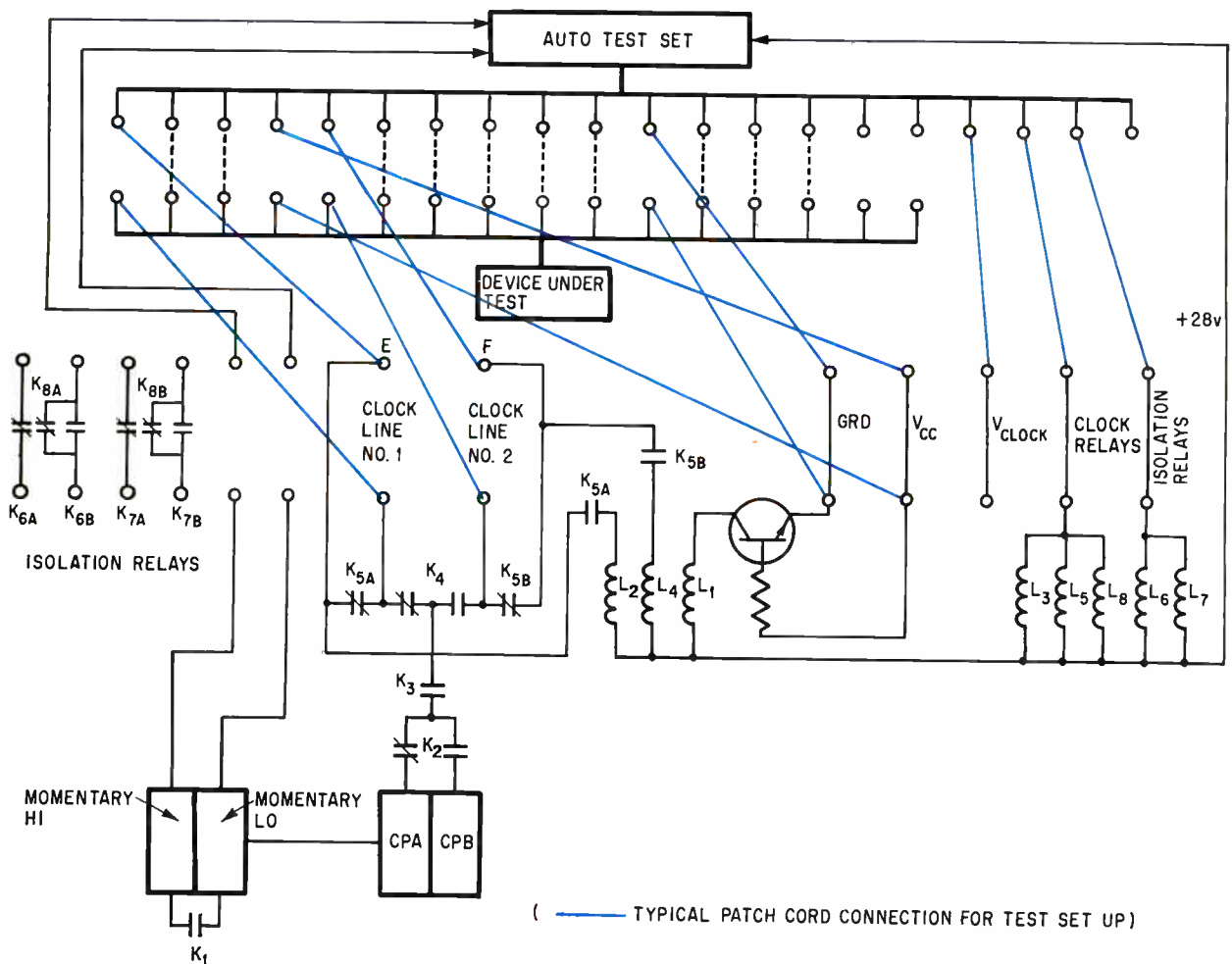

Choice of pulses. Clock pulses from either Q_3 or Q_4 are selected by connecting the automatic test station to a ground through control jacks E or F or both. Relays K_6 and K_7 are connected to decouple the output not being sensed from the tester to eliminate the effects of capacitive loading.

testing, or a poorer clock and good inputs for marginal-clock threshold testing. The diode arrays at the emitters of Q_3 and Q_4 are selected by switches S_4 and S_5 to give a proper clock pulse reference for the desired 0 state.

Capacitors C_3 through C_{10} control the rise and fall times of the desired clock pulses and are connected between the bases and collectors of Q_3 and Q_4 with switches S_2 and S_3 . The rise and fall times in each position are calibrated, recorded, and selected according to the specifications for the flip-flop being tested. Normally, the pulse from Q_3 is used to test input threshold voltages, and the pulse from Q_4 is used to test clock-pulse threshold levels and rates.

The clock pulses from Q_3 or Q_4 are sent to the appropriate pins of the flip-flop by connecting the automatic test station for a ground on control jacks E or F or both, figure above. Relays K_6 and K_7 can be connected in series with the outputs of the flip-flop and programmed so that the output not being sensed is decoupled from the capacitive loading of the test-set wiring harness. While d-c tests are being performed, the pulser relays are de-energized to isolate the pulser from the test circuitry.

Setting up the pulser

With a pictorial program sheet of switch positions, patch-cord wiring, and external connections to the test set, the operator can set up the pulser without knowing about the device to be tested. Two test-set lines are used to control relay switching within the pulser, and a line is used to program 1-state voltage of the clock pulse. When the newer 16-pin devices are being tested, the pulser patch-cord matrix can be connected to allow using two other test-set lines for the relay control. Even many of the more complex logic devices—up to 40 pins, or leads—can be tested with the adapter, since they can usually be broken into groups of 14 pins.

For room-temperature tests, the pulser is normally mounted on the automatic test station's console. An improved version of the pulser can be plugged in to an environmental-chamber door; the pulser is still kept close to the flip-flop in the oven.

The patch-cord matrix could be replaced by a multipole switch with each position hand-wired for a specific flip-flop. Such a switch wouldn't be too complex, because most of the leads from the flip-flop are fed directly to the automatic test station.

Two-step process speeds low-frequency measurements

Counter that first measures period and then converts it into frequency yields an accuracy comparable to that obtained at higher frequencies

By James L. West

Weston Instruments Inc., Lexington, Mass.

Frequency counters designed to precisely measure high-frequency signals aren't suitable for the job at low frequencies. In a conventional counter, the number of pulses accumulated within a given time indicates either the period or the frequency. This, in turn, depends on whether the pulses are counted during an interval determined by a clock frequency, or the clock frequency pulses are counted during an interval set by the input frequency. Either frequency or period can be measured by this method with a resolution of better than 0.01%.

For low frequencies, though, the measuring time must be extended to get the same resolution. Even if the period is measured to hasten the process, the frequency must be calculated long hand or with a desk calculator, and time is again lost.

A new technique based on the period measurement, however, enables rapid direct measurements of frequencies around 1 hertz with a resolution of 0.01%—or one part in 10,000. With it, the period measurement is converted into a frequency that corresponds to the original period measurement.

The method is embodied in a new counter, Weston Instrument's Model 302. This instrument first accumulates clock pulses that pass through a gate opened for one period of the input signal, and then feeds this count to a rate multiplier that syn-

thesizes the corresponding frequency. This frequency—developed from a 2-megahertz clock—is a representation of the input signal period and is counted and displayed.

Period at work

Measurements made from 1 hz to 10 khz may concern the resonant frequencies of mechanical systems, the rotation rates of such prime movers as gas engines or steam turbines, or even the outputs of telemetering devices.

The resolution and measuring speed provided by the new counter make it suitable for determining the separation and absolute value of very close resonant frequencies in mechanical systems. Such a measurement is usually made by exciting the system from an external sinusoidal source and reading those source frequencies where the system resonates. One problem here, however, is that few oscillators are calibrated accurately enough to make the approach work well.

If a spectrum analyzer is used to observe the resonant frequencies, the new low-frequency counter can be attached to the beat-frequency oscillator's output (indicated frequency output) to give an instantaneous and accurate frequency measurement. In the case of prime movers, the various low-precision analog tachometers or magnetic impulse generators now used with conventional counter displays to measure rotation rates are imprecise at very low rates. Moreover, magnetic impulse generators take about a second to measure within ± 1 revolution per minute at rotation rates of, say, 3,000 rpm.

And the resonant reed indicators employed to measure frequencies of 60 to 400 hz have restricted ranges and relatively slow response speeds. The new counter not only speeds up the measurement time but can be programmed to read the output of im-

The author



James L. West is general manager of the Lexington division of Weston Instruments Inc. Prior to this assignment, he was the director of engineering for the division. He holds a MSEE degree from Columbia University.

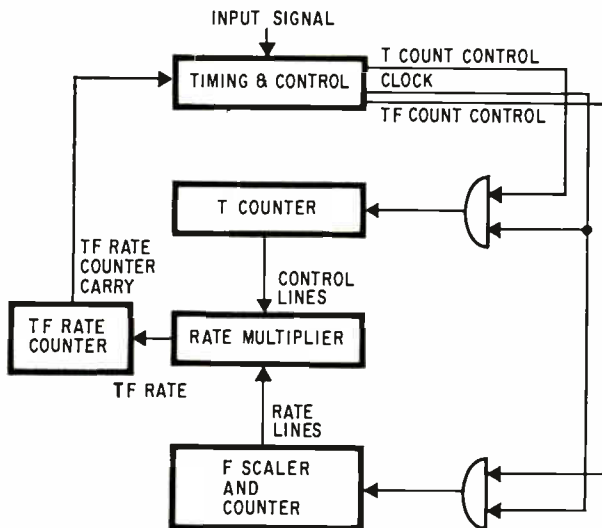

Two stages. Input signal causes T counter to accumulate clock pulse used to generate frequency proportional to the product of the period count and clock frequency.

pulse counters directly in revolutions per minute.

The method involved is essentially a two-step process. Clock pulses are first counted for a given time interval, and are then used to convert the accumulated pulse count to a decimal-coded rate weighted to represent the input frequency.

Clocking the crossings

More explicitly, an input signal to the counter is applied to a timing and control circuit to generate a T count control signal. This signal, which lasts for a time equal to the interval between successive axis crossings of the input, is synchronized to a very-high-frequency clock. It turns on AND gate 1, allowing the T counter to accumulate a number of pulses from the clock that's proportional to the duration of the successive axis crossings.

Immediately after the T count control signal ends, the timing and control circuit generates what's called the TF count control signal. Applied to AND gate 2, this signal switches the clock pulses to the F scaler and counter circuit. The F scaler and counter outputs, or rates, from each counting element are every frequency from 5 hz to 2 Mhz that will ever be needed to develop the final number, or count. They're applied to a rate multiplier that at the same time receives from the T counter the signals that enable or inhibit the summation of the individual F counter rates. These control signals open and close gates to allow the appropriate rates through. The rate multiplier, in essence, adds the rates, or frequencies that pass through the gates. The pulses that make up these rates are added at the output of the rate multiplier to produce a signal with the composite rate. The manner in which the controls are connected make the composite rate the product of the fixed clock frequency and the number in the T counter.

The rate multiplier's output is counted by the TF counter, which generates a control signal when the integrated rate exceeds a preset value. At this point,

the F scaler and counter has accumulated that number of clock pulses which, when multiplied by the period, is a constant—a scaled multiple of the frequency. A trigger is then used to restart the process.

It all equals one

The counting thus determines the number of clock pulses that has a value of unity when multiplied by the period, T; unity is here represented by the number of counts needed to make the TF rate counter have one carry. The clock pulses thus corresponds to frequency; the equation $FT = 1$ is solved.

A simplified logic diagram of the frequency counter permits a more detailed discussion of its operation. The input signal is applied first through a selectable decade scaler to rescale any periodic signal to a one-decade frequency range. The frequency counter's upper and lower limits of operation are determined by the sizes—number of storage elements—of the T counter and the F scaler and counter. The selectable decade scaler converts any input frequency to make it fall within these frequency limits.

The T count control's task is to open a gate and allow 2-Mhz clock pulses to pass to the T counter. The T counter, initially set to zero, has five decade counting stages followed by two binary stages. A total count of 399,999 pulses can be accumulated before the T counter recycles. To prevent the counter from recycling prematurely, high-frequency inputs are scaled down, as is the clock frequency for signals below 5 hz. If the T count control is on for exactly for 0.2 second, therefore, the 2-Mhz clock frequency causes 400,000 pulses to pass into the T counter—just enough to make it recycle once. Any period less than 0.2 second thus allows the T counter to accumulate a considerable number of clock pulses. In 0.1 second, for instance, it accumulates 200,000 pulses, corresponding to 10 hz; in 0.01 second, the T counter accumulates 20,000 pulses, corresponding to 100 hz.

After the T count control signal is turned off, the T counter retains the number of clock pulses accumulated during the T period—the measure of the period of the input signal.

As noted before, the clock frequency is applied through AND gate 2 to the F counter and scaler after the count control signal is turned off. This counter and scaler consists of two binary and five decade scaling elements.

When the 2-Mhz clock pulse is applied, the F counter's first stage output is half the input frequency, or 1 Mhz. This output applied to the next binary stage produces an output of 0.5 Mhz. This then goes to the first decade scaler, which has an output of 50 kilohertz, and the process continues with each decade scaler supplying the input for the next scaler in line. Outputs from each binary element of the decade scalers are, in turn, applied to the rate multiplier. The rates are determined by the position of the scaler element in the chain. The first element produces a rate of 1 Mhz, for instance, the second of 0.5 Mhz. The four lines from the first

decade scaler are the outputs from the 1,2,4,8 binary stages within the decade, and represent rate outputs of 250, 100, 50 and 50 khz respectively.

The rate multiplier produces an output that's basically the product of the clock rate and the number stored in the T counter. The rate multiplier generates a variable rate signal under the control of the T counter. The elements of F counter, T counter, and the rate multiplier associated with generating the highest rates are in the figure on page 126. The elements (flip-flops) in the decade scaler in the F counter are arranged to count in a 1-2-4-8 binary code; their outputs are the carry outputs of the 1-2-4-8 scalers of the first decade. The rate outputs are pulses occurring at the negative trailing edges of the respective outputs. The rate output of the first binary stage is 1 Mhz, of the second, 500 khz, and of the first stage of the decade scaler, 250 khz. Since the second stage of the F counter decade has two negative-going edges for each 50-khz cycle, it appears to have an average rate output of 100 khz. Similarly, since the 4 and 8 binary output scalers have only one negative-going edge for each 50-khz cycle, it appears as if the average frequency of these two counting elements is only 50 khz.

When the rate outputs are applied to the rate multiplier's gates, two negative signals are needed for a positive output—the AND function. The state of the flip-flops in the T counter controls the gates and, consequently, the rate. For instance, the T counter's most significant binary stage controls the least significant binary stage in the F counter, and its most significant decade controls the least significant decade of the F counter. Within each decade there is a logical interconnection between T counter and F counter elements.

The manner in which the multiplier generates a variable rate is shown in the figure below. The topmost pulse train represents a rate obtained

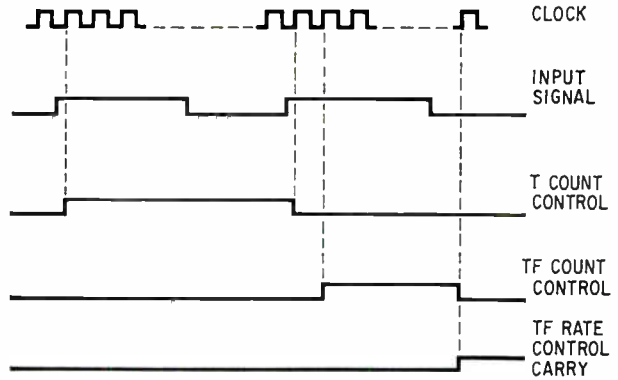

Unlocking gate. T count control signal opens gate in T counter for interval between like-slope axis crossings.

when the outputs of the first and second binary stages are allowed to pass and inhibit all other rates. It appears in this case that three pulses are generated every 2 microseconds, pulses corresponding to an average rate of 1.5 Mhz.

On the other hand, if only the output of the 8 stage of the first F counter decade is allowed to pass through the rate multiplier, an extra pulse occurs every 20 μ sec, giving the appearance of an average rate of 1.55 Mhz. Similarly, if the 2 stage of the F counter's first decade is added to the pattern, an average rate of 1.65 Mhz appears to occur.

Thus, by combining the several rates, it is possible to obtain any desired rate from 50 khz to 2 Mhz in 50-khz intervals. The next decade stage of the F counter scaler has an output of 5 khz, and it's possible to get any rate from that level to 2 Mhz in 5-khz steps by extending the controls to this stage. Repetition of the process makes for finer and finer steps.

The code used in the rate multiplier to count the period must be such that, when stored in the T

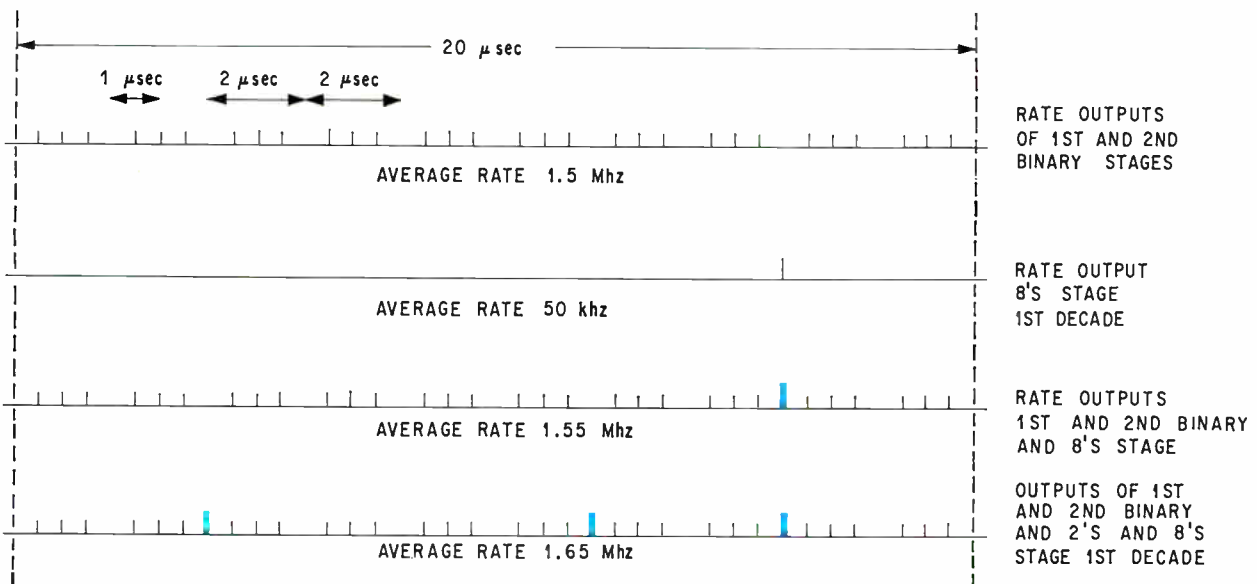

Combination. Variable frequency is generated in rate multiplier. Upper pulse train represents rate obtained by combining only outputs from first and second binary stages. In this case, three pulses appear every 2 μ sec, for an average rate of 1.5 Mhz. Additional output from 8's makes for a 1.55-Mhz average.

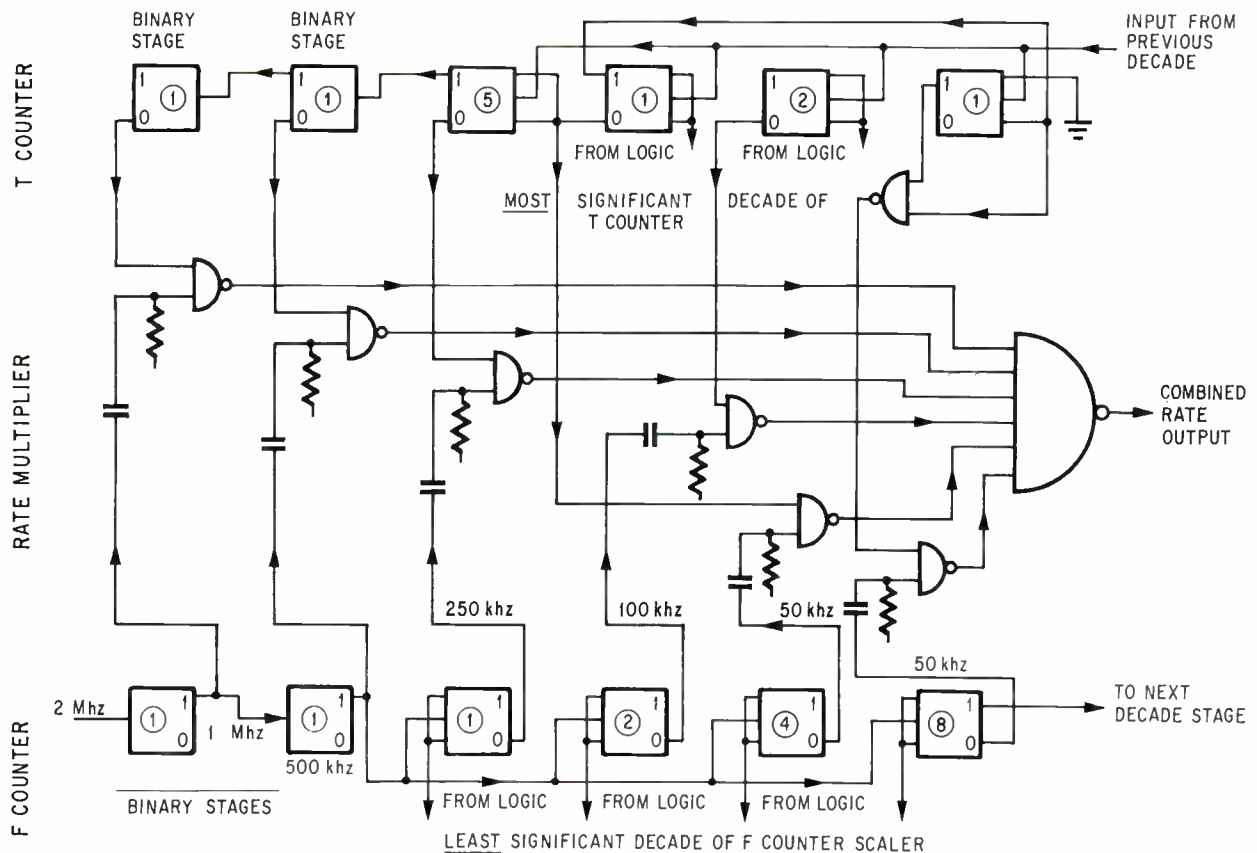

Under control. Frequency rates generated in F scaler and counter are applied to rate multiplier's gates. However, they are combined only according to the states of T counter's flip-flops.

counter, the controls applied to the rate multiplier's gates control the rate in direct proportion to the number in the T counter. For example, the 50-khz rate is obtained because the number in the T counter is 1/40th the maximum. For the 250-khz rate, the number is 1/8th the maximum. The code for the T counter is 1-2-1-5; the gates in the T counter generate this code.

Correspondence

If the T counter registered a number in which the most significant binary digit was 1 and all other elements 0—for example, 200,000 pulses, corresponding to a frequency of 10 hz—only the rate of the least significant digit of the F scaler (1 Mhz) would be allowed to pass through the rate multiplier to the TF rate counter. Since the TF rate counter contains one binary and four decade scalars, and the rate from the multiplier is at 1 million hz, the TF counter produces a carry output after 0.02 second.

In that time, 40,000 pulses are applied to the F counter, and, after scaling through the first two binary stages, 10,000 pulses are applied to the five decade stages of the F counter. Therefore, the decade stages of the F counter contain the number 10,000. This after the decimal point has been appropriately positioned, precisely represents the 10-hz frequency of the applied signal, since that signal had a period of 0.1 second.

If the period is 0.01 second—corresponding to 100 hz—the T counter stores the number 20,000. The

last decade of the T counter stores the number 2, and controls the rate output of the 2's flip-flop in the first F counter decade to generate a rate of 100,000 hz. The TF counter produces one carry output in 0.2 seconds, and the F counter counts 400,000 pulses, storing the number 100,000 in its five decades.

Again by positioning the decimal point appropriately, a frequency of 100,000 hz is counted. Upon a strobe command from the timing and control circuit, the number counted by the F counter is transferred to a storage that activates display devices.

The measurement of the period is accomplished at each range. At 100 hz, the period is measured to within $\pm \frac{1}{2}$ count in 20,000 or 0.0025%, the poorest resolution obtainable. The variable TF rate pulses are counted to 20,000 in a time τ . The irregular TF pulse rate causes the F counter to finalize its count in steps that may correspond to several clock pulses. This irregularity varies with indicated frequency.

Over the nominal range from 10 to 100 hz, the maximum measurement time is 0.21 hz. However, 200 hz may be read on the next highest scale in a time of 0.09 second. Resolution over the nominal range varies from 0.0052% to 0.0075%. The crystal controlling the clock frequency maintains $\pm 0.0025\%$ stability over the temperature range 0 to 60°C. This makes for an over-all accuracy of $\pm 0.0077\%$ for measurements at the lowest nominal frequency, 10 hz, and 0.01% at the highest, 100 hz.

Now — Design with 30 A, 200 W, Silicon Power Complements!

You can design state-of-the-art complementary power and efficiency into the rugged portions of your industrial and military power amplifiers with a true industry first . . . the Motorola 2N4398-99/2N5301-02, 30A silicon power transistor pairs!

Newest additions to the broadest PNP/NPN complementary symmetry capability available, these devices offer 200 watts of dc power to 30 volts V_{CE} — ideal for replacing germanium types in those “extra tough” applications. You’ll realize a higher degree of frequency stability, too, through elimination of expensive, impedance-matching driver transformers. And you’re ensured lighter, simpler, less-costly heat sinking in all designs through low thermal resistance — θ_{JC} of 0.875°C/W maximum.

There’s no power/speed trade-offs with either polarity series in switching designs — at 10 amperes I_C and 30 volts V_{CE} , the delay and rise time is only 400 nanoseconds maximum, an unmatched figure of merit that affords minimum switching losses.

Both series ensure efficient, low-power-loss performance — 1.0-volt maximum saturation voltage at 15 amperes — and provide the capability to swing down in voltage without the loss of current gain to 2 volts at 15 amperes — important in low-distortion audio amplifiers.

Twenty-seven Motorola complementary silicon power pairs ranging from 1 to 30 amperes and 5 to 200 watts are available immediately from your franchised Motorola distributor for the broadest range of cost-cutting, circuit-simplifying PNP/NPN application possibilities in the industry. Evaluate them today!

Send now for 30-ampere, complementary pair data sheets . . . Box 955, Phoenix, Arizona 85001.

Type		I_C Max-Amp		P_D Watts	V_{CE0} (sus) Volts	h_{FE} min @ I_C	$V_{CE(sat)}$ @ I_C Max Volts	f_T MHz	NPN/PNP Comb. Price (100-up)
NPN	PNP	Cont.	Peak						
2N5301	2N4398	30	50	200	40	15 @ 15A	1.0 @ 15A	4	\$12.10
2N5302	2N4399				60	14.15			



MOTOROLA
Semiconductor Products Inc.
— where the priceless ingredient is care!

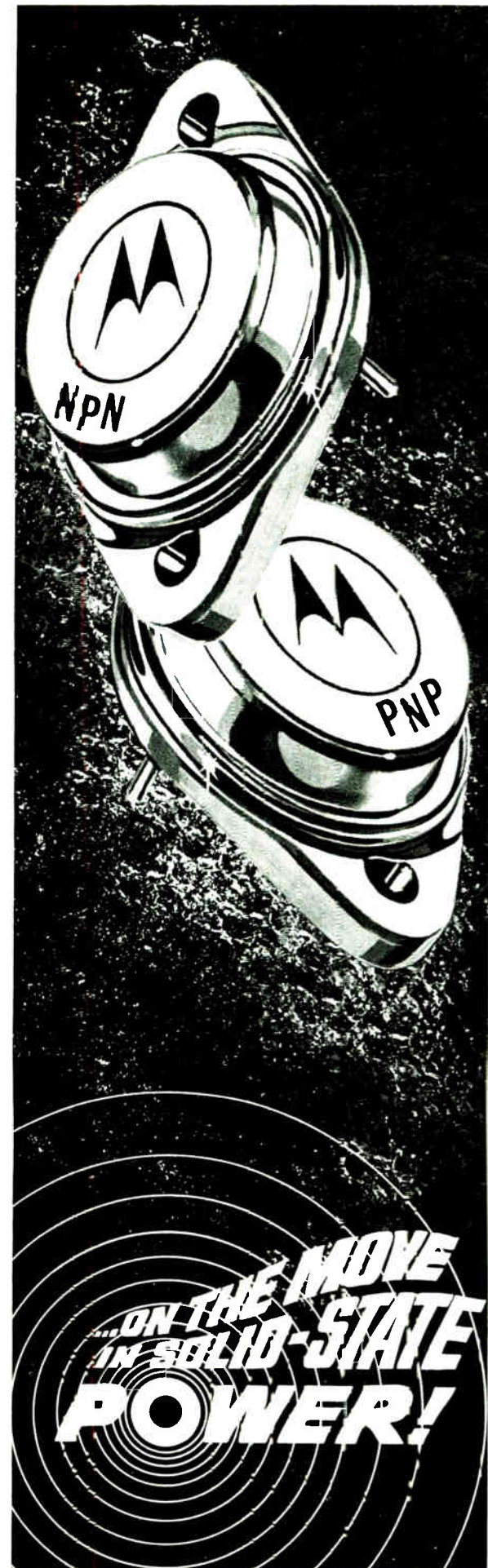



Meet the conformist

At GAF, nobody looks down on conformity. After analysis of industrial x-ray problem areas, GAF research came up with SCREEN-PAK™—a convenient, disposable lead screen “package”—that goes out of its way to be a conformist.

SCREEN-PAK conforms easily to curves. While thicker than other disposable screen packages, it bends easily around a small part.

SCREEN-PAK conforms to the need for contrast. Consistently better visualization of structural defects, thanks to superior absorption of scatter radiation by the pure lead foil (.003” thick).

SCREEN-PAK conforms to exposure requirements. Reduced exposure time over the broadest range of radiation energies (120 KV to 1.25 MeV)—

but with intensification comparable to that with conventional lead screens and superior to that with thinner disposables.

Introduced as Industrial “B” Film, new GAF SCREEN-PAK is also available in Industrial “A” and “H-D” on special request.

A call to your x-ray film distributor or GAF Technical Representative will bring full information on SCREEN-PAK and other GAF products for industrial radiography. Or, write: Industrial X-ray Marketing Department.

62568

another
fine product
from



General Aniline & Film Corporation
140 West 51 Street, New York, New York 10020

Industrial control computers solve some problems, but cause others

An experienced user contends that design and manufacturing oversights make systems hard to install and keep in service

By Paul D. Griem Jr.

Owens-Corning Fiberglas Corp., Newark, Ohio

A kingdom, it's said, was lost for want of a horse-shoe nail. Operators of process-control computers can sympathize with the king. They're haunted by the knowledge that a massive industrial operation can be brought to a halt by the lack of some clamp, connector, or warning light on their control equipment.

Consider an emergency at a plastics plant—this one as mythical as that kingdom. The process-control computer is overheating. There's a fan inside the machine to keep it well ventilated, but unfortunately the computer manufacturer made no provision for situations where the fan conks out. There's no indicator light to warn an operator that the circuitry is being fried.

For want of that light the overheated computer is going to put out erroneous signals. These can keep a fuel valve closed when it should be open. Want of fuel means want of steam, which means want of heat around the pipes carrying the plastics. With no heat, the plastic will harden and the whole process will shut down.

In this case, a control-room operator leans on the front panel of the computer, blows on his

fingers, and rushes over to the console to turn off the power and shift control to a standby system. He depresses what he thinks is a POWER OFF button a few times before he realizes he's only pushing the POWER OFF light!

Disaster? Not this time, happily. A damaged computer, but the process was saved.

Compound situation

Usually, of course, the effects of poor computer design and sloppy manufacture don't offset each other; rather, they compound any problem.

Unregulated power supplies, damaged or poorly designed connectors, interaction between sensitive circuits, poor heat dissipation—these are problems that can be attributed to cost-shaving by the maker. Inconsiderate provisions for maintenance and inadequate wiring schemes can more often be laid to the manufacturer's ignorance of the operational needs of the user and the environment in which the system has to work.

And besides the hardware problem, the variety of terms and nomenclature for lights, switches, and status indicators can confuse the computer programmer and process operator.

All these beefs may—taken one by one—appear trivial in comparison with the benefits of computer control. But singly, and in combination, the problems recounted here can be ruinous to a process and can lengthen the time it takes to install a system—sharply reducing the economic significance of computer control.

The author



Paul D. Griem Jr., applications supervisor in the Control Systems Technology department at Owens-Corning Fiberglas, has installed six direct digital computer-control systems and knows whereof he speaks. He holds a BSEE from the University of California at Berkeley.

 A blue rounded rectangular button with the word "RUN" in white capital letters.

RUN



Power supplies

Of all the users' gripes, unregulated power supplies would probably top the list. Load changes, and the resultant variations in output voltage, affect analog input and output circuits, relays, solenoids, and logic. A drop of only 0.3 volt in the supply can cause circuit malfunction, and propagation of its effect in other parts of the system may not only raise more serious troubles but mask the original failure.

When a circuit fails or modules are added in a computer with an unregulated supply, the system must be shut down and a series of manual adjustments made at the power supply to correct for the load change and to bring the voltage back to the proper value—all of which defeats the system's purpose by increasing its downtime.

Some types of load changes occur frequently. For example, a card reader powered from the same 30-volt supply as the computer draws current every time it senses a hole in a punched card, and the resulting "dance" in the supply voltage can affect sensitive circuits on the same power line.

Many users would prefer regulated power supplies that use feedback to automatically compensate for load changes, but makers don't often provide them because they raise system cost. Besides, these supplies can be tricky, too. Some designers and users feel that the feedback could make the supply oscillate under certain circumstances, seriously disrupting computer operation.

Another factor to consider is that if the feedback voltage is lost through failure of a component or wire, or through certain kinds of malfunctioning in the voltage regulator, the power supply's output will rise to about twice the nominal regulated voltage. If the computer designer doesn't provide some protection against this condition—and he usually doesn't—valuable computer circuits can go up in a cloud of blue smoke.

Heating up

The power supplies in some digital computers use more than 5,000 watts and generate so much heat that a person can't rest his hand on the frame. Unfortunately, most computer makers put their supplies at the bottom of computer; the rising heat thus surrounds the circuitry, much of which will malfunction if overheated.

The problem may disappear in the future as computers require less power. In fact, some machines now on the market need only 1,200 watts, and one uses as little as 100 watts.

For the near term, though, users must continue to ventilate the computer to protect circuits. And as noted at our mythical plastics plant, computer makers install a fan or blower to get rid of the heat, but often don't include an indicator to warn of fan failure. A simple way to tell if there is ventilation is to put a vane switch in the fan's

air path. As long as the fan delivers an air stream, the draft keeps the vane switch open; if the draft stops, the switch closes and sets off an alarm.

But an air stream only infers temperature control. It doesn't assure that the circuits aren't overheating, because, even with ventilation, power overloads can raise the temperature inside a computer.

One computer now being marketed has a two-level failure indicator. When its temperature rises above a preset—but not damaging—level, a light comes on; if the temperature continues to rise, a heat-sensor shuts down the computer.

Circuits can also be protected by connecting a thermocouple to the cards or modules most sensitive to heat. The computer can then scan this thermocouple as if it were one of its process inputs. If the circuit's temperature goes above a safe limit, the system can alert the operator or shut itself down.

Connectors

Many computer makers consistently ignore the essentials of connecting and wiring electronic equipment. One of these essentials is that connectors make firm electrical and mechanical contact at all pins. But some circuit-boards have bifurcated, spring-action male plugs, the two segments of which can get smashed flat during manufacture, assembly, or shipping. Even when pried open some plugs on the connector will have just enough spring action left to make only intermittent and noise-producing contacts—if there's any contact at all—and the computer often can't differentiate between this noise and the input noise from process instruments.

Of course, good connectors are available, but at a higher price. They have the contact-making spring action in the female part, where it's protected by the connector's housing.

That the metal used for the spring should be strong enough to resist deformation when pressure is applied ought to go without saying—but it doesn't.

Computer designers not only specify inadequate and unreliable connectors for their systems but compound the problem by not installing them properly. The slogan "All connectors must have a lock" should be engraved in the walls of all computer-design facilities. It seems hard to believe that someone would put a connector on a vertical surface without something to hold the plug in place, but some companies do it regularly. Surely you should be able to brush against a cable occasionally without breaking the connection.

Another thing to note: if the



lock doesn't bear evenly on the connector, the plug will tend to loosen and perhaps disconnect a few of its pins.

Wiring

As for system wiring, good practice calls for clamping a cable at certain points so that connectors and screw and solder terminals don't have to bear its full weight, but many cables are being installed without any support. Often they are pulled tight between connectors and terminals, and are pinched by doors and moveable modules. And sometimes they interfere with the operation of doors and switches or block access to test points.

Wire-wrapped terminals appear to make secure and reliable connections. And on large wires—#10 AWG and heavier—solderless terminal lugs are sometimes used. This technique is quite adequate as long as the computer maker provides wiring personnel with power-driven crimping tools. If the lug is crimped with a hand tool, however, the wire can slip out, contact an energized circuit, and set off an aurora borealis in the control room at 2 a.m.

The common practice of bunching wires carrying different kinds of signals in the same cable can result in error-producing cross talk. Careful attention to wiring runs during the design stage could eliminate the expensive and time-consuming task of rerouting lines while the user is trying to commission his system.

The choice of wire size is often based on the circuit's normal operating current. If—because of an overload or short—the circuit draws much more current, the insulation around its wire and that of adjacent wires in the cable may melt. Or the wire may break.

There can be chain reaction here. An overloaded conductor on a copperclad printed-circuit board overheats and breaks, then curls away from the

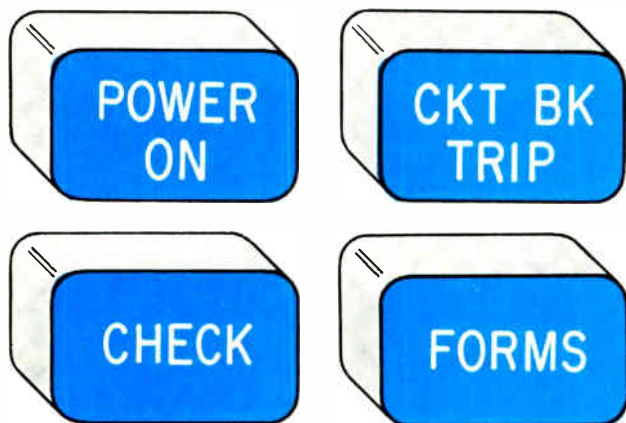

board and touches the circuitry on an adjacent board, causing more damage.

The answer to this kind of wire burnout is to properly fuse the circuit. Wires, including printed wiring on circuit boards, shouldn't be designed as inadvertent fuses. Some device should be designated the circuit's fuse, and all wiring downstream

from this fusing should be able to carry more current than the fuse so it will blow before the wire overheats.

Miniaturization is wonderful, but not when it makes it impossible for an adult to service all parts of a computer system. Access to modules and test points shouldn't require the shutdown and partial disassembly of the machine. The most frequently serviced items—filters, fuses, core memory drivers—ought to be easy to get at. And the machine, of course, should be able to function with all doors, gates, and bays open.

Computers using solid-state circuits for analog and digital process inputs and outputs are liberally fused out to the user's terminals to prevent circuit damage from the accidental grounding or shorting of the terminals. Since the customer is quite likely to blow these fuses—especially when the computer is being installed and wired—they should be located outside the system near the corresponding terminals, not buried in the bowels of the machine where only the manufacturer's service engineer can reach them.

And when the computer designer goes to the trouble to install a red light to indicate that a circuit breaker has tripped, he shouldn't defeat his purpose by hiding the light behind a cabinet door. In fact, good practice demands that all failure indicators be prominently displayed on the front of the equipment and clearly labeled to help the operator locate the source of trouble.

Many extra hours of troubleshooting can be saved simply by clearly identifying modules, terminals, fuses, and cables. Labeling ought to be done in a logical manner, preferably by function rather than by position or some arbitrary numbering scheme.

Terminology should be consistent throughout service manuals, operating instructions, and programming manuals, and should be repeated on the actual labels for the system's hardware. Take the case of a register that contains the address of the next instruction to be executed. It ought to be called simply the "Instruction Address Register," not the "I Register," "I Reg.," "Instruction Counter," "Instruction Pointer," "Instruction Register," and "IAR" sometimes encountered.

The service engineer, operator, programmer, and designer should all be speaking the same language, too. The hardware doing the computing should simply be called the computer, for instance. Such terms as main frame, central processor, central processing unit, CPU, processor-controller, and logic unit may have special meanings in special



cases, but as synonyms for "computer" they serve only as communication hazards.

More than 90% of the operator's contact with the system—and thus with his process—is made through the computer console. Unfortunately, even he will find needless irritations. Designers should note that buttons and rotary switches must be rugged because the operator is bound to take out some of his frustration on them.

Some computer manufacturers use lights and pushbutton switches made of colored translucent plastic. Unhappily, it's difficult for the operator to distinguish between a light and a pushbutton. Both are square shaped and of the same size, and both are engraved with characters of the same size, type style, and color. To make matters worse, lights and pushbuttons in a row across the top or bottom of the console are often arranged in no particular order.

Every console includes some provision for entering binary information directly into the computer. When this process involves pushing interlocked switches, there's trouble: none of the switches can be individually reset. An operator

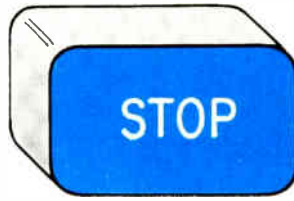

making a mistake in the 22nd bit of a 24-bit binary word has to clear all the bits and start over again.

A simple remedy is to use individual toggle switches for each bit in the word. Toggle up can set a 1 and toggle down a 0, and any error can be corrected without disturbing the rest of the programmed word.

Besides the switches to load binary information, the console should include others that allow the operator or programmer to have instructions executed one at a time as a check to see that the computer has been programmed correctly and is operating properly. Further, the console ought to have sufficient display equipment to show the contents of all the computer's registers.

However, and most important, the console should not be a repository for extraneous switches and lights that the designer found inconvenient to mount elsewhere. For example, the system should have a switch that will, when the operator chooses, disable all interrupts in the computer. But this switch shouldn't be on the main console where anyone might accidentally trip it.

Input-output devices shouldn't provide the computer with ambiguous status signals. The system must be able to tell whether a device is ready to be used or not, and if not, why not. Is the device completing a previous command, is it defective, or is it just waiting for someone to push a START button? Is the disk arm home and ready to read?

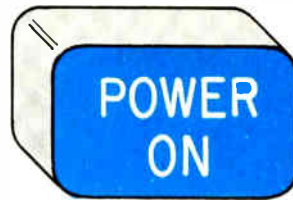

Where is the printer's carriage?

The name a computer manufacturer gives a status indicator must accurately represent the kind of indication it gives. An unclear designation may cause incorrect programming. A bit turned on when a-c power is present, for instance, should be called the A-C POWER indicator; a bit turned on when the printer has been correctly loaded with paper should be called the PAPER indicator. In neither case should the bit be called a READY indicator.

Similarly, a BUSY indicator should signify that a device is actually doing something, not that it has been told to do something but hasn't yet sent a DONE signal. The device may fail during operation and never return the DONE signal.

A bit turned on should indicate a condition desirable for correct operation, such as POWER ON or PAPER INSERTED.

Failures of the computer's sensing circuits will then show NOT OPERABLE conditions. Further, relays and limit switches used as status indicators should fail to a safe or NOT OPERABLE condition.

Using one indicator to signal the occurrence of any of several errors in the same class isn't much help. If the failures can be presented separately to the computer, it can use this information to aid the service engineer.

Regarding analog inputs, certain manufacturers put as many as 16 relays for multiplying the signals on one circuit board. Servicing one failed relay means the disabling of 16 inputs. Since it's rare for more than one relay to fail at a time, more inputs would be kept active if each relay—or perhaps up to four relays—were mounted on individual cards.

Also, analog input multiplexers shouldn't pass an analog through more than two levels of relays because failure of a third-level relay will cause the loss of too many inputs. The more relays grouped per relay, the worse the potential hazard. In an eight-by-eight relay matrix multiplexer, for example, failure of a lowest-level relay will cause the loss of one input, of second-level relay, eight inputs, and of a third-level relay, 64 inputs. In a 16-by-16 matrix, which isn't uncommon in many systems, failure of the third-level relay means the loss of 256 analog inputs—possibly all the inputs to the system.

The following are the only integrated circuits approved as standard by the Minuteman Parts Control Board:

1. SE106J DUAL 5-INPUT GATE EXPANDER
2. SE111J DUAL 4-INPUT HIGH FAN-OUT NAND GATE
3. SE112J DUAL 3-INPUT HIGH FAN-OUT NAND GATE
4. SE116J DUAL 4-INPUT NAND GATE
5. SE124J RS/T BINARY
6. SE125J J-K BINARY
7. SE156J DUAL 4-INPUT CLOCK/CAPACITIVE LINE DRIVER
8. SE161J ONE-SHOT MULTIVIBRATOR
9. SE170J TRIPLE 3-INPUT NAND GATE
10. SE180J QUADRUPLE 2-INPUT NAND GATE
11. CS720J QUADRUPLE 2-INPUT NAND GATE
12. CS721J TRIPLE 3-INPUT NAND GATE
13. CS727J TRIPLE 2-INPUT NAND GATE
14. CS729J RS/T BINARY
15. CS731J QUADRUPLE 2-INPUT GATE EXPANDER

The following are the only companies that make them:

1. SIGNETICS

The Olympus "N".

It puts your samples in the best possible light.

Now you can switch instantly from routine bright field examination to polarization microscopy or the extra definition of dark field viewing, with the new Olympus N. The unique vertical illuminator and Neopak objectives give this

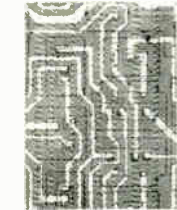

Integrated Circuit

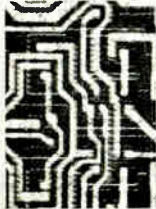

metallurgical and industrial microscope the capability to perform any type of incident light examination, using only the facilities built into the instrument, and only one illuminator and one set of objectives.

And you can make trans-illuminated observations, too, using either the plano-convex substage mirror supplied or an easily-interchangeable 50-watt illuminator.

Which brings us to another virtue of the Olympus N, and of the entire Olympus system of microscopy: modular construction. Olympus microscopes accept a wide variety of bodies and accessories that include 35mm and Polaroid cameras, direct-reading exposure meters, a complete range of eyepieces for viewing or photography and an optional 100X oil immersion Neopak objective.

But even more important is the

quality of the Olympus N. It typifies the precision, performance and versatility that have earned Olympus a world-wide reputation for building the finest optical equipment. And the reasons behind this reputation are apparent in every detail and refinement of the Model N, as well as in its advanced engineering.

The Olympus N
metallurgical,
industrial

microscope with graduated, 90°-revolving polarizer and analyzer holders and integral bright and dark field illumination is just one model in the complete Olympus microscope line, which includes units for a wide variety of scientific and industrial purposes and for the student. All are readily available and reasonably priced. Information on the complete Olympus line—or on microscopes for your particular application—is yours for the asking.

**OLYMPUS CORPORATION
OF AMERICA**



PRECISION INSTRUMENT DIVISION



OLYMPUS CORPORATION
OF AMERICA
PRECISION INSTRUMENT DIV.
P. O. Box 8968 Westgate
Rochester, N. Y. 14624
Send information on Olympus microscopes. My applications include:

Name _____

Title _____

Organization _____

Address _____

City _____

State _____ Zip _____

Measure the world of motion in any direction...instantly, accurately, dependably, in any application, telemetry or control, with United Control's highly reliable servoed miniature accelerometers. You name the application and the environment, we'll provide the best accelerometer. For more information, call or write United Control.

measure

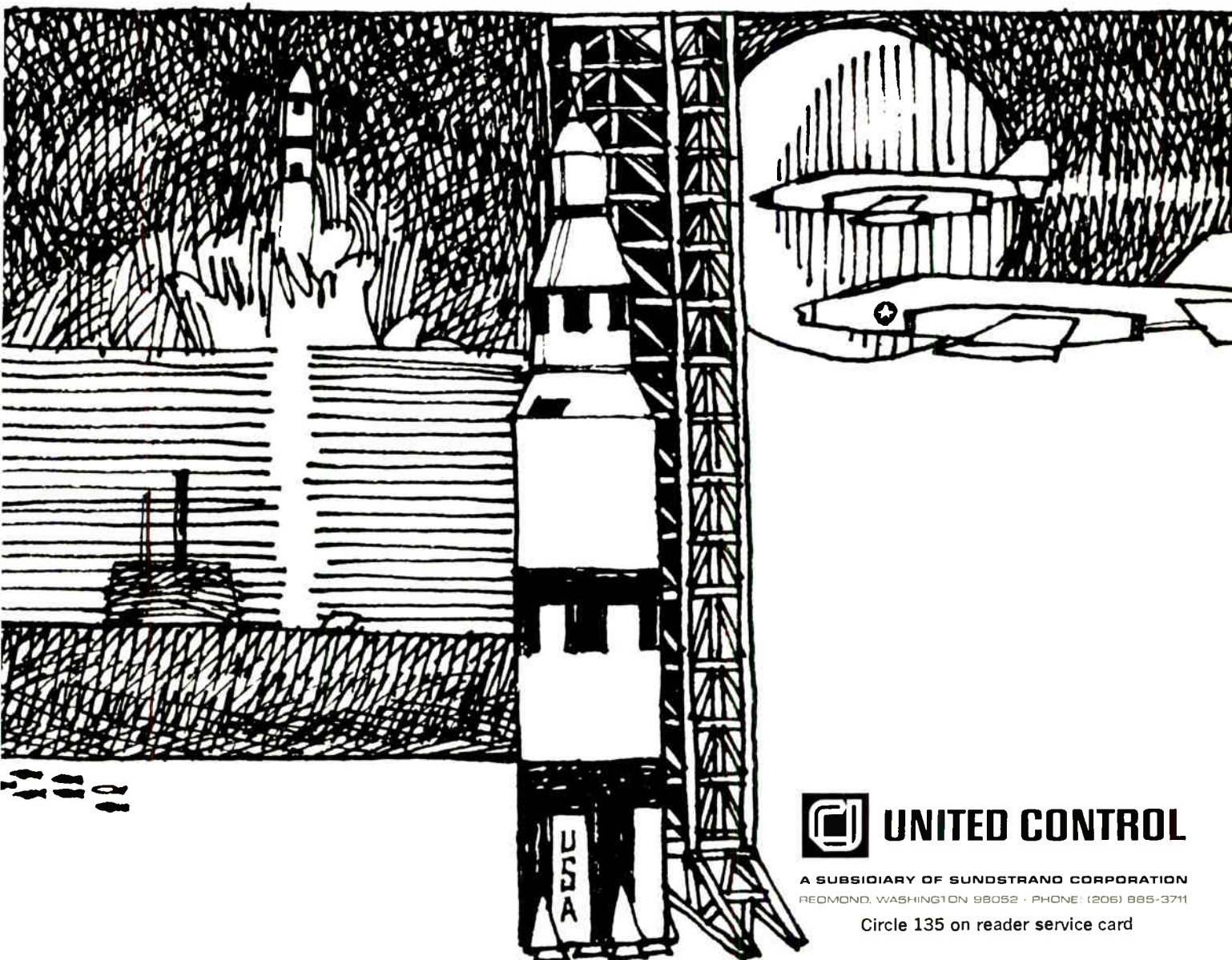

UNITED CONTROL

A SUBSIDIARY OF SUNSTRAND CORPORATION
REDMOND, WASHINGTON 98052 · PHONE: (206) 885-3711

Circle 135 on reader service card

Another announcement in the
STRUTHERS-DUNN
YEAR OF RELAY DEVELOPMENTS
 in which we bring you word of
 new Struthers-Dunn relays
 and relay refinements.

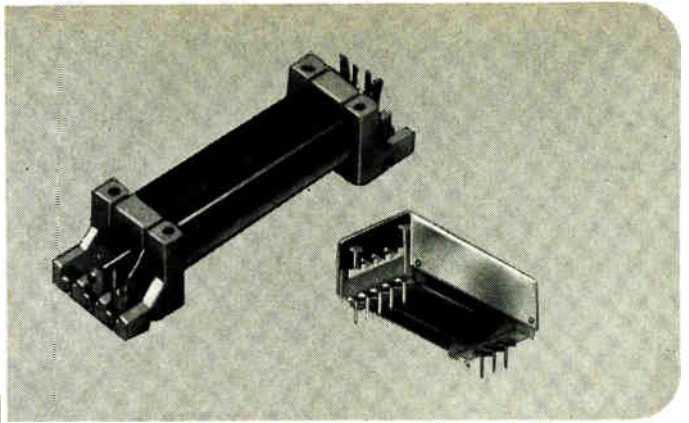

Well...well...well!

Struthers-Dunn now has "open" reed relays . . .

*. . . and the reason isn't
 what you might think!*

No, we aren't introducing our first "open" reed relays because we couldn't design any before.

Or because no one wanted the sophisticated enclosed reed relays for which we're famous.

It's because many customers for our other relays want open reed relays, too. And since we have the world's largest relay line, we don't intend to have customers pointing out any relays we **don't** have!

So, here are the details. Two types: miniature and standard. "Miniatues" in twelve 1-to-4 pole models with various combinations of Form A, Form B, and Form C miniature dry reed switches. Contacts rated from low level to 12 volt-amperes. 1½" long by ¾" above the mounting board. Mercury-wetted reed switch available in ½" wide single-pole package.

"Standard" sizes in seven 1-to-4 pole contact configurations, rated from low level to 15 volt-amperes. Width varies with number of poles, but other dimensions are standard at 2½" long by ¼" above P/C board.

Both series have snap-on metal covers for magnetic shielding. Most models in both series interchangeable with many corresponding competitive models.

So, Struthers-Dunn customers, here are your open reed relays! New customers, check the low cost, long life, other details.

See data listing at right.

Find your ideal relay faster... in the world's largest line!



New idea in protected reed relays. New plastic sealing technique opens way to completely protected reed relays at just a shade higher than cost of open types. Series MRRK reed relays save time, cut cost of mounting, soldering, cleaning. Nine of the most popular 1 to 3 switch contact combinations available in four coil voltages. See data listing below.



Don't "settle" on a motor control . . . select from the varied line at Struthers-Dunn! General purpose AC contactors and motor starters for single phase and polyphase service to 600 volts, sizes 0 to 4. Definite-purpose reversing and non-reversing contactors for one to three horsepower applications. New catalog just out. See data listing below.



Zero in on a commercial relay fast! You'll find thousands here. Power, control, sensitive, latch, sequence, instrument-controlled, timers and special purpose relays! Thousands of modifications, too. Yes, even the old standbys that have stood the test of time for dependability and economy . . . and definitely all the very newest in relay designs for all applications. See listing at right.

SEND FOR THIS REFERENCE DATA!

Check these numbers on Reader Service Card for any or all reference material listed below.

- #515 New open reed relays
- #516 Sealed reed relays
- #517 Motor controls
- #518 Commercial relays



STRUTHERS-DUNN, INC.

PITMAN, NEW JERSEY 08071

Canada: Struthers-Dunn Relay Div., Renfrew Electric Co., Ltd.

How do most companies move a doodling, advanced-thinking, problem-solving computer systems engineer?

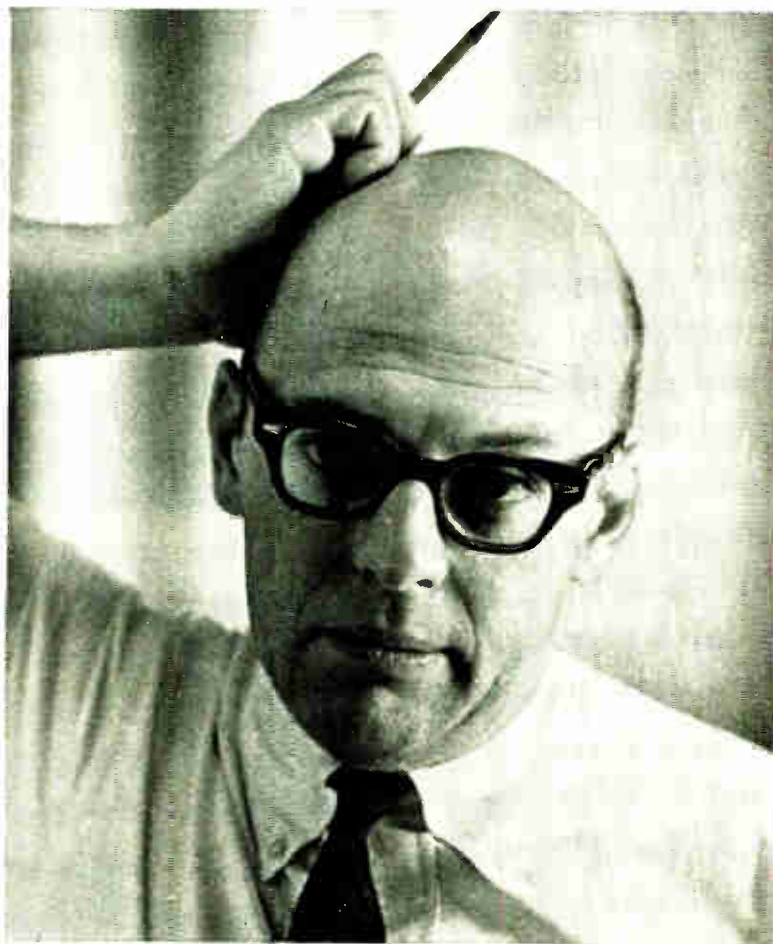

They choose a highly methodical, down-to-earth, know-how van line.

Allied Van Lines moves more computer systems engineers (doodlers and doers) than any other mover.

Call the down-to-earth Allied Agent where you are.



wanted: "big" insulator problems

Solving "big" insulator problems is Lapp's specialty. Wherever insulator requirements call for high strength, special electrical specifications, maximum dependability and long service . . . Lapp is the company to contact.

Lapp has been designing, testing and making insulators for communications installations for almost a half century. On many special jobs, our experience provides the basic engineering and design, which enables us to deliver the job quicker, *and* save you money.

How "big" are the jobs we've done? How about tower base insulators to 9 million lbs. ultimate strength with 500 kv peak wet flashover. Or, compression cone guy insulators to 620 thousand lbs. strength and in strings with grading rings giving wet flashover to 700 kv peak.

Lapp also made 3 of the world's largest RF feed through bushings with wet flashover of 600 kv peak, for continuous operation at 2545 amperes at 140 kv rms at 14-30 kc. Our double-yoked strain insulators have been made to 240 thousand lbs. ultimate strength with a wet flashover rating of 700 kv peak.

From drawing board to delivery, you can count on Lapp when it comes to "big" insulator problems. Write for additional information, Lapp Insulator Co., Inc., LeRoy, N.Y. 14482.

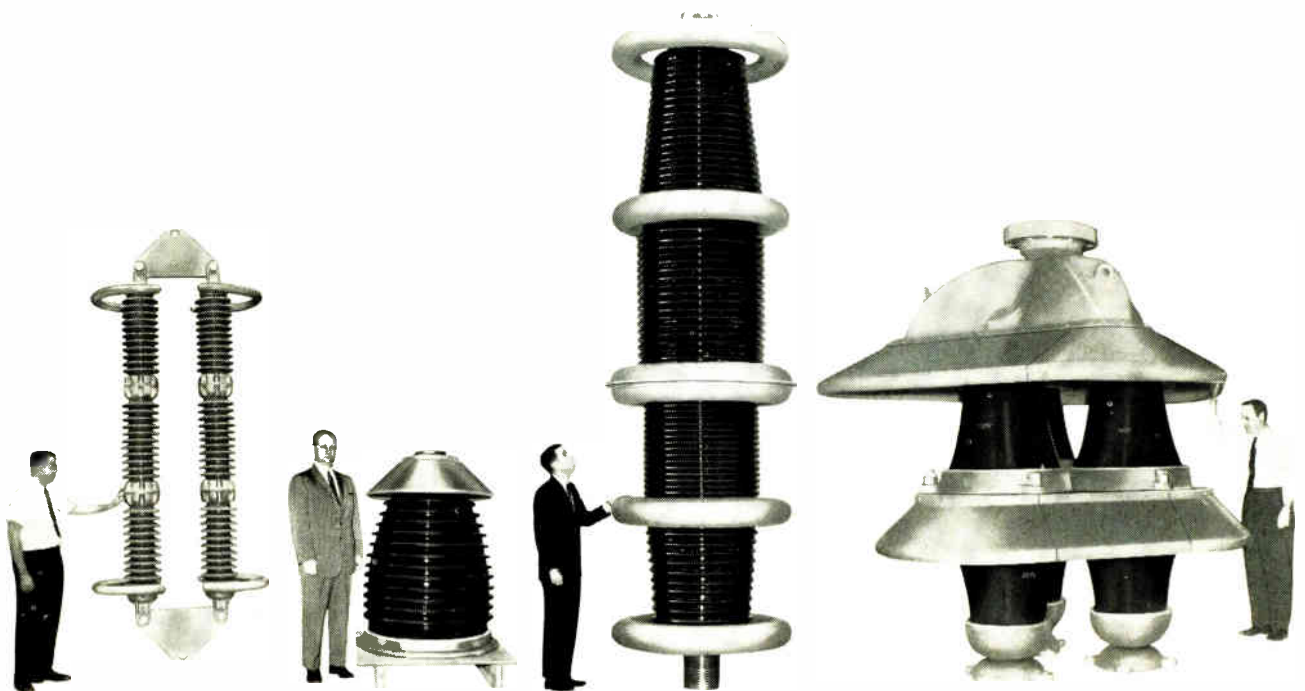
The logo consists of the word "Lapp" in a bold, white, sans-serif font, centered within a solid black rectangular background.

10 kHz to 1000 MHz ± 0.4 Hz Full Scale Deviation Frequency Comparator

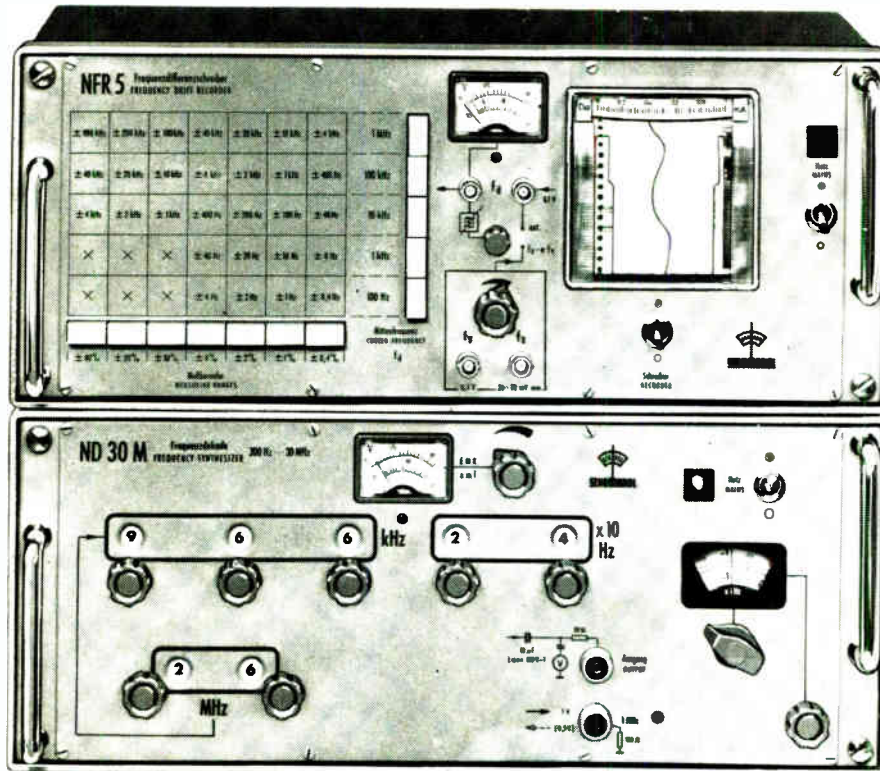

TYPE NFR5 DRIFT RECORDER
TYPE ND30M REFERENCE FREQUENCY SYNTHESIZER

FREQUENCY MEASURING AND DRIFT RECORDING SYSTEM

FEATURES:

- Full Scale Recording Range: ±0.4 Hz to ±400 kHz Deviation
- Selectable Center Frequency: 100Hz - 1MHz in Decadic Steps
- High Sensitivity: 20 mV
- Frequency Synthesis: 300 Hz - 31 MHz
- Stability: ±5 x 10⁻⁷/°C
- Spurious Suppression: 80 dB

Type NFR5 Frequency Drift Recorder provides unambiguous meter reading and strip chart recording of frequency difference. Reference frequency (or harmonic) is varied until it forms decadic beat frequency of 100 Hz-1 MHz. Center frequency and deviation range from ±0.4% to ±40% are selected by push-buttons according to expected frequency drift. Independent selection of center frequency and deviation range provides 29 possible combinations for measurement. For extremely stable frequencies, center frequency of 100 Hz and resolution of ±0.01 Hz/div. are possible. Built-in harmonic generator permits measurements to 1 GHz

with ref. frequency range of only 10 kHz-30 MHz.

A point recorder plots data point every 3 seconds, with accuracy of 2.5% f.s.d. Chart width is ±30 mm. A second variable (e.g. temperature, time, etc.) can be recorded automatically every sixth data point.

Type ND30M+Q4 Frequency Synthesizer provides the external reference and is, of course, usable independently. When used with the Type NFR5, the result is a solid state, high accuracy, frequency measuring and recording system, using the heterodyne technique.

Get The Extra Capability,
Greater Reliability, and
Longer Useful Life Of . . .



ROHDE & SCHWARZ

111 LEXINGTON AVENUE, PASSAIC, N. J. 07055 • 201-773-8010

Inquiries outside the U.S.A. should be directed to: Rohde & Schwarz, Muehlhofstrasse 15, Munchen 8, West Germany.

NEW EG&G PICOAMMETERS

A full line of low-level current measurement instruments

All EG&G Picoammeters include features others only talk about. Like the unique combination of precise accuracy and rapid, accurate calibration capability without resorting to calibration charts or resistor measurement. And, the all solid-state design, including a low level MOS FET input stage. What's more . . . you'll find an

EG&G Picoammeter to meet *your* needs and *your* budget. That's because EG&G offers the most complete line of low level current measurement instruments available. From high precision units or automatic ranging units, both complete with digital readout, to general purpose, manually-operated bench top models.

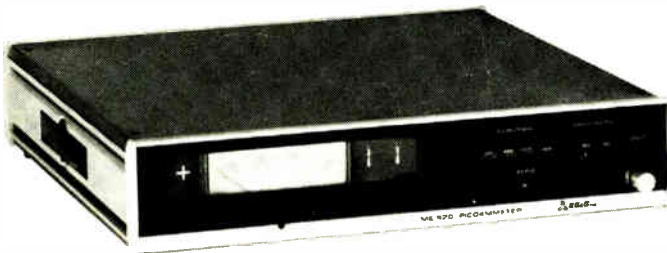

HERE ARE THE SPECIFICS ON FOUR OF THE MOST POPULAR EG&G PICOAMMETERS.

Model ME-1035, Precision Picoammeter — for Standards or Calibration labs. Current measuring range of 10^{-5} amps to 10^{-12} amps with 10^{-15} amps resolution. All solid state design with MOS FET input, temperature controlled feedback resistors for added stability, pushbutton range control, adjustable summing point voltage and current offset monitor, pushbutton controls for rapid internal calibration requiring no external standards or sources. Digital readout. Price: \$3,945.00

Model ME-930, Digital Picoammeter — for general lab work and automatic digital systems. Current measuring range of 10^{-11} amps through 10^{-2} amps full scale in 10 decade steps. A full digital picoammeter with automatic range changing capability and automatic polarity selection. All solid-state design with MOS FET input, remote function control and optional printer drive, digital readout of level and range. Price: \$3,575.00

Model ME-920, Automatic Range Changing Picoammeter — for general laboratory use and production line testing. Current measuring range of 10^{-11} amps through 10^{-2} amps in 10 decade steps. An automatic ranging picoammeter with remote function capabilities. All solid-state design, with MOS FET input and automatic polarity indication. Price: \$2,435.00

Model ME-705, General Purpose Picoammeter — for general laboratory use. Current measuring range of 3×10^{-13} amps through 10^{-2} amps in 22 steps (11 decades with X3 meter multiplier). A general purpose, manually operated bench-top picoammeter. All solid-state design, with MOS FET input stage. Price: \$560.00

For more complete details on the more complete line of EG&G Picoammeters, contact your local EG&G Products Division representative. Or, write EG&G Inc., Laboratory Products Division, P.O. Box 755, Goleta, California 93017.

EG&G

LABORATORY PRODUCTS DIVISION

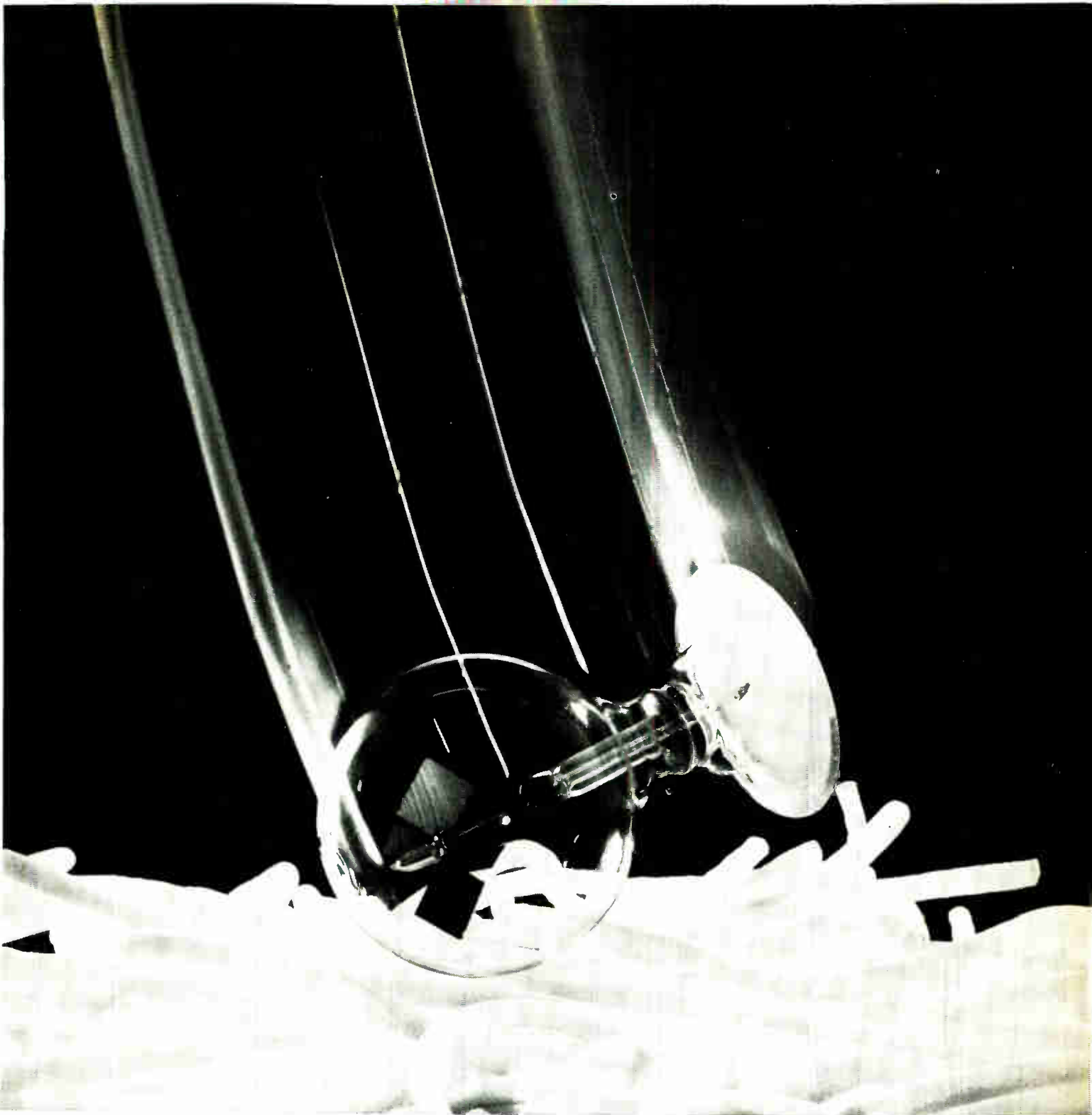

Packaging Sales, The Dow Chemical Company, Midland, Michigan 48640.

Try this on your fragile parts.

Pelaspac[®] loose fill packing. It weighs 3 to 6 times less than most other dunnage. It won't absorb water. It cuts shipping losses. Because it's highly shock-resistant, and it interlocks to prevent settling. It cuts cleanup, too. Because it's clean, nondusting and noncorrosive. Write for details.



Circle 141 on reader service card

these new BURR-BROWN op amps out-perform look-alike units

You can now put Burr-Brown quality in your economy-minded applications for as little as \$11.25. In fact, there's a whole new series of Burr-Brown operational amplifiers which includes units specifically designed for engineers facing tight budget restrictions as well as premium units for more critical applications.

Each amplifier has been carefully engineered from the leads up to give you maximum performance at competitive prices . . . without sacrificing Burr-Brown's usual high quality standards. Even the 7-pin and 9-pin encapsulated packages are new.

MODEL NO.	KEY SPECIFICATIONS	100 UNIT PRICE
3077/12C	Lowest Price — a general purpose ± 10 V, ± 5 mA, 7-pin unit. Drift: $\pm 10 \mu\text{V}/^\circ\text{C}$ and $0.5 \text{ nA}/^\circ\text{C}$.	\$11.25
3119/12C	General Purpose — ± 10 V, ± 10 mA output. Drift: $\pm 10 \mu\text{V}/^\circ\text{C}$ and $\pm 0.5 \text{ nA}/^\circ\text{C}$. 7-pin package.	\$14.25
3118/12C	General Purpose — ± 10 V, ± 10 mA output. Drift: $\pm 5 \mu\text{V}/^\circ\text{C}$ and $\pm 0.4 \text{ nA}/^\circ\text{C}$. 7-pin package.	\$18.75
3117/12C	General Purpose — ± 10 V, ± 10 mA output. Drift: $\pm 2 \mu\text{V}/^\circ\text{C}$ and $\pm 0.2 \text{ nA}/^\circ\text{C}$. 7-pin package.	\$26.25
3104/12C	FET Input — ± 10 V, ± 5 mA output. $\pm 10 \mu\text{V}/^\circ\text{C}$ drift. Input bias current: $\pm 0.01 \text{ nA}$. 7-pin package.	\$21.75
3116/12C	FET Input — ± 10 V, ± 10 mA output. $\pm 15 \mu\text{V}/^\circ\text{C}$ drift. Input bias current: $\pm 0.01 \text{ nA}$. 9-pin package.	\$26.25
3064/12C	FET Input, Wideband — ± 10 V, ± 10 mA output. $\pm 15 \mu\text{V}/^\circ\text{C}$ drift. 5 MHz bandwidth. 9-pin package.	\$33.75
3115/12C	FET Input — ± 10 V, ± 10 mA output. $\pm 8 \mu\text{V}/^\circ\text{C}$ drift. Input bias current: $\pm 0.01 \text{ nA}$. 9-pin package.	\$45.00
3114/12C	FET Input, Low Drift — ± 10 V, ± 10 mA output. $\pm 2 \mu\text{V}/^\circ\text{C}$ drift. Input bias current: $\pm 0.01 \text{ nA}$. 9-pin package.	\$63.75

Demonstrator units are available on all of these models. Contact your Burr-Brown Representative. Most of these units are in Burr-Brown Jet Stock for immediate shipment from your local representative's office.

For Complete Information. To get your copy of the new 4-page Product Bulletin describing these new Burr-Brown op amps, simply use this publication's reader service card or call your local Burr-Brown Representative. For immediate applications assistance, phone (602) 294-1431, and ask to talk to your Burr-Brown Application's Engineer.

BURR-BROWN

RESEARCH CORPORATION

International Airport Industrial Park • Tucson, Arizona 85706
TELEPHONE: 602-294-1431 • TWX: 910-952-1111 • CABLE: BBRCORP



Operational Amplifiers
Instrumentation Amplifiers
Function Modules
Active Filters
Analog Simulators
Geophysical Instruments

ENGINEERING REPRESENTATIVES: ALABAMA, HUNTSVILLE (205) 534-1648 / ARIZONA, PHOENIX (602) 254-6085 / CALIF., LOS ANGELES (213) 665-5181, SAN FRANCISCO (408) 244-1505 / COLO., DENVER (303) 388-4391 / CONN., EAST HARTFORD (203) 874-9222 / D.C., WASHINGTON (SEE MARYLAND) / FLORIDA, ORLANDO (305) 425-2764 / ILLINOIS, CHICAGO (312) 286-6824 / LA., NEW ORLEANS (504) 888-2266 / MD., SILVER SPRING (301) 588-8134 / MASS., BOSTON (617) 245-4870 / MICH., DETROIT (313) 358-3333 / MINN., MINNEAPOLIS (612) 781-1611 / MO., ST. LOUIS (314) 524-4800 / N.C., GREENSBORO (919) 273-1918 / N.J., CAMDEN (215) 925-8711

/ N.M., ALBUQUERQUE (505) 255-1638 / N.Y., ALBANY (518) 436-9649, BINGHAMTON (607) 723-9561, MT. VERNON (914) 968-2200, NEW HARTFORD (315) 732-3775, ROCHESTER (716) 473-2115 / OHIO, CINCINNATI (513) 761-5432, CLEVELAND (216) 237-9145, DAYTON (513) 277-8911 / PENN., PHILADELPHIA (SEE CAMDEN, N.J.), PITTSBURGH (412) 243-6655 / TEXAS, DALLAS (214) 357-6451, HOUSTON (713) 774-2568 / UTAH, SALT LAKE CITY (801) 466-8709 / VIRGINIA, (SEE MARYLAND) / WASH., SEATTLE (206) 767-4260 / CANADA, DOWNSVIEW, ONT., (416) 636-4910 — MONTRÉAL, QUE., (514) 729-6776 — OTTAWA, ONT., (613) 725-1288 — VANCOUVER, B.C., (604) 298-6242

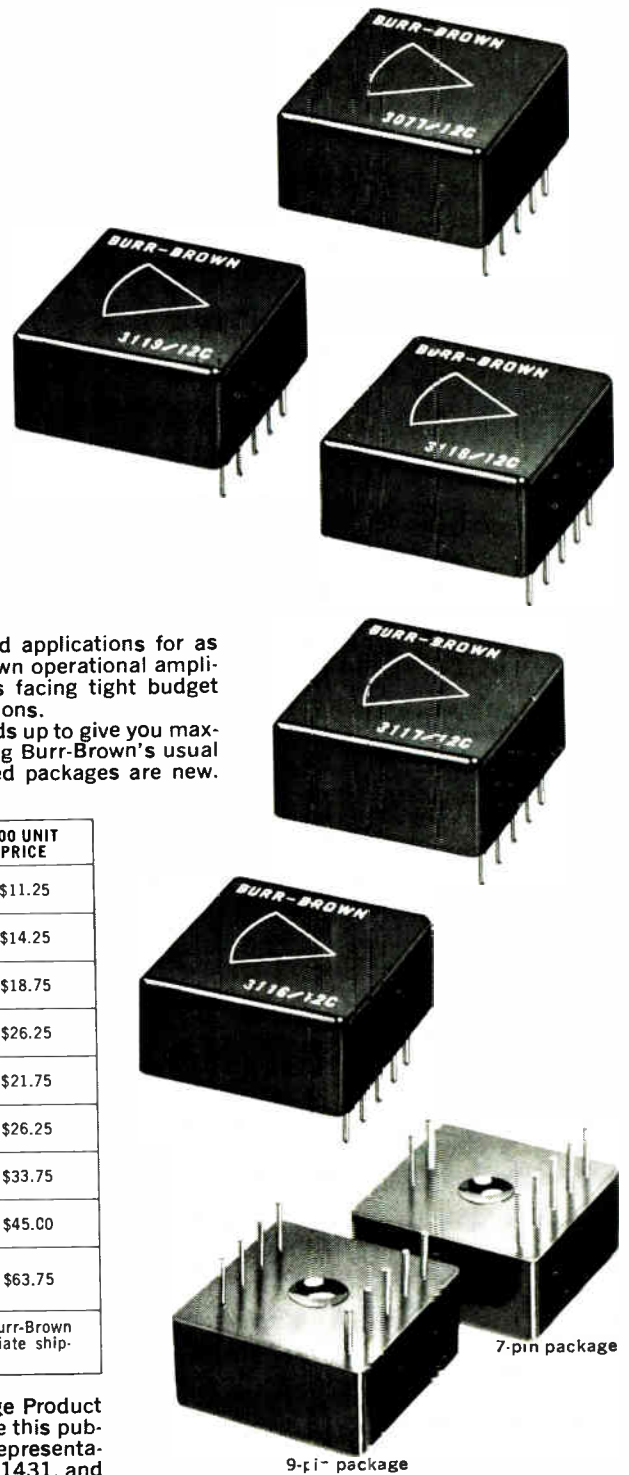

7-pin package

9-pin package

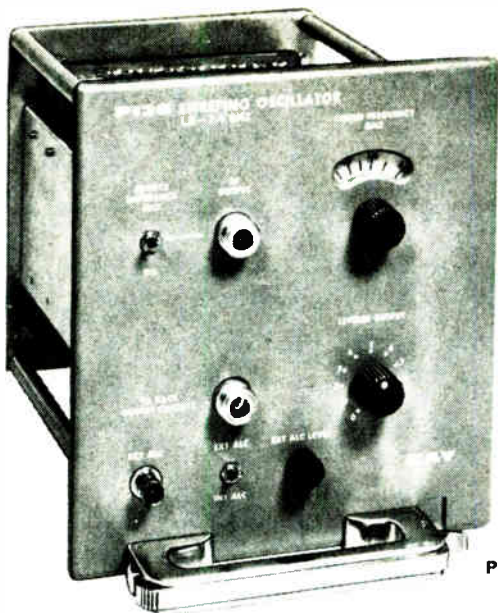

P126

NEW

1.2 - 2.4 GHz

Solid-state Wide sweep Plug-in...

Boosts the range of Kay's 121C to cover 500 KHz to 2.4 GHz



121C

- Stable, narrow sweeps
- Full octave-wide sweeps
- Frequency range: 1.2 - 2.4 GHz
- Sweep width: 0 - 1.2 GHz
- RF output: 10 MW into 50 ohms
- Flatness: $\pm .5$ db overall
- Price: \$1190.

The 121C is a solid-state, electronically swept VHF-UHF wide sweep and marker generator which accepts a variety of UHF and microwave plug-ins to provide extended frequency ranges and sweep widths. In this manner, it covers a range from 500 KHz to 2400 MHz, offers octave-wide sweeps even at low UHF frequencies where most generators in this range are limited to narrow widths, and provides for special applications such as VHF-UHF TV (440-920 MHz wide-sweep plug-in).

The 121C delivers 0.5 volts rms into load—after a built-in attenuator—with excellent flatness and wave-shape. It provides flat, wide sweeps and stable narrow sweeps; linear frequency output, agc'd rf level and a frequency marker system.

Additional plug-ins for the system include:



P121



P122



P123



P124

P121	200-1050 MHz	\$595.
P122	900-1300 MHz	400.
P123	Octaves to 1 GHz	425.
P124	1300-1700 MHz	425.

Basic 121C rack system—\$950.

KAY ELECTRIC COMPANY

Pine Brook, N. J. 07058 • (201) 227-2000 • TWX: 710-734-4347

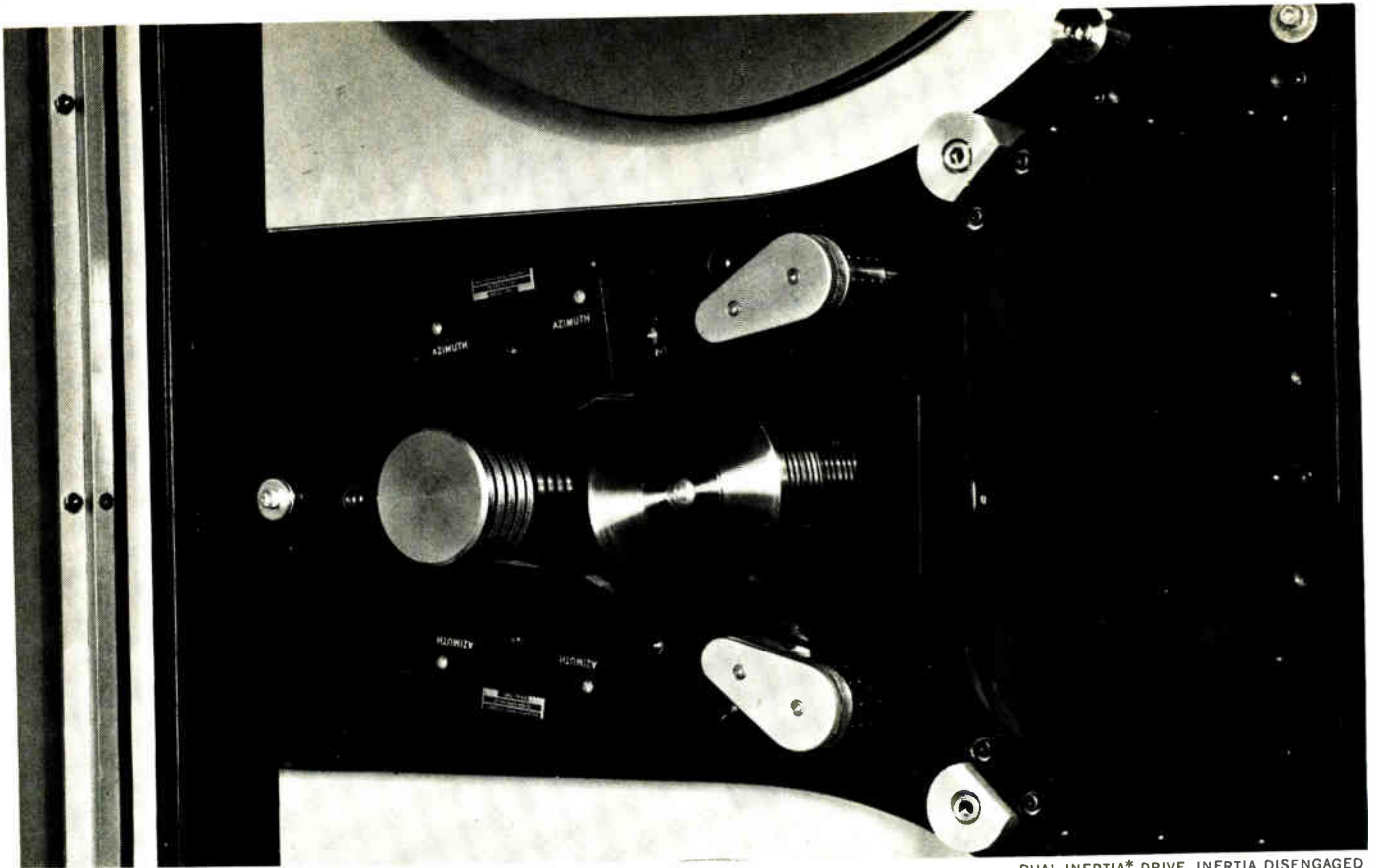

DUAL INERTIA* DRIVE, INERTIA DISENGAGED

Flutter's out—Data's in

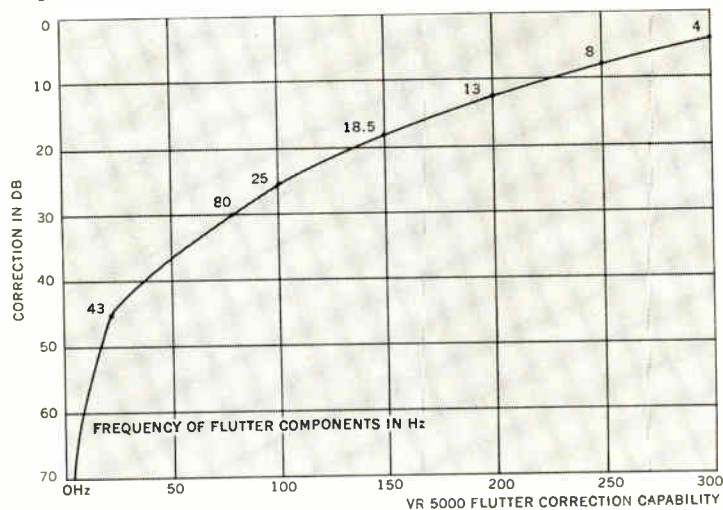

The instrumentation recorder that can do it is CEC's VR 5000. For the "5000" has a flutter correction capability far superior to any other recorder known today (see graph).

As a result, flutter components, spurious sidebands in the reproduced data and tape speed errors common with other systems (due to high vibration environments or other causes) are effectively eliminated.

The VR 5000 has accomplished this by means of its exclusive *Dual Inertia** Drive—added mass for record, minimum mass for reproduce. Consequently, a flutter spectrum results that is uniformly

smooth from *dc* to 300 Hz.

Plus a maximum time base error of ± 400 nanoseconds

Due to this additional advance, the VR 5000 has made possible the ultimate in real-time restoration of data. Tapes made on conventional data acquisition recorders under severe environmental conditions can be successfully reduced with correct time base restored.

CEC also offers a complete line of other analog recorders for mobile, laboratory and aerospace use at considerable savings.

Comparative performance report on the VR 5000 now available.

Call your nearest CEC Field Office, or write Consolidated ElectroDynamics, Pasadena, California 91109. A subsidiary of Bell & Howell. Ask for Bulletin VR 5000-X21.

*Patent Pending

CEC/DATATAPE PRODUCTS

 **BELL & HOWELL**



In composite insulations, the big plus is "Teflon* plus..."

In design, composites of TEFLON plus one of several other materials provide the necessary electricals with a minimum of weight and space.

In installation, "TEFLON plus . . ." composites provide extra resistance to cut-through and abrasion.

In operation, "TEFLON plus . . ." composites offer the nonflammability of TEFLON, plus its resistance to heat aging, thermal stress cracking and embrittlement at low temperatures.

Whenever you need the extremes of performance that only a composite insulation can give, look for TEFLON plus such other materials as nylon, polyimide, glass, asbestos, mineral fillers, polyvinylidene fluoride—or you name it!

For more information on "TEFLON plus . . ." composites, send details of the application you have in mind to Du Pont Company, Room 5886-C, Wilmington, Del. 19898.

*Reg. U.S. Pat. Off. for Du Pont fluorocarbon resins and film.

TEFLON...the sure one



Better things for better living
...through chemistry

20A, 1000V Avalanche rectifiers in DO-4...



...part of a range covering 2.5A to 20A general purpose and 7.5A fast recovery types

36 different types, including 8 new high-frequency devices. Normal or reverse polarity. All in the popular DO-4 encapsulation—the smallest internationally recognised rectifier outline. Here are brief details—
7.5A High-frequency series The BYX30 avalanche series offers low stored charge and the ability to absorb transients without damage. Operation up to 50kHz (sine-wave), without derating, is indeed possible.

New 2.5A series The robust, low-cost BYX38 series, for general industrial use, includes 300, 600, 900 and 1200V types.

New 6A and 20A Avalanche series The 6A, BYX39 and 20A, BYX25 series are extremely competitive on an amps/volts per dollar basis. Working voltages of 600, 800 and 1000V are offered, which make them ideal for use in high-voltage supplies. They are also produced in stack form for this type of application.

All current ratings $I_{(AV)}$ at T_{Stud} 125°C.

New 10A economic series The inexpensive BYX42 range with voltage ratings of 300V, 600V, 900V and 1200V.

Every designer should have a copy of the Mullard Broadsheet which covers rectifiers, as well as thyristors, stacks and modules. Also ask to be put on the mailing list of the Mullard Bulletin—a regular publication which gives details of new components and applications . . . the result of extensive research and development programs in the Mullard laboratories in England. Mullard employ 1000 qualified scientists and engineers and have six major plants, with over 3 million square feet of floor space.

Write today for information on Mullard rectifiers, and for the name of your local Distributor.

Mullard Limited, Mullard House, Torrington Place, London WC1, England.

U.S.A. enquiries to Mullard Inc., 100 Finn Court, Farmingdale, Long Island, New York 11735, U.S.A. Telephone: (516) 694-8989 Telex: 961455.

Mullard LIMITED

Have you talked to an analyst about your identification problem?

The problems of marking and identifying electrical and electronic components can drive a production engineer right up the old wall. "How can you print several color bands on a miniature diode?" "Is there an ink that'll dry on contact and meet Mil specs?" "How can you get fast, smudge-proof marks on things like ceramics, plastics and chrome?" "How can you simultaneously mark the tops and sides of transistors at high rates of speed?"

A Markem analyst thrives on problems like these. He can help you solve them by supplying the best machines, specialty inks, printing elements and other supplies. He can help by being there whenever you need service, whenever an operator needs training. And he can help by showing you how to get better identification for less money. For example, we recently introduced an Instant Type Former which lets you make metal type in-plant, as needed. No waiting for delivery . . . You can form new type inserts in less than a minute by simply "dialing" the legend.

Have a Markem analyst visit your plant to look into your marking operation. His ideas could save you a lot of grief. And a lot of money. Call your local Markem Sales office or Bernie Toomey at 603-352-1130. Write for our new "Problem Solver" booklet. Markem, 305 Congress St., Keene, New Hampshire 03431.

©

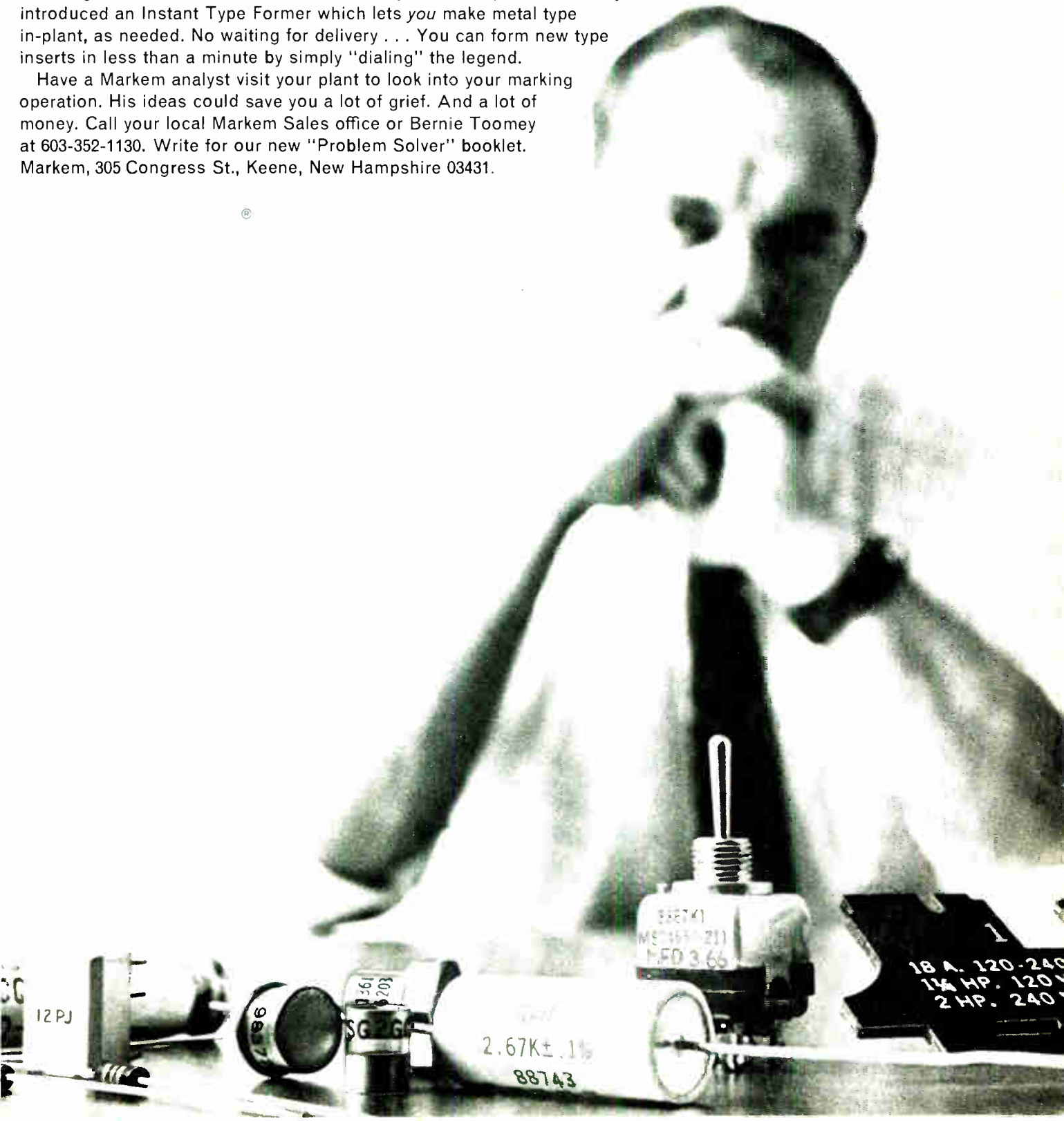

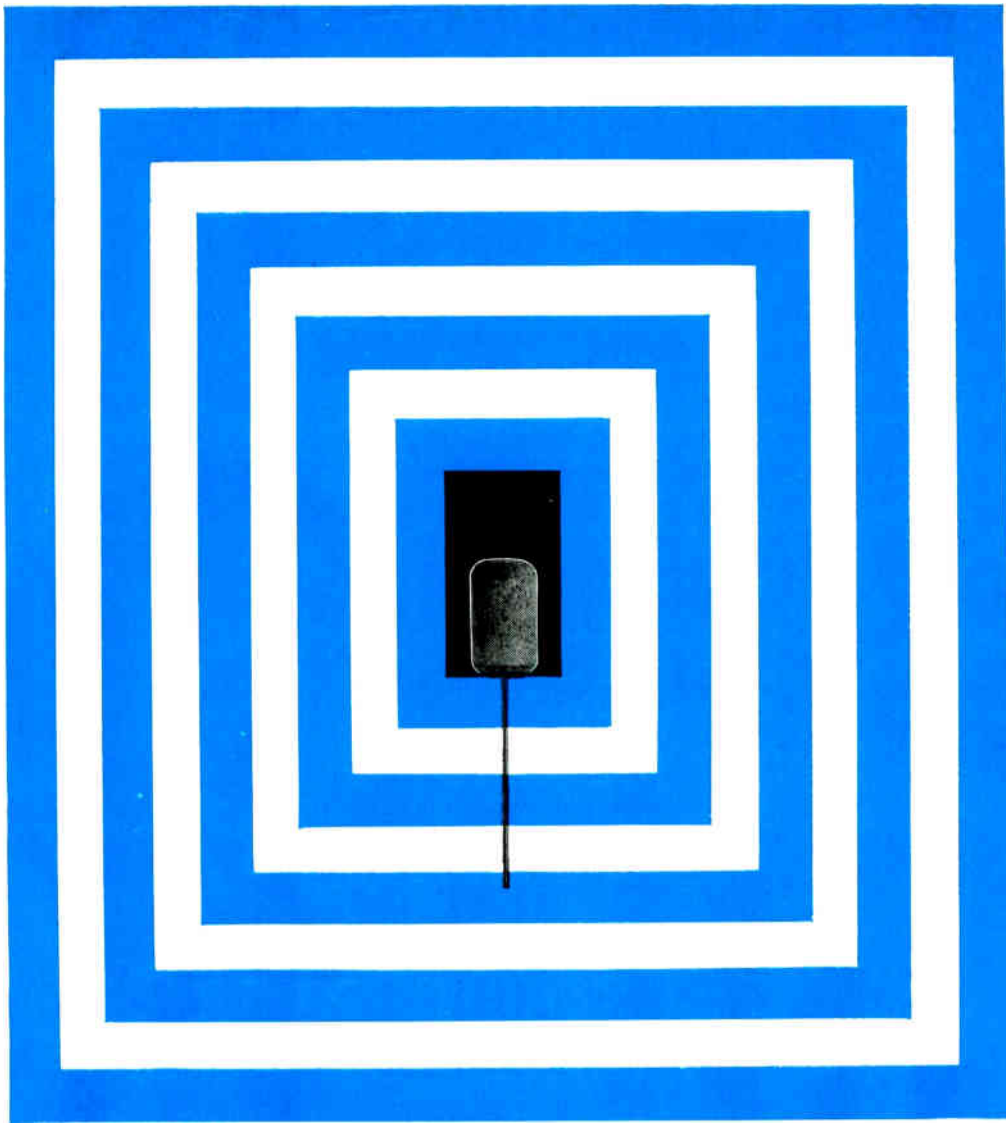

squeeze powder!

Fansteel's "FD" capacitor grade tantalum powder cuts anode size... capacitor cost. Yet improves electrical parameters.

How's that for putting on the squeeze! Compare standard with FD powder. You'll see how FD reduces material cost 35-45% per anode . . . how high purity achieves maximum capacitance without sacrificing electrical properties . . . how low density FD anodes reduce impregnation problems!

As a result of new powder making techniques, you can have smaller, more economical medium and high voltage capacitors. Fansteel FD powder is available in finished anodes or bulk powder form.

Your Fansteel Sales Engineer has detailed technical data. Ask him . . . or write us for your copy.

grade of Ta Powder	Standard	Fansteel FD
weight	4.4 gm	2.3 gm
density	10.5 gm per cc	8.5 max. gm per cc
CV rating	7000	7000

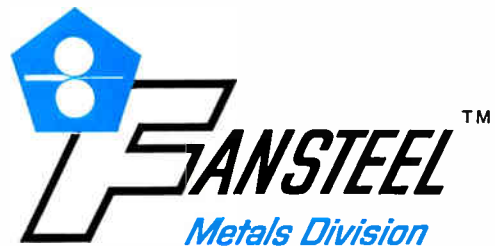

FANSTEEL, INC.
NUMBER ONE TANTALUM PLACE
NORTH CHICAGO, ILLINOIS 60064

Probing the News

Integrated electronics

Putting the stress on IC reliability

Self-interest as well as pressures from customers and Government agencies are the key factors in the industry's move toward higher-quality assemblies

Reliability is the name of the game when it comes to integrated circuits. The IC makers feel they are chalking up a good score. What's more, the other players—the users—agree with but a few reservations that the semiconductor houses are indeed doing a pretty fair job.

Pressures from Government agencies, particularly the Air Force's Rome Air Development Center in upstate New York, are an important reason for the industry's relatively successful attempts to supply customers with reliable IC's. Realizing that device development was rapidly outpacing reliability data and experience, ADC pioneered physics-of-failure techniques in 1961 with an eye to obtaining better physical, chemical, and metallurgical characterizations of solid state assemblies. A failure-analysis laboratory has been in existence at the center since 1963, and a steady stream of guideline publications has been issued. The latest, Military Specification Standard 883, which is now being distributed, not only details many new test methods for microelectronic devices, but also spells out precautionary measures for present procedures. Added to this is material on screening and lot-qualification procedures.

Enlightened self interest

From the IC supplier's standpoint, reliability is simply good business sense. "Everyone wants to push reliability," says Sidney Wiesner, head of the reliability and quality assurance department at the Raytheon Co.'s Semiconductor division. "But most companies have

given more of a sales pitch than accurate information."

At the moment, however, there's no consensus among IC makers on which way to turn in their quest for better reliability because of MIL-STD 883 "We expect some changes, but its impact is uncertain as yet," says Raymond Barnes, supervisor of reliability programs at Sylvania Electric Products Inc.'s Semiconductor division. "There'll probably be a shift to more burn-in requirements and greater demand for visual inspection before packaging."

School of thought. Notwithstand-

ing MIL-STD 883, others in the industry believe that the trend in reliability is toward tighter process controls and away from burn-in and stress testing. One such is James Corzine, who oversees IC quality for aerospace and defense applications at Fairchild's Semiconductor division. As a dramatic example of this turn of events, he cites the company's sale of fully equipped production lines in Fairchild's Mountain View, Calif. plant.

The idea of so-called captive assembly lines originated with the Sandia Corp. which has pioneered

The elite corps

About a year ago, Fairchild Semiconductor found that it couldn't get sufficiently reliable IC's for military applications from the conventional practice of splitting a production run into military, computer, industrial, and consumer batches. Instead, the company set up a separate facility to turn out military-rated IC's. Flow charts, output rates, documentation, instruction procedures, and the like were cooperatively established by both production and quality-assurance staffers.

Manning the military lines are women who wear their own distinct uniforms—yellow smocks. Each operator's work is inspected by a roving monitor at least three times a day. When a defect is found, the operator and her foreman are immediately notified. When two faults are found, the station is shut down and a check is made to determine whether the trouble lies with the machinery or the operator. Should the operator be to blame, the machine downtime is then charged against the operator's standard work rate, which affects her incentive pay.

At the moment, the "Special Forces" in the military department are on the same pay scale as other Fairchild production-line workers. Attempts are being made to get them a pay hike to reinforce their motivation, which is surprisingly high in view of the rigors involved. A good part of the military department's esprit de corps is attributable to the color of their smocks. Other production girls are clad in green, making them somewhat envious of the yellow elite.

To keep the ball rolling, Fairchild picks up the tab for group meal meetings held on company time. At these get-togethers, supervisors try to learn the girls' ideas on what's going right and wrong on the production lines.

How do the girls react to all this? In Shiprock, N.M., where Fairchild has a plant on an Indian reservation, the girls are so proud of their yellow smocks that they wear them even when doing the marketing.

A rogues' gallery of integrated-circuit faults

The photos with this article were taken through an electron-scanning microscope by the Lockheed Missiles & Space Co. as part of its program to learn just how integrated circuits fail.

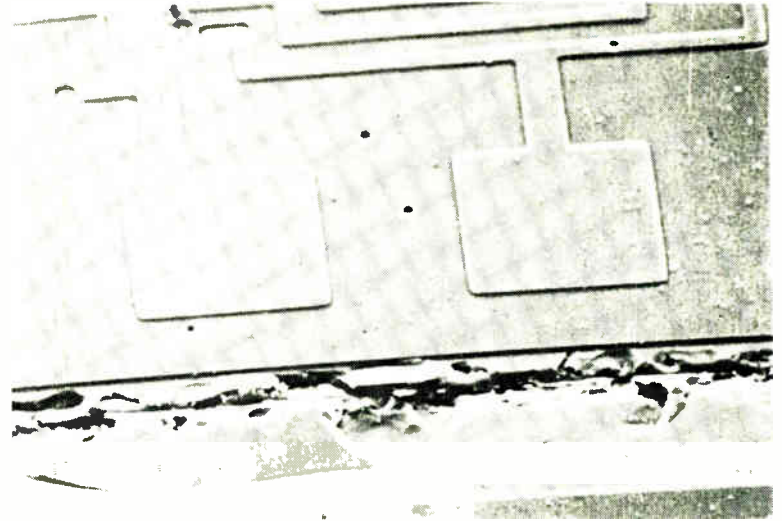

Abortive scribe on die at 300X magnification

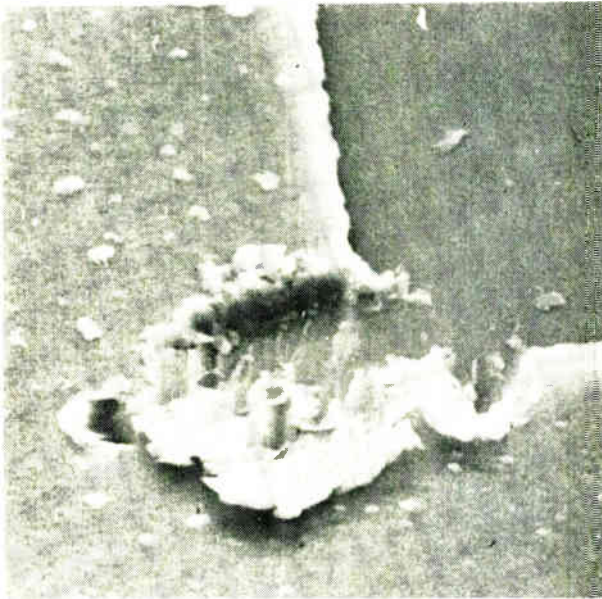

Probe mark at 3,000X magnification



Photoresist embedded in silicon dioxide

efforts to design and characterize semiconductor devices that will operate effectively in post-irradiation environments. In particular, Sandia is interested in developing assemblies for the Poseidon missile's guidance systems. However, the company has no semiconductor production facilities of its own. So last year it solicited bids from the major semiconductor makers for captive assembly lines. Recently, the company designated Fairchild Semiconductor and Texas Instruments Incorporated as "qualified sources," and made a substantial investment in equipment and personnel at each company.

For its money, Sandia is getting a program manager, a couple of engineers, office space, an assembly area, and production machinery. Now that facilities have been bought, Fairchild and TI will compete for an order for high-reliability transistors Sandia wants to use in the Poseidon program.

Next case. Likewise, the Raytheon Co., which also has Poseidon contracts, is considering bids from a number of semiconductor companies for two captive lines to build bipolar, dielectrically isolated, thin-film resistor IC's. Among the candidates are Fairchild Semiconductor, TI, Motorola Inc., Radiation Inc., and the Philco-Ford Corp.

Such deals are advantageous for both the IC vendor and user. Customers have complete control over process rates, bonding temperatures, and assembly techniques, though the lines are manned by vendor employees. As a result the user is able to exercise very tight control over specifications. In the case of Sandia's circuits, extensive production records will be kept, permitting reliability to be related to specific processes. The captive lines are to be sequestered from other assembly areas at the semiconductor manufacturer, and the equipment and people will be used only on projects designated by the customer.

As far as semiconductor houses are concerned, captive lines are a most attractive proposition. They are paid for all the dice that get to the assembly line. And once the production process starts, their responsibility is ended. Competition is reduced to the rivalry between whichever two firms are qualified

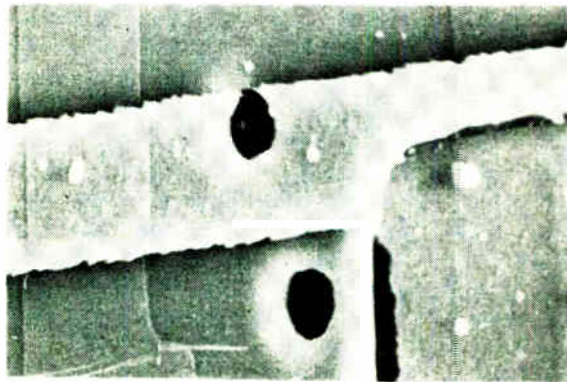

Pinholes in SiO₂

sources. And once a contract is awarded, the winner has what amounts to a monopoly on the business. "You hardly hear the phrase 'sole source' anymore," says Fairchild's Corzine.

Raytheon will pick its qualified sources around mid-June. Other firms reported to be in the market for captive lines include the Lockheed Aircraft Co. and the Autonetics division of the North American Rockwell Corp.

Most IC makers agree with Fairchild's philosophy on process control. "You can't test reliability into a circuit, you have to build it in," says Charles Blankenship, Siliconix Inc.'s vice president. "Customers are writing tougher specs, and they're beginning to exercise control over production." At Texas Instruments, Jim Adams, manager of quality and reliability assurance, says most of the company's quality-control work is aimed at improving process techniques. "Our front-end (prepackaging) work has become better in the last two years," he says. "And we have fewer mechanical problems." The Amelco Semiconductor division of Teledyne Inc. has gone so far as to monitor each production step with a computer. Manufacturing data from each stage is fed into the processor so yields can be related to specific processes.

Burning issue

Pretty much in agreement on the merits of process control, IC makers and users are less of a mind on the efficacy of burn-in.

"Once we thought that you couldn't buy enough burn-in fur-

naces," says Fairchild's Corzine. "But the cost of such stress testing was too great, and now more military buyers want process control. It was this trend that led to the captive production line." Sylvania's Barnes feels that the only reason many users and makers use burn-in is because it's called for in contracts. "There's nothing to prove its worth," he says. "Somebody should take a large number of IC's; burn-in half of them, and leave the balance as a control group. The devices should be installed in systems and the performance of the burned-in assemblies checked against that of the control group.

Barnes reports that some Sylvania customers believe burn-in can lead to problems. "When we went from 300° to 225° C bake-down, we pleased several customers who felt that the higher temperature treatment caused materials failures in later use," he says.

Ed O'Neill, TI's semiconductor marketing manager, also notes a lessening of interest in burn-in tests. "Customers, especially those in the industrial category, are specifying shorter burn-in periods," he says. But Joseph Flood, manager of IC reliability at Motorola Inc.'s Semiconductor Products division, sees burn-in as a valuable way to check manufacturing controls. "If you have a reliable process, you shouldn't get any fallout on burn-in," he says.

Flood is an advocate of reverse biasing as a superior burn-in technique. "When there's a surface instability, it shows up as a function of temperature and voltage

... metalization and bond problems are still causes of IC failures ...

levels. And the device is on all the time, accelerating the burn-in," he says.

The Rome Air Development Center also champions burn-in. "It's the single most effective screen we know," says Joseph Brauer, chief of the solid state application section. "Fallout rates of 1% to 10% of the lot would seem to indicate that burn-in is not only effective but also essential anywhere that rework costs or equipment breakdown rates are important. With burn-in, you can get one to two orders of magnitude improvement

quality assurance manager at the Signetics Corp., a subsidiary of the Corning Glass Works. "Reliability and standardization are related and the Pentagon used to feel that any move toward uniformity might stifle innovation. As a result, testing standards come from individual Government organizations like the Rome Air Development Center and the National Aeronautics and Space Administration."

RADC's reliability effort center on the common-sense approach of characterizing devices from a reliability standpoint rather than meas-

Joe Brauer's are quite unrealistic. They're being generated almost entirely without consultation with the circuit maker. The center takes inputs mainly from the Government and the IC user. Brauer has been trying to force these standards on systems people, who then put the screws to the vendor. He's putting the cart before the horse."

Sins of commission

IC makers admit their products still have shortcomings. And some users are quick to agree. For example, William R. Rodrigues de Miranda, a senior engineer at Raytheon's communication and data processing operation, says: "None of the problems of the last two years or so have been totally overcome; IC's are still being delivered with contamination, poor bonds, purple plague, drift, leaky packages, and other deficiencies." William Cox, of the reliability physics group at the Lockheed Aircraft Corp.'s Missiles & Space division, notes gross errors in workmanship. He points to cracked dice, gold specks in the can, open resistor trace, and loose bonding on special-order assemblies, presumably made under procedures calling for frequent in-process checks. "Commercial customers are resigned to buying devices that fail," says Cox. "This hurts buyers of high-reliability components."

Metalization and bond problems are still the major causes of IC failure, according to RADC. However, the center's engineers say these difficulties are better understood now, thus makers can match processes with applications. Fairchild's Corzine agrees. "During the 1961-1963 period," says Corzine, "about 50% of all failures were due to bonding; a good chunk of the balance was attributable to die attach. These failures stemmed from the gold-to-aluminum and thermocompression bonding techniques then used. At the time, we used gold preform that was put on the header and melted. Now we're doing face-down bonding, and for die attach we coat the back of the wafer with gold before it's even diced."

No panacea. But Arthur Ziskend, who heads the semiconductor engineering section at Honeywell Inc.'s Electronic Data Processing division, doesn't believe IC makers

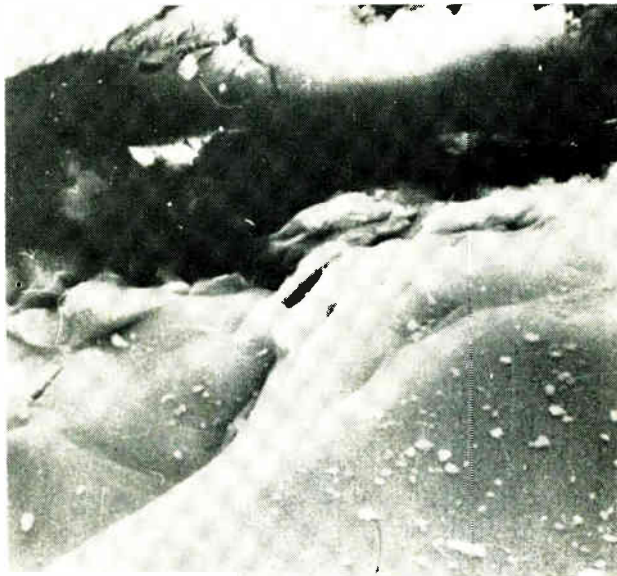

Layering at 3,000X magnification

in failure rates. However, on very high or low-quality parts, you'll get less improvement than at intermediate levels."

Kam Wong, manager of the product effectiveness department at the Data Systems division of the Hughes Aircraft Co., also favors burn-in. "The big advantage is that you can detect failures earlier," he says. "And when you put a component into a system, you know it will be inherently reliable."

Split decision. There is some disagreement among IC manufacturers on the value of periodic nudges from Federal agencies. "The Government's attitude on reliability has been somewhat ambivalent. This is especially true of the Defense Department," says Tim DaSilva,

uring failure rates. Staffers determine stress limits, response, and typical failure modes with respect to design, materials, structure, and processes. The same approach is taken in classifying assemblies. "Since quality defects are a major source of unreliability in IC's, we're sponsoring a study with the Philco-Ford Corp. to detect and classify the reliability risk of faults visible at preseal," says Brauer.

Sylvania's Barnes, among others, applauds Brauer. "He's pointed out a number of pitfalls, especially in 'specsmanship,' and helped put our operations on a more realistic basis." But Motorola's Flood says: "The reliability yardsticks of most customers are generally acceptable. However, military standards like

have solved all of their lead problems. Cracks can show up around leads if the ceramic and metal don't have the same coefficient of temperature expansion, he says. And to compensate for this, some manufacturers have gone to Kovar leads. Unfortunately, if the Kovar isn't properly plated, the iron component in the alloy corrodes. And sometimes an electrolytic cell will be formed in the lead, eventually severing it. Similarly, an engineer at NASA's Electronics Research Laboratory in Cambridge, Mass., still considers metalization problems a fact of life. "The mere replacement of aluminum hasn't solved anything," he says. "And aluminum may very well be the right metal to stick with since so many of its physical characteristics complement the process of IC production.

Monometallic bonding is the most important recent advance made toward IC reliability in the opinion of J. H. Arnim, supervisor of reliability at LTV Electrosystems Inc. "The more internal bonds you can eliminate, the better reliability you'll get," he says.

Inspector general. At the Guidance and Control Systems division of Litton Industries, Inc., Alden Stevenson, vice president and director of applied research, puts stock in visual inspection at the vendor's plant. "With this kind of check, you can spot poor photoresist irregular metalization, uneven oxide thicknesses, or such problems as bumpiness on the IC surface," he says. But Stevenson isn't particularly high on monometallic assemblies.

"All-aluminum devices are touted as the best way to sidestep purple-plague problems," he says. "But their leads aren't as strong as gold. This shows up in centrifuge tests."

As for packaging, Stevenson leans toward cans. Flatpacks, he feels, still have sealing problems since the glass frit used as a lead sealant is apt to crack. However, the push to miniaturize systems, Stevenson says, has led to Litton's using more flatpacks than cans.

Satisfied customers

James Egan, who heads the electron devices section at TRW Inc.'s systems group, is sold on IC's reliability. "We've only seen a couple of dozen IC failures since we've

World's handiest Gas Laser

Our president insisted on having his hand in on this one. So we let him. We have seen smaller hands, but we have not yet seen a more compact He-Ne gas laser by far. At one half milliwatt rated power output of red, coherent light (typical power output exceeds three quarters of one milliwatt) our LAS-2000 is the hottest thing on the laser market. With more than 1.5 milliwatts per pound of capsule, it delivers Ferrari performance at VW mileage. Here is a laser which actually permits you to set up your tripod, even in a crosswind. Also, it will not crowd or outweigh the rest of your system. If you are looking for an eligible laser, send us your marriage broker.

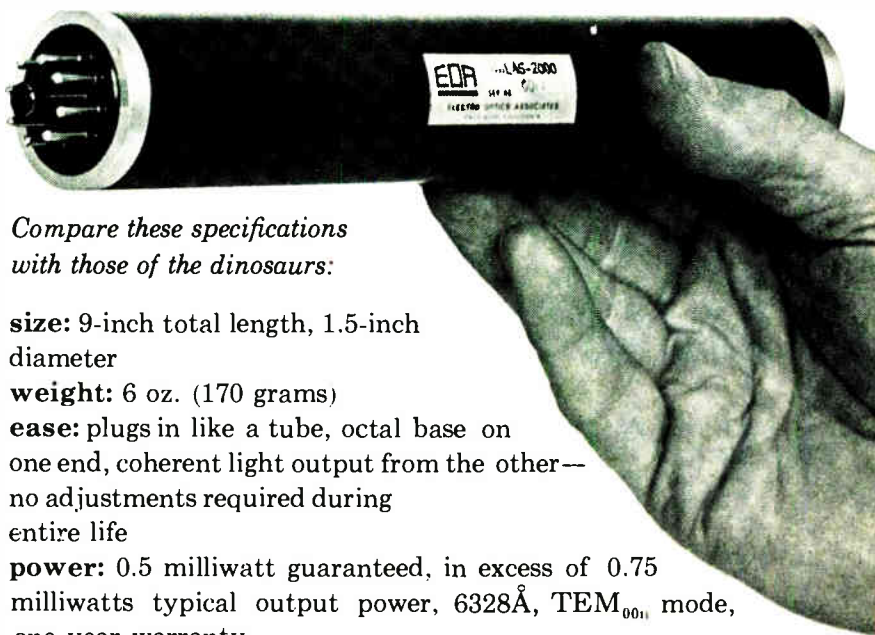

Compare these specifications with those of the dinosaurs:

size: 9-inch total length, 1.5-inch diameter

weight: 6 oz. (170 grams)

ease: plugs in like a tube, octal base on one end, coherent light output from the other—no adjustments required during entire life

power: 0.5 milliwatt guaranteed, in excess of 0.75 milliwatts typical output power, 6328Å, TEM₀₀₁ mode, one year warranty

design: integral mirror, double wall tube coaxial, all optical surfaces sealed within the vacuum envelope

performance: collimated output beam spreads 1.5 milliradians full angle, diffraction limited spread with external optics

price: \$275 f.o.b. Palo Alto, California

Ask Electro Optics Associates, where the Second Generation of Lasers is available now.

Electro Optics Associates

974 Commercial Street Palo Alto, California 94303 (415) 327-6200

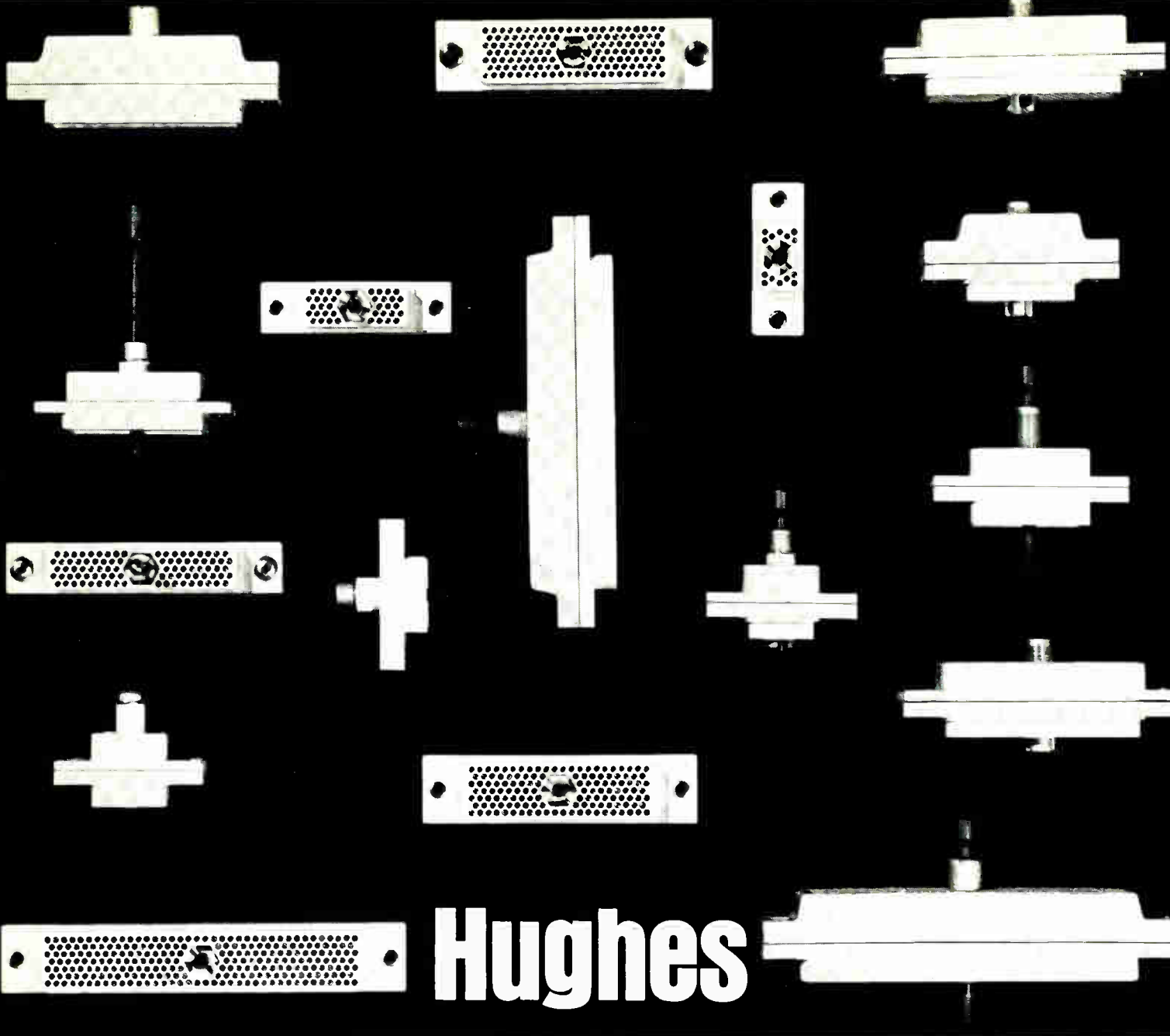

Hughes

lets you scale subminiature connectors to fit your crowded corners

Hughes subminiature rectangular connectors provide you with the greatest space and weight savings available — plus 110 contacts per square inch for the highest density in the industry. *And* without sacrificing contact size or contact spacing. ■ You can specify Hughes subminiatures in contact arrangements to fit any requirement, from 14 to 244 size 22 contacts, and lots of special arrangements in between. All configurations are available in non-environmental, environmental, and potting versions—and all versions use the proven Hughes center

jackscrew PolarHex polarizing and coupling mechanism, glass filled diallyl phthalate connector bodies, crimp snap-in contacts, and the best retention system available. ■ For your convenience, the above photo is shot to scale; perhaps you can measure one of our connectors to fit in *your* crowded corner right now. If not, we'll send you particulars on one that will if you contact your Hughes sales representative or write: Hughes



HUGHES
HUGHES AIRCRAFT COMPANY
 HUGHES CONNECTING DEVICES

Aircraft Company, Connecting Devices, 500 Superior Ave., Newport Beach, Calif. 92663. Phone (714) 548-0671, TWX 714-642-1353.

HUGHES CIRCUIT TECHNOLOGIES: Connecting Devices ■ Contour Cable™ ■ Semiconductors ■ Flip Chips/Equipment ■ Frequency Control Devices ■ Microelectronic Circuits ■ MOSFETs

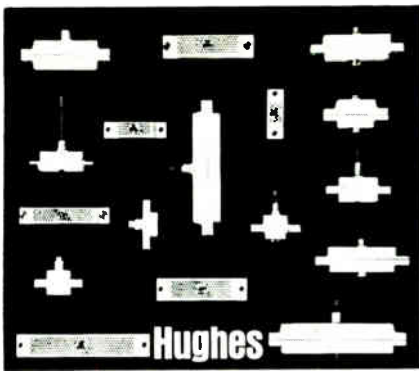

Sales Representatives

CALIFORNIA (Northern) Also Nevada

Deere Electronics, Inc.
Suite D, 20440 Town Center Lane
Cupertino, California 95014 • 408 257-3040

CALIFORNIA (Southern) Also Arizona
W. E. S. T., Inc.

3825 Birch Street
Newport Beach, California 92660 • 714 540-9040

COLORADO Also Montana, Wyoming,
Utah and Southern Idaho

Williams Associates
4971 Jackson Street
Denver, Colorado 80216 • 303 388-4391

CONNECTICUT Also New Hampshire, Maine,
Vermont and Rhode Island

The William McCoy Company
896 Main Street
Branford, Connecticut 06406 • 203 488-2012

FLORIDA Also Alabama, North Carolina,
South Carolina, Georgia, Tennessee

Spectec Engineering Representatives
Division of W. A. Brown & Associates, Inc.
222 Weber Avenue
Orlando, Florida 32803 • 305 425-5505

ILLINOIS (Northern) Also Eastern Wisconsin,
Northern Indiana and Eastern Iowa

Technical Devices, Inc.
6416 North Central Avenue
Chicago, Illinois 60646 • 312 774-8252

MARYLAND Also Virginia, West Virginia, Delaware,
District of Columbia

Kraft Electronic Sales, Inc.
510 Woodbine Avenue
Towson, Maryland 21202 • 301 828-5838

MASSACHUSETTS

The William McCoy Co.
55 Prospect Street
Holliston, Massachusetts 01746 • 617 429-2369

MINNESOTA Also North Dakota, South Dakota,
Western Wisconsin

Fred B. Hill Company
6110 Excelsior Boulevard
Minneapolis, Minnesota 55416 • 612 929-6727

MISSOURI Also Kansas, Nebraska, Western Kentucky,
Western Tennessee, Southern Illinois and
Western Iowa

Ridgewood Sales Company
8754 Big Bend Boulevard
St. Louis, Missouri 63119 • 314 966-6878

NEW JERSEY (Southern) Also Eastern Pennsylvania

Thomas M. Mills Company
13 B Tanner Street
Haddonfield, New Jersey • 609 429-1005

NEW MEXICO

Williams Associates
3221 Silver Avenue, S.E.
Albuquerque, New Mexico • 910 989-0622

NEW YORK (Except Metropolitan area)

Robert Horne Associates
P.O. Box 31
Pompton Lakes, New Jersey 07442 • 201 835-7400

NEW YORK (Except Metropolitan area)

C. W. Floring & H. R. Murray, Inc.
6585 Kinne Road
Syracuse, New York 13214 • 315 446-5555

OHIO Also Michigan, Southern Indiana,
Eastern Kentucky, Eastern Tennessee

Luebbe Sales Company, Inc.
2649 Erie Avenue
Cincinnati, Ohio 45208 • 513 871-4211

PENNSYLVANIA (Western)

Anderson Connector Corporation
P.O. Box 237
Wexford, Pennsylvania 15090 • 412 776-3211

TEXAS Also Oklahoma, Arkansas, Louisiana, Mississippi

Space Electronics Corporation
Suite 409, Irving Bank Towers
Irving, Texas 75060 • 214 631-0905

HUGHES

HUGHES AIRCRAFT COMPANY
HUGHES CONNECTING DEVICES

... IC users are getting smarter about running incoming tests ...

been buying," he says, "and most of them were due to our overstressing devices." A good part of the company's success is probably attributable to the rigorous testing necessarily involved in building space hardware. "A spacecraft is a lot like a Stradivarius; it's checked constantly during fabrication. It may be a couple of years from the time parts are purchased until the bird flies, and we test all the way," says Egan.

"Manufacturers' reliability claims of a couple of years ago are just now being realized in large-lot quantities," says Hughes' Wong. "Until recently, failure rates they cited were far too selective."

Amen corner. IC makers are not unmindful of residual reliability hang-ups, and are working toward, hopefully, universal solutions. Raytheon's Wiesner picks silicon-nitride passivation as the key to greater IC reliability. With this technique, there is deposition over the whole chip, after which windows are cut over the pads for bonding. The advantage, says Wiesner, is that moisture, which corrodes the aluminum interconnections, is effectively kept out of assemblies.

On the beam. Wiesner also thinks beam leads will go a long way toward alleviating IC reliability problems. "You get away from bonding failures and workmanship problems," he says. Motorola's Flood also believes that beam-lead devices are inherently more reliable than metal oxide semiconductor and bipolar IC's. However, Lockheed's Cox feels that beam-lead techniques and flip-chip bonding are still prone to failure. His company has found, he says, that flip-chip transistors have a distressing tendency to fall off their bumps.

Philip Eisenberg, a group scientist at the North American Rockwell Corp.'s Autonetics division, credits the physics-of-failure program with spotlighting potential materials problems. "Until recently, the semiconductor industry didn't have the people to assess such matters as materials incompatibility," he says. "But now chemists and others are coming to the fore to do

stress analysis and study thermal expansion and contraction rates."

Human factors. But static continues to crop up in the dialogue between IC users and makers. "Our biggest problem is correlation of our measurements on incoming inspection with those the vendors make before shipment," says a Honeywell executive. "This problem may never be satisfactorily solved, since every time you change an employee or piece of test gear, difficulties reappear."

Honeywell runs high-temperature checks on incoming IC's, and vibrates devices so loose leads or bonding can be spotted. In addition, the company tests hermeticity. To give its own engineers and vendors a basis of test comparison, Honeywell swaps calibrated IC's with suppliers.

Caveat. Sylvania's Barnes concedes that there are still considerable difficulties involved in correlating users' and makers' test data. "And incoming checks can prove a problem," he says. "Un sophisticated men or poor equipment can make a lot look much worse than it really is. A poorly regulated power supply, for example, can blow a whole rack of IC's under test. But users are getting savvier about such things and the problem is being solved." Barnes also notes that users must test IC's only within specified limits or risk failures and be careful how they handle devices.

Barnes feels that post-application studies are still a difficult proposition for semiconductor makers. "Users tell us about failures on incoming checks, but once the IC's are installed, we rarely hear anything," he says. "Even Sylvania's Systems division, which used some of our circuits in a data processing system, has yet to follow through on our request for data, though they were happy with performance."

Contributions to this report were made by Walter Barney, Peter Vogel, and Bill Arnold in San Francisco; Lawrence Curran and Bill Bell in Los Angeles; Marvin Reid in Dallas; James Brinton in Boston; and Mark Leeds and Howard Wolff in New York. It was compiled by Eric Aiken.

Easy-to-stabilize IC op amp costs no more than the wild ones

Ours is really easy to stabilize. So easy, in fact, it takes one-third or less external components and it doesn't require power supply by-passes. It's designed to function in a broad range of circuits without trimming, selection or individual adjustment. It won't oscillate over its full temperature range and has fully protected input and output. And the parameters are guaranteed. You can have these IC's two ways: T-52 is low-profiled with 8 leads in the TO-5 can and the S-52 is dual-in-line. \$7.50 will bring you a sample by return mail. Then you decide. Just write: Philbrick/Nexus Research, 22 Allied Drive at Route 128, Dedham, Massachusetts 02026.

Philbrick/Nexus welcomes technical employment inquiries



PHILBRICK/NEXUS RESEARCH

A TELEDYNE COMPANY

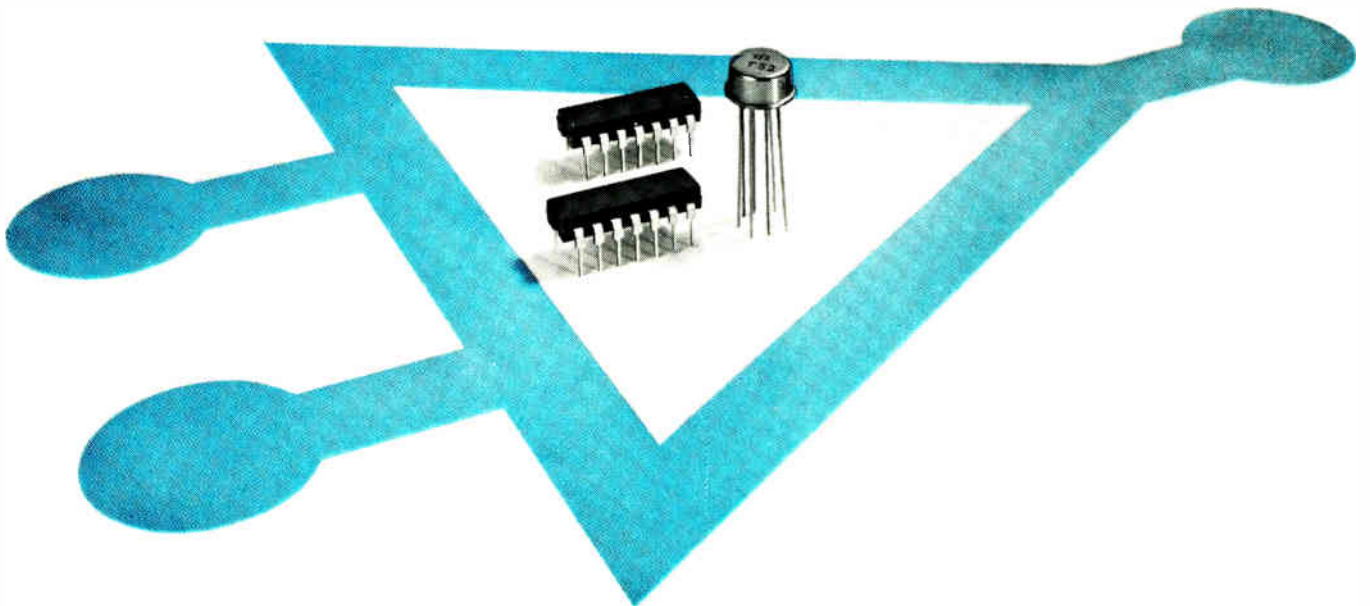

French firm enters U.S. market for nuclear instrumentation

When overseas licensing pacts expired, Intertechnique, a small company, built a plant in New Jersey to sell to universities and hospitals on its own

By Peter Kilborn

Paris news bureau

and Peter J. Schuyten

Assistant editor

There's nothing particularly unusual about an American electronics company establishing a manufacturing subsidiary in France. But when a French firm sets up shop on U.S. soil, that's news.

Recently, Intertechnique S.A., a producer of nuclear instruments, took just such a giant step, opening a plant in Dover, N. J.

Intertechnique is growing fast but is still small; 1967 revenues were only \$21 million. And the record of even large French companies that have tried to reverse the transatlantic traffic in technology is uninspiring at best. For example, CSF—Compagnie Générale de Télégraphie sans Fil—with annual sales of more than \$300 million, last year dealt off its only U.S. installation, Warnecke Electron Tubes Inc., because of profit problems.

Going it alone

But Robert Cohen, sales and marketing manager at Intertechnique Instruments Inc., the U.S. subsidiary, says there was really no other way to go. He estimates that American outlets for nuclear instrumentation represent two-thirds of the world market. But the parent company was getting only a taste of this pie, having licensed Packard Instruments, a subsidiary of the Ambac Corp. (formerly the American Bosch Arma Corp.) to sell its multichannel analyzers in the U.S. When the agreement lapsed last year, Intertechnique decided to

strike out on its own, building equipment instead of collecting royalties. "It was a question of eat or be eaten," says Cohen.

What may well sustain Intertechnique in its U.S. adventure is the momentum of continuing growth. Volume has risen steadily from a \$5 million base in 1960. And Jacques Maillet, president of the parent company, foresees annual sales gains of 15% for the next five to 10 years.

Intertechnique's new subsidiary is the company's first branch plant anywhere, although it owns sales

units in Britain, West Germany, and Sweden. The new facility, which is already making some deliveries, is concentrating on two product lines—multichannel analyzers and liquid scintillation spectrometers, a new field for the company. Both lines are aimed at the hospital and university markets.

Number one. Last year Intertechnique sold \$6.5 million worth of analyzers, making it the world's largest supplier. The scintillation spectrometers, being produced in France, will soon start coming off the assembly line in Dover. Cohen

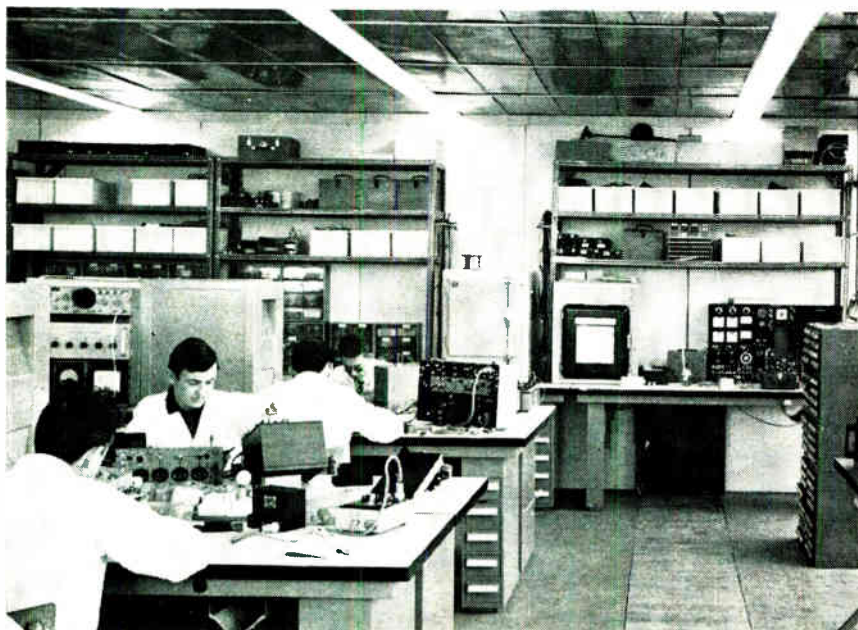

Old world. Multichannel analyzers, produced at Intertechnique's plant near Paris, are put through a series of rigorous checks before delivery.

The Secret of the Seal is in our Head.



All APM SEELSKREWS®, SEELBOLTS® and SEELRIVITS® share the same secret. We've invented (and patented) a specially shaped groove which we coin into the undersurface of the heads of our fasteners. Into this groove we fit our O-ring.

The volumetric relationship (between the O-ring and the groove) is held to an overall tolerance of .0003³ inches. The specially shaped groove allows the O-ring to rotate freely (without binding) until the head of the screw makes full setting contact.

This gives us positive sealing (up to 15,000 PSI) and reusability (10 complete insertions and removals).

All this we guarantee!

SEELSKREWS



SEELBOLTS

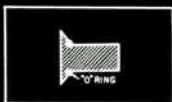

SEELRIVITS

For samples and data get in touch with



APM

HEXSEAL CORPORATION

41 Honeck Street, Englewood, N. J. 07631

... the Dover plant has already begun selling scintillation spectrometers ...

believes they will sell as well as the analyzers. Intertechnique's spectrometers have a competitive edge over those offered by other companies because they are the first to incorporate a preprogrammed digital computer, which can also be set up for a variety of tasks. Cohen estimates the liquid scintillation market at \$20 million—about equal to that for multichannel analyzers.

Maillet says he went to the U.S. partly because the European market alone wasn't big enough to write off the \$650,000 it took to develop the spectrometers. "We had to build in the U. S. to amortize our research and development," he says.

Falling out. Another factor that helped determine Intertechnique's course of action, says Maillet, was the end of the deal with Packard. While the accord was still in effect, Maillet asked for a license on Packard's liquid scintillation counter technology. Packard turned him down, and when the analyzer agreement came up for renewal at the end of 1967, Maillet decided to let it die.

In the meantime, Maillet summoned a team of U.S. engineers, headed by Edward Rapkin, to his plant at Plaisir, west of Paris, to develop spectrometers. "We reversed the brain drain," says Cohen. Once they had assembled a prototype and worked out a production line, Rapkin returned to America to set up the Dover sub-

siary; he is now president.

Big ideas. Rapkin, a former Packard executive, agrees with Maillet's reasons for coming to the U.S., but adds: "We want to keep our eye on U.S. research and development. Most of the big ideas come from here."

The Dover plant has already starting selling the liquid scintillation spectrometers it's going to make. Among its customers are the Union Carbide Corp.'s research center in Sterling Forest, N.Y., the University of Pennsylvania's medical school, the Institute for Cancer Research in Philadelphia, and Columbia University's College of Physicians and Surgeons.

Checkup

The spectrometer, designated the ABAC—for absolute beta activity computer—model SL-40, is used to measure tracer products labeled with tritium or Carbon 14 in blood or urine specimens.

Rapkin explains that the vials contain blood, for example, along with the substance the biologist wants to trace—organic chemicals labeled with radioactive isotopes and a solvent. When the atoms in the sample decay, the energy is transferred through the solvent to the scintillator, which gives off light. The light lasts only 3 to 5 nanoseconds. The amount of light is proportional to the energy of the individual radioactive decay event. There is one burst of light per



New world. Intertechnique, a French manufacturer of nuclear instruments, recently opened its first overseas plant, this installation in New Jersey.

decay event, so the number of decay events is determined by counting bursts. Then the radioisotope can be identified by measuring the amplitude of the decay event.

Rapkin says that one of the attractions of the system is its ability to process data to the individual researcher's requirements. Such calculations are now done on a desktop calculator or a time-shared computer—both of which are slower and more unwieldy than an on-line processor. The Intertechnique system uses a modified Elbit 100 computer, built by Elbit Computers Ltd. of Haifa, Israel.

Self-help. Cohen says an on-line computer is especially useful in making fast corrections. "When you have a count, there are lots of corrections to make, especially for color quenching [when color from the sample absorbs some of the light and attenuates the output pulse from the photomultiplier] and thermal quenching [when energy is turned to heat instead of light]." Color quenching in blood, for example, prevents some of the light photons from reaching the photomultipliers, thus limiting detection. So Intertechnique puts efficiency curves into the computer. The computer then delivers accurate results in terms of true sample activity expressed as disintegrations per minute (DPM).

An eight-digit decade display in the instrument shows sample identification number, time, counts, computed counts per minute (CPM), or DPM. Also incorporated is an analog display, a four-decade log-rate meter with a CPM capacity of 1 million. The company also includes in the system a computer-compatible data recording and input-output device, the Teletype model 33-TY with tape punch, tape reader, and form-out.

Good odds. The company says the ABAC has a tritium counting efficiency of 55% with unquenched standards and a Carbon 14 counting efficiency of 95%. Cohen estimates that 95% of the instrument's circuitry is integrated. It uses IC's in both the digital and analog sections.

The Elbit computer has a ferrite-core, 1024-word, 12-bit memory, which can be expanded to a 2048-word, 12-bit memory. Mem-

GCC makes every type of Teflon coated wire you need today. And some you may need tomorrow.

Everyone agrees Teflon[®] insulated wire is more than a match for outer space. But, can you depend on getting it to your plant on time to meet your production schedule?

GCC is ready to meet your needs, wherever your plant happens to be. 51 GCC distributing centers and a nationwide network of manufacturing facilities are ready, willing and able to back up every order. GCC's delivery

policy goes one step further; tell us your needs and we'll be sure to stock your most popular items, so you'll always have a readily available source close by.

For specific data on the scope of our Teflon insulated product capabilities, drop us a line.

General Cable Corporation,
730 Third Avenue,
New York, New York 10017.

GCC

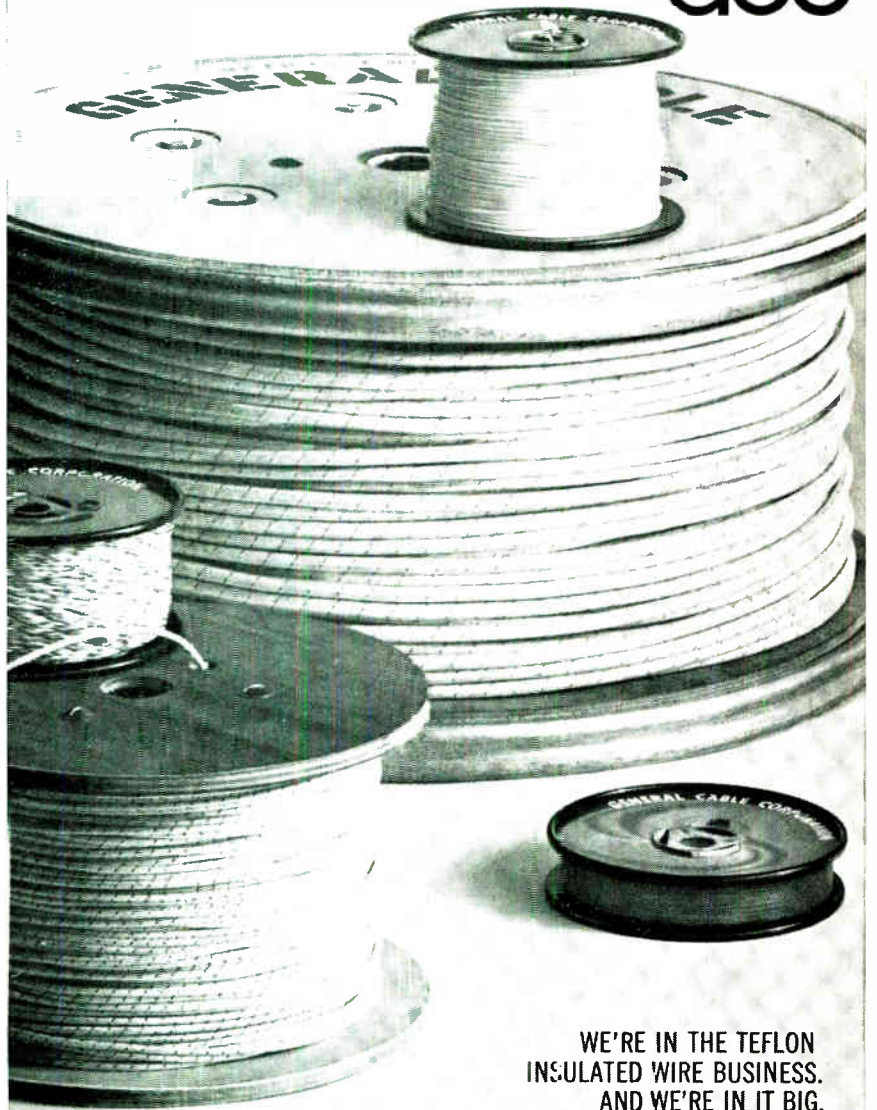

Teflon[®] is a DuPont trademark

WE'RE IN THE TEFLON
INSULATED WIRE BUSINESS.
AND WE'RE IN IT BIG.



HOW SYNCHRON® MOTORS control a better kind of CALF FEEDER

The SYNCHRON Motor on this automatic calf feeder controls the mixing, timing and dispensing of the feed, performing all three functions with complete programmed accuracy. SYNCHRON Motors perform thousands of equally precise timing and control functions in thousands of applications. There may already be one ideally suited to your design, ready to use with only minor alterations or no change at all. For brochure and all the facts phone or write Hansen, or your SYNCHRON representative.

SYNCHRON timing and control motors; 168 different speeds. Right, left or reversible rotations. 8, 20 or 30 oz.-in. torques; 220, 110 or 24 volts; 60, 50 or 25 cycles.

HANSEN

Manufacturing Co., Inc., Princeton, Ind. 47570

HANSEN REPRESENTATIVES: CAREY & ASSOCIATES, Houston and Dallas, Texas; R. S. HOPKINS CO., Sherman Oaks, Calif.; MELCHIOR ASSOCIATES, INC., San Carlos, Calif.; THE FROMM CO., Elmwood Park, Ill.; JOHN ORR ASSOCIATES, Grand Rapids, Mich.; H. C. JOHNSON AGENCY, INC., Rochester, N.Y.; WINSLOW ELECTRIC CO., Essex, Conn., Narberth, Pa., and New York, N.Y.

EXPORT DEPARTMENT: 64-14 Woodside Ave., Woodside, N.Y.

... Intertechnique has received a mixed welcome from U.S. nuclear firms ...

ory cycle time is 2 microseconds. It has a read-only store of 256 wired microinstruction words, a single address format of 12 bits, and an add time of 6 μ sec.

The spectrometer system, which costs about \$20,000, offers three independent preadjusted channels for external standardization. It can analyze 200 vials in one loading. And it operates in three modes—manual, automatic, and group counting.

Foreign relations

In assessing his chances in the U.S. marketplace, Maillet says the Atomic Energy Commission and other Government agencies welcomed his decision to manufacture in the U.S. and assured him that Intertechnique Instruments would be on equal footing with American nuclear instrument makers in non-military markets. It aids the dollar, he says. "The instruments we'll be making in Dover will be in every sense of the word U.S.-made." If Intertechnique had not decided to manufacture in the U.S., he says, its American clients would have had to import its products, and that would drain the dollar.

Xenophobe. However, Intertechnique's reception by the Association of Nuclear Instrument Manufacturers hasn't been particularly cordial. Lyle Packard, a director of ANIM, told an informal gathering of the AEC in January that overseas companies, especially French ones, had an unfair competitive advantage over American companies because foreign governments subsidize their R&D. Thanks to government aid, Packard asserted, a French company—presumably Intertechnique—had become strong enough to manufacture in the U.S.

Not so, counters Maillet. For the past nine years the Commissariat à l'Énergie Atomique (CEA), the French equivalent of the AEC, has supported Intertechnique's analyzer development with contracts totaling \$400,000. But that's no subsidy, says Maillet. He says Intertechnique pays the CEA a 3% royalty on all analyzers developed

under CEA contracts that are sold to clients other than the CEA. The company's royalty payments over the years have come to \$600,000. Further, adds Cohen, all scintillation counter development costs were paid by the company. "We didn't get a penny from the CEA or any other government agency."

Maillet doubts that displeasure with Intertechnique's plant in the U.S. will lead to a reaction severe enough to retard his sales. American industry, he notes, especially in the electronics sector, has built freely in France in recent years. French interests have complained but the government hasn't interfered. "Though it's highly improbable, U.S. Government action against us would almost certainly produce a reaction in official French circles," he says. "U.S. companies won't be able to continue to establish themselves in Europe if Continental companies can't do the same thing in the U.S."

Speaking for ANIM, William E. Barbour Jr., executive manager of the trade organization, says: "As far as we're concerned, Intertechnique Instruments in Dover is an American company, despite the fact that most of its stock is French held. And although it hasn't applied for membership yet, it is certainly



Debut. The need to amortize R&D costs on this scintillation spectrometer underlies Intertechnique's decision to manufacture systems in the U.S.

eligible if it decides to do so.”

Rapkin says: “As it stands, I’ve written to some of the officers of the association concerning Packard’s statements, and have received some private apologies, but no public retraction. I think it’s conceivable we’ll apply for membership in the ANIM, but not for a while yet.”

Although Barbour disagrees, Rapkin feels that the nuclear instrumentation business is in a mess right now. A number of firms have had to run for cover, including Packard Instruments; other examples include Tracerlab, which sought shelter with the Laboratory for Electronics Inc., and the Technical Measurement Corp., which went into bankruptcy. Rapkin feels that customer demands plus manufacturers’ willingness to sell products at almost any cost have created this situation. He says: “Our business is geared toward profit. We’re not going to give discounts, sell demonstration models, or offer phony trade-in payments. We’re also not going to announce products we can’t deliver. The only time we might have to accede to customer demands is when we’re asked for special modifications. Then we may have to make concessions at prices that just won’t cover engineering costs.”

One U. S. policy, however, does irk both Rapkin and Maillet. America prescribes purchases of French military hardware—even that made in the U.S.—unless, of course, it can’t be obtained from domestic sources. On the other hand, while the French government rarely imports military electronics equipment from any where, it buys freely from U.S. firms producing on French soil.

Old-world charm

Intertechnique is young by French standards. Maillet and Marcel Dassault, a French aircraft and publishing entrepreneur founded the company in 1951. Dassault dropped out in 1960, leaving control with Maillet and a few close associates. The next largest stockholder, with 20%, is the Banque de Rivaud.

Originally, the company made only aircraft components—oxygen regulators for high, fast flights, fuel-gauging systems, temperature

The Non-Competitive Plug-in

\$450*

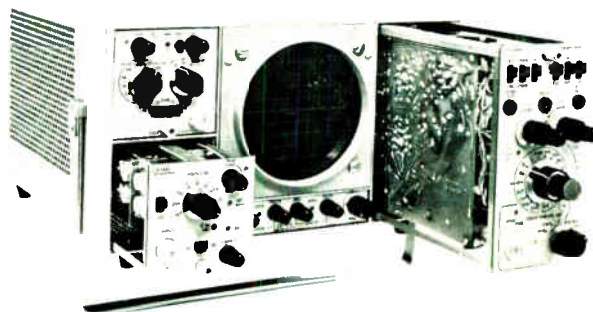

*for main frame

This is Data Instruments CD1400. And the purpose of this ad is to clear up a misunderstanding. The CD1400 is not intended to compete with that other 15MHz, 8 x 10cm display, plug-in scope. Perhaps, it is natural to assume this since the bulk of their applications are identical. But we must insist that they are different breeds altogether.

In the first place, the CD1400 is far better looking. And this, we think is important since it indicates that the CD1400 design is pointed to the future. Secondly, the CD1400 has a true dual beam, PDA tube with individual focus and brilliance controls for each gun. The other has the disadvantages of a chopper. Thirdly, that other scope accepts only Y axis plug-ins; the time base is fixed. The CD1400 accepts plug-ins on both axes allowing flexibility in triggering, sweep control and X amplifiers. To be fair, though, that other scope does have an endless array of amplifiers and what nots, some of which the CD1400 will never have. This undoubtedly gives it greater prestige, although it doesn’t seem sensible to us to produce a plug-in when one can build the entire scope for the same price.

At any rate, here are the current CD1400 plug-ins. Others are coming:

	VERTICAL AMPLIFIERS				TIME BASES		
	CX1441	CX1442	CX1449		CX1443	CX1444	CX1448
<i>Bandwidth</i>	DC-15MHz (-3db)	DC-75KHz (-3db)	DC-10MHz (-3db)	<i>Sweep/cm</i>	.5μs-200ms 18 pos	.5μs-200ms 18 pos	.5μs-1sec 20 pos
<i>Sensitivity</i>	100mv/cm 10mv/cm (10X)	1mv/cm 100μv/cm (10X)	10mv/cm	<i>Trigger</i>	Int, Ext, Norm, Auto, +, -, HF sync	Int, Ext, Norm, +, -, HF sync	Int, Ext, Norm, Auto, Single Shot
<i>Type</i>	Wide Band Single Channel	High Gain Differential	Wide Band Differential	<i>Features</i>	General Purpose	3 sweep delays 0-100ms variable	Single Shot DC trigger
<i>Price</i>	\$91	\$155	\$246	<i>Price</i>	\$142	\$300	\$265

Of course, Price is the real difference. The CD1400—complete with plug-ins for 15MHz single and double beam operation and also for use as a 1° matched X-Y instrument—costs 30% less than the main frame of that other scope.

But don’t take our word for it. Call us for a demonstration and see for yourself. At \$450 you’ll find there is no competition at all.

Data Instruments Division • 7300 Crescent Blvd. • Pennsauken, N.J. 08110

NO. 2, 3, & 4 WILL CONCEDE*

We're No. 1 in RF Voltmeters

So, you better believe it. We've sold more sensitive RF Voltmeters than anyone else because we've been doing a lot of things right. We've given you 2% accuracy. We've given you the highest input impedance to make that accuracy meaningful. We've given you the highest ac and dc overload protection (probe diodes last longer that way). We've given you the fast response you need for peaking and nulling (sluggish sampling voltmeters can't make the grade). We've given you a well-mannered probe which works without any "back-talk" pulses pumped into your circuit (again, sampling voltmeters flunk out)! We've given you a clean, trouble-free design with a choice of features in three models ranging from \$550 to \$700. Why not send for all the specs and see for yourself why our competitors always end up Nos. 2, 3, & 4.

* Alphabetically speaking (and when pressed) Ballantine, Hewlett-Packard, Millivac.

**BOONTON
ELECTRONICS** ||||
CORPORATION

ROUTE 287
PARSIPPANY, N.J. 07054
Telephone: 201-887-5110
TWX: 710-986-8241



Optimist. Jacques Maillet, president of Intertechnique, expects his U.S. subsidiary to be a marketing success.

regulators, fuel-flow meters, and fuel-booster pumps.

But while aeronautic equipment still accounts for 41% of Intertechnique's sales, nuclear instrumentation has 52%. The rest is in pulse-code-modulated satellite and missile telemetry systems, licensed from Radiation Inc. of Melbourne, Fla.

Cosmopolitan. A big part of the company's aeronautic and space business comes from major international programs. For example, Intertechnique supplied pcm telemetry for the first (unsuccessful) satellite of the European Space Research organization and for France's intermediate-range sea-to-ground nuclear missiles. Maillet's next target is an Intelsat spacecraft contract.

Intertechnique is also delivering gauges and regulators for Dassault's Mirage jet fighters and for the Anglo-French Concorde supersonic transport. Maillet predicts that if the Concorde lives up to expectations, it will account for 6% to 7% of the company's sales in 1970. To round out his civil-aviation business, Maillet hopes to get contracts for the proposed European airbus. Rapkin points out that Intertechnique went after but didn't get a subcontract from Boeing on the 747 transport. Despite this disappointment, the company will continue to seek contracts from U.S. airframe manufacturers; such awards would add a new dimension to the Dover plant's production plans.



Why buy price at any cost

To pay too little is to obviously speculate. To spend too much is to be foolishly extravagant. The real value of any purchase is determined in performance, not price. Resistors are like this also.

For years, Stackpole fixed composition resistors have been the standard of value for many leading manufacturers of electrical and electronic equipment. Engineers have become familiar with the testing and evaluation that go into each Stackpole resistor order. Purchasing people know they can expect prompt delivery. And management is assured of complete, in-depth service backed by sixty years of experience.

It's for reasons like these that Stackpole resistors are selected to maintain top performance on so many established products and on a growing number of brand new ones. Such confidence and loyalty cannot be based on price alone, but instead come from the kind of dependability that builds a reputation for your product.

Uniformity is a known characteristic of Stackpole resistors. Unique production methods coupled with thorough testing assure you absolute performance. You can rest assured that the Stackpole resistors you order today will be identical in every way, order after order.

Are you getting what you pay for in a resistor? Why not investigate the value Stackpole resistors can give you. Quality, economically priced and backed by the recognized name . . . Stackpole. There are four sizes to choose from: 2, 1, ½ and ¼ watts.

For samples or a copy of our new booklet, "How to spot a quality resistor", write: Stackpole Carbon Company, Electronic Components Division, Kane, Pa. 16735. Phone: 814-837-7000 — TWX: 510-695-8404.



STACKPOLE

ELECTRONIC COMPONENTS DIVISION



WITH POLAROID CIRCULAR POLARIZERS

Look what happened to the readability when we took the filter away from the top half of our readout.

A 25% transmission neutral density filter would improve the readability by about 4 times.

But the Polaroid Circular Polarizer at the bottom of our readout improves unfiltered readability by about 110 times. Because it polarizes the light that others only filter.

If you're designing a display, and you'd like a sample for testing, write Polaroid Corp., Polarizer Sales, Dept. 76, Cambridge, Mass. 02139.

Then you can prove that no matter how bright room lighting conditions may be, your readout will stand out.

And, after all, isn't that the whole idea?

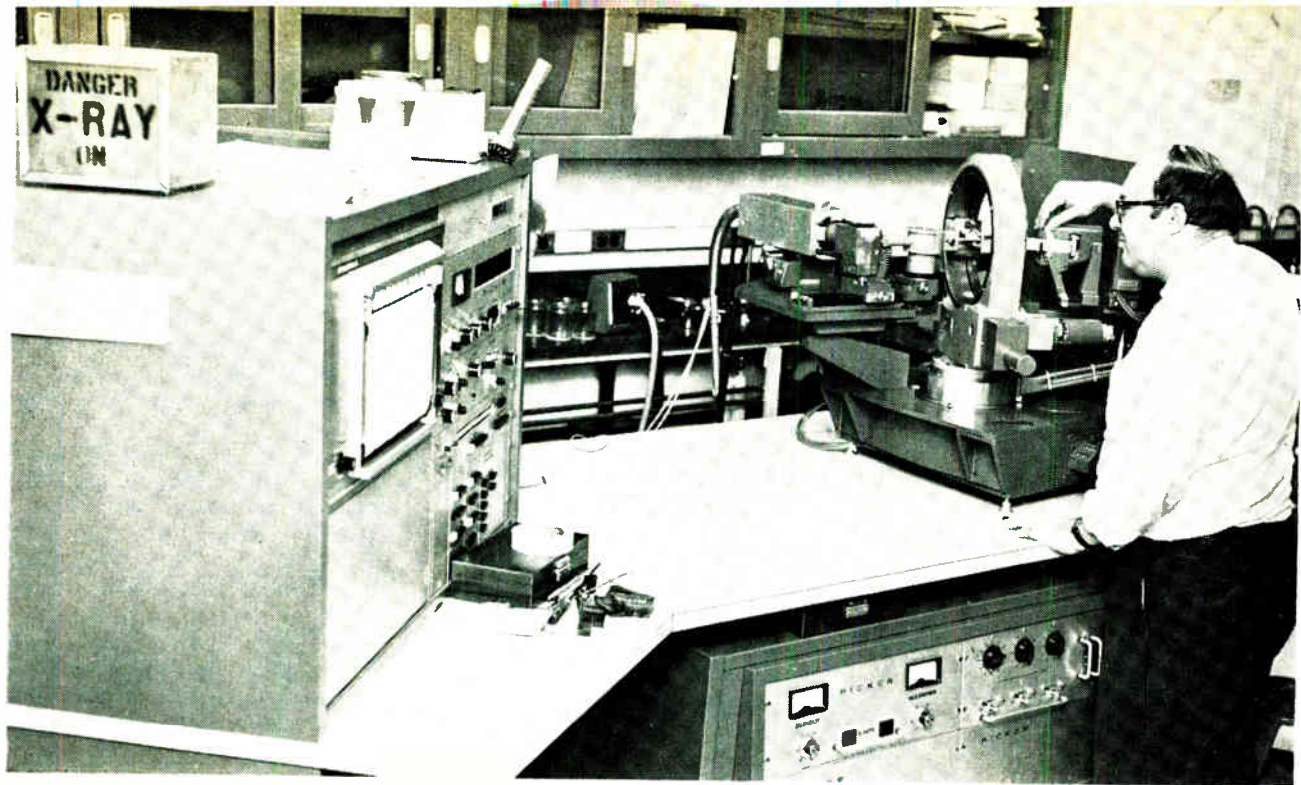

Advanced technology

X rays can find wafer imperfections

Diffraction topographs may help identify faulty wafers before they go through the manufacturing process

There's a strong feeling in the semiconductor industry that present manufacturing techniques, in which faulty devices aren't spotted and discarded until the end of a costly fabrication process, leave something to be desired. X-ray diffraction topography could be that something.

The technique can be described roughly as the use of X rays to detect imperfections in crystals. It's a descendant of the method used for many years to determine the atomic pattern of the basic units of crystals. Irregularities in the way these structural units are stacked to make up the whole crystal—known as crystal-lattice imperfections—can be detected by X-ray topography. The big advantage of the technique is that it's nondestructive.

The two schools

X-ray topography, says Eugene S. Meieran of Fairchild Semiconductor's R&D laboratories, is a diagnos-

tic tool. The idea, he notes, is to understand materials, to identify the reasons for failures, and especially to look for process-induced failures. Meieran is considered the prime practitioner of the West Coast approach to topography; Guenter H. Schwuttke of the International Business Machines Corp. is regarded as the high priest of the East Coast method.

The basic difference between the two approaches is the way the silicon wafer is examined by the camera used to photograph it. Meieran, who has three working cameras, keeps the wafer rigid in one plane as it moves past the X-ray beam. Schwuttke wiggles the wafer in what he calls scanning oscillation technique (SOT).

Schwuttke and IBM won't talk about the number of cameras in use—or even say if any are—but competitors' estimates range from 16 to 24.

Hold still. Aside from the basic

difference, the rigid technique, which uses the Lang camera made by the Jarrell-Ash Co., works the same way as SOT. A narrow beam of highly collimated X rays is diffracted by the crystal lattice onto a film emulsion. The angle at which the rays are deflected depends on the wavelength of the rays; it obeys this formula:

$$\lambda = 2d \sin \theta$$

where λ = the wavelength of the X rays;

d = the distance between the layers of atoms in the lattice; and

θ = the angle at which the rays bounce off the layers.

But life is never simple, and X rays aren't necessarily all at one wavelength. For example, the wavelength from molybdenum, a common source, is 0.707 angstroms—but also 0.711 angstroms. There will be, therefore, two angles of deflection and two images on the film. Typically, the difference between θ_1 and θ_2 will be four minutes of

**Evaluate these
new Babcock Relays
in your system.
You'll find them
"ON THE SHELF"
at these
distributors!**

AVNET ELECTRONICS CORPORATION
10916 Washington Boulevard
Culver City, California
Phone: 213 870-0111, 213 870-6141
TLX 674-354

344 Middlefield Road
Mountain View, California 940-11
Phone: 415 961-7700, TLX 348441

First National Bank Building, East
5301 Central Avenue N.E., Suite 1-000
Albuquerque, New Mexico 87108
Phone: 505 265-7926; TLX 74-6-59

2318 6th Avenue
Seattle, Washington 98121
Phone: (206) 623-8824, TLX 32-2-9

1729 North 28th Avenue
Phoenix, Arizona 85009
Phone: (602) 272-6921; TLX 66-750

1020 W. Ellsworth Avenue
Denver, Colorado 80223
Phone: (303) 623-6255, TLX 45-687

207 Cambridge Street
Burlington, Massachusetts 02103
Phone: (617) 272-3060

3901 Pace Court
Schiller Park, Illinois 60176
Phone: 312 678-6310 TWX 312-678-2522

70 State Street
Westbury, L.I., New York 11590
Phone: (516) 333-8650, TLX 12-5928

4940 Viking Drive, Suite 208
Minneapolis, Minnesota 55435
Phone: 612 920-5866, TWX 910-576-2784,
TLX 029-5250

87 Wingold Avenue
Toronto 19, Ontario, Canada
Phone: (416) 789-1838, TLX 02-29195

1505 Louvain Street West
Montreal 11, Quebec, Canada
Phone: 514 0381-9127, TLX 01-20678

P. O. Q. ELECTRONICS CORPORATION
9559 Irondale Avenue
Chatsworth, California 91311
Phone: 213 882-0500, TWX 910-594-1235

POWELL ELECTRONICS, INC.
S Island Road, P. O. Box 18765
Philadelphia, Pennsylvania 19101
Phone: 215 724-1900; TWX 710-670-0465

10728 Hanna Street
Beltsville, Maryland 20705
Phone: (301) 474-1030; TWX 710-828-9710

P. O. Box 488
Fayetteville, Tennessee 37334
Phone: (615) 433-5737; TWX 810-380-3890

2049 W. Central Boulevard
Orlando, Florida 32805
Phone: (305) 423-8586, TWX 810-850-0155

Foreign Representation:

SWEDISH ELEKTROLINK AB

Stora Nygatan 39
Stockholm C, Sweden

Phone 114595, Cable Teletink

A.E.M.G.P.

115 Avenue J B Clement

Boulogne s Seine, France

Phone 825-96-20, Telex 8-12-27985

BODAMER GmbH

8022 Grünwald Bei München

Kellensstr. 7a, West Germany

Phone: 71862

LAURENTIDE ELECTRONICS, LTD.

52 Morley Road

Basingstoke HANTS, England

Phone Basingstoke 5330

SHOSHIN SHOJI KAISHA, LTD.

P.O. Box 173

Nihonbashi, Tokyo, Japan

Phone 270-5921; TLX: 0222-3423, TOSHOSHIN Tok

**For price, delivery and application
data call Babcock Relays collect.
Be sure to ask for Ext. 1000 when
placing your call.**



arc; to get rid of one component, therefore, the X rays are first beamed down a long, narrow tube and through a slit so that the beam diverges at less than three minutes of arc.

The rays that bounce off the atoms in each layer of the silicon are beamed out through another slit to keep rays that aren't bounced from fogging the film. If there are flaws in the silicon crystal (and even in a perfect crystal there will be flaws introduced by the doping process), the deflections onto the film will be irregular and will form patterns.

If the crystal lattice itself is deformed, the X rays will go bouncing off in a way that the X-ray photographers will find most frustrating. The angle θ will then refer to the crystal lattice, not the surface of the silicon. Schwuttke wiggles the slice to pick up X rays from deformed lattices; the theory is that by moving the plane of the lattice, you will at some time put it at the right angle to deflect X rays onto the film. It's like wiggling a mirror back and forth to move the reflection to a desired spot. In this case, the mirror is warped, like a fun-house mirror, and the angle that is right for one section of the mirror is wrong for another. And since the X-ray beam covers only three minutes of arc, it is necessary to move the whole "mirror" past the stationary beam.

The essence. But Meieran says that wiggling the slice isn't necessary—because today's silicon crystals aren't irregular—and that wiggling is a waste of time. It already takes from one to five hours to make an X-ray topograph (because each part of the target must be covered

Seeing better

X rays have a big advantage over the electron microscope: they show the whole crystal and show all levels of it. Electron microscopy sees only a tiny area and goes only 1,000 or 2,000 angstroms into the crystal. But since silicon has a very low absorption constant for X rays, the beam goes right on through.

The X rays, which make 1-to-1 images on the film and must be optically magnified for analysis, show the strain field caused by the dislocations, rather than the atomic-level dislocations themselves.

Also, two X-ray pictures with slightly different crystal orientations can be put in a stereopticon for a 3-D effect.

with the narrow beam), and if the target has to be wiggled as well, so that in effect one is taking many pictures of the same target, this time is lengthened.

Further, Meieran says, wiggling the slice picks up the θ components, occasionally causing double images.

IBM's Schwuttke just smiles at any mention of the time element and pulls out two topographs of a silicon wafer. "Look at this one made using the Lang technique," he says. "It shows only a small area in the center of the wafer. But what if deformities occur along the outer periphery? This other photo, using SOT, gives a picture of the entire wafer. Time? SOT scans a two-inch crystal, one centimeter wide, and gives a high-resolution plate in one hour."

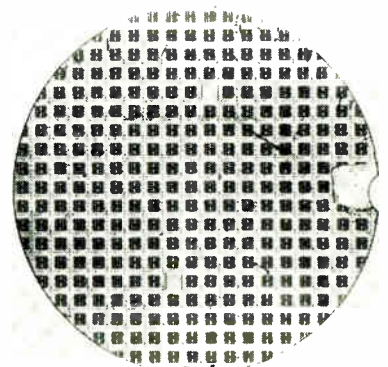
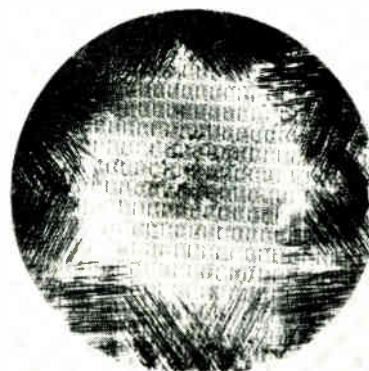

Rough and ready. The scanning oscillator topograph at left shows damage to a silicon wafer; the other is perfect.

**Four
New
Babcock
Relays**

BR42

- Welded Crystal Can
- 2 Amp.—DPDT
- Single-Coil
- Universal Contacts
- To MIL-R-5757

BR30

- One-Inch Cube
- 4 PDT—10 Amp.
- Single-Coil
- All-Welded
- To MIL-R-6106

BR24

- Welded, Low Profile
- 10 Amp.—DPDT
- Single Coil
- Universal Contacts
- To MIL-R-5757

BR26

- Welded Half-Size
- 2 Amp.—DPDT
- Single-Coil
- Universal Contacts
- To MIL-R-5757



BABCOCK RELAYS
Babcock Electronics Corp.
3501 Harbor Blvd.
Costa Mesa, Calif. 92626
Telephone: (714) 540-1234

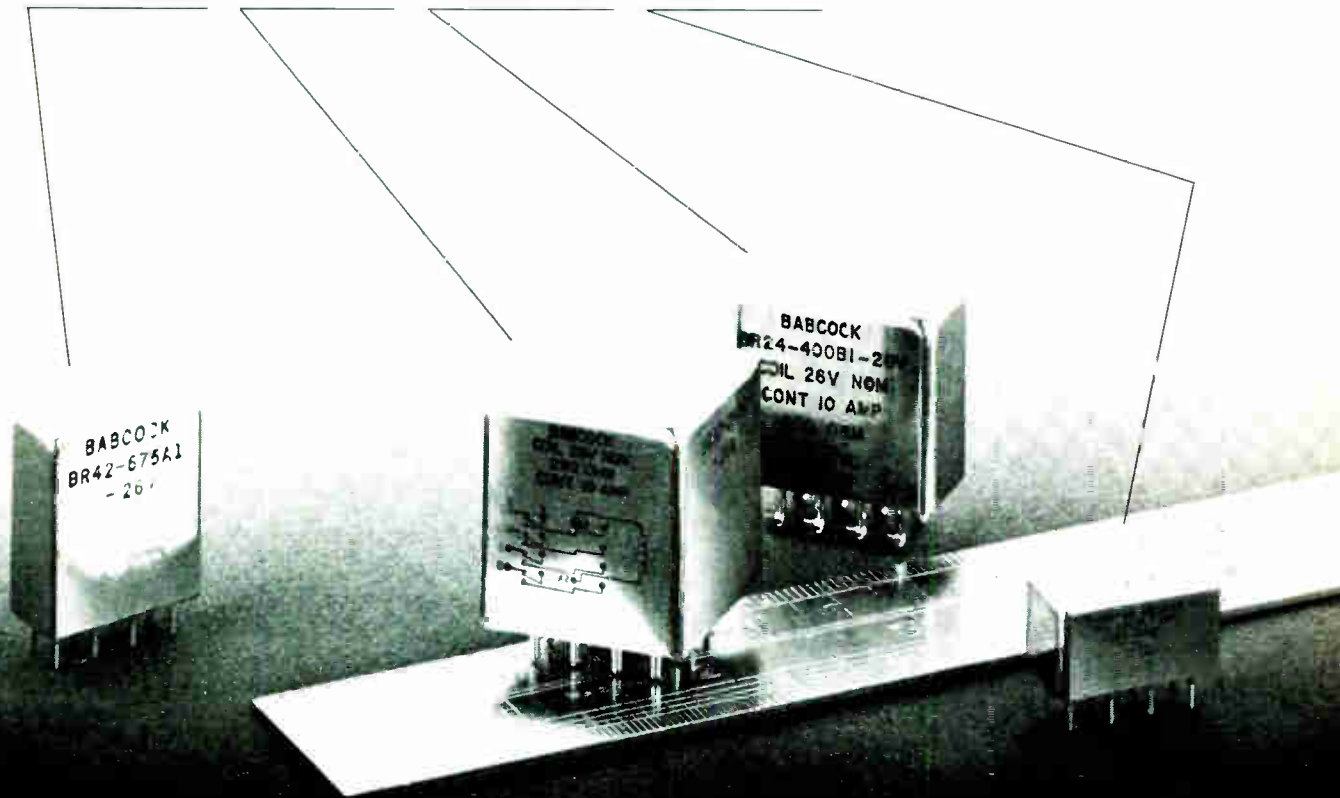

New: At significantly lower prices!

Still the same: Babcock quality

Where: At your Babcock distributor When: Now!

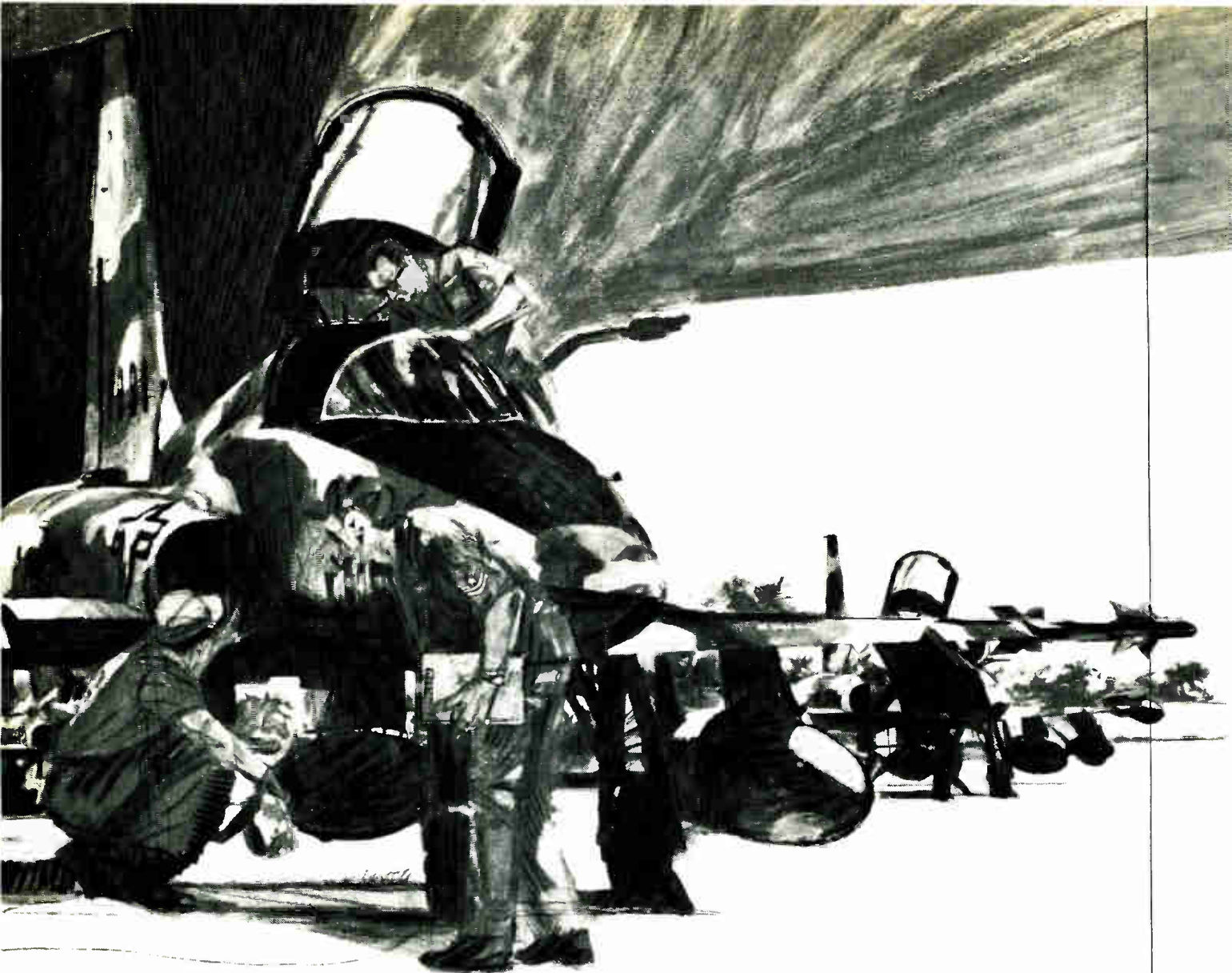

Operationally ready!

New 26482 connector assures ease and speed of field maintenance.

The challenge of the high state of readiness and maintainability required in today's electrical systems —

whether used in aircraft, ground support or subsystems — is met by the new environmental KPSE miniature connector from ITT Cannon. It exceeds the requirements of MIL-C-26482.

Crimp, snap-in contacts make field maintenance fast and easy. Quickly change or repair circuits on the spot with existing military standard contacts, termination and service tools.



Immediately available in 8 shell sizes, 6 service types and up to 61 contacts, the KPSE —

- Internates with any solder or crimp (MS3110 or 3120 series) bayonet-lock coupling connector.
- Features unitized insulator construction of elastomers and plastic . . . eliminates voids.
- Positively locks the insulator in the shell by plastic-to-metal retention . . . no axial movement or push-out.
- Provides maximum contact retaining-clip protection and retention . . . clips are completely surrounded by

plastic.

- Withstands exposure to jet fuels and hydraulic fluids . . . field-proven.
- Seals out moisture and other environments with complete shell, peripheral, interfacial and wire seals.
- Is available from authorized ITT Cannon distributors.

Write for KPSE engineering data. ITT Cannon Electric, 3208 Humboldt Street, Los Angeles, California 90031. A Division of International Telephone and Telegraph Corp.



Circle 168 on reader service card

CANNON ITT

HERE ARE YOUR AUTHORIZED CANNON DISTRIBUTORS

ALABAMA
NELSON RADIO & SUPPLY
COMPANY INC.
1541 S Belt Line Highway
Mobile 36609
Phone 705/479 1471

ALASKA
ALASKAN AIRCRAFT EQUIPMENT
SUPPLY, INC.
4707 Spenard Drive
Anchorage 99503
Phone 907/322 3202

ARIZONA
KIMBALL ELECTRONICS, INC.
3612 North 16th Street
Phoenix 85016
Phone 602/264 4438

CALIFORNIA
ABC CONNECTORS, INC.
11639 Vanowen Street
North Hollywood 91605
Phone 713/875 0665,
765 8881, 983 1738

K ITRONICS
5645 E Washington Blvd.
Los Angeles 90022
Phone 213/685 5888

KIERULFF ELECTRONICS, INC.
3969 E Bayshore Rd
Palo Alto 94303
Phone 415/968 6292

LIBERTY ELECTRONICS
339 South Ivy Avenue
Inglewood 90301
Phone 213/678 8111

RICHY ELECTRONICS INC.
5505 Riverton Avenue
North Hollywood 91601
Phone 213/761 6133,
877 7651

SAN DIEGO INC.
4618 Sanle Fe Street
San Diego 92109
Phone 714/274 3131,
716 2653

COLORADO
HYER ELECTRONICS CO
2895 East Penitence Avenue
Englewood 80110
Phone 303/771 5285

CONNECTICUT
CONNECTOR CORPORATION
OF AMERICA
137 Hamilton Street
New Haven 06511
Phone 703/624 0127

FLORIDA
ELECTRO AIR OF FLORIDA, INC.
410 27th Street
Orlando 32806
Phone 305/241 5461

**INDUSTRIAL ELECTRONICS
ASSOCIATES INC.**
Riverside Drive
Palm Beach Gardens 33403
Phone 305/848 8686

GEORGIA
ELECTRO AIR CORP.
2770 Marietta Blvd., N.W.
Atlanta 30325
Phone 404 351 3545

HAWAII
PACIFIC ELECTRONICS
1105 Dillingham Boulevard,
P.O. Box 2845
Honolulu 96803
Phone 808 810 1111

RADIO TELEVISION CORP., LTD.
432 Keawe Street
Honolulu 96813
Phone 808/564 416,
502 901

ILLINOIS
MEROUPI ELECTRONICS, INC.
7701 North Austin Avenue
Skokie 60076
Phone 312/965 7500

**RADIO DISTRIBUTING
COMPANY INC.**
4636 W Washington Blvd
Chicago 60644
Phone 312/379 2121

INDIANA
RADIO DISTRIBUTING
COMPANY
814 W Senate Avenue,
P.O. Box 1298
Indianapolis 46206
Phone 317 637 5571

RADIO DISTRIBUTING CO., INC.
1-12 Hugh Street
South Bend 46518
Phone 219/287 2911

KANSAS
HALL MARK ELECTRONICS
2707 W 43rd Street
Kansas City 66103
Phone 913/236 4343

LOUISIANA
SOUTHERN RADIO SUPPLY
COMPANY, INC.
1909 Tulane Avenue
New Orleans 70112
Phone 504/524 2345

MINNESOTA
LEW BOWN COMPANY
7275 Bush Lake Rd.
Edina 55435
Phone 612/941 4860

MISSISSIPPI
ELLINGTON ELECTRONIC
SUPPLY, INC.
824 South Gallatin Street
Jackson 39204
Phone 601/355 0561

MISSOURI
ELECTRONIC COMPONENTS
FOR INDUSTRY, CO
2805 S. Hanley Road
St. Louis 63144
Phone 314/647-5505

MONTANA
ELECTRONIC SUPPLY COMPANY
250 11th Street W
Billings 59102
Phone 406/252 2197

NEW MEXICO
HYER ELECTRONICS COMPANY
210 La Veta Drive, N.E.
Albuquerque 87108
Phone 505/265 5767

NEW YORK
PROGRESS ELECTRONICS CO., INC.
Engineers Hill
Plainville, (L.I.) 11803
Phone 516/433-1700

SCHWEBER ELECTRONICS
Westbury 11590
Phone 516/334 2474

**STACK INDUSTRIAL
ELECTRONICS INC.**
45 Washington Street,
P.O. Box 889
Binghamton 13902
Phone 607/723 6376

SUMMIT DISTRIBUTORS, INC.
116 Main Street
Buffalo 14202
Phone 716/884 3450

TIME ELECTRONIC SALES
Community Dr. & Pond Hill Rd
Great Neck, L.I. 11021
Phone 516/487 0100

NORTH CAROLINA
KIRKMAN ELECTRONICS, INC.
873 South Marshall Street
Winston Salem 27108
Phone 919/724 0541

OHIO
HUGHES PETERS INC.
4865 Duck Creek Road
Cincinnati 45227
Phone 513 351 2000

HUGHES PETERS INC.
481 East 11th Avenue
Columbus 43211
Phone 614/294 5351

**RADIO DISTRIBUTING
COMPANY INC.**
4399 Industrial Parkway
Willoughby 44094
Phone 216 946 0900

OKLAHOMA
HALL MARK ELECTRONICS
5708 E. Admiral Blvd
Tulsa 74151
Phone 918 835 8458

PENNSYLVANIA
AERCON INC.
359 E. Madison Avenue
Clifton Heights 19018
Phone 215 522 7500

PHILADELPHIA
ELECTRONICS INC.
1225 Vine Street
Philadelphia 19107
Phone 215/568 7444

RADIO PARTS CO., INC.
6401 Penn Avenue
Pittsburgh 15206
Phone 412/361 4600

TENNESSEE
LEVINER RADIO & TV
SUPPLY INC.
180 S Cooper
Memphis 38104
Phone 901/276 2756

TEXAS
HALL MARK ELECTRONICS CORP.
9100 Markville Drive
Dallas 75231
Phone 214 231 2531

**HARRISON EQUIPMENT
COMPANY INC.**
1422 San Jacinto Street
Houston 77027
Phone 713 224 9131

McNICOL INC.
3012 E. Vandell Drive
El Paso 79903
Phone 915/566 2936

STERLING ELECTRONICS, INC.
2642 Andron Drive
Dallas 75220
Phone 214/357 9131

**WHOLESALE ELECTRONIC
SUPPLY INC.**
2809 Ross Avenue
Dallas 75201
Phone 214/824 3001

Where and when

It's one thing to understand the process and the Lang vs. SOT arguments; it's quite another to determine what to do with X-ray topography.

Kyle E. Lemons, section head for materials and processes R&D at the Signetics Corp. and a former colleague of Meieran's at Fairchild, says that the long-term goal is "100% yield for large-scale integration." Three to five years ago, Lemons explains, the silicon crystals used to make semiconductors had 3,000 to 5,000 dislocations per square centimeter in the pure state. Today, however, the silicon may have as few as five dislocations in the entire wafer, and dislocation-free wafers are common.

New problems. But manufacturing introduces flaws. The initial doping process, in which impurities such as boron or phosphorous are introduced into the silicon, will change the shape of the lattice. The initial oxidation, the emitter diffusion, and the collector diffusion are also dangerous. Some defects result in "precipitation sites," where the dopants can collect in the lattice. This is dangerous because they act as centers for the recombination of electrons and holes.

"Sometimes process problems are ironed out by mixing bats' wings and snails' tongues," Meieran says. "But we are generating a body of knowledge for understanding the pictures we are taking, so that the effects of defects on devices may be understood."

He explains that the contrasting areas in the images made are used to define unambiguously the strains seen. For instance, oxide is deleterious to the silicon crystal. Meieran says that once the engineers understand why a particular oxide makes a particular image on the film, they can think about why it is deleterious to the crystal.

Substance of shadows. Lemons gives a good explanation of the overall process in general terms: "It is the interaction of the crystal structure with monochromatic X rays that produces differential intensities." This is very important, because these differential intensities show the stresses. They look like shadows, but they aren't; they are merely dark lines and darker

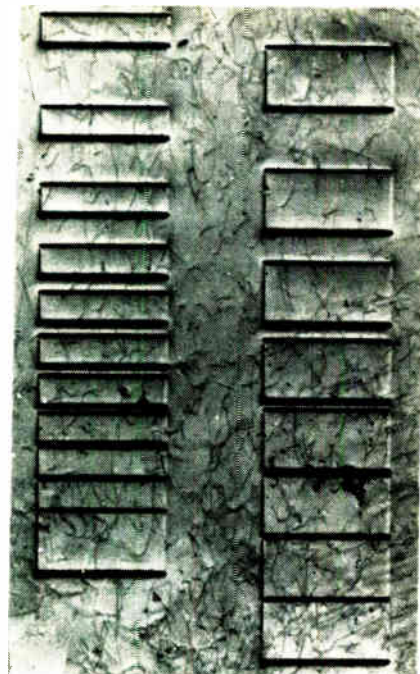

Squeeze. Oxide films in compression. The lines—actually the intensity of X rays—are thicker on one side than the other.

lines, which make a shadow effect in the same way that an artist can create the illusion of shadow and perspective by drawing heavy and light lines.

Meieran says: "We have to live with the oxide; it's like gravity. We hope, though, that we will be able to learn how to lessen its effects."

Meieran says the Schwuttke approach, with a number of cameras making regular scans on raw materials, will never be a routine production method because it takes too long. One wouldn't want to examine every wafer anyway, he says; only samples are needed. "The more we know, the more we can apply in production," he adds. "But at present there are no production applications at Fairchild." What IBM is doing is known but to IBM.

Even so, the list of achievements of the scanning X-ray topographic camera developed by Fairchild and now marketed by Krystallos Inc. indicates some very practical benefits. And Meieran says crystals come regularly to the R&D labs for analysis.

Tweezer trouble. For example, Fairchild has abandoned for now its work on silicon wafers, because topographs indicated a strong correlation between silicon wafers and defective devices. And investigations of gallium arsenide resulted



**Bramco
Custom Designed
LC and
Electromechanical
Filters
Operate from
0 to 200 kHz**

At Bramco we specialize in custom engineering LC and electromechanical filters. We offer experience and speed. And our computer synthesis program makes sure you get optimum design and performance.

Write for helpful literature and data sheets...or outline your special requirements.



**BRAMCO CONTROLS DIVISION,
LEDEX INC.**
542 South Street, Piqua, Ohio 45356
Phone (513) 773-8271

Who needs it?

At least one researcher isn't convinced that X ray topography is all that useful. Donald Hamilton, manager of solidification and deformation for solid state devices at Westinghouse Electric Corp.'s research facility in Pittsburgh, says: "It's not terribly useful. The X ray isn't specific; it shows too many defects too close to the end of processing." Westinghouse has a Jarrell-Ash camera, another from Krystallos, and no intention of buying any more.

To be effective, says Hamilton, the X ray must be specific, accurate, and functional at the early stages of processing. Now, he says, it gives very general information near the end of processing, and almost no electrical information.

Lows and highs. Hamilton credits IBM's Guenter H. Schwuttke for those cameras in use at Fishkill, N.Y., and points out also that IBM uses them for low-power and low-current devices, while Westinghouse tests high-current and high-power assemblies.

Hamilton says Westinghouse is using one of its cameras to test web dislocation, but adds that it's not very useful because the web process is strained only during solidification and has significantly fewer strains than the standard wafer process. Unlike the wafer process, the web method produces a flat sheet of silicon directly from a melt, eliminating surface treatments.

In the web process, a half-inch (or smaller) silicon seed is suspended on a 1/32 inch silicon wire above a silicon melt. This melt is under-cooled—normal temperature is 1,412°C; web is 1,410°C.

Spread. The end of the silicon wire is dipped into the melt and the silicon grows sideways along the surface of the melt. When the crystal is a half-inch wide (it grows a half-inch per minute), two dendrites form from the seed projecting down into the melt. The scientist knows from the shape and size of the seed when to begin withdrawing it from the melt. The silicon web forms between the two dendrites and continuous pulling makes the web wider. When the seed is three feet above the melt, the web will be an inch wide and 8 to 10 mils thick. The dendrites are then removed with a diamond saw, and the process is complete.

in the conclusion that boat-grown GaAs is far superior to Czochralski-grown GaAs.

Further topographs of GaAs and silicon crystals indicated that damage from sawing and polishing goes only 5 to 10 microns deep; this indicated how much etching was needed to erase the damage. Finally, topographs of a GaAs crystal scratched by nickel tweezers showed damage as deep as 20 microns and triggered a switch to plastic tweezers.

Meieran says X-ray topography is where electron microscopy was 10 years ago, and Schwuttke says there's a 10-year gap between development and implementation. Schwuttke asserts that the production people are faced with complicated instrumentation and don't know quite what to do with it, which is why there isn't any real rush to improve present topographic techniques.

Another reason X-ray topography has yet to really get off the ground, he says, is that too many electronics engineers feel it falls within the

domain of the crystallographer. Schwuttke feels the accent should be on the broad area of materials research rather than on the narrow one of X-ray topography.

As for cost, Meieran says his camera costs only \$5,000 while Schwuttke's goes for \$15,000. Schwuttke shrugs off price—"Fairchild is in the camera business," he says. "IBM isn't."

Into the act. Many other companies and research organizations are working with X-ray topography. Krystallos has sold cameras to Stanford University, Hewlett-Packard, Signetics, RCA, Westinghouse, the Massachusetts Institute of Technology, Motorola Semiconductor, Monsanto, Dow Corning, and the Sandia Corp.

Jarrell-Ash has sold its Lang cameras to Texas Instruments, which is looking at epitaxial GaAs, Bell Telephone Laboratories, McDonnell Douglas, General Electric, NASA, Philco-Ford, RCA, and others in the U.S.; in addition, its cameras have been sold in England, Spain, and Egypt.

What is small, has stripes, and shrinks boards?

New CORNING[®] C3 Resistor.

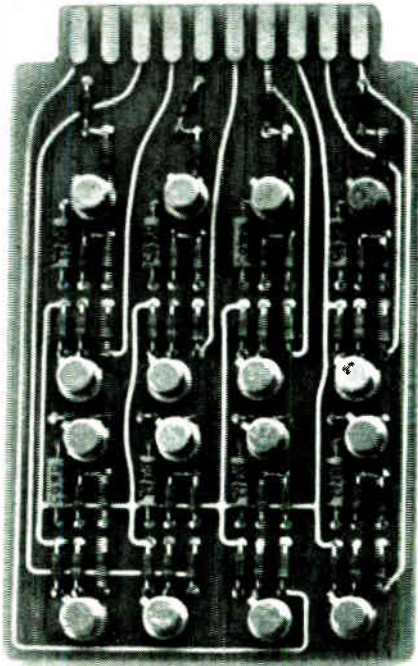

16 transistors
8 capacitors
52 C3 resistors
Actual size

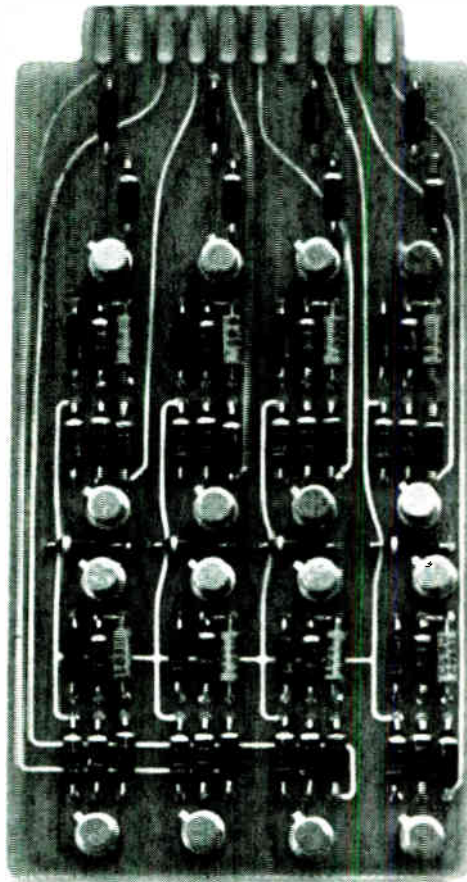

16 transistors
8 capacitors
52 RL07 resistors
Actual size

Now you can get 1/8 watt in a clean lead length of .150" and diameter of .066" maximum. That means a 35% reduction in board size for these eight Schmitt trigger circuits. Plus the proven stability of glass tin oxide film construction.

Put more circuit in the same space.
Or put the same circuit on a smaller board.

For specs and samples, write to Corning Glass Works,
Electronic Products Division, Corning, N. Y. 14830.

CORNING
ELECTRONICS

The drip-dry test bath.

As soon as you pull your electronic circuit or component out of a 3M Brand Inert Fluoro-chemical Liquid test bath, it drains clean, and dries almost as fast as it drains.

No more messy residue. No more time-consuming and expensive cleaning to remove the testing fluid. You can package your component or use it right out of the bath.

This makes our fluids ideal for gross leak testing and integrated circuit performance testing.

Other properties of our Inert Liquids are equally important for test bath applications. You can use them over a wide temperature range. They're completely compatible with the most sensitive materials. A high dielectric strength provides electrical protection during testing. Non-flammability adds safety.

Those are also some of the reasons why 3M Brand Inert Liquids started out to be—and still are—the most reliable electronic coolants on the market. Tests have proved that.

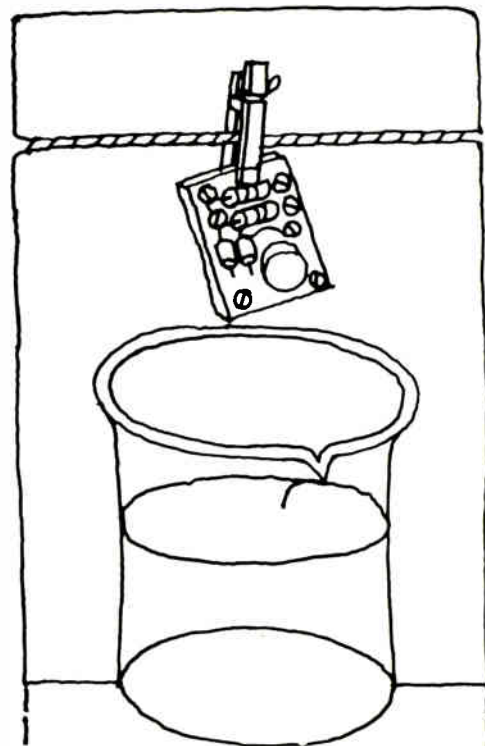

3M Company, 3M Center Dept. KAX 5-68
St. Paul, Minn. 55101

Send me all the details about 3M Brand
Inert Liquids

Name _____

Company _____ Title _____

Address _____

City _____ State _____ Zip _____

Chemical Division 3M

One man's stability is another's slop.

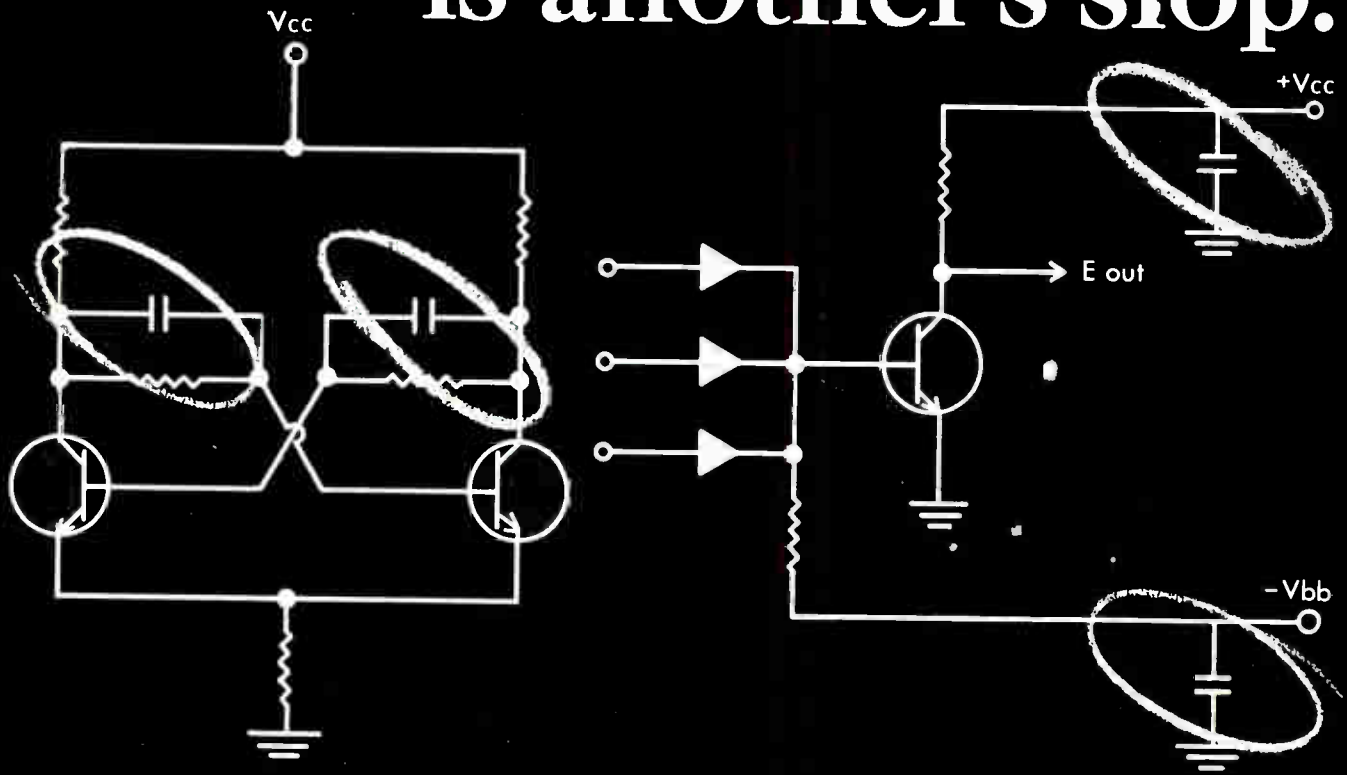

CORNING® Glass-K Capacitors provide both.

Needs vary with circuit function.

A filter can stand some slop. You buy for size and plain reliability.

But in timing or tuning, a capacitance change may not only foul up your signal, but the result may be more damaging than a total stop.

CORNING Glass-K answers both needs.

From 270 to 100,000 pf, just .250" long.

Stability? Choose from three characteristics, with ΔC with life as low as 2% max., at 125° C.

Reliability? Check Apollo, Centaur, Poseidon.

Get size, stability, sureness. Get the figures on Glass-K Capacitors.

Write: Corning Glass Works, Electronic Products Division, Corning, N.Y. 14830

.140"

[.250"]

CORNING
ELECTRONICS

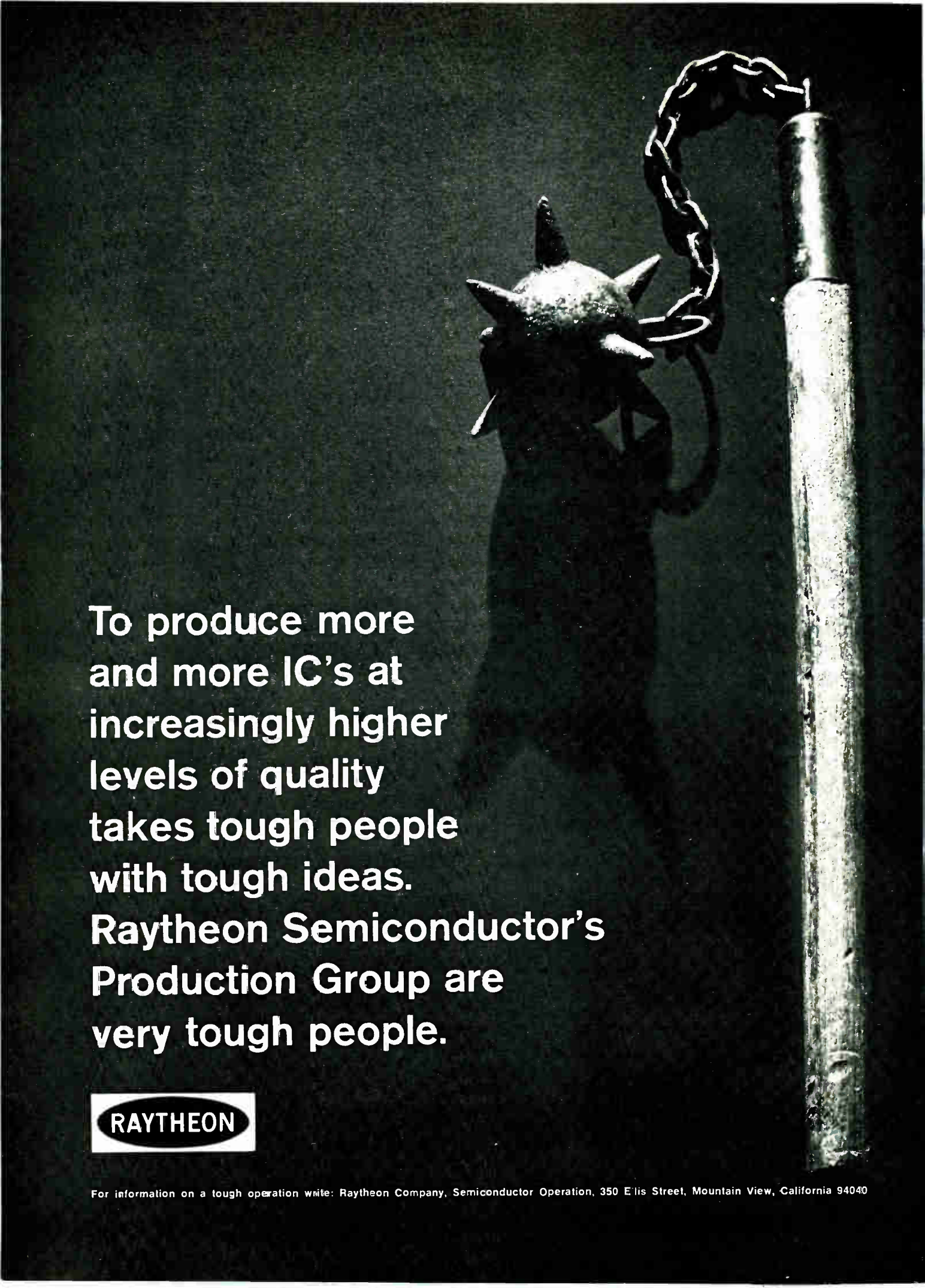

**To produce more
and more IC's at
increasingly higher
levels of quality
takes tough people
with tough ideas.
Raytheon Semiconductor's
Production Group are
very tough people.**

RAYTHEON

For information on a tough operation write: Raytheon Company, Semiconductor Operation, 350 Ellis Street, Mountain View, California 94040

NOW plug in up to
2048 bits, at a speed of
8 MHz for less than
5¢ per bit, with built-in
TTL interface.

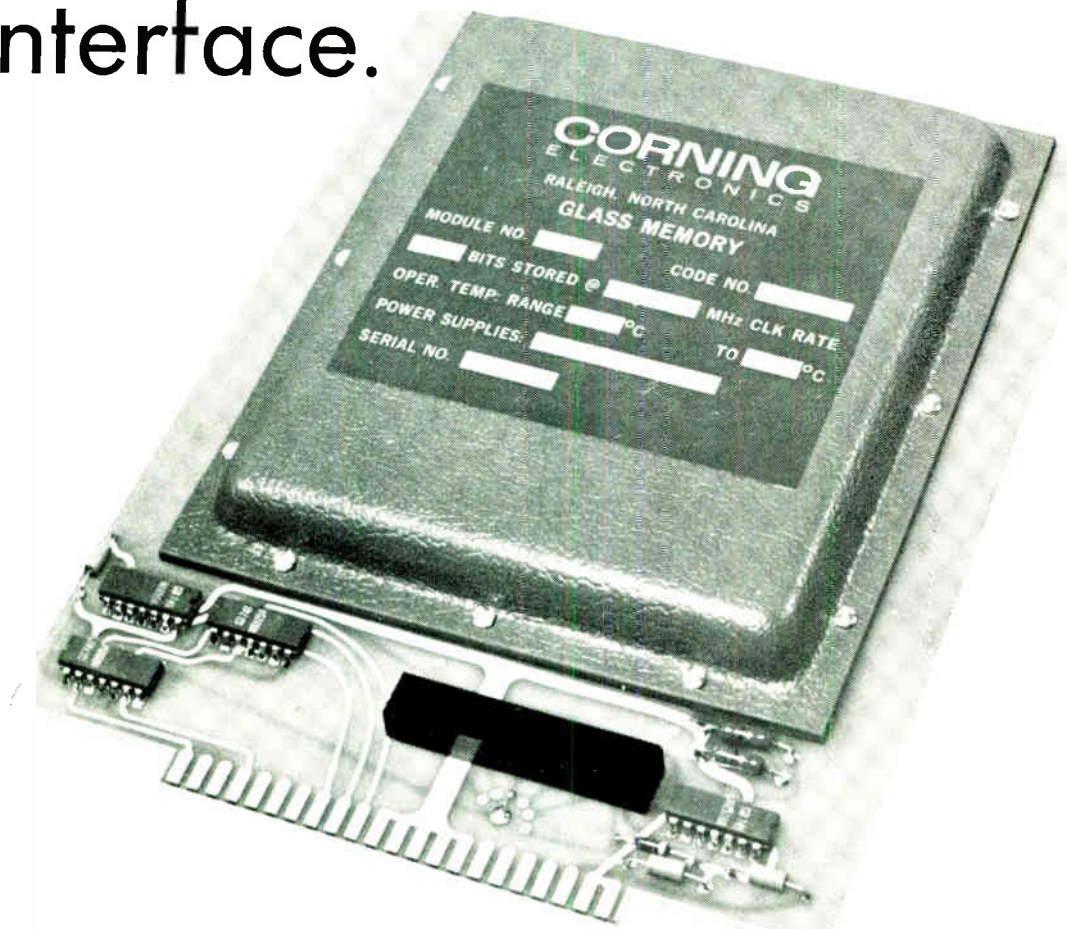

New Low Cost CORNING® Digital Memory Modules.

Fast Available Frequencies	Available Delay Time		
	64 μ sec.	128 μ sec.	256 μ sec.
4 MHz	256 Bits	512 Bits	1024 Bits
8 MHz	512 Bits	1024 Bits	2048 Bits

These are standard. Custom modules available up to 4096 bits and up to 16 MHz.

Easy. Just plug one in and you have serial storage. All the circuitry to interface with TT Logic is built in. You need no special power supplies, no voltage level shifters.

Low Cost. In the 1000 module bracket, for 2048 @ 8 MHz,

each bit costs less than a nickel. More modules—less cost. Even in 100 piece quantity, each bit costs less than a dime. And it's your only cost.

Stable. The medium is proven CORNING® Zero-TC glass.

Here now. These are performing products, not promised potential. Write for full data sheets, or to see our man with samples. Corning Glass Works, Electronic Products Div., Advanced Products Dept., Raleigh, N.C. 27602. Telephone (919) 828-0511, Ext. 262.

CORNING
 ELECTRONICS

APG SERIES MAGNETIC PROTECTORS

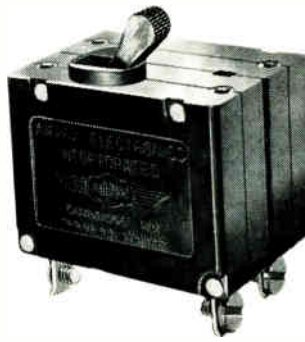

SERIES APG, low cost electromagnetic circuit protectors, are designed for industrial applications and ground support military equipment. The compact size, together with a wide range of current ratings and delays, make it an invaluable component where positive protection is a requisite.

FEATURES

- Low cost
- Compact size
- 1, 2 or 3 poles
- Single toggle
- Choice of delays
- 50V DC; 120/240V 60 and 400 Hz
- Ratings from 50 ma to 30 amperes
- Quick connect or screw terminals
- -40°C to $+95^{\circ}\text{C}$ operating range
- Special contacts quench arc rapidly
- Positive latching
- High rupture current
- Trip free
- Magnetic operation
- Low series R or Z

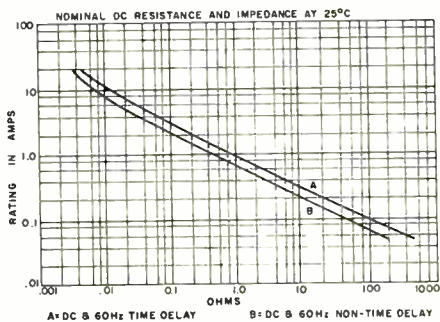
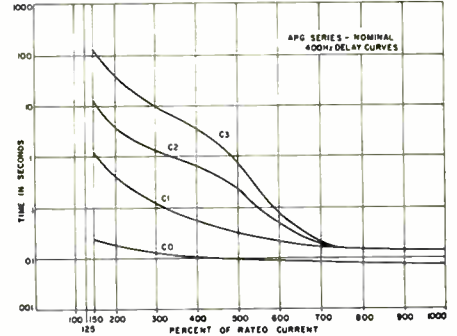
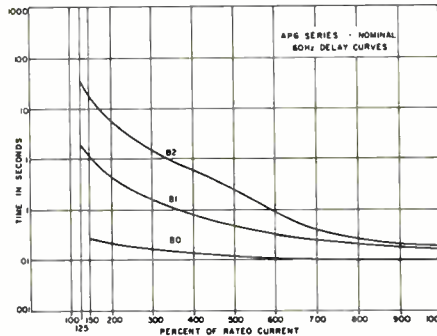
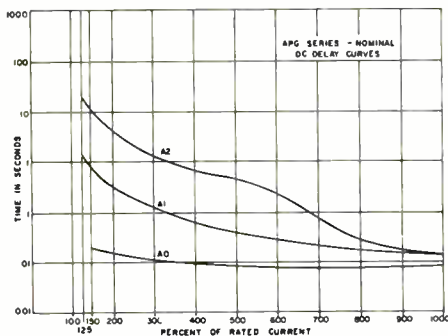
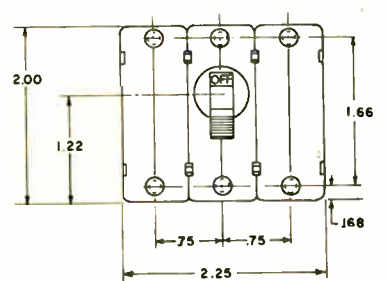
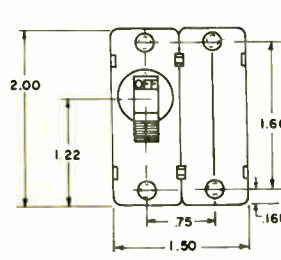
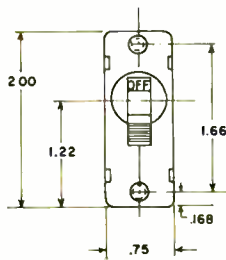
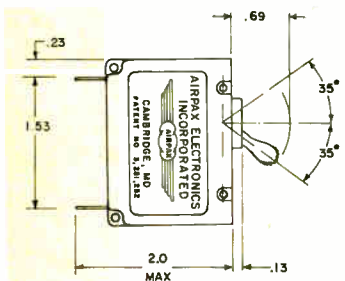

AIRPAX ELECTRONICS

CAMBRIDGE DIVISION, CAMBRIDGE, MARYLAND

Phone (301) 228-4600

TWX 710 865-9655

TELEX 8-7715

New Products

New instruments

The twain meet in new scope

Portable unit jointly developed by Sony and Tektronix gives high performance in a 6-pound package; low power needs permit 10 hours of battery operation

By Carl Moskowitz

Instrumentation editor

Harness an American instrument maker with a Japanese firm experienced in miniaturized design. What will the team's first product be? A portable oscilloscope. Specifically, the model 323, the first fruit of the union between the Sony Corp. and Tektronix Inc.

The 323 is a single-channel scope with a 4-megahertz bandwidth, designed for field maintenance of industrial controls, business equipment, communications gear, computers, and related systems. The scope weighs about six pounds and measures 11 x 8 x 4 inches. It uses 4.5 watts from an external source or operates for about 10 hours on internal rechargeable batteries.

Sony/Tektronix, the Japan-based joint venture that developed the model 323, was formed in 1964 to make and sell Tektronix instruments in Asia. At the same time, however, an effort was made to cash in on the engineering talents of both companies. The net result of this activity is a felicitous combination of high performance and portability that will be sold worldwide.

Solid gains. Except for the cathode-ray tube, the 323 is entirely solid state. There are no integrated circuits but more than 60 transistors are used. The design doesn't depart from conventional construc-

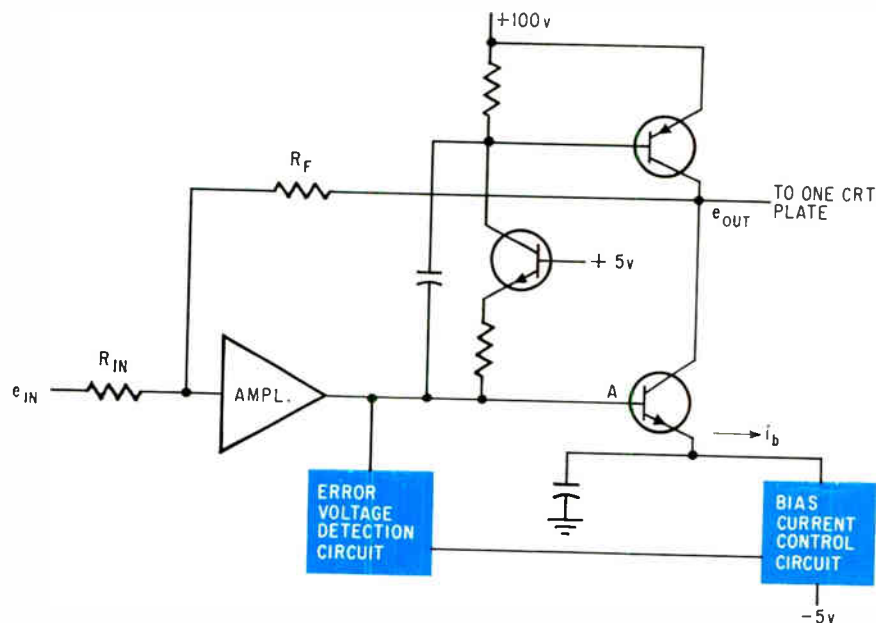

Something new. A unique circuit in the 323 saves a lot of power. If there isn't enough bias current (i_b) for the amplifier to produce an output (e_{out}) that's a faithful version of the input (e_{in}), the error voltage at A increases. The circuit peak detects this error voltage, sending a control voltage to the bias-control circuit. This increases i_b until e_{out} becomes an exact reproduction of e_{in} .

tion techniques, but affords easier access for maintenance and has such convenience features as plug-in transistors.

The battery pack, a self-contained unit that includes charging circuitry, a power transformer, and a line connector, can be easily extracted for recharging, which takes at most 16 hours. A user can buy

additional battery packs to keep his scope operating continuously.

Sony/Tektronix designed the 323 to withstand vibration, shock, and wide variations in temperature, altitude, and humidity.

Powers that be

The 323 is a low-power device so users can get a full operating

... two regulator circuits cut power consumption so that scope runs for up to 10 hours ...

day from the battery. Field-effect transistors are used in the Miller integrator sweep circuit, the vertical amplifier, and the horizontal and trigger input circuits. This not only provides the impedance levels needed to increase stability but also eliminates the need for nuvistor heater power.

Power consumption was cut by incorporating a very low power, direct-heat cathode in the crt. Sony developed the cathode for its 4-inch television set. The actual heater wire is the cathode and provides a direct heat transfer. The required power is only a low 180 milliwatts. This also provides the scope with an almost instant-on quality since warm-up time is reduced to 2 seconds.

Savings account. In conventional scopes, the vertical amplifier is usually biased at a relatively high level to make enough current available to charge and discharge the crt's capacitance at a rate corresponding to the bandwidth or 3-decibel frequency. This approach, however, results in high power dissipation. Furthermore, power is wasted when there is no input signal or when a low-frequency input signal is applied to the scope. To save power, the 323's output amplifier is biased at low current and the signal frequency electronically sensed. If a high-frequency signal is applied, the sensing circuit increases the bias current for the proper high-frequency response. And even more power is saved by connecting the output transistors as a complementary pair for bidirectional drive of the crt.

Simple matter

The horizontal output stage boasts still another power-saving feature. Like the vertical amplifier, this circuit is complementary allowing the npn to charge load capacity negatively and the pnp to charge positively. This saves power because a higher bias point would otherwise be needed. In addition, the current in the pnp's is moved from one to the other as the sweep progresses. This permits essentially the same current to be used, en-

abling the unit to get along on half the normal bias current.

Deflection unblanking sidesteps the circuit complexity that would result if the 323 used grid blanking. Although the cathode is always on during the sweep cycle, the usual cathode currents are only 10 to 20 microamperes, requiring only 20 to 40 mw. In addition, since the sweep duty cycle under free-running conditions is usually large enough, there would be little gain from grid blanking.

The unblanking circuit is low power in the sense that it also uses a complementary npn-pnp arrangement. Because there is no gray-scale capability in deflection unblanking, the 323 always has either the npn or the pnp saturated. Since there is no load resistor in the output, no power is lost. The only load is the leakage currents of the transistors.

Low-power supply

Even the supply itself was designed for low-power usage. Standard regulated supplies dissipate a lot of power in the series-pass transistor because line-voltage variations require considerable voltage



Frugal. The 6-pound portable 323 scope from Sony/Tektronix requires so little power that it can operate on batteries for about 10 hours.

across the transistor. In the 323, a primary-regulated system takes out most of the variation in the raw, unregulated voltage delivered to the ± 5 -volt series reregulators. The drop across the series regulators never exceeds one volt. A second power saving results from the design of the vertical, horizontal, and blanking amplifiers. The +100-volt and +175-volt power supplies that are used need not be reregulated, because of the techniques used in the amplifier designs.

The power supply generates voltages of -1,900, +5, -5, +100, and +175. The primary regulator feedback loop from the -1,900-v unit holds within 1%, so that crt sensitivity doesn't change as a function of load or battery voltage. The -1,900 volts aren't sampled directly; instead, the d-c output of a winding closely coupled to the supply winding is sampled. To handle the change resulting from a varying cathode current that causes a varying drop across high-voltage multiplier diodes, the magnitude of the cathode current at the low-voltage end of the winding is examined, and an open-loop correction voltage introduced into the comparator-amplifier node. This increases the drive to the -1,900-volt supply and maintains a constant voltage at the crt cathode.

A tv technique

The primary preregulation is accomplished with very little dissipation, through use of a tv flyback technique. The repetition rate is adjusted so that the stored energy varies to compensate for load or battery voltage variation in the -1,900 volt output. Lower than usual supply voltages—+5 and -5—were used for most of the circuitry, a decision that also resulted in considerable power savings throughout the various circuits in the instrument.

Power consumption is about 1.6 watts from the six Type C rechargeable nickel-cadmium batteries. At high crt intensity and with a full-screen 4-Mhz signal, the drain increases to about 4.5 watts. At 1.5 watts the 323 will operate about 10 hours on batteries.

The 323 costs \$850, f.o.b. Beaverton, Ore.

Tektronix Inc., P.O. Box 500, Beaverton, Ore. [338]



Let's put our catalogs on the table

Your table (or desk) to be more specific. They're the most valuable set of reference manuals available on magnetic shielding materials and fabrication methods. They cover the complete line of Netic and Co-Netic Alloys from MSD. They're a veritable gold-mine of information from the company that's provided over 80% of the magnetic shield designs currently in use and whose products are the recognized world standard in its field.

They're yours for the asking. Contact your MSD rep or write
West Coast Stocking Reps

Tech Rep Distributor Co.
 10606 W. Pico Blvd., Los Angeles, Calif. 90064
 213. 836-6806 213. 871-0055

Frauman Associates, P.O. Box 959
 Menlo Park, Calif. 94026
 415. 322-8461

MAGNETIC SHIELD DIVISION

PERFECTION MICA COMPANY

1322 N. Elston Avenue • Chicago, Illinois 60622



**We make
it plain.
You make
it fancy.**



If you buy any of Honeywell's standard Series 70 Taut-Band Meters, here's what you'll get:

The Basics.

A plain square case.

A clear Plexiglas cover.

Large, plain markings. (You can read them at arm's length without squinting.)

And the simplest meter mechanism known to man: Honeywell's new Auto-Torque mechanism. (It has about 50% fewer parts than pivot-and-jewel.)

This is a meter with no frills.

The options.

However, frills are available: Fancy dials, with multiple scales and multi-colored sectors. (A fancy dial looks great on a plain meter.)

Lighted dials.

Mirrored scales.

Behind-panel mounting with a bezel. (For 2½", 3½" and 4½" meters.)

Plus just about any other modification you might have in mind.

The specs.

The taut-band mechanism is completely frictionless, so it re-

sponds to the slightest inputs. Hysteresis-free, so its repeatability is near perfect.

And it costs less than pivot-and-jewel.

Honeywell's Series 70 Meters come in 33 standard ranges. And 5 sizes (1½", 2½", 3½", 4½" and 6").

We sell a lot of them.

(We'd like to send you a catalog. Write Honeywell Precision Meter Division, Manchester, New Hampshire 03105.)

The Just Plain Meter from Honeywell

It takes all kinds of meters to make the Honeywell line.

New Components Review

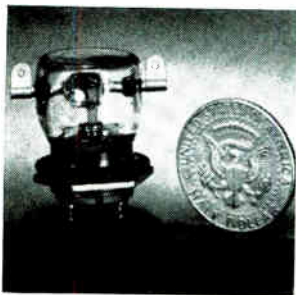

High vacuum relay T-11 is suited for many h-v switching applications including radar, telemetry and r-f switching. It is capable of switching and isolating 10,000 v peak with a contact interruption of 10 kw. Maximum contact resistance is 0.005 ohm. The unit weighs about 1 oz and has a maximum height of 1.7 in. Torr Laboratories Inc., 2228 Cotner Ave., Los Angeles 90064. [341]

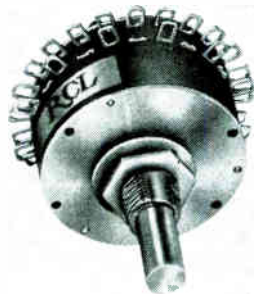

Rotary Switch series E is a 24-position device with a 1 3/8 in. body diameter. Up to 9 decks are available with up to 12 poles on any one deck. One piece molded contact terminal construction has holes large enough to accept two 0.032 in. diameter wires. Contact resistance is 10 milliohms max. initial. RCL Electronics Inc., 700 S. 21st St., Irvington, N.J. 07111. [342]

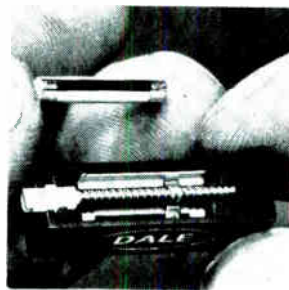

Film element trimmer pot series 8300 is available in sealed and unsealed versions. Units are rated at 3/4 w at room temperature. Operating temperature is from -55° to +105° C, and resistance range is from 10 ohms to 2 megohms. Temperature coefficients are ±500 ppm from 10 to 50 ohms, ±250 ppm above 50 ohms. Dale Electronics Inc., Box 609, Columbus, Neb. 68601. [343]



Molded capacitor style ME features MIL-C-11015 performance. Over-all size is 0.165 x 0.095 in., and it is available with leads 0.016 x 1 in., in either tinned copper or gold-flashed dumet. Capacitance ranges are offered to 39,000 pf in Characteristic AW. Prices range from 25 cents to \$2.38. American Components Inc., Eighth Ave. at Harry St., Conshohocken, Pa. 19428. [344]

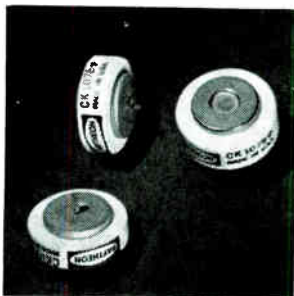

Gold-plated precision spark gaps CK1072, -3, -7, -8 and -9, featuring metal-ceramic construction, are for equipment uses requiring voltage overload protection in the range from 750 to 17,500 v d-c. Units exceed requirements of MIL-E-1E and environmental tests of MIL-Std-202C. Ambient temperature range is -55° to 85° C. Raytheon Co., Fourth Ave., Burlington, Mass. 01803. [345]



Omnidirectional inertia switch 3RO-434 is smaller than 1 cu in. It can be calibrated between a range of 4 to 100 g's and hold an accuracy of ±10%. The unit withstands vibrations of 16 g's and operates in a temperature range from -65° to 250° F. It complies with MIL-Spec E5272. Dimensions are 1 x 1 x 0.875 in. Inertia Switch Inc., 331 W. 43rd St., New York 10036. [346]

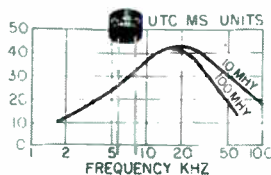

Precision toroidal inductors type MS, designed for operation in the 1 khz to 100 khz range, have a low profile of 0.23 in. by a diameter of 0.35 in. and weigh 1.5 grams. They have a Q of approximately 10 at 2 khz and of approximately 40 at 20 khz. All are precision adjusted ±2% at 0.1v rms at 1 khz. United Transformer Co., 150 Varick St., New York 10013. [347]



Precision wirewound pot type 8403 is a 3-turn 7/8-in.-diameter unit. It features a molded wiper block with precious metal contact on a low temperature coefficient helix that is wound on a high temperature core. Units are rated at 2 w at 25° C. Resistance values are from 50 ohms to 50 kilohms, ±5% tolerance. IRC Inc., 401 N. Broad St., Philadelphia 19108. [348]

New components

Low-drift op amp for less

Price of chopper-stabilized device is cut by integration and design for d-c and very low frequency applications

When you're designing equipment that requires op amps with infinitesimal current and voltage drift and very low peak-to-peak voltage noise you've got to make a choice between paying premium prices or making them yourself. Analog Devices Inc. has developed three op

amps that may make it easier to buy rather than take the do-it-yourself route: the firm has introduced its 230 series, the only units to offer both low current and voltage drift and low noise.

The lowest priced member of Analog's new series, the 230J, has

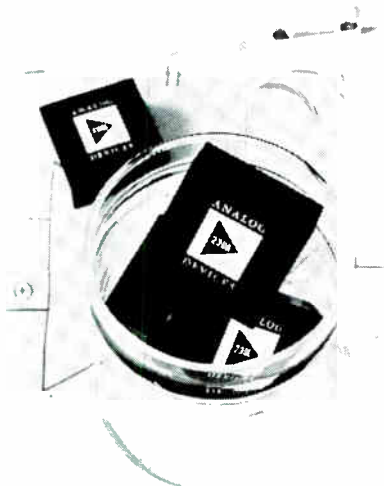

NEW SOLID STATE POWER PACKS

for
regulated
low voltage
applications
from

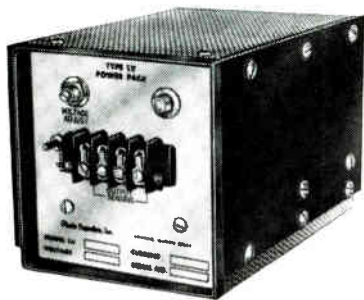

Plastic Capacitor's new LV Series Power Packs, ranging from 12 to 100 volts DC, offer an improved solution to today's system requirements. Models available with DC output voltages of 12, 24, 28, 36, 48, and 100 volts with power ratings of approximately 25, 50, 100 & 150 watts.

FEATURES INCLUDE:

- 0.01% LINE REGULATION
- 0.05% LOAD REGULATION
- 3MV PEAK TO PEAK RIPPLE AND NOISE
- NEGATIVE 0.015%/°C TEMPERATURE COEFFICIENT
- LESS THAN 0.2 OHMS OUTPUT IMPEDANCE
- TEMPERATURE OPERATING RANGE OF 0°C TO 55°C

For positive proof that good things come in small packages... check your power pack needs with Plastic Capacitors. Write for full engineering data today.

Plastic Capacitors INC.

2620 N. Clybourn Chicago, Ill. 60614

Manufacturer

Analog Devices

Model

230 J

230 K

230 L

210

220

Open loop gain, min. (v/v)

10⁷

10⁷

10⁷

10⁸

10⁸

Output voltage, min. (v)

10

10

10

10

10

Output current, min. (ma)

4

4

4

20

25

Voltage drift, max. (μv/°C)

0.5

0.25

0.1

0.5

0.25

Current drift, max. (pa/°C)

1

0.5

0.5

1

0.5

Voltage noise, d-c to 1 hz (μv, p-p)

1

1

1

5

3

Unity gain-bandwidth (Mhz)

1

1

1

20

10

Full power response, min. (Khz)

2

2

2

500

4,000

Price (1 to 9)

89

109

139

157

165

a worst-case voltage drift specification of 0.5 microvolts per degree Centigrade. Current drift is only one picoampere per degree C. The 230J costs only \$89 in single-unit quantities; units with competitive drift specs go for \$135 (Burr-Brown Research Corp.'s model 3010) to \$157 (Analog's own model 210).

Even lower drift is possible with the 230K (0.25 μv, 0.5 picoamperes) and 230L (0.1 μv, 0.5 picoamperes). The K model costs \$109 and the L \$139. No other firm offers chopper-stabilized op amps with drift specs like these; the nearest competition to the top-of-the-line 230L is Zeltex Inc.'s \$155 model 14508.

Lower and lower. Thus, Analog is offering very low drift at a very low price. "We've designed this series to get our price down to the manufacturer's factory cost," says Ray Stata, Analog's marketing vice president. Analog may well be coming close: for the 230J the price falls to \$67 in quantities of 100 or more; for the 230K, it's \$82 and for the 230L, it's \$105.

Having picked a specific market area in d-c and very low frequency use, Analog has been able to make the engineering tradeoffs necessary to reach these prices without depriving its customers of necessary

performance, according to Stata.

To maximize performance and minimize cost, Analog uses a 709-type op amp, an integrated circuit not known for low-drift performance. By using a metal oxide semiconductor FET chopper input stage followed by an amplifying stage just ahead of the IC, the concern was able to come up with low drift and a package one-fourth the size of an equivalent discrete circuit.

Because the IC is used, unity-gain bandwidth in the 230 series is 1 megahertz; full power response bandwidth is 2 kilohertz. Competing units, designed for more applications, span much wider bands. Analog's 210 offers a 20-Mhz unity-gain bandwidth for those who must have it, while Zeltex's model 145 has a 4-Mhz full power response bandwidth. "But in the markets we are shooting for you don't need it," says Stata.

Not so noisy. All three 230's are rated at one μv peak-to-peak voltage noise. Competing chopper amps are specified at 3- to 5-μv noise, with some reaching as much as 10 μv. This specification is as important as drift, since such noise interferes with the measurement of very low voltages from sensitive transducers.

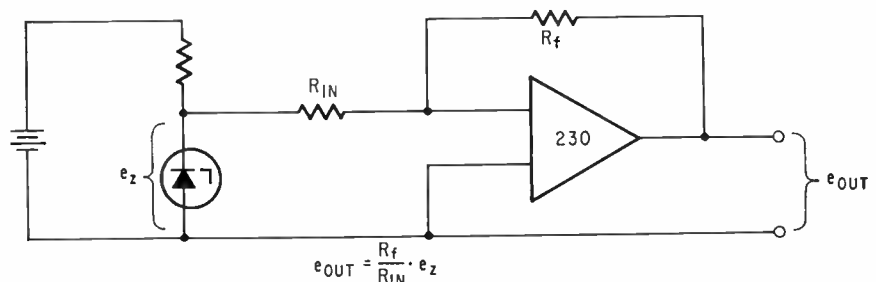

On target. Precision reference voltage amplifier is an application where the 230 can be put to good use because of its long-term stability.

Burr Brown	Zeltex		Philbrick-Nexus	
3010	145	14508	SP25BUF	SP65A
10 ^s	10 ^s	10 ^s	10 ^s	10 ^s
10	10	10	10	10
20	25	25	20	20
0.5	0.5	0.25	1	0.4
1	0.5	0.5	1	0.9
—	3	3	5	6
15	10	10	1.5	1.5
1,000	4,000	400	30	20
135	145	155	135	180

Continuing the “no unnecessary frills” rationale, the 230’s provide an output current of 4 milliamperes, rather than the 10’s or 20’s of ma quoted for competing units such as Analog’s own model 220, rated for 25 ma. But, says Stata, “an easy 80% of our customers don’t need much more than 2 ma, and 5 ma requirements are rare.”

Why the push for such high-spec devices, when low-priced op amps can be adjusted periodically to produce comparable specs?

For one thing, the kind of equipment that uses op amps—analogue computers, automatic checkout gear, and digital voltmeters—often run continuously; hence there are few opportunities to adjust their many operational amplifiers. The same is true of the growing number of automatic checkout systems, also used by workers unequipped to adjust their internal components. Makers of digital voltmeters—which use operational amplifiers in ramp generation, scaling, reference generation, signal comparison, and other applications—have trouble selling them if some components constantly require adjustment.

In these applications, voltage and current offset, or drift, are vital specifications to the design engineer. Until now, if he decided to buy, he had three ways to go in search of low drift. Differential amps have low voltage drift but relatively high current drift. Just the opposite can be true of op amps made with FET or varactor-bridge inputs—low current drift, but high voltage drift. Now the chopper-stabilized op amp will offer a low-cost fourth choice.

Analog Devices Inc., Cambridge, Mass.
[349]

TWINS

It's no Put-On; the one image represents two types of RF Connectors. They look alike enough to be twins. But a lot more goes into the one for MIL-C-39012 applications. At Kings, we believe these unseen differences will make this new spec a standard for all applications. If you'd like the whole picture or MIL-C-39012, ask us.

KINGS 

ELECTRONICS CO., INC.
40 Marbledale Road/Tuckahoe, N.Y. 10707
(914) SW 3-5000/TWX 710-562-0110

The new Johanson 7200 capacitor helps you make ends meet.

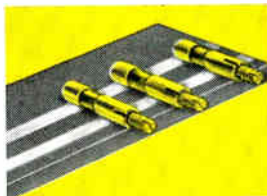

Solder directly on P/C board (minimum stray capacity).



Solder one end to coupling link and other end to cavity wall.



Solder ends to terminals of another component.



Solder one end to P/C board and attach lead to other end.

The new Johanson 7200 capacitor is ideal for balancing of semi-conductors and microwave components, for trimming of small fixed capacitors, for UHF oscillators, for coupling (VHF and UHF), for terminations for UHF coupling links, and for strip lines and modular blocks.

The 7200 features tubular electrodes which provide for low losses and low inductance at microwave frequencies. They also feature a *low minimum capacitance* 0.1 pF (10:1 tuning ratio) and Q of 500 at 200 MHz. Call or write for complete information.



Johanson

MANUFACTURING CORPORATION

Electronic Accuracy Through Mechanical Precision

400 Rockaway Valley Road, Boonton, N.J. 07005 (201) 334-2676

New components

Full compensation added to op amps

Three manufacturers
introduce linear IC's
with built-in capacitors

Almost simultaneously, three fully compensated linear circuits have started to challenge the popular 709 for a share of the general-purpose operational amplifier market. The original 709 was much imitated and much improved; the Amelco Semiconductor division of Teledyne Inc. makes a two-stage 809 op amp, and Robert J. Widlar, who designed the 709 for the semiconductor division of the Fairchild Camera & Instrument Corp., last year created improved versions of the 709 for the National Semiconductor Corp. One of them, the LH101, is itself second-sourced by Siliconix Inc.

Fairchild has contended that no linear circuit will ever approach the 709 in popularity, because the present trend is to special-purpose IC's [Electronics, March 18, p. 47]. Nevertheless, Fairchild is one of the three companies now offering fully compensated "709's"; the others are the Signetics Corp. and the Raytheon Co. Fairchild's μ A741 is pin compatible with the 709 and will be priced competitively, according to Jack Gifford, marketing manager for linear circuits. Raytheon, with the RM4101, and Signetics, with the SE530, are competing with the 709 and the LM101.

Details differ. The three high-performance devices have two-stage gain circuits to minimize oscillation (the 709 has three), and metal oxide silicon capacitors (Fairchild's and Raytheon's are 30 picofarads, Signetics' is 5). All three companies say that new processing technologies have made the circuits possible. Fairchild says its oxide layers for the MOS capacitors are about 700 angstroms thick; Raytheon says its capacitors average about 1,000 angstroms thick.

The circuits differ in detail. Fairchild's 741 doesn't need a monolithic resistor, says Gifford, because

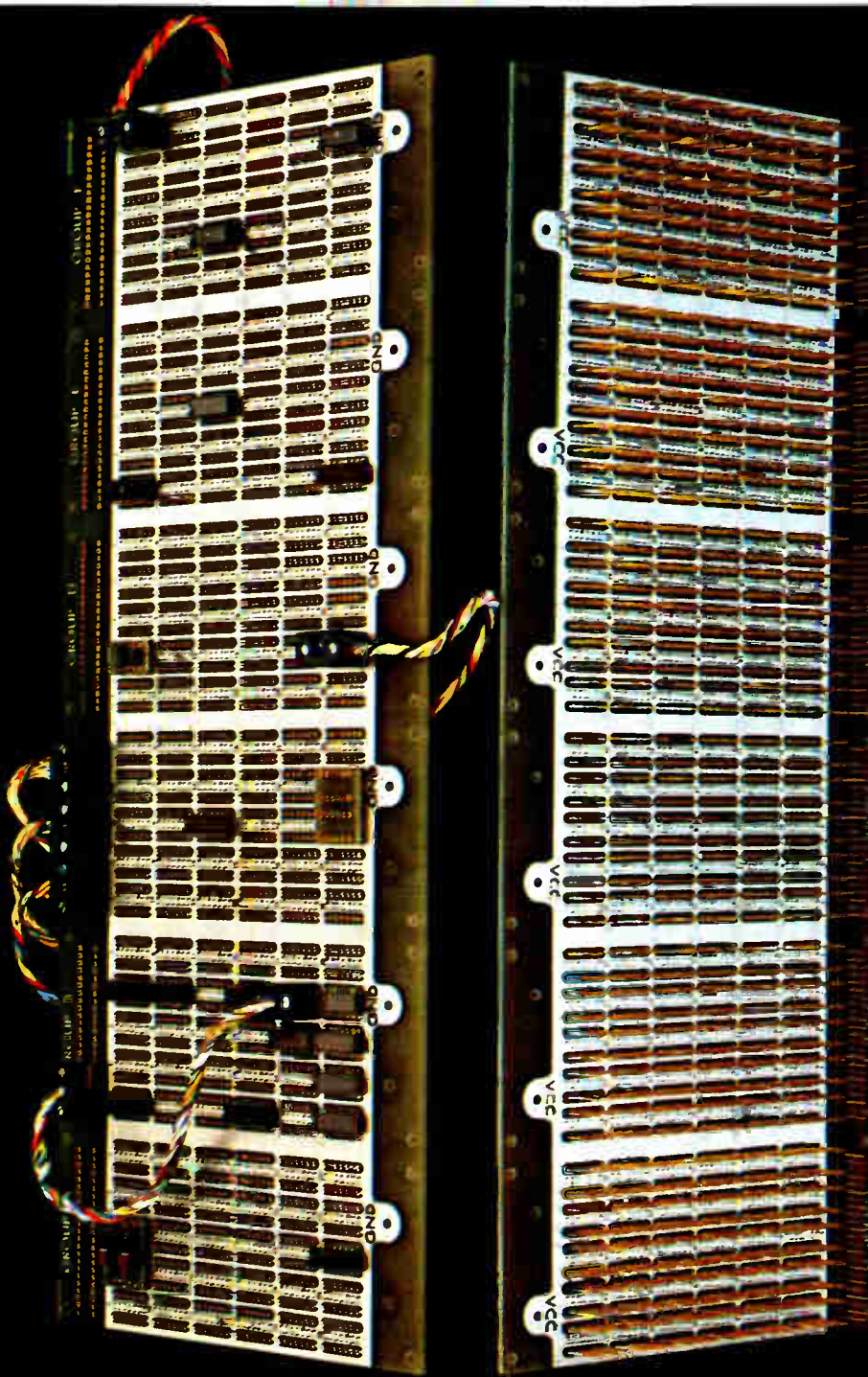

Take the 2-dimensional approach:



Let Augat in-depth design save up to 60% in total IC Packaging costs

That's what our customers tell us about our unique two dimensional approach in IC packaging panels. They simplify design and production operations — no need for functional logic cards. Our high density chassis, with three-level wire-wrap socket pins, is ready for interconnecting any desired logic or function at design, prototyping or production stage. Modular construction of panels permits user to specify any multiple of 30 up to 180 patterns. Available as standard catalog items or built to exact specifications.

Save time making circuit design changes. Simply disconnect one level of wiring on back of panel; plug in new logic and interconnect on other levels of wire-wrap pins — no waiting for design and fabrication

of logic cards. Boards can be automatically, semi-automatically or manually wrapped.

Save space. Boards may be mounted vertically or horizontally. Interconnecting is point to point with components. Also logistics problems minimized. No cards, connectors or back panels.

Eliminate many hidden costs such as designing and producing individual logic cards and maintaining spares.

Let Augat show you how to reduce your IC packaging cost — and give you greater flexibility in prototyping, production and field service.

Tel. 617/222-2202 or write: Augat Inc., 30 Perry Ave., Attleboro, Mass. 02703. **AUGAT** INC.

Circle 185 on reader service card

The one way printed circuit board

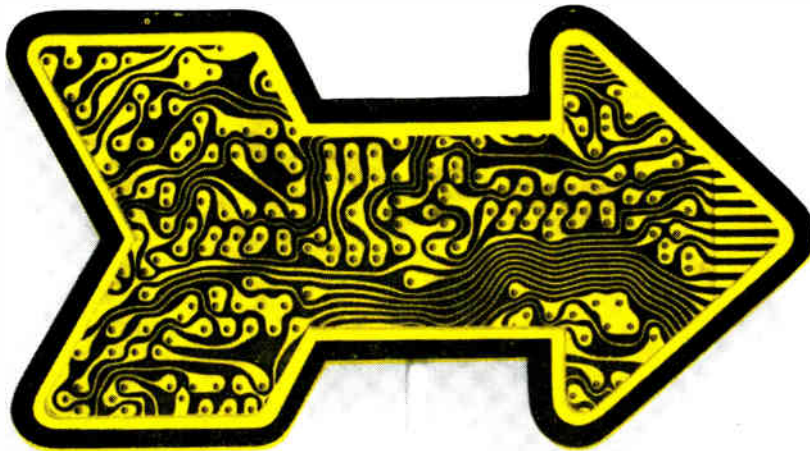

Rejects in the printed circuit business are about as popular as a northbound driver in a southbound lane. They simply must not happen. Since one in four of our employees is concerned with quality control, they almost never do. We know what rejects can cost you. Time, money, special handling. No rejects is the dictum where our shipping line begins.

Fewer rejects mean your programs can be completed on time and with complete accuracy. Your customers will appreciate it. Your P & L statement will look a little rosier. All because "ONE WAY" is the one way Cinch-Graphik knows to build PC boards. Try us?

CINCH-GRAFIK

D I V I S I O N O F U N I T E D - C A R R



200 South Turnbull Canyon Road, City of Industry (Los Angeles), Calif. 91744 • Phone (213) ED 3-1201. Sales offices in 33 principal cities throughout the United States, Great Britain, Canada, Australia and West Germany.

CONSISTING OF CINCH MANUFACTURING COMPANY, CINCH-GRAFIK, CINCH-MONADNOCK, CINCH-NULINE, UCINITE (ELECTRONICS) AND PLAXIAL CABLE DEPT.

it uses the transfer impedance of an active device. For the RM4101, Raytheon chose a buried field-effect transistor as a resistor; Signetics remains mum about the SE530's resistor.

Refining the techniques delayed both Raytheon, which was working on the 4101 last fall for Christmas introduction [Electronics, Nov. 13, 1967, p. 25], and Signetics, which announced the 530 at the IEEE show last March but couldn't give full specifications until now. Signetics' delay is reported to be related to an eleventh-hour decision to go to MOS for the chip capacitor.

Impressed with Widlar's designs, Raytheon tried to match his LM101 by moving the capacitor inside for the 4101. "He's a genius," comments one executive. "We've got to outproduce and outcost him." New processing was the only way.

No latch-up. Like the 741, the 4101 requires no latch-up when the common-mode voltage is exceeded. It gets its high differential input voltage (± 30 , again like the 741) from a series combination of 90-volt pnp and 7-volt npn input-transistor breakdown voltages.

Signetics, a subsidiary of the Corning Glass Work, is expanding its linear product lines. William Slaymaker, newly appointed linear products manager, says, "The introduction of the 530 and five other linear devices is evidence of our beginning a serious commitment to the linear market."

Signetics had experimented with a junction capacitor to stabilize the chip, but went to an MOS capacitor to save space.

No prices. One unexplained novelty on the Signetics chip is the input stage, a 300-kilohm resistor that Slaymaker will describe only as "not a standard base-diffusion resistor." Slaymaker doesn't know of any other company using such a resistor technique in volume IC production. One Signetics source said that the resistor is an active junction, not a metal film or FET.

Neither Raytheon nor Signetics will quote a price, but Fairchild says it will sell the high-grade version of the 741 for \$15 each in lots of 100 or more. It will also sell an industrial version—which varies only 10% from the prime version over a shorter temperature range of 0 to 7° C—for \$7 per 100.

The I.C. Seminar.

(get smarter, invent better and be one-up on practically everybody)

WIDLAR
Great Linear Guru



KVAMME
Wizard of Mos



In case you missed these two brilliant gents last year in Paris, we've got them together again for a seminar on what's happening with Linear and mos. Bob Widlar, who designed more than half the world's linear circuits, will pursue needed ideas and inventive applications. Floyd Kvasme, who has answers to micro-circuit questions that nobody's even thought of yet, will eloquently reveal some new *how to do it* wisdom on mos. We've booked them into the Century Plaza, Los Angeles, on June 18, 1968. We ran out of chairs in Paris, so better reserve one instantly.

Besides lunch you get all this for \$15.

9:00-9:30	CIRCUITS AVAILABLE TODAY	<i>Kvamme</i>
9:30-11:00	VOLTAGE REGULATORS	<i>Widlar</i>
11:00-12:00	MOS IN MEMORY APPLICATIONS	<i>Kvamme</i>
1:00-2:30	OP AMPS & VOLTAGE COMPARATORS	<i>Widlar</i>
2:30-3:00	MOS ANALOG SWITCH APPLICATIONS	<i>Kvamme</i>
3:00-3:45	COMMUNICATIONS CIRCUITS	<i>Hirshfeld</i>
3:45-4:15	FUTURE TRENDS FOR LINEAR DEVICES	<i>Widlar</i>
4:15-5:30	INTEGRATED CIRCUIT CLINIC	<i>Kalb, Thorkelson, Widlar, Hirshfeld & Kvasme</i>

If somebody's grabbed the coupon below, send \$15 to Regis McKenna at National Semiconductor, 2975 San Ysidro Way, Santa Clara, California 95051.

National Semiconductor Corporation
2975 San Ysidro Way
Santa Clara, California 95051

Reserve me a spot *instantly* at The I.C. Seminar.
Here's my check for \$15 to cover everything:

Name _____
Title _____
Company _____
Address _____
City _____ State _____ Zip _____

National Semiconductor

The multiplexer scheme.

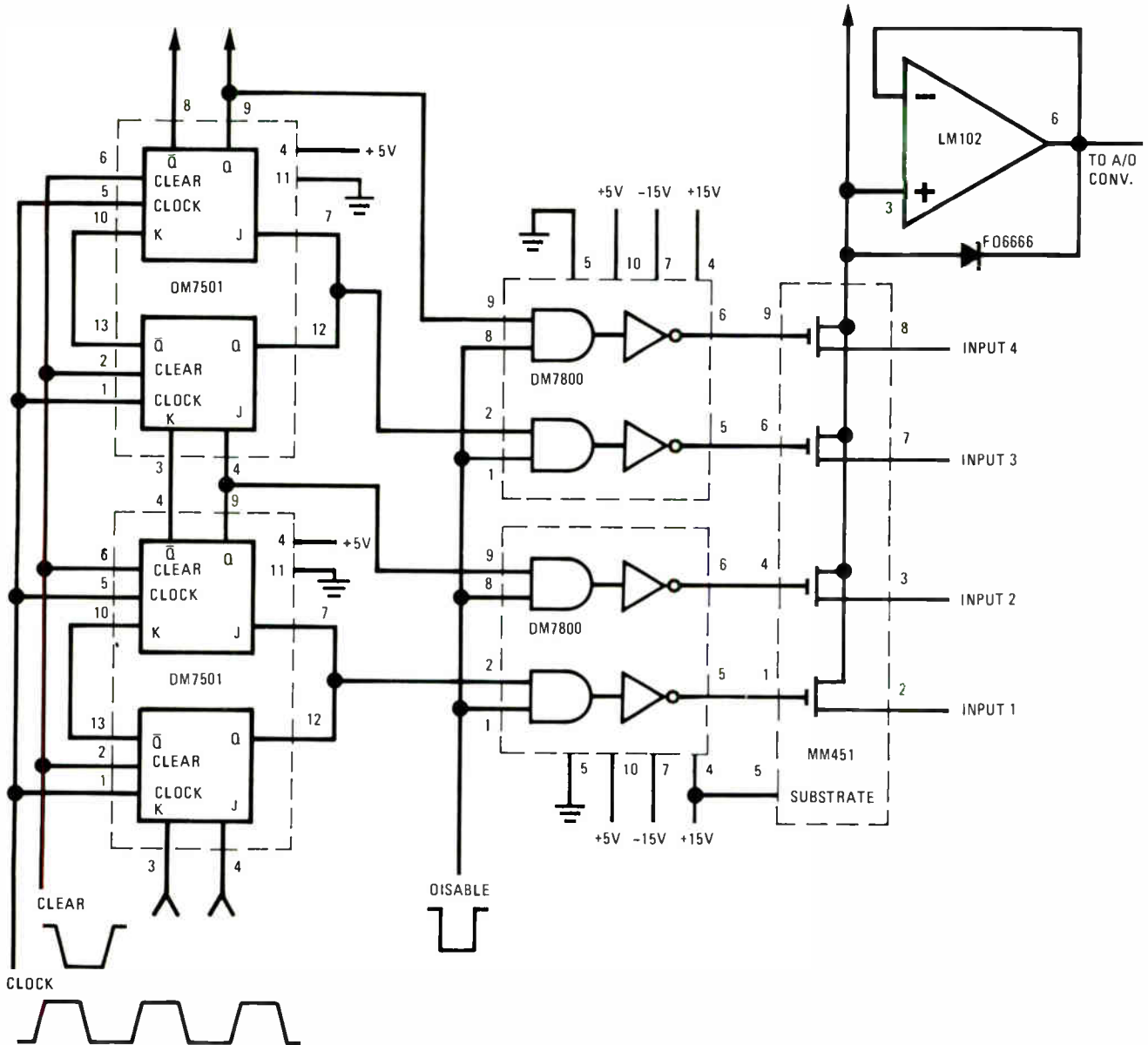

This four-channel expandable analog commutator is part of a cunning plot we've devised to attract you to buy the following:

DM 7501, dual JK flip-flop, functions as a four-bit shift register. It's monolithic, hermetically sealed and is a SN 5473 equivalent. Price at 100-999 is \$8.80.

DM 7800, dual voltage translator, changes TTL or DTL voltage levels to MOS. It's monolithic with gated inputs and with output levels variable between +25V and -25V. Price at 100-999 is \$15.00.

MM 451, a monolithic, four-channel, analog

switch with 200 Ω ON resistance. Price at 100-999 is \$20.00.

LM 102, voltage follower, performs as a buffer amplifier in the multiplexer scheme. It's a monolithic with 10 nA input current and 10V/ μ s slew rate. Price at 100-999 is \$30.00.

Maybe you would like to read a lot more about these devices. If so, write us at 2975 San Ysidro Way, Santa Clara, California 95051. Or call us (408) 245-4320.

National Semiconductor

RMC DISCAPS

the complete Ceramic Disc line

Over the years Radio Materials Company has maintained its leadership in the production of ceramic disc capacitors. A complete line offering outstanding quality has been the key to continuing growth.

STANDARD

Type C, B, BA, JF, JL and JE

SUBMINIATURE

Type SM, BT, TA and Magnacaps

GREENCAPS

Type CG, JG, and BG

SPECIAL

U.L. Listed Discaps, T.C. High Voltage, High K High Voltage and Dual Section By-Pass

RMC
.0039

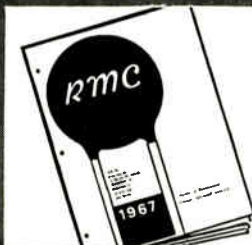

*Send for
Your
Catalog Today!*

Write on your letterhead for a copy of the RMC catalog that lists the complete line of RMC DISCAPS.

DISCAP
CERAMIC
CAPACITORS

RMC

RADIO MATERIALS COMPANY

A DIVISION OF P. R. MALLORY & CO., INC.
GENERAL OFFICE: 4242 W. Bryn Mawr Ave., Chicago 46, Ill.
Two RMC Plants Devoted Exclusively to Ceramic Capacitors
FACTORIES AT CHICAGO, ILL. AND ATTICA, IND.

ance and offset voltage. "We've tried to minimize these in the 841," Smith says. Switch resistance is 2 to 6 ohms and offset voltage is 0 to 2 millivolts. To minimize errors, Ypma adds, the ratio of the voltage reference to the offset voltage must be maximized. "The 841's low offset voltage and high reference capability [± 17 volts] optimize this ratio," he says.

Doing the work. Smith points out that a systems designer has to cope with variations in offset voltage, power supply and temperature as well as system noise. "When he puts together the pieces to make a d-a system," says Smith, "the tolerances are subtle. He can't predict what the interaction of ladder resistance, switch resistance, and switch offset will do to the output. If the designer uses discrete devices, he can't be sure they will give him the needed system specifications. We give him a pre-packaged and pre-engineered device. He knows he can put the system together on a board with any power supply or reference voltage within the range and be sure it will work to specifications. If it doesn't he can return the switch to us; he can't return the discretos when his system doesn't work."

In engineering its hybrid switch, Helipot makes 84 connections that the customer would have to make if he designed with discretos. The 841 contains 22 bipolar transistors, two zener diodes, and one monolithic IC—a series 946 diode-transistor logic. All are mounted on a single 1-by-1-inch alumina substrate having 20 pins. The package is also alumina. Cermet thick-film resistors and capacitors are included within the package.

The switch has a DTL quad two-input gate that is compatible with both DTL and transistor-transistor logic. Although a pure monolithic approach offers lower cost, the hybrid approach was chosen because of its better accuracy and faster switching speed. Says Smith: "Switching speed can be as fast as 500 nanoseconds at 25°C.

The ladder switch is priced at \$100 in quantities up to nine, and \$60 for orders of 1,000 or more. Delivery time is two weeks.

Helipot division, Beckman Instruments Inc., 2500 Harbor Blvd., Fullerton, Calif. 92634 [350]

Read all about our new rf/lf amplifier (below.)

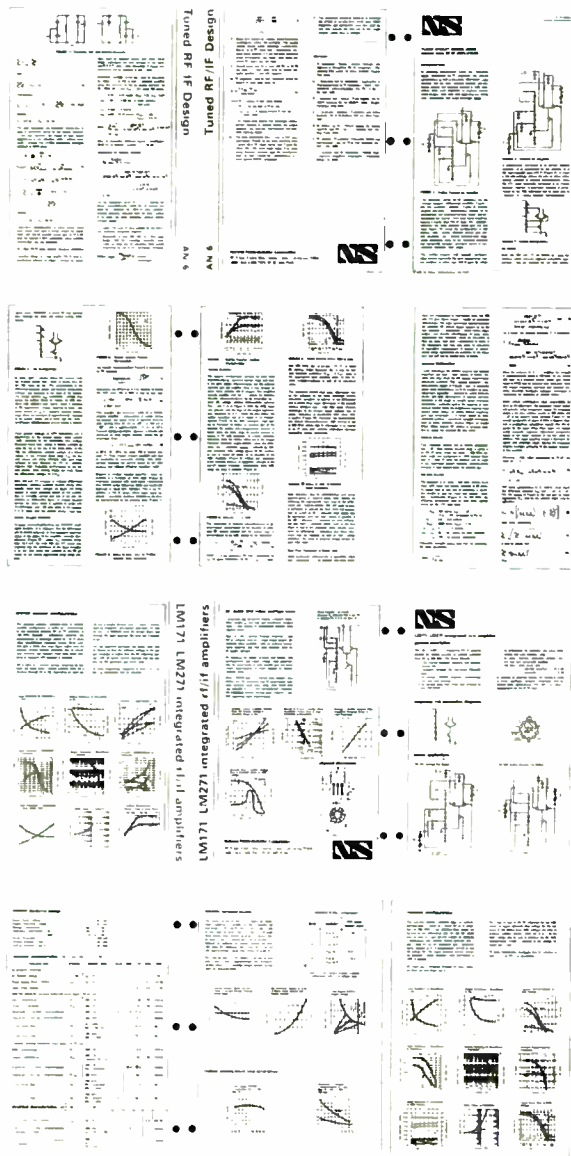

When we put out technical literature, we don't fool around. You want data? You *get* data. Like above, wherein our new LM 171/LM 271 is thoroughly detailed as a *very* general purpose rf/lf amplifier.

Its performance is excellent as an emitter-coupled FM limiting amplifier or AGC cascode to 250 MHz. It's a self-biased, wideband, electrically uncommitted, differential amplifier for video, DC and even switching applications. And the price for the LM 171 is a mere

\$4.95 for 100 to 999. Price for the industrial-commercial LM 271 is \$3.00 for 100 to 999.

Write for our new data sheet and applications note. Or, if you prefer to make do with the ones shown, ask for a magnifying glass. We'll send you one free.

National Semiconductor Corporation, 2975 San Ysidro Way, Santa Clara, California 95051.

National Semiconductor

Reserve space now for *The IC Seminar!* Widlar, Kvamme, and Hirschfeld at the Century Plaza, Los Angeles, June 18. \$15.00 covers *all*.

New Instruments Review

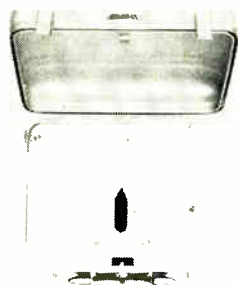

H-f reflection bridge model 62N is designed for measuring the reflection coefficient of antennas and transmission lines based on either a 300 ohm balanced or a 50 ohm unbalanced reference. Swept frequency measurements can be made over the communications range of 2 to 32 Mhz. Price is \$490; delivery, 8 weeks. Wiltron Co., 930 East Meadow Drive, Palo Alto, Calif. 94303. [361]



Solid state generator F320A provides a 10 hz to 10 Mhz span in 6 decade ranges, and produces synchronized sine and square wave outputs. Square wave rise-time is 10 nsec. Distortion is less than 0.5% to 1 Mhz; frequency response, less than 0.1 db 100 hz to 1 Mhz; sine wave output, 0 to 3.16 v rms into 50 or 600 ohm load. Data Royal Corp., 8014 Armour St., San Diego, Calif. [362]



Quartz piezoelectric pressure sensor 607A measures high-level pressures in gun barrels, shock tubes, closed bombs, and in explosive metalforming applications. Its high resonant frequency, 240 khz, suits it for use where fast rise time or high frequency response is required. It measures pressures to 75,000 psi. Kistler Instrument Corp., 8989 Sheridan Dr., Clarence, N.Y. 14031. [363]

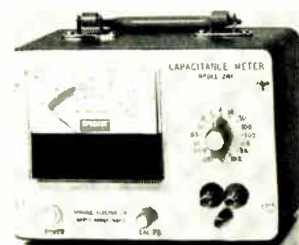

Direct-reading capacitance meter model 2W1 measures from 300 pf to 10,000 μ f in 15 capacitance ranges, and only 1 v a-c is impressed across the capacitor being tested. Measurement time is 1 sec maximum. The read-out is a large 4-in. meter with linear calibration, readable to within 1% of full scale. Sprague Electric Co., 35 Marshall St., North Adams, Mass. 01247. [364]



Memory voltmeter model 5201C, featuring a dual shielded cabinet to prevent radiated transients or common mode errors, holds one-shot or transient voltage peaks permanently or until reset. It will measure pulses with durations as short as 50 nsec, and amplitudes from d-c to 1,000 v; optional probes to 30 kv. Micro Instrument Co., 12901 Crenshaw Blvd., Hawthorne, Calif. 90250. [365]



Digital panel meter series 180 features accuracy of 0.05% of reading ± 1 digit, obtained through the use of high stability circuits. The basic 100 mv full scale range may be extended to 1,000 v by choice of a single range resistor installed internally or externally. Unit occupies 3.25 x 5.6 in. of panel space. United Systems Corp., 918 Woodley Rd., Dayton, Ohio 45403. [366]

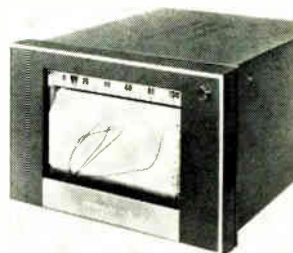

Four-pen versatility for multiple X-Y plots, combined with repeatable accuracy (0.25%) in the null-balancing potentiometric drive, are features of the "contour/riter" II recorder. The unit is suited to unattended recording of process runs, analog traces of computer results and experimental or production test regimes. Texas Instruments Inc., Box 66027, Houston 77006. [367]

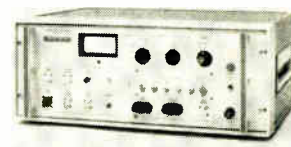

Log amplifier test set series TSL features 100 db range. Units are available from 10 to 100 Mhz and allow for instantaneous scope presentation of the dynamic range of a log amplifier. Nonlinearities to within ± 0.25 db can be observed and measured from +10 dbm to -90 dbm. Prices start at \$2,995. RHG Electronics Laboratory Inc., 94 Milbar Blvd., Farmingdale, N.Y. 11735. [368]

New instruments

IC testers: stepping up in class

Starting off with a low-priced system to evaluate digital circuits, company adds medium-priced unit and another for linears

"Born of desperation" was how one official at Beckman Instruments Inc. described its development of a stripped-down, economy-model IC tester it introduced last year. Priced at \$495 and dubbed the model 999, the system has given rise to a family as two more integrated-circuit

testers have been added to the line.

Making their bow this summer will be the models 998 and 997. Like the 999 [Electronics, Sept. 18, 1967, p. 205], the 997 is a digital-IC tester. But unlike the forerunner, the 997 is an automatic tester and carries a higher price tag—\$3,995. And

where the 999 takes 60 seconds to complete a test, the 997 does it in 100 milliseconds. The 998 is a linear-IC tester and is priced at \$945.

Beckman's linear testers differ from other linear types in that it doesn't use the gain of the device under test to establish the millivolt-level input voltages. Thus, the 998 can test any linear IC not just those having high gain. Moreover, Beckman's instrument prevents the test circuit from oscillating regardless of which pin is used for the input.

All three instruments in the line are programed with a matrix. The 998, however, provides simultaneous input and output readings on



Dual-beam portable oscilloscope model S1302A is operable on either internal battery or line voltage and features a choice of two plug-in Y amplifiers (either 15 or 30 Mhz), and 21 ranges of calibrated sweep speeds from 100 nsec/cm to 0.5 sec/cm. Signal delay is approximately 190 nsec. Motorola Communications & Electronics Inc., 4900 W. Flournoy St., Chicago 60644. [369]

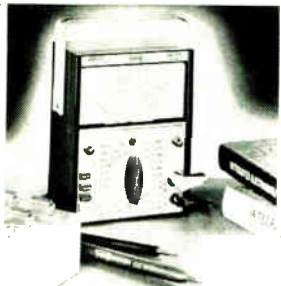

Portable, battery-operated volt-ohm-milliammeter model 601 features push-button function switches, FET circuitry providing input impedance of 11 megohms on all a-c and d-c ranges, low power ohms for IC measurements, and 52 range selections. Accuracy is $\pm 2\%$ of full scale on d-c and $\pm 3\%$ for a-c. Triplett Electrical Instrument Co., Bluffton, Ohio 45817. [370]

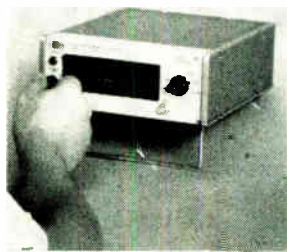

Electronic counters operate at rates up to 10 Mhz. The 5321A uses the power line for a time base, measures frequency with 0.1 or 1-sec gates, and totalizes. The 5321B has a quartz crystal time base of $1/10^6$ /month aging rate, 4 gate times (0.01 to 10 sec), measures frequency and time interval. Hewlett-Packard Co., 1501 Page Mill Rd., Palo Alto, Calif. 94304. [371]

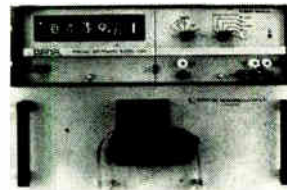

Photoblock comparator test set model 5520 is for the automatic testing of subassemblies. Tests may involve measurement of voltage, current, resistance, frequency, etc., depending on the capability of the dvm. Each test takes $1/4$ sec. Price is \$3,995; delivery is 3 to 6 weeks. Electronic Engineering Co. of California, 1601 E. Chestnut Ave., Santa Ana, Calif. 92702. [372]

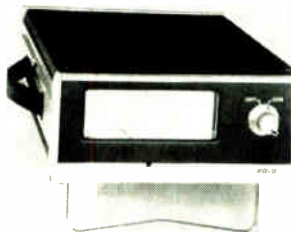

Nine-decade logarithmic current compression amplifier model LN-721 is designed for measurement of positive or negative direct currents from 10 ma to 10 pa which are displayed on one logarithmic meter scale. An output is provided for analog recording or remote meter indications. Price is \$840; delivery, 30 days. EG&G Inc., P.O. Box 755, Goleta, Calif. 93104. [373]

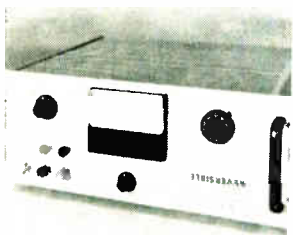

Bipolar power source model OPSIII can function as a reversible d-c power supply, 200 w servo amplifier, or, with external oscillator, as an a-c power source to 20 khz. Applications include semiconductor testing, servo drives, acoustic research, and beam steering. The unit measures 7 x 19 x 15 in. Tidewater Technological Inc., 714 Oyster Point Rd., Newport News, Va. [374]



Counter-timer CF-635R, featuring plug-in IC's and 1 3/4-in. front panel height, is designed for frequency, time interval, ratio, period averaging and totalize measurements in laboratory and system applications. It has a 1 Mhz crystal controlled time base. Sensitivity is 10 mv or 100 mv. Count rate is 15 Mhz. Anadex Instruments Inc., 7833 Haskell Ave., Van Nuys, Calif. 91406. [375]

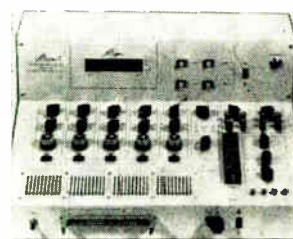

IC analyzer 716 may be manually or semiautomatically operated. It features 4 precision voltage supplies, 1 precision current supply, h-f pulse generator, 3 decimal digit readout, 4 voltage comparators for go-no-go operation, 10 x 40 matrix for manual and 100 pin patch plugs for semiautomatic use. Microdyne Instruments Inc., 225 Crescent St., Waltham, Mass. 02154. [376]

twin analog panel meters. And it can be used with a function generator and an oscilloscope to provide go-no go indication during incoming inspection of IC's.

Curves. When used with the function generator and scope, the 998 slots the output-versus input transfer function. In the plot, at the right, the upper and lower limits of the curve indicate positive and negative output limits: the x-axis deflection at $y = 0$ shows input offset voltage, and the slope of the curve determines gain. Shape of the curve indicates gain linearity.

The function generator calibrates the scope. A 1-hertz signal is fed to

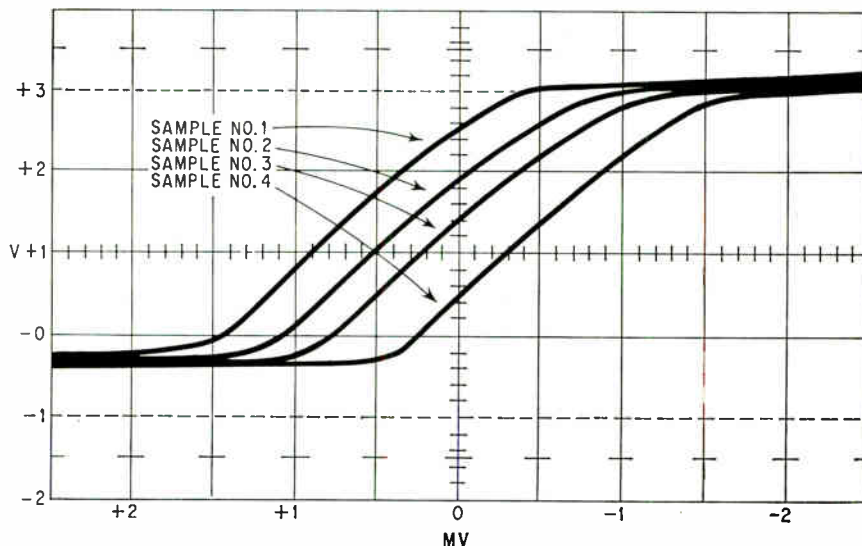

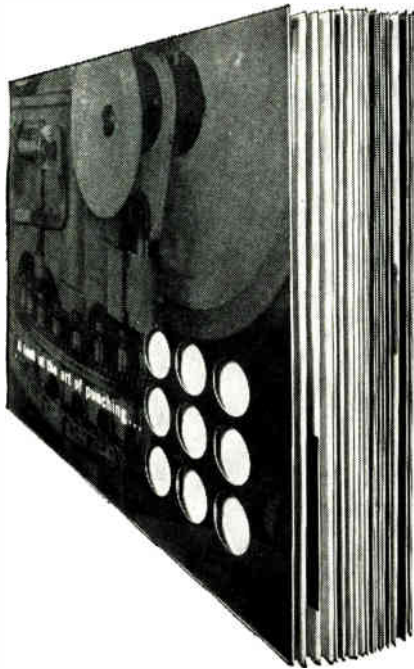

44 brand new pages of helpful punching information

- Six basic punching concepts
- Turret punch presses
- Stylus operated turret punch presses
- OBI punch presses
- Single station punch presses
- New horn punch presses
- Adjustable punch and die sets
- All shapes and sizes of punches and dies
- Template layout machines

Complete information! Illustrations, descriptions, specifications and prices. Ask your distributor for the new 44-page Di-Acro punching catalog or write us.



DI-ACRO

division of



435W EIGHTH AVENUE
LAKE CITY, MINNESOTA 55041

the scope's horizontal-deflection circuit and also, after being attenuated by 1,000, to the 998's transfer input. Thus in the illustration, which was derived from an actual 710 differential comparator under test, horizontal divisions represent 1 millivolt and vertical divisions 1 volt.

If outside limits for the curve are drawn with a grease pencil on the scope, an operator could tell at a glance whether a circuit meets specifications.

The 997 automatic tester is the latest entry in the medium-priced class. After a logic matrix has been set, the instrument automatically steps through a series of tests and provides go, no-go readings. Earlier instruments in this class required special printed-circuit cards for each IC to be tested. These cards cost up to \$100 each. The 997's program matrix is made up simply of sliding contacts.

There are well over 50 IC's in the 997's logic—mainly plastic-packaged resistor-transistor-logic circuits from Motorola Inc.—that control the programing and testing functions. A logic simulator, a device that has already been tested and is known to be good, guards against translating programing errors into test errors. A simulator responding incorrectly to a test indicates a program correction is necessary.

Although the 997 can test up to 36,000 IC's an hour, the actual test rate is limited by the speed at which the circuits can be inserted into the test socket manually. At best, manual insertion runs about 12 a minute. But the tester is compatible with automatic handlers that can accommodate up to 10,000 circuits an hour.

Specifications

model 998	
Device supply	
V_{cc}	variable, 3 to 30 v
V_{EE}	variable, -3 to -30 v
Current source	50 μ a to 100 ma
Current sink	50 μ a to 100 ma
Input voltage	± 2.5 mv to ± 10 v in 8 ranges
Input current	± 2.5 μ a to ± 50 μ a in 5 ranges
Output current (device supply)	± 10 ma and ± 50 ma
Input power	15 w
Operating temperature	+15 to +45°C
Weight	10 lbs
Price	\$945

Beckman Instruments Inc., 2200 Wright Ave., Richmond, Calif. 94804 [377]

BALLANTINE VOLTMETERS

and other Electronic Measuring Instruments

MODEL NUMBER	VOLTAGE RANGE	FREQUENCY RANGE	ACCURACY		NOTES	PRICE
			% OF READING	EQUIVALENT % OF F.S. AT MID SCALE		

ANALOG VOLTMETERS, AMMETERS, OHMMETERS

Average-responding vm's, calibrated in RMS of sine wave

300E	300 μ V-300 V	30 Hz-200 kHz	2	1	9 1/2 in. wide panel, isolated chassis	\$305
300G	1 mV-1 kV	10 Hz-250 kHz	1	1/2	Highest accuracy vtm in the line	315
300H	30 μ V-330 V	10 Hz-1 MHz	2	1	Highest sensitivity vtm in the line	260
300M	500 μ V-500 V	15 Hz-0.5 MHz	2	1	Sealed, militarized type	450
303	100 μ V-350 V	2 Hz-6 MHz	1	1/2	Solid state, choice of battery or line operated	Line 305 Batt. 360
302C	100 μ V-1 kV	2 Hz-150 kHz	3	1 1/2	Battery-operated, accurate to 2 Hz. Batt. inc.	340
310B	100 μ V-300 V	10 Hz-6 MHz	2	1	Wide band, sensitive vtm	345
314A	100 μ V-1 kV	10 Hz-6 MHz	2	1	Wide band vtm with 10 M Ω probe	395
317	300 μ V-350 V	10 Hz-11 MHz	2	1	Exceptionally wide band, with 10 M Ω probe	495

Peak, or peak-to-peak vm's

305A	1 mV-1 kV	5 Hz-0.5 MHz	2	1	Pos. or neg. peaks, or P-P	480
316	20 mV-200 V	0.01 Hz-30 kHz	3	1 1/2	P-P, infrasonic to as low as 0.01 Hz	395

True-RMS vm's

320A	10 μ V-330 V	5 Hz-4 MHz	2	1	Sensitive, accurate to 5 Hz	500
323	100 μ V-330 V	10 Hz-20 MHz	2	1	Wide band, solid state, choice of batt. or line operated	Line 505 Batt. 560
340	300 μ V-3(300) V	0.1 MHz-2 GHz	4	2	Calibrated to 700 MHz. Useful to 2 GHz	620
350	0.1 V-1199 V	50 Hz-20 kHz	0.25	—	Highest accuracy for true-rms measurements	720

True-RMS/Average/Peak vm

321	10 μ V-330 V	5 Hz-4 MHz	2	1	Choice of 3 types of measurements	575
-----	------------------	------------	---	---	-----------------------------------	-----

DC Voltage and Current meter

365	1 μ V-1000 V		1	1/2	Most accurate available	620
	0.001 μ A-1 A		2	1		

DC/AC VOLT/OHMMETER

345	0-1 kV dc		1	1/2	Highest accuracy volt ohmmeter	440
	0-350 V ac	20 Hz-1 GHz	2	1		
	0-5000 M Ω		3	1 1/2		

DIGITAL VOLTMETERS

Model 353 0 to 1000 V dc, 4 digit with over-range to 5, plus interpolation of last digit
Accuracy 0.02% + 0.01% f.s., 1/2 rack module 510

Model 355 0 to 1000 V ac or dc, 3 digit with over-ranging to 4, plus interpolation of last digit
Accuracy 0.25% f.s. to 500 V, 1/2 rack module 640

CALIBRATORS, AC/DC, PORTABLE

Model 420 0 to 10 V dc, or ac at 1000 Hz, RMS, or P-P. Set to any precise value. Accuracy 1/4% 415

Model 421A 0 to 111 V dc, or ac at 400 or 1000 Hz, RMS or P-P. Accuracy 0.15%. Also 0 to 1110 V ac, 400 Hz, RMS or P-P
Set to any precise value. 660

AC VOLTAGE STANDARD DEVICES

Model 390 NBS A-T (Attenuator-thermoelement) Voltmeter, 10 MHz-1 GHz, 0.5 V-300 V. Includes Model 2390 Tee. 1925

Model 393 NBS HF Transfer Voltmeter, with six probes, 1 V-100 V, 25 Hz to 30 MHz Set 1270

Model 440 NBS Micropotentiometer, 4 to 1 range, 15 μ V-1.5 V, 0-900 MHz Each unit 250

AMPLIFIERS, CAPACITANCE METERS, AC TO DC LINEAR CONVERTERS

Model 220C Amplifier, gain of 10 or 100, 10 Hz to 150 kHz, battery-operated and included 180

Model 520 Capacitance Meter, direct reading 0.01 pF to 13 μ F. Includes accessories 455

Model 710A AC to DC Linear Converter, 1 mV-1 kV, 30 Hz-250 kHz, 1 V to 10 V each decade 510

All prices f.o.b. Boonton, N.J. for portable version (except 300E), and are subject to change without notice.

Write for brochures giving many more details



BALLANTINE LABORATORIES INC.

Boonton, New Jersey

Phone: 201-334-1432 TWX: 710-987-8361

Digitran made it big

about so big

Digitran perfected a simple idea... the thumbwheel switch. Making it was simple. Making it perfect was a big job. We did, and called it a Digiswitch[™]. After we made it perfect, we made it small. We call that a Miniswitch[™].

 Making it small was a big job, too. It took lots of time, talent and money. But it was worth it. Miniswitch can help you save up to 50% of your panel space; give you accurate, dependable controls that are simple, easy to set and read; under any conditions, in any environment.

 At Digitran you can count on our know-how to help solve your most complex switching problems. We've the industry's most complete thumbwheel switch application library to prove it. Given the opportunity, we can probably save you both time and money.

 But don't take our word for it, find out for yourself. Send for a complete catalog on switches (big and little). From Digitran. The thumbwheel switch company you can count on.

THE DIGITRAN COMPANY

Subsidiary of Becton, Dickinson and Company 

855 S. Arroyo Pkwy./Pasadena, Calif. 91105

Tel: (213) 449-3110/TWX 910-588-3794

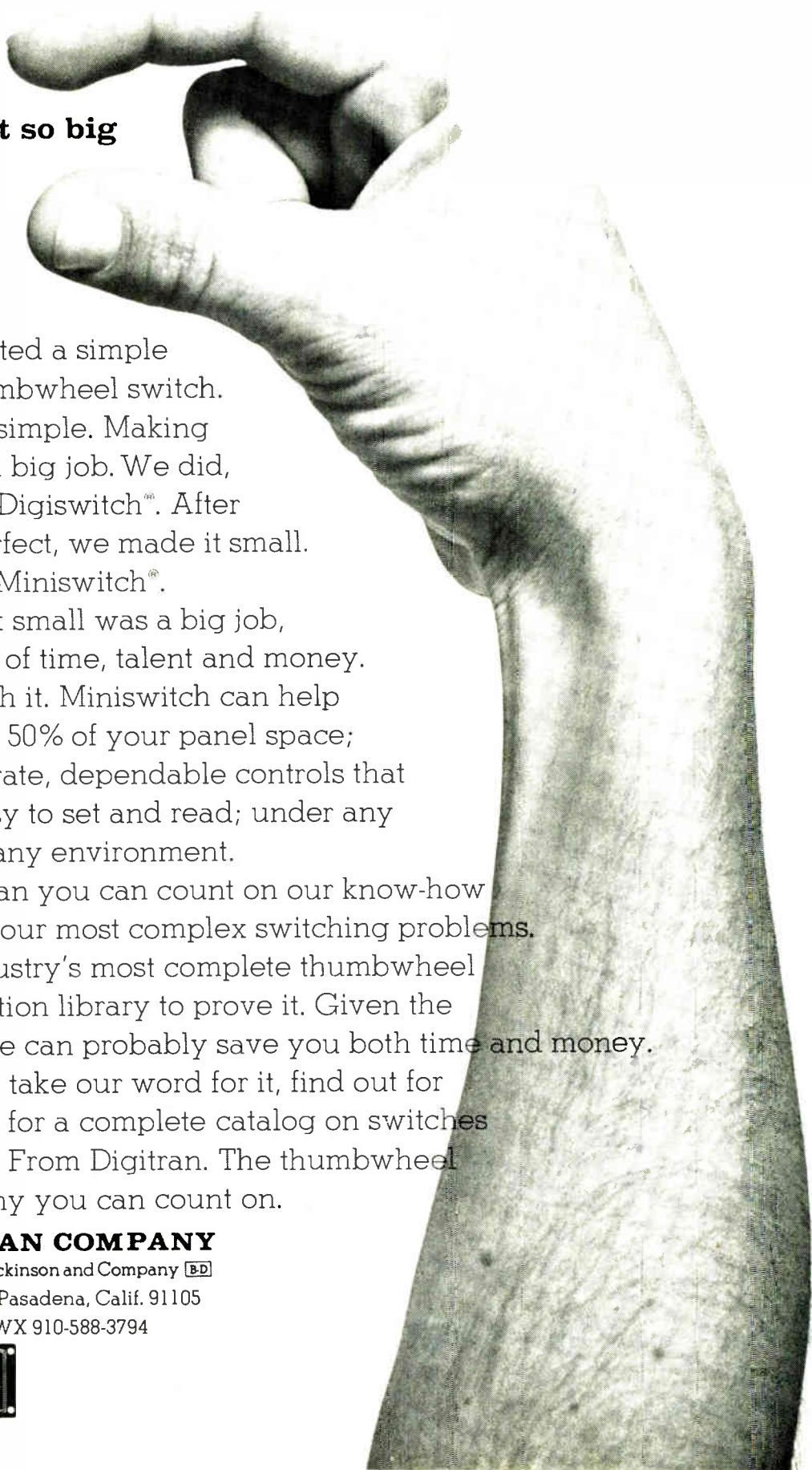

New Semiconductors Review

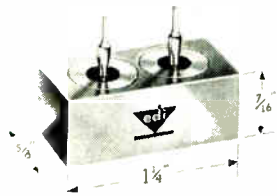

Full-wave, center tap silicon rectifier designated Minisil occupies minimum space while delivering 40 amps d-c at 125°C case temperature. Recovery time is 500 nsec when measured from 1 amp d-c to 30 v d-c reverse voltage. Piv ratings are 50 to 600 v. Price of the 50 piv unit is \$36 each in production lots. Electronic Devices Inc., 21 Gray Oaks Ave., Yonkers, N.Y. 10710. [436]

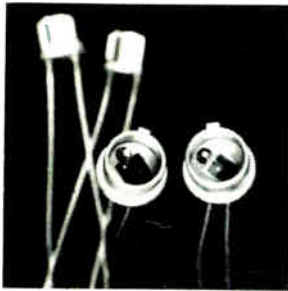

Ultrafast photodiode type 622 is a silicon p-n junction device that becomes totally depleted upon application of about 20 v reversed bias. It is for pulsed laser detection in optical radar, range finding, and optical fusing. It features high quantum efficiency between 0.4 and 1.15 microns. Electro-Nuclear Laboratories Inc., 115 Independence Dr., Menlo Park, Calif. 94025. [437]

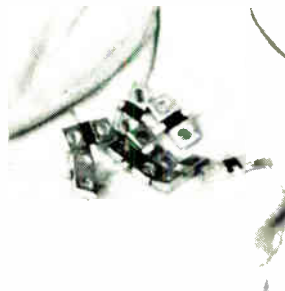

Eight-channel MOS multiplex switch 3705, in a 16-lead package, is compatible with npn bipolar logic. The logic inputs operate on voltage levels of 0 to 5 v and can be driven from CCSL (compatible current sinking logic) devices without using level shifting circuitry. Operating temperature is -55° to +85°C. Fairchild Semiconductor, 313 Fairchild Dr., Mtn. View, Calif. 94040. [438]

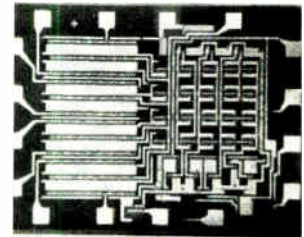

P-i-n diode 5082-3040 behaves as a smooth section of 50-ohm transmission line when the diode is unbiased or has reverse bias. Insertion loss is typically 0.4 db at X band; vswr, typically less than 1.6 up to 18 Ghz. Typically, the time taken to switch from 100 ma forward bias to 50 v reverse bias is 50 nsec. Hewlett-Packard Co., 1501 Page Mill Rd., Palo Alto, Calif. 94304. [439]

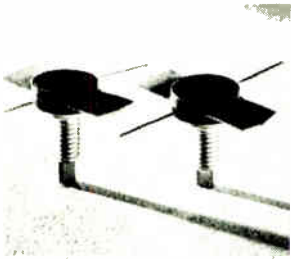

Silicon planar power transistor S1000 offers 3 w output at 1 Ghz. It features 35% efficiency with a gain-bandwidth product greater than 1 Ghz and a thermal resistance less than 10°C/w. When used as an oscillator, it has a typical output of 1.75 w at 1 Ghz or 800 mw at 1.75 Ghz. Price (1-99) is \$35 each. Electronic Components, Div. of United Aircraft, Trevose, Pa. [440]



Varactor diode chips rated over 90 v breakdown are for use in hybrid IC's requiring electronic tuning, harmonic generation, or automatic frequency control. In strip-line applications, the low junction capacitance chips (0.4 pf at -4 v) are useful at frequencies in excess of 9 Ghz. Chips measure 0.020 x 0.020 in. MSI Electronics Inc., 34-32 57th St., Woodside, N.Y. 11377. [441]

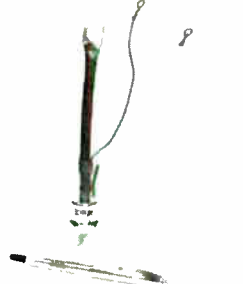

Series 100AC of 100-amp logic triacs have prv ratings as high as 1,000 v. Housed in T0-94 packages, the units are designed to control motors of more than 30 h-p. They feature a transient voltage rating in both directions exceeding the operating voltage rating. Prices (10-99) start at \$72. International Rectifier, 233 Kansas St., El Segundo, Calif. 90245. [442]



High voltage SCR's series MCR-1336 furnish up to 10,000 pps performance in pulse forming networks. The 300 amp (pulse) devices are capable of 75 nsec typical rise time at 100 amps forward current in a capacitive discharge circuit with gate current of 500 ma at 25°C. Peak forward blocking voltages are 300 to 800 v. Motorola Semiconductor Products, Box 955, Phoenix. [443]

New semiconductors

Meeting specifications—after radiation

Transistors and diodes are tested and classified after exposure to fast neutron irradiation

Last year, radiation-resistant components destined for weapons and military communications systems accounted for more than \$10 million in sales. This year, sales should run even higher as work moves along on Poseidon, advanced Minuteman, Sentinel, and

similar programs. But until recently, radiation specifications have been open to negotiation since not much was known about the specific effects of radiation on semiconductor devices. However one manufacturer is doing something about this.

Fairchild Semiconductor has de-

veloped a line of 18 discrete components that meet specifications after being subjected to fast neutron irradiation of 3×10^{14} nvt (the time integral of neutron flux). Minimum and maximum parameters are guaranteed. The electrical characteristics of the devices—including transistor amplifiers, core drivers, rectifiers, switching diodes, and switching transistors—are based on worst-conditions.

The customary approach to radiation-damage problems, explains David K. Myers, Fairchild's radiation effects manager, has been to avoid them either by shutting the system during a radiation burst

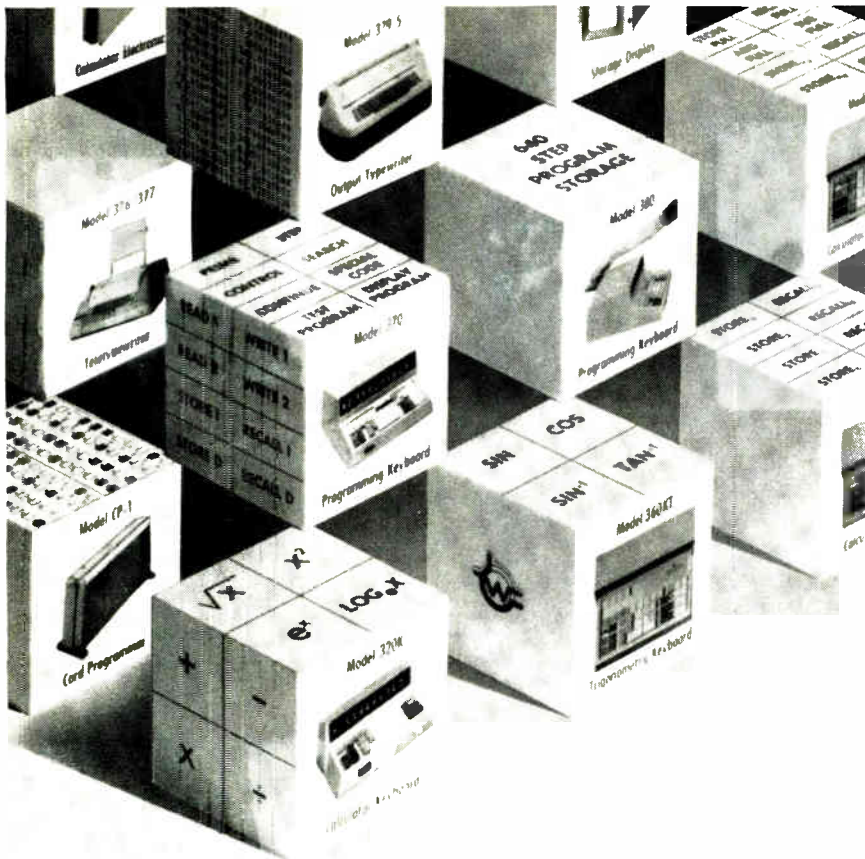

WANG'S versatile, expandable calculator/computing systems

A unique building-block approach. You can specify the exact amount of power and versatility you need from a wide range of optional capabilities. (Wang offers more than all other electronic calculator manufacturers combined.)

Obsolescence-proof problem solving. Begin as simply as budget and requirements dictate. Add-on compatibility ensures that your initial purchase is never obsolete. Simply add modular capabilities to match your needs.

You can standardize on 300 Series. A growing number of companies use them to solve everything from basic arithmetic computations to complex equations and program-

med calculations. Models 370 and 380 Programming Keyboards branch, loop, do sub-routines, make decisions and manipulate arrays to put true desk top computing power at your fingertips. Each is furnished with the most comprehensive program library available.

No waiting for computer time.

Direct accessibility and immediate results on Wang 300 Series enable you to proceed directly to the important areas of analyzing and applying the information generated. Complete Wang systems can be purchased at less cost than renting a larger, less versatile system for 1 year. For application assistance or an immediate demonstration, call your nearest Wang office.



Dept. 5-H, 836 North St., Tewksbury, Massachusetts 01876 • Tel. 617 851-7311

In Major Cities, Tel:

(201) 241-0250	(215) 642-4321	(313) 278-4744	(412) 366-1906	(514) 482-0737	(702) 735-5802
(203) 666-9433	(216) 333-5611	(314) 727-0256	(415) 454-4140	(518) 463-8877	(713) 668-0275
(205) 245-6057	(301) 588-3711	(317) 631-0909	(416) 364-0327	(601) 234-7631	(714) 234-5651
(206) 622-2466	(301) 821-8212	(319) 365-2966	(504) 729-6858	(612) 881-5324	(716) 381-5440
(212) 682-5921	(303) 364-7361	(402) 341-6463	(505) 255-9042	(614) 488-9753	(717) 397-3212
(213) 278-3232	(305) 841-3691	(404) 457-6441	(512) 454-4324	(617) 851-7311	(816) 421-0890
(214) 361-4351	(312) 456-1542	(405) 842-7882	(513) 531-2729	(702) 322-4692	(817) 834-1433
					(919) 288-1695

or by ignoring the data collected during the radiation. And this is possible only when the device isn't permanently damaged.

Cracking down. Permanent damage, he points out, is principally the consequence of fast neutron irradiation which causes decreased conductivity, carrier lifetime, and emitter efficiency. These, in turn, result in degraded current gains and increased saturation voltages and leakage currents. The military, however, is now insisting that systems be capable of operating in both ionizing and permanent-damage types of environments.

According to Ed Farrell, Fairchild's product marketing manager for small signal transistors, semiconductor makers have had to follow two paths: build devices that would be radiation resistant, or develop radiation-environment specifications by subjecting standard products to heavy irradiation.

For the last two years, says Farrell, Fairchild has followed the latter course, conducting extensive evaluations of the electrical characteristics of transistors after they have undergone fast neutron irradiation. Most of the devices in the new line are standard Fairchild products.

Systems manufacturers, says Farrell, have had to spend a great deal of time and money testing devices for radiation tolerance. Unfortunately, their results haven't always been complete. To properly specify a product, says Farrell, engineers must test a large number of devices to account for minor variation between batches.

On guard. What must be avoided, says Farrell, is any change in processing that would alter the characteristics of the device, and hence, its post-irradiation characteristics. This means the process requires very exacting supervision.

Another difficulty is the problem of classified parameters. When the devices are incorporated into classified projects, the company believes that the radiation tolerances will then become classified, too. But until then, both the devices and their specifications will be available from stock. Prices for the transistors run from \$10 to \$15 each.

Fairchild Semiconductor Corp., Mountain View, Calif. [444]

RCA announces

Medium-Power DTL CD2300 Line

at economy prices

45 types / 3 package styles / 2 Temperature Ranges
Gates / Expanders / High Fanout Gates
Clocked Flip-Flops / Hex Inverters
2K Ω and 6K Ω Output Pull-Up Options

- For Your Military Applications:
CD2300 Series—15 circuits in RCA's Unique Ceramic Flat Package.
CD2300D Series—15 circuits in RCA's Unique Ceramic Dual In-Line Package.
- For Industrial and Commercial Applications:
CD2300E Series—15 circuits in RCA's Dual In-Line Silicone Package.
- Compatible with RCA CD2200 and 2200D Low-Power DTL Series.

exact replacements for 830 and 930 series DTL

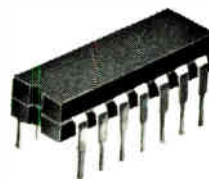
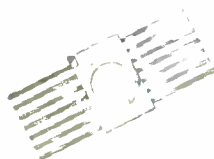

Circuit and Pull-up Option	-55° C to +125° C Operation				0° C to +75° C Operation	
	14-Lead Ceramic Flat Pack	Price (1000 Units)	14-Lead Ceramic Dual In-Line Package	Price (1000 Units)	14-Lead Dual In-Line Silicone Package	Price (1000 Units)
NAND Gates						
Dual-4 Expandable (6K Ω)	CD2300/930	\$2.50	CD2300D/930	\$2.50	CD2300E/830	\$1.05
Dual-4 Expandable (2K Ω)	CD2301/961	\$2.50	CD2301D/961	\$2.50	CD2301E/861	\$1.05
Dual-4 High Fanout, Expandable (transistor output pull-up)	CD2306/932	\$2.75	CD2306D/932	\$2.75	CD2306E/832	\$1.15
Dual-4 High Fanout Expandable (no output pull-up)	CD2307/944	\$2.75	CD2307D/944	\$2.75	CD2307E/844	\$1.15
Triple-3 Input (6K Ω)	CD2308/962	\$2.75	CD2308D/962	\$2.75	CD2308E/862	\$1.15
Triple-3 Input (2K Ω)	CD2309/963	\$2.75	CD2309D/963	\$2.75	CD2309E/863	\$1.15
Quadruple-2 Input (6K Ω)	CD2302/946	\$2.75	CD2302D/946	\$2.75	CD2302E/846	\$1.15
Quadruple-2 Input (2K Ω)	CD2303/949	\$2.75	CD2303D/949	\$2.75	CD2303E/849	\$1.15
Hex Inverters						
Diode Input (6K Ω)	CD2310/936	\$2.90	CD2310D/936	\$2.90	CD2310E/836	\$1.45
Diode Input (2K Ω)	CD2311/937	\$2.90	CD2311D/937	\$2.90	CD2311E/837	\$1.45
Expandable Input (6K Ω)	CD2312	\$2.90	CD2312D	\$2.90	CD2312E	\$1.45
Expandable Input (2K Ω)	CD2313	\$2.90	CD2313D	\$2.90	CD2313E	\$1.45
Flip-Flops						
Clocked RS with JK Capability (6K Ω)	CD2304/945	\$3.00	CD2304D/945	\$3.00	CD2304E/845	\$1.90
Clocked RS with JK Capability (2K Ω)	CD2305/948	\$3.00	CD2305D/948	\$3.00	CD2305E/848	\$1.90
Input Expander						
Dual 4-Diode	CD2314/933	\$2.25	CD2314D/933	\$2.25	CD2314E/833	\$.90

Ask your RCA Representative for details. See your RCA Distributor for his price and delivery. For technical information, write Commercial Engineering, Section ICN 5-4, RCA Electronic Components, Harrison, N.J. 07029.

RCA
Integrated
Circuits

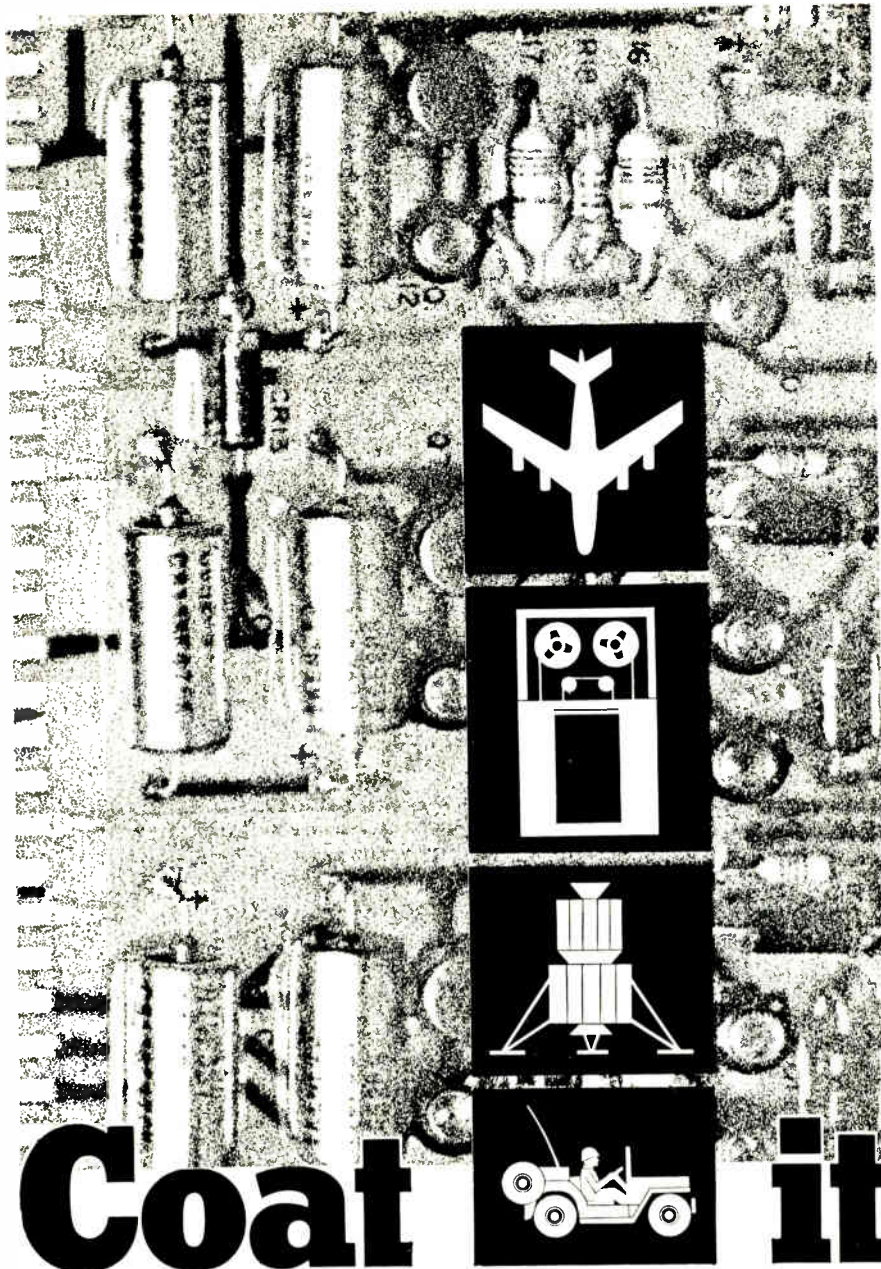

...with one of HYSOL's seven printed circuit coatings by Spray, Dip or Brush

HYSOL, the most experienced producer of printed circuit coatings, offers the widest range of coatings for commercial and military uses. HYSOL epoxy coatings PC12-007-M, PC16-M, PC23-M and PC26-M meet the rigid MIL-I-46058B requirements, and urethane coating PC22 meets NASA MSFC-SPEC-393 specification requirements. Testing in a complete electronic testing laboratory insures precise quality control.

HYSOL epoxy and urethane coatings are in use protecting circuits on military and commercial jet aircraft, aerospace vehicles, control, communication and EDP equipment. All HYSOL coatings are proven fungus resistant (MIL-E-5272) and all are transparent.

Write, wire or phone HYSOL, Dept. EM-58, Olean, New York 14760, for application engineering assistance. Ask for Printed Circuit literature.

HYSOL HYSOL DIVISION
THE DEXTER CORPORATION

New semiconductors

Cubic zener has low drift

Plug-in package
for p-c boards
uses stable chip

A zener reference package that's less than a cubic inch, has been developed by Julie Research Laboratories Inc. The zener, called the ZVR-500, eliminates the need for ovens in circuits requiring high stability. Without an oven, the device reaches rated output within 0.001% immediately and is within

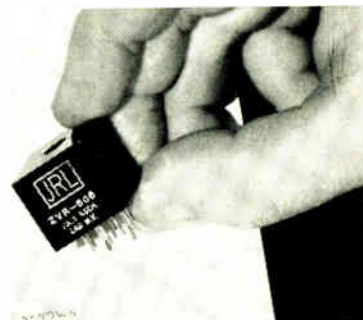

one part per million after 10 minutes.

The temperature coefficient is less than 0.2 ppm per degree Centigrade from 20 to 30°C and less than 1 ppm per degree C from 0 to 50°C. Output stability is held to 1 ppm short-term and 0.001% for 30 days.

The device recovers immediately from accidental short circuits, and all the regulating circuitry is self-contained, permitting the zener's output to remain constant even if the power supply (30 volts at 10 milliamps) changes by 10%.

The initial models have inputs of 22, 24, and 32 volts and outputs of 6.3, 11.4, and 17.5 volts, respectively. Each unit can deliver up to 1 ma to a constant load, and a single external resistor may be used to adjust for load variation.

The units cost \$125 in quantities of one to nine; delivery takes two to three weeks.

Julie Research Laboratories Inc., 211 W. 61st St., New York 10023 [445]

Compare our Ribbon* Connector with the one you're using now

40 TIMES THE LIFE Amphenol's exclusive "Ribbon" contact connector gives you 20,000 insertional/withdrawal cycles compared to only 500 for pin and socket designs. It's engineered for 25 years' service in mated condition, too.

Amphenol Micro-Ribbon Connectors alone have recorded some five trillion terminations without failure.

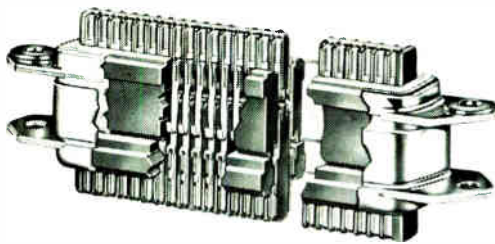

Amphenol Micro-Ribbon Connector

GREATER CONTINUITY Flat, broad "Ribbon" contacts maintain continuity over a much larger area than pin and socket contacts. Double-flexing members give constant contact pressure.

"Ribbon" contacts eliminate misalignment and bent contacts experienced with pin and socket connectors. And, they mate with half the forces.

Unlike pin and socket contacts, the "Ribbon" contacts are self-cleaning and

self-wiping. They dislodge all foreign matter during insertion for greater contact continuity.

LOWER COST Amphenol Blue Ribbon and Micro-Ribbon Connectors cost less than most standard pin and socket contact connectors.

51 CONFIGURATIONS Choose from 28 standard size Blue Ribbon and 23 miniature Micro-Ribbon connectors. Rack and panel, cable-to-chassis, cable-to-cable, right-angle shell, barrier or pin polarization are available.

Applications include telephony, communications, data processing, entertainment, instrumentation, industrial control, avionics, transportation . . . anyplace where current doesn't exceed five amps per contact.

OFF-THE-SHELF DELIVERY Sixty-six Amphenol Industrial Distributors stock "Ribbon" connectors in all major cities. Twenty-two Amphenol Sales Offices are at your immediate service. You'll find them in our catalog or in EEM, ELECTRONIC BUYERS GUIDE, ELECTRONIC SOURCE PROCUREMENT, and THOMAS REGISTER.

*Blue Ribbon® and Micro-Ribbon® trademarks Amphenol Corporation

The first pair's on us.

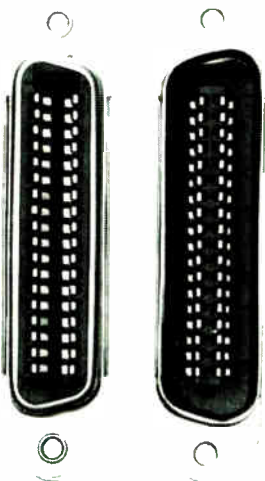

We'll send you the first pair free. Simply fill out and mail the coupon or circle the reader service card number below. We'll take it from there.

NAME _____

TITLE _____

COMPANY _____

ADDRESS _____

CITY _____ STATE _____ ZIP CODE _____

Send to: Amphenol Industrial Division, 1830 South 54th Avenue, Chicago, Illinois 60650.



AMPHENOL

Giant Killers

Fourth in the series



Setting a world's speedboat record is a big job, demanding a high price in time, dollars and sometimes lives. On June 30, 1967, 33-year-old Lee Taylor piloted his hand-built 10,000 horsepower jet boat through the measured kilometer in just under eight seconds, establishing a world's mark of 285 mph. The way hadn't been easy . . . four tough years, nearly a quarter million dollars in cost, and a near-fatal boat crash had been some of the obstacles testing this jet-age giant killer's dedication.

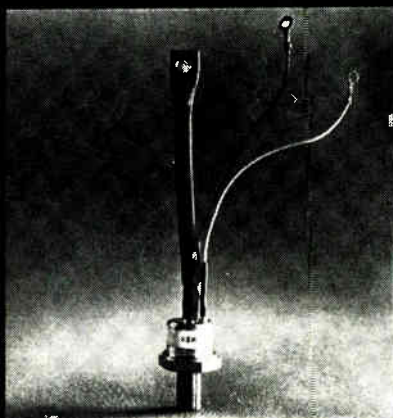

In the 70-ampere SCR race, this same dedication has enabled IR to set records, too. For instance, we offer epitaxial or alloyed-diffused construction and the industry's broadest line, with advantages you can't get from brands G or W.

We have the only production high voltage 70-amp SCRs operating to 150°C. The only production 70-amp SCRs with transient voltage ratings to 2 KV, repetitive ratings to 1.8 KV. And we have fast switching SCRs specially designed for inverters, with appropriate turn-on, turn-off times, di/dt, etc.

But more. Our special-products capability delivers virtually any performance you need . . . at competitive prices! Need 1,000 A/ μ s di/dt? 1,000 V/ μ s dv/dt? Or 90 amperes in a 70-amp package? Ask the giant killer — IR, developers of the 200 ampere logic triac. If we can't deliver, nobody can.

Send for catalog A68/69.



INTERNATIONAL RECTIFIER

Semiconductor Division, 233 Kansas St., El Segundo, Calif. 90245, Phone (213) 678-6281. Field offices and distributors in major cities around the world.

New Microwave Review



Mini-Turret step attenuator 713 covers 0 to 60 db in 10-db steps from d-c to 12.4 Ghz. Low vswr of 1.35 and low insertion loss of 0.5 db (max) are featured. The compact unit weighs 18 oz and is bidirectional. It is suited for field systems and test equipments. Price is \$450; delivery, approximately 6 weeks. Narda Microwave Corp., Commercial St., Plainview, N.Y. 11803. [401]



Solid state harmonic oscillator model EHS3302 has less than 5% linearity deviation. It has 35 db spurious suppression. Its voltage tuning range is 2.5 to 3.5 Ghz. Power output is 15 mw. The unit measures $\frac{5}{8} \times 1\frac{3}{4} \times 3\frac{1}{2}$ in. It is available manually or voltage tunable. Microwave Products Group, Div. of Airborne Systems Inc., 115 Old Country Rd., Carle Place, N.Y. 11514. [402]



Miniature crystal detector mounts with a tangential signal sensitivity of -50 dbm at 2 Mhz video bandwidth come in 2 versions. The DX-106 (coaxial) and DX-108 (strip-line) operate from 8 to 12 Ghz. Vswr is 2.5:1 max. with a 2.2 kilohm video load. They withstand vibration of 20 g's from 0 to 2,000 hz. Raven Electronics Inc., 101 W. Alameda Ave., Burbank, Calif. 91502. [403]



Balanced mixer 29003 is for the 1-2 Ghz octave range with i-f frequencies up to 100 Mhz. Features include high local oscillator to signal isolation, an 8.5 db max. conversion loss, and a 10 db max. noise figure (ssb) which includes 1.5 db i-f amplifier noise. The unit measures $0.375 \times 0.75 \times 1.00$ in. Omni Spectra Inc., 24600 Hallwood Ct., Farmington, Mich. 48024. [404]



Differential phase-shift circulators models CCH20 and CCH30 can operate at c-w power levels up to 6 kw and 10 kw respectively over the 5.9 to 6.5 Ghz range. Both can be supplied with load terminations on ports 3 and 4. Isolation of the units is 20 db minimum; insertion loss, 0.3 db maximum; and vswr, 1.1 maximum. Raytheon Co., 190 Willow St., Waltham, Mass. 02154. [405]

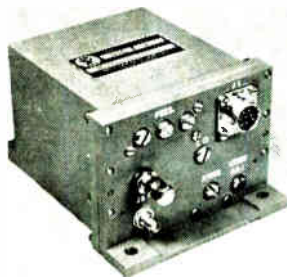

Lightweight (44 oz) transponder model 321C is for a C-band tracking radar. It is used in missile, satellite, drone, rocket and target applications. Despite the light weight, it maintains the electrical and environmental characteristics of superheterodyne transponders. Frequency range is 5.4 to 5.9 Ghz. Vega Precision Laboratories, 239 Maple Ave., Vienna, Va. 22180. [406]

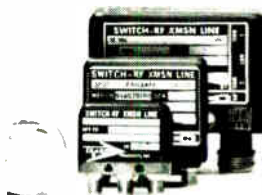

Coaxial switch type MM is a 0 to 18 Ghz device for OSM connectors. It is less than 1 cu in. in size, weighs 1.2 oz, and has 1 million cycle reliability, 5 million as a target. It is available with latching or fail-safe actuators. At 18 Ghz, vswr is 1.5 max.; insertion loss, 0.5 db max.; and isolation, 60 db min. Transco Products Inc., 4241 Glencoe Ave., Venice, Calif. 90291. [407]

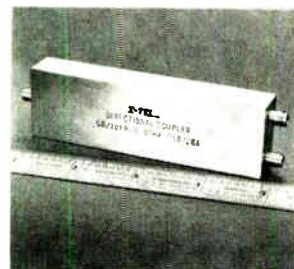

Directional couplers come in ranges from 0.1 to 12.4 Ghz, and feature 2-octave coverage with a single unit. The 1-4 Ghz units measure $\frac{5}{8} \times 1\frac{3}{4} \times 4$ in. Typical performance specifications (1-4 Ghz units) are 3 to 20 db coupling, greater than 20 db directivity, less than 1.20 vswr, and less than 0.5 db insertion loss. I-Tel Inc., 10504 Wheatley St., Kensington, Md. 20795. [408]

New microwave

From Japan, 50-mw Gunn oscillators

Device operates at C and X bands; an optional varactor permits voltage control of frequency at constant output

They never got around to building klystron oscillators at Japan's Mitsubishi Electric Corp., and now it looks as though they never will. Instead, the firm is concentrating on a line of Gunn-effect oscillators that cover the C and X bands.

Mitsubishi's units have continu-

ous outputs of 10, 25, or 50 milliwatts at any center frequency from 6 to 12 gigahertz. Efficiency is typically 1%, operating range is -20°C to $+60^{\circ}\text{C}$, and average life is 5,000 hours. Current drain ranges between 230 milliamps for a low-frequency unit up to 300 ma at the far



For Long Term dependability and outstanding performance insist on Anritsu's Mobile Radio Test Sets.

These units are used for the testing and adjustment of single channel FM mobile radios. The output power and frequency deviation for transmitters, 20dB quieting sensitivity, signal-to-noise ratio under standard modulation, low frequency output, IF center frequency, discriminator characteristics, overall selectivity, can all be easily obtained with these instruments. In addition, the frequency ranges from 60/150/400 MHz band.

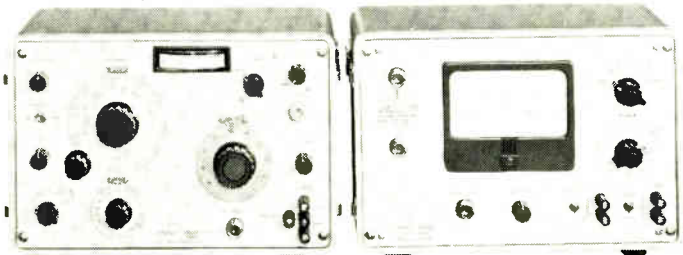

These two outstanding instruments perform very well under the most awesome shop or lab conditions. So for long term dependability and top-notch service be sure to insist on Anritsu's Mobile Radio Test Sets, better known as the MG54A, B signal generator, and the MS52A output tester. Both in low price range. Write today for particulars.

 **Anritsu Electric Co., Ltd.**

4-12-20, Minamiazobu, Minata-ku, Tokyo
cable address ANRITDENKI TOKYO

Circle 262 on reader service card

FREE

Design Engineering Service

from

PERMACOR®

Iron Core Engineers

Only the world's largest iron core producer could offer you the qualified engineering services backed by an unequalled knowledge of iron core usage, applications, limitations, and production to quickly resolve all iron core problems.

With countless years in their research, development, and production, PERMACOR can, from experience, recommend the most efficient and economical solution to your iron core product and production problems.

We have matched over 20,000 iron cores to the needs of countless military, commercial, miniature, and specialized applications. We can do the same for you!

Send us your problems today. Let us show you how PERMACOR "Engineered Economy" can save you time and money. There's no obligation, of course.

PERMACOR®

A Division of Radio Cores, Inc.
9540 Tuttle Ave., Oak Lawn, Ill.

Phone: 312/GA 2-3353

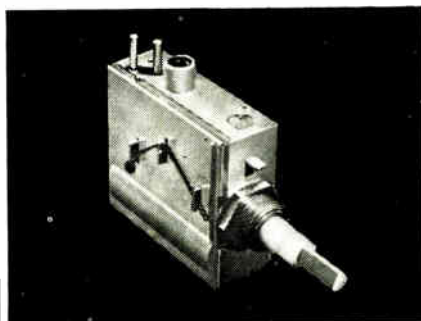

MITSUMI UHF TV TUNER

Far outrating the FCC and VDE specifications, which are widely prevailing in the World as telecommunication standards, the MITSUMI UHF tuner only radiates spurious signals less than 54 dB below the reference field strength. Material, plating, soldering, as well as the proprietary circuit design are the technical achievements by MITSUMI based on a long-term fundamental research.

Specifications	Model	UHF TV tuner UK-A32
Gain (dB)		-10 min.
Noise figure (dB)		14 max.
Image ratio (dB)		30 min.
IF rejection (dB)		60 min.
Frequency stability	Temperature Stability:	± 300 kHz at 25 ~ 65°C
	Voltage stability:	± 100 kHz at 11V ± 1.1V
Outer dimensions (mm)		51 × 62.5 × 24.5



MITSUMI

MITSUMI ELECTRIC COMPANY LIMITED
1056 Koadachi, Komae machi, Kitatama-gun, Tokyo. Tel: 489-5333
Marienstrasse 12, Dusseldorf, W. Germany. Tel: 352701
MITSUMI ELECTRONICS CORPORATION
11 Broadway, New York 4, N.Y. 10004 Tel. HA-5 3085

Circle 263 on reader service card

... mechanical tuning
over ± 125 Mhz range ...

end of the X band.

The company calls its new line the MGO series, for Mitsubishi Gunn Oscillator. Each oscillator gets a four-digit series number, with the first two digits designating center frequency to the nearest megahertz, and the other two designating the output power in decibels. For example, the MGO-0717's center frequency is close to 7 Mhz and its output is 50 mw.

Off-center. Each device is 3 centimeters in diameter and 5 cm long, excluding its connectors. The bottom portion is a solid-copper heat sink, 1 cm long. A Gunn-effect diode is mounted in the center of the base of a coaxial tuning cavity, whose internal diameter is 1 cm. The cavity's center conductor is connected to the upper surface of the diode. The cavity's outer shell and the diode's lower surface are mounted off-center on the heat sink, and the cavity is then packed inside a cylindrical case.

To make Gunn-effect diodes, Mitsubishi engineers grow an epitaxial layer on a gallium-arsenide substrate whose resistivity is 0.002 ohm/cm. The layer is chemically etched to its final thickness, then photoetched to form a 120-square-micron mesa. The final thickness of the layer and substrate is about 120 microns.

The diode's frequency depends on mesa thickness and the impurity concentration of the epitaxial material. For example, a 10-Ghz diode has a 12-micron mesa and a resistivity of 0.3 to 0.4 ohm/cm. In a 7-Ghz unit, the mesa is 18 microns thick and has a resistivity of 0.5.

With a screw on the side of the case, the oscillator can be tuned over a range of ±125 Mhz around the center frequency. Power never changes by more than 0.5 db during mechanical tuning. Tuning can also be achieved by changing the input voltage; any change in the input voltage results in a change in the frequency—at about 10 Mhz per volt. But this is often impractical because the output power varies when the voltage changes.

Another tune. An optional feature is a built-in gallium-arsenide varac-



You get individual recognition at Link in Sunnyvale.

If you feel like just another number in your job, where your project accomplishments go unnoticed, then now's the time to look to Link.

You'll see what individual recognition, responsibility, and freedom can really mean with us. Since we're a dynamic, expanding firm backed by the full resources of a great company, you can't get lost in the shuffle here. Your work gets our immediate recognition. Its significance is visible and appreciated.

At Link, you can become actively involved in a broad range of challenging new projects. We're not in a position to hire engineers and scientists to do routine jobs. You get real responsibility—and the rewards that go with it.

Moreover, you'll live and work in

the heart of the San Francisco Peninsula in Sunnyvale, where the weather couldn't be finer (clear, smog-free skies) and the educational climate better (Stanford, Cal, and other major schools nearby). What's more, you'll be near bay and ocean, redwood forest and wine country in Sunnyvale.

Our present projects include advanced computer-related electronics; advanced microfilm technology; spacecraft and aircraft simulators; participation in U.S. manned space programs; land, sea, and subsea ordnance; and sophisticated traffic control systems.

There's a sunny spot awaiting you at Link in one of the following disciplines:

Scientific Programmers
Optics Engineers

Analog/Digital Circuit
Design Engineers
Digital Test Engineers
Logic Design Engineers
Electronics Sales Engineers
Digital Technicians
Components Engineers
Proposal Engineers

Interested candidates are invited to submit resumes in confidence, with salary history, to Mr. R. E. L. Nadzam, Employment Supervisor.

LINK GROUP
**GENERAL
PRECISION
SYSTEMS INC.**

1077 E. Arques Avenue
Sunnyvale, California 94086
An equal opportunity employer.
A Plans for Progress company.

Low Cost FET Testing

New Test Equipment Corporation Model 57 Field Effect Transistor test system gives you the most inexpensive all digital approach to the testing concept.



Here's a FET test system that gives you the advantages of all digital testing, the versatility of easily interfacing in and out and at a lower cost than you'd expect!

The Test Equipment Corporation Model 57 FET test system measures eight static and two transconductance parameters at an average speed of 100 milliseconds per test. It sequences through six tests (12 test capability optional) on FETs in either manual or automatic testing.

A wide range of electrical capabilities and the versatility of fast, easy program changing make the Model 57 ideal for quality assurance applications. It is equally well suited for incoming inspection, engineering evaluation and production testing.

Write today for full technical and pricing information.

And, check these Plus features!



High visibility projected three digit read-out of test results gives you all test information at a glance.



Easy-to-set thumb wheel switches make possible fast, accurate settings, virtually eliminate operator set-up errors.

Test Equipment

CORPORATION
P.O. BOX 20215, DALLAS, TEXAS 75220 • 214/357-6271

Circle 264 on reader service card

Improve your system reliability by installing GE photoelectric tape readers



PTR60 (Shown Above) and 70 Series:
—reliable, compact, "through-the-tape" Readers of field-proven design.
—choice of reading speeds up to 500 characters per second.

PTR80 (Shown Below) and 90 Series:
—high performance readers designed for speeds up to 1000 characters per second.
—reflected light reading technique eliminates problems of variation in tape opacity and permits reading of both punched and printed tapes.



Install them and forget them. GE photoelectric tape readers give lasting service with minimum maintenance. Features include:

- no electrical adjustments
- unidirectional or bidirectional operation

- simple, complete controls
- all solid state components
- tape handlers available for entire reader line

Numerous options are offered to meet your special requirements. Mail today for full details. 837-04A

Mail to Mr. R. S. Holmes, Printer-Reader Business Section, General Electric Co., 511 North Broad St., Philadelphia, Pa. 19123

NAME _____
ADDRESS _____
COMPANY _____
CITY _____ STATE _____ ZIP _____



Printer-Reader Business Section

GENERAL  ELECTRIC

... device acts
as a pump source ...

tor that allows voltage tuning with constant output. An MGO with such a varactor would have a four-pin input connector so that both the varactor and the Gunn diode have separate voltage sources. In operation, the diode's input is held at -10 volts while the varactor's input is varied. Tuning in this manner doesn't affect the output because the varactor doesn't draw current from the power supply.

With a varactor rated at 10 volts, an MGO's minimum frequency shift is 10 Mhz per each change of 1 volt. However, the company claims it has built units having shifts as high as 200 Mhz per volt. Mitsubishi will supply varactors with higher voltage ratings to produce higher tuning ratios. But the advantage of the 10-volt varactor is that it can be controlled with a voltage divider connected to the Gunn diode's input, so only one power supply is needed for the oscillator.

Making it up. The company says that when the MGO is used as a balanced mixer's local oscillator, noise is the same as that of a low-noise klystron mixer. MGO's have already appeared as local oscillators in radar and communication systems, and some Japanese broadcasters are trying them in remote broadcast equipment. Mitsubishi says the MGO can also be the pump source in parametric amplifiers where low noise is a requirement.

When the MGO—with a varactor—is used as a local oscillator, power to the mixer can be maintained at an optimal level. And since the varactor draws no d-c power, voltage can be easily controlled simplifying the design of automatic frequency-control loops.

The company is already marketing C-band units, and expects to have its X-band oscillators ready for the Wescon show in August. At first, the 10-mw MGO will cost close to \$400 in the U.S., but Mitsubishi expects the price to drop to \$300 when production increases. The varactor option will cost \$50. The basic price is doubled for the 50-mw unit.

Mitsubishi Electric Corp., Tokyo, Japan [409]

This is a Telonic 2003 Sweep/Signal Generator

It's completely plug-in so we can change frequency and attenuation ranges, markers, et cetera, with no sweat

This 2003 has a 5 MHz to 1500 MHz oscillator that's so broad it's in use constantly

So when the boys in telemetry start their new project, we're all in trouble*

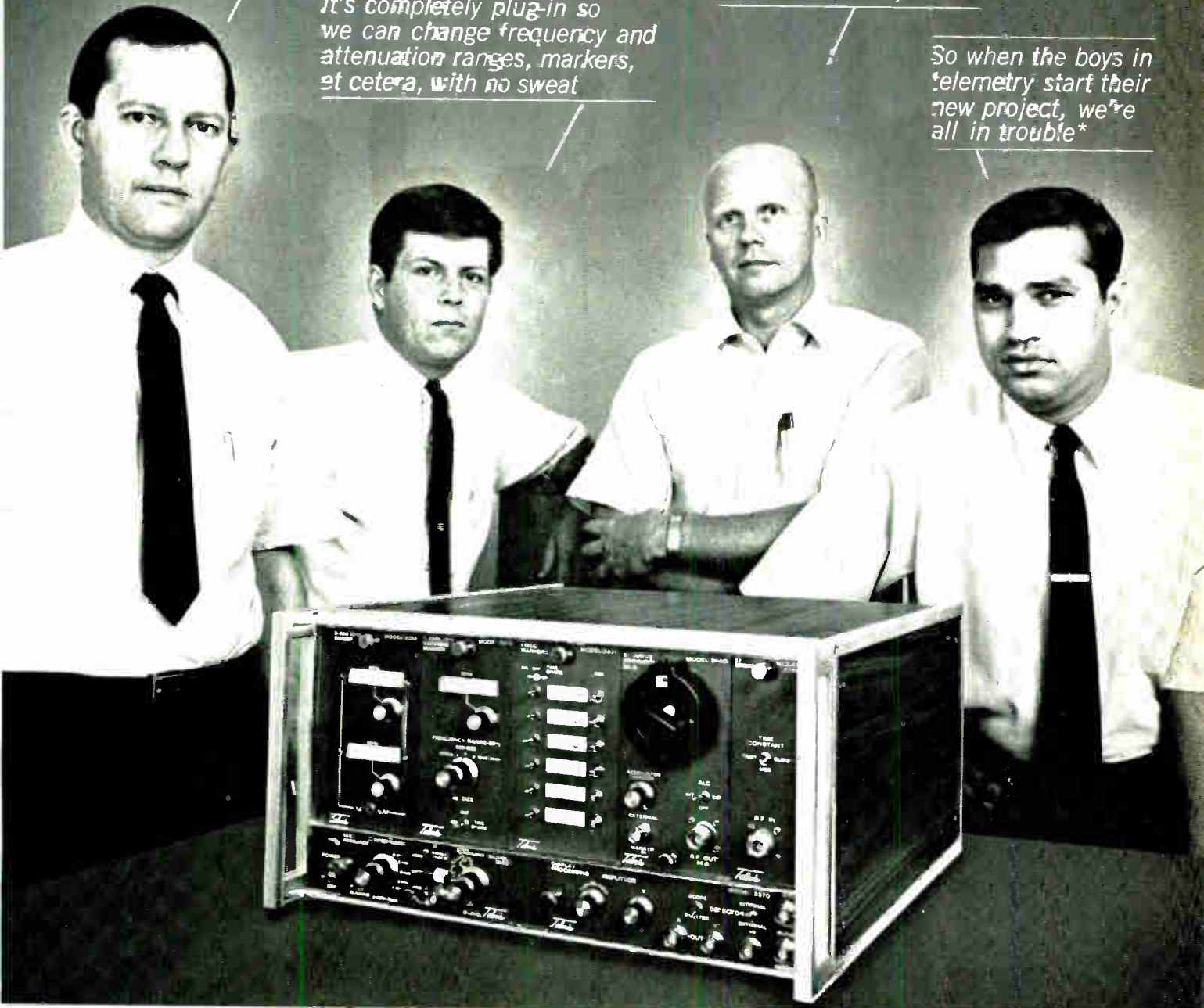

Al's working in I-band, Neil's interested in VHF, Jim is designing receiver gear and Sastry's in mobile communications. Yet they can all use the 2003 Sweep Generator since its 3305 oscillator covers so broad a frequency range—1.F. to microwave.

And they can sweep that 5 to 1500 MHz region at full width or as narrow as 500 kHz. Two calibrated tape dials permit selection of band width by end points (F_1/F_2) or by a symmetrical region around a center frequency ($F_c/\Delta F$).

In addition, the instrument supplies a .35VRMS output over the entire range at a flatness of ± 0.5 dB with absolute linearity of 1.2:1.

Operating parameters of each 2003 Sweep/Signal Generator System will depend on the oscillator, attenuator, marker, and other plug-ins specified.

Here's a list of specifications on the 3305 oscillator plug-in.

FREQUENCY RANGE	5-1500 MHz
SWEEP WIDTH	500 kHz-1500 MHz
MAX. RATED OUTPUT	0.35 v. R.M.S. (+4dBm into 50 Ω)
OUTPUT FLATNESS	± 0.5 dB
ATTN. VERNIER RANGE	3 dB
F. DIAL ACCURACY	5%
ABSOLUTE LINEARITY	1.2
FREQUENCY DRIFT (1 min.)	100 kHz
RESIDUAL FM	50 kHz

Details and further specifications on the 2003 Sweep/Signal Generator System may be found in catalog 70-A and Addendum. Send for your copy.

*You can always get another instrument, Sastry

Telonic INSTRUMENTS

A Division of
Telonic Industries, Inc.

60 North First Avenue, Beech Grove, Indiana 46107 • Tel: (317) 787-3231 TWX: 810-341-3203

Representatives throughout the U.S. and Canada, Distributors Overseas. Branch offices in Maidenhead, England, Frankfurt, Germany and Milan, Italy.

The Unfinished Still.

(We don't call a Barnstead water purification system complete until it's tailored to your specs exactly.)

... And you can be sure of an *economical* answer to special needs, because Barnstead has a huge line of "stock" pure water components with which to build.

HOW BIG? Barnstead water stills come in practically any capacity you could use, from ½ gallon-per-hour lab models to giants putting out 1,000 gph and more.

HOW PURE? Our basic still produces water free from organic, inorganic and volatile impurities, suitable for most pure-water needs. For higher purity water in the 1-to-5 megohm range, we can supply a "high-purity chamber", and for even purer water, a recirculating purification loop. Any combination of demineralizers and filters can be built into your system, too.

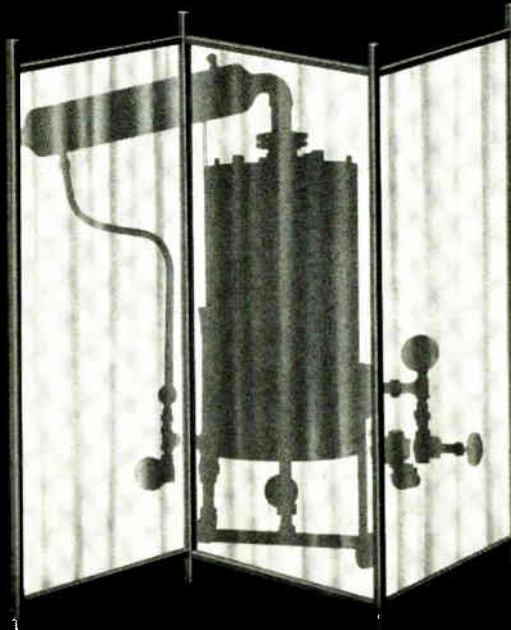

HOW MUCH? Operating costs average only 1c to 3c/gal., and Barnstead stills generally last 15 to 20 years.

STERILE STORAGE? Barnstead tanks, equipped with heavy tin linings (10 times thicker than electroplate), immersion-type ultraviolet units, and Ventgard® air filters ... will keep your distilled water sterile, ready for use.

LABOR REQUIREMENTS? We offer any degree of automatic control in our still/tank combinations ... from manually-operated models to systems that start, stop, fill, empty, and monitor themselves.

MAY WE HEAR FROM YOU? Ask for the details. Barnstead Still and Sterilizer Co., 225 Rivermoor Street, Boston, Massachusetts 02132.

Barnstead

A DIVISION OF RITTER PFAUDLER CORPORATION

New Production Equipment Review

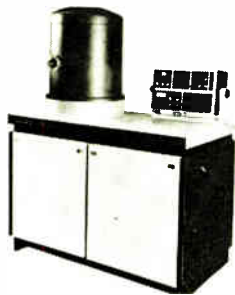

Quantity production of evaporated thin films is achieved by the model CV-1104 evaporator. Its 24-in. diameter stainless-steel chamber is capable of twice the product throughput of a conventional 18-in. belljar system. Its Auto Mate control package prevents product loss from faulty vacuum cycling. Consolidated Vacuum Corp., 1775 Mt. Read Blvd., Rochester, N.Y. 14603. [421]



Lead bender 100C facilitates IC bends for p-c board mounting. It is a hand-operated precision press that will produce a force of 1,000 lbs at the ram. This force, applied to the machine's precision dies, will form, trim and cut burr-free leads in one continuous operation. It can process 100 pieces/hr. D-Vel Research Labs Inc., 555 Bedford Rd., Bedford Hills, N.Y. 10507. [422]

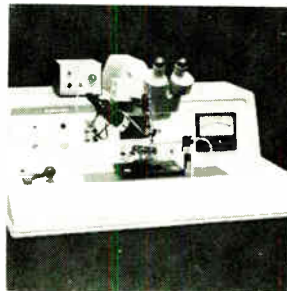

Thermocompression wire bonder 8-146-02 is for lead interconnection of all current package styles. Replacement of a master-cam held by one set screw and plug-in work stages with integral heaters enable simple and fast (20 sec) changeover. Stitch or nailhead bonding is available at the flip of a switch. Weldmatic Div./Unitek, 950 Royal Oaks Dr., Monrovia, Calif. 91016. [423]

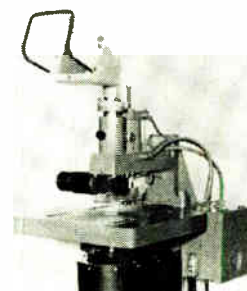

Semiautomatic p-c drilling machine model 115 uses a 10-power optical system for locating the precise point at which to drill the circuit boards. Besides single pieces, stacked boards can also be drilled. Standard spindle speed is 2,500 to 15,000 rpm, governor controlled. Feed rate is 1 to 60 in. per minute. Electro-Mechano Co. 241 E. Erie St., Milwaukee, Wis. 53202. [424]

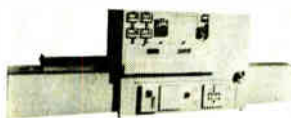

Thick film firing furnaces can be refined to fit almost any application. The basic furnace is of open block and structural design. Two or three zones of heat provide a basic firing curve. On/off time proportioning controllers hold temperatures within $\pm 5^\circ\text{C}$. Belt speeds range between 1 and 20 in./minute. Trent Inc., 201 Leverington Ave., Philadelphia, Pa. 19127. [425]

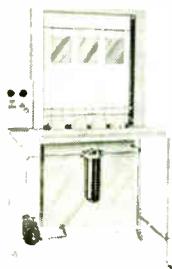

Self-contained, portable dip tank and filtration-recirculation system is for applying photoresists, protective coatings, and conformal coatings to p-c boards and metal flats. Two tank sizes are offered: one for 10 x 20 in. (7 gal. capacity) and the other for 20 x 20 in. (12 gal. capacity) maximum work size. Infra-Red Systems Inc., Route 23, Riverdale, N.J. 07458. [426]

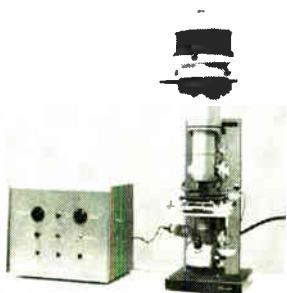

Manual step-and-repeat photo-mask system Watson Mark III is designed for the production of IC's within a 2 x 2 in. field. It provides standard reduction ratio of 10:1. With 120X microscope, images can be positioned to repeatable accuracy of ± 0.00006 in. With 240X microscope, repeatable accuracy is ± 0.00004 in. HLC Manufacturing Co., 124 Orelan Mill Rd., Orelan, Pa. [427]

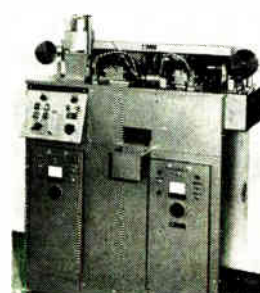

Automatic lead welder type 6.08 provides up to 4,500 double welds or 9,000 single welds per hour. It utilizes wire supplied from continuous rolls and cuts it to desired lead length, which is adjustable from 0.70 to 2.5 in. Wire diameter can vary from 0.016 to 0.039 in., and component length from 0.016 to 0.78 in. B Freudenberg Inc., 50 Rockefeller Plaza, New York. [428]

New production equipment

On your mark . . . get set . . . go!

Position indicators with repeat accuracy of up to 0.0001 inch enable even inexperienced operators to do precise machining

Strange as it may seem, small electronics manufacturers all too often haven't been able to capitalize on electronics technology in their own operations. The cost of electronic production equipment is out of their reach and they have to content themselves with mechanical gear

and methods.

Now, however, a Florida firm—Anilam Electronics—has come up with a digital position indicator for machining operations that promises 50% faster set-up times and greater accuracy than mechanical indicators. And it will sell for as

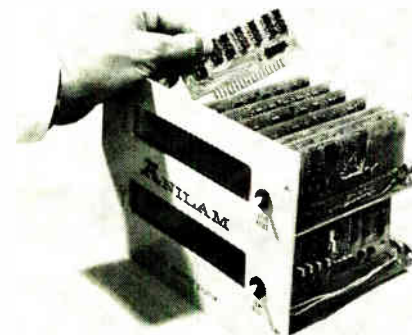

Any number. All TTL circuitry for a digit is on an interchangeable card.

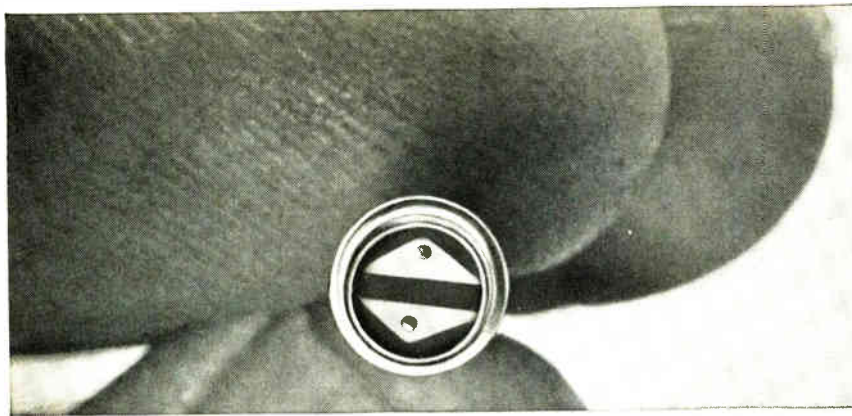

Cds type 6C Photochopper cells combine high efficiency, temperature stability, low-light memory

Efficiency levels range up to 72% at 1KHz; 93% at 400Hz; 98% at 60Hz
 Less than 5% efficiency change from -25 C to 60 C
 Warm up time virtually eliminated
 CDS Bulletin gives all the details.
 Send for your copy.

Clairex may already have a "standard" answer to your "special" photocell problem.



1239 BROADWAY
NEW YORK, 10001

Circle 265 on reader service card

... optical encoder eliminates backlash ...

little as \$3,000.

Usually, an operator moves a machine's table by turning x-axis and y-axis leadscrews. A gearing system converts the screw's rotational motion into linear motion, and the operator reads table position from the leadscrew dials. How precisely the table is positioned depends on the leadscrew accuracy and the operator's touch. As leadscrews wear, they become less reliable, and, as in any gearing system, backlash inaccuracies are unavoidable.

Besides the right touch with the dials, the operator's skill is critical another way: the longer the distance a table is moved, the more inaccurate the positioning becomes. So experienced operators mount the workpiece on the table in a way that keeps the table travel small.

Taping the table. The Anilam system, developed with aid from Texas Instruments, measures position directly. Although leadscrews can still be used to move the table, the number of times the screws are turned is unimportant. Displacement is sensed by two transducers that look like tape measures. A metal tape comes out of the transducer and connects to the table. As the table moves back and forth, the tape moves in and out of the transducer, which contains an optical encoder. The encoder's output is a train of pulses whose frequency is proportional to the length of the tape outside the transducer. The pulses drive a digital display that shows x and y displacement to the nearest 0.001 inch or 0.0001 inch.

The system's accuracy is constant over a 40-in. range, so the workpiece can be fastened to the table in any convenient position. Once the operator establishes his reference position, he pushes the two zero-reset buttons on the display console, and then moves the table. Position is continuously displayed, so he can go immediately to the spots called for on his design plan, and not have to rely on experience to tell him when the table is set just right.

Anilam's system includes four units—x-axis and y-axis transducers, a power supply, and a display unit that can be put at any convenient

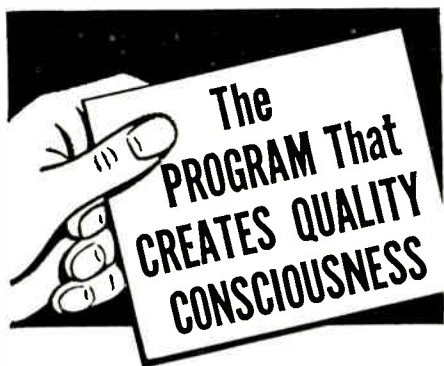

ELLIOTT Q/R SERVICE

This unique visual program achieves remarkable results. It motivates the individual to do his part to improve quality and reliability. Sparks enthusiasm and cooperation in your quality program. Regularly used by top companies throughout U.S. and Canada.



Ask For It on Your Letterhead

ELLIOTT SERVICE COMPANY, INC.
 Dept. Q, 30 N. MacQuesten Parkway
 Mount Vernon, New York 10550

DIFFERENTIAL TRANSFORMERS

For measurement and control use

Capable of obtaining output voltages exactly proportional to any kind of mechanical variation.

Measuring value: 1/100,000~100mm
 More than 500 types are available.



- Features:
- *Outstanding interchangeability
 - *Quite free from outer magnetic field
 - *Insensitive to ordinary shock, water and heat

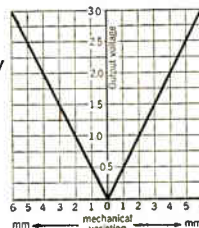

Manufacturers of Differential Transformers

NIPPON COIL CO., LTD.

Amakawa Bldg. 1, 1-chome, Hommachi, Higashi-ku, Osaka, Japan.



In advancing high power TWT technology,
men make the difference.

And the creative engineers at MEC have proven this by developing the first 5 KW cw TWT at X band; by introducing the first complete family of 100 and 200 watt cw traveling wave tubes for military systems; and by being one of the first domestic sources to deliver 5 KW cw TWTs for commercial satellite ground transmitters. In addition, MEC recently demonstrated a 1 KW Peak, 10% duty gridded TWT at X band, thereby establishing a significant advance in the technology of high power pulsed amplifiers.

You can learn more by calling the men at MEC.



MICROWAVE ELECTRONICS
A TELEDYNE COMPANY



THE MILGRAY HOT LINE



IT'S ALSO A TELEPHONE

(CALL US WHEN THE HEAT'S ON)



Milgray/New York 212-YU 9-1600
 Milgray/Delaware Valley 215-BA 8-2000
 Milgray/Washington 301-864-6330
 Milgray/Cleveland 216-881-8800
 Milgray/New England 617-272-6800

Circle 212 on reader service card

Our little black book has over 100,000 phone numbers.

You never had a black book like it. Over 1,500 pages. And those phone numbers! More than 100,000 telling you who to call/where to go, for the over 4,000 different product categories listed and advertised in the yellow pages of the Electronics Buyers' Guide.

It's the industry's one-stop shopping center that lets you find the products and services you need quickly. You can depend on EBG.

Electronics Buyers' Guide

A McGraw-Hill Market Directed Publication,
 330 West 42nd Street, New York, N.Y. 10036

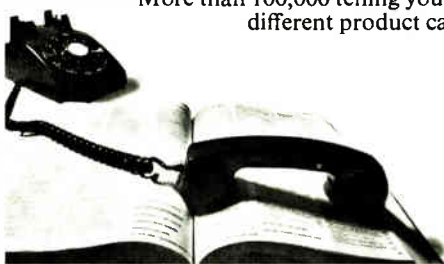

... system has high
resistance to noise ...

place since it measures 10 by 9 by 4½ inches and weighs 8 pounds.

Card trick. The display circuit is made with 60 transistor-transistor logic integrated circuits. All the IC's are made by TI, and about half of them are SN7400N's, which contain four dual-input NAND gates. Each display tube and its associated circuitry are mounted on a 3 by 6-in. printed-circuit card. If one digit fails, the operator could easily replace the card. If backup cards aren't around, he can interchange cards, so at least the lowest significant digits are displayed.

The TTL circuits accept pulses from the transducers at a 15-megahertz rate. Increased speed isn't the only advantage of these IC's. According to Anilam, earlier solid state systems were affected by the



Where it's at. As table moves, output pulse-rate of transducer changes.

magnetic field of starting motors, but this is no longer a problem because of TTL's high resistance to noise.

The Anilam system is available in three models—a five-digit model with repeat accuracy of 0.001-in. accuracy costs \$3,000, a six-digit model with 0.0005-in. accuracy costs \$4,000, and another six-digit unit with 0.0001-in. accuracy costs \$8,000. Delivery time may run as long as three months, but the unit can be installed in less than a day.

Anilam Electronics, 1900 W. 4th Ave.,
 Hialeah, Fla. 33010 [429]

**"Daddy told me,
'Order all of your
power supplies from
Acopian, my boy.
They'll ship any of
62,000
different kinds
in just
3 days!'"**

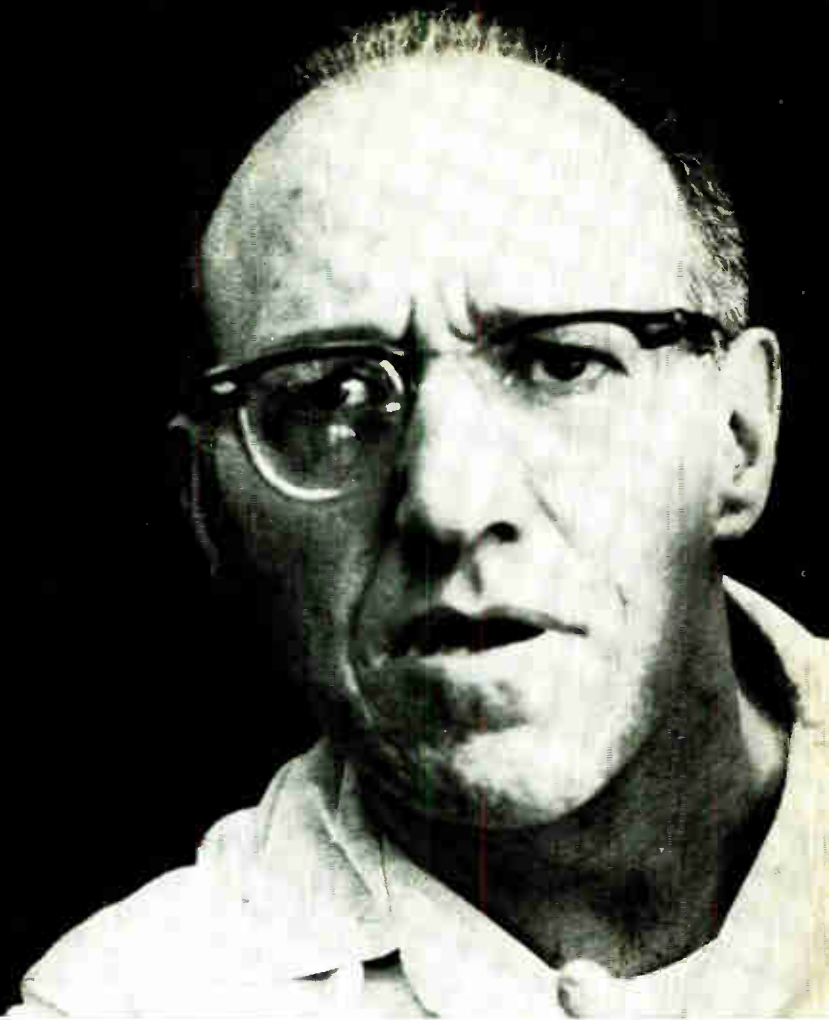

**"On my own initiative
I decided to order
from someone else."**



**"Six weeks later
the power supplies
had still not arrived."**



**"I now have the milk
run from Roxbury
to Hoag Corners."**

Circle 213 on reader service card



Next time you need power supplies in a hurry, contact Acopian and request a copy of our latest catalog. It lists 62,000 different AC to DC plug-in power supplies, any of which will be shipped to you in **just three days!** Choose the exact DC output your need. Singles or duals. Regulated or unregulated. Whether you need one power supply or several, your order will be shipped in just three days! That's our promise. For particulars, contact your local Acopian rep, call us at (215) 258-5441, or write to Acopian Corp., Easton, Penna. 18042.



INTRODUCING All new EECoLogic[®] 2 with double density...

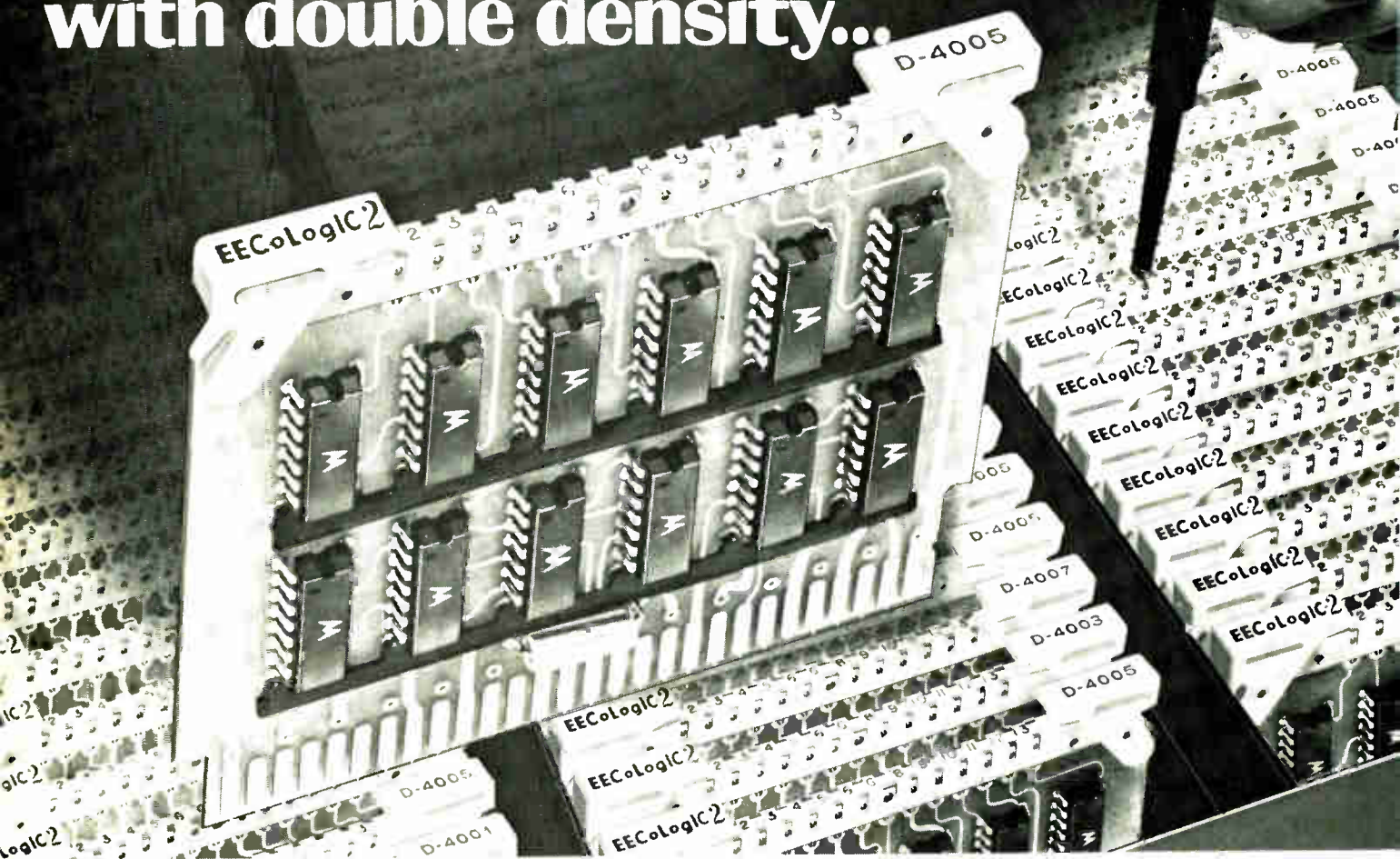

to cut digital system costs

Digital system costs drop with EECoLogic[®] 2 IC Digital Logic Cards because ... prices per logic function are reduced about 10% ... double density cards mean more of any system fits in a standard 19" drawer (up to 6240 pin connections/drawer) ... the number of drawers required can be halved ... wiring costs are minimized since fewer drawers mean less interface wiring and cabling.

OTHER EECoLogic[®] 2 ADVANTAGES:

- WIRE WRAP and TERMI-POINT wiring capability using manual or automatic machines, as well as soldering.
- 13 TEST POINTS accept probes, clips or hooks and make system check-out fast.
- INTEGRAL LOCKING/EXTRACTOR HANDLES hold each card securely in the card frame, identify the circuit and make card removal easy.
- LAMINATED POWER BUSES on each card and in the power wiring of each drawer reduce high frequency noise.

The EECoLogic[®] 2 line of DTL logic modules with over 30 card types is available with a comprehensive selection of hardware and accessories. The new EECoLogic[®] 2 catalog describes the entire line and includes practical application data. Send for your copy today.



COMPONENTS DIVISION

ELECTRONIC ENGINEERING COMPANY OF CALIFORNIA

1441 EAST CHESTNUT AVENUE · SANTA ANA, CALIFORNIA 92701 · (714) 547-5651

New Subassemblies Review



Compact d-c servo amplifier model A461 can be used to drive d-c torquers, small d-c motors, and special loads such as generator fields. It is rated for 5 amps continuous output at $+85^{\circ}\text{C}$ and can be supplied for 10-amp peak capability. It uses an internal carrier generator for a-c carrier amplification. Westamp Inc., 1542-15th St., Santa Monica, Calif. 90404. [381]



Desk-top reader MDR-1000 is for acquiring data from mark-sense documents, mark-sense cards, punched cards, or combined mark-sense/punched cards. Cards can be fed in singly or automatically in batches of up to 500 with an optional automatic hopper. Data can be handled in bit serial or bit parallel form. Motorola Instrumentation and Control Inc., Box 5409, Phoenix 85010. [382]

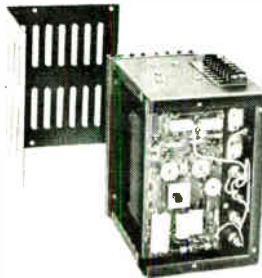

Modular, solid state a-c regulators are intended to replace slow acting magnetic types. Model RT250 provides an output of 250 v-a, and the RT500 and RT1000 have ratings of 500 and 1,000 v-a respectively. Line regulation is within $\pm 0.1\%$ for resistive loads. Load regulation is within 0.2% for 0-100% load change. Electronic Research Associates Inc., Cedar Grove, N.J. 07009. [383]



Precision power supply series SD provides 6 watts single or dual isolated outputs in 1.35 cu in. Transformer coupling provides greater than 100 megohms isolation between outputs and input. Units are designed for critical aerospace and ground support applications. They are priced from \$145 in small lots. Stable Dynamics Corp., 8098 Engineer Rd., San Diego, Calif. 92111. [384]

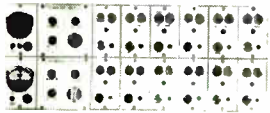

Digital line level converter system 7210A features plug-in modules for digital/digital and digital/frequency shift keying conversion in both directions. A typical 12-channel system includes volume unit and battery meters, modular power supplies, and 12 line-level converters. Tele-Dynamics, Division American Bosch Arma Corp., 5000 Parkside Ave., Philadelphia 19131. [385]



Multisensor power supply model P2011A delivers 200 ma and provides excitation for one to twenty 1,000-ohm transducers. The compact, 12.5 v d-c unit has many industrial and laboratory applications. Its output can be varied $\pm 10\%$ by a simple adjustment accomplished through the front cover. Price is \$85. Robinson-Halpern Co., 5 Union Hill Rd., West Conshohocken, Pa. 19428. [386]



Regulated power source 2330 is for operational amplifiers and comparators. Input voltage is 100-130 v a-c, 50-400 hz; input current, less than 20 ma at full load. Output voltage is ± 15 v d-c at 0-30 ma. Regulation is less than 0.5%. Noise and ripple are less than 10 mv rms for all combinations of line and load. Sola-tron Enterprises, 4079 Glencoe Ave., Venice, Calif. 90291. [387]



Full scale iC memory system model 680 uses computer grade solid state components and features all plug-in p-c modules, including a core memory stack of 1,000 words of 8 bits each. The interface connector has wired-in control lines, with data access in 1.5 μsec , and full or half cycle operation. Unted Telecontrol Electronics Inc., 3500 Sunset Ave., Asbury Park, N.J. 07712. [388]

New subassemblies

Stay-put styluses plot 128-khz signals

Electrolytic recorder has 512 fixed-position pens that are strobed as fast as 0.5 millisecond per inch

Recording a transient or a high-frequency signal is usually a Hollywood production. When mechanical plotters aren't fast enough, out comes a camera. The signal is displayed on an oscilloscope, and the tracings are filmed.

At ITT's Electro-Physics Labora-

tory, it takes a day to get film developed. A day was too long a wait for one group of engineers—they wanted permanent records right away. This led them to build a recorder, called the 6506, that handles signals up to 128 kilohertz.

The 6506 is basically an electro-

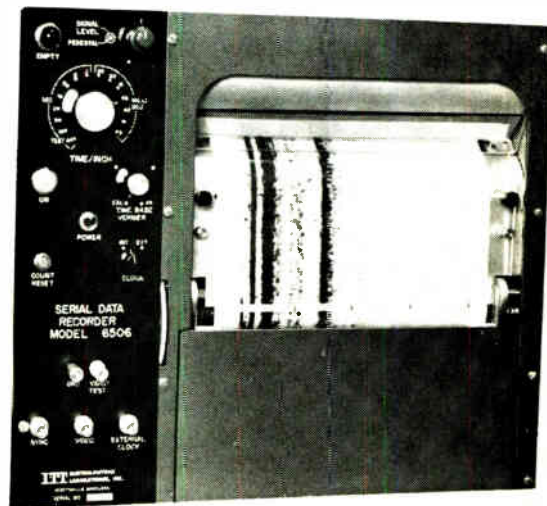

SINCLAIR'S "V-450"

SERIES
450 to 470 MHz

DUPLEXERS

HIGHEST POWER RATING
in the
SMALLEST RACK SPACE
and
ECONOMICALLY PRICED

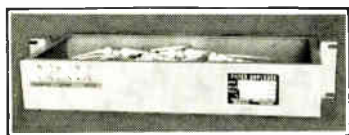

V-450 SERIES SPACE SAVER MOUNT

Seven models in this series, each tunable over the 450 to 470 MHz band, tailored to suit your specific requirement. Frequency spacings are 3 or 5 MHz, and power ratings range from 125 to 200 watts. Fully temperature compensated from -30 C. to 80 C.

Space Saver Rack mount height 3-1/2", width 19", depth 8-1/4". Standard panel available (below).

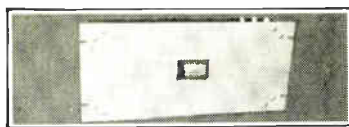

**SINCLAIR RADIO
LABORATORIES**

FREE LITERATURE

TO: SINCLAIR RADIO LABORATORIES, INC.
676 Ensminger Rd., P.O. Box 23
Tonawanda, New York 14150

Name: _____
Title: _____
Company: _____
Address: _____
City: _____
State: _____ Zip: _____

... the higher the input,
the darker the trace ...

lytic recorder. Paper, treated with salt water—to make it conductive—and organic dyes, passes under a thin stainless-steel bar, and then under a stylus. When the bar is positively charged with respect to the stylus, an ionic current flows from the bar, through the paper, and into the stylus. Ferrous ions leave the bar and react with the dye, forming a mark on the paper. The intensity and duration of the current determine the darkness of the mark.

Quick sweep. But instead of having one stylus that is mechanically swept across the paper, the 6506 has 512 styluses over an 8-inch width that are electronically strobed. If there's an input at the instant a given stylus is being strobed, a gating circuit puts a pulse across the stylus and the steel-bar anode, producing a current. Pulse width is proportional to the input, so the larger the input, the darker the trace.

The 6506 has an internal clock, and sweep times can be set from 80 seconds to 4 milliseconds. Albert Schierhorst, one of the engineers who built the 6506, says faster sweeps are possible. "We just haven't had any reason to go lower," he points out.

Except for the paper drive, the recorder has no moving parts, and reset is instantaneous. Sudden changes in input will not lead to overshoot.

The 6506 doesn't come cheaply; it's priced about \$11,500. Schierhorst says the recording paper costs about three cents per square foot.

Spike out. The 6506 can be triggered with either periodic or random signals. And its sweep circuit voltages are low enough not to cause radio interference or voltage spikes.

The company says the recorder can be used for spectral analysis, atmospheric, radar, and sonar soundings, oceanographic mapping, and ultrasonic recording.

The instrument can also be used with an analog-to-digital converter and a matrix that directs the converted signals to specific styluses. This permits scaling of the input.

0.3 MHz SPACING

SINCLAIR'S NEW
148 to 174 MHz
DUPLEXER

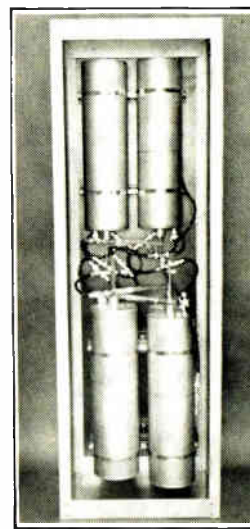

Q-150 - 3R6

The first standard commercial duplexer offered at such close spacing, made possible through Sinclair's new Q-Filter Circuit (Pat. Pend.).

The "Q" Series Filter Circuit combines the most desirable features of band-pass and band-stop filters. The cavities are completely temperature compensated, and no derating in specifications is necessary down to -30 C. due to unusual circuit stability. Power rating is 250 watts, insertion loss 2.2 db, and isolation is 95 db.

**SINCLAIR RADIO
LABORATORIES**

FREE LITERATURE

TO: SINCLAIR RADIO LABORATORIES, INC.
676 Ensminger Rd., P.O. Box 23
Tonawanda, New York 14150

Name: _____
Title: _____
Company: _____
Address: _____
City: _____
State: _____ Zip: _____

announcing the NL-5750 from NATIONAL®



Our lowest priced readout tube, \$3.95 in 1000 quantity.

- ultra long life ■ compact .530" diameter.
- .5" numeral height ■ two decimal points standard
- flexible leads with standoff spacer for ease of pc board insertion.

"Licensed by Burroughs Corporation"

NATIONAL REQUEST BULLETIN
ELECTRONICS, INC. a varian subsidiary
PHONE: (312) 232-4300 • GENEVA, ILLINOIS 60134

Circle 268 on reader service card

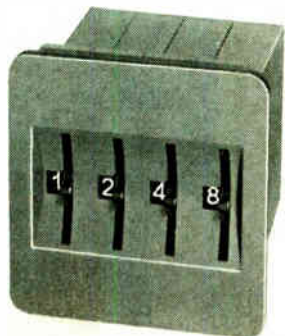

Thumbwheel Switches For Industrial Control

These panel-mounted thumbwheel switches offer you convenient control devices for presetting digital information. A visual indication of the setting is provided by easily-read characters on each thumbwheel.

You can use these switches for binary decimal coding or decoding, or for straight decimal circuitry. They are available for special functions, and the use of four independent contact wipers and built-in diode gates make them readily adaptable to individual circuit requirements. The thumbwheel switches can be used in single pole, double pole and four pole switch applications.

For mounting, standard facades are available to accommodate from 1 to 9 switches on 1/2" centers. Send for technical data now.

AWH AMERICAN
THE WHEEL COMPANY

232 North Elm Street
Waterbury, Conn. 06720
4060 Ince Boulevard
Culver City, Calif. 90231

Timing & Stepper Motors • Electromechanical & Electronic Timing Devices & Systems

Circle 269 on reader service card

Just right for two-way radio!

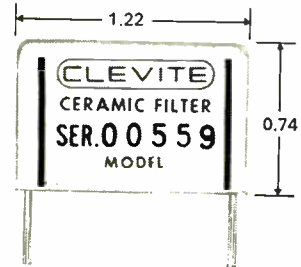

Clevite's computer-designed TCF ceramic filter.

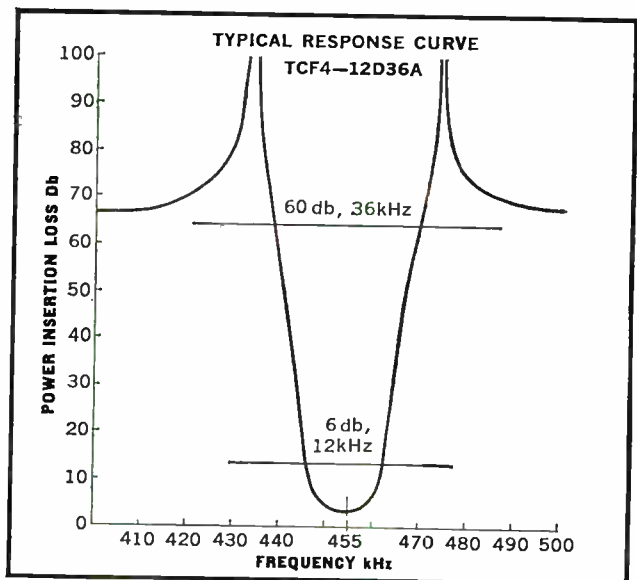

TCF — a hybrid combination of a tuned transformer and ceramic resonators . . . in less than 0.6 cu. in.!

Designed specifically for use in two-way communication sets including mobile two-way, aircraft communication, aircraft navigation SSB receiver applications and CB. The TCF combines the input advantages of a tuned transformer with the stability and high performance of a ceramic filter. Result: manufacturers of quality FM receiving equipment (and AM as well) get greater selectivity at a lower cost. TCF filters are free of unwanted responses, and input impedances are suitable for both transistor and vacuum tube circuits.

Model Number	Bandwidth	
	6 db (Min.)	60 db (Max.)
TCF4-4D10A	4kHz	10kHz
TCF4-8D20A	8kHz	20kHz
TCF4-12D36A	12kHz	36kHz
TCF4-18G38A	18kHz	38kHz
TCF6-30D55A	30kHz	55kHz
TCF6-35D60A	35kHz	60kHz
TCF6-12F36A	12kHz	36kHz (90 db)

PRICES: TCF-4 models: 1—\$15 ea; 25—\$10 ea; 100—\$8.50 ea; 500—\$6.75 ea; 1000—\$6.00 ea; 2500—\$5.45 ea. TCF-6 models slightly higher.

(Prices subject to change without notice)

Send order or request for Bulletin 94026 to: Clevite Corporation, Piezoelectric Division, 232 Forbes Rd., Bedford, Ohio 44146, U.S.A. Or: Brush Clevite Company, Ltd., Southampton, England.

CLEVITE

Circle 217 on reader service card

217

CRYSTAL FILTERS

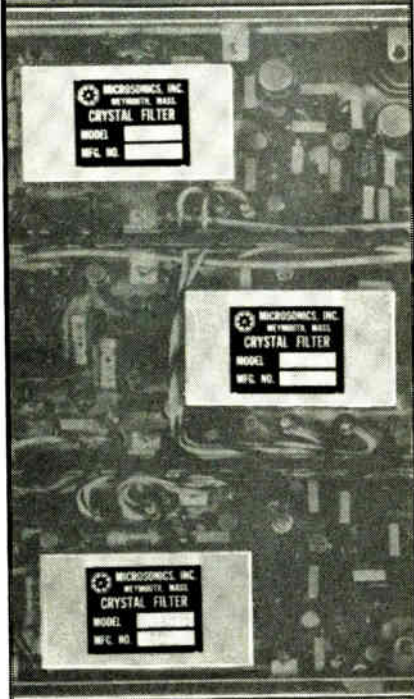

Microsonics, Inc. has designed and developed phase tracking crystal filters, in which the phase between filters will track within close tolerances, over wide temperature ranges, without temperature control. Any one of the standard multi-pole filters such as Butterworth, Tchebycheff, Bessel, etc. may be obtained with phase tracking requirements. In the event of tight tracking requirements, the filters are produced in matched sets according to the customer's requirements.

The set of 3 filters shown above have been produced in production quantities and the specifications are shown below.

SPECIFICATIONS

Center

frequencies:5MC \pm 150 cps
 Bandwidth 3db:1KC \pm 100 cps
 Shape-factor 60/3db:5:1
 Ultimate rejection:70db min.
 Initial phase off-set:1°
 Phase tracking across the
 3db bandwidth:5° max.
 Operating
 temperature: -35°C to +75°C

Send for Microsonics' Brochure
 No. 4350



MICROSONICS, INC.
 60 Winter Street
 Weymouth, Mass. 02188
 Tel: 617 337-4200

A subsidiary of the Sangamo Electric Company

Instead of the internal clock, an external source can be used for the 6506 to sweep at either a constant or changing rate. A nonlinear sweep would be useful, for example, in a radar system where the transmit-receive signals travel over the slant range and the data is to be recorded as a function of ground range.

Ferrous wear. The steel anode, continuously losing ferrous ions during operation, has a lifetime of from 75 to 100 hours. But the bar is held in the recorder in such a way that, regardless of how long the anode has been used, the same voltage will always produce the same mark intensity on the paper.

Besides the 512 recording styluses, the 6506 has 29 other pens, 15 on one side of the paper and 14 on the other. These can be used for printing characters, time marks, or other information. Schierhorst says the company will show customers how to build an alphanumeric generator. However, Electro-Physics will also sell one as an option, for about \$2,000.

The company is also making an electronic-sweep recorder with four channels. Called the 6503, this unit sells for \$18,000.

The 6503's 8-inch width can be subdivided into various formats—for example, one 8-in. channel, two 4-in. channel, or one 2-in. and one 6-in. channel. All four channels can be used to plot different parameters, or, with the proper circuitry, the total sweep for a single parameter can be shown on a 2-in. channel and a magnified part on the 6-in. When more than one channel is used, one stylus between each pair of channels doesn't receive a signal and is used as a demarcation marker.

Delivery time, on either the 6503 or 6506, is 90 to 120 days for the first unit, and 30 days for each additional recorder.

Specifications (6506)

Input signal	\pm 6v
Input impedance	3.3 kilohms, d-c coupled
Rise time	1 usec
Internal sweep control	0.5 msec to 40 sec per in., 14 settings
Input power	200 w max
Paper feed rates	0.8, 1.6, 3.2, 8, 16 in/min
Dimensions	16 x 17 x 22 in.
Weight	65 lbs

ITT Electro-Physics Laboratories Inc.,
 3355-52nd Ave., Hyattsville, Md. 20781
 [389]

Reed Relays



Basic and special REED RELAYS and/or COILS for high reliability and sophisticated switching

Operating Inputs: low as 1mA. and 15mW.
 Standard Coil Voltages: 6, 12, 24, 32, 48V in stock for immediate delivery.

Special Voltage or Resistance, multiple windings for flip flop, memory and crosspoint selection applications — to customer specifications.

Relay Contacts in Form A, B, C and latching. Also high vacuum type 5000V Form A.

Write for Bulletin and Prices

Coto-Coil

COMPANY INC.

61 Pavilion Ave.
 Providence, R. I. 02905
 Phone: (401) 941-3355

Circle 270 on reader service card

**TRANSIENTS
 IN THE AC INPUT LINE
 WON'T HURT YOUR PRODUCT
 DESIGNS IF YOU SPECIFY
 JOSLYN AC PROTECTORS**



For ultra fast precision response
 clamping at extremely low levels
 any kva rating with line voltages up to
 650 v rms max. life expectancy that
 exceeds that of your product no power
 interruption and no line insertion loss
 (exc. 1201-02).

Call or write now for full information on
 1200 single-phase, 1400 three-phase
 60-cycle Series Protectors. Just two
 of many surge arrester lines.



JOSLYN
 ELECTRONIC SYSTEMS

Division of Joslyn Mfg. & Supply Co.
 SANTA BARBARA RESEARCH PARK
 P.O. BOX 817, GOLETA, CALIFORNIA 93017
 Tel. (805) 968-3551.

don't be **develed** by interconnection problems



OUR CONNECTIONS ARE APPEALING
HIGH RELIABILITY LOW COST

Automated "SNAP IN" interconnecting CIRCUITFLEX is supplied with **Your Labor Costs** in the piece price. Shouldered Pins are electrically and Mechanically joined to CIRCUITFLEX. "SNAP IN" CIRCUITFLEX provided with Hi-Temp insulation & Hi-Temp solder for ease of installation.

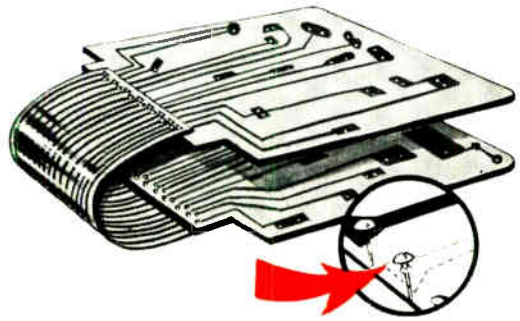

Flexible Circuits Inc.

Paul Valley Industrial Park, Warrington, Penna. 18976
215-DI-3-2300 — Contact Mr. Lee for application Seminar at your Plant.

CIRCUITSTRIP CIRCUITFLEX
POWERBUS CIRCUITGROUND
SPECIALTY LAMINATES ASSEMBLIES

Circle 272 on reader service card

SPECIAL COSMICAR[®] LENSES

COSMICAR lenses have improved in quality as CCTV cameras have improved.

There is no problem whether your cameras are with a built-in EE mechanism or a viewfinder mechanism.

COSMICAR will make whatever new lenses you need for your CCTV cameras to satisfy your every CCTV purpose.



FOR YOUR SPECIAL CCTV CAMERAS

For example, COSMICAR lenses can be adopted to automatic or rear control system by one hand.

Superb lenses of proven ability from 12.5mm to 1,000mm and Zoom lenses are on sale.

For further details, write to:



COSMICAR OPTICAL CO., LTD.

(Former name: ICHIZUKA OPTICAL CO., LTD.)

568, Shimoochiai, 2-chome, Shinjuku-ku, Tokyo Cable Address: "MOVIEKINO TOKYO"

When Only Excellent is Adequate **TURN to Grayhill**

for EXCELLENCE IN
MINIATURE . . .
SUB-MINIATURE . . .
ULTRA-MINIATURE
ELECTRONIC
COMPONENTS



BINDING POSTS

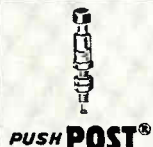

PUSH POST®



LAMP SOCKETS



TEST CLIPS

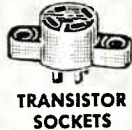

TRANSISTOR SOCKETS



STAND-OFF INSULATORS



INSULATED TEST CLIPS

Grayhill
 . . . the Difference Between
 Excellent and Adequate

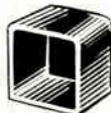

MODULE CASES

Select Materials

- Metal Parts — Steel, SS, Brass, Beryllium Copper
- Finishes — Silver Plate, Nickel Plate, Gold Plate
- Contacts — Fine Silver
- Insulating Material— Molded Phenolic, Diallyl, Epoxies to MIL-M-14

Typical Specifications

All Grayhill Components are designed for long life and high reliability under extreme environmental and operating conditions. Excellence, competitively priced.

Ask for
Catalog G-304-A
 for full details



523 Hillgrove Avenue
 LaGrange, Illinois 60525
 Area Code 312, Phone 354-1040

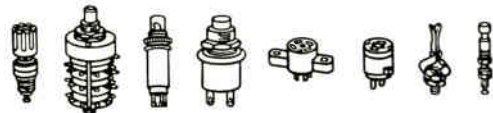

"PIONEERS IN MINIATURIZATION"

ThermaTab records surface temperatures

Apply pressure-sensitive ThermaTabs to any type of equipment (from diodes to diesels) that is subject to overheating. Calibrated to specific temperatures in 10° increments, ThermaTabs provide a permanent record of temperature level by turning black within an accuracy range of ±1%.

THERMATAB

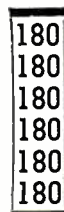

THERMATAB, JR.

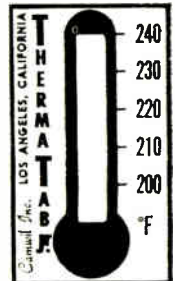

Each package contains 10 1/4 x 1" strips all rated for the same temperatures. Each strip may be cut into units of whatever size & shape are required for the application. Order from a selection of 36 temperatures in 10° increments from 100° through 450°F.

Each plastic-coated unit covers a 50° range in 10° increments starting at a choice of 100°, 150°, 200°, 250°, 300°, 350°, 400°.

Send for literature.

CAMWIL, INC.

835 Keeaumoku Honolulu, Hawaii

Circle 273 on reader service card

TDK CORE

The high-performance ferrite cores that made possible many breakthroughs in Japan's electronics technology

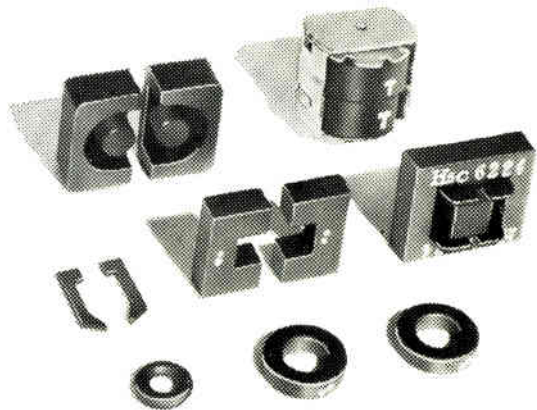

Write to MH&W for full technical data and information applications

Representative in U.S.A & Canada for Ferrite Core for Communications
MH&W INTERNATIONAL CORPORATION
 280 Midland Avenue, Saddle Brook, N.J. 07662
 Phone: Area Code 201-791-6277
 N.Y. Phone: Area Code 212-244-0695

TDK ELECTRONICS CO., LTD.
 2-14-6 Uchikauda, Chiyoda-ku, Tokyo Japan.

what's the winning combination?

Bell & Howell's matchless pair: 007 and 008 OPTimal OP AMPs

(ACTUAL SIZE)

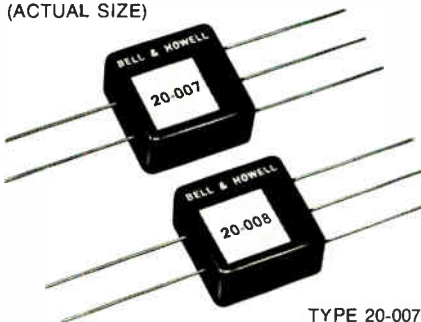

TYPE 20-007
general purpose Optimal op amp
TYPE 20-008
FET input Optimal op amp

They can't be matched in performance, size, and price. And paired, they make the winning combination for universal use. They are identical in package and lead configuration; check the specifications given below for performance and quality. Both have these internal features: voltage offset trim, frequency compensation, and input-output protection.

NOTE: Our quantity prices are based on the total number of units ordered, in any mix. Compared with other op amps of this size and high performance, the matchless pair is your best buy.

	20-007	20-008
Price (in quantities of 100, any mix)	\$16.50	\$26
Voltage offset	200 μ V	200 μ V
Input bias current	150 nA	10 pA
Common mode rejection	100 db	76 db
Gain band width (at 10 kHz)	20,000,000	20,000,000
Output current	5 mA	5 mA

CONTROL PRODUCTS DIVISION

BELL & HOWELL

Write or telephone. 706 Bostwick Avenue,
Bridgeport, Connecticut 06605.
Telephone: (203) 368-6751. Ask for Mr. Isdale.

New Books

Double value

Bio-Medical Telemetry
R.S. Mackay, John Wiley & Sons Inc.,
388 pp., \$12.50

Engineers will find this book valuable on two levels. First, if the reader is working in the biomedical field, or considering it, he'll find the book an excellent reference since it presents information about the possibilities and limitations of telemetering methods. Second, even if an engineer is not directly concerned with telemetry, he'll find that the book covers a fascinating subject, made all the more interesting by the fact that an engineer can approach it well prepared for half the contents and still learn quite a bit.

The author has wisely avoided a division of the book into two separate sections, labeled, say "Electronics" and "Biology." Instead, both subjects are interwoven and given equal emphasis. On facing pages, for example, are a circuit diagram for a telemetry transmitter intended to be swallowed and an X-ray photograph of the transmitter in place in a human subject.

The author's experience with biotelemetering devices and his awareness that engineers in this field work in a foreign environment is demonstrated in chapters such as the one entitled "Plastics and other materials." Since it is important that internal transmitters be constructed with an effective moisture barrier, the effects and limitations of the various encapsulating materials available is critical to the designer.

For example, one topic discussed is often overlooked by biotelemetering designers. This is the losses that can be introduced by materials placed near a coil antenna.

The author gives ample consideration to such new and unusual powering methods as coupling radio-frequency waves and chemical reactions involving body fluids. Even so, he considers batteries adequate for most biomedical applications. Included is a table listing the various battery types available along with their weight, size, voltage, and service capacity.

Because this book is directed par-

Why MARYLAND?

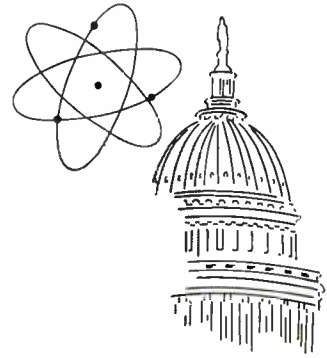

Proximity to federal agencies in Washington, D.C. affords the unique advantage of constant personal contact with government officials working with science-oriented industry. Such contact is an increasingly important locational criterion.

No other state is as convenient to as many Federal agencies as Maryland. For example, Maryland's major government scientific installations include NASA, AEC, NIH, the National Bureau of Standards, plus some 20 others.

Are there other reasons why R&D activities and science-oriented industries should consider locating in MARYLAND?

Yes... emphatically!

The availability of personnel, particularly engineers and scientists, is recognized as a chief criterion governing the location of any science-oriented industry.

There are almost 30,000 scientists and over 25,000 engineers living and working in Maryland and the District of Columbia.

There are 39 four-year colleges and universities in Maryland and the District of Columbia. Graduate and post-doctoral programs considered most significant to research and science industry are available.

Shouldn't you locate in MARYLAND?

Get All The Facts.

MARYLAND DEPARTMENT OF
ECONOMIC DEVELOPMENT
DIVISION E

State Office Bldg. • Annapolis, Md. 21404

Write, Wire Or Phone Collect



High Strength Dielectric

Coors Alumina Ceramics were originally developed to provide high mechanical strength insulators used in extremely high voltage applications. With Coors Ceramics you have high dielectric strength, plus a material with physical properties far superior to porcelain, glass or plastic. They are good structural materials, compressive strengths extend to 380,000 psi. They are inert, have long endurance at high voltages, are impervious to moisture or fungus, and are stable under intense radiation. Use Coors Ceramics, in sizes from micro wafers to large 24" x 60" cylinders. They can be glazed for easy-to-maintain cleanliness, or metalized for brazed ceramic-metal assembly. Faced with a high potential design decision? Get on-the-spot answers, dial Coors—303/279-6565, Ext. 361. For complete design criteria, write for new Coors Alumina and Beryllia Properties Handbook 952.

*consider
Coors
ceramics*

Coors
CERAMICS

ALUMINA • BERYLLIA • MAGNESIA • SPECIAL OXIDES
Coors Porcelain Co., Golden, Colo.

Circle 222 on reader service card



New Books

tially at scientists with little electronics background, any engineer will be able to read it quickly and still pick up some practical tips, not usually included in engineering texts, that are essential to assure the success of the experiments and circuits constructed by non-engineers.

Short 'n sweet

Solid State Electronics
(Texas Instruments' Electronics Series)
Robert G. Hibberd
McGraw-Hill Book Co.
170 pp., \$8.95

Quite an accomplishment, this. Hibberd takes the reader through semiconductor technology from A to Z in just 170 pages.

The compactness is a triumph of logical organization. Starting with the properties of semiconductors, the book proceeds to transistors, basic circuits, device manu-

facture, and testing. Addressed to engineers unfamiliar with the technology, its aim is not to teach the reader how to design devices and circuits but rather how they work and where they should be used.

There are fewer than a dozen equations in this easily read book. Instead, the author uses illustrations to convey key points.

But despite this emphasis on leanness and simplicity, Hibberd by no means skims his subjects. After describing basic devices, he explains compound semiconductors and goes on to cover field effect transistors, varactor and tunnel diodes, zeners, silicon controlled rectifiers, four-layer diodes, triacs, uni-junction transistors, optical semiconductors, and integrated circuits. The section on IC's touches on everything from basic materials through fabrication, isolation, and assembly.

At the conclusion of each section is a glossary of terms and a multiple-choice question drill (with answers) to review the information covered.

Considering the author's affiliation with a components manufacturer, perhaps the most remarkable feature of this book is that it approaches the material from the user's standpoint and maintains that perspective throughout.

Recently published

Physics of Electronic Conduction in Solids,
Frank J. Blatt, McGraw-Hill Book Co., 446 pp.,
\$14.50

Main theme here is that electronic conduction in both metals and semiconductors is fundamentally one and the same phenomenon. View is described in terms of the same transport equation, limited by the same kind of relaxation process, and may be employed as a useful and flexible tool in the study of both conductors.

Detection, Estimation, and Modulation Theory: Part I, Harry L. Van Trees John Wiley & Sons, Inc., 697 pp., \$20.00

Discusses classical detection, estimation theory, and random process representation to provide background on waveform problems and then covers problems of detecting signals in noise, estimating signal parameters in noise, and the continuous modulation theory. Though primarily aimed at graduate students, practicing engineers working on communications radar, or sonar systems will also be interested.

Microwave design is easier now.

business trips rule out evening classes?



here's a practical way to update your knowl- edge of electronics

Are irregular hours, travel and family obligations keeping you from attending classes—even though you worry about becoming technically obsolescent? Check into the Special Programs in Electronics for Engineers developed by CREI, the Home Study Division of the McGraw-Hill Book Company.

These are not simply courses, but comprehensive programs in advanced electronics offering major electives in such fields as:

Communications Engineering, Aeronautical and Navigational, Television Engineering, Automatic Control Engineering, Missile and Spacecraft Guidance, Radar and Sonar Engineering, Nuclear Instrumentation and Control, Computers.

Industry-recognized CREI Programs make it possible for you to catch up on new developments in electronics through study in your own home, at your own pace,

your own schedule. Free book gives complete information and details of technical material covered. For your copy, mail coupon below or write: CREI, Home Study Division, McGraw-Hill Book Company, Dept. 1822-G, 3224 Sixteenth St., N.W., Washington, D.C. 20010.

Founded 1927



Accredited Member of the National Home Study Council



CREI, Home Study Division, McGraw-Hill Book Company
Dept. 1822-G, 3224 Sixteenth St., N.W.
Washington, D.C. 20010

Send me free brochure describing CREI Programs in Electronics for Engineers.

NAME _____ AGE _____

ADDRESS _____

CITY _____ STATE _____ ZIP CODE _____

COMPANY _____

TITLE _____

Technical Abstracts

Counterrevolution

A mechanically despun antenna for communications satellite application
M. F. Eming, S. Marx, and W. Triplett
Philco-Ford Corp.
Palo Alto, Calif.

Mechanically despun antennas have been nosing out electronic despinning techniques for spin-stabilized communications satellites. Mechanical despinning, now on the Advanced Technology Satellite 3 in synchronous orbit over Brazil, will be aboard the Intelsat 3 satellite to be launched later this year [Electronics, April 1, p. 71]. Comsat is also considering the technique for its advanced Intelsat 3½ and 4 satellites.

The Air Force, too, is applying the mechanical approach with a unit being developed by the SRS division of the Philco-Ford Corp. It will operate in the 7- to 8-gigahertz range.

Despinning, counteracting the

normal spin of the satellite, keeps a high-gain antenna at the same speed as the satellite but in the opposite direction. This can be done mechanically, with an electric motor turning the antenna, or electronically, with phase shifters to modify antenna-array direction. To someone on the ground, the antenna mounted on a satellite in a synchronous orbit appears motionless.

Mechanical despinning has several advantages over the electronic method: more precise pinpointing; higher effective radiated power, because there are none of the losses associated with electronic phase shifters, and, in general, less weight, volume, and power for a given mission.

The Philco-Ford mechanically despun antenna has three major elements: a horn-reflector antenna, motor-drive assembly, and control electronics.

The total system, including redundant control electronics and sun and earth sensors, weighs 12 pounds. Average power consumption is less than 5 watts. Design life is five years.

Antenna gain in the on-axis direction is 18.2 decibels in transmit and 18.9 db in receive; gain at 9.5° away from axis direction is down to 15.1 db in transmit, 14.7 db in receive.

To spin the antenna, Philco-Ford selected a d-c brushless torque motor using a rotary transformer type of resolver. Properly aligned, the resolver synchronously commutates the motor's permanent magnet. The brushless motor has the high torque efficiency, infinite resolution, and starting characteristics of the brush-type d-c motor, according to Philco-Ford. The brushless unit was chosen instead of a synchronous stepper motor—another possibility—because it is

There's an easier way to measure magnitude and phase of attenuation and gain.

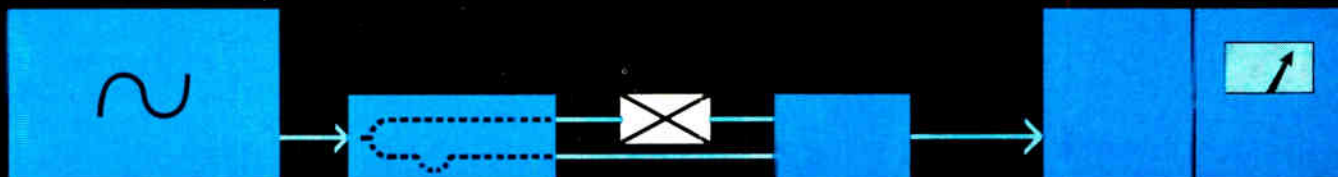

MISSING: a few connections GAINED: new reliability at a bargain price

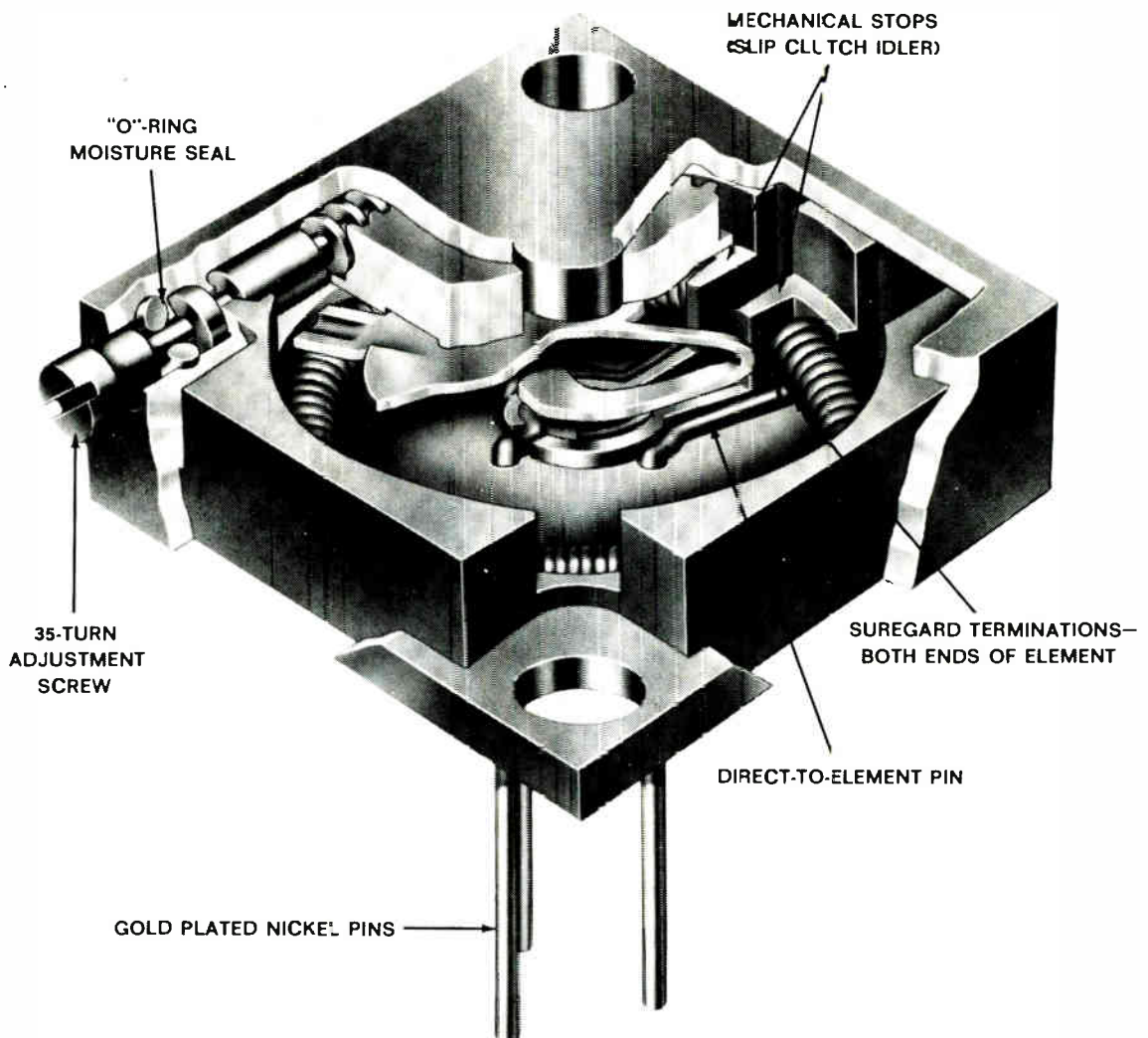

Design omissions can be as important as additions in product performance. An inside look at the new DAYSTROM Squaretrim® 554 Series pot, for example, shows that intermediate pin connections have been eliminated. Two of the weldable base pins are affixed directly to the resistance element. The center pin pivots directly against the rotating tap assembly. Result? A simplified design which also lowers your cost. Made in accord-

ance with MIL-R-27208, these half-inch units are rated for a full watt in still air at 70°C. Sealed models have passed Weston's 100% immersion test. Now thrifty-minded military, industrial or commercial users can have Squaretrim quality features at a bargain price: patented "wire in the groove" construction; 10 ohm to 50 K resistance range; ±5% standard tolerance; -55° to +150°C temperature range; your choice of

pins, flexible leads, and screw configurations; choice of sealed and unsealed models; priced competitively. Write for complete data and evaluation samples of our 550-555 Series potentiometers. Daystrom potentiometers are another product of: WESTON COMPONENTS DIVISION, Archbald, Pennsylvania 18403, Weston Instruments, Inc. a Schlumberger company

WESTON®

Technical Abstracts

half the weight, uses less power, and has fewer problems involved with startup.

Presented at the AIAA 2nd Communications Satellite Systems Conference, San Francisco, April 8-10.

Starting small

Performance of a digital two-term controller
T.H. Thomas and M.T.G. Hughes
University of Warwick,
Coventry, England

When the digital computer was first applied to process control, its major tasks were to calculate an optimum operating condition and adjust the set points of conventional analog controllers. Later, direct digital control undertook to use one computer to provide the dynamic compensation of all control loops, thereby eliminating conventional controllers. This is economical only if the system is large enough to spread the fairly high

cost of a direct digital control system over many loops.

Thus there is a need for a low-cost digital controller that compensates single loops in much the same way as the conventional analog controller does and that could be expanded into a multi-loop control system through multiplexing and programing.

A single-loop digital control that provides compensation similar to the proportional and integral terms of analog controllers uses three registers—for set points, signals, and timing—and simple logic. Its input, or measurement, signal is a pulse frequency that increases linearly with the measured variable. Pulses from the controller operate stepping motors that are tied to the control valves.

There are three gate periods in each measurement and compensation cycle. The first counts input pulses to determine error between measurement and set point, and the second and third compute the rate of change of the output variable.

The controller operates in the following manner. During the first gate period, signal pulses are subtracted from a signal register previously loaded with the number of counts equivalent to the set point. The pulses remaining in the register at the end of this period are the error. As this residue is cleared from the register it moves the stepping motor the same number of increments.

During the second gating period, signal pulses are added to the now empty signal register. Pulses are subtracted from the register during the third period, generally leaving a small residue that is related to the rate of change of the measured variable. This second residue then positions the stepping motor proportionally, the over-all operation thus being equivalent to integration. If the variable hasn't changed, the second residue will be zero, and integral action won't occur.

Presented at the Pulse Symposium of the International Federation of Automatic Controls, Budapest, April 8-11.

←Circle 226 on reader service card

There's an easier way to measure magnitude and phase of reflection coefficient.

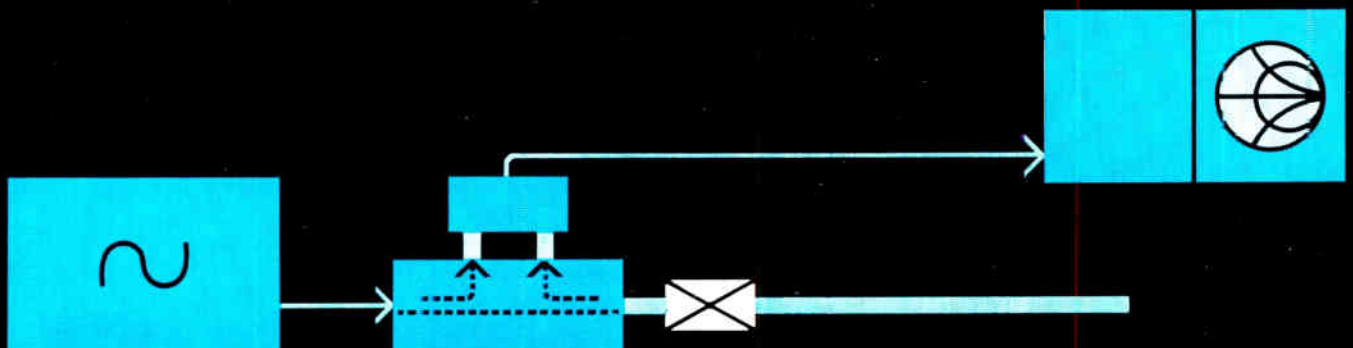

MATSUO

Highly Reliable Capacitors

POLYESTER FILM CAPACITORS.

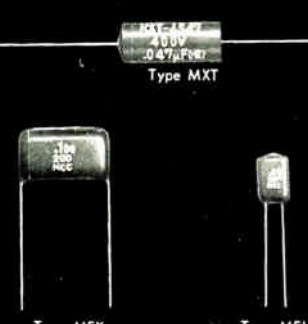

Type MXT In plastic tube.
Capacitance Range: .001 MFD to .22 MFD.
Voltages: 100v, 200v, 400v, 600v DC.

Type MFK Dipped flat shape, non-inductive construction.
capacitance Range: .01 MFD to .47 MFD.
Voltages: 100v, 200v, 400v, 600v DC.

Type MFL Dipped flat shape.
Capacitance Range: .001 MFD to .22 MFD.
Voltages: 50v, 100v, 200v DC.

METALLIZED POLYESTER FILM CAPACITORS.



Type FNX-H Mylar wrapped semioval with epoxy end seal.
Capacitance Range: 1 MFD to 10 MFD
Voltages: 100v, 200v, 400v, 600v DC.

SOLID TANTALUM CAPACITORS.

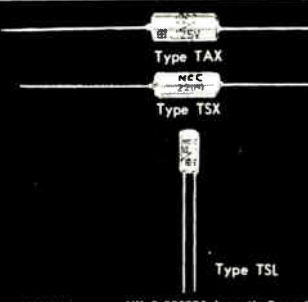

Type TAX MIL-C-26655A hermetically sealed.

Type TSX-TSL Sealed with epoxy resin.
Capacitance Range: .22MFD to 330 MFD.
Voltages: 3v, 6v, 10v, 15v, 20v, 25v, 35v, 50v DC.

for full details, contact :

MATSUO ELECTRIC CO., LTD.

3-chome, Sennari-cho, Tayonaka-shi, Osaka, Japan
Cable Address "NCC MATSUO" OSAKA

Errata

Color video panel

Several errors in the article on the Sony color video panel [April 15, pages 92 to 101] require corrections.

In the diagram at the bottom of page 96, the block at the upper left hand corner should be labelled "video output amplifier" rather than pulse-width modulator converter. This diagram is intended to show the most primitive type of matrix scan, with sampling by the X and Y switches. If pulse width modulation is used, holding circuits are required and they must be inserted after the switch labelled SW_x, not before it. Also, the diagram should be corrected to read $T_V^{-1} \leq 16.7$ milliseconds rather than 16.7 microseconds.

A similar error occurs at the lower right-hand corner of page 97, second line from the bottom which should also be corrected to read 16.7 milliseconds.

Page 97, last paragraph starting on left-hand side of bottom of page, should be corrected to read "The lamp current varies during the entire length of the applied pwm pulse, and almost reaches equilibrium at the end of the 100 μ sec pulses corresponding to maximum brightness." Actually, even after 100 μ sec, the current is still decreasing slightly, and true equilibrium is reached after about 200 μ sec.

A correction is required in the diagram at the top of page 101. The lower of the two 5.6- μ h inductors should not be connected to ground. A notation at the lower end of the lower inductor should be added to read "to succeeding stage of the delay line." The notation next to the input end of the upper inductor should read "sampling pulse from previous stage of delay line."

The first paragraph on the upper left-hand side of page 101 should be corrected to read "On the other hand, it would cost about the same as a color display of comparable size using projection methods, and the projection display cannot [rather than can] be viewed in a lighted room."

FOR Alignment Tools

Think **GC**



Solve your production and service problems with alignment and specialty tools from GC! Designed and manufactured to O.E.M. and Government specifications from the finest materials available, GC tools make production faster, more efficient. And whether you need one or a thousand, all are available from stock for immediate shipment.

FREE! Write today on your Company letterhead for the big **FREE GC Electronic Components Catalog - FR-66-1**... it's your key to greater profits.

GC Electronics
400 South Wyman Street
Rockford, Ill. 61101
A Division of
GC-Hydrometals, Inc.
Shipping warehouses in:
Hicksville, L.I., N.Y.
Los Angeles, California



Circle 276 on reader service card

Cartoon by Whitney Darrow, Jr.



Be a buddy!

One gift works many wonders
THE UNITED WAY

In fact, there's an easier way to measure every microwave network parameter: the Hewlett-Packard 8410A Network Analyzer.



8411A
Harmonic Frequency
Converter

8410A Network Analyzer
mainframe with 8413A
Phase-Gain Indicator

8414A
Polar
Display

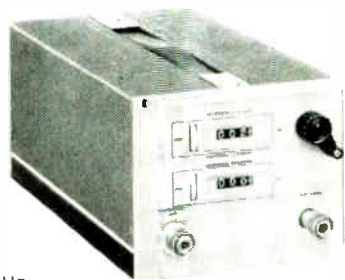

8740A
Transmission
Test Unit
0.11 to 12.4 GHz

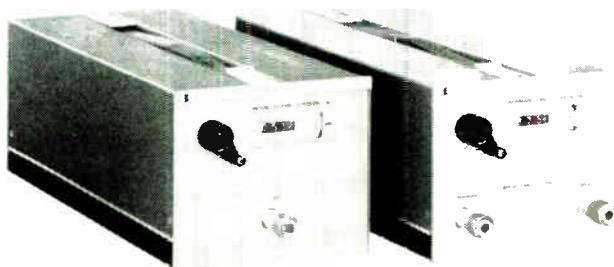

8741A
0.11 to 2.0 GHz
8742A
2.0 to 12.4 GHz
Reflection Test Units

The new HP 8410A is a veritable "multimeter" for microwave measurements. With it you can measure any quantity you need to completely characterize a microwave component or system. That includes phase, gain, attenuation, impedance, admittance and other quantities—in single or swept frequencies, 110 MHz to 12.4 GHz.

In fact, the HP 8410A is so complete, yet so simple to operate, it is the ideal universal microwave tool. Whatever you measure with it, you can do the job more accurately, more completely, in less time, with less work, less equipment and at lower costs than ever before.

The Network Analyzer consists of the basic 8410A Mainframe (\$1800) and the 8411A Harmonic Frequency Converter (\$2500). For transmission measurements over the full range, use the plug-in 8413A Phase-Gain Indicator (\$850) with the 8740A Transmission Test Unit

(\$1300). For reflection measurements, you use the 8414A Polar Display plug-in (\$985) with the 8741A Reflection Test Unit, 0.11 to 2.0 GHz (\$1500), the 8742A Reflection Test Unit, 2.0 to 12.4 GHz (\$1500).

Ask your HP field engineer for all the details about this invaluable new tool. Or write Hewlett-Packard, Palo Alto, Calif. 94304; Europe: 54 Route des Acacias, Geneva.

HEWLETT  **PACKARD**

MICROWAVE NETWORK ANALYZERS

Circle 229 on reader service card

New Literature

Pressure transducer. Robinson-Halpern Co., 5 Union Hill Road, Conshohocken, Pa. 19428, has issued a technical bulletin on a self-contained pressure transducer that can be manually set anywhere in the range of 0 to 120 psig. Circle 446 on reader service card.

Basic switches. Micro Switch, a division of Honeywell Inc., Chicago and Spring Sts., Freeport, Ill. 61032, has released a guide that offers a "letter key" solution to a variety of basic switch application needs. [447]

Ultrastable electrometer. Keithley Instruments Inc., 28775 Aurora Road, Cleveland 44139. A four-page engineering note describes the model 640 vibrating capacitor electrometer with stability of better than 20 microvolts per day. [448]

Wafer and dice. Electronic Components, division of United Aircraft, Trevoise, Pa. 19047, offers a catalog of wafer and dice including pnp transistors, npn switches, npn amplifiers, diodes, zener diodes and silicon dioxide capacitors. [449]

Trigonometric modules. Transmagnetics Inc., 134-25 Northern Blvd., Flush-

ing, N.Y. 11354. A design manual shows more than 45 applications for trigonometric building-block modules. [450]

Decade counters. Wyle Laboratories, 128 Maryland St., El Segundo, Calif. 90245. An application note describes the design and performance of single and multistage presettable decade counters capable of advancing in either forward or reverse directions without deviating from a 1-2-4-8 BCD operating code. [451]

Transistor test set. Baird-Atomic Inc., 33 University Road, Cambridge, Mass. 02138, has published bulletin EP-2A covering the model PB-1 automatic transistor test set. [452]

Correlation/spectrum analyzer. Federal Scientific Corp., 615 W. 131 St., New York 10027. Eight-page technical bulletin 690 describes the model UCA-7 real-time Ubiquitous correlation/spectrum analyzer. [453]

Epoxy systems. Wakefield Engineering Inc., Wakefield, Mass. 01880. Bulletin No. 28 describes filled epoxy resin systems for bonding, coating and encapsulating. [454]

Coaxial connectors. Star-Tronics Inc., Moulton St., Georgetown, Mass. 01830. Engineering bulletin STM-1 describes a line of 50-ohm miniature r-f coaxial connectors. [455]

Military plating. Spec Tech Publications Inc., 8170 Beverly Blvd., Los Angeles 90048, has available a wall chart containing an up-to-date summary of the latest military plating specification information. [456]

Crt displays. Display Division, Data Disc Inc., 1275 California Ave., Palo Alto, Calif. 94304. A 12-page booklet contains four articles on cathode-ray-tube displays. [457]

A/D converter. Bunker-Ramo Corp., 8433 Fallbrook Ave., Canoga Park, Calif. 91304, offers a 12-page brochure describing techniques used in the BR-850 cyclic analog-to-digital converter. [458]

Multilayer p-c boards. National Technology Inc., 220 W. Central Ave., Santa Ana, Calif. 92707. Complete in-house multilayer p-c board manufacturing capability is the subject of an illustrated color brochure. [459]

Magnetic reed switches. Hamlin Inc., Lake and Grove Sts., Lake Mills, Wis. 53551, announces a four-page brochure which can be used by design engineers as a guide to magnetic reed switch application. [460]

CERMET TRIMMERS



Series 340 Top Adjust 1/4" x 1/4" x .220"
Cermet Trimmer

NEW FROM CTS

\$1.25 ea. in 1,000 lots down to
93c ea. in 50,000 lots.

50 Ω through 500K Ω .

$\pm 20\%$ tolerance.

3/4 watt @ 25°C; 1/2 watt @ 85°C, derated to no load @ 150°C.

Single turn.

Prototype Quantities From Stock.
Production Quantities: 4-6 weeks.

Order from: CTS of Berne, Inc., Berne, Indiana 46711.
(219) 589-3111.

 **CTS CORPORATION**
Founded 1896



Series 360 Side Adjust 7/16" x 17/64" x 25/64"
Snap-in Type Cermet Trimmer

NEW FROM CTS

\$1.04 ea. in 1,000 lots down to
80c ea. in 50,000 lots.

50 Ω through 1 megohm.

$\pm 20\%$ tolerance.

1 watt @ 25°C; 1/2 watt @ 85°C, derated to no load @ 125°C.

Single turn.

Prototype Quantities From Stock.
Production Quantities: 4-6 weeks.

Order from: CTS of Berne, Inc., Berne, Indiana 46711.
(219) 589-3111.

 **CTS CORPORATION**
Founded 1896

Iron powder cores. Arnold Engineering Co., Box G, Marengo, Ill. 60152, offers a 44-page designer's catalog (PC-109-B) that gives a complete guide on the selection of iron powder cores. [461]

Heatless dehydrator. Andrew Corp., 10500 W. 153rd St., Orland Park, Ill. 60462. Bulletin 263 introduces a low pressure automatic dehydrator for coaxial cable and waveguide feeder installations. [462]

Solid state products. Texscan Corp., 2446 N. Shadeland Ave., Indianapolis 46219, announces a 68-page catalog on its solid state product line consisting of sweep generators, attenuators, detectors, coaxial switches, portable scopes, multichannel X-Y display scopes and impedance plotters. [463]

Particle accelerators. High Voltage Engineering Corp., Burlington, Mass. 01803, has available a 24-page general catalog describing particle accelerators and accessory systems. [464]

Digital systems. Foxboro Co., Foxboro, Mass. 02035. Bulletin L-27 summarizes the company's digital systems services from system specification to start-up. [465]

Mass spectrometers. Bendix Corp., 3625 Hauck Road, Cincinnati 45241, has issued a 32-page catalog on its complete line of time-of-flight mass spectrometers and accessories. [466]

Voltage tunable magnetrons. General Electric Co., Schenectady, N.Y. 12305. A 15-page brochure (ETD-4838) covers vtm modulation and power supply requirements. [467]

R-f connectors. Applied Engineering Products, Division of Samarius Inc., 26 E. Main St., Ansonia, Conn. 06401. Catalog 168 contains 56 pages of standard screw-on, snap-on, slide-on, and adaptor cable connectors in 50- and 75-ohm sizes according to MIL-C-22557. [468]

Solid state power supplies. Electronic Research Associates Inc., 67 Sand Park Road, Cedar Grove, N.J. 07009, offers catalog 150A describing its current line of solid state power supplies. [469]

Commercial sound components. Ampex Corp., 401 Broadway, Redwood City, Calif. 94063. Data sheets A171 and A183 list features and specifications of commercial sound components such as the 80-w solid state power amplifier and preamplifier plug-in modules. [470]

IR retrieval. Sadtler Research Laboratories Inc., 3316 Spring Garden St., Philadelphia, 19104. A 26-page brochure describes a comprehensive computerized system for retrieving infrared spectral data. [471]

Miniature lamps. Los Angeles Miniature Products Inc., 17000 South Western

Ave., Gardena, Calif. 90247. A 28-page color catalog is available on high reliability illumination with miniature and ultraminiature lamps. [472]

S-element crystal. Reeves-Hoffman Division of DCA, 400 W. North St., Carlisle, Pa. 17013, offers a specification sheet giving technical data, including electrical equivalent parameters and temperature curves, on a 200 khz to 1 Mhz S-element crystal. [473]

Environmental chambers. Bemco Inc., 9908 San Fernando Road, Pacoima, Calif. 91331. A 46-page catalog lists the firm's line of environmental test equipment and space simulation systems. [474]

Multiplier applications. GPS Instrument Co., 188 Needham St., Newton, Mass. 02164. An eight-page booklet is designed to aid the applications engineer in using a new series of six high performance, four-quadrant multipliers. [475]

Plug-in power supply. Acopian Corp., Box 585, Easton, Pa. 18042. A single-page bulletin illustrates and describes a dual 15-v, 60 ma a-c to d-c plug-in power supply for operational amplifiers. [476]

Magnetically shielded chamber. Magnetic Shield Division Perfection Mica Co., 1322 N. Elston Ave., Chicago 60622. Data sheet 196 describes a

CERMET TRIMMERS



Series 165-3/8" x 3/8" x 13/64" Cermet Trimmer

NEW FROM CTS

\$3.25 ea. in 1,000 lots down to
\$2.56 ea. in 50,000 lots.

50 Ω through 1 megohm.

$\pm 20\%$ tolerance.

1/2 watt @ 85°C derated to no load @ 150°C.

25 turns.

Prototype Quantities From Stock.
Production Quantities: 4-6 weeks.

Order from: CTS of Berne, Inc., Berne, Indiana 46711.
(219) 589-3111.



CTS CORPORATION
Founded 1896

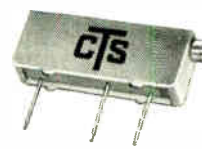

Series 190-3/4" x .160" x .310" Cermet Trimmer

NEW FROM CTS

\$1.24 ea. in 1,000 lots down to
98c ea. in 50,000 lots.

50 Ω through 500K Ω .

$\pm 20\%$ tolerance.

1/2 watt @ 85°C derated to no load @ 125°C.

20 turns.

Prototype Quantities From Stock.
Production Quantities: 4-6 weeks.

Order from: CTS of Berne, Inc., Berne, Indiana 46711.
(219) 589-3111.



CTS CORPORATION
Founded 1896

Keep your equipment cool. Here are a few of our 21 all-metal fans that will do the job...economically.

COMPACT MODEL 8500

**1/8" thinner
than other
3/8" fans ... 45 cfm**



- Unmatched noise level of 28.8 dB
- Ideal for tight dimensional applications where performance and cost are prime considerations.
- Only 3 1/8" x 3 1/8" x 1 1/2" deep.
- Standard mounting dimensions for EIA 3 1/2" rack panels.
- UL recognition number E41168.

ON READER-SERVICE CARD CIRCLE 510

6" MODEL 7500

**Use one to
replace two
or more fans
where maximum
total air movement is required
with extremely low noise level**

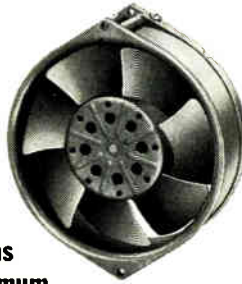

- Moves up to a whopping 265 cfm.
- Ideal for cooling large electronic enclosures with excessive resistance to air flow.
- With new aerodynamic design of pressure type blades, sustains delivery as high as 225 cfm at .2 inches of water back pressure.
- Low noise level of 40.5 dB SIL at 265 cfm.

ON READER-SERVICE CARD CIRCLE 511

LOW-NOISE 4 1/2" MODEL 4500

**115 cfm with
less than
37.5 dB SIL**

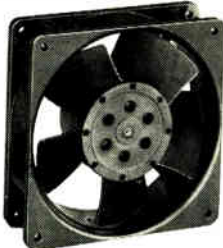

- Operates continuously at room temperature (25°C) for over 100,000 hours—even at 55°C, operates 20,000 hours, continuous duty, without re-lubrication. UL recognition.
- Powerful shaded-pole motor operates with low internal heat rise—efficient inside-out design.
- Interchangeable with similar, less reliable 4 1/2" fans.

ON READER-SERVICE CARD CIRCLE 512

LOW-COST MODEL 2500

**20,000+
operational hours
at 45°C without maintenance**

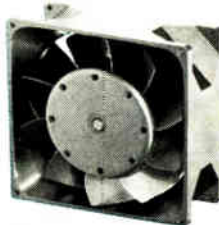

- 4 1/2" fan moves 115 cfm.
- Standard mounting dimensions for interchangeability.
- 50-60Hz operation at 117 or 230 VAC.

ON READER-SERVICE CARD CIRCLE 513

ULTRA-RELIABLE INDUCTION MODELS

**7 models
available
with ratings
from 130 to
65 cfm**

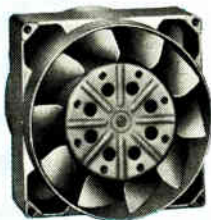

- Models 1000A, 1100, 1300, 2000, and 2050 measure 4 1/16" square x 1 3/32". Models 3000 and 3050 are 3 3/32" square x 1 3/32".
- UL recognition number E41168.

ON READER-SERVICE CARD CIRCLE 514

In addition to giving you a wide choice of sizes and performance characteristics in all-metal fans with shaded-pole or induction type motors, we can give you a special fan to solve your particular cooling problem. We can deliver fans with low, low noise levels, economical "bracket" models, and ball bearing fans for 85°C ambient temperature operation. Extend the life of your equipment... cool it and call us now at (415) 863-5440. Or TWX 910-372-6127. Or write for data to 312 Seventh St., San Francisco, California 94103.

PAMOTOR, INC.

New Literature

magnetically shielded chamber for calibration and checking of magnetometers and other magnetic sensing devices. [477]

Precision resistors. Vishay Resistor Products, a division of Vishay Inter-technology Inc., 63 Lincoln Highway, Malvern, Pa. 19355. Bulletin R-101-F contains construction and specification data for the HA series high stability precision resistors. [478]

Ultrasonics. Branson Instruments Inc., Progress Drive, Stamford, Conn. 06904, has published an illustrated booklet describing applications for ultrasonics in industry and science. [479]

Armature winder. Possis Machine Corp., 825 Rhode Island Ave. South, Minneapolis 55426, has issued a two-page bulletin describing the model ATC-30 solid state, tape controlled armature winder. [480]

Precision switches. Chicago Dynamic Industries Inc., 1725 Diversey Blvd., Chicago 60614. A four-page condensed catalog contains 28 illustrations and technical descriptions of a line of tab-type thumbwheel switches, panel-sealed pushbutton switches, rotary-selector switches and custom assemblies. [481]

Mercury relays. Ebert Electronics Corp., 130 Jericho Turnpike, Floral Park, N.Y. 11002, offers a catalog covering a complete line of silent Hi-Power mercury plunger relays. [482]

Miniature solenoid. Electro-Mechanisms Inc., 407 West Chestnut Ave., Monrovia, Calif. 91016, has issued a brochure on miniature open-frame solenoid actuators. [483]

Wire strippers. Eubanks Engineering Co., 225 W. Duarte Road, Monrovia, Calif. 91016, has data sheets describing operation, features, and capabilities of four automatic wire-processing machines. [484]

Component selector. Cornell-Dubilier Electronics, 50 Paris St., Newark, N.J. 07101, has published a 120-page book that describes and catalogs its entire product line of capacitors, filters, and relays. [485]

Voltage regulator. Beckman Instruments Inc., 2500 Harbor Blvd., Fullerton, Calif. 92634. Data sheet 68935 covers the 3- to 9-volt adjustable-output model 806 d-c voltage regulator. [486]

Sensors. Guardian Electric Manufacturing Co. of California Inc., 5755 Camille Ave., Culver City, Calif. 90230. A six-page brochure provides technical information on a line of solid state controlled sensors. [487]



EMPLOYMENT OPPORTUNITIES

INSTRUMENT TECHNICIANS

Minimum high school education and four years' of industrial electronic experience. Installs and maintains numerical control equipment process control instrumentation systems and devices. Inspects, alters, fabricates, troubleshoots, repairs, and maintains complex equipment and services.

These openings are in a large, modern complex facility. Located in Oak Ridge, Tennessee, heart of the Tennessee Valley region.

Relocation Expenses—Excellent Employee Benefits

U. S. Citizenship Required
Send Complete Resume to:
Central Empl. Office

UNION CARBIDE CORPORATION Nuclear Division

P.O. Box M Oak Ridge, Tennessee 37830
An Equal Opportunity Employer F/M

CIRCLE 980 ON READER SERVICE CARD

EMPLOYMENT OPPORTUNITIES

The advertisements in this section include all employment opportunities—executive, management, technical, selling, office, skilled, manual, etc.

Look in the forward section of the magazine for additional Employment Opportunities advertising.

— RATES —

DISPLAYED: The advertising rate is \$71.00 per inch for all advertising appearing on other than a contract basis. Contract rates quoted on request.

An advertising inch is measured 7/8" vertically on a column—3 columns—30 inches to a page.

Subject to Agency Commission.

UNDISPLAYED: \$3.30 per line, minimum 3 lines. To figure advance payment count 5 average words as a line. Box numbers—count as 1 line.

Discount of 10% if full payment is made in advance for 4 consecutive insertions.

Not subject to Agency Commission.

Send new ads to:

ELECTRONICS

Class. Adv. Div.,

P. O. Box 12, N. Y., N. Y. 10036

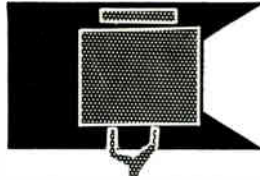

SEARCHLIGHT SECTION

• CLASSIFIED ADVERTISING • BUSINESS OPPORTUNITIES
• USED OR SURPLUS EQUIPMENT

GET IT from GOODHEART!

0.01% SORENSEN Line Voltage Regulator

#1001 regul. against load changes 0-1 kva & line changes 95-130 v. 1 ph 55/65 cy; adj. output 110-120 v. holds to 0.01%. Distortion max. 3%. Response 0.1 sec. Regularly \$570.00. From us, OK

grtd, only \$275.00

#2501 is same but 0-2.5 kva. \$375.00

#5005 is same, 0.5 kva, 0.1% \$89.50

#10005 is same, 1 kva, 0.1% \$99.50

#20005 is same, 2 kva, 0.1% \$179.50

Sup. Electric #IE-5102 is same spec, electronic regul., but 2 1/2 kva, 0.1% \$199.50

Sup. Elect. IE-20060: 3 kva. Same specs as above but 3 ph, 110-130 v. out, all ported xfrms, etc. Holding tank panel 21" h, 14 1/2" dp. no cabinet. Regular \$360. NEW, export boxed, 330# fob Utica, N.Y. (Cabinet for above \$30 fob Utica.) \$279.50

Sorensen R5010 all-solid-state, zener reference, 0-5 kva, 90% efficient. Regular \$792. With cabinet \$450.00

Sup. Elect. IE-5105: Same specs as Sorensen "S" series, 0-5 kva, regular \$665.00. Only \$349.50

Sorensen 10,000S: Same specs as all above, but 0-10 kva, regular \$1272. With spares, 67# fob San Diego. \$695.00

ALL ABOVE are 1 ph 95-130 v. Two below are 1 ph 190-230 v in, adjust. 220-240 v out, 0-5 kva. Same specs, choose Sorensen 5000-2S or Sup. IE-52051 specs. choose Sorensen 5000-2S or Sup. IE-52051P (Picture is #5000-2S.) \$349.50

Above are electronic. Following are electromech. A servo system senses output, turns a Variac or Powerstat, corrects to 1% very fast. Life tested 50 years, 47-63 cy OK, AND NO DISTORTION!

Gen. Radio #1570AL: 0-6 kva, regular \$530. From us only \$199.50

Sup. Elect. EM-4106 in upright metered cabinet, 0-6 kva. \$199.50

Sup. Elect. EM-4115 in metered cabinet, 1 ph 0-15 kva. \$295.00

Sup. Elect. EM-4228 0-27.5 kva 1 ph. \$495.00

Above are all 95-130 v; 190-260 v follows: Sup. Elect. EM-4228, 1 ph, 0-27 1/2 kva, regular \$750. New. EMT 6220Y (transistorized) 3 ph 20 kva, \$1200 value, only. \$450.00

DO NOT ASK FOR CATALOG! ASK FOR SPECIFIC ITEMS OR KINDS OF ITEMS YOU NEED!

R. E. GOODHEART CO. INC.

Box 1220-E, Beverly Hills, Calif. 90213

Phones: Area 213, office 272-5707, messages 275-5342

CIRCLE 970 ON READER SERVICE CARD

Minifluid DISPENSER
AIR OPERATED
for miniature potting and encapsulating
Available in 3 sizes
6cc - 12cc - 30cc
\$34.00
PHILIP FISHERMAN COMPANY
7 CAMERON ST., WELLESLEY, MASSACHUSETTS 02151

CIRCLE 971 ON READER SERVICE CARD

RADAR SYSTEMS GROUND AND AIRBORNE. AUTOMATIC TRACKING ANTENNA SYSTEMS. NIKE AJAX. NIKE HERCULES. M-33. MSQ-1A. MPS-19. MPS-9. SCR 584. TPS-1D. TPS-2B. FAA-ASR-2. AIRBORNE SYSTEMS. APN-84. APN-102. APS-20. APS-27. APS-45. DPN-19. DIGITAL COMPUTERS. IBM 650. IBM 704.

RADIO RESEARCH INSTRUMENT CO.
LARGEST INVENTORY OF RADAR AND MICROWAVE EQUIPMENT IN THE WORLD.
45 WEST 45TH ST. N. Y. 10036 212-JU 6-4691

CIRCLE 972 ON READER SERVICE CARD

If there is anything you want

that other readers can supply

OR . . . something you don't want—

that other readers can use—

Advertise it in the

SEARCHLIGHT SECTION

For Sale

ALL ELECTRONIC EQUIPMENT

Interceptor Control Panel: General Electric No. OA-1046/GPA-23, PN 7302298G2, S/N 240/132/291/133, 4 ea.

Communications Equipment: Track Data Storer, G.E. No. R0-34/GPA-23 PN 7302729G1, 120/208V, 3 phase, 60 cycle, 5 ea.; Interceptor Control Group, G.E. No. OA-1044/GPA-23, PN 7708749P17, Computer-Tracer, G.E. No. CP285/GPA23, PN 7302326G3, 5 ea.; Radar Computing Tracking Group, G.E. No. AN/GPA-23, PN 77087941P3, Reference Signal Generator, G.E. No. SG144/GPA-23, PN 7302722G1, 120/208V, 3 phase, 60 cycle, 1 ea.; Wind Data Distribution Group, G.E. No. OA-1510/GPA-23, PN 7305900G1, S/N 79, 1 ea., and other various items.

Communication Equipment: Power Supply, Breckner Electronics, No. P1-408B/TG, AC input 230V, AC, 60 cycle, 3-phase, DC output, 120V, DC, 25 amp, 2 ea.

Thermos Gas Analyzer: Hays Model SO-102734, 115V, 60 cycle, 2 amp., RFI fuel vapor, 8 sample stations, 2' x 2' x 7', S/N SH 641-2950, 1 ea.

Radio Transmitter: Bendix Aviation, No. BC-640A, includes amplifier panel, oscillator panel, modulator panel, power control and 2 power supply panels, crystal frequency control output emission, 50W maximum power output, 100 to 165 MC frequency, 115/230V, AC, 60 cycle, single phase, 20" x 21" x 72" overall diameter, 3 ea.

Interceptor Control Console: G.E. No. OA-1046/GPA-23, PN 7302298G2, S/N 194/251/280/273.

Communications Equipment: Power Supply Modulator, AC, 115/200V, 3 phase, 60 cycle, PN 2368502G1, 3 ea.; Power unit dual telegraph, including 8 thru 14, AC input, 115V, 60 cycle, single phase, 1200W, DC, output, 110/130V, 3 amp, 1 ea.

Telephone Switch: PN 118711071, 8 5/8" x 3 6/8" x 1 1/8", 2 ea.

Radio Transmitter: National Company, Type TUG, high frequency, 111.1 126.7 MC, 2 ea.

Constant Voltage Rectifier: Flotrol Model 3300 HA, input 230V, 3 phase, 4000 W, frequency 60, output 120V, 25 amp, D.C. 3 ea.

H. C. WILEY

P. O. Box 1991 Anchorage, Alaska 99501

CIRCLE 966 ON READER SERVICE CARD

DIGITAL VOLTMETERS NEW • sold for \$375 & up. Now \$100 to \$125
VTVM Gen. Rad. Mod. 1800A. \$100
VSWR Meter H.P. #415A. \$50
Tube Tester Hickock #800. \$75
Bridge Bal. Midwest #438A. \$200
Radasweep Kay Electric. \$75
Pulsoscope Waterman #S-5. \$100
Menoscope Hughes Mod. 104. \$600
Recorder 2 Pen Brush Model B1202. \$150
Video Tape Recorder Ampex Mod. VR660 * \$4000
Oscilloscope CEC Mod. 5-114-P. \$675
Oscilloscope CEC older 5-107 w/Gayos. \$200
Oscilloscope Century Mod. 420 12 Chan. \$500
Oscilloscope Century Mod. 420 24 Chan. \$600
Galvanometers Century for above. each \$20
Telemetry Ground Station EMR #56A-77 * \$6500
Microwave Osc. PRD broad band Mod. 705. \$175
Klystron Pwr. Sup. PRD Model 801. \$275
* Write for data sheet—Also Microwave, Pwr. Sup. & Misc. older equip. Write needs, can obtain most any equip. If not in stock, J. D. Askew, Box 106, Baldwin Park, Calif. 91706.

CIRCLE 967 ON READER SERVICE CARD

VOLTS EN S O R
VOLTAGE SENSITIVE RELAY DRIVER
• 100 K Input Impedance
• 25 Microsecond Response
• +/- 20 Volt Trip Range
• \$38 ea., \$26.60 at 100 pcs.
• Accuracy 0.01%
Send today for full specifications
CALIF. ELECTRONIC MFG CO.
P.O. Box 555, Alamo, Calif. 94507

CIRCLE 968 ON READER SERVICE CARD

SURPLUS — LIKE NEW
One 419A D.C. NULL
HEWLETT-PACKARD VOLTMETER
PRICE \$350
FS-5582, Electronics
645 N. Michigan Ave., Chicago, Ill. 60611.

CIRCLE 969 ON READER SERVICE CARD

There's something here for everybody.

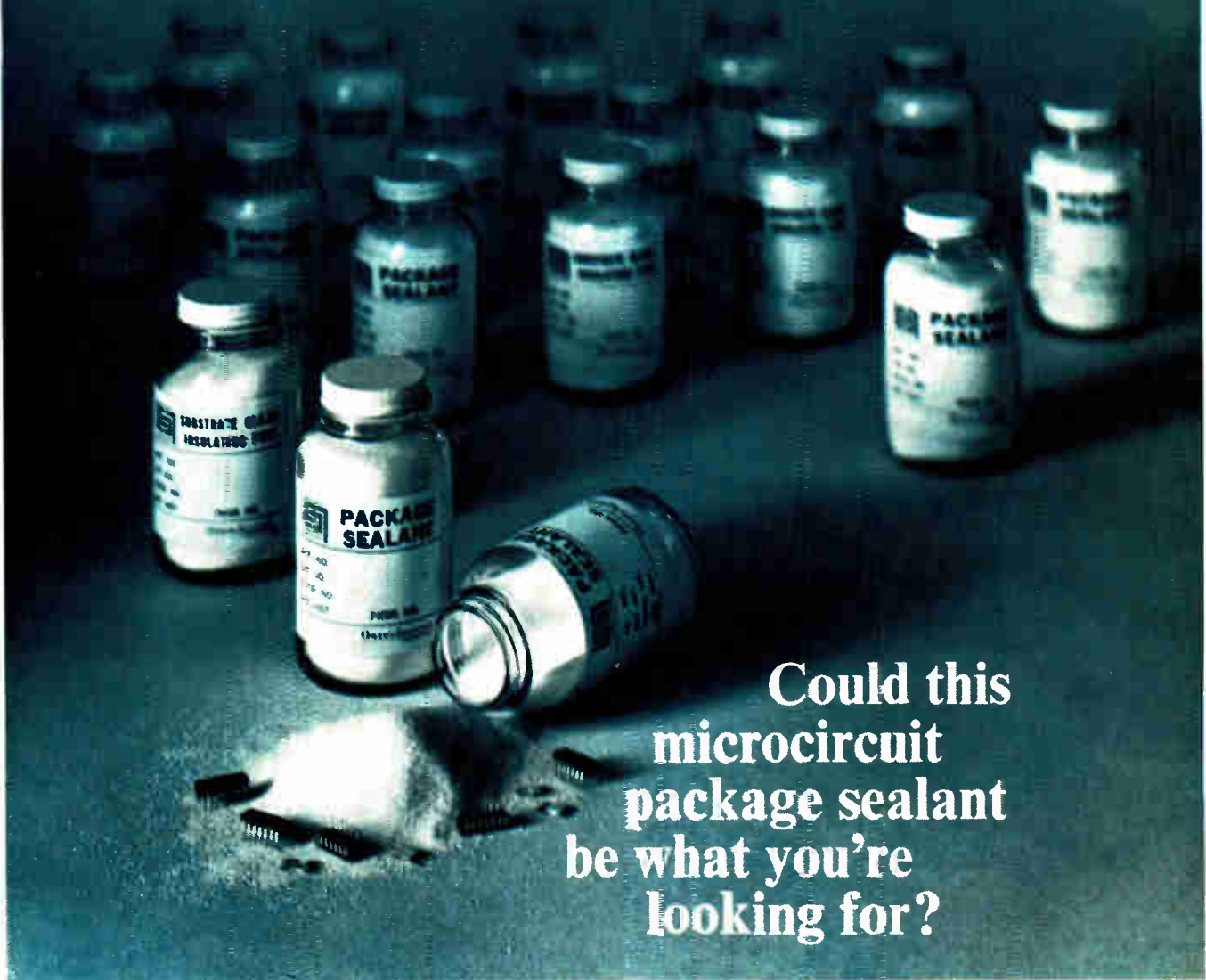

Could this
microcircuit
package sealant
be what you're
looking for?

This particular material seals at 450° C. Reheats to 525°. It's a high strength, crystallizable glass package sealant recommended for Kovar®-alumina packages. With a wide vitreous range, it permits preglazing of parts without crystallization.

Our growing family of new glass materials for microelectronics is comprised of two basic groups; one for package sealants, the other for substrate glazes and insulating films. All tailored formulations with a range of properties and characteristics keyed to a specific need.

Discovered and developed at the Owens-Illinois Research Center where glass-ceramics experience is unequalled, these versatile materials have been customized in dry mixture form. They come packaged in one-, five-, and twenty-pound containers, and are offered in three different grinds.

Two new brochures, free on request, give complete descriptions, specifications, packaging and price information.

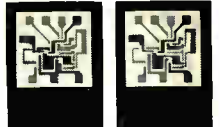

OWENS-ILLINOIS, INC. • Commercial Development
P. O. Box 1035 • Toledo, Ohio 43601

Please send brochures on Package Sealants and Substrate Glazes/Insulating Films

Name _____ Title _____
Firm _____
Address _____
City _____ State _____ Zip _____

See us at Booth 1306 NEPCON — East, June 4-6.

OWENS-ILLINOIS 
Toledo, Ohio 43601

Newsletter from Abroad

May 27, 1968

UK, USSR to swap instrument savvy

British instrument makers will get their first inkling in June of what might come out of the technological cooperation pact signed early this year by Britain and the Soviet Union.

First steps toward implementing the accord will be two meetings next month between the British instrument industry—working through its trade association—and Russian officials. The sessions are intended to initiate exchanges of know-how in the area of spectral analysis instruments. A month later, the British and the Soviets expect to start looking at similar exchanges in the field of electronic measuring instruments.

This is only a modest start toward technological cooperation, but British instrument makers have high hopes that the pact may one day mean considerable business for them. The Soviet drive to expand production of computers, automation equipment, and similar hardware may make that country a major outlet for British instruments.

Bonds may boost Italy's air industry

Legislation that would give the Italian aerospace industry a lift is near the top of the agenda of the new parliament elected last week. The bill, drafted before the elections, calls for long-term government financing—up to \$160 million—for development of nonmilitary aircraft.

Under the scheme, the government money would cover up to 60% of the research and development costs of projects approved by both the Ministry of Industry and Commerce and the Ministry of Transport and Civil Aviation. Prototypes deemed potential commercial successes would get additional help—up to 90% of initial production costs.

Funds for the program would come from a government-guaranteed bond issue, and 30% of the money would be earmarked for companies in southern Italy.

Nixie-tube licenses in sight for Japan

Japanese desk-calculator makers may soon clear up their remaining major patent problem through a licensing pact with the Burroughs Corp. covering the Nixie tube and the drive circuits for it. Burroughs' latest proposal, insiders say, appears attractive to most Japanese producers, who are itching to start exporting their machines to the U.S.

The proposal sets a royalty of 45 cents a tube for calculators shipped to the U.S. before the end of this year. The rate would drop to 35 cents next year, and to 25 cents after that.

For copies of the Nixie tube destined for the Japanese market, royalties would run much lower. Burroughs' patent on the Nixie drive circuit very likely won't stand up in Japan, so the rate would cover the tube alone and might range around 8 cents [see related story p. 243].

Bonn plans to buy U.S.-built airplanes

U.S.-made fighter-reconnaissance planes predominate in West Germany's latest procurement plans, much to the disappointment of the country's avionics industry, which had been counting on a flood of business from the upcoming order.

If the defense ministry has its way, Germany's air arsenal will be bolstered by 88 McDonnell Douglas RF-4E Phantoms and between 50 and 60 Lockheed F-104G Starfighters. The Starfighters will be built in Germany under license and will carry German-made avionics. But electronics

Newsletter from Abroad

firms fear that the only major German-made hardware in the Phantoms will be the engines. There's scant chance that the ministry will insist that part of the avionics be made in Germany and then shipped to the U.S. for installation in the plane.

The ministry's plans have yet to be okayed by the parliament and the Kiesinger government's budget committee. But despite a fuss by the opposition about buying U.S.-made Phantoms at a time when the German aerospace industry is in the doldrums, the split order is expected to go through. Besides the planes, the defense ministry's plan calls for the building of some 130 Sikorsky CH-53A helicopters under license.

Japanese firm seeks Ge planar process

The Nippon Telegraph & Telephone Public Corp. has mounted a research program that could lead to a revival for germanium, the once-dominant semiconductor material that has generally been eclipsed by silicon.

NTT scientists are currently evaluating three different methods they've developed for coating germanium wafers with a protective layer, a processing step crucial to making planar devices. The three coatings: germanium nitride deposited by a process similar to gas-phase epitaxial growth; an evaporated layer of germanium dioxide treated to make it insoluble in water; and an evaporated layer of silicon dioxide.

By fall, NTT's men hope to have prototypes of their first devices; they believe they can produce planar germanium transistors that operate at 10 gigahertz, compared with an upper frequency limit for silicon transistors of about 6 Ghz. The work could eventually lead to faster integrated circuits.

Volkswagen to give electronics a lift

European components manufacturers now have a whopping "new" market in sight—the automobile industry.

Starting next month, Volkswagenwerk AG will offer an electronic fuel-injection system as optional equipment in three VW 1600 models sold in Europe. The system is the one Volkswagen installs as standard equipment on 1600's sold in the U.S.

Volkswagen originally designed the injection system to accommodate U.S. antipollution regulations, but the company's sales pitch for the \$145 option in Europe will stress fuel economy and smoother engine performance. If the injection system turns out a strong seller and other firms follow Volkswagen's lead, components consumption by auto makers will skyrocket. As it is now, popular-make European cars carry only between \$2.50 and \$5 worth of electronic hardware.

Addenda

Norway is taking a hard look at West Germany's Leopard tank as the replacement for its aging U.S.-built armor. German officials think the Norwegians will buy at least 80 tanks from them if a financing arrangement—possibly including an offset deal for the tanks' electronics equipment—can be worked out . . . The Australian government is now running the Weapons Research Establishment at Salisbury on its own. Previously, Britain shared the management of the research facility, Australia's largest. Britain, however, will continue to participate in running the vast rocket range at Woomera in South Australia . . . Italy's post and telecommunications ministry has started trials of mobile radiotelephone systems in Milan and Turin. By the end of the year, the radiotelephone network will cover a good part of the country.

A new concept in x-y recording:

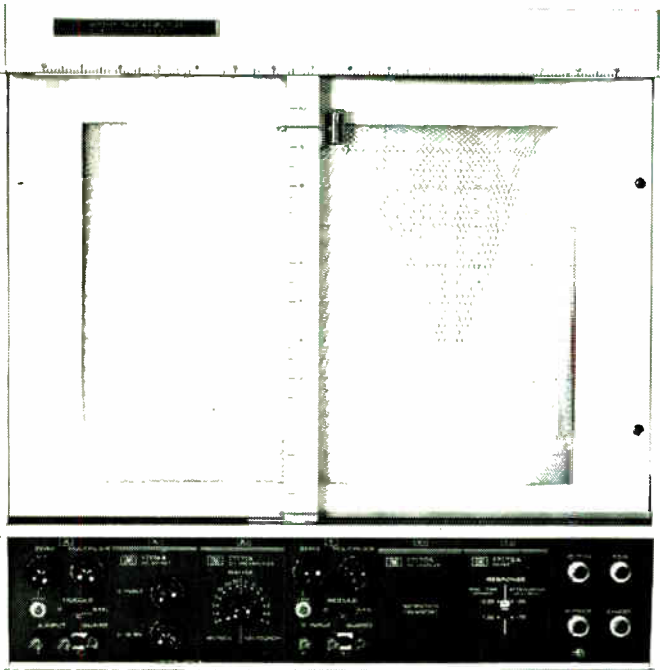

Something new has entered the X-Y recorder field. The new Hewlett-Packard 7004A X-Y Recorder, with dynamic performance of $1000''/\text{sec}^2$ acceleration and slewing speed of $30''/\text{sec}$ —unparalleled in the recorder industry—offers plug-in convenience for unprecedented versatility in either analog or digital applications. SIX plug-ins let you convert this precision, solid-state $11'' \times 17''$ X-Y recorder into many different recorders—and either X-Y, Y-T or X-T operations—and the variations are nearly endless, because there are more to come.

Plug-in expandability with highest dynamic performance!

With plug-in units constantly being developed, the HP 7004A X-Y Recorder offers you guaranteed versatility combined with superior performance. Price: 7004A, \$1295.

Here's what's available now:

- DC coupler, 100 mV/inch. \$50.
- DC amplifier, 0.5 mV to 10 V/inch with 14 calibration ranges. \$250.
- Time base, 8 calibrated sweep speeds. \$200.
- Null detector, up to 50 plots/second. \$200.
- DC offset, continuously adjustable to 1 V. \$100.
- Filter, 55 dB rejection at 50 Hz and above. \$75.

For a complete brochure and data sheet call your local HP field engineer or write Hewlett-Packard, Palo Alto, California 94304; Europe: 54 Route des Acacias, Geneva.



HEWLETT  PACKARD

GRAPHIC RECORDERS

A completely new instrument from Supply with plug-in conversion

Buy the basic LS Series

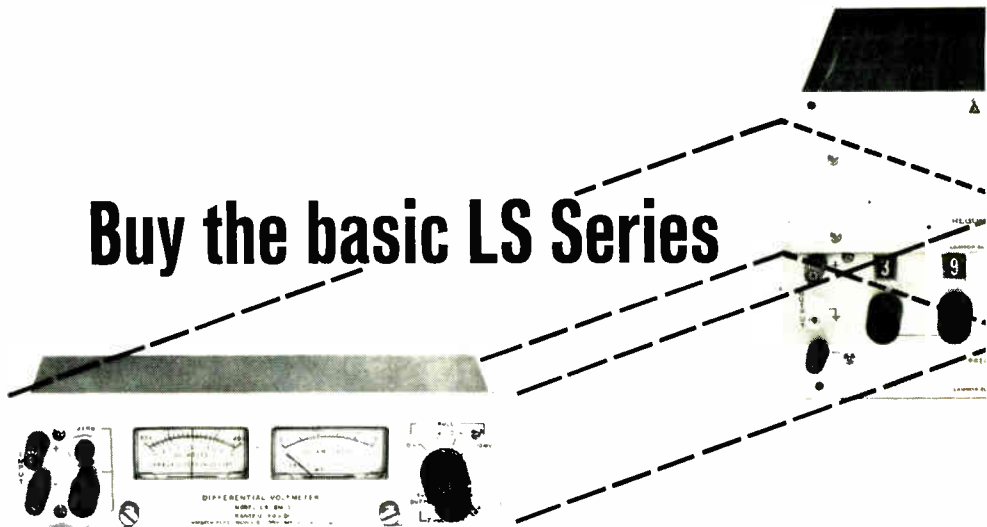

With this plug-in accessory it becomes a High Precision Power Differential Voltmeter that obsoletes any instrument now offered for this service

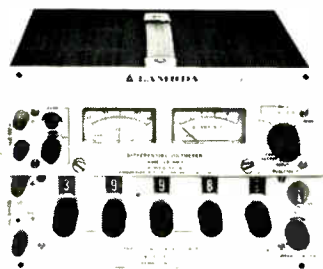

Basic Non-Metered Model	Voltage Range	Max. Amps at Ambient of				Price ²	Diff. VM Accessory	
		30° C	40° C	50° C	60° C		Model	Price
LS-511	0-10VDC	2.8A	2.5A	2.1A	1.7A	\$375	LS-DM1	\$85
LS-512	0-20VDC	1.8A	1.6A	1.3A	1.1A	375	LS-DM2	85
LS-513	0-40VDC	1.0A	0.9A	0.75A	0.6A	375	LS-DM3	85
LS-515	0-120VDC	0.33A	0.29A	0.25A	0.21A	375	LS-DM5	85
LS-516	0-250VDC	0.1A	0.09A	0.08A	0.07A	380	LS-DM6	85

1 Current rating applies over entire voltage range. Ratings based on 55-65 Hz operation.

2 This price is for Precision Power Source only. Addition of Differential Voltmeter Accessory Plug-In (next two columns) is necessary for unit to function as High Precision Power Differential Voltmeter.

- **Draw power as you measure voltage**—The first and only differential voltmeter to furnish high stability power output while being used as a voltmeter . . . no need for a separate power supply.
- **2 meters**—Monitor both voltage and current simultaneously and continuously.
- **Guaranteed for 5 years**—The only 5-year guarantee that includes labor as well as parts. Guarantee applies to operation at full published specifications.
- **All-silicon design** for maximum reliability
- **Convection-cooled** for convenience and reliability . . . no blowers or heat sinks.
- **5 voltage ranges:** 0-10, 0-20, 0-40, 0-120, 0-250VDC—Wide selection of ranges to suit your specific needs.
- **Illuminated Digital Readout Millimatic™** gang dialing—5-digital voltage dials with automatic decade turnover provides convenient precise adjustment.
- **Only 5¼" high**—Convenient half rack size for rack or bench use.
- **0.01% + 1mV accuracy**
- **Stability 0.001% + 100μV for 8 hours**

- **Completely protected:** short-circuit proof; continuously adjustable automatic current limiting
- **Overvoltage protection** available as low cost add-on accessory
- **Rubber Feet** provided for bench use.



- **Mount in Rack Adapters**—LRA-1 (\$60.00) or LRA-2 (\$35.00).
- **AC Input**—105-132 VAC, 47-440 Hz (Ratings based on 55-65 Hz)

Power Supply specifications for Voltmeter same as for Power Supply—see next page

 **LAMBDA**
ELECTRONICS CORP.
515 BROAD HOLLOW ROAD - MELVILLE, L.I., NEW YORK 11746 - (516) 694-4200
A Veeco SUBSIDIARY

VEECO HIGH VACUUM EQUIPMENT/LAMBDA POWER SUPPLIES

Lambda... High Precision Power to Power Differential Voltmeter

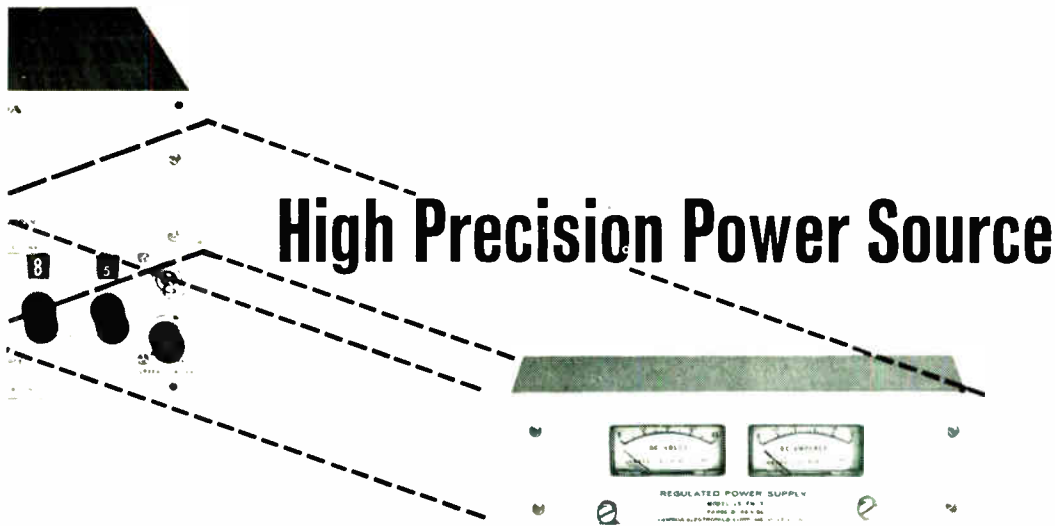

With this plug-in accessory it becomes a Metered High Precision Power Supply that offers all these features

Basic Non-Metered Model	Voltage Range	Max. Amps at Ambient of				Price	Metered Accessory	
		30 C	40 C	50 C	60 C		Model	Price
LS-511	0-10VDC	2.8A	2.5A	2.1A	1.7A	\$375	LS-FM1	\$55
LS-512	0-20VDC	1.8A	1.6A	1.3A	1.1A	375	LS-FM2	55
LS-513	0-40VDC	1.0A	0.9A	0.75A	0.6A	375	LS-FM3	55
LS-515	0-120VDC	0.33A	0.29A	0.25A	0.21A	375	LS-FM5	55
LS-516	0-250VDC	0.1A	0.09A	0.08A	0.07A	380	LS-FM6	55

- 1 Current rating applies over entire voltage range. Ratings based on 55-65 Hz operation.
- 2 This price is for non-metered Precision Power Source. Addition of Metered Accessory Plug-In (next two columns) is necessary to have Metered High Precision Power Supply.

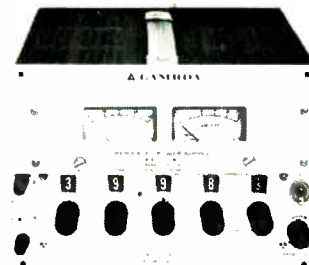

- **0.0005% plus 100 μ V regulation**—Best of any high stability power supply in this price range.
- **Ripple**—35 μ V rms; 100 μ V p=p.
- **Twice the power** in a convenient 1/2-rack package
- **2 meters**—Monitor both voltage and current simultaneously and continuously.
- **Guaranteed for 5 years**—The only 5-year guarantee that includes labor as well as parts. Guarantee applies to operation at full published specifications.
- **Multi-Current-Rated** for 30 C, 40 C, 50 C, 60 C—Covers temperatures most often encountered in laboratory work.
- **5 voltage ranges**: 0-10, 0-20, 0-40, 0-120, 0-250VDC—Wide selection of ranges to suit your specific needs.
- **Illuminated Digital Readout MillimaticTM gang dialing**—5-digital voltage dials with automatic decade turnover provides convenient precise adjustment.
- **Only 5 1/4" high**—Convenient half rack size for rack or bench use.
- **0.01% + 1mV accuracy**
- **Stability 0.001% + 100 μ V for 8 hours**

- **All-silicon design** for maximum reliability.
- **Convection-cooled** for convenience and reliability... no blowers or heat sinks.
- **Remote programming** by changes in voltage or resistance for convenience in systems, test equipment and automatic equipment applications.
- **Auto Series/Auto Parallel** with Master-Slave tracking
- **Constant I/Constant V** by automatic crossover
- **Completely protected**: short-circuit proof; continuously adjustable automatic current limiting
- **Overvoltage protection** available as low cost add-on accessory
- **Rubber Feet** provided for bench use.
- **AC Input**—105-132 VAC, 47-440 Hz (Ratings based on 55-65 Hz)

OVERVOLTAGE PROTECTION

For Use With	Model	Adj. Volt. Range	Price
LS-511	LHOV 4	3-24 V	\$35
LS-512	LHOV-4	3-24 V	\$35
LS-513	LHOV 5	3-47 V	\$35

Circle 239 on reader service card

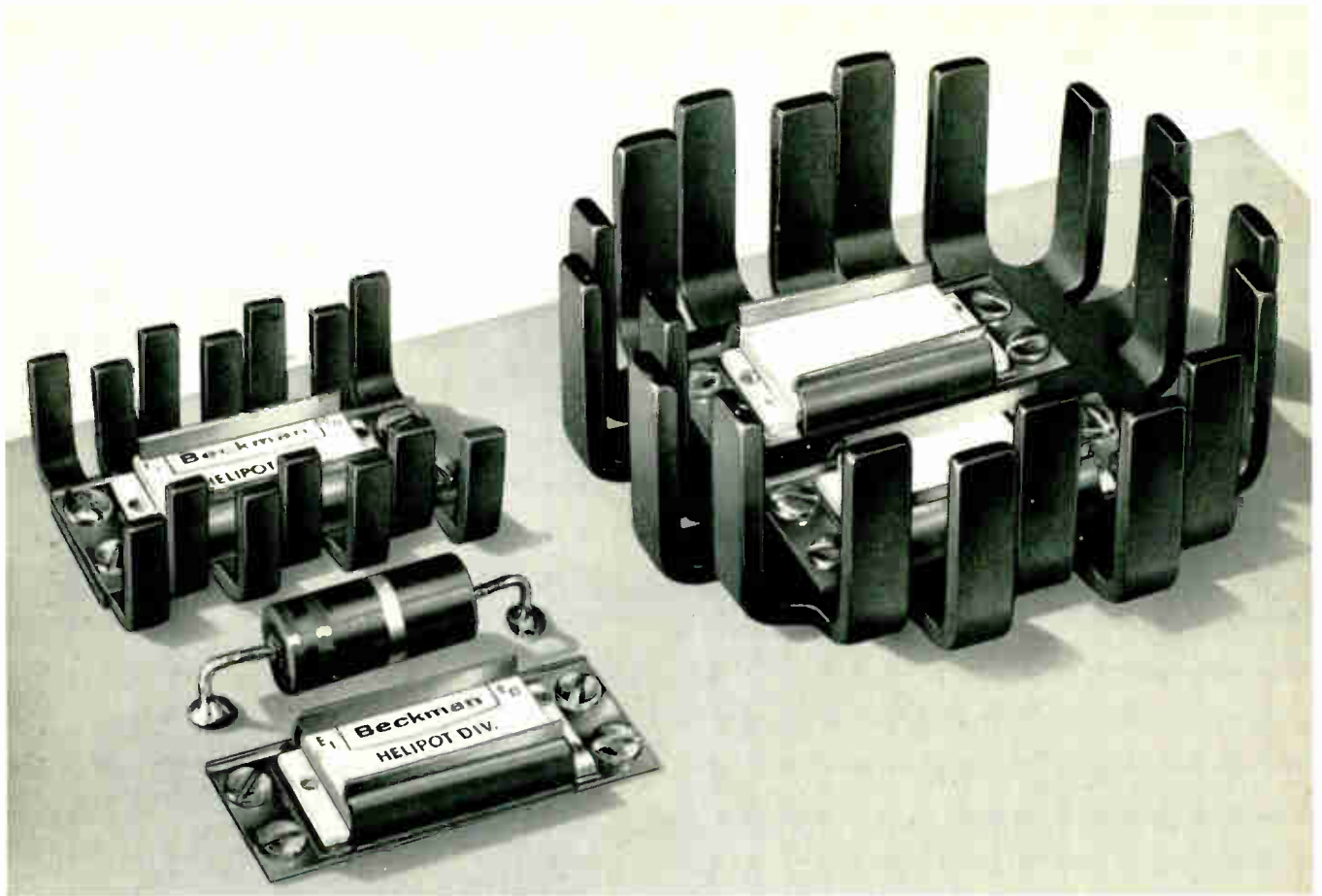

Cool off microcircuit devices with a choice of four new dissipator/retainers. Example: with natural convection, a typical microcircuit device dissipates 1.8 watts with case temperature rise of 103°C.

Add IERC's model LBOC2-61B and you dissipate 5 watts with the same case temperature rise. Retainer-clip may also be used alone to mount package to conduction plane.

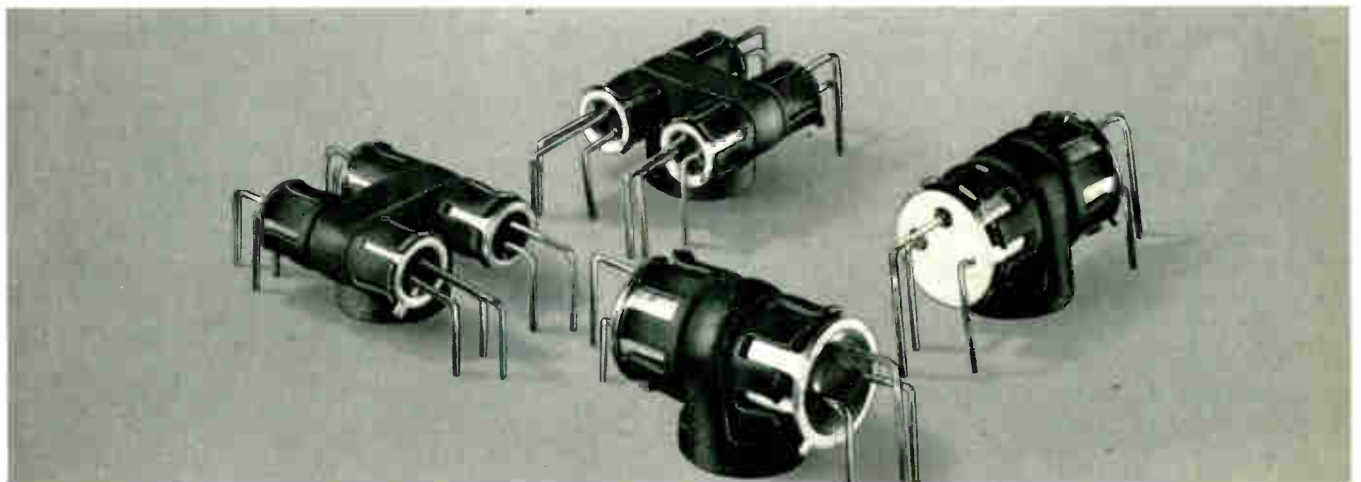

These special dual and quad Thermo-Link dissipators permit thermal mating of matched transistors. Thermo-Link retainers do exactly as their name says: They provide a thermal link between transistors and the chassis or heat sinks. They are also available with

.060" beryllium oxide washers which have the excellent thermal conductivity of aluminum, are electrically insulative and reduce normal mounting capacitance by $\frac{1}{2}$ to $\frac{1}{3}$. The washer is brazed to a brass slug or hex stud for mounting.

Need a non-hygroscopic finish with excellent dielectric properties, 50 K megohms insulation resistance and high heat emissivity? Use Insulube 448. It also protects against salt spray and fungus and other adverse environments.

Tips on cooling off hot semiconductors and microcircuits

Read on. Find out how circuit designers use IERC heat dissipators to protect and improve circuit performance of semiconductors and microcircuits.

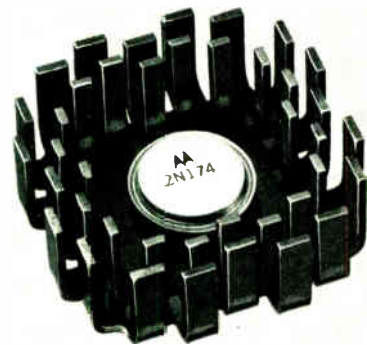
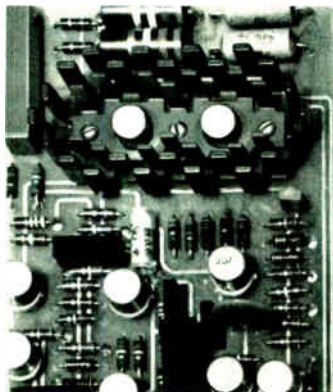
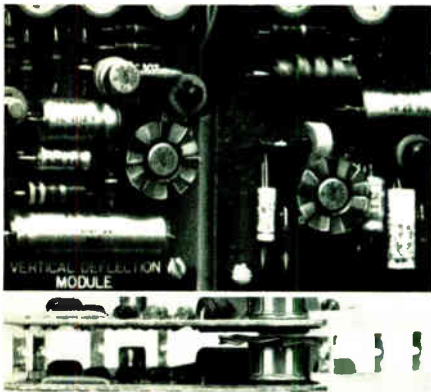

Fan Top Dissipators for TO-5 and TO-18 cases add almost nothing to board height. Don't need much room *on* the board either. Available for both metal and plastic cases. Spring fingers make installation simple. And Fan Tops cost just pennies.

Help low-to-medium power transistors keep their cool with IERC's stagger-fingered LP's. Available in single or dual mounting for thermal mating of matched transistors. They fit both TO-5 and TO-18 cases.

Cool power transistors and diodes with lightweight HP Series devices. High heat transfer rate. HP3 displaces only 9 cu.in. and weighs just 1.5 oz. Yet it dissipates as much heat as many finned extrusions requiring 13.5 cu in. Two sizes for nesting or back-to-back use.

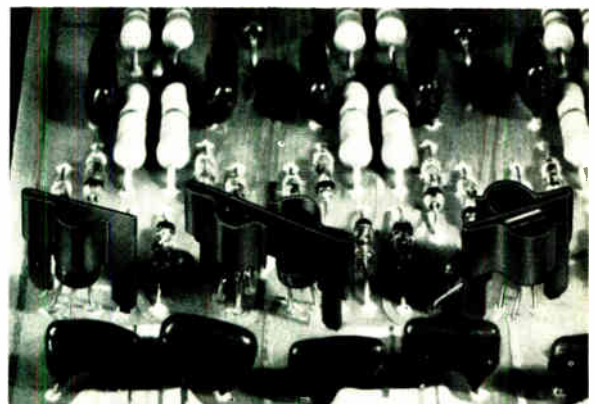
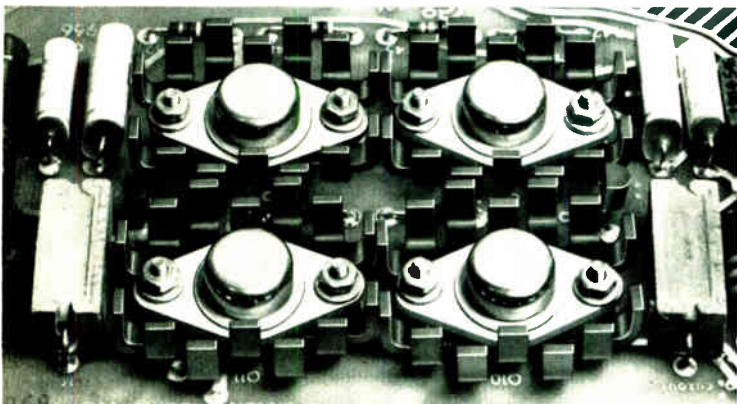

Keep TO-66 transistors cool with any of four IERC dissipators. The application shown is a 100-volt amplifier with four LB66B2B's dissipating 8 watts per transistor. Exclusive staggered-finger design. Choice of finish: black anodize or Insulube® 448 for positive insulation to 500 watts.

New "Universal" Spade Series for plastic transistors fits all D-case sizes. Spring clip allows for variation in case diameters. Excellent dissipation lets you boost operating power 33%. Both single and dual models as shown.

Got a tough one? Our engineers welcome your inquiry for more specific information. Write us on your company letterhead, please.

ierc
SEMICONDUCTOR
HEAT DISSIPATORS

INTERNATIONAL ELECTRONIC RESEARCH CORPORATION  A corporate division of Dynamics Corporation of America • 135 West Magnolia Blvd. • Burbank, Calif. 91502

NOW...RCA tunnel diodes are "axially" wrapped in gold

It's true. But the real story of RCA's new tunnel diodes lies *inside* the practical, axial-lead package. There you'll find RCA-pioneered TD-II technology—a unique process of epitaxially-grown junctions that has brought to these devices a new standard of stability, performance, and reliability. Life tests exceeding 1 million hours prove it.

Leads are gold-plated for soldering efficiency. No pretinning is necessary. And the package lends itself well for high-volume PC-board mounting operations.

In all 14 types, the TD-II process assures low capacitance and mechanical ruggedness. Thermal resistance is improved. Because TD-II is a "batch" production process, you benefit further from low cost and uniform characteristics.

Designed for high-speed switching and high-frequency, signal-processing applications, these units are ideal as threshold detectors and in computer circuitry. Units are available through your RCA Distributor. See your RCA Representative for more information on these types or special selections. For technical data on specific types, write: RCA Commercial Engineering, Section SN5-2 Harrison, New Jersey 07029.

Type	I_p (mA)		I_p/I_v Min.	C (pF) Max.	tr (ps) Typ.
	Min.	Max.			
40561	4.5	5.5	6/1	25	1800
40562	9	11	6/1	25	900
40563	18	22	6/1	30	600
40564	45	55	6/1	40	350
40565	90	110	6/1	40	150
40566	4.75	5.25	8/1	15	1200
40567	9.5	10.5	8/1	15	600
40568	19	21	8/1	20	400
40569	47.5	52.5	8/1	25	200
40570	95	105	8/1	25	100
40571	4.75	5.25	8/1	8	600
40572	9.5	10.5	8/1	8	300
40573	19	21	8/1	10	200
40574	47.5	52.5	8/1	12	100

RCA

Circle 242 on reader service card

ACTUAL SIZE

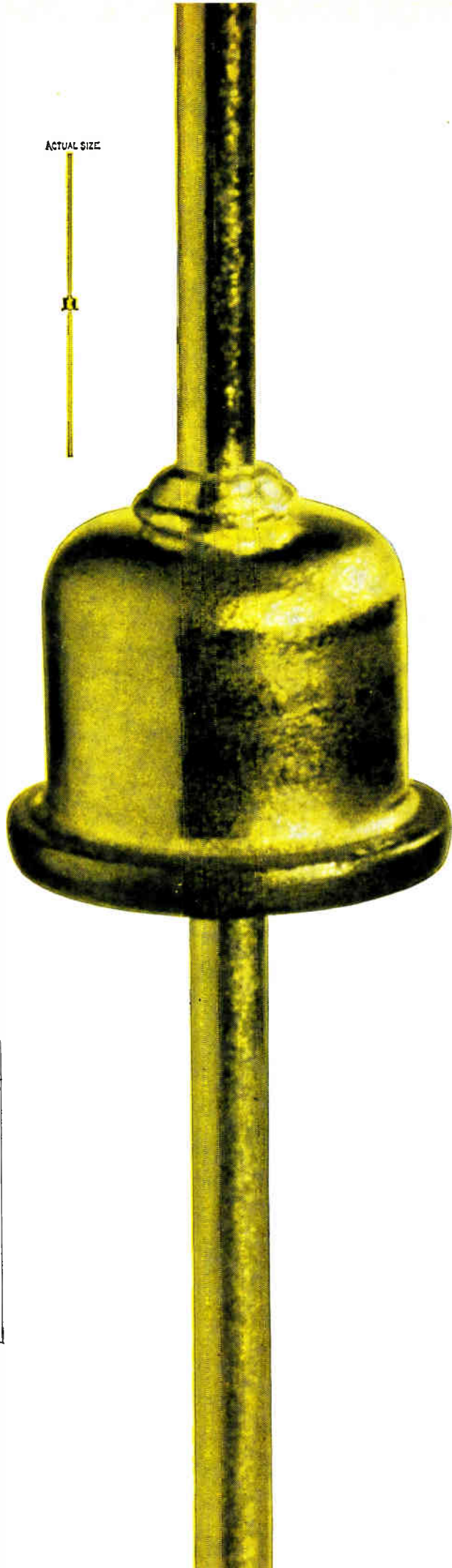

Japan

Pocket video

When the Sony Corp. came out last year with the prototype of a television set with a 2-inch screen, many in the industry figured Sony had gone as far as anyone would want to go in set miniaturization. They were wrong. The Matsushita Electric Industrial Co. has readied a 2-inch set that is considerably smaller and lighter than Sony's.

And where Sony quite frankly admitted it developed its 2-inch prototype essentially to see what sort of reaction it would provoke in the U.S., Matsushita maintains it will have the set on the market no later than spring 1969. At the outset, the price will be about the same as that of a 9-inch portable—comfortably under \$200. This target initial price includes a base with an a-c power supply, a battery charger, and an auxiliary speaker, slightly larger than the one in the set.

Stubby. Like Sony's set, Matsushita's miniscreen model has most of its components packed onto integrated circuits. The big difference between the two tiny-tv prototypes is in the picture tubes.

Sony's tube was developed as much for use as a camera viewfinder as for a tv receiver. As a result, the tube's designers were more concerned about power drain than brightness. So they opted for a 3,000-volt accelerating voltage and magnetic focusing.

The Matsushita tube operates at 5,000 volts with electrostatic focusing. The combination makes possible a much shorter picture tube—about 4½ in. long. Faceplate of the Matsushita tube measures 1-3/16 in. wide by just under 1 in. high. It is paired with a low cost Fresnel lens to bring the viewed picture diagonal to 2 in.



Video on the go. Matsushita's 2-in. black-and-white television set plays two hours between battery changes.

Eight hybrids. Discrete semiconductors turn up only in the tuner of Matsushita's prototype. Other circuit functions are handled by eight IC's, all hybrids. Company engineers say they chose hybrids—rather than slipping in some monolithics—largely to hold down power consumption. By adjusting resistors on the hybrid circuits where necessary, they avoided using power-consuming differential amplifiers. And there's no question that monolithics would have been much harder to develop. All told, the IC's carry 34 transistors and five diodes.

Four discrete transistors and seven diodes are used in the tuner, which eschews conventional mechanical switches and instead employs varactor diodes. Stations are selected by a knob that changes the setting of a voltage-divider that feeds the diodes.

The prototype tuner covers only the very-high-frequency tv band. Matsushita engineers are now rushing to complete design of an ultra-high-frequency tuner that must be incorporated in the set before it

can be sold in the U.S. The uhf tuner, too, will be built around varactor diodes.

Matsushita will have prototype versions of its miniset at the Electronic Industries Association's late-June consumer electronics show in New York.

In the groove

Largely because of the Burroughs Corp.'s panoply of patents, its Nixie tube has had few serious challengers of its position as the best-seller among numerical display tubes.

But Burroughs could eventually be in for stiff competition from the Okaya Electric Industries Co. Okaya has developed a tube that—according to the company's legal eagles—skirts Burroughs' patents. What's more, Okaya says it will undersell Burroughs—in Japan, anyway. There, small Nixie tubes go for about \$2 each when bought in quantity. Okaya says it will start delivering its Elfin tubes—at prices around \$1.50—late this summer.

In deep. If Okaya makes good on its claims for the Elfin, the company's success will be traced back to the grooves molded into the ceramic support for the cathode mosaic that glows with a numeral from "0" to "9," depending on which segments of the mosaic are energized.

The support is 2 millimeters thick and the grooves 0.8-mm deep. The segment wires in them are 0.3 mm in diameter. With this layout, any sputtered cathode material condenses in the grooves. The bane of a mosaic made up of elements attached to the surface of a support is short circuits caused by sputtered metal.

To hold down on sputtering, which shortens cathode life and darkens the bulb as well, Okaya fills the tube with neon gas at a pressure of 120 mm of mercury. This is possible because of the small segments used in the mosaic; large cathodes glow unevenly at high gas pressures. (To get around this, Burroughs has a patented technique; keep the neon gas pressure to 40 mm of mercury and add mercury in the tube to prevent sputtering.) Anode of the tube is a see-through mesh.

Stacked. Okaya's prototype indicator is built into a bulb with a maximum diameter of 10 mm and an over-all height of 39 mm. Height of the numerals inside is 11 mm.

As for power, the tube needs a minimum supply voltage of 190 volts and has a maximum breakdown voltage of 170 volts. For direct-current operation, Okaya engineers say 0.5 milliamperes per lighted segment will suffice. For pulsed operation, a 1 ma current per segment is preferable.

The low current needed to energize the cathode segments makes it possible to use integrated circuits to select the combinations of segments that form the numerals.

Okaya thinks the small, low-power display tubes may bring a new look to desk calculators. Instead of a single row to show answers, several rows could be used to show the steps in an operation. For multiplication, then, two rows would show the multiplied numbers and the third their product.

West Germany

Made for monolithics

Some 19 months ago, Standard Elektrik Lorenz AG chalked up an advance in integrated circuit design with a layout that does away with coils in the intermediate-frequency and discriminator stages of television sound channels.

The circuits—on monolithic chips—soon will be going into production-line tv sets. Meanwhile, Standard Elektrik, a subsidiary of the International Telephone & Telegraph Corp., has turned its hand to tv circuits that have no capacitors. The reason: capacitance values above 100 picofarads send costs of monolithic IC's up sharply, a state of affairs anathematic to cost-conscious consumer electronics producers.

So far, Standard Elektrik's circuit people have successfully put together experimental thin-film oscillators, filters, discriminators and the like, using only transistors and resistors. They're following up these first steps with concrete proposals for monolithics practical—in both performance and cost—for tv receivers. And for other applications they're developing no-capacitor circuits like multivibrators, pulse-width modulators, and band-pass filters.

Slight delay. The circuits exploit

the storage-time phenomenon in transistors, the delay in the drop of output current caused by minority carriers present in the base region when the input current is cut off. By juggling the circuit parameters, the storage time for a transistor can be varied over a fairly wide range. This basic idea is the key to all of Standard's no-capacitor circuits. Karl-Heinz Blank, putting into practice some fundamentals developed by Gerhard-Geunter Gassman at Standard's applications laboratory, has designed a family of tv circuits that use external resistors to vary storage time.

The circuit most likely to be the first to get into production—in perhaps a year—is a three-stage oscillator. It can generate frequencies from about 60 kilohertz to about 2.5 megahertz. Also in the works is a discriminator to demodulate f-m signals. It can be tuned electronically to over a range from 100 khz to at least 1 Mhz.

Sorted out. Still another promising candidate for a tv integrated circuit is an amplitude separator (see diagram). It could replace a conventional stage that needs a tank circuit and two resistance-capacitance networks with relatively large capacitors.

In the circuit, negative line sync pulses are applied to transistor Q_1 and to the inverter stage Q_2 . Since the storage time of Q_1 is much larger than the pulse period, there

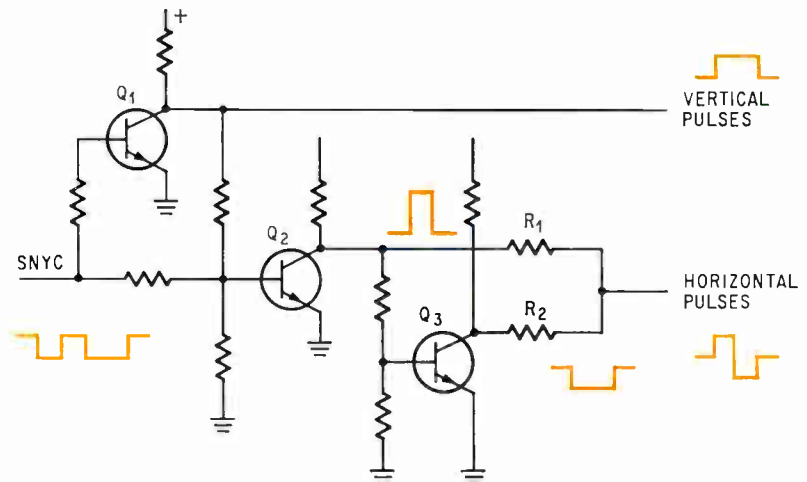

Through channels. Amplitude separator based on transistor storage time was designed with monolithic IC in view. Conventional separators have tank circuit and large capacitors that rule out a monolithic.

are no line sync pulses present at its output. On the other hand, the much longer vertical sync pulses are passed through.

Transistor Q_2 changes the negative input pulses into positive ones and applies them to the "storage-time" transistor (Q_3). The negative pulses at its output have a period twice as long as the input pulses. The resistor network R_1/R_2 adds the outputs from Q_2 and Q_3 to obtain the separated horizontal output pulses.

Great Britain

Cooling with gas

When it comes to their receivers, operators of communications satellite ground stations have to play it very cool. Most use parametric-amplifier stages that work only when kept in liquid helium, which boils at 4.2°K.

There's some defrosting in sight, however, for the deep freeze at ground stations. Researchers at Mullard Ltd. have put together a parametric amplifier whose gain, bandwidth and noise characteristics stand up to temperatures as high as 20°K. Thus, the muss and fuss of liquid helium can be eliminated by cooling the amplifier to 15°K with a mechanical refrigerator.

Colin Aitchison and Ted Huntley, who spearheaded the amplifier development, described their work at a late-May seminar on ground station planning and operation organized by the British Post Office, which runs the country's nonmilitary communications network. Mullard, a subsidiary of Philips' Gloeilampenfabrieken of the Netherlands, first built a three-stage amplifier—with two liquid-helium-cooled stages followed by a stage at room temperature—to meet post office specifications of 26-decibel gain over a frequency band of 3.7 to 4.2 gigahertz. But because of the way the first two stages overlap in frequency, Aitchison and Huntley had little trouble suiting them for operation at 15°K temperature.

Staggered. In conventional parametric amplifiers, the energy utilized comes from the narrow frequency band where the gain tops a specified limit. Energy at frequencies outside this band (for example, outside the 3-dB half-power bandwidth) ordinarily doesn't come into play. Some of this wasted energy, though, is recouped when two amplifiers are cascaded with their peak operating frequencies properly staggered. Instead of doubling the gain-bandwidth performance, the staggered cascading triples it.

Performance is further bettered, say the Mullard researchers, by adding a stage of reactance compensation to each amplifier. The compensation, resonant circuits added to the signal and idler circuits, increases the constant-gain bandwidth nearly four times.

High and wide. All told, the two liquid-helium-cooled stages show a gain of 20 dB over a bandwidth slightly higher than 500 Mhz. The room-temperature stage boosts the gain another 10 dB with no sacrifice of bandwidth.

At 15°K operating temperature, too, there's no loss in available bandwidth within the specified limit for gain. In fact, Huntley points out that there's a slight improvement. This is because the component layout for mechanical cooling is more efficient than for immersion cooling.

Behind the Gunn

So bright are the prospects for Gunn-effect diodes that a shadow of sorts has been cast upon other devices based on the bulk properties of semiconductors.

But you can't keep a potentially good device down, especially when the Royal Radar Establishment decides to give it a lift. And RRE, after helping Mullard Ltd. get the first successful commercial Gunn oscillator on the market, now has a program under way aimed at practical devices based on the electroacoustic properties of piezoelectric semiconductors like cadmium sulfide and zinc oxide.

American researchers have been

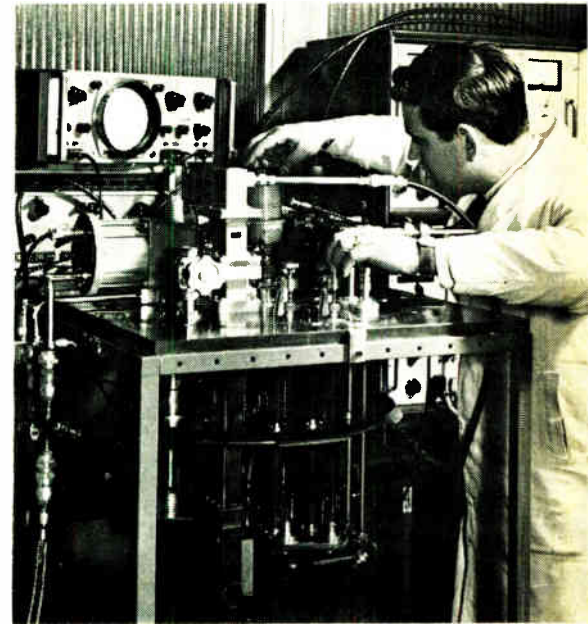

Getting warmer. Frequency staggered parametric amplifier stages need only mechanical refrigeration to 15°K rather than 4°K liquid-helium cooling.

working with electroacoustic amplifiers and oscillators since the early 1960's, but RRE nonetheless seems closest to practical devices. At the mid-May Instruments, Electronics, and Automation Show in London, the Establishment turned up with a small transmitter based on a cadmium-sulfide oscillator. The transmitter has an output power of only a few microwatts, limiting its range to about 100 yards. Carrier frequency is 100 megahertz and the transmission is frequency-modulated. Ted Paige and Dennis Maines led the team that developed the transmitter.

Back and forth. In the cadmium-sulfide oscillator, electrons drifting through the crystal at supersonic speeds amplify the lattice waves as they bounce back and forth between the ends of the crystal. At the right combination of applied voltage and crystal size, spontaneous oscillation starts and continues at a high harmonic of the fundamental acoustic frequency.

Happily, the oscillations develop in relatively thick crystal chips. RRE slices its crystals 200 microns thick and from them can get continuous-wave emissions up to 800 Mhz.

Tuned. The 200-micron crystal slab used in the transmitter meas-

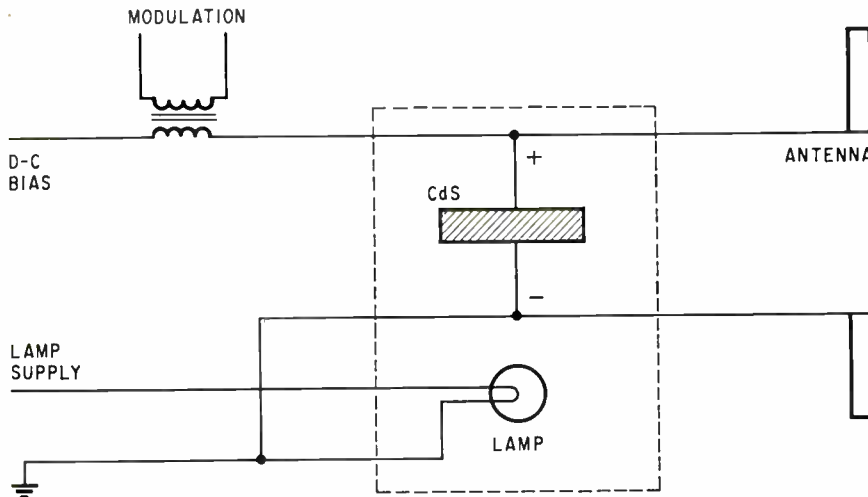

Electroacoustic. Cadmium-sulfide oscillator is frequency-modulated by transformer in low-power vhf transmitter.

ures 1.5 millimeters on a side. It is polished to a flatness of one-quarter wavelength of sodium light with the faces parallel to within 1 minute of arc.

RRE holds the slab in place on a copper heat sink with a spring-loaded plunger. The housing also includes a small lamp. With it, the output frequency can be fine-tuned over a range of about 1/2% since the conductivity of cadmium sulfide varies with the incident light.

Roughly 40 volts is applied across the crystal and an antenna is connected directly to it to transmit the signal. The audio modulation is applied onto the d-c bias through a matching transformer. The frequency shift is about 10 kilohertz per volt.

International

Aerospace tutorial

The North Atlantic Treaty Organization is best known for the heavily armed military forces it keeps stationed on the perimeter of the Western Alliance. But there's more to NATO than just muskets and men to shoulder them; one of its lesser known efforts is an annual sortie of electronics experts to keep engineers in Europe posted on advances in aerospace technology.

NATO's Advisory Group for Aerospace Research and Development

(Agard) has been sending out its electronics patrols for six years now, each time with Edward Keonjian of the Grumman Aircraft Engineering Corp. as platoon leader. This year, Keonjian's crew—seven Americans, two Frenchmen, and a Briton—will hit Amsterdam, Farnborough, and Bologna during early June with a lecture series on computers. Keonjian expects about 800 engineers altogether will sit in on the lectures to get an idea of what's ahead in airborne computers.

Look ahead. One insight as to what's coming will be bared by Earl Kanter, vice president for advanced systems at Teledyne Inc. Large-scale integration, in Kanter's opinion, points the way to a computer that does its own troubleshooting, carries its own spares, and needs no special tools to maintain.

Kanter envisions LSI packages of about 0.05 cubic-inch for computational operators—parallel adders, multipliers, dividers and the like. These tiny packages would be combined to make modules and the modules interconnected to form computers. Logic switching gates distributed throughout the modules would function as a sort of automatic patch panel for the operators. With triple redundant loops and majority voting within each triplet, faulty modules would be cut out automatically. Teledyne's Integrated Helicopter Avionics System already puts into practice some of the ideas Kanter will expound.

Controversy. The Agard lecturers also will review all existing types of memories for aerospace applications. L.M. Spandorfer of Sperry Rand Corp.'s Univac division, for example, will plump for LSI as the optimum answer to the tradeoffs among cost-per-bit, size, speed, and power consumption that memory designers must make. In his talk on tradeoffs, however, J. Chinal of France's Ecole Nationale Supérieure de l'Aéronautique is expected to discount the advantages of LSI because of its high cost.

Additional trans-Atlantic hornlocking should come during the panel discussion—with audience participation—that will wind up the series at each stop. The topic is computer choice—special-purpose or universal, one big central computer or a batch of smaller ones. The U.S. panelists lean toward general-purpose units. Most Europeans, though, favor special-purpose computers, even analog types.

France

Keeping up

The cries of alarm raised off and on in Europe about the technology gap tend to obscure the fact that in some sectors of advanced electronics British and Continental companies are abreast—if not ahead—of their U.S. competitors.

Gallium arsenide Gunn-effect oscillators are an example. Two British companies—Mullard Ltd. and the Plessey Co.—have X-band units in their catalogs. And now RTC-La Radiotechnique-Compelec is offering a Gunn oscillator off-the-shelf for \$220. A few U.S. companies sell Gunn oscillators as specials, but none so far has put them into its standard product line.

Slow seller. RTC, controlled like Mullard by Philips' Gloeilampenfabrieken of the Netherlands, doesn't expect its oscillator to find much of a market. Laboratories, rather than hardware producers, seem the most likely customers at the moment. "We're selling it now

**FOR BETTER, FASTER
WIRE HARNESSING—**

**GUDEBROD
CABLE-LACER**

NOW REDUCED TO \$9.95
[10% OFF. LOTS OF 50] ea.

Production economies enable Gudebrod to offer the production tested Cable-Lacer at a new low price. Holds bobbin of tape. Facilitates lacing and knotting.

**GUDEBROD
GUIDE-SNIPS**

NEW HANDY TOOL— \$3.75
[37.50 IN DOZEN LOTS] ea.

Unique, palm held tape snips. Allow free use of fingers while holding in hand. Right- or left-hand use. Sharp, drop-forged cutlery steel blades. Spring action.

Special Offer!

So that you may try them and see the money-saving way they facilitate the harnessing operation—we'll send you postpaid, one Cable-Lacer, one Gude-Snips and a bobbin of lacing tape for just \$14.00. Test for yourself how these tools can help you make better harnesses, faster and for less money.

BOTH:
ACTUAL SIZE

USE THE COUPON
FOR SPECIAL OFFER

GUDEBROD BROS. SILK CO., INC.

Founded in 1870
12 South Twelfth Street
Philadelphia, Pa. 19107

Check enclosed, send me, postpaid:

- The special offer of Cable-Lacer, Gude-Snips and bobbin— **\$14.00***
- I just want the Cable-Lacer— **\$9.95***
- Send only the Gude-Snips— **\$3.75***

Name _____

Company _____

Address _____

*In Pennsylvania please add sales tax.



Electronics Division

just to familiarize people with the technology," says Maurice Drougard, one of the team of 20 engineers RTC has set up to develop Gunn-effect devices. "People will buy it now only to play with it, he says, "not to put it in equipment."

Later, Drougard figures, there'll be a military market—mainly phased-array radars and low-power transmitters. The French Post Office, which runs the country's communications network, also might turn into an interesting customer—if it ever switches from its emphasis from underground cables to microwave links.

Headed up. RTC's off-the-shelf unit operates over the range from 8 to 12 gigahertz with a continuous wave output of 7 milliwatts. It comes in a varactor-pill package and operates at 2% efficiency when it draws 100 milliamperes. RTC guarantees it for 1,000 hours.

Later this year, the company expects to put a 30-mw X-band oscillator on the market. The efficiency will run between 1.5% and 2%. Meanwhile, laboratory work points to even higher output powers. Drougard says RTC researchers have achieved oscillations at an output of 80 mw and an efficiency of 3%.

Around the world

West Germany. Grundig Werke GmbH has developed a system that transmits still images over standard telephone lines. The equipment uses a television camera with a storage vidicon at the sending station and a monitor plus a Polaroid camera at the receiving end.

Transmission of the image picked up by the camera takes about 60 seconds and is initiated by dialing the number of the telephone at the sending station. Bandwidth of the video signal, transmitted as vestigial sidebands, is 2.2 kilohertz.

Italy. A newly formed company, Ergon S.p.A., will be the first manufacturer of color television picture tubes in Italy. The company, formed

by Italian businessmen, will spend \$11.8 million for a plant with ultimate annual capacity of about 200,000 tubes. First tubes are scheduled to come off the production line in 1969.

Ergon has taken a license for its tube-making know-how from the Admiral Corp. Philips' Gloeilampenfabrieken of the Netherlands and RCA also have color-tube-plant plans for Italy but neither is expected to break ground until the Italian government sets a date for starting color broadcasts.

Spain. The government-run telephone network will extend direct dialing to European countries next year. The calls will be routed via the Intelsat 2 Atlantic communications satellite through a recently completed ground station 55 miles north of Madrid. The \$4 million station has an 85-foot antenna and can handle 300 telephone circuits. It is linked to Madrid by microwave relay.

Great Britain. The Post Office will rebuild its original satellite communications ground station at Goonhilly Downs when its second facility there goes into operation this fall [Electronics, March 6, 1967, p. 357]. The reworking will cost about \$1 million and will include new transmitting, receiving, and amplification equipment with 500-megahertz bandwidth to work with the Indian Ocean Intelsat 3.

Japan. A catheter-type semiconductor radiation detector for diagnosis of cancer in the stomach and the esophagus has been developed by the Tokyo Shibaura Electric Co. in a joint effort with the University of Tokyo. The instrument is based on a p-n silicon junction radiation detector.

Italy. The Ministry of Defense has ordered nearly \$1 million worth of instrument landing systems from Standard Telephones & Cables Ltd., a British subsidiary of ITT. The equipment is destined for the airports of Rome, Turin, Milan, Genoa, Venice, and Naples. ITT says the order is the largest ever for export of British ILS equipment.

If you're concerned with Transistor Pads and Clips— Heat Sinks and Adapters . . .

ACCESSORIES

are worth
a closer
look . . .



Precision made in Kent,
England by JERMYN Industries, these
important items of circuit hardware
are manufactured with traditional
English craftsmanship. They are stocked
and sold exclusively in the U.S. by
GUDEBROD. Ask for our new Catalog
GJ100 which describes the full line—
or tell us about your custom needs.



UDEBROD

Electronics Division

Gudebrod Bros. Silk Co., Inc.
Founded 1870
12 South Twelfth Street
Philadelphia, Pa. 19107

Electronics advertisers

May 27, 1968

■ Acopian Corp. Mort Barish Associates	213	Corning Glass Works Electronic Division—Resistors Rumrill Hoyt Co., Inc.	171	Hansen Mfg. Co. Keller-Crescent Co.	160
Airco Speer Electronic Components Hazard Adv. Co., Inc.	39	Corning Glass Works Electronic Division—Glass Memories Rumrill Hoyt Co., Inc.	175	■ Haydon Co., A.W. Chambers, Wiswell & Moore, Inc.	217
Airpax Electronics, Inc. Welch, Mirabile & Co., Inc.	176	Cosmicar Optical Co., Ltd. Matsushita, Inc.	219	Hewlett Packard, H-P Associates Lennen & Newell, Inc.	63
Allen-Bradley Co. Fensholt Adv. Agcy.	77	Coto Coil Co., Inc. Williams Co., The	218	Hewlett Packard, International Import Div. Lennen & Newell, Inc.	2
Allied Control Co. Michel-Cather, Inc.	247	Couch Ordnance, Inc., Couch Co. Div. Culver Adv., Inc.	48	■ Hewlett Packard, Loveland Div. Tallant/Yates Adv., Inc.	1, 11
Allied Van Lines, Inc. Young & Rubicam, Inc.	137	CREI, Home Study Division of the McGraw-Hill Book Co. Henry J. Kaufman & Associates	224	Hewlett Packard, Microwave Div. Lennen & Newell, Inc.	223, 225, 227, 229
American Electronics, Inc. Alden Adv. of California, Inc.	52	■ CTS Corp. Burton Browne Advertising	230, 231	■ Hewlett Packard, Palo Alto Div. Lennen & Newell, Inc.	80
AMP, Inc. Garceau, Hallahan & McCullough, Inc.	32, 33	Cyclo-Tronics, Inc. Bernard J. Hahn & Associates	251	■ Honeywell, PMD Div. Batten, Barton, Durstine & Osborn, Inc.	180
Amperite Co. H. J. Gold Co.	50	■ Dale Electronics, Inc., Sub. of Lionel Corp. Swanson, Sinkay, Ellis, Inc.	3rd Cover	■ Honeywell, Test Instruments Div. Campbell Mithun, Inc.	108
■ Amphenol Corp. Marsteller, Inc.	201	Data Instruments Division Technical Marketing	161	Hughes Aircraft Co. Foote, Cone & Belding	154, 155
Anritsu Electric Co., Ltd. Diamond Agcy. Co., Ltd.	204	■ Data Technology Bonfield Assoc., Inc.	68	Hysol Corp. Barber & Drullard, Inc.	200
A.P.I. Instruments George Z. Griswold Advertising	64	Defense Electronics, Inc. Harry I. Clarkson Associates	61	■ Indiana General Corp., Ferrites Div. Griswold & Eshleman	24
APM-Hexseal Corp. Mohr & Co., Inc.	158	Di-Acro Corp., Div. of Houdaille Industries, Inc. Charles E. Brown Adv. Agcy.	194	International Electronic Research Corp. Van Der Boom, McCarron, Inc., Advertising	240, 241
■ Augat, Inc. Horton, Church & Goff, Inc.	185	Digitran Co., The Smith-Klitten, Inc.	196	International Rectifier Corp. Botsford, Constantine & McCarty, Inc.	202
Babcock Relays Div. of Babcock Electronics Corp. Jansen Assoc., Inc.	166, 167	Dow Chemical Co., The MacManus, John & Adams, Inc.	141	■ ITT Cannon Electric West, Weir & Bartel, Inc.	168, 169
Ballantine Laboratories Lang-Lawrence Adv., Inc.	195	Dow Corning Corp., Engineering Products Div. Church & Guisewite Advertising	88	■ Johanson Mfg. Co. Josephson, Cuffari & Co. Joslyn, Inc. Chace Co.	184 218
Barnstead Subsidiary of Ritter Pfaudler Corp. Creamer, Trowbridge, Case & Basford, Inc.	208	■ DuPont de Nemours Co., Mylar Div. Batten, Barton, Durstine & Osborn, Inc.	55	Kay Electric Co. Josephson, Cuffari & Co.	143
Belden Corporation Fensholt Adv., Inc.	20, 21	DuPont de Nemours Co., Teflon Div. Batten, Barton, Durstine & Osborn, Inc.	145	Kings Electronics Co., Inc. Caroe Marketing, Inc.	183
■ Bell, Inc., F.W. Wheeler, Kight & Gainey, Inc.	62	E G & G, Inc. Culver Adv., Inc.	53, 140	■ Lambda Electronics Corp. Michel Cather, Inc.	238, 239
Bendix Corporation Electrical Components Div. MacManus, John & Adams, Inc.	36, 37	Electronic Engineering Co. of California Jansen Associates	214	■ Lapp Insulator Co. Wolff Associates	138
■ Blue M Electric Co. South Suburban Advertising	84	Electro Optics Associates Jerry Steimle & Co.	153	■ Ledex, Inc., Bramco Controls Div. Yeck & Yeck, Inc.	170
Boonton Electronics Corp. The Creative Group	162	Elliott Service Co. The Powerad Co.	210	Licon Division, Illinois Tool Works, Inc. Hurvis, Binzer & Churchill, Inc.	34, 35
Brush Instruments Div. of Clevite Corp. Carr Liggett Adv., Inc.	90	Erie Technological Products Co., Inc. Altman-Hall Associates	82	Litton Industries, Inc., Electron Tube Div. West, Weir & Bartel, Inc.	38
■ Brundy Corp. Don Kemper Co., Inc.	83	■ Fairchild Semiconductor, Inc. Faust/Day, Inc.	18, 19	■ Magnetic Shield Div., Perfection Mica Co. Burton Browne Advertising	179
■ Burr Brown Research Corp. N. A. Winter Adv. Agcy.	142	Fansteel Metallurgical Corp. Reincke, Meyer & Finn, Inc.	148	■ Mallory Battery Co., Div. of P.R. Mallory & Co., Inc. Needham, Harper & Steers, Inc.	70
■ Burroughs Corp., Electronic Components Div. Conti Adv. Agcy., Inc.	92	Federal Scientific Corp. Zam & Kirshner, Inc.	91	Markem Machine Co. Creamer Trowbridge Case & Basford, Inc.	147
Cambridge Thermionic Corp. Chirurg & Cairns, Inc.	86	Flexible Circuits, Inc. Sun Advertising	219	Maryland Dept. of Economic Development The Robert Goodman Agcy., Inc.	221
Camwil, Inc. Richard T. Clarke Co.	220	G-C Electronics Co., Industrial Div. Sander Rodkin Adv. Agcy. Ltd.	228	■ Matsuo Electric Co., Ltd. Daiyusha, Inc. Adv.	228
Centralab Div. of Globe - Union, Inc. The Brady Co.	66	General Aniline & Film Corp. L. W. Frohlich & Co./Intercon International, Inc.	128	M.F.E. Mechanics for Electronics Scott Adv. Agcy., Inc.	58
■ Cherry Electrical Products Corp. K & A, Inc.	85	General Cable Corp. Hicks & Greist, Inc.	28, 29, 159	Metal Removal Co., The Advertising Producers Associates	16
Cimron Div. of Lear Siegler, Inc. Phillips-Ramsey, Inc.	67	General Dynamics Fort Worth Div. Glenn Adv., Inc.	40	Microdot, Inc. Gumpertz, Bentley & Dolan Advertising	15
Cinch Graphik Div. of United Carr Fastener Co. Reach McClinton & Co.	186	□ N.V. Polychemie AKU/General Electric	26A-26D	■ Microsonics, Inc. S. Gunnar Myrbeck & Co.	218
■ Clairex Corp. Michel-Cather, Inc.	210	General Electric Co., Electronic Components Sales Operation Robert S. Cragin, Inc.	79	Microwave Electronics Corp., Sub. of Teledyne Bonfield Associates	211
■ Clevite Corp., Piezoelectric Div. Carr Liggett Adv., Inc.	217	General Electric Co., Printer-Reader Business Section Robert S. Cragin, Inc.	206		
Cohu Electronics, Inc. Erwin Wasey, Inc.	76	General Precision, Inc.—Link Group Gaynor & Ducas, Inc.	205		
Consolidated Electrodynamics Corp., Sub of Bell & Howell Hixson & Jorgensen, Inc.	144	General Radio Co. Horton, Church & Goff, Inc.	17		
Control Products Div. Consolidated Electrodynamics Corp., a Bell & Howell Co. Watson-Manning, Inc.	221	■ Grayhill, Inc. Merchandising Adv., Inc.	220		
Coors Porcelain Co. Tallant/Yates Adv., Inc.	222	■ Gudebrod Brothers Silk Co., Electronics Div. Ramsdell-Buckley & Co.	248, 249		
Corning Glass Works Electronic Division—Capacitors Rumrill Hoyt Co., Inc.	173				

■ Milgray Electronics Bliss/Gruenwald, Inc.	212
Minnesota Mining & Mfg. Co., Chemical Div. Young & Rubicam, Inc.	172
Minnesota Mining & Mfg. Co., Scotchpar Div. Young & Rubicam, Inc.	30
■ Mitsumi Electric Co., Ltd. Sanko Tsushinsha, Ltd.	204
Monsanto Co. Foote, Cone & Belding	69
Motorola Semiconductor Products, Inc. Lane & Bird Adv., Inc.	12, 13, 127
Mullard, Ltd. Parker-Rumrill International, Inc.	146
■ National Electronics, Inc. Connor-Sager Associates	217
National Semiconductor Corp. Jay Chiat & Associates	187, 189, 191
Nippon Coil Co., Ltd. Dai-Ichi International, Inc.	210
■ North Atlantic Industries, Inc. Murray Heyert Associates	60
■ Oak Manufacturing Co. Div. of Oak Electro/Netics Corp. Buchen Adv., Inc.	81
Olympus Corp. Kameny Associates, Inc.	134
Owens-Illinois, Inc. Meldrum and Fewsmith, Inc.	234
Pamotor, Inc. Harry P. Bridge Co.	232
■ Philbrick/Nexus Research Culver Adv., Inc.	156
Philco-Ford/WDL Division Hal Lawrence, Inc.	65
Plastic Capacitors, Inc. Sander Rodkin Adv. Agcy., Ltd.	182
Polaroid Corp. Doyle, Dane, Bernbach, Inc.	164
■ Potter & Brumfield Div., American Machine & Foundry Corp. Grant, Schwenck & Baker, Inc.	71
Princeton Applied Research Corp. Mort Barish Assoc., Inc.	42
Radiation, Inc. W. M. Zemp & Assoc., Inc.	89
■ Radio Cores Inc. Sander Rodkin Adv. Agcy., Ltd.	204
Radio Corporation of America 4th. Cover, 22, 57, 199, 242 Al Paul Lefton Co.	
Radio Materials Co., Div. of P.R. Mallory & Co. M. M. Fisher Assoc., Inc.	190
Raytheon Computer Co. Martin Wolfson Advertising	49
Raytheon Semiconductor Botsford, Constantine & McCarty, Inc.	174
Rohde & Schwarz Fletcher-Walker-Gessell, Inc.	139
Semtech Corp. Burress Advertising	9
Signetics Corp. Sub Corning Glass Works Cunningham & Walsh, Inc.	133
■ Siliconix, Inc. Graphics West	7
Sinclair Radio Labs, Inc. John E. Hayes Co., Inc.	216
Singer Co., The, Metrics Division The Stanley Schwartz Co.	78
Solitron Devices, Inc., Transistor Div. Haselmir Pearson Adv., Inc.	107
Sorensen Operation, Raytheon Company Urrutia & Hayes, Inc.	75
Sperry Rand Corp., Sperry Microwave Electronics Div Neals & Hickok, Inc.	72
Sprague Electric Co., The Harry P. Bridge Co.	5, 8
Stackpole Carbon Co., Electronic Components Div. Meek & Thomas, Inc.	163
Struthers-Dunn, Inc. Harry P. Bridge Co.	136
Sylvania Electric Products, Inc., Parts Div. Doyle, Dane, Bernbach, Inc.	41



Systron-Donner Corp. Bonfield Assoc., Inc.	6
TDK Electronics Co., Ltd. Fuji Agency	220
■ Tektronix, Inc. Hugh Dwight Adv., Inc.	47
Teleproducts, Inc. James Lees Advertising	14
Telonic Instruments Jansen Assoc., Inc.	207, 252
Temescal, Division of Airco Allen, Dorward and Scroggin, Inc.	
Tempress Research Co., Inc. Hal Lawrence, Inc.	31
Test Equipment Corp. Dean & Bain Adv., Inc.	206
■ Times Wire & Cable Div., International Silver Co. Mohr & Co., Inc.	56
■ Tracor, Inc. Weekley & Valenti, Inc.	51
■ Tung-Sol Division, Wagner Electric Corp. Feeley & Wheeler, Inc.	188
Union Carbide Co., Solid Tantalum Capacitor Windfield, Inc. Adv.	87
United Control Corp. Botsford, Constantine & McCarty, Inc.	135
■ United Transformer Co., Div. of TRW, Inc. Philip Stogel Co.	2nd Cover
■ Unirode Corp. Silton Brothers, Inc.	59
Varian Data Machines Durel Advertising	54
■ Wang Laboratories Impact Adv., Inc.	198
Waters Manufacturing, Inc. J. Kenneth Fowler	10
■ Weston Instruments, Inc. Archbald Div. Arndt, Preston, Chapin, Lamb, & Keen, Inc.	226
■ Weston Instruments, Inc., Newark Div. Arndt, Preston, Chapin, Lamb, & Keen, Inc.	27
■ White Company, S.S. Resistor Trimmer Div. W. L. Towne Co., Inc.	119

Classified Advertising

F.J. Eberle, Manager

EMPLOYMENT OPPORTUNITIES 233
Union Carbide Corp 233

EQUIPMENT
(Used or Surplus New) 233
For Sale 233

Calif. Elec. Mfg. 233
Fishman, Philip Co. 233
Goodheart, R. E. Co., Inc. 233
Radio Research Instrument Co. 233
Wiley, H. C. 233

■ For more information on complete product line see advertisement in the latest Electronics Buyer's Guide
□ Advertiser in Overseas Advertising Section following Electronics Newsletter

Electronics Buyers' Guide

George F. Werner, General Manager [212] 971-2310
Ray Smyth, Eastern Regional Manager [212] 971-6538
Regina Hera, Directory Manager [212] 971-2544
Thomas M. Egan, Production Manager [212] 971-3140

Circulation Department

Isaaca Siegel, Manager [212] 971-6057

Research Department

David Strassler, Manager [212] 971-6058
Chloe D. Glover, Research Associate [212] 971-6057

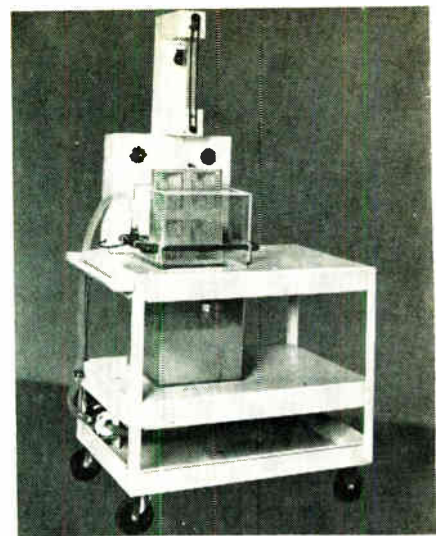

"fine line" etcher

for prototypes—limited runs

Model No. 201 (illus.), etches two 11" x 14" one-sided boards or one 11" x 14" two-sided board: **\$795**
Pat. applied for

**ETCH YOUR OWN
P C BOARDS
AUTOMATICALLY**
(in less than 5 minutes)

from this →
to 11" x 14"

Shown Actual Size



- No cooling or venting required!
- Etches as fine as .001"!
- Cuts costs in half—saves time!
- Complete photo processing instructions!
- Work is illuminated while etching!
- No patterning . . . minimum undercutting!

NOW IN USE BY:

AMP, Inc.
Ampex Corp.
Atomic Energy Com.
Bendix
Charles Bruning
Esso Research
General Dynamics
General Electric
IBM
ITT
Lear Siegler
Magnavox
Micro Switch
NASA
Owens-Illinois

Sprague Electric
Union Carbide
U.S. Air Force
Western Electric
Whirlpool
M.I.T.
Oklahoma State U.
Purdue Univ.
Washington Univ.
Univ. of Calif.
Univ. of Chicago
Univ. of Colorado
Univ. of Georgia
Univ. of Hawaii
Univ. of Penn.

CYCLO-TRONICS, INC.
3858 N. CICERO — CHICAGO, ILL. 60641
TELEPHONE: (312)-282-6141

Airco Temescal's new, compact 6 kw electron-beam power supply

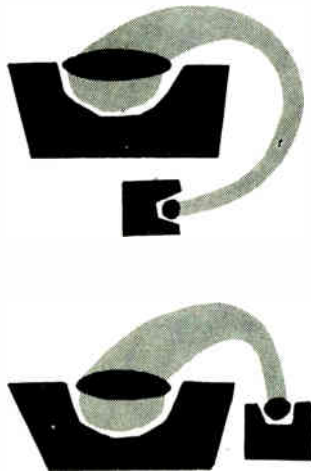
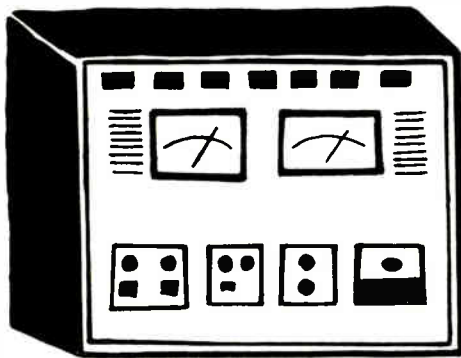

Airco Temescal, the pioneer in electron beam technology, introduces a new, compact 6 KW power supply. It is a logical addition to the 3 and 10 KW supplies which have established new reliability records for electron beam equipment. The ES-6 offers features and a degree of sophistication available only from Airco Temescal.

- 6 KW rating: 10 KV DC, 0.6 amperes; 100% overload protected.
- Single or dual gun operation.
- Closed loop emission control and metering for each source.
- Designed for any Airco Temescal 180° or 270° source.
- Individual controls for emission, focus, beam sweep.
- Triode control insures instantaneous arc-down recovery.
- Air-cooled with built-in over-temperature protection.
- Can be controlled by external monitor.
- Low frequency sweep and compensating wave form distributes energy.
- Designed for rack mounting, 12¼ inches high.

AIRCO Temescal

A DIVISION OF AIR REDUCTION COMPANY, INCORPORATED
2850 Seventh Street, Berkeley, California 94710 Telephone 415 841-5720

Advertising Sales Staff

Frank E. LeBeau [212] 971-6464
Advertising Sales Manager

Wallis Clarke [212] 971-2187
Assistant to sales manager
Donald J. Austermann [212] 971-3139
Promotion Manager

Warren H. Gardner [215] LO 8-6161
Eastern Advertising Sales Manager

Atlanta, Ga. 30309: Michael H. Miller, 1375 Peachtree St., N.E.
[404] 892-2868

Boston, Mass. 02116: William S. Hodgkinson
McGraw-Hill Building, Copley Square
[617] CO 2-1160

Cleveland, Ohio 44113: William J. Boyle, 55 Public Square, [216] SU 1-7000

New York, N.Y. 10036
500 Fifth Avenue
Donald R. Furth [212] 971-3615
James R. Pierce [212] 971-3616
John A. Garland [212] 971-3617

Philadelphia, Pa. 19103:

Jeffrey M. Preston
Warren H. Gardner,
6 Penn Center Plaza,
[215] LO 8-6161

Pittsburgh, Pa. 15222: Warren H. Gardner,
4 Gateway Center, [412] 391-1314

Rochester, N.Y. 14534: William J. Boyle,
9 Greylock Ridge, Pittsford, N.Y.
[716] 586-5040

J. Bradley MacKimm [312] MO 4-5800
Midwest Advertising Sales Manager

Chicago, Ill. 60611: Robert M. Denmead,
J. Bradley MacKimm, Ralph Hanning,
645 North Michigan Avenue,
[312] MO 4-5800

Dallas, Texas 75201: Richard P. Poole, 1800 Republic National Bank Tower,
[214] RI 7-9721

Houston, Texas 77002: Kenneth George,
2270 Humble Bldg., [713] CA 4-8381

Detroit, Michigan 48226: Ralph Hanning
856 Penobscot Building
[313] 962-1793

Minneapolis, Minn. 55402: J. Bradley
MacKimm, 1104 Northstar Center
[612] 332-7425

St. Louis, Mo. 63105: Robert M. Denmead
The Clayton Tower, 7751-Carondelet Ave.
[314] PA 5-7285

James T. Hauptli [415] DO 2-4600

Western Advertising Sales Manager

Denver, Colo. 80202: Joseph C. Page, David
M. Watson, Tower Bldg., 1700 Broadway
[303] 255-5484

Los Angeles, Calif. 90017: Ian C. Hill,
John G. Zisch, 1125 W. 6th St.,
[213] HU 2-5450

Portland, Ore. 97204: James T. Hauptli,
218 Mohawk Building, 222 S.W. Morrison
Street, Phone [503] 223-5118

San Francisco, Calif. 94111:
James T. Hauptli, 255 California Street,
[415] DO 2-4600

Pierre Braude Tel: 225 85 88: Paris
European Director

Paris: Ken Davey
88-90 Avenue Des Champs-Elysees, Paris 8
United Kingdom and Scandinavia
Brian Bowes Tel. Hyde Park 1451
34 Dover Street,
London W1

Milan: Robert Saidel
1 via Baracchini Phone: 86-90-656

Brussels: F.I.H. Huntjens
27 Rue Ducale Tel: 136503

Frankfurt/Main: Hans Haller
Elsa-Brandstroem Str. 2
Phone: 72 01 81

Geneva: Ken Davey
1, rue du Temple Phone: 31 95 60

Tokyo: George E. Olcott, 1, Kotohiracho
Shiba, Minato-Ku [502] 0656

Osaka: Ryoji Kobayashi 163, Umegae-cho
Kita-ku [362] 8771

Business Department

Wallace C. Carmichael, Manager
[212] 971-3191
Stephen R. Weiss, Production Manager
[212] 971-2044

Thomas M. Egan,
Assistant Production Manager [212] 971-3140

Dorothy Carmesin, Contracts and Billings

[212] 971-2908
Frances Vallone, Reader Service Manager
[212] 971-2865

Dale wirewounds can improve your memory.



The computer: General Electric's versatile GE/PAC[®] 4020 Process Control Computer...shown at left.

Resistor assignment: Establish line current values in the GE/PAC[®] 4020 core memory system.

The part used: Dale's Type NS...silicone coated, non-inductively wound.

Reason: Low inductance (less than 1 μ h) and unvarying stability (less than .5%/2000 hours).

Dale wirewounds give you unequalled design freedom in tailoring resistance, power, size and stability to your exact needs. Industrial.... precision.... established reliability.... standard or special....there's always a Dale resistor that can do the job better. Call 402-564-3131 for fast action, or circle 181 for Catalog A.

DALE

for optimum value in wirewound resistors

DALE ELECTRONICS, INC. 1300 28th Avenue, Columbus, Nebraska 68601
In Canada: Dale Electronics Canada, Ltd.

Gard Testing is available to meet Established Reliability requirements at significant time cost savings over typical 100 hr. burn in. Write for Test Report #19590.

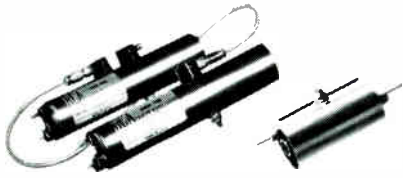

RCA-4060/4061

RCA-6562/5794A

Maybe nobody dreamed of the radiosonde cavity quite that way in 1949. That's the year RCA originated it—primarily for use in weather balloons. Since then, the same basic design concept has been adapted for a number of products, most notably a matched pair of pencil tube cavities,

RCA-4060/4061, for use in airborne transponder service.

We've found that integrating the tube and circuit permits packages that are lightweight and low in cost. System efficiencies and economies result. And on-the-spot maintenance procedures are greatly simplified.

You've found that out, too. Millions of radiosonde cavities, such as RCA-6562/5794A, producing about 500 mW at 1680 MHz, are in use in weather study. The RCA-4060/4061 Master Oscillator Power Amplifier, operating at 1090 MHz with a minimum peak pulse power output of

500 W, meets all the FAA and AIMS requirements for use in new generation AirTraffic Control Transponders to be used in both military and private aircraft.

There's lots more to know about RCA pioneering in integral cavities for microwave applications. See your RCA Representative or write: Manager, Microwave Marketing, RCA Electronic Components, Harrison, N.J. 07029. For technical data on these and other pencil-tubes-and-cavities, write: Commercial Engineering, Sec. E19Q-4, RCA Electronic Components, Harrison, N.J. 07029.

RCA

**Imagine...
one design concept with applications
that are worlds apart**

