

# Electronics®

Cutting noise in sampled-data systems: page 70

Automatic fault-finder for avionics: page 78

Special report on IC's in Japan: page 98

May 13, 1968

\$1.00

A McGraw-Hill Publication

Below: Testing IC's is getting harder, page 88



14Z K55956 44R06 71-02  
R KISSLER  
BASIC COMM ELEC  
NOV 056  
98037



**All counters count.  
This counter thinks  
while it counts.**

Our new 1159 Recipromatic Counter reduces frequency measurements to a single step: connecting the unknown signal to the input terminals. The counter's built-in computer then takes over and *immediately* gives you a six-digit readout of *any* input frequency between 0.6 Hz and 20 MHz. Ranging is taken care of automatically by the counter, and decimal point and unit of measurement are automatically and clearly displayed. Where speed and the need to safeguard against human error are important factors, the foolproof and automatic operation of the 1159 has tremendous value.

How does this counter measure frequencies down to 6 Hz with six-figure resolution in 0.1 second (and to 0.6 Hz in 1 second)? By means of a built-in, IC computer that converts a multiple-period measurement into a frequency readout. In numerous low-frequency applications, precise frequency measurements have been made up to now only by time-consuming and tedious measurements and calculations. The 1159 not only reduces measurement time to 0.1 second in most cases but it also does most of your thinking for you.

To accommodate unusual operating conditions, we have provided some secondary controls and concealed them behind a hinged door on the front

panel. They include the display-time and signal-conditioning controls, all of which are programmable.

Since normal operation of the 1159 is completely automatic, this counter makes an ideal system component. External instructions to the counter are minimal and infrequent as they concern only secondary functions. BCD output for six digits of data, decimal point, and measurement units is provided at the rear.

By using our 1156-A Decade Scaler with the 1159 counter, you extend the upper frequency limit of the 1159 to 100 MHz. A new scaler (1157) to be available soon will extend the limit to 500 MHz. With either scaler there is no sacrifice in the counter's automatic frequency ranging capability. A rear-panel switch enables you to multiply measurement quantities by 1, 10, or 100 to maintain correct decimal location when a scaler is used.

Price of the 1159 is \$2235 in the U.S.A., for either the bench or rack model. For complete information, write General Radio Company, W. Concord, Massachusetts 01781; telephone (617) 369-4400. In Europe, write Postfach 124, CH 8034 Zurich 34, Switzerland.

**GENERAL RADIO**

Circle 900 on reader service card

# Boost Your Low Level AC without Distortion

Get the headaches out of your low level ac measurements with the hp 463A Precision AC amplifier. The hp 463A amplifies your signals without introducing trouble-causing errors. It is designed to meet the most critical requirements for high-accuracy, wide dynamic range and low distortion.

The all-solid-state 463A has an ultra-low distortion <0.01%, an output of 100 Vrms at 100 Hz, and a gain accuracy better than  $\pm 0.001$  dB (0.01%) with long-term stability of 100 ppm/year. These features make it valuable not only in precision measurements and calibration, but as a general-purpose amplifier up to 100 kHz.

It is ideal to amplify output of the most stable solid-state oscillators, or to isolate thermocouple transfer measurements—and as a pre-amp for digital and differential voltmeters.

For complete specifications on the hp 463A, call your hp field engineer. Or, write to Hewlett-Packard, Palo Alto, California 94304. Europe: 54 Route des Acacias, Geneva. Price: \$690.

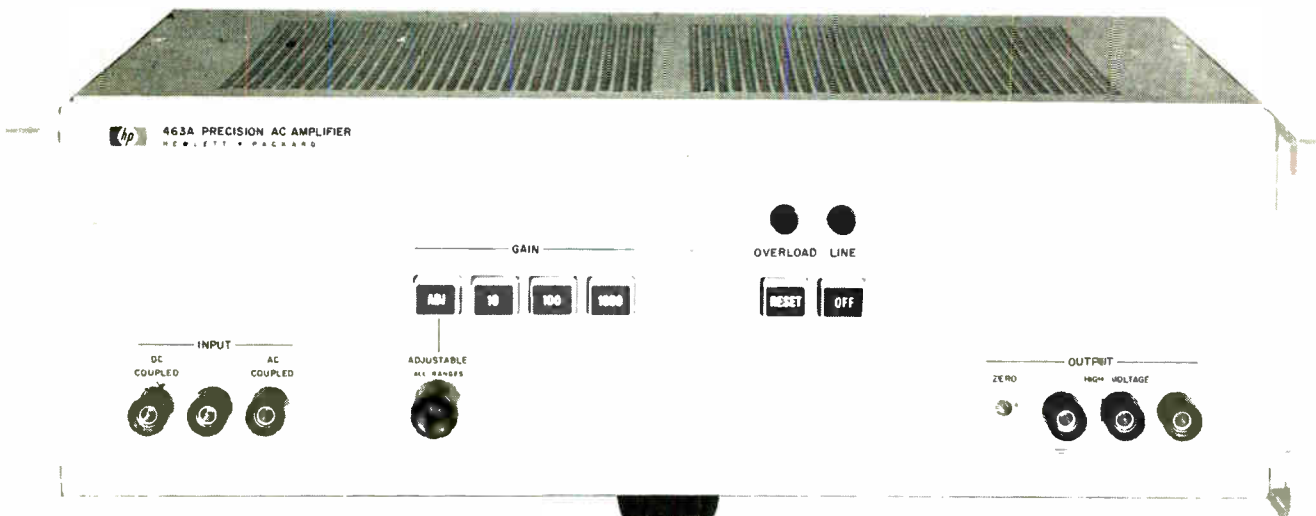

HEWLETT  PACKARD

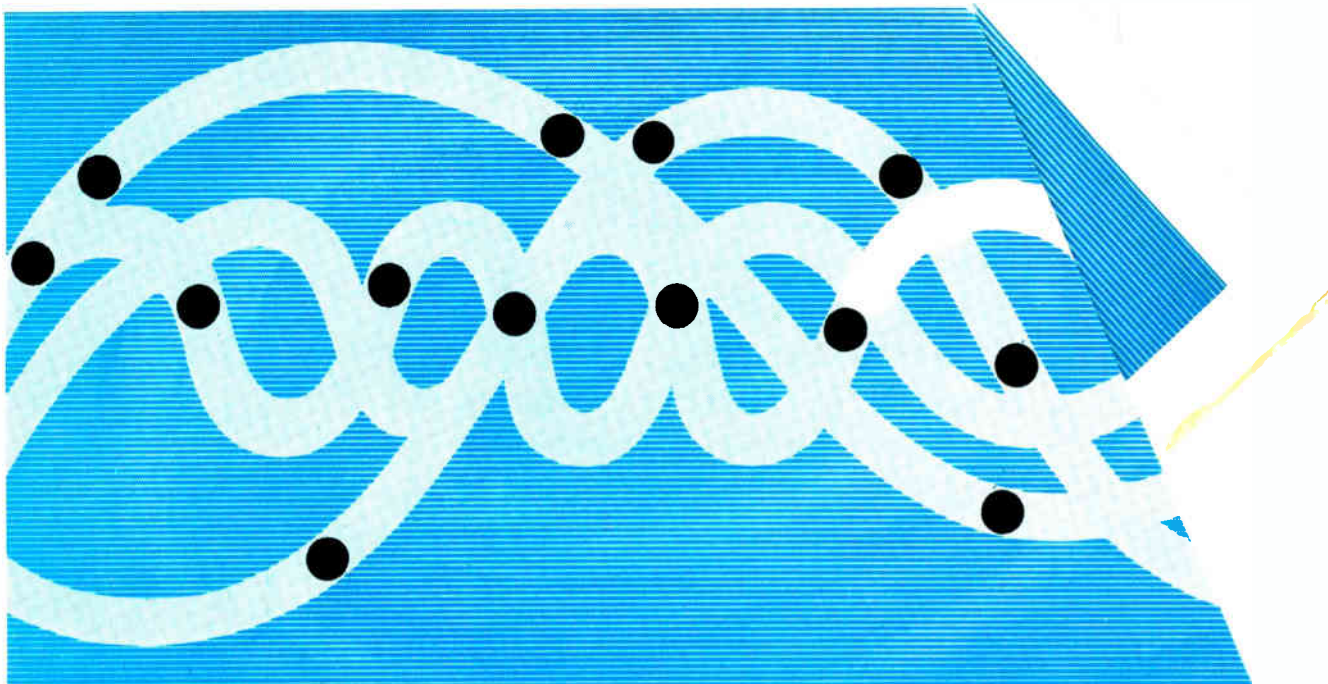

## This universal counter makes its mark most anywhere

If you want to make sure you're getting the ideal counter for your needs, check out the capabilities of Hewlett-Packard's new 5325A Universal Counter. It's called "universal" because it does so many jobs for so many people. It will make all the measurements any counter can make without plug-in accessories—frequency, time interval, period, multiple period, ratio and multiple ratio. It marks trigger points on an oscilloscope as it measures. And it does all this with a versatility and accuracy that are unmatched at \$1200.

Universal counters are most often used by people who need one very versatile counter at a low price; others use them specifically for measuring time interval. The HP 5325A was built for both: It gives you a frequency range of dc to 12.5 MHz with gate times from 100 ns to 10 s and a time interval range of 100 ns to

$10^8$  s. Time base oscillator stability is excellent:  $< 1$  part in  $10^8$ /day aging rate,  $< \pm 2.5$  parts in  $10^6$  total change from 0 to  $50^\circ\text{C}$ . It offers remote programming and BCD outputs. Buffer storage permits printout while the next measurement's in progress. A fast display-time setting readies the counter for a new reading in as little as  $100 \mu\text{s}$ . Further, a CHECK mode lets you automatically test decade counters, gates and time base from the front panel or remotely.

Dual FET input circuits give  $1 \text{ M}\Omega/30 \text{ pF}$  input impedance, and wide-range trigger controls set time interval start and stop points anywhere from 100 mV to 100 V for positive or negative polarities or slopes. You can time the interval between events on a single input signal or between events on two separate signals. For oscilloscope observation of the input waveform

trigger points, the 5325A generates two types of markers shown above: One marks the waveform each time it exceeds the counter trigger level, the other intensifies the waveform section actually being measured.

One other thing. Some counters can give you wrong answers when the time interval stop signal unknowingly disappears or its trigger level is set too high. The 5325A won't respond incorrectly under such conditions—it will simply keep counting and not present a new reading.

Price: \$1200.

Now that you know about the HP 5325A Universal Counter, you're ready to shop for counters. Call your HP field engineer for more information. Or write Hewlett-Packard, Palo Alto, California 94304; Europe: 54 Route des Acacias, Geneva.

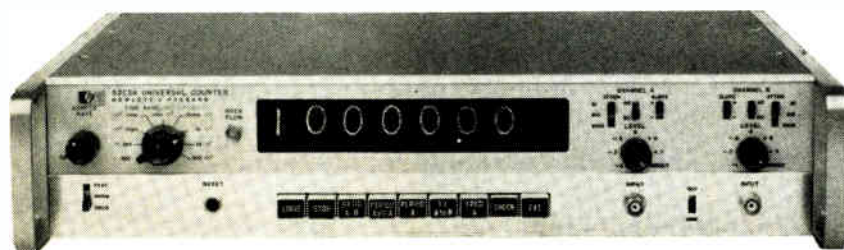

**HEWLETT  PACKARD**  
ELECTRONIC COUNTERS

02807

## News Features

### Probing the News

- 117 **Unpackaged chips set for gains**  
125 **Bell Canada's R&D arm develops reach**

### Electronics Review

- 37 **Computers: Generating half-tones; Shopping for software**  
38 **Companies: Big deal from Burroughs; Philco-Ford looks up**  
39 **Optoelectronics: Laser radar**  
40 **Advanced technology: Lasing with liquid; Gunn effect with germanium**  
42 **Consumer electronics: Color slides on tv**  
42 **Integrated electronics: Smaller SOS circuits; Integrated mixer/modulator**

### Electronics Abroad

- 197 **France: Holograms show stress patterns**  
197 **South Africa: Computers in command at steel-making complex**  
198 **East Germany: Doting on data processing**  
198 **West Germany: Low ceiling for avionics**  
199 **Great Britain: Will success spoil electronics show?**  
199 **Italy: GE becomes sole owner of Olivetti-GE**  
200 **International: Changes loom for Europe's space efforts**  
200 **Mexico: Lasers keep tunnel straight**  
200 **Around the world**

### New Products

- 133 **Color tv cameras go portable**  
141 **Subassemblies review**  
141 **Recorder heads last 5,000 hours**  
144 **Laser tube is replaceable**  
149 **Instruments review**  
149 **FET tester prevents burnout**  
154 **Digital voltmeter prints data**  
159 **Semiconductors review**  
159 **Transistors with speed and power**  
164 **Shift register has 6,400 devices**  
169 **Microwave review**  
169 **Oven used to stabilize crystal**  
173 **Components review**  
173 **Motorless timer has long life**  
174 **Bandpass filters at lower price**

Title R registered U.S. Patent Office; © copyright 1968 by McGraw-Hill Inc. All rights reserved, including the right to reproduce the contents of this publication, in whole or in part.

## Technical Articles

### I. Design

- Communications** 70 **Cutting noise in data sampling**  
Straight-line approximation of signal spectrum helps in designing preprocessing filter  
Thaddeus Kobylarz, Stevens Institute of Technology

- Circuit design** 74 **Designer's casebook**  
▪ Sine waves are squared by a symmetrical switch  
▪ Differential amplifier governs magnetic brakes and clutches

- Avionics** 78 **Height of sophistication in in-flight monitoring**  
Automatic checkout system designed into the avionics from the ground up will find faults and switch modes  
F.H. Hardie and G.E. Simaitis, International Business Machines Corp.

### II. Application

- Instrumentation** 88 **IC testing tries to keep up with gains in IC technology**  
New integrated circuits are making many test techniques obsolete, putting a new burden on users  
Carl Moskowitz, Instrumentation editor

- Integrated electronics** 98 **IC's in Japan—a close-up**  
A review of the Japanese IC technology in three major areas: computers, calculators, and consumer equipment  
Yasuo Tarui, Electrotechnical Laboratory

## Departments

- |    |                        |     |                        |
|----|------------------------|-----|------------------------|
| 4  | Readers Comment        | 38  | Index of Activity      |
| 8  | People                 | 59  | Washington Newsletter  |
| 14 | Meetings               | 178 | New Books              |
| 23 | Editorial Comment      | 180 | Technical Abstracts    |
| 25 | Electronics Newsletter | 184 | New Literature         |
|    |                        | 191 | Newsletter from Abroad |

# Electronics

Editor-in-Chief: Donald Christiansen

## Associate managing editors

Technical: Stephen E. Scrupski  
News: Robert Henkel  
Copy: Sally Powell

## Senior associate editors

Joseph Mittleman, Harry R. Karp

## Department editors

**Avionics & Space:** Alfred Rosenblatt  
**Computers:** Wallace B. Riley  
**Communications:** William Bucci  
**Consumer electronics:** John D. Drummond  
**Design theory:** Joseph Mittleman  
**Industrial electronics:** Harry R. Karp  
**Instrumentation:** Carl Moskowitz  
**Military electronics:** Richard Gundlach  
**Solid state:** Mark B. Leeds

## Domestic bureaus

**Boston:** James Brinton, manager  
**Los Angeles:** Lawrence Curran, manager; Burton Bell  
**New York:** Howard Wolff, manager  
**San Francisco:** Walter Barney, manager; Peter Vogel  
**Washington:** Robert Skole, manager; Paul Dickson

## Foreign bureaus

**Bonn:** John Gosch  
**London:** Michael Payne  
**Tokyo:** Charles Cohen

## Copy editors

James Chang, Frederick Corey, Larry Miller

## Graphic design

**Art director:** Saul Sussman  
**Assistant art directors:** Ann Mella, Valerie Betz  
**Production editor:** Arthur C. Miller

## Editorial research:

Kay Fontana  
**Editorial secretaries:** Lorraine Longo, Claire Benell, Lynn Emery, Patricia Gardner, Barbara Razulis, Frances Vacca

## McGraw-Hill News Service

**Director:** Arthur L. Moore; **Atlanta:** Fran Ridgway; **Chicago:** Bruce Cross;  
**Cleveland:** Arthur Zimmerman; **Dallas:** Marvin Reid;  
**Detroit:** James Wargo; **Houston:** Robert E. Lee; **Los Angeles:** Michael Murphy  
**Pittsburgh:** Louis Gomolak

**San Francisco:** William F. Arnold  
**Seattle:** Ray Bloomberg; **Washington:** Charles Gardner, Daniel B. Moskowitz, Herbert W. Cheshire, Seth Payne, Warren Burkett, William Small, William D. Hickman

## McGraw-Hill World News Service

**Bonn:** Robert Dorang; **Brussels:** George Williamson; **Hong Kong:** Wes Perry;  
**London:** John Shinn; **Mexico City:** Gerald Parkinson; **Milan:** Ronald Taggiasco, Jack Star;  
**Moscow:** Howard Rausch; **Paris:** Robert E. Farrell, Peter Kilborn;  
**Rio de Janeiro:** Leslie Warren; **Tokyo:** Marvin Petal

## Reprints: Susan Nugent

## Circulation: Isaaca Siegel

## Publisher: Gordon Jones

Electronics: May 13, 1968, Vol. 41, No. 10

Published every other Monday by McGraw-Hill, Inc. Founder: James H. McGraw 1860-1948.

Printed at 99 North Broadway, Albany, N. Y. 12207; second class postage paid at Albany, N. Y.

Executive, editorial, circulation and advertising addresses: McGraw-Hill Building, 330 W. 42nd Street  
New York, N. Y. 10036. Telephone (212) 971-3333. Teletype TWX N.Y. 710-581-4235. Cable address:  
MCGRAWHILL N.Y.

Subscriptions solicited only from those professionally engaged in electronics technology. Subscription rates: qualified subscribers in the United States and possessions and Canada, \$8.00 one year, \$12.00 two years, \$16.00 three years; all other countries \$25.00 one year. Non-qualified subscribers in the U. S. and possessions and Canada, \$25.00 one year; all other countries \$50.00. Air freight service to Japan \$50.00 one year. Single copies: United States and possessions and Canada, \$1.00; all other countries, \$1.75.

Officers of McGraw-Hill Publications: Joseph H. Allen, President; Bayard E. Sawyer, Executive Vice President; J. Elton Tuohig, Senior Vice President-Operations; Vice Presidents: John R. Callahan, Editorial; John M. Holden, Marketing; Paul F. Cowie, Circulation; Jerome D. Luntz, Planning & Development; Robert M. Wilhelmy, Controller.

Officers of the Corporation: Shelton Fisher, President and Chief Executive Officer; John L. McGraw, Chairman; Daniel F. Crowley, Donald C. McGraw, Jr., R. E. Slaughter, Senior Vice Presidents; John J. Cooke, Vice President & Secretary; Gordon W. McKinley, Vice President & Treasurer.

Title ® registered in U.S. Patent Office; © Copyright 1968 by McGraw-Hill, Inc. All rights reserved. The contents of this publication may not be reproduced either in whole or in part without the consent of copyright owner.

**Subscribers:** The publisher, upon written request to our New York office from any subscriber, agrees to refund that part of the subscription price applying to copies not yet mailed. Please send change of address notices or complaints to Fulfillment Manager; subscription orders to Circulation Manager, Electronics at address below. Change of address notices should provide old as well as new address, including postal zip code number. If possible, attach address label from recent issue. Allow one month for change to become effective.

**Postmaster:** Please send form 3579 to Fulfillment Manager, Electronics, P.O. Box 430, Hightstown, New Jersey 08520

## Readers Comment

### Time to reconsider

To the Editor:

In your article "Watch out" [Feb. 5, p. 209] you state that "the very best conventional wrist watches err as much as 4 or 5 seconds a day." We would like to point out that although the statement would have been correct a few years ago, this is not the case today. We have for several years been producing a series of wrist-watches for which we guarantee maximum variations of 2 seconds a day in normal wear.

C. Weber

S. A. Girard-Perregaux & Co.  
La Chaux-de-Fonds  
Switzerland

### Error in coding

To the Editor:

Your otherwise excellent article on the use of error-correcting coding in the Pioneer D spacecraft [April 1, p. 36] disappointed us in two respects.

One was the omission of the name of Dr. Dale Lumb, of NASA's Ames Research Center, to whom must go the largest share of the credit for the development of this system.

The other was the statement that the convolutional code used is similar to that previously advanced by IBM. In fact, there are two kinds of coding, block and convolutional; IBM uses the former, whereas the latter is a specialty of Codex Corporation.

We are proud to have assisted Ames Research Center in applying convolutional coding to the Pioneer communications system, with the satisfying results described in your article.

J.M. Cryer Jr.

President  
Codex Corp.  
Watertown,  
Mass.

### Wrong number

To the Editor:

One error appears in my article "Saving money on data transmission as signals take turns on party

# Add **Sprague Series 7400A** to your prints for Series 74N TTL circuits. They're pin-for-pin identical.

SERIES 74N	FUNCTION	SPRAGUE PART NO.
SN7400N	Quad 2-Input NAND	<b>USN-7400A</b>
SN7401N	Quad 2-Input NAND (No Collector Load)	<b>USN-7401A</b>
SN7402N	Quad 2-Input NOR	<b>USN-7402A</b>
SN7410N	Triple 3-Input NAND	<b>USN-7410A</b>
SN7420N	Dual 4-Input NAND	<b>USN-7420A</b>
SN7430N	Single 8-Input NAND	<b>USN-7430A</b>
SN7440N	Dual 4-Input NAND Buffer	<b>USN-7440A</b>
SN7450N	2-Wide 2-Input Expandable AND-OR-INVERT	<b>USN-7450A</b>
SN7451N	2-Wide 2-Input AND-OR-INVERT	<b>USN-7451A</b>
SN7453N	4-Wide 2-Input Expandable AND-OR-INVERT	<b>USN-7453A</b>
SN7454N	4-Wide 2-Input AND-OR-INVERT	<b>USN-7454A</b>
SN7460N	Dual 4-Input Expander	<b>USN-7460A</b>
SN7470N	D-C Clocked J-K Flip Flop	<b>USN-7470A</b>
SN7472N	J-K Master Slave Flip Flop	<b>USN-7472A</b>
	Dual J-K Master Slave Flip Flop:	
SN7473N	Single chip, pin 11 GND	<b>USN-7473A</b>
—	Single chip, pin 7 GND	<b>USN-74107A</b>
SN7474N	Dual D-Type Edge-Triggered Flip Flop	<b>USN-7474A</b>
—	Dual AC Clocked J-K Flip Flop	<b>USN-7479A</b>

Series 5400, full-temperature-range equivalents in 14 pin flat-packs, are also available for rapid delivery from Sprague.



## Don't spend another week without calling Sprague.

For complete technical data on Series 5400 and 7400A circuits, write to Technical Literature Service, Sprague Electric Co., 35 Marshall St., North Adams, Mass. 01247

**SPRAGUE WORCESTER...the world's finest microcircuit facility**



Sprague and '®' are registered trademarks of the Sprague Electric Co.

# We've got a plan for speeding up delivery on Heinemann Circuit Breakers.

Read the fine print:

## AUTHORIZED HEINEMANN STOCKING DISTRIBUTORS

**Alabama**  
Electro-Tech, Inc.  
Huntsville  
(205) 539-1250

**Arizona**  
Kierulff Electronics, Inc.  
Phoenix  
(602) 273-7331

**California**  
Wesco Electronics  
Los Angeles  
(213) 685-9525

Wesco Electronics  
Palo Alto  
(415) 968-3475

Wesco Electronics  
San Diego  
(714) 279-3471

**Colorado**  
Kierulff Electronics, Inc.  
Denver  
(303) 825-7033

**Connecticut**  
MarLe Company  
Stamford  
(203) 348-2645

Grand Light & Supply Co.  
New Haven  
(203) 777-5781

**Florida**  
McDonald Distributors  
of Florida Inc.  
Fort Lauderdale  
(305) 563-1255

Industrial Electronics  
Associates, Inc.  
West Palm Beach  
(305) 848-8686

Parts Service Corp.  
Winter Park  
(305) 647-5343

**Georgia**  
Electro-Tech, Inc.  
Hapeville  
(404) 758-7205

**Kansas**  
Hall-Mark Electronics  
Kansas City  
(913) 236-4343

**Kentucky**  
E & H Electric Supply Co.  
Louisville  
(502) 587-0991

Marine Electric Co., Inc.  
Louisville  
(502) 587-6511

**Louisiana**  
Poulan's Electrical Co.  
Monroe  
(318) 323-7701

Hall-Mark Electronics  
New Orleans  
(504) 242-7581

**Maine**  
Stanley J. Leen Co., Inc.  
Portland  
(207) 774-6266

**Maryland**  
Lee Electric Co.  
Baltimore  
(301) 752-4080

Pytronic Industries Inc.  
Baltimore  
(301) 727-5100

**Massachusetts**  
Apparatus Service Co.  
Allston  
(617) 787-1300

Electrical Supply Corp.  
Cambridge  
(617) 491-3300

T. F. Cushing, Inc.  
Springfield  
(413) 788-7341

**Mississippi**  
Ellington Electronic  
Supply, Inc.  
Jackson  
(601) 355-0561

**New Jersey**  
Valley/Hamilton Electro  
Sales  
Cherry Hill  
(609) 662-9337

Federated Purchaser, Inc.  
Springfield  
(201) 376-8900

**New Mexico**  
Kierulff Electronics, Inc.  
Albuquerque  
(505) 268-3901

**New York**  
Federal Electronics Inc.  
Vestal  
(607) 748-8211

**North Carolina**  
Electro-Tech, Inc.  
Charlotte  
(704) 392-7451

**Ohio**  
Midwest Equipment Co.  
Cincinnati  
(513) 821-1687

Radio & Electronic Parts  
Cleveland  
(216) 881-6060

**Oklahoma**  
Hall-Mark Electronics  
Tulsa  
(918) 835-8458

**Oregon**  
Platt Electric Supply  
Portland  
(503) 222-9633

**Pennsylvania**  
West Chester Electric  
Supply Co.  
West Chester  
(215) 696-7500

**Rhode Island**  
William Dandreta & Co.  
Providence  
(401) 861-2800

**Texas**  
Cummins Supply Co.  
Amarillo  
(806) 373-5379

G. E. Jones Electric Co.  
Amarillo  
(806) 372-5505

Warren Electric Co.  
Beaumont  
(713) 833-9405

Hall-Mark Electronics  
Dallas  
(214) 231-6111

Nelson Electric Supply  
Dallas  
(214) 741-6341

Hall-Mark Electronics  
Houston  
(713) 781-0011

Warren Electric Co.  
Houston  
(713) 225-0971

Messner Electric Supply  
Longview  
(214) 753-4484

The Perry Shankle Co.  
San Antonio  
(512) 223-1801

**Washington**  
Kierulff Electronics, Inc.  
Seattle  
(206) 725-1550

HEINEMANN ELECTRIC COMPANY



Trenton, New Jersey 08602



line [April 15, p. 119]. There had been a question as to whether a "7" or "8" counter should be used in the receiver, and we arbitrarily chose the "8" counter.

Actually, either one would be correct—as long as the number of the counter corresponds to the number of flip-flops in the parallel readout shift register. The reason is that each pulse position transmitted and stored must be counted.

The article has the unfortunate combination of an "8" counter with a seven flip-flop shift register.

James W. Cofer

Georgia Institute of Technology  
Atlanta

## Headache

To the Editor:

I would like to comment on "Cameras that wink can produce 3-D tv" by M.G. Maxwell [March 18, p. 32].

Viewing stereoscopic pictures by means of superimposed images of different colors through colored spectacles is not new. It has been used in magazines and newspapers, and also in movie short subjects for many years before the Polaroid Natural Vision process. A stereoscopic picture coded by superimposed images of different colors is known as a color anaglyph. We could call Maxwell's proposed system a time-multiplexed anaglyph.

Stereoscopists have been experimenting with various anaglyphic systems for many years. While the color anaglyph has some advantages, it also has several disadvantages. For although the effect of stereo will be produced, many people see the images on an alternating background of flashes of red and green. This background-alteration effect, which can cause

severe headaches among a large percentage of viewers, was the reason color anaglyphic motion pictures did not last.

Indeed, this effect was given a name, "color bombardment," years ago. And color bombardment would be just as disadvantageous to the television viewer of today as to the motion picture viewer of yesterday.

Stephen A. Kallis Jr.

Acton  
Mass.

## Transistor genealogy

To the Editor:

In response to Carl V. Erickson's letter [March 18, p. 7] I would like to recommend to your attention the March 1965 issue of Analog. In that issue there is a supposedly factual article describing patents on a type of solid state amplifier that were taken out beginning in 1925 extending to 1930.

The amplifiers closely resemble present day npn-junction transistors although made out of aluminum and cuprous oxide. The article does not unequivocally state that the amplifiers worked, but it might possibly point to some antecedents of the present day transistor.

Arthur W. Long

University of California  
Berkeley,  
Calif.

## Ticklish subject

To the Editor:

Re your story on crystal testing [April 15, p. 50], I hope you never tickle me with "only 0.1<sup>-15</sup> watt."

$$0.1^{-15} = (1/10)^{-15} = 10^{15} \text{ watts!}$$

R.A. Rawson

Berkeley,  
Calif.

## SOLVE INTEGRATED CIRCUIT SEALING PROBLEMS

## WITH WILLIAMS NEW IMPROVED ALLOYS FOR MICROELECTRONIC DESIGN

- ✓ **80% GOLD —  
20% TIN EUTECTIC**  
MELTING POINT 280° C
- ✓ **88% GOLD —  
12% GERMANIUM EUTECTIC**  
MELTING POINT 356° C
- ✓ **WILLIAMS IW32 ALLOY**  
MELTING POINT 520-550° C
- ✓ **SOLDER PREFORMS FOR SEALING  
INTEGRATED CIRCUIT PACKAGES**
- ✓ **TOOLING AVAILABLE ON MOST  
STANDARD SIZES**  
4 to 6 Weeks Delivery on New Tooling

## PARTIAL LIST OF AVAILABLE ALLOYS & SOLDER PREFORMS

88% Gold 12% Germanium (Eutectic Alloy)  
Strip and solder preforms in all sizes

80% Gold 20% Tin (Eutectic Alloy)  
Strip, wire and solder preforms in all sizes

Gold with .1 to 1.2% Antimony  
Wire, strip and solder preforms all sizes

Gold — .05% Min. Phosphorus  
Wire, strip and solder preforms all sizes

95% Gold 5% Nickel  
Wire, strip and solder preforms all sizes

Gold and up to .5% Arsenic  
Strip and solder preforms all sizes

Silver with .1 to 1.2% Antimony  
Wire, strip and solder preforms all sizes

Silver — .1% Min. Phosphorus  
Wire, strip and solder preforms all sizes

95% Silver 5% Nickel  
Wire, strip and solder preforms all sizes

Silver and up to .5% Arsenic  
Strip and solder preforms all sizes

Special alloys produced on request at  
minimum charge.

Precious Metals in 99.9% Pure,  
99.99% Pure, and 99.999% Pure.

*Modern, up-to-date refining of precious metals and complete spectrographic facilities available.*

## HIGH PURITY METALS USED ON ALL ALLOYS

WRITE FOR COMPLETE PRECIOUS METALS CATALOG  
AND SPECIFICATION SHEETS. PHONE 716-834-7204

OVER 50 YEARS OF PRECIOUS METALS EXPERIENCE

## WILLIAMS PRECIOUS METALS



2978 MAIN ST. BUFFALO, NEW YORK 14214  
Division of Williams Gold Refining Co., Inc.

Circle 7 on reader service card

## SUBSCRIPTION SERVICE

Please include an Electronics Magazine address label to insure prompt service whenever you write us about your subscription.

Mail to: Fulfillment Manager  
Electronics  
P.O. Box 430  
Hightstown, N.J. 08520

To subscribe mail this form with your payment and check  new subscription  renew my present subscription

Subscription rates: qualified subscribers in the U.S.: 1 year \$8; two years, \$12; three years, \$16. Non-qualified: 1 year \$25. Subscription rates for foreign countries available on request.

## CHANGE OF ADDRESS

ATTACH  
LABEL  
HERE

If you are moving, please let us know five weeks before changing your address. Place magazine address label here, print your new address below.

name

address

city

state

zip code

# collage 32

## JOIN THE WAR ON CLUTTER

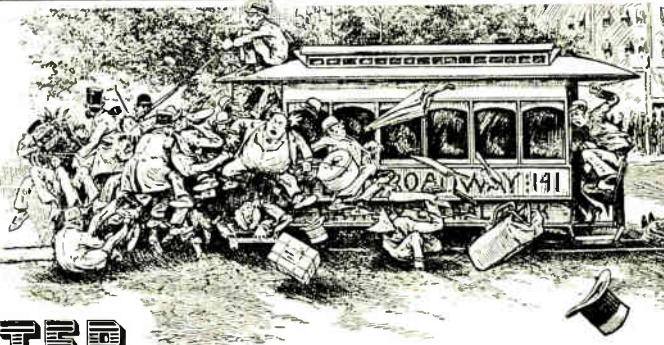

It has been reported that the Maharishi told Mia, "If the clutter power is greater than the power reflected by the target, discrimination is extremely difficult." Actually, one of our engineers said that, but it sounds more like something the swinging Maharishi might have during one of his lucid moments. Rather than ponder the sociological implications of all this, we would like to tell you that we're doing some interesting things in signal processing to suppress clutter on missile guidance

systems, of all things. This should come as good news to those of you concerned with air-to-air, surface-to-air or surface-to-surface missiles. No longer will you have to depend on old-fashioned, not very reliable matched filter techniques when trying to track targets in a clutter environment. In fact, now you missile makers can design types to home in accurately on low altitude or surface targets that are normally impossible to hit because of clutter problems. Isn't that nice? So send a missive of your very own to our Aerospace Center and they'll clutter your desk with literature.

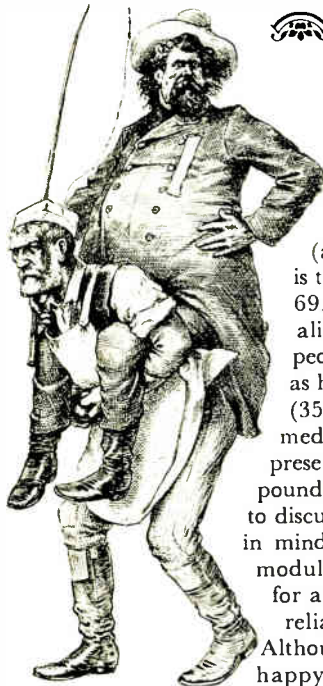

## THAT OVERWEIGHT LIGHTWEIGHT URC

The easiest way to tell Radio Set AN/URC-67 (automatic) from Radio Set AN/URC-69 (manual) is to weigh them. 67 weighs about 30 lbs. more than 69. Other than that both units look pretty much alike and do essentially the same thing. You talk to people in airplanes that are over 230 miles away and as high as 35,000 feet. Both radios are multi-channel (3500) systems, but URC-67 (automatic) offers immediate automatic channel selection to any of 20 preset channels. Why this feature requires all of thirty pounds is something you and our engineers might want to discuss one of these days. But for now, bear constantly in mind that the units are mostly solid state, compact, modular and lightweight (if you'll let us use that term for anything that weighs 300 lbs.). They're also very reliable and we have plenty of TBF's to prove it. Although first applications have been tactical, we'd be happy to sell a few gross to any doves that may read this. Write our Chicago Center for some scintillating spec sheets.

Aerospace Center Dept. 2008  
8201 E. McDowell Rd., Scottsdale  
Arizona 85252, Phone (602) 947-8011

Chicago Center Dept. 985  
1450 N. Cicero Ave., Chicago,  
Illinois 60651, Phone (312) 379-6700



**MOTOROLA**  
Government Electronics Division

## People

When the Fairchild Camera & Instrument Corp. shifted jurisdiction over its microwave group from the Semiconductor division to the Instrumentation division last month, there was much speculation about the group's future. New trends were rumored, and some employees even feared that the unit was destined for the same end as Fairchild's memory products group, which was sold several months ago by the Semiconductor division.

Irwin Solt Jr., manager of the microwave group, is now allaying those fears. "To the best of my knowledge," he points out, "there's nothing very dramatic in the offing."

**New twist.** So far as new directions are concerned, the executive says his group, which has aimed in the past to produce solid state replacements for thermionic devices, will now be extending its efforts into the hybrid microwave field.

"It's fashionable, R&D money is available, and it complements the operations of other Fairchild groups we'll be working with," he explains.

"We are setting up a complete semiconductor processing operation," Solt continues, "and we will be making and developing high-performance r-f transistors. This capability in hybrid work," he adds, "can be useful in the development of new and sophisticated instruments."

Solt indicates that these instruments would use high-speed sampling and logic circuitry, high-frequency amplifiers, and broad-band video amplifiers.

**Expansion.** "Whether we'll get into other things is still undecided," Solt says. "That's up to the future planning sessions." One prediction he will make: "Over the next three to four years, we hope to quadruple our size." The microwave group now employs about 150 people, he noted.

Solt, who has been the manager of the group since its formation in December 1964, previously worked

# TRON RECTIFIER FUSES

*for the  
Protection  
of  
Solid State  
Devices*



TRON fuses are especially designed for the protection of Solid State Devices . . . such as semi-conductor rectifiers, SCR's, thyristors and the like—or wherever a very fast acting fuse is needed.

They provide extremely fast opening on overload and fault currents, with great limitation of the let-thru current.

If each diode is protected by a TRON fuse, the fuse will open very quickly when the current drawn exceeds the rating of the diode.

Thus when a short-circuit occurs in a diode the fuse opens and takes that diode out of the circuit. This protects other good diodes in the rectifier which might otherwise be damaged.

TRON fuses are available in a wide range of physical dimensions and in sizes from ½ to 1000 amperes in voltage ratings up to 600.

For full information and time-current characteristic charts, ask for BUSS Bulletin HLS.

BUSSMANN MFG. DIVISION, McGraw-Edison Co., St. Louis, Mo. 63107

**FOR MODERN ELECTRICAL  
PROTECTION . . . INSIST ON**

SUPPLIED THE ECONOMICAL WAY  
... THRU DISTRIBUTORS  
**BUSS QUALITY**  
FUSES



## "You better believe it's strong!"

... The New 5000 Series from Vent-Rak. Hidden by attractive slim-line styling and modular design is a rugged frame of 12-gauge reinforced steel. The Vent-Rak 5000 Series Electronic Cabinet has exceptionally sturdy all-steel construction, high versatility and an *economical price*.

Components are interchangeable, sides are easily removed, and assembly is simple... accomplished with ordinary hand tools. Separate frames can be bolted together to form bays in unlimited combinations. Add handsome finish, aluminum trim, and choose from a host of accessories... the rugged 5000 Series Cabinet is ideally suited to almost any type of commercial electronic packaging need.

Available through industrial distributors, or write:

**VENT-RAK, INC.**  
**525 South Webster Ave.**  
**Indianapolis, Indiana 46219**



## People

in Fairchild's labs doing basic research on solid state microwave components.

To the men who prepare direct-mail advertisements, the standard envelope is simply bad form. But to the Post Office, the dozens of shapes, sizes, colors, and address formats and placements are a headache.



**Belcher**

Relieving this headache is the job of Harold P. Belcher. The Post Office has just appointed him to be the technical planner responsible for liaison with the computer and communications industries. He'll work directly under Leo S. Packer, the assistant postmaster general who heads the Post Office's Bureau of Research and Engineering.

**Posthaste.** "We have to let industry know what developments the Post Office is making," Belcher says.

He cites as an example the address format of utility bills. Almost all are handled by computers, yet there is little uniformity. The envelopes carry Zip Codes, but an automatic reader can't pick them out because the address is placed incorrectly. "It wouldn't cost the mailers anything to put the address in the right location—if they only knew what our readers could do before they set up their system," says Belcher.

Belcher worked on the first computers at the Pentagon after graduation from Howard University in 1950. He was an assistant commissioner for telecommunications at the General Services Administration before joining the Post Office.

Belcher will also be telling industry of the new hardware needed to keep pace with automated handling. This will extend even to such simple problems as the need for a device to automatically re-ink addressing plates so optical character readers will always get clearly printed addresses.



## Precise!

(resolves envelope delay to 0.1  $\mu$ sec)

Bright digital displays pinpoint relative delay and indicate carrier frequency to the nearest 10 Hz on Sierra's solid-state Model 340B Envelope Delay Test Set. Range of 30 Hz to 110 kHz spans both voice (4 kHz) and group (60-103 kHz) frequencies. A three-position switch sets you up for end-to-end, end-to-end with return reference path, or loop-back operation. Another selects your modulation frequency (25, 83 $\frac{1}{3}$ , and 250 Hz now standard).

Accurate end-to-end delay measurements without a separate reference circuit are assured by the stability of Model 340B's precision internal master clock. To compensate for slight long-term frequency drift, a high-resolution, multiturn potentiometer helps keep the two clock oscillators synchronized.

Each modulation frequency has a single delay range:  $\pm 20,000$   $\mu$ sec at 25 Hz,  $\pm 6000$   $\mu$ sec at 83 $\frac{1}{3}$  Hz,  $\pm 2000$   $\mu$ sec at 250 Hz. The 10V analog outputs for frequency and delay, with internal electronic scan, allow you to record a delay contour in seconds, then tune to any number of discrete points for closer analysis. Optional: A third analog output to record levels of received signals.

Among the numerous other features a Model 340B has to offer: Built-in transformers for balanced or unbalanced 135-, 600-, and 900-ohm, as well as 75-ohm circuits; built-in 1-MHz frequency counter with digital readouts accurate to 1 Hz.

Your signal will produce a product bulletin without delay. Write Sierra/Philco-Ford, 3885 Bohannon Drive, Menlo Park, California 94025. Or call (415) 322-7222, ext. 328.

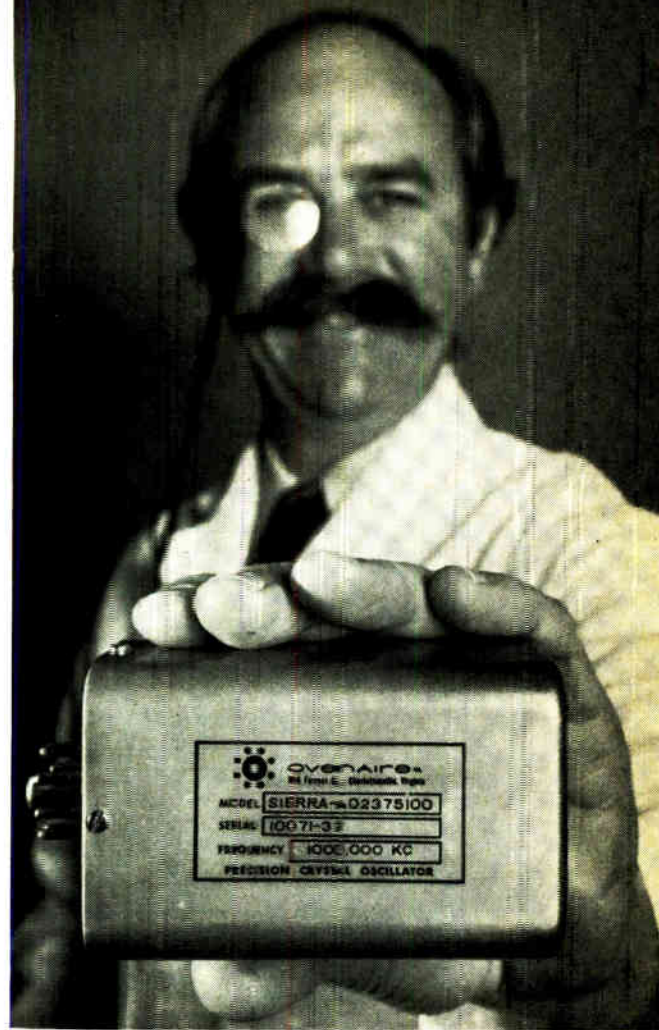

... stability guaranteed  
by this oven-controlled  
master clock oscillator

**PHILCO**

*Ford*

PHILCO-FORD CORPORATION  
Sierra Electronic Operation  
Menlo Park, California • 94025

**Our story starts  
with a very  
superior  
polyester film.**

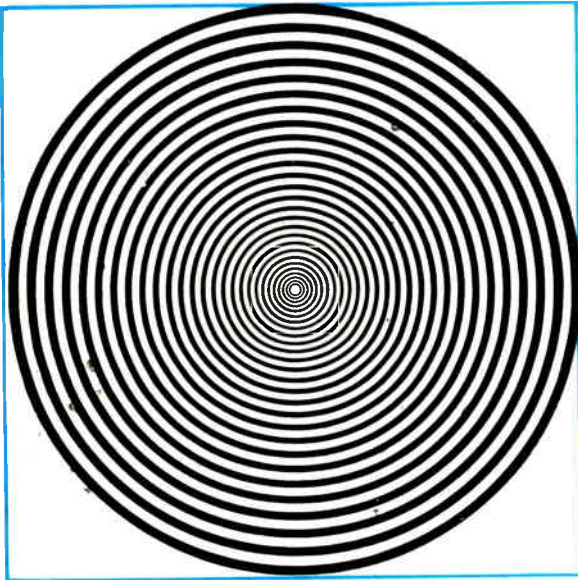

**To which we  
add exceptional  
dimensional  
stability.**

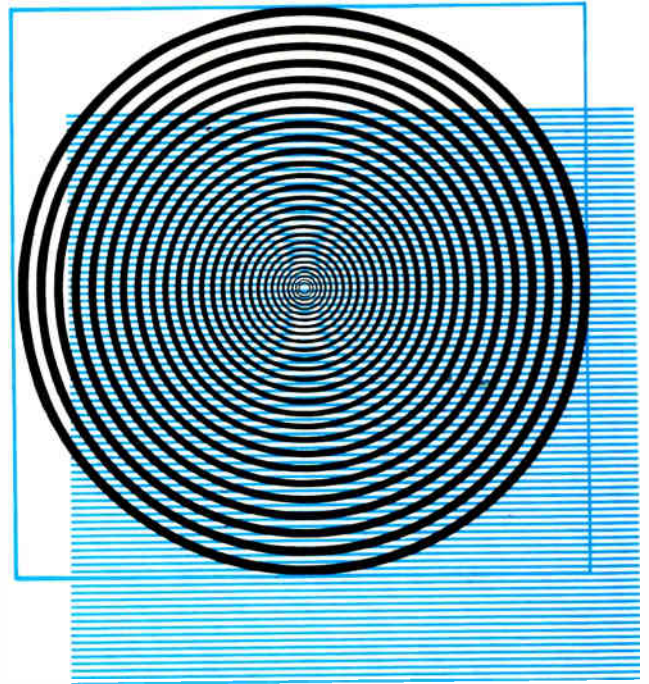

The best dimensional stability of any polyester film. An independent testing lab, DeBell & Richardson, Inc., tested calibrated lengths of Celanar and other polyester films at temperatures from 73F to 120F for over 24 hours. When measured, other films showed up to 77% greater thermal expansion than Celanar film.

# And greater strength.

Celanar is the strongest balanced biaxially oriented plastic film commercially available.

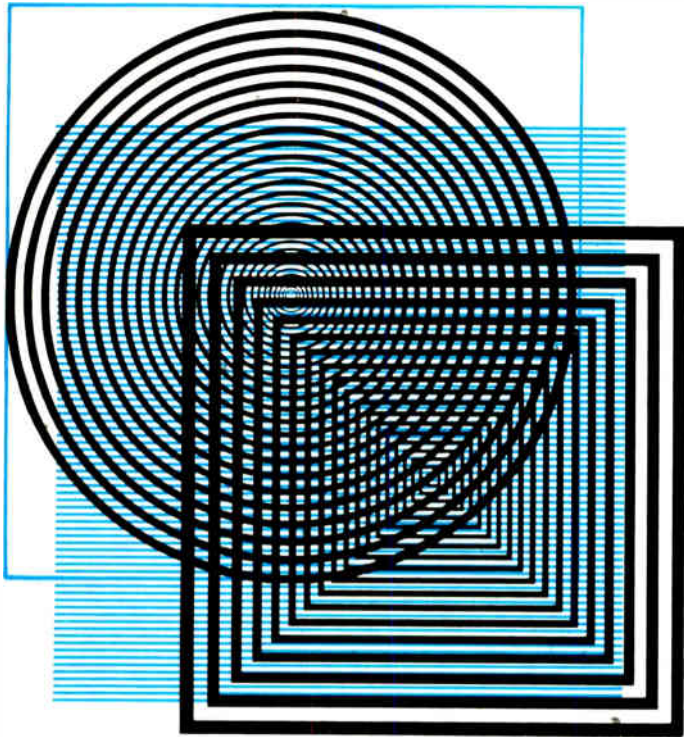

# And insulation resistance.

An outstanding property of Celanar film is its high insulation resistance over a wide range of temperatures. Celanar has superior electrical properties, including excellent dielectric strength, dielectric constant and dissipation factor. Good reasons why Celanar is widely used as an insulating material in electrical insulation applications.

# To bring you Celanar Film with a combination of properties unsurpassed for electrical uses.

Celanar polyester film offers a balance of electrical, mechanical, thermal and chemical properties that make it your best choice for applications from flexible circuits to wire-wrap. Want proof? Just mail the coupon.

Celanese Plastics Company  
Dept. 133-E, P. O. Box 629  
Linden, N.J. 07036

Yes, I want all the facts about Celanar film for electrical applications. And send me a FREE set of gratings printed on Celanar. (Laying one on top of the other produces Moiré patterns that confound the eye.)

Name \_\_\_\_\_ Title \_\_\_\_\_

Company \_\_\_\_\_

Address \_\_\_\_\_

City \_\_\_\_\_ State \_\_\_\_\_ Zip \_\_\_\_\_



**CELANESE**  
PLASTICS COMPANY

Celanese®  
Celanar®

Celanese Plastics Company is a division of Celanese Corporation.

IN JUST

3

DAYS

ACOPIAN WILL SHIP ANY OF 62,000 DIFFERENT POWER SUPPLIES

This catalog lists 62,000 models of AC to DC plug-in power supplies available for shipment in just three days. Choose the exact outputs you need. Singles or duals, regulated or unregulated. Write or phone for your free copy.



Name

Title

Company

City

State

Zip



Acopian Corp., Easton, Penna. 18042  
Phone: (215) 258-5441

## Meetings

### Nothing startling on microwave agenda

If this year's International Microwave Symposium is any indication, nothing very startling is going on in microwave technology. The meeting, in Detroit from May 20 to 22, is one day shorter than last year's and will have one less session. What's more, the number of technical papers has dropped to 49 from 61.

Despite the absence of any breakthroughs, many papers may indicate what's ahead for the microwave engineer.

Three of the six sessions at this year's meeting will be devoted to microwave integrated circuits and other solid state devices.

In an invited paper, M. E. Hines, a vice president of Microwave Associates Inc., will review advances in the use of multiple-avalanche, Gunn, and limited space-charge accumulation diodes for high-power generation.

W. J. Evans and G. I. Haddad of the University of Michigan will then report on a nonlinear analysis of avalanche-diode oscillators. The analysis is designed to determine the efficiency, power output, and tunableness of these devices, as

well as their dependence on external circuitry.

**Making filters.** David K. Adams and Raymond Y. Ho of the Stanford Research Institute will describe the use of grounded collector transistors for making narrow-band microwave filters. By creating negative resistance in the circuit, the authors say they can produce high-frequency resonators with a high-Q component in simple circuit configurations.

In another paper in the same session, Joseph F. White, Kenneth Mortenson, Jose Borrego, and Albert Armstrong of the Rensselaer Polytechnic Institute will discuss the use of bulk-effect semiconductor devices instead of junction diodes for high-power switching and phase shifting.

Static tests have shown that 150-kilowatt r-f pulses can be sustained with a temperature rise of only 50°C. Only 15 kilowatts would destroy a conventional p-i-n diode suitable for switching the 2.6- to 4.0-gigahertz waveguide bandwidth.

For more information write G.I. Haddad, Department of Electrical Engineering, University of Michigan, Ann Arbor.

### Calendar

**Pattern Recognition: the Retina and the Machine;** University of Manitoba, Winnipeg, Canada, May 15-17.

**Meeting of the Society of Automotive Engineers Committee on Electromagnetic Compatibility;** Stardust Hotel, Las Vegas, May 15-17.

**Pulp and Paper Industry Technical Conference,** IEEE; Pfister Hotel, Milwaukee, May 15-17.

**Symposium of the Association for Computing Machinery,** National Bureau of Standards; Gaithersburg, Md. May 16.

**Analysis Instrumentation Symposium,** Instrument Society of America; Marriott Motor Hotel, Philadelphia, May 19-22.

**Pollution Control Symposium,** Analysis Instrumentation Division of the Instrument Society of America;

Marriott Motor Hotel, Philadelphia, May 19-22.

**Radio and Electronics Engineering Convention,** Institution of Radio and Electronics Engineers; Westworth Hotel, Sydney, Australia, May 19-23.

**Region 6 Conference,** IEEE; Sheraton Motor Inn, Portland, Ore., May 20-22.

**International Microwave Symposium,** IEEE; Howard Johnson Motor Lodge, Detroit, May 20-22.

**Cement Industry Technical Conference,** IEEE; Chase Park Plaza Hotel, St. Louis, May 20-24.

**Inter-American Conference on Materials Technology,** Convention Center, San Antonio, Texas, May 20-24.

(Continued on p. 16)



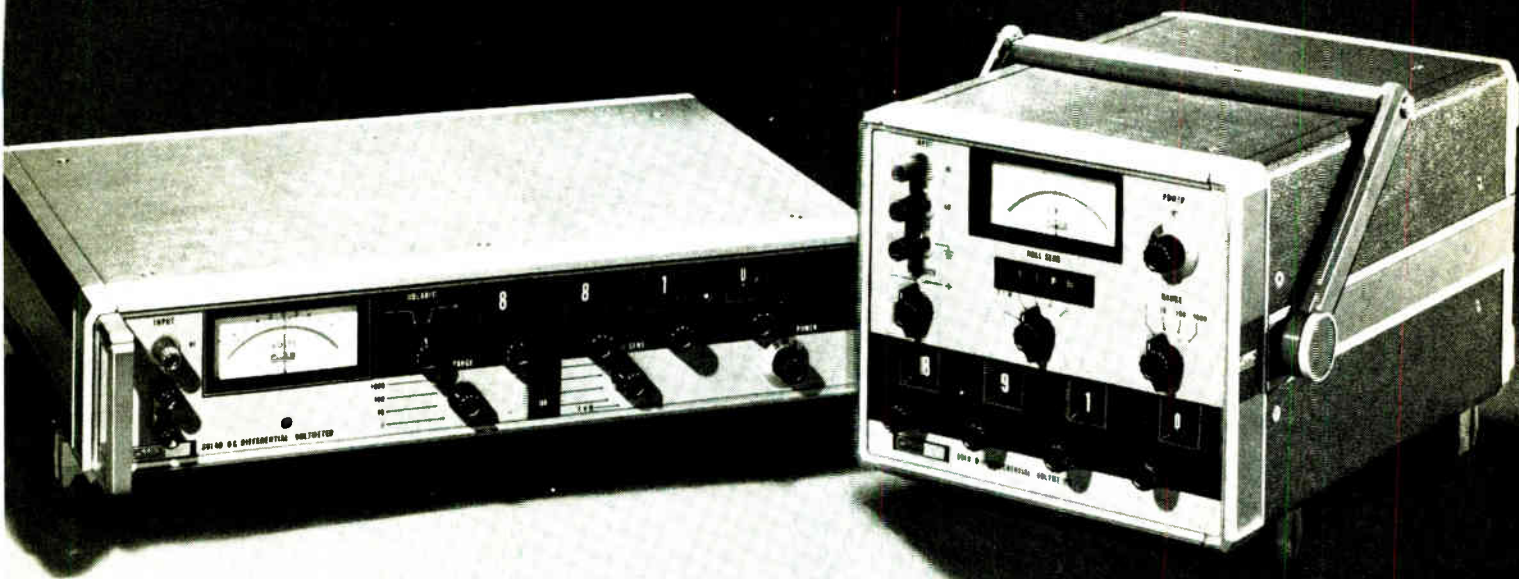

**Now, the low cost differential voltmeter with infinite input resistance at null to 1100 volts, the new Fluke 891A and 891AR. TVM input resistance is 100 megohms. Order in half or full rack models. Add battery operation at any time for \$100.**

The Fluke 891A and AR are the first low cost solid state differential voltmeters with an 1100 volt reference which provides infinite input resistance at null. In the TVM model with 100 megohms input resistance, you can get the advantage of low source loading just as you can with older

Fluke vacuum tube differentials. □ Differential accuracy of the Fluke 891A is  $\pm(0.01\% + 0.001\%$  of range  $+10 \mu\text{V})$ . Ten percent over-ranging is featured. Reference regulation is the best on the market. Reference stability is 15 ppm/hr. Grounded recorder operation can be

added at any time for \$50. Price of either model is \$695. □ For complete details and a demonstration, call your full service Fluke sales engineer (listed in EEM) or write us for full information.

Fluke, Box 7428 Seattle, Washington  
98133. Phone: (206) 774-2211.  
TWX: (910) 449-2850.

In Europe, address Fluke International  
Corporation, P.O. Box 5053,  
Ledeboerstraat 27, Tilburg, Holland.  
Telex: 844-50237. In U. K., address Fluke  
International Corporation, P.O. Box 102,  
Watford, Herts, England.







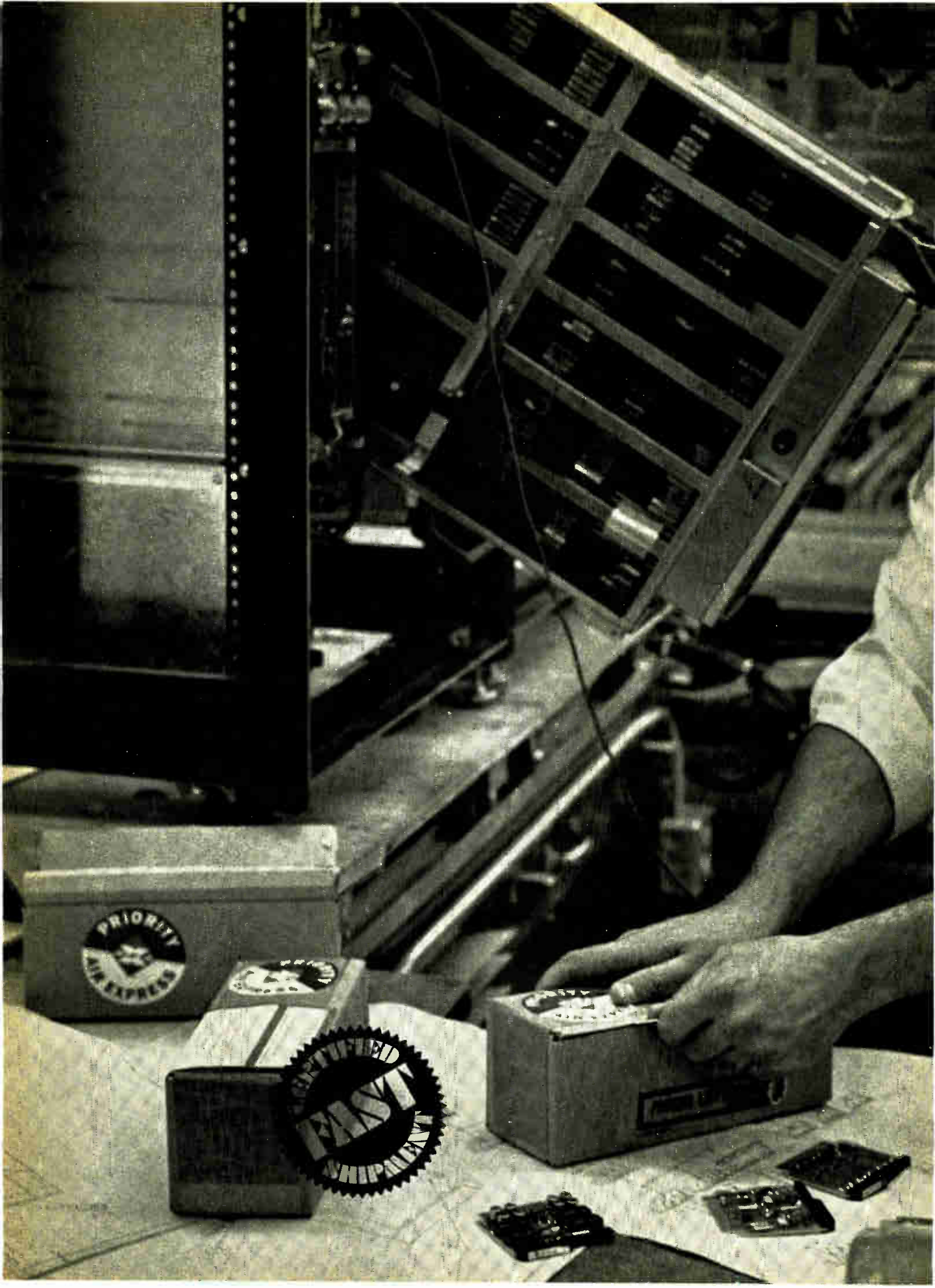



72-hour

## **$\mu$ -PAC logic module delivery . . .**

**Special handling to make sure  
you receive them on time  
-even when you set  
tight schedules.**

We recently reduced  $\mu$ -PAC logic module prices up to 46%. Then we introduced new low-cost 2 MHz modules to let you save another 50% per average system cost.

Now . . . when you say so, we'll give you 72-hour CFS (Certified Fast Shipment). But don't be surprised if we respond to your CFS request in 40/48 hours. Bulk shipments and special logic designs take a little longer . . . but not much. (That's better turn-around time than you'd be able to get even if you owned your own production facility.)

**Breadth of Line** — Only one supplier is necessary when you design with  $\mu$ -PACS — a complete line including interface modules, memory modules, and analog modules as well as the widest, most versatile selection of standard digital logic functions. All necessary mounting hardware, power supplies, and special wiring and design accessories are available at minimum cost. Honeywell maintains a special  $\mu$ -PAC design and fabrication capability to aid the systems designer in solving custom problems.

**Service** — Honeywell maintains world-wide sales and service offices staffed by highly qualified applications engineers to provide technical assistance and design support.  $\mu$ -PACS are fully documented by comprehensive instruction manuals, application notes, wiring and assembly notes, schematic parts lists and logic design aids.

**Experience** — In the past 14 years, Honeywell has delivered over a million digital logic modules. Whether your design requirements involve a one-time logic interface or volume systems assembly, you'll find  $\mu$ -PACS the ideal answer to your hardware problems.

You've been watching us develop the most extensive, economical, highest quality I/C modules. Now, don't you think it's time you called us to talk about your digital logic requirements? Or, write for our new summary brochure. Honeywell, Computer Control Division, Old Connecticut Path, Framingham, Massachusetts 01701.

# Honeywell

 **COMPUTER CONTROL  
DIVISION**

Circle 19 on reader service card

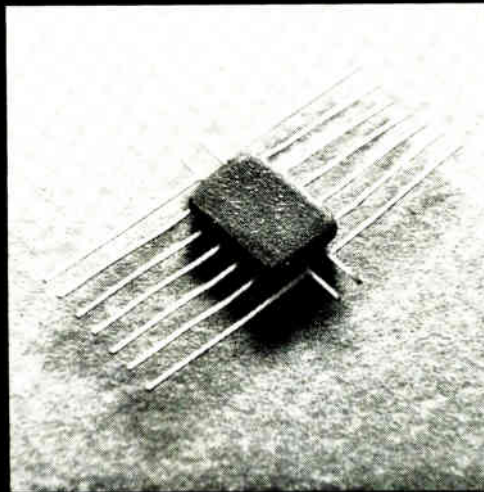

This is our first IC TTL.  
We made it back in '63.  
Since then we've improved it  
361 times. And developed 380  
different types. SUHL<sup>TM</sup>, J-Ks, arrays.  
We're still improving it. And  
every improvement is immediately  
incorporated into our entire line.  
That's what it takes for us to  
stay ahead.  
Which helps you stay ahead.

**SYLVANIA**  
A SUBSIDIARY OF  
GENERAL TELEPHONE & ELECTRONICS

Sylvania Electronic Components, Semiconductor Division, Woburn, Massachusetts 01801

# Which IC Test System does all these things?

**DIAGNOSTIC COMPUTER PROGRAMS** automatically check out system operation.

**FAST TESTING.** 1.5 msec per test. If crosspoint is changed, 5 msec. 10 msec on the lowest current scales.

**DATALOG A FORCING FUNCTION,** such as the input threshold level of a flip-flop needed to produce a specified output.

**AUTOMATIC SELF-CHECKING** assures accurate data transfer between operator, teletypewriter, computer and test instrument.

**GROWING LIBRARY** of improved software packages to insure against obsolescence.

**TEN-YEAR GUARANTEE** for all instrument plug-in circuitry (it's almost all plug-in).

**TYPED SUMMARY SHEETS.** Whenever desired. No interruption in testing. Give total units tested per test station, test yields and bin yields.

**VERY COMPLEX TEST SEQUENCES** can be programmed, yet preparation of simple tests can be learned in two hours.

**NO ADJUSTMENT OR CALIBRATION POINTS.** (Eternal vigilance is the price you pay for a single adjustment.)

**DIRECT ENGLISH data logging** type-out, showing job name, serial number, test number, decimal point and units.

**OPEN AND SHORTED CONNECTIONS** and **OSCILLATIONS** are automatically detected. System stops when a selected consecutive number of these occur.

**ABSOLUTE SOURCE CONTROL.** Sources can be turned **ON** or **OFF** and changed in value in any sequence with variable delays from 100  $\mu$ sec. to as long as you please.

**COMPLETE FRONT PANEL DISPLAY** at any desired step, simultaneously indicating all crosspoint connections, forced values, measured limits, binning decisions—everything about each test.

**DATALOG** at any test station—without slowing down classification tests at any other station.

**MINIMIZED REPETITIVE INSTRUCTIONS** for the operator through data libraries, variable word length programming, and autotyping.

**MULTIPLEXING.** Several jobs simultaneously. Any assigned, at any time, to any test station.

**PROGRAMMABLE CURRENT LIMITS** for each source at each test.

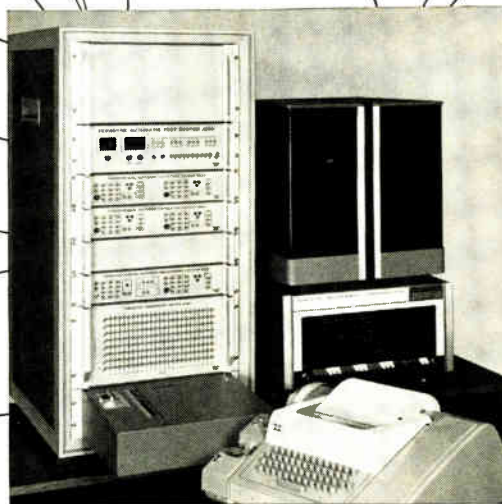

# This one.

(complete for only \$65,000)

This is our J259 computer-operated Automatic Circuit Test System. It includes a general-purpose digital computer, teletypewriter, test instrument (comprising modular elements: 24 x 8 crosspoint matrix, four volt-

age sources, measurement system, and test deck), complete software package, and courses in IC testing, system operation, and maintenance. TERADYNE, 183 Essex St., Boston, Mass. 02111 Phone (617) 426-6560.

**TERADYNE**



---

Editorial comment

---

## Japan chooses its IC road

Japanese manufacturers of integrated circuits may reach an important psychological benchmark this year. In 1968, if the present trend continues, for the first time the Japanese will make more IC's than they import. Their own IC production is now about 1.3 million per month—roughly, 4 million IC's for the first three months of 1968. During the same period, about 2.5 million IC's were imported. [For more on Japanese IC's, see p. 98.]

For the past several years Japan has done its homework well, paying careful heed to IC technology in the United States. Thus prepared, Japan plans to forge ahead in specialized areas avoiding many of the pitfalls encountered months and even years ago by inexperienced American firms.

Generally, the Japanese plan to concentrate on IC development where the country's needs are greatest—in circuits for consumer equipment and calculators, for example. Japan recognizes that its most judicious course is in converting custom circuits to "standards" to get volume up and costs down.

Wisely, Japan will use U.S. IC's, or adaptations of them, in certain applications—like digital computers—for which such circuits are already eminently suited. This won't prevent Japanese engineers from developing their own digital circuits to meet special requirements or from further refining imported circuits.

Before a new design is launched, the Japanese carefully study its end application. For example, the Nippon Telephone & Telegraph Public Corp. wanted circuits that would operate for 40 years in a random, uncontrolled environment. It opted for a form of diode-transistor logic, reasoning that DTL ought to be more reliable than transistor-transistor logic under hostile conditions. The telephone engineers think that over a long period of time, high temperatures and deterioration of passivation can raise havoc with TTL, a consideration not likely to carry much weight in a normal computer environment.

With this careful assessment of alternatives in advance, the Japanese do not plunge prematurely into a program. Since the calculator market could be a big one for Japan, its semiconductor experts are carefully examining the pros and cons of both bipolar and MOS circuits. Though the issue seemed pretty much settled in favor of MOS, executives of one Japanese company were willing to continue listening to both sides of the argument during a recent tour of the United States.

Along with their cautious approach to decision making, Japanese companies are pressing hard for new technology. Hayakawa, in particular, has a reputation for aggressiveness and is encouraging its suppliers to develop new components.

Although Japanese engineers have access to much IC information from the U.S. and should not make the mistakes of U.S. semiconductor makers, the young industry faces difficult times. Not all Japanese customers are satisfied with the quality and reliability of MOS IC's, for example. And there are unique problems. Japanese tradition inhibits the cross-fertilization of ideas among companies through the large-scale movement of talent from one to another; when an engineer joins a company it may well be for life. Furthermore, the complex system of bonuses leads to inequities; occasionally an IC manager may tire of working harder for less money than his counterpart in a more profitable division, and ask for a transfer.

Japan has lost its former built-in advantage over the U.S. in labor costs; they have been steadily rising to close the once-large gap. The cost of raw materials and machinery is rising too. Any advantage that still remains is usually offset by the royalties that Japan must pay to U.S. companies under licensing agreements. Nevertheless, with Japan relying on brains and hard work to move its IC technology forward, U.S. manufacturers can anticipate keen competition in the months ahead.

# To 150°C

## CDE's Extended Temperature Range Aluminum Electrolytic Capacitors with Optimum Reliability and Low Cost.

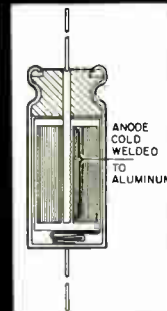

Featuring the exclusive CDE continuous cold weld connection of section to rod...insuring superior mechanical and electrical reliability. With far superior ESR to Temperature characteristics.

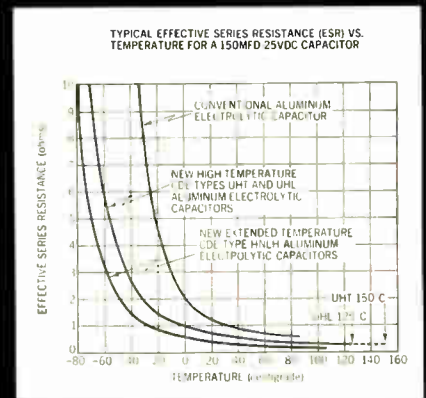

And with high ripple current capability, low DC leakage, Capacitance and DF stability. Low impedance, rugged design for vibration and shock endurance.

## These units are now available for your design considerations.

- |             |   |                                  |
|-------------|---|----------------------------------|
| <b>UHT</b>  | Miniature Axial Lead Case Sizes: $\frac{3}{8} \times \frac{15}{16}$ to $\frac{3}{8} \times 2\frac{1}{16}$ ". Ratings: 3 mfd to 100 mfd, from 3 VDC to 100 VDC.  | <b>-55 to + 150° C OPERATION</b> |
| <b>UHL</b>  | Miniature Axial Lead Case Sizes: $\frac{9}{32} \times \frac{15}{16}$ to $\frac{3}{8} \times 2\frac{1}{16}$ ". Ratings: 3.3 mfd to 1000 mfd, from 5 VDC to 200 VDC, designed to meet and exceed Mil C-39018/1. (Already stock standards on our Distributor's shelves.) | <b>-55 to + 125° C OPERATION</b> |
| <b>UHR</b>  | Large Axial Lead Case Sizes: $\frac{5}{8} \times 1\frac{1}{8}$ to $1" \times 3\frac{3}{8}$ ". Ratings: 10 mfd to 12,000 mfd, from 5 VDC to 200 VDC, designed to meet and exceed MIL C-39018/3.) (Also available in -55 to +85° C specifications.)                     | <b>-55 to + 105° C OPERATION</b> |
| <b>HNLH</b> | Miniature Axial Lead Case Sizes: $\frac{1}{4} \times \frac{5}{8}$ to $\frac{3}{8} \times 1\frac{1}{2}$ ". Ratings: 1 mfd to 600 mfd, from 3 VDC to 150 VDC. (Already stock standards on our Distributor's shelves.)   | <b>-80 to + 110° C OPERATION</b> |
| <b>UFH</b>  | Computer Grade Case Sizes: $1\frac{3}{8} \times 2\frac{1}{2}$ to $3" \times 8\frac{5}{8}$ ". Ratings: 5500 mfd to 300,000 mfd at 5 VDC 240 mfd to 9000 mfd at 150 VDC.  | <b>-55 to + 105° C OPERATION</b> |

For your design considerations, ask for details from your local CDE Sales Engineering Office. Or write:

**CDE** **CORNELL-DUBILIER**

50 Paris Street, Newark, N.J.

---

# Electronics Newsletter

---

May 13, 1968

## Boeing considering multiplexer for SST

Early next month, Boeing is expected to select a contractor to develop a multiplexing system that would greatly reduce the supersonic transport's cabling requirements. In the running are Autonetics, General Electric, Garrett, and Norden.

If the system is approved, the SST would become the first commercial aircraft to have a multiplexer. The Concorde, the joint British-French supersonic entry, has more than 150 miles of cable. The SST's multiplexer would be required to handle about 2,400 signal channels. Boeing, which has been having serious weight problems with the SST, no doubt is looking for the multiplexing system to trim excess pounds.

Autonetics is proposing a 256-kilobit-per-second system, including four multiplexers to handle the 2,400 channels. It would make widespread use of complex MOS arrays.

Boeing has also gone ahead with two companies—GE and Sperry—on the SST flight-control system, dropping Bendix.

## Talking together by the numbers

Philco-Ford engineers have come up with what they say is the first fully duplexed digital-voice conferencing system. It permits any number of callers in a conference hookup to speak simultaneously and hear the same output; previous systems operated on a push-to-talk basis because of difficulties in combining channel vocoders.

Philco's system, called digital-conferencing equipment and developed in-house, has been tested successfully over long distances. Operating on the standard telephone bandwidth of 3 kilohertz, it can be used with microwave, cable, or standard telephone lines.

## Computer makers say LSI research going off target

To hear most computer makers tell it, large-scale integration may be the key to the fourth generation of computers. However, there seems to be a growing feeling that the semiconductor firms are misdirecting their R&D efforts.

At the Spring Joint Computer Conference this month, Linder C. Hobbs, of Hobbs Associates, Corona Del Mar, Calif., indicated that semiconductor makers should be looking at the peripheral gear instead of putting all their R&D emphasis on the central processor. "Even if we gave the central processor away free, it would mean only marginal savings in terms of total systems cost," he said. Hobbs feels that the biggest savings from LSI may well be in memories.

And Webb Comfort, manager of IBM's advanced system organization group, says that LSI won't simplify the computer system. "It takes the complexity away from the programmer and gives it to the engineer."

One likely result of LSI will be acceleration of the trend toward the special-purpose computer, or at least a more specialized version of the general-purpose computer using removable read-only memories.

## Shake-up at Fairchild

Richard Hodgson exercised vigorous control as chief executive officer of Fairchild Camera & Instrument. And he took over the post only last November. So it came as a considerable surprise—both inside and outside the company—when he was suddenly relieved of that control and

# Electronics Newsletter

elevated to vice chairman of the board. Hodgson had dealt off the money-losing DuMont and Davidson divisions, as well as the memory products department of the Semiconductor division. He had also written off tremendous amounts of inventory and obsolete equipment, resulting in a 1967 loss of \$7,698,736, or \$1.80 per share.

But the worst seemed to be over, and Fairchild even showed a per-share profit at 33 cents in the first quarter of 1968. Then, suddenly, Hodgson was out and a four-man directorate was in. Of the four, only group vice president Robert N. Noyce had been active in day-to-day operations.

Fairchild's internal announcement said Hodgson, 51, was making way for a "young management team," but only Noyce, 40, seems to qualify on that score. Insiders figure that he is even now being given a trial run as boss, under the watchful eye of the financial experts. Noyce, who headed the group that founded what is now the Semiconductor division, is keeping his headquarters in Mountain View, Calif.—across the country from the corporate headquarters in Syosset, N.Y.

## Motorola applies 'spider bonding' on IC leads

"Spider bonding" of aluminum leads to IC chips is in pilot production at Motorola Semiconductor and should be in full production before 1969.

When fully implemented, the lead pattern will be stamped out of a continuous ribbon of aluminum, and dice will be automatically fed and aligned with the leads; then the leads will be bonded simultaneously, yielding a device that resembles a 14-leg spider.

The leads will be automatically trimmed and the chip will be fed to an ultrasonic bonding or welding station for attachment to the header strip for plastic dual-in-line packages, which will be the first candidates for spider bonding.

## NASA budget cuts: 4,000 jobs at stake

Congressional cuts in NASA's fiscal 1969 budget could eliminate as many as 4,000 jobs at the space agency. This is the price NASA officials say they will have to pay for a \$4 billion budget. Thus far, \$339 million—\$187 million for Apollo applications and \$152 million for administrative operations—has been trimmed from the agency's \$4.37 billion request.

Although new programs, such as the Mariner satellite scheduled for Mars missions in 1971 and 1973, have escaped budget paring, they will feel the manpower squeeze brought on by the administrative trims. Says one high-ranking NASA official: "We still have the programs, but how are we going to keep them going if we let the people who run them go?"

## Addenda

Lockheed Electronics will introduce a computer at the Fall Joint Computer Conference that will be comparable to Digital Equipment Corp.'s PDP-8, which sells for \$18,000 and up, has a memory of 4,000 to 32,000 words of 12 bits each, and a cycle time of 1.5 microseconds. . . . General Radio is about to launch a thin-film and semiconductor operation at its new Bolton, Mass., plant. The company plans to build custom transistors and diodes for its instrument lines and to back up vendors with an in-house second source. . . . Texas Instruments is adding three large-scale integrated circuits to its catalog line early this summer. The circuits, metal oxide semiconductor devices, include a dual 50-bit shift register, a dual 100-bit shift register, and a 256-bit combination read-write memory. Computer-aided design techniques were used for parts of the array.



## CINCH UNIQUE BACK PLANE DESIGN PERMITS UNEQUALLED SYSTEMS FLEXIBILITY

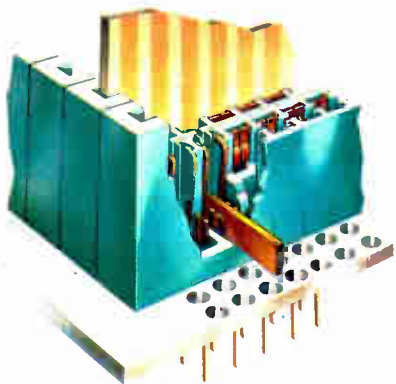

Using the basic connector-plane concept, Cinch engineers have developed an unusual device for data processing equipment and other high density automatic wiring applications. This new system substantially reduces the high labor content of conventional back plane interconnection systems and, at the same time, provides increased design flexibility and precise location of the terminal tips.

- The plane can be bussed from the PC board side or the terminal side.
- Individual contacts, including bussing contacts, can be easily replaced.
- Common voltage input can be provided to any position on the plane.
- Cinch designed automatic assembly equipment inserts an entire row of contacts in a single operation. ■ Contact tail positions on a .125" grid are held to a  $\pm .010$ " radius tolerance when checked on an X-Y coordinate machine, as shown in the illustration.

**HOW IS IT DONE?** A new brochure describing this Cinch interconnection system and the Cinch capabilities available to you is available by writing to Cinch Manufacturing Company, 1501 Morse Avenue, Elk Grove Village, Illinois 60007. C-6812



MEMBER  
CONSISTING OF CINCH MANUFACTURING COMPANY, CINCH-GRAFIK, CINCH-MONADNOCK, CINCH NULINE, UCINITE (ELECTRONICS) AND PLAXIAL CABLE DEPT

# Allen-Bradley hot-molded trimmers

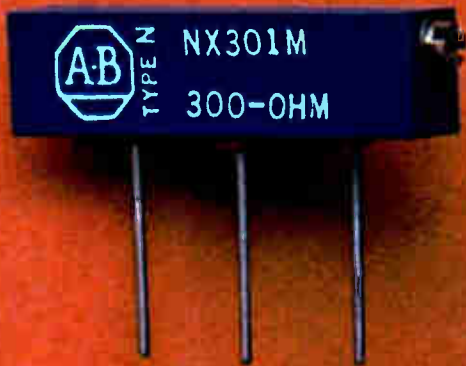

TYPE N



TYPE RH



TYPE RP



TYPE RC



TYPE RS



TYPE RK

TYPE YH



TYPE YS



TYPE YR



TYPE YC



TYPE YN



## best in "set" ability...best in "hold" ability

This family of Allen-Bradley trimmers features a solid resistance track made by A-B's exclusive hot-molding technique. This solid resistance element assures smooth adjustment at all times. It approaches infinite resolution—there are never any of the abrupt changes in resistance which introduce transients as is characteristic of wirewound controls.

When Allen-Bradley hot-molded trimmers are once set, they will remain stable during severe

mechanical shock and vibration. In addition, A-B trimmers have low distributed capacitance and are essentially noninductive, permitting their use at high frequencies where wirewound units are totally useless.

For complete specifications on these high performance trimmers, please write: Allen-Bradley Co., 110 W. Greenfield Ave., Milwaukee, Wis. 53204. In Canada: Allen-Bradley Canada Ltd. Export Office: 630 Third Ave., N.Y., N.Y., U.S.A. 10017.

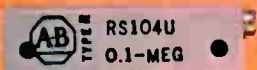

**Type R** trimmers are ruggedly built to maintain their settings under severe shock and vibration. Continuous resistance change is provided over 25 turns of the adjustment screw. Enclosures are dust-tight and watertight. Long operational life—accelerated tests produce less than 5% resistance change after 500 complete cycles (25,000 turns of the actuator). Rated ¼ watt at 70°C, and can be applied in temperatures from -55°C to +125°C. Available in resistance values from 100 ohms to 2.5 megohms. Write for Technical Bulletin B5205.

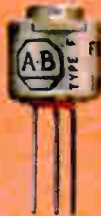

**Type F** trimmers are single turn controls built to withstand severe environmental conditions. They are ½" in diameter and are rated ¼ watt at 70°C. Can be used from -55°C to +120°C. Enclosure is nonmagnetic, corrosion-resistant, and watertight. Available in resistance values from 100 ohms to 5.0 megohms. Various tapers can be furnished. Send for Technical Bulletin B5201.



**Type N** trimmers are similar to the Type R units, and provide substantial economies where environmental conditions are not excessively severe. The 25-turn adjustment screw permits precise settings. The operational life is the same as the Type R. The enclosure is dust-tight and immersion-proof. The rating is ½ watt at 50°C and can operate in ambient temperatures from -55°C to +100°C. Available in resistance values from 100 ohms to 2.5 megohms. Please write for Technical Bulletin B5206.

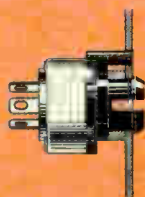

**Type Y** trimmers are economical single-turn units designed for use where environmental conditions are not particularly severe. The low profile construction allows them to fit easily within the commonly used ⅜" stacking. Options for the Type Y include thumb wheel and mount for horizontal installation. Type Y is also made with snap-in mount for panel mounting, as shown in drawing. Rated ¼ watt at 70°C. Resistances from 100 ohms to 5.0 megohms. Please write for technical literature.



**ALLEN-BRADLEY**  
QUALITY ELECTRONIC COMPONENTS

# Capacitor problems?

## General Electric has 1844 application-designed solutions

General Electric's application-designed capacitors are made to solve your problems. Whether you need aluminum, tantalum, or film units, GE has the right answer.

**Circuit design problems?** Many General Electric capacitors are designed by computer to optimize their electrical and mechanical characteristics. You get the highest capacitance in the least volume with electrical properties consistent to your own circuit designs. For example, if you know your installed capacitance requirements in a new power supply, our computers can quickly tell you the best capacitor combination and its electrical characteristics in your circuit.

**Product application problems?** General Electric has experienced capacitor application en-

gineers in Electronic Components Sales Offices throughout the country. These technical specialists are ready to help you select the capacitors you need and to provide specialized information about them.

**Ordering or delivery problems?** Your local Electronic Components Sales Office will be glad to furnish you price and delivery data for General Electric capacitors. We also have stocking distributors who can meet many of your immediate requirements for limited quantities of standard units.

You supply the capacitor problems. General Electric can supply 1844 application-designed solutions. Contact your local sales office, franchised distributor or Capacitor Department, Irmo, South Carolina 29063.

430-32

GENERAL  ELECTRIC

NEW IDEAS IN  
ELECTRONICS



**Aluminum High-performance Computer-grade Capacitors**  
236 standard ratings. 5 to 450 volts,  
75 to 480,000  $\mu\text{f}$ , -40  
to 85C ambient temperature



**Aluminum Miniature Tubular Capacitors**  
151 standard ratings. 3 to 150 volts, 1 to  
790  $\mu\text{f}$ , -40 to 85C ambient temperature



**Aluminum Industrial Tubular Capacitors**  
102 standard ratings. 3 to 450 volts, 2 to  
3500  $\mu\text{f}$ , -20 to 85C ambient temperature



**Tantalum Sub-miniature Wet-slug Capacitors**  
59 standard ratings. 6 to 60 volts,  
0.01 to 450  $\mu\text{f}$ , -40 to 85C ambient temperature





**Metallized Film Flattened Oval Capacitors**  
102 standard ratings, 100 and 200 volts  
d-c, 0.01 to 10.0  $\mu$ f, -55 to 85C



**Metallized Polycarbonate Tubular Capacitors**  
57 standard ratings, 200 volts d-c, 0.010  
to 10.0  $\mu$ f, -55 to 125C



**Micro-flat Polyester Capacitors**  
78 standard ratings, 50 volts  
d-c, 0.0010 to 1.50  $\mu$ f, -55 to 85C

**Polyester Tubular Capacitors (left)**

296 standard ratings, 100  
and 200 volts d-c, 0.0010  
to 2.00  $\mu$ f, -55 to 85C

**Black Hawk Capacitors**  
453 standard ratings, 50  
to 500 volts, 0.0010 to  
1.00  $\mu$ f, at 85C



**Polycarbonate Tubular Capacitors (left)**

44 standard ratings, 100  
and 200 volts d-c, 0.001 to  
1.0  $\mu$ f, -55 to 85C

**Black Lay Capacitors**

50 standard ratings, 100 and  
200 volts d-c, 0.001 to 1.0  $\mu$ f, -55 to 85C



**Aluminum Can-style Capacitors**  
43 case size and minimal com-  
pound voltages—thousands of ratings,  
5 to 450 volts, 5 to 500  $\mu$ f, 1, 2,  
3 or 4 sections



**Aluminum A-c Motor Start Capacitors**  
123 standard ratings, 110 to  
330 volts a-c, 21 to 850  $\mu$ f,  
-20 to 55C amb ent temperature

# NOW

# Measure Noise & Intermodulation of Multi-Channel Communication Systems . . .

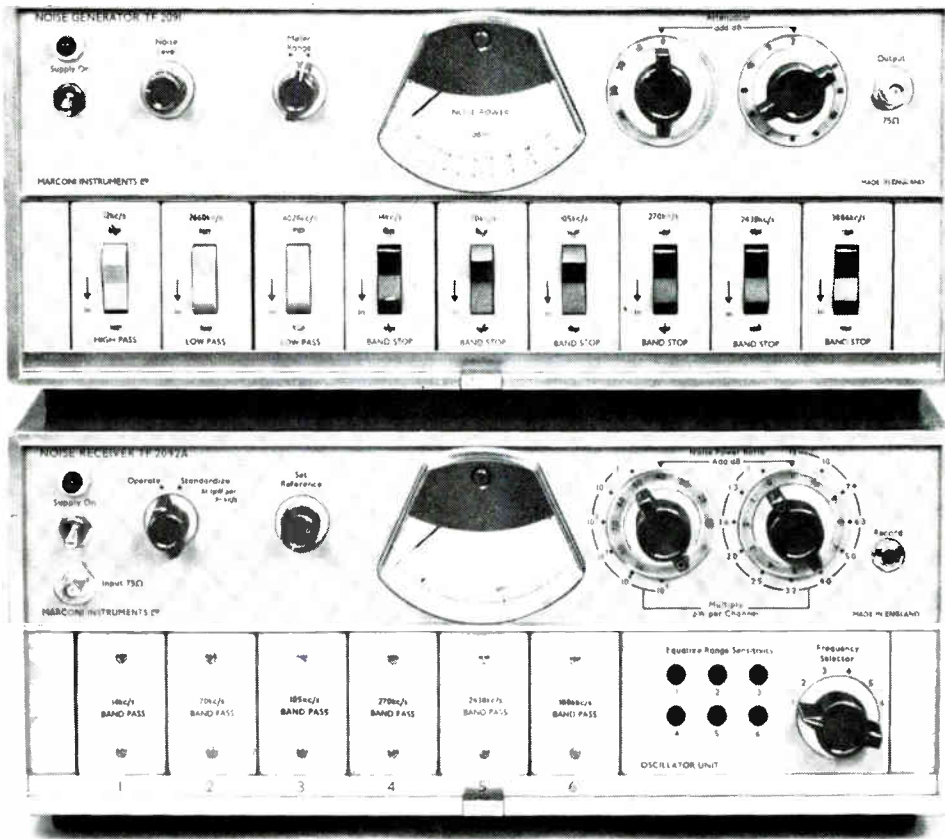

## with the NEW Solid State NOISE LOADING TEST SET Model 2090A by MARCONI INSTRUMENTS

- Checks noise power ratio of microwave relay links, tropospheric scatter systems, multi-channel cable links, video tape systems, system components, etc.
- Generates noise flat to 0.5 db from 12 KHz — 12.388 MHz
- Measures noise power ratio directly in picowatts
- Standardizing noise generator built into receiver
- Band limiting and slot filters to 2700 channels for all CCIR, CCITT and DCA recommendations and out-of-band testing
- All solid state
- Weighs 25 lbs. per unit excluding filters

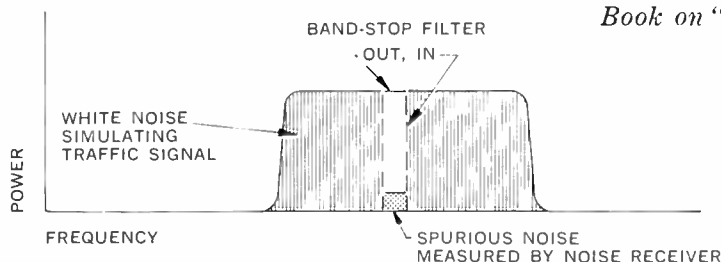

Book on "White Noise Testing Of Multi-Channel Systems" Available Upon Request

702

**mi MARCONI INSTRUMENTS**

Division of English Electric Corporation  
111 CEDAR LANE • ENGLEWOOD • NEW JERSEY 07631  
TELEPHONE: 201-S67-0607



# Vote ITT for the largest, longest, promptest Teflon\* insulated cable from Maine to California.

When you vote ITT, you're backing a machine that turns out Teflon insulated cable instead of political prose. Our new TFE extruder, largest in operation, makes longer lengths and larger gauges—up to 4/0—than any other. Of uniform quality, too. Lengths and sizes of TFE insulated cable that no one else can give you. In fact, the lengths are governed only by reel sizes.

ITT went to great lengths to get this machine. We think it's worth it because it helps us to provide uniform wire and cable in lengths and sizes that reduce your installation costs. Cast your vote where it counts.

Let us help solve your TFE insulated cable problems. ITT Wire and Cable Division, International Telephone and Telegraph Corporation, Clinton, Mass., 01510. In Europe: ITT Wire and Cable Division, Lister Road, Basingstoke, Hants, England.

\*Dupont Trademark

WIRE AND CABLE **ITT**

# What's happening today in keyboards is what's happening at MICRO SWITCH



Typical Communications Keyboard  
Shown Below: Typical Data Preparation Keyboard

An important key to future keyboard design is what's happening at MICRO SWITCH.

Already we have successfully launched Happening No. 1: Introduction of complete wired and encoded keyboards ready to interface with your equipment.

Shown here are two typical keyboards. Each gives you dry reed switch input, solid-state-encoding, and a variety of exclusive options.

And they provide a flexibility that is unavailable elsewhere. You get a customized keyboard. Key array, format, added options, code change—you select the features required for your system.

Options include strobe and electrical monitor outputs, bounce gates and shift. For example, two interlock options are provided to improve operator speed and efficiency. An electrical monitor output triggers a detector circuit for blocking data or initiating error signals. A unique two-key rollover option permits typing at "burst" speeds without generating erroneous codes.



But that's not all. Coming very soon is Happening No. 2. Through advanced design concepts, complete engineering facilities, innovative assembly techniques, and unique quality assurance procedures, MICRO SWITCH is preparing to supply your every keyboard need. This means new reliability and flexibility in mass-production quantities with attractive customized appearance giving new sales appeal to your equipment.

Make no decisions on keyboards until you see what's happening at MICRO SWITCH. Call a branch office or call us at Freeport: phone 815/232-1122.

## MICRO SWITCH

FREEPORT, ILLINOIS 61032

A DIVISION OF HONEYWELL

HONEYWELL INTERNATIONAL • Sales and service offices in all principal cities of the world. Manufacturing in United States, United Kingdom, Canada, Netherlands, Germany, France, Japan.

# IF YOU GET CONSTANT VOLTAGE WHEN YOU VARY CURRENT IN ANY OF OUR ZENER DIODES, WHAT DO YOU GET WHEN YOU VARY TEMPERATURE?

## MOTOROLA TEMPERATURE-COMPENSATED ZENER REFERENCE DIODES

Series	Voltage Change Over Temp. Range $\Delta V_z$ (Max)
1N821-29A <sup>•†</sup>	0.096 to 0.005
1N4565-84A	0.099 to 0.002
1N3154-57A <sup>•†</sup>	0.172 to 0.013
1N4775-84A	0.132 to 0.003
1N935-939B <sup>•</sup>	0.184 to 0.003
1N4765-74A	0.141 to 0.003
1N941-45B <sup>•</sup>	0.239 to 0.004
1N2620-24B	0.191 to 0.003
1N2163-71A	0.115 to 0.004
1N4896-15A	0.198 to 0.010
1N4916-32A	0.298 to 0.014
1N3580-83B	0.239 to 0.009
1N429 <sup>**</sup>	0.050
1N1735-42A <sup>**</sup>	0.400 to 0.050
1N1530-30A <sup>**</sup>	0.014 to 0.007
1N2767-70A	0.316 to 0.079
1N4057-85A	1.550 to 0.038

<sup>•</sup>Available to MIL-S-19500 and Meg-A-Life II  
<sup>\*\*</sup>Available to MIL-S-19500

<sup>†</sup>Precision reference availability

## ONE OF THESE.

It takes a particular kind of Zener Diode — namely a temperature-compensated device — to lock in voltage stability and equilibrium under any fluctuating temperature conditions you might encounter. The Motorola oxide-passivated, 1N945B reference diode, for example . . . allowing reference voltage change of less than 12 millivolts from  $-55^{\circ}$  to  $150^{\circ}\text{C}$  and featuring RamRod\* construction for lower operating junction temperatures and safe, sure, lead-to-die contact.

It and a complete line of TC voltage reference devices for 6.2 to 200 V applications are available from your franchised Motorola distributor — including top-of-the-line Precision Reference units capable of voltage deviation of less than 5 ppm/1,000 hours!

We've prepared a special TC reference diode application package including a brochure and five new Designers Data Sheets\* which discuss important considerations like the three most critical device selection parameters, results obtained when altering test currents, and special applications. It permits design of most circuits entirely from the data presented. Send for it — it's as complete and accurate as we could make it.

So you'll get the right idea about the kind of devices we furnish.

\*Trademark Motorola Inc.

*-where the priceless ingredient is care!*



**MOTOROLA**  
**Semiconductor Products Inc.**

P. O. BOX 955, PHOENIX, ARIZONA 85001

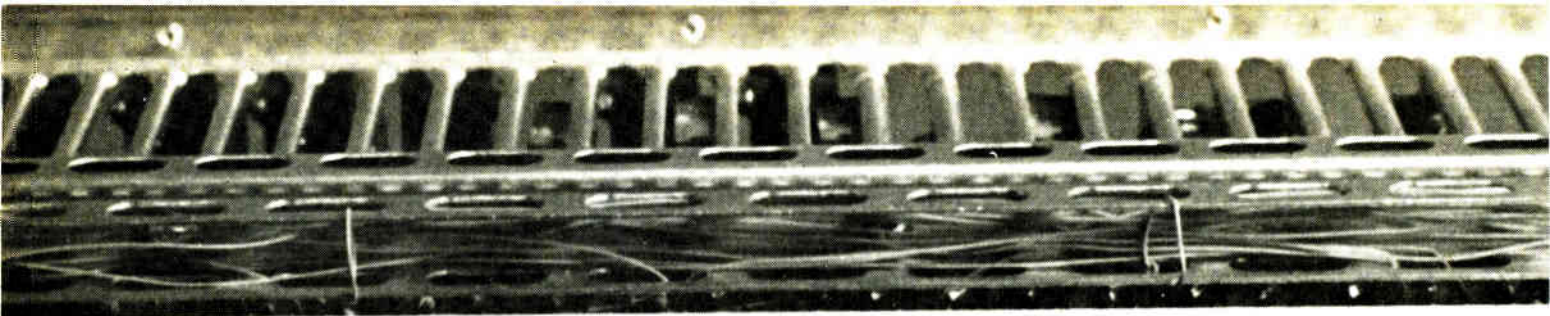

DIGITAL OUTPUT \_\_\_\_\_

2<sup>-5</sup> 2<sup>-6</sup> 2<sup>-7</sup> 2<sup>-8</sup> 2<sup>-9</sup> 2<sup>-10</sup> 2<sup>-11</sup> 2<sup>-12</sup> 2<sup>-13</sup> 2<sup>-14</sup>

MULTIPLEXER A

32 16 8 4

INVERT

CLEAR

STEP

AUTO

M

MD51 MU

# It's the fastest. It's the most accurate.

The MD51 is a high-level 64 channel multiplexer, a sample and hold amplifier and a 15-bit A to D converter, all in a single chassis. It has a total sample and conversion time of 10 microsec-

onds max. and an accuracy of 0.01%. And it sells for under \$10,000. If that doesn't say it all, write for the rest.

Circle 36 on reader service card

**SDS**  
Scientific Data Systems,  
Santa Monica, California

## Computers

### Picture that

Now that computerized character generation and typesetting is a reality, the next logical step is to produce line drawings and photographs at the same time. Working toward this goal, Xerox Corp. researchers have developed an experimental graphical data processor that generates alphanumerics, vectors, and dots for half-tone photos.

Edwin J. Smura, a Xerox researcher, described such a system at the Spring Joint Computer Conference in Atlantic City, N.J., this month. The system was put together with standard data processing equipment, including the Scientific Data Systems 930, interface equipment to get digital information to the analog equipment, and optics and cathode-ray tubes. The final product is either a photographic plate for offset printing or hard copy produced by Xerography.

The system already has success-

fully produced a complete offset plate made up of both text and artwork.

**Composition.** The processor sees all graphical data as combinations of alphanumerics, vectors, or dot patterns. The alphanumerics for the copy are entered through a keyboard, punched cards, or paper or magnetic tape. Characters are coded in the form of digital information on a drum.

This coding is simplified because only the black portions of a letter are digitized. This eliminates redundancy, speeding up the printing process. Also stored on the drum are composition programs that provide instructions on format and page makeup, including hyphenation and line justification.

To generate a page of alphanumerics, a composition program is called from the drum and set up in a section of core memory that is used by the interface. If an "a" is to be printed, digital information describing the position of the "a" is sent to the interface, which converts the digitized "a" into analog

form for the output device.

At the same time, the composition program determines where the "a" should be written on the cathode-ray tube, at what speed, and to what size. A zooming technique is used so that a font can be produced in almost any size. This process is repeated until the whole page is composed.

**Adding art.** Line drawings, such as circuit diagrams or graphs, are made with a vector-mode program. Three factors determine where and how a line should be drawn: the two end points and the time it takes for a constant-velocity beam to scan between them. This constant-velocity system was chosen to ensure uniform exposure of every point on a line.

The end points are transferred from drum to core memory while the computer calculates the velocity, which is transmitted to the interface and then converted to signals to drive the recorder. Special programs insert such constants as page size and revolution into the computer to ensure a uniform ap-

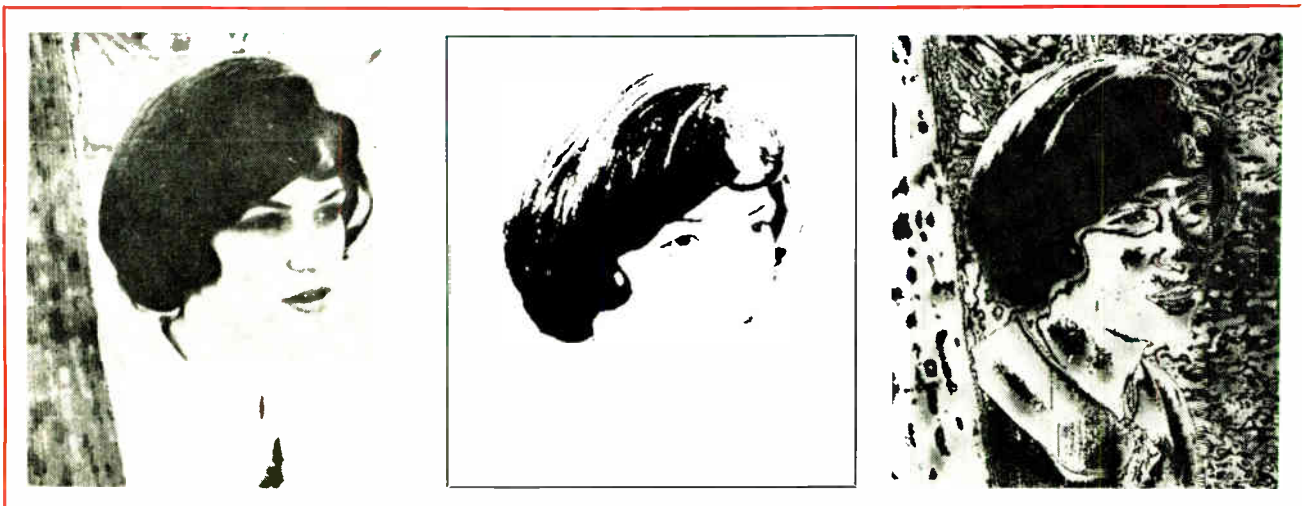

It's a Xerox. Graphical data processor produced the photo at the left using a screen size of 200-by-200 dots per inch, and a four-bit, 16-level intensity code. By printing only the 16th (darkest) intensity level, the center picture was produced; the photo at the right was made by printing the least significant bit in the four-bit code. The system also generates alphanumerics, vectors, and dots.

pearance. The system can generate lines from 3 to 10,000 inches per second, and, on a 10-by-10-inch page, line thickness as small as 2 mils if the vector is specified by a 13-bit word.

To add a photograph on a page, a full-page opaque gray-level scanner is used to convert the photo into digital data. With this information, the graphical processor can size the picture and reproduce it on the page with any desired dot density up to 666 per inch.

Another application, aside from the printed page, is for printed-circuit boards. If geometric shapes are coded instead of alphanumeric, the graphical processor can turn out masks for p-c boards.

### Package deals

In some respects, buying a computer is like buying a suit with a vest. Regardless of whether you want the vest, you're going to pay for it. With a computer, the buyer must also take the software as part of the package. And with the price of software estimated at half that of a computer system, the buyer could probably do far better by shopping around for his own software.

The possibility of bargaining for software separately was explored at a panel session at the Spring Joint Computer Conference, held in Atlantic City, N.J., this month. Most panelists agreed that the prac-

tice of selling hardware-software packages has to stop, but that the first move must come from either the largest computer producer, the International Business Machines Corp., or the largest computer user, the Federal Government.

**Stop action.** During the session, Herbert J. Grosch, director of the National Bureau of Standards' center for computer sciences and technology, said he was proposing to the General Services Administration, the purchasing arm of the Government, that it stop buying computers that come as part of package deals. This, he said, should be done before the introduction of the fourth generation of computers, which is expected by 1970.

Grosch, an outspoken critic of package deals, feels that because a programmer usually has more software than he needs, he runs the risk of using the wrong program. He says Federal action could quickly force a trend towards better and more efficient software.

When questioned about Grosch's proposal, a GSA spokesman said it hasn't been received yet.

### Electronics Index of Activity

May 13, 1968

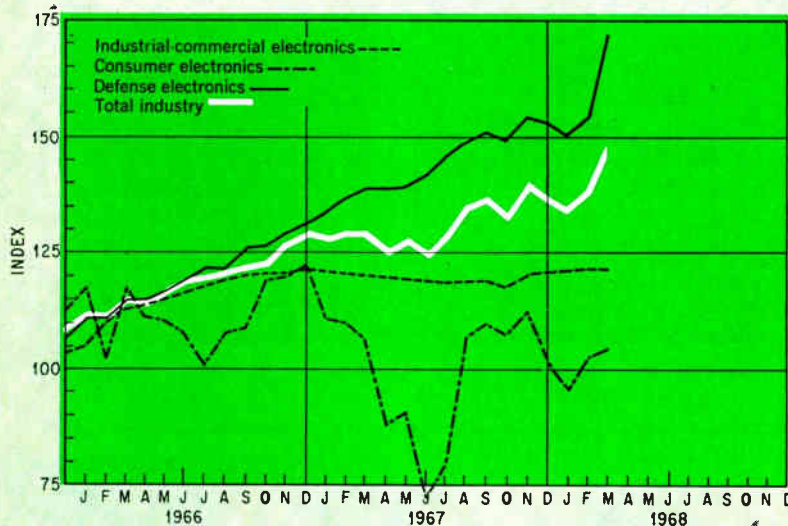

Segment of Industry	March 1968	Feb. 1968	March 1967
Consumer electronics	104.4	103.2	105.9
Defense electronics	172.1	153.9	138.6
Industrial-commercial electronics	121.5	121.6	120.6
Total Industry	145.8	135.8	127.7

Electronics production rose sharply in March to a record 145.8, 10 index points above the February level and 18.1 above the March 1967 figure. Consumer output advanced 1.2 points in the month, while industrial-commercial production edged down 0.1 point. The largest month-to-month change occurred in defense electronics, which spurted 18.2 points from February and 33.5 points from a year earlier.

Indexes chart pace of production volume for total industry and each segment. The base period, equal to 100, is the average of 1965 monthly output for each of the three parts of the industry. Index numbers are expressed as a percentage of the base period. Data is seasonally adjusted.

### Companies

#### Shot in the arm

If you were to rank major semiconductor makers by dollar volume, your list would start with Texas Instruments, Motorola, and Fairchild—and end with Philco-Ford and ITT. Philco's Microelectronics division has had its problems with MOS technology and slipping sales, while the ITT Semiconductors division just never managed to come up with the new or improved devices that bring sales leadership.

But now there's new optimism at the two companies. And it's all based on a whopping three-year order from the Burroughs Corp., an order said to total 37 million diode-transistor-logic circuits divided equally among Philco, ITT, and Fairchild Semiconductor. Burroughs refuses to talk about the deal because it's floating a \$50 mil-



lion bond issue and is forbidden by law to discuss new business until the transaction is completed. But industry sources say the circuits are 930 series gates packaged in ceramic dual in-line packages, and will go into a new accounting machine called the Q model and the TC500 line of computers being sold to British banks.

**How much?** The price—less than a dollar a circuit—is said by one competitor to be a record low for DTL's. Typically, a 930 gate in a ceramic package costs around \$2.50 in lots of 100 to 999.

There is the usual claim by competitors that Philco and ITT were buying in, but it's interesting to note that the ceramic-packaged devices are Philco's highest-yield production item.

Also interesting is Burroughs' decision to go with three suppliers when two are ordinarily considered enough. One reason could be

the size of the order. Another might be that Burroughs wanted at least one supplier from the Big Three as a hedge, a conclusion reinforced by the general belief that Fairchild's price is a bit higher than Philco's and ITT's.

## Optoelectronics

### Tracking with pulses

The more power a radar system puts into a pulse, the better equipped it is to track targets. Optical radar systems are no exception.

In the movement toward higher power, the Raytheon Co.'s Research division, Waltham, Mass., adopted CO<sub>2</sub> lasers as the basis for what it believes is the world's largest and most powerful optical radar transmitter.

Built with Government money, Raytheon's laser system uses a master oscillator and three amplifier stages to produce 10-microsecond pulses 10,000 times a second, with average power reaching more than a kilowatt and individual pulses as much as 10 kilowatts.

**On target.** Carbon-dioxide lasers operating at kilowatt levels have been around for over a year [Electronics, Nov. 27, 1967, p. 48], but the needs of this job created new problems. First, the new radar is to be a doppler system that uses the frequency changes in the returned signal to measure target velocity. This means that output frequency of the giant laser had to be controlled to within a few kilohertz, since any frequency drift could cause an error in a target's measured velocity.

Second, the laser had to be operated in the pulsed mode rather than in the better understood—for

## On the right track

When the Philco-Ford Corp. hired John R. Welty away from Motorola Inc. to take charge of its floundering Microelectronics division, it was widely assumed that Welty's first job would be to put the division in the black. Since Philco's income from bipolar integrated circuits had been slashed when RCA was dropped from the R-13 program [Electronics, Oct. 2, 1967, p. 39], and since the division's problems with MOS technology are well known, Welty's task looked Herculean.

Now, Philco has received a big boost toward that goal in the form of a chunk of the order for DTL circuits to go into the Burroughs Corp.'s new TC-500 computer line. [See related story above.] Still 1967 sales projections for the division were about \$25 million while it's believed that only about half that was actually taken in; and that Philco-Ford itself was putting on pressure to keep Microelectronics' losses from dragging all of Philco into the red for the first time since Robert O. Fickes took over as president.

**What, we worry?** But Welty is feeling no pressure to get the division in the black in a hurry. "The question of how to turn the division around quickly may not be too hard to answer—but it may not be relevant, either," he says. "We must get away from the quarter-to-quarter way of doing business and look at the long range."

Welty says the question to be answered is why the division hasn't prospered despite its "very sizable cadre of technical competence." But he adds that such competence is not the only factor in success—"You must pursue the customers' goals instead of pursuing programs because of engineering enthusiasm in your

own company; that can prove to be a will o' the wisp."

Welty points to this as the key to Motorola's recent success. "Motorola has seldom led in anything," he says. "MECL is the only example that springs to mind. It was late in zener diodes, silicon transistors, and IC's; yet it now just about owns the first two, and I firmly believe that it will become No. 1 in IC's."

**Brick by brick.** At Philco, Welty sees as his first task the rebuilding of the marketing organization, which was almost completely wiped out by last fall's cost-cutting maneuvers.

Beyond that, the decisions on the long rebuilding job have not been made. The Blue Bell, Pa., operation, where Philco manufactures bipolar IC's, is sound, Welty believes. Its Taiwan packing operation is also operating well. The Blue Bell facility will soon complete its introduction of the SUHL line of transistor-transistor logic circuits, Welty says, and will then put more marketing emphasis on its capabilities as a source for bipolar circuits.

He is clearly unworried about Philco's future. He quotes Lester Hogan, his old boss at Motorola, as saying that a semiconductor company must spend \$10 million to \$15 million a year on engineering just to stay abreast of the technology. "No company could afford to put more than 10% of sales into this effort, and so only the \$100 million or \$150 million company is in the clear.

"Under those circumstances," Welty notes, "there are only four companies—Texas Instruments, Fairchild, Motorola, and RCA—that don't have to worry about survival, though there may be others that are profitable at any given time.



**Laser radar.** Raytheon's 10-kilowatt radar uses doppler technique to measure a target's speed. The system is probably the most powerful optical radar in the world. Pulsed CO<sub>2</sub> laser generates 10-microsecond pulses 10,000 times a second.

CO<sub>2</sub> lasers, that is—continuous-wave mode.

Perry A. Miles, Raytheon senior scientist, solved the first problem by using a low-power CO<sub>2</sub> laser as a master oscillator. Though its output is only about 35 watts c-w, its frequency is tightly controlled by piezoelectrically movable mirrors at the ends of its optical cavity.

Downstream from the master oscillator are two laser preamplifier stages, a modulator, and a large power amplifier. First comes a 1-inch-diameter plasma tube, then another twice as long and 1½ inch in diameter. The output of these two preamp stages is about 200 watts c-w.

A rotating disk with holes in it forms the chopper modulator. The pulses then are fed to a 2-inch-diameter power amplifier tube more than 163 feet long and folded into four parallel sections into the next plasma tube. Sapphire mirrors coated with gold guide the light beam around corners.

The other problem he faced was generating high pulse power. Unfortunately, the laws of physics don't allow a CO<sub>2</sub> laser to produce as much power in repeated pulses as in c-w operation. This is because the mixture of CO<sub>2</sub>, helium, and nitrogen in the plasma tube needs

time to recover from previous pulses. Miles found that some gas mixes needed less recovery time than others and eventually decided upon a ratio of 1 torr carbon-dioxide, 1.5 torr nitrogen, and 4.5 torr helium.

## Advanced technology

### Dying light

By turning a knob on a liquid laser, thereby changing the optical path length, IBM scientists have tuned the laser's pulsed output over a range of 700 angstroms, centered at 8,350 angstroms (infrared). The technique can be applied to various liquids and pump sources to cover the optical frequency spectrum all the way from 4,300 to 9,000 angstroms.

The development comes soon after Bell Telephone Laboratories' parametric oscillator, which tunes coherent light over about 1,800 angstroms [Electronics, April 15, p. 52].

The IBM device doesn't have continuous output but is simple and efficient. During tuning, a piston changes the volume of liquid

in the cell (lasing tube), making the end mirrors move. The longer the lasing area, the lower the output frequency. Peak efficiency, at short cell length, is 47%, the developers say.

The liquid used is dimethylsulfoxide (DMSO), the chemical that's recently been tested as a local pain killer. And the dye is 3,3'-diethylthiatricarbocyanine.

### Budding germanium

If the Gunn effect hadn't been discovered, gallium arsenide would have remained pretty much a laboratory curiosity—expensive, unstable, and hard to control. So while some Gunn effect activity has been limited to the cantankerous GaAs, other researchers have been trying to use a material that's far easier to handle and is better understood—germanium—to generate microwaves.

A giant step toward germanium bulk-effect devices has been taken by J. E. Smith Jr. at the International Business Machines Corp.'s Yorktown Heights, N.Y., research center. He has produced microwave oscillations in germanium under stress (along the crystal axis with 10,000 to 20,000 atmospheres of pressure) and at room temperature. They had been previously produced at temperatures of 120°K and below.

IBM researchers point out that n-type germanium will also oscillate in the limited space-charge accumulation mode. And they further believe that the effect may be found in silicon and lead tellurium as well.

**In the ballpark.** Smith reports that efficiency and power, while comparable to GaAs levels at low temperatures, are an order of magnitude lower at room temperature. Frequency range, however, is comparable under both conditions, he adds.

If IBM can get the devices into production, several applications in communications will open immediately.

Also, germanium devices could be used in ultrahigh-speed com-

## Power that's simply super

Useful outputs up to 500 kW, at frequencies up to 50 MHz... that's the story of RCA's A2872A and A2873A, developmental beam power tubes. Designed for use in a variety of applications that includes communications, particle accelerators, radar and control, these high-gain units feature one simplified, all-internal liquid cooling system.

Outgrowths of continuing research by RCA in electronic and mechanical design, A2872A and A2873A employ the well-known superior electron optics of RCA-6806 and -2041. These designs result in excellent linearity, a rugged stability, low RF drive voltages, and exceptionally high RF power output.

Only 12" x 18", the tubes are designed with a centrally located plate surrounded by a circular array employing unitized electron optics. This coaxial structure permits close spacing, accurate alignment, and efficient cooling. The electronic circuit design provides low RF feedback and effective screen-to-cathode RF by-passing.

Find out more about these RCA super power tubes for economical operation, high emission, and long life. See your RCA Representative about details. For technical data, write: Commercial Engineering, Section E19Q-2, RCA Electronic Components and Devices, Harrison, New Jersey 07029.

RF Power Amplifier Class C Telegraphy or Class C Telephony			
Tentative Maximum Ratings up to 50 MHz	A2872A	A2873A	
DC Plate Voltage	25	25	kV
DC Grid—No. 2 Voltage	1500	1500	V
DC Grid—No. 1 Voltage	-400	-400	V
DC Plate Current	25	50	A
Plate Dissipation	125	250	KW
Grid—No. 2 Dissipation	1900	3800	W
Grid—No. 1 Dissipation	1000	2000	W

Super Power Tube, A2873A



# RCA

puters. There, a Gunn-effect source for microwaves could make turn-on and turn-off quick enough to produce a 1-cycle pulse [Electronics, March 4, p. 165]. And germanium, with its stability, would mean higher production yields and better reliability.

**Consumer electronics**

**Slide view**

Dull hosts can always alienate guests and chill a get-together by turning on the television set or dragging out their slide projector. However, a color tv system that can screen color slides—plus provide a running commentary through a built-in tape recorder—may actually liven parties, at least because of its novelty.

The cost of the system is high. The maker, Sylvania Electric Products Inc., has priced its Color Slide Theater at \$995. For that outlay the buyer gets a 23-inch color tv set, a cassette recorder, and a slide tray that can handle both 35-millimeter and Kodak Instamatic slides.

**Entwined.** To project the color

slides on the tv screen, Sylvania engineer Dan Schuster and his colleagues have developed a relatively complex electronic and optical arrangement tied in with the tv's electronics. In fact, the user must turn the television set to a working channel to synchronize the projected image.

Image projection starts in a Kodak gravity-fed Carousel projector holding up to 80 slides. The light source, a cathode-ray tube, projects the slide image onto a mirror [see diagram]. Red, green, and blue segments of the image are then directed via dichroic mirrors onto three photomultiplier tubes.

The scanning circuit in the crt is driven by the tv set's deflection system and is locked to the synchronizing pulses from a television broadcast. Without an incoming signal, there is both vertical and horizontal picture instability.

A video processing unit accepts the red, blue, and green information from the photomultiplier preamplifiers and adjusts gain, performs matrixing, and makes gamma correction to derive the standard x, y, and z signals. The x and z signals are applied to corresponding color demodulators while the y signal is applied to the video driver; all these

are standard circuits in the television receiver.

The slides can be changed manually with a hand-held remote control unit or by a 60-hertz cuing tone on the audio tape. The slides are automatically focused by the spot scanner, but the viewer can use the knobs on the tv set to adjust the brightness and contrast, as well as color hues.

**Integrated electronics**

**Shrinking SOS**

Autonetics doesn't give up easily. When it became apparent that the company's first silicon-on-sapphire (SOS) product—a 70-by-96 diode matrix—wasn't gaining wide acceptance, it sent its engineers back to the drawing boards. The result is a 32-by-32 diode matrix that Autonetics hopes has the appeal the original lacked.

Now in pilot production, the new device is an integrated subsystem—Autonetics terminology for a large-scale integrated array that performs a subsystem function. This one is a 1,024-bit random access read-only

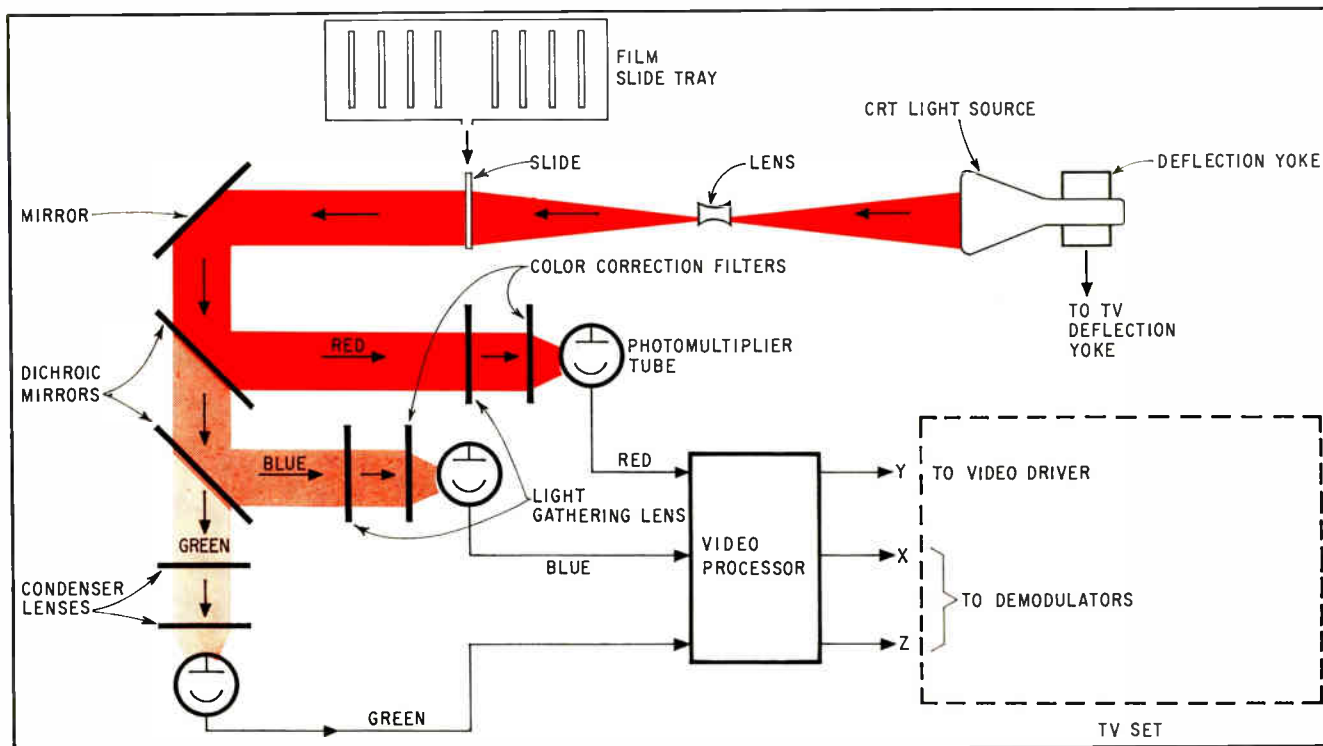

# DON'T THINK IN TERMS OF GATES WHEN YOU DESIGN ENCODING OR DECODING CIRCUITRY.

## THINK DIODE MATRICES.

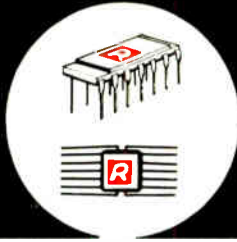

Now you can encode...decode...or time-share both functions...  
inexpensively, efficiently, easily, and without fear of cross-coupling.  
Use Radiation dielectrically isolated diode matrix integrated circuitry.  
Readily available in dual in-line and TO-84 flatpack configurations



Suppose you need a three-bit binary output encoded into a four-bit binary shift code. Why use *five* AND gates and *four* OR gates? Simply combine these nine gate functions into *one* RM-30 six by eight diode matrix and save both time and money.

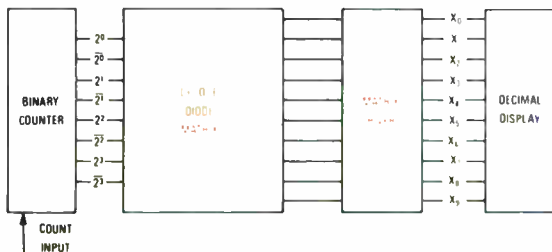

Why use ten logic gate packages to decode from binary to decimal for display read-out? Use only *two* RM-84 eight by five diode matrices. It makes no difference what weighted binary code you are working with. Radiation diode matrices can be easily customized to match.

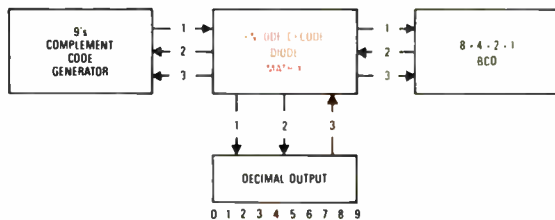

When one logic code must be converted to several other codes for processing, think diode matrices! Specify only *four* RM-84 diode matrices and form a 16 by 10 matrix array. Six conversions can be performed by this single bi-directional array... replacing approximately 80 logic elements.

You never have to think in terms of gates again. Think Radiation diode matrices!

Radiation stocks a complete line of dielectrically isolated diode matrices, easily customized to your particular encode-decode needs. These can be combined with Radiation interface circuits to provide the most economical, convenient and reliable diode logic available today.

Contact your nearest Radiation sales office to find out how inexpensive diode matrix integrated circuitry really is. You'll be surprised how fast we can deliver, too.



**RADIATION**  
INCORPORATED  
SUBSIDIARY OF HARRIS-INTERTYPE CORPORATION  
MICROELECTRONICS DIVISION

Sales Offices 600 Old Country Road, Garden City, N.Y. 11530. (516) 747-3730 — 2600 Virginia Avenue, N.W., Washington, D.C. 20037. (202) 337-4914 — 6151 W. Century Boulevard, Los Angeles, Calif. 90245. (213) 670-5432 — P.O. Box 37, Melbourne, Florida 32901. (305) 727-5430 — International Sales Marketing Department, P.O. Box 37, Melbourne, Florida 32901. (305) 727-5430

memory. The 70-by-96 matrix was originally developed for the Massachusetts Institute of Technology's Project MAC (multiaccess computer). The SOS unit was subsequently undercut in the project MAC application by a cheaper braided-wire memory [Electronics, Jan. 8, p. 52].

**First in space.** Arthur C. Lowell, assistant director of Autonetics' research and engineering division, says the 32-by-32 matrix is the first SOS device made expressly for the commercial market, and is more applicable to read-only memories than the MIT array. He believes it will probably be used first in military and space computers, where high speed and radiation resistance, plus power, weight, and volume savings are necessary.

The device has no designation yet, and will not be completely characterized for about three months, Lowell says. But this much is known: it will be rated at 5 volts so as to be compatible with transistor-transistor logic, and will have an access time of 300 nanoseconds at that level. "If we go to 15 volts the access time will go down to 100 nsec," Lowell comments.

Typical power consumption will be 100 milliwatts, depending on the voltage, but the device could go to 50 mw for high-speed applications; it uses  $\pm 10\%$ , 10,000-ohm resistors in the access circuitry. Nine of the arrays, each measuring 220-by-200 mils, are put on a 1-inch diameter wafer.

**Question mark.** "The memory's speed puts it in the same ballpark with other high-speed semiconductor memories," notes Lowell. "But we don't know yet how much it will cost because we haven't processed enough of them. However, it will be competitive with other memories."

The array will probably be marketed in a 40-lead flatpack, possibly one with a beryllia substrate for increased heat transmissibility over alumina.

Looking ahead, Lowell sees complementary MOS memories with power consumption down in the nanowatt range coming from the Autonetics SOS line. "Complementary devices in bulk silicon have very low power, but SOS looks as

if it can reduce these by another one or two orders of magnitude."

---

## Integrated electronics

---

### Mixer-modulator IC

Texas Instruments has developed a doubly balanced mixer-modulator in a monolithic integrated-circuit form that the company's government products group believes is the first of its kind.

Usually, such mixers are designed with diode rings, which require input and output transformers to balance out the carrier. The TI device doesn't need transformers.

The IC mixer design is equivalent to that of a diode ring modulator. The nonlinear characteristics of the diodes and the functions of the transformers are achieved with two cross-coupled differential transistor pairs driven from a third balanced pair.

Laboratory versions have shown conversion gains of 8 decibels at 30 megahertz with a 60-ohm collector load at a 300-millivolt input. The maximum junction temperature for the device is set at 150°C.

**Small geometry.** However, the small-geometry transistors used in monolithic IC's make it possible to design devices that can operate at 150 to 200 Mhz, according to R. E. Ham, an engineer on the project. Ham notes that TI's components group was asked to provide the smallest-geometry transistors possible for the program.

TI will probably market the new devices late this year. Ham says the price will be competitive with the tags on present diode ring units.

Ham and three other project engineers—C. P. Abbott, S. W. Marshall, and L. D. Wickwar—presented a paper on the new IC at last week's National Aerospace Electronics Conference.

---

## For the record

---

**Timely.** Now that computer time sharing is commonplace, computer

makers are turning out lower-priced systems to attract more users. By altering existing hardware, Scientific Data Systems Inc., for example, is offering its 940 in a smaller, cheaper version. Called the 945, the new system has an 8-million stored character memory, inputs for 24 simultaneous users, and a rental price of \$15,000. The 940 rents for \$26,000.

**Welcome.** Meanwhile, the Hewlett-Packard Co. has joined the time-sharing crowd; its HP200A 16-terminal system uses existing hardware—including the HP2116 computer with its 16,384-wordcore memory. The computer, which interfaces with standard peripherals through plug-in cards and standard cabling, is controlled by a modified ASR-33 teleprinter. It rents for \$16,000 a month.

**Idle hand.** The General Services Administration has a scheme for cutting data-transmission costs. Under the plan, Government agencies already using EDP equipment will specify the number of hours the machines are idle. The GSA will then "lease" the gear during the free time to other agencies in the area and set up computer centers for this purpose.

The first center will be established in Huntsville, Ala. It will use equipment belonging to NASA's Marshall Space Flight Center. The second, also using NASA equipment, will be at the Michoud Rocket Testing facility just outside of New Orleans.

**Down.** General Precision Equipment Corp., which is working on a proposed merger with the Singer Co., reports both earnings and sales down for the first quarter of this year. Sales were \$105.6 million, off \$3 million from the corresponding period in 1967, while earnings dropped from \$5,067,000 to \$5,045,000.

**Earnings up.** Comsat has announced first quarter earnings of \$1.8 million, a jump of \$500,000 over the corresponding period last year.

# new E-H 153 Strobing Voltmeter

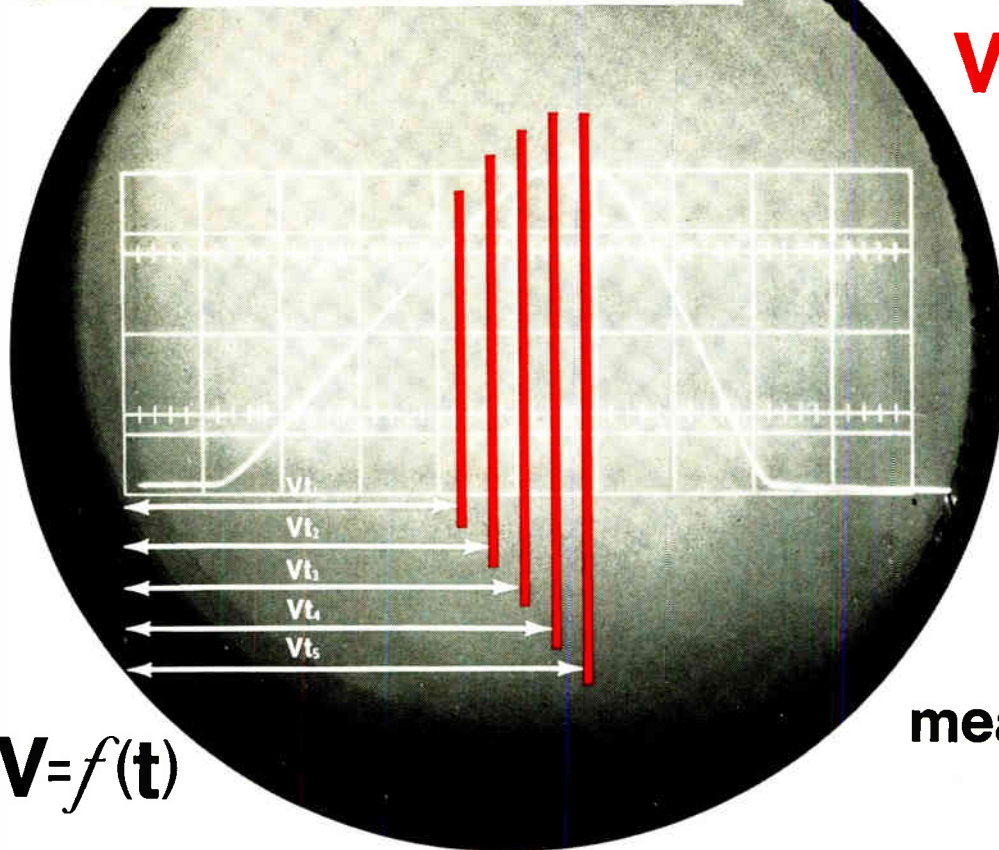
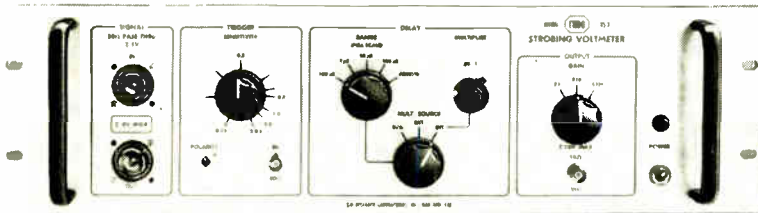

now  
you  
can  
make  
single  
shot  
voltage  
measurements  
on ns  
waveforms

Here is a new tool for measuring voltages at precisely located points in time on nanosecond waveforms. The E-H 153 STROBING VOLTMETER'S single shot and repetitive capability gives you the ability—for the first time—to sample, hold and amplify a short time slice (strobe) of input waveform.

1% pulse voltage measurement accuracy is assured from 5ns pulses to DC by the 153's clean transient response and wide bandwidth. A low noise of 0.5 mV peak-to-peak combined with a dynamic range of  $\pm 1$  volt further extends your measurement capabilities. In addition, BCD or analog strobe time position programming, in 100 ps increments, provides you with an instrument equally suited to laboratory and automated testing. Welcome to the E-H world of single-shot time-domain measurements . . . complete technical information on the E-H 153 STROBING VOLTMETER and its application is available on request.



**E-H RESEARCH LABORATORIES, INC.**

163 Adeline Street • Oakland, California 94607 • (415) 834-3030 • TWX 910-366-7258

In Europe: E-H Research Laboratories (Ned) N.V., Box 1018, Eindhoven, The Netherlands, Telex 51116

In Japan: Iwatsu Electric Co., Ltd., No. 710, 2-Chome Kugayama Suginami-Ku, Tokyo, Japan

# LOOK WHAT TTL IC'S DID FOR ANADIX ELECTRONIC COUNTERS!

- PLUG-IN TTL INTEGRATED CIRCUITS
- 15 MHz COUNT RATE
- HIGH NOISE IMMUNITY
- 10 MV OR 100 MV INPUT SENSITIVITY

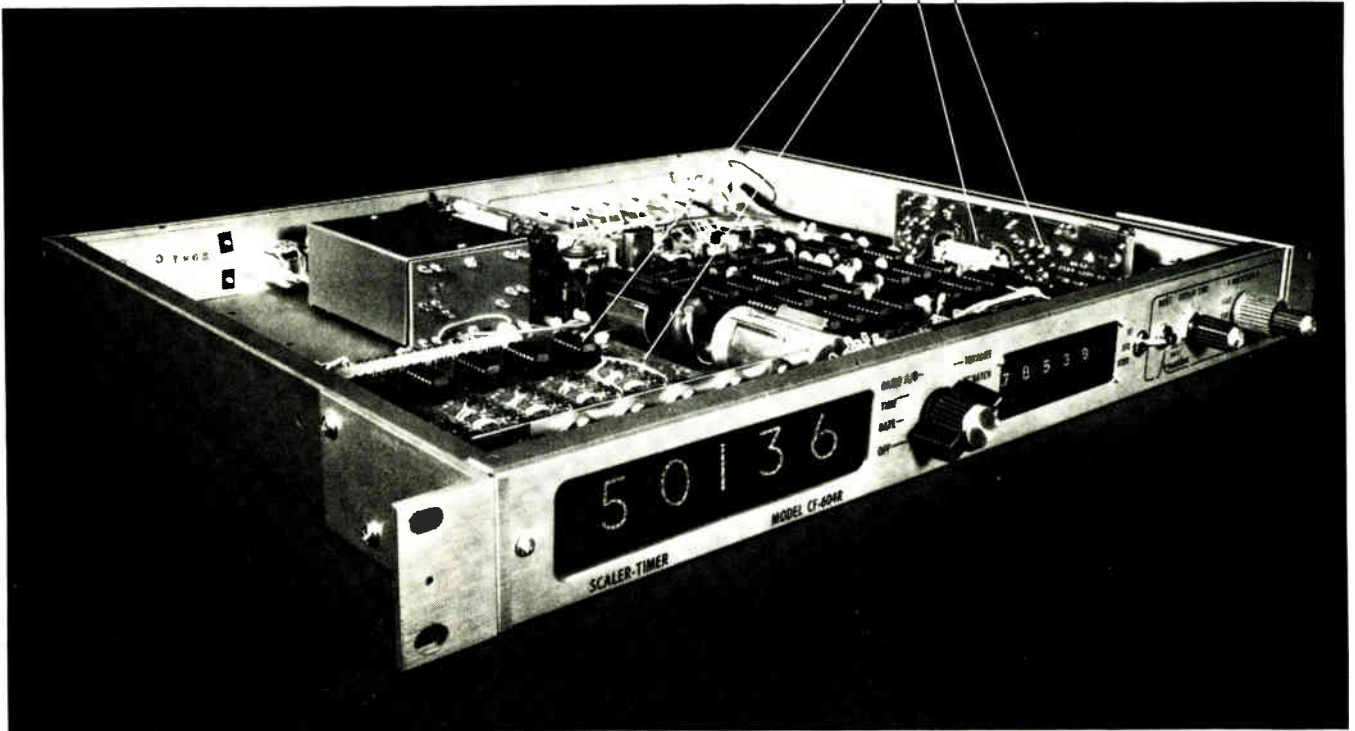

Anadex already had the 1¾" front panel height and still has. Now plug-in TTL IC's high noise immunity, remote programming capability and 15 MHz count rate are added. Anadex counters are not loaded with non-essentials — the ones you pay for in competitive counters. Choose the low-cost optional features you desire. If you're interested in an electronic counter that has the designed-in functions you need and a "makes-sense" price tag, we want to talk to you immediately. Call Ken Mathews, (213) 873-6620. You can count on him.

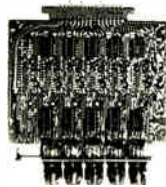

... THE NAME YOU CAN COUNT ON

7833 Haskell Ave., Van Nuys, California 91406 / Phone (213) 873-6620 / TWX 910-495-1762





## if frequency control's your game... think CPD

That's Communications Products Division of Walter Kidde & Co., Inc. The most complete source anywhere for frequency control devices and crystal products.

The name's new. The products and capabilities are well known. CPD is really four companies in one — all involved in areas of frequency control. The four have joined technical and management capabilities to form a team of over 600 people, a staff of 21 engineers and over 70,000 sq. ft. of floor space.

### Who's in CPD?

**Ovenaire Inc.**, of Charlottesville, Va. — oscillators, crystal ovens and component ovens. **Filtaire Inc.**, of Charlottesville, Va. — low frequency quartz crystals and crystal filters. **Croven, Ltd.**, of Canada — high frequency quartz crystals. **Piezo Technology Inc.**, of Orlando, Fla. — IXF® integrated crystal filters and electronic test equipment for the communications industry.

### What does CPD mean to you?

One source for all frequency control needs. And the latest in technology. For example, Piezo Technology Inc., of CPD, was the first commercial producer of monolithic crystal filters for HF-VHF application. Standard models of these IXF integrated crystal filters covering the 5-250 MHz range, have been available "off-the-shelf" for over a year. The small size monolithic construction, high stability and



economy of our IXF filters make them ideal for spectrum clean-up applications in frequency synthesizers, parametric up-converters and many other communication systems applications.

If you're involved in frequency control, make a note of CPD Unexcelled capability. Latest technology. Fastest delivery. Give us a try on your next project.

For complete details on all frequency control products call D. J. Ellis, Vice Pres. Sales (703) 293-5148



**COMMUNICATIONS PRODUCTS DIVISION**  
OF WALTER KIDDE & COMPANY, INC.

**CROVEN LTD.**      **OVENAIRE INC.**      **FILTAIRE INC.**      **PIEZO TECHNOLOGY INC.**  
Whitby, Ontario Canada      Charlottesville Va.      Charlottesville Va.      Orlando Florida

# Join the Bug-of-the-Month Club

It's exclusive . . .

Tailored just for the lighting bug engineer who wants the latest information on miniature lamps at his fingertips. Detailed technical data that fills the information gap on a thousand-and-one industrial applications.

Best of all, Bug of the Month Club members are entitled to receive information on new lamps just as soon as they come off the

production line. And, just to make it official, a membership card and suitable-for-framing certificate are furnished when you enroll.

Why the ballyhoo?

Mostly because Chicago Miniature has the most complete, highest quality line on the market.

It got that way by promptly filling customer needs just like yours and we'd like to share our lamp development and technology on a continuous basis. That's what the Bug of the Month Club is all about

and you can join by circling the reader service number. Anyone can join regardless of race, creed, political affiliation or financial status. And that's about as exclusive as you can get!

For application assistance, contact your Chicago Miniature Sales Representative. For off-the-shelf delivery, contact your local Authorized Chicago Miniature Electronic Distributor.

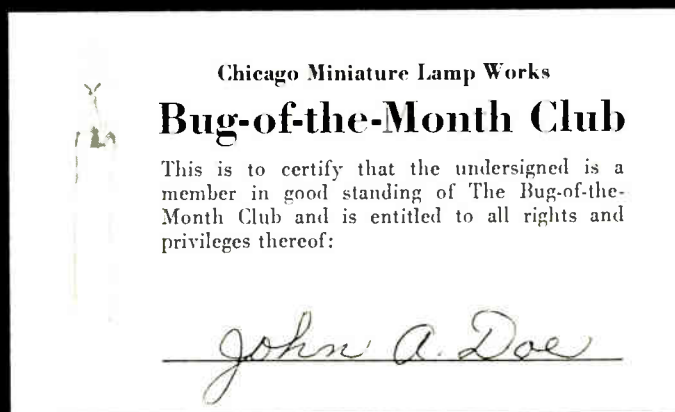

**Chicago Miniature Lamp Works**

4433 N. Ravenswood Ave., Chicago, Illinois 60640, (312) 784-1020

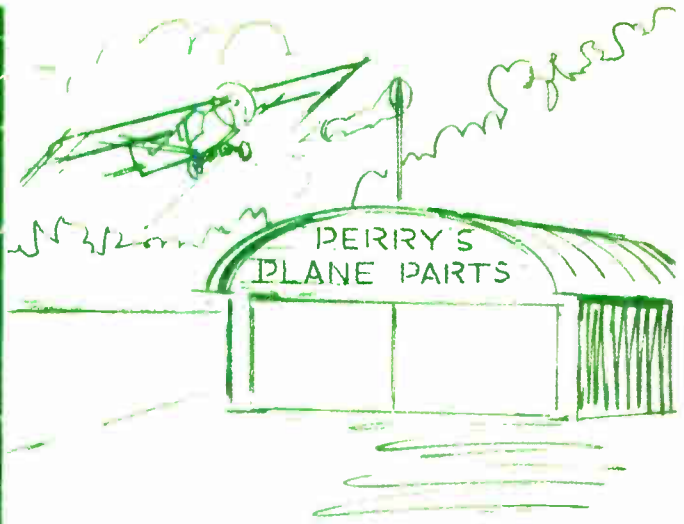
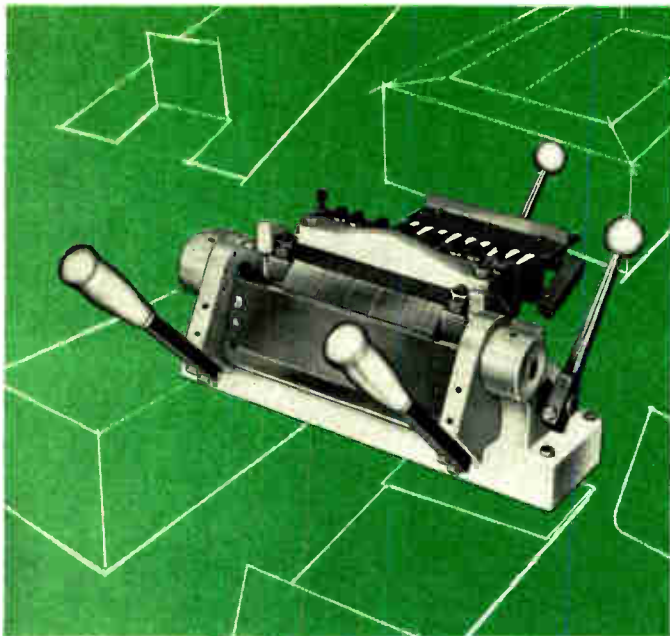

Di-Acro Die-less Duplicating got a lot of metalforming businesses off the ground.



Now those same businesses are flying higher than ever using Di-Acro Punches and Dies.

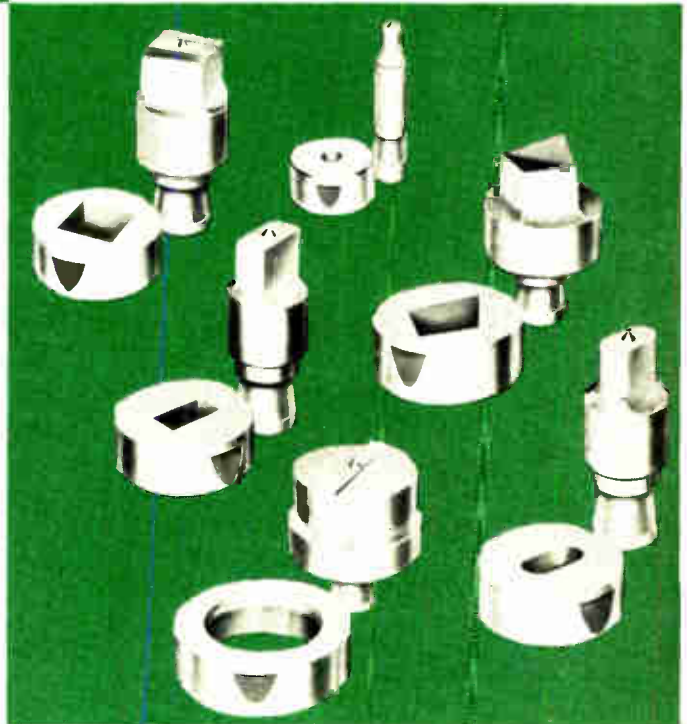

## DI-ACRO QUALITY AND PRECISION SORT OF GROWS ON YOU!

Back when propellers were just about "the only way to fly," quite a few young companies depended on the versatility of Di-Acro Die-less Duplicating to stay in business. They could blank, pierce and form an entire part — and then be ready to repeat the same part or change it completely.

This was a successful approach until quantities grew to require dies for economy and efficiency. Their experience with Di-Acro precision and quality naturally turned these companies to Di-Acro Punches and Dies for piercing.

They were pleased to see concentric centering points, burr-free tolerances, no-slip fit in an inventory containing over 500 sizes and shapes. The craftsmanship was superb — and better still the results!

Di-Acro quality punches and dies are available up to 4 inches in diameter or equivalent in standard round, square, rectangular and oval shapes. Many special shapes such as "electricals" are available at standard prices. Custom shapes can be made to specification. We also have adaptors to fit a wide variety of punch presses. Ask your Di-Acro dealer for our "Art of Punching" book or write us.



**DI-ACRO**

division of

435 EIGHTH AVENUE  
LAKE CITY, MINNESOTA 55041







# I'm tough

## And 15,000 hours says I'm tough

Clifton's long life synchros have exceeded 15,000 hours of continuous testing and remained within specification. Clifton will guarantee a minimum of 5,000 hours for almost any application and, depending upon the end use, may guarantee them much longer.

These synchros retain all the high accuracy or torque of standard Clifton synchros. In fact, you can order them right out of the Clifton catalog without forfeiting a single catalog parameter except friction which is raised slightly. NO PENALTY in phase shift, impedance

angle, torque or input power and only a slight increase in cost over standard synchros. Compare these features with other long life synchros on the market today.

For further information call your local Clifton Sales Office or 215 622-1000 or write 5050 State Road, Drexel Hill, Pa. 19026.

**CLIFTON**   
DIVISION OF LITTON INDUSTRIES

# HERE'S THE LATEST INFORMATION ON THIN-FILM DEPOSITION...

CVC

## Five CVC PlasmaVac® Low-energy Sputtering Systems — to handle thin-film applications from laboratory to production line.

Sputtering thin films with a CVC PlasmaVac® system lets you deposit almost any material on almost any surface—with excellent control over film composition, purity, and thickness. You'll increase efficiency, quality, and yields over any other thin-film

deposition method. Please write for full details on any or all of the PlasmaVac systems described below. Consolidated Vacuum Corporation, 1775 Mt. Read Blvd., Rochester, N.Y. 14603.

	PLASMAVAC 100	PLASMAVAC 200	PLASMAVAC 300	PLASMAVAC 400	PLASMAVAC 501
<b>GENERAL</b>	DC triode sputtering. Metals, conductors.	RF triode sputtering. Conductors, semi-conductors, non-conductors.	RF diode sputtering.	Production-type system with DC Crossfire™ and RF capability on in-line basis with air to air substrate transport.	DC Crossfire™ with rotary work holder, multiple targets.
<b>APPLICATIONS</b>	Laboratory and limited production. Ideal with CV-18 vacuum system.	Laboratory and limited production when used with PlasmaVac 100.	Sophisticated research applications. Reactive sputtering, sputter etching, semi-conductors, dielectrics, etc.	Bridges the laboratory/production interface. Modular concept so process can be developed, then scaled up to meet production needs.	Batch-type production unit for pilot plant operation.
Deposit Metals	Yes	Yes	Yes	Yes	Yes
Deposit Dielectrics	No	Yes	Yes	Yes	Yes*
Deposit Semiconductors	Some	Yes	Yes	Yes	Yes*
Deposit Cermets	No	Some	Yes	Yes	Yes*
Deposit Alloys	Yes	Yes	Yes	Yes	Yes
Deposit Organics	No	No	Some	Some	No
Water Cooled Target (for use of thermally sensitive materials)	No	No	Yes	Yes	Yes
Water Cooled Substrate	No	No	Yes	Yes	No
Reactive Sputtering	No	Some	Yes	Yes	Some
Bias Sputtering	Yes	Some	No	No	No
Sputter Etching	Few	Some	Yes	Yes	No
Type of Chamber	Bell Jar	Bell Jar	Bell Jar	Production-type modular chamber	Low profile metal chamber
Multiple Target Sputtering	Yes	Yes, with PlasmaVac 100	No	Yes	Yes

\*Available on special order.

CVC

A BELL & HOWELL COMPANY

 BELL & HOWELL

See us at NEPCON EAST, Booth 824 June 4-6, The Coliseum

52 Circle 52 on reader service card

Circle 53 on reader service card →

**3½-Digit DVM.  
Volts/Ohms/Amps  
capability: \$349.**

Fairchild's 7050 DVM is four pounds of price/performance efficiency. It's a multimeter that can also function as a panel meter. Resolution is 1mV or 1 Ohm. Accuracy is 0.1%. Input impedance is 1000 Megohms. You also get dual slope integration, automatic polarity, floating input and display storage. A tilt stand/handle and current shunts are available as options. Complete specs are at the other end of your telephone. Call (408) 735-5431, collect. Ask for Del Aquila.



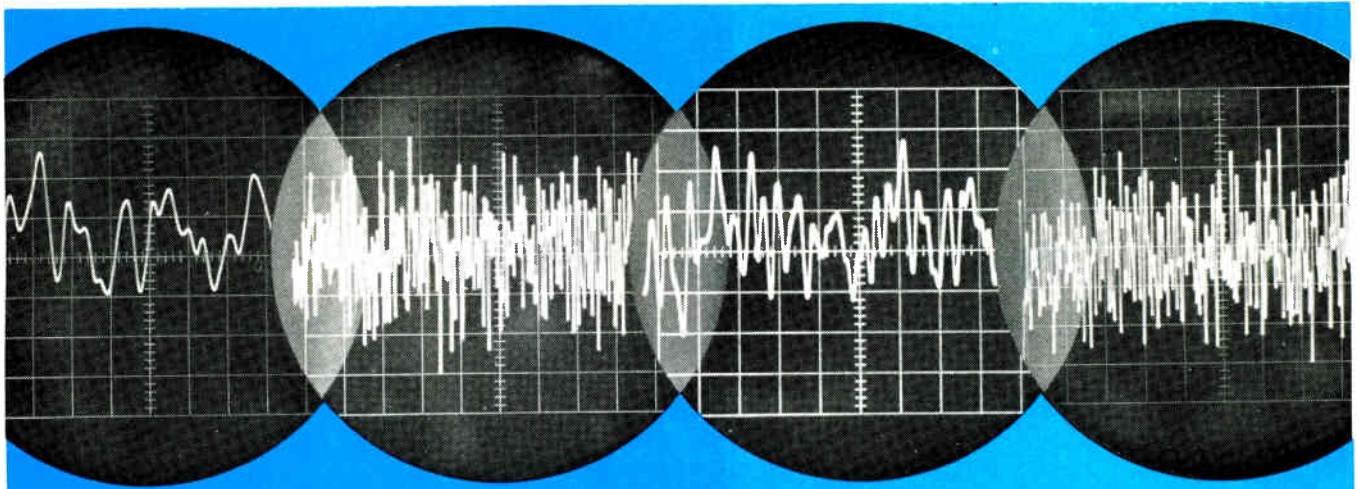

## GUESS WHICH VOLTMETER TAKES THE GUESSWORK OUT OF PEAK-TO-PEAK READINGS?



Only the 3100 Statistical Voltmeter developed by MICOM...because it eliminates the human errors in your test work by providing a steady, direct statistical reading, from either noise-like or periodic voltages.

Unique circuitry in the 3100 assures precise signal measurements for both meter reading and recorder outputs—saving you the tedious and subjective interpretation of scope displays. It reads peak-to-peak statistical limits, between selectable "Percent of Time" ranges on the front panel, in ten steps from 10% to 99.7%. Sensitivity ranges from 1 mV to 100 V peak-to-peak in the frequency bandwidth of 1.0 Hz to 100 kHz.

The 3100 is ideally suited for precision work in specifying or measuring power supply PARD (ripple and noise) from SCRs, corona or other causes. It also allows separate measurement of repetitive spikes and average noise. Or, for communications systems work where peak-to-average ratio measurements of composite signals are critical, the 3100 does the job. And it fits neatly into random signal analysis, for vibrational, acoustical, medical, control-system and test equipment analyses.

There's never been an instrument to do what the new 3100 does. Visual errors cost money...and the 3100 saves both your money and your eyes.

Price: \$600.

For more information, contact MICOM at 855 Commercial Street, Palo Alto, California 94303. Tel: (415) 328-2961.



**MICOM**

A California Corporation



**CENTRALAB IS ACTION IN MINIATURIZATION**

# AIM

Centralab's capabilities are zeroed-in on comprehensive miniaturization — from ceramics to components to microcircuits and back again. We're on target in every area. For example, our thin, precision substrate materials answer a growing need for technical ceramics in a variety of applications. Our potentiometers, resistors, push button and rotary switches, capacitors and semiconductors are manufactured with parameters to meet any requirements. And Centralab leads the industry in microcircuitry, having produced more than 459,700,000 microcircuits of 5,000 different designs. For more information on the Centralab product that's zeroed-in on your need, write Centralab Application Engineering today.



Centralab is Ceramics



Centralab is Components

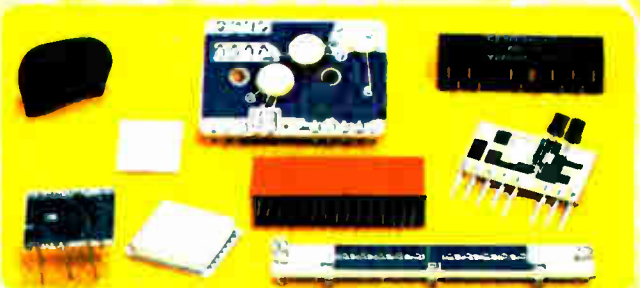

Centralab is Microcircuits



**with Centralab**

CENTRALAB PRODUCTS ARE MARKETED THROUGH CENTRALAB INDUSTRIAL DISTRIBUTORS AND INTERNATIONALLY THROUGH GLOBE-UNION INC. - INTERNATIONAL DIVISION.



**CENTRALAB** Electronics Division • GLOBE-UNION INC.  
5757 NORTH GREEN BAY AVENUE • MILWAUKEE, WISCONSIN 53201

M6818

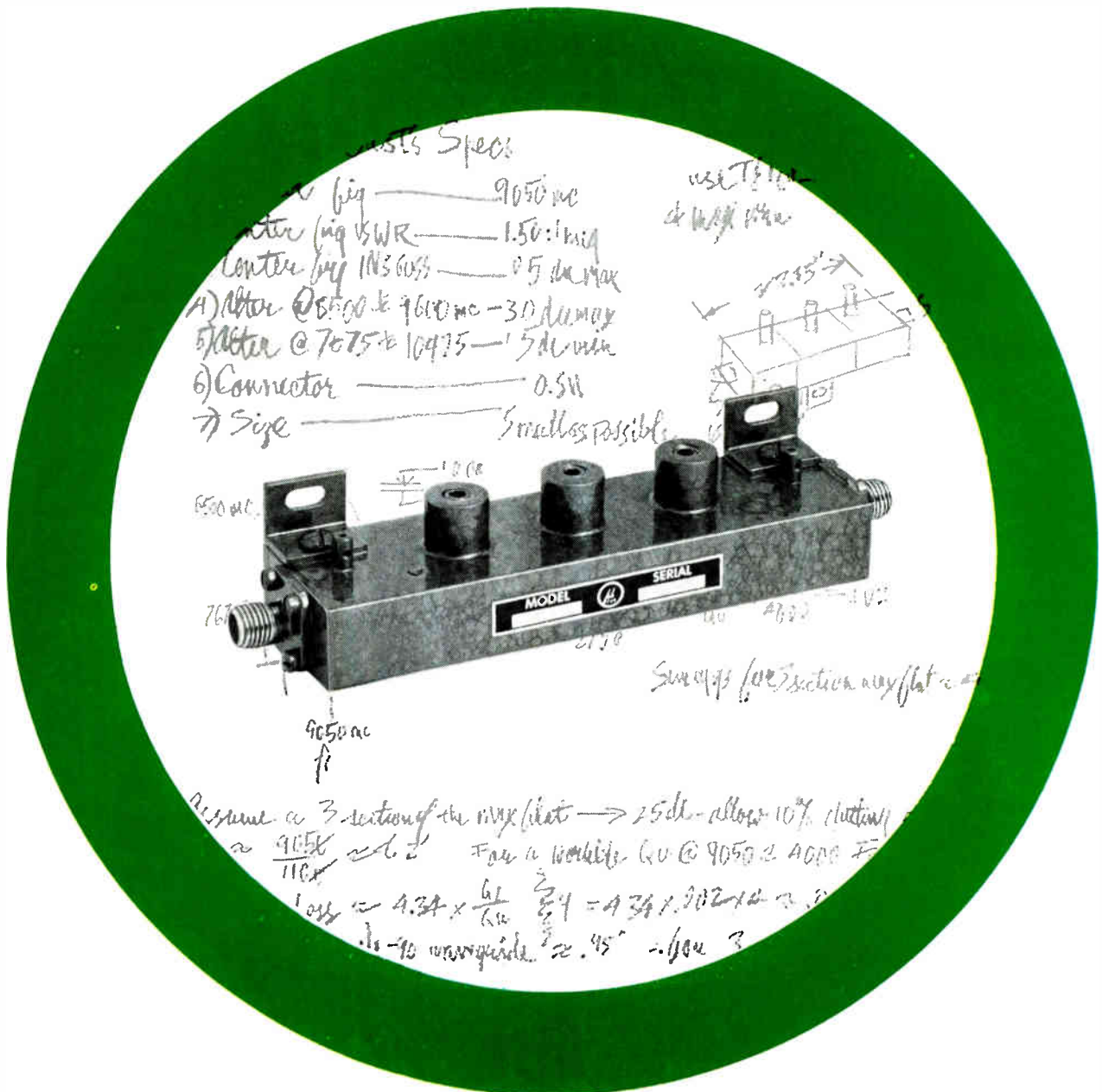

## Ever try to build a filter that's never been made before?

### We do -- all the time!

Maybe we're gluttons for punishment, but it seems that we're doing it all the time. Although we've designed thousands of special filters, our customers keep coming up with new problems that require new answers.

Typically, they present us with some general specifications. We then help them translate these into the specific parameters required for their application.

First we study the electrical specs and mechanical configuration. An optimum filter circuit is selected, based on experience. Calculations are made to determine specific parameters and to verify feasibility. At this point, we sketch the key dimensions, considering form factor, weight, etc.

Environmental specs are analyzed. So are qualification test

requirements, to determine need for special test facilities, equipment, fixtures, etc. Estimates of costs and lead time are made. And a technical proposal is written.

Upon approval, all factors are reviewed again. A model is built to prove the design. Final mechanical drawings are created, and released for the production run.

Sound like a job you'd like to tackle yourself, in house? Probably not. After all, Microlab/FXR can do all this better and at lower cost, because of our wide experience. We make more filters than anyone in the business. Even filters that have never been made before!

Get more information now about Microlab/FXR's filter line and filter capability. Write today to Dept. E-67.



# MICROLAB/FXR

Livingston, New Jersey 07039 Phones: (201) 992-7700; (212) 721-9000

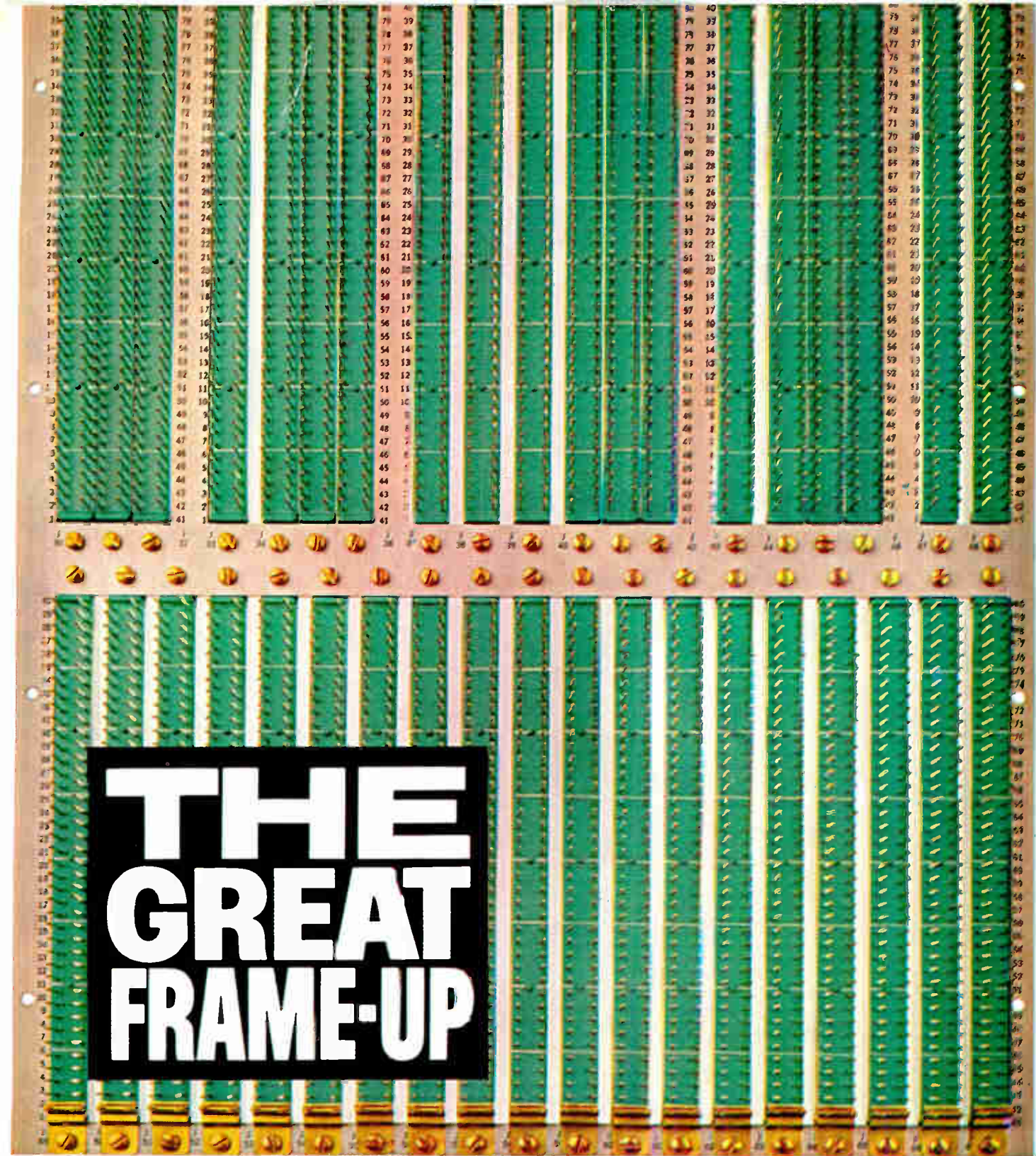

# THE GREAT FRAME-UP

**We call it AccurFrame.  
And it can save you more than 1¢ per contact.**

Our new AccurFrame takes the fuss and bother out of wire-wrapping. It's easy, fast and error-free. And very simple to use.

Here's why. Our HW Series Wire-Wrap\* connectors have two polarized alignment holes in the card insertion side of the block. These fit over accurately positioned pins on the alignment tool. There's no chance of a connector being placed wrong-end-to-

With connectors in perfect position, our frame is placed over the assembly; connectors are quickly attached with machine screws. The frame and connectors lift off—ready for automatic wire-wrapping.

Winchester's long experience has made the whole thing so sure, simple and *fast* that most users are saving 1¢ per contact over other methods. And those pennies add up.

You'll like our Wire-Wrap connectors, too. They're available in sizes ranging from 22 to 50 contact positions. Designed for automatic equipment, high-strip force retention, bifurcated spring contacts for superior interfacing. We integral-mold them in diallyl phthalate SDG-F. Contacts are easily removed. Retained by a 90° twist.

Get all the profitable facts about the Great Frame-Up from your District Sales Office. Or from Winchester Electronics, Main Street & Hillside Avenue, Oakville, Connecticut 06779.

**WINCHESTER ELECTRONICS**  
LITTON INDUSTRIES 

\*Trademark-Gardner Denver Company

Our main claim to fame is the design and application service we provide on every mercury relay we sell. If we don't have the relay you need, we help you develop a new one. And that's not all! Adlake has the most complete line of mercury-wetted and displacement relays in the business. Contact ratings from 100 VA to 100 amperes. Operating speeds from 1 millisecond to 150 milliseconds. Consistent contact resistance—even under adverse environmental conditions. Time delay relays

from one-half second to 30 minutes, all of them tamper-proof. Load relays with an exclusive anti-spinout feature. Relays equipped with epoxy coils that are guaranteed for life. Plus many other special features. We also have a line of dry reed relays. So call us. We'll put you in touch with an engineer who specializes in the type of relay best suited to your needs—mercury-wetted, displacement or dry reed. We can help you solve your circuit design problem creatively, whatever the application.



**THE ADAMS & WESTLAKE COMPANY**  
A SUBSIDIARY OF **ALLIED PRODUCTS CORPORATION**

Elkhart, Indiana, U.S.A. 46514 • (219) 264-1141  
TWX 219 522 3102 • TELEX 25-8458 • CABLE ADLAKE

**Most mercury relays look  
pretty much alike...**

**Except ours have service  
written on them!**



---

# Washington Newsletter

---

May 13, 1968

## Navigation project may chart course for national plan

Without fanfare, the Department of Transportation has launched a study project aimed at establishing a national maritime and aviation navigation plan. The idea is to determine the technologies that can best satisfy the needs of users, and thus eliminate obsolete systems and prevent greater proliferation of systems. There are now at least 30 different systems in use. The study is a joint venture of the Coast Guard and the FAA and is scheduled for completion by January 1970.

Satellite navigation systems will be given prime attention. Some parts of the study will be made by outside firms. The first part most likely will be to determine requirements for short-range, harbor, and port navigation. The Coast Guard is particularly interested in finding ways to phase out obsolete equipment and thus reduce navigational aids operations costs, which now run about \$80 million annually.

## Intelsat conference: a decision on which satellite to build . . .

Next week's Intelsat conference in Vienna is expected to decide the fate of the proposed Intelsat 3.5 communications satellite. Delegates from member nations will weigh the satellite against the proposed Intelsat 4, a larger-capacity satellite. The issue: whether to build both satellites or drop the 3.5 and speed development of the Intelsat 4.

Comsat, majority shareholder and manager of Intelsat, is pushing for both satellites. It has received 3.5 bids from TRW and Hughes Aircraft—on a second go-round—and three proposals for Intelsat 4. But Intelsat's foreign shareholders want guarantees that the 3.5 is needed and will be used before approving the program.

## . . . and a battle over U. S. role

The Vienna meeting will also produce fireworks from France over the permanent agreement for the consortium. The U.S., in a position paper last year, called for continuing the present arrangements, but with a few modifications [Electronics, Nov. 13, 1967, p. 179]. France, however, is demanding that the permanent arrangements provide for less U.S. contracting and a lesser role for Comsat.

France, which is expected to put its demands on the conference table, doesn't want Comsat as permanent manager. Support, so far, for the French position has been labeled by Comsat as "limited."

## FCC rushing phone rulings

The FCC may rule earlier than expected in two cases that could have considerable impact on the Bell System and the future of telephone service. Arguments in the Carterphone and Microwave Communications Inc. cases were heard in April and rulings could come this month. This would be extremely fast for the FCC, which usually announces decisions three to six months after hearings.

The reason: Commissioner Lee Loevinger's term expires June 30. Since a new commissioner wouldn't vote on cases in which he hasn't heard arguments, a 3-3 deadlock is possible without Loevinger's vote.

The Carterphone case involves "foreign attachments" and could pave the way for computers to be hooked up directly to phone networks without a Bell-supplied interface. Microwave Communications seeks a license to run a microwave link between Chicago and St. Louis.

---

# Washington Newsletter

---

## Millimeter waves: on the right path

Millimeter-wave transmission tests by the Defense Communications Agency are going well—all the agency needs now is a military customer. **First tests over a 20-mile path from Washington into Maryland are coming up with the same basic results as found in an earlier 5-mile test** [Electronics, March 18, p. 151]. “There’s no outstanding difference and very few problems,” says the agency.

The 20-mile test, between 28 and 40 gigahertz, has included transmission of 50 million bits of data per second. The agency now plans transmissions at the same data rate, on the same path, but over two additional frequencies: 6 and 35 Ghz. **By comparing the signals of both, the agency hopes attenuation on the 35-Ghz band can be predicted for different atmospheric conditions.**

## Now hear this! Tests set for digital voice transmission

**Sometime this summer, the Defense Communications Agency hopes to begin evaluating systems for transmitting voice signals digitally.** But because of budget cutbacks, there are no definite plans for awarding production contracts for initial equipment, once a design is decided upon. Although the work isn’t being done for the Mallard program, it could wind up there. Mallard, a four-nation, integrated tactical trunking and distribution system, is also planning to use digital communications [Electronics, Oct. 30, 1967, p. 48].

Radiation Inc. was the first to show a prototype to the agency. The system, which cuts out redundant voice data, needs only the standard 3-kilohertz telephone channel, compared with the 12 circuits that would be required if redundant data wasn’t removed. Agency officials say the Radiation system provides fair to high quality and is a “good candidate.”

Honeywell currently is working on two other techniques: one using delta pulse-code modulation and the other using zero-slope detection. A fourth system, using voice-excitable coding, is being developed by Philco-Ford for the National Security Agency. **Both Honeywell systems and the Philco-developed equipment are expected to be demonstrated shortly.**

## NASA steps up aid to Pentagon

Although the space agency isn’t publicizing its ties with defense projects, **it will be taking a more active role in helping the Pentagon solve specific technical problems.** A high-ranking official at NASA’s Office of Advanced Research and Technology says aid given the Pentagon previously had been informal and, for the most part, amounted to little more than sending along studies and reports. But this hadn’t been of much help. The agency will now transfer functioning breadboard and feasible demonstration models to the military—primarily consisting of microelectronics equipment.

**NASA has set up a defense projects support office that will serve as the focal point for Defense Department inquiries.** The new office will operate within the jurisdiction of the Office of Advanced Research and Technology’s special projects section.

## Addendum

An effort by NASA booster Olin E. Teague (D., Tex.) to demonstrate industry support for the space effort has backfired. Teague’s questionnaires to 750 industry leaders resulted in only 449 replies, of which 37% said the \$5 billion average for the past five years was too much; 47% called it just right, and 4.6% said it was too little.

**0-20Vdc @ 1000A**

**0-150Vdc @ 70A**

**0-150Vdc @ 35A**

**0-300Vdc @ 35A**

**0-300Vdc @ 18A**

**0-600Vdc @ 18A**

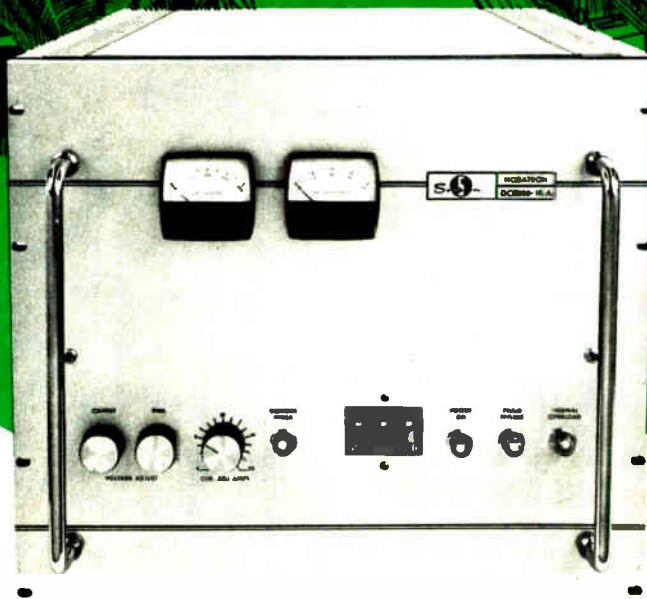

## ***New Sorensen High Power DCR's:***

The addition of 6 new models now brings the total number of Sorensen regulated, high power, high efficiency DCR's to 34—the widest product line from the industry's leader in both DC and AC power supply technology and production.

The DCR Series covers the voltage ranges of 0-20/0-40/0-60/0-80/0-150/0-300/0-600/ and even up to 6000 Vdc at power levels of 400, 800, 1500, 2400, 5000, 10,000 and 20,000 watts. And—Sorensen's 25 years experience in design and manufacture makes it possible to offer these power supplies from stock at prices as low as 19¢/watt.

The DCR Series offers all of the standard features found in state-of-the-art power supplies including Voltage/Current Regulation,

Low Ripple, Remote Programming, Remote Sensing, Operating Temperatures to 71°C and compliance with MIL-I-26600 and MIL-I-6181D.

**FREE!** An illustrated data package containing detailed electrical and mechanical specifications for each DCR power supply and a new CATALOG featuring 176 different Sorensen regulated DC and AC power supplies.

Contact your local Sorensen representative or Raytheon Company, Sorensen Operation, Richards Avenue, Norwalk, Connecticut 06856. TWX 710-468-2940

**RAYTHEON**

for more data on this versatile instrument . . . **Call Sorensen: 203-838-6571**

OF COURSE YOU CAN DESIGN A MULTIPLE  
 CIRCUIT THAT CAN PERFORM THE FUNCTION  
 OF A ROTARY STEPPING SWITCH.  
 BUT WHY BOTHER?

There are hundreds of sequential switching applications that can be answered immediately with a stock rotary stepping switch from Guardian. And that's much quicker and cheaper than designing your own multiple circuit.

No other relay manufacturer makes as many different types of stepping switches as we do. So if you don't have our catalog, it's easy to see why you may have had to do it yourself at times.

The Guardian line puts all these types at your disposal: sequence selecting, automatic resetting, continuous rotation, circuit selecting, pulse multiplying, counting, slave and master, automatic homing, add and subtract, and remote homing. They're available with up to 52 contacts per deck . . . up to 8 undivided circuits. And, they test up to 7½ million steps on the life test rack.

So before you resign yourself to doing-it-yourself again, look into the Guardian Stepping Switch engineer's manual. You'll save lots of time and money. Just ask for Bulletin F32. Guardian Electric Mfg. Co., 1550 W. Carroll Ave., Chicago, Illinois 60607.

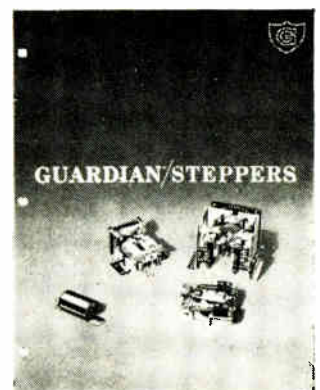

**GUARDIAN**  **ELECTRIC**



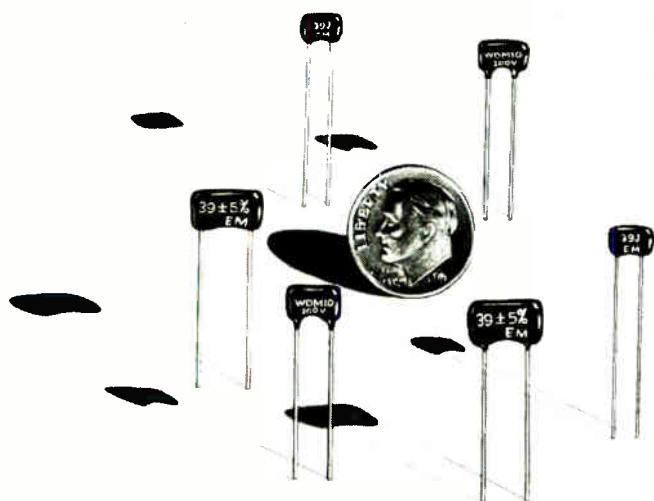

## They're Small and Reliable\*

EL-MENCO DM5 — DM10 — DM15 — ONE COAT DIPPED MICA CAPACITORS

STYLE	WORKING VOLTAGE	CHARACTERISTIC	CAPACITANCE RANGE
DM5	50VDC	C	1pF thru 400pF
		D, E	27pF thru 400pF
		F	85pF thru 400pF
DM5	100VDC	C	1pF thru 200pF
		D, E	27pF thru 200pF
		F	85pF thru 200pF
DM10	100VDC	C	1pF thru 400pF
		D, E	27pF thru 400pF
		F	85pF thru 400pF
DM15	100VDC	C	1pF thru 1500pF
		D, E	27pF thru 1500pF
		F	85pF thru 1500pF
DM5	300VDC	C	1pF thru 120pF
		D, E	27pF thru 120pF
		F	85pF thru 120pF
DM10	300VDC	C	1pF thru 300pF
		D, E	27pF thru 300pF
		F	85pF thru 300pF
DM15	300VDC	C	1pF thru 1200pF
		D, E	27pF thru 1200pF
		F	85pF thru 1200pF
DM10	500VDC	C	1pF thru 250pF
		D, E	27pF thru 250pF
		F	85pF thru 250pF
DM15	500VDC	C	1pF thru 750pF
		D, E	27pF thru 750pF
		F	85pF thru 750pF

Where space and performance are critical, more and more manufacturers are finding that El-Menco miniaturized dipped mica capacitors are the reliable solution. The single coat is available in three sizes: 1-CRH, 1-CRT and 1-CE.

The 1-CRH DM "space savers" easily meet all the requirements of MIL and EIA specifications, including moisture resistance. The 1-CE and 1-CRT units also meet the requirements of MIL and EIA specifications, except that they have less moisture protection because of their thinner coating; these capacitors, therefore, are ideally suited where potting will be used. Note: DM10 and DM15 units are still available in the standard 4-CR size.

**Specify "El-Menco" and be sure . . .** the capacitors with proven reliability. Send for complete data and information.

\*Normally, El-Menco 39 pF capacitors will yield a failure rate of less than 0.001% per thousand hours at a 90% confidence level when operated with rated voltage and at a temperature of 85°C. Rating for specific applications depends on style, capacitance value, and operating conditions.

## THE ELECTRO MOTIVE MFG. CO., INC.

WILLIMANTIC, CONNECTICUT 06226

Dipped Mica • Molded Mica • Silvered Mica Films • Mica Trimmers & Padders  
Mylar-Paper Dipped • Paper Dipped • Mylar Dipped • Tubular Paper

West Coast Manufacturers contact: COLLINS & HYDE CO., 900 N. San Antonio Rd., Los Altos, California 94022  
5380 Whittier Blvd., Los Angeles, California 90022

ALSO SOLD NATIONALLY THROUGH ELECTRONIC PARTS DISTRIBUTORS

# MAKE OR BUY ?

CONSIDER THESE

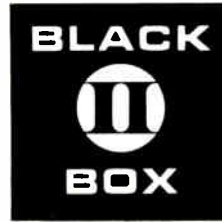

ANSWERS FIRST

Your design and scheduling problems are simplified when you specify Intronics compatible function modules. Proven specifications, stock delivery, and firm prices help you meet your cost and delivery schedules.

Intronics modules feature MIL quality construction and advanced solid state circuit design. Operation from  $\pm 15$  Volt supply is standard with  $\pm 12$  Volt optional.

Modules are designed for compatible operation mini-modular interface problems. No customer furnished feedback networks, pots or other adjustments are normally required. All units have short-circuit proof outputs. Standard units operate over a temperature range of  $-25^{\circ}\text{C}$  to  $+85^{\circ}\text{C}$  with  $-55^{\circ}\text{C}$  to  $125^{\circ}\text{C}$  operation available in most models.

## MULTIPLICATION/DIVISION SQUARING/SQUARE ROOTING

All models feature true linear four quadrant operation, differential or single ended input operation, and excellent stability with respect to temperature and supply voltage variation. All types function in multiply, divide, square, or square root mode by appropriate pin interconnection.

Model	Type	Accuracy	X = Y = 0V Output Offset	X, Y Inputs	XY/10 Output	Bandwidth	Input Impedance	Output Impedance	Case Size	Price 1 - 9
M101	General Purpose time division	0.25%	$\pm 10$ mV max	$\pm 10\text{V}$ , AC or DC	$\pm 10\text{V}$ , 5 ma	both X, Y inputs DC to 1000 Hz	X: 5 meg min Y: 75k min	1 ohm max	3" x 2" x .625"	\$445.00
M102	High Accuracy time division	0.1%	$\pm 5$ mV max	$\pm 10\text{V}$ , AC or DC	$\pm 10\text{V}$ , 5 ma	DC to 100 Hz	X: 5 meg min Y: 75k min	1 ohm max	3" x 2" x .625"	\$495.00
M201	FET wide bandwidth	1.0%	$\pm 20$ mV max	$\pm 10\text{V}$ , AC or DC	$\pm 10\text{V}$ , 5 ma	DC to 1 MHz	X: 10k min Y: 10k min	1 ohm max	3" x 2" x .625"	\$545.00
M301	Lowcost general purpose, time division	1.0%	$\pm 20$ mV max	$\pm 10\text{V}$ , AC or DC	$\pm 10\text{V}$ , 5 ma	DC to 1000 Hz	X: 10k min Y: 10k min	1 ohm max	3" x 2" x .625"	\$245.00

## SAMPLE AND HOLD

Model	Type	Sample Command	Input Range	Input Impedance	Output	Acquisition Time	Aperture Time	Output Decay	Case Size	Price 1 - 9
FS101	0.1% accuracy fast acquisition non-inverting.	on: +3.5v to +7.5v off: 0 to +0.5v	$\pm 10\text{V}$ , AC or DC	Sample: 500pf + 100 Hold: $10^{10}$ ohm min	$\pm 10$ V, 5 ma 0.1 ohm output impedance	2 $\mu\text{sec}$ for $\pm 10$ volt, 0.1% accuracy	50 nsec.	0.1v/sec, max with internal 500 pf capaci- tor, provision for ex- ternal capacitor	2.05" x 1.15" x .625"	\$185.00

## IMPEDANCE BUFFERING (Voltage Follower)

Model	Type	Accuracy	Linearity	Voltage Gain	Input/Output	Input Impedance	Input Current	Output Impedance	Case Size	Price 1 - 9
FA101	FET, Non Inverting	.05%	.005%	+ .0 Unity, -.0005	$\pm 10\text{V}$ , AC or DC, $\pm 5$ ma out	$10^{11}$ ohm min	30 pA max	0.1 ohm max	1.12" x 1.12" x .625"	\$78.50
FA102	FET, Non Inverting	.1%	.01%	+ .0 Unity, -.001	$\pm 10\text{V}$ , AC or DC, $\pm 5$ ma out	$10^{11}$ ohm min	50 pA max	0.1 ohm max	1.12" x 1.12" x .625"	\$68.50

## ELECTRONIC SWITCHING (Multiplexing)

Model	Type	Turn-On Time	Turn-Off Time	Offset Error	Input/Output Voltage	"On" Input Impedance	Sample Command	Voltage Drift	Case Size	Price 1 - 9
ES101	Fast Diode Gate	300 nsec	50 nsec	$\pm 2$ mv max	$\pm 10\text{V}$ , 1 ma output	20 ohms	On: +3.5 to +7.5V	50 $\mu\text{V}/^{\circ}\text{C}$	1.12" x 1.12" x .625"	\$65.50
ES102	Diode Gate with FET Output Buffer	300 nsec	50 nsec	$\pm 2$ mv max	$\pm 10\text{V}$ , 5 ma output	$10^6$ ohms	Off: 0 to +0.5V	100 $\mu\text{V}/^{\circ}\text{C}$	2.05" x 1.15" x .625"	\$145.00

## ANALOG TO DIGITAL CONVERSION

Model	Type	Input Voltage	Input Impedance	Output	Conversion Time	Accuracy	Temp. Drift	Power Input	Case Size	Price 1 - 9
AC101	100 KHz complete conversion rate, 10 bit successive approximation, with internal clock and reference	0 to $-10.23\text{V}$ (0 to $+10.23\text{V}$ optional)	10 K ohms	10 bit serial and parallel binary, com- plete pulse	10 $\mu\text{sec}$ (includes settling time)	0.1% or 1 bit $-25^{\circ}\text{C}$ to $+85^{\circ}\text{C}$	10ppm/ $^{\circ}\text{C}$ max $-25^{\circ}\text{C}$ to $+85^{\circ}\text{C}$	$\pm 15\text{V}$ , 125 mA $+5\text{V}$ , 50 mA	3" x 4" x .625"	\$995.00

Other solid state function modules available for: precision voltage / current amplification, linear-log conversion, sin/cos generation, absolute value, D-A conversion, Binary -BCD conversion, coordinate rotation and transformation subsystems.

Contact our applications engineering department to discuss your requirements.



**intronics**

57 Chapel Street, Newton, Massachusetts 02158

TEL.: 617 - 332 - 7350 TWX: 710 - 335 - 6835

# Progress Report

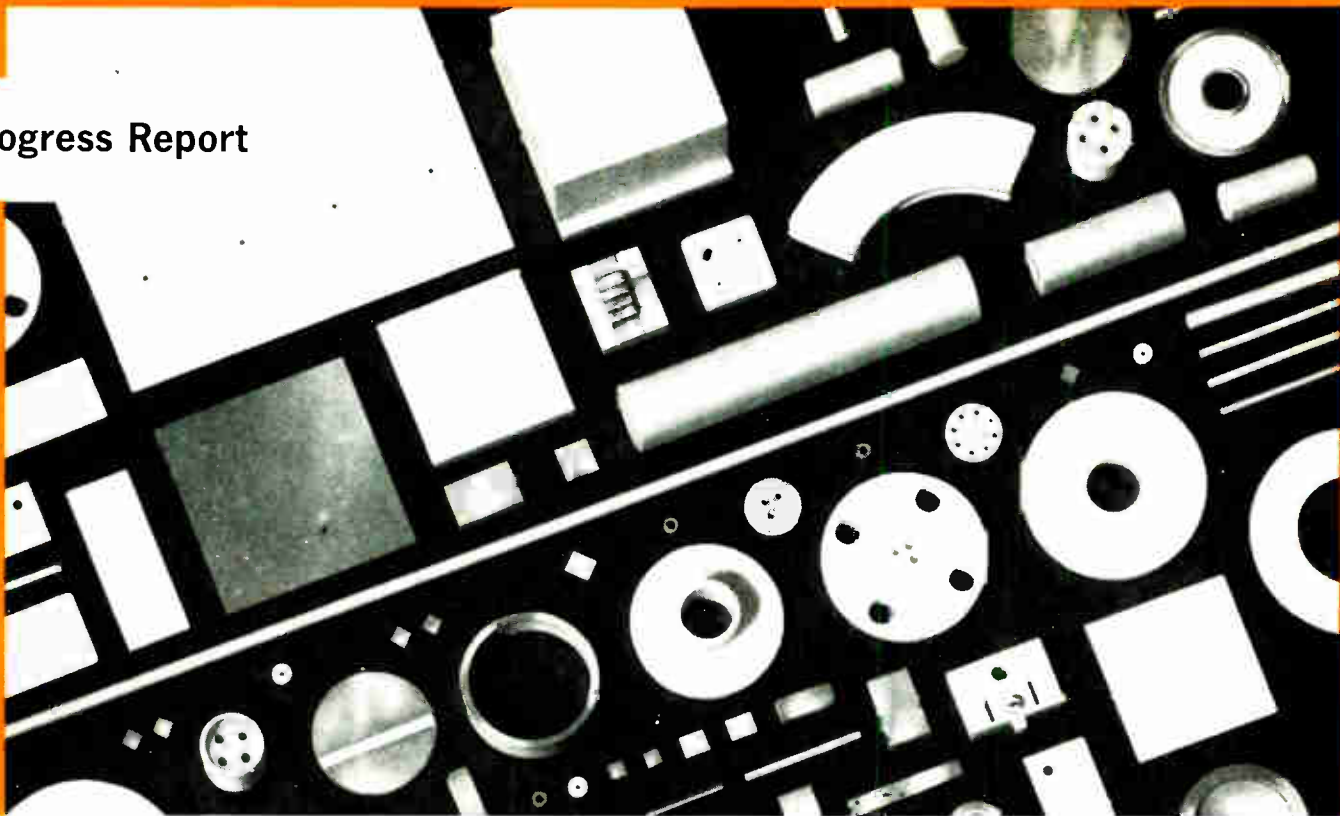

The high thermal conductivity of AlSiMag Beryllia Ceramics is coupled with electrical properties in the same range as alumina ceramics. Beryllia ceramics have high dielectric strength and low dielectric constant. Their high melting point also means high plastic deformation. High thermal conductivity gives superior resistance to thermal shock. The material is chemically stable and has high modulus of elasticity.

Advances in processing AlSiMag Beryllia Ceramics continue to widen their usefulness. In general, AlSiMag Beryllia Ceramics are now fabricated in the same wide range as AlSiMag alumina ceramics. This includes small precision parts, small rods and tubes such as helix rods, cores for carbon deposited, metal deposited or wire wound resistors, substrates, base for composite substrates, packages and other applications where heat dissipation is important.

Unusual requirements including improved strength and controlled dielectric constant can be met in some designs. American Lava offers single-source responsibility on a wide range of processes on AlSiMag Beryllia Ceramics including precision fabrication, grinding, lapping, metallizing and plating.

Outline your requirements. Prototypes can be furnished promptly for your evaluation.

## ALSiMAG<sup>®</sup> BERYLLIA (Heat Conductive) CERAMICS

Bulletin  
675  
on AlSiMag  
Beryllia  
Ceramics  
sent on  
request

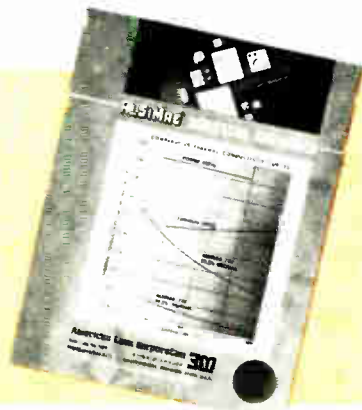

CODE IDENT. NO 70371

**American Lava Corporation** **3M**  
A SUBSIDIARY OF COMPANY

PHONE 615 265 3411, CHATTANOOGA, TENN. 37405

For service, contact American Lava representatives in Offices of Minnesota Mining and Manufacturing Company in these cities (see your local telephone directory): Boston: Needham Heights, Massachusetts • Chicago: Elmhurst, Illinois • Dallas, Texas • Elyria, Ohio • Laurens, S. C. • Los Angeles, California • Metropolitan New York: Ridgefield, N. J. • Up-State New York and Canada: Phoenix, New York • Orange, Conn. • Philadelphia, Penn. • Roanoke, Va. • St. Louis: Lee's Summit, Mo. • South San Francisco, Calif. • 3M International: c/o American Lava Corp., Chattanooga, Tenn. 37405, U.S.A. 615/265-3411.

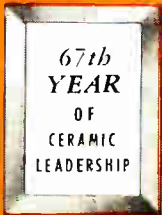

Actual photographs show the filtering effect of Stackpole ferrite beads on critical electronic circuits. Left — without beads, right — with beads.

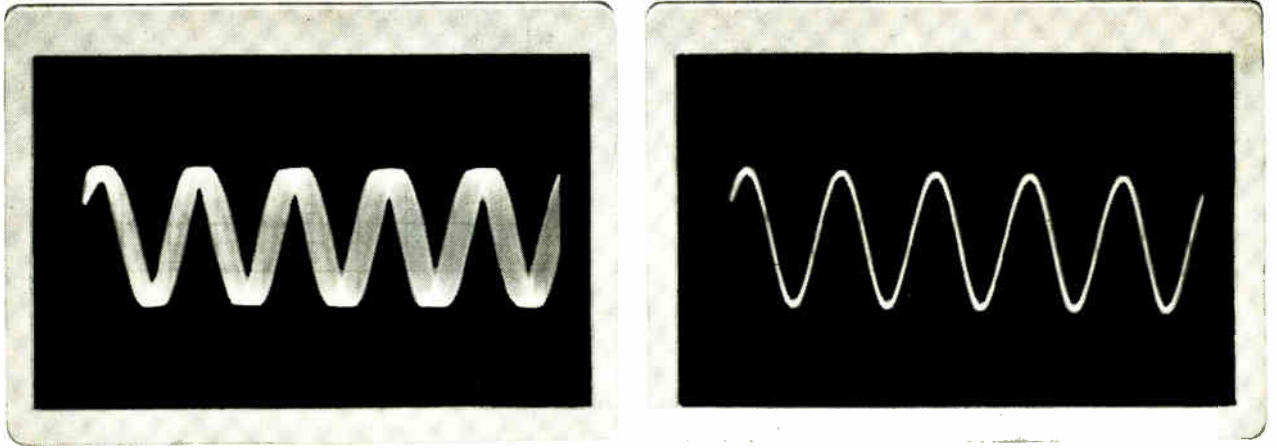

## Stackpole Ceramag® beads solve noise and filter problems easily and economically



Ceramag® ferrite beads offer a simple, inexpensive, yet effective means of obtaining RF decoupling, shielding, and parasitic suppression without sacrificing low frequency power or signal level.

Unlike conventional RF chokes, beads are compact, have no DC losses, and will not couple to stray capacity and introduce detuning or spurious oscillations. Ceramag® beads offer an impedance which varies from quite low at low frequencies to quite high at noise frequencies. Beads need not be grounded; how-

ever, chassis contact is permissible when desired, as beads possess sufficiently high resistivity to preclude grounding.

Installation of Stackpole beads is easy. Simply slip one (or several) over appropriate conductor(s) for the desired noise suppression or high frequency isolation. Beads are available in sleeve form in a range of sizes starting at .025 ID, .060 OD, and .400 long. For special compact filtering applications such as cable connectors, beads can be supplied to tight mechanical tolerances.

Several ferrite grades provide a variety of attenuation characteristics. Inductance tolerance is normally  $\pm 30\%$  as measured on an LC meter. The performance of a Ceramag® 7D bead as a parasitic suppressor is shown in Figure 1.

Other typical applications might include: decoupling in "B" circuitry; noise suppression; RF isolation in filament circuits; use in combination with capacitors to form "L" networks.

FIGURE 1

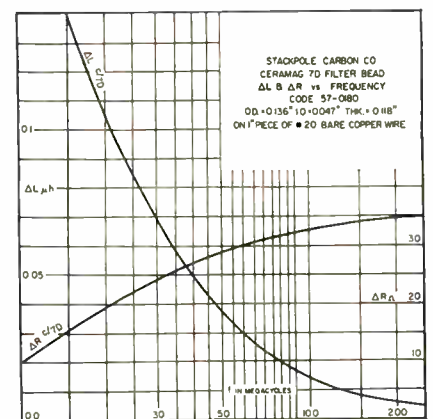

Sample quantities of Ceramag® beads are available without charge upon request. Send your requirements to Stackpole Carbon Company, Electronic Components Division, St. Marys, Pennsylvania 15857. Phone: 814-781-8521. TWX: 510-693-4511.



# TRW SPACE SAVING SOLID TANTALUM CAPACITORS

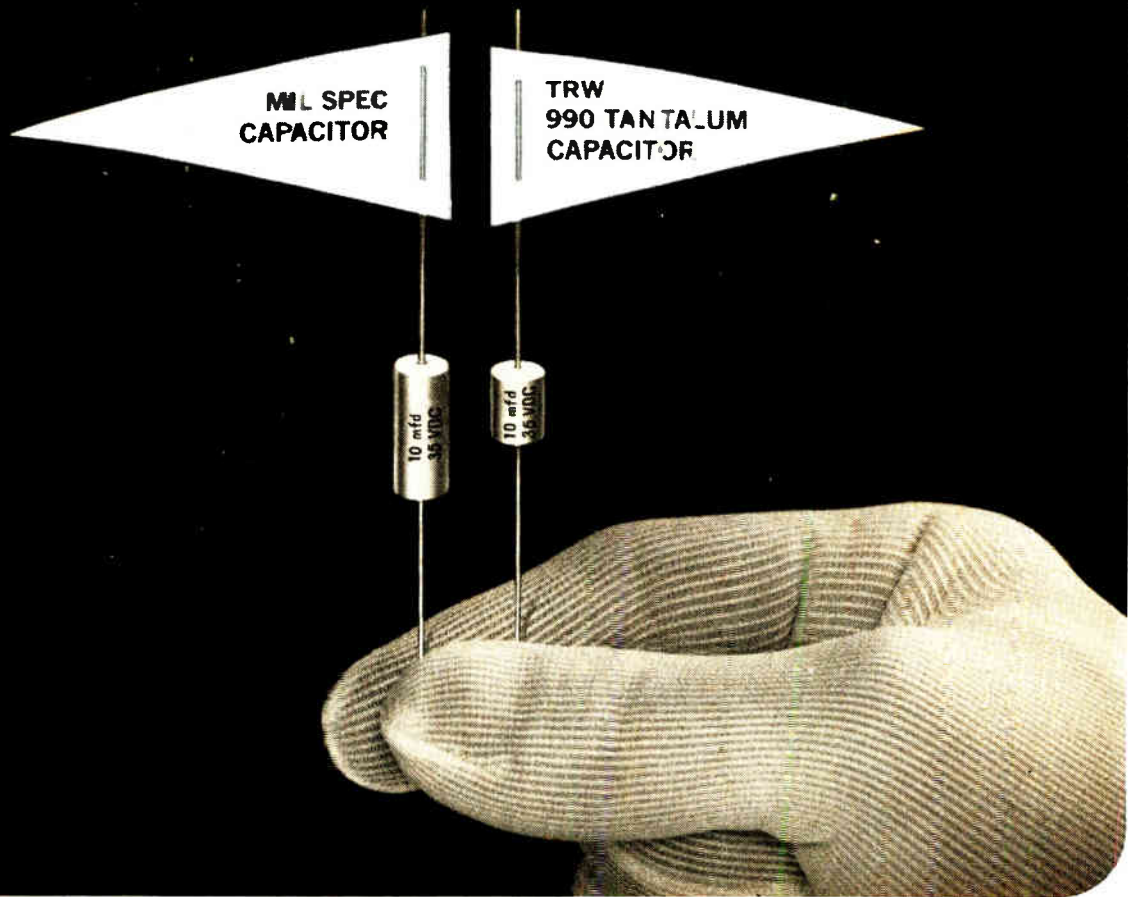

## MIL spec performance...in half the space!

Type 990 miniature solid tantalums typify TRW's creative engineering. They're *designed* to fit in half the space. *Designed* to give better shock and vibration resistance. *Designed* to MIL

specs. They're *designed* to be the best hermetically sealed tantalums you can buy. Values from 8.2 to 330 mfd, 5 to 35 V.

Get the TRW tantalum story on space-savers like the 990,

on standard MIL types and tantalum hi rel capability. Contact TRW Capacitor Division, TRW INC., Box 1000, Ogallala, Nebraska. Phone (308) 284-3611. TWX: 910-620-0321.

# TRW

# Helipot rings up the twelve dollar C. P. pot.



The new Model 3351 conductive plastic potentiometer is our twelve dollar solution to your age-old budget problem. It's a new low price for a non-wirewound precision potentiometer, and yet performance and quality have not been sacrificed. This new model excels wherever high precision and long, trouble-free life are needed at minimum cost.

If you like the \$12.00 price, then check these specs. ■ Essentially infinite resolution. ■ Standard resistance range; 1K to 75K ohms. ■ Long life. ■ Linearity;  $\pm 0.5\%$ .

■ Power rating; 0.75 watts at 70 C. ■ Resistance tolerance;  $\pm 10\%$ . ■ Operating temperature range;  $-65^{\circ}\text{C}$  to  $+125^{\circ}\text{C}$ . ■ Factory stocked.

Also, Helipot has other all-new non-wirewound pots to satisfy most every application. Standard servo mount models with either conductive plastic or cermet resistance elements are available in  $7/8$ " and  $1-1/16$ " diameter. And they are priced under \$25.00.

Ask your local Helipot sales representative for the complete non-wirewound pot story... now.

**Beckman®**

INSTRUMENTS, INC.

HELIPOT DIVISION

FULLERTON, CALIFORNIA • 92634

INTERNATIONAL SUBSIDIARIES: GENEVA; MUNICH; GLENROTHES, SCOTLAND; TOKYO; PARIS; CAFETOWN; LONDON; MEXICO CITY



# Technical Articles

---

**Cutting sampling-induced noise**  
page 70

Sampling of data in a communications system is effectively a form of modulation, and, as such, can introduce unwanted noise. The phenomenon, called aliasing, can be sharply reduced using a filter that cuts out the high-frequency components before sampling. But designing such a filter isn't easy; it requires knowledge of the power content of sampled signals. The use of straight line segments to approximate the spectrum of a worst-case signal can give this knowledge.

**Sophisticated fault-finder for avionics gear**  
page 78

Not only does the Automatic System Self-Test (ASST) detect a malfunction in the avionics equipment aboard, say, a bomber, but the technique proposed by IBM will switch the avionics gear to an alternate mode automatically. The checkout proceeds by finding a malfunction at the highest possible system-performance level, then working its way down until it isolates the fault to a line-replaceable unit.

**IC users face testing challenge**  
page 88

## Electronics



Advances in integrated-circuit technology and increased IC production are making testing more difficult. Most users are attacking the problem by taking shortcuts. Some make only certain checks, and a few don't test at all. And vendors have their own testing problems. One of the most sophisticated test procedures is that of Sylvania's semiconductor division, which uses the automatic equipment shown on the cover.

**A review of integrated circuits in Japan**  
page 98

Your introduction to an integrated circuit that's made in Japan may well come with the purchase of a Japanese-built radio, television set, or tape recorder. Japanese electronics companies are still concentrating on consumer products, and their most sophisticated IC's are designed to fill needs in this area. Meanwhile, Japan is satisfied to make use of U.S. IC designs for its computers. But its efforts to overhaul U.S. technology in the digital field may soon begin to pay off, and unique circuitry, particularly for calculators, may start to appear.

---

## Coming Threshold logic

Threshold logic is perhaps only half as costly as conventional Boolean gates—especially when it's integrated in large arrays of threshold gates. An RCA engineer will describe a new circuit arrangement that makes this possible, and show how it can be designed into common logic functions.

# Cutting noise in data sampling

Straight line approximations of a worst-case signal's spectrum can help an engineer estimate power distribution and design a preprocessing filter

By Thaddeus Kobylarz

Stevens Institute of Technology, Hoboken, N.J.

**Noise caused by sidebands** during data sampling can be reduced by applying a simple method for calculating signal-to-noise power ratio.

By estimating a worst-case signal and breaking up its waveform into straight line segments, it's possible to choose a near optimum sampling frequency and to design a preprocessing filter that will provide the signal-to-noise ratio required for a specific communication system. The filter attenuates the signal's higher-frequency components before sampling, distorting the waveform somewhat, but it more than makes up for this by reducing "aliasing," the overlapping of sidebands and signals.

The method itself is the result of efforts to determine and eliminate one of the major causes of error in a telemetry system being developed at Picatinny Arsenal, N.J., for transmitting information from accelerometers in artillery shells to control stations. The telemetry system sampled the output of each one and passed on the information derived. Investigations showed aliasing to be one of the principal causes of noise.

Aliasing occurs because sampling is equivalent to modulation. A train of sampling pulses,  $S(t)$ , modulates the continuous signal,  $c_s(t) \cdot S(t)$ , representing a function that varies as  $c_s(t)$  when  $S(t) = 1$ , and is zero when  $S(t) = \text{zero}$ .

Since  $S(t)$  is a periodic signal, it can be represented by a Fourier series given by

$$S(t) = \frac{T_w}{T} \left[ 1 + 2 \sum_{n=1}^{\infty} \frac{\sin(n\omega_s T_w/2)}{(n\omega_s T_w/2)} \cos(n\omega_s t) \right]$$

where:  $\omega_s = 2\pi/T$

If  $c_s(t)$  is a sinusoidal signal, then  $c_s(t) = E_M \cos \omega t$ . The modulator output is this factor times the Fourier series.

The trigonometric product  $(\cos \omega t) (\cos n\omega_s t)$  represents suppressed carrier modulation at the carrier frequency  $n\omega_s$ . That is:

$$(\cos \omega t) (\cos n\omega_s t) = \frac{1}{2} [\cos(n\omega_s - \omega)t + \cos(n\omega_s + \omega)t]$$

Combining this product and the modulator output equation yields the following infinite series:

$$e_o(t) = \frac{T_w}{T} E_m \left[ \cos \omega t + \sum_{n=1}^{\infty} \frac{\sin(n\omega_s T_w/2)}{(n\omega_s T_w/2)} \times \right. \\ \left. \cos(n\omega_s - \omega)t + \sum_{n=1}^{\infty} \frac{\sin(n\omega_s T_w/2)}{(n\omega_s T_w/2)} \cos(n\omega_s + \omega)t \right]$$

Sampling, therefore, results in a superposition of sinusoidal signals varying at  $\omega$ ,  $\omega_s - \omega$ ,  $\omega_s + \omega$ ,  $2\omega_s - \omega$ ,  $2\omega_s + \omega$  . . . where  $\omega_s$  is the sampling frequency and  $\omega$  the sampled frequency. If  $\omega_s - \omega > \omega$ , then a low-pass filter placed after the sampling circuit can be designed to remove components at and above  $\omega_s - \omega$ , thereby restoring the original signal.

If a signal is a complex wave with many frequency components, sampling will preserve the original signal spectrum but create sidebands at  $\omega_s$ ,  $2\omega_s$  . . . The sidebands are attenuated by the factor  $(T_w/T) \sin(n\omega_s T_w/2) / (n\omega_s T_w/2)$ . If, as Shanon determined, the sampling frequency is set at a level double the highest-frequency component of the sampled signal, an ideal low-pass filter that cuts off at  $\omega_s/2$  and has no phase shift can be used to completely eliminate the sidebands and recover the original signal.

Unfortunately, complex waves approach zero am-

## The author



Thaddeus Kobylarz is an assistant professor of electrical engineering at Stevens Institute of Technology. He holds a Ph.D. from North Carolina State University and has also taught at Princeton University. His experience includes work as a components designer for the General Electric Co.



plitude asymptotically for high frequencies. It's therefore impractical to set the sampling frequency at twice the sampled frequency. So, because  $c_s(t)$  has frequency components beyond  $\omega_s/2$ , sidebands can overlap the original signal, acting as a noise source.

The first problem of the design engineer is to determine the amount of noise attributable to aliasing in a communications system with a given signal spectrum and Nyquist frequency. To simplify his task, he assumes that the system's receiver has a low-pass filter that recovers only frequencies between d-c and  $\omega_s/2$ . Overlapping sidebands in the same frequency band as the signal will then be the only cause of noise.

Considering the noise contributed by modulation only at the fundamental sampling frequency,  $\omega_s$ , the overlap exists in the following frequency range with the following proportionality constant:

$$-\frac{\omega_s}{2} \leq (\omega_s - \omega) \leq \frac{\omega_s}{2}$$

$$\frac{T_w}{T} \frac{\sin \frac{\omega_s T_w}{2}}{\frac{\omega_s T_w}{2}}$$

The amplitude spectrum of a signal modulated at the fundamental sampling frequency is preserved but is shifted in frequency by an amount equal to  $\omega_s$  and also attenuated by the factor  $(T_w/T) \sin(\omega_s T_w/2) / (\omega_s T_w/2)$ . This means that an attenuated segment of the original amplitude spectrum folds over the modulated signal; finding this segment requires solving for the  $\omega$  range of the inequality

$$\frac{\omega_s}{2} \leq \omega \leq \frac{3\omega_s}{2}$$

Overlapping segments and proportionality constants are expressed generally as

$$\frac{2n-1}{2} \omega_s \leq \omega \leq \frac{2n+1}{2} \omega_s$$

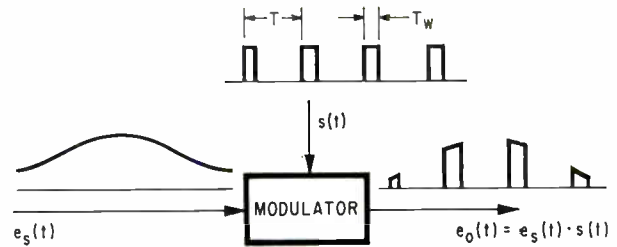
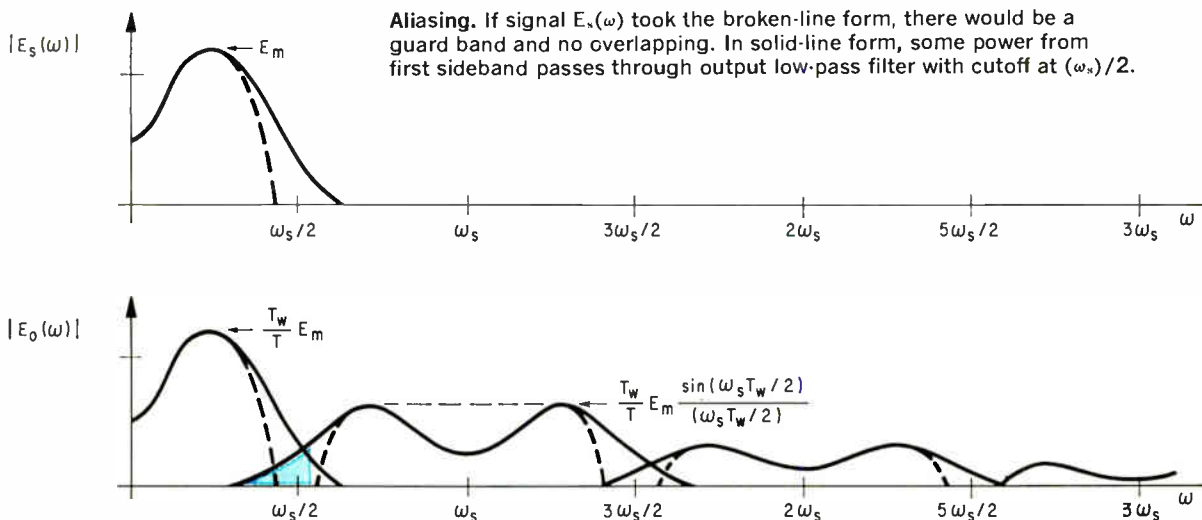

**Mixing.** Modulator combines sampled wave with sampling pulses. Output contains sum and difference frequencies.

$$\frac{T_w}{T} \frac{\sin(n\omega_s T_w/2)}{(n\omega_s T_w/2)}$$

Assuming that a worst-case signal spectrum can be estimated its power content must be measured to determine the signal-to-noise ratio possible with given system parameters. Only one form of spectral function need be considered, fortunately, because the spectrum of any wave can be broken into segments. And total power can be found by integrating each segment—essentially calculating the area under each segment and adding up these areas. If  $c(t)$  has a continuous amplitude spectrum expressed by  $|E(f)|$ , the total energy available from the signal is given by

$$W_s = \int_{-\infty}^{\infty} |E(f)|^2 df = 2 \int_0^{\infty} |E(f)|^2 df$$

Since this equation indicates total energy, the average power for a duration  $T_D$  is  $W_s/T_D$ . It applies both to noise and usable signal. Sampling doesn't generate noise in the absence of a signal, so average noise power is expressed by  $W_N/T_D$  and the quantity  $T_D$  cancels out when the signal-to-noise ratio is expressed. For this reason,  $T_D$  will be neglected. The factor 2 in the equation will also be neglected, again because of the cancellation.

It's useful to consider amplitude spectra of the form:

$$|E(f)| = Af^{m/20} \quad (f \geq 0)$$

because on a decibel log frequency-spectrum plot this is a straight line of slope  $m$  and  $y$ -intercept  $20\log_{10}A$ .

$$20 \log_{10} |E(f)| = 20 \log_{10} A + m \log_{10} f$$

Thus, neglecting the factors 2 and  $T_D$ , the power can be calculated from this basic power equation

$$P = \int_{f_1}^{f_2} |E(f)|^2 df = \int_{f_1}^{f_2} A^2 f^{m/10} df$$

$$= \frac{10A^2}{m+10} [f_2^{(m+10)/10} - f_1^{(m+10)/10}] \quad (m \neq -10)$$

Most amplitude spectra for signals and filters can be approximated by a family of straight line segments on a logarithmic scale. Therefore,  $m$  and  $A = 10(A_{db}/20)$  can be determined directly from the graph for each of the segments, and power can be computed from the integral equation. The value, of course, isn't exact because the straight line segments only approximate the actual amplitude spectrum.

The power equation doesn't include the case where the slope is  $-10$  db per decade. This leads to the form  $\ln f$ , which will be disregarded not only because it's very difficult to work with but also, happily, infrequent.

Because it's often more convenient to evaluate power in decibels, the power is often written:

$$P \text{ (db)} = 10 \log_{10} P$$

$$= 10 + A_{db} + 10 \log_{10} \left[ \frac{f_2^{\frac{m+10}{10}} - f_1^{\frac{m+10}{10}}}{m+10} \right]$$

where:  $A_{db} = 20 \log_{10} A$

Several common variations of the power equation are:

\* Case 1:

$$m = 0 \quad P_1 = A^2 (f_2 - f_1)$$

$$P_1 \text{ (db)} = A_{db} + 10 \log_{10} (f_2 - f_1)$$

\* Case 2:

$$m = 0, \quad f_1 = 0 \quad P_2 = A^2 f_2$$

$$P_2 \text{ (db)} = A_{db} + 10 \log_{10} (f_2)$$

\* Case 3:

$$m \neq -10, \quad 20 \log_{10} |E(f_1)| = K_{db}$$

$$P_3 = \frac{10^{(K_{db}+10)/10}}{m+10} f_1 \left[ \left( \frac{f_2}{f_1} \right)^{(m+10)/10} - 1 \right]$$

$$P_3 \text{ (db)} = 10 + K_{db} + 10 \log_{10} \left\{ f_1 \left[ \frac{(f_2/f_1)^{(m+10)/10} - 1}{m+10} \right] \right\}$$

\* Case 4:

$$m < -10, \quad f_2 \rightarrow \infty, \quad 20 \log_{10} |E(f_1)| = K_{db}$$

$$P_4 = - \frac{10^{(K_{db}+10)/10}}{m+10} f_1$$

$$P_4 \text{ (db)} = 10 + K_{db} + 10 \log_{10} \left[ - \frac{f_1}{m+10} \right]$$

\* Case 5:

$$m > -10, \quad f_1 = 0, \quad 20 \log_{10} |E(f_2)| = K_{db}$$

$$P_5 = \frac{10^{(K_{db}+10)/10}}{m+10} f_2$$

$$P_5 \text{ (db)} = 10 + K_{db} + 10 \log_{10} [f_2/(m+10)]$$

The figure on page 73 shows how power content is computed in decibels by approximating the waveform with four line segments. Computing the power in the first region,  $P_a$ , requires the application of case 5.

$$P_a \text{ (db)} = 10 + 20 + 10 \log_{10} [100/(10+10)]$$

$$= 37 \text{ db}$$

Case 1 applies in the second region:

$$P_b \text{ (db)} = 20 + 10 \log (1100 - 100) = 50 \text{ db}$$

Cases 3 and 4 are used for the third,  $P_c$ , and fourth,  $P_d$ , regions, respectively

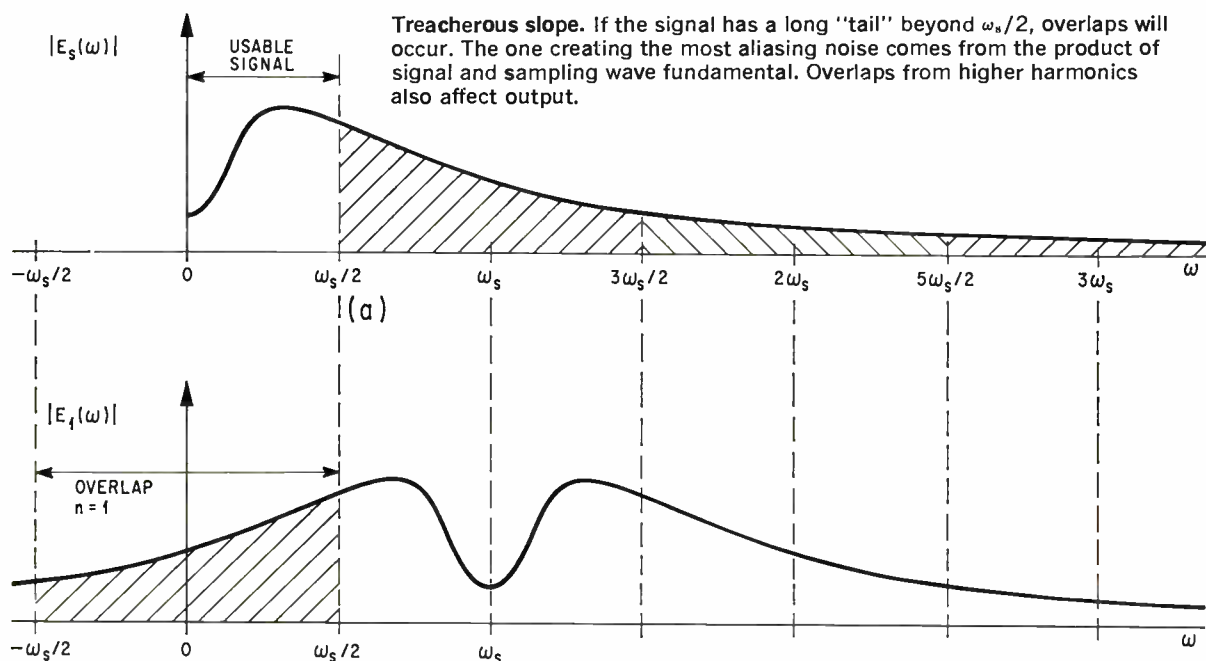

$$P_c \text{ (db)} = 10 + 20 + 10 \log_{10} \left\{ 1100 \left[ \frac{(11000/1100)^{-1} - 1}{-20 + 10} \right] \right\} = 50 \text{ db}$$

$$P_d \text{ (db)} = 10 + 0 + 10 \log_{10} \left[ -\frac{11000}{-32 + 10} \right] = 37 \text{ db}$$

If only the total power of the entire waveform has to be determined, the use of linear rather than logarithmic relationships saves some labor. Total power of the previous example is:

$$P_T = 10^{P_a \text{ (db)}/10} + 10^{P_b \text{ (db)}/10} + 10^{P_c \text{ (db)}/10} + 10^{P_d \text{ (db)}/10} = 2.1 \times 10^6, \text{ or } P_T \text{ (db)} = 53.2 \text{ db}$$

Without the straight line approximations, the calculations would require a computer.

If the power computations are used in synthesis, the preprocessing filter design and sampling frequency—can be arrived at through trial and error.

The first step is to estimate a worst-case amplitude spectrum—selecting one that has the greatest percentage of its power beyond  $\omega_s/2$ . Since components beyond  $\omega_s/2$  cause aliasing, this type signal has the lowest signal-to-noise ratio.

The figure on this page shows such a worst-case signal with an  $f_s$  of 2,200 hertz and a  $T_w$  of 45.5 microseconds. Because the usable signal and the noise are both attenuated by  $T_w/T = T_w f_s$  after sampling, this factor can be ignored; the usable signal power from 0 to  $f_s/2$  thus is:

$$P_s = 10^{P_a \text{ (db)}/10} + 10^{P_b \text{ (db)}/10} + 10^{P_c \text{ (db)}/10} = 2.05 \times 10^5, \text{ or } 50.2 \text{ db}$$

Modulation at  $f_s$  contributes the greatest amount of noise. Therefore, a reasonable lower limit on the noise power is case 3 where:

$$P_{NL} \text{ (db)} = 10 + K_{db} + 10 \log_{10} \left\{ \frac{f_s}{2} \left[ \frac{(2 \cdot 3f_s/2f_s)^{(m+10)/10} - 1}{m + 10} \right] \right\} + 20 \log_{10} \left| \frac{\sin(\omega_s T_w/2)}{(\omega_s T_w/2)} \right|$$

$$= 10 + 20 + 10 \log_{10} \left[ (1100) \frac{(3)^{-1} - 1}{-20 + 10} \right] + 20 \log_{10} \left| \frac{\sin[(2200)(45.5 \times 10^{-6})\pi]}{(2200)(45.5 \times 10^{-6})\pi} \right| = 48.5 \text{ db}$$

Without a preprocessing filter, the sampling noise of such a signal would be down less than 1.7 db, an unacceptable value for any communications system. To improve the signal-to-noise ratio, straight line approximations can be made for various types of low-pass filters and sampling frequencies. For instance, a preprocessing filter that is flat to 1,100 hz and breaks downward at  $m_r$  decibels per decade will have an effect on the noise that can be determined by recomputing the third term of the  $P_{NL} \text{ (db)}$  expression with  $m = m_r - 20$ .

If  $m_r = -60$  db per decade, the upper-bound sig-

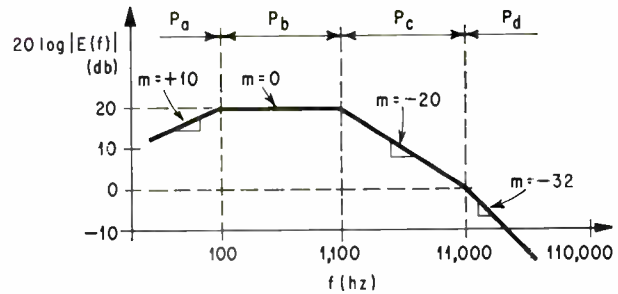

Under the line. Use of straight lines to approximate slopes of signal spectrum eases power calculations.

nal-to-noise ratio increases to 11.4 db. This is still inadequate and points to the necessity of a “guard-band”—a band of frequencies between the first upper breakpoint of the filtered signal and  $f_s/2$ . Increasing  $f_s$  to 22 kilohertz produces a guard band of 8.9 khz. If  $T_w = 4.55 \mu\text{sec}$ , the unfiltered signal with this guard band will have an upper-bound signal-to-noise ratio expressed by:

$$P_s = 10^{P_a \text{ (db)}/10} + 10^{P_b \text{ (db)}/10} + 10^{P_c \text{ (db)}/10} = 2.05 \times 10^5$$

$$P_s \text{ (db)} = 53.1 \text{ db}$$

$$P_{NL} \text{ (db)} = 10 + 0 + 10 \log_{10} \left[ (11000) \frac{(3)^{-2.2} - 1}{-32 + 10} \right] + 20 \log_{10} \left| \frac{\sin[(22000)(4.55 \times 10^{-6})\pi]}{(22000)(4.55 \times 10^{-6})\pi} \right| = 36.4 \text{ db}$$

$$R_U \text{ (db)} = P_s \text{ (db)} - P_{NL} \text{ (db)} = 16.7 \text{ db}$$

A low-pass filter with a cutoff at 1.1 khz and a slope of  $m_r = -20$  db per decade will increase the upper-bound ratio to 37.52 db.

If the ratio  $T/T_w$  exceeds 2, a lower bound on the signal-to-noise ratio can be determined by assuming that case 4 applies with  $f_1 = f_s/2$ . The significance of this assumption is that the attenuation term is the same as that for  $f_s$  at all modulating frequencies. The attenuation will therefore be greater than the assumed amount. The lower-bound ratio of the filtered signal is:

$$P_{NL} \text{ (db)} = 10 - 20 + 10 \log_{10} \left[ \frac{-11000}{-52 + 10} \right] + 20 \log_{10} \left| \frac{\sin[(2\pi)(22000)(4.55 \times 10^{-6})]}{(2\pi)(22000)(4.55 \times 10^{-6})} \right| = 14.02 \text{ db}$$

$$R_L \text{ (db)} = P_s \text{ (db)} - P_{NL} \text{ (db)} = 37.56 \text{ db}$$

The lower and upper bounds of 37.52 db and 37.56 db indicate that more exact computations are unnecessary. Fortunately, most system specifications don't demand more precise ratios. If they do, however, it becomes necessary to index  $n$  in the attenuation factor for the modulating frequencies. Noise powers are computed for the overlap ranges and added together.

Generally, though, additional noise from the overlaps for  $n = 2, 3 \dots$  is so small that the computation of the noise for  $n = 1$  is adequate.

# Designer's casebook

Designer's casebook is a regular feature in Electronics. Readers are invited to submit novel circuit ideas, packaging schemes, or other unusual solutions to design problems. Descriptions should be short. We'll pay \$50 for each item published.

## Sine waves become square, with a symmetrical switch

By George W. Candel

Autonetics, Anaheim, Calif.

**Square-wave signals** that demodulate the output of servocontrol amplifiers must be stable in frequency and high in peak voltage. Fortunately, in the aircraft and ships where these servocontrols are used there is an extremely stable 400-hz line voltage that can be converted into a square wave. This is essentially accomplished by paralleling a transistor's base emitter junction with a diode.

The sine wave's positive portion causes current flow through  $R_1$  and forward biases  $D_1$ . The forward voltage drop across  $D_1$  can never be greater than 0.7 volt, low enough to prevent breakdown of the reverse biased base-emitter junction of  $Q_1$ . Since this transistor is not conducting, there is no current flow through  $R_2$  and  $R_3$ . Consequently, the  $-18$  volts that acts as  $Q_2$ 's emitter supply appears at  $Q_2$ 's base thereby keeping that transistor biased into nonconduction.

With  $Q_2$  off, the positive 18-volt collector supply pulls current through  $R_4$  and forward biases  $Q_3$

into conduction. The 18 volts, minus the small collector emitter drop, appears at emitter of  $Q_3$ . This voltage remains at the output for 1.25 milliseconds, half the wavelength of the input signal, and triggers the circuit on the other side of  $D_3$ . If this pulse is used as the positive square wave it goes out the line that has no diode.

As the input voltage falls to zero, current flow through  $R_1$  becomes small enough to take  $D_1$  out of conduction. Since carriers do not have to be swept out by negative swing of the input voltage,  $Q_1$  is quickly driven into saturation when the negative voltage becomes high enough. This places the collector of  $Q_1$  at ground and allows forward biasing of the base-emitter junction of  $Q_2$  to drive  $Q_2$  into saturation.

With this 18 volts at the collector of  $Q_2$ ,  $Q_3$  is back biased and  $D_2$  forward biased. The current that flows through  $D_2$  develops a negative voltage across  $R_5$  that remains at the output for 1.25 milliseconds. The negative voltage is coupled through  $D_4$  into the circuit that requires a negative pulse or straight out to complete the negative portion of a square wave. Although this circuit was designed to trigger demodulators with field-effect transistor inputs it is possible to trigger transistors, SCRs, SCSs, and vacuum tubes by adjusting  $R_5$  to match the circuit's output impedance to the different loads presented by these devices.

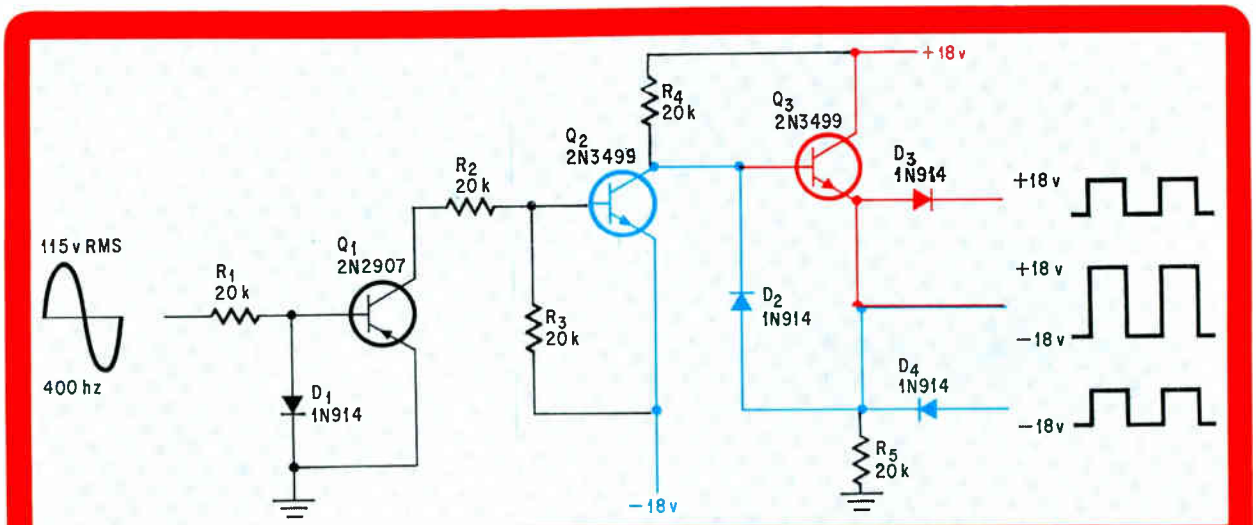

**Alternate gating.** Transistor  $Q_1$  is driven into cutoff when the positive portion of the 400-hz signal is present at the input. Transistor  $Q_2$  is driven into saturation when the negative portion of the 400-hz signal is present at the input.

# Differential amplifier governs magnetic brakes and clutches

By Pellervo J. Kaskinen

Finnish Cable Works Ltd., Helsinki

**In an assembly plant**, an overhead trolley carrying jet engines and fuselages must be gently stopped and started at work stations. Jackrabbit starts and jerky stops can throw these massive loads into swings that damage machinery and injure workers. A differential amplifier, added to a conventional unijunction transistor in a control circuit, makes braking and accelerating respond to a single control.

Because this control can't brake and accelerate at the same time, the jerks caused by simultaneous

application of separate brake and power controls can't occur.

When the contact in the control switch is moved to the positive voltage position, transistor  $Q_1$  in the differential amplifier is biased into conduction. Collector current in the conducting transistor flows through  $R_1$  and  $R_2$ . The potential drop developed across  $R_2$  moves base 2 of the UJT from the supply's 29 volts to a lower voltage. How much lower depends on the magnitude of collector current, which depends on the positive control voltage. As can be seen by the equation

$$V_p = \eta V_{BB} + V_D$$

where  $V_p$  = UJT trigger voltage

$\eta$  = intrinsic standoff ratio of UJT; 0.65 in 2N2646

$V_{BB}$  = voltage between base 1 and base 2 of the UJT

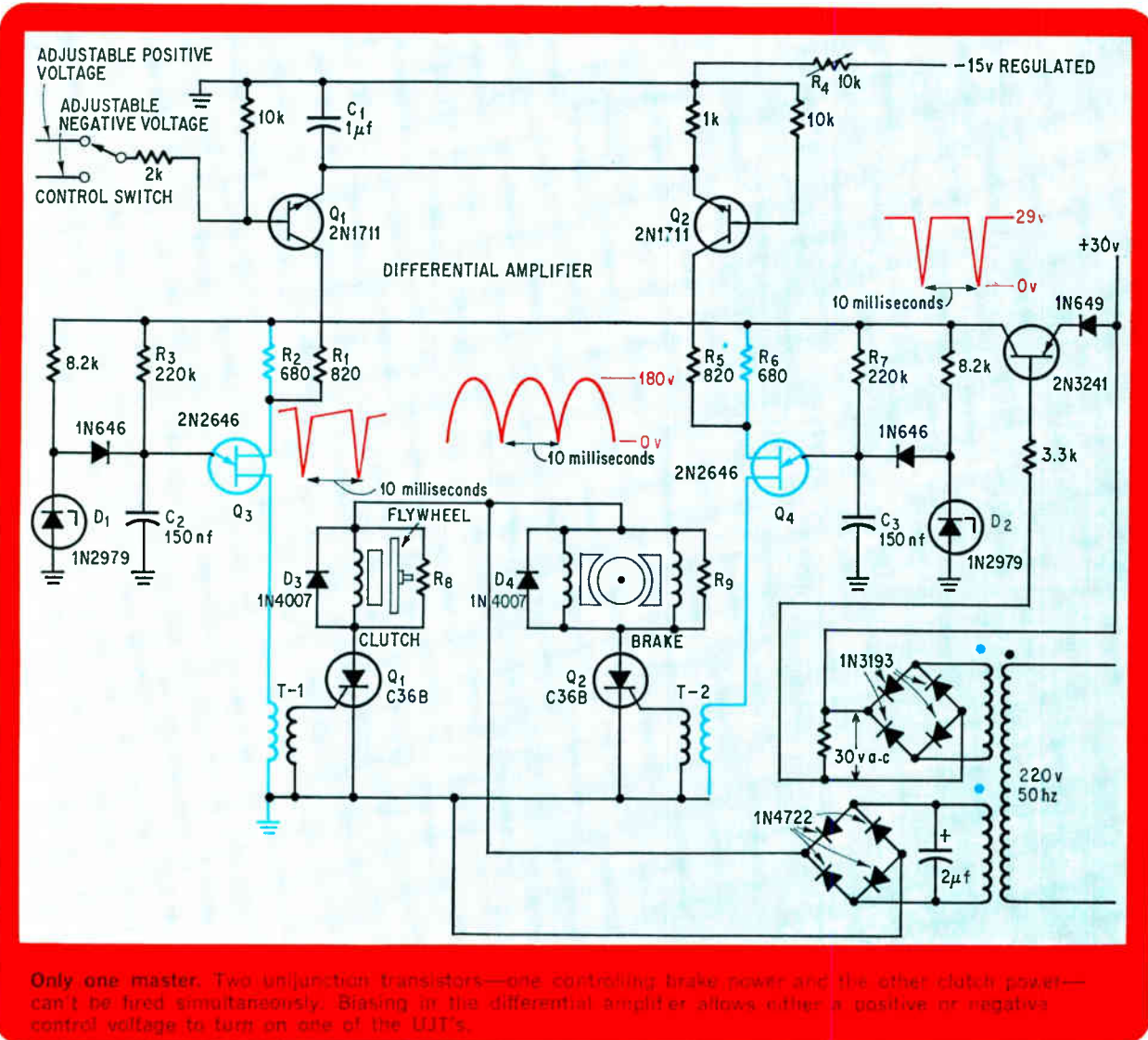

$V_D$  = voltage between the emitter and base 1 of the UJT

A lower base voltage results in a lower trigger voltage for the UJT. If the interbase voltage drops enough and the UJT is triggered, capacitor  $C_2$  discharges through UJT's emitter-base junction and the primary of  $T_1$ .

The voltage induced in the secondary of  $T_1$  by  $C_2$ 's discharge through the primary, gates a silicon controlled rectifier,  $SCR_1$ , into conduction. After  $C_2$  completes its discharge, the emitter-base junction 2 returns to a reverse bias and the UJT is shut off. The SCR, however, remains in conduction until the half cycle in which it started returns to zero. During the half cycle,  $C_2$  charges through  $R_3$ , turns on the UJT, discharges through the primary coil, and places pulses at the gate of  $SCR_1$ . These pulses—about 10 of them—have no gating effect on the conducting SCR.

While  $SCR_1$  is conducting, current flows through the coil in the magnetic clutch. The fields generated inductively couple the load-bearing clutch plate—the one with the coil—to the rotating flywheel on an electric motor's shaft. The amount of power transmitted from the motor to the gears in the trolley depends on the intensity of the magnetic fields induced in the clutch. If the rectified supply voltage on the anode of the SCR is gated into the coil at a point early in each half cycle, average coil current is high and the magnetic fields are strong. Consequently, coupling between the clutch and the flywheel is close; they rotate at the same speed and most of the motor's power is transmitted into the gear system.

A gating late in the half cycle results in low average coil current and, therefore, the transmission of only a fractional part of the motor's power through the clutch. Since the SCR can be gated on for any desired conduction angle, the amount of power coupled through the clutch is continuously variable from full power to zero.

The conduction angle in the SCR depends on both the trigger voltage in the UJT and the synchronization provided by the 29-volt supply. Every 10 milliseconds the rectified voltage drops from 29 volts to zero, thus making base 2 of the UJT zero. Since base 1 of the UJT is always at ground potential, there is now no voltage drop across the bases. This makes the term  $V_{BB}$  in the equation zero. Thus, the above equation becomes

$$V_P = V_D$$

The voltage on capacitor  $C_2$ —regardless of its value—is now the trigger voltage of the UJT, and transistor  $Q_1$  fires. A pulse is induced in the secondary of  $T_1$  and  $SCR_1$  is gated on. No current flows through the SCR despite the gating, because the an-

ode voltage of the SCR is zero, like the UJT's supply.

Synchronization, therefore, establishes a fresh starting point for the circuit every 10 milliseconds. Indiscriminate triggering of the SCR is prevented; the first trigger after the zero voltage point is the one that gates the SCR on. How soon after synchronization the first pulse appears depends on the collector current in  $Q_1$ . If the positive control voltage is high, collector current is high and  $V_{BB}$  in the UJT is low. Capacitor  $C_2$ , charging through  $R_3$ , doesn't have to reach a high voltage before it can trigger the UJT. Consequently, the SCR is gated on early in the half cycle and the conduction angle is large. The total range of positive control voltage is directly related to the conduction angle in the SCR. The waveform at the emitter of UJT drops to a low voltage at points between zero voltages (this isn't shown in the diagram).

Moving the control switch to the negative voltage contact stops conduction in  $Q_1$ . UJT  $Q_3$  triggers now only at the zero-voltage synchronizing point. There is no conduction through  $SCR_1$ , and the clutch is disengaged. The positive voltage present at the emitter of  $Q_2$  while  $Q_1$  was conducting is now removed and replaced by a negative voltage. Transistor  $Q_2$  conducts, draws current through  $R_5$  and  $R_6$ , triggers  $Q_4$ , and causes conduction in  $SCR_2$ . The sequence of events in this circuit is the same as that in the clutch-control circuit. The number of pulses generated in the UJT is directly related to the magnitude of the negative control voltage, and the 29-volt rectified voltage synchronizes unijunction transistor,  $Q_4$ .

The magnetic braking action that takes place when  $SCR_2$  is in conduction is similar to the coupling that takes place in the clutch. Fields generated by the conducting coils retard the rotary motion of the flywheel by inducing eddy currents in it. The strength of braking is directly related to the conduction angle in the SCR, which depends on the magnitude of the negative voltage. Slow braking is accomplished by gradual reduction of the negative voltage.

The potentiometer,  $R_4$ , should be adjusted to a value that keeps  $Q_2$  slightly in conduction when either of the control voltages is zero. A pulse generated by the UJT just before the end of each half cycle gates  $SCR_2$  on for a small conduction angle. Low average current drawn through the coil results in a slight braking pressure.

Resistors  $R_8$  and  $R_9$  and diodes  $D_3$  and  $D_4$  absorb most of the high-frequency voltages generated by switching in the SCR's. Capacitor  $C_1$  prevents the emitters of  $Q_1$  and  $Q_2$  from ever being at the same voltage. Thus these transistors can never conduct simultaneously.

Zener diodes  $D_1$  and  $D_2$  must have breakdown voltages low enough to protect the emitter-base diodes of the UJT's.

# HeNe GAS LASERS

Together with extreme reliability and low cost, ENL Models LS-30 and LS-32 feature:

- Advanced coaxial plasma tube design
- Compact, lightweight laser head for easy mounting
- Simple to operate
- Mechanically rugged design for industrial, laboratory, and classroom applications
- Needs no adjustment, except in the case of multimode operation
- Requires no alignment or maintenance
- Excellent output stability, exceptionally long life
- Fast delivery from stock

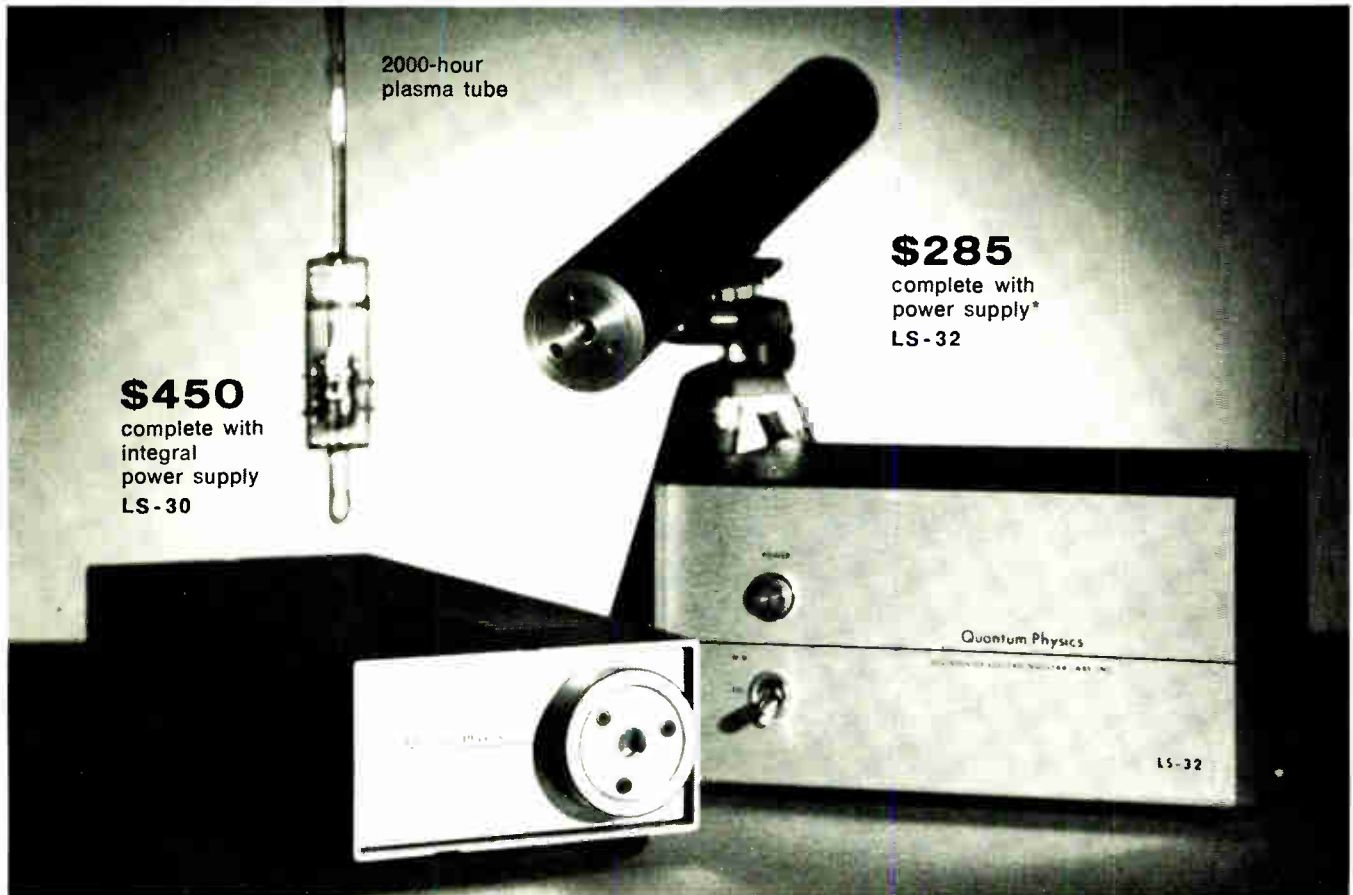

\*Tripod extra

**LASER MODEL LS-30** Extremely compact, low noise CW gas laser with 1% regulated integral power supply. Portable, easy to operate. Features, in common with the entire Quantum Physics laser line, sealed interferometer mounts that require no adjustment, but have the capability for tuning all of the Fabry-Perot interferometer modes. Optical power at 6328 Å, single mode 2.0 mw.

**LASER MODEL LS-32** Educational / laboratory HeNe gas laser of exceptional quality and performance at minimal cost. A complete laser system (including 2% regulated dc power supply). Designed for ease of operation, mounting, stability, ruggedness, and long life. Serves as an excellent source of highly collimated optical radiation at 6328 Å. Output power, single mode 1.5 mw.

**Guaranteed operating life, both models, 2000 hours or one year shelf life.**  
**Ask also for information about ENL's ultra-fast laser and infrared detectors.**  
**Literature available on request.**



**QUANTUM PHYSICS DIVISION**  
**ELECTRO-NUCLEAR LABORATORIES, INC.**

115 Independence Drive, Menlo Park, California 94025 • (415) 322-3451

# Height of sophistication in in-flight monitoring

This approach not only provides for fault detection and mode switching, but prescribes a method of integrating the test and operational systems

By F.H. Hardie and G.E. Simaitis

Electronics Systems Center, International Business Machines Corp., Owego, N.Y.

**Some call it** in-flight performance monitoring, others, airborne automatic checkout. Either way, it's as if the airplane were undergoing a continuous physical examination by an on-board doctor.

Today's high-speed, multipurpose combat planes require just this sort of constant checking of their complex avionics. Faulty operation of any part of the system—and a mission may have more than 150 different modes of operation—must be compensated for or called immediately to the crew's attention.

All modern combat craft feature some degree of automatic monitoring capability, either built in or retrofitted [Electronics, April 29, p. 81]. But what's seen for planes of the future are completely integrated computer-controlled monitoring systems designed into the avionics from the ground up.

One such technique is now being developed by the International Business Machines Corp.'s Elec-

tronics Systems Center. Called Automatic System Self-Test (ASST), the approach is the most advanced yet proposed for in-flight and ground checkout.

The first application of many of the ASST techniques may be in the D and E versions of the LTV Aerospace Corp.'s A-7 attack plane, for which IBM is the systems integrator. IBM will use the test equipment already built into the avionics supplied for the aircraft, plus its on-board 4 Pi computer.

Under the ASST concept, monitoring hardware and software would be designed right along with the operational elements at each stage of an avionics system's development. Full implementation is at least five years away, but when it comes, the ASST system will:

- Evaluate the status of a plane's avionics while the craft is in flight, and will permit the pilot to choose the optimum operating mode for each subsystem.
- Have the capability to shift an operation from a degraded mode to an alternate mode.
- Check out the avionics before a mission, performing the test functions now handled by a ground maintenance crew.
- Diagnose faults and isolate them to a line-replaceable unit (LRU) or module.
- Eliminate the need for any vehicles on the flight line to service the avionics except, perhaps, power-supply and air-conditioning vans.

## Systems approach

The basic approach here goes several giant steps beyond those that require a pilot to check his instruments in flight. Even if he had the time, the interrelationships in modern avionics are so complex that the equipment cannot be evaluated on the basis of its individual elements. A doppler

### The authors



Fred Hardie, manager of integrated test systems and interface engineering at Owego, has been developing diagnostic techniques for aerospace systems and computers at IBM since 1963. He's been with the company for 18 years and is handling the design and development of the automatic self-testing system.



Gervydas Simaitis, an electrical engineer with a master's degree from Penn State, was responsible for the interfacing in the Skybolt and Hound Dog missile systems. He's been working on test systems for the advanced manned strategic aircraft since 1965 and is now a department manager.



radar, for example, carries out its navigation function in combination with inertial equipment and a computer; monitoring the three subsystems separately won't ensure the capability of the three to work together in this one function. ASST takes a systems approach, checking out complete operations as well as individual subsystems.

It provides for automatic, computer-controlled monitoring of dynamic, controlled, and simulated operational variables. However, since both test and monitoring circuits are dispersed throughout the avionics, it isn't possible to point out a single black box as the ASST box. Test routines are run right in with the operational programs, and perhaps the greatest concentration of ASST "equipment" is actually found in the memory of the on-board digital computer.

The way to get such a thorough-going monitoring system into an aircraft is to decide right at the beginning of the design phase that it will be integrated with the avionics, not added after the equipment is already built. The designers must then decide what operations are to be tested and how. And as changes are made in the avionics subsystems as the design process moves along, similar changes must be made in the monitoring and checkout scheme.

### Guide book

A logical and generally accepted approach has evolved for the development of modern avionics systems. After the operational requirements of the mission are analyzed, equipment configurations that will satisfy these requirements are specified, and, finally, the equipment is designed.

Unfortunately, there's no universally accepted approach to designing an integrated monitoring system. ASST does, however, spell out a procedure that follows along, step by step, with the design of the avionics.

In the mission-analysis phase, the operational functions that must be checked are listed. Tests for these functions are then selected, as are the systems needed to carry out the tests. In the final phase, the specific test and interface circuitry is developed.

Though ASST proceeds at the pace of the avionics development, the system has nothing to do with design verification. It does diagnose the basic system functions; if all the system's interrelated modes are operating properly, it assumes that the individual components are performing as designed, ignoring the highly improbable case of compensating errors. In short, ASST isn't concerned with circuit parameters.

### Alterations

When ASST senses the degradation or complete failure of an operational mode, it can switch the system to the next best, or next most accurate, mode. The pilot can, of course, also take a hand; he can choose an alternate mode himself after getting an indication that something is wrong. How-

ever, if a really hazardous fault should occur—failure of the terrain avoidance radar on a low-level mission, for instance—the system would immediately and automatically take action.

ASST evaluates all the operational modes that can be employed on a certain mission before choosing the order in which they should be substituted for each other. Navigation may, for example, be done with stellar-inertial-doppler, stellar-inertial, or doppler-inertial systems. If one is degraded, ASST will switch to the next most accurate mode. But if ASST finds that the degraded mode is still more accurate than the next available one, it will hold the system in that mode.

Monitoring signals are generated in the system status sensors and sensor circuits dispersed throughout the LRU's of the avionics system, as shown on page 80. Also included in the avionics are special signal simulators that may be needed to exercise portions of the system, plus any built-in test equipment that may already have been designed into a piece of gear.

### Data adapter

Signals from the ASST hardware elements are processed—amplified, conditioned, converted, and combined with other signals—either in the avionics or at a special data adapter interfacing between the ASST circuitry and the on-board computer. The data adapter also controls the special ASST status display, and has access to the regular avionics display in the aircraft. And there's an auxiliary unit for storing program controls and diagnostic routines.

If alternate paths have to be provided for the monitored signals because, for example, they are simulated rather than operational, they can come through separate ASST connectors on each piece of equipment.

The simulating units are needed when operational signals aren't available. Radars, for example, often have to be checked out when there's no target to return a live signal. The simulator provides the test signal in such cases, and the response is compared with precomputed data in the avionics computer to determine functional status.

### Double duty

In general, ASST aims for an economy of space and effort; one stimulus generator may be used for several pieces of equipment, and signals generated in one part of the avionics may be used to test another. The test program controls the signal simulation through the data adapter.

ASST has its own display, and, while operational data is shown only on the avionics displays, test data appears on both the avionics and ASST displays. Certain subsystem status signals—generated by built-in test equipment, for example—are used in the operational programs and are monitored and evaluated by ASST along with the operational and simulated data. The stored diagnostic routines required to locate a fault in an LRU are generally

# Signal paths

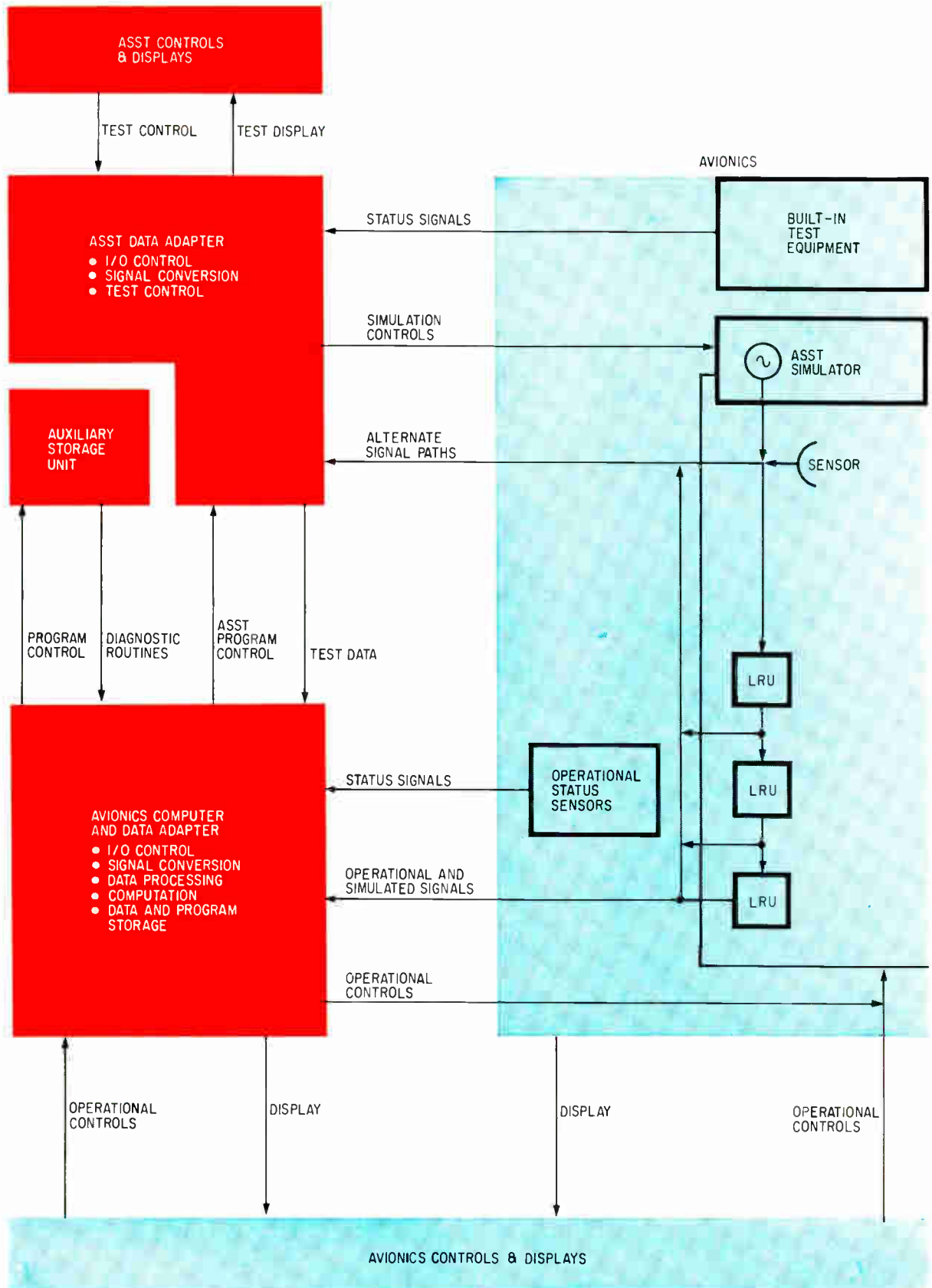

Going through channels. Signals generated in the LRU's are monitored through the data adapter and processed from instructions stored in the digital computer.

called up during ground checkout; faults discovered while the aircraft is in flight need be located only to the level of an operational mode.

### Breaking it up

Perhaps the hardest part of working ASST into an aircraft system is deciding how to divide, or partition, the avionics on the basis of function. This partitioning varies from system to system, but the result in all cases is a functional tree of tasks the equipment must perform. And from this comes a tree of functional test routines.

The routines must be able, of course, to discriminate between faults in the test elements and those in the equipment being monitored. The ASST system is so designed that failures in any of its hardware won't affect the performance of the avionics.

In the partitioning process, the avionics is first divided into sets of primary operational functions—the tasks that must be performed during a mission. These tasks, which include navigation, guidance, and weapons delivery, are further broken down into their component and support functions. Navigation, for instance, involves measurements of velocity and bearing.

The partitioning orders these in a systematic way to develop a tree in which functions branch into subfunctions, subfunctions into modes, modes into submodes, and so on until the level is reached at which faults are to be pinpointed. Theoretically, this level could go beyond an LRU to a circuit or even a component. The fault-location programs would be tremendously complex at these levels, however, and the feeling is that the job should be left to ground maintenance depots.

Once the designer has drawn up his functional tree, the tests to be performed at each level must be determined. In general, tests should be made at the highest functional level so that the fewest possible need be performed. Thus, if each of the primary functions are found within limits, no further testing is needed. Lower-echelon operations are tested only when they can't be covered at a higher level, or, more often, when a fault has been detected in a prime function and its source must be isolated.

### Branching out

In partitioning the avionics, the system (S) is divided into its basic operational functions ( $S_i$ ), where

$$S = \bigcup_{i=1}^n S_i$$

**U** stands for "union" and S is the symbol for a system made up of a set of functions. If each function,  $S_i$ , is tested and found to be okay, it's concluded that the entire avionics must be operat-

ing properly.

A typical system can be partitioned into the following primary functions:

$S_1$ , Navigation—determines the position of the aircraft relative to the earth.

$S_2$ , Guidance—determines how to control the motion of the aircraft relative to the earth.

$S_3$ , Target acquisition—determines the relative position of a target, fix point, or terrain feature with respect to the aircraft.

$S_4$ , Weapons delivery—triggers a weapon.

$S_5$ , Communications—transmits and receives information over radio frequencies.

$S_6$ , Terrain avoidance—determines the instantaneous flight vector that allows the aircraft to fly safely at low levels.

$S_7$ , Defense—detects, identifies, and counters potential threats to the aircraft.

$S_8$ , Reconnaissance—accumulates information on potential targets for future action.

$S_9$ , Damage assessment—accumulates and interprets information on present targets for immediate or later action.

$S_{10}$ , Test—The ASST function of in-flight and ground testing and fault isolation.

Each primary function can, in turn, be partitioned into subfunctions ( $S_{ij}$ ):

$$S_i = \bigcup_{j=1}^m S_{ij}$$

The table at the top of page 83 presents a matrix of the first- and second-level partitioning of the typical avionics system. Each row of the matrix contains the subfunctions of the primary jobs. The interdependence is indicated by the columns. For example, the attitude of the aircraft,  $S_{1,4}$ , is involved in the navigation function,  $S_1$ , but it's also a factor in target acquisition,  $S_3$ , weapons delivery,  $S_4$ , terrain avoidance,  $S_6$ , defense,  $S_7$ , and reconnaissance,  $S_8$ .

Even the identification of the main source of a subfunction is somewhat arbitrary. Aircraft attitude is here derived in the navigation function because this information is produced by equipment that primarily performs navigation. The source could as well have been target acquisition, though, because attitude is critically associated with the stabilization and steering of the earth-sighting sensors.

### Down by six

If each of the primary system functions could be validated by testing just one critical system subfunction—shown shaded in the table—no further testing would be needed. Such a critical subfunction represents the central output task the primary function must perform. For example, aircraft position ( $S_{1,1}$ ) is the critical system function for navigation.

Six levels of partitioning have been defined for

one avionics system IEM is studying, as shown in the table below.

This arrangement—again, quite arbitrary—provides a complete functional description of the avionics. The significance of each level is best explained by referring to an example such as navigation, part of whose functional tree is developed further in the table on page 85.

The second-level navigation subfunction considered in this table is the aircraft's position. Knowing position means knowing three third-level elements—latitude, longitude, and altitude. To simplify things, only one of these subfunctions—latitude—is developed further.

On the fourth level, there are 10 parameters that have to be measured to determine latitude accurately. There is the initial latitude at which the aircraft began its mission, the incremental latitude through which the aircraft has moved, and the present computed latitude. Then there are the values supplied by various pieces of equipment aboard the aircraft—stellar-fixed latitude, radar-fixed latitude, infrared-fixed latitude, and so on. All of these are compared, and the value likely to be most accurate is selected by the ASST routines.

The fifth level brings the process down to where the pilot can finally get an indication that either a piece of equipment or an operating mode is in trouble. He may be told, for example, that the stellar-inertial computer isn't operating properly and that the stellar-inertial latitude is therefore inaccurate. Or that degradation of the air data computer is causing it to register erroneous values for the terrain-comparison latitude.

This fifth echelon is generally the lowest at which faults are isolated during a mission. The sixth level, at which a problem is narrowed to a line-replaceable unit, is important only when the aircraft has returned to base.

### Squeezing in exams

The next step after partitioning is the development of testing routines at each level. ASST test routines and decision logic are sandwiched in amongst the basic operational routines.

Navigation may be validated by checking two values for position, one during position fixing and the other between fix points. During position fixing, the computer value for the aircraft's position is

compared with the value measured by the fix-taking equipment. If the difference between these values doesn't exceed some predetermined limit, the functional test routine exits to the navigation routine. However, if the difference is wide, the test program branches to a mode test routine, which performs lower-level tests—outside the navigation function's mainstream—to determine the reason for the disparity in the  $S_{1,1}$  values.

In this case, the mode test routine would check one or more of seven subfunctions. As indicated in the table on the facing page these are:

- $S_{1,2}$  —Velocity
- $S_{1,3}$  —Heading
- $S_{1,4}$  —Attitude
- $S_{1,7}$  —Actual flight vector
- $S_{1,8}$  —Relative position
- $S_{1,10}$  —Communication
- $S_{1,18}$  —Time

The communication subfunction here refers to the information coming in from various sensors. The validity of this data is established by simulating return signals to the gear used to determine aircraft position with respect to a fix point.

### Timing

The system timing, perhaps the most critical subfunction, would probably be generated by redundant circuitry with built-in self-test capabilities.

The exact nature of the individual tests depends on the configuration of the avionics. A fairly sophisticated system will have several sources for velocity, heading, and attitude measurements, and the validation of these readings will involve comparisons of the variables among the sources.

Where there are more than two sources for any variable, it's relatively easy to identify the one that's faulty. If there are no alternate sources, on the other hand, the subfunction checkout may have to be performed at a lower level. On the fifth partitioning level, the response to simulated signals injected into the front end of a suspected piece of gear could be compared to a reference.

### Educated guesses

During the dead-reckoning phases of navigation between fix points, a measured value for a plane's position isn't available as a reference. The test routine for this phase in the system's operational flow would therefore involve the figuring of an implicit value for position. The rate of position change would be measured and tested against limits either preset or variable, depending on the specific mission.

Other test parameters could, however, be used to validate navigation during dead-reckoning phases. In one ASST scheme, the scalar value for distance traveled is computed and compared to reasonable limits, while headings from at least two

### Stepping down

Partition Level	Identification	Symbol
First	Primary function	$S_i$
Second	Subfunction	$S_{i,j}$
Third	Subfunction element	$S_{i,j,k}$
Fourth	Element parameter	$S_{i,j,k,l}$
Fifth	Equipment and/or operating mode	$S_{i,j,k,l,m}$
Sixth	Line-replaceable unit	$S_{i,j,k,l,m,n}$

## Functional partitioning

Symbol	Subsystem Function	Subfunction																	
		Level	Aircraft Position	Aircraft Velocity	Aircraft Heading	Aircraft Altitude	Inert Data	Flight Vector Command	Actual Flight Vector	Relative Position	Weapon Initialization	Communication	Required Flight Vector	Threat Detection	Threat Identification	Defense Decision	Damage Assessment	Test Decision	Target Data
S <sub>1</sub>	Navigation	S <sub>1,1</sub>	S <sub>1,2</sub>	S <sub>1,3</sub>	S <sub>1,4</sub>			S <sub>1,7</sub>	S <sub>1,8</sub>		S <sub>1,10</sub>								S <sub>1,18</sub>
S <sub>2</sub>	Guidance	S <sub>2,1</sub>	S <sub>2,2</sub>	S <sub>2,3</sub>		S <sub>2,5</sub>	S <sub>2,6</sub>	S <sub>2,7</sub>	S <sub>2,8</sub>		S <sub>2,10</sub>	S <sub>2,11</sub>							
S <sub>3</sub>	Target Acquisition	S <sub>3,1</sub>	S <sub>3,2</sub>	S <sub>3,3</sub>	S <sub>3,4</sub>	S <sub>3,5</sub>			S <sub>3,8</sub>		S <sub>3,10</sub>								
S <sub>4</sub>	Weapon Delivery	S <sub>4,1</sub>	S <sub>4,2</sub>	S <sub>4,3</sub>	S <sub>4,4</sub>	S <sub>4,5</sub>				S <sub>4,9</sub>									
S <sub>5</sub>	Station/Station Communications										S <sub>5,10</sub>								
S <sub>6</sub>	Terrain Avoidance	S <sub>6,1</sub>	S <sub>6,2</sub>	S <sub>6,3</sub>	S <sub>6,4</sub>	S <sub>6,5</sub>			S <sub>6,8</sub>		S <sub>6,10</sub>	S <sub>6,11</sub>							
S <sub>7</sub>	Defense	S <sub>7,1</sub>	S <sub>7,2</sub>	S <sub>7,3</sub>	S <sub>7,4</sub>	S <sub>7,5</sub>			S <sub>7,8</sub>	S <sub>7,9</sub>	S <sub>7,10</sub>	S <sub>7,11</sub>	S <sub>7,12</sub>	S <sub>7,13</sub>	S <sub>7,14</sub>				
S <sub>8</sub>	Reconnaissance	S <sub>8,1</sub>	S <sub>8,2</sub>	S <sub>8,3</sub>	S <sub>8,4</sub>											S <sub>8,15</sub>			
S <sub>9</sub>	Damage Assessment	S <sub>9,1</sub>															S <sub>9,16</sub>		
S <sub>10</sub>	Test																	S <sub>10,17</sub>	

First two levels. Primary functions of a typical avionics system can be checked out by monitoring certain critical subfunctions (shown shaded).

alternate sources are tested against predetermined limits. If these limits aren't exceeded, the ASST program passes from the functional test block to the operational service routine. Here the data needed for another operational function can be transferred to that part of the system.

A limit on the time between fix-point checks is programed into the functional test routine to guard against excessive drift error during relatively long periods of dead-reckoning navigation—on transoceanic flights, for instance. When this time limit is exceeded, the navigation function branches to the mode test routine, where heading and velocity inputs can be checked for accuracy. Lower-level simulation tests may also be performed to assure that individual pieces of equipment are bearing up under the long trip.

### Seven-point program

As shown in the functional data-flow diagram on page 84, ASST is organized to handle seven separate functions: program storage; test selection, initiation, and control; data evaluation; status display; and data storage. Each of these functions is controlled either directly or indirectly by the test program, which itself divides naturally into three types of routines. Executive and functional routines are used in flight, while, as noted earlier, diagnostic routines are pretty much for ground maintenance.

These routines, interlaced with the avionics operational routines, are arranged in a logical decision tree in which the individual tests can be stepped from a functional level down to an equip-

ment check. Each additional step depends on the outcome of the preceding test.

In more detail, ASST's functional blocks are:

**Program storage.** Executive and functional routines are stored in the active core memory of the on-board digital computer. The diagnostic routines that can pinpoint a line-replaceable unit as faulty are in the auxiliary tape storage and can be transferred to the active core memory as required. Constant and variable data associated with each routine are stored at the same location as the routine.

**Test selection.** The executive routines operate on the system level to select and sequence the functional routines, as well as to control the decision logic that adapts the test procedures to changing operational conditions. A pilot can intervene manually in the normally automatic process of test selection—generally at the executive level.

The selected functional routines in turn select the individual functional and modal tests. These routines contain decision logic that determines to what level the tests have to go. When an error is detected, the routine automatically branches to a set of modal tests to locate the source. And manual commands during ground checkout call up diagnostic routines to further isolate the fault.

**Test initiation.** When a specific test is set, ASST energizes test control circuitry and selects the appropriate signal channels and control lines. The test-initiation block determines the required switching functions and makes the connections between the ASST system and the individual avionics black boxes.

Stimuli and load controls are also provided by

## Data flow

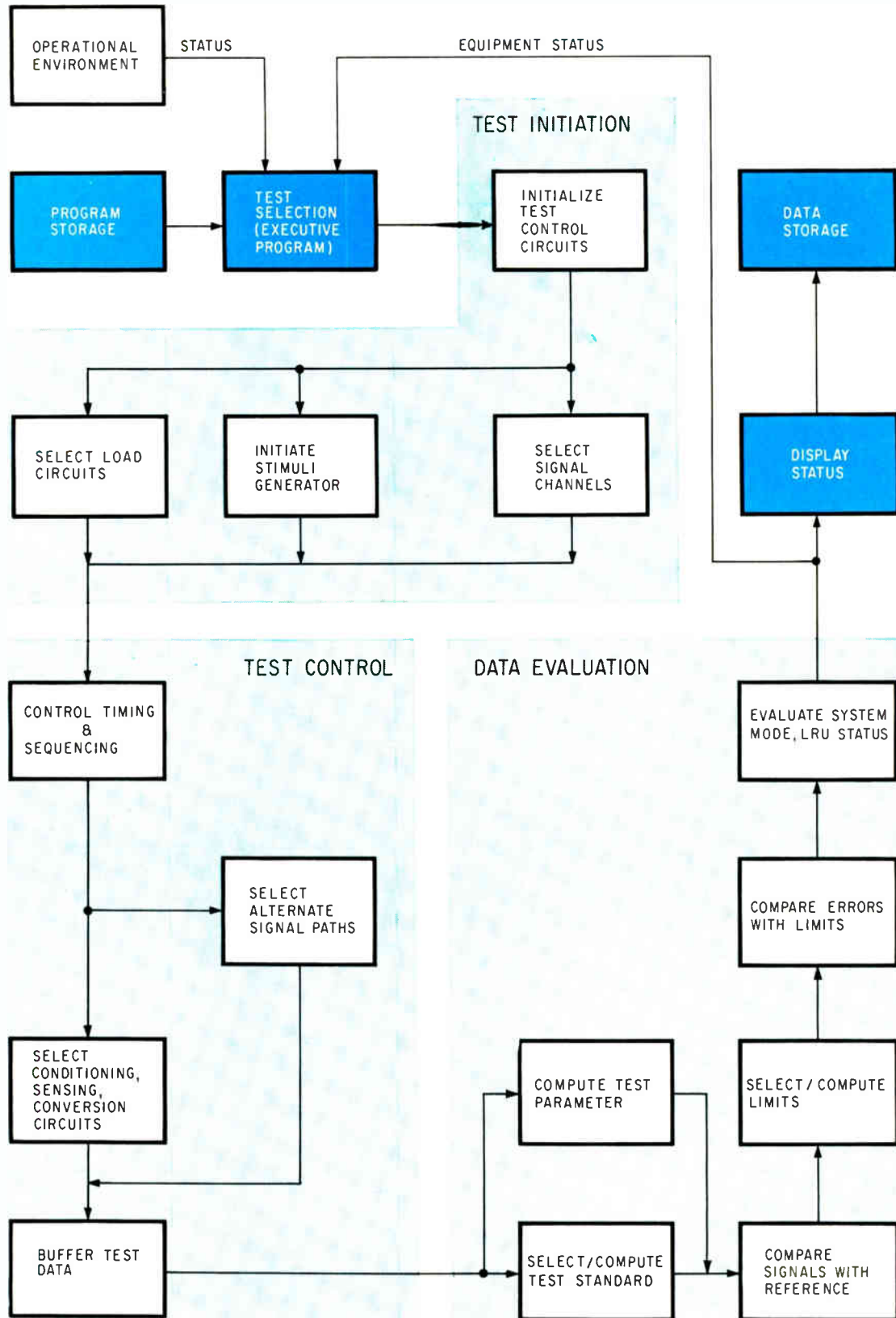

Chain of command. Executive program controls every level of testing, evaluation, storage, and display.

Partial partition tree for navigation function

Subfunction	Subfunction Element	Element Parameter	Equipment/Mode Parameter
S <sub>1,1</sub> Aircraft position	S <sub>1,1,1</sub> Aircraft latitude	Initial latitude	SSCD
		Incremental latitude	Computer
		Computed latitude	Computer
		Stellar-fixed latitude	SIE/Computer
		Radar-fixed latitude	FLR/Computer
			SLR/Computer
			TFR/Computer
			RLR/Computer
		Infrared-fixed latitude	FLIR/Computer
			VIR/Computer
			LLLTV/LRF/Computer
		TERCOM-fixed latitude	ADE/RA/Computer
			ADE/TBD/Computer
		LORAN-fixed latitude	LORAN/Computer
		TACAN-fixed latitude	TACAN/Computer
	S <sub>1,1,2</sub> Aircraft longitude		
	S <sub>1,1,3</sub> Aircraft altitude		

**Key**

- SSCD—second-station controls and displays
- SIE—stellar-inertial equipment
- FLR—forward-looking radar
- SLR—side-looking radar
- TFR—terrain-following radar
- RLR—rearward-looking radar
- FLIR—forward-looking infrared
- VIR—vertical infrared
- LLLTV—low light level television
- LRF—laser rangefinder
- ADE—air data equipment
- RA—radar altimeter
- TERCOM—terrain comparison
- TBD—to be determined

this block. It can activate the signal simulators, apply special circuit loads, and connect transducers and measuring circuits to the selected test points.

**Test control.** The timing and sequencing of the tests, as well as data buffering and signal conditioning and conversion, are handled by the control block. It also runs the process of isolating faults at all levels.

**Data evaluation.** Subfunctions performed in this block include selection of test criteria and computation. The basic method of evaluating test data is, as indicated earlier, to compare it with preset or computed limits. In this process, the system:

- Selects or computes a test parameter.
- Selects or generates a parameter reference.
- Computes the parameter error by comparing the measured signal with its reference value.
- Selects or generates allowable error limits.
- Compares the computed error with these limits.
- Evaluates the functional status of the subsystem on the basis of this comparison.

The parameter reference used to validate measurements will normally be a predetermined nominal value—a computed “correct” answer. The reference in a monitoring test, however, will usually be a signal from an alternate source or the preceding value of the monitored signal. Because dynamic operational signals from the avionics subsystem are used in the latter case, the allowable error limits have to be computed as a function of the immediate conditions.

**Status display.** Here the test results are presented to the human eye. System, functional, and mode

status are displayed both in flight and on the ground.

**Data storage.** Test and status information can be stored during the mission for postflight analysis. Readouts appear on either the system or maintenance displays.

It's estimated that an ASST system integrated throughout a fairly sophisticated aircraft would add only a little more than 3.5 cubic feet to the total volume of the avionics. It will weigh a little more than 76 pounds and consume about 465 watts of power. The amount of hardware in the plane would be increased by less than 5%.

The confidence factor for a complete checkout of an advanced system in flight or on the ground would be better than 0.95.





The monitoring system would take up about three-quarters of the main storage unit and roughly 1/10th of the auxiliary tape store.

About 5,900 words, 32 bits in length, would be needed in the main store. The auxiliary store might need as many as 50,000 words, each also 32 bits long. A multiplexing unit may also be included in the ASST system, but whether it would stand alone or be integrated with other multiplexers in the avionics system would have to be decided in each specific case.

The greatest amount of space—2 cubic feet—would be taken up by hardware for simulating and monitoring test signals with the avionics. This gear, made up of such elements as r-f couplers, logic gates, oscillators, amplifiers, and detectors, will weigh 30 pounds and dissipate 400 watts over-all, but will be dispersed throughout the aircraft.

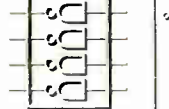
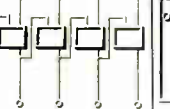
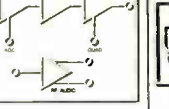
# Fairchild has introduced 32 new products in the last 32 weeks.

Our goal is fifty-two new integrated circuits in fifty-two weeks. To obtain the Reader Service Number for any product announcement ad, simply add 100 to the new product number. For example, New Product No. 3 is Reader Service No. 103.

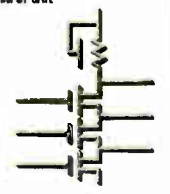
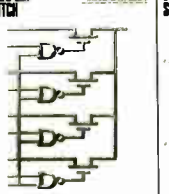
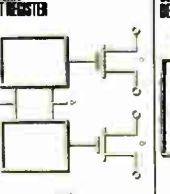
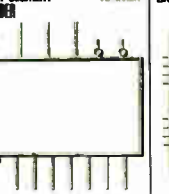
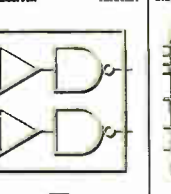
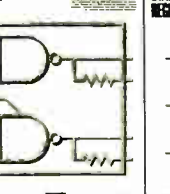
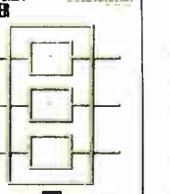
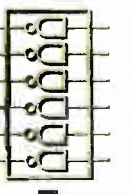
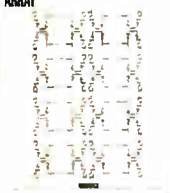
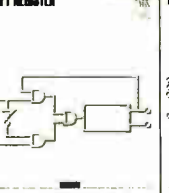
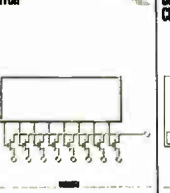
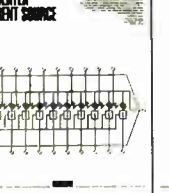
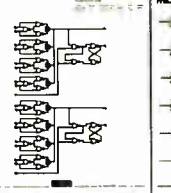
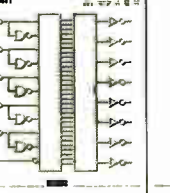
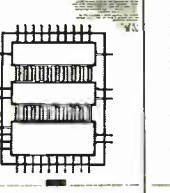
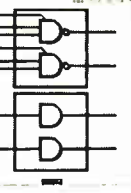
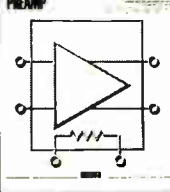
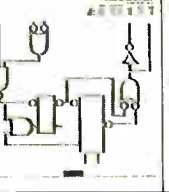
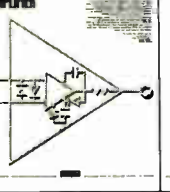
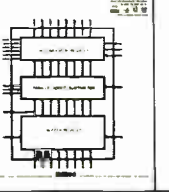
<p><b>9189</b> HIGH LEVEL HEX CONVERTER</p> 	<p><b>9192</b> HIGH LEVEL HEX CONVERTER</p> 	<p><b>9888</b> FOUR-BIT BINARY COUNTER</p> 	<p><b>94710</b> HIGH FREQUENCY COMMUNICATIONS SYSTEM</p> 	<p><b>9825</b> EXPANDABLE HEX INVERTER</p> 	<p><b>3701</b> SIX-CHANNEL MULTIPLEX SWITCH</p> 	<p><b>9816</b> TTL HEX INVERTER</p> 	<p><b>9822</b> DUAL JK FLIP-FLOP</p> 
<p><b>3382</b> MOS THREE-INPUT GATE</p> 	<p><b>3700</b> FOUR-CHANNEL MULTIPLEX SWITCH</p> 	<p><b>3383</b> DUAL 25-BIT DYNAMIC SHIFT REGISTER</p> 	<p><b>9307</b> BCD TO SEVEN-SEGMENT DECODER</p> 	<p><b>9820</b> DUAL DIFFERENTIAL LINE RECEIVER</p> 	<p><b>9821</b> DUAL LINE DRIVER</p> 	<p><b>3300</b> 25-BIT MOS STATIC SHIFT REGISTER</p> 	<p><b>9190</b> HIGH LEVEL LOGIC HEX INVERTER</p> 
<p><b>4500</b> BIPOLAR MACROMATRIX ARRAY</p> 	<p><b>3320</b> MOS 64-BIT 4-PHASE SHIFT REGISTER</p> 	<p><b>3705</b> 8-CHANNEL MOS MULTIPLEX SWITCH</p> 	<p><b>94722</b> PROGRAMMABLE D/A-A/D CONVERTER CURRENT SOURCE</p> 	<p><b>4510</b> DUAL FOUR-BIT COMPARATOR</p> 	<p><b>9824</b> 256-BIT READ-ONLY MEMORY</p> 	<p><b>3750</b> 16-BIT MOS-LSI D/A CONVERTER</p> 	<p><b>9240/925</b> INTERFACIAL CIRCUITS</p> 
<p><b>94727</b> TEMPERATURE-CONTROLLED DIFFERENTIAL PREAMP</p> 	<p><b>9601</b> 16-TIMEBASEABLE MULTIMULTIPLIER</p> 	<p><b>94761</b> HIGH FREQUENCY COMPENSATED OPERATIONAL AMPLIFIER</p> 	<p><b>3800</b> 3801-41 BIT PARALLEL ACCUMULATOR</p> 	<p>May 20, 1968</p>	<p>May 27, 1968</p>	<p>June 3, 1968</p>	<p>June 10, 1968</p>
<p>June 17, 1968</p>	<p>June 24, 1968</p>	<p>July 1, 1968</p>	<p>July 8, 1968</p>	<p>July 15, 1968</p>	<p>July 22, 1968</p>	<p>July 29, 1968</p>	<p>August 5, 1968</p>
<p>August 12, 1968</p>	<p>August 19, 1968</p>	<p>August 26, 1968</p>	<p>September 2, 1968</p>	<p>September 9, 1968</p>	<p>September 16, 1968</p>	<p>September 23, 1968</p>	<p>September 30, 1968</p>



# More about:

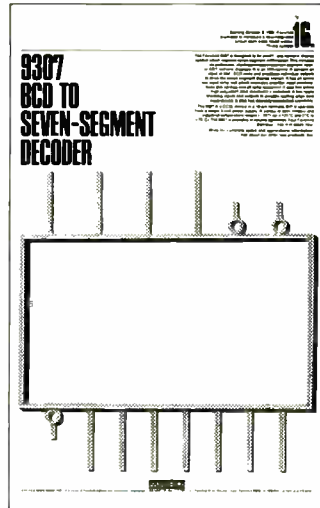
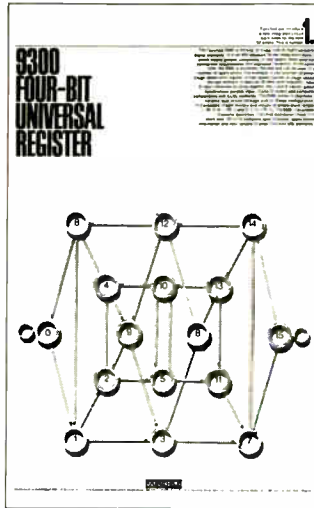

## BINARY TO DECIMAL 7-SEGMENT DISPLAY CONVERTER.

Put new products #1 and #16 together, and you've got the basis of a whole new subsystem. Using five 9300s and four 9307s, combined with a variety of four other Fairchild components (19 packages in all), you can build a subsystem that would normally require 60 discrete integrated circuit packages. (Each 9300 replaces six IC packages and each 9307 replaces five IC packages.)

This application demonstrates the excellent interfacing compatibility of CCSL circuitry. It allows you to combine the best features of each circuit family: MSI for complexity and economy, DT $\mu$ L for wire-OR and lower power applications, and TT $\mu$ L for speed and line driving.

The 9300 and 9307 are MSI. Like the rest of the family, they're designed to work as basic building blocks in any digital logic system. They work together with a minimum of interface circuitry.

The new subsystem converts a 12-bit binary number (in serial form) to the individual outputs required to drive four 7-segment numeric displays. These could include incandescent, electroluminescent, 7-segment neons or CRT numeric displays.

The conversion takes place in two steps: (1) conversion of the 12-bit binary number to parallel BCD code and (2) conversion of the BCD to outputs necessary to drive the 7-segment displays.

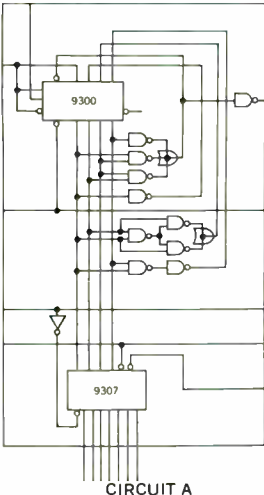

The logic diagram and control counter count sequence illustrates how the conversion takes place. When the START conversion goes high, the 9300 control counter transfers from the 1101 state to the 0111 state (the display outputs, that is, the 9307 decoders, are enabled only in the 1101 state, thus they become disabled and remain so during the entire conversion process). In the 0111 state, the four 9300 shift registers containing the results of the last conversion are cleared to zeros. After the 0111 state is reached, the clock signal is enabled both to the binary source and to the

conversion registers until twelve clock pulses have occurred. After twelve clock pulses, the 1101 state is again entered, at which time the display decoders are enabled to display the results of the conversion, and the clock pulse to the conversion logic and binary source is disabled. The 9300 control counter shifts to the parallel enable mode when the 1101 state is reached, and will remain there until the START conversion goes high again.

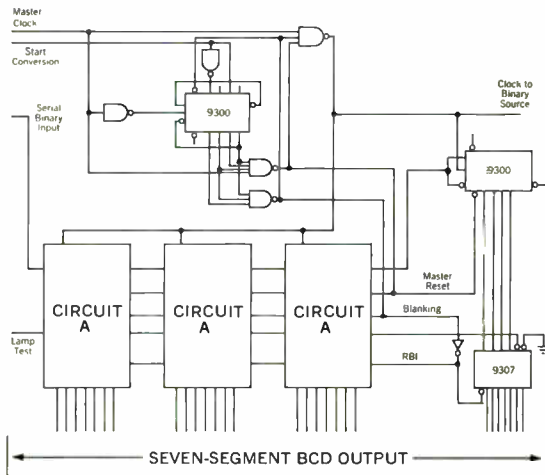

PARTS LIST	Quantity	Part Number	Description
3	.....	9936	DT $\mu$ L Hex Inverters
5	.....	9946	DT $\mu$ L Quad Two-Input Nands
1	.....	9099	TT $\mu$ L Power Driver
1	.....	9003	TT $\mu$ L Triple Three-Input Gate
5	.....	9300	MSI Universal Shift Registers
4	.....	9307	MSI Seven-Segment Decoders

Conversion from the serial binary input to parallel 8421-BCD occurs in the following way: After each bit is shifted into the conversion register (most significant bit first), the numeric contents of every 4-bit register (except the last) are examined. If a register contains a value of 5 or greater, the mode of the register is converted to parallel enable. On the next clock, 3 is added to the present contents of the register and the results are shifted one place.

For complete specs and other application information, circle Reader Service Numbers 101 and 116. If you have an immediate application requirement, call your local Fairchild distributor now.

**FAIRCHILD**  
SEMICONDUCTOR

Fairchild Semiconductor A Division of Fairchild Camera and Instrument Corporation, 313 Fairchild Drive, Mountain View, California 94040 (415) 962-5011 TWX: 910-379-6435

# IC testing tries to keep up with gains in IC technology

Greater speed, complexity, and volume of new devices have been making many test techniques obsolete, forcing users to take shortcuts; most new approaches are still in developmental stages

By Carl Moskowitz  
Instrumentation editor

**Testing of integrated circuits** is getting harder as the IC's become faster and more complex and are produced and used in greater volume. The testing trend is putting a burden on users, who naturally can't spend much time or money on checking IC's as components and have applications to think about. Most users attack the problem by taking shortcuts. Some just see if an IC will work in a given circuit and don't worry about parameters. Others perform d-c but not a-c checks, or take samples instead of testing 100%. And a few users simply don't test.

The testing headaches are the price of progress. The new devices constantly appearing make many testing techniques obsolete. Faster digital devices such as transistor-transistor and emitter-coupled logic modules are examples. The switching time—about 5 nanoseconds or even less—that accounts for their growing popularity is the very parameter that's hard to test.

## Choosing a test method

Functional testing is usually good enough—especially for the low-volume IC user—unless the supplier's parameters are used to the limits of the specification. In this case, a different type of testing, usually d-c (static) or a-c (dynamic), is necessary.

Computer manufacturers and others who rely on an IC's dynamic characteristics call a-c testing a must. But others feel that the results don't justify the cost of dynamic test equipment unless the device is being used to the limit of its specifications.

"D-c tests by themselves aren't adequate performance checks," says Luther Hintz, principal development engineer for digital IC's at Honeywell Inc.'s Aerospace and Defense group. "A-c or pulse tests must accompany d-c tests if all possible de-

fects are to be found." Hintz cites as a typical example a logic element that passed all d-c tests but gave an output in the wrong state for a given input.

Engineers at the Digital Equipment Corp. not only share Hintz's views but also go a step further: they subject IC's to thermal shock just before electrical testing to weed out weak bonds, a frequent cause of failures at DEC.

The Univac Federal Systems division of the Sperry Rand Corp. also tests for an IC's dynamic characteristics. Like DEC and Honeywell, Univac has found much of the commercially available test equipment unsuitable for a-c testing. One of the problems is that commercial testers accommodate a specific type of device or only those of one manufacturer. Univac attacked this problem by designing and building a digitally controlled a-c tester, but Honeywell developed a universal adapter that converts a Fairchild series 4000 d-c tester into a pulse checker for the digital IC's of any manufacturer.

The adapter applies a controlled clock pulse through short leads to test flip-flops for input threshold values to make sure the device has noise immunity. R. G. Parks, development engineer for digital IC's at Honeywell, says, "Few vendors check this on a 100% basis, and those that do don't check all the possible switch and hold positions." The pulser has been used for slightly more than a year, with what Honeywell calls excellent results. "Circuits that meet the specified d-c parameters but have marginal threshold values are easily weeded out with little added test time," Parks says.

Those who buy their testers instead of making them pay from about \$2,000 to more than \$80,000, depending on the complexity of the machine and the degree of automation. The choice depends on how

many IC's are to be tested and which parameters are important. A small user of IC's may prefer a low-cost tester like Microdyne Instruments Inc.'s \$1,695 set. The machine performs d-c and functional tests and can check out an IC in 30 seconds. High-volume IC users would probably prefer a computer-directed machine such as the Fairchild Camera & Instrument Corp.'s series 5000. The basic system performs d-c, functional, and d-c linear tests at a rate of 100 tests per second. Such a machine costs about \$68,000.

Some low-volume users, such as the General Radio Co., save even more money by not using a machine for testing. GR, whose IC failures have almost all been catastrophic, designs jigs for functional tests. For IC's used in a counter, for example, a test jig that closely simulates the counter checks 30 to 40 parameters as if the circuit were in actual use. About the only circuits given a 100% check are the encoder drivers.

### Sampling or service

GR is far from the only user to shy away from 100% testing. In fact, users usually prefer sampling. Lyle Montagne, staff engineer in the reliability and maintainability section at Honeywell's Aerospace and Defense group, says, "Although 100% testing does significantly reduce field failures, it doesn't improve an IC's reliability." Montagne is directing a program to determine whether the benefits of high-reliability testing are sufficient to justify the cost. "It may be that hi-rel tests only provide more data than standard IC tests, not a better part," he says.

Among the small IC users that do away with testing entirely is Adar Associates Inc., Cambridge, Mass. Printed circuit boards for the company's line of memory testers and data generators are manufactured with sockets for the IC's. This simplifies any repairs that must be made after the board is assembled and tested in the final product. The company thinks it's at the break-even point between the cost of the sockets and the testing expense saved. However, the use of sockets is generally less reliable than soldering or welding.

Moderate-sized IC users can also use a testing service. Subsidiaries of Fairchild and of Texas Instruments Incorporated offer complete testing for IC's purchased from any manufacturer. Such services provide even the smallest user with the type of testing facilities usually found only in plants of the largest users and IC vendors.

Both these services use standard computerized test procedures for commercially available IC's. Such tests are the least expensive, costing only pennies per device. Special testing procedures are available at extra cost.

### Going to the source

Another way to attack the problem is to go to the manufacturer. Roger French, programs manager of the Raytheon Co.'s components division, says, "We would prefer testing IC's as a functional element at the supplier's facility, since it is the only

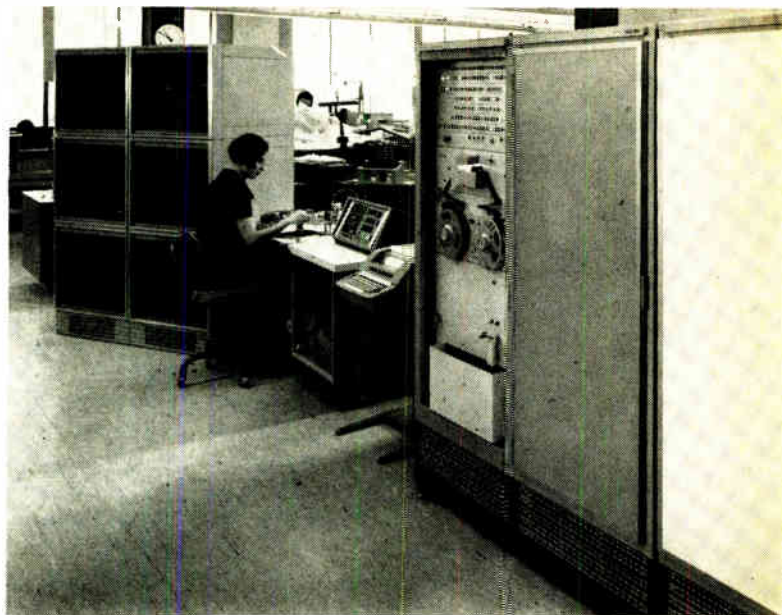

**Adaptive system.** TI's adaptive tester consists of model 553 dynamic test system and 861 digital controller. The controller keeps track of test results and makes decisions; for example, it stops the test cycle as soon as a device fails any check.

way to pinpoint the responsibility for a failure." French feels that small IC users can circumvent a lot of the testing just "by developing a proper interface between themselves and their suppliers;" many problems arise because a manufacturer doesn't understand the user's requirements or the user doesn't understand the manufacturer's specifications. Large users, on the other hand, must establish rigorous testing procedures, generally with digitally controlled testers.

"One problem with such a tester is that the user doesn't know what is being tested," French says. This is partly because the maker of the tester does the programming; a custom program costs extra. Users say that equipment such as Fairchild's 4000 or Texas Instruments' 553 IC tester uses test procedures—sequences and loads—based on manufacturer's specifications rather than user needs. This leads many users to seek testers that can be programmed at their facilities by their engineers. Often, users select a tester that includes a general-purpose computer.

### Programming in English

However, the use of these computers brings its own problems. The proliferation of companies that do nothing but prepare programs for computers such as DEC's PDP-8 attests to the difficulties many users have. Moderate-sized IC users often can't maintain a full-time computer programmer and must consult either the company that made the tester or a group of software specialists whenever the testing techniques or device types are changed.

One way out is to use a digitally controlled tester that can be programmed directly by technicians with

Continued on page 93

## Testing an IC every two seconds

Testing every parameter of an IC is no simple matter. Sylvania does it with testers under the control of a Scientific Data Systems Inc. model SDS-92 computer with a 96,000-bit drum memory. Sylvania's current production volume is supported with two of these automatic testers; a third is being readied for operation.

Each machine has four d-c test stations and one a-c station. The d-c stations consist of four temperature-controlled test chambers—for 75°C, 0°C, 125°C, and -55°C. The a-c switching tests are performed at 25°C, essentially room temperature. The IC's to be tested are stacked in an automatic feed station, and a new IC is inserted in the tester every two seconds.

As each IC enters a test chamber, it is placed on a large wheel and rotated through 180° to the testing head. The rotation time is regulated to make it equivalent to about five IC thermal-time constants. This procedure ensures that the device to be tested stabilizes at the temperature of the chamber before any tests are made.

Two probes make contact with each lead of the IC. One probe senses whether electrical contact has been established and the other makes the actual

test. The tester checks up to 100 parameters at the rate of 17 milliseconds per test. This d-c test procedure is repeated at each of the four temperatures, and the results of each test series are stored in the computer memory.

**Into a bin.** The IC then moves to a fifth test position for dynamic tests down to 2 nanoseconds. Rise time, fall time, turn-on delay, and turn-off delay are verified to the specification for each IC. In this test, each input is individually checked through its appropriate gate structure for all parameters. Each input is verified, not just one input of one multiple-input gate. The results of each a-c test are also stored in the computer memory.

After each IC emerges from the a-c station, the complete test history is reviewed and the IC's are sorted, by electrical performance, into one of 20 bins. Any number of device parameters can serve as sorting criteria. For example, a high input load current for a dual-quad gate is often enough to preclude military use of the IC. Usually, however, the computer considers more than one parameter. The bins can represent categories such as military prime, industrial prime, industrial standard, retest, and rejected.

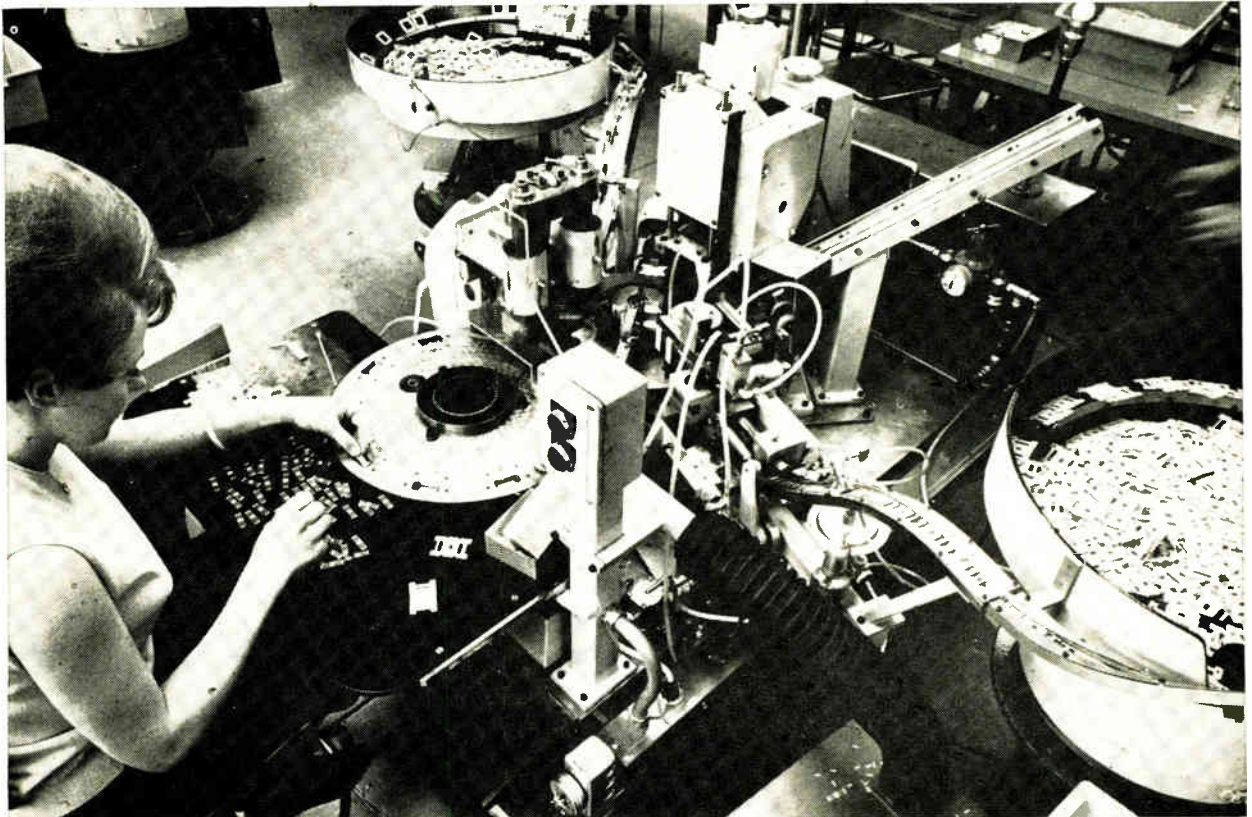

**Getting ready.** Operator loads packaged IC's into automatic machine that trims leads and inserts IC into carrier. The carrier protects leads during subsequent handling and testing and permits Sylvania's automatic tester to accommodate different package configurations.

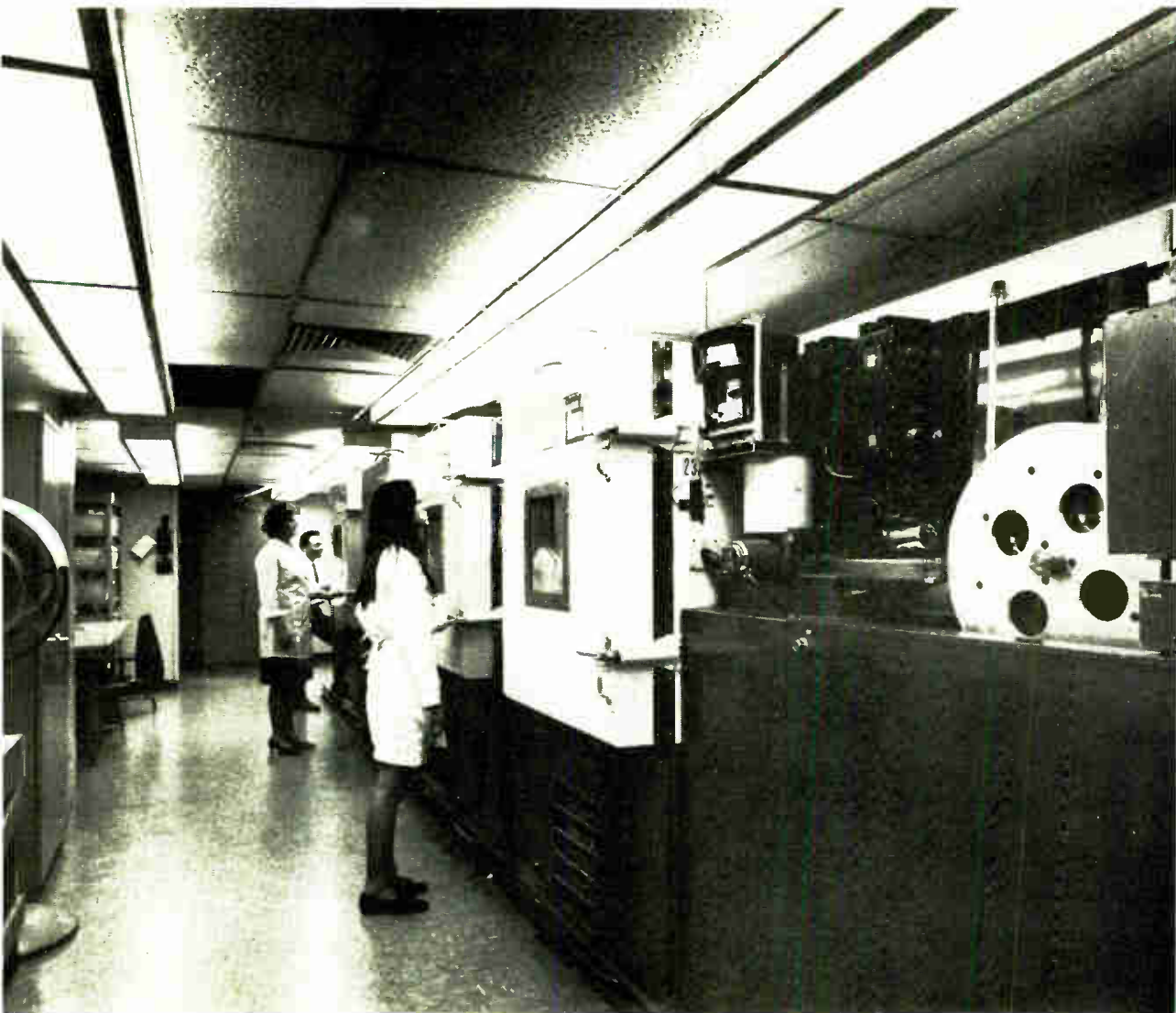

**Hands-off testing.** Test-chamber operating temperatures are checked as IC's progress through the Sylvania tester. Devices are stacked into tester where the man is standing and move through each chamber. They undergo room-temperature a-c tests at the last station.



**Updating.** Test technician and programmer use keyboard to write test programs for new devices or to update programs in the memory. Typewriter printout can be used to record data on the devices being tested.

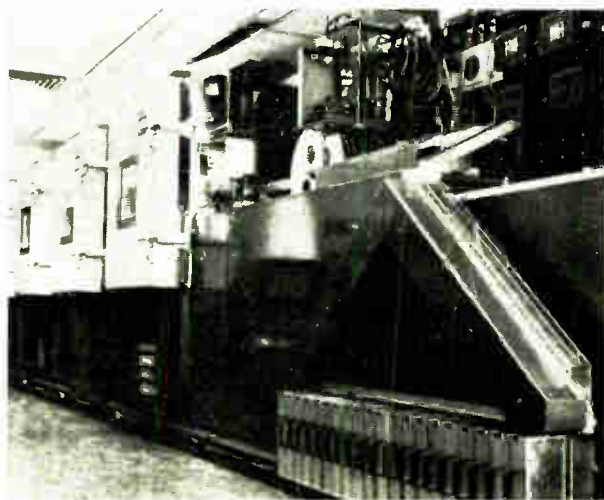

**The output.** The devices are sorted into one of 20 bins according to test results stored in the computer memory.

## Process control pays off

Many IC failures are subtle and undetectable by external electrical tests. One such failure stemmed from an unauthorized change by the maker in the diffusion processes for a logic circuit used in a Univac aerospace computer.

The logic circuit, after serving reliably in several applications, suddenly began to fail at low temperatures when used in the computer in a one-shot configuration.

The records indicated that all the devices that failed in use met every one of Univac's acceptance requirements. One clue, however, was the recent manufacturing date code on all the failed parts. When these devices were opened and compared with counterparts bearing earlier date codes, it was obvious to Univac's failure analysts that a change had been made in the manufacturing process of the offset diodes.

The surface views of the two designs made it

look as if an additional diffusion had been used to make the offset diodes. This suspicion was confirmed when the IC's were sectioned and their diffusion profiles brought out with angle-lapping and staining techniques.

The photographs below show that these diodes were formed by the n and p diffusions for the transistor emitter-base junctions. But in the later designs, an additional diffusion had been driven into the p-type base material. This was found to be a p<sup>+</sup> step designed to form a so-called stoppered diode.

Although the offset properties of this diode design indeed were better than those of the earlier version, the added diffusion layer provided more capacitance. This capacitance resulted in a slow-recovery diode, which combined with the normal low-temperature beta loss in the driven transistor and often caused the offset diode to latch up.

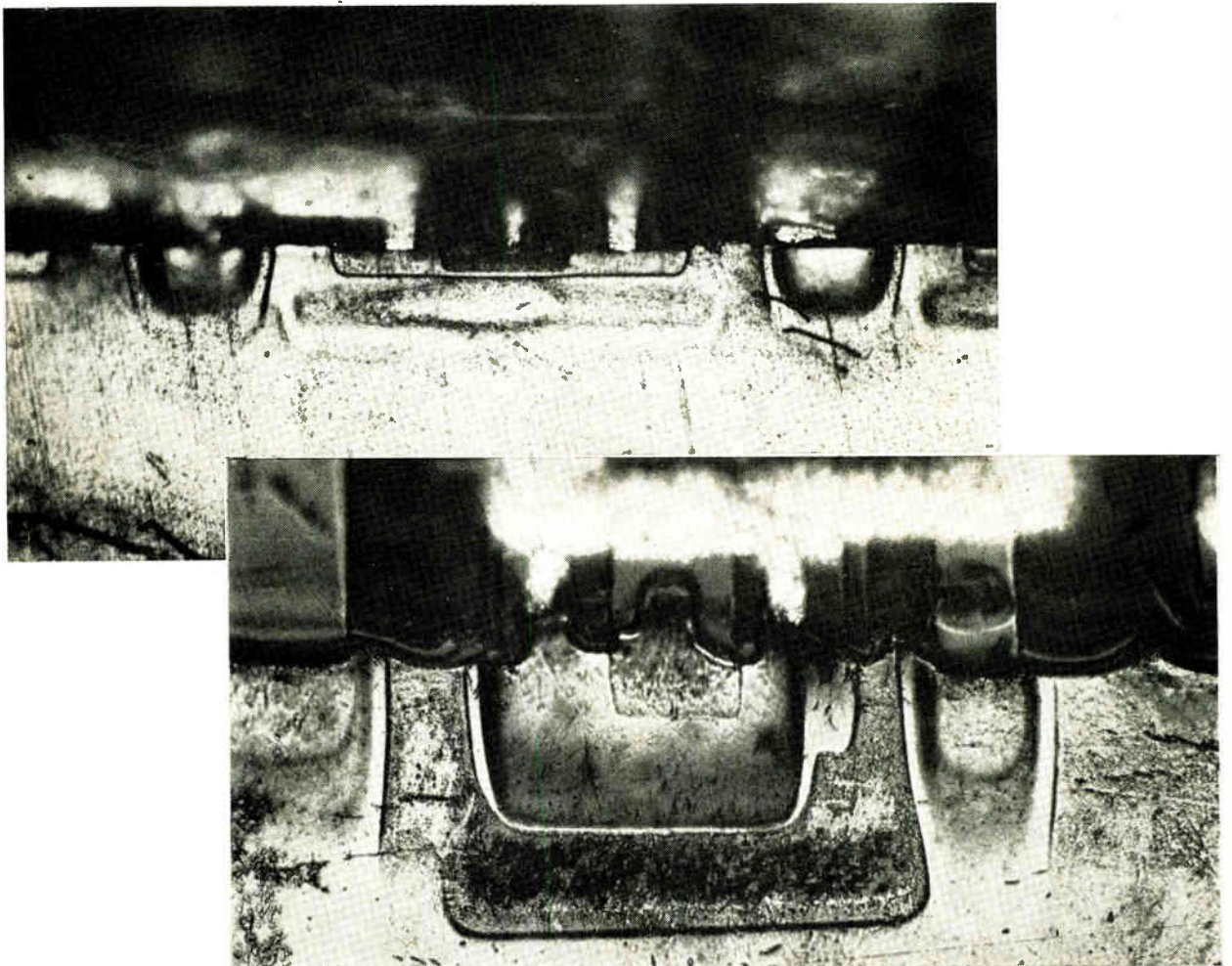

**Telltale stains.** Angle lapping and staining were used to bring out the diffusion profiles. Stained section of unit with early date code (top) shows the n<sup>+</sup> emitter surrounded by the p-type base material. The stained section of the later units (bottom) clearly shows the additional p<sup>+</sup> step between the n<sup>+</sup> emitter and the p-type base material. It was this extra step that caused the problem.

Continued from page 89

a minimum of training. An example is Optimized Devices Inc.'s model 5000 IC test system. Its test programs are stored on interchangeable magnetic disks—100 tests per side. New programs can be entered by technicians in less than 15 seconds per test. All they have to do is set data on direct-reading dials and press a record button. The data for the entire test is then transferred to the disk storage. All bias levels, limits, ranges, test numbers, test types, and commands are set with digital switches on the program module.

Users' requirements change rapidly, however. According to Jorge R. Acosta, senior reliability engineer at Raytheon's Missile Systems division, anything bought now could be obsolete by the time it's installed. "Currently, we are working with 10-megahertz clock rates but already are looking at machines with 100-Mhz clock rates," he says.

Users must also decide whether to test parameters at different temperatures. "The semiconductor industry lags in the development of temperature-testing capabilities," asserts Robert Erikson, Univac's manager of material engineering. "Extrapolating from room-temperature tests isn't a suitable method for predicting a device's performance at temperature extremes," Erikson says. Univac's a-c tester is being modified to include a temperature-testing capability.

### Hot and cold

At Honeywell, there are four groups of IC tests—d-c tests at  $\pm 25^{\circ}\text{C}$ ,  $-55^{\circ}\text{C}$ , and  $+125^{\circ}\text{C}$ , and an a-c, or propagation-time, test. The IC's are tested 100% before assembly. "Without this," says Hintz, "it is impossible to determine whether a failure is the vendor's fault." From 2% to 7% of the IC's fail. "But," emphasizes Hintz, "about 1½% of these devices may fail because of tester-induced defects."

This situation isn't unusual. Paul Nelson, manager of the environmental engineering department at Raytheon's Space and Information Systems division, says, "Many users often do more damage than not during testing" by pushing the IC's to their design limits or causing physical damage.

The physical damage induced by testers can be prevented by protecting the IC's with carriers during handling and testing. As a result, carriers have become integral parts of automated, or even semi-automated, test and handling systems. Ken Hook, sales manager of the Barnes Corp., asserts that "lead damage during final test and handling is one of the primary factors contributing to low IC yields. The basic function of a carrier, whether for flat packs, dual in-line, or TO packages, is to prevent lead damage during handling or testing."

### Mechanical defects

"A large number of the IC failures in the Apollo program's inspection test," comments Raytheon's Roger French, "were caused by the leaky packages that passed undetected through the leak tester." Leak testers available commercially just weren't



**Blowup.** Scientists at NASA's Electronics Research Center used a scanning electron microscope to look at aluminum leads ultrasonically bonded to an IC pad. They discovered these transverse microcracks, shown magnified 2,300 times.

fine enough for high-reliability programs. Another difficulty was that the liquid used in the bubble-type leak testers reacted with and corroded the leads when it got into the IC package. Leaky devices that passed the leak tests, therefore, failed subsequent electrical tests.

Raytheon engineers developed a leak test—now in-house only—that uses analytical scales to detect the weight increase of leakers. The use of an inert gas eliminates corrosion problems.

Leakers have also caused trouble at Hughes Aircraft Co.'s Aerospace group. There, however, the problem wasn't in detecting leaks in individual hermetically sealed packages but in deciding how best to detect leaks from IC's already assembled on printed circuit boards. Hughes engineers solved this problem by using a high-dielectric gas and measuring the capacitance changes the gas causes if it gets in the device through a leak.

### Standard complaint

A great complaint among IC users is a lack of standards.

Testing standardization has made some progress; the first military standard for testing IC's—MIL-STD-883—was released in March. It's divided into four categories: environmental tests, mechanical tests, electrical tests for digital devices, and electrical tests for linear devices. The specification attempts to include almost every test that would be performed routinely.

However, Col. J. W. Elder, deputy director of technical data and standardization policy in the office of the Secretary of Defense, is still maintaining that "premature application of piece-part standards" places unnecessary constraints on the designer. Elder indicates that early specifications often become outdated quickly and that those already re-

Continued on page 96

# An IC morgue

Failure analysis seeks to pinpoint the causes of defects in IC's. These analyses are made by both vendors and large users, but the cost of the required equipment usually leads smaller users to depend on the manufacturer. Requests for analysis come from both testers and users. Among the typical failures are those shown on these two pages.



Scratches in metalization . . .



Partial lead short . . .



Stained metalization . . .

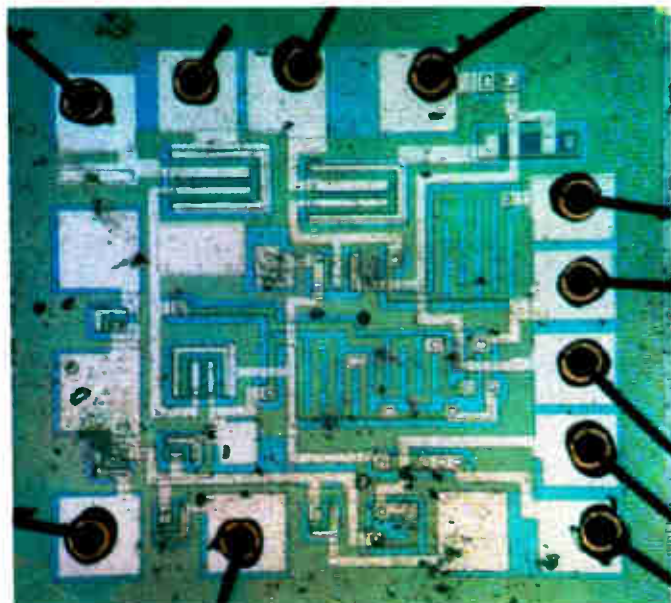

Contamination . . .



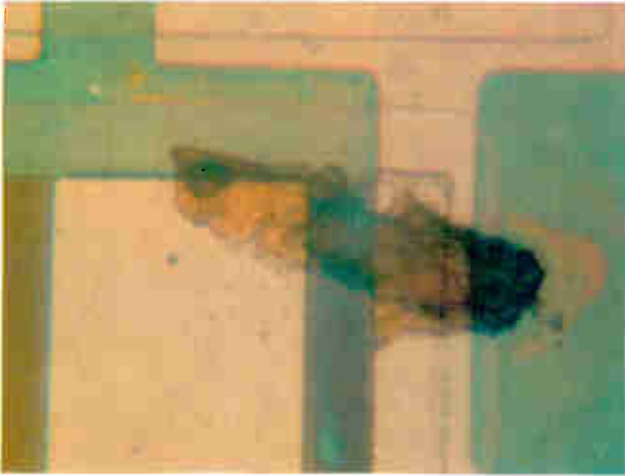

Shunting particles . . .



Metalization gaps . . .

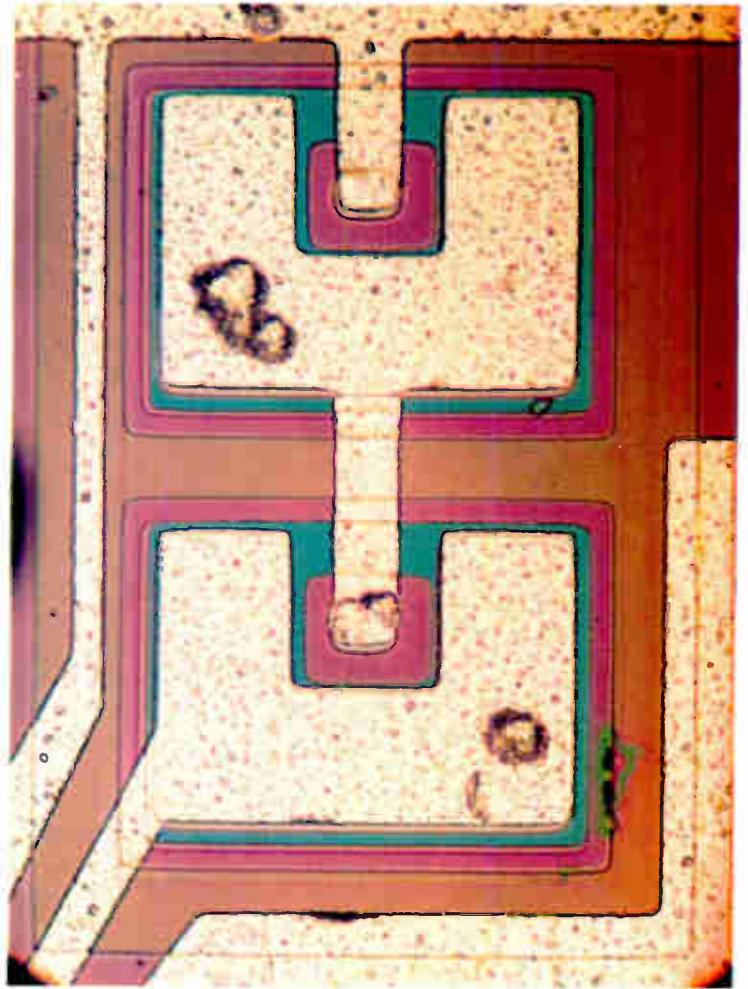

Probe damage . . .

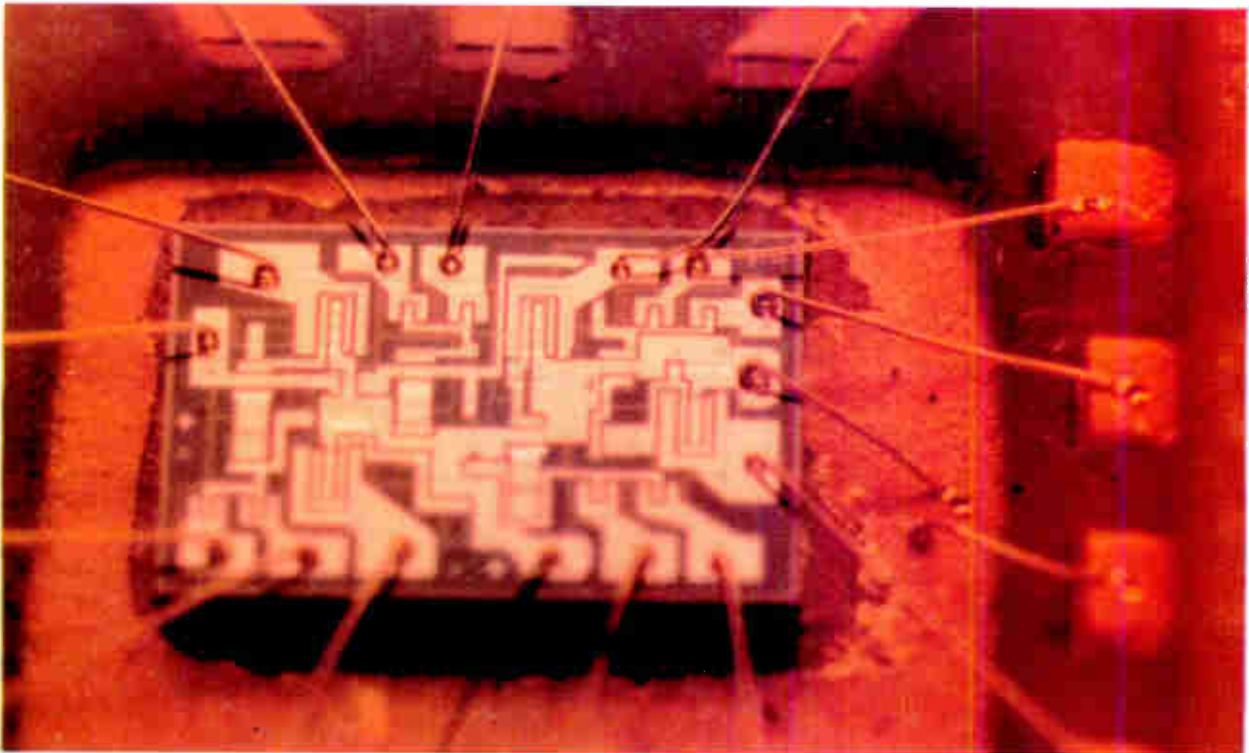

Lead-to-lead intermittent short.

leased by the Pentagon should be considered tentative. The IC terms and definition standards released just last fall are already being revised.

### Controlling the process

Users often say that makers change their manufacturing process for increased yields without giving sufficient thought to secondary effects. In many instances, the results are disastrous but can't be detected with electrical tests.

Consider, for example, a logic element used in Univac's aerospace computers. The IC had a good reliability record, but suddenly devices that had met every specification requirement and passed incoming electrical tests began to fail at certain times.

An intermittent failure like this is probably the worst kind a computer manufacturer faces; tracking it down is extremely difficult. Eventually, the trouble was traced to a manufacturing-process change (see page 92).

A user's main defense against such situations is a process-control procedure. For example, once a device is qualified at Univac, the manufacturer's process is frozen. Changes can be made only after the user has been informed and evaluates the possible effects on the equipment the IC's are to be used in. The user keeps photographs of the IC's structure as a record of the process. Univac also does a destructive analysis to monitor the workmanship of its sources.

Many other large users have similar controls. For example, Raytheon initiated a process-control specification for IC's after a high incidence of failures in purchased circuits. In effect, Raytheon tells the supplier how to make the device. Raytheon specifies the requirements for materials, processes, construction, workmanship, and inspection procedures. The idea is to prevent defects that hurt reliability but don't

### Linears out of line

The story for linear IC's is very different. Universal, programmable testers are available for testing digital IC's, but not for linear devices. Because parameter definitions and testing specifications and methods for linear IC's differ from manufacturer to manufacturer, it has been almost impossible to design a universal tester. But the picture is brightening.

Two engineers at the Grumman Aircraft Engineering Corp's Microelectronics Laboratory studied manufacturers' parameter definitions for linear IC's and drew up a set of recommended standards. From this, the engineers developed a standardized set of testing specifications and procedures [Electronics, April 15, p. 223].

Most current linear testers are extensive modifications of digital test equipment and require skilled operators. And they can usually measure only a few parameters. Such testers are acceptable for engineering laboratories but don't meet IC makers' need for readily available equipment that can be operated by production-line personnel.

necessarily affect electrical parameters.

To most IC users, weeding out the failures is only the first step in their reliability process; the only way to take corrective action, of course, is to find the cause of a failure.

### Performing an autopsy

Failures arrive for analysis from several sources—development projects, qualification tests, manufacturing, and the field. Analysis begins with an attempt to reproduce the failure. Nondestructive techniques are used wherever possible, and important steps in the analysis are documented by such techniques as photography and radiography.

Failure analysis, however, requires a heavy investment. NASA's Electronics Research Center, for example, already has spent more than \$250,000 for such analytical instruments as a hot-stage metallograph, electron microprobe, and spectrographic analyzer. And even this isn't enough, according to James E. Cline, a section head. Currently under development for Cline's group is a holographic microscope for 3-D inspection of IC's that will make it possible to detect changes that occur as the device heats up. Many reliability experts agree that one weakness of automatic testers is that their operating speed makes it impossible to determine what happens as the IC chip heats up.

Reliability problems are sometimes discovered only by chance. For example, Cline decided recently to take a close look at ultrasonically bonded aluminum leads. The manufacturer usually inspects these bonds through optical microscopes, but Cline used an electron microprobe and a scanning electron microscope. He found microscopic cracks in the bond. This was the first time these cracks were seen, but the extent of their importance hasn't been determined yet.

### Makers have troubles, too

Manufacturers spend a lot of money on their own testing; some say testing and inspection account for about half their labor costs on IC's. "The minimum a medium-size IC manufacturer must spend for test equipment," says Bernard Johansen, ITT's manager of quality assurance, "is about \$250,000 to \$500,000. And you need about 60 people for testing for every million IC's produced per month." But cost can seem like a minor problem compared with some of the real headaches.

For one thing, many makers say the variety of package styles makes it hard to use automatic testers, which are almost indispensable in dynamic test programs. Sylvania designed and built its own carriers to adapt the various packages to its automatic tester. The company also developed supplementary a-c equipment that can perform 40 tests per device at a rate of 3,500 devices an hour.

All manufacturers test first at the wafer level to eliminate bad circuits early in the manufacturing cycle. At this stage, the wafer consists of about 500 individual circuits. Not all the circuits that pass the wafer tests are acceptable, because testing such

vital characteristics as switching time and propagation delay of faster devices is difficult if not impossible at the wafer level. The long leads that connect the probes to the tester and their associated capacitance often make measurements of such parameters invalid. As a result, most makers perform only d-c tests at the wafer level, except for the relatively slow digital devices.

Once the IC's that passed the electrical tests at the wafer level are processed completely, they are tested electrically again—on a 100% basis—before shipment. Although IC vendors all agree on the validity of 100% testing, there is no agreement on the type and number of tests performed during final electrical checkout. For example, Sylvania's semiconductor division uses a computer to perform a total of 500 d-c and a-c checks on each logic module produced. Fairchild, on the other hand, performs only about 50 checks on each logic module.

### Computers in control

Sylvania isn't alone in using computers for final electrical testing. Many large manufacturers have installed them to cope with the proliferation of devices and tests per device.

For example, Fairchild's semiconductor division uses computer-controlled testers developed at its instrumentation division. The company uses two testers, a series 4000 and series 8000. Each device is first tested functionally. The faster, more complex devices are tested with the 8000, which can do 60,000 tests per second and makes from 50 to several thousand combinational tests on one IC. Fairchild is working on new testing techniques for even more complex IC's.

Texas Instruments, which does final electrical inspection with its digitally controlled 553 tester, has added a new ingredient: an adaptive procedure that enables the 553 and the model 861 controller to do more complete and accurate testing than at manual stations—and in about one-tenth the time.

Don Retzlaff, supervisor of test methods, explains that this procedure adapts to data it gathers by stopping a test or changing, say, from a commercial to a military test pattern. A device that might fail a test for one type of user could pass a different check. If a device fails any test, the machine skips to the next device.

"The speed," Retzlaff says, "yields more complete data. For example, when circuit gains are checked it is usually necessary to adjust the input until the output reaches a fixed level, and then measure the input to compute the gain. But in the adaptive system, the controller increases the signal generator's amplitude from the lowest allowable level in very small increments until the output is within the desired limits, and automatically computes the gain. Such a step-by-step measurement would be impossible from a time consideration without the controller."

The adaptive technique not only reduced the amount of test equipment required but also solved a manpower problem. Says Retzlaff: "Even if we



**Crystal detector.** Hot spots on IC's can be detected with liquid crystals. In the IC above, the hot spot is the blue resistor-diode circuit. The heat dissipation across the IC's surface is shown by the color change from blue to red. The coating, supplied by Liquid Crystal Industries, changes color with minute changes in temperature.

had been willing to set up the necessary number of manual test stations, the technically oriented people needed to handle them simply aren't available."

### Another new idea

Wafer microprobes are used by IC designers and manufacturers to measure the electrical performance of those components that can't be reached through the outside connections. However, the microprobes are difficult to use and often damage the IC surface or upset the circuit's thermal balance or electrical performance.

The Qualifications and Standards laboratory of NASA's Electronics Research Center is studying the recombination radiation emitted by semiconductor junctions as a possible means of testing semiconductor devices. Determining whether this transient radiation can be detected and used as a measure of the current at the IC junctions is the task of Raytheon's advanced infrared development laboratory. This approach wouldn't require physical contact with the device, but so little energy would be emitted that new detection and measuring techniques would have to be found.

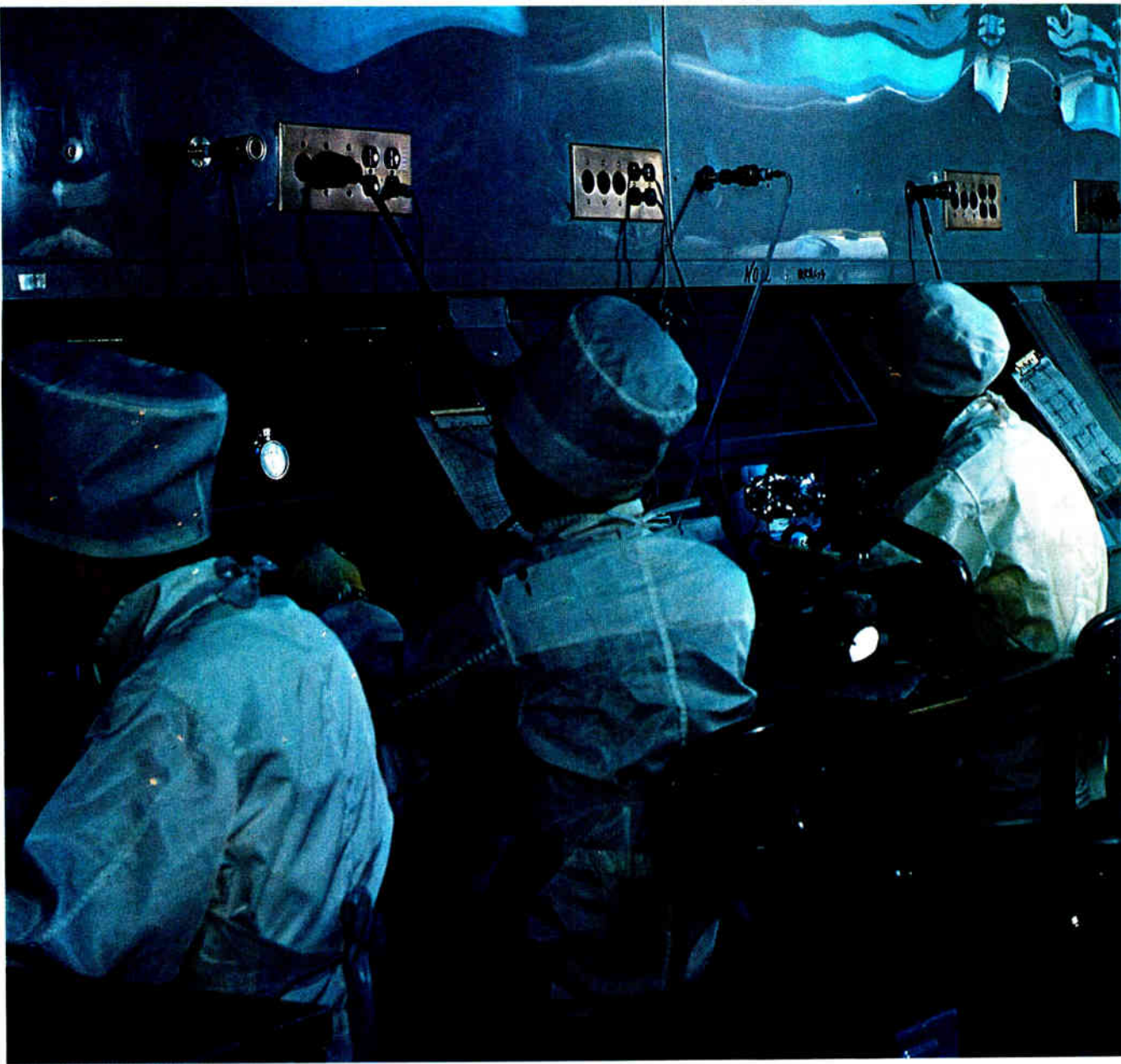

Integrated electronics

## IC's in Japan—a closeup

- Where Japanese technology stands today
  - How it compares with U.S. technology
  - What direction it is taking — and why

By Yasuo Tarui

Electrotechnical Laboratory, Tokyo



**Their toddling days** behind them, Japan's semiconductor producers are beginning to hit their stride in integrated circuits—not by following the path taken by U.S. semiconductor makers, but by charting a course that reflects Japanese needs.

To be sure, American-type IC's are still dominant in Japan. But this dominance is being challenged by circuits that are uniquely Japanese—linear and digital IC's tailored to the country's mushrooming computer, calculator, and consumer-products business. And though there's still a wide gap between the two technologies, Japanese engineers are beginning to narrow it somewhat. One reason: the emphasis is now placed on originality, not duplication.

Unlike U.S. firms, which benefited from large Government outlays for military and aerospace programs, and were encouraged by a large computer industry, Japanese companies channeled their efforts along the lines dictated by their own industry requirements. Thus, U.S. semiconductor makers were able to develop complete bipolar-logic fam-

ilies and general-purpose linear circuits, while their Japanese counterparts had to content themselves with turning out specific circuits for specific applications. This explains the heavy flow of IC imports from the U.S.

Today, Japanese firms have reached the point where they are producing IC's at a rate of about 1.3 million per month. And the total is climbing. With imports during the first three months of 1968 put at about 2.5 million circuits, Japan is well on the road toward achieving its goal of no more than 10% dependence on foreign IC's by 1972. In fact, this goal may well be reached earlier.

### **Growth factors**

In a way, the position of the Japanese semiconductor industry with respect to the U.S. can be likened to the situation in the U.S. computer industry. U.S. IC manufacturers are collectively to the Japanese as the International Business Machines Corp. is to each U.S. computer maker. American firms aren't earning huge profits from their computer operations not because they're producing inferior equipment or having trouble with yield, but because they are being hard-pressed in keeping up with IBM development and product variety—caused in part by their smaller investment and sales.

Although Japanese IC makers may be able to keep up with their U.S. counterparts in some sectors, it's not their intent to match U.S. firms development for development.

For one thing, the demand for computer circuits is limited in Japan. And that demand had largely been damped by the fact that many Japanese computers were designed before IC's became available; a quick changeover to IC's would have proved too costly. As sales started to pick up, common sense dictated a turn to U.S.-designed IC's as the basis for domestic technology in this field.

And when Japanese firms decided to go with integrated circuits, they ran into patent problems—particularly with Texas Instruments—which necessitated licensing arrangements. For a long time, calculator producers were worried that the licenses wouldn't come soon enough. But the agreements were negotiated in time for Japanese government approval late last month. This was welcome news in Japan, where many believe calculators will eventually become the leading market for IC's. And as the calculator market grows, the need for Japanese-made circuits will also increase—particularly since the Japanese are counting heavily on the U.S. for a goodly share of their exports.

Electronics is currently a \$3 billion industry in Japan. Of this, 41% is consumer, 33% is industrial—including computers—and 26% is accounted for by components. So far as IC consumption is concerned, computers rank No. 1, calculators No. 2, and consumer items No. 3.

### **Linears on the move**

Most manufacturers are heavily involved in both logic and analog IC development, reflected by the

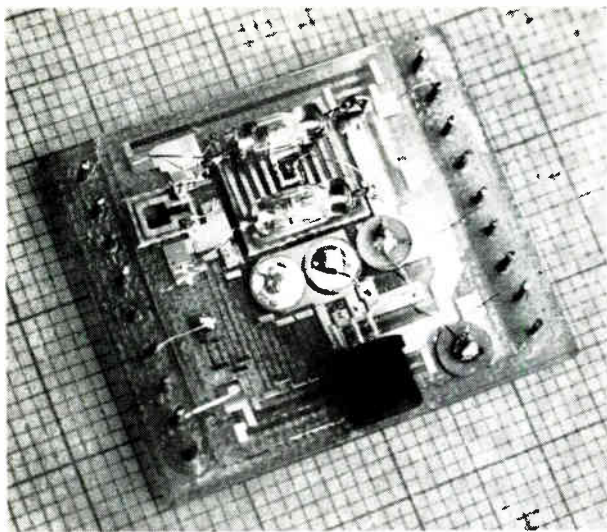

**Wave maker.** Toshiba's hybrid thin-film local oscillator uses varactor diode chips and operates between 110 and 240 Mhz over two channels.

broad range of circuit production and projects. But compared with digital circuits, linear IC's are farther ahead in development—primarily because of Japan's emphasis on consumer-oriented products. In terms of circuit sophistication, the number of components and how they are arranged, Japanese linears come close to rivaling U.S.-made circuits.

Highlighting the Mitsubishi Electric Corp.'s linear effort is a two-chip IC for amplitude-modulated radios. The tandem provides such functions as conversion, intermediate-frequency amplification, automatic gain control, detection, audio power drive and output, and voltage regulation. An unusual feature is that each of the chips can be used separately in other equipment.

Shown on page 102, the Mitsubishi circuit contains 17 transistors and more than a dozen associated resistors and diodes. It is encapsulated in a 19-lead epoxy dual-in-line package that has a large heat-sinking tab at one end. Maximum power dissipation is 700 milliwatts. Designed for both battery-powered and a-c line-driven radios, the IC has a harmonic distortion of less than 3% and delivers a 50 mw output for inputs of 43 to 45 decibels above 1 microvolt—slightly less than 200  $\mu$ v. The circuit is connected to an output transformer to drive 3-to-4-inch speakers.

Unlike the regulators found in many circuits of this type, in which zener diodes provide the voltage reference, the Mitsubishi circuit employs a transistor element. The reference is obtained from the base-to-emitter differential, which the company's engineers found easier to control. The regulator maintains a 3.8-volt supply.

All that remains to complete the radio circuit are eight external capacitors, a few resistors, and tuned circuits. The IC operates between  $-10^{\circ}$  and  $+50^{\circ}$ C, provides an agc of 40 db, and has an audio-stage input impedance of 10 kilohms. Nominal voltage requirements: 4 to 9 volts.

Mitsubishi is also developing a 3-watt audio amplifier IC that operates with a 12-volt power supply. The circuit is designed for radios not requiring output transformers, and for tape recorders, and other equipment requiring medium-power outputs.

### Complex amplifier

Representative of the Sony Corp.'s IC developments is a multifunction chip for radio applications [Electronics, April 3, 1967, p. 177]. The IC, shown on page 104, provides three stages of i-f amplification, agc, detection, and audio amplification, and has its own temperature compensation.

Four transistors make up the i-f amplification section. Two transistors—for the input—are connected as a Darlington amplifier to which reverse agc is applied. Via an external capacitor, the amplifier's output is a-c coupled to a third i-f transistor. The operating points of these transistors are stabilized by feedback through a diode-resistor pair.

The collector of the fourth i-f stage is d-c coupled to the base of a fifth transistor, which serves as a detector; level shift is provided by a diode network. Operation of the detector transistor is similar to that of the infinite impedance detector found in tube radios. Thus, average collector current increases when signal strength increases, and the detected audio signal appears across the emitter load resistor. Collector voltage, which falls when signal strength rises, is filtered and applied to the base of the Darlington i-f amplifier as reverse agc voltage.

The audio section is made up of three audio-amplification stages, a level shift diode network, and a transistor-biasing element. Through an external capacitor, the output volume control is coupled to the first stage. The remaining audio stages are d-c coupled. Temperature compensation is provided by the same transistor that sets the bias level.

The i-f amplification section is a wideband, untuned circuit that has an essentially flat response from 0.1 megahertz to about 10 Mhz; low-frequency rolloff is determined by the capacitor that couples the second and third i-f stages. Depending on the supply voltage, the i-f section's over-all gain varies between 40 and 80 db. Maximum output power is 35 to 45 mw at temperatures between  $-15^{\circ}$  and  $+50^{\circ}$ C.

This circuit, as is the case for almost all of Sony's IC's, was earmarked specifically for consumer electronics applications. Unlike many U.S. semiconductor makers, which put their top designers on circuits destined for military equipment, a second team on circuits for computers, and a third team on those headed for consumer products, Sony concentrates its best engineers on projects in the latter area because that's the field in which it makes almost all its sales. Perhaps no other major Japanese IC maker is as consumer-conscious as Sony.

Among Kyodo Electronics Laboratories Inc.'s linears are a monolithic IC for radios, and hybrid

circuits for television-audio i-f functions and computer sense amplification. The monolithic, the LA200, shown on page 103, is a multifunction circuit that has an i-f amplification section, an oscillator, and an output stage. The IC is made up of two differential amplifiers that are coupled by an emitter follower, a regulator section that controls the power supply, a transistor that performs the local oscillator function, and a second transistor for gain-control. The last two transistors are uncommitted.

Kyodo's circuit operates with a 6-volt supply, and has a 9-Mhz bandwidth, a 50-db voltage gain and a 10-kiloohm input impedance. Although designed primarily for a-m radios, the chip is suitable for limiting functions in f-m sets. This is achieved by using the two free transistors as limiter amplifiers.

### Tuning up

Typical of the IC's developed specifically for tv applications is Tokyo Shibaura Electric Co.'s

thin-film hybrid local oscillator, shown on preceding page. Designed for use in very-high-frequency tuners, Toshiba's circuit contains a varactor tuning diode, a varactor switching diode, evaporated resistors, film capacitors, and microminiature inductors. For diode biases between 3 and 30 volts, the frequency shifts are 110-130 Mhz for the lower channel and 180-240 Mhz for the upper channel.

The main substrate of the IC is glass; evaporated aluminum is used for the wiring. The coils are constructed of etched copper on separate glass-epoxy substrates; the resistor material is nichrome, and the capacitor is composed of aluminum film. Completing the circuitry are external ceramic capacitor pellets for the frequency trimming function, and a separate trimmer.

A number of Japanese semiconductor makers—among them Hitachi Ltd., Mitsubishi, Toshiba, and the Tokyo Sanyo Electric Co.—have been turning out monolithic video i-f circuits. But many of these IC's are similar to those developed in the U.S., in-

### Forward-looking techniques



Alloying operation



Wafer probing



Computer testing

**Modern equipment.** Most Japanese semiconductor makers have turned to the latest equipment and techniques in producing and testing IC's. Typical is Kyodo's alloying facility, Sony's slice-probing station, and Toshiba's automatic, computerized IC tester.

cluding such circuits as RCA's 3013 and 3014 special-purpose combination f-m/i-f amplifier, discriminator, and audio-frequency amplifier units. Other circuits, however, reflect Japanese innovation by including a higher degree of limiting functions on the chip.

One manufacturer, the Nippon Electric Co., has developed its own audio i-f amplifier-discriminator IC. The prototype contains a built-in power-supply regulator and uses limiting action on the i-f stages; a ratio detector is employed for the actual f-m discrimination. The circuit as a whole, however, has sections that are similar to those found in Fairchild Semiconductor's  $\mu A703$ .

### Outside control

In addition to radio and tv circuits, Mitsubishi has developed a multifunction IC for a broad range

of tape recorders. The unit performs preamplifier, driver, and power-output functions, and has a built-in age provision.

Called the M51018, the Mitsubishi circuit, shown on facing page, contains 11 transistors, three diodes, and eight resistors. It can be used for both recording and play-back functions. Accommodating manual as well as age, the IC operates on a power supply of between 4.5 and 12 volts, and provides output power of between 0.8 and 2 watts.

The preamplifier portion consists of two stages, each of which is a grounded-collector, grounded-emitter pair. D-c feedback is applied through an external 47-kilohm resistor. Nominal operating supply voltage is 6 volts and voltage gain is 55 db. Input impedance is controlled by another external resistor, but the intrinsic impedance of the circuit itself is high—exceeding 300 kilohms. External

### On a sound track

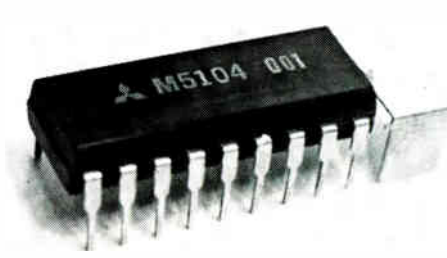
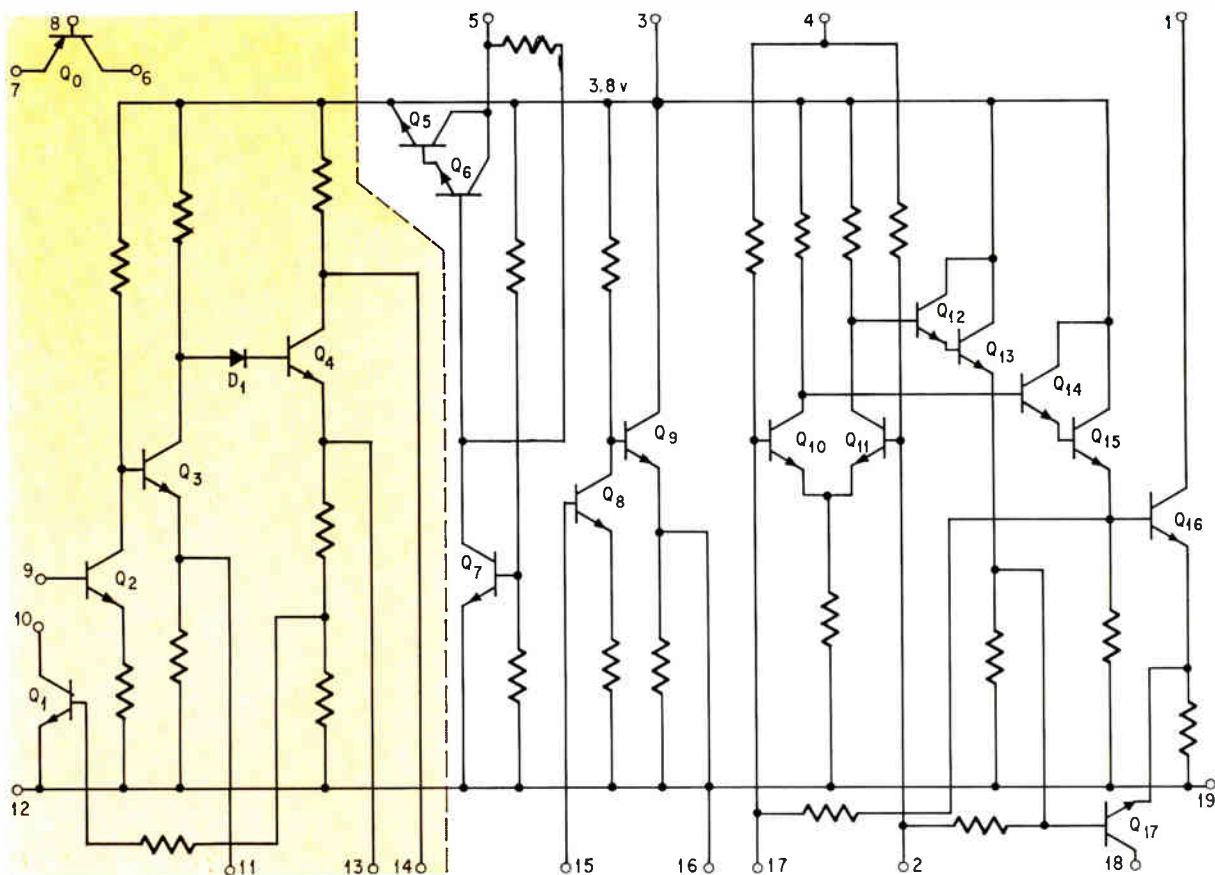

**Multichip.** One of Mitsubishi's linear radio IC's (above) is a two-chip combination of i-f amplifier network, left, and audio section. Encased in an epoxy, dual in-line package, the circuit can handle outputs of 700 milliwatts because of the external heat-sinking booster tab at right in photo.



negative feedback is applied between the collector of the preamp output and the emitter of the preamp input. Equalizer characteristics can be obtained with an external resistor-capacitor network. Also, the desired circuit gain can be obtained by applying negative feedback to adjust the over-all gain.

During the recording mode, a diode is used for level control. During playback, the diode can be switched out of the circuit by an external resistor. Noise of this amplifier stage, expressed as the equivalent input noise for a flat amplifier, is approximately  $2 \mu\text{v}$ . The preamplifier output signal is approximately 4 volts peak-to-peak.

The driver amplifier resembles the preamplifier, except that its second stage consists of a single grounded-emitter transistor. D-c negative feedback is applied across the amplifier to stabilize its operating point. A terminal, connected to ground through a 150-ohm impedance for a-c, receives a-c negative feedback from the output transformer's secondary. Open-loop voltage gain, including the output stage, is 65 db. The driver amplifier's input impedance, like that of the preamplifier, is primarily dependent on external resistors, and is nominally 47 kilohms. The driver stage is coupled to the output stage through a transformer, whose impedance ratio stepup is 4,000 to 8,000.

The power stage is a class-B amplifier. Maximum current gain occurs when the collector current in the power transistors is about 500 milliamperes; stage current gain is high—about 4,000. Temperature compensation of the output transistors is provided by two diodes. Mitsubishi designed the IC so that the power stage current is 10 ma when the current through the diodes is 2 ma, a ratio that minimizes crossover distortion. Feedback from the output transformer's secondary is applied to the driver stage to further decrease distortion.

The chip measures about 67 mils by 47 mils, and of the 11 transistors, nine are signal types and two are power elements. The power transistors occupy approximately one-third of the chip area; each transistor consists of two individual double-base stripe power transistors connected in parallel. Current gain peaks at about 500 ma, with a relatively low saturation resistance of 2.5ohms.

Since the two power transistors are located in close proximity, they are well matched; gain unbalance of the two is held to within 2%. Furthermore, the diodes are located symmetrically with respect to the two power transistors and thus provide compensation over a wide range of temperature. The IC's frequency response, with all external components connected, covers 70 hertz to 8 kilohertz.

### Innovation turns the trick

Sanyo's emphasis on design ingenuity is reflected by a self-compensating technique to minimize gain variations. Sanyo's method calls for a special pinch resistance element simultaneously diffused with the base and emitter portions of a critical transistor network. The resistor is then

wired between the input and output portions of an IC stage as a feedback path as shown on page 105. Resistivity and length are chosen to produce an effect equal and opposite to the gain variations of the transistor circuit. The net result: a stage gain that remains fairly constant.

Although far from equaling the efforts of their American counterparts, Japanese engineers have spent considerable time developing other analog circuits, particularly operational amplifiers. This has led to Nippon Electric's 1-Mhz op amp that has a voltage gain of 4,000, Hitachi's 0.5-Mhz unit that has a gain of 20,000, and the Matsushita Electric Co.'s 250-Khz, 1,200 gain unit. Nippon Electric has an IC video amplifier that has a 5-Mhz cutoff frequency and produces a 10-mw output. Matsushita has a 100-Mhz unity-gain video amplifier, and Sanyo developed an i-f amplifier with agc provisions; Toshiba has produced a linear series that

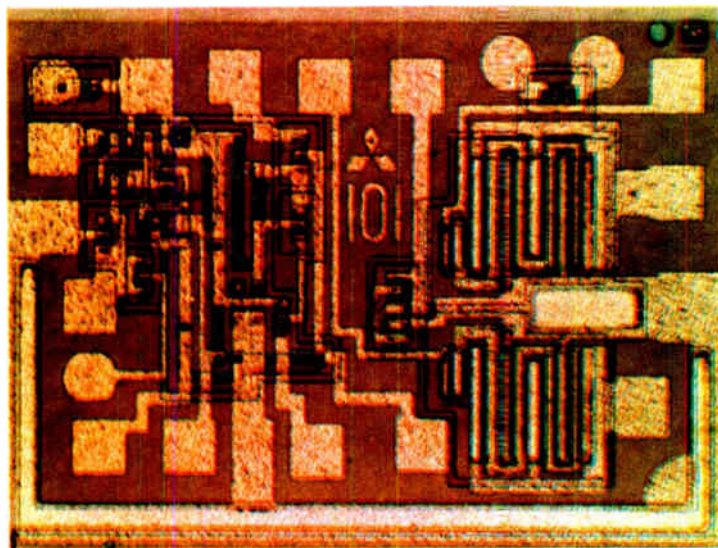

**Tailored.** Complex linear IC from Mitsubishi is designed for tape recorders, but circuit's characteristics lends it to a variety of applications.

is similar to RCA's CA30001-CA3006 line.

The Japanese government is supporting development of specific linear circuits. But compared to the role played by Washington, the aid given by Tokyo isn't substantial. Nevertheless, this support is sufficient to spur development of wideband amplifiers at Fujitsu and Toshiba, a large-signal amplifier at Hitachi, a high-frequency amplifier at the Shiba Electric Co., and three advanced amplifiers at Toshiba—a wideband device, a vhf unit, and a combination low-frequency voltage and power amplifier. In addition, the government is sponsoring the development of a linear metal oxide semiconductor IC at the Nippon Columbia Co. and a low-frequency amplifier at Nippon Electric.

In the hybrid area, Tokyo is helping to underwrite a vhf amplifier at Fujitsu, a wideband amplifier-demodulator at the Matsushita Communication Industrial Co., a low-frequency oscillator and a demodulator circuit at Nippon Electric, and a high-

frequency amplifier and d-c amplifier at the Toyo Communication Equipment Co.

### Lag in digital circuits

Thus far, Japanese engineers have been far more successful with the development and production of linear IC's than with digital circuits. It is in the latter area that Japan trails far behind the U.S. In hopes of narrowing this gap, stemming from their late start on IC's, Japanese engineers have launched a multi-faceted effort. Rather than concentrate on bipolar logic, they are placing almost equal emphasis on MOS IC technology. Also, most companies are second-sourcing U.S.-originated transistor-transistor-logic, diode-transistor-logic, and current-mode-logic circuits. And little wonder. By second-sourcing, the semiconductor makers are filling the growing needs of the computer industry and, at the same time, gaining technological and production know-how with digital IC's.

Behind the Japanese effort is the belief that calculators and similar desk-top data-processing equipment will soon become the country's No. 1 volume market. And calculators, like computers, will require sophisticated digital circuits. Accordingly, designers are attempting to build on U.S. technology, using it as a jumping off point to medium-scale integration. Thus it is understandable that much of what has already been achieved in logic IC's bears a strong resemblance to U.S. designs. These include bipolars and MOS IC's ranging from simple gates

and flip-flops to sophisticated shift registers and counters.

Nippon Electric's MOS IC line, for example, features static flip-flop stages with cross-coupled switching elements, and are similar to the bipolar flip-flop arrangements found in U.S.-designed direct-coupled transistor-logic bipolar families.

Static flip-flops differ from dynamic flip-flops in that data is stored in d-c coupled stages rather than in gates. Although the element count for a given function in the static approach is 50% higher than in the dynamic approach, frequency stability is twice as good and operating frequency range extends all the way down to d-c. Except for the final stage, MOS transistor elements are used as internal circuit loads. External resistors are employed at the final stage because they provide higher fanout and require less power consumption.

Among Nippon Electric's complex MOS IC's are: a combination eight-bit-plus-four-bit shift register; a triple flip-flop; and a four-bit paralleled output flip-flop.

Hitachi's MOS IC's include eight-bit plus-eight-bit shift registers, four-bit paralleled output flip-flops, dual four-input AND gates, and several simpler gates and flip-flops. Hitachi, preferring greater component densities, uses dynamic flip-flops as the basic element. And unlike Nippon Electric's circuits, which require a 24-volt supply, Hitachi's can operate with either 24- or 12-volt supplies. But Hitachi's IC's have a higher noise margin and dissipate 30%

### Chips fill several functions

Sophisticated designs. Complex, multi-function chip from Sony, (right), performs i-f, agc, detection, audio, and self-compensating functions. Other circuit, made by Kyodo, performs i-f, oscillator, and output functions in radio. Kyodo's chip has two uncommitted transistors available for additional functional needs.

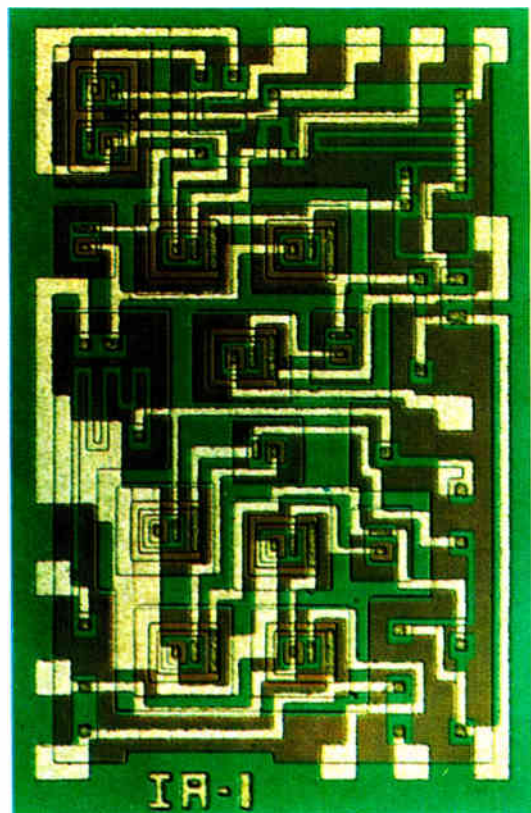
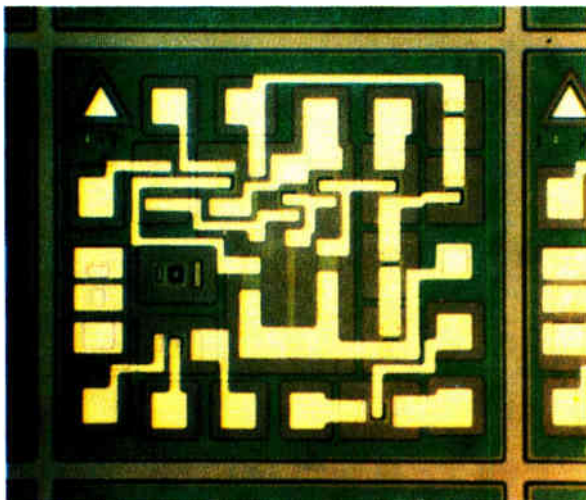

## Offsetting beta variations

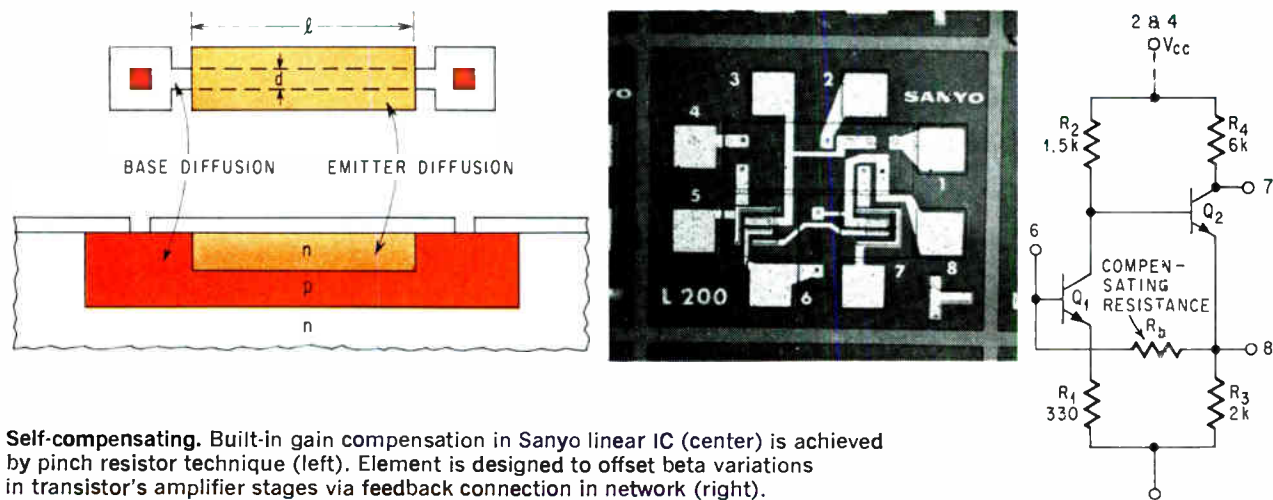

**Self-compensating.** Built-in gain compensation in Sanyo linear IC (center) is achieved by pinch resistor technique (left). Element is designed to offset beta variations in transistor's amplifier stages via feedback connection in network (right).

less power.

Another leader in the digital technology is Kyodo, which has developed an eight-bit, 44-gate TTL scratch-pad memory. Among its MOS IC prototypes are dual four-input OR and NOR gates, a single eight-input NOR gate, and a dual three-input expandable NOR gate. The company has also developed J-K and R-S MOS flip-flops, and expects to have an off-the-shelf line of MOS IC's available later this year.

### Bipolars moving up

Bipolar IC's are the only digital circuits really in volume production. And here, as well as in almost every area of Japan's digital IC technology, Mitsubishi, Hitachi, and Nippon Electric are the acknowledged leaders.

Mitsubishi is the nation's largest producer of bipolars and the major supplier for the desk calculator makers. Its total digital-IC production: 200,000 units a month. The company's bipolar line includes an eight-bit TTL shift register and a dual J-K master-slave flip-flop. Among Mitsubishi's best sellers is a moderate-speed TTL line that has two sets of electrical specifications—the tighter specifications for computer applications, and the other for calculator applications. The company is also pushing a DTL line of more than a dozen circuits that are logic-level compatible with the firm's TTL circuits. The DTL line's characteristics are similar to those of the U.S.-made 930-series IC's.

Hitachi's digital-IC production, running at upwards of 100,000 units monthly, include CML units for its modified version of the RCA Spectra-70 computers and MOS IC's for desk calculators. Hitachi, too, is readying a 930-type DTL line and a TTL line that resembles the U.S.-made series-74.

At Toshiba, volume production is starting up on 50- and 25-nanosecond DTL lines, a TTL line that is similar to Sylvania's SUIHL-2 line, four CML circuits, and several MOS units. The firm is emphasizing plastic encapsulation, using TO cans only on the slower DTL circuits.

Nippon Electric, the nation's largest IC producer, is concentrating on TTL, DTL, and CML lines for present-generation computers and data-processing systems.

The company's DTL products are used in its licensed version of Honeywell Inc.'s Series-2200 computer line, and in data-processing equipment for industrial control. Most of the circuits are packaged in TO-5 metal cans and have 10 leads (In the U.S., 14-lead packages have become standard). A few circuits, such as the J-K flip-flops, have been placed in 12-lead packages.

Nippon Electric's TTL and CML lines, however, are offered in dual in-line plastic packages as well as in the TO-5 cans—both of which have 14 leads. The company is now working on a line of digital circuits for a nationwide electronic telephone exchange, another for a government-sponsored, large-scale-integration project, and still another for advanced-generation computers. These three lines are still in the development stage and the company refuses to speculate on when they will be made available.

Presently, Nippon Electric is producing about 300,000 digital IC's per month, including 20 DTL circuits, seven TTL units that are similar to SUIHL IC's, 11 CML circuits, and 10 MOS IC's. Also being produced are thin-film digital IC's.

Both Fujitsu and Kyodo are turning out Series 74-type TTL units. But while Fujitsu is also producing a few CML circuits, variable-threshold-logic units, and precision thin-film items, Kyodo is preparing some hybrid DTL's and MOS IC's for calculators, and a Series-74 TTL line. And, the Oki Electric Industry Co. expects to be producing MOS IC's for calculators later this year.

### Noise breaker

Fujitsu's efforts to develop a bipolar digital IC suitable for industrial applications may pay off. Using a form of variable-threshold-logic, Fujitsu engineers have produced IC's that have high, adjustable noise margins. Typical is the R-S flip-flop

## Behind the mask

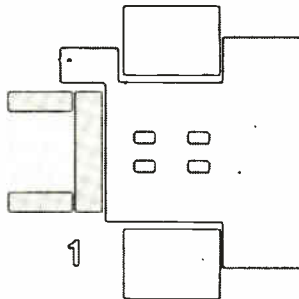
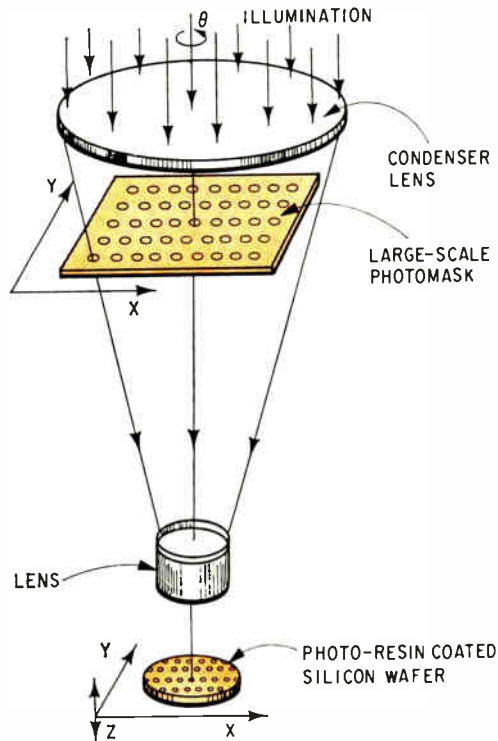

**Sharper.** Hitachi's single-step optical mask-making technique (top) provides superior resolution than conventional methods.

on facing page, in which the margin can be set between 1.3 and 4.3 volts by merely selecting a supply level between 6 and 12 volts. Heart of the technique is a gate-transistor element whose threshold is established by a simple, two-resistor voltage divider. This feature minimizes the IC's susceptibility to noise signals commonly found in industrial equipment and environments.

### Toyko steps in

Government funds are helping to underwrite bipolar IC development. The Ministry of International Trade and Industry is sponsoring a high-speed computer project that includes the development of LSI

circuits. Three companies—Fujitsu, Hitachi, and Nippon Electric—are sharing a \$1.1 million research grant for the development of the complex IC's.

Although a decision is yet to be reached on the logic type to be used, it appears CML may have an edge. Moreover, it seems almost certain that medium-scale integration may be used for some of the circuits.

The IC's are to have propagation delays of 1 nsec, a speed some experts believe will be difficult to achieve without advanced emitter-coupled logic or high-speed TTL.

Presently, to reduce its own imports, Nippon Electric's computer group uses three types of Japanese-made logic circuits—DTL for its small computers, circuits similar to Fairchild Semiconductor's complementary-transistor logic for its large computers, and discrete circuitry for some of its data-processing gear. The company believes, however, that it will eventually settle on one logic, perhaps something on the order of SUHL-type TTL. Hitachi, Fujitsu, Toshiba, Mitsubishi, and Oki may also settle on a particular type of logic. Like Nippon Electric, they are computer makers as well as semiconductor producers.

Also affecting the direction the technology takes is the Nippon Telegraph & Telephone Public Corp., which is a major user of IC's. In a joint effort, the Electrical Communication Laboratory of NT&T and Nippon Electric are developing a logic family that is basically DTL, but has some of the characteristics of TTL. These include totem-pole output circuits, similar saturation control schemes, and TTL voltage levels and noise margins. DTL was chosen because the engineers feel it has superior reliability and higher-temperature performance.

NT&T wants the circuits to be capable of operating for 40 years without failure in an unconditioned environment. The company's engineers believe high temperatures and deterioration of the passivation element can result in an increase in the reverse beta of the input transistor in a pure TTL scheme and thus cause faulty operation.

### New look in masks

Not only are Japanese firms developing IC's, they are also improving production techniques. Their goal: higher resolution and faster wafer processing. For example, Hitachi has developed an optical masking photoresist technique that permits 100-150 IC's to be fabricated on a 1-inch silicon wafer. Developed by a team headed by Kenzo Sato at the company's Musashi Works, the method is applicable to all planar semiconductors. Unlike conventional photoetching, Hitachi's photomask isn't in contact with the wafer; instead, its image is optically reduced to size, as shown at left.

The patterns on a large-scale photoplate are projected onto the photosensitive material covering the wafer's silicon-oxide layer. A special lens with a wide image field is used, enabling fabrication of patterns down to almost 1 micron wide, after photoengraving. An alignment scope is used to align dif-

## Digital offerings vary

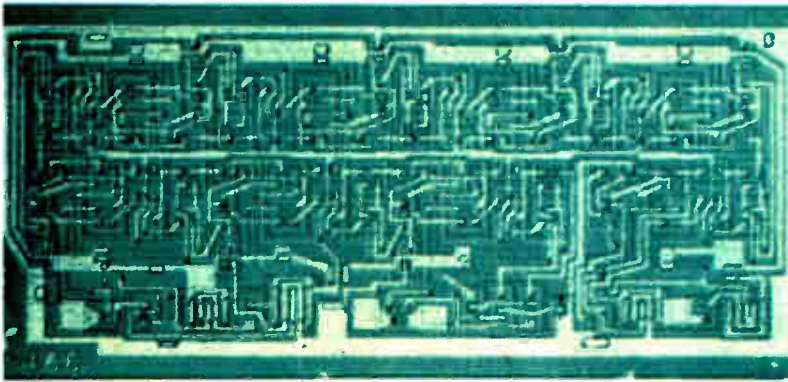

TTL register

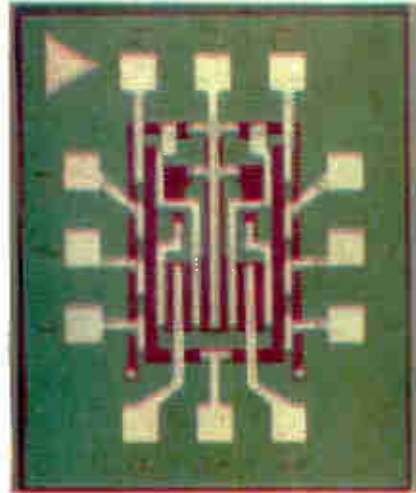

MOS gate

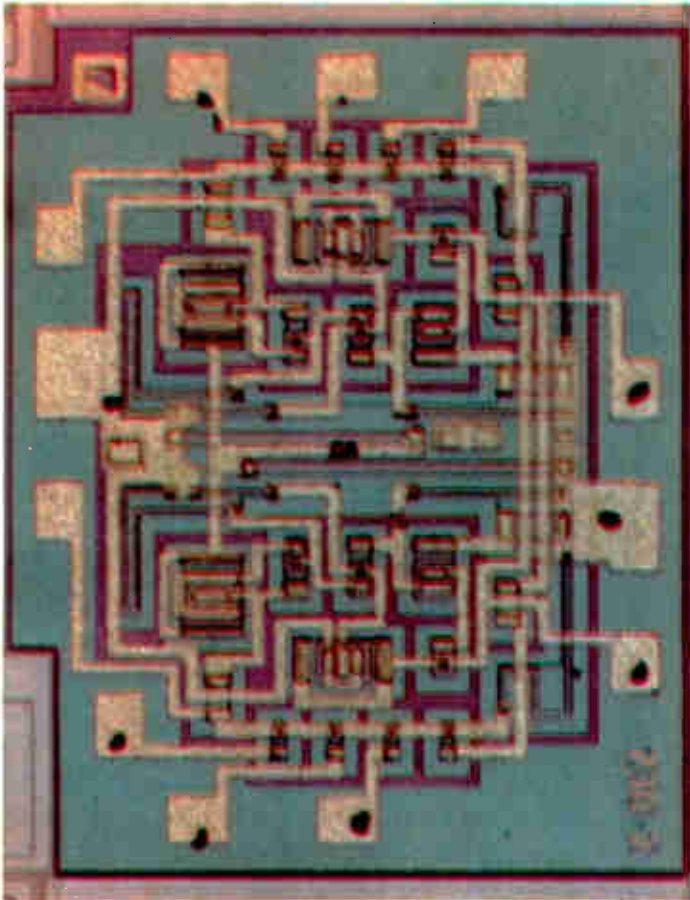

VTL flip-flop

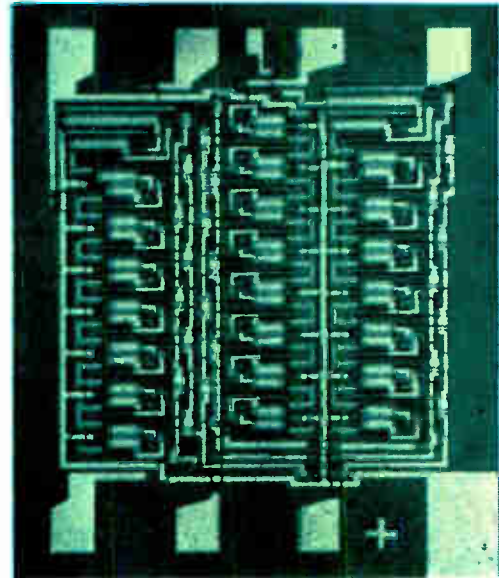

MOS register

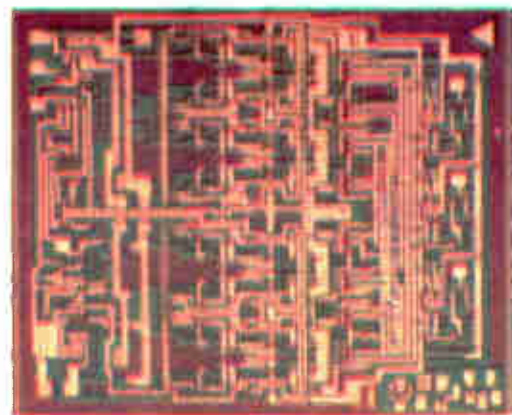

MOS memory

Logic spectrum. Using both bipolar and MOS technologies, Japanese engineers have designed a broad range of logic circuits. Typical are Kyodo's eight-bit MOS scratch-pad memory, Mitsubishi's eight-bit TTL shift register, Nippon Electric's MOS four-plus-eight-bit shift register, Fujitsu's variable-threshold-logic R-S flip-flop, and Kyodo's MOS dual four-input NOR gate.

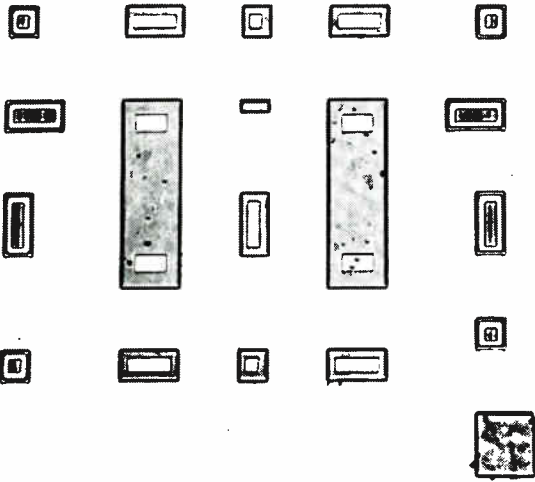
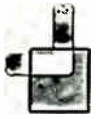

Patterns. Variety of IC-element geometries made by electron-beam exposure system developed by Electron Optics Laboratory and Electrotechnical Laboratory. System yields faster processing and higher resolution than conventional photoetching methods.

ferent patterns in a set.

Resolution is at least twice as sharp as that obtained with conventional contact masks. With the conventional approach, the slightest distortion on the wafer makes it impossible to maintain contact over the entire surface. Where the wafer doesn't contact the chip, resolution suffers. With the Hitachi technique, however, resolution is uniform over the entire chip area.

The Hitachi technique avoids scratching of the emulsion on the wafer or of the emulsion-forming mask patterns by dust particles or projections. Slight imperfections on the large mask can be tolerated in the Hitachi system because they are made negligible by the optical reduction. Pattern life is orders-of-magnitude longer than that of conventional techniques.

Typically, a conventional camera lens has resolutions of 100-lines per millimeter; the lens used by Hitachi has a resolution of 650 lines per millimeter—sufficient for lines only 1 micron wide. The wide image-field of the lens keeps the system distortion-free.

Resolutions of 0.7 micron have been achieved by an electron-beam exposure system developed jointly by Japan Electron Optics Laboratory Co. and the government's Japanese Electrotechnical Laboratory. This system is an alternative to standard photoetch-exposure methods, and can reduce processing time.

The electron-beam system employs a sweep method that scans only the region of exposure, cutting both the exposure time and the memory capacity needed for pattern storage by several orders of magnitude. Designed to expose only one IC chip at a time, the system exposes the rest of the wafer

by mechanically indexing to each chip position.

Thus, exposure time itself is reduced in proportion to the exposed area divided by the total area of the chip. The actual time taken is slightly longer because of the waiting time between exposures. The scanning process is designed to expose chip areas up to 2,000 by 2,000 microns, with a minimum line width of 0.7 micron.

Information for the chip is stored in a memory. Only four words, which specify the corners, are needed to determine a square or rectangle. Thus the memory capacity is rather small, and is a function of the particular chip configuration.

The computer used in this system has a capacity of 4,000 words, of which about 1,000 are used for the program and 3,000 for the pattern. The 3,000-word pattern capacity gives a system capacity of exposing chips with up to 750 areas, making it applicable to some medium and large-scale integration circuits.

The beam system is fairly simple. A series of overlapping circles are exposed one at a time. A circle at a corner is exposed for a short time increment, the beam is then turned off and indexed one position, and then it is turned on again for the same increment. This cycle is repeated until an entire rectangle has been exposed. The beam is then turned off, indexed to a new position, and the process is repeated for a second rectangle, and so on.

During the beam sweep, reflected electrons or secondary electrons are detected to determine where the pattern lies, and the engraved mark is used by the computer as a zero reference—the point from which all dimensions are measured.

In the conventional process, an optical mask is placed in contact with the sensitized surface of the chip and the entire chip is exposed through the mask to a source of ultraviolet radiation of about 3,000 angstroms. Including the lining up of mask and exposure period, the total time for a single 1-inch wafer is 5 to 10 minutes. Resolution: about 1 micron.

In the beam process, no optical mask is needed. The standard for pattern generation is a punched tape or similar computer-type input.

Alignment by the scanning electron beam is automatic, and exposure of each IC unit takes from 5 to 30 seconds. The slow exposure time is caused by a low sensitivity of the conventional photoresist, whose characteristics have been optimized for the 3,000-A radiation. Total time for exposure of the entire wafer is 10 to 20 minutes.

#### The author



Yasuo Tarui holds a doctorate in engineering from the University of Tokyo. With the Electrotechnical Laboratory for 17 years, he's in charge of integrated-circuit research activities.

# announcing: the new standard of computer diode reliability

# NITRODES™

a General Instrument exclusive



Millions of NITRODES currently in customer equipments and extensive testing have shown conclusively that which had previously been generally hypothesized:—that semiconductor devices passivated with silicon nitride rather than with silicon dioxide would demonstrate unprecedented reliability. General Instrument NITRODES are the industry's first and only silicon nitride passivated computer diodes. Their inherent reliability is derived from the total imperviousness of silicon nitride to the migration of sodium ions, and its extreme chemical inertness. As a result, many of the most common modes of diode failure — unstable reverse breakdown, increasing leakage current and the effects of contamination occurring during chip handling and packaging — are minimized. *In fact, the failure rates measured on NITRODES are an order of magnitude less than those obtained with oxide passivated units.*

Now in mass production, NITRODES are available in a series of epitaxial planar diodes having tightly controlled forward characteristics as well as low capacitance and ultra-fast switching speeds. NITRODES' reliability is parametrically defined by operational ratings at 175°C, the highest such rating available in standard diodes today. They are packaged in the popular DO-35 size employing whiskerless, unitized construction. Although primarily intended for fast switching computer applications, they are also ideal for general purpose applications including low power rectification, RF switching, voltage regulation and a large number of other uses.

Write for full information. (In Europe, to: General Instrument Europe, Via Turati 28, Milano, Italy.)

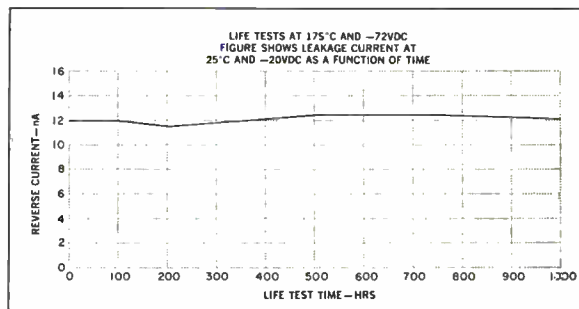
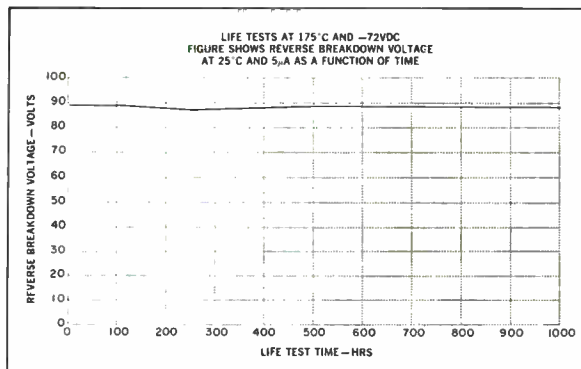

The figures above show the extreme stability of NITRODES under high temperature DC blocking test conditions.



GENERAL INSTRUMENT CORPORATION • 600 WEST JOHN STREET, HICKSVILLE, L. I., NEW YORK

# Designed AS An Industrial...

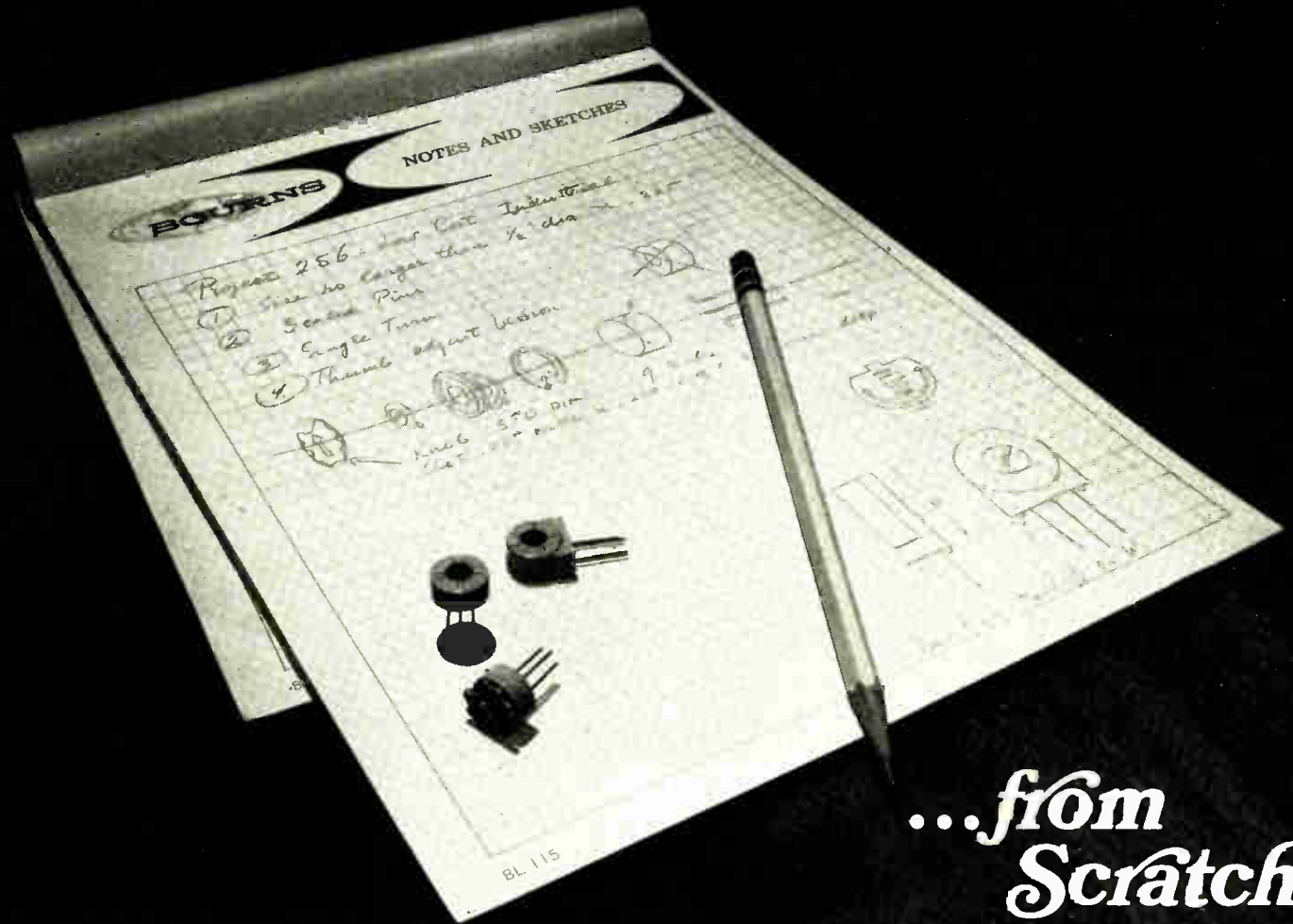

...from  
Scratch

The Model 3365 TRIMIT® adjustment potentiometer is an industrial unit . . . designed from the ground up for industrial applications. It is brand new! This low cost single-turn wirewound unit is available in two printed circuit styles . . . each style is also available with thumb adjustment knob. Standard and special resistances are from 10 ohms to 50K. Resistance tolerance is  $\pm 5\%$ . It is small . . .  $\frac{1}{2}$ " diameter by less than  $\frac{1}{4}$ ". It is light weight . . . approximately 0.05 oz., in an all-plastic case.

There are several other points we would like to mention about the Model 3365. Its pins are sealed, its terminals gold plated, making it suitable for production fluxing and soldering processes employed on printed circuit boards. The exclusive SILVERWELD® process is used, thus eliminating vulnerable single wire terminations.

We think you will be even more impressed when you have read the complete, detailed specifications and technical data . . . they are available to you by contacting your nearest Bourns office or representative, or writing the factory direct.

Circle 208 on reader service card



#### SPECIFICATIONS:

Standard Resistance Range	10 to 50K ohms
Resistance Tolerance	$\pm 5\%$ standard
Resolution	0.08 to 0.68%
Power Ratings:	
40°C Ambient	0.5 watt
105°C Ambient	0 watt
Operating Temperature Range	-55 to +105°C
Temperature Coefficient	70 PPM/°C
Humidity, MIL-STD-202, Method 103	100 megohms min. insulation resistance
Shaft Torque	8 oz-in max.
Mechanical Adjustment	280° nominal



BOURNS, INC., TRIMPOT DIVISION • 1200 COLUMBIA AVE., RIVERSIDE, CALIF.  
TELEPHONE 714 684-1700 • TWX: 910-332 1252 • CABLE: BOURNSINC.

TRIMPOT® AND PRECISION POTENTIOMETERS—RELAYS—MICROCOMPONENTS: TRANSFORMERS, INDUCTORS, RESISTORS AND CAPACITORS



# NEW

## HIGH GAIN PLANAR TRIODES

# 20 dB

FOR U. H. F.  
TELEVISION  
TRANSLATORS  
470 - 960 Mcs

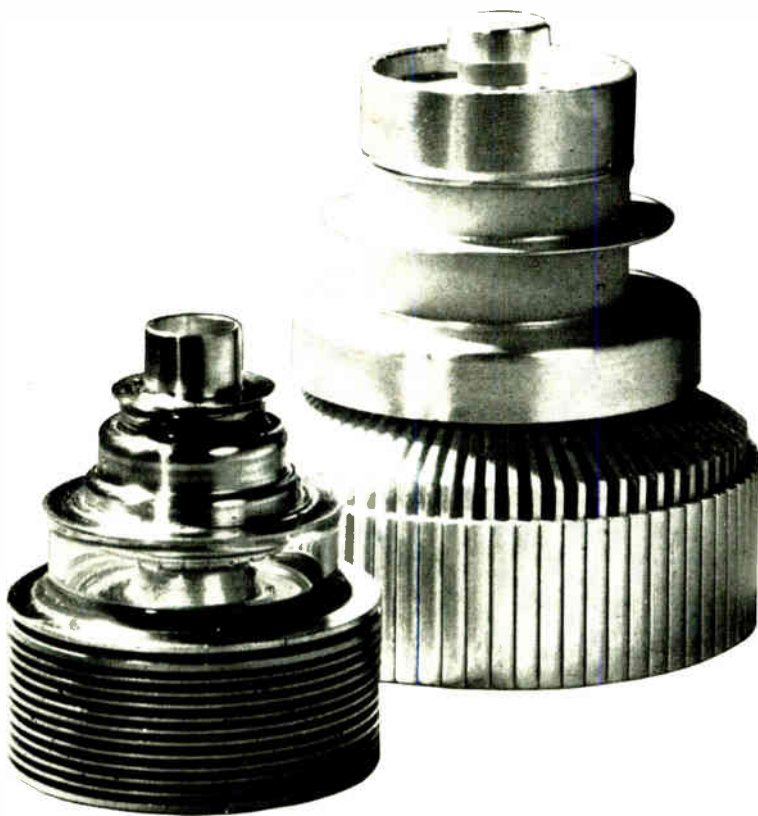

*...a trusted name*

**LONG LIFE - HIGH RELIABILITY**

RATINGS		TH. 302	TH. 328
HEATER VOLTAGE	V	5	5
HEATER CURRENT	A	1,9	5
ANODE VOLTAGE	kV	1,6	2
ANODE CURRENT	mA	130	250
OUTPUT POWER	W	25*	100*
INTERMODULATION LEVEL (3 Tones Test)	dB	> 52	> 52

\* The indicated output power corresponds to critical linear class A operation in U.H.F. Television translator handling both sound and vision signals and complying with C.C.I.R. - F.C.C. - O.I.R.T. specifications.

- \* THE MOST ADVANCED TECHNOLOGY
- \* THE LOWEST OPERATION COST

These tubes are designed for use in power amplifiers associated with solid-state drivers.

High gain U.H.F. Planar Triodes TH 302 and TH 328 are also recommended for use in Communication and Television Transmitters.

*We are ready to solve your problem. Please contact for specific information*

**THOMSON HOUSTON - HOTCHKISS BRANDT**

ELECTRON TUBE DIVISION - 8, RUE CHASSELOUP-LAUBAT - PARIS XV\* - FRANCE - TEL. : 566.70.04

THOMSON ELECTRIC Co INC. 50 ROCKEFELLER PLAZA - ROOM 916 NEW-YORK, 10020 N.Y. U.S.A. - Phone : 212 245 3900

Hi-G provides the most complete line of *miniature* coaxial relays that meet or exceed the applicable portions of MIL-R-5757/D . . . and at competitive prices. These hermetically sealed coaxial relays have been specifically designed for high frequency RF



switching applications. Their trouble free performance characteristics are a result of Hi-G's long experience in the design and manufacture of sophisticated switching devices. All Hi-G relays are built to withstand extremely tough environmental conditions.

## SOLVE YOUR HIGH FREQUENCY RF SWITCHING PROBLEMS WITH THESE QUALITY COAXIAL RELAYS

The following configurations are available:

### Dice Cube



**Relay Type** RFC  
**Size** 0.5-Inch Cube  
**Rated Contact Current** 1 Ampere RF  
**Maximum Weight** 0.3 Ounce (without terminations)

### Half Size Crystal-Can



**Relay Type** RFK  
**Size** .4 x .8 x .4 inch  
**Rated Contact Current** 1.5 Amperes RF  
**Maximum Weight** 0.37 Ounce (without terminations)

### Crystal-Can

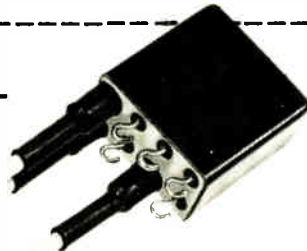

**Relay Type** RFB  
**Size** .875 x .800 x .400  
**Rated Contact Current** 1.5 Amperes RF  
**Maximum Weight** 0.95 Ounce (without terminations)

### High Sensitivity

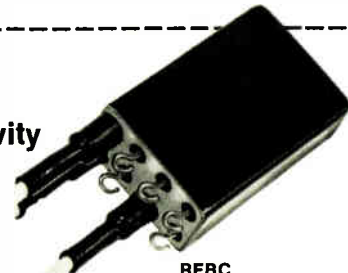

**Relay Type** RFBC  
**Size** 1.275 x .800 x .400  
**Rated Contact Current** 1.5 Amperes RF  
**Maximum Weight** 1.0 Ounce (without terminations)

#### RADIO FREQUENCY CHARACTERISTICS

Frequency Range	0-500 MHz*
Voltage Standing Wave Ratio (VSWR)	<1.1:1 typical
Insertion Loss	0.16DB typical
Characteristic Impedance	50 Ohms†
Crosstalk	-50DB typical

Standard input and output connections from R.F. contacts are RG-196/U Teflon insulated coaxial cable, 6" in length, unterminated. Other lengths, types of cable, or coaxial connector terminations available on special order.

\* Usable to 1000 MHz with reduced R.F. Characteristics † Other impedances available on special order

Call, write, or check the reader service card for your copy of Hi-G Product Bulletin 155. Hi-G radio frequency relays are available through Hi-G distributors and, if you need applications engineering assistance, an experienced Hi-G representative awaits your call. Telephone: 203-623-2481.



SPRING STREET & ROUTE 75 / WINDSOR LOCKS, CONNECTICUT 06096



**It's new. Our Molex 1820 Switch. You can use one, or a gang of them, for an infinite variety of applications. Its lighted push button can be wired to light independently of the switch. And there are colors galore. But what's really nice is price. About seventy cents in quantity.**

**It's a good example of the Molex creative approach to design problems. And the ability to design reliability and ease of assembly into a product without letting costs run wild due to over-engineering.**

**The 1820 is really one you have to see to believe.**

**And we would like to show it to you. For a free sample of our new switch, write or phone (312) 969-4550.**

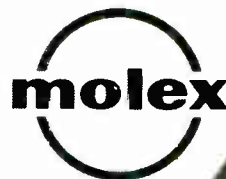



## Throw away your insulation handbook. All you need is Nomex®.

Nomex® nylon paper is the one insulation you can use for just about every application. It won't melt or support combustion—it's UL-rated at 220°C, and it complies with MIL-I-24204. Durable "Nomex" paper won't crack when creased or bent and does not flake. It can be easily slit or punched for close tolerance and can be used in automated operations.

\*Du Pont registered trademark

"Nomex" is compatible with all major resins, varnishes and enamels. It is relatively unaffected by moisture, and there are no shelf-life problems.

"Nomex" is available in a wide variety of fabricated forms designed to fit any application. So look to one material—"Nomex"—for all your insulation needs.

To get more information, write:

Du Pont Company, Nomex Marketing,  
Room J-4, Wilmington, Delaware  
19898. In Canada, write Du Pont of  
Canada Ltd. In Europe, Du Pont de  
Nemours Int., S.A., 81, Route de l'Aire,  
Geneva, Switzerland.

**DU PONT** **NOMEX**®  
REG. U.S. PAT. OFF. NYLON

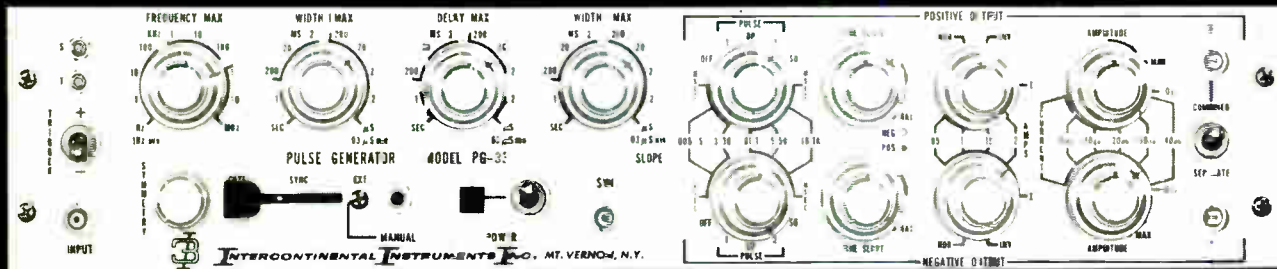
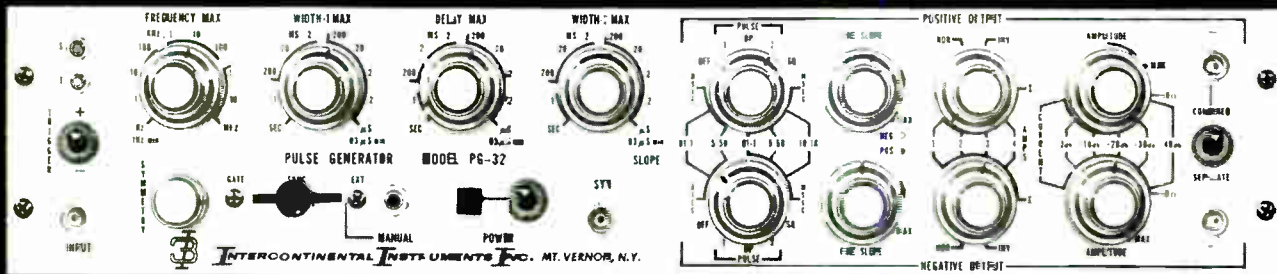
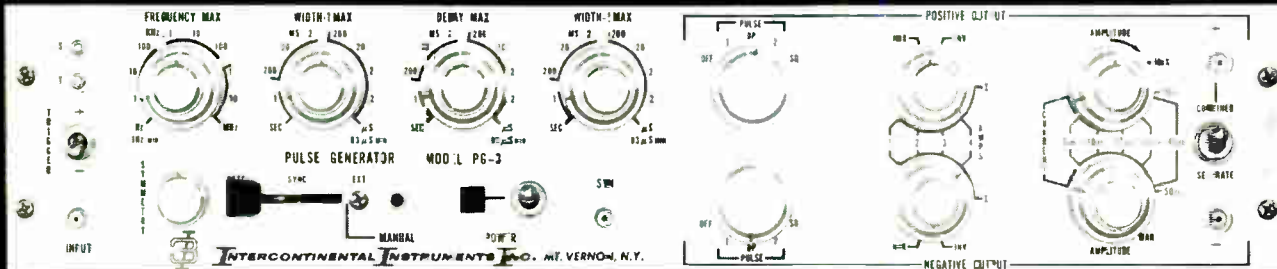
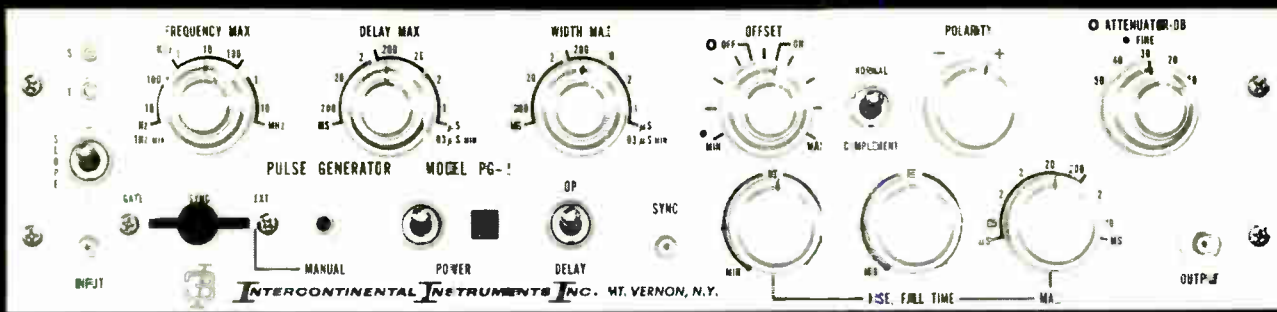

## THE PLUS PULSERS.

These four solid-state pulse generators offer you more in the 0.1 Hz to 20 MHz range than any others available at equivalent prices.

More range in prf, width, delay, rise and fall, and amplitude. More versatility: PG-31, PG-32, PG-33 are dual, independent channel bipolar pulsers voltage or current outputs, normal or complementary, single or double pulses square waves plus sync and one-shot. PG-2 is a single

channel unit: positive or negative out, single or double pulse or square wave plus sync plus one-shot. All four are DC-coupled: no low frequency or duty cycle limitations.

The plus pulsers.

Compare specs — not nameplates.

Intercontinental Instruments, Inc., a Subsidiary of Chronetics, 500 Naber Avenue, Mt. Vernon, New York (914) 699-4400. In Europe: 39 Rue Rothschild, Geneva, Switzerland (022) 31 31 80.

MODEL	CLOCK PRF	AMPLITUDE	Z OUT	RISE / FALL TIME	WIDTH	DELAY	DUTY CYCLE (MAX)	DC OFFSET	PRICE
PG-2	1 Hz-10 MHz 20 MHz Max. <sup>1</sup>	10 mV-10V + or -	50 ohms	< 10 ns-20 ms <sup>4</sup>	< 35 ns-200 ms	0-200 ms	100%	± 5V	\$ 925.
PG-31	0.1 Hz-10 MHz 20 MHz Max. <sup>1</sup>	20 mV-20V <sup>3</sup> + and - 2 Channels	50 ohms or 500 ohms	10 ns	< 30 ns-1 sec <sup>5</sup>	50 ns-1 sec	100%	To 10V To 400 mA	1225.
PG-32	0.1 Hz-10 MHz 20 MHz Max. <sup>1</sup>	20 mV-20V <sup>3</sup> + and - 2 Channels	50 ohms or 500 ohms	10 ns-1 sec <sup>4</sup>	< 30 ns-1 sec <sup>5</sup>	50 ns-1 sec	100%	To 10V To 400 mA	1385.
PG-33	0.1 Hz-10 MHz 20 MHz Max. <sup>1</sup>	10 mV-10V <sup>3</sup> + and - 2 Channels	50 ohms or 500 ohms	5 ns-1 sec <sup>4</sup>	< 30 ns-1 sec <sup>5</sup>	50 ns-1 sec	100%	To 10V To 400 mA	1350.

### Notes:

- 1 Effective PRF in double pulse mode
- 2 Max. Range into 50-ohm loads
- 3 Separate or combined (bipolar) channels;

- 4 same polarity on Special Order
- 5 variable linearly — 100:1 dynamic range.
- 6 separate control of Rise and Fall Times

- 5 Independent control Pulse 1/Pulse 2 (double pulse mode)
- 6 fab. Mt. Vernon, N. Y., domestic



PRODUCTS OF  
CHRONETICS

# NEW Tektronix 50-ps Sampling Oscilloscope

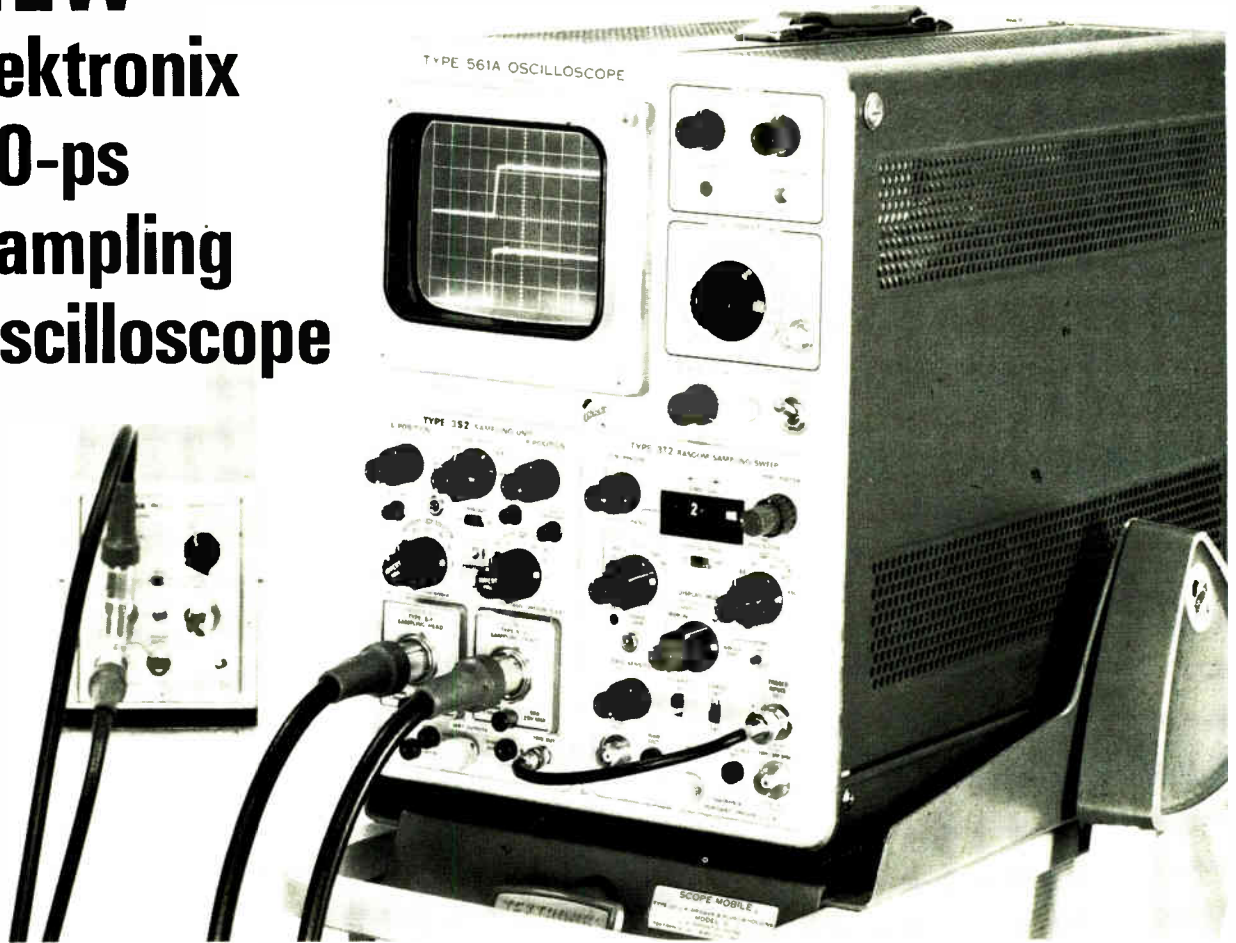

The Tektronix Type 561A Oscilloscope with the Type 3T2 Random Sampling Sweep and Type 3S2 Dual-Trace Sampling Unit provides new convenience when making fast pulse measurements. Random sampling permits triggering before or after the displayed pulse, eliminating the need for delay lines or a pretrigger.

The new Type 3S2 Dual-Trace Sampling Unit with plug-in Sampling Heads lets you change your measurement capabilities to meet your changing measurement needs. Two sampling heads are presently available: the Type S-2 features a 50-ps risetime and the Type S-1 features lower noise with a 350-ps risetime. Any combination of two Sampling Heads provides dual-channel operation in the Type 3S2. The Sampling Heads have a 50- $\Omega$  input with an internal trigger pick-off and a 2 mV/div to 200 mV/div calibrated deflection factor. Sampling Heads can be plugged into the Type 3S2 or attached by a 3 foot or 6 foot cable for remote use. An interchannel delay control compensates for signal cables or other external delays.

The Type 3T2 Random Sampling Sweep provides all the measurement capabilities of a conventional (sequential) sampling sweep, plus it features the added

advantage of random sampling operation. When used in the random sampling mode, the triggering event may be displayed on screen without the use of delay lines or a pretrigger. The Type 3T2 has a calibrated sweep range from 100  $\mu$ s/div to 200 ps/div extending to 20 ps/div with the X10 magnifier.

The Type 561A Oscilloscope has an 8 by 10 cm CRT with an illuminated internal graticule. In addition to the sampling plug-in units described, the Type 561A offers a wide range of measurement capabilities with 10 MHz Multi-Trace Plug-ins, 10  $\mu$ V/div Differential Plug-ins and Spectrum Analyzer Plug-ins covering the spectrum from 50 Hz to 36 MHz. The Type 564 Storage Oscilloscope uses the same plug-in units and offers the added advantage of split-screen storage.

Type 561A Oscilloscope .....	\$ 530
Type 564 Split-Screen Storage Oscilloscope .....	\$ 925
Type 3T2 Random Sampling Sweep .....	\$ 990
Type 3S2 Dual-Trace Sampling Unit .....	\$ 800
Type S-1 350-ps Sampling Head .....	\$ 250
Type S-2 50-ps Sampling Head .....	\$ 300
Scope-Mobile® Cart, Model 201-2 .....	\$ 135

U.S. Sales Prices FOB Beaverton, Oregon



**Tektronix, Inc.**



For a demonstration, contact your nearby Tektronix field engineer or write: Tektronix, Inc., P. O. Box 500, Beaverton, Oregon 97005

# Probing the News

Solid state

## Unpackaged chips set for gains

Semiconductor houses are not too pleased with their new market in dice, but steady demand from a growing number of customers is boosting volume

**Steady demand** from customers, notably hybrid-circuit makers and systems companies, has put most semiconductor houses in the business of selling unpackaged chips—both discrete devices and integrated circuits—during the last few years. Marketing managers are, however, something less than delighted with their new outlet. Orders are usually small, and there are a number of very tricky problems in the trade. In addition, some producers feel they may be passing on proprietary technical and yield information.

Dealings in unencapsulated dice are also a bit imperfect from the customer's standpoint. Says an engineer at a major systems company: "Buying unpackaged chips is like asking the cow for chewed cud rather than milk. Device makers don't have to have the full facts on their product at this stage. Semi-finished items involve problems in pricing, shipping, specifications, yields, testing, and reliability."

But for all these difficulties, unpackaged chips now claim a \$20 million to \$30 million chunk of the semiconductor market. Generally, however, the bigger semiconductor houses assert that no more than 2% of their output is in dice. The percentage runs much higher—to 10%, in some cases—at smaller concerns.

### Once over lightly

Motorola Inc., a ranking member of the semiconductor establishment, typifies the ambivalent attitude of the leading houses toward unpackaged chips. The company's Semiconductor Products division recently announced a standard line of 14 unpackaged discrete silicon transistor chips [Electronics, April

15, p. 47]. "But the division's in no hurry to push IC chips since we can sell all we make in packages," says Leo Lehner, manager of product marketing.

But while Lehner pooh-poohs the size of the dice effort at his own company, he acknowledges that the industry may be moving in this di-

rection. And Motorola might set up a formal program to get a piece of the action within the year. "Customer needs will dictate output," says Lehner. "But linear operational amplifiers are probably the most likely place to start; diode-transistor and transistor-transistor logic are also candidates."

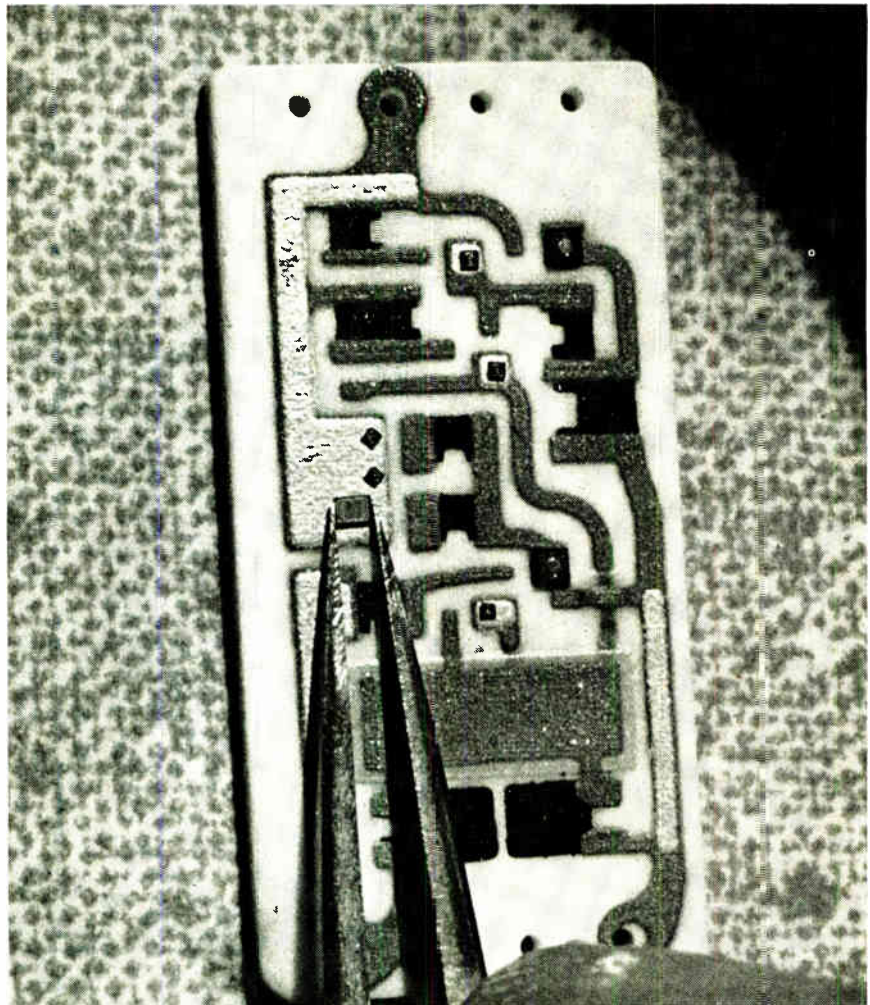

**Chipping in.** Unpackaged pnp transistor is put in place in hybrid thick-film circuit built by Helipot division of Beckman Instruments.

Now in  
publication!

# A Fully Documented Analysis of International Electronics

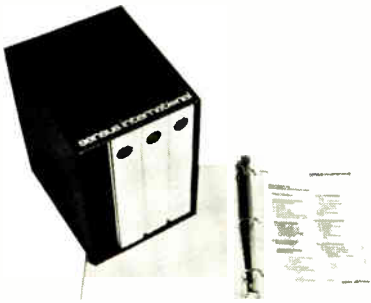

Four volumes of incisive data—by country—basic elements in planning and maintaining a position of marketing strength in the international electronics markets.

Updated regularly, information is gathered on the spot and covers all aspects of doing business in electronics in every major electronics market of the world. Tariffs, government policies, exchange controls, credit, trade unions, even the impact of smuggling are covered in these in-depth reports.

Send for complete, free information

**sensus international**

Please send me your free,  
descriptive literature.

Name \_\_\_\_\_

Title \_\_\_\_\_

Company \_\_\_\_\_

Street \_\_\_\_\_

City \_\_\_\_\_

State \_\_\_\_\_ Zip \_\_\_\_\_

**SENSUS INTERNATIONAL**  
712 Montgomery Street,  
San Francisco, Calif. 94111

If you can't wait,  
call (415) 989-6973

## ... unpackaged chips are a first step toward large-scale integration ...

**Wishful thinking.** A spokesman at another top semiconductor house dismisses the situation this way: "You can describe unpackaged chip marketing in the IC field as a hobby. There just isn't very much being done, except where a user has a particular need."

As it happens, quite a few users have particular needs. One such is the Hughes Aircraft Co.'s Data Systems division, which has been using unpackaged chips since 1965. According to Jay Block, who heads the division's advanced microelectronics development section, the increasing demands being made on circuitry are the principal reason for the boomlet in dice. "We need devices like 1-nanosecond flip-flops," he says. "They have to be extremely small to operate at such high speeds. We're finding out that unpackaged chips are better suited to our purposes in many cases than conventional packaged devices. Block cites radar signal correlating computers, 100-megahertz counters, and wide-bandwidth linear amplifiers used with thin-film memories as examples of equipment in which unpackaged chips are widely used.

Hughes' microelectronics labora-

tory also goes in for chips in a big way, using them in hybrid circuits sold to systems houses. The main factors, according to Richard Belardi, the lab's manager, are, again, customers' size and weight requirements, but he also notes that unpackaged chips fit into Hughes' large-scale-integration efforts. The company buys devices with a maximum amount of circuitry and interconnects them on a common substrate.

**Military might.** R. M. Bucheister, purchasing agent at the Autonetics division of the North American Rockwell Corp. credits such Defense Department programs as MERA (microelectronics for radar applications) and Sentinel with being a big factor in breaking down the resistance of semiconductor houses to unpackaged chips, observing that the hybrid circuits used in these projects constitute a relatively large market. "However, it's still not a buyers' market," he adds.

The Helipot division of Beckman Instruments Inc. seems to agree. George Smith, supervisor of the microcircuit product development group, says: "We still have to go after the semiconductor houses. To

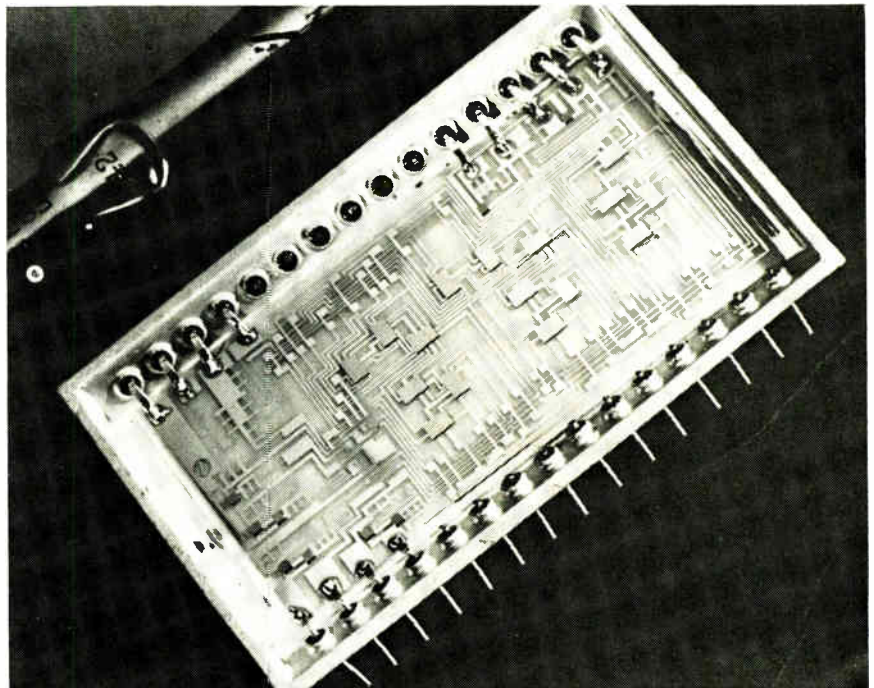

**Mix.** In this seven-bit counter, made by Autonetics, unpackaged transistor dice are bonded to the passive, thin-film circuitry.



get them interested we have contracts with minimum release quantities."

Until Helipot signed agreements with four suppliers about a year ago, it had been having both price and delivery problems. But the firm squared away its specifications, set up a vendor rating program, and managed to get its purchasing operation out of the small-lot category. On Helipot's shopping list are high-conductance and high-speed diodes, digital and linear IC's, zener diodes, junction field effect transistors, silicon controlled rectifiers, and npn and pnp transistors of all kinds.

**Fast work.** LTV Electrosystems Inc. buys unpackaged chips for the usual user reasons. But Mike Shannon, who directs the microcircuit and process engineering department, notes that time is also a factor. "An engineer came to me recently for circuits that weren't on the market," he says. "He had a schematic, no money, and nine working days. But we were able to design and make what he wanted with chips."

Suppliers have to be convinced that you know how to handle the chips before they'll sell, Shannon says. But once they're satisfied, there's little trouble.

He notes that the user of unpackaged chips must set up a production line rather like that of its suppliers, albeit on a smaller scale. "What's needed is a chip moulder, microprobes, microbonding equipment, and package sealers," he says.

At the Hewlett-Packard Co., Art Fong, senior staff engineer, says the use of dice has permitted the company to reduce the size of its model 8601A signal generator by 25% and add a sweeper to the unit.

Still another buyer of unpackaged chips is the Systems Group of TRW Inc. Leonard Martire, manager of microelectronic products, says 80% of the dice now purchased by his firm are for discrete devices; however, he estimates that within the year there will be a 50-50 split between monolithic IC's and discrete assemblies. The devices are used in hybrid circuits the group supplies in-house and to outsiders. Martire says that geometries have proved a problem. "There are differences in the same device from a single maker over short runs as well

## Now from Sprague!



## All the advantages of tantalum in one **LOW COST** capacitor!

### EPOXY-DIPPED TANTALEX® CAPACITORS . . .

**For industrial, commercial, and entertainment electronic applications where tantalum capacitors were previously too expensive!**

— Type 196D Solid-electrolyte Tantalum Capacitors have special epoxy-dip coating which keeps costs down without sacrifice in dependability. Positively seals capacitor section while providing excellent electrical insulation. Protects against mechanical damage in handling.

— Radial lead design for plug-in mounting on printed wiring boards. The .250" lead spacing will fit standard .125" grids.

— High stability—very little capacitance change, even at outer limits of operating temperature range.

— Low dissipation factor of these capacitors permits higher ripple currents.

— Meet environmental test conditions of Military Specification MIL-C-26655B.

— Prime capacitance and voltage ratings. Based on rating popularity of other types of solid tantalum capacitors.

— Designed for continuous operation at temperatures from -55 C to +85 C.

For complete technical data, write for Engineering Bulletin 3545 to Technical Literature Service, Sprague Electric Company, 35 Marshall Street, North Adams, Massachusetts 01247.

**Now available for fast delivery  
from your Sprague Industrial Distributor**

### SPRAGUE COMPONENTS

CAPACITORS  
TRANSISTORS  
RESISTORS  
INTEGRATED CIRCUITS  
THIN-FILM MICROCIRCUITS  
INTERFERENCE FILTERS

PACKAGED COMPONENT ASSEMBLIES  
FUNCTIONAL DIGITAL CIRCUITS  
MAGNETIC COMPONENTS  
PULSE TRANSFORMERS  
CERAMIC-BASE PRINTED NETWORKS  
PULSE-FORMING NETWORKS



\*Sprague and ® are registered trademarks of the Sprague Electric Co.

# LET'S GET TECHNICAL!



## KEPCO POWER SUPPLIES

### PROGRAMMING SPEED

With the advent of fast-programming d-c power supplies (pioneered by Kepco three years ago), there has arisen a problem about how best to describe the speed with which a power supply's voltage can be switched from level to level. Properly stated, this rather vital parameter becomes, also, the measure of sinusoidal amplitude-frequency bandwidth—in the frequency domain, and the response time of a current regulator's recovery from a step load change.

Unfortunately, there is yet little agreement among the manufacturers of fast programming equipment on measuring technique—or even the units.

On the theory that a possible user, informed of the method, can easily ascertain for himself the probable performance in his application. The following is offered:

KEPCO'S PROGRAMMING SPEED MEASURING PROCEDURE:

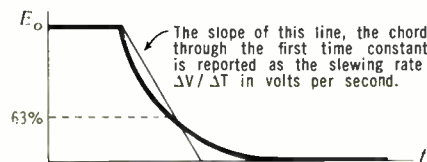
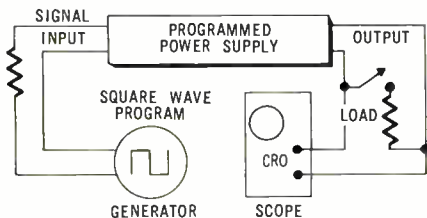

RISE AND FALL. NO LOAD AND FULL LOAD ARE MEASURED, THE NO LOAD FALL (SLOWEST) RATE IS REPORTED AS THE POWER SUPPLY'S SLEWING RATE

Our reader's comments are invited. If you'd like the specs on our various high speed power supplies, circle the number below or write Dept. AB-14



131-38 SANFORD AVENUE • FLUSHING, N.Y. 11352  
(212) 461-7000 • TWX #710-582-2631  
Telex: 12-6055 • Cable: KEPCOPOWER NEWYORK

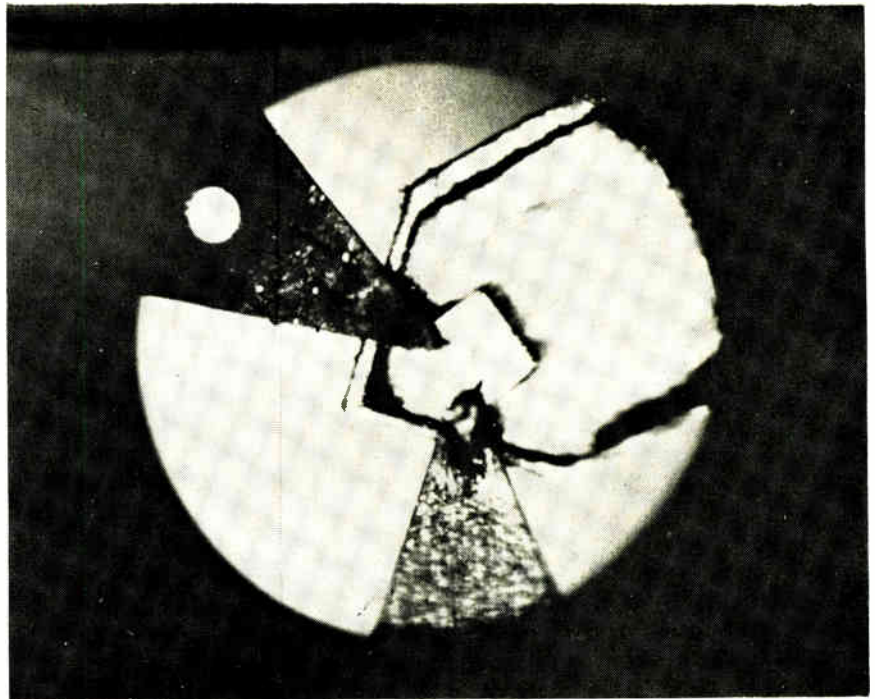

**Check-in.** Transistor chip is probed before use at Hewlett-Packard in a test system designed by staff engineers to take risk out of dice buys.

as among the products of a number of suppliers," he explains.

### Self depreciation

Despite the sizable and growing market for unpackaged chips, most of the bigger semiconductor houses go to some lengths to emphasize the problems involved. For example, the Semiconductor division of the Fairchild Instrument & Camera Corp. is willing, if not eager, to sell chips. "How do you define what you're selling and the customer's buying?" says Tom Bay, the division's general manager. "You can't tell enough from the wafer probe."

According to Jerry Sanders, marketing manager, there are two reasons for Fairchild's reluctance: the difficulty of bringing test specifications up to customer needs and the loss of the packaging profit. "How big the dice business gets depends on how soon semiconductor makers convert to multibump units," he says. In other words, hybrid packages will do a lot better when the dice can be bonded face down because costs will be lower.

However, Ben Anixter, IC marketing manager at the Semiconductor division, takes a more pragmatic approach. "If people are going to buy chips, they might as well buy from us," he says. Fairchild's capacity is limited more by assembly than by wafer fabrication, he goes

on, and it's no real trick to put a couple of extra slices in the boat.

Fairchild plans to market flip-chip devices in TTL and a couple of DTL lines, and will soon have sample lots in the hands of distributors. Small lots, on the order of 10 chips or so, will cost slightly less than packaged versions—about \$4 for what would cost \$5 packaged—and the prices of large quantities will be determined, Anixter says, by the forces of supply and demand. In other words, by dickering.

**Diffident Texans.** Texas Instruments is similarly reticent when it comes to unpackaged chips. Less than 1% of the company's IC output is in this area, says Ed O'Neill, marketing manager for the Semiconductor Circuits division. Though the company doesn't actively solicit dice business, it's willing to work closely with customers on size and weight problems requiring chips.

### Advocates

Smaller firms are more willing, and even anxious, to engage in the unpackaged chip trade. For example, the Dickson Electronics Corp., a firm best known for zener diodes and tantalum capacitors, says that dice volume is now running at 10 times the year-earlier pace. In addition to supplying makers of hybrid circuits, the company has been

# you get a choice,



# not a challenge

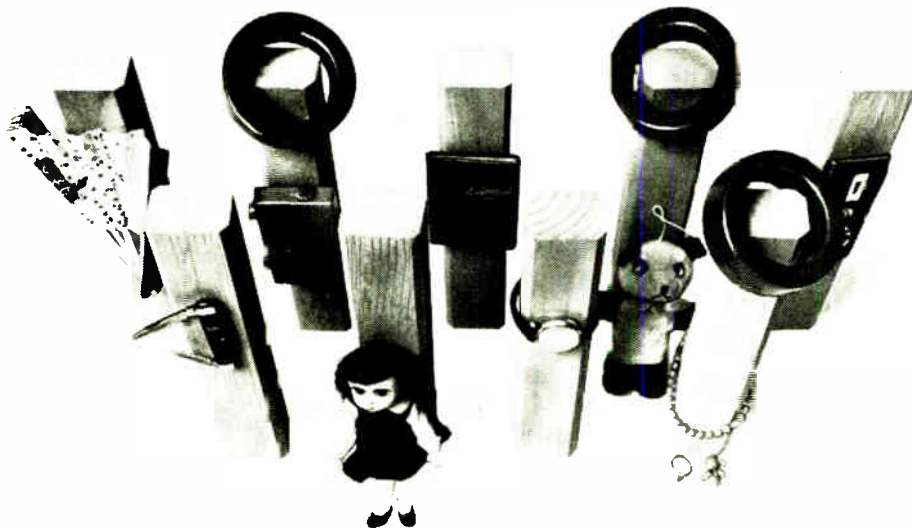

## Industry's widest selection of powder cores gives you greater design flexibility

The trend toward smaller circuits and higher density packaging has posed a compaction problem for electrical design engineers—finding quality components small enough to do the job. Magnetics gives the designer more “elbow room” by providing the industry's most complete line of moly-permalloy powder cores—sizes as small

as 0.110" I.D. in the widest range of permeabilities and stabilizations.

We also give the designer involved with highly critical inductor stability factors more latitude with guaranteed temperature stabilization in miniature powder cores. All of these types are designed so they can be wound on present miniature toroidal winding equipment. The “M” type limits the change in inductance to  $\pm 0.25\%$  from  $-65$  to  $+125^\circ\text{C}$ . The “D” type limits the

change to  $\pm 0.1\%$  from  $0$  to  $55^\circ\text{C}$ . The “W” type limits the change to  $\pm 0.25\%$  from  $-55$  to  $+85^\circ\text{C}$ . These stabilizations are available in all sizes and permeabilities.

If condensing a circuit design is your bugaboo, check Magnetics' powder core line—the one that gives you a choice, not a challenge. For the complete story, write Magnetics Inc., Butler, Pa. 16001

**MAGNETICS inc.**  
®

# Bulova forks solve low frequency problems

Let the experience behind 300,000 forks per year help you!

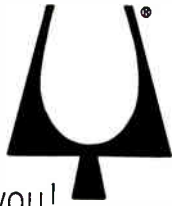

American Time Products forks are now available up to 25 kc, thanks to years of experience plus new design techniques developed by Bulova. (Including the tiny forks for Accutron® electronic timepieces, Bulova made 300,000 last year alone!)

Result: ATP units provide lower cost, smaller size, lighter weight and greater long term stability in such applications as Computers, Navigation Systems, Doppler Radar, Motor Drives, Encoders and Timers. Accuracies of up to 0.001% are available.

Bulova fork oscillators offer the added advantage of simplicity of design and circuitry. Fewer components mean greater reliability. Finally, Bulova fork products are uniquely capable of withstanding severe shock and vibration environments. No wonder Bulova sold 300,000 last year!

## FS-11 FORK FREQUENCY STANDARD

Standard Frequencies: Up to 10,000 cps

Accuracy: Up to  $\pm 0.001\%$   
Input: 28V DC (others on request)

Output: 5 volts p-to-p min. into 10K ohms  
Temperature Range: As low as  $-55^{\circ}\text{C}$  to as high as  $+85^{\circ}\text{C}$   
Size:  $1\frac{1}{2}$  in. sq. x  $\frac{3}{8}$ "



## SUB-MINIATURE TF-500 TUNING FORK

Standard Frequencies: Up to 2400 cps

Accuracy: Up to  $\pm 0.001\%$  at  $25^{\circ}\text{C}$

Input: 28V DC (others on request)

Output: Up to 5V rms into 20K ohms

Temperature Range: As low as  $-55^{\circ}\text{C}$  to as high as  $+85^{\circ}\text{C}$

Size:  $\frac{3}{8}$ " x  $\frac{3}{4}$ " x  $1\frac{1}{2}$ " max.

Write or call for specifications on Bulova's complete line of tuning fork products.  
Address: Dept. E-16.

# BULOVA

AMERICAN  
TIME PRODUCTS

ELECTRONICS DIVISION  
OF BULOVA WATCH COMPANY, INC.

61-20 WOODSIDE AVENUE  
WOODSIDE, N.Y. 11377, (212) DE 5-6000

## . . . not all systems houses are keen on unpackaged semiconductor chips . . .

dealing with a concern that wants to buy its devices for repackaging outside the U.S. This prospect doesn't in the least dismay Donald Dickson, president of the company. "The volume would have to become pretty great before I became concerned," he says.

Dickson Electronics has set up a 100% burn-in program for all its high-reliability products, including chips. "The way we do this is to package the chips, test them, then take them out of the package," says Dickson. "In such cases, it's not at all unusual to find chips going for more than packaged assemblies."

At the Microelectronics division of the Philco-Ford Corp., Richard Rogoff, product marketing manager for bipolar IC's, observes a growing sophistication among users in the way they design with and use unpackaged chips. "They'll soon be ready for medium-scale-integration devices and even LSI," he says. "We even have some customers to whom we'll sell unmetallized wafers and masks so they can fabricate complex networks."

**Realist.** Another happy warrior is Donald Valentine, marketing manager for the National Semiconductor Corp. "Unpackaged chips account for 5% of our volume," he says. "Eventually, the level will be 10%. We go in for it because it's a source of revenue and we're in business to make money. In addition, we frequently get a foot in the door by going this route."

National generally sells scribed wafers rather than diced chips. "I fail to see how a wafer can be analyzed by a rival so they can learn how to duplicate your processing," says Valentine. "And it's easier for our customers to probe a wafer than to check hundreds of separate devices."

But the wafer bugaboo persists. Joe Obot, a senior engineer with ITT Semiconductors, says most big IC houses feel that in selling wafers they might reveal yield information that could compromise their market position and hurt their finished-product prices. "In addition," he says, "they're reluctant to vend chips because some of the required

guarantees can't be made."

Not all systems houses are sold on unpackaged chips. James Mintern, senior components engineer with the Space and Information Systems division of the Raytheon Co., says: "In my experience, 95% or more of all failures are related to other than the basic chip. Failures occur in handling, bonding, sealing, and related operations. If you're going to buy chips, you're undertaking the solution of big problems, as well as the overhead involved in gearing up for packaging. If at all possible, avoid unpackaged chips like the plague."

Interestingly, Raytheon's Semiconductor division is very keen on unpackaged chips. Says Dick Greene, product manager for semiconductor materials: "The package is an interim solution to handling semiconductor devices. Several years ago we got interested in the hybrid market because users were having trouble meeting size and space requirements with hermetic packs. They pushed for chips from us. And now we will sell any of our devices in unpackaged form."

**Risky business.** Bipin Kapadia, product manager of large-scale systems at Honeywell Inc.'s Electronic Data Processing division, is not particularly interested in unpackaged chips. "They just aren't attractive to a commercial computer concern," he says. "I'd say only aerospace firms could take maximum advantage of chips. They're willing to experiment and can afford to take the cost beating on ruined devices."

But, of course, this is what the semiconductor houses have been saying all along. Harry Luhrs, IC product marketing manager at the Semiconductor division of Sylvania Electric Products Inc., sums it up this way: "Although the user doesn't pay as much for the chip itself, he pays for the uncertainty involved. We aren't able to guarantee a chip since they are shipped before a-c tests are made. About the best a manufacturer can do is package a selected few IC's, check them, and hope they're typical of the lot."

Report from

**BELL  
LABORATORIES**

# Breadboarding the modern way



Scientist Barry J. Karafin of Bell Laboratories checks chart recorder waveforms from a BLODIB simulation. Karafin uses the computer console at his right to interact with the simulation program. This feature was developed for the BLODIB program to give users the flexibility of making changes in such things as component values without having to re-program an entire system.

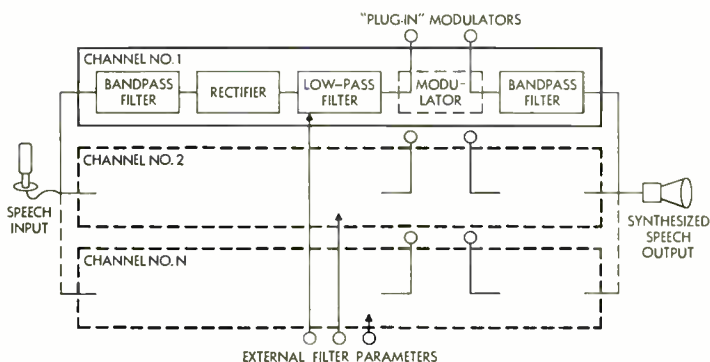

A hypothetical voice-analyzing/synthesizing system (resembling Bell Laboratories' "vocoder")... and how it might be simulated with BLODIB. The system would have a number of band-limited channels, each consisting of such blocks as BANDPASS FILTER, RECTIFIER, and LOW-PASS FILTER. Once the experimenter specifies one channel, he can call upon it, complete, as many times as necessary. Such a system analyzes a voice input into "channels" (narrow frequency bands). It then synthesizes (recombines the channels) so that the speech output can be heard on earphones or over a loudspeaker. It might be used to test relationships between channel width and intelligibility. To experiment with various MODULATORS, the user can leave "open terminals" (blank sections) in the program and "plug in" (supply sub-programs for) simulated modulators. The LOW-PASS FILTERS have externally variable parameters, such as cutoff frequencies; these parameters may be supplied by a user during simulation or by another computer program.

More and more, engineers use digital computers to simulate new electronic systems. It's often faster and cheaper than breadboarding... building an experimental system.

But simulation is most useful if the experimenter can "talk" to the computer in his own language... a block diagram symbolizing an electronic process. To translate such a diagram into a computer simulation program, scientists at Bell Telephone Laboratories designed an intermediate program or "compiler." The latest version is called BLODIB for BLOck Diagram compiler B (pronounced "Bloody Bee"). BLODIB's output is a simulation program—in machine language.

The BLODIB user needs little programming experience. He writes a description of a block diagram and its connections in terms from the BLODIB dictionary... which contains abbreviated names for most blocks, such as AMP for amplifier. The descriptions need not follow signal flow; BLODIB arranges it properly.

The BLODIB dictionary cannot contain a block for every possible electronic function. But many new blocks can be built up from those available. And, if one combination will be used many times in a design, it can be named and used as often as necessary.

To test prototype systems, the experimenter can leave parameters variable, or he can even arrange for their values to be supplied by another computer program for automatic simulation throughout a range of settings. Also, if he is doubtful about, say, a filter, he can simulate his system without the filter and "plug in" simulation programs for various experimental filter designs. In this way, several designs can be tested before investing in a laboratory model.

The BLODIB program has been used to simulate acoustical and visual systems and was recently used to study automatic equalization techniques for Bell System data sets.

The first block-diagram compiler, BLODI, was conceived and developed at Bell Laboratories by V. A. Vyssotsky, John Kelly, and Carol Lochbaum. B. J. Karafin recently formulated the BLODIB program which extends the original BLODI program so it can interact with non-BLODI programs and provide the flexibility described above. This makes it an even more powerful tool for probing potential systems over a broad range of operating conditions.



**Bell Telephone Laboratories**  
Research and Development Unit of the Bell System

**Four reasons for using heat-shrinkable tubing of Kynar\*!** (1) It's two to three times tougher than any other shrinkable plastic tubing. (2) It's thermally stable... operates at 150°C, flexible at -65°C. (3) It shrinks 50% at 175°C. (4) It's UL approved for 600 volt rating at 150°C. And how can you use it? Here are just five of the many ways.

**For corrosion protection**—Resists chemicals and weathering at battery terminals.

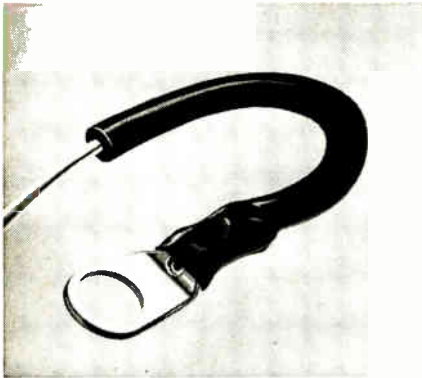

**For strain relief**—Transfers flex stress away from joint; protects conductors.

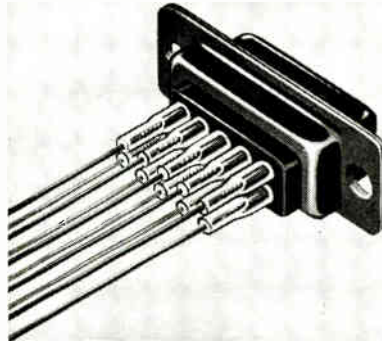

**For insulation and mechanical protection**—Capacitors, resistors, diodes.

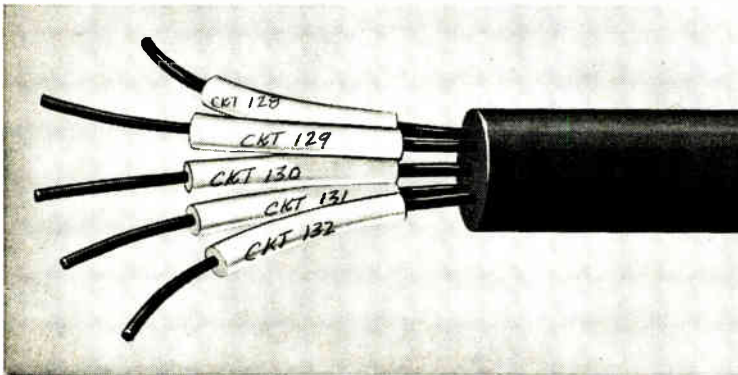
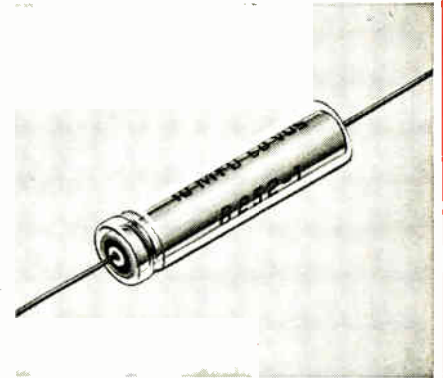

**For identification**—Eliminates the need for stocking colored or printed wire.

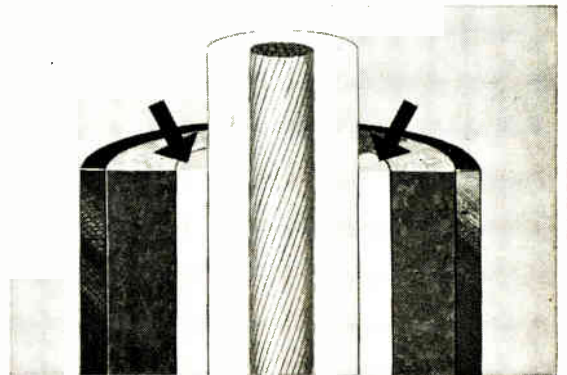

**For sealing out moisture**—Used over TFE insulation to bond with potting compounds.

If you are using or considering heat shrinkable tubing, investigate all the advantages of specifying Kynar. It's available in a range of diameters from Raychem Corporation as Thermofit\*\* Kynar. For information, write Plastics Department, Pennsalt Chemicals Corporation, 3 Penn Center, Philadelphia, Pa. 19102.

**Kynar... a fluoroplastic that's tough!**

\*Kynar is a registered trademark of Pennsalt Chemicals Corporation for its vinylidene fluoride resin

\*\*Registered trademark of Raychem Corporation



# Bell Canada's R&D arm develops reach

Northern Electric, once dependent on Bell Labs and Western Electric for design and manufacturing information, has developed space-age capabilities on its own

By Charles Law and Barry Shockett

Toronto correspondents

**There was little surprise** last month when the Canadian government picked the Northern Electric Co. to prepare a detailed proposal for the design and manufacture of a domestic satellite communications system [Electronics, Sept. 4, 1967, p. 131]. The company, one of two potential prime contractors, has had extensive experience in telecommunications systems and ground stations. In addition, around the turn of the year, Northern Electric established a working relationship with the Hughes Aircraft Co. and Canadair Ltd., a subsidiary of the General Dynamics Corp., to upgrade its spacecraft abilities.

Though Northern Electric dates back to 1882, when it was set up as the manufacturing arm of the Bell Telephone Co. of Canada, its advanced-technology skills are of comparatively recent vintage. As the result of a U.S. antitrust investigation of the American Telephone & Telegraph Co., Northern Electric was put on short rations by the Bell Telephone Laboratories and the Western Electric Co., long its principal sources of product design and manufacturing information. Since then, the nature of AT&T's consent decree has restricted the northward flow of data largely to what the Bell System is prepared to furnish any U.S. or foreign company.

**Success story.** Notwithstanding the cutting of its AT&T ties, Northern Electric has become a brawny industrial research organization—the largest in Canada—on its own. The wholly owned subsidiary of Bell Canada currently has a staff of 1,600 at its central lab near Ottawa and at six regional facilities.

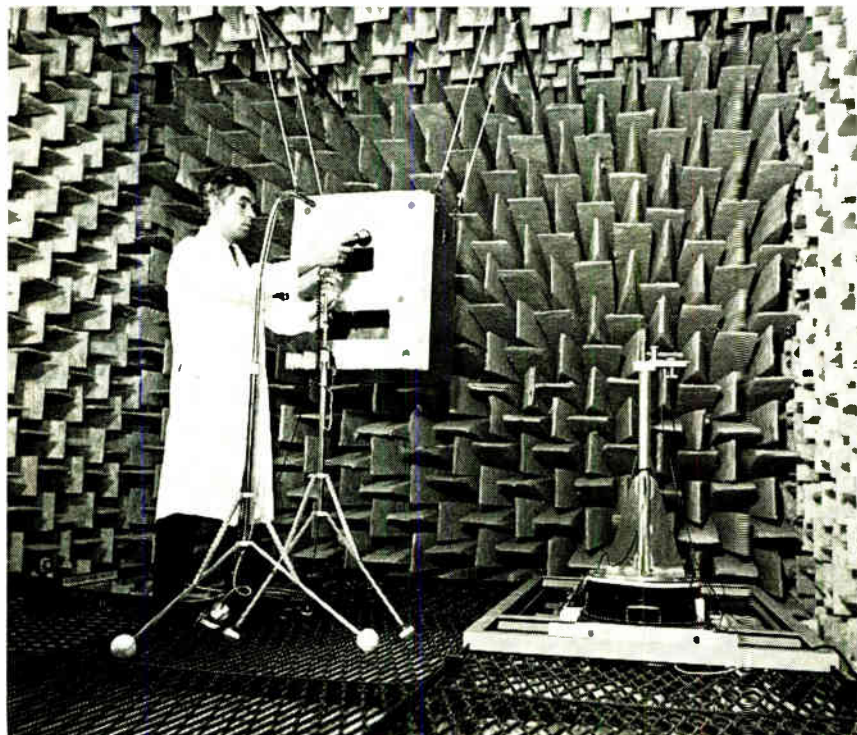

**Sound of silence.** Scientist checks transducer devices for telephones in quiet atmosphere of anechoic chamber at Northern Electric Laboratories.

And this year's R&D budget is \$35 million, about 10% of anticipated hardware sales.

Northern Electric's efforts have been primarily directed toward keeping its parent among the front runners in Canada's telecommunications industry. Northern Electric had dabbled in video and broadcast equipment, but the promise of electronic switching and transmission systems in telecommunications prompted the company to phase out of such peripheral activities.

## Bird watching

Northern Electric's only rival for the satellite contract is RCA Victor Ltd., which has joined forces with

TRW Inc.'s Systems Group. The two competitors are due to submit detailed proposals to the Federal Department of Industry by year's end.

Northern Electric may have an edge because of its manufacturing capability and early start in the design of ground stations. The company, in association with Bell Canada, began studies on communication satellite systems early in 1964. Among the first fruits of this effort was a 30-foot steerable tracking antenna for the Defense Research Telecommunications Establishment. And a later result was development of a novel mode coupler duplexer system, which will be used in modified form in Northern

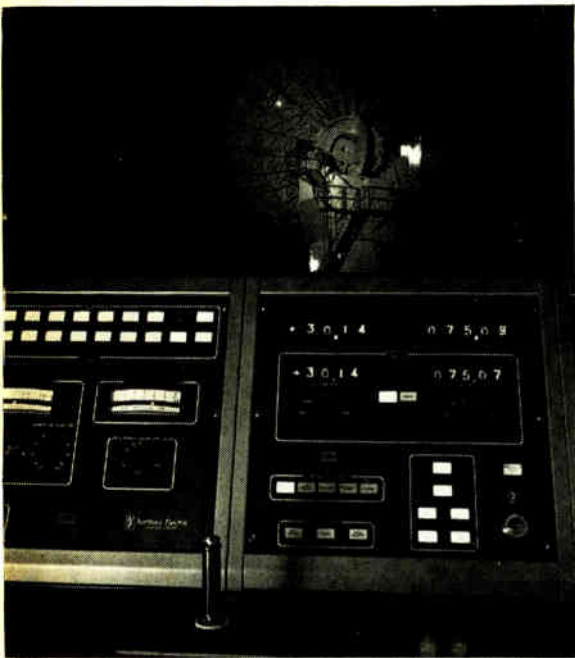

**Night watch.** This 30-foot satellite tracking antenna was the first space hardware built by Northern Electric.

Electric's experimental arctic communications ground station in Quebec. The station should be completed next month.

**Do it yourself.** Northern Electric is counting on its manufacturing skills to make a good impression on the federal government, which is eager to give Canadian companies 50% to 60% of the work on any satellite system.

Northern Electric's manufacturing edge is its ability to make its own discrete semiconductor devices and integrated circuits. Its \$8 million Advanced Devices Center at Crystal Bay wasn't built with the satellite program in mind, but the installation permits the company to assume complete responsibility for development of the communications and other electronic systems in a spacecraft. (Canadair will concentrate on the power system and structural work, while Hughes will provide expertise in synchronous-satellite technology and specialized components.)

**Under wraps.** The center has given Northern Electric a position in the Canadian electronics industry that it has yet to exploit. The discrete devices and IC's being produced are used only in telecommunications equipment; there are no plans to sell components on the open market. If there were, Western Electric would probably have

to be consulted, because of cross-licensing agreements. Similarly, the advances in IC technology have helped make Northern the only Canadian company able to get into the computer business, but it hasn't entered this field yet.

Sales are rising rapidly anyway. This year sales of discrete germanium and silicon devices should hit \$6.5 million; by 1972, volume should be around \$15 million, and IC's will add another \$2.5 million.

### Switching over

Electronic devices are being cut into Bell Canada's switching and transmission systems. Most local switching in Canada is still done on step-by-step equipment, although crossbar systems are gradually taking over to allow greater versatility and more complicated routing. Originally, Bell Canada chose No. 1 ESS (the American Bell's electronic switching system) for Canada's larger metropolitan centers, and the first installation using electronic stored-program control was at Expo '67. A Toronto exchange will have it next. But Bell Canada is now placing its bets on Northern Electric's SP-1.

Since Western Electric is restricted by consent decrees from selling outside the U.S. Bell system, the first ESS in Canada was fabricated by Northern Electric. The center, having geared up for electronic switching later, was able to update the design to incorporate the planar process for the discrete silicon transistors. Western Electric used the mesa process at first and is only now beginning to switch to planar.

**Cost plus.** Bell Canada and Northern Electric realized that the cost of stored-program control is now very high. Economies of scale, in the form of larger machines, are required to justify installation of No. 1 ESS. As a matter of fact, the system is expected to handle about 50,000 working lines, about double the capacity of a mechanical, common-control system.

The result was Northern Electric's development of a switching system with a lower cross-point cost for smaller networks. Dubbed the SF-1 Crossbar System, this common-control telephone switching for small communities overseas relies on a new electrically oper-

ated relay mechanism called Minibar.

The Minibar switch, a 200-point, six-wire arrangement, is half the size of standard crossbar switches and, when used the same way, twice as fast. The Minibar is slower than the sealed-contact ferreed switches used in No. 1 ESS, but offers switching time on the order of 30 milliseconds and better operating characteristics than the conventional crossbar switch. The Minibar switch is the basic element in all line, trunk, and route networks, and in the incoming and outgoing register links in the smaller SF-1.

The SP-1 stored-program switching system will be field-tested in 1970 in the Britannia exchange, which covers Crystal Bay and Ottawa West. The fact that it's a second-generation setup in which IC's are to be used wherever practicable without ferreed switches attests to Northern's confidence in Minibar.

### On the beam

By the time the SP-1 makes its debut, the center hopes to be building its IC's with beam leads rather than bonded leads. Pilot production of IC chips with beam leads will begin this December. Later, the technique will be applied to discrete devices and used to bond chips to tantalum thin-film circuits.

Northern is also attacking the problem created by the dielectric properties of silicon. The standard industry practice is to use a layer



**Viewpoint.** Engineer checks broadband parametric amplifier built by Northern Electric for satellite ground station.



Most Honeywell solutions, you naturally pay for.



# This one's free!

It's our brand new Instrumentation Handbook – a hardbound, permanent reference with more than 250 pages packed full of information about Honeywell test instrumentation.

We call it a "solution" because the Handbook contains helpful application and technical notes plus product selection guides which will help you find, understand, and select the right instrumentation for specific applications. It's not going to make your Honeywell Sales Engineer's job easier overnight, but with the book at your fingertips, those

little problems that crop up at odd hours can probably be taken care of without even a phone call.

For your personal copy of the Honeywell Instrumentation Handbook, please complete the coupon and mail it to us on your company letterhead. We expect the Handbook to be in great demand, so to get yours as soon as possible, get your coupon in the mail packet!

**Honeywell**

Honeywell engineers sell solutions

Honeywell Test Instruments Division  
P.O. Box 5227, Mail Station 218B  
Denver, Colorado 80217

Yes, send me my complimentary copy of the Honeywell Instrumentation Handbook today!

Name/Title \_\_\_\_\_

Company \_\_\_\_\_

Department/Mail Station \_\_\_\_\_

Address \_\_\_\_\_

City/State/Zip \_\_\_\_\_

**COMPANY MARKET CLASSIFICATION**

- Research & Development
- Aerospace/Government
- Industrial
- Electronics Manufacturer
- Bio-Medical
- University/Educational

**JOB CLASSIFICATION**

- Management
- Sales/Marketing
- Research
- Purchasing
- Engineering, Chief or Project
- Engineering, Design
- Production or QA
- Service, Test & Calibration
- Technical Library

**ELECTRONIC INSTRUMENTATION I USE OR SPECIFY:**

- Measuring
- RFI
- Transducers
- Data Acquisition Systems
- Recording
- Signal Conditioning
- Signal Sources
- Bio-Medical

I purchase or directly specify electronic test instrumentation.

- No
- Yes

**Supplies for Contempra**



Model 220

**Budget Price!**

**\$540\*** buys this completely self-contained RFL Hall-effect gaussmeter (\*plus probe). Measures flux density from 0.2 gauss magnet, DC and AC fields up to 20,000 gauss; permanent magnet, DC and AC fields up to 50 kHz, allowing measurement of sinewave and pulsed magnetic fields with a time base down to the microsecond region. Better than  $\pm 3\%$  accuracy with self-calibrating feature which requires no reference magnets. Accuracy capabilities to  $\pm 1\%$ . Wide application in production, engineering, research and QC.



For detailed data and free Magnetic Application Booklet, write or call Herb Brumbach.

**RFL Industries, Inc.**

FORMERLY RADIO FREQUENCY LABORATORIES, INC.

Instrumentation Div. • Boonton, N. J. 07005  
Tel: 201-334-3100 / TWX: 710-987-8352 / CABLE: RADAIRCO, N. J.

**... push-button dialing will soon replace rotary dialing in Canada ...**

of silicon dioxide over the silicon for surface passivation. The center has come up with a process that uses the silicon dioxide as masking between the components and circuits and then deposits a layer of silicon nitride on top of the dioxide. The silicon slice is etched from underneath, so the only dielectric between circuits is air. The nitride layer also keeps out moisture and contaminants. The connections between components are made by the beams only, so that cross-talk in microwave circuits is eliminated.

A parallel program at the center involves tantalum thin film. Trial devices, typically four IC's deposited simultaneously on a glass substrate and then cut into 1-inch by 1.7-inch pieces, are now being produced at the center for digital dial telephones.

**Repeat performance.** These thin-film passive circuits can also be put together with silicon IC's to form 1,000-circuit large-scale-integration devices. Yields have proved to be a problem in this area, so the Northern Electric laboratories came up with what they call Redundancy Adjustment of Probabil-

ity. Building in redundant circuits usually provides enough good ones in the end so the necessary connections for a complete LSI subsystem can be made. Prototype LSI devices produced at the center have already been used experimentally in the push-button dialing for the Contempra telephone. When the all-electronic telephone becomes a reality in about four years, Northern Electric believes, LSI will have come into its own.

Meanwhile, Northern Electric has found that the increased complexity of LSI has created yet another problem. "As each LSI slice becomes more specialized," says I.A. Davidson of the silicon microcircuit laboratory, "the total number of any particular type is drastically reduced." He points out that this increases design costs. The company is now studying how a computer can be used in design to minimize this cost increase.

**Master plans**

The design of the SP-1 electronic switching system in 1965 spotlighted the need for a more elaborate computer system than the

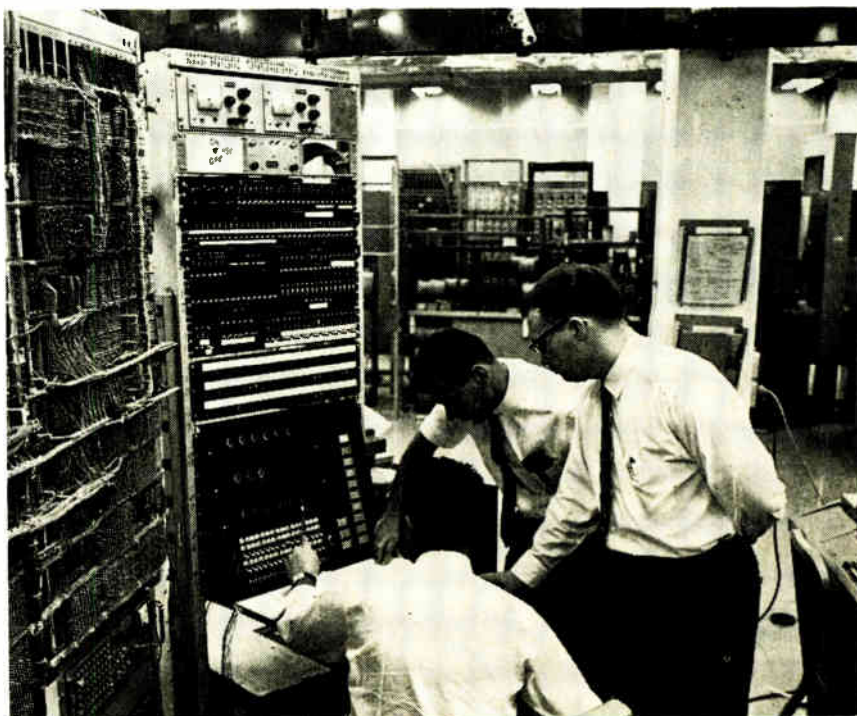

Soft job. Engineers in Northern Electric Labs work on the programming for central processor in the company's new SP-1 electronic switching system.

# "Miss Foster... why are you filing Price Electric and Hi-Spec industrial relays under C?"

IBM 620 at the center. Moreover, the increases in lab staffs and system-applications activity made multiaccess time-sharing equipment a must.

Northern Electric had a supervisory routine—MATS, or multiple-access time sharing—ready for remote users when its first big machines were cut in to form a mass-storage operating system.

To permit programs to be processed in batches with a sequential processing technique, an executive routine, Master, was introduced last October to give a turnaround time of five to 10 minutes. The big innovation, however, was the subsequent combination of MATS and Master to give Canada its first "true" computer time sharing. The system can now handle up to 200 batch jobs a day in an average of two minutes each.

The MATS/Master operating system with its sophisticated software—Northern developed a compiler to convert Fortran to PL-I to machine code—has been adopted by Sir George Williams University in Montreal and Oregon State University.

**Many masters.** The present system serves 200 users at the central laboratories in Ottawa, where there are 12 terminals, and 125 at four regional laboratories. When the CDC 3500 is installed in late 1968 or early 1969, execution time will be more than halved.

Typical of the kind of work possible with MATS/Master is the computation procedure that Northern Electric developed to simulate the behavior of transistors and diodes, including field-effect devices. For example this technique is being used to predict how uhf transistors will behave at high currents with different epitaxial layer thicknesses and junction depths.

Another problem is determining how the switching behavior of junction diodes is influenced by carrier recombination and the distribution on dopant in the vicinity of the junction. "In addition," says D.M. Caughey, who developed the procedure, "simulation is being applied to investigations of gold-doped diodes and metal oxide semiconductor devices."

Northern Electric also uses small computers like the PDP-8 to check silicon slices before deposition. By

Miss Foster knows her relays . . . CONELCO . . . is the new name for the complete line of Price Electric and Hi-Spec military and industrial relays . . . A completely new selection of commercial/industrial relays to fit your applications from low level to 10 amp 28VDC/115VAC res.

SZC

**SPDT Low Level**

Coil: 100 MW 690 ohms  
High speed, 2 coil, polarized, bi-stable or mono-stable relay with 50 million operation contact life.



228

**SPDT 2AMP 28VDC/115VAC res.**

Coil: 50 MW Typical: 12VDC 1760 ohms  
Completely dust covered, for direct PC mount.



1010

**SPDT 10AMP 28VDC/115VAC res.**

Coil: 176 MW Typical: 12VDC 440 ohms  
Solder or PC terminals.

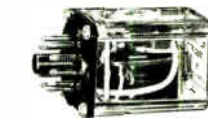

31

**SP 3AMP 28VDC/115VAC res.**

Coil: 176 MW Typical: 12VDC 440 ohms  
Stabilized Memory Relay—every other pulse to relay coil closes the contact. Open or completely dust covered with 8 pin octal plug.



220

**DPDT\* 2AMP 28VDC/115VAC res.**

Coil: 572 MW Typical: 12VDC 110 ohms  
Completely dust covered, for direct PC mount.



230

**DPDT/SPNO 5AMP 28VDC/115VAC res.**

Coil: 290 MW Typical: 12VDC 220 ohms  
Completely dust covered, for direct PC mount.



1000

**SPDT 3AMP 28VDC/115VAC res.**

Coil: 44 MW Typical: 12VDC 1760 ohms  
Dust cover for contact area, solder or PC terminals.



L

**Up to 4PDT 5 or 10AMP**

**28VDC/115VAC res.**

Coil: Typical: 12VDC 120 ohms

115VAC 2250 ohms

Open or completely dust covered with 8/11 pin octal plug.

Send for complete specs. If you are in a hurry, call 301/663-5141, Price Electric Corporation, Frederick, Maryland 21701, TWX: 710/862-0901

PRICE ELECTRIC CORPORATION

**CONELCO**  
SWITCHING DEVICES

HI-SPEC ELECTRONICS CORP.



# now in 9 sizes HELIAX<sup>®</sup> elliptical waveguide covers the microwave spectrum

With the addition of two new sizes, flexible HELIAX elliptical waveguide is available for all microwave communication bands from 1.7 to 13.2 GHz. The continuous single lengths of HELIAX waveguide assure reliable system performance, with electrical characteristics better than conventional rigid

waveguides at less cost. ■ Investigate HELIAX Elliptical Waveguides for your next microwave system whether it be for a short haul installation or a long high density system. ■ Write for specifications—Andrew Corporation, 10500 W. 153rd Street, Orland Park, Illinois 60462. 2-67



*Andrew*  
CORPORATION  
30 YEARS OF ENGINEERING INTEGRITY

### 9 SIZES OF ELLIPTICAL WAVEGUIDE

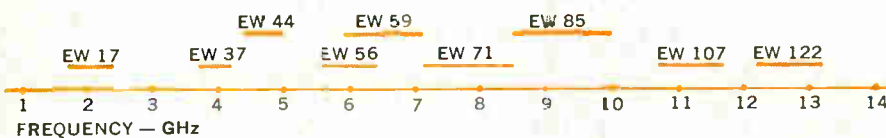



**Unbuttoned.** Push-button telephone called Digitone is being developed in Northern Electric's Apparatus Lab.

testing parameters before production, the company cuts its rejection rate on finished items.

Push-button dialing—Northern Electric calls it Digitone—will soon replace rotary dialing in Canada; calls will be announced by voice-frequency chimes rather than ringing. These changes will eliminate the need to transmit d-c pulses and 20-hertz ringing current from local telephone plants.

**Foiled.** Northern Electric's acoustic devices group, recognizing that modern transmission and electronic switching systems have much less distortion and allow lower subscriber loop current, have sought to replace the carbon microphone with an electret device. The polycarbonate foil selected, when combined with a semiconductor amplifier, has proved an excellent telephone transducer with life estimated at 500 years. It has the necessary bandwidth and is readily adaptable to existing telephone station apparatus. Company spokesmen say that they may eventually modify the loop circuit to take advantage of the low-current requirements.

Installation of electret mikes in consumers' phones will probably await the introduction of integrated, all-electronic systems.

Parallel work on receivers and transmitters is also under way at Northern Electric. And new devices and network interfaces are being investigated for see-and-talk service and new data transmission and retrieval schemes.

You should seriously consider using—

# Hypalox®

## Electronic Components

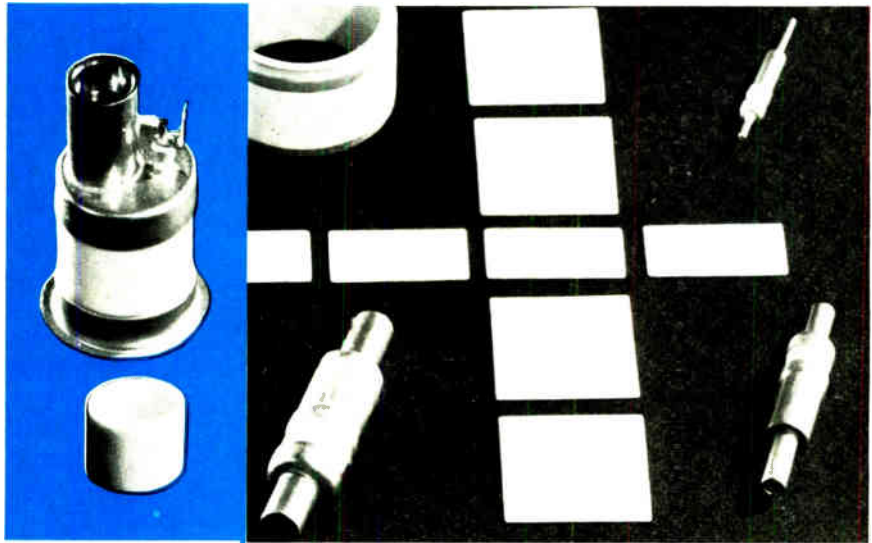

**There Is A Hypalox® Distributor Near You.**

**ALLEN ASSOCIATES**  
Phoenix, Arizona 85257  
**ALLIED COMPONENTS, INC.**  
Dallas, Texas 75218  
**ASSOCIATED INDUSTRIES**  
Seattle, Washington 33611  
**COY COMPANY**  
Dayton, Ohio 45429  
**GARNER ASSOCIATES**  
Liverpool, New York 13088  
**KENNEDY ENGINEERING, INC.**  
Chicago, Illinois 60631  
**LONG & ASSOCIATES, INC.**  
Redwood City, Calif. 94063  
**R. P. MAHAN COMPANY**  
Wellesley, Mass. 02181  
**NAUDAIN ASSOCIATES**  
Philadelphia, Penna. 19103  
**FRANK C. NICKERSON CO., INC.**  
Decatur, Georgia 30033  
**TECH-SOURCES UNLIMITED**  
Burbank, Calif. 91503  
**FRANK TYLINSKI CO., INC.**  
Great Neck, L. I., N. Y. 11021

Hypalox® is made from sintered alumina (Al<sub>2</sub>O<sub>3</sub>) with purity ranging to greater than 99.7%. Owing to its highly uniform micro-crystalline structure, Hypalox® has superior mechanical, chemical and, particularly, electrical properties.

**Hypalox® has a wide range of applications including:**

- **Transmitter Tubes**—Envelopes, windows, cathode supports
- **Substrates**—For micro-modules, surface finish to your specs
- **Insulators**—For coils and resistances
- **Envelopes**—For transmitter tubes, clystrons, magnetrons, traveling wave tubes
- **Housings**—For mercury vapor and silicon rectifiers, thyristors
- **Terminals**—For high vacuum installations and measuring instruments



**AMERICAN FELDMUEHLE CORP.**

P.O. Box 2160 • Glerbrook, Conn.  
Tel. (203) 325-1511

Circle 226 on reader service card FC-36

## Our little black book has over 100,000 phone numbers.

You never had a black book like it. Over 1,500 pages. And those phone numbers! More than 100,000 telling you who to call/where to go, for the over 4,000 different product categories listed and advertised in the yellow

pages of the Electronics Buyers' Guide.

It's the industry's one-stop shopping center that lets you find the products and services you need quickly.

You can depend on EBG.



**Electronics Buyers' Guide**

A McGraw-Hill Market Directed Publication,  
330 West 42nd Street, New York, N.Y. 10036



## digital to resolver/synchro converters... here's the next generation!

North Atlantic now brings you a new generation of solid-state digital-to-analog converters. They offer major advances in resolver/synchro conversion accuracy along with drift-free and stable performance unobtainable with currently available resistor/amplifier devices.

Typical of these new instruments are the Model 536 D/R and Model 537 D/S "shoebox" converters (11-13 bit) and the Model 538 D/R-S converter (14-17 bit). Both models use solid-state switched trigonometric transformers and feature input data storage registers thereby saving computer time. Conversion speed exceeds 10 microseconds. Built-in overload and short circuit protection assures trouble-free system integration and reliable on-line performance.

Your North Atlantic representative (see EEM) has complete specifications and application information. He'll be glad to show you how these new converters can be the answer to critical interface problems.



**NORTH ATLANTIC** industries, inc.  
TERMINAL DRIVE, PLAINVIEW, NEW YORK 11803 • 516-681-8600

### Tradeoffs

Would-be designers of portable color tv cameras are immediately confronted with a basic choice: whether to use microwave or cable links between camera and control unit.

A microwave link gives the cameraman greater mobility under the best conditions and eliminates the need to lay cable. However, the backpack is weighted down with batteries that have a limited operating life, and extra personnel are required to man the directional antennas used to keep the cameraman and his control point in contact.

Cabling gives unlimited operating time and doesn't suffer from line-of-sight constraints. In addition, the camera can be operated up to 30 feet from the backpack with lightweight cable connection. On the other hand, the camera can be no more than 3,000 feet from its control unit. Also, laying the cable is a difficult job that's only partially eased by lightweight coax.

transmits each twice—once when received and once during the fraction of a second when the delay device receives a signal of the second color.

**Light of foot.** The BC-100 incorporates a horizontal synchronization pulse generator that's timed by signals from a video signal comparator built with integrated circuitry. This setup permits the use of coaxial cable weighing only 375 pounds per 3,000 feet, a considerable reduction from the 3,000 pounds of conventional cabling of the same length. Besides increasing a cameraman's mobility, the lighter cable costs less—25¢ a foot, as against \$1.

The BC-100 weighs 42 pounds when rigged for cable operations and 57 pounds when fitted with microwave link equipment and batteries. Total cost is \$130,000, and Ampex puts the delivery time at 60 days. Microwave Associates Inc. is supplying—logically—the microwave portion of the backpack, including a 13-gigahertz video transmitter and a 950-megahertz command receiver for camera control.

**Late start.** Norelco's PCP-70 portable color camera, after being

## HERE'S HOW...

THE ELECTRONIC INDUSTRY IS USING  
THESE FAMOUS ULANO FILMS IN  
ULTRAMINIATURE MASK TECHNOLOGY  
AND COMPLEX PRINTED CIRCUITRY

Cut a piece of the desired film large enough to cover area to be masked. Tape it down firmly at the top with dull-side up.

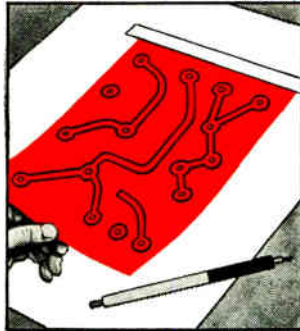

With sharp blade, outline the areas to be masked. Do not cut through the backing sheet. The Ulano Swivel Knife does the job quickly, easily.

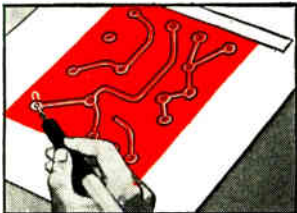

Using the tip of the blade, lift up a corner of the film thus separating it from the backing sheet.

Now carefully peel off the film as outlined leaving a completed mask, positive or negative, that corresponds exactly to the desired pattern.

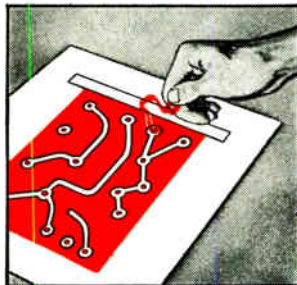

# Ulano<sup>TM</sup>

## RUBYLITH<sup>TM</sup> AMBERLITH<sup>TM</sup>

HAND CUT MASKING FILMS FOR THE GRAPHIC ARTS

**ULANO RUBYLITH** . . . a revolutionary knife cut red film is laminated to a stable transparent plastic backing sheet. The red film is "light safe" so that when contacted to a sensitized emulsion and exposed to a suitable light source, light passes through the cut-out portions only . . . not through the red film. ■ The polyester backing is absolutely stable . . . insures perfect register. ■ Special effects such as crayon tones, paste ups, benday sheets, and opaquing are easily combined with versatile ULANO RUBYLITH.

**ULANO AMBERLITH** . . . a companion to Rubyolith serves as a color separation medium used as the master on camera copy board to secure negatives or positives.

*A wide variety of Ulano films—  
in rolls and sheets—is readily available*

## Designed FOR YOUR PARTICULAR NEEDS

Ulano offers the most versatile line of hand-cut masking films, including:

**.0075—RUBYLITH 75 DR\* .005—RUBYLITH 5 DR†**

**.005—AMBERLITH 5 DA†**

Where exact register assures a critical importance, you will find these new, thick, polyester based films the positive answer.

\* Available in sheets only, cut to your specifications

† Available in rolls and sheets



**WRITE TODAY**  
on your letterhead for free  
special sample kit 1748

"Ulano"—"Rubyolith"—"Amberlith" are registered trade marks of the Ulano Companies.

# ulano

610 DEAN STREET, BROOKLYN, N.Y. 11238

In Europe: ULANO A.G., Untere, Hesiibachstrasse No. 22, Kusnacht, Zurich, Switzerland

# Service...Engineering...Experience

MAKE THE **BIG** DIFFERENCE  
BETWEEN A YOKE SPECIALIST  
AND A YOKE SUPPLIER



1" ID 12 oz. Single Gap  
Shielded Dynamic/Static  
Focus Coil

Syntronic Yoke Specialists have more yoke knowledge and provide more engineering assistance than anyone else in the field.

The most extensive line of deflection yokes available is offered by Syntronic... in production quantities or custom designed to special requirements. See the **BIG** Difference for yourself the next time you specify a yoke.

***syntronic*** INSTRUMENTS, INC.  
100 Industrial Road, Addison, Illinois Phone 312, 543-6444

Circle 228 on reader service card



Above it all, RCA's portable color tv camera, tested here at a baseball game, is being readied for the conventions.

announced with great fanfare last autumn, missed the boat to Grenoble for the winter Olympics. However, the company has finally debugged the equipment—dubbed Little Shaver by an enterprising marketing man—and has been making deliveries to all three networks since the end of last month.

A Little Shaver, which has three 1-inch Plumbicon image tubes, weighs in at 44 pounds with backpack and costs \$41,450. The purchase price doesn't include a control console, but all the networks already own Norelco's PC-70 units. The portable camera system can work with up to 200 feet of miniaturized coax developed by the company. At greater ranges, however, heavy standard cabling must be used.

Norelco unveiled an experimental portable color tv camera at the National Association of Broadcasters convention in Chicago earlier this spring. Built as a test bed for 5/8-inch Plumbicon tubes, the nameless unit weighs but 6½ pounds and is about the size of a 16-millimeter movie camera. Norelco is also working on a radio-frequency system that would eliminate the cable.

After having been tested during a baseball game between the Boston Red Sox and Cleveland Indians last month, RCA's portable color tv camera was retired for further work. However, the company is confident that it will be available for use by the National Broadcasting Co. an RCA affiliate,

# Vector

## Vector systems help you **CUT BREADBOARDING TIME**

Choose the type that meets your needs

1. Circuit set-up kits and parts with solderless transistor and tube sockets, and new solderless T-32 U-clips.
2. Same as above but with solderable push-in terminals.
3. Handsome new extruded aluminum rails that make into expandable circuit cases or chassis in virtually any size and shape. Hardware for mounting in plug-in racks or chassis.
4. Pre-punched Copper Clad Plugboards for do-it-yourself, etched circuit cards.

May we send you complete information including sample Vectorbord and terminals? There is no obligation.

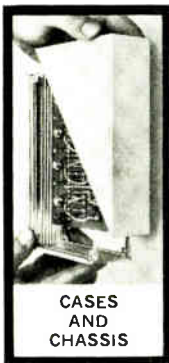
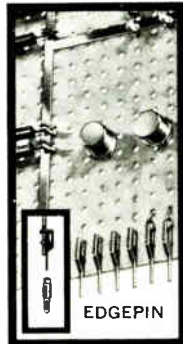

CASES  
AND  
CHASSIS



SOLDERABLE

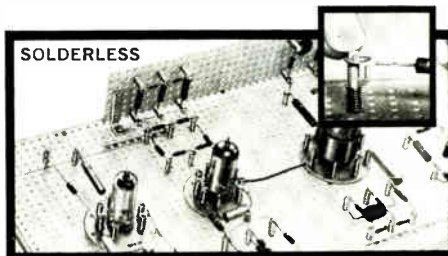

SOLDERLESS

4 WAYS

**VECTOR ELECTRONIC CO., INC.**  
1100 Flower Street, Glendale, Calif. 91201 • 245-8971



# Our first new MOS switch is so good, it's almost embarrassing.

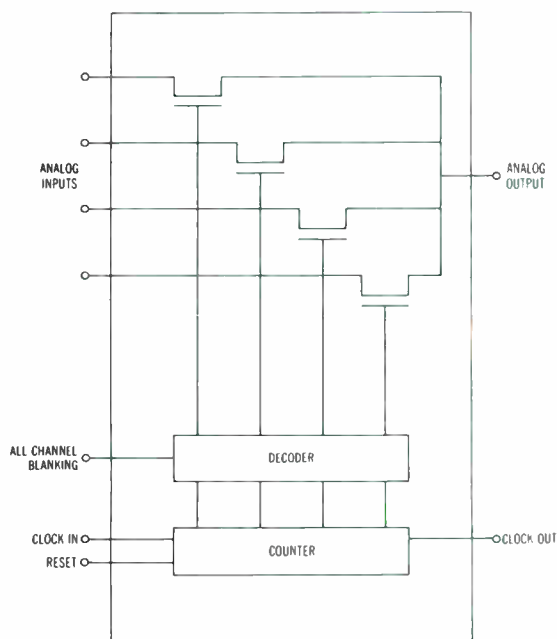

MM454 Commutator

It's the MM454, a monolithic, four-channel commutator, that's capable of handling  $\pm 10V$  analog signals. And it provides all driver and decode circuitry eliminating the need to construct a separate counter. All-channel blanking and a reset capability are a couple of bonus features.

We've also introduced four other new switches not quite so remarkable, but still worth crowing about. Our MM450 is a dual differential switch. Our MM451 is a four-channel unit. Then there's our MM452 which is comprised of four separate switch devices in a single flat pack with 14 leads. The last one, our MH453, is a dual differential analog switch with a built-in DTL/TTL interface circuit.

Not bad for openers. And these aren't just being designed. They're already stocked on your distributors' shelves complete with price tags:

	Quantity: 100-999
MM 450 Dual differential MOS switch . . . . .	\$20
MM 451 Four-channel MOS switch . . . . .	\$20
MM 452 Four MOS transistors . . . . .	\$30
MH 453 DTL/TTL compatible MOS switch . . . . .	\$40
MM 454 Four-channel commutator . . . . .	\$50

Write for data. National Semiconductor Corporation, 2975 San Ysidro Way, Santa Clara, Calif. 95051. Phone (408) 245-4320.

## National Semiconductor

**4.5V, 20 MIL LAMPS  
GIVE TUNG-SOL READOUTS  
LOW POWER DRAIN,  
MINIMUM HEAT,  
MAXIMUM RELIABILITY**

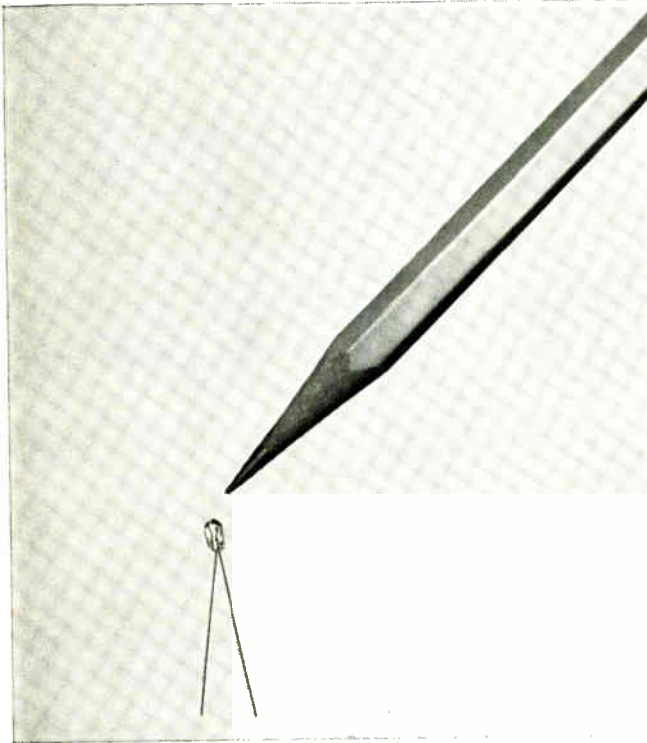

The new T-3/4 lamps used in Tung-Sol readouts, both digital and alphanumeric, provide important performance advantages without loss of effective brilliance. The low-power factor is especially advantageous where energy-source weight must be minimized—such as in aircraft and space vehicles.

Tung-Sol digital and alphanumeric readouts have excellent off-on contrast and a 150° viewing angle. They are designed to be intermixed. Write for brochure T-431, which contains 12 pages of detailed information. Tung-Sol Division, Wagner Electric Corporation, One Summer Avenue, Newark, N.J. 07104.

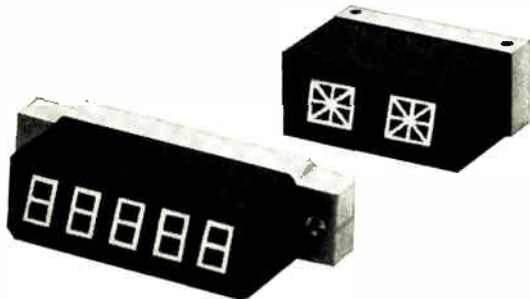

**TUNG-SOL®**  
**OPTIMUM CONTRAST**  
**DIGITAL AND ALPHANUMERIC**  
**READOUTS**  
© REG. T.M. WAGNER ELECTRIC CORPORATION



**Mighty mite.** Experimental portable color tv camera built by Norelco uses 5/8-inch Plumbicon tubes.

during the political conventions.

Called the Manpack, the self-contained unit weighs 54 pounds and uses three 1-inch hybrid—electrostatic convergence as well as electromagnetic deflection—vidicon tubes. The transmitter operates at 12 Ghz, and there is a 950-Mhz command receiver. The Manpack can be rigged to work with conventional cabling. At the moment, RCA has no plans to make the unit commercially available to rivals of NBC.

**Nominee.** CBS Labs' hopeful, designated the Minicam Mark VI, is a 48-pound backpack arrangement with a microwave link that can be adapted to cable operations. The company is readying four for use by CBS at the conventions.

The Minicam, which uses three 1-inch Plumbicon tubes, is described by its designers as the first tv broadcasting unit to incorporate digital remote-control techniques borrowed from computer technology. These free the cameraman from such chores as focusing, color registering and centering; such jobs are seen to at a central control point that can ride herd on up to six cameras at a time. CBS is buying 2-Ghz receivers as well as associated components from Microwave Associates, but is handling the rest of the equipment on its own. Though marketing plans are extremely tentative at the moment, Marvin Kronenberg, a CBS Labs branch manager, says the Minicam in one form or another may be made commercially available.

Contributions to this report were made by Walter Barney and Peter Vogel in San Francisco and Stephen Fields, Peter Schuyten, and John Drummond in New York. It was compiled by Eric Aiken.

# Of the following 14 MOS devices, some are merely equal, a few are slightly superior, a couple are almost unbelievable, and one is plainly incredible.

	0°C to +70°C		-55°C to +125°C	
<b>Merely Equal:</b> DUAL 3-INPUT NOR GATE DUAL EXCLUSIVE OR GATE	MM 480 MM 481	100-999 \$12.00 18.00	MM 580 MM 581	100-999 \$ 8.00 12.00
<b>Slightly Superior:</b> DUAL 25-BIT DYNAMIC SHIFT REGISTER <i>Low power with 1MHz guaranteed.</i> DUAL DIGITAL MULTIPLEX SWITCH <i>Ideal for routing information in dynamic register memory.</i>	MM 400 MM 482	25.00 12.00	MM 500 MM 582	9.85 8.00
<b>Almost Unbelievable:</b> DUAL 50 BIT DYNAMIC SHIFT REGISTER <i>14.8¢/bit.</i> DUAL 16-BIT STATIC SHIFT REGISTER <i>Single clock, 1MHz operation up to 125°C.</i>	MM 402 MM 404	40.00 30.00	MM 502 MM 504	14.80 12.00
<b>Plainly Incredible:</b> DUAL 100-BIT DYNAMIC SHIFT REGISTER <i>200 register bit in a single package.</i>	MM 406	60.00	MM 506	30.00

Amazingly, they're all available now. For a list of stocking distributors and additional information, write: National Semiconductor Corporation, 2975 San Ysidro Way, Santa Clara, California 95051. (408) 245-4320.

## National Semiconductor

**The new AO  
StereoStar/ZOOM  
Microscope  
gives you high  
resolution,  
new convenience,  
superior optics  
and wide  
magnification  
range.**

Here are a few of the outstanding advantages that make the new AO® StereoStar/ZOOM Microscope the finest instrument of this type available today:

■ Widest total magnification range: 3.5–210X ■ High resolution to meet the most exacting needs ■ The most convenient zoom control available ■ Choice of five interchangeable, rotatable zoom power bodies ■ Crisp, sharp images at all magnifications ■ Extra large field of view and high eyepoint eyepieces ■ Wide choice of stands for every purpose ■ Long working distance ■ Even illumination over the entire field ■ Coolest operating illuminator.

See for yourself. Contact your AO Sales Representative for a demonstration, or write for our 24-page, full-color brochure on the newest in stereo microscopes—the AO StereoStar/ZOOM.

\*TM Reg., American Optical Co.



**AO INSTRUMENT  
COMPANY**

SCIENTIFIC INSTRUMENT DIVISION  
BUFFALO, N.Y. 14215

Formerly Instrument Division of AMERICAN OPTICAL COMPANY

Circle 140 on reader service card

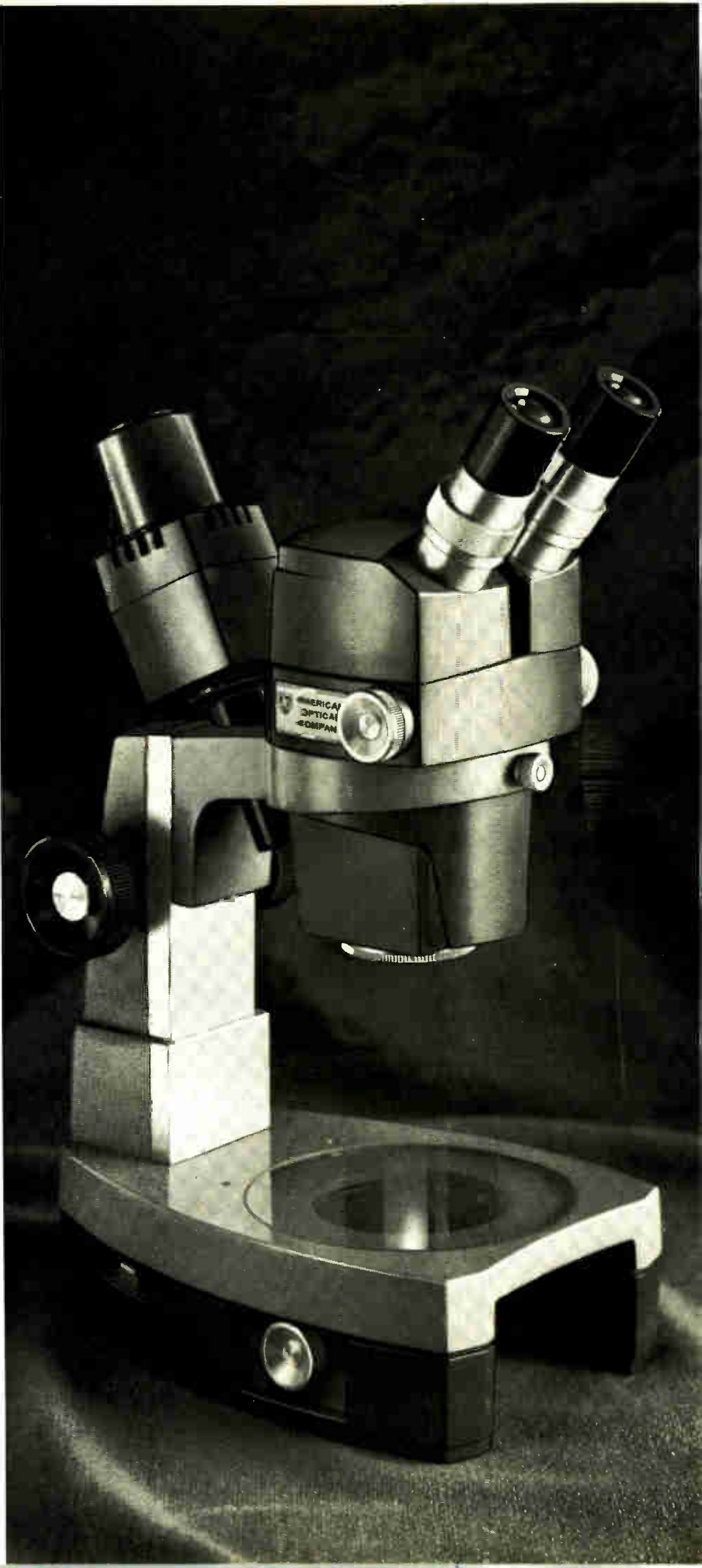

## New Subassemblies Review

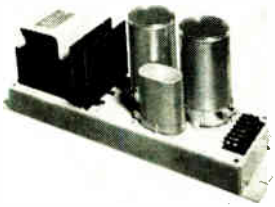

Regulated d-c power supplies include a total of thirty 50-and 60-hz models with output voltages ranging from 10 to 200 v d-c. Output voltage will not vary more than  $\pm 1\%$  for a change in input voltage over the rated range of 97 to 130 v a-c. Units operate in ambient temperatures from  $-10^\circ$  to  $40^\circ\text{C}$ . They fit 19-in. relay rack. General Electric Co., Schenectady, N.Y. 12305. [381]



H-v power supply model K30 is for use in the manufacture of multiplier phototube systems. It is a d-c/d-c converter capable of delivering from 600 to 3,000 v at 0.5 ma, with output proportional to input. Ripple is less than 0.4%, peak to peak, at full load. Price is \$188, with volume discounts available. Venus Scientific Inc., 25 Bloomingdale Road, Hicksville, N.Y. [382]



Low-profile FET differential amplifier model 133 offers an input impedance of 100,000 megohms, 6 v/ $\mu\text{sec}$  slew rate, and a d-c gain of 300,000. Rated output is  $\pm 10$  v at 5 ma, minimum; input voltage drift is 25  $\mu\text{v}/^\circ\text{C}$ ; and input bias current is 15 pa. Price is \$27 each in production quantities; availability, from stock. Zeltex Inc., 1000 Chalomar Road, Concord, Calif. 94520. [383]



Pre-amplifier model LA2300-13 offers a maximum input vswr of 1.5. Maximum noise figure is less than 1.5 db from a 50-ohm source. Center frequency is 30 Mhz, and 3-db bandwidth is 10 Mhz. Gain is greater than 50 db, and the 1 db compression point is 50 mw output. Price is \$230. Consolidated Airborne Systems Inc., 115 Old Country Road, Carle Place, N.Y. 11514. [384]



Precision operational rectifier model PR-7 is for a-c to d-c conversion, control of a-c levels, transducer control systems, a-c bridge measurements and rectification of many types of a-c waves. Frequency range is 60 hz to 10 khz. Voltage gain accuracy of output to input is better than 0.1%. North Hills Electronics Inc., Alexander Place, Glen Cove, N.Y. 11542. [385]

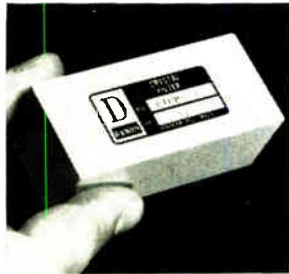

Low-loss, band-rejection crystal filter 6108A is for use in radar and missile systems. It is designed to preserve systems noise figure when operating from a known source into a low-noise amplifier, and to permit rejection of local oscillator and related feedthrough without degrading noise figure. Damon Engineering Inc., 115 Fourth Ave., Needham Heights, Mass. 02194. [386]

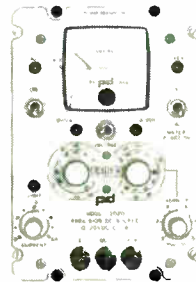

Power supply model 2020 combines the functions of a precision calibrator with a laboratory power supply at low cost. Output range is 0 to 20 v d-c at 0 to 2 amps with a calibration accuracy of 0.1%+100  $\mu\text{v}$  of the output voltage. Stability is better than 0.001%+100  $\mu\text{v}$  per 8 hours. Price is \$475. Power Designs Inc., 1700 Shames Drive, Westbury, N.Y. 11590. [387]



Two-quadrant squarer model 9751 operates in the d-c to 30 khz range. It is typically used in frequency doubling, power measuring, sine-cosine generation or general computation applications. Conformity is 0.5%. Input is  $-10$  to  $+10$  v into  $\infty$  kilohms minimum and output is 0 to  $+10$  v, 50 ohms output impedance. Transmagnetics Inc., 134-25 Northern Blvd., Flushing, N.Y. [388]

### New subassemblies

## Recorder heads good for 5,000 hours

Ferrite units are employed in analog instrument that uses d-c servosystems to control tape speed

"Up till now, the best guarantee on recording heads was 1,000 hours," says Victor Ratner, president of the Video Research Corp. "And even this was prorated; if the heads wore out in 500 hours, you got half your money back. Our heads are guaranteed unconditionally for

5,000 hours."

It's a case of good timing. Video Research Corp. decided to build its first tape recorder just when ferrite heads became available. Unfettered by old designs or retooling expenses, the concern's engineers developed an analog recorder to fit

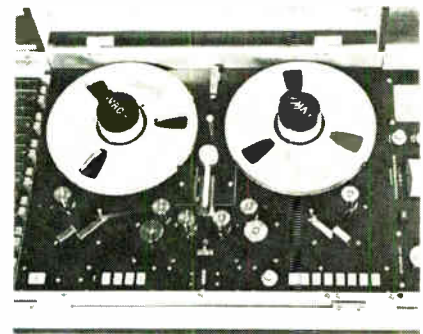

Long life. The 9000-B is the first analog recorder to use ferrite heads.

# FAST, ACCURATE COUNT/CONTROL

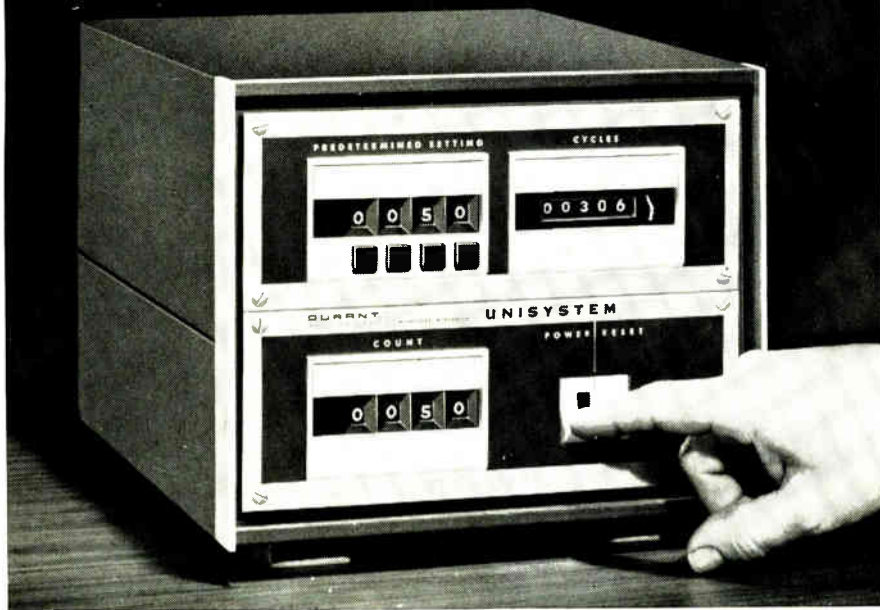

## Durant Unisystem

It's the lowest cost and most thoroughly proven way for counting and controlling—and it's the most versatile. Durant Unisystem can be used for high speed counting, single and multiple level predetermining, repeat cycle predetermining, remote readout, data storage, programming, recording, batching, cycling, timing, time indication.

A complete series of models make these functions ideal for metering, processing, converting, testing or manufacturing of all kinds.

On every application, you get fast, accurate recording and controlling with speeds up to 40 cps. And exceptional reliability, because Unisystem is not subject to hours of usage. It's fail-safe—retains accumulated data even if power fails.

Unisystem is modular, too. Available in panel or desk mounted models.

For complete information on Unisystem, write for catalog 90-1, 622 North Cass St., Milwaukee, Wis. 53201.

### UNISYSTEM MEETS YOUR NEEDS EXACTLY

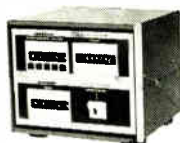

Cabinet models assembled and wired—ready to install

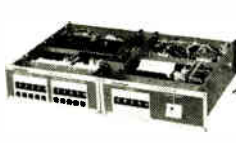

Modules without cabinets for 19" rack mounting



Wired models without cabinets for 9 1/2" rack mounting



Individual Unipulser Decade counters for building your own systems

# DURANT®

MANUFACTURING COMPANY

COUNT / CONTROL INSTRUMENTS

MECHANICAL / ELECTROMECHANICAL / ELECTRONIC

In Europe: Durant (Europa) N.V. Barneveld, Netherlands

... servo system replaces belt and rollers ...

the characteristics of the new, more durable heads.

"You just can't pull out the metallic heads and plug in the ferrites," explains Ratner. "The ferrites have special mechanical and electrical properties that force you to make a lot of changes on a standard head assembly."

The company says the chance to start from scratch is the reason it's the first U.S. manufacturer to offer a ferrite-head instrumentation recorder, the 9000-B.

**Simple servo.** There's another reason for the 9000-B's long life expectancy. It uses a simplified tape transport mechanism that has no solenoids, pinch rollers, or drive belts. In their place are two servo-controlled capstans that keep the speed of the tape constant within 0.25%.

In the transport mechanism, tape passes around one capstan, around the shaft of a tachometer, and finally around the other capstan. The output of the tachometer, a train of pulses whose frequency is proportional to tape speed, feeds a binary divider. Here the frequency is scaled down by an amount determined by the setting of the speed-control switch. A phase detector compares the divider output with the signal from a crystal oscillator, and the d-c error signal from the detector feeds a servo-amplifier that drives the capstans' motors.

The 9000-B records seven channels of data on half-inch tape or 14 channels on 1-inch tape. A man with a screwdriver can modify the recorder for half-inch or 1-inch operation in 10 minutes, changing only the head assembly and six tape guides.

The recorder has eight tape speeds, from 15/16 to 120 inches per second, and uses either direct-response modules that handle signals up to 500 kilohertz at 120 ips, or f-m modules that record up to 40 kilohertz.

**Tighten up.** Tape tension is kept constant by a pair of closed-loop systems that adjust the rotational velocities of the two reels. Associated with each reel is a spring-loaded tension arm connected to the shaft of a potentiometer. The out-

6381

The Hewlett-Packard 4204A Digital Oscillator in one instrument gives you an accurate frequency source of measured amplitude. It provides 0.2% frequency accuracy in highly stable test signals for both lab and production applications. Low distortion, 0.01% frequency repeatability and a flat frequency response of 0.3% variation add to your dollar value.

The 4204A allows you to select any frequency between 10.0 Hz and 999.9 kHz to four significant figures... 36,900 discrete frequencies are available. One vernier

control provides infinite resolution and extends the upper frequency limit of the 4204A Oscillator to 1 MHz.

This oscillator also has a built-in impedance voltmeter to measure output. It is calibrated to read volts or dBm into a matched 600 ohm load. The output attenuator has an 80 dB range and is adjustable in 10 dB steps with a 20 dB vernier. Price is \$695.

Call your local HP field engineer for more information, or write Hewlett-Packard, Palo Alto, California 94304. Europe: 54 Route des Acacias, Geneva.

## Stable and repeatable signal accuracy

HEWLETT  PACKARD  
S I G N A L   S O U R C E S

18-01





## Our films really get to you



We deliver metal alloy and metal oxide film resistors fast. You get a full range of precision and semi-precision types when you want them. Mallory precision MAF in  $\frac{1}{8}W$  and  $\frac{1}{4}W$ ; semi-precision MAL in  $\frac{1}{2}W$ ; metal oxide MOL's in 2W to 7W. Values ranging from 30.1 ohms to 499K. All are 100% inspected. Get prompt delivery from Mallory. For details, write or call Mallory Controls Company.

**MALLORY**

**MALLORY CONTROLS COMPANY**

a division of P. R. MALLORY & CO. INC.  
Box 231, Frankfort, Indiana 46041

put of the pot, which is proportional to the tension, is compared with an adjustable reference voltage, and the difference signal controls the reel's drive motor.

Pressing the stop button shorts the capstan motors' armatures, generating electromotive forces that damp armature rotation. Since the degree of damping is proportional to tape speed, braking is always smooth. When the tape stops, there's no output from the tachometer; a relay closes, removing power from the reel motors.

**Foot counter.** Among the options offered with the 9000-B are a four-digit counter that measures tape footage instead of reel revolutions, a photocell system that detects the end of the tape and breakage, a voice annotator, and a remote control assembly.

The first 9000-B's have been purchased by the Navy, and the company expects the military and NASA to be its biggest customers. But Ratner notes that some security agencies want to try the devices in surveillance systems. And he feels the 9000-B has a place in medical research and industrial monitoring.

The instrument weighs 100 pounds and can be packaged either for rack mounting or portable use. Price is \$20,000 and delivery time is 90 days.

Video Research Corp., P.O. Box 1428, Rockville, Md. 20850 [389]

New subassemblies

## Laser's tubes a snap to change

Plasma units replaceable  
without optical realigning  
or reflector adjustment

A laser whose plasma tube can be replaced without optical realignment will be introduced this month by the Spectra Physics Corp. at the International Quantum Electronics Conference in Miami. The model 120 helium-neon laser has a 5-milliwatt output at 6,328 angstroms and a separate reflector laser



# JFD announces

## THE SMALLEST HIGH RF POWER CAPACITORS AVAILABLE!



### Uniceram – UFP Series

JFD's new Uniceram UFP Series offers the design engineer a broad line of miniaturized high voltage and high current fixed ceramic capacitors for use in RF circuits. These highly stable, small, reliable UFP's have been used up to 200 MHz. They are the ideal 'space-savers' for today's military communications, mobile, commercial broadcast and amateur radio transmitters.

UFP1's measure only 35/64" square X 11/64" thick. High Q 'Uniceram' proprietary ceramic material with special internal monolithic construction yields high power handling capabilities per unit volume. Glass encapsulation insures a moisture seal. Wide fine silver ribbon leads are used because of their low inductance and high RF current carrying capabilities.

- Capacitance values from 10 pf to 3,000 pf ( $\pm 5$  pf for low capacitance values;  $\pm 5\%$  and  $\pm 10\%$  for higher values).
- Rated at 8 amperes at  $+25^{\circ}\text{C}$  with derating for higher temperatures.
- Voltage rating (Typ.) at  $+25^{\circ}\text{C}$  is 3,000 vrms peak for values up to 150 pf (UFP1) and up to 330 pf (UFP3) with derating for higher temperatures.
- Q at 1 MHz and  $+25^{\circ}\text{C}$  for values of 1,000 pf and smaller are 5,000 minimum.
- Typical UFP1 rating is 12 KVAR at  $+25^{\circ}\text{C}$ .
- Temperature coefficient at 1 MHz ( $-55^{\circ}\text{C}$  to  $+125^{\circ}\text{C}$ ) is  $+95 \pm 25$  PPM/ $^{\circ}\text{C}$ .

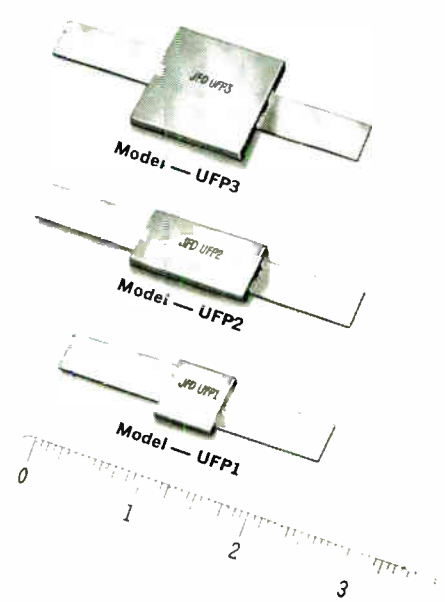

For additional information, write for catalog UNM-UFP-68.

"TODAY'S COMPONENTS BUILT FOR TOMORROW'S CHALLENGES"

**JFD** JFD ELECTRONICS CO. / COMPONENTS DIVISION / 15th Avenue at 62nd Street / Brooklyn, New York 11219 / Phone 212-331-1000  
Offices and subsidiaries in principal cities, world-wide.



## Why pay more for the "same" transformer? To find out, send for the informative booklet shown here.

Both of these transformers look alike...but they're not!

The \$25 transformer on the left is typical of the units which have established Raytheon's reputation for transformer quality in vital military systems.

The \$50 unit is a high reliability transformer. It costs more because it was designed to meet defined MTBF goals and manufactured in a separate, environmentally-controlled facility. This transformer also underwent rigorous screening and qualification testing to make certain it met the specified high reliability standards.

Raytheon is an experienced manufacturer of high reliability magnetic components, having participated in numerous NASA and DOD programs such as Apollo, Sert II, and MOL.

Get your free copy of the Raytheon transformer brochure shown above. It describes our high reliability facilities and programs. And it shows why Raytheon's high reliability transformers are well worth the difference in price. Send the reader service card or write directly to: Raytheon Company, Magnetics Operation, 180 Willow Street, Waltham, Mass. 02154.



... do-it-yourself  
in 5 minutes ...

for polarized output.

The tube, which has Brewster angle windows, fits snugly into a carriage and is attached with one thumb-turned coupler nut at each end of the tube and one set screw. The tube's alignment with the optical axis of the separate reflectors usually permits an output phase error of about 1/40th of a wavelength. Frank Kelliher, the project engineer, says, "This means that for most users reflector realignment is unnecessary." However, in case a user wants to squeeze out another half milliwatt, four external alignment screws are fitted on each reflector.

"This means," Kelliher says, "that the engineer on a job in Montana doesn't have to stop work to send his instrument back to California to have a new tube installed and aligned. He can now do it himself in five minutes."

**Roughhousing.** The user saves money by not having to get new

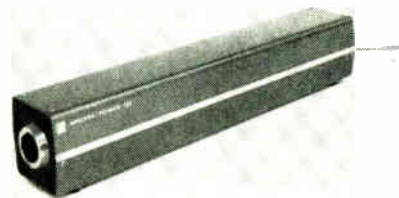

Fast change. Plasma tube can be changed without reflector alignment.

reflectors when he replaces a tube. And the instrument can take much rougher handling than others without going out of alignment.

"Not everyone needs a laser that has the characteristic polarized output of a separate reflector laser," says Kelliher. "You don't need a modulated signal for simple construction-alignment purposes, but why not have as much flexibility as possible?"

The model 120 is 18 by 2 1/4 by 2 1/4 inches; the laser head weighs eight pounds and the power supply, which draws 50 watts, weighs five pounds. The laser will sell for \$1,450 in unit quantity.

Spectra Physics Corp., 1255 Terra Bella Ave., Mountain View, Calif. [390]

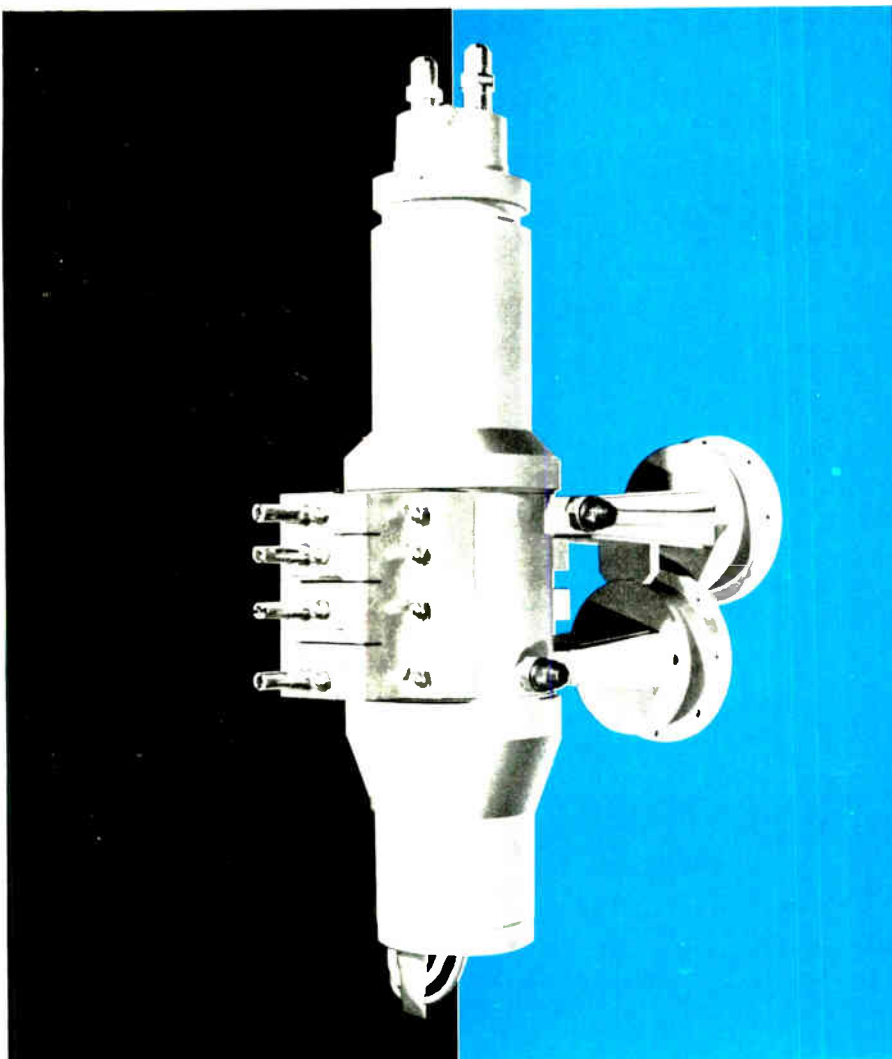

### SAC-4062 Klystron Amplifier

Frequency range	4.4 to 5.0 GHz
Tuning range	600 MHz
Power output	10 to 20 kW CW
1 db bandwidth	10 MHz
Gain	53 db
Efficiency	40%
Weight (Tube & Magnet)	105 lbs.

## Get 10-20 kW of troposcatter power from a 105 lb. tube/magnet package

Building a C band troposcatter system that must be easily transportable, highly reliable and easily maintainable? Power it with a new Sperry klystron, the SAC-4062.

Designed for optimum operation at 17.5 kW, this 4-cavity amplifier comfortably covers the 10 to 20 kW range, with adequate gain bandwidth for troposcatter operation. It can be operated as low as 5 kW at some expense in gain and efficiency. With its magnet it weighs only 105 lbs.

The SAC-4062 is field tunable across a 4.4 to 5.0 GHz range with a unique bellows-type tuner which is

warranted for 500 full-range tuning cycles. Tube replacement can be accomplished in your system in five minutes or less.

Although this is a new tube, all its major functional components have been system proved. Electron gun, collector, pole pieces, tuner, electromagnet assembly etc. are common to the entire Sperry family of high-power CW klystrons, and their reliability has been well established. For more information about the SAC-4062 or other klystrons in Sperry's remarkable high-power CW line, contact your Cain & Co. representative today.

**SPERRY**  
ELECTRONIC TUBE DIVISION  
GAINESVILLE, FLORIDA

# Astro/348: Amphenol's hi-density miniature to MIL-C-81511A.

Astro/348® was designed for two purposes:

1. Meet MIL-C-81511A design/performance specs.
2. Provide the greatest number of improved features:
  - One-piece dielectric retention system eliminates metal retention clips.
  - Contact dielectric separation of .021 inches on .085-in centers, equivalent to existing miniatures with .130-in centers.
  - Monoblock construction eliminates air voids between contacts.
  - Wire sealing range of .030 to .054 in.
  - Dual environmental mating protection providing interfacial and shell "O" ring seals.
  - Damage-proof mating. Pins recessed beyond reach of shells.
  - Closed entry hard socket inserts, prod-proof socket contacts.
  - Grounding springs mate prior to electrical engagement. Shielding for EMI protection.
  - Front release, rear serviceable crimp contacts.
  - Front or rear mounted receptacles.

Ask an Amphenol sales engineer or distributor about the complete family of Astro/348 connectors (6 shell styles, 4 to 85 contacts). Or write Amphenol Connector Div., 2801 S. 25th Ave., Broadview, Ill. 60153.



## AMPHENOL

™

Specify Amphenol electronic components . . . produced in Canada, England, France, Japan, Mexico, United States, West Germany.

Circle 148 on reader service card



## New Instruments Review

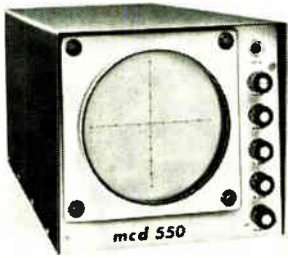

X-Y monitors models 550 and 560 feature identical d-c amplifiers and a full 4½ in. usable screen display. Model 550 is rated at 20 foot lumens and requires 50 va; the 560 is rated at 80 foot lumens, utilizing a 100-v power source. Price of the 550 is \$320; the 560, \$425. Availability is 4 weeks. Measurement Control Devices Inc., 2445 Emerald St., Philadelphia 19125. [361]



A-c frequency changer model 200 has an output power of 0-200 va, single phase. Units may be stacked for 2- or 3-phase operation. The basic unit will accept any of 40 interchangeable plug-in oscillator modules. These provide fixed or variable output from 45 hz to 10 khz, accurate from 0.1 to 0.0001%. Elgar Corp., 8046 Engineer Rd., San Diego, Calif. 92111. [362]

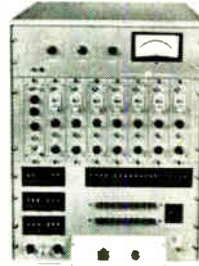

IC test set IC102 features semi-automatic operation and modular function generators. The basic unit will measure voltage or current at any of 20 device pins and will supply voltage, 0-100 v, or current, 0-200 ma, to any of the device pins. The unit can perform sequential measurements at various device pins without reprogramming. Optimized Devices Inc., Pleasantville, N.Y. [363]



Automatic capacitance readings with 0.1% accuracy unaffected by loss factors up to 10% are accomplished with the Autobalance capacitance bridge model B541C. It features an over-all capacitance range of C pf to 10 µf at 1,000 hz and can be operated on line supply or in a portable, internal battery-operated mode. Wayne Kerr Corp., 22 Frink St., Montclair, N.J. 07042. [364]



Radiometer model 151 takes the ratio of any two d-c signals even while they both vary rapidly in amplitude (over 100:1 dynamic range). It features a scale expansion technique and chopper stabilization to eliminate zero drift problems. The unit has a 20-msec response time. It provides 10 v full scale output. Brower Laboratories Inc., Turnpike Rd., Westboro, Mass. 01581. [365]



Compact counter model 103A offers an average frequency from 5 hz to 12.5 Mhz, frequency ratio of 1 to 10<sup>4</sup>, time interval from 0.1 sec to 10<sup>4</sup> sec, and totalization from 0 to 10<sup>4</sup>. The equipment contains a line frequency clock and has provision for an internal accessory clock. Sensitivity is 50 mv. Price is \$345. Monsanto Co., 620 Passaic Ave., West Caldwell, N.J. 07006. [366]

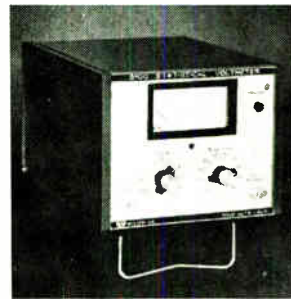

Voltmeter 3100 analyzes random or noise-like waveforms on a statistical basis. It has an a-c coupled input with a bandwidth of 0.5 hz to 100 khz. The unit will accept input levels from 1 mv to 100 v full scale with 1-meg input impedance. It accommodates a-c signals only, so appropriate transducers must be selected. Micom Inc., 855 Commercial St., Palo Alto, Calif. [367]



Panel-mounted meter model 4025 converts analog voltage to digital. Digital output is stored between reading for recording by an output device. Normal input range is 0 to 0.999 v. Alternative ranges may be selected by mounting shunt or multiplier resistors to display voltage or current measurements. Beckman Instruments Inc., 2400 Harbor Blvd., Fullerton, Calif. 92634. [368]

## New instruments

### FET tester keeps out the 'zot'

It protects devices, and itself, from static electricity while rapidly performing eight or more different tests

You'll rarely see girls wearing Orlon sweaters in shops producing field effect transistors, nor will you find carpeting on the floor of a FET-testing lab. The reason is the same one that explains why FET's just out of the manufacturer's box have their leads connected by a wire

loop. All these are precautions aimed at "zot-proofing" the devices—protecting them from static electricity.

Charges can build up in the most unexpected places, and the discharge of their energy through the transistor can burn out the device.

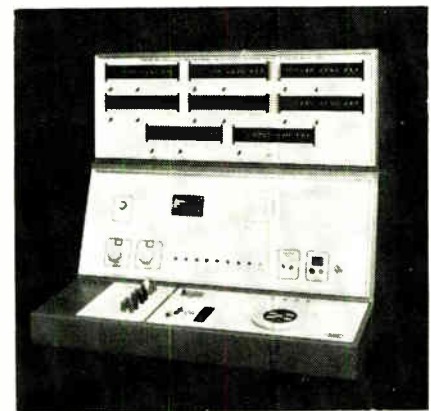

Setup. Switch registers in upper panel of the T311 are used to set parameters. Test fixture is at the lower right.

## These 3 men recently put plants on the Niagara Frontier:

*We asked them why.*

Ralph Webster  
General Manager  
Edwards High Vacuum



C. H. Fraser  
Vice President  
Electronic Automation Systems



Leonard McDonald  
General Manager  
G.I.E. Corporation

☛ *We're near our markets and we'll make more money!* ☛

All three gentlemen above gave the same answer. Two of the three companies are Canadian and they selected the Niagara Frontier for one major reason: 70% of Canada's population and 55% of United States' population live within a 500 mile radius of the Frontier. We have other inducements too: plenty of fresh water and electric power; superb transportation; research and development facilities among the best in the country; 13 colleges and universities turning out the brains you need; top drawer cultural and recreational advantages and just plain good living. Want to hear more? Send in the coupon.

## The future is here on the Niagara Frontier

Mr. Edward Rath Erie County Executive Erie County Hall, Dept. E-38 Buffalo, N. Y.	O.K. Mr. Rath. Send me your new book that tells why the Niagara Frontier (Erie County) is a profitable spot for our plant.	
Name _____		
Title _____		
Address _____ City _____ State _____ Zip _____		
Company _____		
<input type="checkbox"/> Check if you want convention information.		

... tester handles

1,000 units an hour ...

The Orlon sweater, like a carpet, is home to potential static charges. And having taken all possible zot-proofing steps during manufacture, plus looping a wire around the leads to keep the potential equal across all parts of the transistor, the FET manufacturer will, of course, use a zot-proof tester.

One such unit is the T311 from Teradyne Inc. In this unit, designed for quantity testing by either maker or user, Teradyne has combined several kinds of zot-proofing with the capability to automatically perform eight or more different tests rapidly. The tester, which itself is protected, has high sensitivity and a level of reliability that's good enough to be backed up by a 10-year guarantee.

A standard T311 checks and gives a go/no-go indication of FET leakage ( $I_{gdo}$ ,  $I_{gso}$ ,  $I_{gss}$ ), breakdown voltage ( $BV_{gdo}$ ,  $BV_{gso}$ ,  $BV_{gss}$ ), OFF performance ( $I_{ds}$  OFF,  $BV_{ds}$  OFF,  $V_p$ ), ON performance ( $V_{ds}$ ,  $I_{ds}$  ON,  $R_o$ ), and transconductance.

**On the panel.** Eight or more switch registers are used to select tests and set test parameters. Toggles beneath each register tell the T311's logic circuitry whether these parameters are to be considered maximum or minimum conditions. Another toggle under each switch register indicates whether the tests are for enhancement or depletion type FET's. And a knob sets conditions for either n- or p-channel devices.

Once the registers are set, an operator can test 1,000 or more FET's an hour. Red no-go lights flash when a device flunks.

For applications where the transistors must be rated by levels of performance, the T311 includes an automatic binning feature. Standard T311's are fitted with binning logic and a plug board the operator uses to select the tests that a transistor must pass before entering a given bin. Lights indicate whether the FET is fit for one of three bins—or for the wastebasket.

The T311 operates without adjustment or calibration. Critical circuits are sealed in replaceable modules, guaranteed themselves for 10 years. Even so, Teradyne has in-

# bench accuracy at system speed

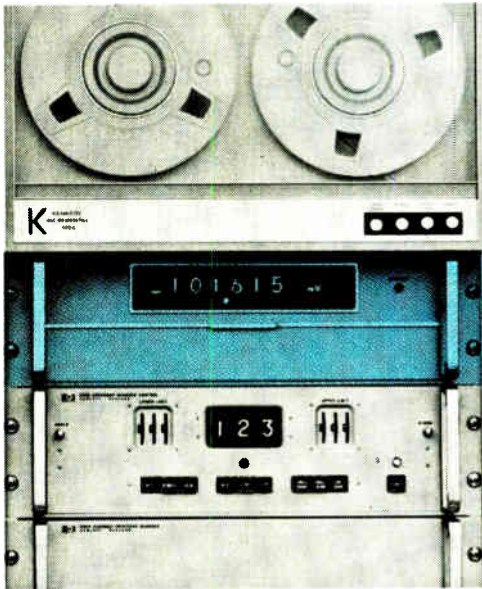
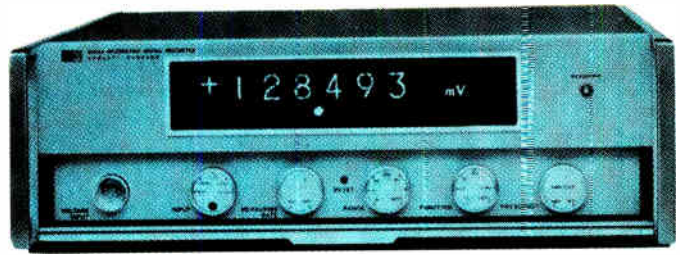

Cover protects 2402A controls for systems use.

Both in an integrating DVM with 1 microvolt resolution.

Take 40 readings per second, integrate and resolve the answers to a microvolt with the new Hewlett-Packard 2402A IDVM... get resolution never before available in this speed range. With the accuracy of a lab instrument (0.01% of reading  $\pm 0.003\%$  of full scale), the 2402A is excellent for system applications... with full programmability and all the features you'd expect from a systems voltmeter. (Of course, it's an excellent lab instrument, too.)

Guarding and integration permit accurate measurement of low-level signals in the presence of common mode and superimposed noise—over 120 dB effective common mode rejection... even at 40 readings per second. Designed for low-cost multimeter expandability: AC, resistance and frequency measurement capabilities can be added easily with optional plug-in circuit cards. Five ranges

to  $\pm 1000$  Volts, including a 0.1 Volt range for high-accuracy millivolt measurements.

The 2402A: \$4800. Plug-in options are reasonably priced—AC, for example, only \$450.

For more information, call your local HP field engineer or write Hewlett-Packard, Palo Alto, California 94304; Europe: 54 Route des Acacias, Geneva.

HEWLETT  PACKARD

DIGITAL VOLTMETERS

# Ballantine Sensitive AC-DC Digital Voltmeter



## Measures Wide Range of AC or DC Voltages in one Economical Package

Ballantine's Model 355 accurately measures a wide range of ac or dc voltages with a versatility that makes it ideal for production or quality control applications.

### FEATURES:

- ★ Replaces analog instruments to reduce personnel errors and to speed up production
- ★ Maximum sensitivity of 10 mV f.s. ac, and 100 mV dc
- ★ Frequency range of 30 Hz to 250 kHz
- ★ Accuracy, % f.s. to 1000 V: ¼% on dc and on ac from 50 Hz - 10 kHz; ½%, 30 Hz - 50 kHz; 1%, 30 Hz - 250 kHz
- ★ Servo-driven, 3 digit counter with over-ranging to 4, plus ability to interpolate for additional digit. This feature is not possible with electronic digital displays
- ★ Well-lighted readout, illuminated decimal point. Indicator warns against over-ranging or wrong polarity
- ★ An optional foot-operated switch for retaining readings speeds up successive readings

Price: \$640

Write for complete technical data today



**BALLANTINE LABORATORIES INC.**  
Boonton, New Jersey

CHECK WITH BALLANTINE FIRST FOR DC AND AC ELECTRONIC VOLTMETERS/AMMETERS/OHMMETERS, REGARDLESS OF YOUR REQUIREMENTS. WE HAVE A LARGE LINE, WITH ADDITIONS EACH YEAR. ALSO AC/DC LINEAR CONVERTERS, AC/DC CALIBRATORS, WIDE BAND AMPLIFIERS, DIRECT-READING CAPACITANCE METERS, AND A LINE OF LABORATORY VOLTAGE STANDARDS FOR 0 TO 1,000 MHZ.

cluded a bias check to shunt the bias programed at the switch registers to front-panel test jacks, and has included an accuracy test for the T311's internal references and comparator.

**Self-protection.** Even if the operator sets the controls improperly, no harm is done; the T311 won't blow out a p-channel device, for instance, when set to test an n-channel FET. Also, since the various power supplies on the T311 are limited in output, the operator can't harm the tester itself by improper adjustment.

The FET is protected by current limiting during leakage and breakdown tests, and by voltage clamping during all conducting tests. Teradyne engineers have also included gate-isolation networks.

During tests for which drain currents above 10 milliamperes are programed, the T311 automatically applies bias as a series of 300-microsecond pulses, rather than as direct current, to keep the transistor from overheating.

Finally, all voltage supplies are gated off and grounded automatically at the end of each test. Thus, stray capacitances in the test circuit discharge their energy to ground instead of through the FET.

The tester measures leakage even below the average levels of hum pickup in the laboratory. According to a Teradyne spokesman, hum from 60-hertz house wiring averages at least a nanoampere, even in a well-designed test fixture. The T311 gets down to the picoampere measurement level, however, by testing the FET above ground potential. Teradyne engineers have also included comparator circuitry that rejects all line-frequency stray pickup, regardless of its harmonic or phase.

**Special attention.** Since transconductance is important to the designer of FET-equipped circuits, Teradyne has provided for tests at any point on the FET's voltage-versus-current transfer curve. After  $V_{ds}$  and  $I_{ds}$  are set, the T311 applies a 10-millivolt, 1,000-hz signal to the gate and measures the resulting  $I_{ds}$  at the source.

Tests on the T311 average only about 35 milliseconds each. And since even the fastest operator will take three or four seconds to load



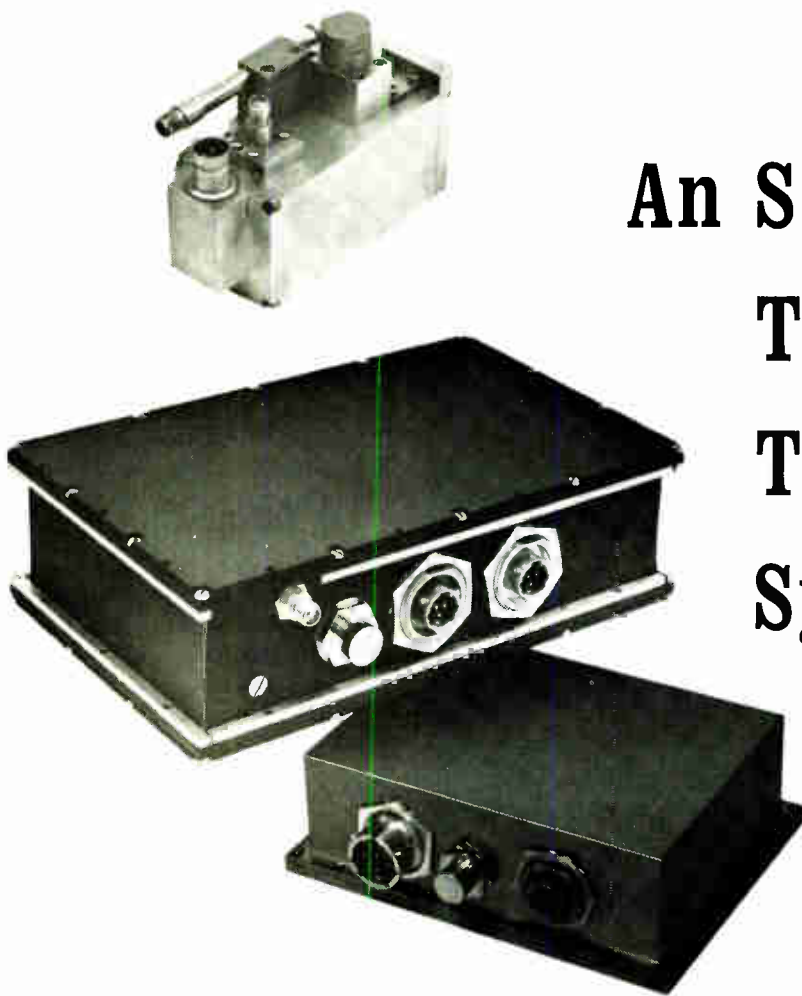

# An S-Band Telemetry Transmitter System

for Missile  
and Spacecraft  
Applications

The WJ-4528 delivers 20 watts of output power in the frequency range 2.2 to 2.3 GHz. Designed especially for the severe environments encountered in missile launch, this transmitter is equally reliable for use in spacecraft missions. Frequency accuracy is  $\pm 0.001\%$  and frequency stability is  $\pm 0.0025\%$  over the operating temperature range of  $-40^\circ$  to  $+85^\circ$  C. Here is another reason to keep looking to W-J for innovative accomplishments in advanced microwave systems!

See Us at AFCEA

WATKINS  JOHNSON

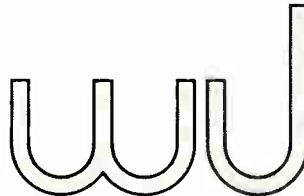

3333 HILLVIEW AVENUE  
STANFORD INDUSTRIAL PARK  
PALO ALTO, CALIFORNIA 94304

In the East, Contact W-J's Subsidiary  
COMMUNICATION ELECTRONICS, 6006 Executive Boulevard, Rockville, Md. 20852

# Compacts even control tempers

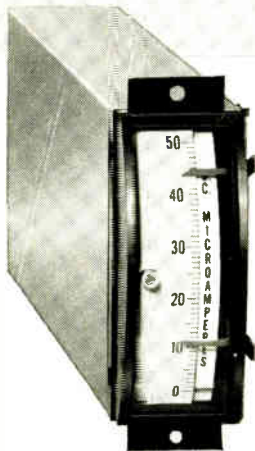
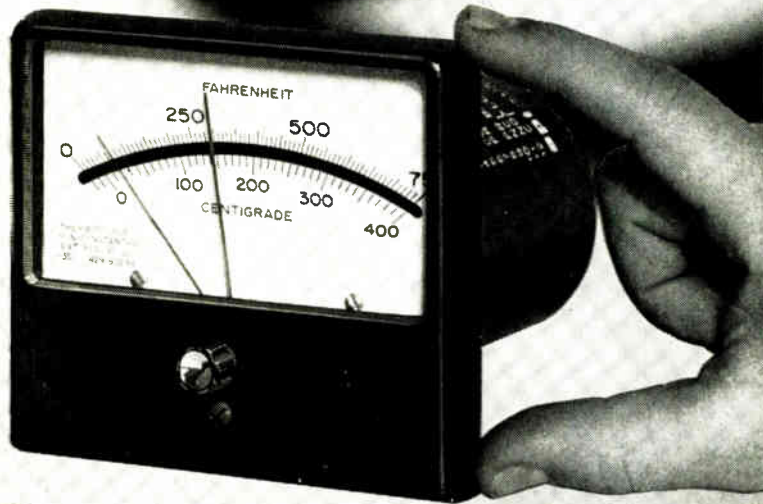

You won't fume or fret over delivery of API's versatile little controllers. Both the upright and edge-reading styles are waiting on the shelf in the most popular current, voltage, speed or temperature ranges.

Compacts are built around reliable solid-state circuitry. Just specify the control action you need for any signal, DC or AC.

Either single or double set points are adjustable immediately. The existing signal is always displayed.

Compacts not only preserve your good nature—they'll downright spoil you.

Read all about them in Bulletins 48 and 49.

**api**  
**INSTRUMENTS CO.**

CHESTERLAND, OHIO 44026 • (CLEVELAND-216) 729-1611 • TWX: 810-427-9230  
In Canada: Oshawa, Ontario • (416) 576-1541

and unload each FET, about 93% of the T311's time could be spent doing nothing. Teradyne's answer to this is multiplexed test stations that enable several operators to share the same T311; four or more of these can be attached to boost productivity.

But the best solution to the time problem is computer control. With the addition of a Digital Equipment Corp. PDP-8 computer, the T311 becomes the T331, a unit capable of performing as many as 50 different tests and classifying FET's into as many as a dozen bins. The computer stores test plans, controls the tester, processes the data, decides binning procedures, and prints out results. Handling of the FET's is mechanized to get the most out of the computerized T331's speed.

The T311 is priced at \$23,500; delivery time is three to four months.

Teradyne Inc., 183 Essex St., Boston 02111 [369]

New instruments

## Dvm-printer costs less than \$1,000

Meter will print and log values up to 1,100 volts, has four-digit display

If you were to buy them separately, the total cost of a digital voltmeter, a digital printer, and an automatic logger would be over \$1,500. The Dytro Corp. has put all three into one package, called the Logmatic Printing Digitizer, and kept the price under \$1,000.

The full range of the Logmatic is 0 to  $\pm 1,100$  volts d-c, and there are attachments available that permit the unit to measure resistance and a-c voltage. The Logmatic prints the values of measured voltages, and sequentially numbers them up to 100. It was designed primarily for use in high-volume and multi-point test systems where permanent records are needed.

In operation, the Logmatic meas-



## "Vee Jem" Chips make a big point!

The point: these capacitors are the only chips known to be designed expressly for thin- and thick-film micro-circuits.

No matter which common circuit materials you use, "Vee Jem" Chips make component attachment a past problem.

The unique capacitors are only .085" long, .055" wide, and .040" thick — but they have a trio of precious-metal mounting cones to insure superior bonding. (No surface oxides or frit to inhibit soldering, either.)

So, if you're having attachment problems with your ultrasonic, thermal compression, or reflow soldering techniques, make a point to try the "Vee Jem" Chip.

- Capacitance: 100 to 10,000 pf
- Voltage Ratings: 50 and 25 VDC
- Temperature Range: -55°C. to +125°C.
- Temperature Characteristic: ± 15% or better

For complete information, request Data Sheet C 21 and Technical Bulletin 10.

**Vitramon**<sup>®</sup>

VITRAMON, INCORPORATED  
BOX 544  
BRIDGEPORT, CONN. 06601

## mechanical refrigeration to -85° F for only \$745



### Only Associated Gives You Full Range Military Testing At This Low Price!

Associated's Model SW-5101 Temperature Chamber offers a new concept in mechanical refrigeration that enables you to perform 90% of all military low-high temperature tests at equipment cost-savings of up to \$200.

#### SPECIAL FEATURES OF THE SW-5101:

- full 1 cubic foot test area
- temperature range from -85 to +350°F.
- all solid state controller with ± 3/4 °F stability
- delivery from stock
- adjustable high-temperature fail-safe with signal lamp
- indicating thermometer in door
- combination hinged and removable door
- bench-top design, can be modified for stacking
- stainless steel feed-through port, 3/4" diameter

Check the SW-5101 specifications against your testing requirements. You'll find they add up to outstanding performance at a down-to-earth price — without sacrifice of quality or reliability.

*The new Associated catalog of environmental chambers is yours for the asking. Write for your free copy today.*

**ASSOCIATED  
TESTING  
LABORATORIES  
INC.**



200 Route 46, Wayne, N. J. 07470 • (201) 256-2800

**Low Noise Generation  
High Shock Resistance**

# RSC ROTARY SWITCHING

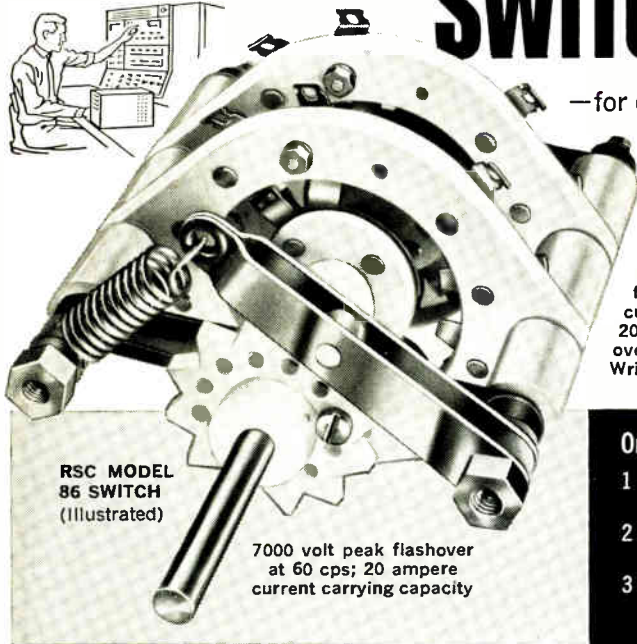

—for electro/mechanical dependability!

Manufactured under continuous quality verification tests, RSC rotary switches assure superior performance in low level circuitry. Types from 10 to 100 ampere current carrying capacity 2000 to 24000 volts flash-over, and 20° to 90° detents. Write for illustrated catalog.

RSC MODEL 86 SWITCH (Illustrated)

7000 volt peak flashover at 60 cps; 20 ampere current carrying capacity

### One to Eighteen Positions

- 1 Circuit per Section, 1 to 11 Poles per Circuit
- 2 Circuits per Section, 1 to 4 Poles per Circuit
- 3 Circuits per Section, 1 Pole per Circuit

**RADIO SWITCH CORPORATION**

Marlboro, New Jersey 07746—Telephone: (201) 462-6100



Founded 1933

Circle 229 on reader service card

... readout shows value, sign, log number ...

ures a voltage and displays the value when the read button is pushed; it records when the print button is pushed. The mechanical readout has eight positions, two for the log number, four for the first four significant figures of the measured value, one for the polarity sign and one for the decimal point. There are three manually selected ranges: 10.999, 109.99, and 1,099.9 volts.

The system has a variety of operating modes, including one in which the instrument reads and records periodically.

The Logmatic uses successive-approximation scan logic circuits to measure the voltage. Resolution is better than 0.01% of the full-scale reading, and accuracy is  $\pm 100$  parts per million plus one count in the least significant decade. Maximum reading time is 1.4 seconds and the average is 0.9 seconds. Input impedance is more than 100 megohms, and the input can be either double- or single-ended.

Dytro will make three Logmatic models, each designed for a specific application. The 8040, which will be available this summer, is intended for use on production lines and at inspection stations. The 6040 is suited for such laboratory jobs as testing breadboards and prototypes, and troubleshooting. It has a preamplifier that improves resolution by a factor of 10.

The 4040 is for automatic systems such as industrial process monitors.

Dytro Corp., 63 Tec St., Hicksville, N.Y. [370]



On record. The Logmatic Printing Digitizer can log 100 measurements.



## Every Engineer or Draftsman should have the NEW 1968 BY-BUK CROSS REFERENCE GUIDE P-45

(supersedes By-Buk Catalog No. P-42)

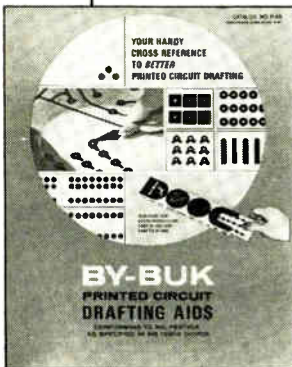

to better printed circuit drafting.

This FREE 24 page booklet contains color-coded standard MIL-SPEC SIZES and design standards ... plus a newly added numerical index for easy reference to over 2000 pre-cut tapes, pads, shapes, transistor tri-pads, spaced IC

terminal pad sets and other drafting aids for faster, more accurate, distortion-free printed circuit master drawings.

Send for your FREE guide today!

**BY-BUK COMPANY**

4326 West Pico Blvd. • Los Angeles, Calif. 90019 • (213) 937-3511



# Fountain of youth: Kodak's ESTAR Base Films

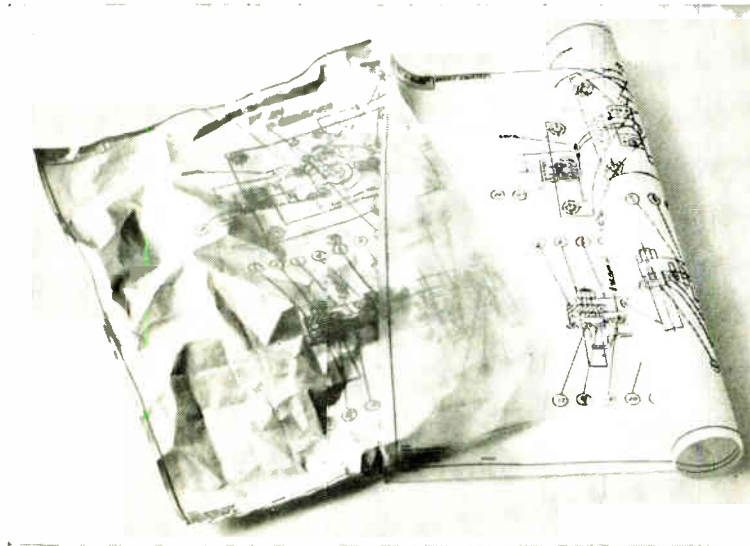

## Reclaim old drawings the easy way.

When an original drawing becomes old, faded and yellowed, you can bring it back to a youthful condition by restoring it on KODAGRAPH ESTAR Base Film. Faint detail comes back strong, creases and stains all but disappear. Your reproduction looks as good as the original the day it was drawn. And it will stay that way.

Once you've reclaimed a drawing with an ESTAR Base second original, you'll love it—for the years

it will last in everyday use. Drafting surface is new (and tougher), will take more erasures than ever before. And it takes your drafting additions in pen or pencil beautifully.

Ask your reproduction department or commercial blueprinter to show you the cosmetic magic possible with ESTAR Base Films. It's going to save you redrafting time and dollars.

Write: Eastman Kodak Company,  
Business Systems Markets  
Division, Rochester,  
N.Y. 14650.

Kodak

DRAWING REPRODUCTION SYSTEMS BY KODAK

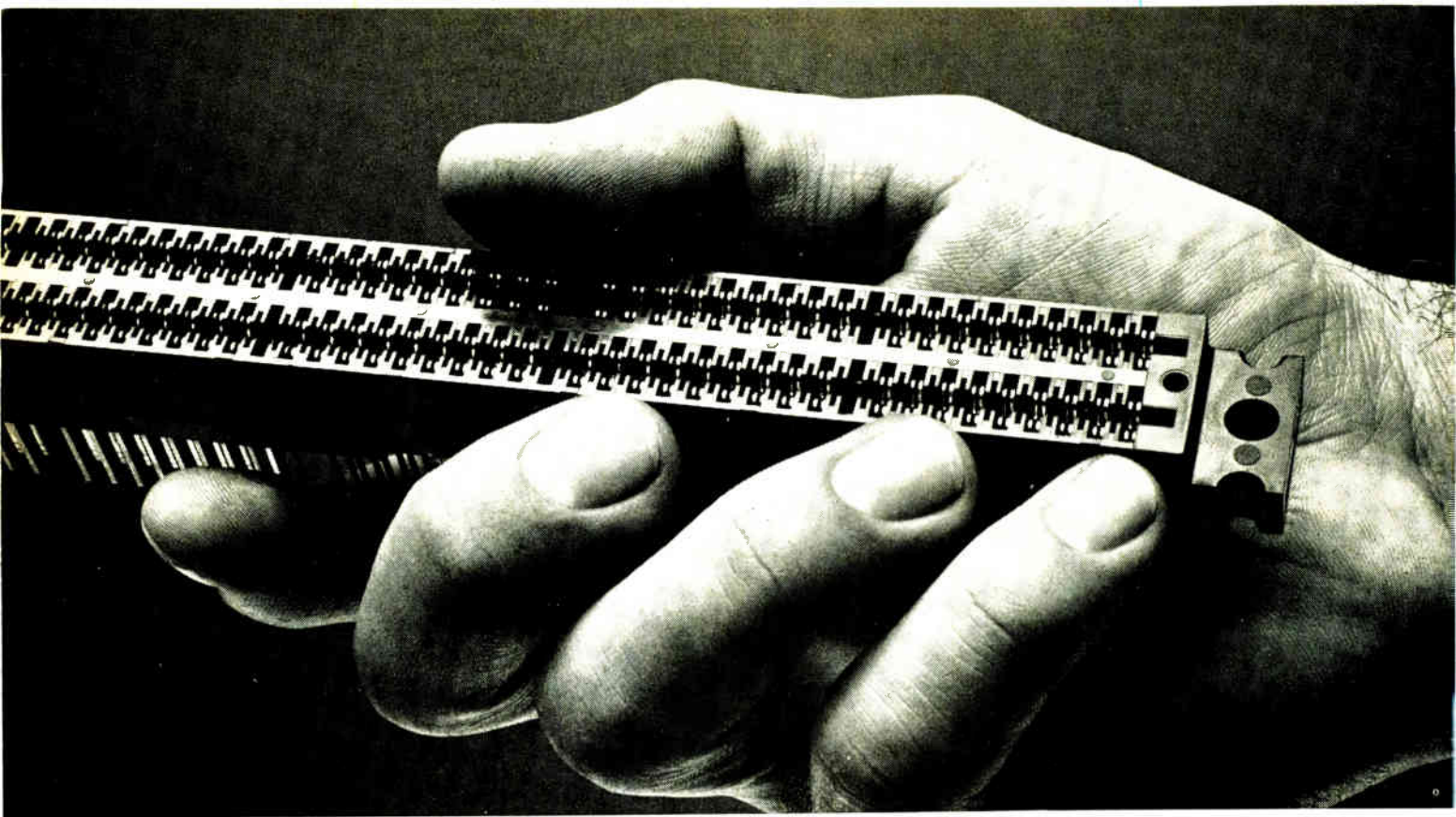

# Our connectors are better. Of course, you have to pay a little less.

Everybody knows that gold makes the best electrical contact.

So we put ten times more gold at the contact area than any plater does.

But everybody knows that gold is expensive.

So, we developed a special welding process that lets us put the gold exactly where you want it. So overall, we use much less gold.

As a result, you get a better, longer-wearing, more reliable connector for

less money.

Sounds simple, but it takes some doing.

It not only calls for advanced technical know-how, but also precise control of all fabricating processes. Well, at Sylvania, we leave nothing to chance—or to outside suppliers.

First, we draw our own wire for the contacts. Then we do our own coining, forming, bending, solder plating, and gold dot welding. Next, we mold our

own plastics bodies to assure precise control of tolerances.

And, finally, we assemble the whole thing ourselves.

And we do it all to your specifications.

So if you want the best connector, and you don't mind paying a little less, give us a call. Sylvania Metals & Chemicals, Parts Division, Warren, Pa. 16365.

**SYLVANIA**  
A DIVISION OF  
GENERAL TELEPHONE & ELECTRONICS

## New Semiconductors Review

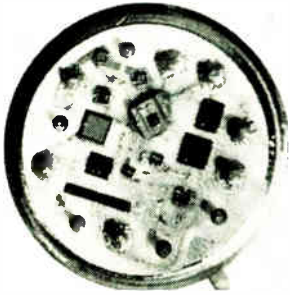

Hybrid IC voltage regulator NC562 is supplied preset and guaranteed to maintain an output voltage of  $\pm 12$  v  $\pm 0.4\%$  over the following compound conditions with no external adjustments or components: input voltage change,  $15$  v  $\pm 10\%$ ; output current change,  $0$ - $100$  ma; change of temperature,  $-55^\circ$  to  $125^\circ$ C. General Instrument Corp., 600 W. John St., Hicksville, N.Y. 11802. [436]

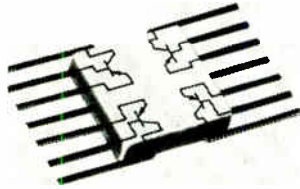

Quad transistor 2N5146 is for medium-current, high-speed switching and driver applications where space limitation or minimum lead inductance are important factors. The 4 individual transistors comprising it are pnp silicon Annular devices, each with a beta of 40 at a collector current of 1 amp d-c. Motorola Semiconductor Products Inc., Box 13408, Phoenix, 85002. [437]

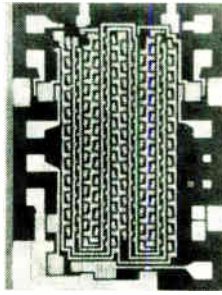

Dynamic shift register 3303, which operates in a frequency range from 10 khz, to 500 khz, contains two 25-bit serial strings of storage elements, each controlled by a common 2-phase clock or shift line. Power dissipation is typically  $200 \mu$ w per bit at 500 khz. The 3303 package is a 10-lead TO-5. Fairchild Semiconductor, 313 Fairchild Dr., Mountain View, Calif. 94040. [438]

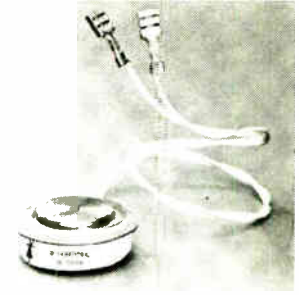

Pressure-assembled SCR's series 250HA and 110HA are designed with current switching capabilities as high as 250 amps average and 110 amps average respectively. Units offer a voltage range selection from 500 to 1,200 v suiting them for use in high power, high voltage switching applications. International Rectifier Corp., 233 Kansas St., El Segundo, Calif. 90245. [439]

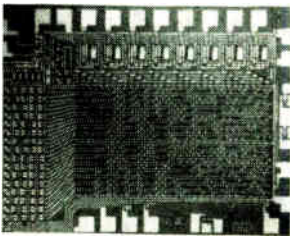

The 1,024-bit read-only memory PL4M1024 is a complex MOS array containing an alterable, fixed ROM pattern consisting of 128 words of 8 bits each. The array includes a 7-bit address decode matrix and provides a read access time of under 1  $\mu$ sec. Bit pattern may be altered for one-time tooling cost of \$750. Philco-Ford Corp., Tioga and C Streets, Philadelphia 19134. [440]

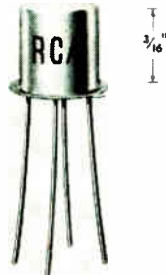

Silicon MOS FET 3N152 is for vhf amplifier use up to 250 Mhz in military and industrial communications equipment. Low noise figure of 3.5 db max. and max. usable unneutralized gain of 14.5 db minimum at 200 Mhz, coupled with a feedback capacitance of only 0.2 pf, suit the device for use in high performance front-end circuits. RCA/Electronic Components, Harrison, N.J. 07029. [441]

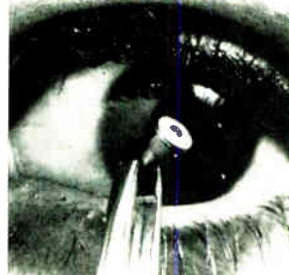

Three photodiodes employing avalanche effect have spectrum responses shaped for optimum laser wavelength sensitivity. The TIXL55 and TIXL 56 (silicon devices) and the TIXL57 (germanium detector) offer variable photocurrent gains peaking at 100 to 200. Peak spectral response range is from 0.9 to 1.5 microns. Texas Instruments Inc., P.O. Box 5012, Dallas 75222. [442]

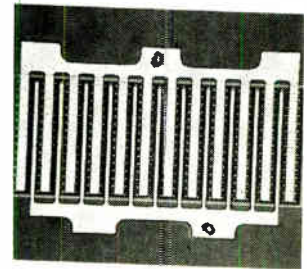

Silicon npn epitaxial planar transistor S1050 is a 10-w at 1 Ghz amplifier type. Employing an overlay emitter technique, it has been designed for high power output uhf class C amplifier service. The modified stud-mounted device features 30% efficiency with a gain bandwidth product of 1.5 Ghz and thermal resistance of  $7^\circ$ C/w. United Aircraft Corp., Trevose, Pa. 19047. [443]

### New semiconductors

## Switches combine speed and power

Off-the-shelf devices operate in nanoseconds, handle 5 to 30 amps with high-gain bandwidths

**TRW Semiconductors**, known for its power transistors, has used its experience in making fast power switches for such missiles as Poseidon and Minuteman III to produce an off-the-shelf line of switching transistors in the 5-to-30-ampere range. The switches, with comple-

mentary power diodes, operate in nanoseconds rather than microseconds.

Robert Austin, engineering manager for the Power Products division, says that the speeds are twice those of other commercial devices and that radiation resistance is

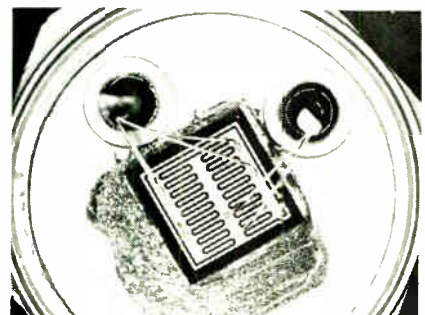

**Weaving.** Interdigitation in new power transistors is one of the contributors to higher output.



# PARKER

*"The Modern Movement"*



## NOW! Available from STOCK

- **PRICE** — Competitive pricing, with quantity purchase discounts, yields lowest possible customer costs.
- **CHOICE** — 6 models & sizes available to fit your panel meter requirements.
- **SPECIFICATIONS** — Meets ALL ASA requirements.
- **RELIABILITY** — Long life and long term stability due to Alnico VIII magnets. Inherently rugged PARKER movement with High Shock, high overload etched circuit coil.

**STOCKED IN DEPTH BY ALL LEADING DISTRIBUTORS**

For Further Information Consult  
Your Local Electronics Distributor  
or write

200 Harvard Ave. • Stamford, Conn. 06904 • (203) 325-4361



**PARKER** Instrument Corp.

Circle 230 on reader service card

## Weapons Systems Planning

Studies leading to future generations of tactical and strategic weapons systems

### Cost/Operations Research

Conduct research studies in: systems effectiveness, operational requirements, weapons system optimization and cost effectiveness as applied to nuclear missile and defense systems.

### Systems Analysis

Design analysis of over-all weapons systems objectives, requirements and parameters, including environment; performance and integration of systems and subsystems.

### Missile Defense Systems

Systems analysis, evaluation and requirements for defense interceptors, sensors, data processing and command/control subsystems. Math modeling of offense/defense interactions, effectiveness trade-offs, and optimization of defense systems.

Degree in physics, mathematics or engineering with appropriate training and experience is required for the above positions.

For more information please write Mr. R. C. Birdsall, Professional Placement Manager, P. O. Box 504, Sunnyvale, California 94088. Lockheed is an equal opportunity employer.

**LOCKHEED**  
MISSILES & SPACE COMPANY  
A GROUP DIVISION OF LOCKHEED AIRCRAFT CORPORATION

... four transistors  
make up the line ...

better than that of military versions.

The improved speeds and radiation resistance—and high-gain bandwidths—were achieved by making the bases narrower than those of other commercial transistors. The widths were reduced by the shallow-diffusion technique. This process produces surface characteristics that are superior to those experienced in earlier efforts to reduce base widths.

The devices are also rugged, Austin says. He points out that similar designs met severe second-breakdown requirements for missile systems and consistently passed military tests requiring 2,000 hours of on-off repetition.

**The lineup.** Included in the new line are transistors for 5, 10, 20, and 30 amps, and two high-speed power diodes, 1N5409 and 1N5410. With the companion diodes, Austin says, TRW can offer a customer a complete pairing system. Without the diodes, the high-speed characteristics of the power transistors would just be lost in application. The 5-amp transistor is for use in gyro motor drivers, inverters, and switching regulators through 100 kilohertz, high-frequency linear amplifiers for deflection systems, and radiation-resistant single-side-band equipment. Called the 2N5326, it is packaged in an isolated TO-59.

The 10-amp transistor can be used in inverters and switching regulators through 100 khz, squib drivers, medium-current motor drivers, and linear amplifiers for deflection systems. It is available in two types of packages. The 2N5327 comes in an isolated TO-5 and the 2N5328 in an isolated TO-59.

The 20-amp transistor is for use with high-inductance loads—such as those for solenoids—power inverters and switching regulators through 50 khz, squib drivers, and linear amplifiers for deflection systems. The 2N5329 is in an isolated TO-61.

The 30-amp transistor can go in high-power inverter and switching regulators through 60 khz, power amplifiers for sonar and very-low-



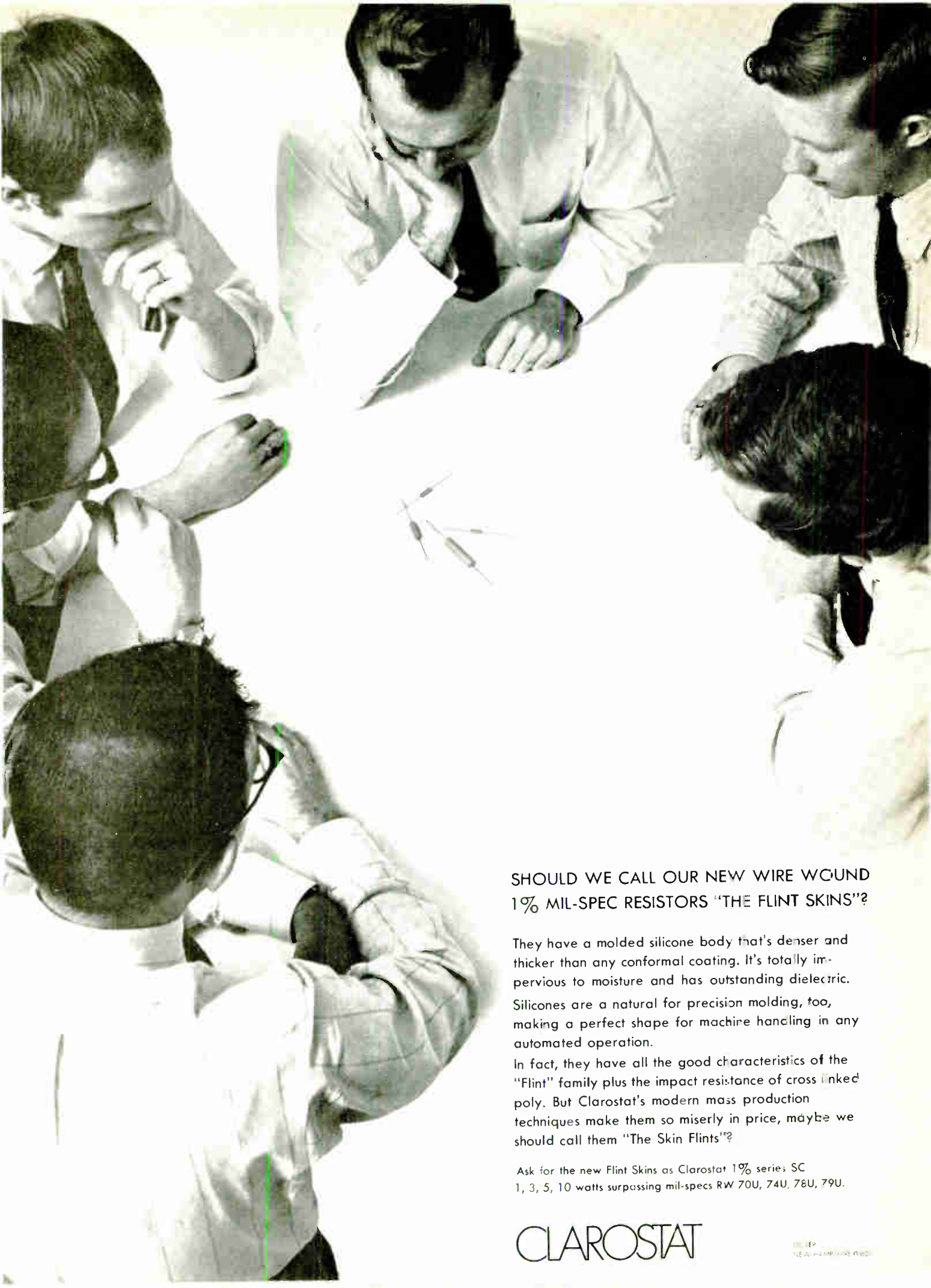

SHOULD WE CALL OUR NEW WIRE WOUND  
1% MIL-SPEC RESISTORS "THE FLINT SKINS"?

They have a molded silicone body that's denser and thicker than any conformal coating. It's totally impervious to moisture and has outstanding dielectric. Silicones are a natural for precision molding, too, making a perfect shape for machine handling in any automated operation.

In fact, they have all the good characteristics of the "Flint" family plus the impact resistance of cross linked poly. But Clarostat's modern mass production techniques make them so miserly in price, maybe we should call them "The Skin Flints"?

Ask for the new Flint Skins as Clarostat 1% series SC  
1, 3, 5, 10 watts surpassing mil-specs RW 70U, 74U, 78U, 79U.

CLAROSTAT

CLAROSTAT  
NEW HAMPSHIRE

**Bunker-Ramo's Environmental Test Laboratory has developed two revolutionary new test instruments now available for the first time.**

BR-650 Chatter and Transfer Detector. A versatile, precision test instrument used to monitor closed circuit relay contacts, connector-pair contacts, continuous conductor paths, slip ring and brush assemblies, printed circuit boards, integrated circuits, diodes, transistors, to name a few.

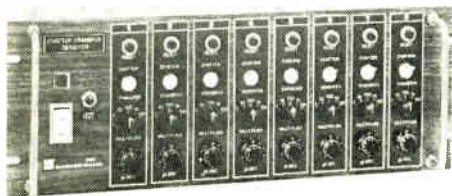

BR-650 Chatter & Transfer Detector



BR-651 Automatic Test Controller

BR-651 Automatic Test Controller. Automated sequencing and monitoring of cyclical test procedures. Significantly reduces technician man hours by providing automatic performance verification or test sampling in extended test runs such as accumulated life, temperature and humidity tests.

For more information on our test instruments or our commercial environmental test laboratory, call Mr. Bill Spaulding —Test Instrument Operations, (213) 346-6000, Extension 283, or write:

**THE BUNKER-RAMO CORPORATION**  
DEFENSE SYSTEMS DIVISION  
8433 FALLBROOK AVENUE • CANOGA PARK, CALIFORNIA 91304

Circle 251 on reader service card

**FREE!**



**12-PAGE CATALOG**  
for electronic engineers, designers,  
draftsmen . . . illustrating PreKut StikOn  
Sequential Reference Designations.

New from Bishop — especially designed for the electronics/aerospace industry. PreKut StikOn Sequential Reference Designations now available in opaque black, transparent red, transparent blue and in reverse reading. Made to conform to Government Standards. All shown in our complete new catalog SRD-1. All new from Bishop . . . your prime source for a complete line of PreKut Drafting Aids.

Send today for your  
free catalog and sample pack.

**Bishop Industries Corporation**  
11728 Yose St., N. Hollywood, California 91605  
Phone (213) 982-2000

**offset and scaling  
simultaneously!**



**NUS**  
**MODEL 3020 OFFSET/SCALING COUNTER**

Now, for the first time, the NUS Model 3020 makes it possible to offset and scale frequency variant signals **SIMULTANEOUSLY**. The end result is precise data, clearly displayed in the engineering units required. The units' BCD output may be recorded for computer processing of the data.

Employs Nixie readout with display storage . . . Accepts a wide variety of signal inputs . . . Features broad-data acquisition applications . . . Integrated circuitry assures reliability . . . Counting periods up to 100 seconds, for high resolution. For further information and specifications, please contact:

**NUS Corporation**  
Electronic Systems Division

9 Keystone Place Paramus, N. J. 07652  
Phone: (201) 265-2400

Circle 231 on reader service card

**. . . next come  
microwave units . . .**

frequency transmitters, and squib drivers. The 2N5330 comes in an isolated TO-61 and the 2N5331 in a TO-63.

The 5- and 10-amp transistors have the best radiation resistance because they have the smallest base area. Both of these transistors have a 2-amp saturation of only about 0.1 volt.

**Looking ahead.** Within a year, TRW expects to be offering devices for higher current and voltage but on smaller chips. Austin says they'll be cellular structures with substantially reduced output capacitances.

Most of the chip area in power transistors isn't being used, Austin points out. The firm is doing lab work with devices that have been formed by breaking chips into smaller structures. By using heavy interdigitation, it has made faster and harder power devices.

Multiple-cell structures, Austin says, will lead to devices able to withstand higher power surges. The surges burn out only a few cells, so the transistor still performs in the circuit.

Both the new line and devices in the labs are expected to be used in missile and sophisticated airborne systems.

The line is being offered off-the-shelf, according to Austin, to show what the Power Products division can do. For example, the packages listed above represent more a suggestion than a limit to production capabilities.

TRW's new transistors are viewed by engineers as the next step in producing off-the-shelf, high-power microwave devices. TRW already has a device that is capable of producing 50 watts at 500 megahertz and is working on one that will produce 1 watt at 3 gigahertz. All of these devices employ the interdigitation technique. The only challenger to this process is RCA with its overlay design.

The devices cost from \$35 each in quantities of 1,000 for the 5-amp to \$74.50 in quantities of 1,000 for the 30-amp.

TRW Semiconductors Inc., 14520 Aviation Blvd., Lawndale, Calif. 90260 [444]

# Coming up with a special-purpose tube?

## We'd like to have a part in it.

Our stampings have been part of special-purpose tubes, integrated circuits, relays—wherever precision electronic stampings are needed—since Volkert began. Why? Exact-ing tolerances are one reason. Our ability to produce in volume and deliver on time is another. Competitive prices are a third. (You'd be surprised at the way our unique diemaking skills and production techniques can cut costs without cutting quality.) And our engineering service that transforms your original designs into work-able stampings is a fourth. But after all, we haven't been leaders in electronic stampings for 30 years by accident.

Next time you come up with a good idea that requires precision stampings, follow it up with another. Write or call Volkert Stampings, Inc., Subsidiary of The Stanley Works, 222-35 96th Avenue, Queens Village, L. I., N. Y. 11429. Tel.: 212-464-8400.

***Volkert*** STAMPINGS, INC.

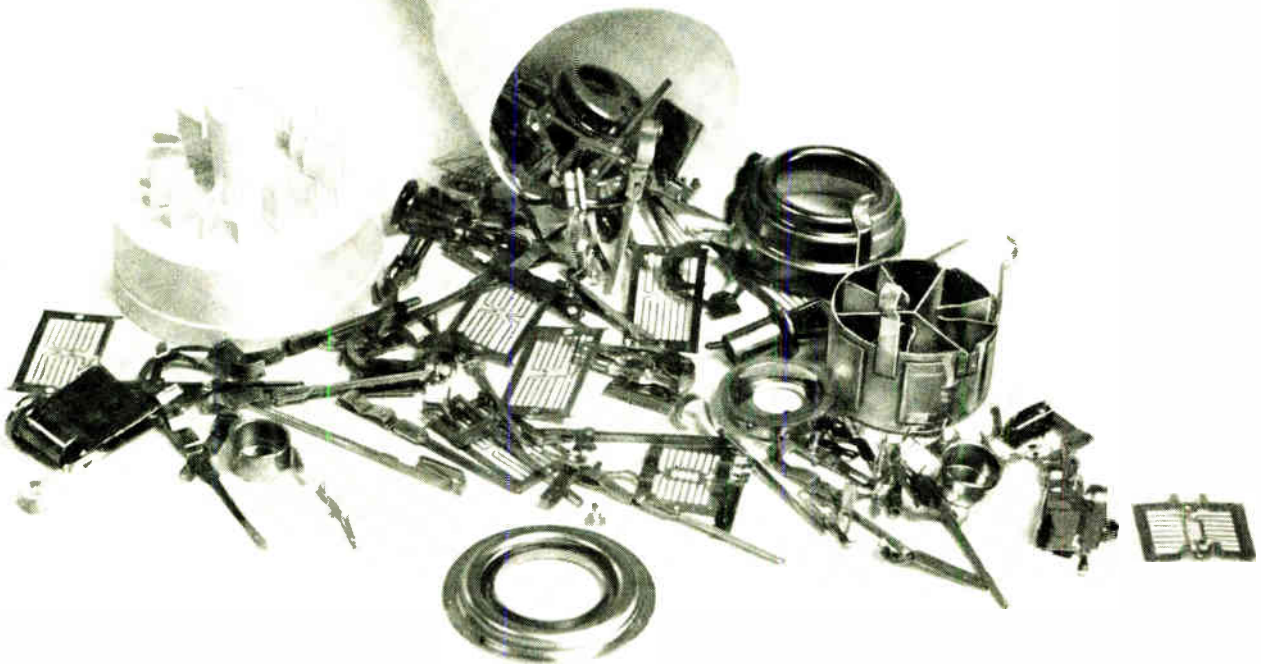

The Material  
of Unlimited Uses...

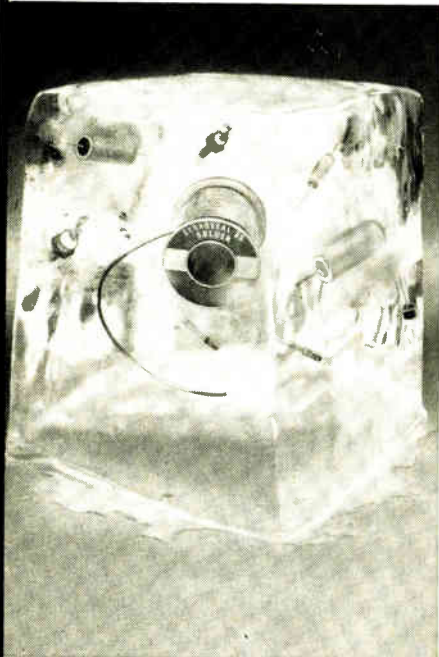

## SOLDERING "UNSOLDERABLES"

...is but one of the thousands of uses for advanced low-melting-temperature alloys such as Cerroal® 35. Cerroal 35 melts between 238 and 260° F., and can be used with ordinary soldering techniques. When soldered with this versatile alloy, "toughies" such as glass-to-metal, ceramic-to-metal and metal-to-metal seals stay tight even in a deep vacuum. Other Cerro® Alloys, including specials made to your individual specs, are perfect for joining ultra-delicate parts like integrated circuits which cannot be heat-sunk during soldering. Low-temperature soldering as cool as 117° F. can also be accomplished with certain Cerro Alloys.

For detailed information contact Cerro Alloy Dept., Cerro Copper & Brass Company, Stamford, Conn. 06907... R. S. Darnell (203) 327-0550.

# CERRO®

New semiconductors

## Second integrated subsystem bows

Serial shift register containing some 6,400 transistors operates at 1 megahertz

**Integrated subsystems**—Autonetics' term for large-scale integrated arrays—are moving closer to full production at the firm, a division of the North American Rockwell Corp. The next device to reach the market will be a 1,024-bit serial shift register containing some 6,400 metal oxide semiconductor field effect transistors.

Autonetics' first commercial LSI products were announced last December [Electronics, Dec. 25, 1967, p. 25].

Arthur C. Lowell, assistant director of Autonetics' research and engineering operation, says working models of the new shift register exist and that specifications should be complete by mid-June. The unit will consume 150 milliwatts and be specified at a speed of 1 megahertz. Lowell adds, however, that it appears the device may operate at up to 4 Mhz.

**Four levels.** "This is a quad 256 device," he explains, "and it's a four-phase device, so you can get information out at levels of 256 bits, 512 bits, 768 bits, or 1,024 bits." The 140-mil square chip contains protective diodes as well as the MOS FET's.

Besides handling the traditional shift-register applications—in delay lines and some computation functions—the new unit should find jobs in signal analysis. "If you want to find out if the signal you're receiving is the right one, you would want to employ this type of function," Lowell says. "The device will also find use in such special processors as clutter eliminators."

The shift register will be available in standard flatpacks or in a special beryllia package Autonetics has developed. Lowell says the new package has excellent hermetic and good thermal properties, and

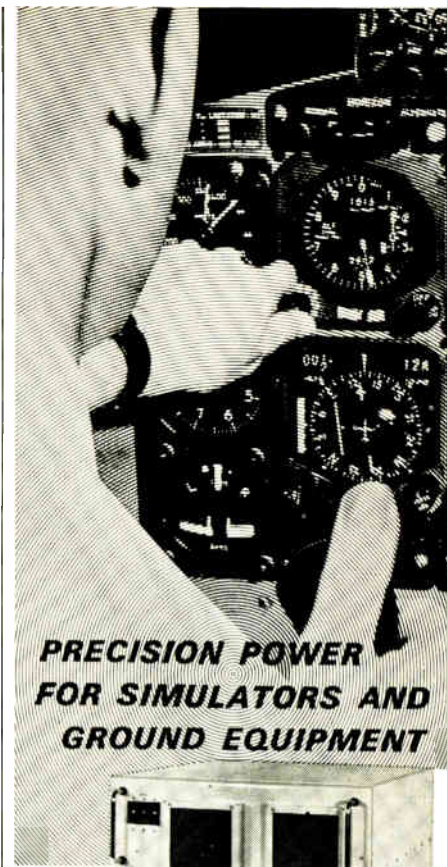

**PRECISION POWER  
FOR SIMULATORS AND  
GROUND EQUIPMENT**



MODEL PS67-325-1

## UNITRON FREQUENCY CONVERTER 60 Hz to 400 Hz 2 KVA Sine Wave Output

**Completely protected — INPUT: Over/undervoltage, phase loss, overcurrent. OUTPUT: Overload and short circuit**  
• Stable frequency and voltage regulation • Designed to meet applicable RFI specifications

One of several all-silicon solid-state converters providing precision 400 Hz, 2 KVA power from a 50/60 Hz source, with virtually no audible noise. A stable output is assured by complete frequency and voltage regulation. This and similar 2.5 KVA unit will handle severe surge currents. A separate 28 VDC, 350 W output is optional, and a rack-mount, fully-metered configuration is available. Typical applications are flight simulators, and testing and ground support equipment. Other units with 1 and 8 KVA outputs.

Write for complete information.

# UNITRON

Division of Electric Machinery Mfg. Company  
1624 N. FIRST ST.  
GARLAND, TEXAS 75040 (214) 276-8591

# CEC

# announces the world's most prolific amplifier.

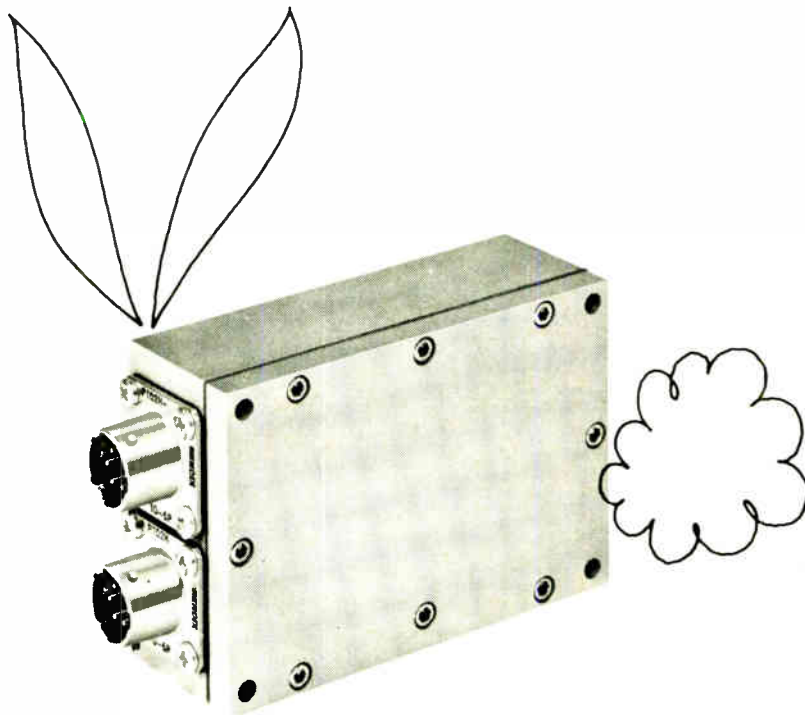

On the surface, CEC's new 1-370 looks like any other dc differential amplifier. But inside, it's more flexible than a politician's promise. For the 1-370 is readily available with *over 1450* different configurations and performance characteristics.

How is that possible? Simply because all the modules needed to tailor the amplifier to fit most signal conditioning applications were designed to meet

custom requirements with off-the-shelf delivery. Once the application form is filled out, CEC can meet your specifications *precisely, promptly and economically.*

Quite a claim? Not when you're the world's leading producer of transducers and associated electronics.

For further information and an on-the-spot quote, call your nearest CEC Field Office. Or write Consolidated

Electrodynamics, Pasadena, California 91109. A subsidiary of Bell & Howell. Ask for Bulletin 1370-X2

**CEC/TRANSUCER PRODUCTS**

 **BELL & HOWELL**

# GREAT NEW WAY TO BUY DC POWER



## ERA's Wide-Range, Variable, All-Silicon DC Power Modules at Low, Low Prices

ERA's new Value-Engineered DC Transpac® power modules provide all-silicon, DC power in a wide-range, variable, low cost module.

Stocking problems are reduced to a minimum and power module obsolescence is practically eliminated. Design changes are easily accommodated since all units can be set to desired voltages by a simple external tap change.

Output Voltage (DC)	Current (71°C)	Model	Price
4-32	0-750 ma	LC32P7	\$ 89.00
4-32	0-2 amps	LC322	\$115.00
4-32	0-5 amps	LC325	\$179.00
4-32	0-10 amps	LC3210	\$215.00
30-60	0-1 amp	LC601	\$145.00

Over-Voltage Protector Option: Add \$35.00 to above prices and Suffix V to Model No. (i.e. LC325V, etc.).

### SPECIFICATIONS

**Input:** 105-125 VAC, 50-400 cps  
**Ripple:** Less than 800 microvolts RMS or .005%, whichever is greater  
**Line Regulation:** Better than  $\pm 0.01\%$  or 5 mv for full input change  
**Load Regulation:** Better than 0.05% or 8 mv for 0-100% load change  
**Voltage Adjustment:** Taps and screwdriver adjustment  
**Short Circuit Protected:** Automatic recovery  
**Vernier Voltage:** External provision  
**Transient Response:** Less than 50 microseconds  
**Operating Temperature:** -20°C to + 71°C free air, full ratings  
**Maximum Case Temperature:** 130°C  
**Temperature Coefficient:** Less than 0.01% per degrees C or 3 millivolts  
**Long-Term Stability:** Within 8 millivolts (8 hours reference)

Write Today for Catalog #147



## ELECTRONIC RESEARCH ASSOCIATES, INC.

Dept. ED-9, 67 Sand Park Road  
 Cedar Grove, N. J. 07009 • (201) 239-3000  
 Subsidiaries: ERA Electric Co. • ERA Acoustics Corp.  
 ERA Dynamics Corp. • ERA Pacific, Inc.

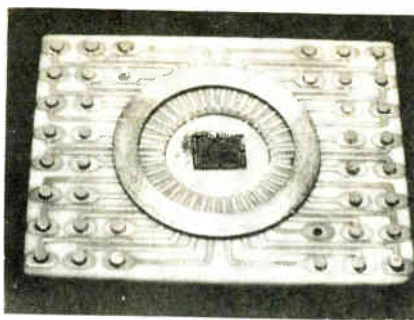

Container. Special beryllia package offers better heat transfer for IC.

notes that beryllia has seven times the heat transmissibility of alumina. "Most who have seen it prefer it to the large 40-lead flatpack because it will be easier to use in system manufacturing," he adds.

With standard flatpacks, each lead must be individually soldered to the circuit board on which the package is mounted. The special plug-in pins incorporated in the beryllia package make for easy insertion into the board followed by a one-step wave-soldering operation. The reduction in the amount of solder needed not only decreases installed weight but improves thermal properties, Lowell says.

**Arms akimbo.** The beryllia package also eliminates the need to bend leads at the package interface, indicating potentially greater reliability because lead forming often disturbs the hermetic seal. Most of the leads are bent well away from the new package; the plug-in pins are mounted on centers measuring 100 mils.

Autonetics estimates that sample devices—in either standard flatpack or beryllia package—will be available in about a month. The initial production devices will cost about \$250 in quantities up to 100, a price Lowell says is competitive with those for conventional flatpack LSI arrays. "In larger quantities, the price will be down in the area of the 10-cents-a-bit tag on 100-bit shift registers," he says.

Looking beyond the 1,024-bit shift register, Lowell sees Autonetics making read-only memories with both bit and access circuitry in this same size chip. In the next two years, he says, the division will be going to between 4,000 and 6,000 bits in read-only memory chips.

Autonetics division, North American Rockwell Corp., 3370 East Miraloma Ave., Anaheim, Calif. 92803 [445]

## FREE SAMPLE eccospheres® LOW V. GLASS AND CERAMIC MICROSPHERES MICROBALLOONS™

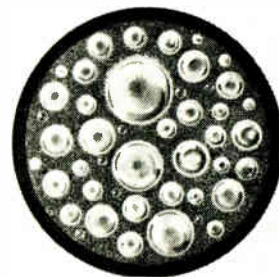

Micron sized hollow particles look like fine sand. Under the microscope they appear as in photo. The ideal filler for low weight and high strength. Excellent electrically and mechanically.

Circle 291 on Reader Service Card

## STYCAST® CASTING RESINS CHART COMPLETELY REVISED



This chart for notebook or wall mounting has just been brought up to date. It contains comparative property data on over 20 Sty-cast® epoxies and urethanes.

Circle 292 on Reader Service Card

## ECCOBOND® ADHESIVES FREE WALL CHART



Fully illustrated fold-out chart gives complete physical and electrical data on over 20 adhesive systems—conductive, non-conductive—liquids, powders, pastes—for electrical or mechanical applications—various chemical types.

Circle 293 on Reader Service Card

## Emerson & Cuming, Inc.



CANTON, MASS.  
 GARDENA, CALIF.  
 NORTHBROOK, ILL.  
 Sales Offices  
 in Principal Cities

EMERSON & CUMING EUROPE N.V., Davel, Belgium

**For a state that ranks fourth in the nation  
in the production of electric motors,**



**Arkansas sure knows how  
to produce for industry.**

**And our specialized Task Forces  
are ready to prove it.**

Arkansas leads the South in electric motor production. The reasons are clear. Stable, adaptable labor. Strategic location. Arkansas is within a day's trucking of over 76 million people in Mid-America. Our professionally staffed Task Forces are anxious to tell you about Arkansas' electronics field — and eight others. Write the Arkansas Industrial Development Commission, State Capitol, Little Rock 72201. It's the current thing to do.

**ARKANSAS**

"We admit that competitive integrated circuits are sometimes equal, but problems never are. That's why we put stress on solving our customers' problems. We sell more integrated circuits that way."

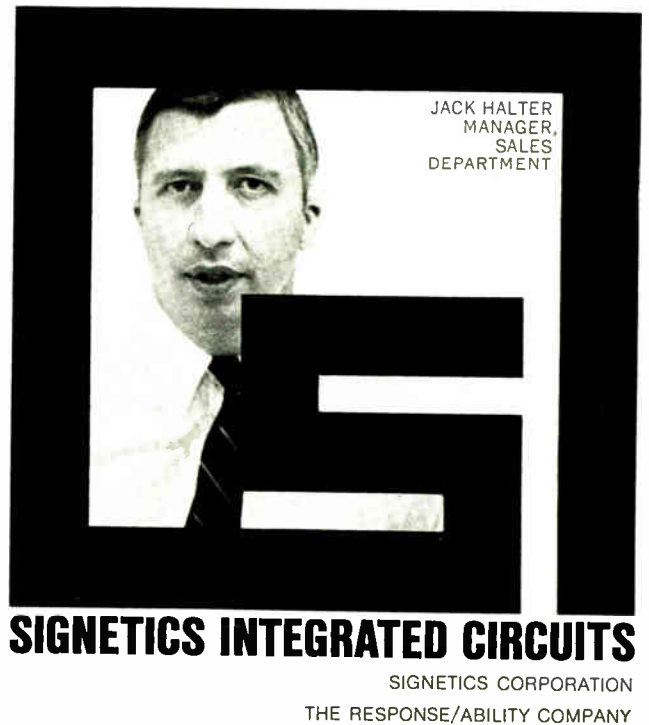

JACK HALTER  
MANAGER,  
SALES  
DEPARTMENT

**SIGNETICS INTEGRATED CIRCUITS**

SIGNETICS CORPORATION  
THE RESPONSE/ABILITY COMPANY



## New Microwave Review

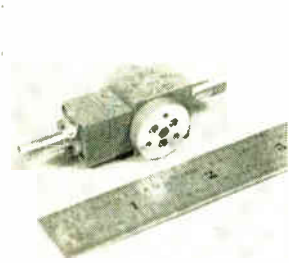

Latest addition to a line of reflectometers extends frequency coverage to include K band. Frequency range is 10 to 18 Ghz, directivity is 30.5 db minimum, and residual swr is 1.06. The measuring port comes with various precision and standard r-f connectors in both fixed and interchangeable configurations. Alford Mfg. Co., 120 Cross St., Winchester, Mass. [401]

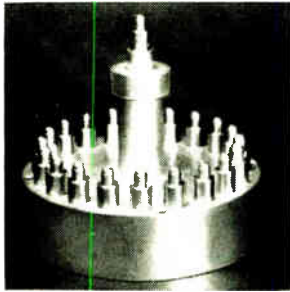

Resistive power divider model KF-C15 employs 1 input and 20 output arms. The unit operates over the frequency range of 3.15 to 3.5 Ghz. Isolation between output ports is 33 db minimum and the maximum loss between the input and any output port is 27 db. Input vswr is 1.5 maximum; input power is 27 w. Microlab/FXR, Ten Microlab Road, Livingston, N.J. [402]

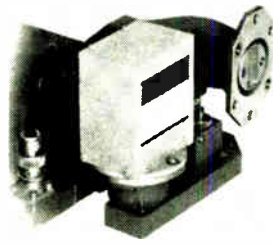

Solid state local oscillator replaces the 2K25 klystron tube used in commercial and military radars. Basically, it consists of a uhf oscillator followed by a multiplier to the X-band region. Frequency can be factory set over any 100 Mhz segment from 8.5 to 10 Ghz. Input power is 110 ma at +28 v. Airtron Division, Litton Industries, Morris Plains, N.J. 07950. [403]

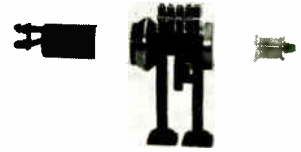

Five-cavity klystrons VA-911 deliver c-w output of at least 10 kw over a 250-Mhz tuning range between 10 and 10.5 Ghz. Designed for use in advanced military systems, the tubes use a lightweight electromagnet for focusing and are liquid cooled. When broadband tuned, gain is more than 50 db and 1-db bandwidth is 60 Mhz. Varian Associates, 611 Hansen Way, Palo Alto, Calif. [404]

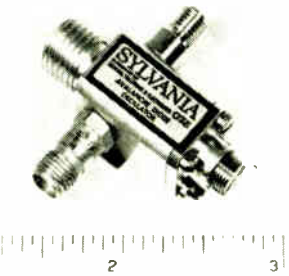

Tunable, coaxial avalanche diode oscillators convert d-c power directly into r-f power in the 8.2 to 12.4 Ghz range and are designed for use in communications or radar equipment as local oscillators or beacon transponders. Model SYA-3201 has an output power level of 10 mw. Price (1 to 9) is \$250. Sylvania Electric Products Inc., Woburn, Mass. [405]



Log periodic dipole antennas are available in any 10:1 frequency range from 100 Mhz to 12 Ghz. A structural technique utilizing lightweight aluminum suits them for tough environments such as those demanded in communications, countermeasures, and broadband instrumentation. Price is \$400 to \$700 depending on frequency. Nurad Inc., 2165 Druid Park Dr., Baltimore, Md. [406]

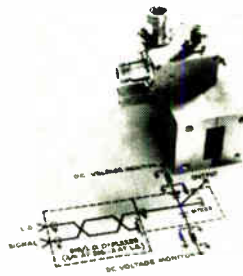

Custom-engineered up-converters accept a signal input of 1.5 Ghz and provide a 7.9-8.4 Ghz output, flat to  $\pm 0.15$  db per 50 Mhz. The package includes 2 matched hybrids forming an input diplexer, a coax-in/waveguide-out balanced mixer, and 2 d-c monitoring circuits. R-f interconnections are minimized. Sage Laboratories Inc., 3 Huron Drive, Natick, Mass. 01760. [407]



Three cavity-stabilized klystron oscillators are announced. Model 814A-C-10-S tunes over a 5.2 to 5.7 Ghz range and delivers a nominal power output of 300 mw. The 814A-X-21-S covers 9.6 to 10.2 Ghz and generates 300 mw. The 814A-X-3M is tunable from 10.6 to 11.8 Ghz and puts out 100 mw. Price range is \$4,300 to \$5,150. LFE Electronics, 1075 Commonwealth Ave., Boston, Mass. [408]

### New microwave

## Frequency stabilized with oven in an oven

Crystal oscillator held at constant temperature, for better accuracy, with heating coils

Taking care of an instrument is important. But, unless he works in a calibrations laboratory, an engineer usually isn't in a position to pamper his equipment. Vectron Laboratories Inc. has tried to remedy this with the FS-321 frequency standard. "It'll do the job in a standards

lab, but we built it rugged so it can be used in systems," says Alfred Camhi, Vectron's president.

The FS-321 simultaneously puts out signals of 5.0, 1.0, and 0.1 megahertz. It has the features of a calibration instrument. The aging rate of the crystal oscillator is  $5 \times 10^{-10}$

Rock solid. Oscillator's stability comes from a crystal in an oven.

per day at the time of shipment, and drops to  $1 \times 10^{-10}$  after a year. The output frequency changes by less than  $\pm 1 \times 10^{-11}$  for a 10% change in input voltage or a 20% change in the resistance of a 50-ohm load.

Now Cover the

## ULTRASONIC SPECTRUM

with the new  
**MULTISONS®** series  
of BROAD BAND  
POWER GENERATORS

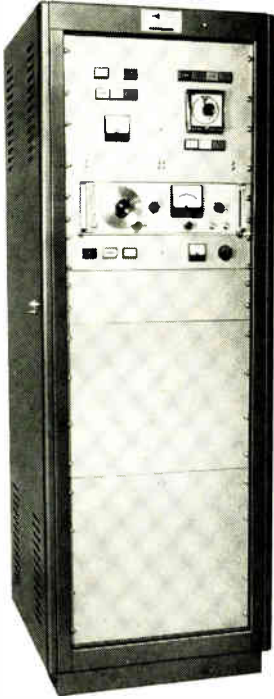

- Bandwidth 10 kcps to 1 mcps
- Average standard power outputs available: 100, 250, 500 and 1 KW (within 3 db)
- Choice of four impedances: between 18 and 2400 ohms
- Push-pull low harmonic distortion driver and output stages
- Standard parts used exclusively
- All power circuits fuse protected
- Maximum accessibility to all sections for ease of servicing tubes
- Variable D.C. bias for magnetostrictive transducers
- Plug in 60 min. timer for automatic programming

Write for Bulletin 105



PIONEERS IN APPLIED SONICS  
AND ULTRASONICS

### MACROSONICS CORPORATION

880 Elston Street, Rahway, New Jersey  
Phone: 201-382-2030

FRENCH REPRESENTATIVE:  
Societe Luziesca, 70 Rue J. P. Timbaud,  
75 Paris XI. Rel: 023.48.22

**Twin heats.** Vectron was particularly concerned about the temperature stability, since slight changes in crystal temperature cause large changes in crystal frequency.

"We want the engineer to be able to use the instrument indoors and out and not worry about changing frequency," says Camhi.

In the FS-321, a double-oven technique is used to keep a constant temperature. The crystal is put inside one heating coil, which, in turn, is put inside another coil. Each coil has its own closed-loop system to control temperature. The amplifier that feeds d-c power to a given coil is driven by the unbalance voltage from a bridge. One arm of this bridge is a thermistor.

Putting integrated circuits in the feedback loops allows more precise control of the temperature since high-gain amplifiers can be used.

The temperature stability of the FS-321 is  $3 \times 10^{-10}$  for  $25^\circ\text{C} \pm 25^\circ\text{C}$ . With an optional selected crystal, the stability can be increased to either  $1 \times 10^{-10}$  for  $25^\circ\text{C} \pm 25^\circ\text{C}$ , or  $2 \times 10^{-10}$  for  $25^\circ\text{C} \pm 35^\circ\text{C}$ .

**Packed in.** The heating coils, the crystal, the control circuits, the regenerative dividers that split the crystal's 5-Mhz signal, buffer amplifiers that isolate the outputs from each other, and some thermal insulation are all packed into a metal box that is then sealed. It stands 100% humidity and 50-G shocks.

The FS-321 also has a power supply and, for use when line voltage is cut off, a nickel-cadmium battery that can drive the unit for 40 hours.

The complete instrument is 5 by 19 by 14 inches, weighs 30 pounds, and costs \$2,000. Vectron is also selling the sealed module by itself for \$1,250. It's 4 by 4 by 10 in. and contains a complete frequency standard except for power supplies.

#### Specifications

Output frequency	0.1, 1.0 and 5.0 Mhz
Output level	1 v rms $\pm 50\%$ , $-10\%$ into
Short-term stability	50 ohms
	$4 \times 10^{-10}$ at 1 ms
	$1 \times 10^{-10}$ at 10 ms
	$1 \times 10^{-11}$ at 100 ms
Harmonic outputs	45 db below rated output
Frequency adjustments	$1 \times 10^{-7}$ ; 10-turn calibrated dial
Fine	setable to $1 \times 10^{-10}$
Coarse	$1 \times 10^{-6}$ ; screwdriver adjustment
A-c input power	115 v $\pm 10\%$ , 47-420 Hz; 15 w

Vectron Laboratories Inc., 146 Selleck St., Stamford, Conn. 06902 [409]

**NEW**  
**FROM SODILEC S.A.**

**UNIVERSAL  
LABORATORY  
POWER SUPPLY  
LOW COST**

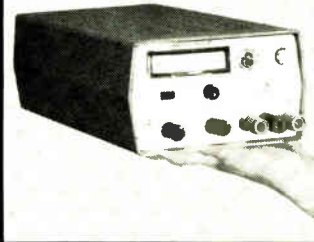

**REDUCED DIMENSIONS**  
**SDE 9 V - 2,4 Amp**  
**SDE 18 V - 1,2 Amp**  
**SDE 36 V - 0,6 Amp**

Tunable voltage output from 0,1 V to V max 0,1 % resolution of V max.  
Current limitation from 0 to 1 max.  
Line regulation 5 - 10-4.  
Load regulation 5 - 10-4.  
Ripple and noise 500  $\mu$  V peak to peak.  
Temperature coefficient 3 - 10-4 of V max per degree Cent.  
Response time  $\leq 30 \mu$  S.  
Overload protection.  
Overvoltage protection on 9 V Model (for IC).  
Serie or parrallel connection.

**140 \$ FOB PARIS**

421

**Sodilec SA**

11, rue Léon Morane, PARIS XV  
FRANCE

Tél. : 250-90-79 - 842-52-56

# Self-contained Gunn effect oscillator generates 5mW from 7V supply...



... part of a range of  
advanced microwave  
components

Don't waste time and effort developing cavities for Gunn effect devices. These oscillators, for the next generation of radar equipments, consist of a GaAs device (type 106CXY) fitted in a resonant cavity which is mechanically tuned over the specified range. Other types will have electronic tuning.

Oscillators available are

CL8360 for 8 to 9GHz    CL8370 for 9 to 10GHz

CL8380 for 10 to 11GHz    CL8390 for 11 to 12GHz

They only need a 7V supply to generate a typical X-band output of 5mW—an obvious advantage over conventional low-powered klystron sources.

Other specialist microwave devices include varactor diodes with resonant frequencies of 9 and 30GHz and high figures of merit. And low noise mixer diodes in small, rugged ceramic and titanium casings with a wide frequency range.

Every designer should have a copy of the Mullard Quick Reference Guide giving information on semiconductor microwave devices. Also ask to be put on the mailing list of the Mullard Bulletin—a regular publication which gives details of new components and applications . . . the result of extensive research and development programs in the Mullard laboratories in England. Mullard employ 1000 qualified scientists and engineers and have six major plants, with over 3 million square feet of floor space.

Write for information on Mullard semiconductor microwave devices, and for the name of your local Distributor.

Mullard Limited, Mullard House, Torrington Place, London WC1, England.

U.S.A. enquiries to Mullard Inc., 100 Finn Court, Farmingdale, Long Island, New York 11735, U.S.A. Telephone: (516) 694-8989 Telex: 961455.

# Mullard LIMITED

another  
breakthrough  
from  
**FRANKLIN  
ELECTRONICS**

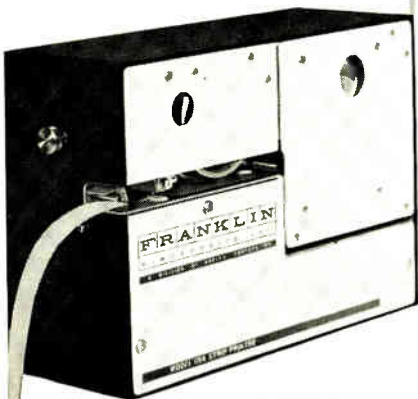

the Model 120A  
**STRIP PRINTER**

- Full alpha-numeric font of 64 characters and numerals.
- 1200 characters per minute.
- Serial entry.
- Impact printing with inked roller option.
- 8 $\frac{1}{2}$ " D x 3" W x 6 $\frac{1}{4}$ " H.
- Less than 5 lbs.
- Front paper exit.
- Less than \$300 w/o electronics, \$500 with.
- Franklin reliability!

SEND FOR  
**ENG. DATA 3010**

**FRANKLIN**  
electronics, inc.

East Fourth St. • Bridgeport, Pa. 19405  
A Subsidiary of Mohawk Data Sciences Corp.

0.2% repeat accuracy, a value comparable to that of the firm's best motor-driven unit. Their big problem was matching the accuracy of the older unit's dial setting. According to Parker, customers who have several machines doing the same job often run tests on one to determine proper cycle times, and then set these times on the other machines. So they demand that the same dial setting on all their timers give the same cycle times.

The first solid state units designed at Automatic Timing could be set to within only 5% of the timer's full range. But in later models, the voltage in the potentiometer circuit was reduced to allow the use of a very linear 10-kilohm pot instead of a 1-megohm carbon pot. This greater linearity boosts the accuracy of the P803's dial setting to 0.5%.

**Any input.** The timer accepts any input greater than  $\pm 12$  volts d-c. Since it signals the end of a cycle with an output voltage rather than with a relay closure, the P803 isn't interchangeable with motor-driven units. It can be built with a relay output, but this modification shortens its lifetime to 10 million operations.

The company says it can build P803's with timing ranges up to 300 seconds.

The timers will be available in quantity this summer; delivery time will be six weeks and the cost will be about \$75 each.

Automatic Timing & Controls Inc.,  
King of Prussia, Pa. 19406 [349]

New components

**Bandpass filters  
go off-shelf in vhf**

Fixed-tuned device  
has center frequencies  
from 10 to 150 Mhz

**RLC Electronics Inc.** is now offering very-high-frequency bandpass filters as off-the-shelf items at prices 25% to 50% under their cost as custom units. Bandpass

# Fast acting.

The Electronics Buyers' Guide can get you on the right frequency in a hurry. For example, there are 14 different kinds of oscillators listed. Everything from AF oscillators to voltage controlled crystal oscillators. There are three sections in your EBG, devoted to products, manufacturers and trade names. So see your fast-acting EBG.



**Electronics Buyers' Guide**  
A McGraw-Hill Market Directed Publication,  
330 West 42nd Street, New York, N.Y. 10036

# Now tight spec low-noise low-price Op Amps

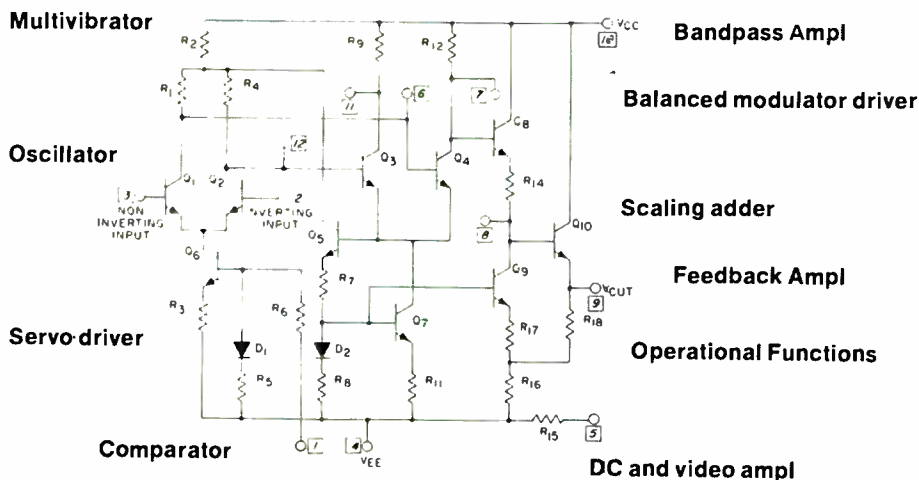

## CHARACTERISTICS

	± 6V types	± 12V types
Open-loop gain (min)	57 dB	66 dB
Input offset voltage (max)	2.0 mV	2.0 mV
Input offset current (max)	1.5 μA	1.6 μA
Input bias current (max)	4.0 μA	6.0 μA
Input impedance (min)	15 kΩ	7.5 kΩ
Common-mode rejection ratio (min)	70 dB	80 dB
Static power drain (typ)		
@ 12V	—	175 mW
@ 6V	30 mW	30 mW
@ 3V	7 mW	7 mW
Operating temperature range in plastic package	0 to +70°C	0 to +70°C
in hermetic packages	-55° to +125°C	-55° to +125°C
NOISE FIGURE (1 kHz with R <sub>s</sub> = 1 kΩ)	12 dB max	16 dB max

See your RCA Representative for details. Ask your RCA Distributor for his price and delivery. Write for data sheets File #310 and related Application Notes to RCA Electronic Components, Commercial Engineering, Harrison, N. J. 07029. Or ask for File #316 and related Application Notes covering related op amps for use in applications with less-demanding specifications.

# RCA

Integrated Circuits

**CA-3010A** (± 6V) \$5.75 (1,000 units)  
**CA-3015A** (± 12V) \$6.25 (1,000 units)

**CA-3029A** (± 6V) \$3.75 (1,000 units)  
**CA-3030A** (± 12V) \$4.50 (1,000 units)

**CA-3037A** (± 6V) \$5.75 (1,000 units)  
**CA-3038A** (± 12V) \$6.25 (1,000 units)

**CA-3008A** (± 6V) \$7.50 (1,000 units)  
**CA-3016A** (± 12V) \$8.00 (1,000 units)

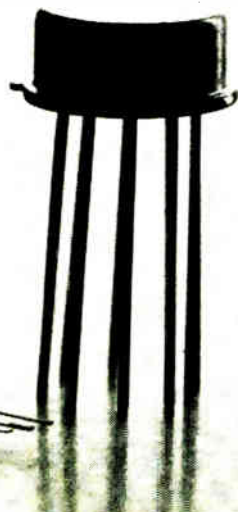



## THE NEW SHAPE IN PLASTIC TUBING

*may fit your problem exactly*

FLEXITE Shrinkdown Plastic Tubing shrinks 50% in diameter upon application of moderate heat to form a tight-fitting sheath around objects of irregular shape. It's being used to solve many different problems . . . like insulating electrical connections; protecting delicate components; strengthening assemblies; binding things together; resisting corrosion, heat or moisture; preventing wear, vibration and noise. What problems do you have that a tight sheath of tough plastic might solve? Markel offers Shrinkdown in three distinct types to meet a broad range of needs. Your call or letterhead request will bring samples and data.



**L. FRANK MARKEL & SONS, INC.**  
Norristown, Pa. 19404 • Phone: 215/272-8960  
INSULATING TUBINGS AND SLEEVINGS  
HIGH TEMPERATURE WIRE AND CABLE

filters are used in most information-transmission systems, particularly telemetry and radio.

Called the Model VBPF, RLC's new filter is fixed-tuned and has center frequencies from 10 to 150 megahertz.

RLC makes a VBPF by stringing together three to six half-wavelength resonant sections, each containing both lumped and distributed capacitances and inductances. The more sections, the sharper the filter's transition from passband to rejection. But adding sections also increases the insertion loss.

**Passing through.** An engineer ordering a VBPF specifies the number of sections, a center frequency, and a 3-decibel bandwidth—2%, 5%, 10%, or 20%. The passband is defined by the filter's 3-db bandwidth. For example, if its center frequency is 100 Mhz and its bandwidth is 10%, a VBPF attenuates signals between 90 and 110 Mhz by no more than 3 db. The 40-db bandwidth, a measure of the filter's sharpness, is similarly defined. Ben Weisman, sales manager, says the 3-db and 40-db points were chosen to help the design engineer; attenuation is a linear function of frequency between these two points on each side of the passband. The steeper the slope of this line, the sharper the transition from pass to reject.

The VBPF comes with type N, BNC, TNC, or RSM connectors. Its voltage standing-wave ratio is 1.5, impedance 50 ohms, and power rating 25 watts.

Length—3 to 15 inches—and weight—6 ounces to several pounds—are determined by the filter's center frequency and number of sections.

A three-section filter costs \$225 and each additional section \$50. Delivery time is four weeks.

### Typical specifications

3-db bandwidth	40-db bandwidth/ insertion loss (db)
5%	
3 sections	30%/3.0
4 sections	18%/3.5
5 sections	12%/4.5
6 sections	10%/5.0
10%	
3 sections	60%/1.5
4 sections	35%/2.0
5 sections	25%/2.5
6 sections	20%/3.0

RLC Electronics Inc., 25 Martin Place,  
Port Chester, N. Y. [350]

## For Production Efficiency

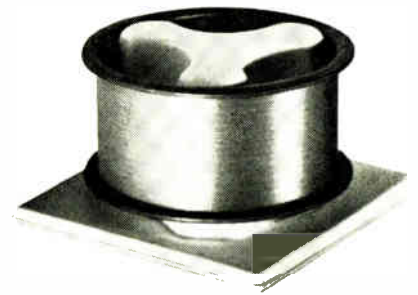

## CRM FINE WIRE

for Ultrasonic and  
Thermocompression Bonding  
Gold and Aluminum  
Bonding Wires

featuring  
**Cleanliness • Strength • Uniformity**

Contact CRM engineers for recommendations  
for your application.



Write for  
latest catalog.

**CONSOLIDATED  
REACTIVE  
METALS, inc.**

115 Hoyt Ave. — Mamaroneck, N. Y.  
914-698-2300 — TWX 914-835-3380

**NEW**

# techni-rite LOW COST LINEUP OF HIGH SPEED RECORDERS

Two Channel: **\$995**

Single Channel: **\$395**

Imagine! A complete, fully transistorized high speed inkless, rectilinear recorder for only \$395. And, a two channel model for only \$995.

These are husky recorders, designed for field or lab use, yet they are small and light weight.

Need accessories such as Markers, Strain Amplifiers, High Gain D.C. Amplifiers? We've got them!

Want a special model for a particular problem? We're at your service.

Check these features:

- D.C. to 125 Hz Frequency Response
- Inkless, True Rectilinear Coordinates
- Electric Chart Speed Selection
- Compact and Portable
- Complete Range of Accessories and Special Purpose Pre-Amplifiers

Want Full Details? Phone, Wire or Write:



**techni-rite**  
ELECTRONICS INC.  
Subsidiary of Gulton Industries  
Techni-Rite Industrial Park  
Warwick, Rhode Island 02887  
Telephone (401) 737-2000  
TELEX 927725

Circle 235 on reader service card

# Darcy Can Prove The DM 440 is The Best DVM Value!

**COMPARISON OF PERFORMANCE vs \$s Tells the Story in DVM Values.** Just a few of the DM 440 specifications and features are:

**EXTREMELY STABLE** — accuracy will remain as specified for not less than 90 days from calibration over the temperature range of 15 C to 35 C.

**HIGHLY ACCURATE** —  $\pm 0.01\%$  of reading  $\pm 1$  digit.

**HIGH COMMON MODE REJECTION** — infinite at DC, 140 dB at all frequencies up to 1 KHz with up to 1 K $\Omega$  source imbalance in either input lead. Common mode voltage up to 1000 VAC peak.

**SYSTEM ORIENTED ACCESSORIES AND OPTIONS** — DCmV, K Ohms, AC, and DC accessories and over 13 options (as many or as few as you like).

**COSTS ONLY \$995!** Sound like a big value? It should, it's from DARCY. Write for the whole DM 440 story today and compare for yourself. Darcy Industries Inc. 1723 Cloverfield Blvd., Santa Monica, Calif. 90404. Phone (213) EX 3-9611 or TWX (910) 343-6963.

## DARCY INDUSTRIES

- AC and DC Power Supplies
- Electronic Counters and Nuclear Scalers



- Digital Voltmeters
- Instrumentation Systems for Industry

Representatives in principal cities throughout the world  
1723 CLOVERFIELD BLVD. • SANTA MONICA, CALIF. 90404  
Phone (213) EX 3-9611 TWX (910) 343-6963

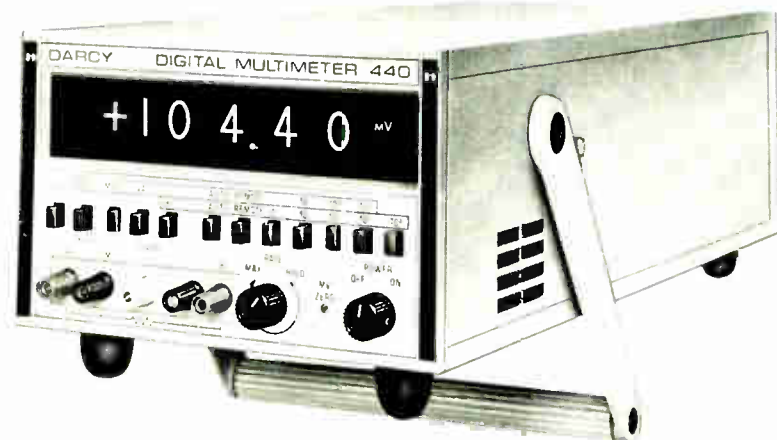

**SUPERIOR  
COAXIAL  
ATTENUATORS**

**continuously  
variable**

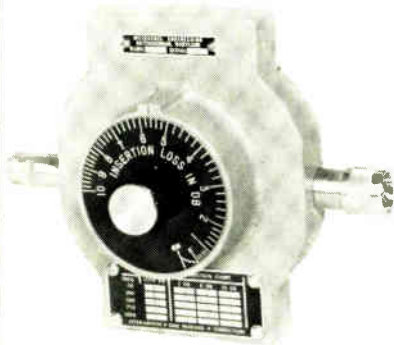

**attenuators**

The DC to 1 GHz (useful up to 3 GHz)  $\Psi$  Model 933 is a heretofore unavailable combination of attenuation and frequency range. Insertion loss values up to 120 dB over the entire frequency range, low minimum loss, and low VSWR are among the many other features of the 933. For those who demand less attenuation, the  $\Psi$  Model 905 is designed for use in low level coaxial systems where long life, accuracy, and stability are the prime requirements. Both the  $\Psi$  Models 905 and 933 are direct reading at 500 MHz. They operate smoothly and are extremely long wearing. Also, they are easily convertible for panel mounting.

Designers and  
Manufacturers of Precision  
Microwave Equipment

**WEINSCHEL  
ENGINEERING**  
Gaithersburg, Maryland

## New Books

### Professional view

Excellence in Engineering  
William H. Roadstrum  
John Wiley & Sons  
247 pp., \$8.95

The message of Roadstrum's book is that the engineer must always concern himself with the effects his work will have on mankind. In the context of this social consciousness, the author examines such aspects of engineering as drawings and reports, laboratory work and experiments, designs and applications.

He also discusses PERT (program evaluation and reporting technique), an approach in which the methods of scientific investigation are used to solve one-time or very probabilistic engineering problems, often in conjunction with computers.

Roadstrum suggests that the engineer apply the criterion of money to his work. In the business and marketing fields, he notes, "profit and loss are the basic measures of how successfully engineering work is being performed." Employing this standard, he shows the engineer how to organize production, use quality control, and combine large and complex groups of equipment.

He also stresses the importance of the social relations between worker and worker, worker and boss, and engineer and customer.

Diagrams and charts are used effectively throughout the book.

### Uncommunicative engineers

Technical Correspondence: A Handbook and Reference Source for the Technical Professional  
Herman M. Weisman  
John Wiley & Sons Inc.  
218 pp., \$6.95

The author states, quite correctly, that most engineers have a hard time communicating their ideas in letters and memos. No argument there, but this handbook of writing rules and recommendations is no remedy.

Its approach to the problem is too narrow. The engineer's inability to express ideas on paper largely reflects a narrowness of view, and

Weisman, by restricting himself to the construction of technical messages, only reinforces the inhibiting concept of a professional community using a special language to transmit classified information. It can only encourage the engineer to treat the English language as some kind of 26-letter code—something too many do.

With few exceptions, the words engineers use are the same ones we all do—and the few exceptions are usually jargon. If a technical man wants to improve his writing ability, he'd do well to read a more general work, such as Copperud's "Words on Paper." It's vitally important in this age that engineers be able to tell other professionals and laymen what's going on behind the lab door, but Weisman's handbook is strictly in-house.

Not that it has nothing to recommend it. If the reader can wade through the examples, charts, and tables, he will learn something of the mechanics of composing technical inquiries, replies, sales and promotion letters, resumes, and notices of meetings.

It has a place in the company library as a reference, but not on the shelves of working engineers.

### Recently published

Conditional Markov Processes and Their Application to the Theory of Optimal Control,  
R.L. Stratonovich, American Elsevier Publishing Co., Inc., 350 pp., \$14.75

Graduate-level text discusses mathematical problems that can be used for constructing optimal cybernetic systems processing statistical input information. Book should interest pure and applied mathematicians, electrical engineers, and computer specialists.

Design and Application of Transistor Switching Circuits, Louis Delhom,  
McGraw-Hill Book Co., 278 pp., \$14.50

Describes the electrical characteristics of transistors, and then relates these characteristics to switching circuit performance. Particular attention is given to the popular transistor logic circuits, as well as flip-flop counting circuits, diode decoders, and pulse-generating circuits.

Electromechanical Devices for Energy Conversion and Control Systems, Vincent Del Toro, Prentice-Hall Inc., 617 pp., \$13.75

Offers an integrated treatment of the theory and operating principles of electromechanical energy conversion devices. Provides a basic understanding of their steady-state and dynamic behavior and includes an introduction to direct energy conversion devices.



7 of a series

TRANSICOIL SOLVES SERVO PROBLEMS

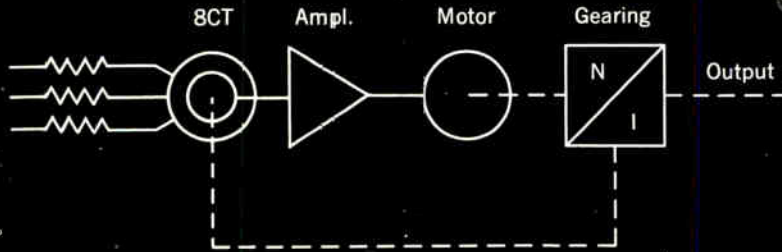

shown without cover

## New Transicoil size 23 servo repeater

Developed specifically as a plug-in replacement for a size 23 synchro torque receiver, this unit uses a closed-loop position servo to provide superior response. Synchro data at 90V, 60 CPS is scaled down by series resistances, then fed into a conventional size 8CT. Amplified synchro error applied to a size 8 motor closes the loop and drives the synchro and output shaft to a null position with improved sensitivity, stiffness and static error. Internal circuitry includes a power supply for the solid-state servo amplifier, making the entire assembly only slightly longer than the synchro it replaces.

**PERFORMANCE** Input: 90V, 60 CPS, 3-wire synchro ■ Output: Shaft position—5 oz. in. at stall ■ Accuracy: Static,  $\frac{1}{2}\%$ ; Dynamic, 1° at 20 RPM ■ Slew Speed: 20 RPM ■ Power Required: 115V, 60 CPS ■ Weight: 38 oz. ■ Size:  $2\frac{1}{4}$ " dia. x  $6\frac{1}{8}$ " length

Weston Instruments, Inc., Transicoil Division, Worcester, Pa. 19490.

**WESTON**<sup>®</sup> *prime source for precision . . . since 1888*

Circle 236 on reader service card

How to put the  
**SQUEEZE**  
on sharp edges

**HEAT-GRIP**<sup>®</sup>

IRRADIATED  
POLYOLEFIN TUBING

No matter how sharp the edge, Heat-Grip heat shrinkable tubing shrinks down tight and won't split or tear. It's the fast sure way to protect or insulate. Shrinks 50% in diameter under moderate heat to form a strong, flexible shield. Conforms to spec. MIL-I 2053A, Classes 1 and 2. Available  $\frac{3}{8}$ " to 1" I.D. in five colors and clear.

Excellent for mechanical protection, color identification, product encapsulation, insulation.

Send for technical data and FREE samples.

**NATVAR CORPORATION**  
P. O. BOX 67 • RAHWAY, N. J. 07065



**FREE**



## FASTENER KNOW-HOW

Here's complete design and application data on self-tapping TAP-LOK<sup>®</sup> inserts . . . the quickest, most practical and economical way to put strong threads in soft materials. Get your copy of this helpful 12-page catalog by writing: Groov-Pin Corporation, 1121 Hendricks Causeway, Ridgefield, N.J. 07657. WH-5-6780.

FASTENER DIVISION

**GROOV-PIN CORP.**

# LMI

## Shielded rooms won't let obsolescence box you in

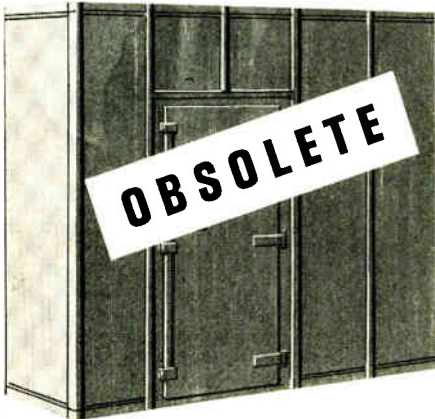

**Design** • Changes in Government and Industry RF shielding specifications can quickly obsolete costly shielded rooms. That's why LMI RF shielded rooms are designed with built-in capability for upgrading. Any of the seven standard rooms designed and manufactured by LMI can be upgraded with appreciable savings over the cost of a new room. LMI designs utilize solid membrane, clamp-together or all-MIG-welded seams and provide maximum shielding over the widest frequency range.

**Upgrade** • For example, Class D Rooms can be upgraded by MIG welding all seams and/or adding an additional shield.

All-welded Class C and higher rooms can be upgraded by the addition of an inner shield, acoustic and microwave anechoic material at any future date.

Class AA and AAA are all-welded dual wall, solid shielded rooms for the highest performance from low audio to highest microwave frequencies.

**Cost** • The initial low cost and final costs are one and the same with LMI all-seams-welded rooms. There is no seam leakage nor any maintenance requirements over the life of the shielded room.

**Technical Bulletin** • For a complete description on all classes of LMI shielded rooms, write for your complimentary copy of Technical Bulletin (TB-101) "Technical Discussion and Specifications for Electromagnetic Shielded Rooms."

**Quick Reaction** • For fast personal service on your shielding problems telephone or write direct to Fred J. Nichols, Carl T. Luce or James C. Senn.

*LectroShield Division*  
**LectroMagnetics, Inc.**

## Technical Abstracts

### Zap and sizzle

Telemetry in lightning-infested area  
 Darrell L. Vines  
 Texas Technological College  
 Lubbock, Texas

Industrial telemetering systems that monitor geographically dispersed oil-production operations send the data collected at individual well sites to a central control station through buried cables. The cables must withstand extreme changes in temperature, and, of particular interest, frequent lightning strikes. For example, Texas and Louisiana have 45 to 70 days of lightning storms a year. A circuit has been developed to minimize the effects of a lightning strike on buried cable and the electronic equipment connected to it.

The magnitudes of currents and voltages that ultimately appear at the ends of the telemetry cable depend on cable resistance and capacitance, soil resistivity, and the magnitude of the current generated by the lightning strike. Voltage and current vary with time and distance from the strike.

Most strikes generate a current of 35,000 to 70,000 amperes, and some strikes reach as high as 200,000 amperes. When a large-current strike hits a moist area, the energy in the strike converts soil moisture to steam at high enough pressure to actually crush and destroy the communication cable.

After lightning strikes near a cable, current will first be induced into the cable's sheath before it can get to the conductor. Then, as the current enters the conductor, the voltage between the sheath and the soil is minimum, while the current is at maximum. The current travels in both directions along the telemetering cable toward the ground at one or both ends of the cable. Near the end of the cable, the voltage increases considerably.

In a strike on a cable 1.3 miles long, the cable was severely punctured, melted, and charred along a stretch of 60 feet from the strike location, and even terminal boxes about a mile away were damaged.

A circuit to protect the cable and electronic equipment has been devised and will be installed in an

oil field on each conductor that terminates at the central location. The circuit contains a carbon block—with a gap—across the conductors to the equipment, followed by a fuse in one of the lines, followed by a zener diode across the equipment's input. The carbon block, like those used by telephone companies to protect their lines, breaks down at about 400 to 600 volts.

Following a lightning strike, the zener diode limits the voltage to a predetermined safe value. But the current rises to a very high value, burning out the fuse and disconnecting the equipment from the cable. This protects the electronics. The voltage across the cable, however, continues to increase, but the carbon block limits the voltage to its breakdown value. This value is less than the insulation rating of the cable, so the cable is protected.

Presented at the IEEE National Telemetering Conference, Houston, April 8-11.

### Punched powders

New techniques for production of ferrite cores  
 W. Wiechec  
 Core Memories Ltd.  
 Dublin, Ireland

The large demand for small ferrite cores has produced a new output method: form the ferrite powder, the main ingredient, into sheets, then stamp out the cores with multiple-tool presses. This process is on the production line, yielding cores that have high electrical uniformity at low cost.

This sheeting process avoids some of the major problems of the widely used method of pressing powder directly into core shapes. For small cores the powder must be very fine to fill the small die cavity. But the screening procedure to obtain these fine powders lowers the usable yield of material.

Now the fine powder is added to a binder to form sheets about 0.0002 inch thick. The sheets are then sliced into tapes from which the cores are punched. Because the ferrite tapes are soft, miniature low-force presses can be used. Each tool press punches 10 cores at a time.

The cores are then fired in a dif-

# Blackstone beats tough cleaning problems.

Alone...

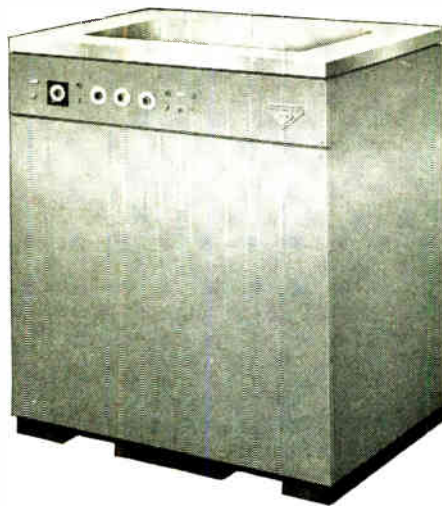

Blackstone VE 6.5

or in a gang.

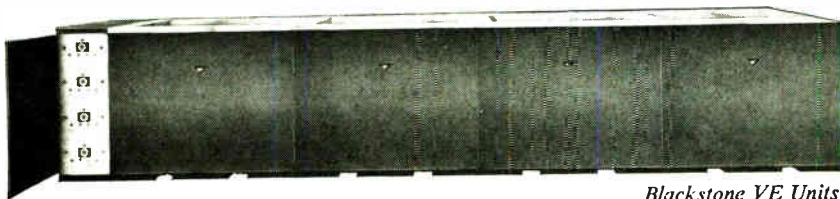

Blackstone VE Units  
in Modular Series

Never before has so much cleaning flexibility been designed into an ultrasonic system!

Blackstone VE units, available singly with tank capacities of 1.9 and 6.5 gallons, or in modular series with tank capacities of 11.2 and 28 gallons, solve hundreds of cleaning problems, including . . .

- Printed circuit boards.
- Aircraft components.
- Automotive bearings and carburetors.
- Diesel parts.
- Electric motors.

And Blackstone VE units come complete with both ultrasonic and vapor rinse, 300 series stainless steel tanks, 0 to 100% power control (optional), filtering down to 5 microns, solid state automatically tuned generators, and the convenience of up-front service for easy access to the controls.

### The Blackstone Challenge

Send us a sample of your work and a description of your cleaning process. If we cannot precision clean it to your complete satisfaction and lower your cleaning costs while doing it, we will not risk your good will by accepting your order.



## BLACKSTONE ULTRASONICS, INC.

1400 Howard Street · Sheffield, Pa. 16347  
Circle 238 on reader service card

UCON® SOLVENTS

## Free control knob catalog

Broadest selection of commercial and military knobs: colorful new PANELRAMA series, self-locking types, aluminum-cap and designer series, MIL-spec, custom knobs of all shapes and colors. Send reader service card or write: Raytheon Company, Components Division, Fourth Avenue, Burlington, Mass. 01803.

**RAYTHEON**

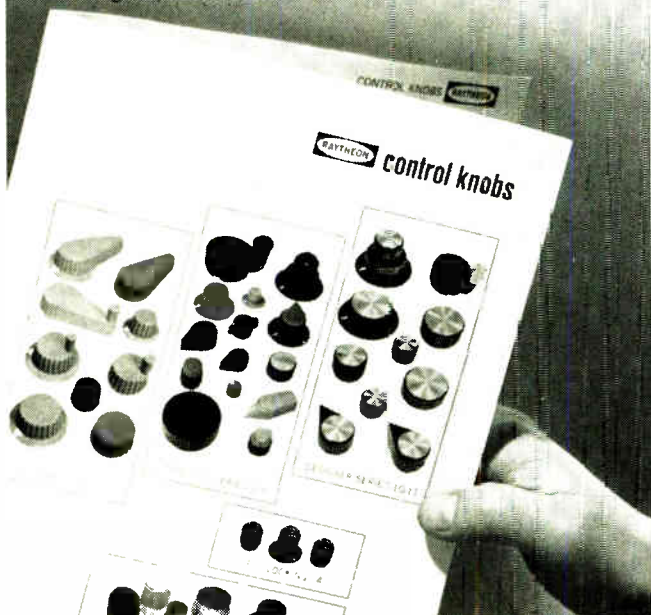

Circle 239 on reader service card

## THUMBWHEEL SWITCHES

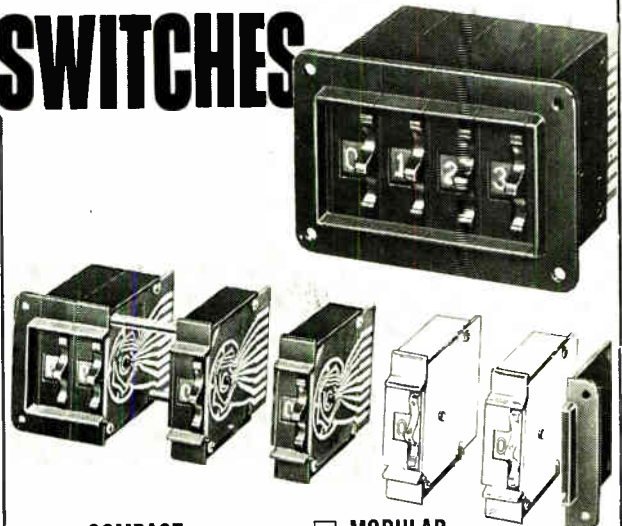

- |   |  |
|---|--|
| <input type="checkbox"/> COMPACT                    | <input type="checkbox"/> MODULAR                 |
| <input type="checkbox"/> POSITIVE OPERATION         | <input type="checkbox"/> WIDE RANGE OUTPUT       |
| <input type="checkbox"/> SIMPLE, CLEAN INSTALLATION | <input type="checkbox"/> EDGE LIGHTING AVAILABLE |
| <input type="checkbox"/> ECONOMICAL                 |  |

Send for further information

### TECH LABORATORIES, INC.

Palisades Park, New Jersey  
Phone: 201 — 944-2221 · TWX: 201 — 947-4730

Circle 181 on reader service card

TUBE/TRANSISTOR/COMPONENT  
RETENTION AND COOLING DEVICES

## 2,000 WAYS to get maximum semiconductor reliability and performance

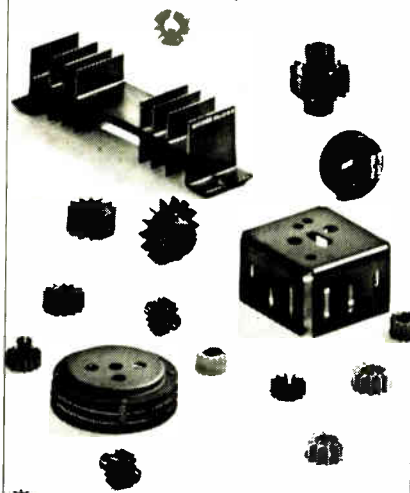

Semiconductor device retention and cooling requirements are dictated by packaging density, power requirements, air flow, etc., which vary from circuit to circuit and from package to package. To insure you of the optimum in semiconductor packaging, performance and reliability in every job, Birtcher offers you more than 2,000 sizes and styles of heat dissipating devices.



Write for catalog and test reports on the world's largest line of semiconductor cooling and retention devices

Available from authorized distributors coast-to-coast

**the BIRTCHER CORPORATION**  
INDUSTRIAL DIVISION

745 Monterey Pass Road  
Monterey Park, California 91754

Mailing Address:  
P.O. Box D, Monterey Park, California 91754  
Tel: (213) 268-8584 • TWX 910-321-3076

## Technical Abstracts

fusion furnace at a temperature of about 2,000°F, controlled to about 1°F. The cores travel through the furnace on a belt, making production fast and continuous.

Presented at the 1968 InterMag Conference, Washington, April 3-5.

### Plastic protection

Silicone encapsulants and dielectrics for electronic components  
F.J. Lockhart  
Dow Corning Corp.  
Midland, Mich.

Seeking faster, higher-yield, less expensive ways of protecting semiconductors, device users and makers are considering plastic materials to replace metal and glass. One advantage of plastics is their ability to protect junctions against moisture and contamination, and against physical damage during the encapsulation process.

Silicones are among the plastics that seem to have many desirable characteristics. They are chemically inert, and thermally and dimensionally stable, and have excellent electrical and moisture-resistant properties.

Silicones are semi-organic polymers with a quartz-like structure—various organic groups are attached to the silicone atoms. All forms of silicone, from liquid resin systems to rigid thermosetting plastics, offer device protection.

Silicone compounds containing rigid resins and quartz fillers are well suited to the encapsulation of such devices as signal diodes and transistors. Compounds containing flexible resins with quartz and glass fillers are more appropriately used to encapsulate power devices and integrated circuits, which have more demanding specifications.

Silicones are much more resistant to moisture, tests show, than are epoxy and phenolic plastics. Under 93% relative humidity at 70°C for 1,000 hours, moisture gain-in-weight for silicones at the conclusion of the tests ranged from 0.1% to 0.4%, while the other plastics increased their weight by 0.9% to 2.0%.

Presented at the American Institute of Chemical Engineers Materials Conference, Philadelphia, March 31-April 4.

During 1967

# 296

new manufacturing plants  
opened in Texas!

# 370

Texas plants expanded!  
*Do they know  
something you don't?*

Perhaps! The new electronic firms have learned that a Texas location means lower taxes, higher income, and a steady supply of stable, trainable labor efficiently filling contracts and meeting the demands of a booming population. To the expanded firms, a Texas location simply means business. Big business! Write or phone for the new Texas Fact Book and find out what it could mean to you.

Turn to TEXAS  
Contact  
TEXAS INDUSTRIAL COMMISSION  
Phone (512) 475-4331  
Box JJ-E, Capital Station  
Austin, Texas 78711

Circle 242 on reader service card

**Intermold**  
die cast ZINC ALLOY  
molded PLASTICS  
Coil Bobbins  
Gears & Pinions  
GRIES REPRODUCER CO.

Samples Show How NEW MOLDING PROCESS JOINS 2 DIFFERENT PLASTICS IN A SINGLE SMALL PART

- Combine different colors, physical, chemical properties of different plastics in a single tiny component.
- Movable-element parts, separable parts, two-color parts, numbered and lettered parts, combination-of-materials parts.
- Saves assembly costs, enhances appearance, performance of your product.

Write today for "Intermold" samples and detailed bulletin.

**GRIES**

Division of Coats & Clark Inc.  
World's Foremost Producer of Small Die Castings  
151 Beechwood Ave, New Rochelle, N.Y. • (914) 633-8600  
Plants in: New Rochelle, N.Y.; Warren, R.I.; Toccoa, Ga.

Circle 243 on reader service card

# RENT - don't rant...

Name the kind of electronic test equipment you need and we'll send it to you the NEXT DAY! Rent it for a week, month, you name it, and forget about lost down time forever.

All our equipment is the latest available. We'll even up-grade your present instruments to newer models. We check and test each unit before shipping to assure performance. If desired, a CLC man will provide instruction in the use of any instrument.

Shipping — we pay one way. Insurance — available for a small charge. Warantee — guaranteed to operate to original manufacturers' specifications. Availability — call collect, 24 hours a day, 7 days a week for NEXT DAY DELIVERY. (617) 643-7750.

Write now for our "Rentals 68" catalog before an equipment emergency arises. Offices, coast to coast.



**Continental Leasing Co., Inc.**

30 PARK AVENUE, ARLINGTON, MASS., 02175  
(617) 643-7750

"Continental,  
pioneer in electronic  
equipment rentals".

Circle 240 on reader service card

- **400 cycle power**
- **1% distortion**
- **.5% frequency and voltage regulation**



The completely transistorized model CRS-100A frequency converter (100VA output) offers all this in only 3 1/2" panel height... and high reliability, too!

Others are available rated at 30 VA to 15 KVA with fixed or adjustable output frequencies. Call or write today for complete details.

**CML, Inc.** 

A subsidiary of Tenney Engineering, Inc.  
350 Leland Avenue, Plainfield, New Jersey 07062  
(201) 754-5502 • TWX: 710-997-9529

Circle 241 on reader service card

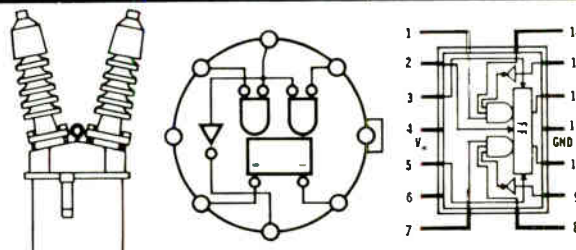

**The second time you draw these  
(or any other repetitive element)  
you're wasting creative time!**

Use STANPAT repetitive symbols for any diagram, spec, detail, title block... or any other detail you draw. It's like adding another draftsman to your staff. STANPAT will preprint your own symbol. You'll always have it ready for application to your drawings and tracings on any medium. It will be accurate, permanent, reproducible, and... most important you will gain creative time!

STANPAT reproduces the drawing you need on top-quality tri-acetate sheets. You simply apply the STANPAT to your tracings whenever you need to, as often as you need to. Adherence is instant. Reproductions are crisp and clean, even when microfilming.

Send for literature and samples today.

*faithfully serving the engineer and architect for a quarter of a century*

**STANPAT PRODUCTS INC.**



Covert and Main Street, Dept. J5  
Port Washington, N.Y. 11050  
Telephone: 516 883-8400



Circle 183 on reader service card

183

Here's a little something that will save more time, space and money in circuit design than anything else.

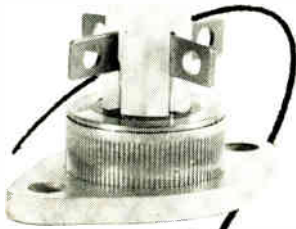

IBR® from Varo.

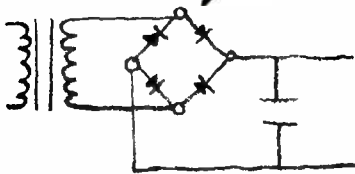

Varo's Integrated Bridge Rectifier requires just one-half to one-twentieth as much space as its competition. Saves design and installation time and reduces error.

Our IBR® is available as a 10-Amp, 10 Amp fast recovery and 25-Amp full-wave bridge rectifier. 200V, 400V and 600V controlled avalanche ratings. Electrically insulated case for direct chassis mounting. Three mounting options: Press mount, TO3 flange, single stud.

**25-Amp IBR® only**  
**\$3.05\***

**10-Amp fast-recovery IBR® only**  
**\$4.75\***

**10-Amp IBR® only**  
**\$2.35\***

\*In 200V rating and quantity of 1,000 (press mount).

Write for complete information on Varo IBR® products. It could solve problems you didn't even know you had. Available now from Allied Electronics.

\*Registered trademark of Varo, Inc.



**SPECIAL PRODUCTS DIVISION**  
2203 WALNUT STREET, GARLAND, TEXAS 75040  
(214) 272-3561

184 Circle 184 on reader service card

## New Literature

**Nuclear instrumentation.** EG&G Inc., 35 Congress St., Salem, Mass. 01970, has issued a 24-page catalog and guide to high-energy nuclear instrumentation. Circle 446 on reader service card

**Terminal blocks.** Curtis Development & Mfg. Co., 3250 N. 33rd St., Milwaukee 53216. A complete line of terminal blocks is featured in 24-page catalog No. 368. [447]

**Zener voltage regulators.** Sarkes Tarzian Inc., 415 N. College Ave., Bloomington, Ind. 47402, has released a 12-page catalog on its expanded line of zener voltage regulators. [448]

**Resistance welders.** Sciaky Bros. Inc., 4915 W. 67th St., Chicago 60638. A six-page bulletin depicts three-phase resistance welders of the PMCO STQ series featuring solid-state controls. [449]

**Vector voltmeter.** Hewlett-Packard Co., 1501 Page Mill Road, Palo Alto, Calif. 94304. Application Note No. 91 describes several uses for a 1- to 1,000-Mhz vector voltmeter in electronic design. [450]

**Operational amplifiers.** Analog Devices Inc., 221 Fifth St., Cambridge, Mass. 02142. A 37-page application note, containing 16 technical illustrations, discusses common-mode errors in operational-amplifier circuits. [451]

**Air core yoke.** Syntronic Instruments Inc., 100 Industrial Road, Addison, Ill. 60101. Advance technical bulletin 68-1 covers the type C5380 ferrite-shielded air core yoke designed for high-speed character positioning and writing. [452]

**Nanovolt amplifier.** Keithley Instruments Inc., 28775 Aurora Road, Cleveland 44139. A four-page engineering note describes the model 140 nanovolt amplifier, which has 0.01% accuracy. [453]

**Cathode-ray tubes.** Fairchild DuMont Electron Tubes, 750 Bloomfield Ave., Clifton, N.J. 07015, has a two-color brochure on its complete line of standard high-resolution cathode-ray tubes. [454]

**H-v supply.** ITI Electronics Inc., 369 Lexington Ave., Clifton, N.J. 07015, offers a one-page bulletin describing a high-voltage supply with special features required for vacuum sputtering. [455]

**Filter design.** Nytronics Inc., Third Ave., Alpha, N.J. 08866. A 12-page manual provides important engineering data featuring an in-depth description of many of the low-, high-, and band-pass

## NORTON Magnetic Tape Heads

5218 1" Tape

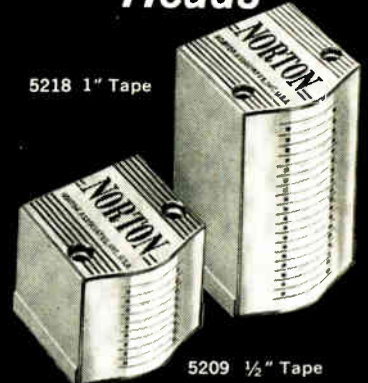

5209 1/2" Tape

### SERIES 5200

Crosstalk—40 DB  
+75°C Temperature Operation

Send now for complete technical literature.

**NORTON**  
ASSOCIATES, INC.

10 Di Tomas Court, Copiague, N.Y. 11726  
Phone: 516 598-1600

Circle 244 on reader service card

## MICO NEW MODEL 885 SEVEN RATIO WIDE-RANGE ENGRAVER

NO. 885

FOR LONG AND  
MULTI-LINE WORK

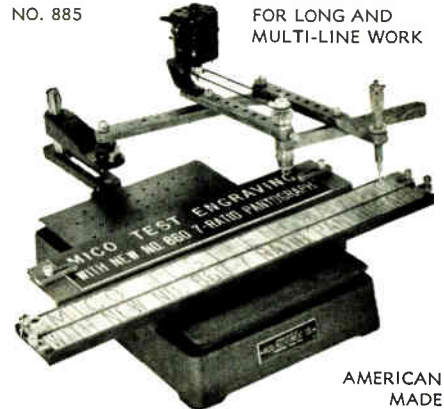

AMERICAN  
MADE

- A time-saver for large plate work
- Engraves 3" x 19" area in one set-up.
- Seven pantograph ratios—from 1:5:1 to 6:1.
- Choice of 3-ball-bearing spindle assemblies for 1/8", 3/16" or taper-shank cutters.
- HSS, COBALT and Solid Carbide Cutters.
- Single and multi-line copy carriers for holding. Blanks 3/4" to 3 1/2" high.
- Accommodates Mico standard accessories.

Send for bulletins and prices

**MICO INSTRUMENT CO.**

77 Trowbridge St. Cambridge, Mass. 02138

Circle 245 on reader service card

# Here Come the Headed Parts!

**Millions of them!** . . . from General Electric. Miniature cold headed parts that you can weld, solder, stake, glass seal, or plastic mold. Wire diameters of .015, .020, and .025 in. Lengths from .095 to .500 in. Meets 1% AQL specifications. Formed with one or two heads . . . and available in all workable metals and alloys including nickel, brass, copper, aluminum, Dumet — and many more! Plated finishes of gold, silver, nickel, copper or tin. Price? 70 cents to 90 cents per thousand . . . minimum order of 250,000. Write for product data sheet. General Electric Company, Lamp Metals & Components Department, 21800 Tungsten Road, Cleveland, Ohio 44117. Tel: (216) 266-3472.

**GENERAL  ELECTRIC**

Circle 246 on reader service card

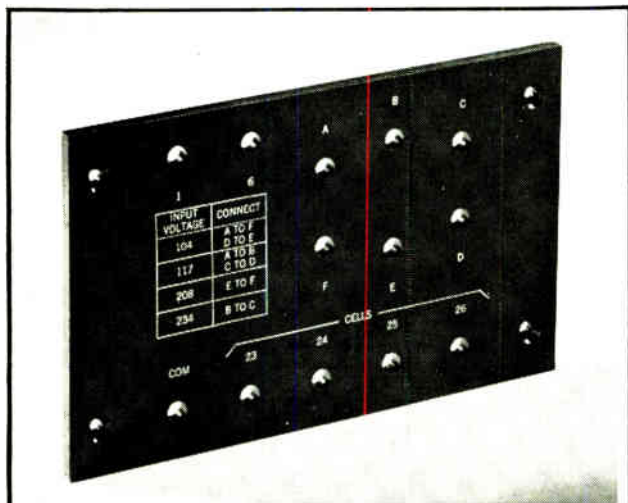

## Put Laminated Plastics of "Instrument Quality" to work for you

It doesn't make sense that your high quality scientific instruments and apparatus could use anything but the highest quality laminated plastics. That's why so many top-flight instrument makers buy their laminated plastics materials and fabricated parts from Synthane. Synthane is approved under MIL-Q-9858A and quality is built in from beginning to end. Write for information—Synthane Corporation, 36 River Road, Oaks, Pa. 19456—or call (215) 666-5011.

**SYNTHANE**

CORPORATION  OAKS, PA. 19456

Laminated Plastic Sheets, Rods, Tubes and Fabricated Parts

Circle 247 on reader service card

## Save space, time and money with RIB-LOC™ insulated terminals

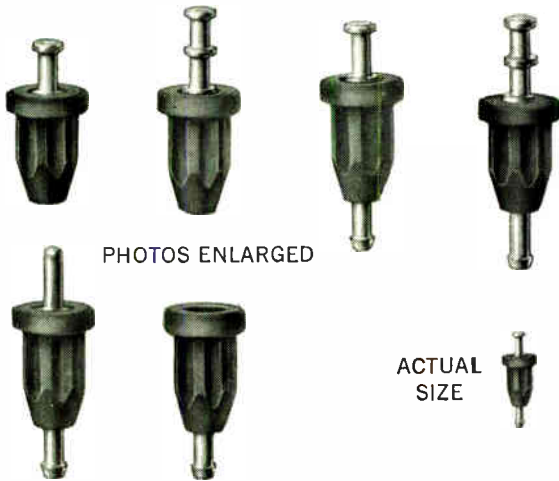

### New stand-offs, feed-thrus, tip jacks and plugs press in, provide secure mounting

Johnson RIB-LOC polyamide insulated components make it possible for your commercial equipment designs to reflect size reductions formerly limited to military equipment because of cost. The RIB-LOC line offers advantages over TFE insulated types at a substantially lower price. Though lower in cost, RIB-LOCs provide considerably better retention than most widely used TFE insulated types.

RIB-LOC components include single turret stand-off, double turret stand-off, single turret feed-thru, double turret feed-thru, .040" tip plug, and tip jack for .040" plug. All press into .136" dia. panel holes.

Terminals are brass, silver-plated and Iridited for good solderability. Available in six colors to Federal Standard 595: white, red, black, green, yellow and blue. Pullout force 21 lbs.; turning torque 18 oz. in.; capacitance (.050" panel at 1 MHz) 1.00 pf.; flash-over voltage 5300 DC; max. temp. 250° F.; leakage current (at 3500 VDC) only .01 ua.

**FREE CATALOG** includes detailed specs and prices on these and other high quality E. F. Johnson components. See your E. F. Johnson representative or write for your copy today.



**E. F. JOHNSON COMPANY**

3051 Tenth Ave. S.W., Waseca, Minn. 56093

Providing nearly a half-century of communications leadership

Circle 185 on reader service card

185

# IT TAKES A LOT OF ADJECTIVES TO DESCRIBE THE SPACE VII..

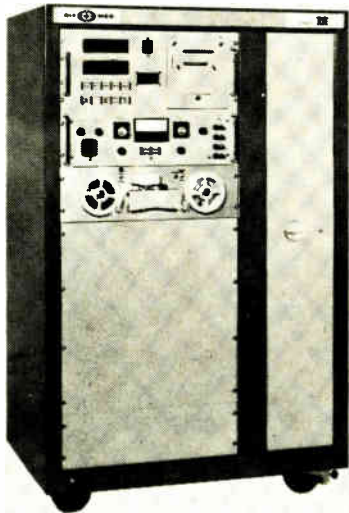

★ Adjectives like FAST, ACCURATE, FLEXIBLE, RELIABLE, VERSATILE, ECONOMICAL and MANEUVERABLE. If you doubt for one minute that a humble wiring system analyzer from the middle west can live up to these labels, then try testing this tester for yourself. It was designed and developed (after thorough lab and field testing) especially to meet today's demand for speed, accuracy, versatility and economy. DIT-MCO's Space VII operates on the fully automatic tape input and printout concept. Design and construction are of the highest quality. The "total speed" function of the Space VII gives you faster overall test time because of adaptation and hook-up ease, rapid tape feed, speed of test plus speed of fault determination time, scan time, error recording and printout.

WITH THIS ADVANCED SYSTEM you can test up to 2,000 terminations at a rate of more than 400 per minute! Electronic engineers who've tried it, call DIT-MCO's Space VII the best intermediate size testing system on the market. We won't disagree.



**DIT-MCO INTERNATIONAL**  
A DIVISION OF XEBEC CORPORATION  
5612 BRIGHTON TERRACE  
KANSAS CITY, MISSOURI 64130  
TELEPHONE (816) 363-6288 TELEX 42-6149

IT'S NO WONDER APPROXIMATELY 90% OF ALL MAJOR MANUFACTURERS IN THE COMPUTER AND AEROSPACE INDUSTRIES ARE SATISFIED USERS OF DIT-MCO SYSTEMS.

Circle 186 on reader service card

## Our little black book has over 100,000 phone numbers.

You never had a black book like it. Over 1,500 pages. And those phone numbers! More than 100,000 telling you who to call/where to go, for the over 4,000 different product categories listed and advertised in the yellow pages of the Electronics Buyers' Guide.

It's the industry's one-stop shopping center that lets you find the products and services you need quickly. You can depend on EBG.

### Electronics Buyers' Guide

A McGraw-Hill Market Directed Publication,  
330 West 42nd Street, New York, N.Y. 10036

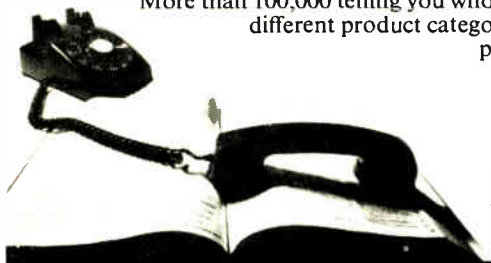

## New Literature

filters used in the electronics industry today, as well as how best to specify them. [456]

**Positive followers.** GPS Instrument Co., 188 Needham St., Newton, Mass. 02164, has published a brochure on the FO-200 series of miniaturized FET-input positive followers. [457]

**Resin dispensers.** Hardman Inc., 600 Cortlandt St., Belleville, N.J. 07109. A data sheet on two-portioner, two-part resin dispensers covers both the series 900 hand-cranked model and the 901 motorized model. [458]

**Resistance sensing amplifiers.** Curtis Development & Mfg. Co., 3250 N. 33rd St., Milwaukee 53216, announces a revised four-page, two-color bulletin, DS-170, featuring its new line of electronic resistance sensing amplifiers. [459]

**Programing devices.** Sealectro Corp., 225 Hoyt St., Mamaroneck, N.Y. 10543. A booklet entitled "Design Ideas for Engineers" gives case-history applications for Sealectroboard program boards and Sealectroswitch program switches. [460]

**Instrumentation tape recorders.** Ampex Corp., 401 Broadway, Redwood City, Calif. 94063. Brochure DO92 and data sheet DO93 describe wideband instrumentation tape recorders for use in telemetry stations and laboratories. [461]

**Push-button switch.** Switchcraft Inc., 5555 North Elston Ave., Chicago 60630. Bulletin 174 gives complete details on the model 65000DW multiple-station push-button switch. [462]

**Hybrid IC's.** CTS Research Inc., Box 1278, Lafayette, Ind. 47902. "The Total Capability Source For Hybrid Microelectronic Circuitry" is the title of an eight-page facilities brochure. [463]

**Ceramic capacitors.** American Lava Corp., Manufacturers Road, Chattanooga, Tenn. 37405, has issued bulletin 682 showing eight stock sizes of Multi-Cap ceramic capacitors. [464]

**Bonding capillaries.** Specialty Glass Products Inc., 148 Terwood Road, Willow Grove, Pa. 19090. Glass bonding capillaries that cost only 1/6 to 1/10 as much as conventional metal capillaries, and provide superior wire bonding of IC's are described in a technical bulletin. [465]

**Mass spectrometer.** Consolidated Electrodynamics Corp., 360 Sierra Madre Villa, Pasadena, Calif. 91109. Sixteen-page brochure 21621 describes a fully modular mass spectrometer. [466]

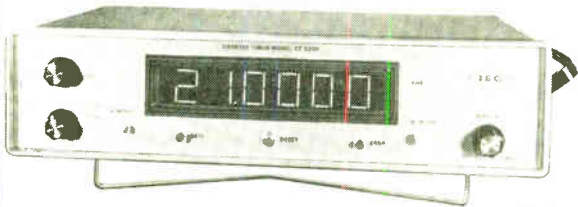

**IEC****20 MHz  
COUNTER/TIMER**

model CT520P

**\$1075.00****FUNCTIONS:**

Frequency, Period, Multiple Period, Elapsed Time, Ratio, Multiple Ratio, Manual Start/Stop, Totalize, Test

**FEATURES:**5 HZ-20 MHz both channels, BCD Output  
Clock Output (1 MHz)  
Power Requirements 115/230 V, 50-60 Cycle or 12 VDC, 35 Watts  
Sensitivity 10 MV RMS, both channels**TIME BASE:**

1 MHz Oven Controlled Crystal

**IEC****INTERCONTINENTAL  
Electronics Corp.**260 MACEDON CENTER ROAD  
FAIRPORT, NEW YORK 14450**Other Products:**RF Signal  
Generators  
Receivers  
Probes  
Preamps, Probes  
Detectors, Custom Systems  
Phone  
716-377-5990"See us at the U.S. TRADE CENTER - London, England, May 15th through May 23rd".  
Circle 248 on reader service card**Our Newest Series****MINIATURES**

Outperforms Competitive Models

This advanced "A" Series is a modified version of the original Alcoswitch with the case improvements of our top-of-the-line "E" Series. Case design has double high voltage barriers, and low-loss, high impact, high temperature materials. Wide silver contacts. Available in 1-2-3-4 pole configurations, all in compact unitized bodies. 6 Amps @ 125 VAC.

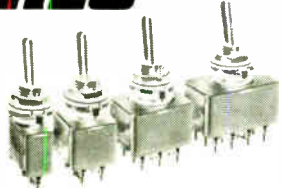
**FREE**  
12-PAGE  
CATALOG  
WRITE!**ALCOSWITCH**

DIV. OF ALCO ELECTRONIC PRODUCTS INC., LAWRENCE, MASS.

**Small — Positive Grip  
MINIATURE  
"Locking" Switches**

Alco has managed to reduce the size of the handle on this unusual miniature switch series and still have a perfect grip. Currently available in single and double pole in maintained and momentary locking configurations. Designed for accident-proof applications. 6 amps @ 125 VAC.

**FREE**  
12-PAGE  
CATALOG  
WRITE!**ALCOSWITCH**

DIV. OF ALCO ELECTRONIC PRODUCTS INC., LAWRENCE, MASS.

# alpha

number one source for economical

reliable soldering materials...

a complete range of

compatible fluxes, soldering

chemicals and solders

• **PRECLEANERS**

Removal of oil, grease and other organic soils. Tarnish (oxide, etc.) removal for solderability.

• **PROTECTIVE COATINGS**

Protection of surface solderability. Prevention of contamination.

• **SOLDER RESISTS**

Permanent resist for selective soldering. Temporary, easily removable soldering mask.

• **FLUXES**

Fluxes for every method of application — dip, wave, spray, brush, foam, etc.

• **FLUX THINNERS**

Control of flux density. Maintenance of flux properties.

• **SOLDERS**

Manufactured to specification — produced from virgin metals and available in both Vaculoy® and standard types.

• **POST-SOLDERING CLEANER**

Post-soldering cleaning and residue removal for rosins and icr-izables.

• **SOLDER BLANKET**

Dross control of solder bath surface. Reduce surface tension of molten solder.

• **RESOLDERING OR TOUCH-UP**

Core solder manufactured to the material specifications required by the process.

For further information on the complete range of Alpha solders, fluxes and soldering chemicals call or write for Bulletins A-103A and A-104.

**ALPHA METALS, INC.**56 WATER ST., JERSEY CITY, N. J. 07304 201-434-6778  
Los Angeles, Calif. • Alphasoy Corp. (Div.), Chicago, Ill.  
Alpha Metals, Inc. (U.K.) Ltd., Hounslow, Middlesex, Eng.

9339

Look for us at NEPCON '68 EAST—Booth No. 317

Circle 187 on reader service card

187



*"Put Yourself in the  
Other Fellow's Place"*

# TO EMPLOYERS TO EMPLOYEES

Letters written offering Employment or applying for same are written with the hope of satisfying a current need. An answer, regardless of whether it is favorable or not, is usually expected.

**MR. EMPLOYER**, won't you remove the mystery about the status of an employee's application by acknowledging all applicants and not just the promising candidates.

**MR. EMPLOYEE** you, too, can help by acknowledging applications and job offers. This would encourage more companies to answer position wanted ads in this section.

We make this suggestion in a spirit of helpful cooperation between employers and employees.

This section will be the more useful to all as a result of this consideration.

Classified Advertising Division

**McGraw-Hill, Inc.**

330 West 42nd St.  
New York, N. Y., 10036

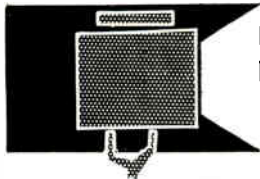

## SEARCHLIGHT SECTION

• CLASSIFIED ADVERTISING • BUSINESS OPPORTUNITIES  
• USED OR SURPLUS EQUIPMENT

### AUTOTRACK ANTENNA MOUNT

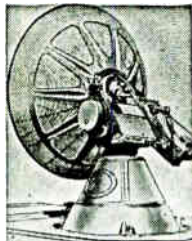

360 degree azimuth, 210 degree elevation sweep with better than 1 mil. accuracy. Missile velocity acceleration and slewing rates. Amplidyne and servo control. Will handle up to 20 ft. dish. Supplied complete with control chassis. In stock—immediate delivery. Used world over by NASA, USAF, MP-61-B. Type SCR-584. Nike Ajax mounts also in stock.

### PULSE MODULATORS

#### MIT MODEL 9 PULSER 1 MW—HARD TUBE

Output 25kv 40 amp. Duty cycle .002. pulse lengths .25 to 2 microsec. Also .5 to 5 microsec. and .1 to .5 microsec. Uses 6C21. Input 115v 60 cycle AC. Mfg. GE. Complete with driver and high voltage power supply. Ref: MIT Rad. Lab. Series, Vol. 5, p. 152.

#### 2 MEGAWATT PULSER

Output 30 kv at 70 amp. Duty cycle .001. Rep rates. 1 microsec 600 pps. 1 or 2 msec 300 pps. Uses 5948 hydrogen thyratron. Input 120/208 VAC 60 cycle Mfr. GE. Complete with high voltage power supply

#### 250 KW HARD TUBE PULSER

Output 18 kv 16 amp. Duty cycle .002. Pulses can be coded. Uses 5D21, 715C or 4PR60A. Input 115 v 60 cy. AC \$1200 ea.

#### 18 MEGAWATT PULSER

Output 150KV at 120 amps. Rep rate: 50-500 PPS. Pulse length: 5 msec. 15KV 120 amp. into pulse transformer. Rise time 1.5 msec. Filament supply 5V 80 amp. Incl. 17.5KV 1.5 amp DC power supply Input: 220V 60 cy AC.

#### INDICATOR CONSOLES

AN/SPA-4A, PPI 10" to 300 ml.  
AN/CPA-25, PPI 10" to 250 ml.  
VL-1 RHI 12" to 200 ml, 60K ft.

### IBM 704 IBM 650

These computers in stock  
for immediate delivery

#### SCR 584 AUTOTRACK RADARS

Our 584s in like new condition, ready to go, and in stock for immediate delivery. Ideal for telemetry research and development, missile tracking, satellite tracking. Fully Desc. MIT Rad. Lab. Series, Vol. 1, pps. 207-210, 228, 234-286. Comp. Inst. Bk available \$25.00 each.

### SONAR SYSTEMS IN STOCK

AN/FQS-1A, AN/FQS-1B. (111)a scanning sonars. Rochelle salt hydrophones 6 ft. \$150 ea.

### MICROWAVE SYSTEMS

#### L BAND RF PKG.

20 KW peak 990 to 1040 MC. Pulse width .7 to 1.2 micro sec. Rep rate 180 to 420 pps. Input 115 vac Incl. Receiver \$1200

#### 200-225 mc RADAR SYSTEM

1 Megawatt output. 200 nautical mile range for long range detection of medium and high altitude jet aircraft as well as general search AN/TPS 28

#### SURVEILLANCE DRONE RADAR SYSTEM

X-Band tracking system with plotting boards. Type AN/MTQ-29 Drone also in stock.

#### 5 MEGAWATT C-BAND

Klystron RF package delivering nominal 5 megawatt pulse RF. Complete with pulser and power supply.

#### 500 KW L BAND RADAR

500 kw 1220-1359 msec. 160 nautical mile search range P.P.I. and A scopes. MTI. thyratron mod 5J26 magnetron. Complete system.

#### 100 KW X BAND RADAR

Complete 100 kw output airborne system with AMTI. 5C22 thyr. mod. 4J52 magnetron. PPI. 360 deg sweep. 60 deg. elev. sweep. gyro stabilizer, hi-gain revr. Complete with all pluses and cables.

#### AN/GPG-1 SKY-

#### SWEEP TRACKER

3 cm. automatic tracking radar system. Complete package with indicator system. Full target acquisition and automatic tracking. Input 115 volts 60 cycle New. In stock for immediate delivery. Entire System 6' long, 3' wide, 10" high. Ideal for Infrared Tracker, Drone Tracker, Missile Tracker, R. & D

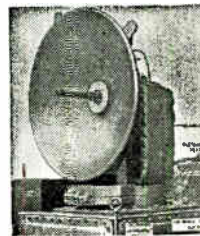

#### 500KW S BAND RADAR

250 miles search 115V 60 cy AC. Mfg. G.E.

RADAR SYSTEMS GROUND AND AIRBORNE. AUTOMATIC TRACKING ANTENNA SYSTEMS. NIKE AJAX. NIKE HERCULES. M-33. MSQ-1A. MP5-19. MP5-9. SCR 584. TPS-1D. TPS-28. FAA-ASR-2. AIRBORNE SYSTEMS. APN-84. APN-102. APS-20. APS-27. APS-45. DPN-19. DIGITAL COMPUTERS. IBM 650. IBM 704.

LARGEST INVENTORY OF RADAR AND MICROWAVE EQUIPMENT IN THE WORLD.  
**RADIO RESEARCH INSTRUMENT CO.**  
45 WEST 45TH ST. N. Y. 10036 212-JU 6-4691

CIRCLE 970 ON READER SERVICE CARD

### VOLT SENSOR

VOLTAGE SENSITIVE RELAY DRIVER

- 100 K Input Impedance
- 25 Microsecond Response
- 1-20 Volt Trip Range
- \$38 ea., \$26.60 at 100 pcs.
- Accuracy 0.01%

Send today for full specifications  
CALIF. ELECTRONIC MFG. CO.  
P.O. Box 555, Alamo, Calif. 94507

CIRCLE 971 ON READER SERVICE CARD

**New** for picking up miniature parts \$7.50 ea.

**VACUUM PENCIL**

Selected Distributors available.

**PHILIP FISHMAN COMPANY**  
7 CAMERON ST., WELLESLEY, MASSACHUSETTS

CIRCLE 972 ON READER SERVICE CARD

### ELECTRON TUBES

KLYSTRONS • ATR & TR • MAGNETRONS  
SUBMINIATURES • C.R.T. • T.W.T. • 5000.  
6000 SERIES  
• SEND FOR NEW CATALOG A2 •  
**A & A ELECTRONICS CORP.**  
1063 PERRY ANNEX  
WHITTIER, CALIF.  
696-7544

CIRCLE 973 ON READER SERVICE CARD

*If there is anything you want  
that other readers can supply  
OR... something you don't want—  
that other readers can use—  
Advertise it in the  
SEARCHLIGHT SECTION*

# FOR SALE



When you have used electronics equipment to sell, advertise in Electronics Searchlight Section for fastest results.

For information:  
Searchlight Section  
Classified Advertising Division  
Post Office Box 12  
New York 10036

# 930 DTL Problems? Get 120 Solutions from Kierulff

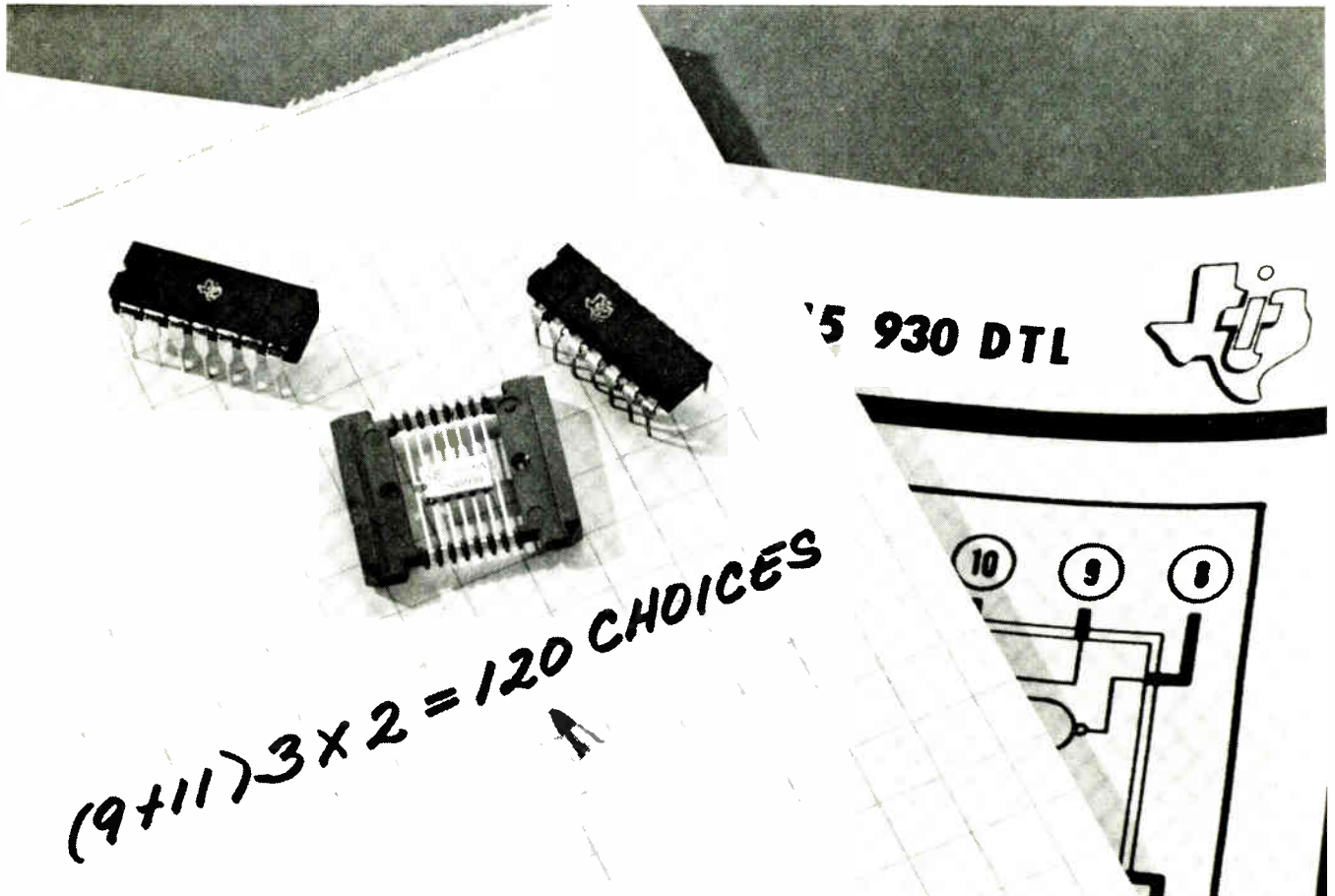

$(9+11) \times 3 \times 2 = 120 \text{ CHOICES}$

Figure it out for yourself.

Nine new 930 DTL circuits added to the 11 already available. Three package types. Two temperature ranges. Total it up and you've got 120 different versions of Texas Instruments' 930 DTL—industry's widest selection.

The nine new circuits include four dual flip-flops, two hex inverters and three fast-rise-time gates. These are

combined with eleven Series 15 930/15 830 circuits previously in the TI line for a total of 20 device types available. All are offered in any of three 14-lead packages: flat pack, dual-in-line plastic and the new dual-in-line hermetic ceramic. Finally, you have a choice of two temperature ranges—military or industrial—for each circuit. All circuits are pin-for-pin and spec-for-spec

replacements for other 930 DTL series.

Why shop around for the numbers you need? Call us for fast delivery of 120 solutions to your DTL circuit problems.

For your copy of a new specifying guide and interchangeability chart, circle 290 on the Reader Service card.

	<p style="text-align: right;"><b>ELECTRONICS</b></p> <p style="text-align: center;"><b>KIERULFF</b></p> <p style="text-align: center;">A SUBSIDIARY OF DUCOMMUN INCORPORATED</p>
---	--

#### ALBUQUERQUE

6405 Acoma Road, S.E.  
Albuquerque, New Mexico 87108

#### PHOENIX

2633 E. Buckeye Road  
Phoenix, Arizona 85034

#### PALO ALTO

3969 East Bayshore Road  
Palo Alto, California 94303

---

# Newsletter from Abroad

---

May 13, 1968

## Color-set prices shaved in France

Two small tv-set producers have forced the two largest French consumer-electronics companies to change their marketing strategies for color sets.

The giants—Compagnie Francaise Thomson Houston-Hotchkiss Brandt and La Radiotechnique—priced their sets from \$1,000 to \$1,200 when color broadcasts started last fall. They hoped to hold the price line for at least a year while they recouped part of their production start-up costs; but now the two have trimmed their tags to \$850-\$900.

Even at the lower prices, Thomson-Brandt and La Radiotechnique, a Philips' Gloeilampenfabrieken affiliate, figure to trail the two smaller companies in color sales this year. One, Electronique Moderne l'Oise, has set a \$550 list price for its 19-inch set. The other, Pizon Bros., markets a portable for \$570. Unlike other French color sets, though, Pizon's portable cannot pick up the 819-line broadcasts of France's black-and-white-only first network (color is aired on the 625-line second network).

## Swedes itching to build satellite

Sweden's aerospace and electronics industries, fussing for a national satellite program, apparently have found a sympathetic ear in the government. Krister Wickman, the nation's economics minister and a strong man in the ruling Social-Democrat Party, has a group looking into the possibilities of an all-Swedish satellite that would be launched by a U.S. booster.

Wickman's group is thinking of spending something like \$10 to \$12 million on the project over three to four years. It would be Sweden's first venture in space on its own; so far the country's space activities have been mainly limited to participation in the work of the European Space Research Organization [see related story on page 200].

## Plant investment on rise in Japan

Japanese electronics producers continue to post records for spending on production facilities. For the current fiscal year, which ends in March 1969, the industry has scheduled investments totaling \$224 million, about \$15 million more than the previous year.

The rise will come despite a sharp drop in new-plant starts. Close to \$195 million of this year's spending is earmarked to complete plants started last year, when producers of color-tv sets, computers, and integrated circuits hustled to get new facilities under way. This year, semiconductor makers will slow their investment pace; of an estimated \$27 million tagged for new-plant starts, nearly 90% will come from two color-tube plants, a computer plant, and three defense-hardware plants.

The powerful Ministry of International Trade and Industry terms the year's electronics investment plans as "satisfactory." And the ministry has nothing to complain about regarding the industry's outlook for production in 1968. The estimate: an output of \$4.7 billion, up 19% over the 1967 figure.

## Arab air defense: Britain on target

Britain may be on its way to dominating the Arab-bloc market for air-defense systems. Libya has tapped the British Aircraft Corp. as contractor for a \$250 million installation based on BAC missiles. Earlier, BAC had scored in Saudi Arabia with a \$300 million system.

With two Arab countries on their client list, BAC executives think

---

# Newsletter from Abroad

---

they have an edge for further defense business in the Mideast. Most Arab nations want package systems, which puts U.S., Russian, and British suppliers in the running. The British contend they can undersell U.S. producers, largely because American hardware is more sophisticated. The British advantage over the Russians is largely political; nonaligned Arab states steer away from the ties—actual or implied—that come with Russian aid.

## Germans to buy Swedish phones

Sweden's Telefonaktiebolaget L.M. Ericsson is all set to cut itself in for a share of the West German telephone market—until now the preserve of domestic producers.

The Federal Post Office, after nearly six months of testing, approved this month two of Ericsson's handset models for use in private branch exchanges. Ericsson's West German subsidiary plans to launch a big advertising drive to popularize its stylish handsets in Germany. Meanwhile, the Swedish company will move to get them approved for use in the public telephone system.

## Oscilloscope sets frequency mark

An oscilloscope that can handle—without sampling—waveforms at frequencies from d-c to several hundred megahertz is on the way from Matsushita Communications Industrial Co. The company showed the prototype of the scope, far and away the world's fastest, last week.

The instrument has its 3-decibel response point at 300 Mhz and a rise time of 1.2 nanoseconds. This compares with a rise time of 2.4 nsec for the fastest realtime scope now on the market.

Crucial to the scope's performance is its traveling-wave cathode-ray tube, manufactured by Philips' Gloeilampenfabrieken, which has close ties with Matsushita Communications' parent company, Matsushita Electrical Industrial Co. Accelerating voltage for the tube is 15,000 volts, but the deflection sensitivity is nonetheless high: a 12-volt swing for a full deflection of 6 centimeters.

The company expects to have production models on the market by early 1969.

## Cashbox in Sweden tied to computer

Cash-short depositors at Sweden's Oxie Haerads Sparbank in Malmo now can get money anytime—as long as they have enough in their accounts to cover withdrawals dispensed from a money machine.

A handful of other Swedish banks have machines—made by Meteor AB—that dispense money to holders of special credit cards. But Oxie Haerads is the first to have its dispenser linked directly to its bookkeeping computer. It makes sure—before any cash is paid out—that the identification number punched into the dispenser matches the code on the credit card and also that the account has a suitable balance.

## Addendum

The European airbus project may get off the ground even though the 75-plane market that once was considered a prerequisite for a go-ahead is nowhere in sight. Spokesmen for Britain and Germany have indicated their governments are strongly behind the project, despite a lack of enthusiasm for the 300-passenger jet by the national airlines of the two countries and of France, third partner in the affair.

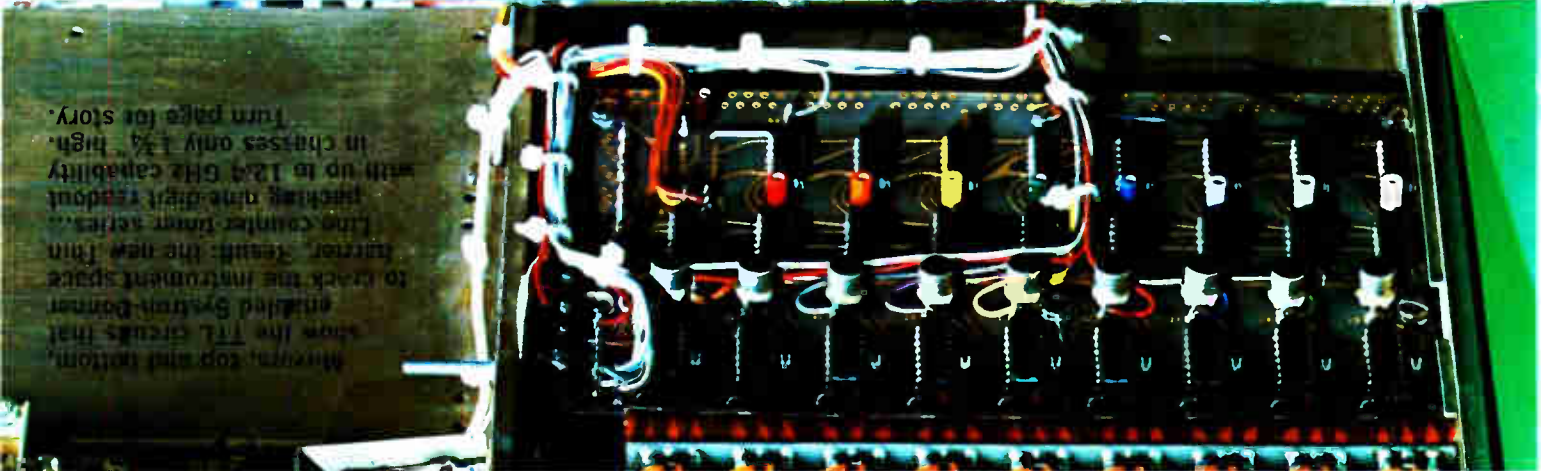
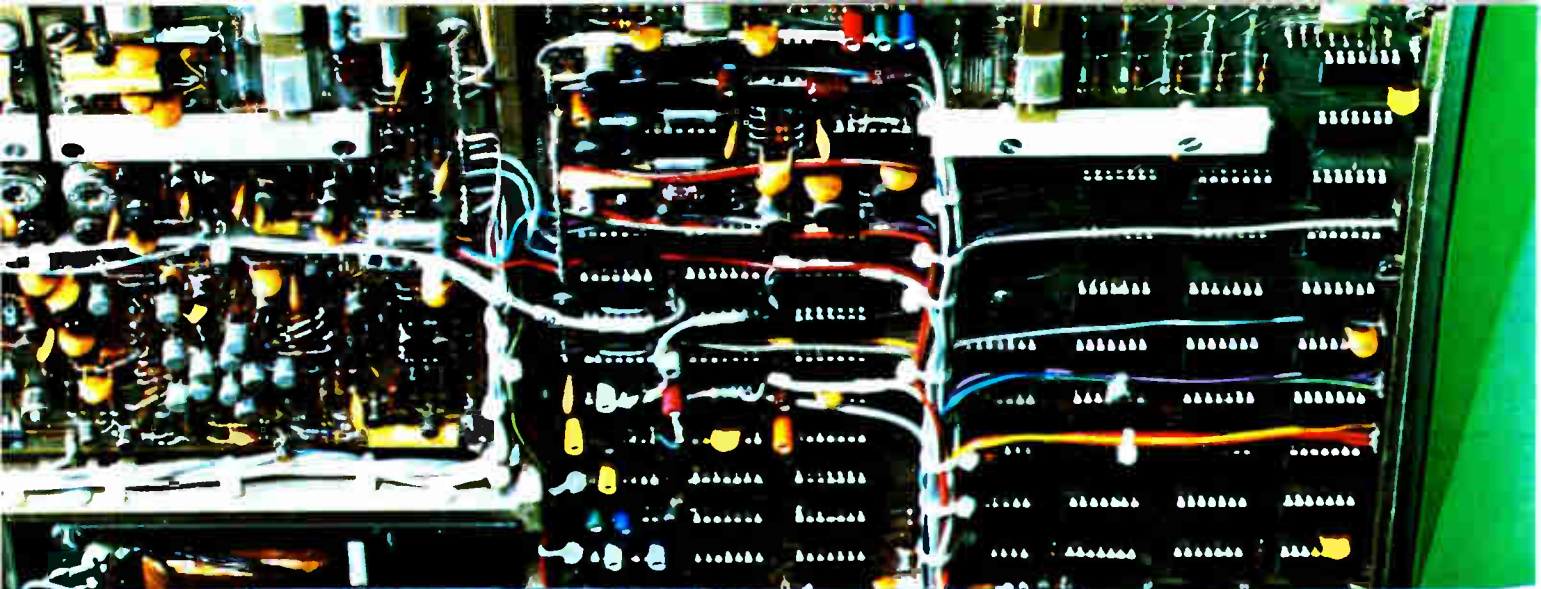

Shows, top and bottom,  
the TTL circuits that  
enabled System-Demon  
to crack the instrument space  
further, result: the new thin  
line counter timer series,  
providing one-digit readout  
with up to 12.9 GHz capability  
in chassis only 1 1/2" high.  
Turn page for story.

from Texas Instruments

# TTL Trends

# How TTL helped slim fat counters

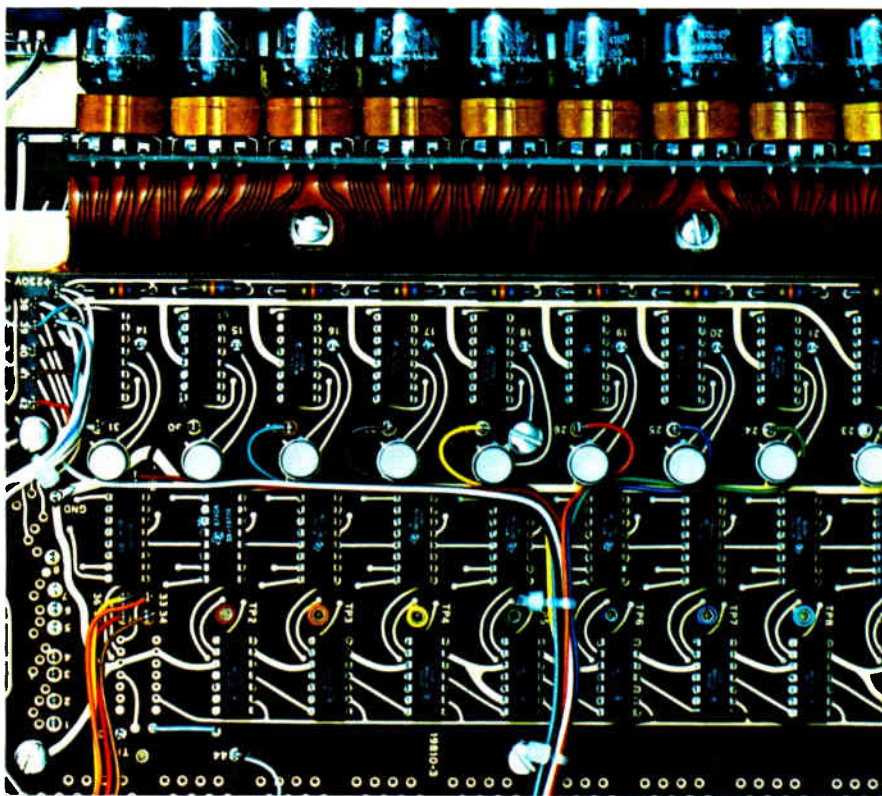
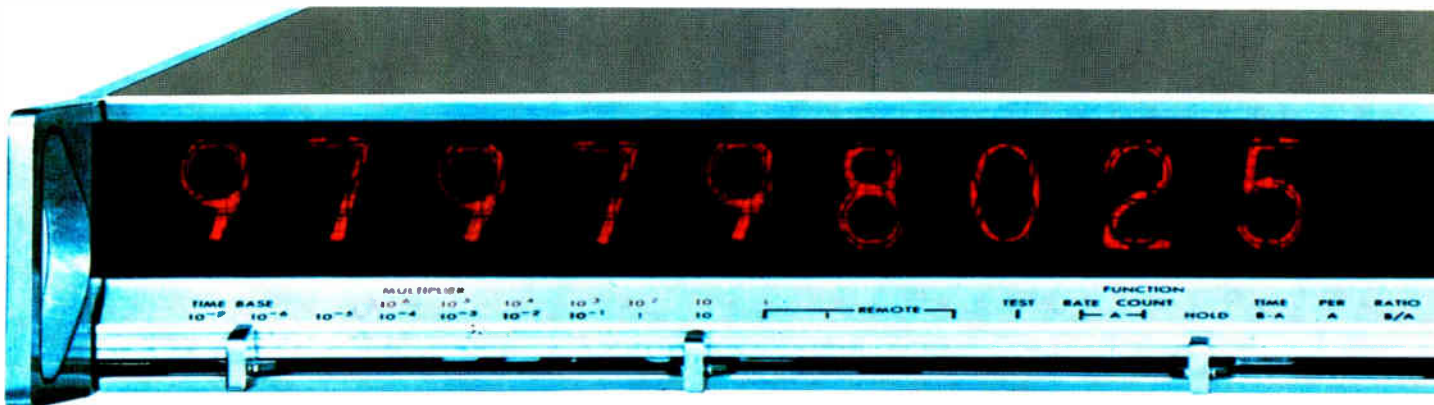

Twenty-six TI Series 74 complex-function integrated circuits form the decade chain and decoder-driver section of this Systron-Donner Thin Line counter. Without circuits such as SN7441N BCD-to-decimal decoder-drivers, hundreds of separate transistors and simple integrated circuits would have been necessary to perform the required functions.

Mission impossible? It may have seemed so to project engineers at Systron-Donner Corp. They had the assignment of designing a radically new line of high-frequency counters—one that would give them a big jump on competition.

A key requirement was reduced panel height. Systron-Donner engineers wanted a *skinny* counter—one only 1¾" high.

But, they also wanted nine-digit readout for top resolution.

Plus a 100 MHz direct counting range.

And greater freedom from repairs than ever before possible.

Integrated circuits were the obvious solution. But *which* ICs posed the tough question. Answering it triggered a two-year search that covered all major IC suppliers as well as many smaller producers. Systron-Donner's analysis included RTL and ECL logic types, in addition to TTL and DTL. Breadth of product line, depth of manufacturing facilities and competence of personnel were considered—along with price, service and performance—before the final selection was carefully made.



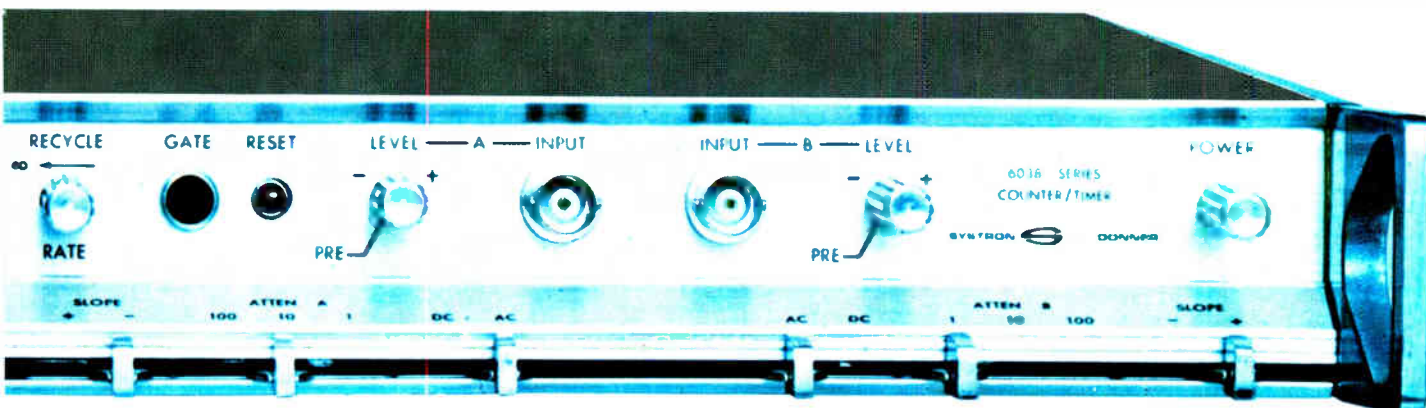

Texas Instruments got the nod, and its Series 74 TTL integrated circuits were selected to carry the major share of the chassis-shrinking job.

#### Cutting package count with complex-function ICs

Availability of complex function circuits was a prime factor in the selection of Series 74 TTL. With these advanced ICs, Systron-Donner engineers were able to make major reductions in package count — particularly in the decade-chain and related storage-readout driver section. Eight SN7490N decade counters, nine SN7475N quadruple latches and nine SN7441N BCD-to-decimal decoder-drivers replaced hundreds of simple integrated circuits and transistors. Without these TTL circuits, the new Thin Line counter design would have been virtually impossible.

#### Other benefits from TTL

Even where complex functions were not required, TI's Series 74 TTL line permitted significant package and space savings. For example, SN7473N dual J-K master/

slave flip-flops assured high switching speeds for control binaries. A further reduction in package count resulted from use of multiple-input SN7470N J-K flip-flops.

In addition, Series 74 gates — SN7400N, SN7410N and SN7420N — provided a solid 10 MHz switching capability in those sections where such speed was desired. And the high driving capability of these gates (resulting from low output impedance) gave Systron-Donner engineers greater flexibility in wire routing and circuit board layout, without compromising switching speed.

And high noise immunity — typically 1.9 V for logical one and 1.2 V for logical zero — further simplified board layout. Series 74 ICs also permitted much faster evaluation of pilot board runs than had ever been achieved with discrete components.

#### Reliable, maintenance-free operation

Field experience to date indicates Systron-Donner has achieved its design goals for reliable, trouble-free service. Expectations are that the MTBF for the new Thin Line

counters will far exceed that of older counters using discrete components. This improved reliability is due, in large measure, to the reduction in package count and even greater reduction in number of soldered connectors made possible by the Series 74 TTL logic family from Texas Instruments.

#### Planning for tomorrow

By using industry's most modern logic family, Systron-Donner has also provided for future design opportunities — at minimum cost, time and effort.

TI's growing family of TTL complex functions has provided Systron-Donner a link with the MSI and LSI semiconductor circuits of tomorrow. Why not also put this advanced IC line to work for you?

Three of the most recent additions to the TI complex function line of shift registers are featured on the next page. They typify the increasing versatility and complexity that has characterized the evolution of TI's family of TTL circuits. One of these ICs may be just the ticket for breaking that design log jam of yours.

**TEXAS INSTRUMENTS**  
INCORPORATED

# 3 new shift registers expand industry's broadest logic line

These complex-function TTL shift registers are far more than basic registers. Applications include shift counters, Johnson and ring counters, and shift-register generator counters.

These registers incorporate additional gating as well as input and output connections, and are recommended for many storage and counting applications in addition to such shift functions as serial-to-parallel, parallel-to-serial, right-shift and left-shift operations. In all cases, substantial savings in packages, interconnections, design time and overall costs will be realized.

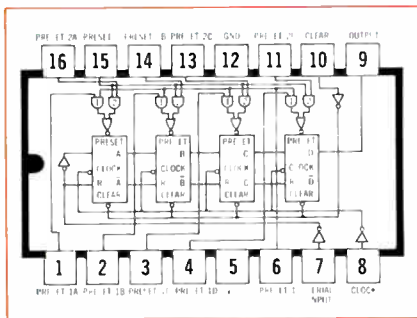

## SN7494 4-bit shift register

This parallel entry, serial shift register includes four AND-OR-INVERT gates, four inverter drivers, and four R-S master-slave flip-flops. The result is a versatile circuit which performs right-shift operations as a serial-in, serial-out register or as a dual source parallel-to-serial converter.

All flip-flops may be cleared simultaneously — independently of

clock input. Also, the circuit has asynchronous loading capability from two strobe-controlled sources.

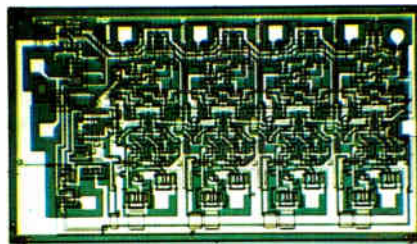

## SN7495 4-bit shift-right, shift-left register

This parallel or serial-input shift register incorporates four AND-OR-INVERT gates, one AND-OR gate, six inverter-drivers, and four R-S master slave flip-flops.

This versatile register can be used in a wide variety of applications, including serial-in, right-shift/left-shift, and parallel loading operations.

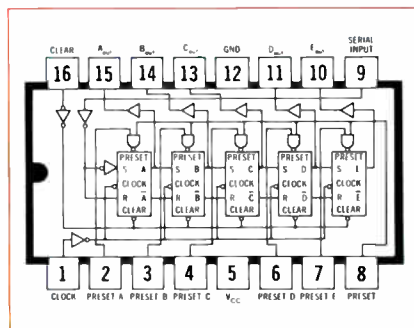

## SN7496 5-bit shift register

This register consists of five R-S master/slave flip-flops, with gates and inverter drivers, connected

as a shift register to perform parallel-to-serial or serial-to-parallel conversion of binary data. Since both inputs and outputs to all flip-flops are accessible, parallel-in/parallel-out and serial-in/serial-out operations may be performed.

A common clear line and strobe-controlled, individual presets permit loading of any binary information into the register. Preset is independent of the state of the clock input.



A note from you, on your company letterhead, will bring this goldmine of information . . . data sheets on these 3 new shift registers plus application information on all our 54/74 counters and shift registers... a data book on the entire 74 N complex-function family ... and finally, an in-depth 48-page brochure covering all 54/74 TTL integrated circuits. Just address your letterhead request to Texas Instruments, Incorporated, MS980, P.O. Box 5012, Dallas, Texas 75222.



**TEXAS INSTRUMENTS**  
INCORPORATED

## France

### Stress on holograms

Optics researchers some years ago realized that holograms—three-dimensional images recorded as light-interference patterns—are an excellent way to study stress patterns. But anyone who wanted to work with the technique had to put the hologram setup together himself.

Engineers of the French construction-industry association, however, will be spared this do-it-yourself effort. The association's Public Works Laboratory is the first customer for an off-the-shelf hologram system developed by the Compagnie Générale d'Electricité, France's largest electrical-electronics concern.

The test engineers will use the equipment to spot potentially dangerous stress areas on models of construction projects. But CGE says that's just one use for its hologram system, which can handle objects up to about 20 inches square and 8 inches deep. Mrs. Michel Leblanc, who heads the company's hologram work, uses the system to study deformations in power transistors and their heat sinks. And it can be used with complex shapes at high temperatures—hard to handle with earlier techniques.

**Twice over.** To analyze stresses and deformations, Mrs. Leblanc first makes a hologram of the object with no external stress on it. Then heat or a slight force is applied and a second hologram is made on either the same plate or another one.

Because of the very slight displacements caused by the applied stress, fringe rings show when the two superimposed holograms are illuminated by laser light. The equipment, of course, won't work



**Heat waves.** Superimposed holograms show deformation of hot power transistor and its heat sink.

when stresses are intense enough to produce significant strain. If the displacement is greater than a wavelength of the laser illumination, it's impossible to superimpose the images.

Compagnie Industrielle des Lasers, a joint venture of CGE and Compagnie Saint-Gobain, markets the hologram system, which costs about \$14,000. The laser that comes with the system is a standard 20-milliwatt helium-neon unit.

## South Africa

### Hands off

Just getting production at a steel mill that's controlled by a computer is a difficult task. Ask any steel company that's tried. Imagine, then, the job faced by a steel maker determined to automate its entire operation with a realtime system that takes charge when an order is fed into it and controls everything—from production on through billing.

Work is well along on just such a system at the South African Iron and Steel Industrial Corp. (Iscor) at Vanderbijlpark. The \$4.2 million

system—which won't be fully operational until 1973 or 1974—ultimately will cover some 35 separate mills, linking them to about a half-dozen sales offices and the headquarters of this integrated steel producer.

Work on similar large, realtime computer systems is under way at the plants of at least two European integrated steel producers. But neither is as far along as Iscor's system.

**Side by side.** Actually, Iscor will have two data-processing chains working in tandem when it gets the system into action—a decade after it started feasibility studies. One, already in operation, supervises the flow of orders through the company. The other, getting a gradual introduction at the Vanderbijlpark works, will run the plants. This portion of the system is at work in the melting and slabbing operations. Program debugging has started at the plate mills and next will be the rolling mills. The last operation that will be brought into the system will be basic iron production.

Work has yet to start on the process-control system at Iscor's older works at Pretoria.

Kingpin hardware for the system is a pair of U.S.-made CDC 3300 computers. Each has a main frame memory of 128,000 words made up 24 bits each. There are also two Westinghouse Prodac 50 process computers tied into the system and Iscor plans to add two more process computers within two years. At the moment, 25 communications terminals are operating; the number will eventually climb to about 120.

**Always there.** Major realtime job of the 3300 computer is to collect and display data from plant terminals and automatic data-logging units so that it can schedule production and do management reporting.

An order is entered directly into the realtime system, via the order-

control system, from a sales-office terminal. The order, including product specifications, is loaded on a mathematical model of the works and a forecast is made of when the order can be delivered. Once the order is accepted, it remains in the system until it is shipped.

For example, the rolling of an ingot at the slab mill is scheduled several days in advance. The ingot's progress and specifications are reported into the system via terminals at the melting plant, the weighing station, and the soaking pits. Detailed rolling instructions are issued only when the ingot is moved into the soaking pit to be heated, about six hours ahead of the rolling.

When the ingot enters the rolling mill, the instructions from the real-time system are read into the process computer by a punched card. This computer then controls the process of rolling the ingot into a slab and shearing it.

Data on the slab is sent by the computer to the realtime system, which changes its files so that up-to-date records of material stocks, production status, and order progress are available at all times.

**Charges.** Once an order has been produced and is ready to be shipped, the 3300 system is advised through the data-collection terminals and the order-control system comes back in the picture. It sends all the data needed for getting the product to the customer to the shipping-department terminal. It also prints out invoices and updates customer accounts in batches.

Computer Data Corp.'s William M. Lambert, a systems analyst who's helping Iscor get the ambitious system in operation, described parts of it at the Spring Joint Computer Conference early this month.

---

### East Germany

---

#### Computer craze

Judging by Soviet-bloc norms, East Germany isn't doing at all badly in computers. But the belief that data processing can somehow cure the country's economic woes is so

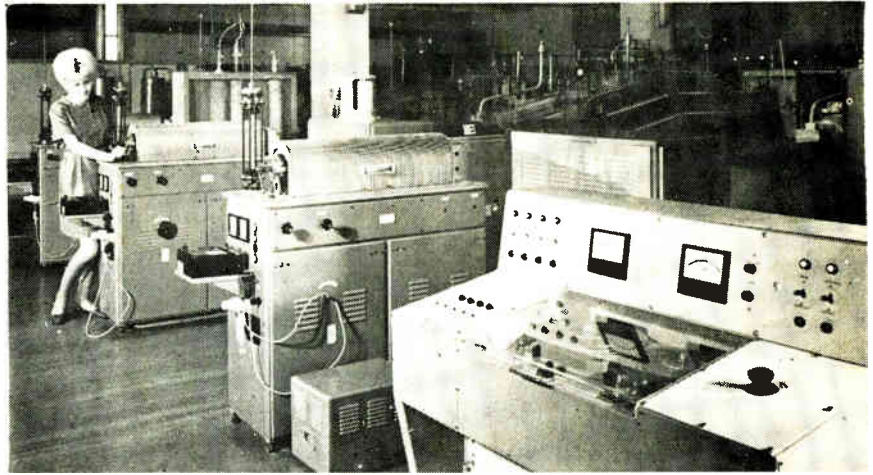

**Debugged.** East Germans have overcome yield problems at their main semiconductor facility at Frankfurt on Oder.

strong that government planners still fret over the slow growth of computers in industry. Western experts estimate that upwards of 200 small computers are in use.

Planners complain that plant managers have yet to put their data-processing equipment to full use. One reason for this state of affairs is that many of the managers see little advantage in computerized operations. This was dramatized at last year's national conference on data processing in East Berlin; only 19 of 92 invited managers bothered to show up.

**Shortcomings.** But a far more compelling reason is East Germany's shortage of qualified personnel. Alois Braeutigam, a high-ranking Communist Party official, made much ado recently about the work force at VEB Optima, a producer of office machines. Braeutigam found only 2.5% of the total force to be technicians. And of the technicians, only a third had university training.

These shortcomings will be overcome if Guenther Kleiber, state secretary for data processing, has his way. Kleiber has started to push for a program at Dresden Technical University under which all students would study cybernetics, electronic computer techniques, and numerical control.

What's more, Dresden plans to help VEB Rafena-Werke, the country's leading computing producer, to streamline its manufacturing techniques.

**Discrete.** Rafena-Werke, though, needs more than engineers. The plant's mainstay hardware is the year-old Robotron 300, a medium computer intended mainly for commercial use and roughly equivalent to the IBM 1401. A larger and faster machine, the Robotron 400, is in the works, but its designers will probably have to settle for discrete components and thin-film circuits rather than the monolithic integrated circuits that mark an up-to-date computer in the Western world.

Except in monolithics, the East Germans have apparently cleared up the yield and quality problems that plagued their computer-component production as recently as two years ago. At the Leipzig Spring Fair, they displayed plastic-packaged silicon epitaxial transistors, metal oxide semiconductor transistors, switching diodes with 4-nanosecond delay times, and thin-film circuits with silicon oxide dielectric and nickel chromium resistors.

---

### West Germany

---

#### Low ceiling

This year's Hanover Industrial Fair found the German electronics industry looking ahead to a balmy 1968; but out at the city's Langenhagen Airport, where the country's

aerospace producers were concurrently holding their air show, forecasters were predicting stormy weather.

Oddly enough, these predictions follow a year that saw total aerospace sales soar 25% to \$375 million. But industry seers are quick to point out that the figure amounts to only 0.33% of West Germany's over-all output of goods and services, well below the portion of gross national product that goes for aerospace in France and Britain.

What's worse, they don't anticipate production orders large enough to keep the industry up with the leaders technologically. To be sure, the Kiesinger government plans to buy a batch of 150 or so fighters, either McDonnell Douglas Phantoms or Lockheed F-104 Starfighters. But the order, first expected to come early this spring but now apparently off until June, won't lift the industry much this year even though the planes are to have a large West German content.

Largely as a result of the heel-dragging on the fighter order, avionics producers figure they'll be lucky this year if they hold their 1967 sales level, about \$120 million.

**Persevering.** Despite their woes, Germany's avionics producers managed to come up with some noteworthy advances for the air show.

For example, Fluggeraetewerke Bodensee GmbH has developed an automatic throttle-control system that Lufthansa will install in its Boeing 707 jets. Fluggeraetewerke, an affiliate of the Perkin-Elmer Corp., will put the \$20,000 system into serial production soon.

With this hardware, an analog computer works out the throttle corrections usually made by the pilot during a landing approach. All the pilot does is select the air-speed he wants at all flaps. The computer then keeps the plane's speed scaled to this reference as the pilot progressively lowers the flaps.

**On the spot.** Another avionics standout at the show was a landing aid from Dornier GmbH that guides pilots down to within 30 feet of a spot painted near the end of a runway.

What the pilot sees, projected

apparently to infinity on a semi-transparent mirror, is a cross in a circle, plus a moving bar. Inputs from a gyro keep the circle-cross symbol fixed despite pitch and roll movements. An angle-of-attack sensor positions the bar, which moves across a red-green-red background. By keeping the spot on the runway centered in the circle and the bar in the green sector, the pilot flies the plane down a glide path that originates at the spot. Dornier says the system will probably sell for less than \$1,500 once it's in serial production.

---

## Great Britain

---

### Side shows

The promoters of the 1968 Instruments, Electronics, and Automation Exhibition are touting their show as the "biggest ever." Few would dispute them. The mid-May IEA fair sprawls over all 11 acres of London's massive Olympia exhibition area; there are more than 900 exhibitors at some 600 stands. As for attendees, there's little doubt that the record figure of 111,000 will go by the boards before the affair ends its six-day run on May 18.

Impressive as these numbers are, they've become a source of concern to the five trade and scientific associations that sponsor the exhibition—and to participants. Convinced that the show has become too big and helter-skelter, two of the heavyweights on the British electronics scene have decided to sit this one out. Both Texas Instruments Ltd. and EMI Electronics Ltd. are holding private displays in hotels near the Olympia instead of taking their usual stands at the show.

The reason: big as they are, the TI and EMI subsidiaries felt they would have trouble attracting serious prospects to exhibition-hall stands. Showgoers looking for semiconductors have to run a sort of combination long-distance obstacle race and technical treasure hunt because exhibition stalls

aren't grouped by product category.

Although TI and EMI Electronics are the only major 1968 dropouts, marketing managers at many other big companies have been grumbling about the sprawl at the show. It's a good bet that the 1970 edition of IEA will have a new format.

---

## Italy

---

### Computer concentration

Over-all, the General Electric Co. has fared poorly in its bid to become a big money-maker in the data processing market. But the company definitely backed a winner four years ago when it bought a 75% share in Olivetti-GE, a computer concern formed from the electronics division of Ing. C. Olivetti & Co.

The joint venture flipped into the black two years ago, largely because of its fast-selling GE-115 machine. Italian sources estimate that Olivetti-GE has picked up orders for 1,000 machines since they went on the market in November 1965. And to back up its best seller, the company introduced at the Hanover Fair this month a faster and larger computer—the GE-130—that uses the same peripherals and programs.

**Olivetti out.** So for Italian business circles, GE's decision to buy out Olivetti's 25% interest in the venture late last month came as no surprise. GE had taken an option on the Olivetti holding when the deal was first made.

And Olivetti officials can trot out some convincing reasons why the sale of their share makes sense. Olivetti wants to concentrate on three areas of data processing where it already has strong market positions—desk-top computers, data-transmission terminals, and numerical controls for machine tools. The terminals and controls are designed to work with the computers of all major producers, so Olivetti thought it best not to be linked so closely to just one.

Olivetti says rumors of a government-fostered group of companies

working in advanced electronics had nothing to do with its decision to untie itself from GE. However, the change will make it easier for the government if it does decide to put together a group.

---

### International

---

#### Alone together

Europe's space effort is fast taking on a new look. Once-promising multinational efforts are losing steam, and countries intent on finding a place in space seem determined to go it alone or make it as part of a small group.

Britain put two kingpin communal ventures in jeopardy late last month. The Wilson government announced that it wanted no part of a proposed European television-relay satellite, and made it clear that there would be no further outlays from the Exchequer for the Europa rocket program after the country's treaty obligations to the European Launcher Development Organization (ELDO) run out in 1971.

Days after the British move, Italy forced the 10-nation European Space Research Organization (ESRO) to drop plans to launch two 880-pound spacecraft with U.S. Thor-Delta rockets. Development contracts had already been let for the projects, called TD-1 and TD-2.

**Carrying on.** The contracts, in fact, were the cause of the Italian pullout. Down for a 10% share of ESRO's bill, the Italians had no TD-1 or TD-2 business but expected to recoup in a follow-on project, the 1,800-pound Large Astronomical Satellite (LAS). But when the costs of other ESRO programs got out of hand, LAS was dropped and the Italians balked at further payments for TD-1 and TD-2. Originally pegged at \$20 million, TD-1 and TD-2 cost estimates have tripled.

With ESRO projects foundering, Italy may solo. The government has called for bids on an experimental communications satellite. As yet, its characteristics haven't been made public, but it's known that

about a dozen aerospace firms have been invited to submit proposals.

**Parlez-vous?** And another possible chunk of space business surfaced soon after the ELDO and ESRO setbacks. Quebec province wants a series of communications satellites for a broadcast network that would link French-speaking schools and universities in Canada.

The first French-Canadian satellite—the series is dubbed "Memini" (Latin for "remember")—is targeted for a late-1972-early-1973 launch. France, apparently, will pick up part of the tab for the satellites since President de Gaulle last summer promised he'd take new initiatives to promote Gallic culture in Canada. Belgium will also participate. The design contract already has been awarded to Laboratoire Central de Télécommunications, a Paris-based subsidiary of the International Telephone & Telegraph Corp.

Although they may have trouble getting a launcher, France and West Germany are still determined to go ahead with their Symphonic communications satellite. The two now have signed on a junior partner, Belgium, which has come in for a 4% slice of the \$50 million project. Before it decided to go it alone, Italy had considered taking a small part of Symphonic.

---

### Mexico

---

#### Underground laser

The National University has gone into the laser business in a modest but surprising way.

Its first customer is a contractor rather than a research laboratory. Solum S.A. will use three units to guide tunneling machines in a Mexico City sewer project.

The lasers are helium-neon types with an output of only 1.5 milliwatts. Except for the mirrors, from the Spectra Physics Corp., the parts were made in Mexico. Rogelio Magar, of the university's Center for Materials Studies, notes that the laser will have aluminum electrodes based on a Spectra Physics

design. The electrodes were made by Daniel Malacara of the university's Astronomy Institute, which uses lasers to align its equipment and helped the materials center put the new units together.

**On the roof.** Solum plans to use its lasers much as the U.S. pioneers in the tunnel technique have been using theirs during the past year and a half. The lasers will be attached to the tunnel roof and lined up with a transit. Then, a spot on the back of the tunnel machine will be kept on the beam—literally—to guide the machine along an absolutely straight line. The lasers will be paired with an afocal telescope to get an 18-millimeter beamwidth from the 2-to-4 mm laser beam.

---

### Around the world

---

**Japan.** The government has approved a packet of deals that add up to a reasonably happy ending to its four-year-long hassle with Texas Instruments. Now officially cleared: the semiconductor company that TI plans to set up with the Sony Corp.; a cross-licensing agreement between TI and the Nippon Electric Co., which holds the Japanese rights to Fairchild Semiconductor's planar-process patents; and integrated-circuit licenses from TI for Hitachi Ltd., the Mitsubishi Electric Corp., the Tokyo Shibaura Electric Co., and Sony.

**Czechoslovakia.** The state-owned electrical-electronics organization, Tesla, has signed the pact that gives it the right to produce the Gamma 140 computer developed—but never marketed—by France's Bull-GE. [Electronics, Dec. 11, 1967, p. 248]. Negotiations started months ago but were stalled by the change of regimes in Czechoslovakia.

**Belgium.** Manufacture Belge de Lampes et de Matériel Electroniques (MBLE) has won a \$12.5 million contract to supply the electronics for 300 Leopard tanks Belgium will buy from West Germany under an offset deal. MBLÉ will farm out \$2.5 million of the business to SAIT Electronics.

# This is when cheap relays get expensive

OUT  
OF  
ORDER

Cheap, unreliable relays in your product aren't cheap to your customers. Downtime and repairs cost them money. Lots of money.

And they blame your product. Not the relays.

AE's new Class H relay is inexpensive, but that's where its resemblance to cheap relays ends.

The Class H is a versatile "telephone type" relay that uses the same reliable and high-speed components demanded by the telephone industry. But in a small package the size of a 1.3 inch cube.

It offers reliability that's important if you manufacture business machines, communications equipment, aircraft and missile simulators, computer peripheral equipment or entertainment equipment.

Reliability that's important to your customers, too, in a reduction of costly downtime.

Find what the Class H relay can do for your product. And your customer relations. Ask us for a copy of Circular No. 1100. Write to Mr. V. E. James, Director, Relay Control Equipment Sales, Automatic Electric, Northlake, Illinois 60164.

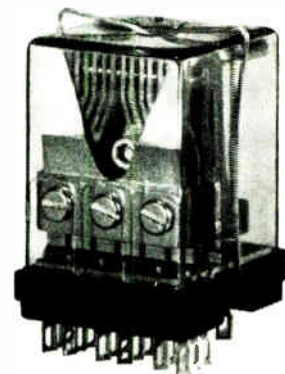

New Class H relay combines small size and mounting versatility with life expectancy in excess of 100 million operations.

## **AUTOMATIC ELECTRIC**

SUBSIDIARY OF GENERAL TELEPHONE & ELECTRONICS



# Polysulfone I.C. Carriers help make integrated circuits what they are today.

The Barnes Corporation, producers of the largest, most complete line of integrated circuit carriers, uses only BAKELITE Polysulfone.

BAKELITE Polysulfone's resistance to high temperatures is vital for successful I.C. temperature testing, which ranges from minutes to months at 150°C.

This thermoplastic won't shrink, grow or gas. Because of these capabilities, efficient handling and testing of up to 50,000 packages an hour happens every day at leading I.C. manufacturers.

For other applications, here's why BAKELITE Polysulfone beats other thermoplastics, even some metals:

- Non-conductive
- Retains its physical properties from -150°F. to well over 300°F.
- Has a 150°C. U.L. temperature rating
- Is self-extinguishing
- Has a very low mold shrinkage for exceptional precision in molding
- Can be easily metal plated, threaded, painted
- Costs less than many metals
- Holds close tolerances and provides dimensional stability

BAKELITE is a registered trade mark of Union Carbide Corporation.

**UNION  
CARBIDE**

**THE DISCOVERY COMPANY**

For detailed information about BAKELITE Polysulfone, write: Union Carbide Corporation, Dept. EM-5, 270 Park Avenue, New York, N. Y. 10017  
Circle 202 on reader service card



# Electronics advertisers

May 13, 1968

■ Acopian Corp.	14	□ Dow Chemical Europe S.A.	OAS 21	Marconi Instruments	32
Mort Barish Associates		MacManus John & Adams S.A.		McCarthy, Scelba & DiBiasi	
Adams & Westlake Co.	58	Durant Manufacturing Co.	142	Adv. Agcy., Inc.	
Kasper & Assoc., Inc.		Franklin Mautner Advertising		□ Marconi Instruments, Ltd.	OAS 12
□ AEG—Telefunken	OAS 24	Eastman Kodak Co.,		Taylor Advertising, Ltd.	
Werbungs—Makler		Business Systems Markets Div.	157	■ Markel & Sons, L. Frank	176
■ Alco Electronic Products, Inc.	187	J. Walter Thompson Co.		George Moll Adv., Inc.	
Marketronics Adv.		E-H Research Laboratories, Inc.	45	Mico Instrument Co.	184
Allen-Bradley Co.	28, 29	Steedman, Cooper and		Micom, Inc.	54
Fensholt Adv. Agcy.		Busse Advertising		Lennen & Newell, Inc.	
Alpha Metals, Inc.	187	■ Electro Motive Mfg. Co.	63	Microlab/FXR	56
Black-Russell-Morris		Reynolds & Foster, Inc.		Frank Best & Co., Inc.	
American Feldmuehle Corp.	131	Electronics Buyers' Guide	174	■ Micro Switch Div. of Honeywell	34
Emil Mark & Co., Inc.		Plansboard Adv., Inc.		Batten, Barton, Durstine & Osborn, Inc.	
American Lava Corp., Sub. of		■ Electronic Research Associates, Inc.	166	Molex Products Co.	113
Minnesota Mining & Mfg. Co.	65	Josephson Cuffari & Co.		Fensholt Adv., Inc.	
Designers, Inc.		Electro-Nuclear Laboratories	77	Motorola Government Electronics Div.	8
Amphenol Corp.	148	Hal Lawrence, Inc.		Botsford, Constantine & McCarty, Inc.	
Marsteller, Inc.		Emerson & Cuming, Inc.	166	Motorola Semiconductor Products, Inc.	35
Anadex Instruments, Inc.	46	Edwin F. Hall		Lane & Bird Adv., Inc.	
Eastman Adv. Agcy.		■ Fairchild Semiconductor, Inc.	86, 87	Mullard, Ltd.	171
Andrew Corp.	130	Faust/Day, Inc.		Rumrill-Hoyt, Inc.	
Fensholt Adv., Inc.		Fairchild Instrumentation	53	National Semiconductor Corp.	137, 139
AO Instrument Co.	140	Faust/Day, Inc.		Jay Chiat & Associates	
Fuller & Smith & Ross, Inc.		Fluke Manufacturing Co., John	15	Natvar Corp.	179
■ A.P.I. Instruments	154	Bonfield Associates		Sanger-Funnell, Inc.	
George Z. Griswold Advertising		■ Franklin Electronics, Inc., Sub. of	174	■ North Atlantic Industries, Inc.	134
Arkansas Industrial		Mohawk Data Sciences Corp.		Murray Heyert Associates	
Development Commission	167	Kimberly-James Advertising		■ Norton Assoc., Inc.	184
Cranford/Johnson & Associates		■ General Electric Co.,		J. J. Coppo Co.	
Associated Testing Laboratories, Inc.	155	Capacitor Division	30, 31	Nus Corp., Electronic Systems Div.	162
Murray Heyert Associates		Robert S. Cragin, Inc.		Graphic Associates	
□ Ates Componenti Elettronici, S.P.A.	OAS 8	□ General Electric, IGE Export Div.	OAS 17	■ Parker Instrument Corp.	160
Automatic Electric Co., Sub. of General		Robert S. Cragin, Inc.		HPM Advertising	
Telephone & Electronics Corp.	201	General Electric Co.,		Pennsalt Chemicals Corp.	124
Marsteller, Inc.		Lamp Metals & Components Div.	185	Aitkin Kynett Co., Inc.	
Ballantine Laboratories	152	Dix & Eaton, Inc.		Philco Ford Corp.	
Lang-Lawrence Adv., Inc.		■ General Instrument Corp.,		Sierra Electronics Operation	11
■ Beckman Instruments, Inc.,		Semiconductor Products Div.	109	Hal Lawrence, Inc.	
Helipot Div.	68	Norman Allen Associates		□ Philips Eindhoven N.V.	OAS 1, OAS 3
Hixson & Jorgensen, Inc.		General Radio Co.	2nd Cover	T.A.G. De La Mar	
Bell Telephone Laboratories	123	Horton, Church & Goff, Inc.		■ Price Electric Corp.	129
N.W. Ayer & Son, Inc.		□ Globe Union, Inc.,		H.W. Buddemeier Co., Inc.	
Birtcher Corp., The	182	International Division	OAS 10	Radiation, Inc.	43
Guerin, Johnstone, Gage, Inc.		The Brady Co.		W.M. Zemp & Assoc., Inc.	
Bishop Industries Corp.	162	Gries Reproducer Co.	182	Radio Corporation	
Eastman Adv. Agcy.		Harold Marshall Adv.		of America	4th Cover, 41, 175
■ Blackstone Ultrasonics, Inc.	181	Groov-Pin Corp.	179	Al Paul Lefton Co.	
Carr-Liggett Adv., Inc.		Feeley & Wheeler, Inc.		■ Radio Switch Corp.	156
Bourns, Inc., Trimpot Div.	110	■ Guardian Electric Mfg. Co.	62	Carpenter, Matthews & Stewart, Inc.	
Lester Co., The		K & A Advertising		■ Raytheon Co.,	
Buffalo Erie County N.Y.	150	Heinemann Electric Co.	6	Industrial Components Div.	181
Barber & Drullard, Inc.		Thomas R. Sundheim, Inc.		Fuller & Smith & Ross, Inc.	
■ Bulova Watch Co., Electronics Div.	122	■ Hewlett Packard,		Raytheon Co.,	
Frank Best Co., Inc.		Colorado Springs Div.	3rd Cover	Microwave & Power Tube Div.	146
Bunker-Ramo Co.	162	Tallant/Yates Adv., Inc.		Fuller & Smith & Ross, Inc.	
Diener & Dorskind, Inc.		■ Hewlett Packard, Frequency & Time Div.	2	RFL Industries, Inc.,	
■ Busmann Mfg. Div. of		Lennen & Newell, Inc.		Instrumentation Div.	128
McGraw Edison Co.	9	■ Hewlett Packard,		Josephson, Cuffari & Co.	
Henderson Adv. Co.		International Import Div.	143	□ Rochar Electronique,	
By-Buk Co.	156	Lennen & Newell, Inc.		Division of Schlumberger	OAS 9
Albert Frank Guenther Law Adv., Inc.		■ Hewlett Packard, Loveland Div.	1	Promotion Vente Publicite	
Celanese Corporation of America,		Tallant/Yates Adv., Inc.		□ Rotron Manufacturing Co.	OAS 6
Celanese Plastics Div.	12, 13	■ Hewlett Packard, Palo Alto Div.	151	Lescarboura Adv., Inc.	
West, Weir & Bartel, Inc.		Lennen & Newell, Inc.		□ Schiumberger A.C.B.	OAS 7
Centralab Div. of Globe—Union, Inc.	55	Hi-G, Inc.	112	Industrie et Publicite	
The Brady Co.		Marketing Assistance, Inc.		□ Schiumberger, Ltd.	OAS 5
Cerro Copper & Brass Co.	164	Honeywell, Computer Control Div.	18, 19	Sodipa Contact	
Feeley & Wheeler, Inc.		Franklin P. Folts, Inc.		Scientific Data Systems	36
Chicago Miniature Lamp Works	48	■ Honeywell, Test Instruments Div.	127	Doyle, Dane, Bernbach, Inc.	
Buti-Roberts Advertising		Campbell Mithun, Inc.		Sensus International	118
■ Cinch Manufacturing Co.	27	Intercontinental Electronics Corp.	187	John W. Hall	
Stral Adv. Co.		Copy House Adv. Agcy.		□ SESCO	OAS 13
Clarostat Manufacturing Co.	161	Intercontinental Instruments, Inc.	115	Maurice Ridant, Editions Techniques &	
Horton, Church & Goff, Inc.		J. S. Lanza & Associates		Publicite de Firmes	
■ Clifton Precision Products Co.,		■ International Crystal Mfg. Co.	16	Signetics Corp.,	
Div. of Litton Industries	51	Robert V. Freeland & Associates		Sub. Corning Glass Works	168
Ivey Adv., Inc.		■ Intronic, Inc.	64	Cunningham & Walsh, Inc.	
■ CML Division of Tenny Engineering Co.	183	Marketing Assistance, Inc.		□ Silec Electronique	OAS 20
Keyes, Martin & Co.		I R C, Inc.	132	Publicite y Ch. Lambert	
Communications Products Div. of		Gray & Rogers, Inc.		■ Siliconix, Inc.	172
Walter Kidde & Co. Inc.,	47	ITT Wire & Cable	33	Graphics West	
Shattuck/Roether Advertising		West, Weir & Bartel, Inc.		Sodilec	170
Consolidated Electrodynamics Corp.,		■ J F D Electronics Co.,		Promotion Vente Publicite	
Sub. of Bell & Howell	165	Components Div.	145	□ Sogie	OAS 22
Hixson & Jorgensen, Inc.		Delphi Adv., Inc.		Études et Créations Publicitaire	
■ Consolidated Reactive Metals, Inc.	176	Johnson Co., E. F.	185	□ Solartron Electronic Group, Ltd.	OAS 11
Charles V. Corbin Assoc., Inc.		Midland Associates		Southern Adv., Ltd.	
Consolidated Vacuum Corp., Sub. of		■ Kepco, Inc.	120	■ Sorsensen Co., Raytheon Operation	61
Bell & Howell	52	Weiss Advertising		Urrutia & Hayes, Inc.	
Wolff Associates, Inc.		LectroMagnetics, Inc.	180	□ Souriau & Cie	OAS 18
□ Contelec	OAS 23	Van Der Boom, McCarron, Inc., Adv.		Ariane Publicite	
Werbegraphik		■ Leosona Corp.	17	□ S. P. Electronica	OAS 14
Continental Leasing Co.	183	Whitten-LaTucky, Inc.		Publicitas SPA	
Scott Adv. Agcy., Inc.		■ L E L Division of Varian Associates	204	Sperry Rand Corp.,	
■ Cornell-Dubilier Electronics	24	Snow & Depew Adv., Inc.		Sperry Electronic Tube Div.	147
Daniel & Charles, Inc.		Litton Industries, Inc.	57	Neals & Hickok, Inc.	
□ C. S. F.	OAS 2	Winchester Electronics Div.		Sprague Electric Co., The	5, 119
S P I Agency		West, Weir & Bartel, Inc.		Harry P. Bridge Co.	
Darcy Industries	177	Lockheed Missiles & Space Co.	160	■ Stackpole Carbon Co.,	
Hobco Arts, Inc.		McCann-Erickson, Inc.		Electronic Components Div.	66
Di-Acro Corp. Div. of		□ LTT	OAS 4	Meek & Thomas, Inc.	
Houdaille Industries, Inc.	49	Promotion-Vente-Publicite		Stanpat Products, Inc.	183
Charles E. Brown Adv. Agcy.		Macrosonics Corp.	170	Morton Adv., Inc.	
Dit-Mco International Division of		Carpenter, Matthews & Stewart, Inc.		Sylvania Electric Products, Inc.,	
Xebec Corp.	186	■ Magnetics, Inc.	121	Electronic Components Group	20, 21
Martin Fromm & Assoc., Inc.		Lando Adv. Agcy., Inc.		Doyle, Dane, Bernbach, Inc.	
DuPont de Nemours Co.,		■ Mallory & Co., P.R., Mfg. Div.	144	Sylvania Electric Products, Inc.,	
Industrial Fibers Nomex	114	Aitkin-Kynett Co.		Parts Div.	158
Batten, Barton, Durstine & Osborn, Inc.				Doyle, Dane, Bernbach, Inc.	

# NEW Telemetry Downconverter Systems

- Convert 2200 — 2300 MHz to 215 — 315 MHz or
- Convert 1435 — 1535 MHz to 215 — 315 MHz



Telemetry Downconverter  
Stock Model No. SFC-2250-1

These compact, weatherproof, high performance units are complete frequency conversion systems. They are designed and manufactured for high performance operation under all the environmental conditions normally encountered at telemetry installations. These converters offer excellent stability, low noise, low VSWR and high image rejection.

Check these specifications and send now for full information.

## specifications

(Model No. SFC-2250-1)  
 RF Range ..... 2200 — 2300 MHz  
 RF Range ..... 1435 — 1535 MHz\*  
 IF Range ..... 215 — 315 MHz  
 RF — IF gain ..... 25 dB  
 Noise Figure  
 (max.) ..... 7 dB\* or 10 dB  
 VSWR ..... 1.5:1  
 Image rejection ..... >70 dB  
 L.O. Stability ..... ±1 part in 10<sup>7</sup>  
 per 24 hours  
 1 dB Compression... —15 dBm input  
 L.O. Radiation ..... Down 60 dB  
 Intermodulation .... Down 30 dB for  
 2 sigs. @ —25 dBm\*  
 Intermodulation .... Down 30 dB for  
 2 sigs. @ —35 dBm  
 RF — IF Ripple ..... 1 dB  
 Power Input ..... 115V, 60 Hz  
 Size ..... 12" x 12" x 6"  
 Connectors ..... Type N

\*1435 — 1535 MHz Range

**IEL** DIVISION  
 VARIAN ASSOCIATES  
 AKRON ST., COPIAGUE, L. I., NEW YORK 11726  
 (516) AMityville 4-2200/(516) PYramid 9-8200  
 TWX Code 510-224-6692



Synthane Corp. Arndt, Preston, Chapin, Lamb & Keen, Inc.	185
■ Syntronic Instruments, Inc. Burton Browne Advertising Syntron, Division of FMC Corp. De Sales Adv., Inc.	136 50
■ Tech Laboratories, Inc. Lewis Adv. Agcy. Techni-Rite Electronics Fern/Hanaway, Inc.	181 177
□ Technique et Produits Ste de Publicite de Films et de Documentaires	OAS 15
■ Tektronix, Inc. Hugh Dwight Adv., Inc. Teradyne, Inc.	116 22
Quinn & Johnson Adv., Inc. Texas Industrial Commission The Pitluk Group	182
Texas Instruments Incorporated Components Group 190, 193, 194, 195, 196 Don L. Baxter, Division of Albert Frank-Guenther Law, Inc.	111 67
Thomson Electric Co., Inc. TRW Electronics, Capacitors Div. Fuller & Smith & Ross, Inc.	138
■ Tung-Sol Division, Wagner Electric Corp. Feeley & Wheeler, Inc.	135
Ulano Graphic Arts Supplies, Inc. Lory Roston Associates	202
Union Carbide Corp. Group I— Chemicals & Plastics Div. J.M. Mathes, Inc.	164
Unitron, Div. of Electric Machinery Mfg. Co. Warren Associates	184
Varo, Inc. Tracy-Locke Co., Inc. Vector Electronics Co. Van Der Boom, McCarron, Inc.	136 10
■ Vent-Rak Quinlan Keene Peck & McShay, Inc.	155
Vitramon, Inc. Ted Sommers, Inc. Volkert Stampings Fred Wittner Co., Inc.	163 153
Watkins-Johnson Co. William C. Estler Pub. Rel. ■ Weinschel Engineering Co. E.G. White Adv., Inc.	178
■ Weston Instruments, Inc. Transicoil Div. Arndt, Preston, Chapin, Lamb & Keen, Inc. Williams Gold Refining Co., Inc., Precious Metal Div. Stahlka, Faller & Klenk, Inc.	7
□ Zivy & Cie, S.A., N. Hans Buner	OAS 16

## Classified Advertising

F.J. Eberle, Manager

EMPLOYMENT OPPORTUNITIES	188
Motorola	188
Union Carbide Corp.	188
EQUIPMENT (Used or Surplus New) For Sale	189
A&A Electronics Corp.	189
California Elec. Mfg. Co.	189
Fishman, Philip Co.	189
Radio Research Instrument Co.	189

■ For more information on complete product line see advertisement in the latest Electronics Buyer's Guide  
 □ Advertisers in Overseas Advertising Section following Newsletter from Abroad

## Electronics Buyers' Guide

George F. Werner, General Manager  
 [212] 971-2310  
 Ray Smyth, Eastern Regional Manager  
 [212] 971-6538  
 Regina Hera, Directory Manager  
 [212] 971-2544  
 Thomas M. Egan, Production Manager  
 [212] 971-3140

## Circulation Department

Isaaca Siegel, Manager [212] 971-6057

## Research Department

David Strassler, Manager [212] 971-6058  
 Chloe D. Glover, Research Associate  
 [212] 971-6057

## Advertising Sales Staff

Frank E. LeBeau [212] 971-6464  
 Advertising Sales Manager

Wallis Clarke [212] 971-2187  
 Assistant to sales manager  
 Donald J. Austerman [212] 971-3139  
 Promotion Manager

Warren H. Gardner [215] LO 8-6161  
 Eastern Advertising Sales Manager

Atlanta, Ga. 30309: Michael H. Miller, 1375  
 Peachtree St., N.E.  
 [404] 892-2868  
 Boston, Mass. 02116: William S. Hodgkinson  
 McGraw-Hill Building, Copley Square  
 [617] CO 2-1160  
 Cleveland, Ohio 44113: William J. Boyle, 55  
 Public Square, [216] SU 1-7000  
 New York, N.Y. 10036  
 500 Fifth Avenue  
 Donald R. Furth [212] 971-3615  
 James R. Pierce [212] 971-3616  
 John A. Garland [212] 971-3617  
 Philadelphia, Pa. 19103:  
 Jeffrey M. Preston  
 Warren H. Gardner,  
 6 Penn Center Plaza,  
 [215] LO 8-6161  
 Pittsburgh, Pa. 15222: Warren H. Gardner,  
 4 Gateway Center, [412] 391-1314  
 Rochester, N.Y. 14534: William J. Boyle,  
 9 Greylock Ridge, Pittsford, N.Y.  
 [716] 586-5040

J. Bradley MacKimm [312] MO 4-5800  
 Midwest Advertising Sales Manager

Chicago, Ill. 60611: Robert M. Denmead,  
 J. Bradley MacKimm, Ralph Hanning,  
 645 North Michigan Avenue,  
 [312] MO 4-5800  
 Dallas, Texas 75201: Richard P. Poole, 1800  
 Republic National Bank Tower,  
 [214] RI 7-9721  
 Houston, Texas 77002: Kenneth George,  
 2270 Humble Bldg., [713] CA 4-8381  
 Detroit, Michigan 48226: Ralph Hanning  
 856 Penobscot Building  
 [313] 962-1793  
 Minneapolis, Minn. 55402: J. Bradley  
 MacKimm, 1104 Northstar Center  
 [612] 332-7425  
 St. Louis, Mo. 63105: Robert M. Denmead  
 The Clayton Tower, 7751-Carondelet Ave.  
 [314] PA 5-7285

James T. Hauptli [415] DO 2-4600  
 Western Advertising Sales Manager

Denver, Colo. 80202: Joseph C. Page, David  
 M. Watson, Tower Bldg., 1700 Broadway  
 [303] 255-5484  
 Los Angeles, Calif. 90017: Ian C. Hill,  
 John G. Zisch, 1125 W. 6th St.,  
 [213] HU 2-5450  
 Portland, Ore. 97204: James T. Hauptli,  
 218 Mohawk Building, 222 S.W. Morrison  
 Street, Phone [503] 223-5118  
 San Francisco, Calif. 94111:  
 James T. Hauptli, 255 California Street,  
 [415] DO 2-4600

Pierre Braude Tel: 225 85 88: Paris  
 European Director

Paris: Ken Davey  
 88-90 Avenue Des Champs-Elysees, Paris 8  
 United Kingdom and Scandinavia  
 Brian Bowes Tel. Hyde Park 1451  
 34 Dover Street,  
 London W1

Milan: Robert Saidel  
 1 via Baracchini Phone: 86-90-656  
 Brussels: F.I.H. Huntjens  
 27 Rue Ducale Tel: 136503  
 Frankfurt/Main: Hans Haller  
 Elsa-Brandstroem Str. 2  
 Phone: 72 01 81

Geneva: Ken Davey  
 1, rue du Temple Phone: 31 95 60

Tokyo: George E. Olcott, 1, Kotohiracho  
 Shiba, Minato-Ku [502] 0656  
 Osaka: Ryoji Kobayashi 163, Umegae-cho  
 Kita-ku [362] 8771

## Business Department

Wallace C. Carmichael, Manager  
 [212] 971-3191  
 Stephen R. Weiss, Production Manager  
 [212] 971-2044  
 Thomas M. Egan,  
 Assistant Production Manager [212] 971-3140  
 Dorothy Carmesin, Contracts and Billings  
 [212] 971-2908  
 Frances Vallone, Reader Service Manager  
 [212] 971-2865

# SEE MORE...DO MORE...

## For the first time there's Four-Channel Capability in a Portable, All-solid-state Scope—the hp 180 Scope System

Now—*whenever* and *wherever* you need four channels of high frequency information, the new hp 1804A Four Channel Vertical Amplifier plug-in provides more than twice the measurement capability of a two-channel scope. As a part of the lightweight 30-pound 180 scope system, the 1804A gives you 50 MHz, 20 mV/cm sensitivity, with four-channel capability in your lab, in the field or in your production area.

Use the hp 1804A amplifier with 180A mainframe for making timing comparisons or measuring relationships of up to four inputs. Use the 1804A for designing computer logic circuitry, or for checking digital logic pulse trains. You'll save time

by comparing four inputs at one time!

Use the 1804A with 181A Variable Persistence and Storage mainframe to make measurements of four low rep rate pulses. Use variable persistence to eliminate annoying flicker. For time comparison of four channels of computer logic—which often are single shot phenomena—use the storage feature to capture and hold traces for accurate comparison.

The new hp 1804A amplifier offers a choice of selectable triggering or composite triggering. When set in SELECT mode, you can trigger on any one channel and see the time relationship with each of the other channels. For composite triggering, set the SYNC MODE switch to ABCD and each channel is triggered individually.

An UNCAL indicator lights when the CAL vernier setting on any channel is out of calibration. Channels are identifiable through use of the identification button next to the position controls.

The hp 1804A amplifier is another addition to the growing group of versatile plug-ins now available for use with the

hp 180 scope system. It is compatible with either the 1820A Time Base or the hp 1821A Time Base and Delay Generator. Other plug-ins available for use with the 180A conventional display scope and the 181A Variable Persistence and Storage scope are the 1801A 50 MHz 5 mV/cm Dual Channel Amplifier, the 1802A Dual Channel Amplifier with fully usable bandwidth to > 100 MHz, the 1803A Differential/DC Offset Amplifier with its 40 MHz bandwidth and >0.5% accuracy.

Get the full story on the new hp 1804A Four-Channel Vertical Amplifier and the SEE MORE . . . DO MORE hp 180 Scope System. Contact your nearest hp field engineer. Or write to Hewlett-Packard, Palo Alto, California 94304. Europe: 54 Route des Acacias, Geneva. Price: hp 180A Oscilloscope, \$825; hp 181A Variable Persistence and Storage Oscilloscope, \$1850; hp 1804A Four Channel Vertical Amplifier, \$975; hp 1820A Time Base, \$475; hp 1821A Time Base and Delay Generator, \$800.

Circle 901 on reader service card

HEWLETT  PACKARD

OSCILLOSCOPE SYSTEMS

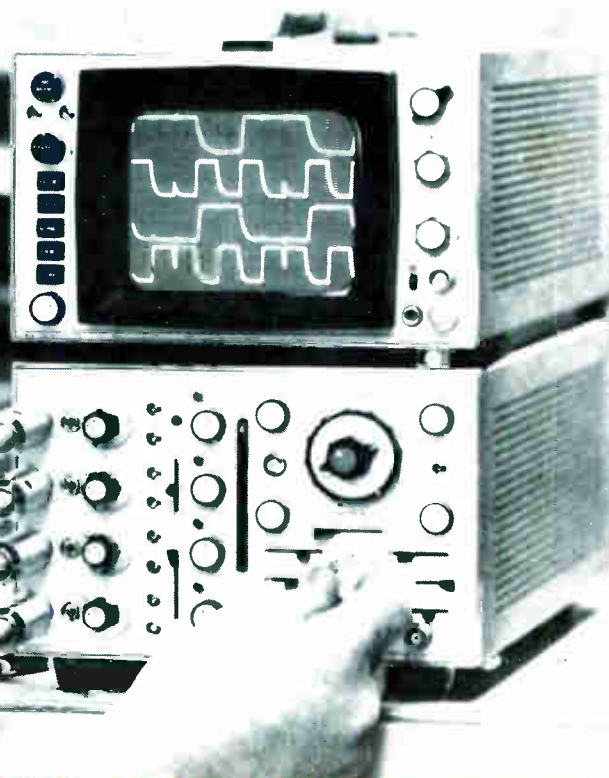

# Four power levels for SSB

New...  
four tubes for SSB. And four power levels—500 W,  
1 kW, 5 kW, and 10 kW. These rugged Cermolox<sup>®</sup>  
tubes, developed from proved, in-use designs, feature  
new lows in feedthrough capacitance and screen and  
cathode inductance plus superb IM characteristics.  
Their rugged construction makes them suitable for  
mobile service in shipboard and airborne equipment  
as well as in fixed stations.

Available at surprisingly low cost, the four are: 8791,  
8792, 8793, and 8794. In addition to their efficient use  
in SSB service, the tubes are attractive for FM,  
VHF-TV, and VHF/UHF communications.

See your RCA Representative for details, including  
prices and delivery. For technical data on specific  
types, write: Commercial Engineering, Section E19-Q,  
RCA Electronic Components, Harrison, N. J. 07029.

## RCA

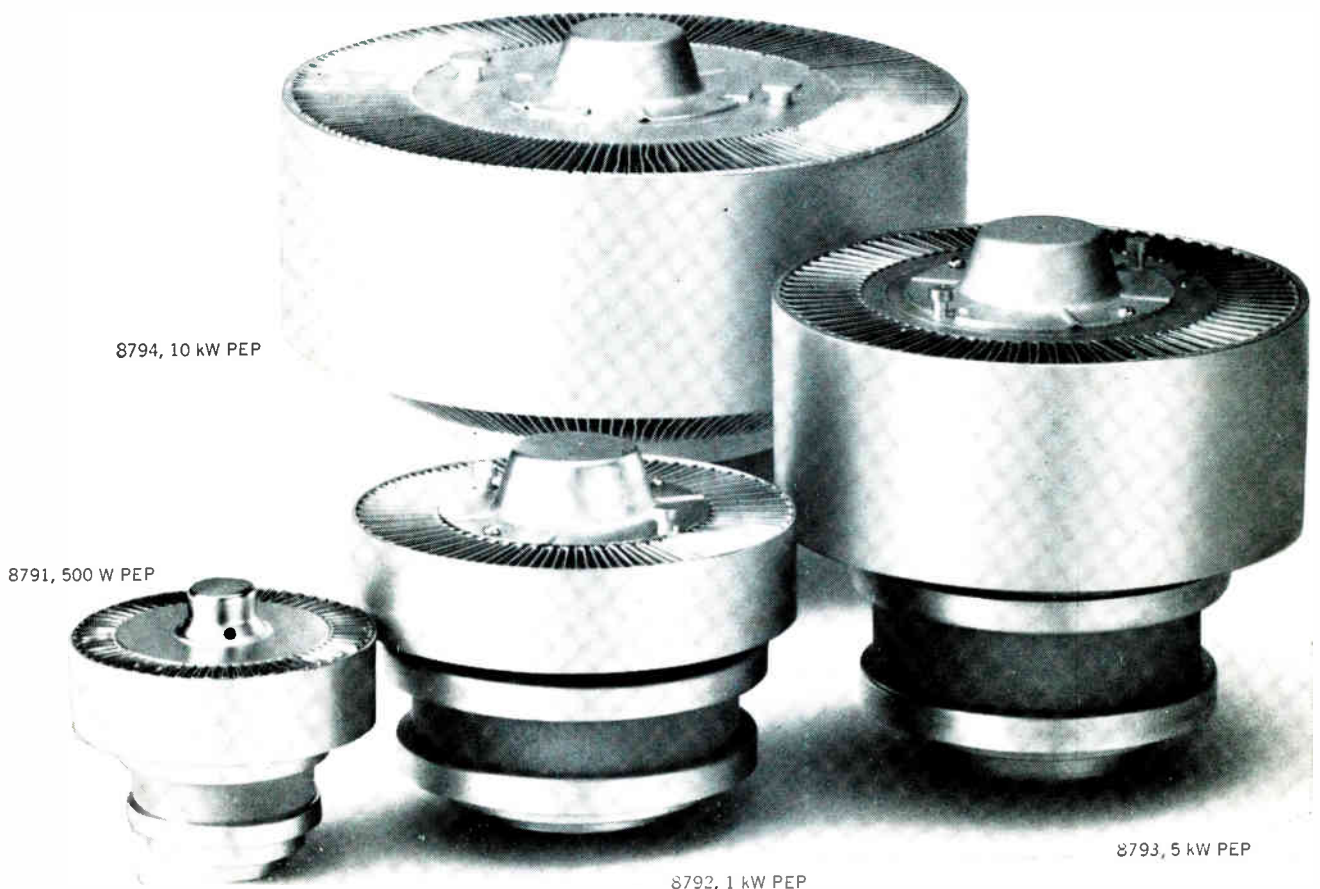

8794, 10 kW PEP

8791, 500 W PEP

8792, 1 kW PEP

8793, 5 kW PEP