

Electronics®

Computers analyze transients: page 84

How good are plastic packages? page 101

Cooling IC's with liquid dielectrics: page 123

April 17, 1967

\$1.00

A McGraw-Hill Publication

Below: Superconductive loops form big
cryoelectric memory, page 111

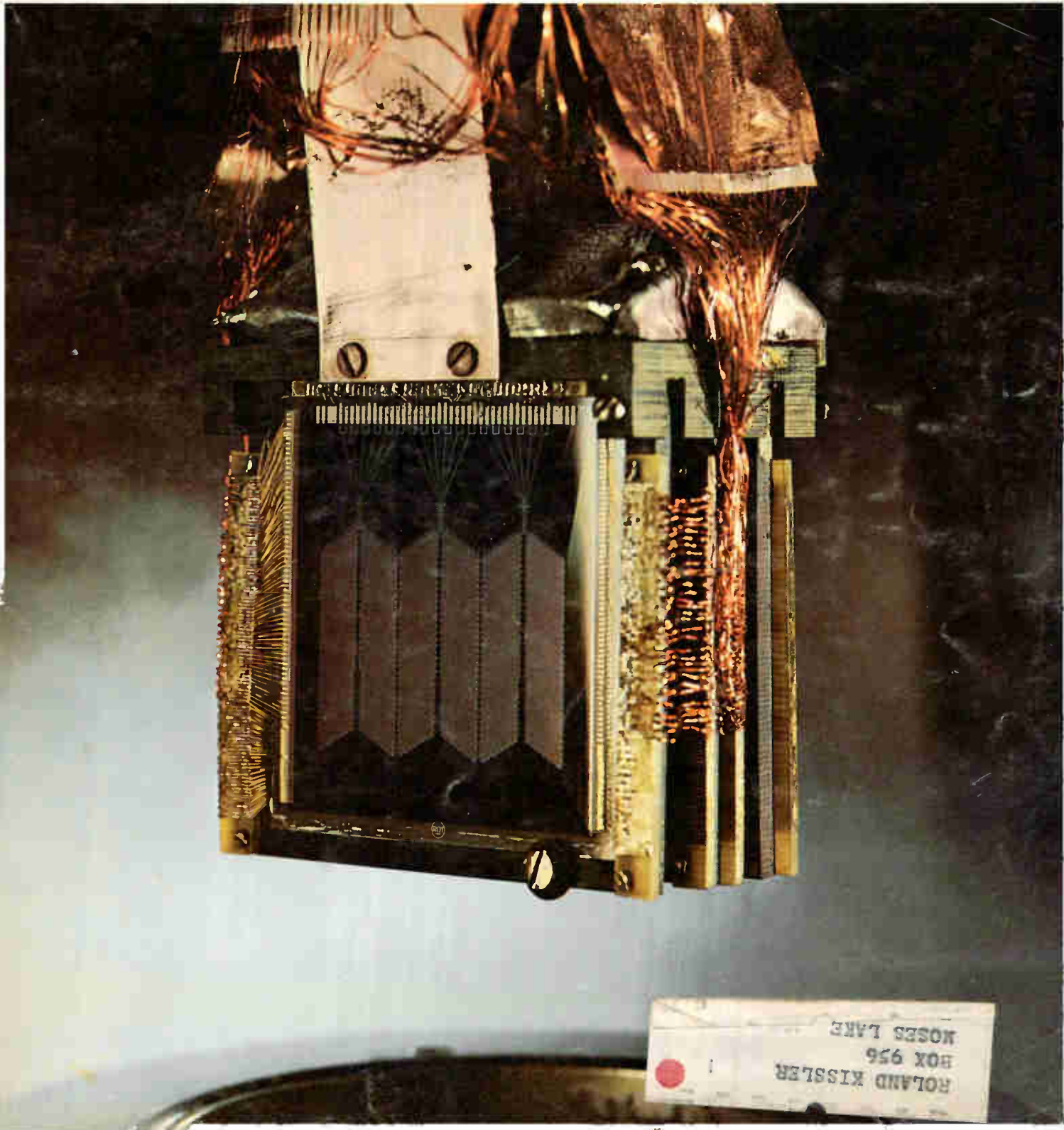



Fourier Components
bandwidth: 3 Hz
recording range: 80 dB

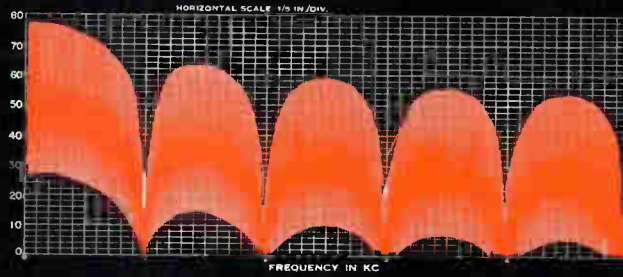

Periodic Wave
bandwidth: 50 Hz
recording range: 40 dB

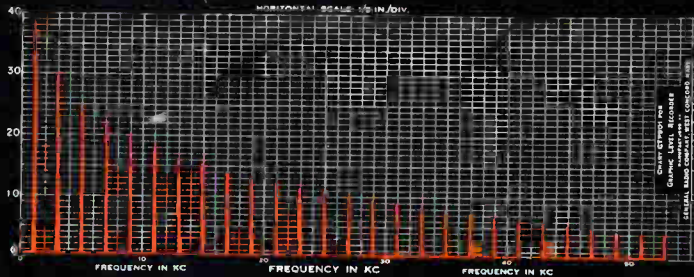

Modulation Noise
bandwidth: 10 Hz
recording range: 80 dB

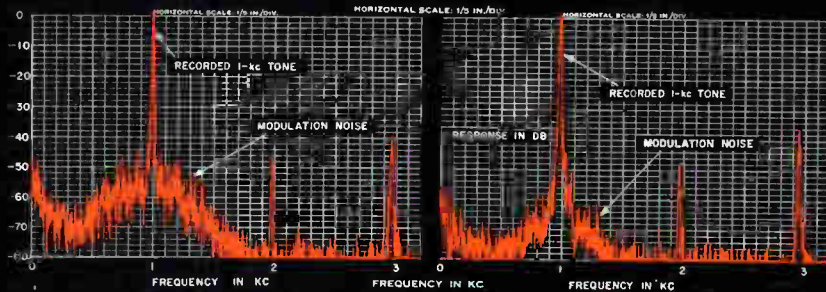

Spectrum Uniformity
bandwidth: 50 Hz
recording range: 20 dB

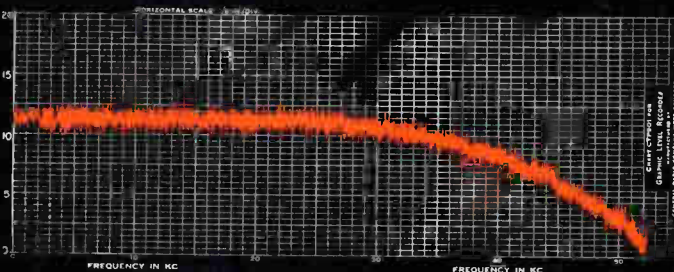

Choose from one different model



The GR Type 1910-A Recording Wave Analyzer does the work of several less-versatile instruments. With it you can select the bandwidth, recording range, averaging properties and chart resolution to match scores of different analyzing needs.

The 1910-A is a combination of a wave analyzer (Type 1900-A) and a graphic level recorder (Type 1521-B). It automatically sweeps and records input levels of 2 μ V to 300 V over a range of 20 to 54,000 Hz with 80-dB dynamic range (when set to read 100 mV, or more, full scale). Included are 3-, 10-, and 50-Hz bandwidths, 40- and 80-dB full-scale recording ranges, and several sweep and writing speeds. Optional accessories (at extra cost) extend the sensitivity to submicrovolt levels,

add a 20-dB full-scale recording range and provide still more sweep speeds.

For a complete listing of the many operating modes of the 1910-A, write General Radio Company, 22 Baker Avenue, W. Concord, Massachusetts 01781; telephone (617) 369-4400; TWX 710 347-1051.

GENERAL RADIO

Circle 900 on reader service card

Type 1910-A Recording Wave Analyzer . . . \$3955 in U.S.A.

SOLID STATE



Model 7000A

featuring
AUTOGRIP*
electric
holddown

All the advantages of solid-state design and construction are yours in a wide variety of Hewlett-Packard 8½" x 11" and 11" x 17" x-y recorders. Compact, rugged construction; solid-state reliability and long life; all with optional metric calibration and unprecedented performance characteristics. Check the list, then talk to your Hewlett-Packard field engineer about the models most useful for your task. Or write for complete information: Hewlett-Packard, Palo Alto, California 94304, Tel. (415) 326-7000; Europe: 54 Route des Acacias, Geneva.

Data subject to change without notice. Prices f.o.b. factory.

***EXCLUSIVE, CARE-FREE, DEPENDABLE PAPER HOLDDOWN.**

8-1/2" x 11" X-Y RECORDERS

- Bench/rack model in one, portable, 0.5 mv-5 v in., X-axis time base; Model 135, \$1650.
- 2-pen version of 135, 0.5 mv-50 v in.; Model 136A, \$2650.
- High-sensitivity model, 1 MΩ input impedance, time base either axis, 0.1 mv-20 v in.; Model 7030A, \$1895.
- Economy model, 1 mv-10 v in.; Model 7035A, \$895.

11" x 17" X-Y RECORDERS

- Versatile recorder, X-axis time base, 0.5 mv-50 v in., high-impedance, computer reference models available; Model 2D Series, from \$1950.
- Economy model of 2D Series, 0.5 mv-10 v in.; Model 2D-4, \$1490.
- 2-pen version of 2D Series; Model 2FA, \$3375.
- High-sensitivity ac/dc recorder, time base either axis, 0.1 mv-20 v in. dc, 5 mv-20 v in. ac; Model 7000A, \$2495 (also available without ac input, Model 7001A \$2175).
- Automatic data plotting system, null detector and character printer built in, 0.5 mv-10 v in.; Model 7590C, \$1985.

**HEWLETT
PACKARD**  **MOSELEY
DIVISION**

AC MICROVOLT METER

SEES THROUGH NOISE!



*New hp 3410A Measures
300 nanovolts
Buried in Noise*

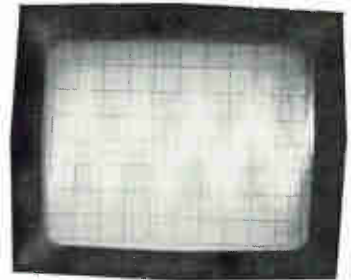

Measure 1 μ V, 500 kHz signal out of 40 dB noise.



Measure 10 mV, 5 Hz amplitude modulating
1 V, 400 Hz.



Measure 300 nanovolts, 10 kHz
signal superimposed on 10 μ V, 1 kHz.

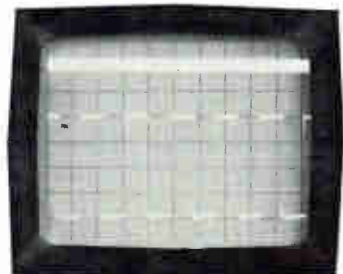

Measure frequency of signal in noise up to 560 kHz
by using square wave output,
i.e. as a counter preamplifier.

New hp Model 3410A AC Microvoltmeter measures low level repetitive signals obscured by noise—3 μ V to 3 V full scale—accuracy = 3%. RMS noise voltages up to 20 dB above full scale *do not* affect readings. Sensitivity, low cost and ease of operation are the 3410A's contribution.

This new microvoltmeter uses an hp designed phase-locked synchronous detector to separate effects of noise from signal. The detector is an electronic gate controlled by an oscillator phase-locked to the input signal. No external reference is required to lock to the input signal. Simply adjust front panel tuning control within 1% of signal frequency and phase-lock circuits *lock-on and track* input signal with $\pm 5\%$ variation in the 5 Hz to 600 kHz frequency range. Phase-lock circuits track 0.5%/sec change in signal frequency without a change in voltmeter accuracy. Input impedance is 10 M Ω shunted by 20 pF.

The new Model 3410A has two outputs on the rear panel. One is a dc recorder output for monitoring long term drifting ac voltage amplitudes. The other is an output for driving an electronic counter to make precise frequency measurements.

For full specifications on the new hp Model 3410A AC Voltmeter, call your hp field engineer. Or, write to Hewlett-Packard, Palo Alto, California 94304, Tel. (415) 326-7000; Europe: 54 Route des Acacias, Geneva. Price: hp Model 3410A, \$800.00.

HEWLETT  **PACKARD**
An extra measure of quality

097/11

News Features

Probing the News

- 149 **Bloom's gone from 1967's rosy outlook**
157 **Safeguarding time-sharing privacy—
an all-out war on data snooping**
161 **Instrument makers are measuring
up to systems engineering standards**

Electronics Review

- 47 **Manufacturing: Boosting IC's**
48 **Communications: Dial h for help**
48 **Integrated electronics:**
Complementary samples
50 **Companies: Turnaround in Phoenix**
52 **Military electronics: Unstoppable
shot? Ears to see with**
54 **Industrial electronics: Still out of
control**
56 **Computers: Not-so-firm ware**
56 **Avionics: View from above**
58 **For the record**

Electronics Abroad

- 219 **Great Britain: Trends and trails**
219 **Soviet Union: Corporate comrades;
Computers ahoy**
220 **France: Maskless marvel; Anchors
away**
222 **Japan: A new entry**
222 **West Germany: Plus-power laser;
Stressing the heart**

Departments

- 4 Readers Comment
8 People
14 Meetings
16 Meeting Preview
23 Editorial
25 Electronics Newsletter
61 Washington Newsletter
169 New Products
169 New Products Index
202 New Books
206 Technical Abstracts
210 New Literature
217 Newsletter from Abroad

Title R registered U.S. Patent Office; © copyright 1967 by McGraw-Hill Inc. All rights reserved, including the right to reproduce the contents of this publication, in whole or in part.

Technical Articles

I. Design

- Design theory** 84 **Computer-aided design: part 8**
Picking a transient analysis program
When the right combination of network design program and integration routine is chosen, transient characteristics show up quickly
W.G. Magnuson, Jr., Lawrence Radiation Laboratory
- Circuit design** 88 **Designer's casebook**
■ Making an SCR operate as a high-voltage switch
■ Monostable vibrator plus SCR yields chopper
■ Telemetry tone oscillator consumes microwatts
■ Isolated multiple oscillators provide wide frequency range
■ Feedback T yields high input impedance
- Reference sheet** 92 **Nomograms solve tough problems of shielding**
Effectiveness of a shielding design and the metal thickness needed to eliminate interference are given by charts
R.B. Cordell, Genisco Technology Corp.

II. Applications

- Solid state** 101 **Plastics for packaging: handle with care**
Plastic encapsulations lower the cost of transistors and integrated circuits but the wrong materials will degrade the devices instead of protecting them
J.J. Licari, North American Aviation Inc.
- Advanced technology** 111 **Taking cryoelectric memories out of cold storage**
Hopes for mass memories that are fast as well as cheap are renewed by a newly designed storage loop that overcomes processing problems of superconductive thin-film elements
R.A. Gange, Radio Corp. of America
- Packaging** 123 **Dielectric bath promotes togetherness in IC's**
Liquid cooling of exposed integrated circuits may offset rising power densities to allow more IC's to go into smaller, faster systems
R.R. Weirather and Tiong Go, Motorola Inc.

Electronics

Editor-in-Chief: Lewis H. Young

Associate managing editors

Design: Samuel Weber
Application: George Sideris
News: Robert Henkel
Copy: Sally Powell

Senior editor

Special projects: Donald Christiansen

Senior associate editors

John F. Mason, Joseph Mittleman, Stephen E. Scrupski

Department editors

Advanced technology: Stephen E. Scrupski
Avionics: W.J. Evanzia
Communications: Leonard Weller
Computers: Wallace B. Riley
Design theory: Joseph Mittleman
Industrial electronics: Alfred Rosenblatt
Instrumentation: Carl Moskowitz
Military electronics: John F. Mason
New products: William P. O'Brien
Staff writer: Paul Dickson

Section editors

Electronics abroad: Arthur Erikson
Electronics review: Stanley Zarowin
Probing the news: Eric Aiken

Regional bureaus

Domestic

Boston: Thomas Maguire, manager; Robin Carlson
Los Angeles: Lawrence Curran, manager; June Ranill
San Francisco: Walter Barney, manager; Mary Jo Jadin
Washington: William D. Hickman, Patricia C. Hoehling, correspondents

Foreign

Bonn: John Gosch
London: Michael Payne
Tokyo: Charles Cohen

Copy editors

Albert Tannenbaum, James Chang, Frederick Corey

Graphic design

Art director: Saul Sussman
Assistant art directors: Ann Mella, Valerie Betz
Production editor: Arthur C. Miller

Editorial secretaries: Marlene Angrist, Claire Benell, Lynn Emery, Lorraine Fabry, Kay Fontana, Patricia Gardner, Lorraine Longo

McGraw-Hill News Service

Director: John Wilhelm; Atlanta: Fran Ridgway; Chicago: James Rubenstein;
Cleveland: Arthur Zimmerman; Dallas: Marvin Reid;
Detroit: N. Hunter; Houston: Robert E. Lee; Los Angeles: Michael Murphy, Gerald Parkinson
Pittsburgh: Louis Gomolak
San Francisco: Margaret Drossel
Seattle: Ray Bloomberg; Washington: Arthur L. Moore, Charles Gardner,
Herbert W. Cheshire, Seth Payne, Warren Burkett

McGraw-Hill World News Service

Bonn: John Johnsrud; London: John Shinn;
Mexico City: Bruce Cross; Milan: Ronald Taggiasco;
Moscow: Howard Rausch; Paris: Peter Kilborn;
Rio de Janeiro: Wes Perry; Tokyo: Marvin Petal

Reprints: Susan Nugent

Publisher: Gordon Jones

Electronics: April 17, 1967, Vol. 40, No. 8

Published every other Monday by McGraw-Hill, Inc. Founder: James H. McGraw 1860-1958.

Printed at 99 North Broadway, Albany, N.Y. 12207; second class postage paid at Albany, N.Y.

Executive, editorial, circulation and advertising addresses: McGraw-Hill Building, 330 W. 42nd Street, New York, N.Y. 10036. Telephone (212) 971-3333. Teletype TWX N.Y. 212-640-4646. Cable address: MCGRAWHILL N.Y.

Subscriptions are solicited only from those actively engaged in the field of the publication. Position and company connection must be indicated on orders. Subscription prices: United States and possessions and Canada, \$8.00 one year, \$12.00 two years, \$16.00 three years; all other countries, \$25.00 one year. Single copies: United States and possessions and Canada, \$1.00; all other countries, \$1.75.

Officers of McGraw-Hill Publications: Joseph H. Allen, President; Bayard E. Sawyer, Executive Vice President; Vice Presidents: J. Elton Tuohig, Operations; John R. Callahan, Editorial; John M. Holden, Marketing; Huber M. Gemmill, Circulation; Angelo R. Venezian, Production; Robert M. Wilhelm, Controller.

Officers of the Corporation: Donald C. McGraw, Chairman of the Board; Shelton Fisher, President; L. Keith Goodrich, Donald C. McGraw, Jr. and Robert E. Slaughter, Executive Vice Presidents; John J. Cooke, Vice President and Secretary; John L. McGraw, Treasurer.

Title registered in U.S. Patent Office; © Copyright 1967 by McGraw-Hill, Inc. All rights reserved. The contents of this publication may not be reproduced either in whole or in part without the consent of copyright owner.

Subscribers: The publisher, upon written request to our New York office from any subscriber, agrees to refund that part of the subscription price applying to copies not yet mailed. Please send change of address notices or complaints to Fulfillment Manager; subscription orders to Circulation Manager, Electronics at address below. Change of address notices should provide old as well as new address, including postal zip code number. If possible, attach address label from recent issue. Allow one month for change to become effective.

Postmaster: Please send form 3579 to Fulfillment Manager, Electronics, P.O. Box 430, Hightstown, New Jersey 08520

Readers Comment

One approach

To the Editor:

In response to the article "No wane in brain drain" [March 20, p. 171], may I suggest that a possible solution to the problems lies in having more U.S. companies establish subsidiaries in Europe. These subsidiaries could operate those laboratories and departments in which the shortage of engineers at home is most acute, staffing them mostly with locally recruited engineers, while maintaining a close working relationship with the parent companies. In addition to solving the brain drain problem to the satisfaction of everyone concerned, such an approach may hold in the balance, some direct, as well as indirect, advantages for the companies themselves.

Uri F. Gronemann

Research engineer
Electronic Systems Laboratory
Massachusetts Institute of
Technology
Cambridge, Mass.

Some companies have earned the "international" in their name in this way. Others have established cross-licensing arrangements or have farmed out a particular development problem to an overseas specialist. But these are not direct solutions to a critical gap in the engineering staff at home.

No help needed?

To the Editor:

I agree that government research and development contributes significantly to technical progress, as pointed out in your editorial, "Transferring technology" [Jan. 23, p. 23]. However, I am surprised that you cited the transistor as a development which might have remained a laboratory curiosity without pressure from a Federal program.

A solid state amplifier was a dream of many communications engineers in the 1930's and 1940's, and Bell Telephone Laboratories' research in semiconductor physics was stimulated by this hope. Therefore, after invention of the tran-

Sprague has what it takes to cope with any problem in electromagnetic interference or susceptibility control

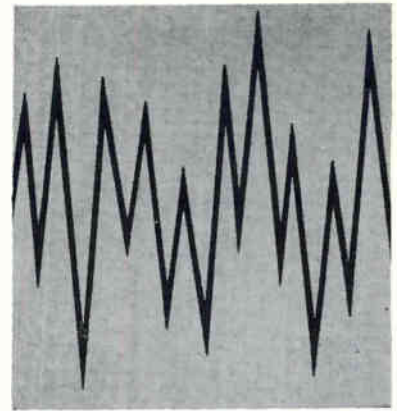

And we mean any problem . . . arising at any point in the development of any equipment or system!

Sprague's interference control facilities provide one of the most complete, fully integrated capabilities you can call on . . . embracing *every* aspect of interference and susceptibility control.

Design Assistance: Black boxes . . . subsystems . . . complete systems. Using advanced interference prediction techniques, Sprague engineers replace design by "hunch" with precise analysis of electrical schematics. Suppression and shielding can be designed into pre-prototype plans so accurately that little or no modification is required upon evaluation of the model. With today's more complex equipment and increasingly stringent EMI requirements, Sprague assistance in initial design can pay for itself in a dozen different ways by helping you be right the *first* time!

Measurement, Evaluation: Sprague can help you measure interference and susceptibility characteristics of your breadboard, prototype, or production equipment to the applicable interference specification. You know where you stand before investing in further development. We can also research such areas as shielding effectiveness, screen room integrity, transient susceptibility of digital equipment, and cable cross coupling.

Component Design: Sprague Filter Engineering Specialists can design, evaluate, and sample interference control devices to your particular requirements. These range from standard feed-thru capacitors and radio interference filters to the more sophisticated packages, such as frequency-controlling electric wave filters.

Component Production: Each of four Filter Development Centers maintains a well stocked model shop for the rapid fabrication of special

components in prototype quantities. Full scale production facilities are maintained in Visalia, Calif.; North Adams, Mass.; and Vandalia, Ohio.

Compliance Testing: Sprague can test your equipment or system and report on its compliance to the applicable specification: MIL-I-6181, MIL-I-26600, MIL-I-16910, MIL-E-6051 or to such other specialized interference documents as GM07-59-2617A, AFBSD Exhibit 62-87 (Minuteman WS133B), LSMC Specification ERS11897 (Polaris A3) or MIL-STD-449. If compliance is not indicated, a Sprague engineer will make concise recommendations and will, if you desire, give you every assistance in achieving that compliance.

Regional Service: Wherever you may be, this integrated EMI capability is readily available to you from strategically located Filter Development Centers in North Adams, Mass.; Annapolis Junction, Md.; Vandalia, Ohio; and Los Angeles, Calif. Each is fully equipped and staffed to evaluate, modify, or qualify your equipment.

In-plant Service: Sprague can put competent Interference Control Specialists at your service in your plant for consultation on, or supervision of, special projects.

Whether your work involves military or industrial electronic equipment or systems, Sprague Filter Development Center personnel can help assure substantial savings in dollars and hours at many points during development. Get complete information from the development center nearest you or by writing for a comprehensive brochure (FD-101) to Technical Literature Service, Sprague Electric Company, 35 Marshall Street, North Adams, Mass. 01247

FILTER DIVISION PRODUCTS AND SERVICES

INTERFERENCE FILTERS AND CAPACITORS
PRECISION TOROIDAL INDUCTORS
FREQUENCY SPECTRUM SIGNATURES
COMPONENT ENVIRONMENTAL TEST FACILITIES

ELECTRIC WAVE FILTERS
TELEMETRY FILTERS
EMI TEST FACILITIES
EMI SYSTEMS ENGINEERING



Sprague and ® are registered trademarks of the Sprague Electric Co.



Don't be manipulated on SCR's—trust IR.

IR's Application Fact Book lets you select only specs that count.

SCR specifications take on a refreshing air of common sense when you read the new IR Application Fact Book. When do premium parameters really affect circuit performance? What do you give up to get a given parameter? What *combinations* of premium parameters are needed *and possible*...and at what price? You get the answers straight from IR, and you make your selection from quality SCR's rated from 4.7 amps to 550 amps RMS—25 to 1300 volts.

Specifying engineers are in the pivotal position today to smooth out production problems, to end delivery dilemmas, and protect performance. How? By writing specs around the parameters actually needed and

actually available...off-the-shelf, overnight. Most of the information needed to write such common sense specs can be found right in the book. If your application is farther out, call an IR sales engineer. We are pioneers, too, and know how to help you innovators.

APPLY YOURSELF TO THE FACTS OF SCR DESIGN. Write for IR's Application Fact Book. It's free, and it's packed with data to help you sidestep problems from design to delivery of: regulated power supplies, frequency converters, DC motor drives...*you name it!*

IR INTERNATIONAL RECTIFIER
(213) OR 8-6281 • TELEX 6-74666 • EL SEGUNDO, CALIF.

ZENER AND REFERENCE ZENER DIODES SILICON CONTROLLED RECTIFIERS SELENIUM RECTIFIERS SILICON ASSEMBLIES

Circle 6 on reader service card

sistor, we formed a group in 1948 to develop the transistor for communications use. Bell Laboratories contributed to rapid dissemination of transistor technology by its policy of immediate publication and by symposia held in 1951 and 1952 for military and licensee engineers. In 1956, a symposium for licensees disclosed the diffusion technology that permitted low-cost mass production.

Your impression that the Bell System began putting transistors into telephone systems only a few years ago probably stems from recent announcements of new electronic switching systems, which certainly will make more use of transistors than ever before.

Transistors have been used in telephone equipment since the early 1950's. The junction transistor, first realized in 1951, was immediately put to use in the headset amplifier for telephone operators, in rural telephone carrier amplifiers, and by other companies in radios and hearing aids. By 1958, transistors were also used in amplifier telephone sets, signaling sets, card translators, and other equipment. And we were experimenting with electronic switching, pcm transmission, microwave and video amplifiers, electronic PBX's and other transistor equipment.

Bruce E. Strasser
Technical information manager
Bell Telephone Laboratories
Murray Hill, N.J.

Strasser's letter goes on to cite significant military and space equipment developed at Bell Labs with transistors. It still seems to be a chicken-and-egg question. Could other developers of semiconductor devices have survived

the early years if the Government had not been ready to pay \$100 or so for a transistor and \$200 for an integrated circuit?

Radio astronomy

To the Editor:

In the Newsletter from Abroad item, "Soviets discount far-out broadcasts" [April 3, p. 258], the pass frequencies are indicated as 1 hertz and 0.1 hertz. Shouldn't this be 1 khz and 0.1 khz?

Daniel C. Weinstein
Brooklyn, N.Y.

No. One problem in attempting to receive signals from other worlds is that the time spent searching for signals could also become astronomical. Therefore, the Russians suggested simultaneous reception on many channels with pass bands as narrow as 1 to 0.1 hz.

An earlier version

To the Editor:

In my article, "Space for small computers" [March 20, p. 127], the diagram on page 128 is the data system of the early IMP spacecraft, rather than the single-channel-encoder data system described in the caption and referred to on page 129.

Rodger A. Cliff
Goddard Space Flight Center
National Aeronautics and Space
Administration
Greenbelt, Md.

The drawing that should have been used shows a commutator on the left of the telemetry encoder and a single pfm oscillator on the right, feeding the transmitter.

We've discovered the missing link!



Now you can link any oscilloscope and X-Y or strip recorder with one of PM's display converters. Fast phenomena that could only be observed on the CRT before can now be recorded. Your oscilloscope displays are recorded on large, easily read, easily stored paper charts. You can write directly on them... make notes, comments, and annotations. You can keep progress reports of each circuit change or product improvement; make historical records for quality assurance trends; and distribute proof of performance data.

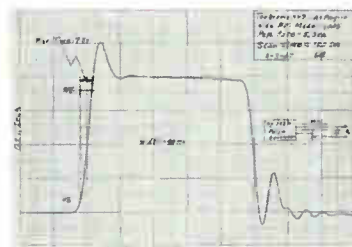

PM Display Converters permit the recording of displays from dc to 50 MHz. Does not degrade oscilloscope performance.
PM-1001 Standard Unit \$490.00
PM-1001-02 with curve tracer option \$635.00
PM-1005 Manual Scan. Very low repetition rates. \$690.00

PM PACIFIC
MEASUREMENTS
INCORPORATED

940 INDUSTRIAL AVENUE,
PALO ALTO, CALIFORNIA
(415) 328-0300

SUBSCRIPTION SERVICE

Please include an Electronics Magazine address label to insure prompt service whenever you write us about your subscription.

Mail to: Fulfillment Manager
Electronics
P.O. Box 430
Hightstown, N.J. 08520

To subscribe mail this form with your payment and check new subscription renew my present subscription

Subscription rates: in the U.S.: 1 year \$8; two years, \$12; three years, \$16. Subscription rates for foreign countries available on request

CHANGE OF ADDRESS

ATTACH LABEL HERE

If you are moving, please let us know five weeks before changing your address. Place magazine address label here, print your new address below.

name

address













city

state

zip code

All from Sprague!

TWELVE OF OUR MOST POPULAR METALLIZED CAPACITOR TYPES

SPRAGUE TYPE	Case And Configuration	Dielectric	Temperature Range	Military Equivalent	Eng. Bulletin
 680P	hermetically-sealed metal-clad tubular	metallized Metfilm* 'A'	-55 C, +85 C	no specification	2650
 431P	film-wrapped axial-lead tubular	metallized Metfilm* 'E' (polyester film)	-55 C, +85 C	no specification	2445
 155P	molded phenolic axial-lead tubular	metallized paper	-40 C, +85 C	no specification	2030
 156P					
 218P	hermetically-sealed metal-clad tubular	metallized Metfilm* 'E' (polyester film)	-55 C, +105 C	CH08, CH09 Characteristic R	2450A
 260P	hermetically-sealed metal-clad tubular	metallized Metfilm* 'K' (polycarbonate film)	-55 C, +105 C	no specification	2705
 121P	hermetically-sealed metal-clad tubular	metallized paper	-55 C, +125 C	no specification	2210C
 118P	hermetically-sealed metal-clad tubular	metallized Difilm® (polyester film and paper)	-55 C, +125 C	CH08, CH09 Characteristic N	2211D
 143P	hermetically-sealed metal-clad "bathtub" case	metallized paper	-55 C, +125 C	no specification	2220A
 144P	hermetically-sealed metal-clad "bathtub" case	metallized Difilm® (polyester film and paper)	-55 C, +125 C	CH53, CH54, CH55 Characteristic N	2221A
 284P	hermetically-sealed metal-clad rectangular case	metallized paper	-55 C, +105 C	no specification	2222
 283P	hermetically-sealed metal-clad rectangular case	metallized Difilm® (polyester film and paper)	-55 C, +125 C	CH72 Characteristic N	2223
 282P (energy storage)	drawn metal case, ceramic pillar terminals	metallized paper	0 C, +40 C	no specification	2148A

*Trademark

For additional information, write Technical Literature Service, Sprague Electric Company, 35 Marshall St., North Adams, Mass. 01247, indicating the engineering bulletins in which you are interested.

SPRAGUE COMPONENTS

CAPACITORS
TRANSISTORS
RESISTORS
THIN-FILM MICROCIRCUITS
INTEGRATED CIRCUITS
INTERFERENCE FILTERS
68C-6135

PACKAGED COMPONENT ASSEMBLIES
FUNCTIONAL DIGITAL CIRCUITS
MAGNETIC COMPONENTS
PULSE TRANSFORMERS
CERAMIC-BASE PRINTED NETWORKS
PULSE-FORMING NETWORKS



*Sprague and ® are registered trademarks of the Sprague Electric Co.

People

Relying almost exclusively on Pentagon purse-strings isn't a problem for **Burton Cutler**, new president of ITT Gilfillan, Inc., a Los Angeles-based producer of radar systems, countermeasures, and displays.



Burton Cutler

"Our sales are about 95% to the military," says the 6-foot-6-inch, 40-year-old official, adding that he doesn't plan to alter the picture significantly. Air-traffic control radars for foreign governments account for the remainder of Gilfillan's volume.

Cutler notes that as one of more than 400 members of the International Telephone & Telegraph Corp. family, Gilfillan doesn't have to concern itself with an unfavorable military-to-commercial ratio. "We're seeking maximum penetration of the area assigned to us, which isn't at all limiting," he says. However, the company is moving quietly to broaden its foundation in systems other than the ground-control approach radars for which it is probably best known.

The executive is sold on the future of solid state phased-array radar, and Gilfillan's most important current research effort is concentrating on that technology. The program began in January and is expected to run three years.

Cutler succeeded E.S. Phillips, who was named chairman of the ITT subsidiary last month. The new president, formerly a vice president and director of engineering, has an MSEE from Stanford University, and holds several radar patents.

Gilfillan employs about 2,600 and had sales last year of about \$40 million. Cutler predicts a volume rise this year to \$50 million, with the initial production of newly developed three-dimensional air defense radars accounting for most of this gain. Already operational with the Navy is the firm's AN/SPS-48 3-D radar, the primary sensor for Tartar and Terrier surface-to-air missiles. Another 3-D radar system, the long-range AN/TPS-32, is being developed for the Marine



1967 Guide to Machlett and Machlett-Penta Electron Tubes

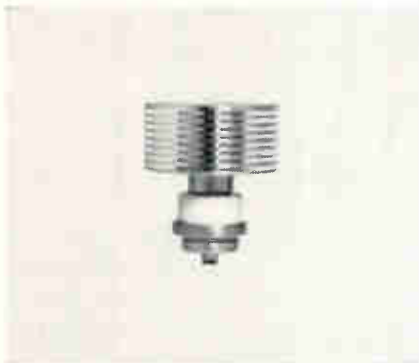

Planar Triodes.

Grid pulsed to 1 kw at 6 Gc. To 35 kw in pulse modulator service. For communications, radar beacons and navigation.



Magnetic Beam Triodes.

Pulsed ratings to 6 Mw with only 2.5 kw drive. CW ratings to 200 kW with only 0.7 kW drive.



Heavy Duty Tetrodes.

Includes vapor cooled tetrodes, to 300 kw CW.



Pulse Modulators.

Shield grid triodes (oxide cathode) to 4.5 Mw, 80 kv peak. High voltage triodes (thoriated tungsten cathode) to 20 Mw with plate voltages to 200 kv peak.



Heavy Duty Triodes.

Includes vapor cooled triodes, to 440 kW CW.



Vacuum Capacitors, Variable.

RMS amperes to 75A; voltage to 15 kv peak. Capacities from 5-750 pF to 50-2,300 pF.



Machlett-Penta Intermediate Power Pentodes.

Vane suppressor pentodes to 300 w PEP with -40 db 3rd order IM without feedback; to 10,000 w PEP, -35 db 3rd order IM without feedback,

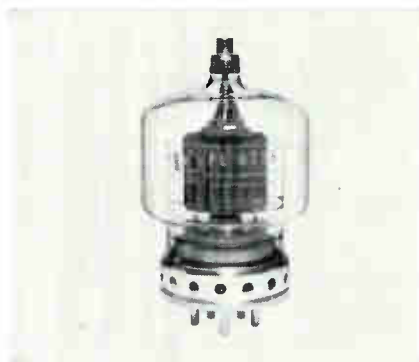

Machlett-Penta Intermediate Power Tetrodes and Triodes.

Power to 3.4 kW CW.



High Vacuum Rectifier Tubes.

To 165 PKV (Machlett) to 60 PKV (Penta).

Send for latest condensed catalogs

covering the entire line of Machlett electron tubes and Machlett-Penta power tubes. Write: The Machlett Laboratories, Inc., Springdale (Stamford) Conn. 06879.



THE MACHLETT LABORATORIES, INC.

A SUBSIDIARY OF RAYTHEON COMPANY

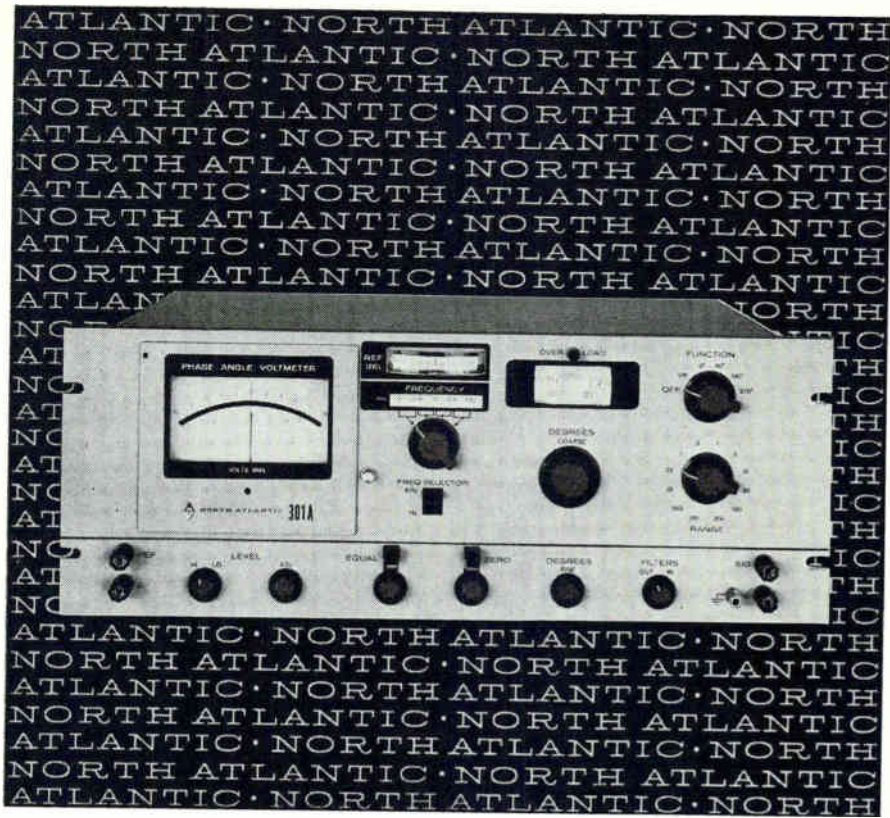

how to measure phase angle down to .25° from 10Hz to 100KHz (plus in-phase and quadrature!)

North Atlantic's Model 301A Broadband Phase Angle Voltmeter* adds a new dimension to AC by enabling you to measure phase angle, in-phase and quadrature while frequency is varying over half-decades...without recalibration. It provides complete coverage from 10Hz to 100KHz and incorporates plug-in filters to reduce the effects of harmonics in the range from 27Hz to 28KHz with only 11 sets of filters. Vibration analysis and servo analysis are only two of the many applications for this unit. Selected specifications are listed below:

Voltage Range.....	1 mv to 300 volts full scale
Voltage Accuracy.....	2% full scale
Phase Dial Range.....	0° to 90° with 0.1° resolution (plus 4 quadrants)
Phase Accuracy.....	0.25°, 31.6Hz to 31.6KHz (derating to .6° at 10Hz, 1° at 100KHz)
Input Impedance.....	10 megohms, 30μf for all ranges (signal and reference inputs)
Reference Level Range.....	0.15 to 130 volts
Harmonic Rejection.....	50 db
Nulling Sensitivity.....	less than 2 microvolts
Size.....	19" x 7" x 13½" deep
Price.....	\$2290.00 plus \$160.00 per set of filters

North Atlantic's sales representative in your area can tell you all about this unit as well as other Phase Angle Voltmeters* for both production test and ground support applications. Send for our data sheet today.



NORTH ATLANTIC industries, inc.
 TERMINAL DRIVE, PLAINVIEW, NEW YORK 11803 • 516-681-8600

*Trademark

People

Corps.
 But Cutler isn't ignoring opportunities to apply Gilfillan's experience to new fields. The firm has embarked on a campaign to recruit a team of systems engineers with aerospace backgrounds, for example. It's also working to enhance its expertise in the field of electronic countermeasures, and is quite proud of winning an Army contract to develop a battlefield surveillance radar.

Robert B. Lomerson, 37, built a better integrated-circuit package and engineers began to beat a path to the door of his Flying L Co. in Saginaw, Texas. His packages could be made smaller than conventional ic flatpacks, yet were easier to solder than large, plug-in packages because they stood on stiff, square legs. The idea looked great; requests for information came in from most of the nation's major electronics firms and from companies as far away as Argentina and Finland.



R. B. Lomerson

Last fall and winter, Lomerson kept a few employees busy building sample packages while he crisscrossed the country talking to potential customers. Between trips, he worked on new versions of the package and assembly methods [Electronics, April 3, p. 139].

Assembling sample packages was one thing, but assembling the capital needed to mass produce them was another. Lomerson's pleas to banks fell on deaf ears. For a while, he fended off electronics companies' offers to buy Flying L, clinging to the idea of a company of his own. But finally his savings ran out.

Two weeks ago, he sold his firm to Varo Inc. of Garland, Texas.

Lomerson will continue to work on his packages as Varo's senior development engineer. He says the company plans to produce his packages and keep Flying L in Saginaw.

Model QRE 7.5-10



Model QRE 10-3.7

Sorensen Off-the-Shelf Power Supplies Designed for Integrated Circuits:

Sorensen has provided stock availability of the new QRE Series. This series was designed specifically for use with integrated circuits, micro miniature chips, and digital logic circuitry. QRE provides overvoltage protection within 10 microseconds, voltage regulation, line and load combined, is $\pm 0.005\%$ or $\pm 0.01\%$.

All QRE units include these Sorensen features, series/parallel operation, remote sensing, remote programming and high stability. Designed as a space saving system the QRE Series may be selected from either modular or 3 $\frac{1}{2}$ " high rack units.

MODEL	V/A RANGES	PRICES
QRE 10-2.2	0-10V, 0-2.2A	\$135
QRE 10-3.7	0-10V, 0-3.7A	155
QRE 7.5-10	0-7.5V, 0-10A	.295
QRE 7.5-20	0-7.5V, 0-20A	465
QRE 7.5-50	0-7.5V, 0-50A	595

For QRE details, or for information on other stock or custom DC power supplies, AC line regulators, frequency changers, or for our free catalog #662A, contact your Sorensen rep., or Raytheon Company, Sorensen Operation, Richards Ave., Norwalk, Conn. 06856. Tel: 203-838-6571.





Nanosecond switching.

**A shortcut through
the basement.**

**Isolated buried layer
transistors.**

Invented here.

FAIRCHILD
SEMICONDUCTOR

there's a better way to do it!

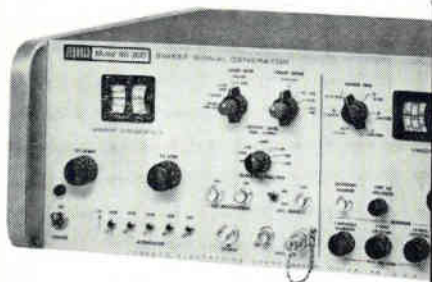

JERROLD SS-300 Sweep System

Jerrold has come up with a new idea — a solid-state sweep frequency system that does it all — in one compact unit. The extraordinary SS-300 incorporates a sweep generator (500 kHz to 300 MHz), plus a variable frequency marker generator and a detector system.

Features include:

- Remote Programming
- Start-Stop Frequency Tuning
- Exceptional Sweep Frequency Linearity
- Automatic Leveling Without Frequency Shift.

There's a brochure detailing every exciting feature . . . and we'll be happy to send it to you on request.



MEASUREMENT AND
TEST INSTRUMENTATION

JERROLD ELECTRONICS CORPORATION
Government and Industrial Division
Philadelphia, Pa. 19105

there's a better way to do it!

Jerrold TECH/NOTE No. 5001 details "a better way to do it" than the static point-to-point technique of determining AM rejection of limiter design. Request your copy.

Meetings

Spring Joint Computer Conference, IEEE; Atlantic City, N.J., April 18-20.

Southeastern Instrument Conference, Instrument Society of America; Cocoa Beach, Fla., April 18-20.

Conference on Semiconductor Device Research, IEEE; Federal Republic of Germany, April 19-22.

Southwestern IEEE Conference and Exhibition, IEEE; Dallas, Texas, April 19-21.

Semiconductor Device Research, IEEE; Bad Nauheim, West Germany, April 19-22.

Symposium on Vacuum Science & Technology, New Mexico Section of the American Vacuum Society, Holiday Inn, Albuquerque, New Mexico, April 19-21.

Meeting on Welding Design and Reliability, Engineering Institutes; University of Wisconsin, Madison, Wis., April 20-21.

Textile Industry Technical Conference, IEEE; Charlotte, N.C., April 20-21.

Seminar on Computer Graphics and Time-Sharing Systems, Association for Computing Machinery, Holiday Inn, Atlantic City, N.J., April 21-22.

Aeronautic Meeting, Society of Automotive Engineers; Statler-Hilton Hotel, New York, April 24-27.

Conference For Protective Relay Engineers, Electrical Engineering Department; Texas A&M University, College Station, Tex., April 24-26.

Engineering Conference, American Society of Tool and Manufacturing Engineers; McCormick Place, Chicago, April 24-28.

Conference on Integrated Circuits, IEEE; London, April 24-May 1.

Simulation and Training Conference, Society of Automotive Engineers; Statler-Hilton Hotel, New York, April 24-27.

National Relay Conference, National Association of Relay Manufacturers; Oklahoma State University, Stillwater, Okla., April 24-25.

Frequency Control Symposium, U.S. Army Electronics Command; Shelburne Hotel, Atlantic City, N.J., April 24-26.

Institute on Management Technology and the Optimization of R&D, American University; Twin Bridges Marriott Hotel, Washington, D.C., April 24-27.

Joint Railroad Conference, IEEE and American Society of Mechanical Engineers, Erie, Pa., April 25-26.

Symposium on Test Methods and Measurements of Semiconductor Devices, Scientific Society for Telecommunication; Budapest, April 25-28.

Symposium on Advanced Technology Available for Commercialization, North Carolina Science & Technology Research Center; Research Triangle Park, N.C., April 26-27.

Aerospace Instrumentation Symposium, Instrument Society of America; Marriott Motor Hotel, Philadelphia, Pa., May 2-4.

National Telemetering Conference, American Institute of Aeronautics and Astronautics; San Francisco Hilton Hotel, San Francisco, May 16-18.*

Call for papers

International Pulse-Symposium, International Federation of Automatic Control; Budapest, April 9-11, 1968. June 1 is deadline for submission of papers to International Pulse-Symposium, Budapest 112, POB 63, Hungary.

Electronics and Aerospace Systems Technical Convention, IEEE; Shelton Park Hotel, Washington, D.C., April 16-18. June 1 is deadline for submission of papers to Donald Hagner, Bionics Comm Inc., 1107 17th St. N.W., Washington, D.C. 20036.

Marine Sciences Instrumentation Symposium, Instrument Society of America; Florida, January 1968. June 1 is deadline for submission of abstracts to Fred Alt, director, Testing Division, Naval Oceanographic Office, Washington, D.C. 20390.

* Meeting preview on page 16.

Use the new Fluke 931A to measure virtually any waveform within 0.05% from 30 Hz to 50 KHz. Make these measurements without losing null sensitivity as the voltage decreases. For in the Fluke 931A, the null meter indicates percent deviation from the dialed voltage. Overall frequency response is 10 Hz to 1 MHz. Range is 0.01 to 1100 volts. Ten to one crest factor takes care of effects caused by voltage spikes and pulse trains. Other features include low capaci-

tance, high resistance input, inline digital readout with lighted decimal point, all solid state design, and linear recorder output. Meets MIL-SPEC shock and vibration requirements. Ten percent overranging cuts down range changing. Available with or without probe in both line and combination line rechargeable battery powered versions. Base price \$895. Call your full service Fluke sales engineer (see EEM) for a demonstration or write us for full information.



When you use the probe to make true RMS measurements with the Fluke 931A AC differential voltmeter, you don't do a thing to the circuit or the meter. All you do is move the input 30 inches closer to the measurement without added loading or loss of sensitivity. That's just one more reason AC metrology isn't the same anymore.

FLUKE

Fluke. Box 7428, Seattle, Washington 98133 • Phone: (206) 774-2211 • TWX: (910) 449-2950
In Europe, address Fluke International Corporation • Suite D, Ambassador Hotel,

You Can Get All These Microcircuits from Sprague Electric

*SERIES SE100, NE100, US700 DTL LOGIC (Signetics CS700)

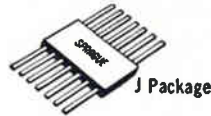

Eighteen functions in two operating temperature ranges: -55 C to $+125\text{ C}$ and 0 C to $+70\text{ C}$. Circuits include NAND/NOR gates, clock and line drivers, gate expanders, RST and JK binary elements, one-shot multivibrator.

Circle 494 on readers service card

SERIES SU300, LU300 UTILOGIC



K Package

For use in commercial, industrial, ground support applications. Available in two operating temperature ranges, -20 C to $+85\text{ C}$, and $+10\text{ C}$ to $+55\text{ C}$. Propagation delay of 15 to 40 nanoseconds.

*Trademark of Signetics Corp.

Circle 495 on readers service card

*SERIES SE400, NE400 LOW POWER LOGIC

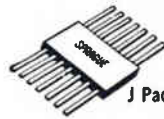

J Package

Operating temperature ranges: -55 C to $+125\text{ C}$, and 0 C to $+70\text{ C}$. For use in Aerospace and other applications where low power drain is required. Optimized speed, noise margin.

Circle 496 on readers service card

*SERIES SE500 LINEAR AMPLIFIERS



K Package

Operating temperature range: -55 C to $+125\text{ C}$. Two linear circuits available in 10-lead low silhouette TO-5 case. SE501K is a video amplifier, SE505K is a general purpose differential amplifier.

Circle 497 on readers service card

*SERIES SE800, NE800 TTL LOGIC

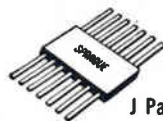

J Package

Designed for high-speed avionics systems. Eight high level circuits including four NAND Gates, Power Gate, Exclusive-OR Gate Input Expander, J-K Flip-Flop.

Circle 498 on readers service card

DIGITAL-TO-ANALOG CONVERSION CIRCUITS



	4-BIT SERIES	5-BIT SERIES
Ladder Network	UT-1000	UT-1001
Ladder Switch	UD-4001	UD-4036
Buffer Amplifier	UD-4024	UD-4037

Circle 499 on readers service card

*Series SE100, NE100, CS700, SU300, LU300, SE400, NE400, SE500, SE800, NE800 are all available from Sprague Electric under technology interchange with Signetics Corp.

For data on the microcircuits in which you are interested, write Technical Literature Service, Sprague Electric Company, 35 Marshall St., North Adams, Massachusetts 01247

488-7100

SPRAGUE
THE MARK OF RELIABILITY

*Sprague and ® are registered trademarks of the Sprague Electric Co.

Meeting preview

Telemetry trends

The program of the National Telemetering Conference, to be held May 16-18 in San Francisco, continues last year's trend away from aerospace and military applications. Scheduled talks will concentrate on oceanographic, industrial, and biological uses for telemetry gear, and will emphasize techniques and problem-solving more than new products.

Six sessions to brief attendees on recent advances in the state of the art will cover the latest in transducers, signal conditioning, detection and modulation theory, multiplexing and encoding systems, and data management. Later workshop meetings will give engineers the chance to compare notes and possibly find solutions to their particular telemetry problems.

Ocean links. The problem of moving data through the water will be the major topic at the oceanography sessions. R.F. Hill of the University of Rhode Island and L.R. LeBlanc of Raytheon Co.'s Submarine Signal division will present papers on the ocean as a data-transmission medium. They will describe their techniques for modeling the ocean as an acoustical communications channel to determine the available bandwidth and the amount of data that can be transmitted through it.

Other papers discuss work at the Navy's Underwater Weapons Laboratory and Underwater Sound Laboratory, and ocean communications experiments at Pennsylvania State University's Ordnance-Research Laboratory.

At a medical telemetry session, members of the Bioengineering Research Laboratory at the Women's Medical College of Pennsylvania will present a paper on a multi-channel telemetry system that has been used to monitor amniotic fluid pressure in the human womb, as well as fetal respiration and heartbeat, just before and during childbirth.

The problems of rapid transit will be discussed in a paper on the automatic train system for Canada's Expo-67 World's Fair in Montreal.

Honeywell engineers sell solutions

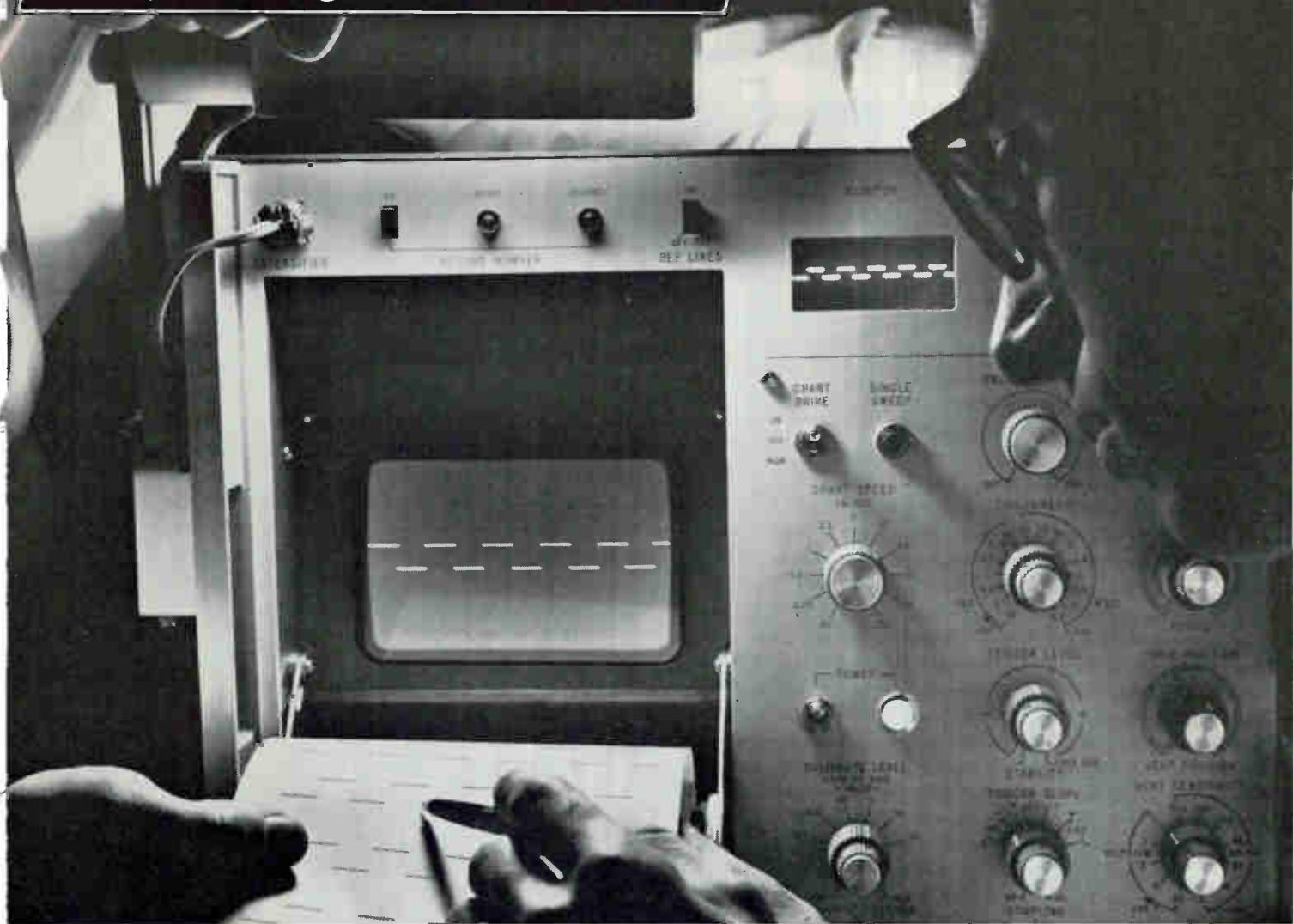

The 1806 records a 60KC square wave during a high-frequency pulse train check.

New fiber-optics CRT Visicorder oscillograph records to 1MHz!

The remarkable new Honeywell Model 1806 fiber-optics CRT Visicorder oscillograph is an important state-of-the-art breakthrough in direct-recording technique. It gives you X-Y-Y¹-Z axes recording flexibility and a frequency response of DC to 1 MHz—100 times greater than any previous oscillographs, including our industry-leading Visicorders!

We've shown just a few of 1806's capabilities; frankly, we think its applications are near-infinite, being limited only by the user's imagina-

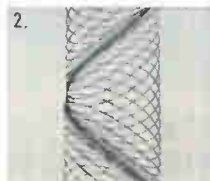
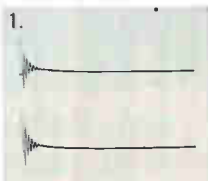

1. X-Y-Y¹ triggered oneshot recording (with automatic record length control)
2. X-Y recording mode (to 1MHz response in both axes)
3. X-Y-Y¹-Z recording mode (continuous or one shot per frame with 3.5 MHz response in Z axis)

tion. Yet, for all its sophistication, the 1806 is as easy to use as an ordinary oscilloscope. It's another example of how Honeywell's broad line, backed by local sales and service, can provide the *precise* solution to your instrumentation problems. For full details on the new 1806, call your local Honeywell Representative, or write: Honeywell, Test Instruments Division, 4800 East Dry Creek Road, Denver, Colo. 80217.

Honeywell

Circle 17 on reader service card

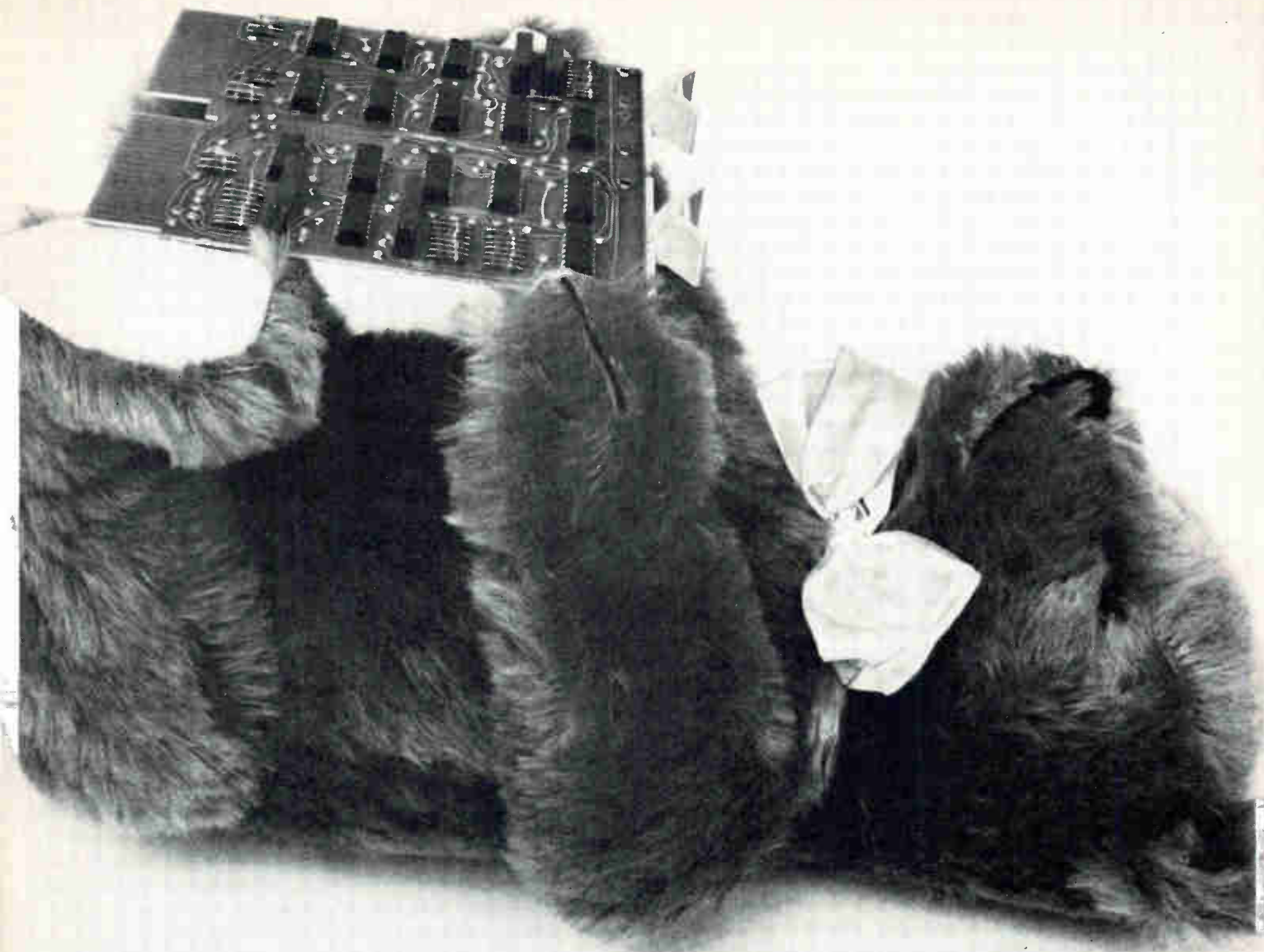

Security is having a module with a lot of compatible friends.

If you manufacture equipment, and price, delivery and reliability mean something to you, it's best to stay loose. Pick modules from a line that gives you options — so you can optimize the design for price, or speed, or ease of assembly, or something else that you're worried about.

DIGITAL'S module line is the broadest, most functional, most complete module line anywhere. Integrated circuits, discrete components, hybrids. More

than 120 of them. And each is electrically, physically, and logically compatible with each and every other.

It takes 330 pages of our Digital Logic Handbook to describe our series of Flip Chip* modules, details of the logic, and applications. It's yours for the asking.



And here's some added security: each of our modules is guaranteed for 10 years.

digital
MODULES · COMPUTERS

DIGITAL EQUIPMENT CORPORATION, Maynard, Massachusetts 01754. Telephone: (617) 897-8821 • Cambridge, Mass. • New Haven • Washington, D. C. • Parsippany, N. J. • Rochester, N. Y. • Philadelphia • Huntsville • Pittsburgh • Chicago • Denver • Ann Arbor • Houston • Los Angeles • Palo Alto • Seattle • Carleton Place and Toronto, Ont. • Reading, England • Paris, France • Munich and Cologne, Germany • Sydney and West Perth, Australia • Modules distributed also through Allied Radio

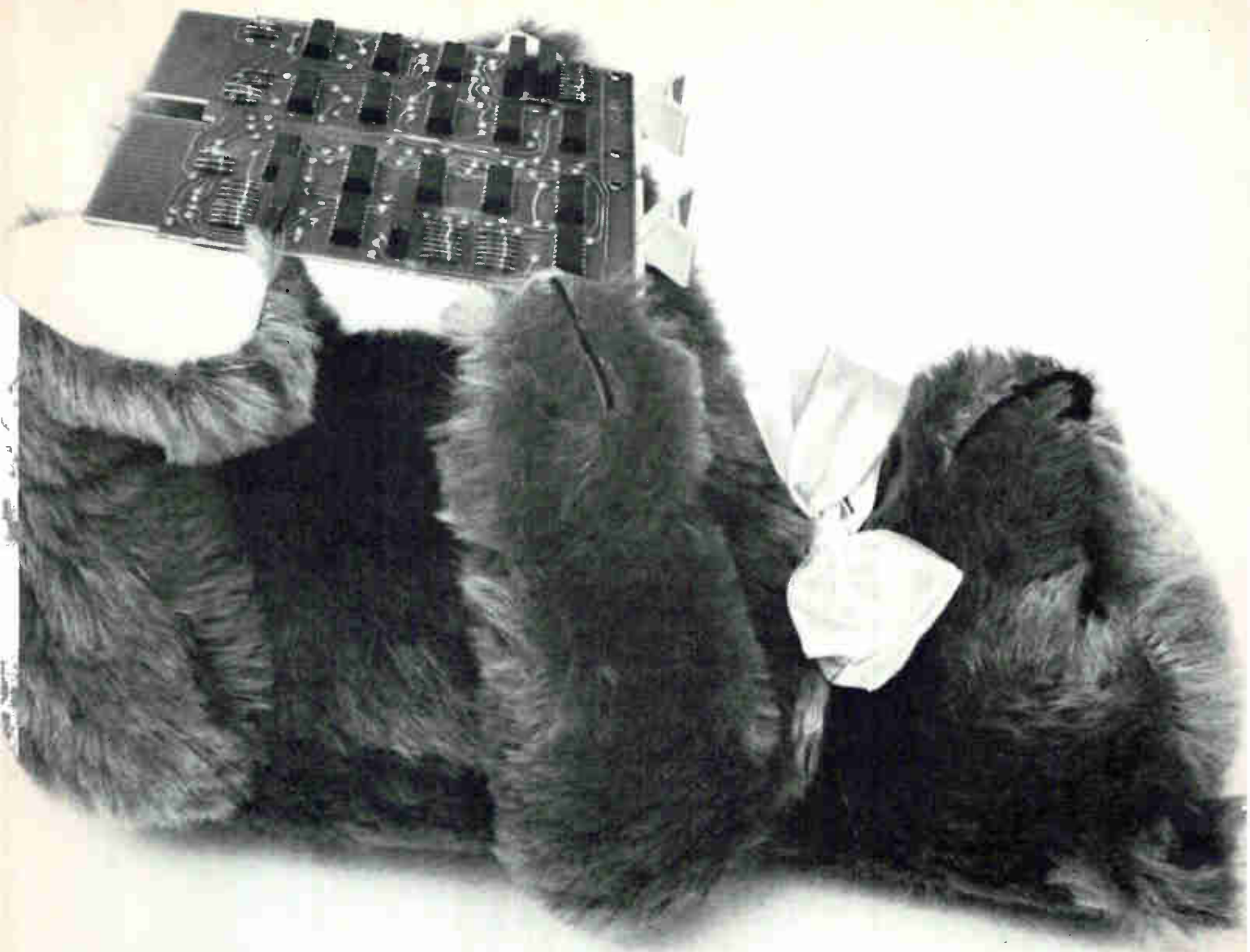

Security is having a module with a lot of compatible friends.

If you manufacture equipment, and price, delivery and reliability mean something to you, it's best to stay loose. Pick modules from a line that gives you options — so you can optimize the design for price, or speed, or ease of assembly, or something else that you're worried about.

DIGITAL'S module line is the broadest, most functional, most complete module line anywhere. Integrated circuits, discrete components, hybrids. More

than 120 of them. And each is electrically, physically, and logically compatible with each and every other.

It takes 330 pages of our Digital Logic Handbook to describe our series of Flip Chip* modules, details of the logic, and applications. It's yours for the asking.



And here's some added security: each of our modules is guaranteed for 10 years.

digital
MODULES • COMPUTERS

DIGITAL EQUIPMENT CORPORATION, Maynard, Massachusetts 01754. Telephone: (617) 897-8821 • Cambridge, Mass. • New Haven • Washington, D. C. • Parsippany, N. J. • Rochester, N. Y. • Philadelphia • Huntsville • Pittsburgh • Chicago • Denver • Ann Arbor • Houston • Los Angeles • Palo Alto • Seattle • Carleton Place and Toronto, Ont. • Reading, England • Paris, France • Munich and Cologne, Germany • Sydney and West Perth, Australia • Modules distributed also through Allied Radio

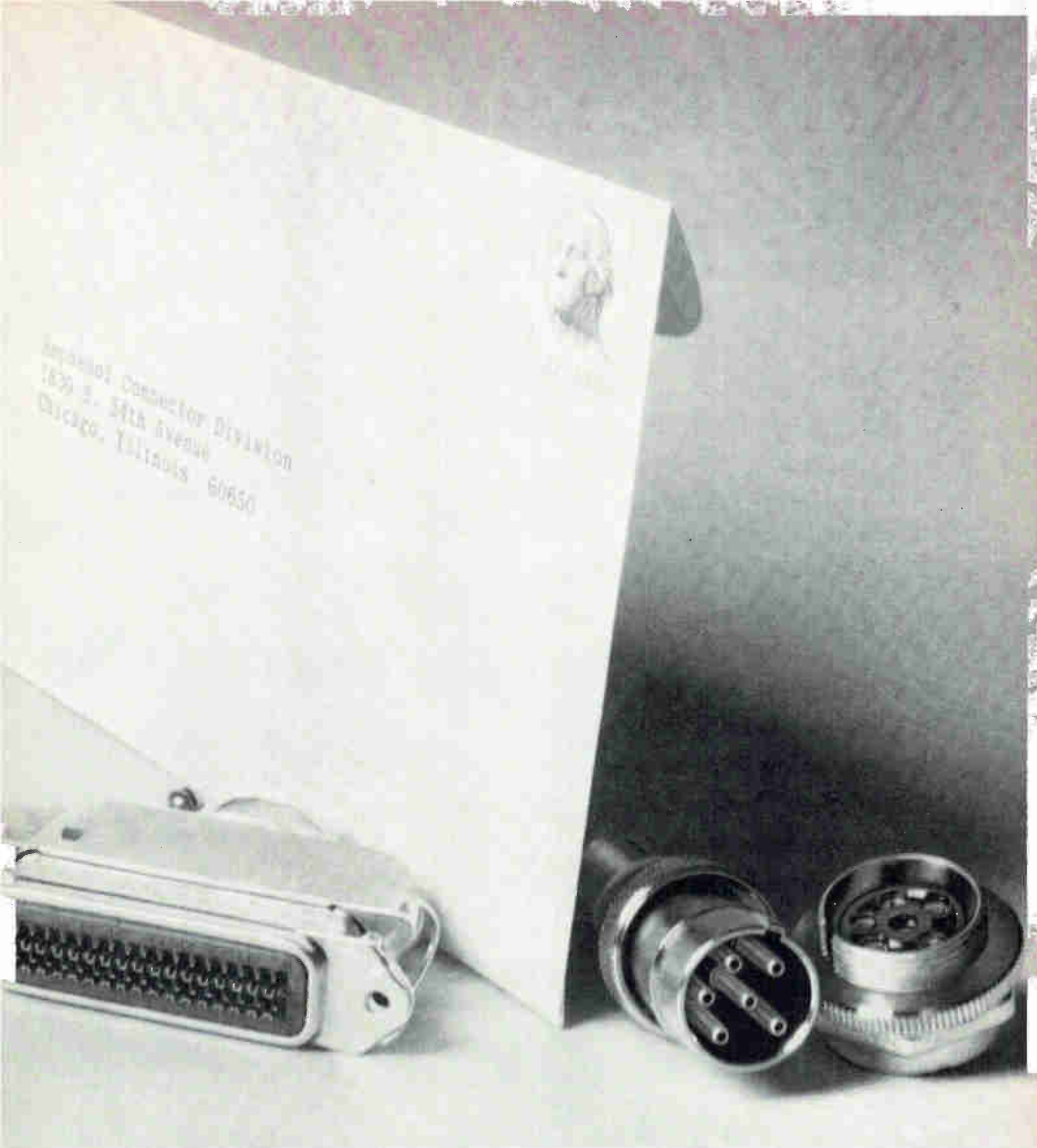

Trim production and servicing costs with Amphenol connectors:

1. NEW UL-CSA RECOGNIZED PLUG AND SOCKET helps gain faster UL approval.

2. SOLDERLESS RELAY SOCKET allows the use of wiring harnesses and lug-type connections to cut

equipment wiring time and costs.

3. NEW MICRO-RIBBON® RACK AND PANEL CONNECTOR has polarized shells to reduce need for visual alignment — can't mismatch.

4. NEW AUDIO CONNECTOR in bright nickel or chrome adds to appearance of the equipment.

5. WRITE US for the complete profit-making picture. **Amphenol Connector Division**, 1830 S. 54th Ave., Chicago, Illinois 60650.



AMPHENOL

Specify Amphenol . . . the leading name in cable, connectors, assemblies, RF switches, potentiometers, motors, microelectronics

Circle 21 on reader service card

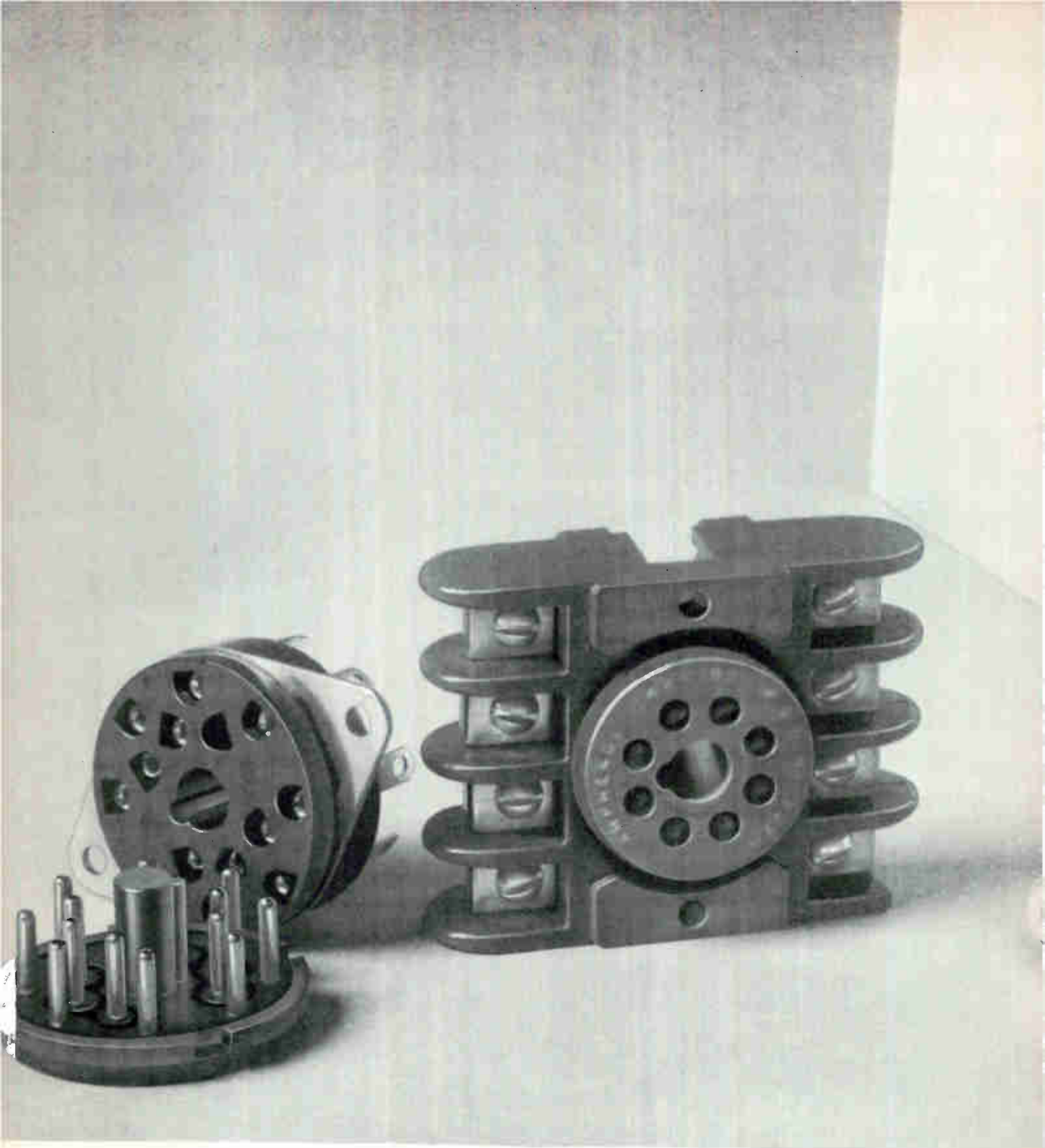

**Five ways to succeed in
commercial electronics.**

you can't make with

AE Class E Relays

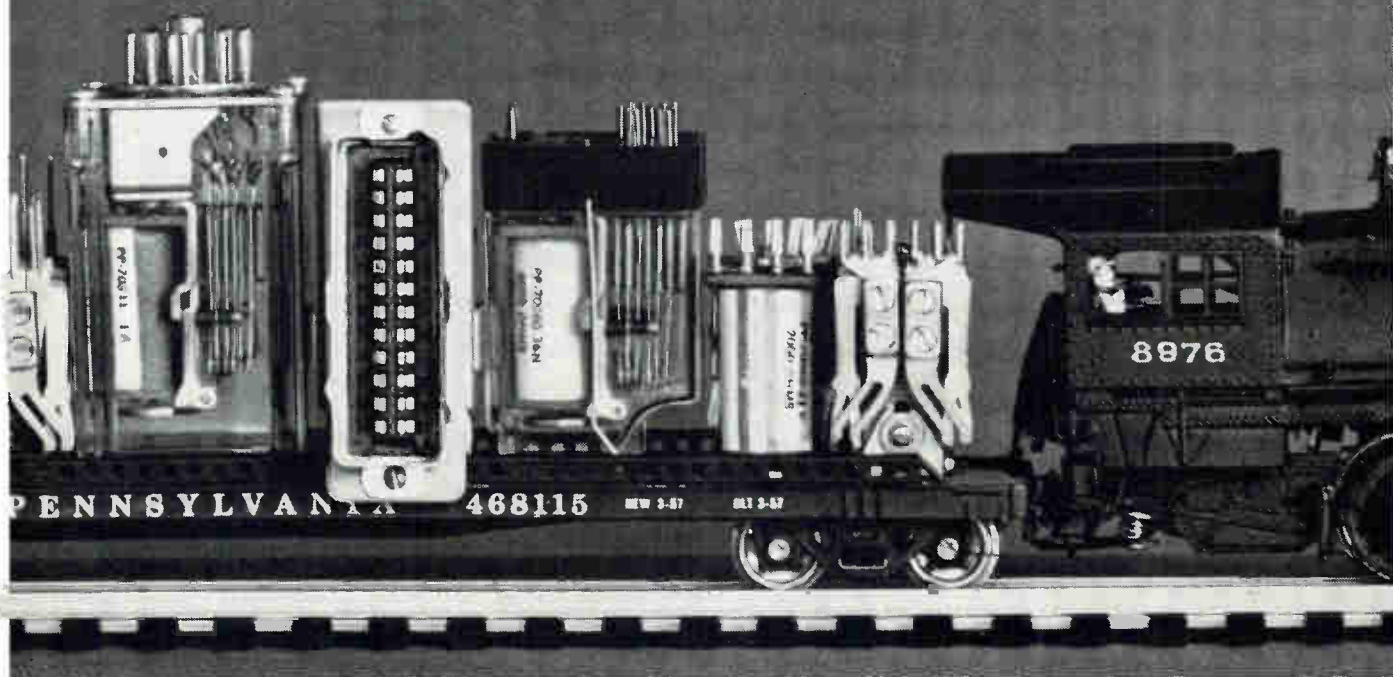

E Relays are available in hermetically sealed enclosures with either hook terminals or plug-in headers. Or plastic dust covers that snap on to the chassis- or printed-circuit type of socket.

For full information on the limitless variations in mounting and connections for AE Class E

Relays, ask for Circular 1942-C. Write to the Director, Relay Control Equipment Sales, Automatic Electric Company, Northlake, Ill. 60164.

AUTOMATIC ELECTRIC

SUBSIDIARY OF

GENERAL TELEPHONE & ELECTRONICS

GTE

Try to find a connection

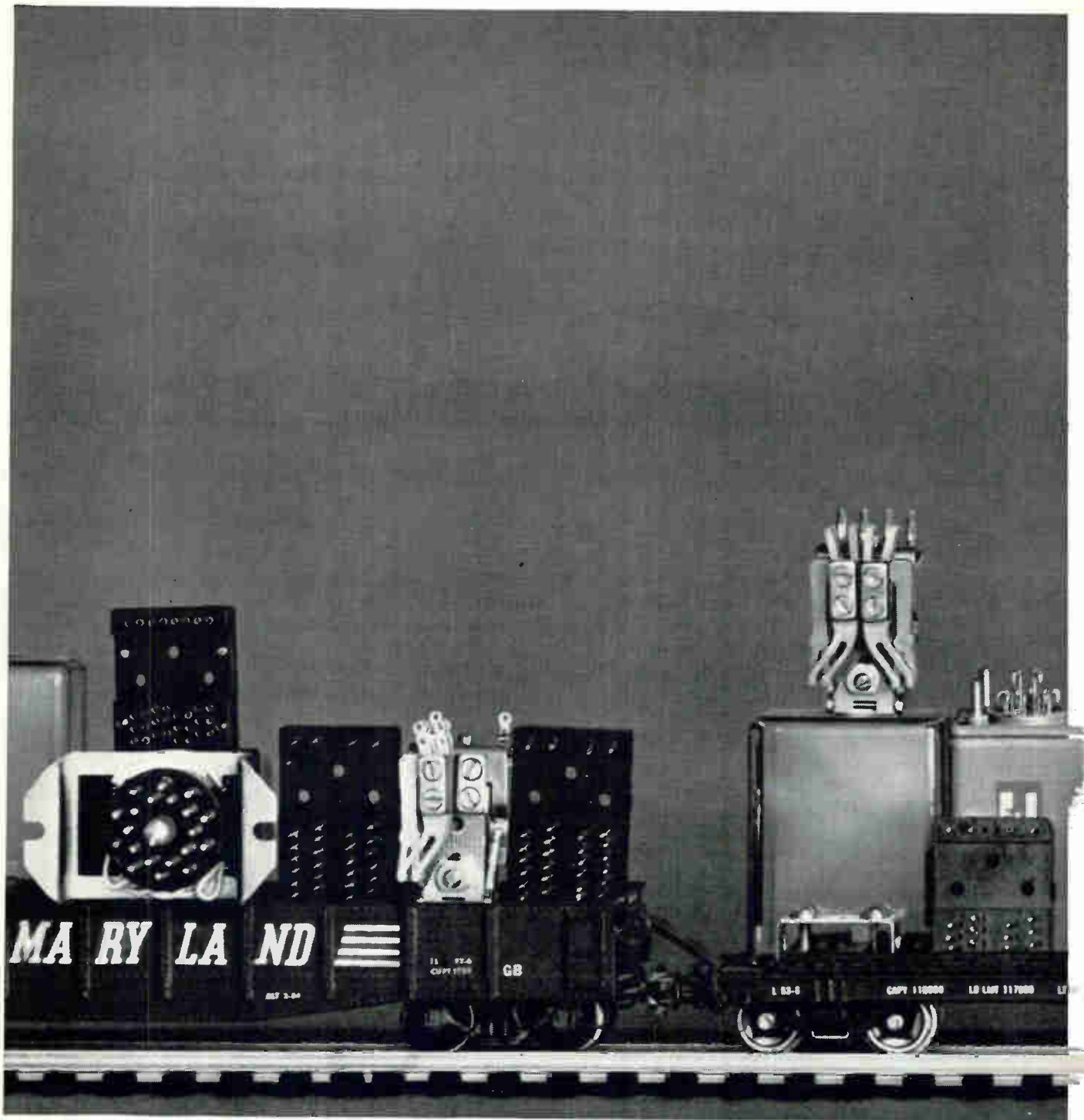

The growing popularity of AE's Class E Relay as the "workhorse of the industry" has set off a demand for a wide variety of mounting techniques.

Now AE can accommodate virtually every type of circuit connection or mounting used in electrical and electronic equipment designs.

Wherever designs call for "wiring in," AE Class

E Relays are available with solder-type, wrapped-wire, taper-tab and printed-circuit terminals.

AE has also developed special sockets for chassis or printed-wiring board mounting, that accommodate Class E Relays with PC or taper-tab terminals. And prewired types with octal plug-in bases.

Where extra protection is required, AE Class

Honeywell engineers sell solutions

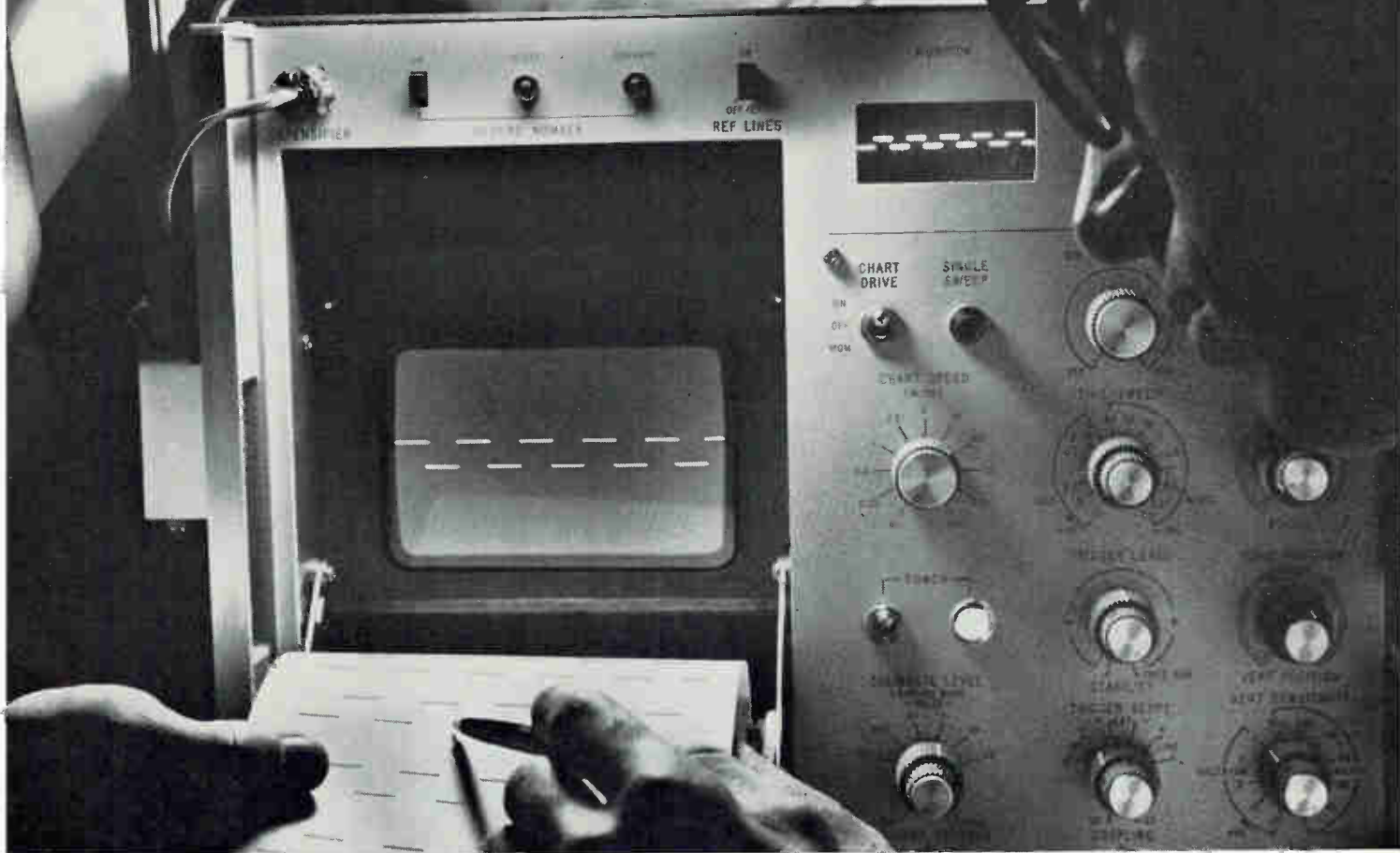

The 1806 records a 60KC square wave during a high-frequency pulse train check.

New fiber-optics CRT Visicorder oscillograph records to 1MHz!

The remarkable new Honeywell Model 1806 fiber-optics CRT Visicorder oscillograph is an important state-of-the-art breakthrough in direct-recording technique. It gives you X-Y-Y¹-Z axes recording flexibility and a frequency response of DC to 1MHz—100 times greater than any previous oscillographs, including our industry-leading Visicorders!

We've shown just a few of 1806's capabilities; frankly, we think its applications are near-infinite, being limited only by the user's imagina-

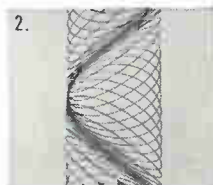
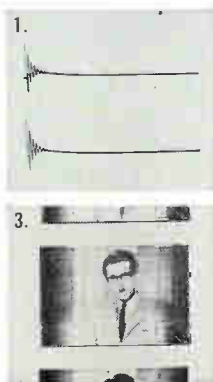

1. X-Y-Y¹ triggered oneshot recording (with automatic record length control)
 2. X-Y recording mode (to 1MHz response in both axes)
 3. X-Y-Y¹-Z recording mode (continuous or one shot per frame with 3.5 MHz response in Z axis)

tion. Yet, for all its sophistication, the 1806 is as easy to use as an ordinary oscilloscope. It's another example of how Honeywell's broad line, backed by local sales and service, can provide the *precise* solution to your instrumentation problems. For full details on the new 1806, call your local Honeywell Representative, or write: Honeywell, Test Instruments Division, 4800 East Dry Creek Road, Denver, Colo. 80217.

Honeywell

Circle 17 on reader service card

Editorial

IC's change the industry . . .

With **integrated circuits** now showing up routinely in new products, companies are worrying that the conversion to ic's will alter the structure of the electronics industry. And it will. Some traditional component makers will see their markets shrink to a few specialized applications where high frequency or high power preclude the use of integrated technology.

But the greatest pressures are on the instrument manufacturers, whose traditional role in the industry is being invaded from opposite directions: semiconductor processors are building instruments that use their integrated circuits, and computer makers are adding instruments to their computers.

The force behind what's happening is a new demand by instrument users for information rather than measurements. These customers no longer are so interested in measuring temperatures, flows, or voltages and amperages. They

are demanding complex measurements that correlate or manipulate raw data. To do this a computer is required.

In addition, automatic testing, both on the production line and in the laboratory, is spurring the use of computers to program the tests and produce refined information.

The trend is clear when you see the growing number of computers being designed just for instrument applications. For these computers, integrated-circuit technology has come just at the right time. A small, reliable, and inexpensive general-purpose machine with limited memory and mathematical capacity can be fabricated with off-the-shelf ic's.

Only the instrument makers have been slow to see what's happening. Of hundreds of companies, only Hewlett-Packard has moved to set up its own integrated-circuit facility and to design its own instrumentation computers.

. . . and the engineers' role

And engineers are worrying about how their role will change.

Semiconductor specialists have been playing an increasingly prominent part in the development of new products from innovations. In fact, in some recent cases the semiconductor engineers all but took over the development process. They decreed how the circuits would perform, how much would be integrated, and how the equipment would be arranged.

Whether this situation is temporary or is to become the normal way of doing business will depend on how willing other engineers are to learn about semiconductor processing and integrated-circuit technology.

The use of integrated circuits requires a lot broader knowledge than many engineers are used to applying. Embarrassingly, it takes broader knowledge than many engineers have. With ic equipment, the circuit design pales in importance—particularly when off-the-shelf digital units are involved—and other aspects of design gain in significance.

For example, application may determine the kind of package or the method of dielectric isolation used, or how the ic's are assembled and interconnected.

Testing ic's turns out to be one of the trickiest problems. As more components are crammed onto silicon chips, standard electrical tests become less useful and new functional tests have to be devised. Thermal examinations can often

show flaws that electrical tests can't detect.

Along with understanding the design, the engineer has to understand semiconductor processing, because the complexities and limitations of fabricating may determine what devices can be put into a circuit.

In the next phase of technical progress, large-scale integration, the gap between the product designer and the semiconductor specialist will grow even wider. The importance of circuit design—the traditional strength of electronics engineers—will be further diminished. With thousands of components built on a single chip, circuit design will be largely a computer's job.

Already, product designers, instrument engineers, and communication specialists are finding it difficult to talk to the integrated-circuit specialist. While the equipment people are concerned with circuit design and end use, the semiconductor specialists are immersed in planar processing technology, the problems of parasitics, and lead-bonding techniques.

To attain a broader view of their new technology, some semiconductor specialists are studying product application. But most product engineers haven't shown the same interest in integrated-circuit processing.

The semiconductor specialist has taken over product planning with ic's mostly by default. He'll hold onto it permanently unless other engineers start learning a little about integrated-circuit technology.

9 good reasons why Philco Epoxy Transistors (PET) are your best buy.



1. PET TO-18 is rated from 360 to 675 mW at 25°C (chip dependent).



2. PET TO-5 is rated from 550 mW to 1.2 W at 25°C (chip dependent).



3. PET packages have reliability factors equal to or exceeding that of metal cans.



4. PET's are immediately available in large volume production quantities.



5. PET's have a special deep-well interlock construction that insures hermeticity and reliability.



6. PET packages are permanently and legibly marked—lettered black on white.

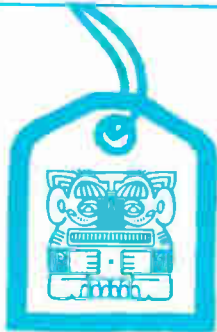

7. PET's are packaged in our low-cost Taiwan production facility—to keep your cost low.



8. PET amplifiers operate on currents ranging from 10 μ A to 1 A; PET switches to speeds 8 ns turn on and 11 ns turn off.



9. PET's cover frequencies from 40 MHz to 1400 MHz.

Call or write: **Philco-Ford Corporation Microelectronics Division Sales Offices:** 2920 San Ysidro Way, Santa Clara, California (408-245-2966) / 999 North Sepulveda, El Segundo, California (213-772-6226) / Northwest Industrial Park, Second Avenue, Burlington, Mass. (617-272-1600) / Benson Manor, Suite 114B, Washington Lane, Jenkintown, Pa. (215-885-0430) / 1215 Drew St., Clearwater, Florida (813-446-0124) / 815 Connecticut Avenue, N.W., Washington, D.C. (202-298-7810) / Suite 208, 700-108th St., N.E., Bellevue, Washington (206-454-5061) / New York, N.Y. (212-244-1373).

PHILCO



PHILCO-FORD CORPORATION
Microelectronics Division
Santa Clara, California • 95051

Electronics Newsletter

April 17, 1967

Microwave device: EIA formats fail to measure up?

A boycott of microwave transistor registration may be shaping up. Because none of the several Electronic Industries Association formats available can accurately characterize such devices, at least one manufacturer, Texas Instruments, may not register any new microwave transistors until the formats are revised. The scanty information on performance that can be accommodated by the present formats impedes designers in evaluating microwave devices.

With the present setup, TI says, a specification written for a 3-gigahertz transistor could not honestly guarantee 3-Ghz performance. TI had troubles in registering its new high-frequency 2N5043, the first transistor to be characterized by S parameters; the firm had to stretch some points to fit the format.

The EIA formats use only parameters that can't be accurately measured at 3 Ghz, such as Y parameters. Some engineers think Y parameters are doomed to obsolescence. Below 30 megahertz, they recommend H parameters, above 30 Mhz, S parameters. The latter parameters are based on power ratios rather than the current or voltage ratios that determine the Y and H types.

Photocomposition system uses digital technique

An all-digital photocomposition technique for printing, capable of generating several thousand characters per second on a continuously moving strip of photographic film, has been developed by Alphanumeric Inc. of Hicksville, N.Y. Character and pattern images are displayed on a digitally controlled cathode-ray tube and are exposed on the film, from which printing plates are made.

Alphanumeric now has an off-line system—the APS-2—driven by magnetic tape rather than directly by computer. The computer first prepares the tape, which includes instructions on type size and font as well as the text to be set. This tape is read by the APS-2 into its ferrite core “matrix memory.” The APS-2 then decodes the text, and, following the instructions, generates the proper image in the proper position on the crt by drawing a series of short lines for each individual character.

An advanced system—presumably on-line—is in development. Negotiations are now going on with IBM, but Alphanumeric is silent on whether it's looking at the giant computer maker as a vendor or as a supply source.

Alphanumeric's system differs from CBS Laboratories' Linotron [Electronics, April 3, p. 113], which uses an analog mask in a tube separate from the crt; from General Dynamic's Charactron, which uses a mask in the crt; and from RCA's Videocomp, which exposes an intermittently moving film a line at a time.

Ultrahigh-speed computer display

A computer display that operates at speeds up to 250,000 characters per second—twice the speed of currently available displays—has been developed by Tasker Industries Inc. Its ultrahigh speed frees the computer for other tasks and makes it practical to hook up several displays to the computer without taking up too much of the machine's time.

A redesigned version of the display, capable of speeds 20% faster, will be used in a new military air traffic control system—the AN/TFX-42. The character generator and display will enable alphanumeric equip-

Electronics Newsletter

ment to display aircraft identification and altitude information digitally on the traffic controller's radar scope during the radar's dead time, eliminating the need for a two-gun cathode-ray tube display.

Homer G. Tasker, the firm's chairman, attributes the speed capabilities to a redesign of the amplifier circuits used for deflecting the crt beam. Says Tasker: "With our technique, we could go to a speed of 500,000 characters per second if the demand was there."

IBM slates more satellite-link tests

Despite persistent claims that it has no firm plans to link computers by satellite, IBM will continue to test computer-to-computer hookups via Early Bird. Some "highly successful" trials were run earlier this year, the company says [Electronics, March 20, p. 59], and more will be conducted in May.

Tunnel diodes face loss of big market

Prospects for tunnel diodes in the 1-to-2-gigahertz range appear bleak, with bipolar transistors finding wider applications in amplifying and some logic-switching jobs. The transistors have always had the edge in stability, noise figures, and packaging, and now that their high-frequency capabilities have been boosted, they are rapidly taking over this multimillion-dollar market.

Spokesmen at KMC Semiconductor, Micro-State Electronics, Polarad, Texas Instruments, and Watkins-Johnson confirm this trend. One implied that there is an "understanding" among Government agencies to avoid tunnel diodes whenever possible because of their instability.

TI reports increased sales of high-frequency transistors, even to microwave-amplifier manufacturers making tunnel diodes.

Computer undergoes rigorous time study

Researchers at the University of California at Los Angeles are, in effect, running a time study on a computer and all its peripheral equipment to measure the efficiency of the machine and its software and to find ways to improve operations.

The UCLA study is called Computer Instrumentation Automation, and—presumably as a take-off on the acronym CIA—is informally known as "snuper."

Basically, the project involves the counting of the number of times certain key activities occur in programs as the computer executes them. The counting is initially being done by adding instructions to the programs at those key points—a process that slows the program. External equipment will later be added to handle the counting and to monitor the program without slowing it. The researchers say the study, which will be implemented on an IBM 7094 with an SDS Sigma 7 connected to it, should be applicable to a broad class of general-purpose computers.

Office copier uses xenon flash lamp

Xenon flash lamps, long used for the pumping of lasers and in stroboscopy and scientific instrumentation, have found a new application—commercial office copiers. The Dennison Manufacturing Co., Framingham, Mass., this month will introduce a high-speed, roll-fed electrostatic copier that uses a xenon flash lamp as a high-intensity light source. The new machine, driven by a precisely regulated high-voltage power supply, will compete with the Xerox Corp.'s copiers.

IDEAS

from SYLVANIA Electronic Components Group

PHOTOCONDUCTORS

Now, highly reliable UV detection ... even in IR ambients

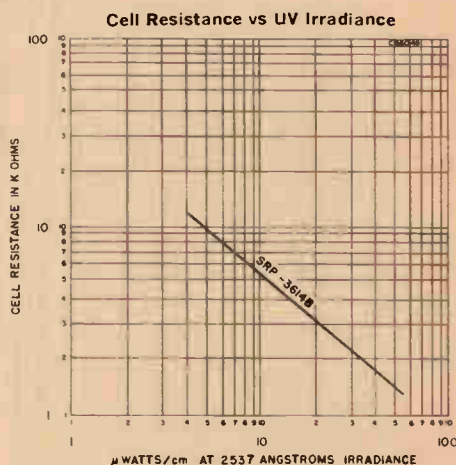

A shortcoming of many ultraviolet detectors is that they're also sensitive to infrared radiation. Thus it's often difficult, if not impossible, to use them to detect just UV in an ambient containing both infrared and ultraviolet radiation. Last year, Sylvania introduced a UV cell with attenuated infrared characteristics. Now, an improved version of this device has greater sensitivity and shows even better infrared attenuation.

Sylvania's new Type SRP-3614B ultraviolet photoconductor improves further the detection and measure-

ment of UV radiation. Like previous designs, the new device requires only simple low voltage circuits to provide an inexpensive, highly reliable UV detection system. The SRP-3614B does differ from earlier types in two important characteristics: it is less sensitive to IR radiation and uses a more sensitive photocell.

Key electrical ratings for the new unit are a power dissipation rating of 300 mW, an ON resistance of 1,300 ohms at 64 μ W/cm² irradiance, and a dark resistance of 100,000 ohms. Ascent time is 130 msec (at 64 μ W/cm²)

while descent time is 40 msec at the same radiation level.

The SRP-3614B has the proven high reliability of Sylvania's hermetically sealed cadmium-sulfide photoconductors, but with the spectral response characteristic shifted into the ultraviolet region in the range of 2500 to 4000 angstroms.

The excellent electrical character-

(continued)

This issue in capsule

Integrated Circuits — How to prevent unused inputs from degrading IC performance.

CRTs — Eliminate unnecessary trade-offs when choosing computer displays.

Microwave Diodes — Punch-through varactors, new route to improved harmonic efficiency.

Photoconductors — How photoconductor-lamp assemblies are making music sound better.

Diodes — With whiskerless diodes, you can get more components on a board.

ELECTRICAL DATA RATINGS (Absol. Max.)

	SRP-3614	SRP-3614A	SRP-3614B
Dissipation at 40°C	300mW	300mW	300mW
at 70°C	25mW	25mW	25mW
Temp. Rge.	-40 to +70°C	-40 to +70°C	-40 to +70°C
CHARACTERISTICS			
Cell (Light) Res. (ohms)	2500	5500	1300
Dark Res. (ohms)	1,000,000	1,000,000	100,000
Ascent Time at 64 μ W/cm ²			130 ms
at 4 μ W/cm ²			720 ms
Descent Time at 64 μ W/cm ²			40 ms
at 4 μ W/cm ²			260 ms

PHOTOCONDUCTORS (continued)

istics of this improved photoconductor are protected by a small, rugged package with a maximum diameter of 0.70" and a length of 1.625".

Coupling the small size, long life, analog response characteristic with the simple associated circuit requirements makes the SRP-3164B ideal for applications where UV detection, measurement, control or regulation are needed, such as intrusion and fire alarm systems. The new photoconductor can effectively and economically replace many avalanche or continuous monitoring devices.

CIRCLE NUMBER 300

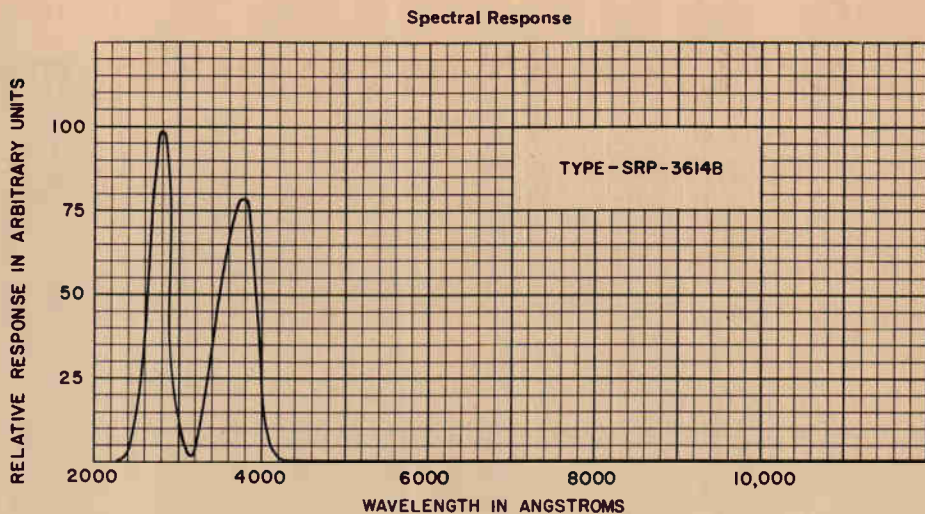

MARKETING MANAGER'S CORNER

Circuit Designer-IC Manufacturer... Conflict or Complement?

The rapid growth of the integrated circuit industry has given rise to a pertinent question: whether or not there is a functional conflict between the IC manufacturer and the manufacturer of electronic equipments and/or systems. In other words, are we, as IC manufacturers who produce complete functional circuits, overstepping our bounds and infringing on the functions of circuit designers? What about circuit design engineers? Will they become high priced order clerks, purchasing all the circuits they need to build an equipment out of an IC catalogue?

To aggravate the picture, the trend in the IC industry appears to be headed for even greater density. LSI (large scale integration) is now in the horizon, cramming many more and larger circuits into a single package. It may be possible to eventually encapsulate an entire automated operation or computer function into a single IC package. Will this development turn the computer manufacturers into automated factories, whose purpose it will be to merely assemble various combinations of IC packages?

Not at all! On the contrary, as the electronics industry expands, all its constituent components will expand along with it. With standard circuits such as flip-flops, gates, registers, and counters available as packaged items, the design engineer can concentrate on larger and more complex circuit configuration. Furthermore, many cir-

cuits required for equipment design have a unique configuration, in one aspect or another, and, therefore, must be designed by the equipment manufacturer; the IC manufacturer only fabricating these "customized" circuits.

With reference to this last point, it should be remembered that in order to work effectively with the integrated circuit manufacturer, the circuit designer must familiarize himself with integrated circuit technology, its advantages, its applications, and its limitations. He should know the IC circuits that are available as "off-the-shelf items." He should also be knowledgeable of the manufacturing process of integrated circuits so that he can design new circuits which are most applicable to the present state of the art. This will result in a reduction of IC costs, a functionally superior IC, and a better working relationship between circuit designers and integrated circuit manufacturers.

The same situation exists with regard to system designers. No matter how complex and dense ICs become, they will only serve as building blocks for large systems. Furthermore, the systems of today will become the subsystems of tomorrow's larger, more complex and sophisticated systems. Therefore, with the availability of larger and more efficient "building blocks," system design engineers will be able to concentrate on solving the design problems associated with cre-

ating larger and more efficient systems.

Finally, it must be noted that the trend toward LSI is not a self-generating movement. IC manufacturers are not simply producing denser ICs just for the sake of cramming more circuitry into a package. This trend, to a great extent, is the result of certain design requirements dictated by military and industrial contractors. The great need for space and weight savings, and the requirement for extended operation reliability within the space program has had a significant effect on IC design. The noise immunity requirements of high frequency circuitry and high speed computers also have dictated the direction which IC manufacturers have had to take. However, when one looks at the total picture, he finds the word that describes the relationship of equipment and systems manufacturers, and IC manufacturers, is "complementary"; each has its own function which complements the other. And the very evident direction of motion is upward. The electronics industry continues to grow; equipment and systems are becoming more complex and sophisticated. Keeping up with this growth in complexity and sophistication is the IC manufacturer.

Roger A. Swanson

R. A. SWANSON

How PL assemblies are making music sound better

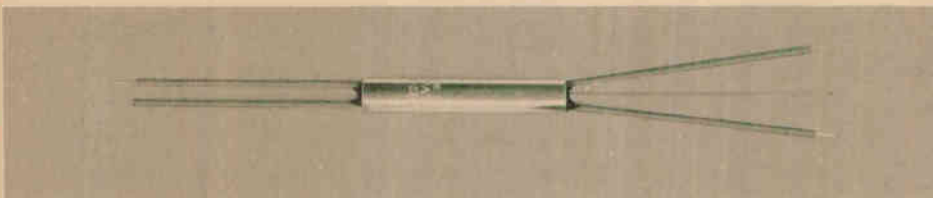

Photoconductor-lamp (PL) assemblies are being used to produce special musical effects such as tremolo, vibrato and percussion. What makes these units ideal for these applications is the intrinsic characteristics of the photoconductor-lamp combination. It provides noise-free operation because of electrical isolation between control and signal circuitry. This, of course, eliminates the introduction of hum from the control circuit. Result is an effect pleasing to the listener. Here's how a tremolo circuit using a Sylvania PL assembly makes an electric guitar sound more pleasing.

Tremolo effects—subsonic modulation of an audio signal—can be produced easily and reliably by an electric guitar amplifier which uses Sylvania's PL assembly. The circuit shown uses a PL-8224C assembly and a phase shift oscillator to get the tremolo effect. The oscillator output frequency of 40 to 8 Hz is controlled by a 1-megohm potentiometer in one

arm of the phase shift network. Output of the oscillator is decoupled by a 330 K resistor into another 1-megohm potentiometer which varies the level of the control signal voltage fed into the PL driver stage.

The on/off switch can ground the arm of the 'Depth' potentiometer to remove modulation from the light source portion of the PL assembly. The dc operating current of the light source is determined by the setting of cathode resistor in the PL driver stage. The ac output of the 'Depth' control is superimposed on this dc level, providing an ac variation in the resistance of the PL. Shunting this ac varying resistance divider across the volume control gives the desired modulation of the audio signal. Depth of modulation depends on the setting of the 'Depth' control and may approach 100 percent.

Basic action of this circuit is that of a volume control being varied around its operating point at a sinusoidal rate

with the rate controlled by a low frequency oscillator.

The type PL-8224C assembly used in this application consists of a hermetically sealed cadmium sulfide photoconductor and an incandescent lamp potted in a metal cylinder 1.75 inches long and 0.31 inches in diameter. Its cell voltage is rated at 300 V max and can handle up to 50 mW at 25°C. Cell resistance varies from below 60 K (ON) to above 10 megohms (OFF).

The PL-8224C is just one of many standard and custom PL Assemblies available from Sylvania. These PL assemblies, because they have the characteristics of both a switch and a potentiometer, have many other circuit applications in addition to generating musical effects.

Such applications as: On-Off Switch, Sequential Switch, Logic Functions, Gain/Volume Controls, Electrically Controlled Circuit Functions (Delays, Oscillators, Filters), Linear Amplifiers, Voltage and Current Regulators, Motor Speed Regulators and Modulators.

In all these applications the PL assemblies provide moderate power handling capability, noise-free operation, and high circuit isolation.

CIRCLE NUMBER 301

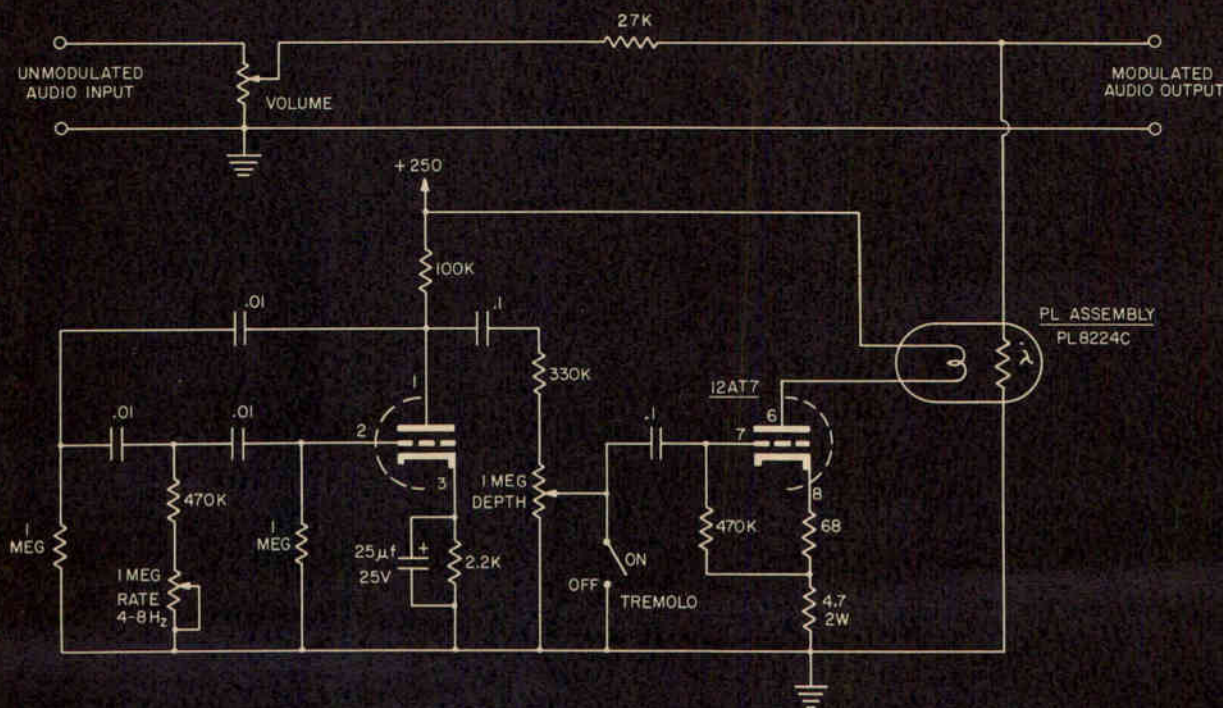

Preventing unused inputs from degrading IC performance

Frequently, all inputs of an integrated circuit are not required in a particular application. What does the circuit designer do with these unused inputs? They may be left open, but this could degrade circuit operation; or additional components can be added to insure top performance. SUHL™ devices by Sylvania require only simple wiring and no extra components to obtain optimum performance characteristics. Here's the how and why for gates and flip-flops.

The high drive capability of SUHL I and II output networks allows unused gate inputs of these ICs to be tied directly to signal inputs with insignificant sacrifice in speed or static characteristics. In the same way, unused inputs of these SUHL flip-flops can be tied to active inputs or outputs to maintain propagation delay time, clock width, and amplitude. With SUHL gates and flip-flops it's basically a matter of eliminating the effect of the capacitance associated with each of the unused inputs.

In SUHL gates, each input has a capacitance to ground of about 1.2 pF (package and chip). If wiring is also connected to the emitter, then additional capacitance is added. How the capacitance of unused inputs influences circuit operation can be explained by Figure 1. Here, if input A goes to logic "0" and input B is float-

ing, the voltage at B tries to follow the voltage at A. In time, B falls to logic "0." When A rises to logic "1," B is held down until its capacitance charges through the base resistor. This action slows down the recognition of the logic "1" data at A.

To prevent this, unused emitters should be terminated with a voltage greater than the logic "1" threshold voltage. In this way, stray capacitance on the inactive inputs will always be at logic "1" and won't slow circuit operation. There are a number of ways to insure that these gate inputs remain at logic "1."

The unused inputs can be connected to a dc voltage as shown in Figure 2A. For SUHL units, the voltage should never be higher than 5.5 V, the breakdown rating of the inputs. A 5.0 V supply is satisfactory if it never goes above 5.5 V, even during power turn on. Should the supply go above 5.5 V, then a resistor (ranging from 500 to 5000 ohms) is placed between the emitters and the supply as indicated in Figure 2B.

Many emitters can be tied together. One convenient method of supplying the required voltage is to use one NAND gate with its inputs grounded to hold all unused emitters at Logic "1."

A more convenient neutralization technique is to tie unused emitters to

one of the signal emitters as shown in Figure 2C. This requires no extra components. Only simple wiring is needed and performance of the system is not degraded. In this approach, when the data signed goes to "0," all capacitance is directly discharged to "0" through the driver. Since this capacitance is small and the drive capability of SUHL is high, there is a negligible effect on speed (about 0.03 nsec/pF). In this configuration, input current is the same as if only one input were used, because the base resistor limits current flow.

In Figure 2C, when the driver rises to logic "1," each input and its capacitance is pulled to a positive voltage. Again, because of the high drive capability of SUHL output networks, pull-up speed is negligibly affected by the small capacitance increase (about 0.4 nsec/pF). The high current capability of the output network of all SUHL elements also means that static characteristics remain constant.

These SUHL output characteristics are shown in Figure 3. Even with many milliamps of loading, logic levels are still high and well above threshold.

In flip-flops, it is extremely important that all inactive inputs be terminated. Not only is propagation delay time effected, but so is clock width, amplitude and the waveform required

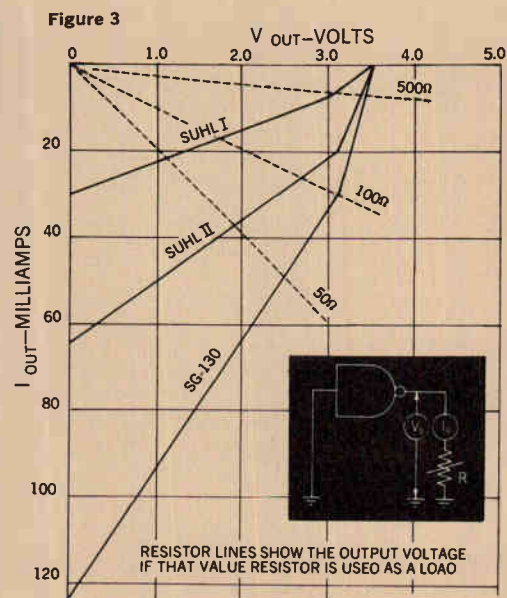
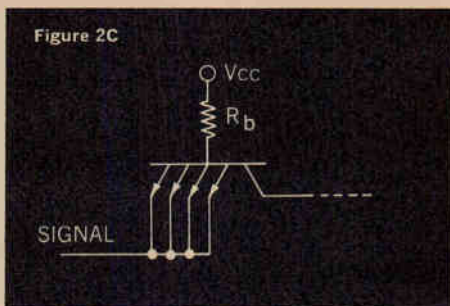
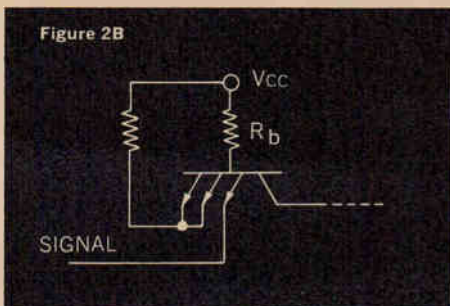
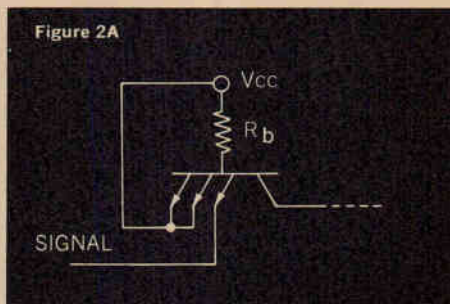
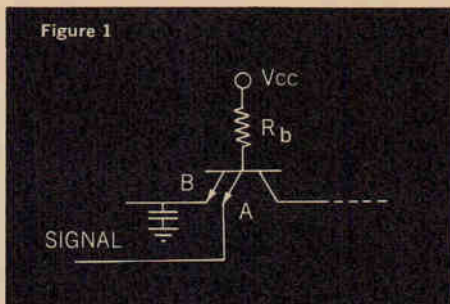

for triggering.

Synchronous or data inputs of flip-flops can be terminated with dc in the same manner as a gate, but for each flip-flop there are signal carrying inputs or outputs to which unused inputs can be connected. Examples are

shown in Figures 4 and 5.

Unused asynchronous input terminals (DC Set, Preset, Reset) can also have a degrading effect on performance, particularly if they are connected to wiring or board metalizing which increase capacitance. Even at

low frequencies it is important that asynchronous inputs be connected to a positive voltage or terminated in some other way. The same techniques used for gates or those shown in Figures 4 and 5 can be employed.

CIRCLE NUMBER 302

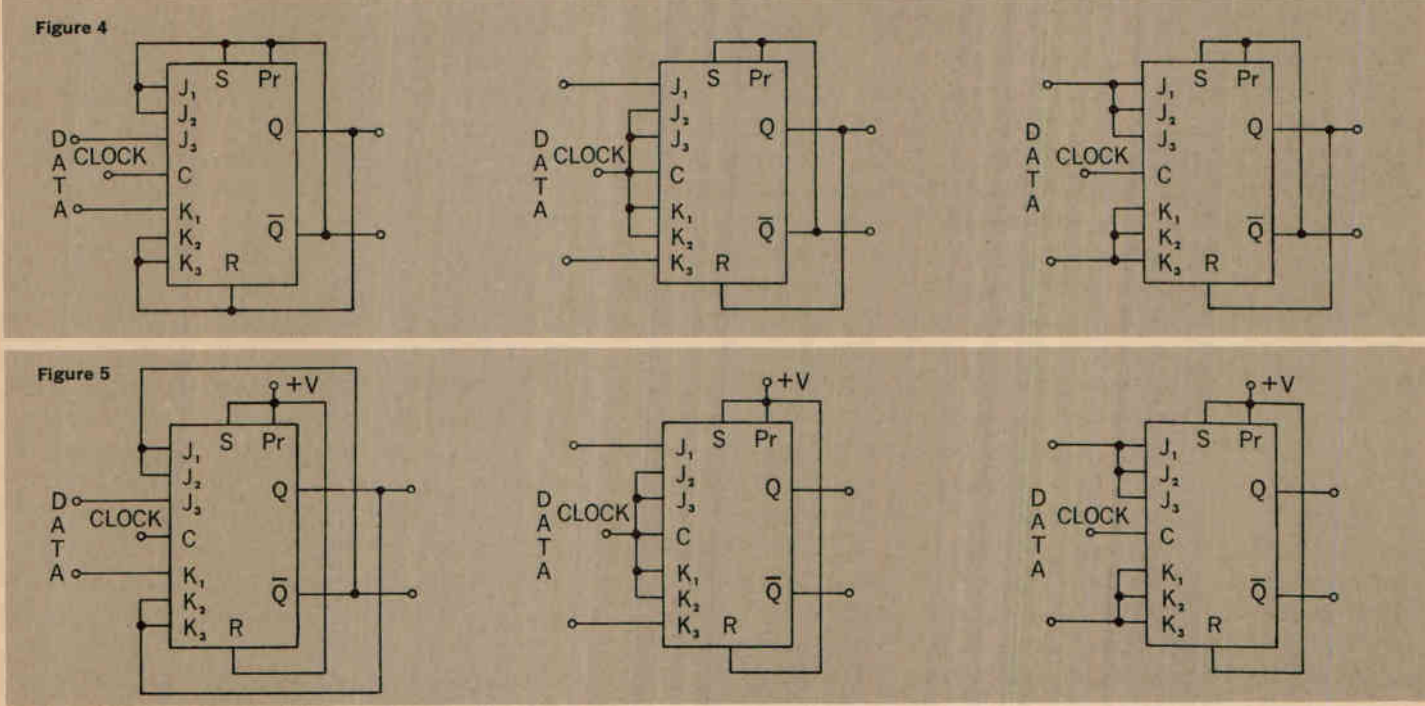

CRTs

Eliminate unnecessary trade-offs when choosing computer displays

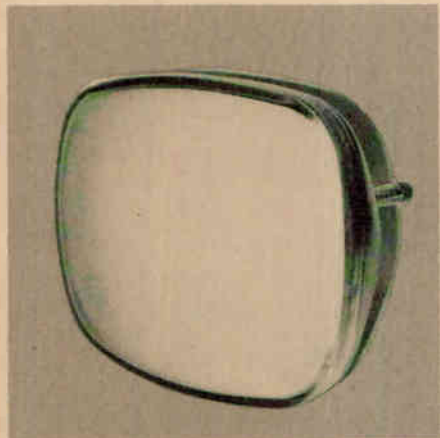

The value of a computer often is directly related to how fast the information output can be obtained by the people who need the information. CRTs provide an effective and very fast graphic display of such information. But picking the right tube (and the right tube manufacturer) for computer display applications is not simple. Many factors must be evaluated. A good way to start is to look at the manufacturer's present capability in CRTs for computers.

Years of leadership in CRT technology and display design give Sylvania the full capability needed to meet demands for computer CRTs. This capability is based on a solid background of providing CRTs for the computers of several manufacturers.

These CRT displays offer many advantages. Display of alphanumeric information on a tube face is much faster than waiting for a typed output. A dynamic display also permits on-line program debugging, text editing and revision, and rapid scanning of stored material. Coupled with a camera, these displays can give a hard-copy output. The growing interest in using displays to permit on-line, two-way conversation with the com-

puter opens up a host of applications. For instance, results of calculations can be plotted, and the user can select regions where he wants calculations to be carried out in more detail.

Selecting the optimum tube for such applications can be a difficult chore. Many factors must be considered; such factors as size of display, deflection, focusing method, sensitivity, resolution, brightness, power requirements, and phosphor characteristics. Trade-offs may be necessary. But, at Sylvania these trade-offs are kept at a minimum; because the designer isn't limited to a few off-the-shelf items. Sylvania's wide range of standard and custom tubes permit a better match of tube to application.

TYPICAL COMPUTER TYPES				
Basic Type	Deflection Angle	Screen Size	Useful Scan	Overall Length
SC-4649	70°	7"	5-3/4" x 4-3/8"	10"
8QP-	90°	8"	7-3/16" x 5-3/8"	9-15/16"
8KP-	90°	8"	7-3/16" x 5-3/8"	11-15/16"
17DWP-	70°	17"	11-1/8" x 14-5/16"	19-3/16"
21EYP-	72°	21"	19-1/16" x 15-1/16"	23-1/32"

CIRCLE NUMBER 303

Punch-through varactors: new route to improved harmonic efficiency

There's a great deal of confusion in the microwave industry regarding high-order multiplier diodes. Names such as step diodes, step recovery varactors, snap diodes, snap-off varactors, etc. are being used to describe diffused diodes having a varying capacitance-voltage relationship. Sylvania uses the term PTV, or Punch-Through Varactor, to better describe a diode which was developed to have a sharp decrease in junction capacitance, as well as a series resistance at a reverse bias 15 to 20% of the rated breakdown voltage. This deflection point occurs when the depletion width "punches-through" the thin epitaxial layer of high-resistivity silicon.

The Sylvania D-4410 PTV exhibits little capacitive nonlinearity in the reverse bias region, but shows a marked nonlinearity in the forward bias region because of charge storage. The relatively flat capacitance change over a large reverse bias range offers several advantages, such as minimal detuning over the temperature range,

simplified tuning procedure, and improved dynamic range. Simplified matching techniques can be employed, and under broad band operating conditions improved operating efficiencies can be realized.

If PTVs are driven into the forward bias region, high conversion efficiencies can be obtained as a result of the marked non-linear capacitance curve. The lower average R_s value over the drive cycle also contributes to better efficiency by reducing the power dissipation. Harmonic generators operating with multiplication ratios as high as 27:1 or as low as 2:1 will yield highly efficient performance at frequencies from VHF to Ku-band. These diodes, made from epitaxial silicon, have diffused junctions tailored for punch-through at a reverse bias voltage which is low relative to the breakdown voltage.

Electrical specifications and typical operation in a multiplier circuit for a Sylvania PTV are given in the table.

Carefully controlled fabrication techniques give Sylvania's PTVs

these additional advantages: uniformity of performance characteristics, higher power handling capability, improved circuit stability, higher power, and frequency operating range.

All units are baked at a minimum temperature of 200°C for at least 16 hours prior to final hermetic sealing. Finished devices see these test procedures: centrifugal acceleration of 20,000 G, temperature cycling from -65°C to +150°C; breakdown checking at 150°C; 48 hour burn in at 200°C; and gross and fine leak (Radioflo) testing.

Units in the new PTV series are available in four packages: the 017, 023, 075, and 099.

ELECTRICAL SPECIFICATIONS (Type D-4440)	PERFORMANCE IN MULTIPLIER (Type D-4440)
$V_B = 45$ Volts	$F_{in} = 1$ GHz
$C_j(-6V) = 1 - 1.5$ pF	$F_{out} = 10$ GHz
$T_s = 250$ picosec	$P_{in} = 1$ watt
$T_L = 60$ nanosec	Efficiency = 13%
$R_s = 0.8$ ohms	
$I_F = 100$ milliamps	
$R_T = 45^\circ\text{C}/\text{watt max}$	

CIRCLE NUMBER 304

PTV DIODES

In a varactor multiplier, power handling capability and conversion efficiency are determined by the breakdown voltage, junction capacitance, junction conductance, and series resistance. Breakdown voltage is determined primarily by the resistivity of the N-type semiconductor material used in the P-N junction. The other parameters are shown in the simplified equivalent circuit of Figure 1.

The nonlinearity of the voltage-variable junction capacitance is the dominant factor in the frequency multiplication process. Junction conductance and series resistance dissipate power, limiting output power and conversion efficiency. The frequency conversion process also depends on the quality factor Q or cut-off frequency ω_{co} . These are given by the equations $Q = 1/\omega R_s C_j$ and $\omega_{co} = 1/R_s C_j$.

Specifically, frequency conversion depends on the average values of

these factors over the drive cycle of the multiplier. Since both R_s and C_j vary with reverse voltage, their values should be kept at a minimum over most of the drive cycle. The nature of these nonlinear parameters can be examined with the aid of the simplified P-N junction of Figure 2. Here, a thin layer of lightly doped, n-type semiconductor of thickness t is grown epitaxially on a substrate of heavily doped, n-type material, and p-type dopant is diffused to a depth X into the n-type layer.

A reverse bias voltage applied to the varactor sweeps mobile carriers out of the lightly doped n-region. These carriers recombine in the p region, forming a depletion region of width W in the n layer. Width of this region varies with applied voltage as; $W = K_1 (\phi - V)^\gamma$. Where ϕ is the built-in voltage of the junction, K_1 is a constant, and V is the applied reverse bias. The term γ varies from 1/3 to 1/2 depending on the type of junction. The depletion region boundaries

act as a parallel plate capacitor with capacitance of:

$$C_j = EA/w = k_2 (\phi - V)^{-\gamma}$$

where E is the dielectric constant of the n-type material, A is the junction area and k_2 is a constant. Increasing the applied reverse voltage V increases w and decreases C_j .

Two additional factors determine

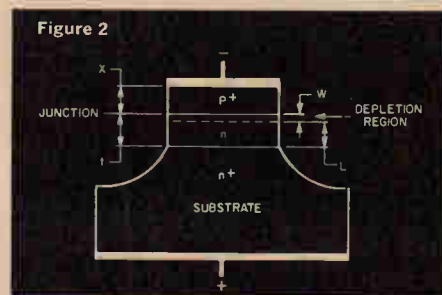
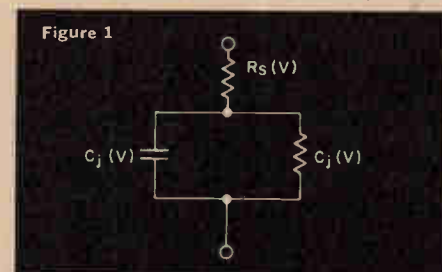

Figure 3

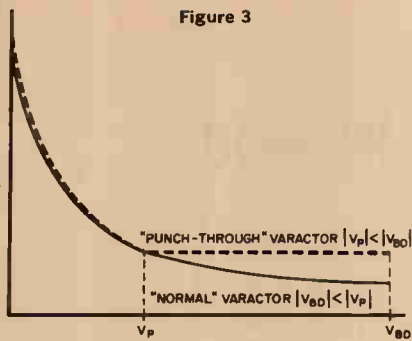

Figure 4

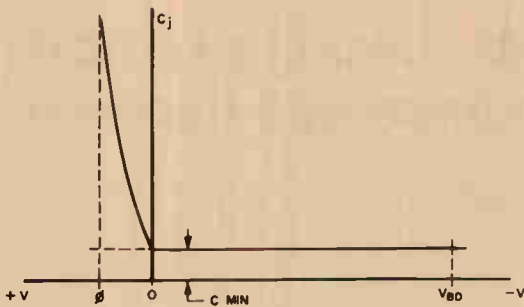
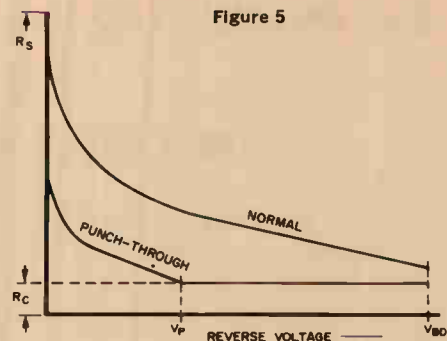

Figure 5



the variation of C_j as V increases. One is the maximum allowable applied reverse voltage, with the reverse breakdown voltage V_{bd} . At V_{bd} , avalanche multiplication takes place and a large current flows through the diode.

The second factor is the thickness t of the n-type layer. Depletion width, w , increases continuously with applied voltage, but it cannot exceed thickness t , because at that point the depletion region boundary is in contact with the heavily doped n^+ substrate. When $w = t$, no further decrease in junction capacitance can occur.

Depending upon thickness and resistivity of the n-layer, avalanche breakdown may occur at a reverse voltage either lower or higher than that at which $w = t$. The voltage at which $w = t$ is the punch-through voltage, V_p . Figure 3 shows the junction capacitance and applied reverse voltage relationship for the punch-through and conventional (or "normal") varactors.

If the punch-through voltage occurs at a voltage which is low with respect to the breakdown voltage, then the overall capacitance-voltage relationship approaches the case where $\gamma = 0$ and C_j is constant for any applied reverse voltage beyond

the punch-through point.

While the PTV exhibits little capacitive nonlinearity with a reverse bias, a marked nonlinearity occurs with a forward bias. This is due to charge storage. This charge storage capacitance, sometimes called the diffusion capacitance, is an exponential function of forward voltage, and also depends upon the recombination lifetime of the semiconductor material. For effective charge storage, the recombination lifetime should be large compared to a period of the drive frequency. Figure 4 shows an idealized capacitance-voltage plot ($\gamma = 0$) of a punch-through varactor.

The series resistance, R_s , of an epitaxial varactor consists of a sum of four terms: $R_s = R_p + R_n + R_{n^+} + R_c$. Resistance R_p is that of the p-layer; R_n that of the n-layer; R_{n^+} that of the substrate; and R_c that of the ohmic contacts.

In practice, R_c is usually a few tenths of an ohm at uhf frequencies, but may be higher at high microwave frequencies because of skin effect in the connecting leads. For surface concentrations normally used in epitaxial varactors, R_p is usually negligible compared to R_c and R_n .

Likewise, R_{n^+} is negligible for a highly doped substrate. Thus, the re-

sistance of the epitaxial layer, R_n , is the dominant component of R_s , and is given by $R_n = \rho_n L / A = \rho_n (t-w) / A$. ρ_n is the resistivity of the epitaxial n-layer, and L is as shown in Figure 2.

Since w varies with reverse voltage, R_n and R_s also vary with V . As with C_j , if $|V_{bd}| < |V_p|$, then R_s decreases continuously as voltages from zero to V_{bd} are applied. If $|V_p| < |V_{bd}|$, then R_n vanishes at V_p . This is because $w = t$, $L = 0$ and the total series resistance is $R_s \approx R_c (|-V| \geq |V_p|)$. Figure 5 shows the variation of R_s for the normal and punch-through cases. The change in series resistance with reverse voltage may be quite appreciable. For epitaxial varactors with breakdown voltages of 50 to 100V, the ratio of series resistance at zero bias to that at the breakdown voltage may be greater than 2:1 and up to 10:1 for higher-voltage varactors.

Varactors with the same value of R_s at breakdown may have quite different values of R_s at lower reverse voltages. In the PTV, the R_s is lower at zero bias than in a conventional varactor and reaches its minimum value at the punch-through voltage. The result is a lower average R_s over the drive cycle and higher conversion efficiency than in the normal varactor.

CIRCLE NUMBER 304



FIRST CLASS
Permit No. 2833
Buffalo, N.Y.

BUSINESS REPLY MAIL
No Postage Stamp Necessary if Mailed in the United States

POSTAGE WILL BE PAID BY

SYLVANIA ELECTRONIC COMPONENTS GROUP

Sylvania Electric Products Inc.
1100 Main Street
Buffalo, New York 14209

Dept. B4 4

Use Sylvania's "Hot Line" inquiry service, especially if you require full particulars on any item in a hurry. It's easy and it's free. Circle the reader service number(s) you're most interested in; then fill in your name, title, company and address. We'll do the rest and see you get further information almost by return mail.

How whiskerless diodes let you get more components on a board

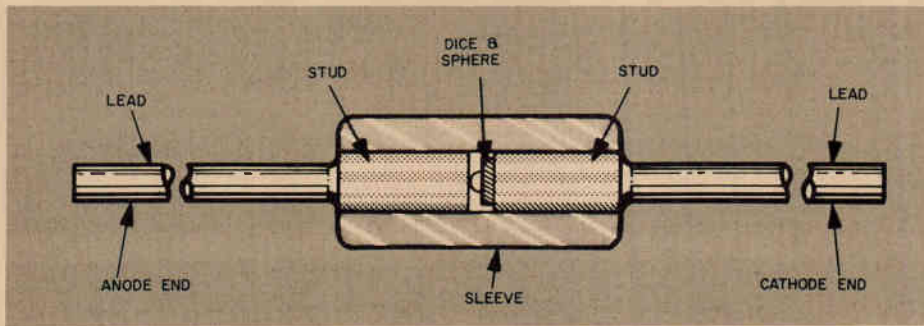

Designing computers or other equipment which requires fast logic circuits or small signal switching? Here's your chance to get more money for your diode dollar. Use Sylvania's miniature whiskerless diodes to replace DO-7 types, to get significant savings in mounting space, and improve reliability without any increase in cost.

Because Sylvania's miniature dual stud whiskerless diodes are much smaller than DO-7 types, they allow designers to decrease circuit board requirements significantly. Costing no more than their electrical equivalents in DO-7 packages, the rugged whiskerless units have a package volume which is 68 percent smaller. But smaller size is not the only advantage of these newer diodes. The single unit construction makes for higher reli-

ability and for devices able to take shock and vibration environments.

With these 0.075" dia. by 0.160" long Sylvania units you get top electrical performance. Typical reverse leakage currents of units in the whiskerless line are a low 15 na. Switching speeds are in the order of 4-10 nsec. Ratings for these silicon epitaxial diodes include average rectified currents of up to 150 mA (with surges of 500 mA) and a power dissipation of 500 mW.

Key construction features of the whiskerless devices are: use of a plated silver sphere to make contact to the junction, dumet studs for good heat conduction away from the junction, and protection of the active area with a soft glass sleeve. What results is a rugged single-piece device capa-

ble of taking high-g shocks.

Reliability of this simple structure is enhanced further by the pains taken during the manufacturing process. Sylvania has developed special production techniques to make sure the silicon dice used is more symmetrical and is free from any jagged edges, cracks, or out-of-tolerance parameters.

Sylvania's whiskerless diodes can be used with standard automatic insertion equipment.

CIRCLE NUMBER 305

SILICON EPITAXIAL DIODES

Type	Outline	DO-7 Electrical Equivalent
1N4148	DO-35	IN914
1N4149	DO-35	IN916
1N4151	DO-35	IN3604
1N4152	DO-35	IN3605
1N4153	DO-35	60V IN4152
1N4154	DO-35	IN4009
1N4446	DO-35	IN914A
1N4447	DO-35	IN916A
1N4448	DO-35	IN914B
1N4449	DO-35	IN916B

ABSOLUTE MAXIMUM RATINGS:

Average Rectified Current, I_o	75 mA
Peak Forward Current, I_{pk}	225 mA
Forward Surge Current, (1 sec)	500 mA
Power Dissipation, P_T	500 mW
Junction Temperature, T_J	-65°C to +175°C

This information in Sylvania Ideas is furnished without assuming any obligation.

SYLVANIA

SUBSIDIARY OF
GENERAL TELEPHONE & ELECTRONICS GTE

NEW CAPABILITIES IN: ELECTRONIC TUBES • SEMICONDUCTORS • MICROWAVE DEVICES • SPECIAL COMPONENTS • DISPLAY DEVICES

NAME _____

TITLE _____

COMPANY _____

ADDRESS _____

CITY _____ STATE _____

Circle Numbers Corresponding to Product Item

300 301 302 303 304
305

Please have a Sales Engineer call



HOT LINE INQUIRY SERVICE

Need information in a hurry? Clip the card and mail it. Be sure to fill in all information requested. We'll rush you full particulars on any item indicated.

You can also get information using the publication's card elsewhere in this issue. Use of the card shown here will simplify handling and save time.

The Tantalum Rock

KEMET C-Series Solid Tantalum Capacitors. Tailored for today's go-go electronics.

The KEMET C-Series lets you design tantalum reliability into the whole field of consumer products: radios and TV... CB sets... electronic organs and other instruments... audio equipment... appliances. The reason is simple: we've priced the C-Series in line with conventional aluminum electrolytics.

Abbreviated specs: 0.1 to 220 microfarads. 6 to 50 vdc. -55° to $+85^{\circ}$ C without derating. And remember the unique Union Carbide delivery plan: ultra-fast or staged deliveries of any quantities from thousands to millions—assured.

Now, can you think of any good reason not to use tantalum? See our representative, or mail the coupon.

Clip, fill in name and title, attach to letterhead.

Union Carbide Corporation
Components Department
Dept. E-43
270 Park Avenue
New York, N. Y. 10017



Please send details on C-Series
KEMET Solid Tantalum Capacitors

Name _____

Title _____

KEMET is a registered trade mark of Union Carbide Corporation.



REGIONAL SALES OFFICES. New England: T. J. Roper, 300 First Ave., Needham Heights, Mass. Phone: 617-444-5400. Mid-Atlantic: R. H. Robecki, 1341 Hamburg Turnpike, Wayne, New Jersey 07472. Phone: 201-696-2710. Mid-West and South: K. S. Collart, P. O. Box 6087, Cleveland, Ohio 44101. Phone: 216-221-0600. C. F. Fields, 2 Talcott Road, Park Ridge, Ill. 60068. Phone: 312-825-8189. West Coast: D. Purcell, 701 East Whittier Boulevard, Whittier, California 90605. Phone: 213-698-8077. C. E. Volpe, 2680 Bay Shore Frontage Road, Mountain View, California 94041. Phone: 415-969-9390. For Overseas Inquiries contact: J. G. Egan, 1341 Hamburg Turnpike, Wayne, New Jersey 07472. Phone: 201-696-2710.

Circle 35 on reader service card

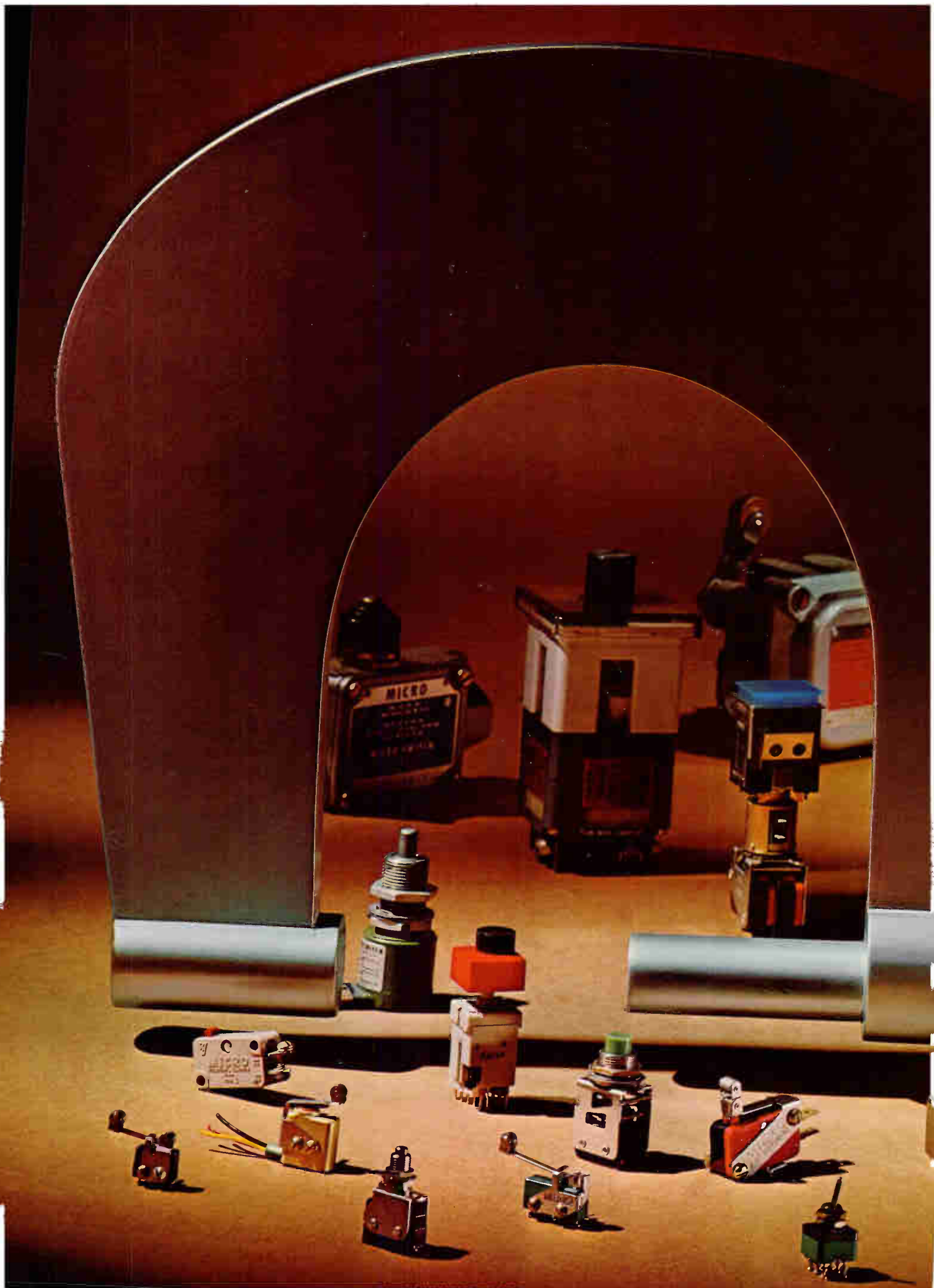

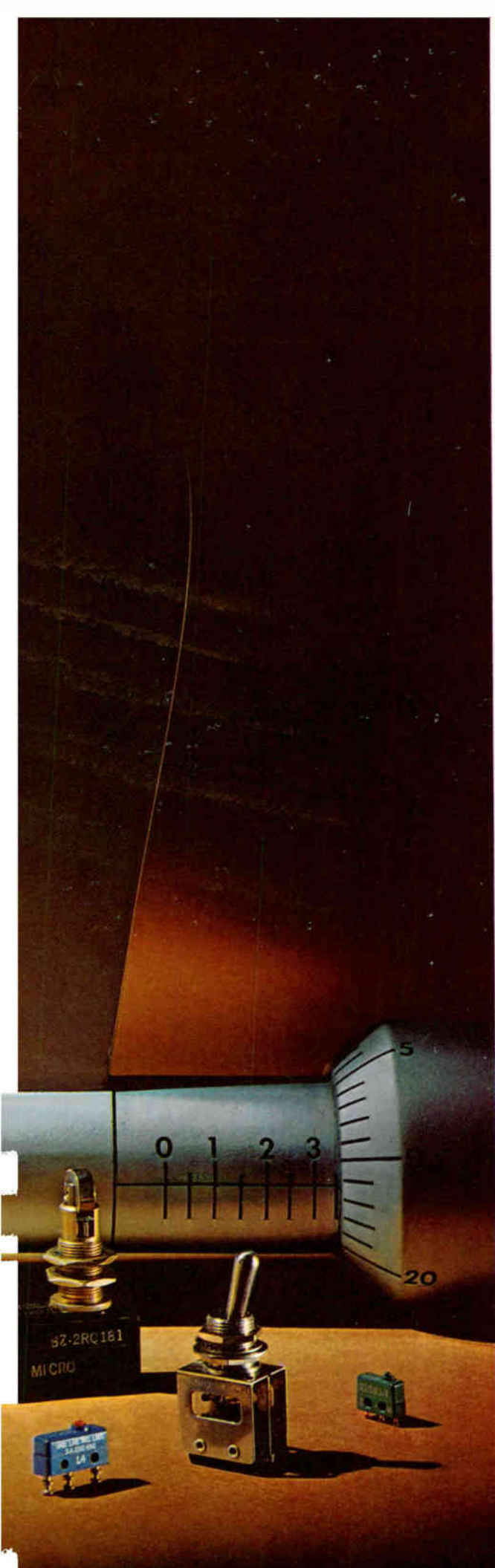

We're a little more careful... to make you a little more sure

Dependability. That's the big word about any product with the name "MICRO SWITCH" on it.

There are a number of reasons for this dependability but they can be narrowed down to two words: quality control. MICRO SWITCH is big enough—in both experience and facilities—to take extra steps to see to it that each switch holds up as well in your equipment as it does in our grueling laboratory tests. *MICRO SWITCH assures reliability before manufacturing begins.*

To feel a little more secure, and to find out for yourself the many ways MICRO SWITCH is a little more careful, write for our free booklet, "Quality Assurance for our Customers." No obligation, of course. Write . . .

MICRO SWITCH

FREEPORT, ILLINOIS 61032
A DIVISION OF HONEYWELL

HONEYWELL INTERNATIONAL • Sales and service offices in all principal cities of the world.
Manufacturing in United States, United Kingdom, Canada, Netherlands, Germany, France, Japan.

Circle 37 on reader service card

Now there's a "4th generation"



of signal instrumentation



*First Prize, Enclosures, NEP/CON '67 West.

This new Monsanto™ Model 3100A Digital Frequency Synthesizer has a computer-optimized design that creates new standards of stability, purity, precision and value for general purpose signal generators.

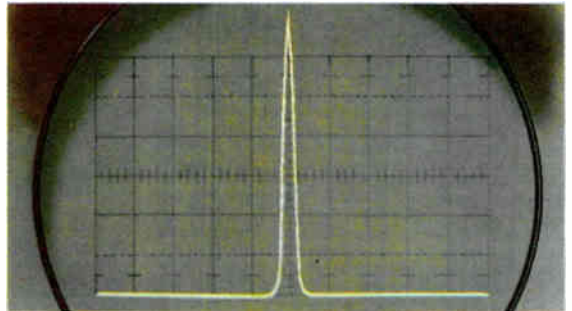

1 MHz OUTPUT SPECTRUM.

Gather 'round and look it over. From its clean, functional, prize-winning* cabinet to its all-solid-state, I/C circuitry, this unique design is all new . . . the first of our "fourth generation" instruments.

The 3100A outperforms all other synthesizers. Select or program any frequency from 0.01 to 1.3 MHz (in 130 million steps). You've never had it so pure—from any signal source. Harmonics are down at least 50 db, and spurious components are down at least 80 db! Stability? 1 part in 10^9 /day, by an oven stabilized crystal oscillator.

The output is DC coupled with a ± 2 v offset bias control at a constant 50 ohms, through an accurate 90 db stepping attenuator. There is a flexible dual-frequency internal sweep and external AM, too. For maximum computer-system compatibility, the programming time is less than 20 microseconds. This versatile instrument has more of what you need in a signal source.

Here is the clincher. At \$3950, the Monsanto 3100A sells well below old-styled frequency synthesizers. (USA price f.o.b. New Jersey) Write or phone us for the full story. Monsanto Electronics Technical Center, 620 Passaic Avenue, West Caldwell, N.J. 07006 (201) 228-3800.



ELECTRONIC
INSTRUMENTS

Circle 39 on reader service card

<1% distortion sine, <250 ns square,
<1% linear triangular waveform outputs.

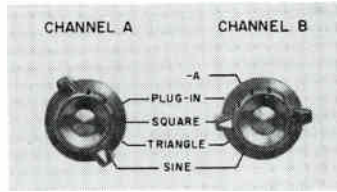

**COVER THE SIGNAL
SPECTRUM TO 100kHz
WITH HP MODEL 3300A
FUNCTION GENERATOR
AND HP MODEL 3302A
TRIGGER/PHASE
LOCK PLUG-IN!**

hp 3302A TRIGGER/PH

Multiple or Single bursts,
controlled by external signal with 360°
variable Start/Stop Phase.

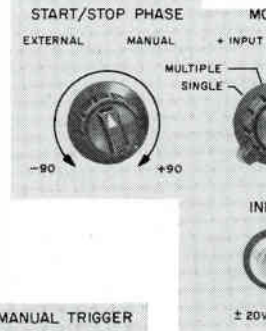

Manually select single or multiple
cycles by the push of a button. Frequency is
controlled by Frequency dial.

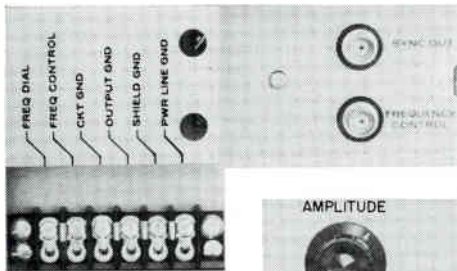
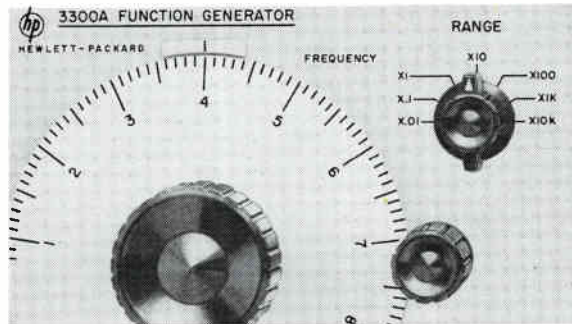

External frequency programming
greater than 1 decade can be achieved
with 0 to -10 V input.



Frequency range
0.01 Hz to 100 kHz through
seven decade ranges.

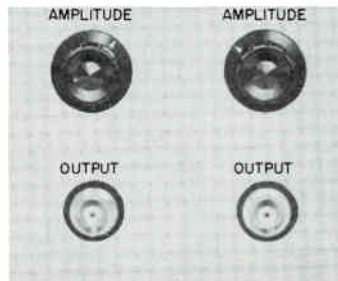

Two independently amplified fully floating
outputs with separate controls for 35 V p-p.

Any two functions
(sine, square or triangle) can
be phase locked to any external
periodic signal. Phase can be
controlled 360° ±10°.

Price: hp 3300A Function Generator Mainframe, \$625.00; hp 3301A Auxiliary Plug-In, \$20.00; or hp 3302A Trigger/Phase Lock Plug-In, \$190.00. For full specifications, contact your nearest hp field engineer. Or, write Hewlett-Packard, Palo Alto, California 94304, Tel (415) 326-7000; Europe: 54 Route des Acacias, Geneva.

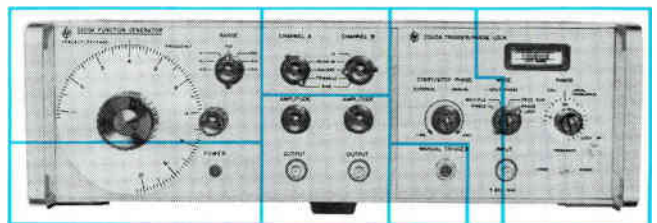

097/12

HEWLETT  **PACKARD**
An extra measure of quality

Time's up:

Honeywell now has a taut-band meter that actually goes for even less than a pivot-and-jewel meter.

(About 10% less, on the average.)

What kind of a taut-band meter could we possibly sell at those prices?

An ingeniously simple one.

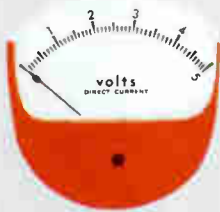

We designed every single unnecessary part right out of it. (Fewer parts: fewer things to go wrong.)

And we make this meter by machine. (This not only gives us a very good cost advantage. It also gives you a more reliable meter.)

It'll last practically forever because there's no friction in the moving parts. It'll mount anywhere with-



out special calibrating because it's self-shielded.

And you can get one of these low-cost taut-band meters in just about any style you like.

But don't make up your mind yet. Take a look at our catalog first. Write Honeywell Precision Meter Division in Manchester, N.H. 03105.

Honeywell

How long have you waited for a low-cost taut-band meter?

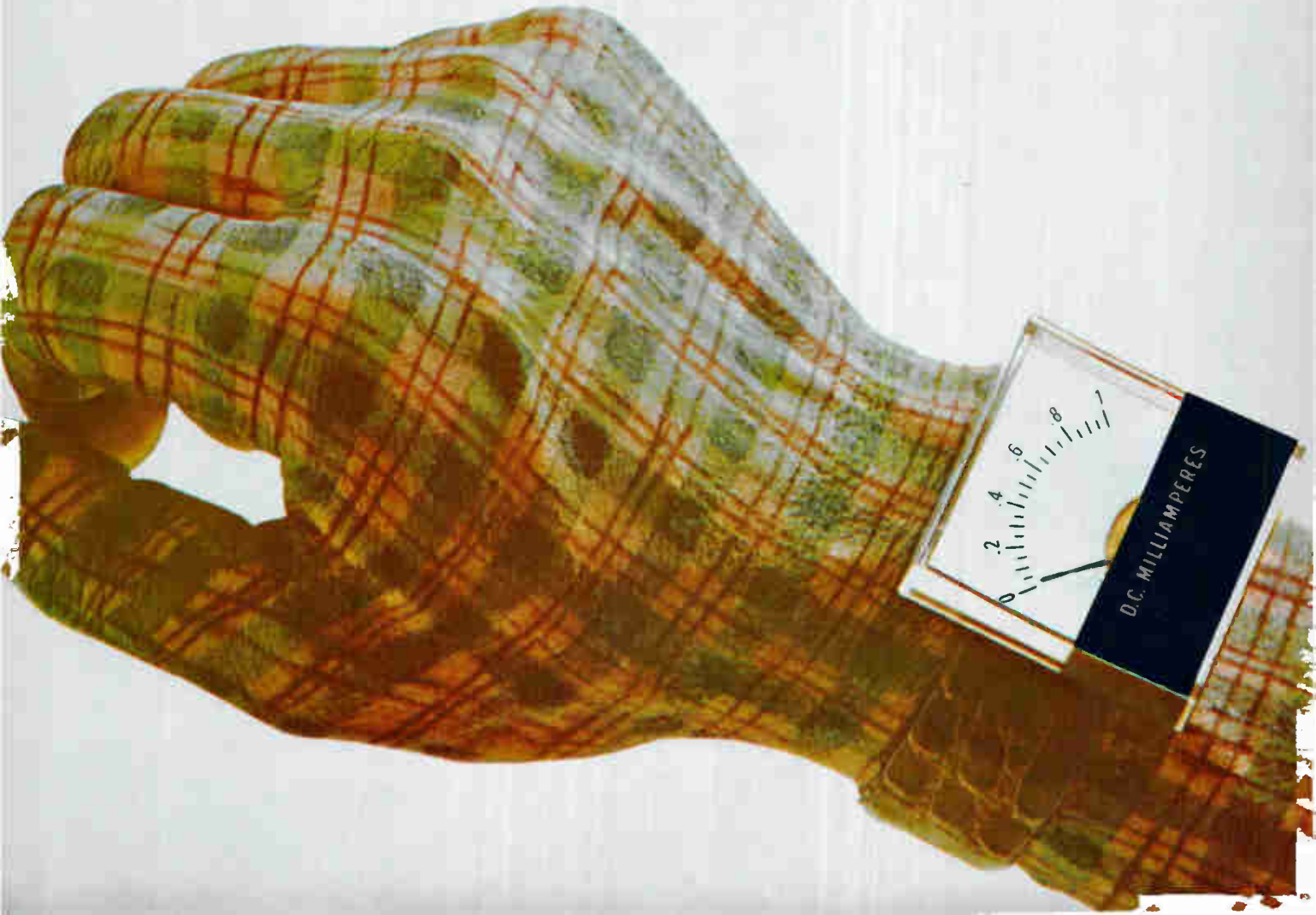

ASSEMBLE THIS WEATHERPROOF CONNECTION

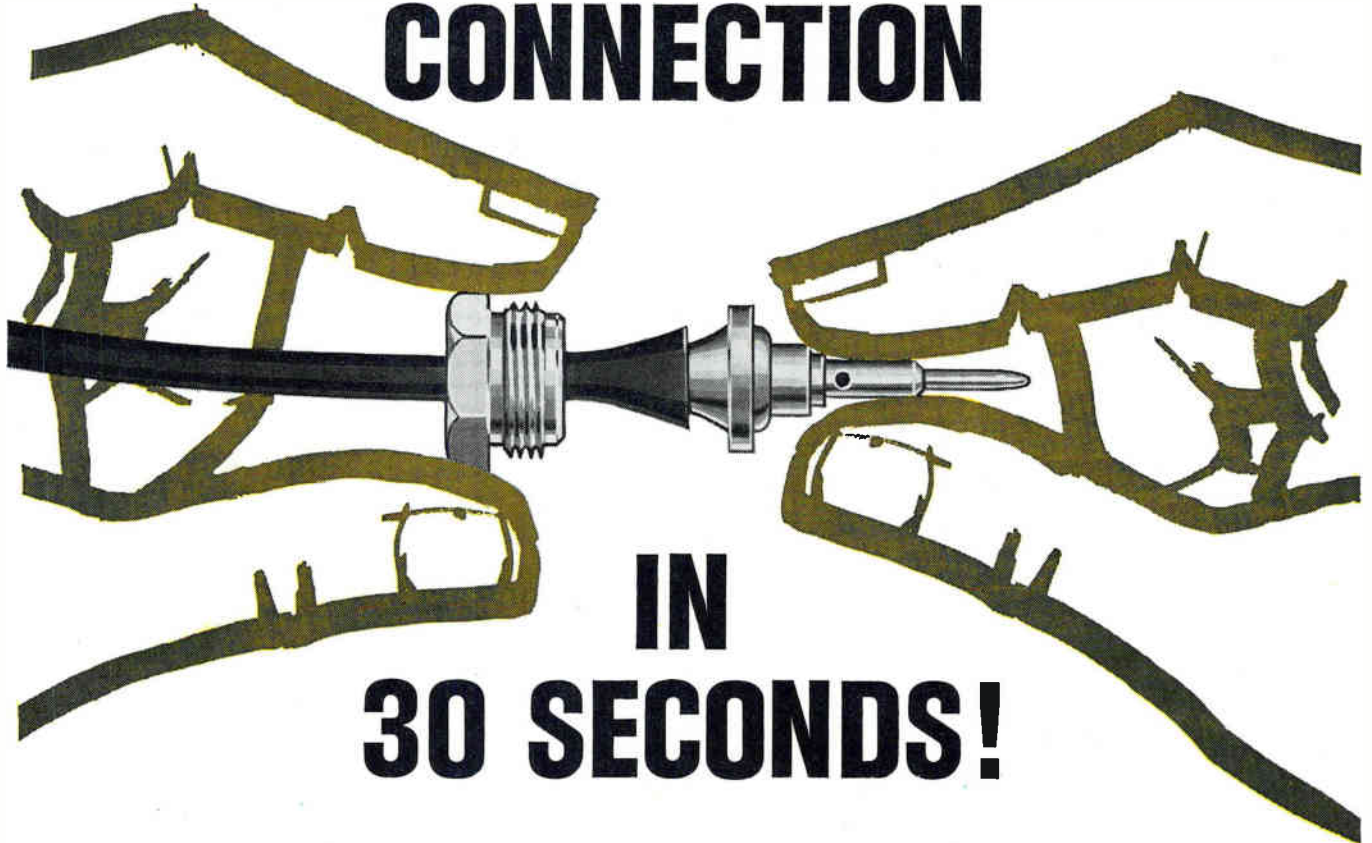

IN 30 SECONDS!

Again, BENDIX/DAGE engineering has solved a major problem for equipment builders! New DAGE Square-Cut RF Connectors reduce assembly time 50%-75% ... produce weathertight seals with a pull test of 50 lbs. Only 3 parts—no special tools required!

Time-and-money-saving benefits of

Square-Cut Connectors are typical of BENDIX/DAGE contributions to the state of the art ... *practical* ideas that help you design for greater capability in *your* circuitry and equipment.

Write for Square-Cut literature. If you have a special problem, call Dage Engineering Department. Call today!

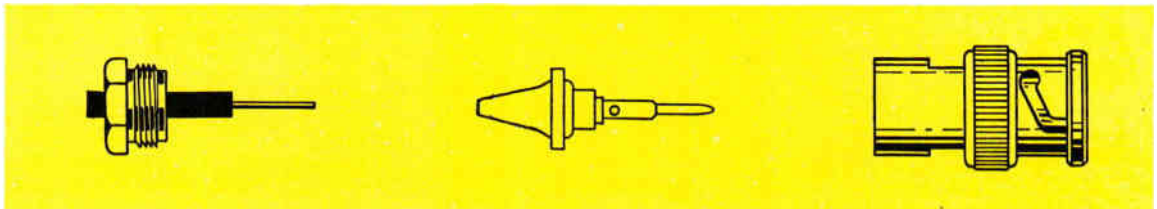

Bendix

DAGE

ELECTRIC COMPANY

a subsidiary of the Bendix Corporation

Hurricane Road • Franklin, Ind. • Phone 317/736-6136

FIRST WITH IDEAS • FIRST WITH QUALITY • FIRST WITH SERVICE

"When we use A-B hot molded resistors instead of some other make, it's one less component we have to worry about"

Digital Equipment Corporation



FLIP CHIP T.M. Modules—The Digital Equipment Corporation trademark for a new kind of digital system module uses Allen-Bradley hot molded resistors exclusively.



Digital Equipment Corporation's PDP-8 programmed data processor, in which these modules are used, is a compact general purpose digital computer with a high speed, random-access, magnetic-core memory for engineering, scientific, and educational applications.

■ Allen-Bradley hot molded resistors have established such a consistently superior performance record over the years that Digital Equipment Corporation uses them exclusively in their computers—with no substitutes permitted under any circumstances!

While Allen-Bradley quality is the number one reason for this standardization, Digital reports that *excellent service* from Allen-Bradley is an advantage of vital importance to them, too. For example: "Recent expansion of FLIP CHIP production to meet the demand for PDP-7 and PDP-8 computers quadrupled our component needs. With Allen-Bradley's help there wasn't a single hitch in the production speedup."

The unvarying quality of Allen-Bradley resistors—million after million, year in and year out—results from an *exclusive* hot molding process. The precision automatic

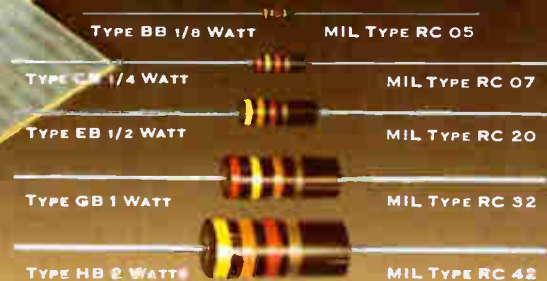

HOT MOLDED FIXED RESISTORS are available in all standard EIA and MIL-R-11 resistance values and tolerances, and can usually also be furnished in values above and below standard limits. Shown actual size.

equipment developed and used only by Allen-Bradley produces such uniform properties that long term resistor performance can be accurately predicted. Please note, Allen-Bradley hot molded resistors have never been known to fail catastrophically in service.

For complete specifications on Allen-Bradley hot molded fixed and variable resistors, please write for Technical Bulletin 5050: Allen-Bradley Co., 222 W. Greenfield Ave., Milwaukee, Wis. 53204. In Canada: Allen-Bradley Canada Limited. Export Office: 630 Third Ave., New York, N.Y., U.S.A. 10017.

65-08-6E



ALLEN-BRADLEY
QUALITY ELECTRONIC COMPONENTS

An Allen-Bradley announcement of importance to motor designers

The new MO6-C ferrite magnet having 30% higher intrinsic coercive force

■ The new Allen-Bradley MO6-C ceramic permanent magnets provide at least 30% increase in the highest previously available intrinsic coercive force—obtainable with A-B's MO5-C material. This advance is achieved with the same high residual flux density.

Designers of permanent magnet motors have a choice of these advantages—30% higher resistance to demagnetization, or 30% increase in motor output, or 30% increase in cold temperature protection. In fact, where the higher coercive force is not required, the designer can give himself a 30% reduction in magnet size.

This new Allen-Bradley MO6-C material opens the door to such motor designs where permanent magnets heretofore were not practical, namely for motors used in many portable tools and appliances. Like with the MO5-C material, these new MO6-C magnets are radially oriented, and are available in virtually all sizes and shapes currently being produced in segments for motors from 3/4" diameter to 10 hp. While MO5-C magnets will continue to satisfy most needs, MO6-C enables designers to satisfy more exacting motor design requirements because of its unusually high intrinsic coercive force.

Allen-Bradley application engineers will be pleased to help you obtain maximum economy in your motor design through optimizing magnet performance. Please let us hear from you. Allen-Bradley Co., 222 West Greenfield Avenue, Milwaukee, Wisconsin 53204. In Canada: Allen-Bradley Canada Limited. Export Office: 630 Third Ave., New York, N.Y., U.S.A. 10017.

TYPE MO6-C CERAMIC PERMANENT MAGNETS

Typical Characteristics

—stated values have been determined at 25°C.

Property	Unit	Nominal Value
Residual Induction (B_r)	Gauss	3300
Coercive Force (H_c)	Oersteds	2800
Intrinsic Coercive Force (H_{ci})	Oersteds	3100
Peak Energy Product ($B_d H_d$ max)	Gauss-Oersteds	2.5×10^6
Reversible Permeability	—	1.09
Curie Temperature	+°C	450
Temperature Coefficient of Flux Density at B_r	%/°C	-0.20
Specific Gravity	—	4.9
Weight per Cu. In.	Lbs.	0.177

ENERGY PRODUCT $B_d H_d \times 10^6$ 2.5
3.0 | 2.0

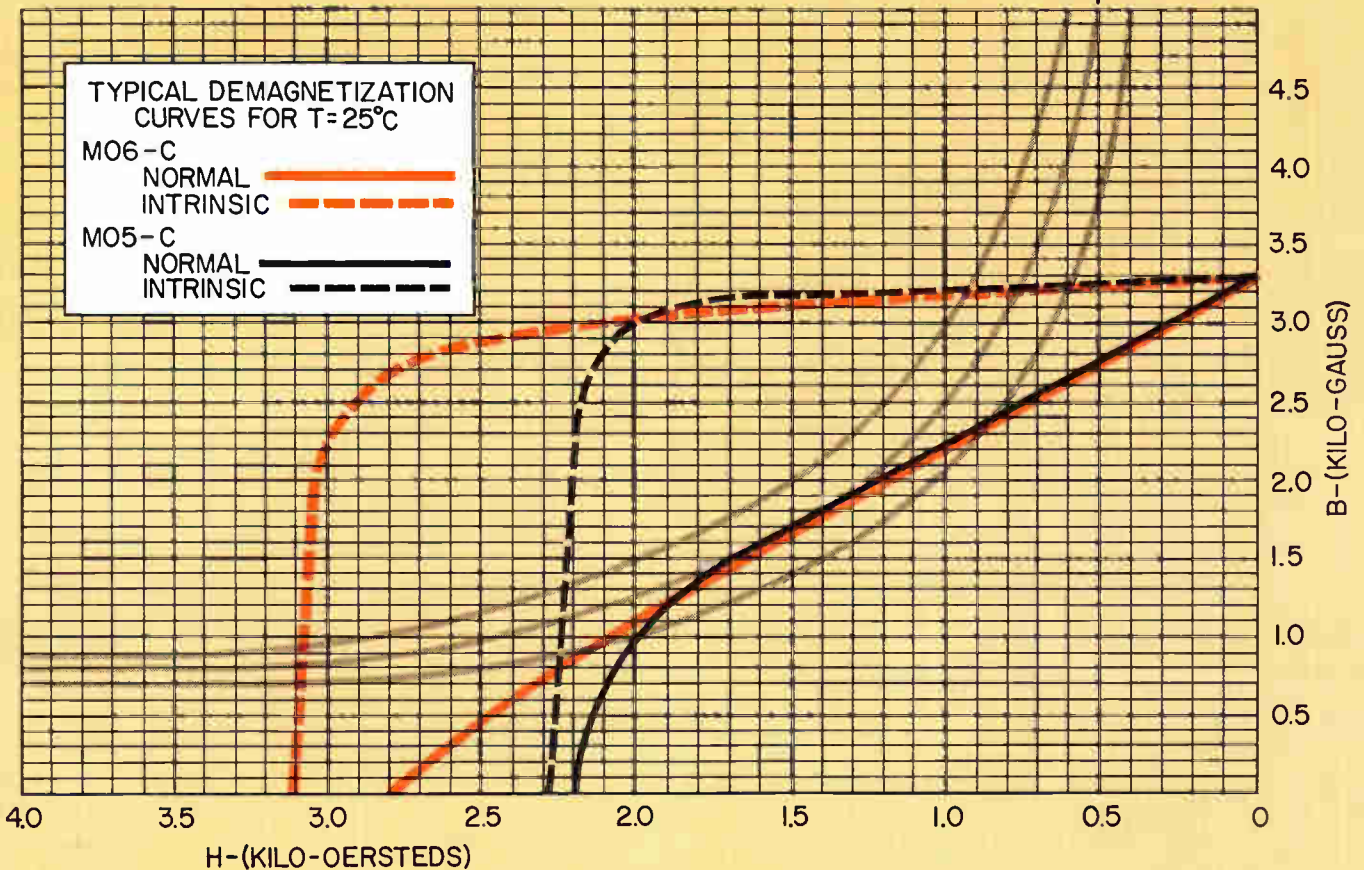

ALLEN-BRADLEY

QUALITY MOTOR CONTROL

QUALITY ELECTRONIC COMPONENTS

**if you could
find a more
stable
polyester film
you'd use
it.**



right?

Users report a measurable stability advantage with Celanar polyester film. In printed circuits Celanar polyester film means less shrinkage—hence a more reliable circuit.

Celanar has other substantial advantages, too. Its tensile (pull) strength is 30% stronger than other films. And Celanar film is the cleanest, freest from contamination, in the industry. We produce Celanar in a "White Room" where air filtration systems effectively trap dirt specks as tiny as 0.3 microns—infinitesimal as the point of a needle.

What's more, we lean over backwards to supply

Celanar film in the roll lengths, widths and gauges most convenient for you. Ship it with temperature recording flags, even impact recorders where necessary, to assure your receiving quality as high as we produce.

Those are reasons why major automotive manufacturers use Celanar film for under-the-dash printed circuitry.

And why you should know the full facts about Celanar film. All it takes is a letter to: Celanese Plastics Company, Dept. 233-D, P. O. Box 629, Linden, New Jersey 07036. Celanese® Celanar®



Celanese Plastics Company is a division of Celanese Corporation.

Bendix LJT Connectors— first and only to be fully scoop-proof



No mismating, damaged pins or short circuits.

The Scoop Test is a pretty tough test to give a connector. To pass, you can't damage or short the pins, no matter how much you misalign the plug and receptacle during mating.

Bendix® LJT Connectors *pass* the Scoop Test—and scoop the rest. And it doesn't matter if the pins are in the plug or the receptacle! Because all contacts are totally recessed. They're stronger, too. And mismating is a thing

of the past. Five-key polarization assures it.

But that's not half the story. Hard, glass fiber-filled epoxy inserts improve electrical and thermal characteristics, are impenetrable by pins and probes. Plug shells are provided with grounding fingers for EMR and RFI shielding. Safer, too, because the shell is grounded before contacts engage. Insert assemblies are staked and bonded for a sturdy

moisture-proof seal. You can specify shell sizes from 9 to 25. Get from 3 to 67 contacts in 16, 20 and 22M sizes, with solder terminations. Select flange mount, line mount, straight plug, jam nut or hermetic types. All built as rugged as you can find.

Write today for complete information on our LJT connectors. The Bendix Corporation, Electrical Components Division, Sidney, New York 13838.

Bendix  **Electronics**

Manufacturing

Boosting IC's

To boost integrated-circuit yield and performance, IC mask makers are turning to interferometer-equipped masking cameras. The reason: plate positioning errors in conventional cameras are limiting the potential of IC's by forcing designers to make circuit elements larger and spacing wider to ensure registry of superimposed images on the master plate.

Using light as a measuring tool, the new cameras can place IC's on the master plate with at least four times the accuracy of conventional camera systems. To the IC builder, greater accuracy means higher device and plate yield. Closer circuit and interelement spacing will lead to faster production of more complex IC's.

First to use an interferometer-equipped camera on its IC production line is the Hewlett-Packard Co.; [Electronics, April 3, p. 26]; Motorola Semiconductor Products, Inc., a Motorola Inc. subsidiary and Texas Instruments Incorporated are operating experimental models. ITT Semiconductor Research Laboratories is building one and Spectra Physics Inc. will begin selling such cameras late this year; Optomechanisms Inc. is now selling a small model.

Fringe benefits. The new interferometric positioners use coherent light as a yardstick rather than micrometric gears, scribed grids, or other mechanical references. Because there are no built-in mechanical inaccuracies, the new cameras register or position images with 5- to 12-micron accuracy. Conventional cameras, at best, can only achieve accuracies of 45-50 microns. Accuracy with the new cameras are maintained over the entire master plate.

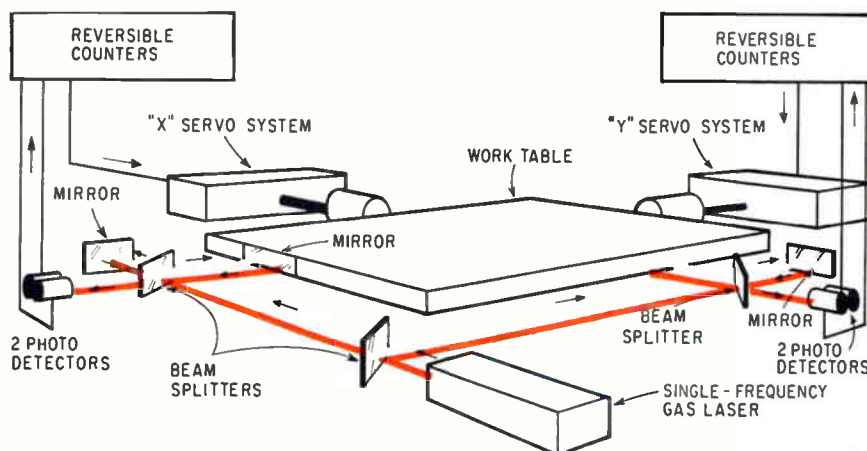

Light beams, shown in color, are the measuring elements in a laser interferometer that servopositions IC master plates with high accuracy.

Interferometers measure distance and find position by counting "fringes"—alternate periods of darkness and light that appear when two beams of coherent light mix. In the new masking cameras, two interferometers are used, one for X-axis and the other for Y-axis positioning.

Each interferometer has one leg of known length and another that becomes longer or shorter as it is reflected from a mirror on the moving plate-positioning stage. The two beams combine at a photodetector and their respective phases cancel out, causing alternating light and dark periods—fringes. A fringe corresponds to a movement of the stage; when a helium-neon 6,328-Angstrom-wavelength laser is used as the light source, a fringe corresponds to a distance of 3,164 Angstroms. The detected fringes pass from the photodetectors to counters or computers.

Beyond the fringe. Various companies use fringe data differently. Hewlett-Packard, TI and Spectra Physics use reversible counters and digital computers to servocontrol stage position, set spacing between IC images, and trigger exposure. Motorola's experimental unit is simpler, with the detectors feeding

Nixie-tube counter readouts and the operator positioning the stage manually; he also controls exposure.

The digitally controlled cameras automatically count a preset number of fringes, make exposure, and step to the next position. They can leave unexposed positions in the image pattern, dropping in other images later without degrading positional accuracy. This capability is important to builders of large-scale integrated arrays because many different masks are often used on an LSI plate.

The excellent registration possible with the new cameras may also make possible closer placement of IC images, smaller elements, and closer interelement spacing. Carl Betz, manager of mask-making research and development at Motorola, predicts interelement spacing as close as a half micron. Motorola is already planning to make masks for a highly complex, 80 by 80 mil LSI array with very small elements.

With such accuracy, overall plate yield should be increased; there should be fewer plates shot with out-of-register images to cause circuit rejection. By the same token, it takes less time to "debug"

a set of master plates. Each set still has to be inspected, but the new cameras will be able to reshoot bad plates in a single operation. Conventional masking cameras usually need five or six attempts to shoot a well-registered plate because of mechanical inaccuracy.

On the dark side. The new cameras' biggest drawback is cost stemming from their susceptibility to vibration. To get the full benefit of interferometric accuracy, the IC mask maker may need a \$200,000-\$300,000 stable table in a controlled environment, according to William Winslow, president of Qualitron Inc., the country's largest mask-making firm. Add this to Spectra Physics' predicted camera price of more than \$100,000 and it's a large capital investment. TI spent about \$500,000 on its camera setup, which includes a 16-ton, spring-suspended concrete stable platform.

Communications

Dial h for help

Complaints about high telephone bills have a familiar ring to most phone companies, but the tone of the grumbles from users of time-shared computer systems is alarming.

Rates levied by the American Telephone & Telegraph Co.'s Bell System are prohibitive and account for a disproportionately high share of data-processing costs, users claim. Some go so far as to say that the giant communications carrier is blocking the growth of computer utilities by not reacting to the technology's needs.

Billing gripe. The most outspoken critic of AT&T is Richard G. Mills, assistant director of the Massachusetts Institute of Technology's Project MAC, a prototype computer utility. Mills would like the Federal Communications Commission to spur AT&T to speedy action [Electronics, April 3, p. 25]. He terms unfair the company's rate structure as it affects computer communications.

A computer service bills the user only for computer use time. The phone companies, however, bill the users for circuit-use, regardless of how much time is actually spent in transmitting data. Mills wants AT&T to charge "by the bit."

AT&T's move to pulse-code modulation, which eventually will replace all of today's analog circuitry, is too slow to suit Mills. "Eventually isn't fast enough," he points out.

Others agree. Says one user: "AT&T's operating companies' representatives don't understand our problems. They just take our suggestions and lose them."

The problem will be further aggravated when the International Business Machines Corp.'s 360-67 and the General Electric Co.'s 645 as well as other time-sharing computers are put into full use—probably within the next couple of years.

Lewis Cimino, a manager of information systems and computers at GE, says his company "has an AT&T representative in here almost all the time and it's a continual debate. The carrier either doesn't understand our needs or seems to lose our suggestions in its daisy-chain of command."

General Electric has data banks around the country and has tried to interconnect them several times using AT&T's coaxial cables, but each time it had to discontinue the links because the transmission costs were prohibitive, says Cimino. GE also has 13 regional time-sharing computer utilities facing the same problem.

Says Cimino: "When the Government becomes a big user of time sharing, it'll feel the communications cost bite just as we do and the FCC will do the rest."

Devil's advocate. James D. Babcock, president of the Allen-Babcock Computing Co., a Los Angeles time-sharing service, won't knock AT&T's refusal to junk \$30 billion in plant equipment "just for the sake of a few time-sharing nuts."

Thomas J. O'Rourke, president of Tymshare Inc., in Los Altos, Calif., also backs the carrier. "Our feeling is that it makes good business sense to base commercial use

rates on the same basis as the phone company. Admitting the carrier was caught flatfooted by the growth of time sharing, he comes up with a gripe of his own—the unsuitability of AT&T's interfacing. "Teletype terminals may be fine for batting orders back and forth but they are inadequate for a time-sharing computer." He cites low speed and a limited number of characters as causes of inefficient transmission.

The giant communications carrier is taking the attacks in its stride and refuses to comment on them.

Integrated electronics

Complementary samples

Lured by its bright prospects for achieving fast integrated circuits that dissipate little power, the Radio Corp. of America has successfully produced complementary (n and p channels) metal-oxide-semiconductor (MOS) elements in a single chip. The company has used the new complementary technique to build a dual 3-input NOR gate.

The 14-element IC will contain the two gates and an inverter stage in one silicon chip. It is expected to be available on a sample basis to customers within the next two months.

While the complementary concept is well known, its development has proven difficult. Some researchers have slowed their efforts and still others have turned to alternate methods.

RCA's technique was developed by the company's IC department in Somerville, N.J. To produce both n- and p-channel elements on the same chip, a p-isolation region is diffused into the n-silicon substrate. The p region serves as the local substrate for the n-channel MOS device.

RCA attributes the circuit's low standby power—about 10 nanowatts—to the high impedance of the off unit, which blocks the power supply voltage in both the high and

low states. Operating power is low, too, since power is dissipated only during switching to charge and discharge capacitance. The gate, when run from an 8-volt supply dissipates 400 microwatts at 100 kilohertz, while driving a capacitance of 30 picofarads. Good speed of the unit is attributed to the output node capacitance always being charged and discharged through the low-impedance on unit. Propagation delay, RCA says, is 25 nanoseconds. While comparable semiconductor bipolar integrated circuits can match these speeds, power dissipation is much greater—of the order of tens of milliwatts.

A difficult road. Last year, Motorola Inc.'s Semiconductor Products division introduced what was

probably the first complementary mos switch. But the device isn't listed in the firm's catalog and its current mos program is shrouded in secrecy. Nevertheless, Motorola says the mos device is available for sale. North American Aviation Inc.'s Autonetics division is also putting n- and p-channel elements on one chip, but with some difficulties. Such devices, says Autonetics' Richard Platzek, are usable only in low-voltage systems—12 to 15 volts—because of their low breakdown voltage.

Critics claim complementary devices don't use silicon real estate effectively, since p- and n-channel elements must be isolated. The beauty of mos technology, the Philco-Ford Corp. believes, is in

simplicity of design, fabrication, and high manufacturing yields—not the case with the complementary approach. Gordon Moore, director of research at Fairchild Semiconductor, a division of Fairchild Camera & Instrument Corp., agrees.

But, RCA engineers say a direct comparison is misleading. The complementary circuitry, they contend, may be built with less precision than comparable single-channel circuits, and also, despite the more complex steps and larger area consumed, yields are potentially very high. They claim for example, that the new dual NOR gate will operate from any voltage between 6 and 12 v, whereas single-channel circuitry often requires a power supply accurate to within 1%.

Where it's tops. The real role of the complementary mos device, according to engineers at Philco-Ford, is in low-power memory applications. But while the technique may pay off in the combination of low power and higher frequencies, they believe the complementary method is not the basic solution to high speeds. Instead, Philco-Ford sees within a year faster p-channel devices and circuit improvements that will reduce propagation delay to a few nanoseconds.

A better way to achieve the speeds required for computers, says Autonetics' Platzek, could be through the use of a technique in which four separate clock signals, out of phase with each other, are routed through an all p-channel circuit.

Theoretical limits of the two devices—complementary and four-phase clock—are about the same, says Platzek; both are ultimately capable of about 250 kilohertz. He recommends the four-phase clock approach in fabricating complex digital differential analyzers. In comparing the two methods, Platzek says that one advantage of the four-phase clock is that it employs current technology. But it takes up more real estate on the silicon chip and it requires more metal than do complementary devices, decreasing the yield of the device.

Fairchild Semiconductor is working with the complementary mos

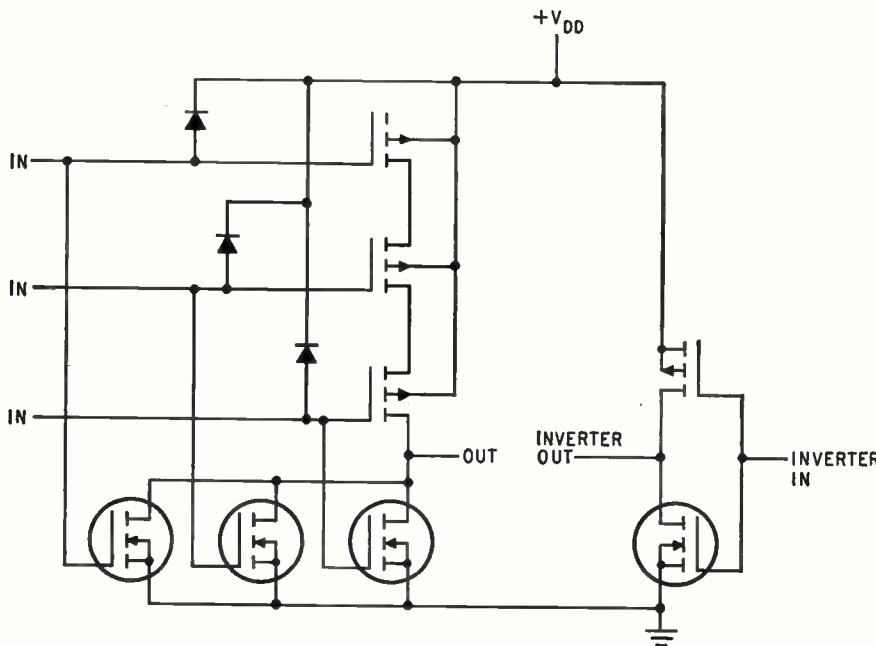

Complementary MOS device to be introduced by RCA is a dual 3-input NOR gate, and inverter on one silicon chip. Only one gate is shown, with the p-channel elements circled in color. Supply voltage may range from 6 to 12 v.

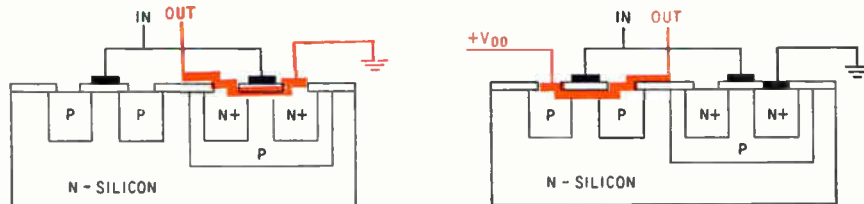
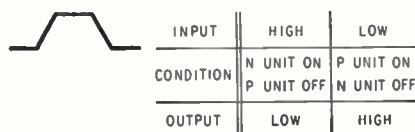

Diagram on left corresponds to high input, diagram on right, to low input. Output current paths are shown in color. N-channel device is at right of section drawings. Output current paths are shown in color.



Input and output waveforms with corresponding high- and low-level circuit conditions.

approach to high-speed, but now favors the single-polarity multi-phase clocking system. Using a four-phase clock system, Fairchild has achieved propagation delays of the order of 10 nanoseconds.

Companies

Turnaround in Phoenix

Last week, workmen moved back into the almost empty shell of a plant in Mesa, Ariz., that is to add 300,000 square feet of manufacturing space to Motorola Inc.'s integrated-circuit capability. Construction work had been stalled for about three months as tight money and high interest rates—not slumping sales as reported in *Electronics* (March 20, p. 54)*—forced the company to stretch out its capital spending plans, which also include new semiconductor facilities in France and Korea.

Slack period. Also, Motorola, like others in the industry, now has an expanding volume of orders for its discrete semiconductor products, but it earlier had to endure a spell of slack demand as some of its customers lived off accumulated inventories during the autumn and win-

* In the story "Motorola rollback," put together from industry reports and interviews, several errors appeared. The story reported that the Semiconductor Products division had a \$5 million loss in 1966. Commenting on the story, Daniel E. Noble, Motorola's vice chairman and chief technical officer, declared: "Sales and profit records were set by the firm's Semiconductor Products division in 1966. The division was one of the major profit centers of the corporation. The \$5 million loss erroneously reported was confused with our 1966 investment in integrated-circuit research and development."

Noble also explained that the layoffs described in the story followed abnormal peak production early in 1966 caused by anticipatory buying by customers. "Inventory balance has been achieved and we are now rehiring," he added.

The report of the drop in deliveries of tantalum capacitors was erroneous. Motorola does not and never has made this product.

Noble minimized the impact on Motorola's Semiconductor Products division of the production cutback in the automobile industry, another point made in the story. "It had only a minor effect on our rectifier sales," he said. "But, as someone recently pointed out, the number of cars being sold today is still quite high." Noble observed that the division manufactures 18 major categories of semiconductors covering 80% of all types required by industry, thus minimizing the company's dependence on any one market.

ter of 1966. Early last year, some customers, particularly in consumer-oriented industries, stocked up on semiconductor components, fearing that heavy military buying for the Vietnam war would cause materials shortages. The shortages failed to develop—largely because semiconductor production capacity was expanded—and these companies stopped buying until they could work off their stores of diodes, transistors, and silicon controlled rectifiers.

To handle the flood of orders last year's hedge buying created, Motorola increased its production force sharply during the spring of 1966. When customers started drawing from inventories instead of buying, it laid off the extra workers, about 2,700 of them.

Profit record. Fueled by the spurt in orders in early 1966, Motorola's Semiconductor Products division last year recorded its best sales and earnings in history—with profit estimated at more than \$10 million. Even during the time when demand for discrete devices suffered the effects of inventory liquidations, the division's operations remained profitable. The report in *Electronics* that the division sustained a \$5 million full-year loss should have specified that the loss applied only to integrated-circuit operations.

The deficit figure represented a giant investment in research and development, mainly for new products. Daniel E. Noble, vice chairman of Motorola, notes that "the division added 151 integrated circuits to its product line" last December and January.

The big ic investment signalled a change in Motorola's marketing strategy. Four years ago, when the company developed integrated circuits with emitter-coupled logic, it put the lion's share of its marketing effort into that one type, which it called MECL. But the move was regarded as premature by many computer designers, who were wary of MECL's sensitivity to external noise. In response, Motorola has added all kinds of ic logic to blanket the market. It now offers the widest range of integrated circuits in the industry—633 digital circuits and 33

linear circuits. Lester Hogan, division general manager, boasts: "Today we will deliver any kind of logic the customer wants." This includes diode-transistor logic, resistor-transistor logic, transistor-transistor logic, and MECL.

Where they go. As a result of this change, says Motorola, the firm in December delivered more ic's than any other supplier. The greatest number were digital circuits for the Radio Corp. of America's Spectra 70 computer, and for Minuteman missile guidance systems, flight simulators, and the R-13 project, a classified National Security Agency program. By adding all kinds of logic to its product line, Motorola has built for itself a steadily growing position as a second source. In addition, the company has been delivering linear ic's to General Dynamics Corp.'s Pomona division for the Redeye missile, an infantryman's rocket using 20 integrated circuits in its guidance system.

During the period of slowed demand for discrete devices last year, Motorola's output of integrated circuits continued to climb steadily. Work forces on the ic lines were reduced slightly, despite the increasing sales, however, because of sharply improved production yields.

Now, with sales of discrete semiconductor products rebounding, Motorola has started hiring again. According to Hogan, "the number of inquiries and requests to bid we received suddenly increased in February and March. A spurt in these always precedes orders." The official expects the production work force in Phoenix to return to its peak 1966 level by next September.

Modular construction. Because Motorola's Mesa plant was built to accommodate growth over the next three years, the company hasn't moved to complete it quickly, and this has given rise to a lot of rumors. In Phoenix, for example, gossip has had it that the company will never occupy the Mesa facility. But at the plant's dedication in November, Noble emphasized that only a portion of the plant was completed, and that it had been designed so that modules in the shell could be completed as needed.

The work on the facility's interior



In-depth documentation...

**... speeds you from sketch
to I/C μ -PAC system
installation without
costly re-design**

You get documentation that means a lot more than just a spec sheet when you design with I/C μ -PAC digital logic modules. It means design aids, detailed instruction manuals, reliability facts, wiring & assembly notes, application notes. It means the best design support you can get — support based on nearly 14 years of module experience.

Whether you face design of a one-shot black box, or an entire product line, why not rely on μ -PACS. You'll never have to read between the lines to figure out what to do with them. It's spelled out in page after page of documented facts. Write for details. Honeywell, Computer Control Division, Old Connecticut Path, Framingham, Massachusetts 01701.

Honeywell

 **COMPUTER CONTROL**
DIVISION

Circle 51 on reader service card

that was started up again last week will cost nearly \$1 million and will complete about half the plant. The renewed construction allays the rumor that the company plans to abandon the plant.

One reason Motorola is so bullish about its IC operations is that it believes computer designers are finally ready for emitter-coupled logic. Most have learned how to shield the circuits from noise and now know how to package and interconnect them to take advantage of their exceptionally high speed. Motorola believes emitter-coupled logic will surpass transistor-transistor logic in high-speed applications because TTL units may be troubled by internal noise at exceptionally high speeds.

Next, Motorola will develop integrated-circuit memories. The company has already built prototypes of two 16-bit random access memories in IC form. One, for use with saturated logic such as DTL or TTL, will compete with other IC memories already on the market. The other is the first designed for use with emitter-coupled logic. These devices are slated to be the forerunners of the company's proposed line of commercial memory elements, some of which will have logic and memory on the same chip.

Military electronics

Unstoppable shot?

Since spear-and-shield times, the development of a new weapon has been quickly followed by equipment to counter it. Now, however, the Navy thinks its Standard missile will break this cycle.

For one thing, the Navy will be able to modify the versatile Standard with kits, and these modifications, the service believes, will keep the missile one step ahead of any measures an enemy employs to baffle its guidance and homing system. While most of the possible design changes are classified, there is talk of changing the missile's terminal guidance from a semi-



Going out. Tartar missile, here being launched from a destroyer, will be replaced by the Standard starting early next year.

active radar mode to an infrared homing mode.

Ten-year hitch. Under terms of a \$120 million contract, the General Dynamics Corp.'s Pomona, Calif., division is to supply 4,000 Standards for installation aboard 50 warships. Optimistic officers feel the missile can handle the job of protecting the fleet from surface and air attack for 10 years after the first one becomes operational in early 1967.

There will be two basic shipboard models, identical except in their propulsion units. The extended-range Standard will be able to cover distances of more than 30 miles, while the other version will have a range of more than 10 miles.

The Standards will also use several types of fuses—contact fuses against ships and proximity fuses against planes, for example.

As another measure of the missile's versatility, a model is being developed for launching from aircraft against enemy radar sites. Called the interim ARM (anti-radiation missile), it will replace the Shrike missile that Texas Instruments Incorporated has been building for several years [Electronics, Dec. 26, 1966, p. 36].

Crossing the T's. The shipboard Standards are to replace the trouble-plagued Terrier and Tartar missiles, which, along with the Talos, have cost the Government more than \$3 billion. The air-breathing Talos won't be replaced for the time being because its range is greater than the Standard's.

Like the three T's, the Standard—initially, at least—will use cur-

rent shipboard fire-control radars for guidance [Electronics, Dec. 27, 1965, p. 112]. The radars, with a range of more than 75 miles, will "illuminate" the target with radio beams, and these signals will be followed by the missiles' receivers. Installation of the Standards will require only minor modifications in the shipboard radars.

Long-run production. The Navy's award to General Dynamics runs six years; few defense contracts cover more than three years. General Dynamics did the research and development work on the missile, but it had to face competition for the production order. The contract covers the Standard's guidance, control, and fusing systems.

Ears to see with

Helicopter pilots flying combat missions in Vietnam often don't know when they are being fired upon from the ground. Noisy engines drown out the sound of the shots, and it's only when the craft is hit that a pilot knows he's the target.

Now being tested in Vietnam is a simple, cheap system that enables helicopter crews to detect and determine the direction of ground fire. It does this by picking up the sound of enemy projectiles as they pass the aircraft. Developed by Philip Lieberman, staff scientist at the Air Force's Cambridge Research Laboratories, the acoustic bullet detector is being tried out by the Army Concept Team in Vietnam.

By telling him that he's being

SPEER COMPONENT COMMENTS

How to get a real reading on a resistor's true function... resistance.



That's right, we mean plain old electrical resistance.

The problem with this particular parameter is that it's just too basic. It doesn't have the exotic intrigue of such items as temperature coefficient, moisture resistance or load life. As a result, almost everyone takes it for granted—and naturally neglects to verify whether or not the resistance is actually being properly measured.

For example, if you don't realize the importance of using the proper test voltage, you can get all kinds of remarkable results.

The culprit in this case is the coefficient, not the component you're measuring. You can decrease the measured resistance of a carbon composition resistor by simply increasing the voltage applied... and vice versa.

Now with low value resistors be-

low 100K improper applied voltage won't wreck your readings since the VC is comparatively insignificant. But if you're measuring resistors above 100,000 ohms this voltage coefficient can throw a real curve.

So what should your test voltage be? According to EIA Specifications RS-172, MIL-R-11, and MIL-R-39008, resistors above 100K must be tested at 80 to 100 volts.

Yet most commercial testing units used by receiving inspection departments and component evaluation laboratories apply, at most a mere 15 volts. So, unless compensation is made for this Voltage Coefficient, many lots of perfectly good resistors which are well within the parameters specified could be indicated as somewhat beyond the limit.

Needless to say, Speer tests and sorts all of its resistors at EIA/military voltages.

In addition, we've prepared an article that explores this entire subject in greater detail. This article has the appropriately basic title: "Resistance—How It Is Measured." If you'd like a copy, just mail the coupon.

Are you and your inductor supplier committing Typical Test Error #6?

If you've been purchasing any of the superb inductors manufactured by our Jeffers Electronics Division, we may well have warned you about this error already.

It consists of failing to obtain correlation between your supplier and your own incoming inspection, in cases where inductance tolerances of less than 5% are involved.

Ideally, this step should be completed before the actual manufacturing operation starts. Your supplier should measure and tag sample parts and then forward them to you for correlation.

There are seven other possible errors that you should also be aware of when you're using MIL-C-15305 testing procedures to measure inductance and Q. We've covered a number of these errors already. The others will be along shortly.

SPEER Speer Carbon Co.

St. Marys, Pennsylvania 15857

Speer Carbon Co. is a Division of Air Reduction Company, Inc.

Rush a copy of "Resistance—How It Is Measured."

Name _____

Title _____

Company _____

Street _____

City _____ State _____ Zip _____

Microsonics

State of the Art Design in Filters Oscillators and Delay Lines



Continuously
Variable Delay
Systems
Bulletins 4301 and 4302



Broad Bandwidth
Highly Selective
Crystal Filters
Bulletin 6350

Comb. Filter Sets
Bulletin 6350



Broad Bandwidth
Delay Lines
Bulletin 4300

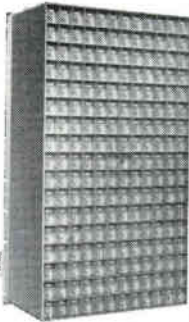

Highly Stable
Oscillators — Bulletin 6350



Voltage Controlled
Crystal Oscillators
Bulletin 6350

High Density
Digital Storage
Systems

Bulletin
5350



Send for literature.



MICROSONICS, INC.
60 Winter Street
Weymouth, Mass. 02188
Tel: 617 337-4200

A subsidiary of the Sangamo Electric Company

shot at, the detector enables the helicopter pilot to employ evasive tactics or offensive action against the source of the ground fire.

The system consists of two microphones positioned beneath the helicopter, and a high-pass filter. Critical to the system is the use of an artificial "head." The microphones are attached to either side of this head, simulating human ears. The signal from each microphone is channeled separately to each phone of the pilot's headset which provides natural directional information. The microphones are designed to have the same sound diffraction pattern as the human head.

Amplified signal. Signals received by the microphones are high-pass filtered at 3.5 kilohertz. The filtering removes the major frequency components of the helicopter noise, leaving half of the sound energy of gunfire, which is then amplified. This amplification enhances the gunfire signal-to-noise ratio approximately 30 decibels for most helicopter and certain fixed-wing aircraft. The pilot and crew listen to this signal through the normal intercom system, or through separate hearing aid-type devices inserted into the ear under the headset.

The Cambridge acoustic bullet detector differs from a system now being developed at the Army's Aberdeen Proving Ground in Maryland [Electronics, Jan. 23, p. 153] that would provide a similar warning to helicopter pilots. The more complex Aberdeen system uses a ranging technique in which the differences in the time each acoustic sensor on the craft detects a shot are measured to indicate the source of the ground fire. In this system the pilot has a visual display for readout.

The Cambridge detection system had previously been tested in an H-13 helicopter, a C-47 and a liaison aircraft at Fort Devens, Mass., Eglin AFB, Florida, and at Camp Edwards, Mass. In one of the tests a 7.62-mm machine gun fired short bursts of live ammunition near the helicopter as it flew at altitudes from 100 to 400 feet and at distances to 200 yards.

The system is rugged, self-powered, and uncomplicated. Its electronic components can be miniaturized to less than 10 cubic inches and it can be produced at a cost less than \$100 per unit.

Industrial electronics

Still out of control

"Every one of the 58 Sperry traffic controllers we installed failed," gripes New York City's traffic commissioner, Henry A. Barnes, whose comments leave no doubt that the city's problems with its new electronic traffic control system are far from over. In fact, they may only have begun.

Last January, about eight months behind schedule, the city began installing solid state traffic-light controllers, the first elements of the system developed by the Sperry Gyroscope division of the Sperry Rand Corp. [Electronics Jan. 23, p. 26]. At the time it was believed that Sperry had worked out the bugs, but the city found plenty.

Barnes burning. "As far as the radar vehicle-speed detectors are concerned, none of them have even been delivered. "We still don't know if they work," Barnes said earlier this month. "We also found that the sonic detectors supplied by the company didn't work either." Sperry has declined to comment on these problems other than to point out that brand-new hardware often runs into snags. It's known that it is reevaluating the program, originally established under a \$5.4 million contract signed in August 1965. This reevaluation should be completed by May 15.

Commissioner Barnes says he will then either agree to a reasonable time extension for components delivery or will cancel the contract. However, the commissioner would probably be reluctant to cancel because of the extra delay involved in evaluating new bids.

The traffic-control system is supposed to tie 2,700 of the city's 9,000 traffic-lighted intersections into a coordinated network. Citywide in-

An oscilloscope picture in 10 seconds: any longer is a waste of time.

Polaroid Land films don't make you wait to see if your trace zigged when it should have zagged.

They let you know in ten seconds.

They give you an oscilloscope picture you can study, attach to a report, send as a test record with a product shipment, or file for future reference.

You have a choice of 5 films for oscilloscope recording.

The standard film has an A.S.A.

equivalent rating of 3000. It comes in both roll film [Type 47] and pack film [Type 107]. They both give you 8 pictures $3\frac{1}{4} \times 4\frac{1}{4}$ inches. This emulsion is also available in 4 x 5 sheets [Type 57].

For extremely high-speed recording, there's Polaroid PolaScope Land film [a roll film, Type 410]. It has an A.S.A. equivalent rating of 10,000.

It can take pictures of traces too fleeting for the human eye: such as a scintillation pulse with a rise time of less than 3 nanoseconds.

One thing all these films have in common is a sharp, high-contrast image that's easy to read. Because the films are so sensitive, you can use small camera apertures and low-intensity settings.

To put these films to work on your scope, you need a camera that will take a Polaroid Land Camera Back.

Most oscilloscope camera manufacturers have one. For instance: Analab, Beattie-Coleman, BNK Associates, Fairchild, EG&G, General Atronics, Hewlett-Packard, and Tektronix.

You can get complete information by writing to Polaroid Corporation, Technical Sales Department, Cambridge, Massachusetts 02139, or by writing to one of the manufacturers mentioned above.

It will probably take a little longer than 10 seconds, but we promise the information won't be a waste of time.

"Polaroid" and "PolaScope"®

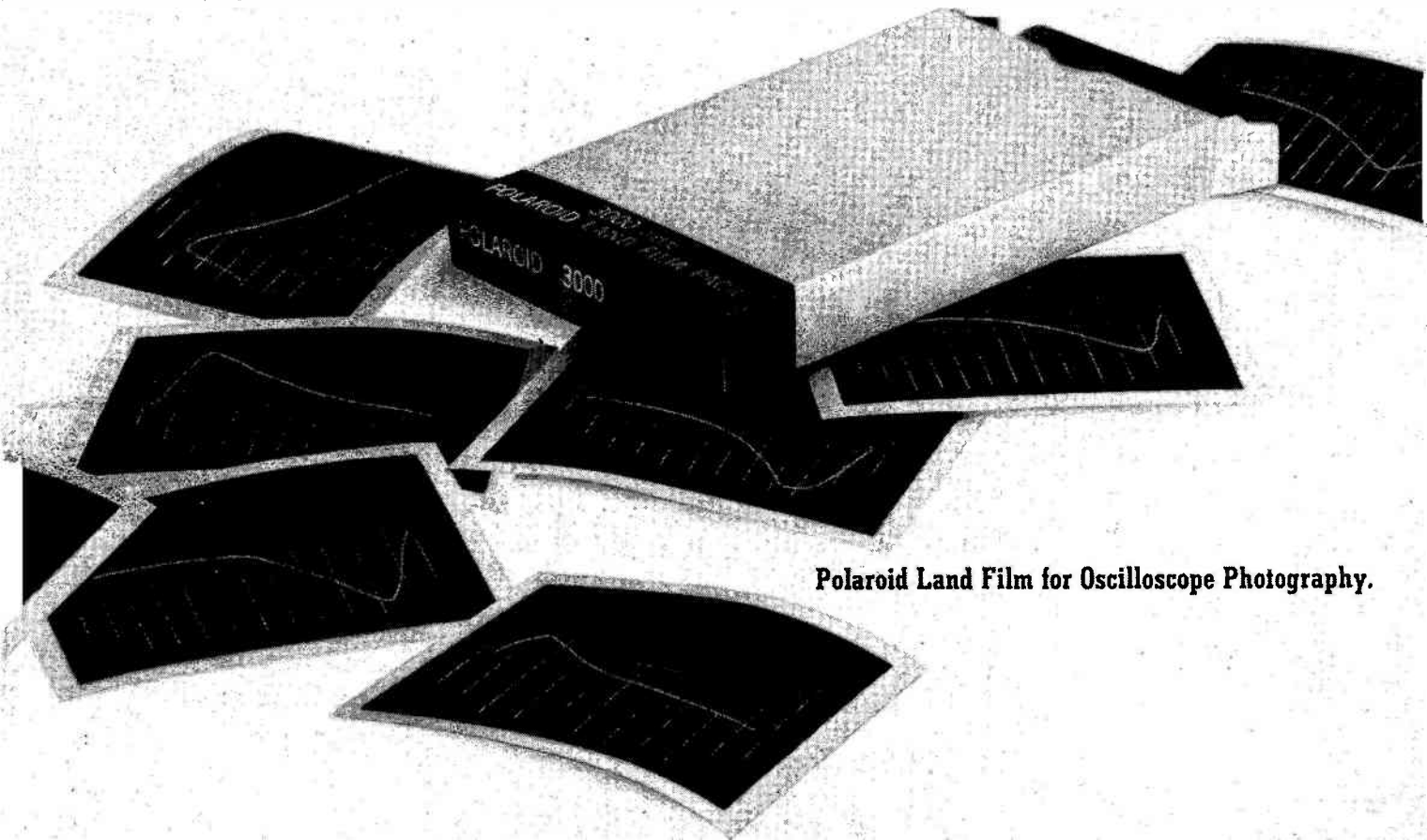

Polaroid Land Film for Oscilloscope Photography.

"Just building a lipstick size relay that worked would have been easy."



Building one around our great high-rel idea was another story."

Wedge-action*, our great high-rel idea, is 9 years old. Our 2PDT lipstick-case size relay has been around for less than 2 years. But it's already a standard replacement for the competition in lots of MIL-R-5757/8 applications.



Why? Because it outperforms every spec requirement for both high and low-level loads. Like all our wedge-action relays, it combines long contact wipe with high contact force to give you continually clean precious-metal mating surfaces throughout life. Competitively priced with fast delivery.

The lipstick is just one of our family of wedge-action relays, which cover almost every dry-circuit to 2 amp application. When you need a high-rel relay that really works, test one of ours and try your darndest to prove we're wrong. You won't be able to.

* U.S. Patent No. 2,866,046 and others pending.



Electro-Tec Corp.

SLIP RINGS • RELAYS • SWITCHES • OPTICS

P. O. Box 667 • Ormond Beach, Florida
(904) 677-1771 • TWX 810-857-0305

Manufacturing Facilities:
Ormond Beach, Fla. • Blacksburg, Va.

Electronics Review

formation on traffic volume and speed would be collected by the radar sensors and sent over leased telephone lines to about a dozen digital computers. The computers would then determine what overall patterns of "stop" and "go" lights would allow the quickest traffic flow, and would direct local traffic-control equipment to recycle the lights to these patterns. The sonic detectors at key intersections could control traffic lights directly, out of step with the central computers but responding to local conditions.

Foiled again. The solid state traffic controllers were delivered by Sperry to control lights on a fixed timing cycle pending installation of the digital computers. They failed for many reasons.

"Power supplies broke down, transients on the power lines blew up transistors and the cabinets leaked when it rained," says Barnes. "We even found that when the controllers were installed in an east-west direction they might work fine; put them in a north-south direction and some contacts would close when they weren't supposed to or would drop out." Barnes said the trouble was caused by the effect of the earth's magnetic field on the devices.

Computers

Not-so-firm ware

Computer designers have pretty much agreed that firmware offers one way to ease the software problems of computer users. But they are still arguing about whether the firmware—microprograms stored in read-only memories—should be alterable or not [Electronics, March 20, p. 159].

The engineers at Honeywell Inc.'s Electronic Data Processing division in Wellesley Hills, Mass., have chosen the route of electrical alteration. They designed a read-only memory for the H-8200 computer that can be altered, but not by the user.

"Many of the functions and capabilities that were either built into

hardware or written into software in previous machines can now be handled by the memory in this machine," says Joseph Phillips, manager of the H-8200 project. The fact that our read-only memory is electrically alterable makes our firmware considerably more flexible—less firm, if you will, but certainly not 'softer'—than the firmware in other current machines."

The memory is actually a read-write unit with a 125-nanosecond access time; but for everyday use, data is only taken from it, not put in. If the contents need changing, a Honeywell maintenance man can do it in milliseconds with a magnetic tape record of the new data and a special loading program that isn't available to the customer.

This isn't the first time Honeywell has used such a memory. Its Alert series of military computers had a read-only unit made of Biax cores, permitting a nondestructive readout [Electronics, Aug. 23, 1965, p. 40].

Honeywell's engineers have also made a decision on another controversial type of memory: the all-integrated-circuit scratchpad. In this design, the company is going all the way—using 16-bit chips in flatpacs. The scratchpad contains 256 words of 30 bits each, and is mounted on 20 printed circuit boards that together occupy only one-sixth of a cubic foot.

The prototype of the 8200 is now being debugged; hardware and software will be demonstrated next October, and the first machine will be delivered in April 1968. The 8200 will compete with large-scale computers such as the IBM 360/65, the Univac 1108, and the General Electric 635.

Avionics

View from above

Already hurting for helicopter station-keeping radar, the Army is rushing development of an helicopter-borne formation-flight simulator—the country's first—to give

IN TWO CONVENIENT SIZES

Small...

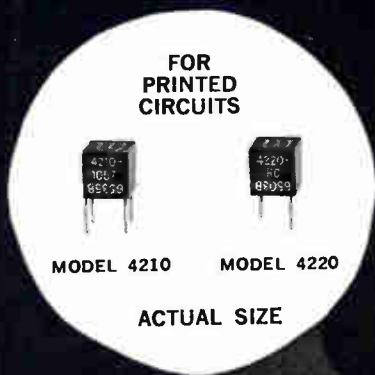

& Now

*Smaller
Than
Small...*

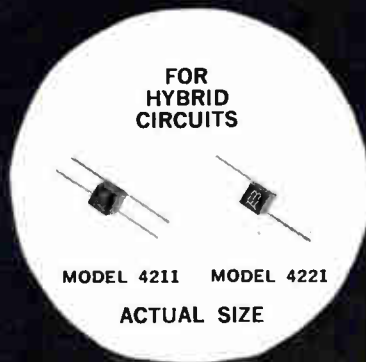

MICROTRANSFORMERS AND MICROINDUCTORS

from Bourns

Introducing the new smaller than small models 4211 microtransformer and the 4221 microinductor. The units are packaged in a 1/8" cube, sealed against cyclic humidity per MIL-STD-202B and designed specifically for use in hybrid circuits.

This ultimate performance to size ratio in microtransformers and microinductors is now available from Bourns in addition to the proven small 1/4" cube models 4210 microtransformer and 4220 microinductor.

Both sizes exceed the environmental requirements of MIL-T-27B, Grade 5.

For those applications beyond the scope of the standard unit, design flexibility permits taps, wide turns ratio range, various core materials, split coils, and bifilar windings. Application engineering service is available for quick response on such special prototype units.

For additional information and detailed specifications on Bourns microtransformers and microinductors, contact your nearest Bourns sales office or representative, or write the factory direct.

SPECIFICATIONS

Size
Maximum operating temperature
Frequency response
Maximum distortion
Power rating
Insertion loss
Primary impedance range
Secondary impedance range
Turns ratios

**MODEL 4210
MICROTRANSFORMER**

1/4 x 1/4 x 1/4
130°C
± 2 db, 400 to 250kHz
± 5% at rated power
50MW at 1 kHz
± 3 db max.
100Ω to 100KΩ
3.2Ω to 10KΩ
to 15:1

**MODEL 4211
TRANSFORMER**

1/8 x 1/8 x 1/8
105°C
± 2 db, 2K to 500kHz
± 5% at rated power
25MW at 10kHz
± 3 db max.
10Ω to 10KΩ
10Ω to 10KΩ
to 10:1

SPECIFICATIONS

Size
Maximum operating temperature
Inductive range

**MODEL 4220
MICROINDUCTOR**

1/4 x 1/4 x 1/4
130°C
.08 to 66 hy

**MODEL 4221
MICROINDUCTOR**

1/8 x 1/8 x 1/8
105°C
0.1 to 3.5 hy



BOURNS, INC., TRIMPOT DIVISION • 1200 COLUMBIA AVE., RIVERSIDE, CALIF.
TELEPHONE 714 684-1700 • TWX: 910 332-1252 • CABLE: BOURNSINC.

TRIMPOT® AND PRECISION POTENTIOMETERS — RELAYS — MICROCOMPONENTS: TRANSFORMERS, INDUCTORS, RESISTORS AND CAPACITORS

Etch your own PC boards automatically!

(in less than 5 minutes)

from this →
to 11" x 14"



Shown
actual
size!

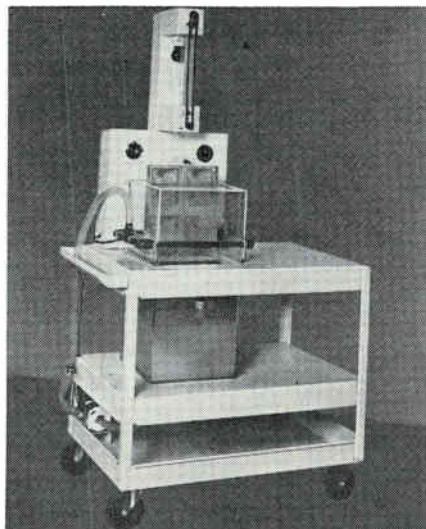

"fine line" etcher

for prototypes—limited runs

No cooling or venting required!
Etches as fine as .001"!
Cuts costs in half—saves time!
Complete photo processing instructions!
Work is illuminated while etching!
No patterning... minimum undercutting!

Model No. 201 (illus.), etches two
11"x14" one-sided **\$695**
boards or one 11"x14"
two-sided board: Pat. applied for

NOW IN USE BY:

AMP, Inc.
Atomic Energy Com.
Bendix
Beta Corp.
Charles Brunning
C.G. Conn
Esso Research
General Dynamics
IBM
ITT Gilfillan
Jordan Elect.
Lear Siegler
Micro Switch
Microwave Elect.

Sonotone
Sprague Electric
Union Carbide
U.S. Air Force
Varo, Inc.
Whirlpool
Woodward Gov.
Univ. of Chicago
Univ. of Colorado
Univ. of Georgia
Univ. of Hawaii
Univ. of Penn
Oklahoma State U.
Washington Univ.

Representatives: Some Territories Still Available.

CYCLO-TRONICS, INC.

3858 N. CICERO—CHICAGO, ILL. 60641
TELEPHONE: (312)-282-6141

Electronics Review

it a better idea of systems needs. Because many proposed station-keepers have failed to meet the specifications derived from ground simulations, the Army has decided to run flight tests to get more realistic data.

The Army Electronics Command will let a contract for the simulator by the end of April and wants delivery in time for early-1968 tests of the unit. The equipment won't simulate proposed systems; its mission is to record the responses of pilot and aircraft during formation flight. The Army needs formation-flight systems in Vietnam now; the Integrated Helicopter Avionics System's station-keeper will be delivered too late for installation aboard early models of the AH-56A fire-support helicopter [Electronics, April 3, p. 65].

Problems, problems. Since helicopters fly in larger and closer formations than do other aircraft, their pilots need more accurate positional data and more frequent updates. According to the Army, the data rate provided by currently proposed systems is too slow for safety. Also most of the systems lack proximity-warning devices, and there are interface problems between the radar and the helicopter autopilot.

All of these problems will be investigated with the flying simulator, as will the Army's current ranging specification. Currently specified is 25- to 17,600-yard ranging with altitude resolution of 20 feet. Several proposed systems have failed here, but data from flight tests could loosen the requirements.

One problem the simulator won't be able to help overcome is weight. None of the systems proposed or flying is light enough to meet the Army's needs.

To be installed aboard an HU-1B, the simulator will consist of a pre-programmed computer, a "proximity locator," data records, and a display to show the helicopter's position in a hypothetical formation.

Follow the leader. The simulator will accept data from the Huey's doppler navigator, radar altimeter, and compass, and will send to the display the craft's distance from

a simulated lead helicopter, and its desired altitude and bearing. In next year's flight tests at Fort Rucker, Ala., a pilot will view the computer-generated display pattern showing his position and will maneuver in response to the moves of the simulated lead helicopter.

Just what the simulator will look like when it gets off the ground depends on the winner of the contract. Only size and weight are specified in the request for proposals; the system must fit a 19-inch rack mount, be 3 feet high and weigh no more than 150 pounds.

For the record

Tune in later. Plans for the proposed national educational tv service are still out of focus and it appears that only the Government will be able to tune them in. The Senate will hold hearings later this month in hopes of setting guidelines to determine who will build, operate, and own the proposed network. Comsat's offer to build a pilot system free is opposed by the Ford Foundation, which wants any decision as to the system's ownership delayed for at least another year. In the interim, the foundation wants NASA to build an experimental system.

Smooth flying. A clear-air-turbulence detection system that promises to give pilots from 2½ to 4 minutes warning of disturbances will be installed in a Pan Am 707 jetliner late this month. The prototype infrared system was developed by North American Aviation Inc.'s Autonetics division.

The system picks up infrared radiation from the atmosphere. It has three elements: an infrared sensor head, an electronics processor, and an indicator that will display the direction and severity of the turbulence. On the Pan Am jet, the sensor head will be mounted on top of the fuselage, just aft of the cockpit. Dials on a cockpit display will indicate whether the turbulence is ahead or to the side of the aircraft.



Just \$3500

Simplicity:

New RF Attenuation Calibrator from AIL

Now there's a simpler, faster way to measure attenuation at RF. Thanks to AIL's new Type 137 solid-state Attenuation Calibrator.

This new instrument, designed around the series substitution principle, reduces operator controls to four—greatly simplifying and speeding calibration procedures. A unique noise-injection system extends the instrument's range to greater than 100 db in a single step. Accuracies range as high as .007 db, error never exceeds $\pm .4$ db for a 100 db measurement.

Through a new design concept, the self-contained AFC system provides an exceptionally large frequency capture range and eliminates the need for frequency control of the external local oscillator. An indicator positively confirms AFC operation, and an exclusive "prohibit" circuit prevents false measurements.

Plug-in mixers provide continuous coverage from 100 MHz to 40 GHz. The reference attenuator is of the wave-guide-below-cutoff type, and is easily removed for NBS calibration.

See your nearby AIL Sales Representative for complete information.

TYPE 137—SPECIFICATIONS

RF Attenuation Range (db)	Receiver Accuracy	Attenuator Accuracy	Measurement Accuracy
10	± 0.01	± 0.05	± 0.06
20	± 0.01	± 0.10	± 0.11
40	± 0.01	± 0.15	± 0.16
80	± 0.05	± 0.20	± 0.25
90	± 0.07	± 0.25	± 0.32
100	± 0.10	± 0.30	± 0.40

Note: These errors are not cumulative. The error for a 100-db single step is ± 0.4 db. The measurement accuracy of the system can be improved by calibration of the attenuator at NBS.

Scale Resolution	Normal 0.2 db/div Expanded 0.01 db/div
Automatic Frequency Control (Internal AFC)	500 to 1 reduction of signal frequency drift
Indicator Light	Indicates when AFC is locked properly
Measurement Frequency Range	100 MHz to 40 GHz
Power Required	115/230 volts AC, 50 to 400 Hz, 30 watts
Dimensions	19 $\frac{1}{2}$ w by 9 $\frac{1}{2}$ h by 12 $\frac{1}{2}$ d
Weight	40 pounds



AIL
DIVISION

AIRBORNE INSTRUMENTS LABORATORY
DEER PARK, LONG ISLAND, NEW YORK



DALE[®]

**3-in-1 T-pot design
gives you more
for your money!**



**One simple, rugged design adds reliability
to all three rectilinear Mil wirewound styles**

RT-10, RT-11, RT-12 – Dale meets all three with a single design. You benefit from this simplification through increased reliability, faster delivery, better price. Call us today!

- ① **ALL-MOLDED HOUSING** design eliminates seal problems. Meets MIL-STD-202 and MIL-R-27208A.
- ② **RUGGED COLLECTOR SYSTEM** assures you of noise levels well below mil requirements.
- ③ **FULL LENGTH WINDING** allows increased power handling capability. Permits use of large diameter thermoconductive mandrel which eliminates "hot spots" by acting as high mass heat sink.
- ④ **1-PIECE WIPER ASSEMBLY** of precious metal insures setting stability under all environmental conditions.
- ⑤ **STAINLESS STEEL ADJUSTMENT SCREW** is electrically isolated by insulated head. Metal-to-metal clutching prevents over-travel damage.
- ⑥ **CONSTANT LEAD SCREW SEAL** is assured by shaft-retaining spring which maintains unvarying pressure against high temperature silicone rubber "O" ring.

DALE MIL-R-27208A MODELS

RT-10



Model 691 P.C. Pin
Model 697 Flex. Leads

RT-11



Model 1287 P.C. Pin
Model 1288 Flex. Leads

RT-12



Model 1680 P.C. Pin
Model 1697 Flex. Leads

RT-22



5000 Series – ½" square-trim models meet RT-22, made with same basic design considerations shown here.

WRITE FOR CATALOG B – containing specifications on 57 Dale T-Pots including many special models.



DALE ELECTRONICS, INC.
1300 28th Avenue, Columbus, Nebraska



Washington Newsletter

April 17, 1967

Navy orders speedup in work on Poseidon

Navy contractors and subcontractors have been directed to speed up their efforts on the Poseidon ballistic missile. Program officials say the acceleration may get the Polaris successor into submarines one year earlier than originally planned. The Defense Department won't say when the missile will be operational; it indicates only that Poseidon should be ready "in the early 1970's." Congress is now considering a Pentagon request for \$900 million for Poseidon funding in fiscal 1968.

One reason for the speedup reportedly is that Pentagon officials aren't sure of the reliability of the Minuteman 2 missile and want the Poseidon ready as soon as possible as a backup system. However, an Air Force spokesman says he knows of no reliability difficulty in the Minuteman 2 program.

Poseidon has improved penetration aids, greater range, and a larger warhead than the Polaris, and will be installed on many of the current Polaris-carrying submarines at a cost of about \$3.3 billion. Prime contractor is the Lockheed Missile & Space Co. Fire-control and guidance contracts are held by General Electric, Raytheon, and MIT.

Pentagon takes aim at contractor costs

Overhead costs that companies charge off to military contracts are rising. The Pentagon is disturbed about it, so much so that it has formed a group to study the problem and to recommend whether special controls are needed to keep these costs down. Companies can charge to military contracts such overhead as costs of bidding, patents, independent research and development, special tooling, computers, and production engineering.

Defense officials aren't sure why these charges are increasing or by just how much they are growing. But they believe that in a noncompetitive atmosphere, contractors don't feel the normal pressures to keep expenses down. Despite the trend toward more competitive contracting, about one-half the dollar volume of military orders is still awarded on a sole-source basis.

Satellites to detect atom blasts will keep an ear to the ground

America's first two satellites capable of detecting atomic explosions on the earth's surface are to be launched this week from Cape Kennedy. The pair—the first in the Vela Advanced Satellite Program—will also have the job of detecting clandestine nuclear blasts in space, joining six other Velas now in orbit in this duty.

The new satellites are more than 200 pounds heavier than the earlier models, which weigh about 500 pounds. The advanced Velas, built by TRW Systems, have a pneumatic gas system that will keep them 180° apart in their 60,000-mile circular orbits—a spacing enabling them to cover the entire world at all times.

Defense spending is still climbing

Federal spending on defense contracts was supposed to level off by now—at least that's what the Pentagon had expected. But the procurement surge is continuing because of the military needs in Vietnam. In the first eight months of fiscal 1967—July through February—military hardware contracts totaled \$17.7 billion, up \$4 billion from fiscal 1966.

Aircraft contracts, including avionics, rose \$2.1 billion, ships, \$1 bil-

Washington Newsletter

lion, electronics gear exclusive of weapons systems, \$318 million; missiles, however, were down \$109 million.

War reverses job downtrend

Although the findings haven't been made public, a Pentagon study has verified what industry observers had suspected: that the war in Vietnam has spurred employment in military electronics. The survey of 422 plants—about one-third of the defense industry—puts military electronics employment at 228,000 in these plants as of June 1966, up 9% from the previous year and a reversal of a downtrend that started in 1963.

The boost, however, falls short of the 16% overall gain posted by the entire defense industry.

Project Mallard goes on despite British pullout

Three teams of contractors reportedly have been tapped by the Army to carry out program definition studies of Project Mallard—a billion-dollar, multination tactical communications system. Scheduled to be operational by the mid-1970's, the system would provide computer-switched short-range voice and data communication for U.S., Canadian, and Australian troops via ground-station repeaters and possibly satellites.

Meanwhile, Washington is pushing hard to lure back the project's fourth partner—Britain—which pulled out earlier this year fearing another "Skybolt incident." Skybolt was a U.S. missile program that Britain had counted on for its nuclear arsenal before Washington canceled it.

It's hup 2-3-4 . . . rally 'round IC's

The Pentagon's long-awaited directive calling for the consideration of integrated circuits in all new research and development projects is about to be put into effect. Assistant Defense Secretary Paul R. Ignatius is expected to sign the microelectronic policy this week to make it official.

The directive's final form is almost identical to the version first submitted to industry last fall [Electronics, Oct. 31, 1966, p. 26].

Pentagon contract study backfires

The Pentagon has just supplied its Congressional critics with new ammunition. In defense of concentrating prime contracts in just a handful of states, the Pentagon has long contended that military subcontracts have a wide geographic distribution. This contention has just been shot down, unintentionally.

A recently completed Pentagon study shows that subcontracts are even more concentrated than prime awards. Findings reveal that 65% of all prime contracts is in 10 states, with these same states accounting for 77% of all subcontracting.

Addenda

In its scathing report on the fatal Jan. 27 Apollo spacecraft fire, a NASA-appointed board calls for a detailed design review of the entire spacecraft communications system. The board lashed out at the space agency, prime contractor, and subcontractors, and cited shoddy workmanship, poor quality control, and deficiencies in the command module design . . . A \$4.5 million contract to improve NASA's Goddard range and range-rate tracking system won by General Dynamics could expand into a \$25 million effort. The network's 200,000-mile range will be extended to 350,000 miles.

FET CHOPPERS ARE THE ONLY ANSWER

Part ELEVEN of a Series On The State of The Chopper Art.

MODEL 8000



Booze is the only answer at my house, but they frown down at the office when I suggest there is more than one way to solve problems. They should have my mother-in-law — they'd stick to booze, not electronics.

It turns out that an FET chopper is a distinct improvement over photo-choppers, what with 6 volts being enough drive instead of a couple hundred. Now the photo-chopper was better than the transistor choppers, because it looked like a resistor instead of a diode. So there ain't any voltage drops that have to cancel out. Mostly they don't. (Cancel, that is.)

As matters stand on noise and offset — and we sell choppers for only one purpose, which is to allow D.C. amplifiers with very little offset — the best of FET choppers are only two to three orders of magnitude worse than the best of mechanical choppers. Which is real progress. Last week it was three to four orders — before we invented this model 8000 FET chopper. The offset available is below 10 microvolts at 10,000 ohms, and would be lower if there weren't such wierd alloys inside the FET that have to come out eventually to copper.

So today's best mechanical choppers reach down below some 50 nanovolts, the FET chopper gets to about 5 microvolts. That's two orders of magnitude and crowding. Good thing we make solid-state choppers too.

Speaking only of offset, and anyway, what else is speakable about a chopper? I suppose you could say Mechanical Choppers \ll FET Choppers $<$ Photo Choppers $<$ Transistor Choppers.

AIRPAX ELECTRONICS
Cambridge, Maryland 21613

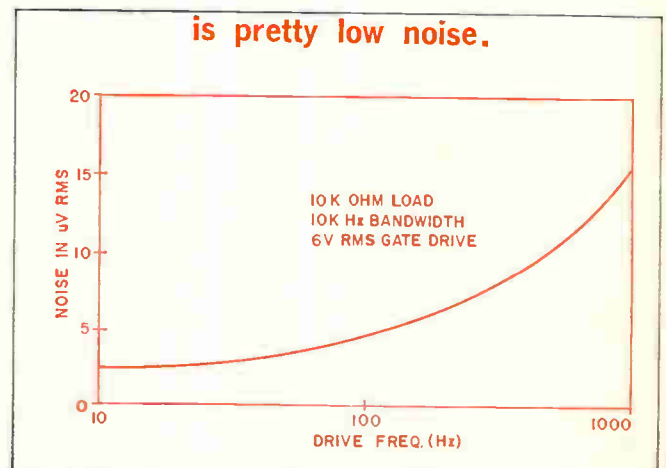
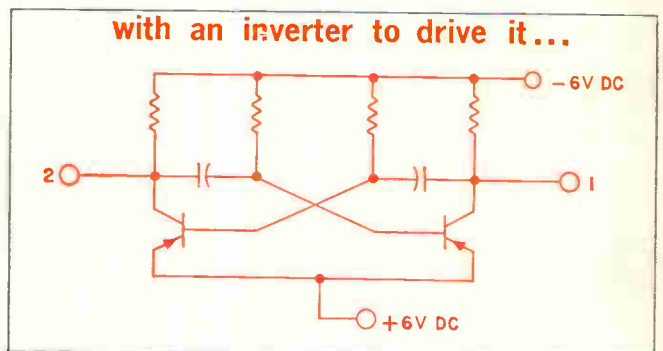
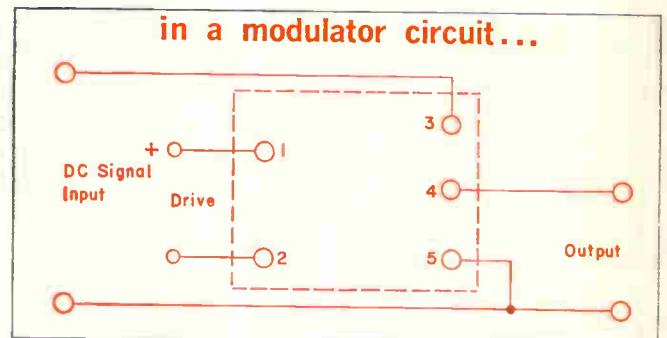
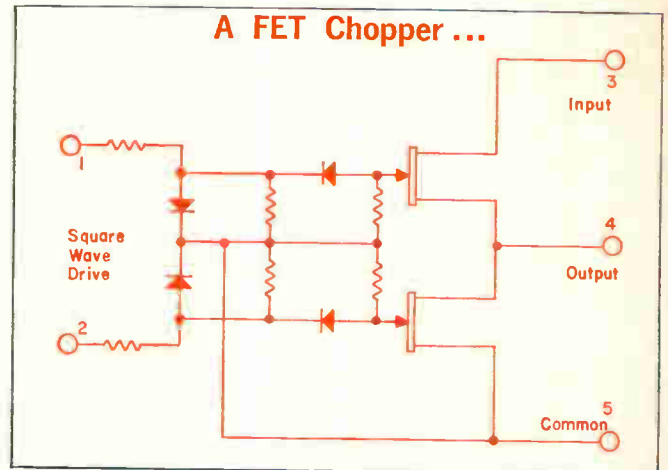

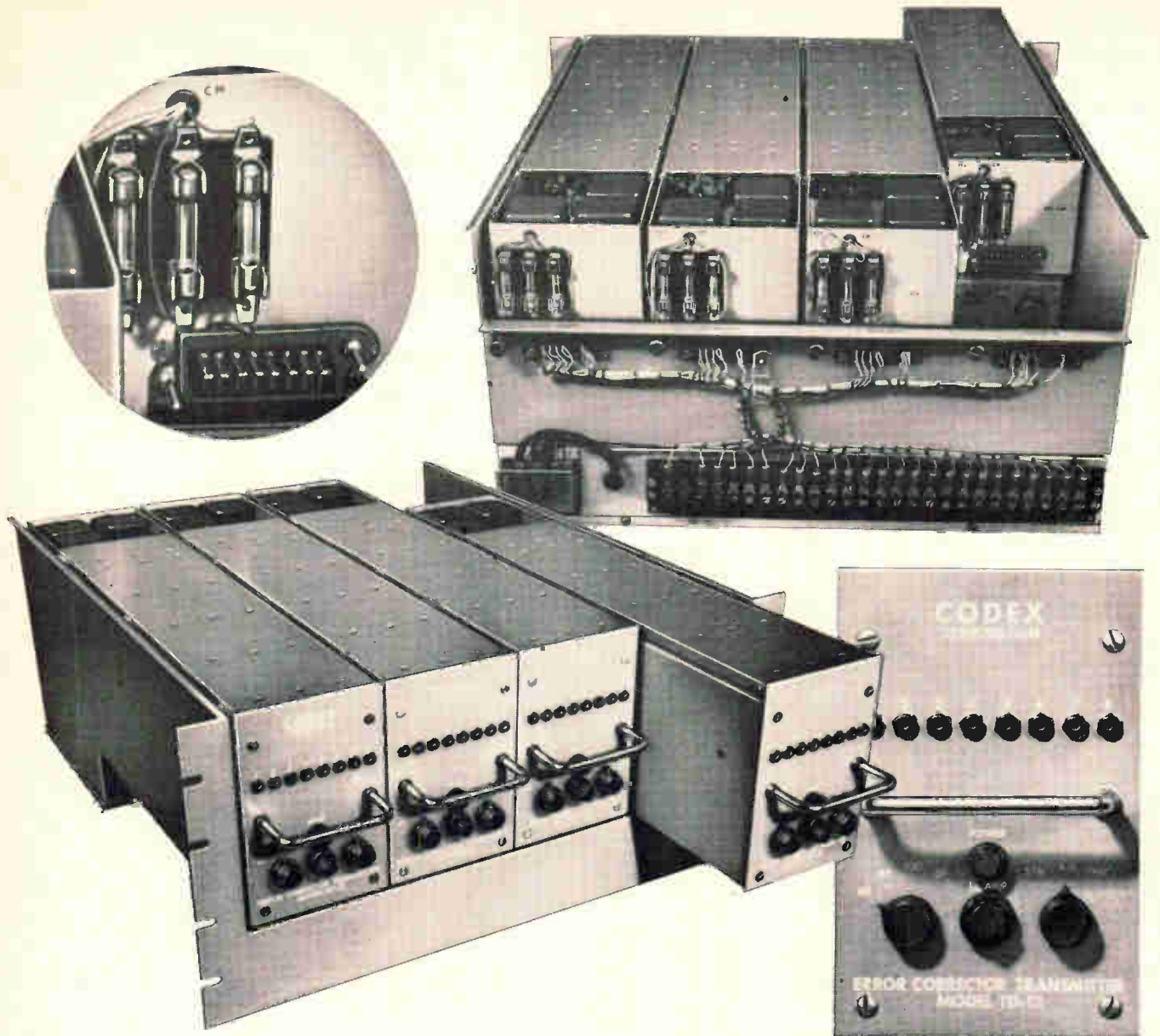

...AND WE HAVE THE HARDWARE

Codex telegraphy error correctors are not coding theory. Daily on-line use in operational systems proves the effectiveness of these equipments and their ability to correct transmission induced errors.

The Codex TD-12 operates in start-stop mode at transmission speeds of 60, 67, or 100 wpm, or in a synchronous mode with any input speed up to 1200 bps. The TD-12 is a synchronous device which may be operated either from its own internal clock or from an external baud rate clock.

Our warranty guarantees both good transmission and free maintenance for two years. For additional information write, phone, or Telex Codex — the company that makes the most efficient, least expensive telegraphy error correctors on the market.

**CODEX
CORPORATION**

• 222 ARSENAL STREET, WATERTOWN, MASSACHUSETTS •
ZIP CODE 02172 • (617) 926-3000 • TELEX 094-6332 •

A hand is shown holding a torn piece of paper. On the paper, there is a postage stamp in the top left corner and a photograph of various Guardian Solenoids. The solenoids are shown in different sizes and configurations, including a large one with a long plunger and a smaller one with a complex mounting bracket. The background of the photograph is dark with a mountain range silhouette.

GUARDIAN[®] SOLENOIDS

You need this catalog

THE WORLD'S MOST COMPLETE LINE OF SOLENOIDS are here in one book . . . just off the press. It's packed with informative, detailed data and pictures: Operating temperatures, duty cycles, life expectancy, power requirements, pull charts and dimensions. In addition, there's a full description of how to select the proper solenoid for your particular application—from miniature to heavy duty—AC or DC—or custom engineered jobs.

send for your copy today!

GUARDIAN[®] ELECTRIC

Guardian Electric Mfg. Co. • 1550 W. Carroll • Chicago, Ill. 60607

Circle 65 on reader service card

Influence the acceptance of your product... generate increased sales

CLASSIC CABINETS

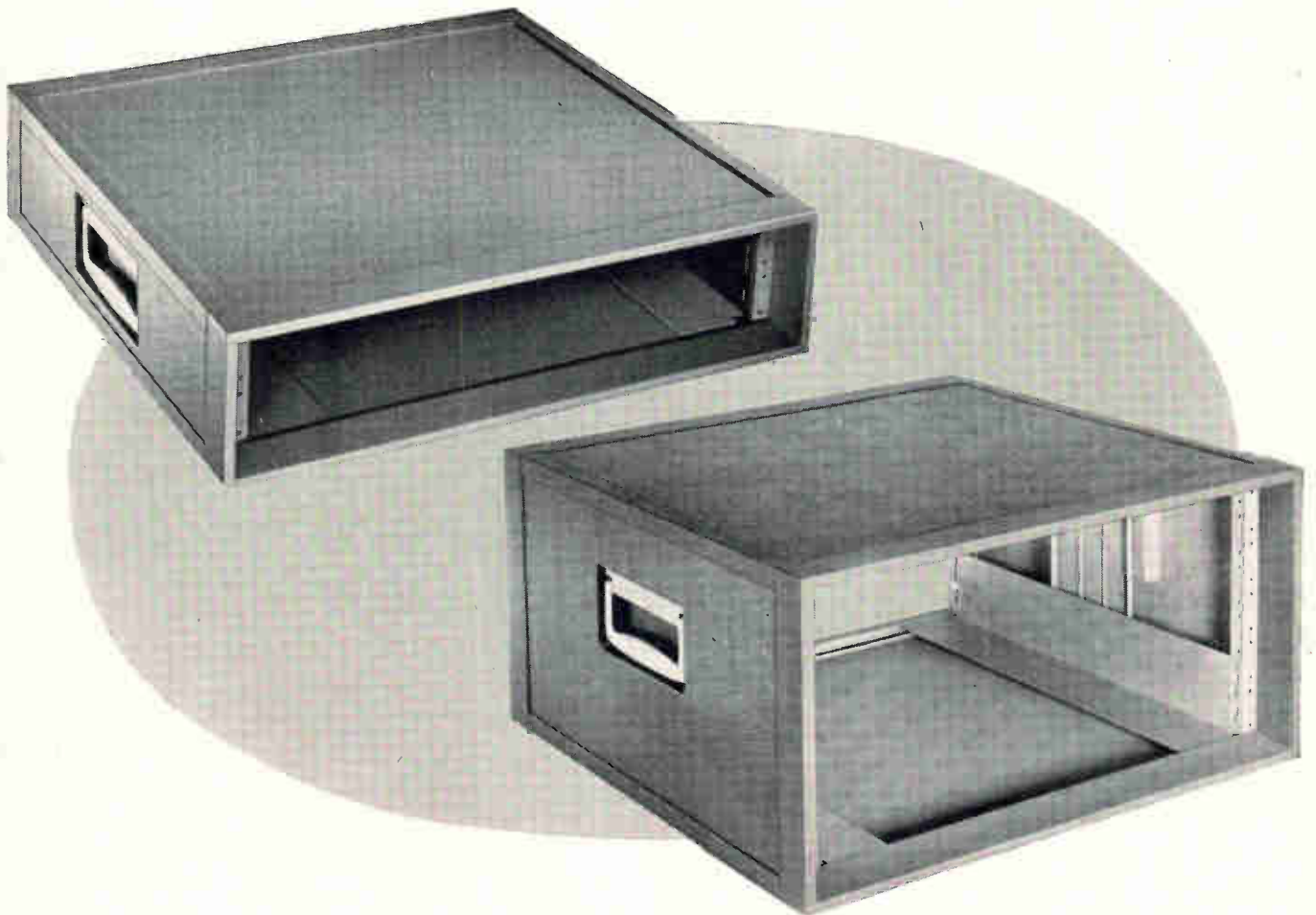

Classic Cabinets provide extra sales appeal by presenting an image designed to enhance the value of the contents. They are the most distinguished enclosures for electronic instrumentation and systems.

Uniquely designed and fabricated with a welded aluminum frame to which is affixed

patterned aluminum paneling. Classic Cabinets are available from stock in a selection of 15 practical sizes and two colors.

Write us for descriptive literature or see the Classic Cabinets at your authorized Bud Distributor's showroom. We'll be glad to supply his name to you.



BUD RADIO, INC.
WILLOUGHBY, OHIO

ANOTHER OUTSTANDING DEVELOPMENT BY THE MAKERS OF BUSS FUSES

TRON RECTIFIER FUSES

for the
Protection
of
Solid State
Devices



TRON fuses are especially designed for the protection of Solid State Devices such as semi-conductor rectifiers, SCR's, thyristors and the like or wherever a very fast acting fuse is needed.

They provide extremely fast opening on overload and fault currents, with great limitation of the let-thru current.

If each diode is protected by a TRON fuse, the fuse will open very quickly when the current drawn exceeds the rating of the diode.

Thus when a short-circuit occurs in a diode the fuse opens and takes that diode out of the circuit. This protects other good diodes in the rectifier which might otherwise be damaged.

TRON fuses are available in a wide range of physical dimensions and in sizes from $\frac{1}{2}$ to 1000 amperes in voltage ratings up to 600.

For full information and time-current characteristic charts, ask for BUSS Bulletin HLS.

BUSSMANN MFG. DIVISION, McGraw-Edison Co., St. Louis, Mo. 63107

SUPPLIED THE ECONOMICAL WAY... THRU
ELECTRONIC DISTRIBUTORS

FOR MODERN ELECTRICAL
PROTECTION *Insist on...*

BUSS QUALITY

V for... Butterfly®

The unique Licon® Butterfly® double-break switch design is as simple as that—two blades that flex simultaneously, then actuate with a positive snap. That simple engineering concept has led to a full line of 2, 4 and 6-circuit miniature, sub-miniature and heavy-duty Butterfly® switches that fight hard to keep your products reliable and durable. It takes a book to tell the story. **This is what it looks like.**

We'd like to send you a copy. Ask.



**Be Victorious with LICON...
fastest growing
full-line switch supplier**



LICON

DIVISION ILLINOIS TOOL WORKS INC.
6615 WEST IRVING PARK ROAD — CHICAGO, ILLINOIS 60634

**Remember, you're never more than a few feet away from a product of ITW®*



The Ins and Outs...

of large hybrid computing systems are well known to COMCOR

The concept of Total Systems Responsibility is applied from insertion of the first wire in the analog subsystem through interface with the digital computer and preparation of software. Experts from COMCOR/ASTRODATA combine their specialized skills to form a team intimately familiar with all facets of design and production of large systems.

Most of the large hybrid computer complexes operating successfully today were designed and built by COMCOR. The

vast experience gained in producing these systems is available to you. So — when looking for a manufacturer who can meet your requirements, look to COMCOR — for Total Systems Responsibility.



COMCOR INC.

A Subsidiary of Astrodata, Inc. / 1335 S. Claudina St. / Anaheim, California 92803

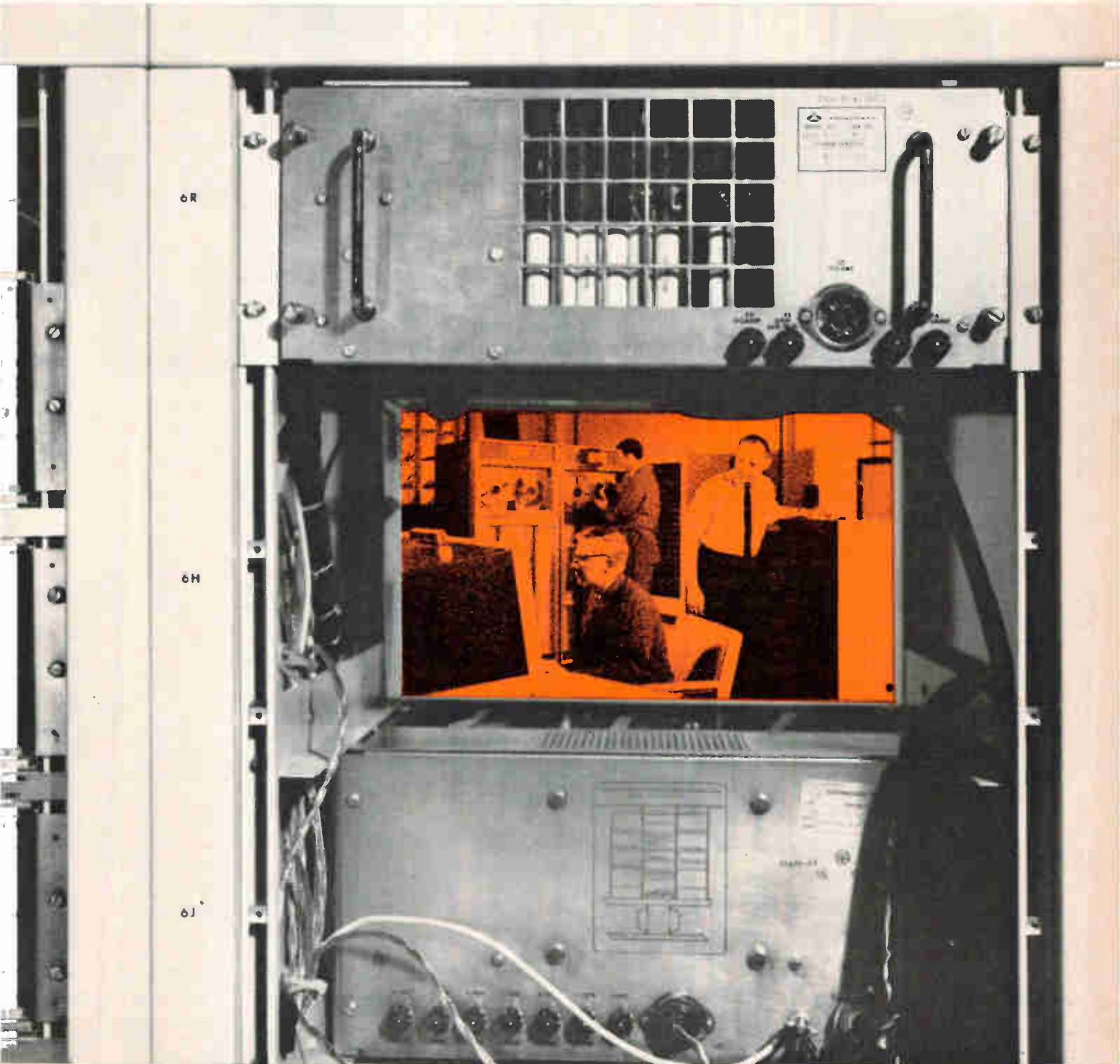

Circle 69 on reader service card

NEW TRIPLE DIFFUSED PLANAR



A NEW CONCEPT OF POWER

POWER

Silicon Transistor Corporation is now a major source for triple diffused planar NPN silicon power transistors. The new STT2650-STT2656 25 MHz series is immediately available from stock at low prices. They have a voltage range of 30V-150V, maximum T_j is 175°C, C_{ob} is 200pf and they are packaged in a TO-61 case. Prices for this series range from \$12 to \$36 per unit on orders of 100. High power high frequency inverters and converters, switching type regulated power supplies and power linear amplifiers are just a few applications. For further information, call or write today.

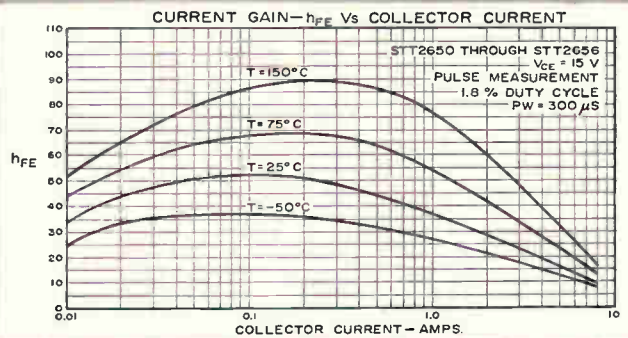

TRIPLE DIFFUSED PLANAR—NPN

	V_{CEO}	V_{CBO}	V_{EBO}	I_{cmax}	P_{max} (100°C)	$V_{BE(sat)}$	$V_{CE(sat)}$	h_{FE}	f_t (typ)	I_{CES}	
	Volts	Volts	Volts	Amps	Watts	Volts	Volts	—	MHZ	Volts μA	
STT 2650	150	150	12	7.5	75	1.3	0.6	30-90	25	60 1	
STT 2651	120	140	12	7.5	75	1.3	0.6	30-90	25	60 1	
STT 2652	120	140	12	7.5	75	1.3	0.6	50-150	25	60 1	
STT 2653	100	120	12	7.5	75	1.3	0.6	30-90	25	60 1	
STT 2654	80	100	12	7.5	75	1.3	0.6	30-90	25	60 1	
STT 2655	60	75	10	7.5	75	1.3	0.6	30-90	25	40 1	
STT 2656	30	40	10	7.5	75	2.0	1.0	25	25	20 500	
CONDI- TIONS	I_c	I_B	V_{CE}	200mA	5mA	10mA	2A	2A	2A	0.15A	
						0.2A	0.2A	15V	15V		

Silicon Transistor Corporation produces the broadest line of silicon power transistors in the industry.

SILICON TRANSISTOR CORPORATION

Executive offices and main plant: EAST GATE BLVD., GARDEN CITY, N. Y. 11530 (516) Pioneer 2-4100, TWX 510-222-8258



Why do so many TV sets use so many **NORYL**[®] components?

THERMOPLASTIC RESIN

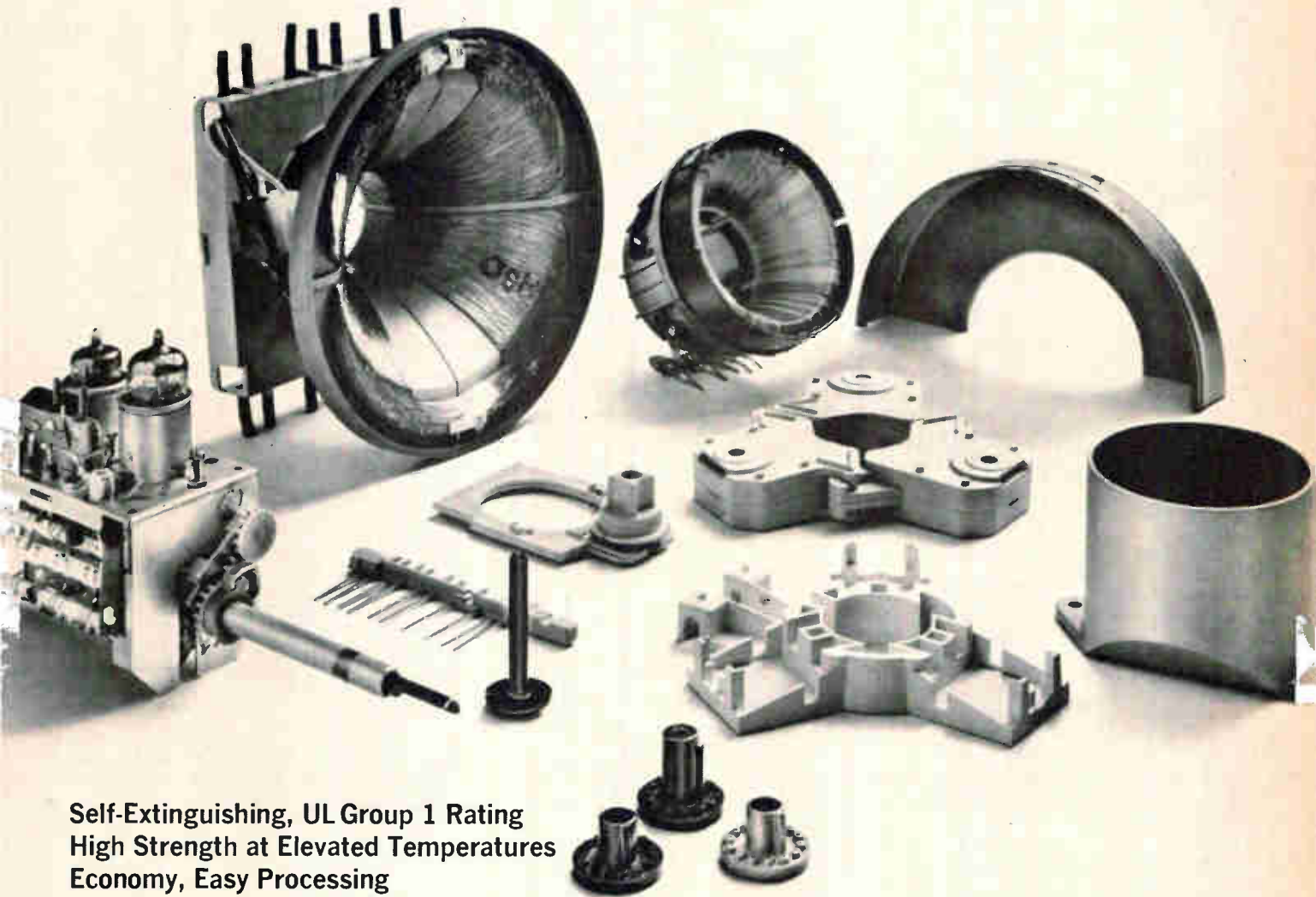

**Self-Extinguishing, UL Group 1 Rating
High Strength at Elevated Temperatures
Economy, Easy Processing**

Because it withstands higher temperatures caused by miniaturization and color, Noryl is being specified more and more for TV parts like these tuner components, deflection yoke and convergence coil parts, tube sockets, high voltage cups and control shafts.

No more need to choose between premium priced plastics and lower cost materials with only marginal performance. Noryl combines excellent physical and electrical properties with easy processing and economy; a low resin cost with a specific gravity of only 1.06. Noryl's high heat deflection temperature (265°F at 264 psi), low creep and high modulus mean parts that remain dimensionally stable under load at TV receiver operating temperatures. Noryl also has

provisional UL rating for support of current carrying parts at 212°F (100°C).

Parts can be precision molded economically. Noryl offers low, predictable mold shrinkage, tight tolerances are held in thin sections and parts are ejected easily for fast cycles.

Look into Noryl for an economical answer to premium performance. It offers the extra properties without the extra cost.

For more information contact your GE Chemical Materials Sales Representative, or write Polymer Products Operation, General Electric Company, One Plastics Ave., Pittsfield, Mass. 01201. In Europe, N. V. Polychemie AKU-GE, 76 Velperweg—Arnhem (The Netherlands).

Aging test for Noryl shows excellent performance at elevated temperatures. SE1 Noryl maintains its impact and tensile strength after thermal aging at 115°C (240°F).

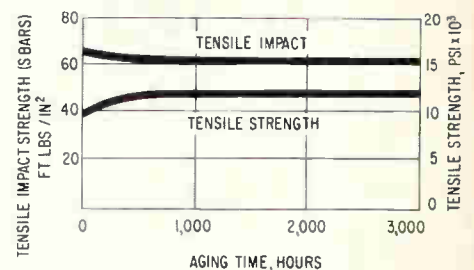

Leader in Engineering Plastics
PPO[®] • LEXAN[®] • NORYL[®] • PHENOLICS

GENERAL  ELECTRIC

LET THERE BE LIGHT OR TELL ME ABOUT THE FREE \$50 SWITCH

It's yours absolutely, unconditionally free. All we ask is that you give us \$50 for it. Why do we call it "free" when we are earnest about getting paid for it?

Two reasons:

First of all, when you throw the mechanical switch on, nothing happens until a teeny solid-state device senses that the voltage passes through zero. Then the switch turns the circuit on. When you throw the mechanical switch off and the current passes through zero, the circuit is turned off. That means that the on-off switching is done at the point of minimum energy. And that means no step function voltage to generate high-frequency components. And that means that the switch is *free* from radio frequency interference. *Quod est demonstrandum.*

The second reason we call it "free" is we thought that if you thought you could get a \$50 switch for nothing you'd probably be greedy enough to read this ad. There appears to be some justification for this assumption.

Circle 489 on reader service card

OUR TELEMETRY GEAR WILL NEVER GET OFF THE GROUND

Because we manufacture only equipment associated with checking out telemetry transmission while the transmitter is still nice and accessible.

For example, our new, compact FM Discriminator for playback in FM/FM telemetry systems. The pulse average design has 0.1% linearity. The Model 71-282 operates on all IRIG channels, 1-21, and A through H, with an input sensitivity of 20 mV. Accommodates any center frequency from 300 Hz to 300 KHz. Each one weighs less than a pound. Disgustingly inexpensive, too.

Circle 490 on reader service card

HOW WE INVENTED THE SANDWICH

To make the ruggedest possible field portable tape recorder we suspended the entire tape transport mechanism between two parallel flat plates. This gives double support to all members, and as the tape contacts only the primary drive mechanism, reel hubs, two turn rollers and the head surfaces, its oxide coating gets maximum protection.

As you know, the flanges on tape reels are cantilevered members which can be supported against extreme shock and vibration only at the cost of a substantial increase in the rotational inertia of a system. So we got rid of them. The tape can't slip off the reel because hoop tension

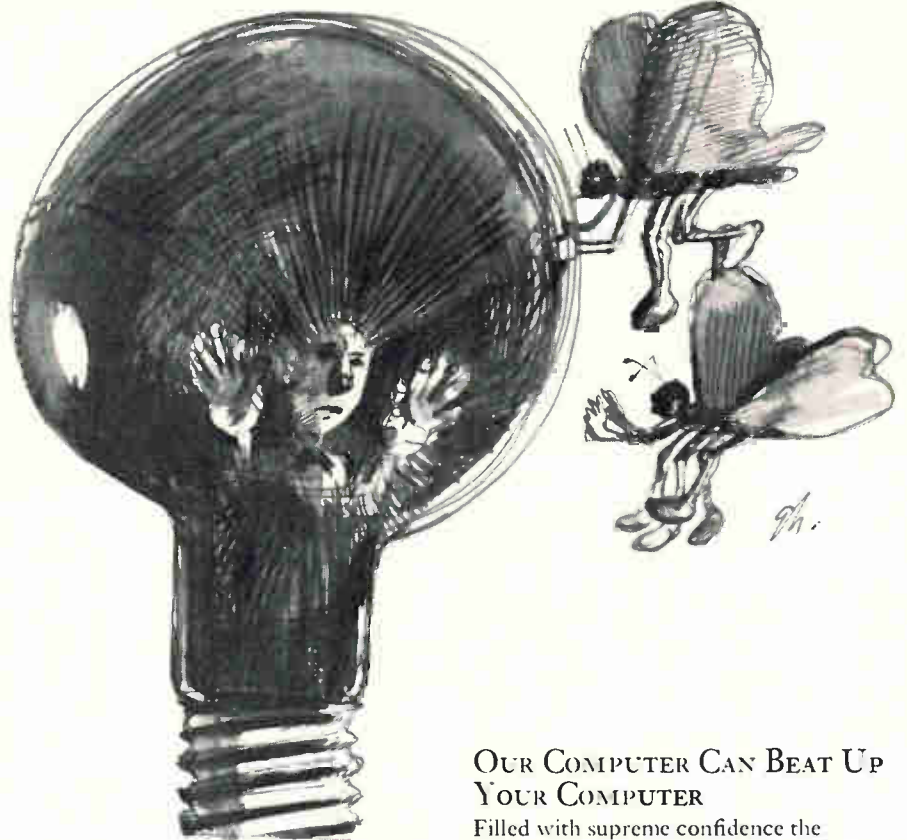

forces resulting from normal pulling of the tape provide great compressive forces within the reel stack. It would take in excess of 300 g's for slippage to occur.

The result of our Sandwich and Flangeless design approaches (plus a few other neat ideas): a rugged, high performance field portable tape system. Request full information.

Circle 491 on reader service card

OUR RATE-OF-TURN TABLE LAUGHS AT ABUSE



Our new Model 1147 maintains high precision performance regardless of rough handling and transportation. (One reason it's used as the AGE gyro test table for F-111 Aircraft System.) Hydrostatic bearings give precise dimensional stability, excellent alignment, low runout and eccentricity, low mechanical noise and long life. The bearing is capable of smooth rotation at less than sidereal rates (.004°/sec.). And up to 1500°/sec.

The Model 1147's compactness makes it ideal for field or bench checking. Its ruggedness makes it ideal in case you just happen to feel like kicking hell out of a fine piece of equipment.

Circle 492 on reader service card

OUR COMPUTER CAN BEAT UP YOUR COMPUTER

Filled with supreme confidence the engineer plugs in his newly designed gem of a system. Then discovers that it's too noisy. So off to the supplier for a custom filter. It's expensive and its weird configuration makes it almost impossible to maintain a hermetic seal under the stresses of high pressures and extreme temperature variations.

We can help you avoid the what-me-need-a-filter syndrome. Give us a work statement. For free, we'll crank the system parameters into our computer and it will design the Perfect Filter. It will do the job right, and cost you about 40% less than one that must be produced downstream.

Out of the hundred or so companies in the industry only two or three use computers. We're better at it than they are, and besides our salesmen know good jokes. Come on, give us a break.

Circle 493 on reader service card



GENISCO TECHNOLOGY CORPORATION
18435 SUSANA ROAD
COMPTON, CALIFORNIA 90221

**Proven in 3rd generation computers –
 CTS Series 770 HIGH-POWER PRECISION
 CERMET RESISTOR MODULES
 can open new design
 concepts for you!**

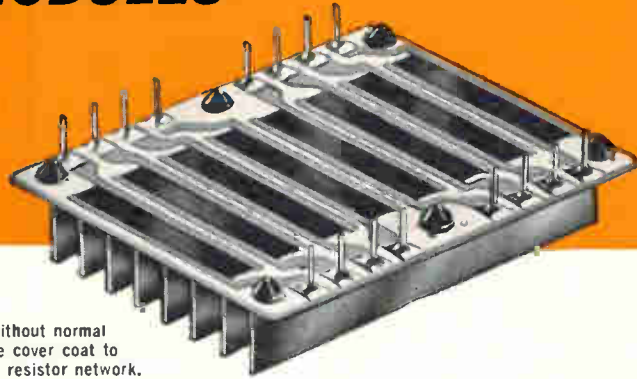

Shown without normal insulative cover coat to illustrate resistor network.

Consider these characteristics

- Cermet reliability now available for power applications.
- Compact modular packaging—overall dimensions are only 1.500" by 1.225" by 0.370" with heat sink.
- High power—8 to 20 watts per module depending upon allowable operating temperature, air flow, duty cycle and number of pins used.
- Low inductance—less than 10 nanohenries up to 200 megacycles.
- Layout flexibility—up to 24 external pins on .125" centers can accommodate a dozen or more cermet resistors.
- $\pm 1\%$ standard tolerance from 20 ohms to 1 megohm.
- Special low resistance values available down to 10 ohms.
- Available in quantity NOW—over 250,000 already produced.
- Available with copper heat sink bonded to alumina substrate.
- Dual-in-line staked pins for rapid insertion—can withstand 7.5 lbs. tensile or compressive force.

**770 Series Environmental
 Specifications**

Load Life: 9 watts for 1,000 hours at 55°C ambient in 300 fpm air flow	0.4% ΔR max. 0.1% ΔR av.
Moisture Resistance: 95% R.H. at 70°C, 10 days load, 10 days no load	0.2% ΔR max. 0.05% ΔR av.
Standard temperature coefficient of resistance	-50 to +350 ppm/°C
Thermal Cycling: 5 cycles, -60°C to +125°C no load	0.10% ΔR max. 0.03% ΔR av.

**Samples are available off the shelf.
 Kit of three modules for \$13.00.**

order yours today!

Think about it!



Founded 1896

CTS RESEARCH, INC./LAFAYETTE, INDIANA

Subsidiary of CTS Corporation, Elkhart, Indiana

ARNOLD IS

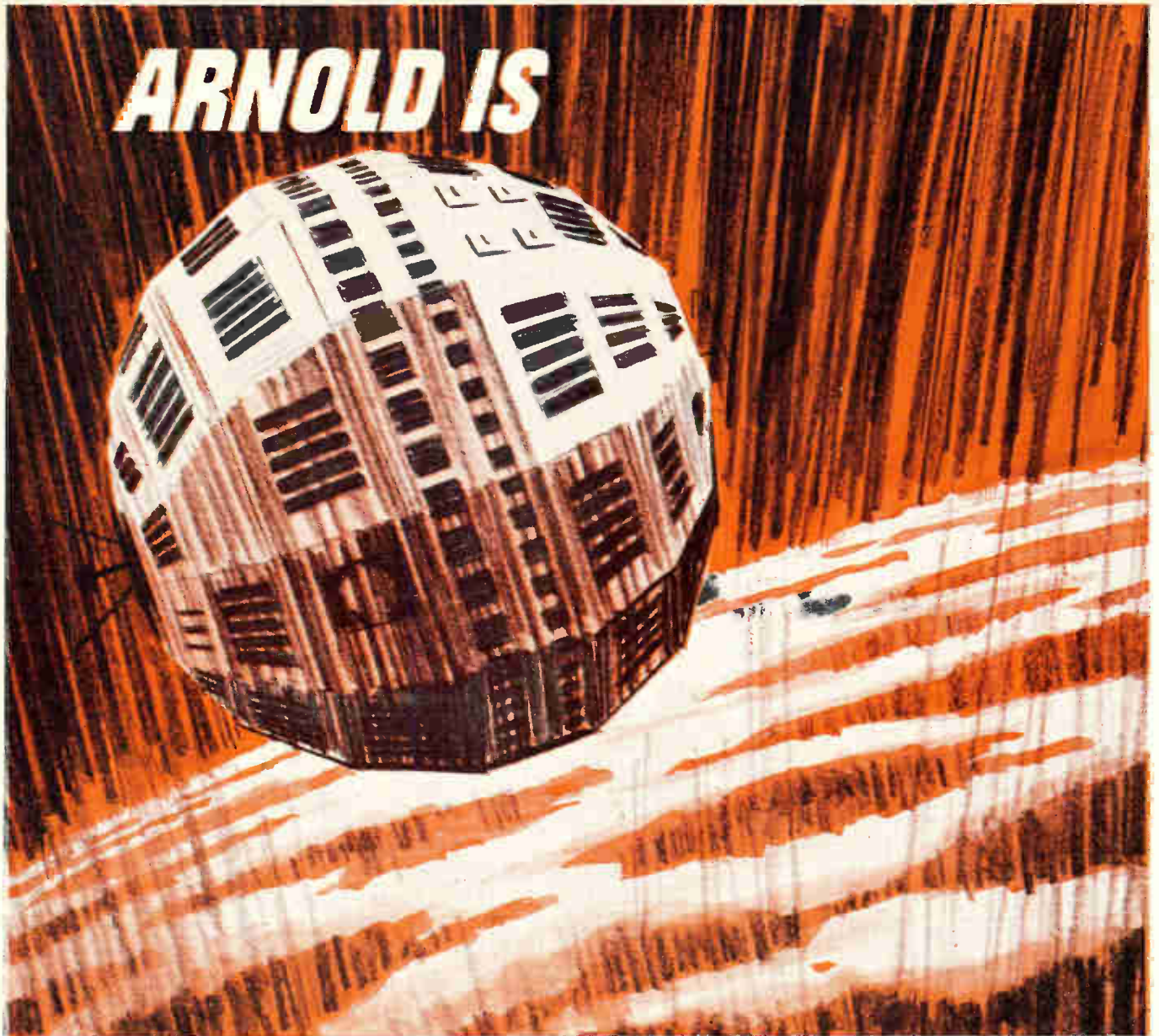

MPP CORES

From communications satellites to telephone high and low pass filters—from loading coils to inductors and RFI filters, Arnold has total MPP Core capability. With 386 sizes, varieties and electrical parameters available from stock, Arnold is the leading producer of Molybdenum Permalloy Powder Cores.

Available in many toroidal sizes—from ¼" dia. to 5" dia. in eight standard permeabilities (205, 173, 160, 147, 125, 60, 26 & 14 Mu). Most of these cores can be furnished with a controlled temperature coefficient of inductance. Arnold MPP Cores show best stability to DC magnetization and modulation factor—also least change in core loss with variation in current level.

Arnold is also ■ Permanent Magnets ■ Sillectron Cores ■ Tape Wound Cores ■ Bobbin Cores ■ Iron Powder Cores ■ Electrical Alloy Transformer Laminations ■ Transformer Cans and Hardware ■ Magnetic Shielding ■ Special Magnetic Materials.



ARNOLD

SPECIALISTS in MAGNETIC MATERIALS

THE ARNOLD ENGINEERING COMPANY, Main Office MARENGO, ILL.
BRANCH OFFICES and REPRESENTATIVES in PRINCIPAL CITIES

Flaming resistor failure used to be a catastrophic danger.

So Corning changed resistor failure.

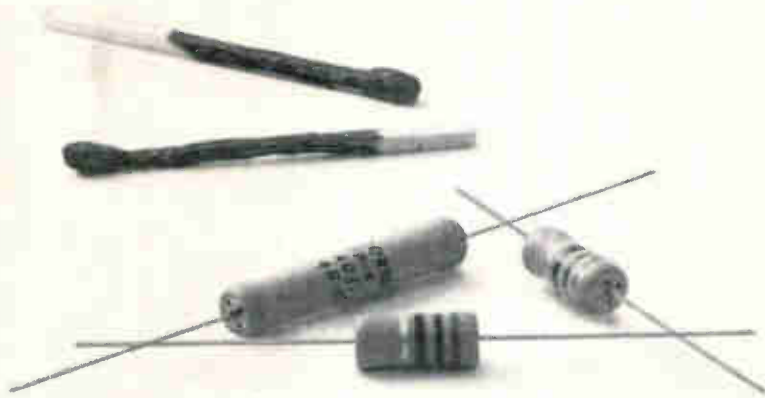

The fact is, new CORNING® FP Resistors just won't burn. Even if a circuit smacks one with an overload of a hundred times or more, it won't burn. It knows how to fail gracefully. It will open up, but no flame and no short. But don't just take our word. Test this new resistor yourself.

FP resistors come in 2, 3, 4, 5, 7 and 10 watt sizes, from 9 ohms to 90K.

Just write for free samples and complete data.

Meanwhile, we're looking for more changes that will improve resistors. That's how our line of glass tin oxide film resistors has grown to be one of the most extensive and useful. That's how we've earned our qualifications for exceptional stability and reliability.

Corning Glass Works, 3904 Electronics Drive, Raleigh, N.C.

CORNING
ELECTRONICS

you've got it made

...when you
let **FANSTEEL** do it!

Let FANSTEEL make your electronic parts for you. What type of parts? For instance:

(1) **FANTORK™ Chassis-Mounted Heat Sinks** that give you up to 3-times greater shank torque and provide comparable heat dissipation of wrought copper alloys. With a complete FANTORK part . . . all you do is die-bond, attach leads and assemble. Or, we'll do any . . . or all . . . of these steps for you . . . braze the steel threaded shank into the sintered copper base . . . add pre-form backing discs (with or without coatings) . . . put on a steel weld ring . . . coin a projection into sintered copper base for direct ultrasonic welding of can . . . insert pins . . . or plate entire assembly. (2) **Lead Assemblies**—from refractory to conventional lead materials in close tolerance diameters from .025" to .125" . . . plated to your specifications. (3) **Semiconductor Backing Discs**—either pressed and sintered . . . punched . . . or cut . . . from tungsten or molybdenum. Fansteel coating technology assures positive wetting action. All sizes throughout the power ratings. Whatever your component parts need . . . LET FANSTEEL DO IT! Our diverse packaging technologies will help you reduce component assembly time and costs. For complete information on value engineered Fansteel parts, call your Fansteel representative . . . or write us.

1.



2.



3.



See FANSTEEL at
NEP/CON EAST
BOOTH No. 711



FANSTEEL

METALLURGICAL CORPORATION

ELECTRONIC PARTS DIVISION
NUMBER ONE TANTALUM PLACE
NORTH CHICAGO, ILLINOIS 60064

**this AMELCO FET
combines low R_{ON} ,
low I_D (OFF) and low C_{DG}
better than ever before...
2N4091**

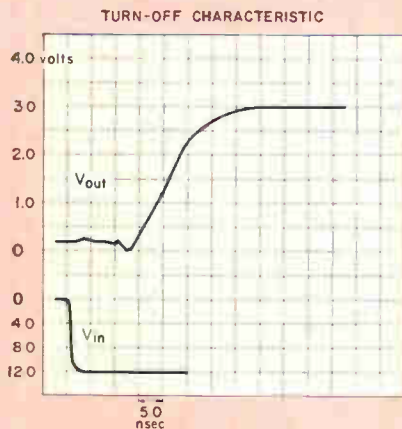

SPECIFICATIONS:

R_{ON}	30 ohms MAX	t_{OFF}	40 nsec MAX
$I_{D(OFF)}$	200 μ A MAX	V_P	10 V MAX
C_{DG}	5 pf MAX	$I_{D(SAT)}$	30 mA MIN
t_{ON}	25 nsec MAX	BV_{DSO}	40 V MIN

Now being mass produced, this FET switch is available from Amelco Distributor stock for only \$6.35 in quantities of 100 or more.

Amelco's new 2N4091 FET switch offers extra high speed with the highest switching ratio ever available in a standard device. If you are working with multiplexing, commutating, analog switching or DC chopping, consider these facts... R_{ON} is 30 ohms max., the lowest of any FET on the market with C_{DG} of less than 5 pf; I_D (on)/ I_D (off) ratio is better than 10³. Designers may now consider FET devices where previously the requirement for very low on resistance demanded use of bipolar transistors. In addition, applications presently using FET's can benefit from this improved performance.

AMELCO SEMICONDUCTOR

DIVISION OF TELEDYNE, INC. • 1300 TERRA BELLA AVENUE • MOUNTAIN VIEW, CALIFORNIA • Mail Address: P.O. Box 1030, Mountain View, California • Phone: (415) 968-9241 / TWX: (415) 969-9112 / Telex: 34-8416 • REGIONAL OFFICES: Southwest—Suite 213, 8621 Bellanca Ave., Los Angeles, California 90045, (213) 678-3146 • Northwest—1300 Terra Bella Ave., Mountain View, California, (415) 968-9241 • East—27 Traphagen Road, Wayne, New Jersey, (201) 696-4747 • Southeast—711 Magnolia Avenue, Orlando, Florida 32803, (305) 423-5833 • Northeast—805 High Street, Westwood, Massachusetts 02090, (617) 326-6600 • Midwest—650 West Algonquin Road, Des Plaines, Illinois, (312) 439-3250 • Canada—Deskin Sales, Montreal, Quebec, (514) 384-1420.

“Why do more and more executives say MICHIGAN has more of everything?”



“...because the seaway brings the whole import-export world right to Michigan’s door.”

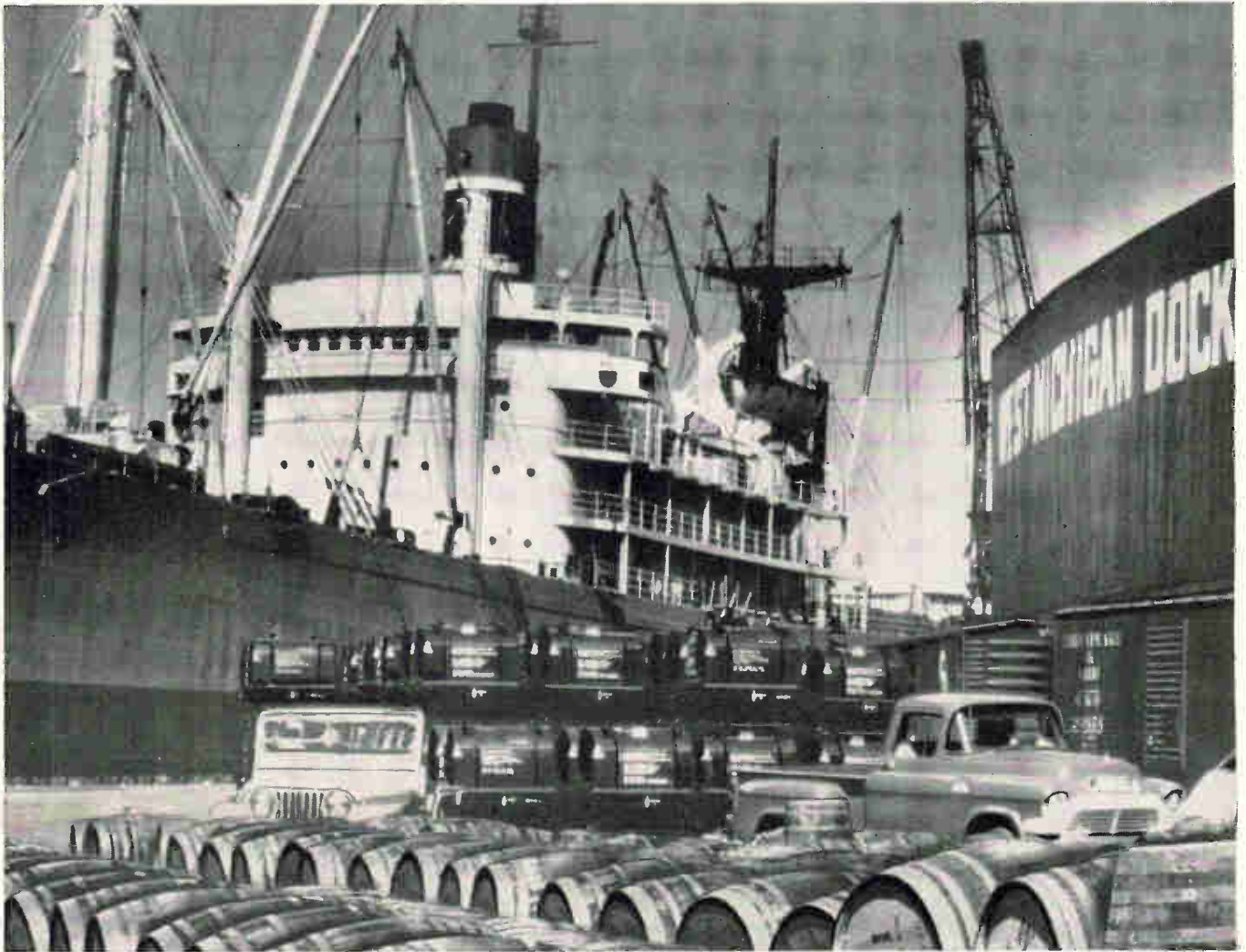

Yes, you can locate right in the vital heartland of America and still reach out to the world, economically and profitably. Five Michigan ports are active in international trade. More than 900 Michigan firms are engaged in overseas business. The state ranks second in volume of U. S. customs receipts. Between 1960 and 1966, tonnage on the St. Lawrence Seaway increased two-and-a-half times.

Interested in completely detailed and current data on harbors and port sites in Michigan’s Lower Peninsula? Contact us now for full information in confidence.



Consumers Power Company

216 West Michigan Ave. Jackson, Michigan 49201 Area Code 517-788-0502
W. N. McClelland, Director of Area Development

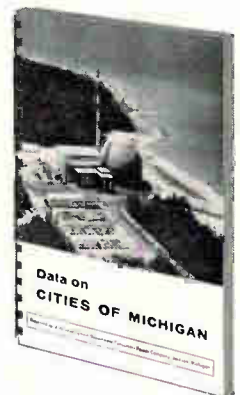

Ask for your copy



SCR's in GE's new
PRESS PAK . . . another
packaging innovation



Also available soon:
PRESS PAK rectifier diodes
rated up to 1200 V.

Forget internal soldered joints. GE PRESS PAK SCR's are mounted by externally applied pressure. Double sided cooling increases their average current rating up to 60%. Reversibility eliminates the need for special reverse polarity units. Rated up to 1300 volts at either 115 amps average or 235 amps average, PRESS PAK SCR's cost 10% less than equivalent stud mounted units. Motor drive control, phase control and electromechanical applications are excellent typical uses. Circle Number 90 on the magazine inquiry card for more information.

Volt-Pac® variable
transformers:
maximum life with
minimum maintenance

Every GE Volt-Pac transformer features corrosive resistant parts throughout: ① Spring-loaded, grain oriented solid carbon brush assures even contact . . . reduces wear. ② Self-lubricating nylon bearing causes low friction in voltage selector. ③ Polyesterimide insulation for coil windings provides extra dependability. ④ Aluminum radiator and base dissipate heat evenly . . . extend life. ⑤ Low-resistant gold plated track lessens heat build-up at brush contact.

Specify precision-built Volt-Pac transformers for continuously adjustable output voltage. A complete line of manually operated and motor-driven models, including plug-in cord units, is now available. Circle Number 91 for more facts.

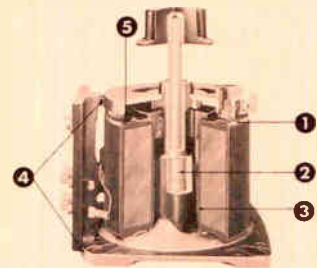

New Horizon Line®
panel meter
relay



Features solid-state,
light-sensitive switching

New Type 196 Meter Relay takes advantage of totally new contactless control action . . . gives you exceptional control simplicity and reliability. Install it quickly and easily by just plugging in the unique "piggyback" control module. The module can be readily removed without interrupting measurement circuit, as its indicator mechanism connections are on the rear of the meter. Horizon Line Meter Relays, available in 3½" and 4½" sizes with single or double setpoints, can be front-mounted or back-of-panel mounted. Circle Number 92.

What's new
for peripheral
computer equipment?

Instant response—inertial time constants as low as 1 millisecond—is what you get with the new GE Hyper-Servo* motor. And it accelerates faster than any other motor ever developed by General Electric. Hyper-Servo motors greatly increase the overall capacity of peripheral data processing equipment. They're available in 3.4-, 4.6-, and 4.8-inch diameters. Performances include torque-to-inertia ratios in excess of 350,000 rad/sec² and continuous torque ratings from 32 oz-in at 2700 rpm to 326 oz-in at 2800 rpm. A wide variety of models can provide the high performance drive motor for nearly every computer peripheral application. Circle magazine inquiry card Number 93.

*Trademark of the General Electric Company.



Hyper-Servo® Motors

Typical 32-Frame Models

Here's Blue Jay*—
GE's newest
film foil capacitor



Superior Blue Jay polycarbonate capacitors feature:

- EXCELLENT CAPACITANCE STABILITY over their entire operation range (−55 C to 125 C). Maximum capacitance change at 25 C will not exceed −2.0% to +0.3% over the entire operating range. Capacitance change is negligible over the 25 C to 65 C range, and nearly linear with a negative coefficient in the +65 C to 125 C range.
- HIGH INSULATION RESISTANCE. Typical resistance, measured on units rated 0.1 μf 200 volts, is 2x10⁹ megohms.
- LOW DISSIPATION FACTOR—does not exceed 0.3% over the temperature range of 25 C to 125 C at 1000 Hz, making Blue Jays ideal for many AC applications.

Circle Number 94.

*Trademark of the General Electric Company.

MORE ▶



Speeds as low as
one revolution per day
with GE
D-C torque motors

GE d-c Torque Motors, with low speed capability, eliminate gearing with inherent backlash and windups . . . permit direct connection to the driven load. This combined with low inductance and low-reflected motor inertia means you can design your system to accelerate, decelerate, or position high-inertia loads with excellent precision and accuracy. Rapid-response GE d-c Torque Motors, with permanent-magnet or wound field excitation, are available with or without endshields and/or bearings to meet your mechanical requirements. Circle magazine inquiry card **Number 95**.

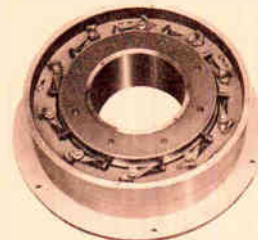

Available with from
30 to 200,000 lb-ft torque

Versatile
ignitrons . . .
still going strong

GE Ignitrons provide application versatility—year after year in circuit after circuit. They're unmatched for economy and ruggedness in high power applications. Here are four typical circuit applications:

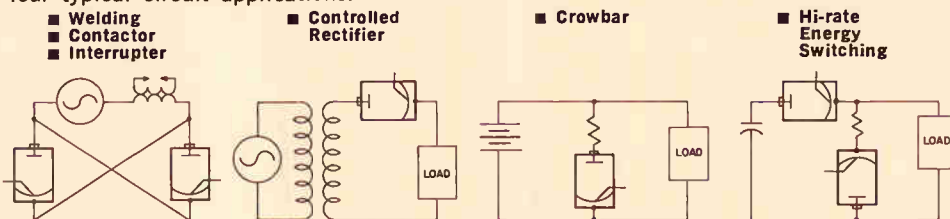

Circle **Number 96** for more Ignitron facts.

COMING YOUR WAY—GE'S MICROWAVE TUBE VAN. CIRCLE NUMBER 97.

Insert PTC
thermistors
automatically

GE Positive Temperature Coefficient Thermistors (PTC's) are small, rugged, hermetically sealed units with weldable/solderable gold-plated Dumet leads. A temperature coefficient of resistance of approximately +0.875% per degree Centigrade operable to 150 degrees Centigrade makes them ideal for temperature compensation in silicon transistor circuits. They can also be used as sensors in temperature indicators and temperature controls. Their small size and uniform dimensions permit automatic insertion into printed circuit boards. Circle **Number 98**.

PTC—actual size

Reel drive
motors for
computer tape
transports



Fractional HP
DC Motor

GE's full line of fhp direct-current motors includes four frame sizes widely used for reel drives: 3 $\frac{1}{16}$ " , 3 $\frac{3}{16}$ " , 4 $\frac{5}{16}$ " and 6 $\frac{5}{16}$ " diameters. Special end mountings and shaft extensions meet exacting application requirements. Series, split-series, compound, shunt, and compensated-shunt winding designs offer a broad design choice. Stall torque ratings from 3 to 120 ounce-feet and higher span various application needs, and motor voltage requirements are normally matched to your system design. Circle **Number 99** on the magazine inquiry card for more information.

New thumbwheel
switches require
less panel space;
simplify
data input



CR103
Thumbwheel Switch

GE space saving CR103 Type F Thumbwheel Switches—rated 150 volts a-c/d-c—are ideal for welding control, computer systems and numerical control. Manual data insertion is made easy by simply dialing in the information. Both standard-duty and oiltight forms are constructed of unbreakable Lexan*. Large easy-to-read colored numerals (or symbols) are neat in appearance. Assemble your own non-oiltight standard-duty switches, if you prefer, by purchasing individual switch modules, end blocks, spacers and shafts. Circle **Number 100**.

*Registered trademark of General Electric Company.

WE MAY NOT OFFER EVERYTHING YOU WANT FROM ONE COMPONENTS SUPPLIER. BUT WE DO COME A LITTLE CLOSER THAN ANYONE ELSE.



CH 1191 Less Than 2 Nanoseconds Firing Time Without Pulse Jitter

Linear accelerators involve speeds closely approaching that of light. To accelerate a beam as it passes through a half-inch gate at those velocities, requires a high energy pulse of critical precision. Tung-Sol CH1191 hydrogen thyratrons do just that.

The elimination of pulse jitter has been achieved by employing a priming, or 'prefiring' electrode. The result is the achievement of a variation in anode firing time of less than 2 nanoseconds—not only at full power but down to as little as one-sixth of full power.

CH1191 has a peak power output of 100 megawatts. Two other Tung-Sol types (CH1198, 60 megawatts and CH1180, 10 megawatts) provide a range of service obtainable from no other source.

Write for fully detailed technical information. Tung-Sol Division, Wagner Electric Corporation, One Summer Avenue, Newark, N.J. 07104.

**TUNG-SOL®
HYDROGEN THYRATRONS**

©REGISTERED T.M. OF WAGNER ELECTRIC CORPORATION

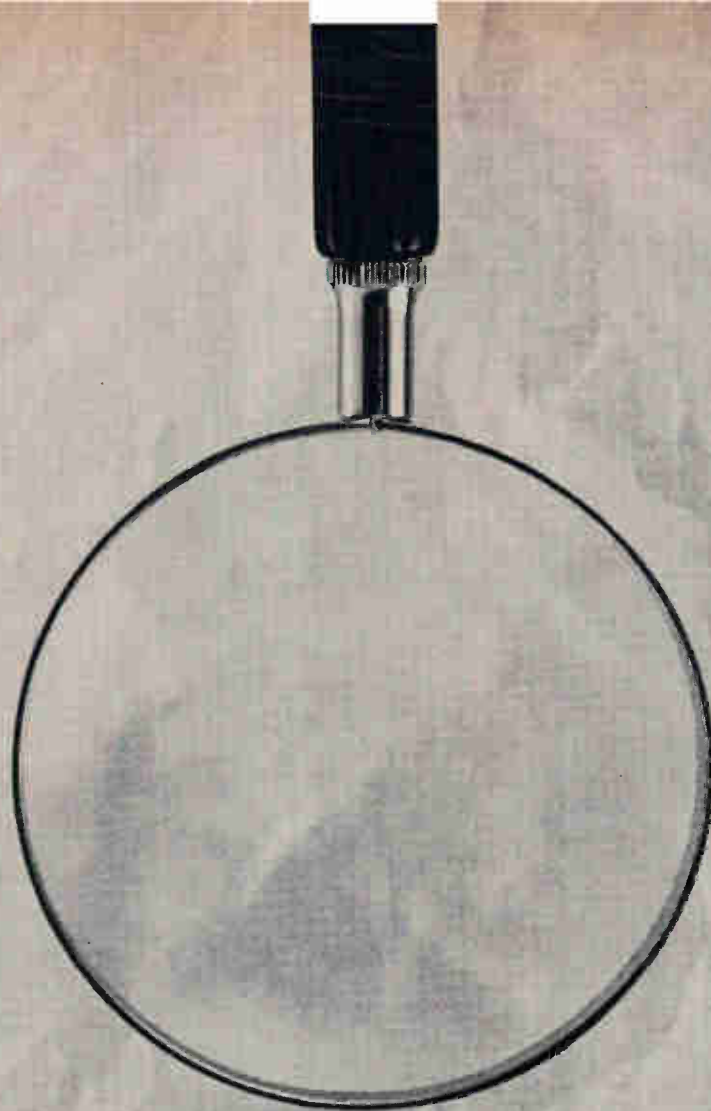

Want to record aphid feeding?

An unerring record of aphid feeding and salivation! (Details on request.) That's one of scores of interesting applications of Esterline Angus Speed Servo® Recorders. ■ These recorders have earned exceptional popularity in laboratories and industry because: ▷ their servo motors have only one moving part . . . no drive cords to break or gears to wear ▷ they are available with either 4½" or 10" spans ▷ their response is faster than any other servo recorder . . . 1/8 second for 4½" span and 2/10 second for 10" span ▷ they have conductive plastic feedback potentiometers that can't develop open, broken or shorted turns common to wire wound potentiometers ▷ you can choose a variety of automatic or manual chart drives. ■ Outstanding options include: ▷ Adjustable Zero Adjustable Span (AZAS) with zero adjustable from 0 to ±100 MV for any span from 1 to 100 MV ▷ multi-range selector switch for ranges of 0-1, 5, 10, 50, 100, 500 MV and 0-1, 5, 10, 50, 100 V ▷ conductive plastic retransmitting potentiometers ▷ alarms ▷ event pens. ■ Another plus feature is fast delivery . . . 7 days for 4½" span Speed Servos® and 10 days for 10" span Speed Servos®.* ■ For complete information

You can do it

with an

Esterline Angus

Speed Servo®

about these recorders, call your Esterline Angus sales engineer or write for Speed Servo® information. ■

** Seven and 10 working day delivery (ARO) is possible on Speed Servo® Recorder models which have become so popular they're now in production at all times.*

ESTERLINE ANGUS INSTRUMENT COMPANY, INC.
BOX 24000 • INDIANAPOLIS, INDIANA 46224



Technical Articles

**Computer-aided design,
part 8: picking a
transient analysis program
page 84**

With a computer, an engineer can thoroughly investigate circuit characteristics that vary with time, such as sensitivities. Most of the major network design programs will do the job, but valuable computer time will be wasted if the wrong combination of program and integration routine is used. One program may require five minutes, another only 30 seconds.

**Plastics for packaging:
handle with care
page 101**

Transistors and integrated circuits cost less in plastic packages, but the controversies about device reliability haven't been settled. Military and space system designers are still unsure about using them in adverse environments. Tests show that chemicals in some plastics degrade the components, but that improved semiconductor passivation and the use of inert plastics can solve this problem.

**Taking cryoelectric
memories out of
cold storage
page 111**



Fabrication problems have stalled commercial production of superconducting memories for more than a decade. A new memory element design that depends upon bulk properties of the materials rather than tight process control can lead to cheap, fast, billion-bit memories. On the cover, an experimental system is being placed into liquid helium at the Radio Corp. of

America. Each of the four planes is 2 inches square and stores 6,000 bits in loop cells of tin film.

**Dielectric bath
cools IC's
page 123**

Integrated-circuit designers hope to improve digital system speed and reliability by putting many IC's on a chip. This will increase power density and require a 10-fold improvement in cooling. Air cooling and heat sinks won't meet the need, so packaging engineers are looking at a new technique—flowing liquid dielectrics over exposed circuits. The liquid boils, but the chips keep cool.

**Coming
May 1**

- Braided wires program read-only memories
- Apollo spacecraft antenna tracks ground stations
- Models simplify integrated-circuit design
- Automatic digital pulse analyzer

Computer-aided design: part 8

Picking transient analysis programs

Employing the proper integration routine is the key to solving transient problems. A really good choice reduces computation time and increases accuracy

By Waldo G. Magnuson Jr.

Lawrence Radiation Laboratory, Livermore, Calif.

Most of the major network design programs can handle transient analysis problems but rarely with equal speed or capacity. Program flexibility also varies widely. Therefore the engineer must evaluate the alternatives carefully so that he makes the best use of both his and the computer's time.

Circuit analysis programs have one primary objective—to obtain responses to prescribed input signals. In a transient analysis program, these responses are expressed as a function of time rather than frequency. Thus, an engineer can investigate circuit rise times, over-shoots, d-c stabilities, switching speeds, circuit sensitivities, and signal level changes at various times during a circuit's operation. The requirement for time-domain analyses occurs frequently and calculating their effects manually is tedious, if not impossible. However, techniques for performing transient analysis have been included in many computer programs.

In a computer-aided transient analysis, either a set of simultaneous first-order differential equations must be established that relate the circuit elements to the node voltages and loop currents or a network transfer function must be formed from topological methods [Electronics, Nov. 14, 1966, p. 112].

The author



Since 1964, Waldo G. Magnuson Jr. has been at the Electronics Engineering Department of the Lawrence Radiation Laboratory working with digital computer network analysis programs as an aid in engineering design.

In the matrix approach, the equations are formed from a branch-node circuit description supplied by the engineer. The currents and voltages are expressed as a function of time by integrating a set of differential equations in the computer. The circuit response at any point in time is then obtained by substituting the appropriate time value into the current and voltage equations. The response at the next point in time is obtained by integrating the set of equations and again substituting the appropriate time value and other variables into the equations.

Selecting integration routines

The solution of a transient network problem is largely controlled by the selection of an integration routine. Typically, the solution procedure begins with known initial conditions and solves the network equations at a particular time, usually time zero. An integration routine is then applied to obtain the initial conditions for the next solution step. If too small a time interval is chosen, excessive computation time results. Conversely, too large a time step reduces the accuracy of the output. Choice of the appropriate time interval is somewhat of an educated guessing game—it is based largely on intuition and a working knowledge of the circuit element values. A good rule of thumb is that the time step should not be larger than the smallest circuit time constant. Some of the analysis programs for electronic circuits make this selection automatically.

There are several integration routines available for solving first-order differential equations. These are usually classified into two groups—single-step or multi-step. The most widely used of the first

How the programs stack up

	Calahan	ECAP	NET-1	Predict	Sceptre
Program input features					
Must use specific labels	No	Yes	Yes	Yes	Yes
Sequential node numbering	Yes	Yes	Yes	No	No
Random location of input	No	Limited	Yes	Yes	Yes
Voltage or current sources	Current sources only	Yes modification of the built-in model (not convenient)	Through a modification of the built-in model (not convenient)	Yes	Yes
Tabular input for branch descriptions	No	No	No	Yes	Yes
Tabular input for signal sources	Yes	Yes	Yes	Yes	Yes
Analytic description of branch elements	No	No	No	Yes	Yes
Analytic description for signal sources	Yes (available from a modified subroutine)	No	No (has several built-in signal sources that may be picked)	Yes	Yes
Automatic modification of input (repeated runs)	Yes	Yes	Yes	No	Yes
Modeling capabilities					
Built-in models	No	No	Yes (transistors-diodes)	No	Yes
Allows small-signal models	Yes	Yes	No (inconvenient)	Yes	Yes
Allows large-signal models	No	No (inconvenient)	Yes (Built-in)	Yes	Yes
Output options					
Transfer functions	Yes	No	No	No	No
Pole-zero locations	Yes	No	No	No	No
Symbolic expression for time response	Yes	No	No	No	No
Time-response output	Output node only—at fixed intervals	Selected variables at fixed intervals	Node voltages and semi-conductor currents at fixed intervals	Selected branch voltages and currents at every time step	Selected variables at fixed intervals
Steady state solution	No	Separate analysis	Yes	Separate analysis	Yes
Programing features					
Programing language	Fortran II, IV	Fortran II, IV	Madcap & FAP	Fortran II & FAP	Fortran IV
Memory capacity recommended	32,000	32,000	32,000	32,000	32,000
Network formulation	Topological	Matrix	Matrix	Matrix	Matrix
Primary integration routine	Runge-Kutta (& inverse Laplace)	Implicit numerical integration	Predictor-Corrector	Runge-Kutta (2 & 4 pass)	Runge-Kutta Predictor-Corrector
Features at Lawrence Radiation Laboratory					
Operating on computers	IBM 7094 CDC 3600 CDC 6600	IBM 7094 CDC 3600 CDC 6600	IBM 7094	IBM 7094	IBM 7094
Graphical output	Calcomp & CRT plots	None	None	Calcomp & CRT plots	Printer
On-line capability (LRL CDC-6600 time-share system)	Yes	Yes	No	No	No

Comparing two key integration routines

Two popular integration routines are the Runge-Kutta and Predictor-Corrector techniques. The first is a one-step method that obtains a numerical solution from a weighted formula without having to carry forward any knowledge of previous steps of the differential equation or its solution. However, to get high accuracy the method requires many small time-steps that increase the computing time greatly. Furthermore, several time-consuming evaluations of the first derivative are needed and the method does not provide an estimate of numerical round-off errors.

The transient analysis starts with a knowledge of the first-order differential equations that describe the network, dv/dt , and the initial conditions at some time, say $t = t_0$. These values are then substituted into the Runge-Kutta prediction formula and a value of voltage, v , is predicted for the time $t_1 = t_0 + \Delta t$. The formula is expressed as follows:

$$V_{t_0+\Delta t} = \frac{1}{6} [K_1 + 2K_2 + 2K_3 + K_4]$$

where

$$K_1 = \Delta t \left. \frac{dv}{dt} \right|_{(v_0, t_0)}$$

$$K_2 = \Delta t \left. \frac{dv}{dt} \right|_{\left(v_0 + \frac{K_1}{2}, t_0 + \frac{\Delta t}{2}\right)}$$

$$K_3 = \Delta t \left. \frac{dv}{dt} \right|_{\left(v_0 + \frac{K_2}{2}, t_0 + \frac{\Delta t}{2}\right)}$$

$$K_4 = \Delta t \left. \frac{dv}{dt} \right|_{(v_0 + K_3, t_0 + \Delta t)}$$

K_1 represents the product of the selected time step, Δt and the value of dv/dt at the initial value t_0 , v_0 . The other K terms are as indicated.

Substituting the known quantities into these equations yields the first values $t_1 = t_0 + \Delta t$, $v_1 = v_0 + \Delta v$. To find a third pair of values, the same formulas are used with t_1 and v_1 replacing t_0 and v_0 , respectively. When t_2 and v_2 are found, use the equations with t_0 and v_0 replaced by t_2 and v_2 , etc. The error of the Runge-Kutta method is not easy to estimate. If $\Delta t = 0.1$, the designer should expect an error in Δv affecting the fifth decimal place.

An example. Find three pairs of values of t and v for the solution of $dv/dt = -t + v$ with the Runge-Kutta formulas if the initial values of the variables are $t = 0$, $v = 2$.

Solution. The first value is $t = 0$, $v = 2$. Choose $\Delta t = 0.1$, $t_0 = 0$, $v_0 = 2$ in the Runge-Kutta formulas, keep five decimal places during the computation, but round off the value of Δv to four decimal places. This gives

$$K_1 = (-0 + 2) 0.1 = 0.2$$

$$K_2 = \left(-0 - \frac{0.1}{2} + 2 + \frac{0.2}{2}\right) 0.1 = 0.205$$

$$K_3 = \left(-0 - \frac{0.1}{2} + 2 + \frac{0.205}{2}\right) 0.1 = 0.20525$$

A transient analysis problem

Function	Calahan	ECAP	NET-1	Predict	Sceptre
Computer time required for transient analysis of sample problem in minutes	2.16	5.64	2.0	3.18	0.53
Computer used for sample problem	CDC 3600 (2 to 3 times the speed of IBM 7094)	IBM 7094	IBM 7094	IBM 7094	IBM 7094

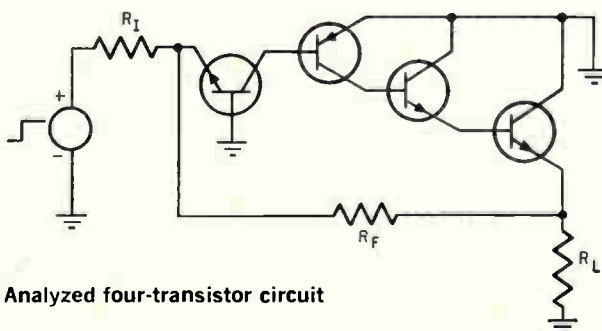

Analyzed four-transistor circuit

Output response for sample circuit

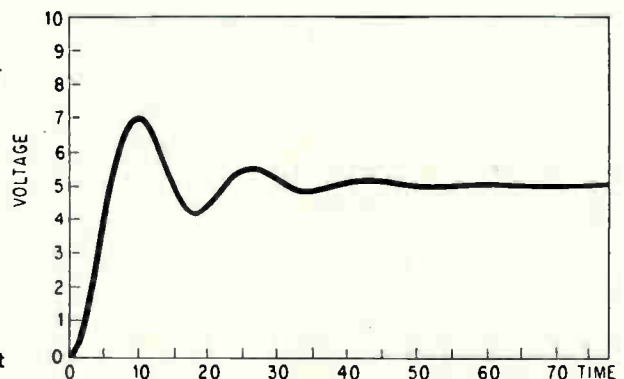

$$K_4 = (-0 - 0.1 + 2 + 0.20525) \cdot 0.1 = 0.21053$$

$$\Delta v = \frac{1}{6} (0.2 + 2(0.205) + 2(0.20525) + 0.21053) = 0.2052$$

Hence, $t_1 = 0.1$, $v_1 = 2.2052$

Substituting these values of t_1 and v_1 for t_0 and v_0 , and $\Delta t = 0.1$ in the Runge-Kutta equations yields: $K_1 = 0.21052$, $K_2 = 0.21605$, $K_3 = 0.21632$, $K_4 = 0.22215$, and $\Delta v = 0.21624$. Hence the third pair of values of t and v is $t_2 = 0.2$, $v_2 = 2.4214$. The next pair of values is computed by replacing t_0 and v_0 with t_2 and v_2 , respectively. The results are plotted at the right.

Predictor-Corrector. Unlike the Runge-Kutta routine this is a two-step technique. The first step predicts a value at a specified time for a prediction formula and the second step adjusts the obtained value by applying a correcting formula. Both formulas are based on a weighted interpolation of a Taylor-series expansion.

As before, the transient analysis starts with a knowledge of the differential equation, dv/dt , and the initial conditions for v , for at least one value of time, t . These values can be inserted into the predictor formula and a value of voltage at a time, $t + \Delta t$ can be calculated from the predictor formula:

$$|V|_{t+\Delta t} = |V|_t + \frac{55\Delta t}{24} \left. \frac{dv}{dt} \right|_t - \frac{59}{24} \Delta t \left. \frac{dv}{dt} \right|_{t-\Delta t} + \frac{37}{24} \Delta t \left. \frac{dv}{dt} \right|_{t-2\Delta t} - \frac{3}{8} \Delta t \left. \frac{dv}{dt} \right|_{t-3\Delta t}$$

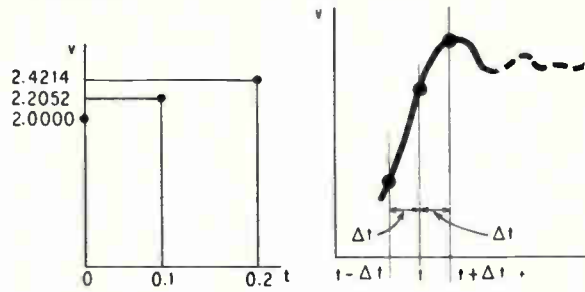

The first term on the right represents the voltage at time t , the second term is dv/dt at time t , the third term is dv/dt at time $t - \Delta t$, etc. See the output response curve above. Next, the program applies a corrector formula and calculates the voltage at the same time interval. The corrector formula is given by:

$$|V|_{t+\Delta t} = |V|_t + \frac{9}{24} \Delta t \left. \frac{dv}{dt} \right|_{t+\Delta t} + \frac{19}{24} \Delta t \left. \frac{dv}{dt} \right|_t - \frac{5}{24} \Delta t \left. \frac{dv}{dt} \right|_{t-\Delta t} + \frac{\Delta t}{24} \left. \frac{dv}{dt} \right|_{t-2\Delta t}$$

The program now compares the two calculated results to see if they are in close agreement. If they are, the integration process is speeded up by doubling the length of the time interval for the next integration. If they are not, the process is slowed down by cutting the original time interval in half. When simultaneous equations are to be solved, a sorting technique included in the program integrates in ascending order of time constants.

group is the Runge-Kutta method and of the second, the Predictor-Corrector method. In designing a system for solving the differential equations describing the network response it is desirable to use as large a time step as possible consistent with an allowable error in the results. Both the Runge-Kutta and the Predictor-Corrector methods can allow for increasing or decreasing the integration interval and the choice of which method is used is not always well defined. Sometimes a combination of the methods is used. Although both work well for both nonlinear and linear circuits, Predictor-Corrector is the most popular because it offers a checking routine. The very small time steps of the Predictor-Corrector method compensate for the nonlinearity by assuming the nonlinear function is linear over a small increment of time.

To determine an output response by any method, v , as a function of time, the designer starts with a first-order differential equation of the form $dv/dt = P v + Q$ and the initial conditions for v at a value of time, t . The terms P and Q are matrixes of the circuit elements, where P is a function of the voltage [$P = f(v)$] and Q is a function of both the voltage and time [$Q = f(v, t)$]. If the circuit is composed of linear elements only, the computer could obtain an output response by direct integra-

tion; however, most circuits contain nonlinear elements, thus P varies with time. Integration of such a nonlinear circuit requires repeated multiplication by an inverted matrix.

Both Runge-Kutta and Predictor-Corrector are outlined in the panel above together with a numerical example that demonstrates Runge-Kutta.

Comparing the programs

Five computer programs that perform transient analysis are compared for speed in performing an analysis of a four-transistor circuit in the table on the opposite page. In all of them, the engineer need merely describe the circuit's topology to formulate the network equations. The programs are: Predict (Circuit Analysis Program) developed by IBM's Space Guidance Center, Owego, N.Y.; NET-1 (Network Analysis Program) [Electronics, Feb. 6 p. 76] developed by the Los Alamos Scientific Laboratory, Los Alamos, N.M.; ECAP (Electronic Circuit Analysis Program) [Electronics, Feb. 6, p. 82] developed by IBM, Los Angeles, Calif.; Linear Network Analysis Computer Program (designated Calahan) developed by the University of Illinois, Urbana, Ill.; Sceptre (System for Circuit Evaluation and Prediction of Transient Radiation Effects) developed by IBM, Owego, N.Y.

Designer's casebook

Designer's casebook is a regular feature in Electronics. Readers are invited to submit novel circuit ideas, packaging schemes, or other unusual solutions to design problems. Descriptions should be short. We'll pay \$50 for each item published.

Making an SCR operate as a high-voltage switch

By G.V. Wintriss

Naval Air Station, Patuxent River, Md.

Operating a silicon controlled rectifier below the rated holding current, I_{ho} , produces an inexpensive high-voltage switch. The SCR turns off when the gate current is removed, much like a high-gain transistor switch.

Resistor R_1 is chosen to limit the SCR anode current to below I_{ho} . Up to +400 volts may be switched by a General Electric Co. C22D SCR with an R_1 of 40 kilohms, since I_{ho} for this model is 10 milliamperes. Current gain is quite high; as

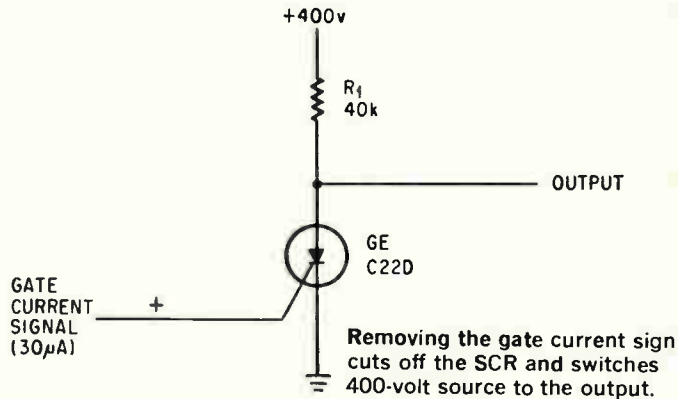

little as 30 microamperes switch the SCR.

With a gate-controlled a-c switch (Triac) such as the GE SC45D, d-c voltages of either polarity can be switched by positive or negative gates.

Monostable multivibrator plus SCR yields chopper

By K. Watanabe, R. Yamada, and M. Ito

Shizuoka University, Hamamatsu, Japan

A monostable multivibrator becomes a highly stable, inexpensive, high-current chopper when combined with a silicon controlled rectifier. The circuit eliminates the saturable reactor and autotransformer of conventional SCR choppers, and produces an output squarewave whose width is independent of the supply voltage.

Transistors Q_1 and Q_2 are connected as a Darlington current amplifier. When the 50-volt supply is switched on, the transistors are forward biased, and emitter current, I_e , charges capacitor C with the polarity shown. At a given time (called $t = 0$ in the waveform diagram), the SCR is triggered, and power is delivered to the load, R_1 . At the same time, the accumulated voltage V_c across C produces a current through C, the SCR, the inductance, L, and diode D_2 . This current is referred to as

a resonant current, I_{res} , having a frequency of $1/2\pi\sqrt{LC}$. At a time equal to a half-period of resonant frequency, $\pi\sqrt{LC}$, C is charged to the value at $t = 0$ but of the opposite polarity.

With the SCR conducting, diode D_1 prevents

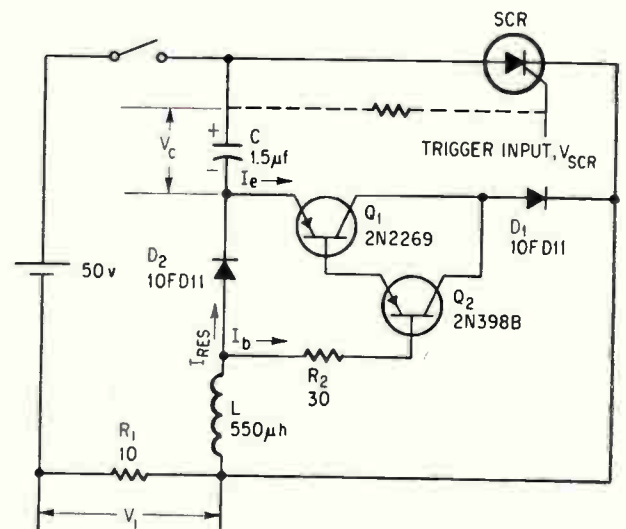

When SCR conducts, resonant current, I_{res} , charges C to a voltage opposite to the polarity shown.

transistor destruction by reverse collector-to-emitter bias. The forward voltage drop across D_2 biases the emitters off and increases the forward breakdown voltage. Diode D_2 also prevents resonant current flow in the reverse direction.

At the end of the resonant half-period, the sum of the supply voltage and the reversed voltage across C causes a large base current, I_b , to flow. The transistors saturate, and V_c reverse-biases the SCR, turning it off. Base current flow is only momentary, because V_c decreases as emitter current flows with the SCR off. Capacitor C is then charged to its original voltage by the emitter current, and the cycle begins again with the next SCR trigger.

The output pulse width is a function of the resonant frequency of C and L ; with the values given, a width of 0.1 millisecond is obtained. If the SCR is self-biased with an additional resistor, shown with dotted leads, the circuit becomes an astable multivibrator.

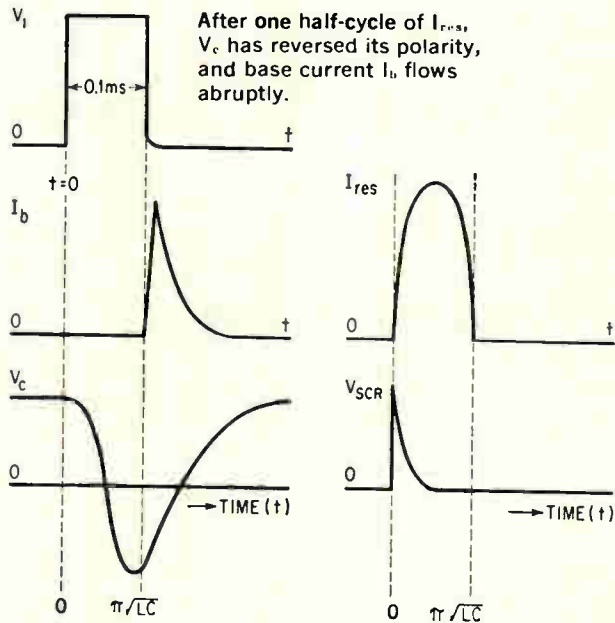

Telemetry tone oscillator consumes microwatts

By Anthony C. Caggiano

Safety Research & Development Corp.
Ridge, N.Y.

A tone-oscillator activated by pulses of less than 2 milliwatts provides a telemetry signal. The circuit

consumes less than 150 microwatts when dormant and 150 milliwatts when transmitting. Thus, it is ideally suited to telemetry applications where power consumption is critical.

With all transistors biased off between transmissions, the only battery drain is from transistor leakage and the voltage divider formed with resistors R_1 and R_2 . Some of the power during the off time is conserved by capacitor C_1 , which charges up during this interval.

Although it takes the small current nearly a minute to recharge C_1 , slow recovery is not a problem

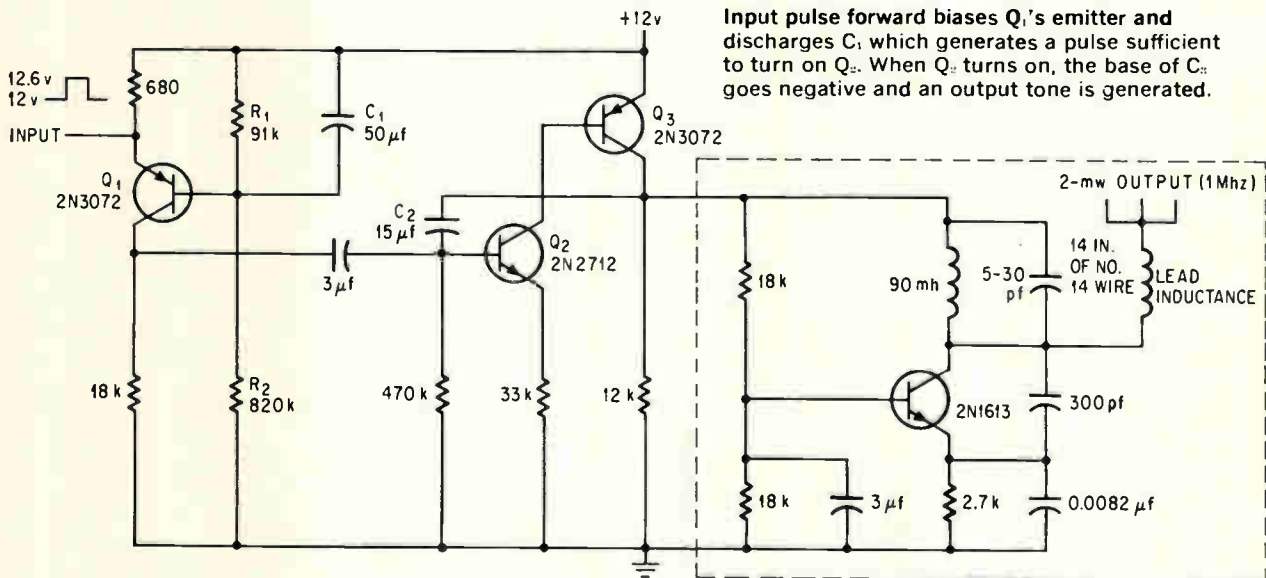

in most present-day telemetry applications.

When an incoming 0.6-volt pulse forward-biases the emitter of Q_1 , the transistor turns on and forms a low-resistance path through which C_1 quickly discharges. The additional power provided by C_1 enables Q_1 to generate an output pulse sufficient to trigger the one-shot multivibrator formed by Q_2 and Q_3 . The output pulse from Q_1 raises the base potential of Q_2 and turns it on. With Q_2 conducting, the base of Q_3 goes more negative and turns on Q_3 .

The collector current generated by Q_3 turns on the tone oscillator-transmitter and starts charging

C_2 , the timing capacitor. During the 8 seconds that elapse before C_2 is fully charged, the tone oscillator transmits a 1-megahertz tone with 2 milliwatts of power via the antenna. When C_2 is fully charged, its bottom plate is sufficiently negative to turn Q_2 off. This shuts Q_3 off and terminates the oscillations. The duration of the power tone may be varied by choosing an appropriate value for timing capacitor C_2 .

A similar circuit appeared in Designer's Casebook, Aug. 22, 1966, page 98. That circuit didn't require small power pulses to turn it on.

Isolated multiple oscillators provide wide frequency range

By Max E. Peterson

Collins Radio Co., Dallas, Texas

Wideband frequency generation is achieved without mechanical switching by combining the outputs of several oscillators on one line. Interaction between the units is reduced when diodes are

inserted between each oscillator and the common output lead. A typical application would be a frequency synthesizer covering the range of 2 to 30 megahertz.

An emitter follower provides power gain in each of the modified Colpitts oscillators shown below. Varactors supply the capacitance for the tank circuits, permitting remote tuning control. Assuming that power switch S_1 (usually a transistor) is closed, diode D_1 conducts and the quiescent emitter voltage of Q_1 is approximately 2 volts. With power removed from the other stages (S_2, S_3, \dots, S_n open), diodes D_2, D_3, \dots, D_n are back-biased

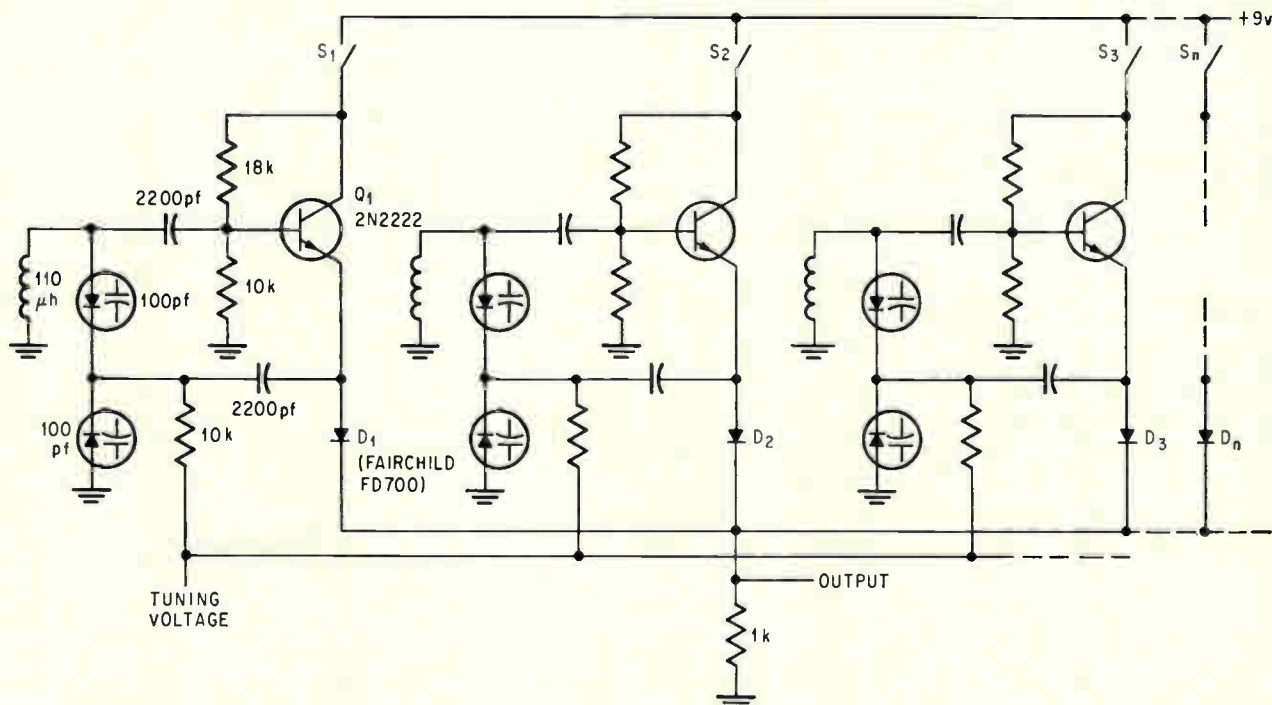

With Q_1 conducting, diodes D_1, D_2, \dots, D_n are back-biased, isolating the respective oscillators from the common output lead.

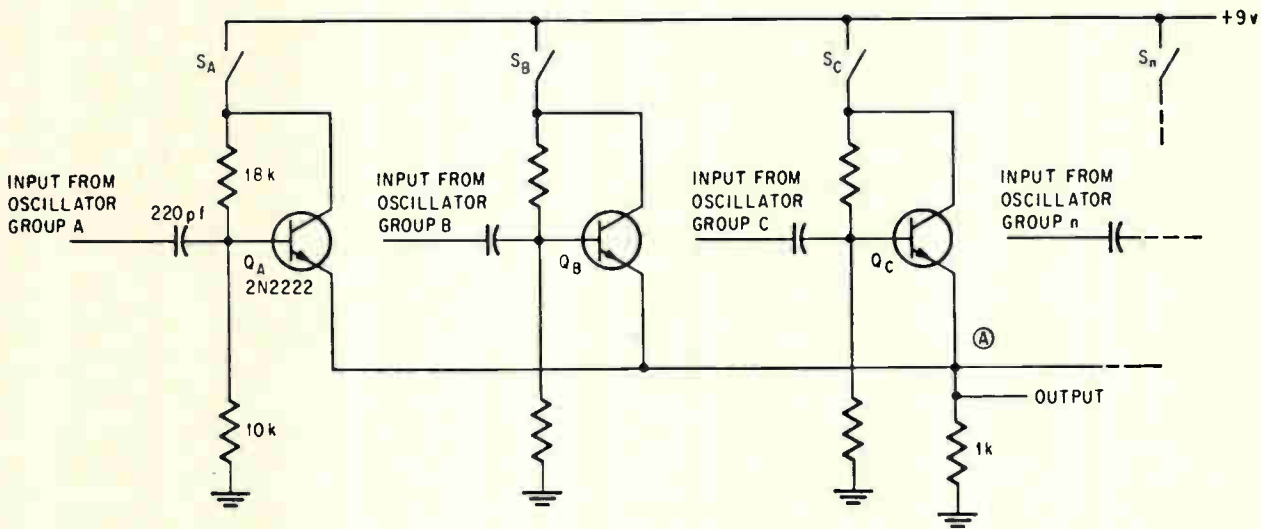

Conducting transistor associated with an oscillator group back-biases the other transistors, isolating group outputs.

through the base-emitter junction of each corresponding transistor and 10-kilohm bias resistor to ground. The typical capacitance of an FD700 diode, when back-biased to 2 volts, is 0.7 picofarad; this represents an impedance of 120 kilohms at 2 megahertz and 8 kilohms at 30 megahertz. A group of 10 oscillators on a common lead has less than 7 picofarads in parallel with the active varactors.

To extend the frequency band, outputs from

groups of oscillators can be combined by the circuit shown above. With S_A closed, Q_A conducts, and the quiescent voltage at point A is between 2 and 3 volts. This voltage back-biases the base-emitter junctions of Q_B, Q_C, \dots, Q_n , isolating the operating group from the others.

The circuits have been used to combine 15 oscillators in five groups of three operating between 2 and 33 megahertz. With a 9-volt supply, the total power dissipation was 23 milliwatts.

Feedback T yields high input impedance

By George Cook and William F. Elder Jr.

Merrick Engineering Inc., Nashville, Tenn.

Operational amplifiers used as preamplifiers in a servocontrol system require high input impedance and wide-range gain control. A 10-turn feedback potentiometer will provide the desired gain control, but since these potentiometers are not available with resistances greater than 100 kilohms, a 1-kilohm input resistor is required for a maximum gain of 100.

By incorporating the 10-turn potentiometer in a variable T-network feedback control, a 100-kilohm input resistor can be used. The gain of the circuit is given by:

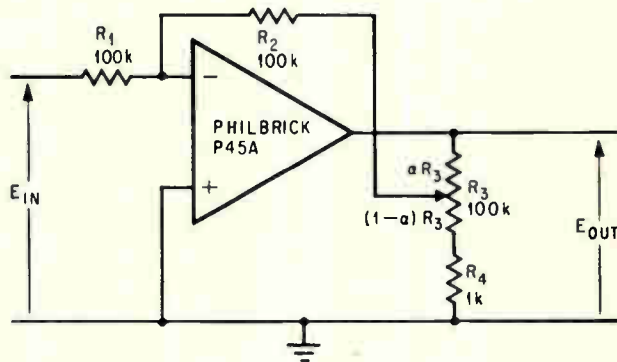

T-network that includes 10-turn potentiometer provides wide gain-adjustment range.

$$-\frac{E_{out}}{E_{in}} = -\frac{R_2}{R_1} \left[1 + \frac{\alpha R_3}{R_2} + \frac{\alpha R_2}{(1-\alpha)R_3} + R_4 \right]$$

where α is the fractional portion of R_3 included in the feedback loop. For the values shown, the gain is -1 when $\alpha = 0$, and -102 when $\alpha = 1$.

Nomograms solve tough problems of shielding

Even nonexperts can design shielded enclosures. Charts help any engineer to quickly determine the thickness of metal required to eliminate interference or evaluate design

By Robert B. Cowdell

Genistron Division of the Genisco Technology Corp., Los Angeles

Protecting sensitive electronic systems and circuits against extraneous fields is a difficult and complex design problem because a detailed analysis of a shielding problem usually requires cumbersome equations or time-consuming graphical methods. Since the results are not always satisfactory, the work is usually left to specialists in shielded enclosure design.

Now, armed with a newly developed set of nomograms, an engineer who has a knowledge of the frequency and the type of field to be suppressed can determine quickly the thickness of metal shield needed to do the job or to evaluate the effectiveness of a shield.

Shielding effectiveness

A metal enclosure can protect against interference caused by the electromagnetic fields that are generated in nearby circuits. These fields may store energy equally in the electric or magnetic components or, as is more usual, they may be predominantly electric or magnetic fields. [See "Magnetic and electric fields" on page 94]. Although an enclosure's shielding effectiveness varies

with the type of field, there are reflection and absorption factors which are important in any shielding problem.

When a field impinges on a shielding material some of the field's energy is reflected from the outer surface, some is absorbed in the material, some is reflected at the shield's inner surface, and the remainder gets through. The shield's effectiveness, S , is given by

$$S = R + A + B$$

where all terms are in decibels. R , the loss due to reflection, is a function of the material, frequency, and the type of field. Absorption losses, A , are a function of the material and frequency but are independent of the type of field. If the absorption loss is greater than 10 db the secondary reflection loss, B , at the shield's inner surface can be ignored. Consequently

$$S \approx R + A$$

where R will be represented as R_E , R_H , or R_P depending on whether the incident field is an electric (E) field, magnetic (H) field, or a radiated plane-wave field (P).

Four nomograms have been designed to make calculating shielding effectiveness easy. The nomograms supply values of the variables needed in the equation. The nomogram on page 98 determines the absorption loss for any type of field. One of three other nomograms is used to determine the reflection loss— R_E , R_H , or R_P —for the particular type of interfering field.

The nomograms are based on equations developed by Schelkunoff¹ and expanded for engineering applications over the years.^{2,3} A recent study

The author



Robert B. Cowdell is manager of systems engineering, responsible for Genistron's consulting and research activities on the West Coast. He has worked on electromagnetic interference studies and designs for the Skybolt missile, XB70 weapons system, Minuteman guidance and ground support system, and communications links.

Electric field reflection losses— R_E

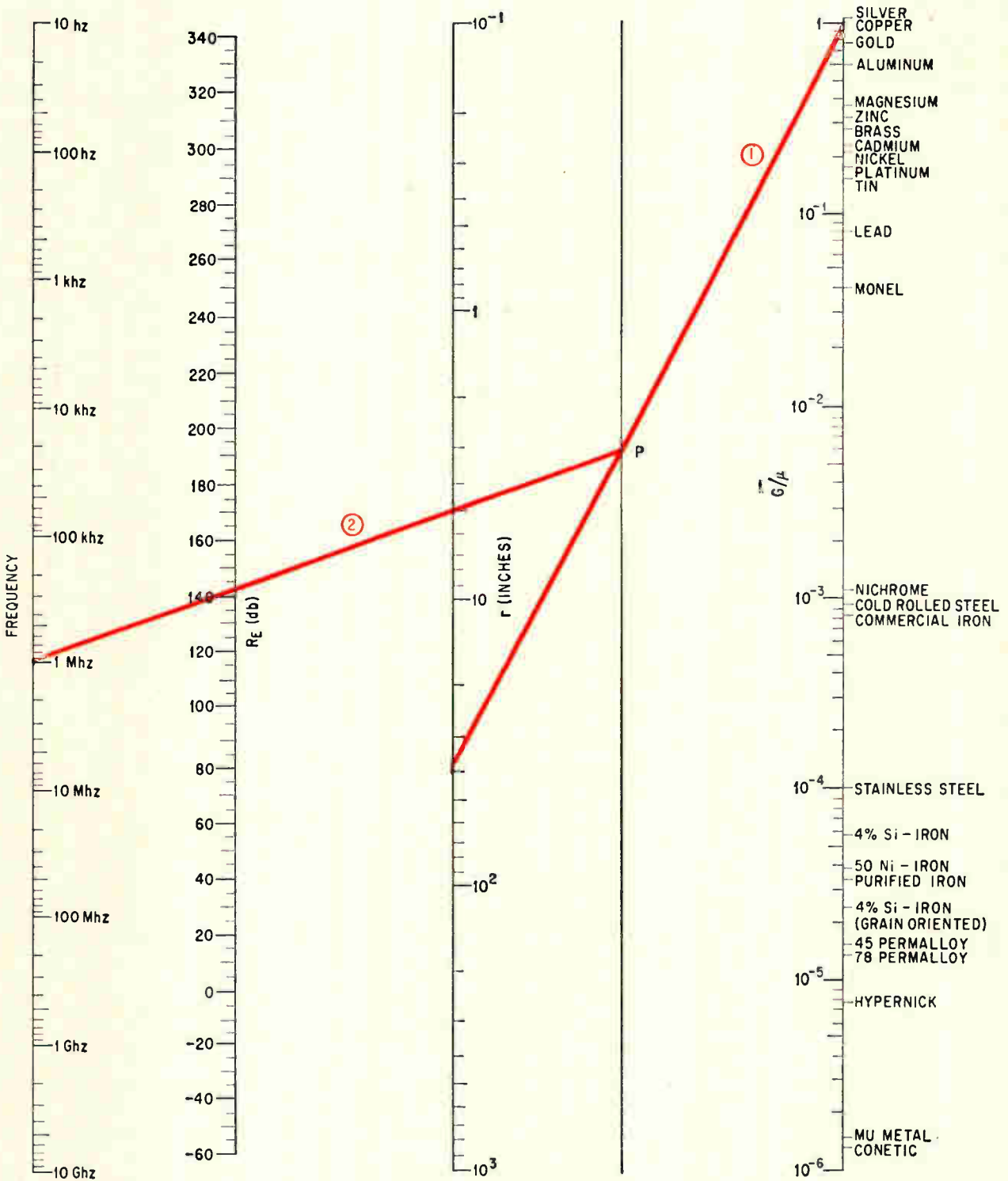

Electric field reflection loss is determined from this nomogram. The distance from the source, r , is 40 inches and the material is copper. Line 1 is drawn through these points intersecting the unmarked scale at P. Line 2 through P and the frequency (1 Mhz) intersects R_E at 142 db. Negative values of R_E indicate increased coupling that can occur at certain combinations of parameters.

Properties of magnetic and electric fields

In any simple a-c circuit there is an electric field vector associated with the voltage and a magnetic field vector associated with the current. These field components can interfere with nearby circuits which then must be shielded to prevent trouble.

When the field varies with time, the electric and magnetic components exist simultaneously, although one of the field components can be stronger than the other. If most of the energy is stored in the electric component, the field is referred to as an electric field. If most of the energy is stored in the magnetic component, the field is magnetic.

In general a field that is predominantly magnetic or electric will occur close to the generating source—within one wavelength. For fre-

quencies up to about 1,000 Mhz, a wavelength is a relatively large distance and such fields will cut across many circuits. For example, at 1 gigahertz a wavelength is 1 foot long; at 1 megahertz a wavelength is about 950 feet long. As a consequence many shielding problems involve predominantly electric or magnetic fields.

At a distance of about six wavelengths from a simple radiating source, the field may propagate as a plane wave, in which the field energy is divided equally between the magnetic and electric components. A shield that is effective for either magnetic or electric fields is also usually effective for plane-wave fields.

A useful quantity in any discussion of field theory is the characteristic impedance—defined as

the ratio of the electric to the magnetic field components. For a plane wave in free space the characteristic impedance is 377 ohms. For a predominantly electric field the characteristic impedance is greater than 377 ohms and the field is said to be a high impedance field. A magnetic field has an impedance that is less than 377 ohms, and is said to be a low impedance field.

Strong magnetic fields are associated with circuits characterized by low impedance, high current flow, and small voltage drops. A low-impedance magnetic field transfers energy readily to a surface or circuit with low impedance.

High intensity electric fields are produced by conductors with large series impedance, high voltages, and little current flow. Such fields couple energy most readily into a high impedance conductor or surface.

indicates that the shielding theory is valid even at extremely low frequencies.⁴ The nomograms indicate maximum values of R_E , R_H , R_P , and A .

Reflection losses

Reflections and associated losses, R , are caused by a difference in characteristic impedance between an incident field and the shield. This is analogous to the situation that occurs in a transmission line not terminated in its characteristic impedance. When the impedance of the incident field is much higher or lower than that of the shield, reflection losses are very high.

At all frequencies, electric fields are high impedance and magnetic fields are low impedance.

A shield's characteristic impedance varies with the frequency and the material's permeability and conductivity. Generally the impedance is low at low frequencies and high at high frequencies.

At low frequencies, magnetic reflection losses R_H , are small because there is a reasonably good match between the low impedance of the shield and the field. Thus most of the energy is coupled to the shield. For good shielding effectiveness, it is usually necessary to employ ferromagnetic materials with high absorption losses. As the frequency increases, the impedance mismatch becomes greater and R_H increases.

For low-frequency electrical fields, the mismatch between field and shield impedance is large and R_E is large. As the frequency increases, R_E decreases because the shield's impedance gradually increases.

R_H and R_E nomograms

The equation for reflection loss in an electric field is given by

$$R_E = 353.6 + 10 \log_{10} \left[\frac{G}{f^3 \mu r^2} \right]$$

For magnetic fields, the reflection loss is

$$R_H = 20 \log_{10} \left[\frac{0.462}{r} \left(\frac{\mu}{fG} \right)^{1/2} + 0.136 r \left(\frac{\mu}{fG} \right)^{-1/2} + 0.354 \right]$$

R_E and R_H are expressed in decibels. In these equations

r = distance in inches between the source of energy and the shield.

μ = material permeability relative to copper

G = material conductivity relative to copper

f = frequency in hertz

Both R_E and R_H can have negative values, which indicate enhanced coupling to the shield rather than reflection loss. Such increases in coupling have been observed experimentally and are caused by a resonance between shield and source. Dashed lines in the graph at right plot a negative value of R_H .

Similar procedures are followed for determining either R_E on page 93 or R_H at the right. For example, determine the electric field reflection loss at 1 Mhz caused by a copper shield 40 inches from a source.

- Locate a point on the G/μ scale corresponding to copper. If a desired metal is not listed, compute G/μ and plot on the numerical scale.

- Locate the distance between the energy source and the shield on the "r" scale ($r = 40$ inches).

- Place a straightedge between r and G/μ and locate point P on the blank scale.

- Place a straightedge between point P and the

Magnetic field reflection losses— R_H

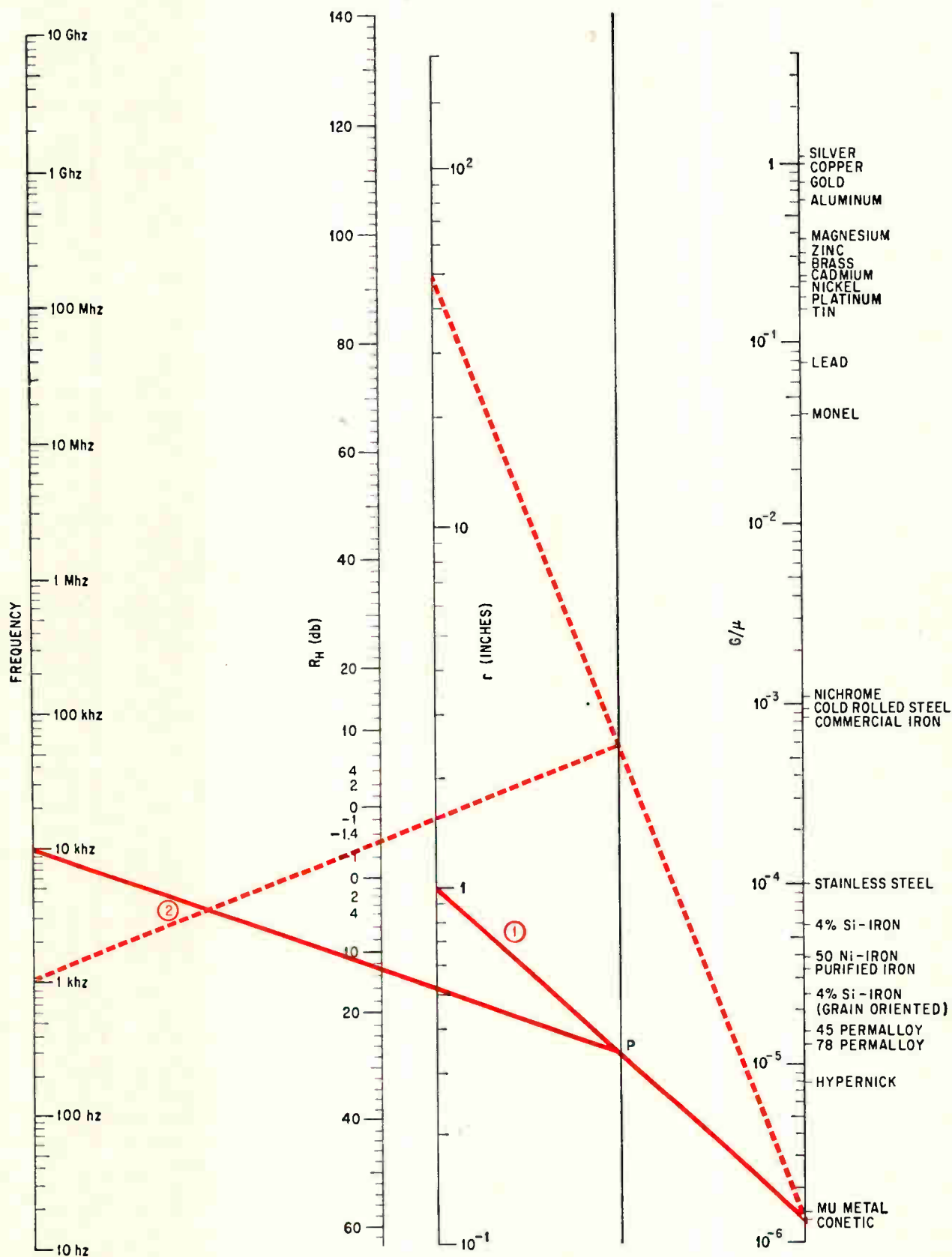

Magnetic field reflection loss, R_H , is calculated in the same way as the electric field loss. Solid line in color is for a Conetic shield located 1 inch from a source of magnetic field. Line 1 fixes point P on unmarked scale. This point and the frequency (10 kHz) fixes line 2 and the value of R_H —13 db. Broken line in color indicates that at certain distances and frequencies coupling to the shield is enhanced.

Plane-wave reflection losses— R_p

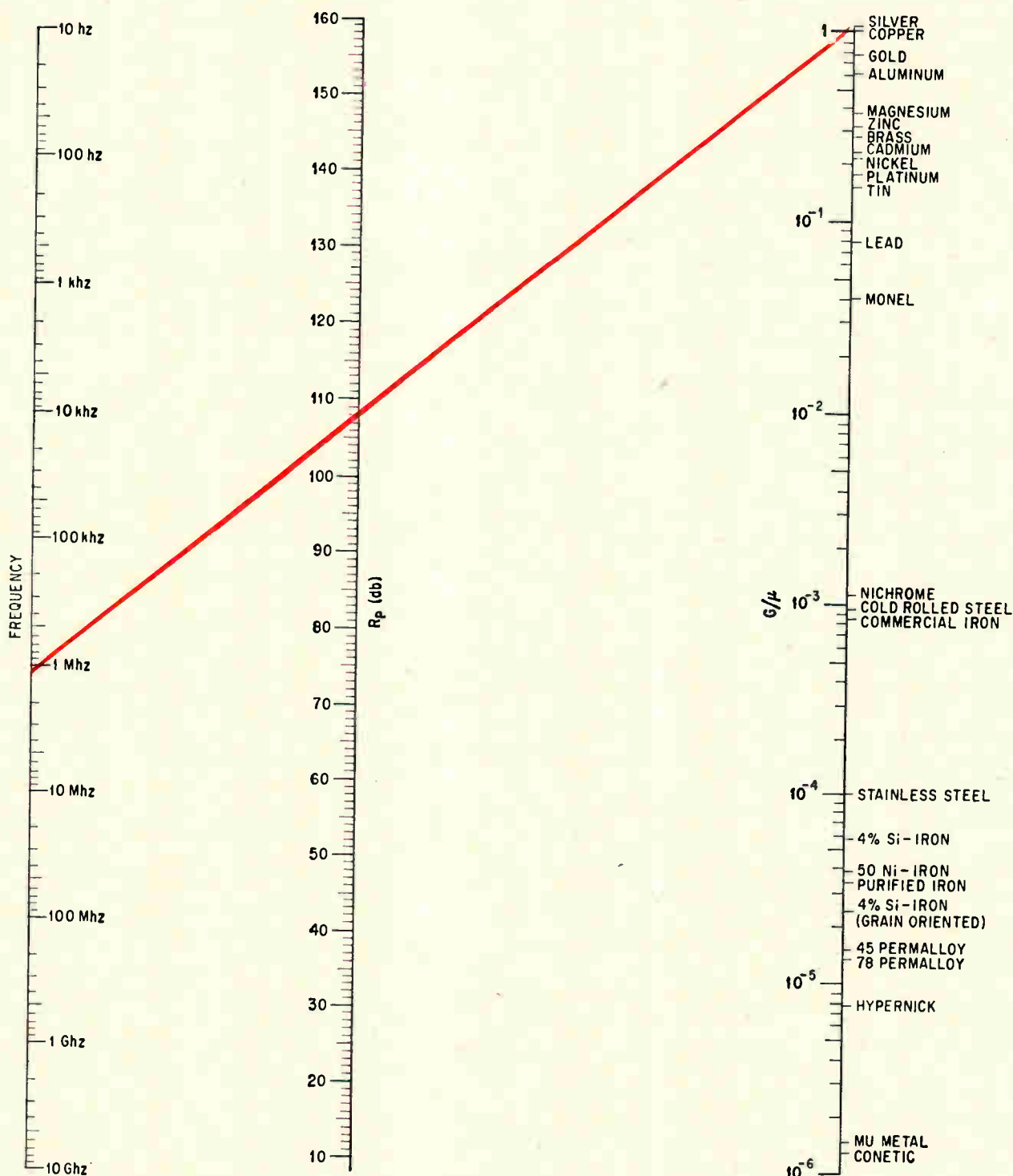

Plane-wave reflection losses R_p are calculated easily by a line connecting the frequency with the appropriate value of G/μ . A plane wave will exist only if the source is located at least five or six wave lengths from the circuit that is to be shielded. An enclosure designed for magnetic and electric fields will also be effective for plane-wave fields.

desired frequency on the f scale ($f = 1$ Mhz in this example).

▪ Read the reflection loss from the R_E or R_H scale. (In the example, the loss, R_E , is 142 db.) By pivoting the straightedge on point P, R_E or R_H as a function of frequency can be determined.

Plane-wave reflection losses

The nomogram for plane-wave losses should be used when the source of radiation is located more than 5 or 6 wavelengths away from the shield. The distance requirement is for simple antennas that have gains equal to or less than a dipole.

The equation for reflection losses in decibels for a plane wave impinging on a metallic shield is

$$R_P = 168.2 + 10 \log_{10} \left(\frac{G}{\mu f} \right)$$

To use the nomogram on above/below, the procedure is as follows:

- Locate a point on the G/μ scale corresponding to one of the listed metals.
- Place a straightedge between the G/μ scale and the desired frequency.
- Read the plane-wave reflection losses from the R_P scale.

Absorption losses

Absorption losses, caused by attenuation through the material, are given by

$$A \text{ (db)} = 3.38 \times 10^{-3} t (\mu G f)^{1/2}$$

where t is the metal thickness in mils (10^{-3} inches). For a given thickness, magnetic materials like steel have higher absorption losses than nonmagnetic materials like copper. Therefore, relatively thick, high-permeability materials are needed to increase the absorption loss for good shielding.

As an example of applying the absorption loss nomogram on page 98, assume that it is necessary to determine the thickness of metal needed to give a 10-db absorption loss at 100 kilohertz. The steps are as follows:

- Locate the frequency (100 khz) on the frequency scale and the desired absorption loss (10 db) on the A scale.
- Using a straightedge, extend a line through these two points until it intersects the unmarked scale at point P.
- Draw a line connecting the desired metal on the $G\mu$ scale and point P and extend it to the left, to intersect the t scale. By pivoting the straightedge around point P, thicknesses for a number of metals can be rapidly determined. In this example t is 9.2 mils for copper and 5.2 mils for commercial iron. In the reverse process, the nomogram yields the absorption loss if the frequency, type of material, and thickness are known.

Frequency dependence

Good shielding against electric fields is possible at low frequencies because reflection losses, R_E , are inherently high even though absorption

R_E for copper 40 inches from source

Frequency	R_E (db)	Re-quired A (db)	Re-quired t (mils)	A (db) for $t=1.2$	$S_E = A + R_E$ (db)
1.5 khz	227	0		0.15	227.0
100 khz	172	0		1.3	173.3
1 Mhz	142	0		4.0	146.0
10 Mhz	112	10	1.0	13.0	125.0
100 Mhz	83	37	1.2	40.0	123.0
1,000 Mhz	52	68	0.62	130.0	182.0

losses, A , are small. In fact since most of the incident energy is reflected, the absorption loss can be neglected at low frequencies.

In contrast, at high frequencies, electric fields undergo small reflection losses but large absorption losses. Thus, even though most of the transmitted energy is coupled to the shield, effective shielding is still possible. In shielding against high-frequency electric fields, the main problem is to maintain high absorption by eliminating all nonconductive openings in the shield. This prevents leakage currents from flowing on the supposedly shielded side of the metal surface.

For magnetic fields, both the absorption losses and reflection losses R_H are small at low frequencies. As with electric fields, eliminating all nonconductive openings in the shield maintains the benefit of high absorption losses. At higher frequencies, both R_H and A become very large and shields perform very well.

Selecting a shield

Generally the amount of attenuation required is known, and it is desired to determine the material and the material thickness. In some applications, it may be necessary to find a number of materials that will give the desired shielding effectiveness, and the final choice is based on other factors such

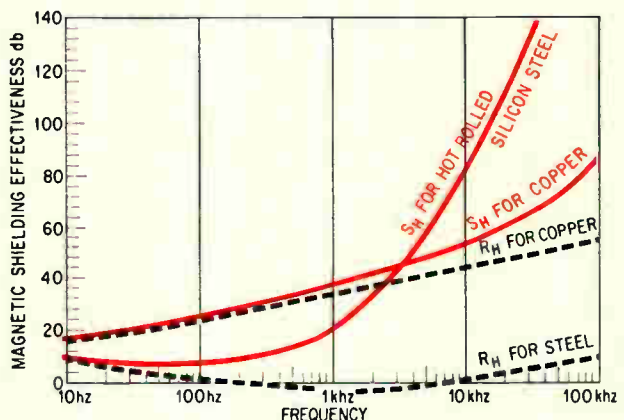

Magnetic shielding is plotted for copper and hot rolled silicon steel 15 inches from source of interference. Broken lines are reflection losses; solid lines in color plot sum of absorption and reflection losses.

Absorption losses-A

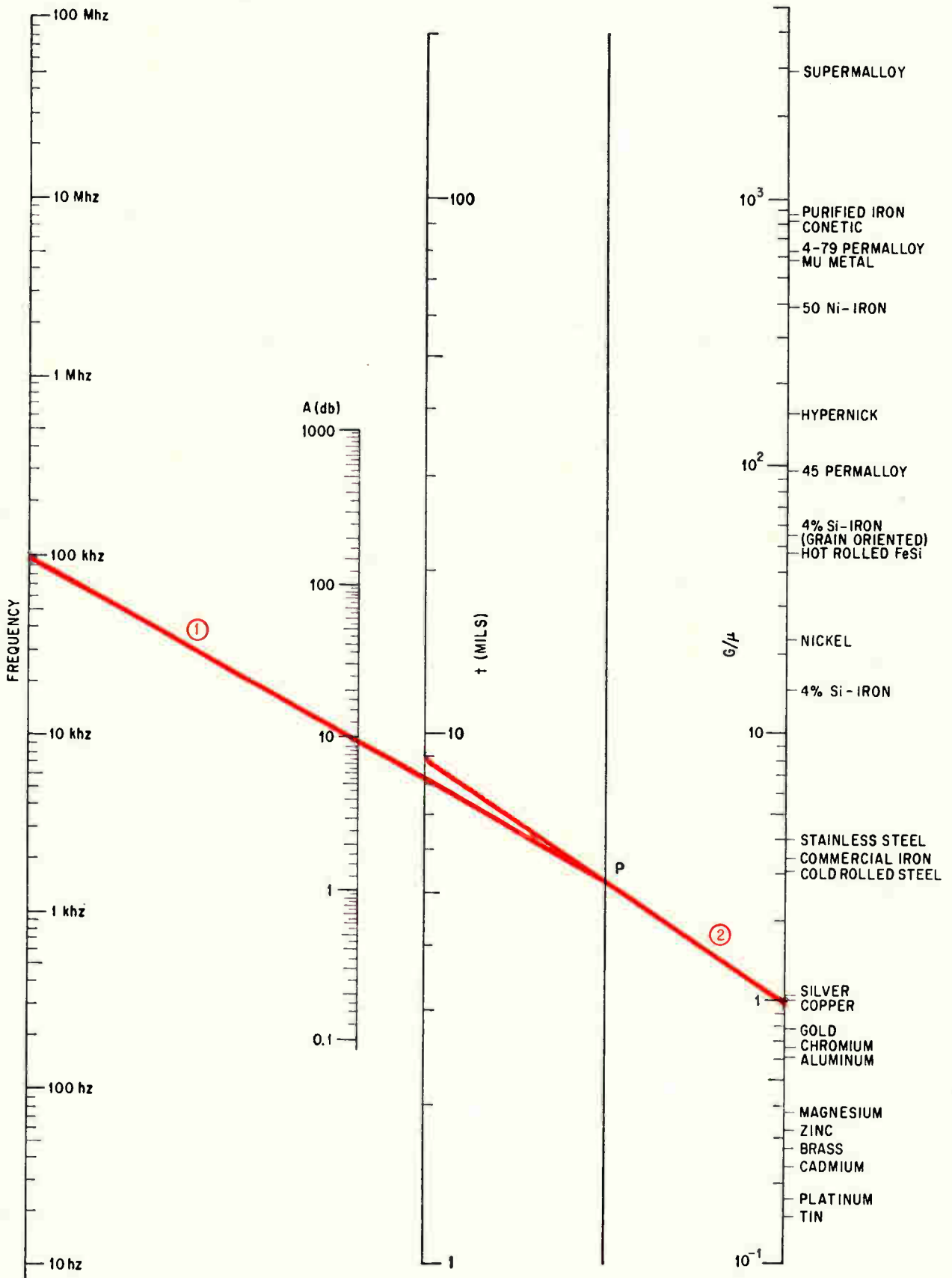

This graph selects material or material thickness for a specified absorption loss. The lines in color are plots for an absorption loss of 10 db at 100 khz. Line 1 intersects the unmarked scale at P. This new point and the material (copper) fixes line 2 and determines the thickness, 9.2 mils.

Magnetic shielding for materials 1 inch from source

Frequency	Copper			Commercial iron			Purified iron			Conectic			4% silicon-iron		
	R _{II} (db)	A (db)	t (mils)	R _{II} (db)	A (db)	t (mils)	R _{II} (db)	A (db)	t (mils)	R _{II} (db)	A (db)	t (mils)	R _{II} (db)	A (db)	t (mils)
1 khz	13	67	>1,000	0	80	300	10	70	22	22	58	21	11	69	90
10 khz	22	58	160	-1	81	120	3	7	8.5	13	67	7.5	4	76	32
100 khz	32	48	45	4	76	<120	-1.4	82	3	5.5	74.5	2.6	-1	81	11
1 Mhz	42	38	12	12	68	<120	2	78	3	-1	81	<1	1	79	<11
100 Mhz	62	18	1	32	48	<120	18	62	<3	6	74	<1	17	63	<11
10 Ghz	82	10	1	52	28	<120	38	42	<3	24	56	<1	36	44	<11

as weight, strength, and cost.

The following example outlines a typical procedure for selecting a material. Assume that a sensitive circuit, highly susceptible to electric fields, is located near a high-voltage terminal. An enclosure located 40 inches from the terminal must provide 140 db of shielding at 1.5 khz and 120 db at all other frequencies between 1 khz and 2 gigahertz.

From the nomogram for R_E and with r = 40 inches, determine R_E as a function of frequency for copper, and list the values as in the table on page 97. The shielding at 1.5 khz is already greater than the 140 db desired. However, since R_E falls off with frequency, the thickness required is one that provides sufficient absorption loss to bring the shielding effectiveness up to 120 db at the higher frequencies. Values of A are computed from A = 120 - R_E and are listed in the required A column. With these values of A determine the thickness t from the absorption loss nomogram.

The highest value of t—1.2 mils—maintains the level of shielding at 120 db. To determine the actual shielding effectiveness, values of A are computed using this thickness. The effectiveness against an electric field, S_E, for this thickness is indicated in the last column of the table.

The above example results in an extremely thin shield that is not mechanically self-supporting. For mechanical strength, the actual design would need either a much greater thickness of copper or some other material.

As another example, consider the design of a magnetic shield that is one inch from a source. Shielding effectiveness must be greater than 80 db from 1 khz to 10 Ghz. The table above lists values of magnetic reflection loss R_{II}, required A and required t for various materials. Again the largest value of t in each column determines the thickness of the material.

Copper—and typically all nonferrous material—would be over 1 inch thick to produce 80 db of shielding. Commercial iron is inexpensive, but requires a 300 mil thickness and would be very heavy. Purified iron—22 mils thick—would have sufficient strength, reduce weight, and be economical. The more expensive Conectic and 4%

grain oriented silicon-iron appear to offer no advantages.

Careful does it

No material should be ruled out in a given application. In some situations copper is a better magnetic shield than some ferrous materials. This is particularly true at very low frequencies where R_{II} for copper is high.

In the case of a shield located 15 inches from a high-intensity magnetic source, copper 30 mils thick is more effective than 30 mils of hot rolled silicon steel at all frequencies below approximately 3 khz as indicated by the lines in color in the graph on page 97.

Selecting a material is only part of the problem in designing a shielded enclosure. In practice, gaps appear in the metal. These are openings for components mounted on the enclosure or seams between metal plates. Low- or high-frequency energy leaking past these discontinuities may seriously degrade the shielding effectiveness.

Although careful design overcomes many of the difficulties resulting from these breaks in the surface, no one has completely solved this portion of the shielding problem.²⁻⁵ In some applications a simple test fixture can be used to evaluate materials such as gaskets or plates with holes.

For more complicated structures, an r-f signal can be fed directly into an enclosure to determine its shielding effectiveness. An antenna-receiver system outside the unit can measure the signal that leaks out.

References

1. S.A. Schelkunoff, "Electromagnetic Waves," the D. Van Nostrand Co., 1943.
2. C.S. Vaska, "Problems in shielding electrical and electronic equipments," U.S. Naval Air Development Center Report NADC-EL-N5507, June 8, 1955.
3. H. Dinger and J. Raudenbush, "A technique for measuring the effectiveness of various shielding materials," Naval Research Laboratory Report 4103, Jan. 22, 1953.
4. R.B. Schulz, "EIF and VLF shielding effectiveness of high permeability materials," the Boeing Co., Renton, Wash., 1965.
5. W. Jarva, "Shielding efficiency calculation methods for screening, waveguide ventilation panels, and other perforated electromagnetic shields," 7th Conference on Radio Interference Reduction and Electromagnetic Compatibility, November 1961, p. 478.

Are you sure you can't afford Heinemann circuit breakers?

Here's one you can have for just \$4.05.

We really are trying to meet you half-way. We've gone to a lot of trouble to produce a breaker which would lower the price barrier without lowering our standards.

The result is our little Series JA breaker. It has all of the advantages inherent in hydraulic-magnetic operation, all of the features of our larger, more expensive models.

But it's priced to make new friends out of passing acquaintances.

In quantities of just six to twenty-five, OEM's can buy this breaker for a nickel more than four dollars. And of course, as the quantity goes up, the price goes down even lower.

The JA is our idea of meeting you half-way. If you'd like to learn more about it, or any of our other breakers, drop us a line. We'll be happy to send you more complete information.

Heinemann Electric Co., 2600 Brunswick Pike,
Trenton, N. J. 08602.

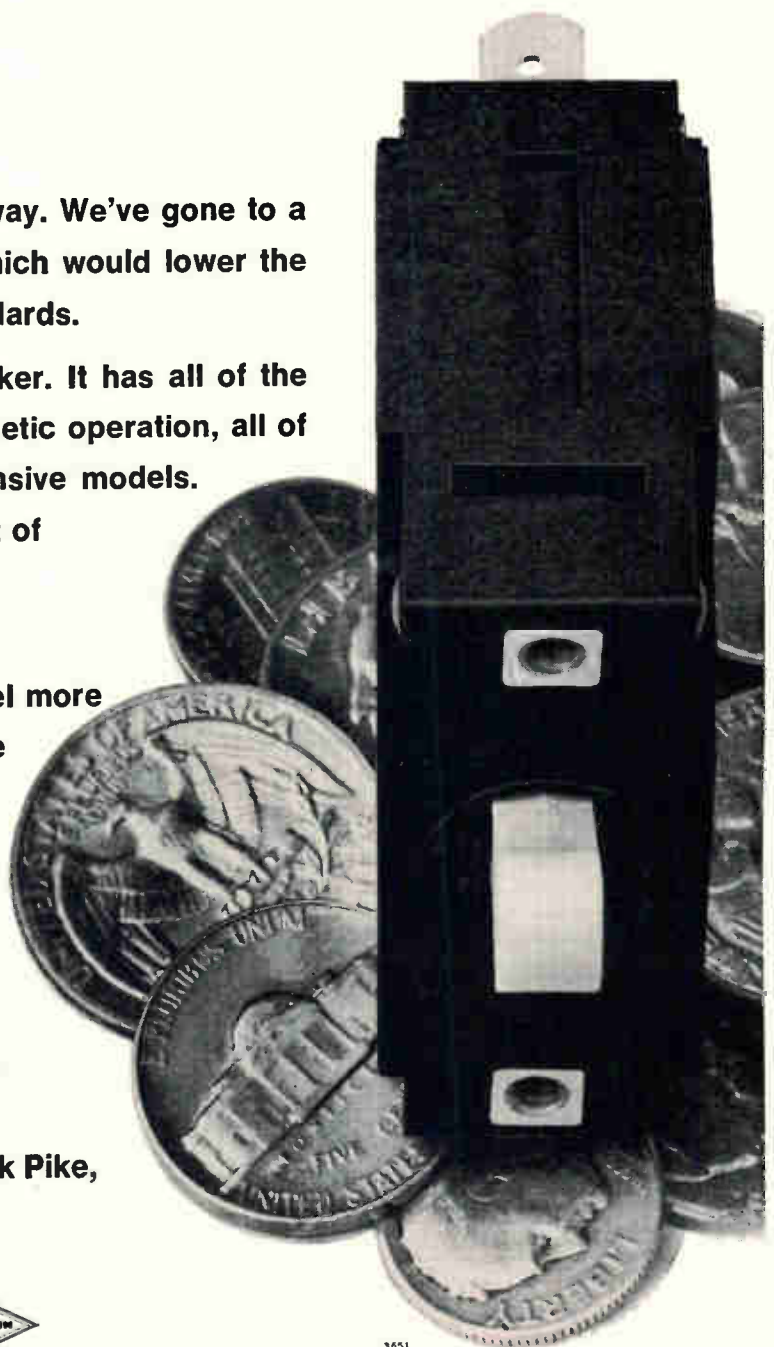

HEINEMANN



3051

Plastics for packaging: handle with care

Tests have traced some device degradation to impurities stemming from the plastics or the packaging process. Caution is required, therefore, in cases where high reliability and long life are demanded

By J.J. Licari and G.V. Browning*

Autonetics Division, North American Aviation Inc., Anaheim, Calif.

While transistor and integrated-circuit manufacturers and users are generally sold on the use of plastics to package devices for commercial applications, some doubt lingers about the reliability of plastics in military and space applications.

Traditionally, plastics have been used to encapsulate or pot electronic assemblies in which the active devices have first been hermetically sealed in protective casings. But the trend now is to apply plastic covering directly to active device chips that are highly sensitive to moisture, contaminants, or stresses.

Unquestionably, some impurities inherent in the plastics or resulting from plastic processing steps degrade the chips. The appeal of the plastic-pack-

aged transistors and integrated circuits currently on the market lies chiefly in their low cost, though sometimes they've been selected because they resist shock and vibration better than their sealed-can counterparts.

The reliability of plastic-cased devices, it should be emphasized, isn't a function of the plastic alone, but also depends on the nature of the device being packaged and on the quality of its passivation layer.

Among the possible drawbacks related to the plastics themselves are permeabilities with respect to moisture and contaminants, dimensional instability that can cause stresses on encapsulated leads, and impurities.

Minuteman II studies

Signs of potential trouble with plastic packages appeared when transistor surfaces were exposed to gases in physics-of-failure studies for the Minuteman II program.¹ Excerpts from those studies are tabulated on page 102. The table shows how reverse leakage characteristics were affected by contaminants such as benzene and carbon dioxide; contaminants have been detected in device packages by gas chromatography, and their presence has been partially correlated with device performance.

One might guess that other organic solvents structurally analogous to benzene, such as toluene or xylene—also used in the synthesis or processing of plastics—may also be entrapped in device packages during processing. Separate studies indicate that small amounts of ammonia gas and organic amines affect parameters such as reverse current.^{2,3}

In the Minuteman II studies, it was shown that with a microdiode packaged in an inner layer of silicone and an outer rigidizing layer of phenolic

*Now a reliability consultant specializing in physics-of-failure studies.

The authors



For six years J.J. Licari has had the responsibility for selecting materials used for the Minuteman programs, and more recently for the Apollo program. He holds a Ph.D from Princeton and supervises the organic chemistry section of the materials laboratory at the Research division of Autonetics.



G.V. Browning is a specialist in electronic materials and processes. He holds degrees in chemistry and physics. He earned his Ph.D at the University of Wisconsin, and was manager of the materials and processes laboratory at Autonetics.

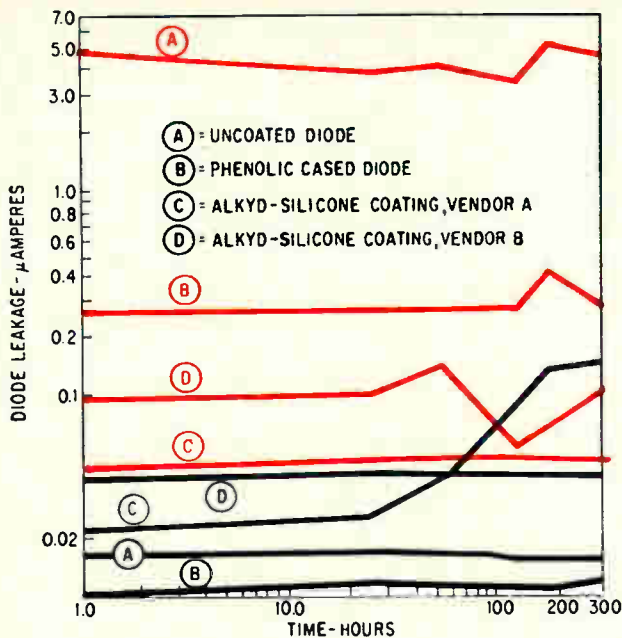

Leakage currents of microdiodes react under exposure to dry ammonia (curves in color). The curves in black represent the same devices in a dry nitrogen atmosphere.

plastic, ammonia could be generated by the degradation of the hexamethylenetetramine present in the outer layer as a curing agent.

The ammonia affected the reverse leakage characteristics of the semiconductor diode after it had permeated the inner silicone barrier coating, as shown in the curve directly above. This problem was solved by substituting a silicone molding compound for the phenolic; no ammonia is generated in curing the silicone.

Why leakage increases

Temperature-voltage inversion is the label often applied to the mechanism by which reverse leakage current increases. It is postulated that contaminants such as NH_4^+ ions on the surface are positioned in an orderly fashion in the region of a reverse-biased junction by the fringing electric field that extends through the oxide.⁴ This positioning is abetted by either high humidity or high temperature. The ordered ions attract oppositely charged carriers in the underlying semiconductor material, thus effectively inverting that region from its majority carrier status to that of a minority carrier layer. The inverted region provides a much greater junction area and thus increases the leakage current of the original junction. If the device is heated for a time at zero bias, the ions once again assume a random arrangement.

A second mechanism, space-charge buildup within an oxide layer, may also be susceptible to unwanted chemicals from plastics and may also degrade device performance. The sources of contamination relevant here are usually attributed to the device processing.

As an example, space-charge buildup resulting from the migration of ions under the influence of

an electrical field is thought to occur in the insulating oxide under the gate of an MOS device when potential is applied to the gate. It's easy to see how such a space charge could influence the performance of the MOS device, since it affects the electrical field the gate exerts in modulating the channel in the silicon under the gate oxide. Indeed, the space charge itself can act as a gate field when the external gate voltage is removed. No exact mechanism for this effect has yet been defined. It has been attributed variously to alkali ion, hydrogen ion, and oxygen vacancy migration.^{5, 6}

Permeability factor

The plastic package's permeability is perhaps its most important characteristic. Impurities exert their influence as a function of this permeability whether they are gases and vapors outside the package or chemicals generated internally. The permeability of typical plastic coatings with respect to moisture is tabulated on the opposite page. Note that cellophane, cellulose acetate, and Neoprene are included in the table for comparison purposes. It is unlikely that any of these materials would be used in packaging devices. Coatings most likely to be used are epoxy-anhydride, epoxy-aromatic amine, silicone-alkyd, with or without microdiode coating, polytetrafluoroethylene (PTFE), PTFE dispersion coat, fluorinated ethylene propylene (FEP), polyvinyl fluoride, polyvinylidene fluoride (Teslar), p-polyxylylene (Parylene C and N).

Another important factor is dimensional stability, since shrinkage can lead to induced stresses. Epoxy will decrease in volume during curing, for example, and other plastics will shrink when solvents evaporate. Unexpectedly large forces can result when plastics are solidified from a gel or colloidal state.

Reverse current leakage of dual pnp signal transistors shifts with gas ambient

Conditions	Leakage current, I_{CBO} (anoamps) @ 20 v reverse bias	
	Transistor A	Transistor B
Before vacuum bakeout	3.0	2.5
After exposure to benzene vapor and reverse bias on transistor A only	2,400	—
After exposure to water vapor and reverse bias on transistor A only	10,000	—
Vacuum bake at 300°C and no bias	2.5	2.5
Bias on transistor B in vacuum	2.5	3.0
After exposure to carbon dioxide and bias on transistor B only	3.0	650
Vacuum bake at 300°C	3.0	3.0

If it were feasible in all cases to remove the solvent at its critical temperature, there would be practically no effects from surface tension as the solvent was withdrawn.

Shrinkage stresses produced in a coating formed by solvent removal can be serious enough to fracture an integrated circuit's interconnection wires. In a typical example, several 0.7-mil-diameter wires with individual breaking strengths of several grams were broken in a single ic. The solvent in this case was removed by evaporation from a non-elastomeric silicone coating on the ic.

Typical test results

The varieties of plastic tested by the Autonetics division of the North American Aviation Inc. fall into four categories: epoxies, phenolics, silicones, and fluorocarbons.

In the case of the epoxies, a variety of chemical and ionic species can be formed during their degradation, as shown in the table on page 104. Carry-over and retention of many of these chemicals in the final cured plastic is highly probable. Yet only limited tests have been performed and there is no indication of which impurities are critical to device performance, or of what the threshold levels of impurities are.

Emission spectrographic analysis has been found to be a good technique for determining kinds and relative amounts of metallic constituents down to 0.5 ppm (based on ash content). In tests, plastic samples were deposited and cured directly onto the graphite electrodes, since it was previously determined that curing in glass or aluminum dishes introduces additional impurities from these receptacles. A large variety of metallic impurities were found in the samples tested (see table on page 105), especially in the case of epoxies and highly filled molded compounds. Other silicone coatings, and fluorocarbons such as Teflon, displayed a relatively low metallic content.

Many of these metallic impurities aren't inherent in the resin polymer itself. For example, silicones after synthesis are extremely pure materials. The impurities may be introduced in mixing or in formulating with fillers, or may stem from metal storage cans or drums.

Measuring ionic material

To detect and measure ionic material in plastics, samples of the plastics can be pulverized and then digested in distilled water at 160°F for eight days. The electrical conductivity of the water extracts is then measured.

Although there is uncertainty about the extent of hydrolysis that occurs during the digestion period, the results are useful as a relative indication of the amounts of ionic and ionizable species in the sample, as well as of the hydrolytic stability of the plastic under these conditions. Of the materials tested, the epoxies and phenolics had rather low resistivity values, as shown on page 106. This isn't surprising considering the types of probable

Moisture resistance of plastic coatings

Plastic coating	MVTR*	Source
Epoxy-anhydride	2.38	Autonetics data
Epoxy-aromatic amine	1.79	Autonetics data
Neoprene	15.5	Baer (Ref. 11) (39° C)
Polyurethane (Magna X-500)	2.4	Autonetics data
Polyurethane (isocyanate-polyester)	8.72	Autonetics data
Silicone-alkyd	6.13	Autonetics data
Silicone-alkyde (microdiode coating)	7.9	Autonetics data
Olefane, polpropylene	0.70	Avisoun data
Cellophane (type PVD uncoated film)	134	du Pont
Cellulose acetate (film)	219	du Pont
Polycarbonate	10	FMC data
Mylar	1.9	Baer (39° C)
Polystyrene	1.8	du Pont data
	8.6	Baer (39° C)
Polyethylene film	9.0	Dow data
	0.97	Dow data (1 mil film)
Saran resin (F120)	0.97 to	Baer (39° C)
	0.45	
Polyvinylidene chloride	0.15	Dow data (1 mil film)
Acrylonitrile co-polymer		
Polytetrafluorethylene (PTFE)	0.32	Baer (2 mil sample 40° C)
PTFE, dispersion cast	0.2	du Pont data
Fluorinated ethylene propylene (FEP)	0.46	Baer (40° C)
Polyvinyl fluoride	2.97	Baer (40° C)
Polyvinylidene fluoride (Teslar)	2.7	du Pont data
p-polyxylyene (parylene N)	14	Union Carbide data (2 mil sample)
p-polyxylyene (parylene C)	1	Union Carbide data (2 mil sample)

* (Moisture vapor transmission rates in grams/mil/100 sq. in. in 24 hours)

contaminants and the emission spectrographic results. The silicone and fluorocarbon extracts, on the other hand, had comparatively low conductivities.

It has also been demonstrated (curves, p. 105) that the deviation from stoichiometry of the epoxy system affects the water extract conductivity. By stoichiometry is meant the exact proportions in which the resin and hardener will combine according to molecular equations.

Electrical effects

In one experiment, plastic coatings were applied to bare microdiodes. To study surface inversion, the diodes were then reverse biased at elevated temperatures. Because of the high insulation resistance values for most plastics (see graph on page 105), ohmic leakage through the plastic coating was assumed to be negligible compared to the reverse conduction current exhibited by the device. With some plastics, however, such as the cast epoxy

Contaminants originating in epoxy plastics

Ingredient	Types	Synthesis ingredients	Potential contaminant
Epoxy resin	Epon 828 815 (etc)	Epichlorohydrin Dichlorohydrin Allylchloride Propylene NaOH Bisphenol-A Acetone Benzene HCl or HBr catalysts Phenol Sodium orthosilicate	Cl ⁻ HO Cl Na ⁺ , OH ⁻ —C ₆ H ₄ —OH, Na ⁺ , OH ⁻ (CH ₃) ₂ C=O C ₆ H ₆ H ⁺ , Cl ⁻ , H ⁺ , Br ⁻ C ₆ H ₅ O ⁻ , H ⁺ CO ₂ H ₂ O, Na ⁺ , CO ₃ =Na ⁺ SiO ₄ ⁻⁴
Curing agents	Ethylene diamine Diethylene triamine Polyamides (Versamids) Acid anhydrides	Dichloro-ethylene NH ₃ Polymerized vegetable Oil acids Polyalkylene amines Polyalkylene chlorides Carboxylic acids	NH ₄ ⁺ , Cl ⁻ NH ₃ RCOO ⁻ , H ⁺ Cl ⁻ R(COO ⁻ , H ⁺) ₂
Fillers	Alumina Cabosil Silica	— —	Al ⁺³ Si ⁺⁴ Trace metal ions
Pigments	Titania Carbon blacks Calcium carbonate	— — —	Ti ⁺⁴ C Ca ⁺² , CO ₃ =
Solvents	Ketones Esters Ethers Halogenated hydrocarbons Toluene Xylene Alcohols Cellosolves	— — — — — — — —	(R) ₂ C=O R COO ⁻ , H ⁺ , RO-H ⁺¹ ROR Cl ⁻ C ₆ H ₅ CH ₃ C ₆ H ₄ (CH ₃) ₂ ROH
Flow control agents	Beetle resins SR-82 Butvar	Urea Silicone Polyvinyl butyral	NH ₄ ⁺ , NH ₃ , CO ₂ H ₂ O, CO ₃ =H ⁺
Fire retardants	Antimony trioxide Arochlors Brominated or chlorinated resins	— Chlorinated polyphenyls	Sb ⁺³ Cl ⁻ Br ⁻ , Cl ⁻

This table should not be construed as a complete list of ingredients and contaminants. Potential contaminants are those constituents inherent in the material or, under some conditions of temperature, hydrolysis, or other stress, derivable from the material. Unreacted or excess synthesis ingredients due to nonstoichiometry may also act as contaminants. A listing of fillers and reinforcements is given in reference 9; solvent and solvent combinations commonly used with epoxies are given in reference 10.

listed in the graph, ohmic leakage could be a factor. Polyethylene is included in the graph for comparison purposes; it is not a candidate for packaging semiconductor devices.

In the diode experiments, technical-grade and specially purified epoxies (employing molecularly distilled reactant materials), epoxies with stoichiometric and nonstoichiometric ratios of resin to hardeners, and fluorocarbons (TFE and FEP Teflons) were applied to devices and cured according to vendors' recommendations. The devices were then subjected to 150°C heat for varying periods of time, with a reverse bias of 75 volts. After this, they were cooled to room temperature with the voltage removed. Changes in reverse current observed under these conditions are tabulated below.

Similar plastic-coated microdiodes were exposed to 95% relative humidity at 160°F with a 75-volt reverse bias. Typical values of reverse current measured after the diodes were removed from this atmosphere are shown on page 108.

The fluorocarbon-coated and silicone-coated diodes generally exhibited smaller changes in reverse current than did the epoxy-coated diodes. However, large changes in reverse current—from nanoamperes to microamperes—indicate that the commercial-grade epoxies tested contained sufficient amounts of ionic or other contaminants to affect the semiconductor. Also, the epoxies with nonstoichiometric resin-to-hardener ratios displayed high values of reverse current. One or more high values or electrical opens occurred in each category; the latter were probably due to stress or mechanical damage rather than to impurities.

In other studies,² microdiodes coated with phenolic material exhibited high I_R; both experimental results and theoretical considerations suggest the presence of large amounts of such impurities as ammonium ions. The table below shows that the reverse-current characteristic decreases after heating for a time without electrical bias, presum-

How temperature affects reverse current of plastic coated diodes

Coating systems	Initial reading I _R (na) @ 50v	I _R (na) @ 50v after 20 hours @ 150°C and 75v rev. bias	I _R (na) @ 50v after additional 20 hours @ 150°C no rev. bias
Epoxy, stoichiometric purified	10	548	14
Epoxy, nonstoichiometric purified	9	10 × 10 ³	10 × 10 ³
Epoxy, stoichiometric technical	12	237 × 10 ³	121 × 10 ³
Epoxy, nonstoichiometric technical	12	31 × 10 ³	14 × 10 ³
Fluorocarbon, resin, FEP Teflon	17	18	16

Spectrographic analysis of plastics

Sample	Condition	Metals detected	Relative amounts*
Epoxy, Epon 828	As received	Copper, aluminum, magnesium silicon, calcium	Traces
Epoxy, Epon 828	Still residue after molecular distillation	Silicon, Magnesium, aluminum, iron copper, chromium, calcium, manganese	Major
Epoxy, Epon 828	Distilled, light molecular weight fraction	Copper	Traces Trace
Silicone, Sylgard 182	Cured	Silicon,** Titanium, magnesium	Major Slight traces
Silicone coating, DC 644	Cured	Silicon Copper, magnesium	Major Slight traces
Silicone molding compound, DC-305	As received and molded	Zinc Silicon, chromium Lead, titanium, nickel, copper, manganese, aluminum and magnesium	Trace Major
Silicone gel coating, DC-51	Cured	Iron, cobalt Silicon	Traces Minor Major
Phenolic molding compound	As received	Calcium Magnesium Iron, silicon, sodium Copper, manganese, aluminum	Major Minor Traces Slight traces
Teflon, TFE Teflon, FEP Teflon, TFE Teflon, FEP Kynar	Dispersion coating, fused Dispersion coating, fused Molded solid Molded solid Dispersion coating, fused	Copper, magnesium Copper, titanium, magnesium Titanium Copper, titanium, magnesium Titanium, copper, magnesium	Slight traces Slight traces Slight trace Slight traces Slight traces

* Major, 5% or more; Minor, 0.10 to 5%; Trace, 0.01 to 0.10%; Slight trace, 0.0001 to 0.01% (percentages are by weight of ash).
** Silicon is a structural constituent of silicones and should not be considered an impurity.

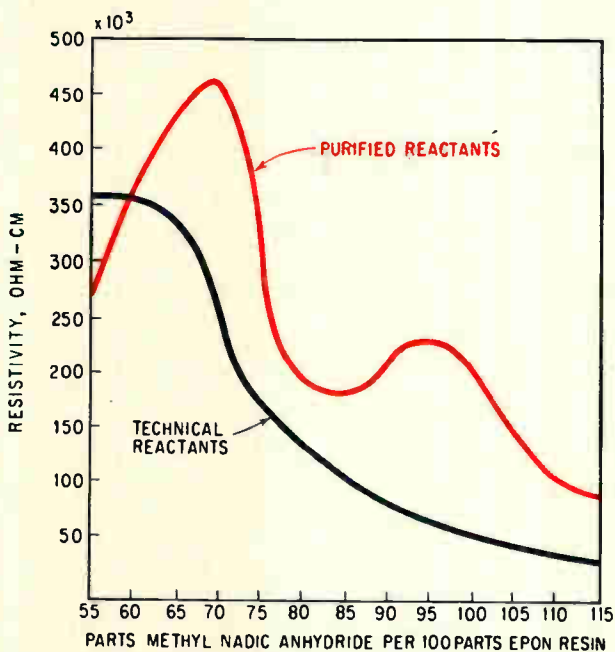

The ratio of hardener to resin affects the volume resistivity of the plastic encapsulant. Technical reactants are commercial-grade chemicals; purified reactants are those that have been further purified to remove contaminants.

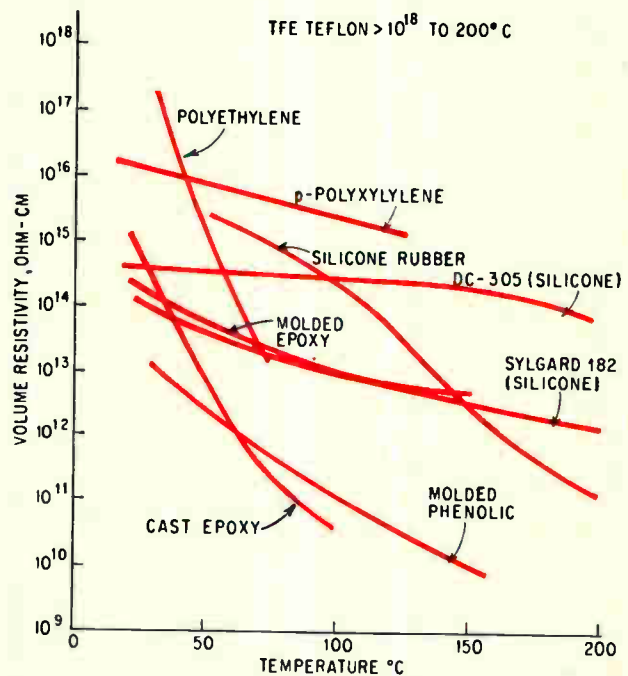

Volume resistivity of plastic coatings varies with the type of plastic. It decreases with rises in temperature. Molded epoxy gave results similar to the Sylgard 182, and resistivities for a molded phenolic sample ranged from 10¹⁰ to 10¹⁰ ohm-cm.

Water extract resistivities

Material	Average resistivity (ohm-cm) × 10 ³
Epoxy-anhydride-epoxy coating.....	9.0
Epoxy molding compound.....	107
Phenolic molding compound.....	4.7
Alkyd-silicone coating (DC 1400).....	11.5
Alkyd-silicone coating, Vendor A.....	14.7
Alkyd-silicone coating, Vendor B.....	65
Methyl-phenyl silicone coating.....	270
Silicone molding compound (DC 305).....	155
Silicone molding compound (DC 304).....	290
Silicone (Sylgard 182).....	195
Silicone coating A.....	60
Silicone coating B.....	180
Silicone coating C.....	190
Silicone gel coating, DC-51.....	360
TFE, Teflon, dispersion coating.....	93
TFE, Teflon, molded solid.....	350
FEP, Teflon, dispersion coating.....	177
FEP, Teflon, molded solid.....	198
Kynar, dispersion coating.....	212
Kynar, solid.....	335
Distilled water (control).....	732

ably because ordered ions on the surface are moving to a more random state.

The excellent results with fluorocarbons may be attributed to these plastics' inherently inert, stable, and symmetrical structure. In fact, TFE and FEP Teflons are unique among plastics in their purity, thermal and oxidative stability (up to 500-600 F), chemical inertness, low rate of moisture permeability, and electrical stability.⁹ Teflon essentially has a zero temperature coefficient of resistance to temperatures above 200°C, in contrast to the high negative values of most plastics.

MOS studies

Discrete metal oxide semiconductor devices and MOS integrated circuits containing a number of functional MOS elements have been plastic-coated and tested to evaluate the space-charge mechanism described on page 102. Dual MOS transistors without diode-protected gates or surface passivation were mounted in TO-5 cans without lids and were coated with a variety of silicones. Among the parameters measured were those identified in the table on the opposite page as "failure indicators."

When attempts were made to apply Teflon plastics to MOS devices, the high temperatures—500°F to 700°F—needed to fuse the fluorocarbon particles raised havoc. Interconnection-bond failures were probably caused by purple plague or, more generally speaking, by the formation of brittle gold-aluminum intermetallics due largely to the heat.

Plastic semiconductors: like glued-together automobiles?

Caution urged by users such as Autonetics is shared by some device manufacturers; others back their confidence in plastic with guarantees to meet military specifications

The trend to nonhermetically sealed device packages seems irreversible—even for highest-reliability military and aerospace applications.

Last month, both the Signetics Corp. and Motorola Inc. announced that they have accumulated sufficient data to guarantee their dual in-line plastic-packaged integrated circuits over the full military temperature range, -55°C to +125°C. In this regard they join Texas Instruments Incorporated, who as long ago as last August was extrapolating the results of 2 million hours of transistor testing to suggest that plastic-covered IC's could meet the military specification.

Today, says TI's manager of IC quality control, James Adams, "we are getting many requests for plastic IC's over the full military temperature range."

Negative vote. Tending to agree

with those equipment manufacturers who remain skeptical of the reliability of plastic packages in unlimited applications, Fairchild Semiconductor, a division of the Fairchild Camera & Instrument Corp., files a dissenting opinion among vendors. Says Fairchild's quality control manager, Bryant Rogers, "We only build plastic packages for certain markets—primarily industrial and consumer."

Rogers acknowledges that competitors have published some impressive test results on the performance of plastic-packaged IC's. "The trouble lies," he says, "in correlating those figures with conventional tests. Hermeticity gives a figure of merit for the predictable life of IC's, but you can't test for hermeticity where there is no void. Tests of the plastic package have a different criterion, which you can't yet correlate with the old."

The new tests performed by plastic-device manufacturers may be valid, concedes Rogers, but they are different. "Suppose someone marketed an automobile that was put together with Elmer's glue, and published data to show that it was as good as a welded car. You might believe the data—but would you buy the car?"

For Fairchild, the question of plastics is in some respects moot, since it is banking on a flip-chip dual in-line package [Electronics, Mar. 6, p. 153] to reduce costs. Plastics cost just as much as ceramic, Fairchild insists. "The flip-chip ushers in a new era of reliability," says Rogers, "which will exploit automatic assembly techniques to cut costs."

Inner sanctum. New methods of passivating the semiconductor chip, such as the silicon-nitride approach pursued by Bell Telephone Laboratories and others, may be fore-runners of techniques that will get to the heart of the device and make the purity of additional protective coatings not at all critical.

What vendors claim for today's devices depends partially on the

Test results for silicone-coated MOS transistors*

Coating	Sample size	Number of failures		Failure indicator	
		After 77 hours	Additional after 1000 hours	After 77 hours	After 1000 hours
Controls (uncoated canned)	10	none	none	—	—
Coated, Silicone A	7	2	1	$V_{(th) GS}$ 2 failures BV_{DSS} 2 failures I_{DSS} 2 failures	$V_{(th) GS}$ 1 failure BV_{DSS} 1 failure I_{DSS} 1 failure
Coated, Silicone B	13	none	2	—	$V_{(th) GS}$ 1 failure BV_{DSS} 2 failures I_{DSS} 2 failures
Coated, Silicone C	7	2	1	$V_{(th) GS}$ 1 failure BV_{DSS} 2 failures I_{DSS} 1 failure	$V_{(th) GS}$ 1 failure BV_{DSS} 1 failure I_{DSS} 1 failure
Coated,** Silicone dielectric gel	10	none	none	—	—

* Static tested 125°C, 150 milliwatts.

** Gel-coated devices were subjected to an additional 1,000 hours of temperature-power stresses to complete a total of 2,000 hours without in-test failures. Three in-test failures occurred among the controls toward the end of this second 1,000-hour period.

This wasn't a problem in the other tests where fluorocarbons were applied to diodes, because more thermally stable gold-silicon bonds were employed.

While test results indicated little initial reaction to the encapsulant, many silicone-coated devices operating in a static life test at 125°C with power applied failed at about 70 hours.

Notable exceptions were devices coated with a silicone dielectric gel (DC-51); in these cases, 20,000 socket hours were achieved without any in-test failures. Although some failures cropped up in the control units, none occurred with the units coated with DC-51. This can be attributed to the coating's high degree of purity, evidenced by low

kind of plastic used. The Signetics Corp.'s mil spec package is all silicone, but it is made in two layers. The company first tried an epoxy outer layer, but switched to the silicone because it provided better resistance to moisture and made a better thermal match with the initial silicone layer.

TI uses a single-material epoxy system that, like the Signetics package, is transfer molded. Motorola has a two-layer system but won't disclose the materials used.

RCA, after expressing some doubt about the need for plastic IC packages [Electronics, Sept. 5, 1966, p. 38], last month announced plans for IC's in silicone packages.

Bandwagon. Companies such as Sylvania Electric Products Inc., a subsidiary of the General Telephone & Electronics Corp., and the Transiron Electronic Corp., who have experience with discrete semiconductor components in plastic, plan to market plastic IC's.

Transiron envisions a May or June introduction of a line of epoxy-encapsulated IC's. Edward Shaut, the firm's IC product sales manager, says: "We aren't promoting them

for military use, but if they turn out the way we expect them to, they will be reliable enough for military equipment."

Sylvania, too, plans to put integrated circuits in epoxy packages. Roger Swanson, marketing manager for the company's semiconductor division, says: "Except for the extreme reliability required for missiles and some other aerospace uses, epoxy packages appear to be adequate for most semiconductor applications, and in fact are being designed into computer, industrial, and consumer gear."

Mufti or military? At least one vendor is surprised that aerospace equipment manufacturers would consider plastic. "If you're going to buy junk, you're going to get junk," he declares. "For military-grade equipment, you just don't use it."

But, TI's Adams feels such comments reflect the "emotion that was prevalent in 1961." There was some trouble with plastic packaging in the early 1960's, he says, "but great strides have been taken since then in both materials and methods."

Engineers at Autonetics plan to conduct physics-of-failure studies of plastic-packaged devices to explain anomalies observed in earlier tests, rather than to intensively study the purity and properties of the plastics. The plastics will, however, be categorized with respect to known or probable impurities and their concentrations.

Such information could be obtained from chemical analysis, manufacturing-process data, or estimates of rates of likely deterioration modes. Also useful, Autonetics notes, is information from degradation studies being carried out for space applications, such as data on plastics in an oxygen space-capsule atmosphere¹ and on radiation effects.² But Autonetics cautions that potentially harmful levels of impurities may not be detectable with present instruments.

References

1. W.D. English, "Man-Materials Interactions in Space Flight Systems," SAMPE Journal, June 1966.
2. R. Bolt and J. Carroll, "Radiation Effects on Organic Materials," Academic Press, 1963.

water-extract conductivity and the absence of metallic impurities in spectrographic analysis. Since the material is also very soft, it imparts little stress to devices in the curing process. Because of its softness, though, it requires the use of an auxiliary rigidizing plastic to complete the package.

Because such characteristics as dipoles in the molecule or the plastic's adhesion to the devices may contribute to the deterioration of electrical parameters, no one property in the other silicone

coatings can be confidently designated as the principal cause of failure. However, it's noteworthy that none of the other three silicone coatings tested exhibited the high purity and resistance to mechanical stress of the DC-51.

Recommendations

Preliminary tests of the interaction of epoxy, phenolic, silicone, and fluorocarbon plastics with semiconductor devices under various environments have indicated that contaminants inherent in or generated by the plastics can affect device performance. Therefore plastics must be classified with respect to contaminants in resins, hardeners, and formulation ingredients, and in terms of their probable effects on semiconductors.

To assess the effects of molecular polymer structure and polarity on semiconductor parameters, ultrapure polymer types will have to be prepared. The task requires new or refined ultramicroanalytical methods.

For the packaging of high-reliability, long-life military and space devices, a more fundamental understanding of plastics' characteristics and their effect on electrical parameters is necessary.

Epoxies or silicones may well be satisfactory for the outer rigidizing coating, which also provides an additional barrier to ambient moisture and contaminants. In this case, the inner barrier should probably be a high-purity flexible coating. However, until long-term exposure data is acquired on the transmission of impurities to the semiconductor through the flexible inner coating, caution should be employed in using such packages for high-reliability, long-life applications. The ideal, of course, would be an ultrapure material for both the surface coating and encapsulant.

However, the purity of the initial plastic layer may become less important as improvements are made in the integrity of the passivation layer and as more reliable passivation materials and techniques are developed.

References

1. J.J. Licari, S.M. Lee, and A.G. Valles, "Properties of Plastic Materials and How They Relate to Device Failure Mechanism," Physics of Failure in Electronics, Vol. 4, M. Goldberg and J. Vaccaro, Eds., RADC Series on Reliability, 1966.
2. G.A. Katsev, et al, "Effect of the Absorption of Certain Amines on the Semiconductor Surface on the Principal Parameters of Germanium Transistor Triodes," Surface Properties on Semiconductors, A.N. Frumkin, Ed., 1964.
3. Ibid., R.O. Litvinov and Hsu Tung-lian, "Effect of the Surface State in Silicon p-n Junction on the Reverse Currents and Drift."
4. Supp. Proc. of the Institute of Electrical Engineering, London, 1959.
5. J.E. Meinhard, "Hydrogen Isotope Investigation of Passivation Silicon Oxides," Journal of the Electromechanical Society, 112, 786, 1965.
6. J.E. Thomas and D.R. Young, IBM Journal of Research and Development, Sept. 1964, p. 368.
7. "Fluorocarbon Plastics," Materials in Design Engineering, Feb. 1964, pp. 93-104.
8. Engineering Design for Plastics, E. Baer, Ed., Reinhold Publishing Corp., 1964.
9. R.C. Hosford, "A Guide to Fillers and Reinforcements for Thermosets," Plastics Technology, February 1965, p. 34 ff.
10. H. Lee and K. Neville, Epoxy Resins, McGraw-Hill Inc., 1957.

How humidity affects reverse current of plastic coated diodes

Coating systems	Condition	Initial I, (na) @ 50V	I, (na) @ 50v after 96 hr @ 160°F & 95% RH, 75v rev. bias
Epoxy-anhydride*	Stoichiometric purified	8	11
		8	7
		8	9
		6	5
		8	8
11	12		
Epoxy-anhydride	Nonstoichiometric, purified	10	10
		8	7
		13	8
		11	69,000
Epoxy-anhydride	Stoichiometric, technical	10	9
		8	9
		9	Open failure
		13	650
Epoxy-anhydride	Nonstoichiometric, technical	9	9
		11	9
		10	193
		16	Open failure
		12	199
14	11		
Fluorocarbon, FEP Teflon**	Dispersion coating	11	8
		12	12
		8	8
		32	13
		9	9
		17	19
Fluorocarbon, Kynar	Dispersion coating	8	8
		10	10
		52	45
		17	13
		15	16
		15	15
Silicone, elastomeric room temperature curing	Dispersion coating	14	15
		20	17
		14	15
		13	9
		19	18
		9	8
		1.16x10 ³	Open failure
Uncoated	Not applicable	9	Open failure
		6	Open failure

* All epoxy-anhydride systems were cured 16 hours at 248°F followed by 1 hour at 356°F.

** Three thin coats were used with fusion at 575°F for 5 minutes after each coat.

NEW!

IMMEDIATE DELIVERY
FROM STOCK

30-480 MHz

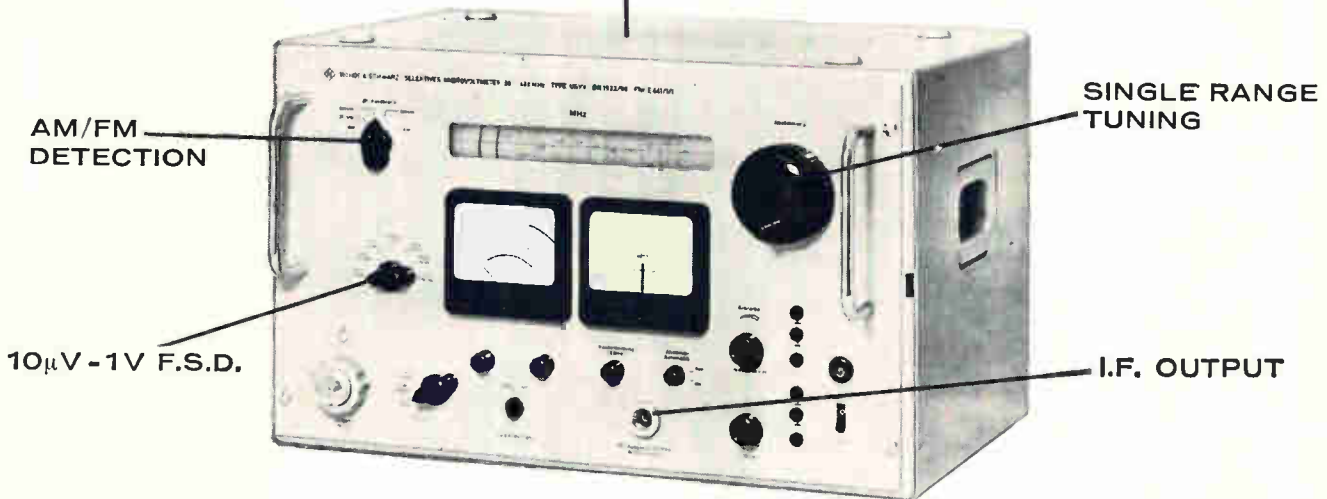

TYPE USV

SELECTIVE MICROVOLT/AMMETER

FEATURES:

- Single range tuning covers 30-480 MHz
- Measure Voltage: 10 μ V to 1V f.s.d. (-100dB to +2dB)
- Measure Current: Clip-on current probe (optional, 30-300 MHz) 1 μ A to 1A, f.s.d.
- AFC provides lock-in range, ± 100 kHz
- AM/FM detection with bandwidth of 20 & 300 kHz
- Frequency Response: ± 1 dB to 350 MHz, ± 2 dB to 480 MHz
- IF, recorder, phone outputs provided
- Retransmitting potentiometer (optional) for indication of frequency setting
- Internal reference makes unit self-calibrating

TYPE USV SELECTIVITY

Bandwidth 20 kHz

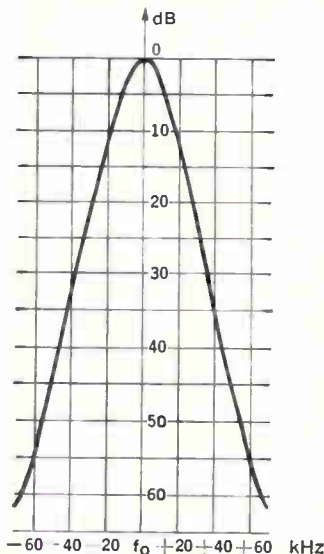

Type USV Selective Microvolt/ammeter is continuously tunable over the wide frequency range of 30-480 MHz. High sensitivity and selectivity are outstanding features of this superheterodyne receiver with direct indication in volts and decibels. AFC provides a lock-in range of ± 100 kHz. Voltage measurement range is from 10 μ V to 1V, f.s.d., with accuracy of $\pm 3\%$ (referred to 200 MHz). Type USV also features two selectable intermediate frequency bandwidths of 20kHz for AM and 300 kHz for AM/FM. Measurements with a 500 Hz bandwidth can be made by connecting IF output to R/S Type USVH Selective Microvoltmeter. Applications include: attenuation and gain measurements on four terminal networks, as a null indicator for slotted lines, measurement of distortion and modulation, for determination of directional patterns and power gain of antennas, and analysis of components in a complex signal.

Get The Extra Capability,
Greater Reliability, and
Longer Useful Life Of . . .



ROHDE & SCHWARZ

111 LEXINGTON AVENUE, PASSAIC, N. J. 07055 • (201) 773-8010

Inquiries outside the U.S.A. should be directed to Rohde & Schwarz, Muehlhofstrasse 15, Munchen 8, West Germany

Mounting, connecting and

MOUNTING AND CONNECTING VERSATILITY

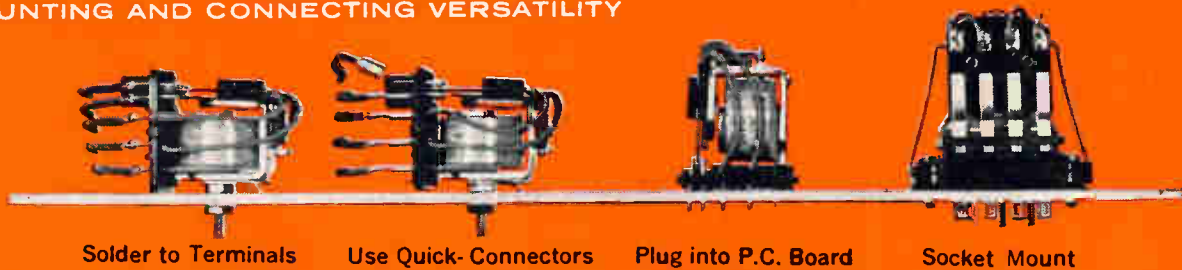

maintenance are easier

VERSATILE ENCLOSURES

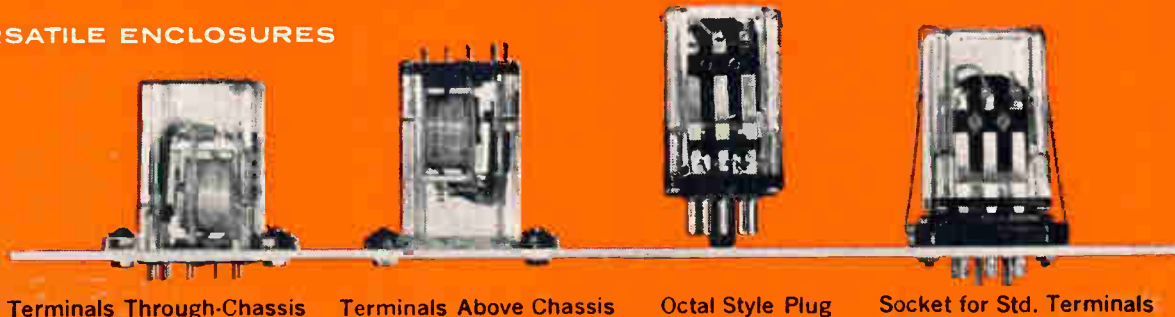

with OHMITE GPR relays...

EXCLUSIVES AND OTHER VARIETIES

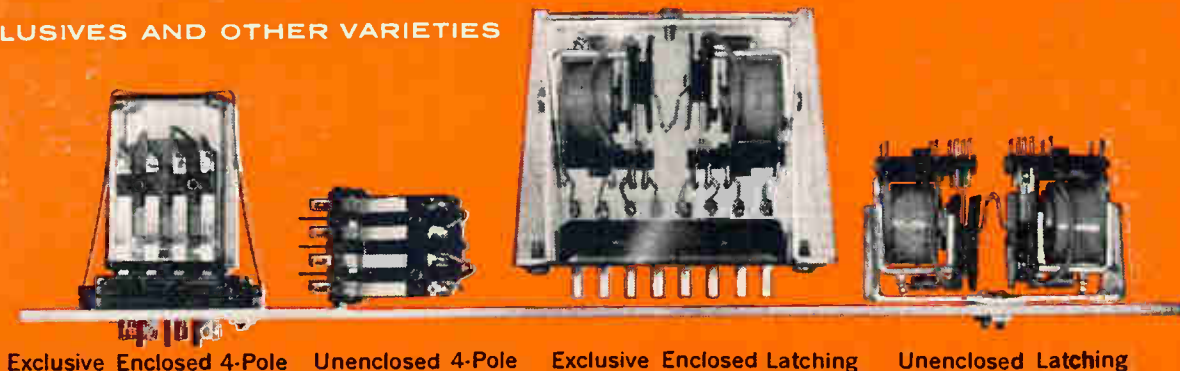

5 & 10-amp contacts... catalog 700

RHEOSTATS • POWER RESISTORS • PRECISION RESISTORS • VARIABLE TRANSFORMERS • RELAYS
TAP SWITCHES • TANTALUM CAPACITORS • SEMICONDUCTOR DEVICES • R.F. CHOKES

OHMITE

MANUFACTURING COMPANY
3610 Howard Street • Skokie, Illinois 60076
Phone: (312) ORchard 5-2600



Taking cryoelectric memories out of cold storage

A new loop cell operating in a new memory organization renews hope for a low-cost, high-speed cryoelectric mass-storage medium to replace magnetic disks and tapes

By Robert A. Gange

Radio Corp. of America, Electronic Components and Devices Division, Princeton, N.J.

Successful operation of a 14,000-bit cryoelectric memory system that combines a new memory element and a new organization once again thrusts cryoelectrics into contention as a means for attaining a fast, large, low-cost memory. The twin developments should serve to bring new emphasis to a field that has suffered from a marked decrease in interest during the past few years.

Although many cryoelectric memory elements have been developed in the past, none led to a full-scale memory system. There are three major reasons why success has been so elusive; the memory elements weren't able to take wide ranges of dimensional tolerances, little work was done on designing the optimum memory system, and the address decoding trees were built as cryoelectric switching elements instead of normal, room-temperature decoders. The new system either avoids or overcomes these obstacles.

The first experimental model of the new system uses four cryoelectric memory planes to provide a cycle time of 4 microseconds, $\pm 10\%$ tolerance on drive currents, and operates in a Dewar flask at liquid helium temperature of 3.5°K. Each plane measures 2 by 2 inches and contains 6,000 bits at a density of 6,500 bits per square inch, although a total of only 14,120 bits are actually used in the system. A 250,000-bit plane with 13,200 bits in² density now is being assembled to serve as the basic building block of a larger system. The success of the experimental system thus points the way toward systems as large as a billion bits. The economics of a memory of this size is feasible because of low-cost storage and savings in driving circuitry.

The memory elements are constructed to have no cell-to-cell interaction, provide adequate sense

signals, and operate in a cryoelectric mode which does not depend on a critically small film thickness for success. The structure of the cell is a loop with one side placed over a hole in the ground plane.

Loop cell stores current

The loop cell consists of four insulated thin-film metallic layers deposited on a glass substrate. The first layer deposited on the substrate is a lead (Pb) ground plane into which holes are etched (one hole per loop cell). Following an insulation layer, a tin

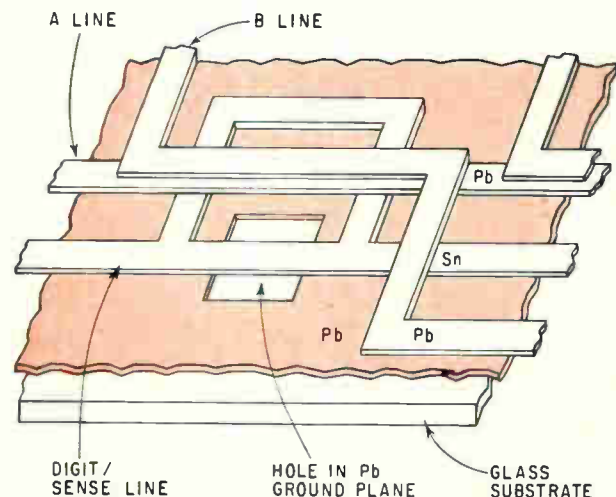

Typical loop cell has four superconductive layers separated by silicon monoxide insulating layers (the insulating layers are omitted for purposes of clarity). The hole in the ground plane produces more inductance in the portion of the loop which crosses over it than in the other three sides of the loop. The flux produced by current flowing over the hole is trapped in the loop and causes a circulating current, which corresponds to a stored logic binary 1.

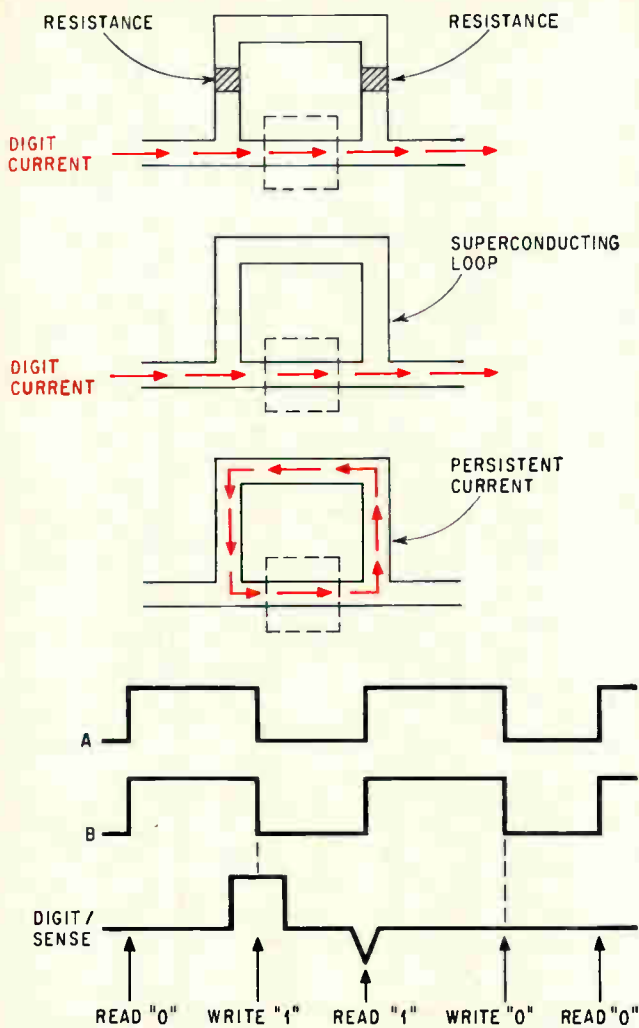

Operation of the loop cell: the A and B line current pulses switch two portions of the loop to the resistive state, forcing the digit current to flow through the high inductance path over the hole in the ground plane. When the A and B currents go to zero, the resistance disappears and the flux set up by the digit current causes a circulating current to flow in the loop. The circulating current corresponds to a binary 1. The contents of the cell can be read on the leading edge of the A and B current pulses. If a current is stored in the loop, the resistance caused by the A and B currents force it to decay to zero, inducing a voltage in the digit-sense line.

digit strip, or sense line, containing the rectangular loops is laid down. Three sides of the loop project from the sense line. The fourth side of the loop crosses over the hole in the substrate. Two lead (Pb) drive line layers then are deposited over an insulating layer that covers the layer containing the loops. The drive lines A and B are superimposed, in line and insulated, as they cross the loop perpendicular to the sense line about midway between the sense line and the outer edge of the loop. Current in these drive lines will switch part of the loop to the resistive state.

The inductance of the path that crosses the hole is higher than the inductance of the path formed by the other sides of the loop that pass over the ground plane.

A binary 1 is written into a cell by applying select currents to the A and B lines and a digit current to the sense line and then removing the select currents before removing the digit current. The following events occur in sequence:

The select currents switch the tin to the resistive state, and the digit current flows through the high inductance path over the hole in the ground plane, where it sets up a flux in the loop.

When the select currents are removed, the low inductance path returns from the resistive to the superconducting state.

The flux produced by the digit current passing through the high inductance zero resistance path, however, is trapped in the loop.

When the digit current is removed, a circulating current is established in the loop, which corresponds to the binary 1.

Readout is obtained by monitoring the voltage across the sense line during the leading edge of the select current in the absence of a digit current.

If a 1 had been stored in the cell, the sudden change to the resistive state would cause the circulating current to decay to zero and a voltage would be induced in the sense line as the flux in the loop collapses.

Hybrid organization

The new hybrid system enhances the fundamental advantages of cryoelectric memories over those of conventional ferromagnetic core memory system. The relatively high inductance of the magnetic core memory's drive lines and cells is conducive to noise and necessitates repetition of the electronic hardware as the bit capacity of the system is increased. In addition, the number of bits a single decoder may drive decreases with faster cycle time.

In the cryoelectric hybrid system, essential for this application rather than the word and bit-organized systems, the substantially perfect diamagnetic property of metals in the superconducting state results in negligible inductance of the drive lines even in very large bit capacity memories, and it also effectively eliminates all interaction and noise on the substrate. Thus, only one pair of decoders and drivers is required for the entire hybrid system. The decoders and drivers are quite modest in size and complexity, and the reliability of the electronics can be made very high. The isolation between cells and high signal-to-noise ratio at the substrate permits the unambiguous detection of sense signal levels of very low energy content, which in turn permits very high cell packing density.

The cell's energy density, however, causes interdependencies among the system components which are not present in the conventional, rather large storage elements. Therefore, both the cryoelectric cells and the system in which they are to operate were developed together.

In the hybrid (word-bit) system, the select drive lines are designated as A and B lines. A memory

cell or storage loop exists beneath each A and B line intersection. The A drive lines are serially interconnected from plane to plane in the stack. A single A decoder, functioning at room temperature, drives a select A line through all the planes of the stack. Only one A decoder is required because of the negligible inductance of the drive lines.

The B drive lines intersect the A lines many times on a plane, requiring few B lines per plane for a large bit capacity. The selection of a particular A and B line results in the simultaneous activation of a number of bits on a plane, which constitute an entire word. The number of digits in the word is equal to the number of intersections of any A line with any B line on a plane. The B lines on each plane are grouped into digit segments and are independently connected to a decoder at room temperature.

The B line digit segments identify memory cells common to a given digit of all the words on the plane. Each of the storage loops common to a given digit on a plane comprises one digit strip. There-

fore, the number of digit strips on a plane is equal to the number of digit segments or digits of a word. The output of all digits of a selected word simultaneously appears across the terminals of the digit strips of the selected plane. Each plane, then, consists of a number of words equal to the product of the number of A and B lines.

A given number of digit strips, one per plane, and common to a given digit of the word, are connected in series and across the primary of the output transformer. Write current is applied serially to the group of digit strips associated with a common digit. The sense signal output from any one of these digit strips appears across the primary winding of the sense output transformer. Since only one B line is activated, for a given address, only one of these digit strips is activated during a given read interrogation.

The hybrid system provides for a length of digit strip substantially shorter than in other memory organizations, which increases the yield and reduces the sense output signal attenuation and the write

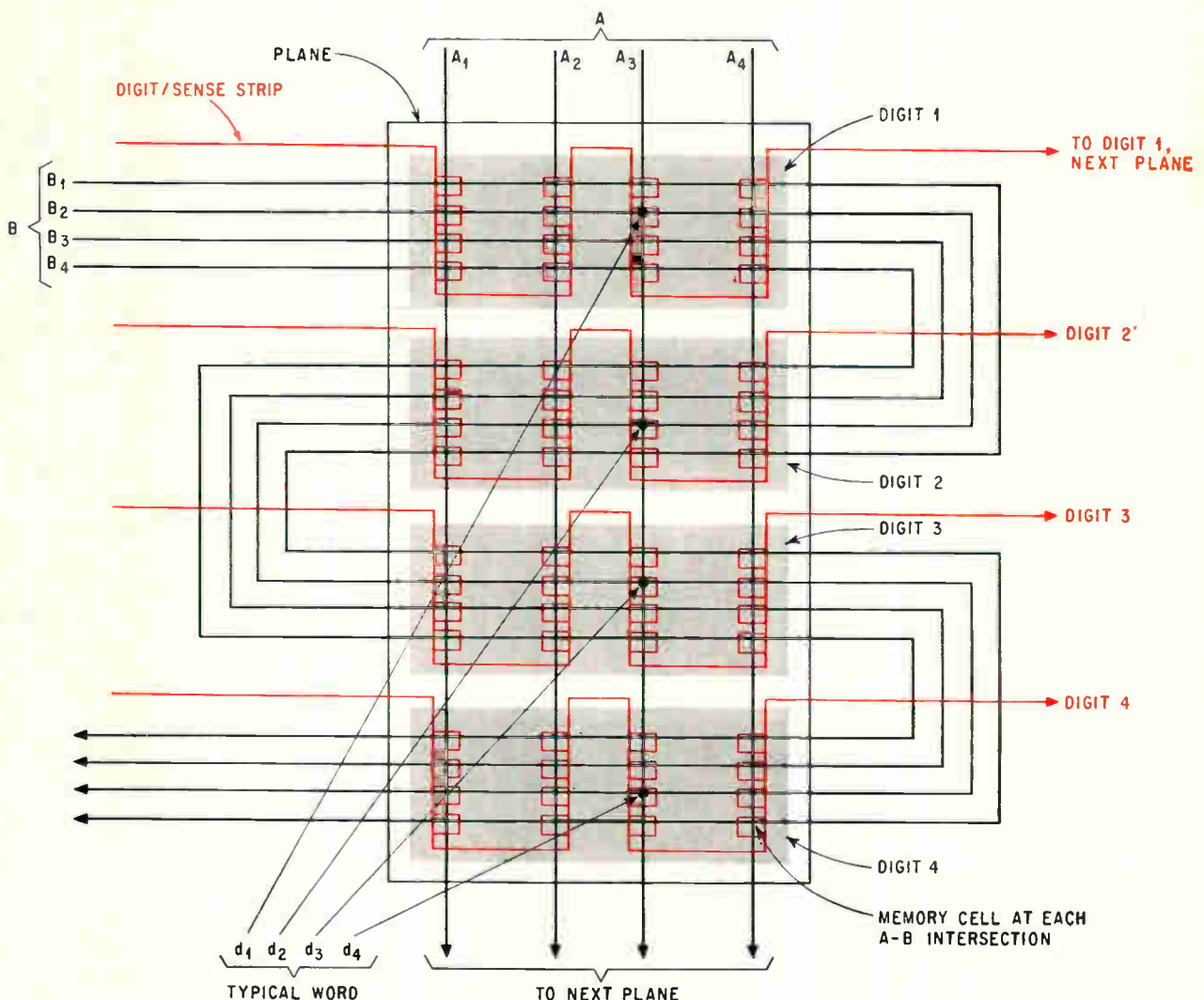

Conductor arrangement for the hybrid memory organization is shown for a hypothetical 16-word, 4-digits-per-word memory plane. Shaded areas represent the four digits of the words. The four digits of a particular word are located by the four intersections of a particular A line and a particular B line; lines A₂ and B₃ are shown as an example. One digit-sense strip is used for each digit area. Thus, if a binary one were stored in each of the A₂-B₃ intersections, each of the sense lines would produce a simultaneous readout.

Cryoelectric memories: will they finally make good?

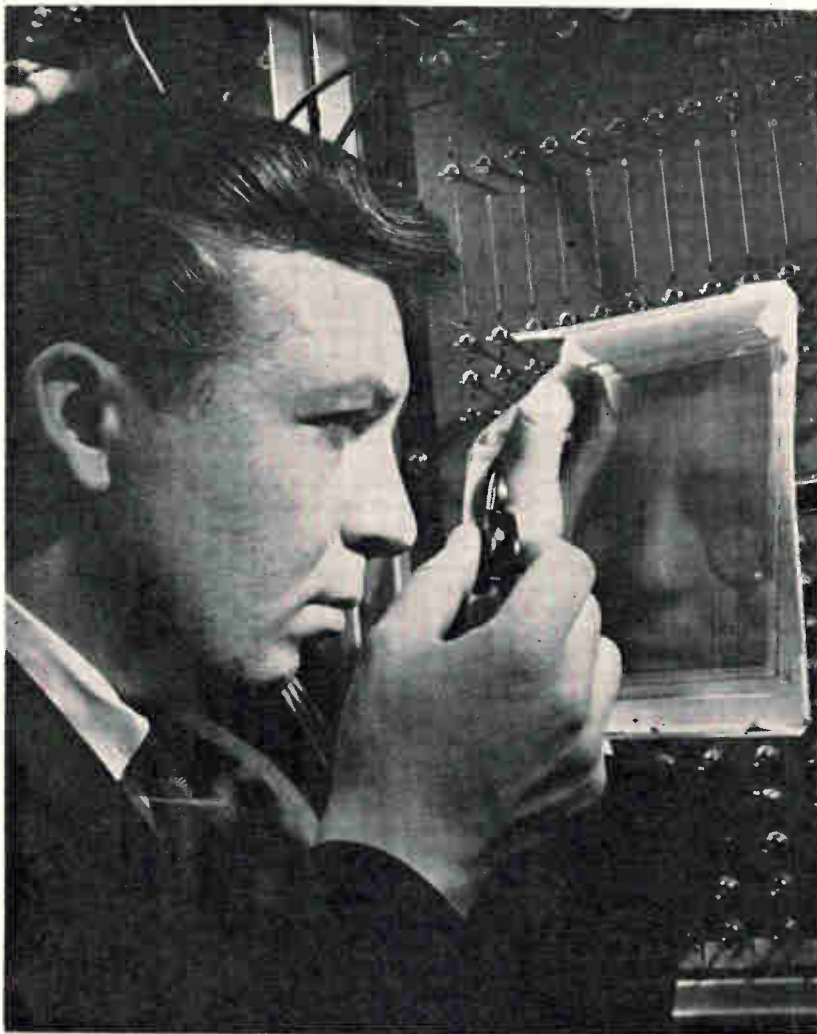

Author Gange examines a 250,000 bit cryoelectric memory plane arranged in 64 modules of 4,096 bits each. Studies indicate that it is feasible to build a 10^8 bit memory using 512 of these planes operating in a coincident-current, random-access mode and with microsecond cycle times. Successful operation has already been obtained with smaller, 6,000-bit planes operating in a 14,000-bit cryoelectric memory. The planes are arranged in stacks and operated at liquid helium temperature, 3.5°K .

RCA's success with a cryoelectric memory comes at a time when there is a greater need than ever for a fast mass store to replace magnetic tape and disk memories. Software costs—now greater than hardware costs—could be decreased greatly, since much of the software is devoted to shuffling information back and forth between the main core memory and the large, slow, tape or disk memory. With a high-speed memory as the mass store, these software costs might be cut by as much as 10:1. Further, computer through-put could be increased with a corresponding decrease in cost per computation.

A high-speed mass store would also find ready use in information switching, where data arrives at a central location from many sources, is stored, and then is retransmitted. Though the individual data rate on each line is only moderate, the total rate of data assimilation by the memory in this application is quite high.

The new loop-cell cryoelectric memory is the latest, most promising development in the long, checkered history of superconductivity and its application to computing techniques.

Buck's cryotron. The first application of cryoelectrics to computer elements occurred during the early 1950's when Dudley Buck, an engineer at the Massachusetts Institute of Technology's Lincoln Laboratory, developed a resistance switch, which he labeled a "cryotron".¹ It consisted of a piece of superconducting tantalum wire operating below its critical temperature of 4.4°K , about which was wound a coil of superconducting

noise. The hybrid system, since it is of modular construction, also permits the memory to be evaluated plane by plane instead of in a complete stack. Thus the stacks can be designed for complete plane-to-plane isolation instead of forcing a design where memory cells on different planes must operate simultaneously with no interaction.

Cryotrons eliminated

The use of room temperature decoders endows the system with many advantages over a system that uses cryotron decoders. First of all, if the cryotron decoder is built on the same substrate as

the memory cells, it is difficult to evaluate them separately. Ideally, the decoding tree should be evaluated with a fully checked out memory plane and vice versa. But with cryotron decoders, they are substantially inseparable.

With the cryotron decoder, the address currents and the cell drive currents are sent down into the Dewar flask to the decoding tree. One address line is used for each digit of the address. The drive currents are controlled by the address currents in the cryotron tree and routed to the proper cell in the plane. The address currents run serially from plane to plane and since many cryotrons must be

niobium whose magnetic field switched the tin from the superconducting to the resistive state. The major disadvantage of the device, however, was its slow speed, caused by the long time constant associated with its high inductance-to-resistance ratio, and the long thermal recovery time of the tantalum.

Soon thereafter, a thin film version of the cryotron was proposed in which the inductances of both the control and the switched element were substantially reduced by the proximity of a superconducting ground plane. Difficulty in the vacuum deposition of thin films of tantalum and niobium soon brought about a change to tin and lead.

Many thin film memory devices were proposed during the 1950's, but each appeared to suffer from one or more serious problems, which, when solved, resulted in a cryoelectric system with minimal advantages over existing magnetic memory systems. A further obstacle to researchers was the lack of a comprehensive theory of superconductivity.

BCS theory. In December 1957, Bardeen, Cooper, and Schieffer, of the University of Illinois published their now celebrated "BCS" theory of superconductivity in which the phenomenon's relationship to basic solid state theory was defined, and basic material parameters were related meaningfully to observed constants.² This perspective of the superconducting phenomenon led to an understanding of the behavior of very thin superconducting films in response to normal components of applied field, such as occurred along the edge of the cryoelectric cell.

Sheet memory. In 1960, Burns and his coworkers at the Radio Corporation of America Labora-

tories published a paper describing outstanding performance characteristics of a "continuous sheet memory," which was void of edges.³ In the period between 1960 and 1964 many investigators both here and abroad attempted to develop a practical memory of this type. However, the performance could not be systematically reproduced, especially over large areas due to formidable material problems. Work in the area of superconductive random access memories substantially declined thereafter.

Nonlocal mode. Gange and his group made a sober appraisal of the developments between 1954 and 1964 and saw a characteristic essentially common to the many diverse approaches; the devices operated in a "local" mode, where the current density at every point is directly related to the magnetic field at that point, or is "locally" related to the field. The criterion for operation in this mode is that the magnetic field penetration depth must be greater than the distance between two bound electrons, which travel as a pair through the superconductor. If the film is thin, then the superconductor will operate in this mode.

In such a mode, however, the operating current levels are indirectly dependent upon such factors as grain size and orientation, impurity concentration and type, film thickness, dislocations, vacancies, interstitial atoms, and point defects. At the state of the art which existed at that time (and which still exists) it was impossible to control these parameters to the extent necessary for the realization of a practical memory and therefore the cells had uniform electrical characteristics.

Thus, in 1964, an operating

mode which depended only on the gross bulk material properties was seen as a requirement for achieving a practical cryoelectric memory. To operate in this "nonlocal" mode, it is necessary to ensure a film thickness larger than the separation between two bound electrons.

However, the film thickness cannot be indiscriminantly large or the inductive time constant of the device will be excessive due to the smaller restored resistance value. This film thickness requirement necessitated the reintroduction of structure to the element to ensure flux trapping, and a photolithographic fabrication technology to ensure reasonably systematic elimination of tapered film edges, which would cause local-mode operation.

Hybrid organization. Because of the difficulties with the earlier memory cells, the memory organizations were never fully evaluated. After designing a new memory cell that operated with wide tolerances, Gange, working with J.J. Carrona, manager of the cryoelectric device laboratory, and engineers H.G. Scheible, E.M. Nagle and J.F. Thompson, developed the new memory organization.

The work was partially sponsored by the Air Force Systems Command, Wright-Patterson Air Force Base, Ohio.

References

1. D.A. Buck, "Magnetically Controlled Gating Element," Patent No. 2,832,897, filed July 27, 1955.
2. J. Bardeen, L.N. Cooper and J.R. Schieffer, "Theory of Superconductivity," *Physical Review*, Dec. 1, 1957, pp. 1,175-1,203.
3. L.L. Burns, G.W. Leck, G.A. Alphonse and R.W. Katz, "Continuous sheet superconducting memory," *Proceedings of the Symposium on Superconducting Techniques for Computing Systems*, 1960, Office of Naval Research, Washington, Symposium Report ACR-50, pp. 167-185.

switched, the address currents must be large enough to switch the poorest cryotron.

For example, if the planes were made up of a matrix of 1,024 by 1,024 bits, then 10 address currents would be needed for the A direction and 10 for the B direction. Two drive currents per plane would be used, one for A and the other for B. The address currents steer the drive currents on the substrate, and therefore must be much larger than the drive currents. In turn, the drive currents control the digit currents in the individual cell and are still larger. Thus, the address currents end up being many times larger than the currents in the cells

which are eventually used to store the data.

This causes interaction between the cryotron tree and the memory cells close to the tree, and tolerances on the cell operation are affected. The address current must be high enough to assure switching the weakest cryotron in the tree common to a given address. At these high levels, the address currents will start to switch imperfections in the lead film as they pass over the imperfections through the cryotron decoder tree. The flux produced by the high currents will also couple into the memory cells and disrupt operation. At high current levels, the generation of heat can also cause undesirable thermal

switching of the cryotrons, which is particularly difficult to detect during check out of a memory plane.

Additional current tolerance losses are incurred because of the inductive division of currents in the cryotron tree. At the first instant of current application to the tree, the current inductively divides among the branches and, as resistance is introduced in the unwanted paths, inductively decays and collects in the desired path. The time constant for this in a cross film tree is in the 20-microsecond range, so the cycle time is in the 60 to 80- μ sec range, which would be unacceptable for the high-speed mass store originally intended for the memory. The time could be decreased by putting more drive current into the apex of the tree but extra current might be so high as to cause partial switching of the undesired cells.

With room temperature decoders, we can reduce the heat load on the cryogenic refrigerator, we can increase the number of memory cells on the plane with the space we gain, we can reduce the cycle time since we will not have to wait for the decay of the drive current to switch the cryotrons, and we can make significant cost reductions through redundancy techniques on the plane not heretofore applicable. We also can increase the plane yield because fewer film layers are required.

The absence of the decoders from the substrate reduces the number of decoding elements by two or three orders of magnitude and also reduces evaluation costs. Thermal requirements of the system are also greatly reduced.

Ambient decoders cut heat

Although room temperature decoders require many more lines to enter the Dewar flask, only a few lines are carrying current at a time, and the currents are quite low compared with the high currents used with the cryotron decoders. The I²R loss thus is negligible.

For the lines into the Dewar flask, a conductor material having a low thermal conductivity and an electrical resistivity that is not excessive is desirable. Of the materials considered, lead appears to offer great promise. Lead's thermal conductivity is only about 10% of copper's. Although its electrical resistivity is higher than copper by a factor of 10, the total resistance of a conductor is only a few ohms.

As an example, the over-all thermal requirements of a 10⁸ bit memory system have been evaluated assuming lead conductors of 10-mil width, and 3 mil, 1 mil, and 0.33 mil thickness, respectively, between the three heat-exchanger staging temperatures of 300° to 90°, 90° to 15°, and 15° to 3.5°; lengths of 25 cm, 35 cm, and 35 cm were assumed, respectively, between the same staging temperatures. With A and B line currents of 100 milliamps and a sense-line current of 20 ma, the load for each heat exchanger due to lead-ins is 81 mw, 443 mw, and 4.50 w, respectively, at 3.5°K, 15°K, and 90°K heat stations, which is well within the present state

of the art for cryogenic refrigerators. The I²R heat including nonsuperconducting contacts is calculated to be 4.2 mw. Thus, with a hybrid organized memory, capacities as high as 10⁸ bits will not put unreasonable burdens on the refrigeration system. Estimates of older systems put the thermal requirement at the 3.5°K station at about 1 to 5 w for comparable memory capacities.

Standard planes in large memories

For the multimillion-bit memories, the capacity of the basic memory plane must be carefully chosen. The low interconnection costs of a high bit-capacity plane must be balanced against the decreased yields that would be experienced with a high capacity plane. The higher the bit capacity, the fewer interconnections needed, but the lower yields raise processing costs. A cost minimization analysis reveals that 250,000 bits is a reasonable estimate of the optimum bit capacity. This will be used as a standard plane. The discussion that follows is based on this figure.

The standard plane concept is akin to the building block philosophy. Synthesis of large memory systems with a standard plane has several advantages: hardware and evaluation processes can be shortened and hardware fabrication can be improved through repetition. The hybrid design also allows redundancy techniques.

The standard plane contains 512 A lines, eight B lines and 72 digit-sense lines designed to conform to the loop cell array. The plane is designed to give a word length of 64 bits; therefore, it contains a digit line redundancy provision of eight lines, or about 12%. The 512 A lines and eight B lines should be sufficient to give redundancy potential in these lines when incorporated into a memory system.

To synthesize very large hybrid memory systems with standard planes, the planes must be interconnected to fit the particular specifications of the memory system. In this way, electrical path lengths can be custom cut for a given system, and compatible delays of the A and B select pulses over the stack may be realized. The hybrid organization provides sufficient flexibility to permit the necessary interconnections.

The interconnection patterns can be of two general types: a single interconnection pattern which defines the over-all system organization or an interconnection pattern common to a local region which repeats itself over the entire system. The second pattern strongly suggests a basic building block philosophy, in which the block is a plate or frame defined by the judicious interconnection of two or more standard 250,000-bit planes.

Four memory building blocks

The specific configuration of the basic block or plate is determined through practical considerations, such as existing interconnection technology. Sufficient flexibility exists with the hybrid system organization to allow selection of a plate configura-

Hybrid memory organization

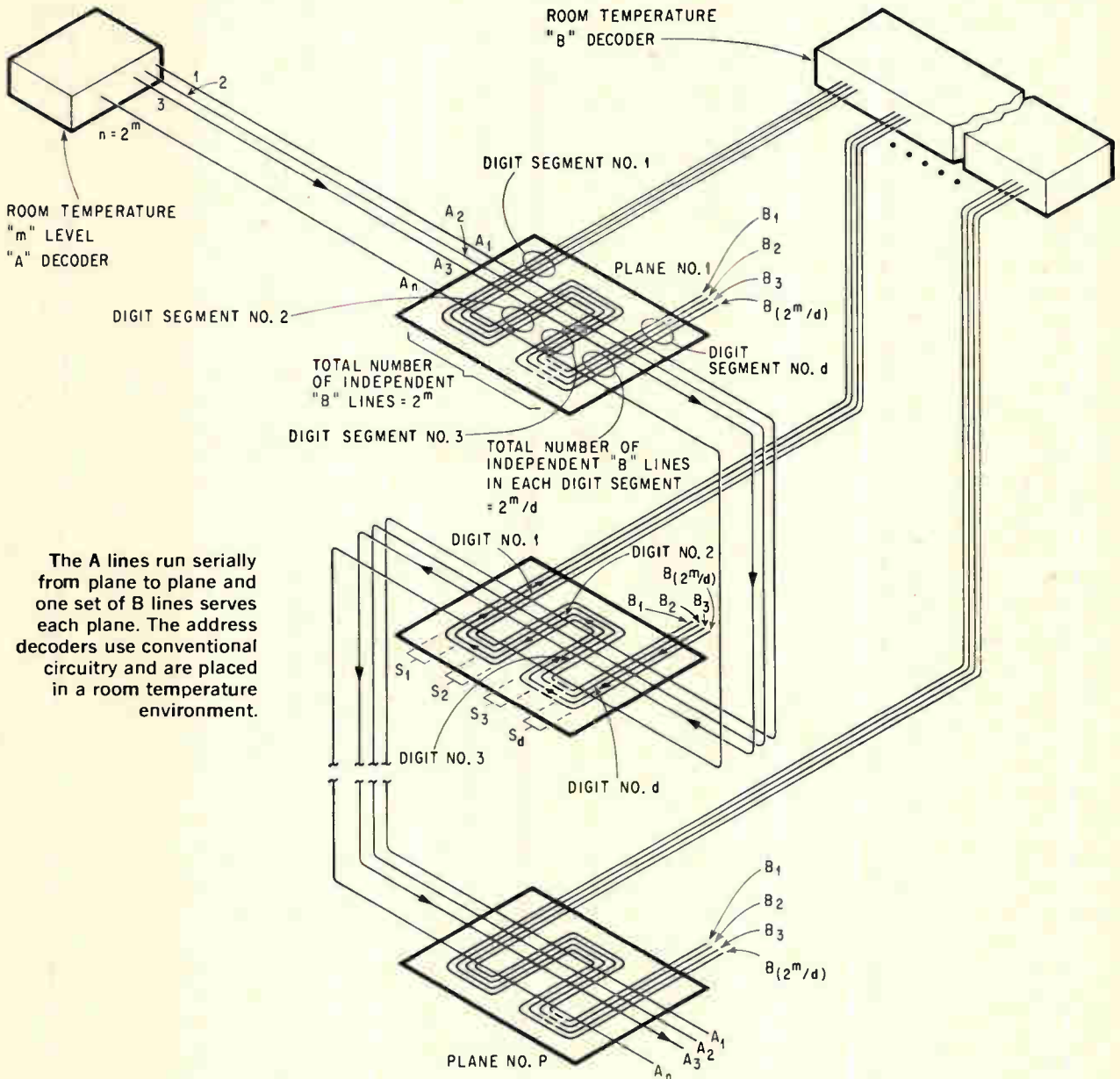

The A lines run serially from plane to plane and one set of B lines serves each plane. The address decoders use conventional circuitry and are placed in a room temperature environment.

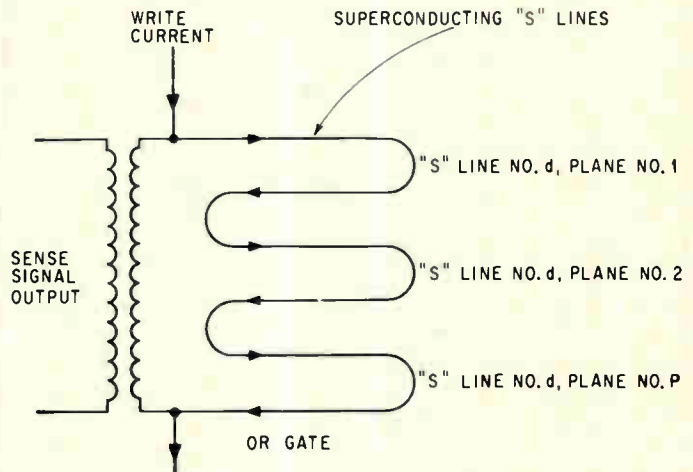
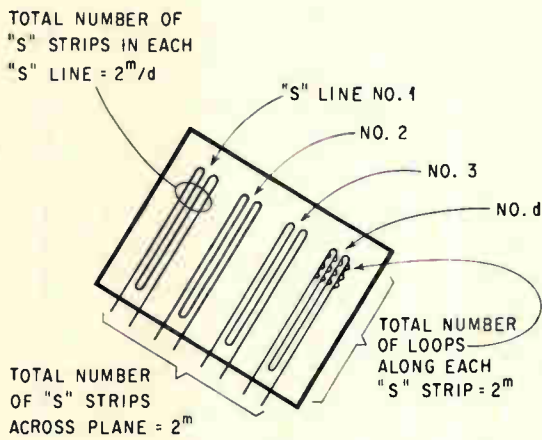

Each sense line on a plane runs through all the memory cells on the plane associated with a common digit.

The sense lines serving a common digit on each plane are connected in series through the stack.

Choosing optimum bit capacity

The hybrid memory organization lends itself well to modularization but deciding on the number of bits to include in each module is not a simple matter. The two extremes are impractical: if only a few bits were used per module, then the wiring costs are far too high; if millions of bits are used per module, then the yield decreases drastically since many modules would have to be made before one completely functioning module is achieved. Between these two extremes lies an optimum number of bits which should be placed on each module. [Note that magnetic core memories are in the first category, with high interconnection costs. Plane yields are high since each core can be tested separately and the bad ones discarded, but the wiring costs are very high.]

Thus, finding the optimum number of bits to be placed on a single module is one of the most important aspects of practical cryoelectronic memories.

There is a maximum substrate area which can be processed with existing deposition equipment. Call this area A , which might practically be about six inches by six inches. This area will contain a total number of bits B , which will be proportional to the area:

$$B = K_1 A$$

The plane is exposed to various hazards during processing. These hazards are either area dependent or area independent. Examples of area independent hazards are a technician accidentally scratching the thin films or a wrong exposure due to a defective ultraviolet bulb. Area dependent hazards include defects in the substrate, an occasional module during film deposition, or a piece of dirt.

The larger the area, the greater the area-dependent defects, the lower the yield, and the higher the cost. The yield may be increased by partitioning area A into n sub-areas a of a bit capacity b . In this way, defective modules may be discarded, resulting in higher overall bit yield.

$$B = nb$$

$$A = na$$

In the following analysis we assume that:

- Parallel processing is feasible.
- The area independent hazards are interdependent of the partition n .
- The determination or classification of a particular defect as repairable or unrepairable is independent of the partition n .

The increase in cost attributable to the repair of n units of area a over the cost to repair a single unit of area A is offset by the savings afforded by the option to discard a fraction of the n units during defect inspection.

Let $1-P$ denote the probability that all b bits are satisfactory over unit area a . The probability of failure P is some function $P(b)$ where P increases with increases in b .

Processing Cost. If C_1 is the cost of all necessary process sequences to produce a perfect multilayered structure for $P = 0$ of area A , and C_{of} is some fixed cost, then the total fabrication cost C_f to produce B satisfactory bits is:

$$C_f \approx C_{of} + \frac{C_1}{1-P}$$

The cost C_{oe} , which excludes interconnections, is the cost of evaluating n times b bits including material, labor, and overhead and is comparable to that required to evaluate B bits.

The total number of interconnections i per module of b bits is approximately related to b as:

$$i \approx K_2 b^{1/2}$$

where K_2 is some constant.

Interconnection cost. If C_2 is the cost per interconnection then the total interconnection cost is $C_2 ni$.

The total evaluation cost C_e over all necessary runs per machine to evaluate B bits is then:

$$C_e \approx C_{oe} + C_2 ni$$

The total cost is given in terms of a fixed cost C_o , a device cost, $\frac{C_1}{1-P}$, and an interconnection cost $C_2 ni$ as:

$$C = C_o + \frac{C_1}{1-P} + C_2 K_2 \frac{B}{b^{1/2}}$$

Since $\frac{dP}{db} > 0$, a minimum in the total cost C occurs at a value of b for which:

$$b^{3/2} \frac{dP}{db} - \frac{1}{2} K_2 B \frac{C_2}{C_1} = 0$$

If the variation of P with b were known, we would now be able to find the optimum b .

Consider a probability of failure P which varies linearly with area and thus varies linearly with the number of bits, b , in a module. Let the quantity K_3 denote the number of bits over the area A for which a defective bit is reasonably certain; if K_3 bits were put on a substrate of area A , a failure in at least one bit would occur. If K_3 were partitioned into smaller modules with bit capacity b , the probability of failure in each b -bit module would decrease and would be inversely proportional to the total number of bits K_3 :

$$P = \frac{b}{K_3}$$

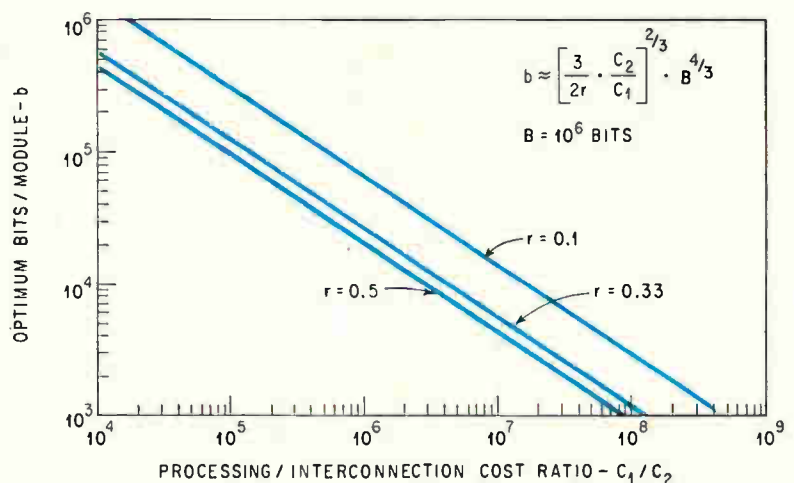

Optimum bit capacity varies with processing-interconnection cost ratio and a confidence parameter, r , related to memory plane production.

Note that if b equalled K_3 , the probability of failure would be 1, which follows from the definition of K_3 .

Confidence factor. Since the occurrence of at least one defective bit is likely in K_3 bits, and since B bits corresponds to an area A beyond which one defective bit is likely, the quantities K_3 and B are of the same order of magnitude. One may therefore introduce a confidence parameter " r " of the form:

$$B = r K_3$$

$$0 < r < 1$$

Therefore if K_3 bits were placed on the plane at least one failure would occur, but if a fraction of K_3 were placed on the plane, there is a chance at success. The parameter r is this fractional confidence factor and denotes the percentage of K_3 bits over which adequate yield is likely. Thus, combining the above two equations,

$$P = r \frac{b}{B}$$

Optimum bits. The number of bits b at which the minimum cost occurs now may be obtained as:

$$b_{opt} = \left[\frac{K_2}{2r} \cdot \frac{C_2}{C_1} \right]^{2/3} B^{1/3}$$

Unlike semiconductor integrated circuits, cryoelectric devices are relatively insensitive to defects, and a value of 10^6 for B may not be unreasonable for the loop structure.

A logarithmic plot of b as a function of C_1/C_2 is shown for $r = 0.1, 0.33,$ and $0.5,$ and for $K_2 = 3$ (a typical value). The curves show that the device and interconnection costs, C_1 and C_2 respectively, have a significant effect on the optimum number of bits b per substrate. As an example, a cost $C_1 = \$10,$ and $C_2 = 0.01$ cents ($C_1/C_2 = 10^5$) gives a value of about 127,000 bits for b while a cost $C_1 = \$500,$ and $C_2 = 0.001$ cents ($C_1/C_2 = 5 \times 10^7$) gives a considerably smaller value of $b,$ about 1,500 bits (both estimates at r about 1/3).

Standard plane. As another example, a cost ratio of 3.5×10^4 with a confidence parameter of 0.33 gives an optimum substrate bit capacity of 250,000 bits. A plane with this capacity is referred to as a standard plane.

tion satisfying both the interconnection schemes for which A and B electrical path lengths are compatible, and the interconnection technology through which manufacture of the system may be realized. We will consider basic building blocks for four systems: 1.6×10^7 bits, 3.2×10^7 bits, 6.4×10^7 bits and 1.28×10^8 bits.

▪ The basic block from which a 1.6×10^7 -bit memory may be synthesized consists of two standard planes back-to-back to form a 0.5-million bit plate. The system requires 32 plates. The A lines run serially through all the planes while the B lines are brought out separately from each plane.

▪ The basic block from which a 3.2×10^7 -bit memory may be synthesized consists of four standard 250,000 bit planes, two coplanar pairs back-to-back to form a 1-million bit plate. There are 32 such plates. The number of A lines in the system is 1,024, 512 of which run serially through all planes stacked on the left, and 512 of which run serially through all planes stacked on the right. Separate B lines run serially through each pair of planes on each surface of each plate in the system.

▪ The basic block which characterizes a 6.4×10^7 and a 1.28×10^8 -bit memory consists of eight standard planes, four of which are back-to-back with the four which are coplanar. The number of A lines in both systems is 2,048, 512 of which run serially through each plane stacked in each of the four quadrants of the systems. In the 6.4×10^7 -bit system, separate B lines run serially through each pair of planes on each surface of each plate in the system. There are 32 plates, each consisting of 2 million bits, and a total of 1,024 B lines.

In the 1.28×10^8 -bit system, separate B lines run serially through all planes on each surface of each plate in the system. There are 64 plates, each of 2 million bits, and a total of 1,024 B lines.

The various plate configurations on page 120 may be redefined by performing the folds along different axes, provided the basic interconnection pattern remains unaltered. For example, the 1.28×10^8 -bit memory plate configuration may be altered to permit the A lines to run across pairs of planes on each surface of each plate in the system. The pair of A lines so defined would then run serially through all halves which were in common through each plate in the system. The total number of A lines would remain at 2,048.

The B lines would run serially through a pair of planes common on each surface of a plate. The B lines (two on each side of the plate) are orthogonal to the two planes per plate through which each A line runs, permitting the unique selection of one plane in the system at any one time. The total number of B lines remains at 1,024, and the electrical path lengths remain the same for either plate configuration.

100-million bit memory

A memory system of 10^8 bit capacity may be synthesized from the basic plate consisting of eight standard planes. The over-all volume occupied by

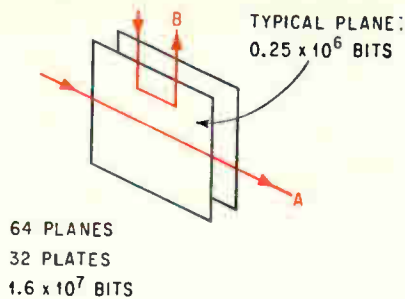

64 PLANES
32 PLATES
1.6 x 10⁷ BITS

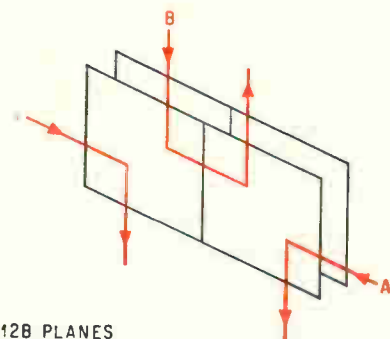

128 PLANES
32 PLATES
3.2 x 10⁷ BITS

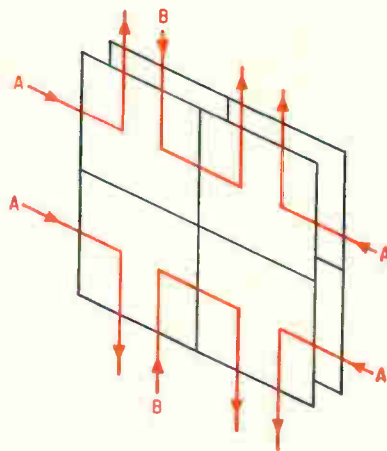

256 PLANES
32 PLATES
6.4 x 10⁷ BITS

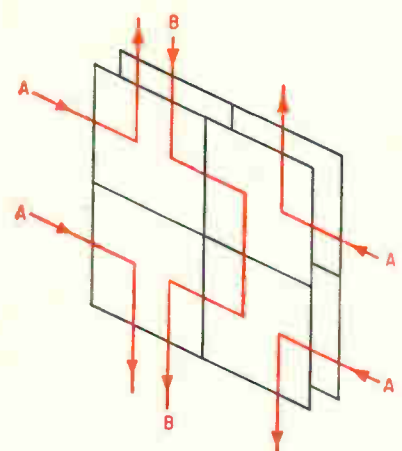

512 PLANES
64 PLATES
1.28 x 10⁸ BITS

With a 250,000-bit memory plane as the basic building block, four ascending-order memory plates are depicted with A and B select lines. Each plate uses the basic planes arranged back-to-back. A 10⁸-bit memory thus may be built with 512 planes of 250,000 bits each. The A and B line currents would be 100 milliamperes, and the sense line current 20 ma. Power dissipation is estimated as 81 milliwatts at 3.5° K.

the resulting 64-plate stack at the liquid-helium environment is about 1 cubic foot.

In the memory, 512 A lines run serially through each plane stacked in a common quadrant. The total number of A lines is 2,048; the total number of A wires including returns is 4,096. The B lines are serially interconnected through each of the four planes at each surface of each plate in the system. The total number of B lines is 1,024, the total number of B wires is 2,048. A number of sense lines, say 32, each common to a given digit of the word, and each on separate planes, may be serially interconnected and connected across the primary of an output transformer.

Room temperature amplifiers

In this case, each of the quadrants of the memory system will have four output transformers for each digit of the word. The outputs of these transformers are connected to amplifiers at the room temperature environment, and correspond to a particular digit of the word. The total number of lines per quadrant is the product of the number of planes per quadrant (128) and the number of lines per plate (digits per word = 64). Therefore, the number of sense wires per quadrant, including returns, is 512, and the total number of sense wires over the entire memory system, including returns, is 2,048.

The number of wires required for write current is determined by permitting independent write current to exist at each quadrant. The total number of digit wires including returns is 512. The total num-

ber of wires required for the entire 10⁸-bit system memory system, including returns, is 8,704.

Reliability and cost aspects

Another major advantage of the new cryoelectric memory over conventional random access magnetic memories is that only one set of decoders will be required for the million bit memory. In conventional memories, a separate decoder is required for about each 4,000 bits because of the high inductance of the drive lines. This reduction in the quantity of the electronic circuitry not only delivers substantial cost savings, but, more important, it greatly improves reliability.

The cryoelectric memory does, of course, require a refrigerator, but the feasibility of continued cryogenic operation has been amply demonstrated in recent years by such systems as masers. The extremely low cost of the cryoelectric memory on a per-bit basis should serve to lessen the importance of the initial cost of the cryogenic refrigeration system.

The author



Robert A. Gange received his A.B. degree in physics from Rutgers University in 1958. He is now a group leader in the cryoelectric device applied research laboratory of the Radio Corp. of America's Electronic Components and Devices Division.

150 MHz, 2.4 ns

NOW! at the probe tip



The Tektronix Type 454 is an advanced new portable oscilloscope with DC-to-150 MHz bandwidth and 2.4-ns risetime performance where you use it—at the probe tip. It is designed to let you make convenient measurements of fast-rise pulses and high-frequency signals previously outside the range of conventional oscilloscopes.

The Type 454 is a complete instrument package with dual-trace vertical, high-performance triggering, 5-ns/div delayed sweep and solid-state design, all in a rugged 31-lb. instrument. You also can make 1 mV/div single-trace measurements and 5 mV/div X-Y measurements with the Type 454.

The 2.4-ns risetime and DC-to-150 MHz bandwidth are specified at the tip of the new miniature P6047 10X Attenuator Probe. The dual-trace amplifiers provide the following capabilities with or without probes:

Deflection Factor*	Risetime	Bandwidth
20 mV to 10 V/div	2.4 ns	DC to 150 MHz
10 mV/div	3.5 ns	DC to 100 MHz
5 mV/div	5.9 ns	DC to 60 MHz

*Front panel reading. Deflection factor with P6047 is 10X panel reading.

The Type 454 features a new CRT with distributed vertical deflection plates and a 14-kV accelerating potential. It has

a 6 by 10 div (0.8 cm/div) viewing area, a bright P-31 phosphor and an illuminated, no-parallax, internal graticule. The Type C-30 and the New Type C-40 (high writing speed) cameras mount directly on the oscilloscope.

The instrument can trigger to above 150 MHz internally, and provides 5-ns/div sweep speeds in either normal or delayed sweep operation. The calibrated sweep range is from 50 ns/div to 5 s/div, extending to 5 ns/div with the X10 magnifier. Calibrated delay range is from 1 μ s to 50 seconds.

The Type 454 is designed to be carried and has the rugged environmental characteristics required of a portable instrument. A rackmount, the 7-inch-high Type R454 oscilloscope, is available with the same high performance features. Also available is the new Type 200-1 Scope-Mobile® Cart.

For further information about the Type 454, or about the new Tektronix DC-to-100 MHz *plug-in* oscilloscope, the Type 647A, contact your nearby Tektronix field engineer, or write: Tektronix, Inc., P. O. Box 500, Beaverton, Oregon 97005.

Type 454 (complete with 2 P6047 Probes and accessories)	\$2550
Type R454 (complete with 2 P6047 Probes and accessories)	\$2635
C-30 Camera	\$ 390
C-40 Camera	\$ 540
Type 200-1 Scope-Mobile® Cart	\$ 60

U.S. Sales Prices FOB Beaverton, Oregon



A new Technical Center:



230,000 square feet devoted to R&D
... part of the Tektronix commitment
to progress in the measurement sciences

TEMPERATURE SCANNER SYSTEMS

50 POINTS/SECOND

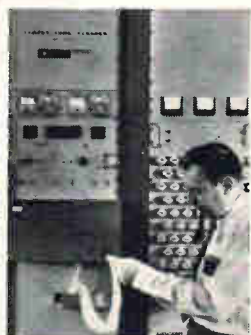
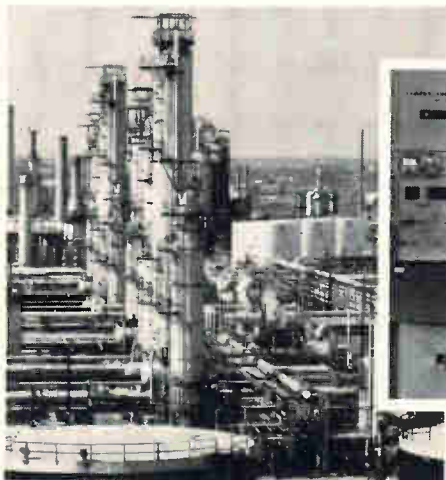

Proven EMC temperature scanner systems are now available for countless applications in a variety of industries. Monitoring temperatures at a rate of up to 50 points a second from 0°C to 500°C with a demonstrated accuracy of 0.1% of full scale, these systems have already saved thousands of man-hours for users in the chemical industry. These modularly-constructed systems are simple to install, operate and maintain. Pushbutton controls provide monitoring ease and flexibility. Modular units are interchangeable. The highly reliable systems are constructed from circuit modules with proven reliability of 4.5 million hours MTBF. This gives the typical system an MTBF in excess of 8,000 hours. *(Other scanning requirements can be accomplished with the same basic techniques and systems components.)*

DIGITAL REMOTE CONTROL DATA SYSTEM

The EMCON Digital Remote Control Data System, designed for railroad, utility, pipeline and other remote applications and proven by over 10,000 system hours of actual field operational testing, provides supervisory control and/or alarm capability using existing communications media without disturbing voice communications, if the latter also uses the same link. It provides for remote control of relays, signals and other devices with positive answer-back. EMCON uses digital computer techniques and solid state circuit modules throughout to ensure positive performance and adjustment-free service. EMCON generally consists of a control receiver at each of the remote stations and a dispatcher's control console and control transmitter at the dispatcher's or controller's office.

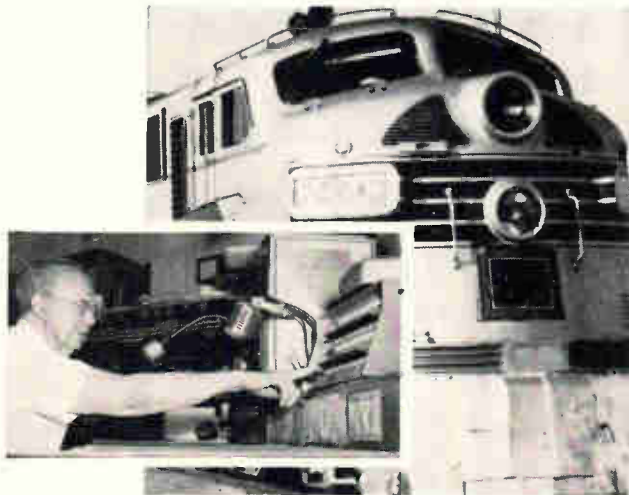

SOLID STATE TEMPERATURE CONTROLLERS



Precision temperature control of remotely located processes is provided by the EMC Temperature Control System which is composed of a Model D6100 Controller, a Model D5085 Load Driver, and a sensor. The Model D6100 narrow band proportional Temperature Controller contains an A.C. bridge (sensor and calibrated ten-turn set-point potentiometer are in one leg of the bridge), error signal amplifiers, bias adjust circuitry and SCR firing circuitry. Temperature response of the controller is extremely rapid with temperature lags less than 0.05°C. Proper design and location of the heater with respect to the load and the sensor are also necessary for optimum performance.

Our representative will be glad to provide additional information on how these and other EMC systems can meet your requirements for monitoring and control.

**ELECTRONIC
MODULES
CORPORATION**

Electronic Modules Corporation • SYSTEMS DIVISION
P.O. BOX 141 TIMONIUM, MARYLAND 21093 TWX-301-0723 301-666-3300

Dielectric bath promotes togetherness in IC's

Liquid cooling may be the answer to the heat dissipation problem that is a major barrier to shrinking the size and expanding the operating speed of integrated circuit systems

By Robert R. Weirather

Government Electronics Division, Motorola Inc., Scottsdale, Ariz.

Tiong C. Go

Semiconductor Products Division, Motorola Inc., Phoenix, Ariz.

Naked integrated-circuit chips may be bathed by liquid coolants in the future. The technique is being explored as a solution to the thermal problems posed by developments that will raise component density in systems. A 10-fold improvement in heat removal methods will be needed when IC's are packed closely together in two-dimensional arrays.

Power density—the number of watts dissipated in a cubic foot of system volume—is the crux of the problem. The density will increase as large-scale integration and other means of packaging circuits come into use,^{1,2} and so will the amount of heat that must be removed.

Today, IC packages transfer heat from the semiconductor chip to either the surrounding medium, usually air, or a heat sink. Forced air, cold plates, and other conventional ways of cooling IC packages have already been exploited, but they limit density.²

Liquid cooling of the chip itself may be a better method. It is estimated that a packaged digital IC that becomes overheated in air at a power level below 250 milliwatts would be safe in a dielectric coolant even if the power applied to the circuit were to be raised above 10 watts. Not that a digital IC could or should be expected to dissipate that much power—but a large number of IC's could go into that cubic foot.

Speed and power

Thermal transfer calculations indicate that un-packaged chips, bonded directly to a substrate, could match the power dissipation of packaged and air-cooled circuits. Chips could be placed in large

numbers on a common substrate, with each chip dissipating between 250 and 325 mw.

The rise in power density that liquid cooling allows is significant to both system and circuit design. It can mean higher system speed and lower packaging costs. In general, denser packaging results in a faster system because wiring delays are less [see "Smaller systems are faster systems," page 129]. Better electrical performance and reliability, reduction in weight, and savings in construction materials, connectors, and other packaging components are also possible when more circuits are put on either a monolithic IC, a substrate or a circuit board.

The speed of some types of logic circuits are also power-dependent. If the designer can count on using more power, he can drive the circuit output further and improve the fanout to other circuits.

Picking a dielectric

Liquid cooling has proved to be highly efficient in power tubes—cooled by water jackets—transformers immersed in oil, in engines and many other applications.

However, the effect of liquid cooling on tiny, relatively fragile IC's wasn't known when the experiments began at Motorola Inc. last July. The results thus far have been encouraging.

Ample proof has been accumulated that liquid cooling allows a multiplication of power density. Assemblies have been operated for several months in dielectric baths without degradation of the IC's or interference with their electrical operation. At

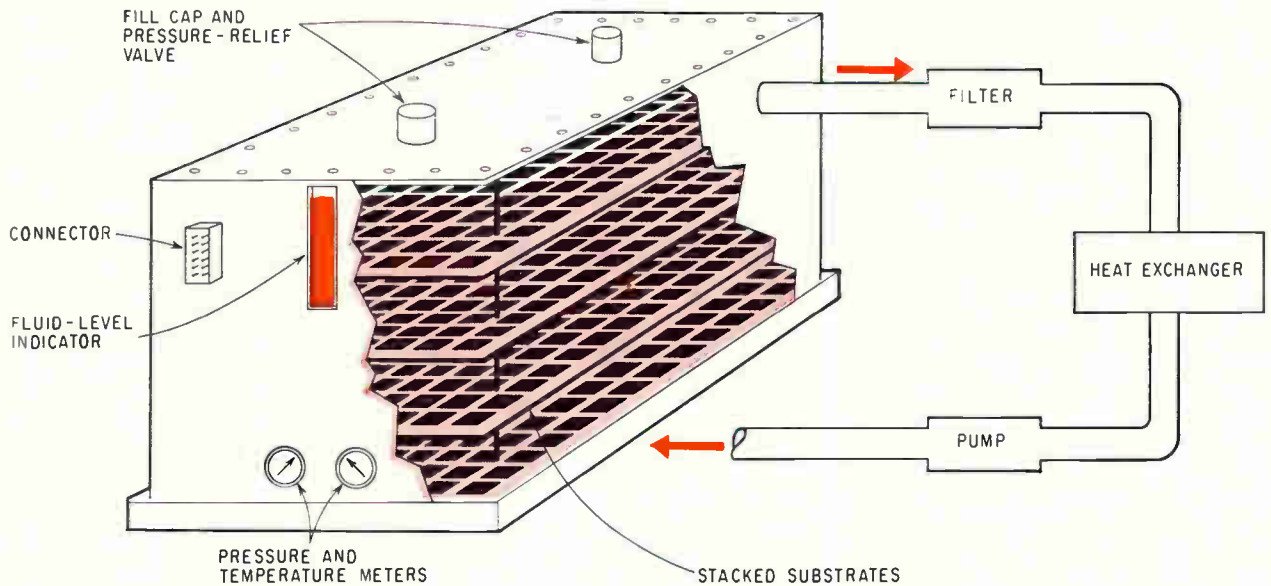

Integrated-circuit chips or packages could be put close together on substrates stacked in liquid-cooling housing. In some applications, external heat exchanger could be replaced by cooling fins on the housing.

first, there was some fear that boiling and circulation of the liquid around the exposed ic chips could rip lose the lead wires bonded to the chips. That hasn't happened during the experiments and fluid mechanics studies indicate it to be highly unlikely.

Water couldn't be used as a coolant, since it degrades ic's—chips in water failed in a few days. Most of the conventional liquid dielectrics are unsuitable because they lack the necessary physical, electrical, or chemical characteristics.

The choice of coolants boiled down to the Freons made by E.I. du Pont de Nemours & Co. and fluorochemicals made by the Minnesota Mining and Manufacturing Co. (3M). These meet the following requirements:

- Chemically, they are highly inert to semiconductor-device materials.
- Electrically, they have a low dielectric constant,

which keeps signal propagation velocity high in the ic intraconnections and losses low.

- Thermally, they have a high heat of vaporization and other desirable thermodynamic properties, so heat easily flows from the ic into the liquid. Their boiling points are lower than the ic's safe operating temperature, but high enough to allow heat transfer when the ambient temperature is well above normal room temperature.

- Physically, they are viscous enough to be pumped without difficulty.

The heat transfer and physical stress computations that follow are based on the properties of Freons.

Experiment startup

In the initial tests, one circuit was operated in Freon C51-12 six weeks without detectable degra-

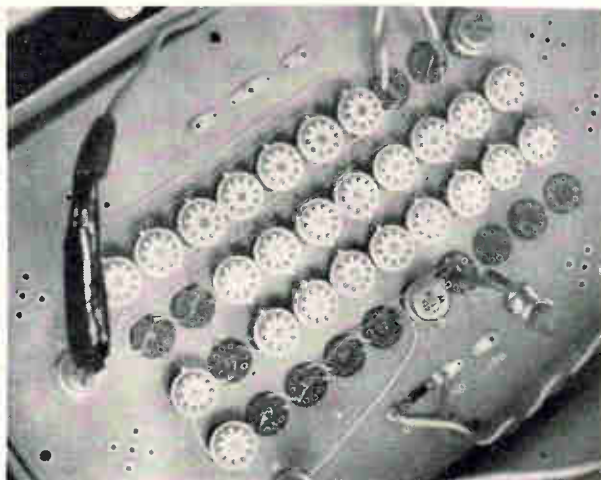

Experimental cooling chamber is simply a housing with a close-fitting plastic cover and tube sockets for connections through housing walls. Lamp at front of housing flickers when test circuitry is operating.

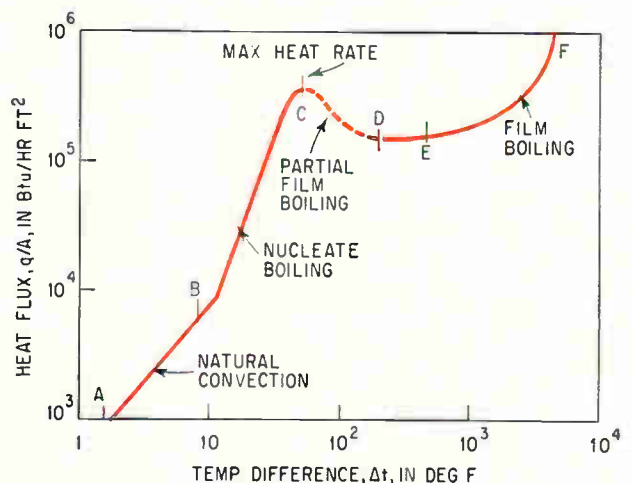

Boiling curve indicates relationship between heat flux and difference between temperatures of heat source and liquid. Heat is removed rapidly from heat source until at point C vapor film forms and impedes heat transfer.

dation. This is a perfluorodimethylcyclobutane that boils at 45° C [see table on page 127]. Approximately the same results have been obtained with FC-78, a 3M fluorochemical with properties similar to Freon C51-12.

Initial tests with single circuits showed that liquid cooling tends to stabilize the temperature of an ic, even though power applied to the circuit continues to increase [see graphs below and on page 128]. In contrast, an ic operated in air gets hotter and hotter as the applied power is increased.

To monitor chip temperature, a diode in the test ic was calibrated. With a constant forward current of 100 microamperes, a diode forward voltage drop of 2.06 millivolts corresponds to a temperature rise of 1° C, graph below, left. The adjoining graph shows the results of using different types of Freon to cool sample circuits mounted on TO-5 headers. The package tops were left off, so the coolants were in direct contact with the bare chips.

Examination of the graphs will show that an ic

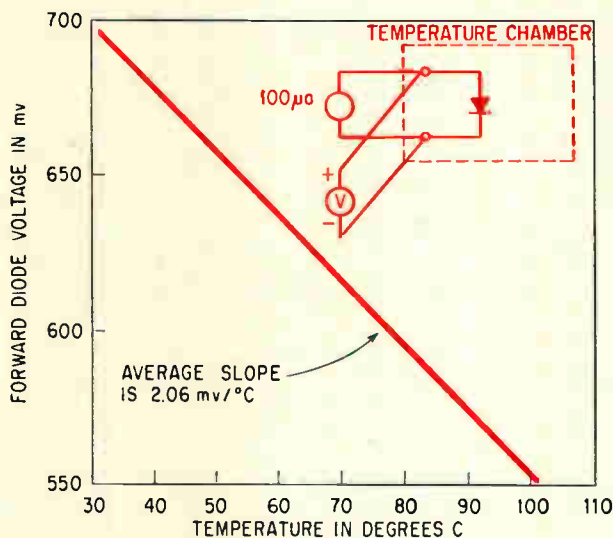

Temperature of IC's is monitored by measuring diode voltage. This calibration curve was obtained with the test setup shown in color.

mounted on a TO-5 header and cooled in Freon will have a temperature of around 140° F at a power dissipation of about 2 watts. This same circuit, operated in air, would reach that temperature at a power dissipation of only 200 mw. If the package were in air, but cooled by either forced air or a heat sink with radiating fins, power dissipation might safely be raised to 300 mw or so.

Boiling point

Liquids transfer heat by convection, conduction, and boiling. Once a liquid reaches its boiling point, it remains at about that temperature if the vapor pressure is constant. The chip temperature also remains close to the boiling point if the coolant has a sufficiently high specific heat—defined loosely as its capacity to absorb heat. The chip won't overheat unless it dissipates so much heat that a wall

of vapor forms between it and the liquid.

A boiling curve clarifies the heat transfer process. The curve on page 124 is the heat flux, q/A , versus the temperature difference, Δt , when water is boiled by an electrically heated platinum wire.⁴ The temperature difference is that between the wire temperature, t_w , and the liquid's saturation temperature, t_s . The curve is a general one, not restricted to the case of a heated wire.

Natural convection removes the heat from the wire until—at point B on the curve—vapor bubbles start rising from the wire. The bubbles stir the liquid and heat is transferred more rapidly than by natural convection so q/A rises sharply. The section of the curve from B to C is known as the nucleate boiling region.

At point C—the peak of the nucleate region—so many bubbles have formed that they tend to merge and spread over the entire wire surface. Here, the circuit begins to run into trouble. The curve from point C to point D is known as the partial

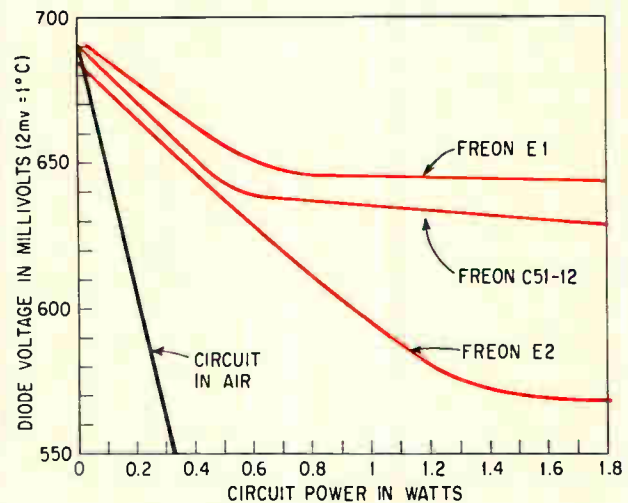

Integrated circuit operated in air quickly heats up, as indicated by sharp drop in diode voltage (black curve). In dielectric fluids, same circuit remains relatively cool at several times the applied power (color curves).

nucleate, or partial film boiling region. An unstable film of vapor may form on the wire, collapse and reform due to circulation currents. The heat flux drops to point D. This type of boiling heat transfer is abnormal.

Usually, the curve will jump from point C to point D and rise until the metal melts at point F, unless the power input is reduced or an auxiliary heat sink is placed on the package. The chip surface temperature will rise rapidly because the temperature difference between the surface and the liquid must be large before a large amount of heat can be rapidly transferred across the vapor layer by conduction and radiation.

Heat flux is raised if the boiling liquid is forced to flow over the hot surface. Heat flux due to forced convection is then added to boiling heat transfer, as in equation 1 [all equations are given on page 126,

Cooling equations

- 1
$$\left(\frac{q}{A}\right)_{\text{total}} = \left(\frac{q}{A}\right)_c + \left(\frac{q}{A}\right)_b$$
- 2
$$\left(\frac{q}{A}\right)_{\text{max}} = \rho_v h_{fg} = 0.18 \left[\frac{\sigma(\rho_f - \rho_v) g g_o}{\rho_v} \right]^{1/4} \left[\frac{\rho_f}{\rho_f + \rho_v} \right]^{1/2}$$
- 3
$$\frac{C_{sf}(t_w - t_a)}{h_{fg}} = C_{sf} \left[\frac{q}{\mu_f h_{fg}} \sqrt{\frac{g_o}{g(\rho_f - \rho_v)}} \right]^{1/3} \left[\frac{\mu_f C_{sf}}{k_f} \right]^{1.7}$$
- 4
$$\frac{q}{A} = 6.063 (t_w - t_a)^3 = 6.063 \Delta t^3$$
- 5
$$\frac{q}{A} = 125 \Delta t^3$$
- 6
$$\left(\frac{q}{A}\right)_{\text{min}} = 0.09 \rho_v h_{fg} \left[\frac{g(\rho_f \rho_v)}{\rho_f + \rho_v} \right]^{1/2} \left[\frac{g_o \sigma}{g(\rho_f - \rho_v)} \right]^{1/4}$$
- 7
$$\Delta t_{\text{min}} = 0.127 \frac{\rho_v h_{fg}}{k_v} \left[\frac{g(\rho_f - \rho_v)}{\rho_f + \rho_v} \right]^{2/3} \left[\frac{g_o \sigma}{g(\rho_f \rho_v)} \right]^{1/2} \left[\frac{\mu_f}{g_o(\rho_f - \rho_v)} \right]^{1/3}$$
- 8
$$q = h A (t_w - t_f)$$
- 9
$$h = 0.664 K_f \left(\frac{\mu_f C_{sf}}{K_f} \right)^{1/3} \left(\frac{V_\infty}{\nu L} \right)^{1/2}$$
- 10
$$h_x = 0.332 K_f \left(\frac{\mu_f C_{sf}}{K_f} \right)^{1/3} \left(\frac{V_\infty}{\nu X} \right)^{1/2}$$

Stress equations

- 11
$$V_b \approx 1.18 \frac{t_c}{t_c + t_d} \left[\frac{g_o g \sigma (\rho_f - \rho_v)}{\rho_f^2} \right]^{1/4}$$
- 12
$$\frac{F_D}{A} = C_D \left(\frac{\rho_f V_b^2}{2} \right)$$
- 13
$$N_{RE} = \frac{V_b D}{\nu_f}$$
- 14
$$S = \sqrt{\left(\frac{F_D L^2}{8_f} \right)^2 + \left(\frac{F_D L}{2} \right)^2}$$

Chip cooling values

Value	E2	C51-12
q/A_{max} in Btu/hr ft ²	48,500	64,000
Δt_{max} in °F (gold surface)	20	8
q/A_{min} in Btu/hr ft ²	2,320	2,350
Δt_{min} in °F	135	321
h in Btu/hr ft ² °F	650	650
h_x in Btu/hr ft ² °F	458	460
C_{sf} (see equation 3)	0.0105	0.00111

terms are defined on page 127, and values given in the tables below and on page 127].

A still higher heat flux can be achieved by pumping the liquid away from the chip, cooling the fluid, and reflowing it over the chip. Heat flux will depend upon the liquid velocity as well as the chip-liquid temperature difference.

Heat transfer characteristics of Freons E2 and C51-12 near the peak point of nucleate boiling can be estimated with equation 2.^{5, 6} The q/A_{max} values for a gold surface have been calculated and are tabulated below. Du Pont researchers have experimentally determined the temperature difference, Δt , at q/A_{max} . Values for silicon or glass surfaces aren't known yet because of experimental difficulties. However, to calculate heat transfer from an ic chip, Δt can be assumed to be about the same as for gold.

Equation 3 is used to estimate heat flux when Δt is less than that of q/A_{max} .⁷

The constant, C_{sf} in, equation 3 is 0.0105 for Freon E2 and 0.00111 for Freon C51-12, when the given values of q/A_{max} and Δt are used to solve equation 3. Now, equation 3 can be simplified to equation 4 for Freon E2, and to equation 5 for Freon C51-12.

Heat flux can be calculated conveniently with the plots on page 129 of equations 4 and 5. The curves correspond to the boiling curve between points B and C. The C to D portion of the curve can be predicted from the minimum heat flux and temperature difference, found with equations 6 and 7.

These equations yield q/A_{min} and Δt_{min} values tabulated below. The minimum and maximum values are plotted as the black curves on page 129.

A header helps

Under adverse conditions, a 50-mil-square ic chip mounted on a TO-5 header will dissipate at least 2 watts in Freon E2 and 3 watts in Freon C51-12 before the circuit burns out. This would be the power limit if many ic's were placed in a small container or if the ambient temperature was high.

The chip would withstand more than 10 watts if the Freon E2 is pumped out of the container at a velocity of 10 feet per second, cooled to 77° F, and then returned to the container. If Freon C51-12 is used, dissipation should be at least 8 watts.

Most of the heat is given off by the header, whose surface is much larger than the chip's. If the bare chips are mounted directly to a circuit board, the maximum boiling heat transfer rate per chip will be 0.327 watt per chip in C51-12 and 0.248 watt per chip in Freon E2.

The rate can be greatly stepped up by pumping and cooling the liquid. The rate would vary from chip to chip. The rate depends on a chip's distance from the leading end of the circuit board for two reasons: the coolant becomes warmer as it flows over the chips, and the board may act as an airplane wing to alter the liquid flow (this is known as the boundary-layer effect).

If the boards carrying the headers or circuits are

Properties of Freon dielectric coolants

Property	near boiling point			At 77° F		
	E1	E2	C51-12	E1	E2	C51-12
Boiling point, °C.....	39.0	101.0	45.0			
°F.....	102.2	213.8	113.0			
C_f = specific heat in Btu/lb. °F.....	0.254	0.274	0.285	0.245	0.244	0.253
h_{fg} = heat of vaporization in Btu/lb....	41.4	31.3	40.1			
K_l = thermal conductivity of liquid. (est.) in Btu/hr. ft. °F.....	0.050	0.0501	0.060	0.05	0.05	0.06
K_v = thermal conductivity of vapor. (est.) in Btu/hr. ft. °F.....	0.0080	0.0089	0.0070			
Molecular weight.....	286.03	242.08	300	286.03	242.08	300
μ = dynamic viscosity in lb./hr. ft....	1.09	0.714	1.82	1.21	2.66	2.38
γ = kinematic viscosity in ft. ² /sec....	0.325×10^{-5}	0.215×10^{-5}	0.505×10^{-5}	0.364×10^{-5}	0.715×10^{-5}	0.632×10^{-5}
ρ_l = liquid density in lb./ft. ³	93	92.1	100	96.0	103.5	104.4
ρ_v = vapor density in lb./ft. ³	0.70	0.92	0.730			
σ = surface tension in lb./ft.....	5.85×10^{-4}	4.18×10^{-4}	6.61×10^{-4}	7.13×10^{-4}	8.85×10^{-4}	7.96×10^{-4}

angled about 10 degrees from the horizontal, freshly cooled liquid will strike each circuit. The convection heat rate will rise, the circuits will cool more quickly, and the power dissipation can be increased significantly. Also, the boiling heat rate can be raised still higher by ultrasonically agitating the liquid.

Resistive wire bonds, incidentally, are hot spots. The liquid boils more quickly above these spots. This could provide a means of identifying faulty bonds in liquid cooled assemblies.

Boiling heat transfer

The estimates above are ball-park figures obtained by calculations. To keep the estimates of boiling heat transfer conservative, it was assumed that the liquid container is a poor heat conductor. Therefore, the heat from the circuits would build up in the liquid. Even a low power input would cause the liquid to approach its boiling point.

As a starting point, profiles of the temperature gradient across a TO-5 header were estimated and plotted, see page 128. Stable dissipation was assumed. Using these profiles as a guide, temperatures of different header surface areas were estimated. The heat dissipation from each area on the top and bottom of the header was obtained from the graphs on page 129.

Thermal resistance of the ic chip and its bonding area was assumed to be 3° F an hour per British thermal unit (Btu). This gave an estimate of the chip's surface temperature and allowed the chip's heat dissipation to be taken from the graphs.

The predicted heat transfer for Freon C51-12 is given by the upper curve in black in the graph on page 128. The lower curve in the graph represents experimental results when the liquid was in an aluminum container, a good heat conductor. Since calculations were based on the worst conditions and the experiments on best conditions, real-

Definitions of terms

A = surface area in square feet

C_D = drag coefficient

C_f = specific heat

C_{sf} = constant dependent on surface-fluid combination

D = diameter of wire (0.001 inch in examples given)

f = sag of wire

F_D = fluid drag over a given area

g = gravitational acceleration

g = gravitational constant (32.16 ft./sec./sec.)

h = average coefficient of heat transfer in Btu/hr. ft.² °F

h_{fg} = heat of vaporization in Btu/lb.

h_x = local heat transfer coefficient

K_l = thermal conductivity in Btu/hr. ft. °F

K_v = thermal conductivity of vapor in Btu/hr. ft. °F

L = length of surface in feet

N_{RE} = Reynolds number

q = heat dissipation in Btu/hour

q/A = heat flux in Btu/hr./ft.²

$(q/A)_b$ = boiling heat transfer

$(q/A)_c$ = convection heat transfer

S = stress in pounds per square inch

t = temperature in degrees Fahrenheit

t_c = temperature of the chip

t_d = temperature of dielectric

t_l = liquid temperature

t_s = saturation temperature of liquid

t_w = surface temperature of heat source

Δt = difference between temperature of heat source and saturation temperature of liquid

V_s = velocity of liquid flow

V_b = bubble velocity in ft./hr.

X = distance from leading edge in feet

μ = dynamic viscosity in lb./hr. ft.

ν = kinematic viscosity in ft.²/sec.

ρ_l = liquid density in lb./ft.³

ρ_v = vapor density in lb./ft.³

σ = surface tension in lb./ft.

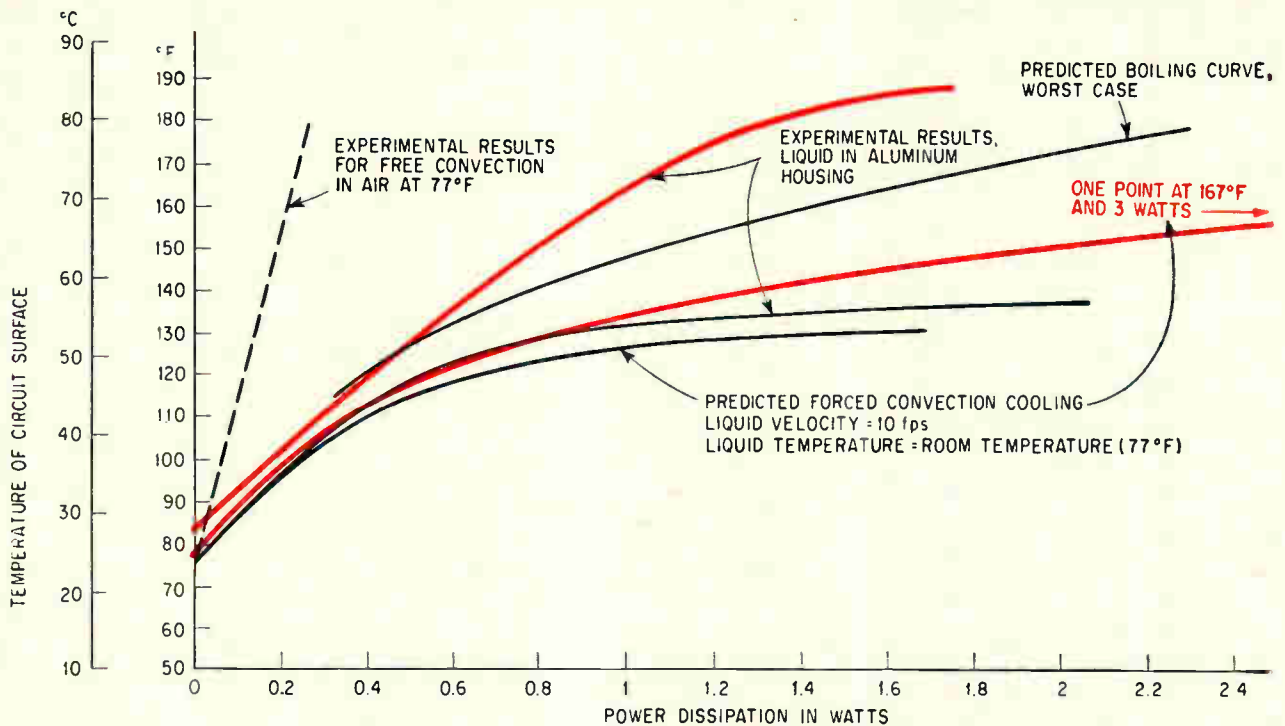

Experimental results are contrasted with calculated cooling rates for Freon C51-12 (black curves) and Freon E2 (color curves). Even without forced convection, a circuit in Freon E2 gets no hotter than a circuit in air despite a five-fold increase in applied power.

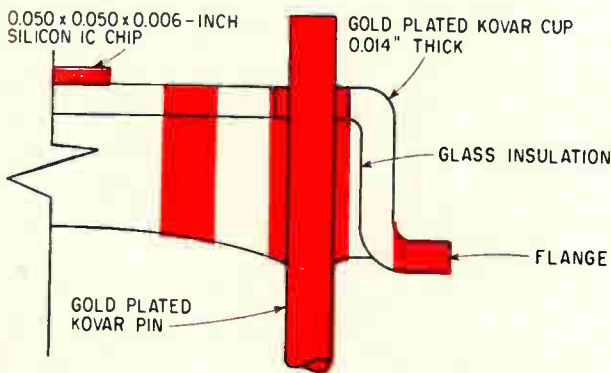

Header surfaces are divided into chip area and six concentric rings to aid heat transfer computation.

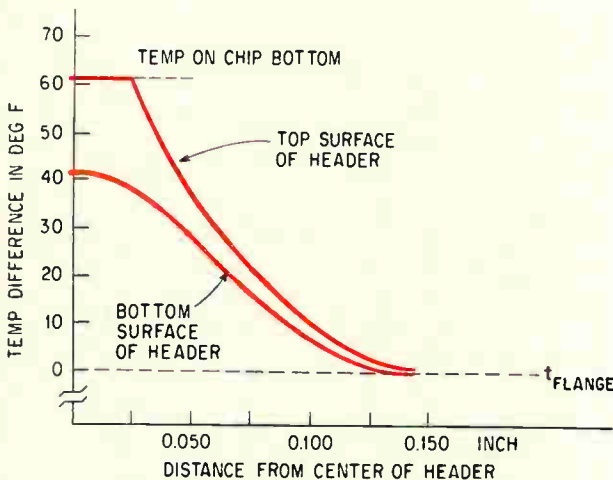

Thermal profiles at the top and bottom of a typical header. Heat flows from chip toward the flange.

istic values would most likely fall between the two curves.

Lower temperatures than those indicated by the curves would result if the container had cooling fins or more liquid were used, but these would be impractical for most applications.

The lower curve is an estimate based on pumping the liquid out of the container at a rate of 10 feet per second and cooling it to room temperature, 77° F. This curve is obtained by combining the heat transfer calculations and convection heat transfer calculations, using equations 8, 9 and 10. Values of the heat transfer coefficients h and h_x are tabulated on page 126; h_x is used to calculate convection heat transfer from the chip surface.

Heat transfer by convection and boiling can now be calculated and the total heat dissipation obtained with equation 1. The results are those plotted in the lower curve in black on the graph above.

If the ambient temperature is below 113° F (45° C), Freon C51-12 is the better choice because it dissipates more heat at any given circuit temperature. However, Freon E2 must be used when the ambient temperature is only slightly below 113° F or above that temperature. The curves in color in the graph above are heat transfer curves for Freon E2.

No estimate was made for Freon E2 in a poorly conducting chamber that lacks an external heat exchanger. The chip temperature would be close to the burnout point when Freon E2 approaches its boiling point. For instance, the header will dissipate only about 2.3 watts at 300° F (150° C) under the adverse conditions.

Sloshing around

Some packaging engineers have worried about the possibility of the moving liquid tearing loose lead wires bonded to the chip. There was no damage to the test IC's and analysis shows it to be unlikely as long as moderate coolant flow rates—for example, 10 feet per second—are used.

Three forces act on the wire: buoyant force, the weight of the wire, and drag due to fluid flow and circulation currents in the rapidly boiling coolant. In Freon, the buoyant force is about 0.42×10^{-4} pounds per inch of wire and the weight is 0.548×10^{-3} pounds per inch.

Assume the liquid velocity on the header top equals the velocity of the rising bubbles. This is calculated by equation 11^{6,7} as 0.16 feet per second. Then the next equations may be used to calculate drag force.

The resultant drag force, F_D , on the wire is negligible compared with the wire's weight and therefore too small to affect the bond strength. Drag caused by boiling alone in Freon E2 is calculated as about 0.30×10^{-4} pounds per inch of wire, from equation 12. The term C_D in equation 12 is usually found in fluid mechanics tables, from the Reynolds number. The Reynolds number is calculated with equation 13.

If the coolant is pumped past the wire at a rate of 10 fps, in a convection cooling system, the drag force will still be too low to break the wire bond. F_D will be about 0.03 pounds per inch of wire.

An approximate stress analysis can be made using the catenary equations for flexible wires,⁸ since the gold lead wires are only 1 mil in diameter and have a span of 100 mils (0.1 inch). Assuming the curvature stress is negligible, equation 14 gives a stress of 9,000 pounds per square inch when the coolant

Smaller systems are faster systems

If all the integrated circuits in a 10,000-circuit digital system were placed end to end, the designer would probably be fired. He might try putting the IC's cheek-by-jowl in a two-dimensional plane—on a circuit board.

If the IC's are in flatpacks or TO-5 cans, the linear assembly would be nearly 100 yards long, causing some ridiculous wiring delays. However, the planar assembly would pare down the worst-case wiring length to 33 inches. Each package forces a spacing of about $\frac{1}{3}$ inch between centers of neighboring circuits. On the average the path length would be around 15 inches. An electromagnetic signal takes some $2\frac{1}{2}$ nanoseconds to travel 15 inches in an epoxy-glass printed-circuit board.

Such a planar assembly would be a reasonable design only if the propagation delay per logic stage is far less than $2\frac{1}{2}$ nsec. There is no point in using the design to interconnect the fast logic gates, which have a propagation delay of less than 1 nsec. The wiring delays reduce the effective speed of the gates to $3\frac{1}{2}$ nsec.

To capitalize on the circuit speed, the designer would have to reduce path lengths by putting more circuits in a package—that is, large-scale integration.¹ In the extreme case, he might try to put the entire system in one package.

This approach may bring some cost advantages also, since packages represent much of the cost of conventionally packaged IC's. Furthermore, the protection of the circuits from contaminants would depend on only one hermetic seal rather than 10,000.

Liquid cooling alone certainly won't make 10,000-circuit IC's feasible. But it could allow the designer to put the IC's into a relatively small number of large-scale integrated arrays or onto small substrates packed closely together.

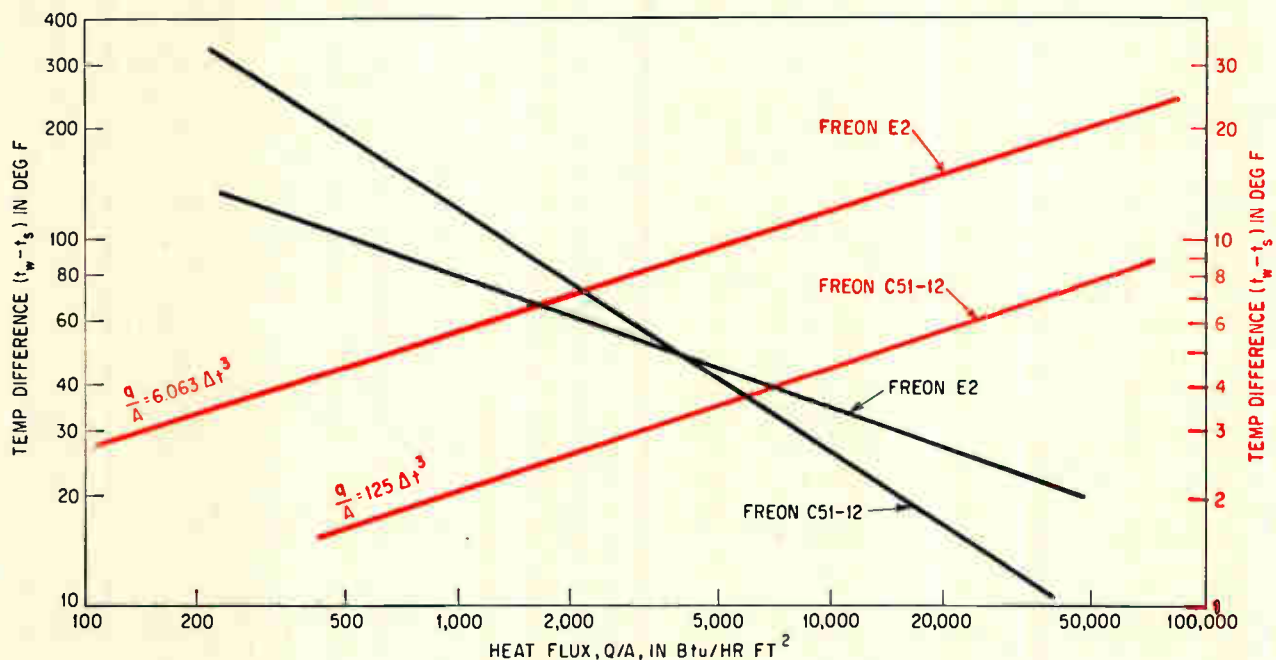

Heat transfer rates of IC's in two types of Freon. Curves and temperature scale in color represent solutions to equations for nucleate boiling and those in black for partial nucleate boiling.

flow is 10 fps. The tensile strength of gold is 20,000 pounds per square inch, so the safety factor is 2.2.

System tryout

As a realistic test, a 32-chip test system was put into a liquid-filled housing [photo on page 124] to determine whether the liquid would degrade the IC's.

The circuits ran in Freon C51-12 for 14 weeks with no IC failures and then four weeks in FC-78 fluorochemical liquid, again without failures. A very slight pitting of the chips occurred, but did not affect operation. The system operated continuously except for short periods when the housing was opened to replenish coolant lost through a slow leak.

The housing has a tight-fitting Plexiglass cover. As the coolant evaporates, the vapor pressure raises the boiling point slightly and prevents outside contaminants from diffusing into the housing. The vapor condenses on the upper walls and cover, and returns to the bath.

The system tested is a ring oscillator, frequency divider, and lamp. The oscillator frequency of 6 megahertz is reduced by the divider to 23 hertz at the lamp, causing it to flicker. A glance tells if the system is working.

There are 14 OR/NOR gates in the oscillator, a total of 28 gates. The average propagation time of these circuits is less than 1.5 nanoseconds and maximum power dissipation per package is 360 mw. The 18 master-slave flip-flops in the divider can be toggled at 250 Mhz. Effective delay per flip-flop is 4 nsec and maximum power dissipation is nearly 300 mw.

The OR/NOR gates have a single layer of thin-film wiring and the flip-flops have two layers. Both types are mounted on 10-pin TO-5 headers. Two octal-pin tube sockets are the connections through the housing walls.

Before immersion, the a-c and d-c characteristics of the IC's were measured, and microphotographs made of three of each type of chip. After immersion, when the liquid temperature stabilized, photos were taken of the oscillator period, risetime and waveforms, and the divider's waveform. There has been no detectable change in the operation and only minor changes in appearance of the IC's since the experiments began in mid-1966.

To monitor temperature by the diode technique described earlier, connections were made through the circuit board to a diode in each type of circuit. The gate diode was found to be shorted. However, measurements of a flip-flop diode showed that chip temperature stabilized at 52° C when the system power was 1 ampere and the bias voltage 5.2 volts—normal power dissipation for these IC's. The IC temperature was held at about 75° C below the normal maximum operating temperature.

System cooling

An actual operating digital system would have a much higher power density than the test system.

Liquid would be circulated through an external heat exchanger, and methods of monitoring liquid level, temperature, and pressure would be provided, as in the sketch on page 124.

Circulation of the liquid through the heat exchanger might be eliminated by making the chamber walls cold plates. Or, the chamber could be made lower and wider to increase the radiative cooling area. For additional radiation the chamber walls could be finned.

Miniature circuit boards or other substrates could be stacked in the housing and coolant flowed between them. Bare chips would be bonded to the substrates and interconnected by wiring on the substrates.

References

1. Samuel Weber, et al, "LSI: the technologies converge," *Electronics*, Feb. 20, p. 123.
2. E.C. Garth and Ivor Catt, "Ultraplasmic IC's require shorter faster interconnections," *Electronics*, July 11, 1966, p. 103.
3. E.I. du Pont de Nemours & Co. Inc., "Freon Technical Bulletins X-149 and EL-8A," Wilmington, Del.
4. S. Nukiyama, Japanese Society of Mechanical Engineers, Japan, Vol. 57, p. 367, 1934.
5. N. Zuber, *Transactions ASME*, Vol. 80, p. 711, April 1958.
6. N. Zuber and M. Tribus, "Further Remarks on the Stability of Boiling Heat Transfer," UCLA Report No. 58-5, January 1958.
7. W. Rohsenow and H.Y. Choi, "Heat, Mass and Momentum Transfer," Prentice Hall, Englewood Cliffs, N.J., 1961.
8. S. Timoshenko and D.H. Young, "Engineering Mechanics, Part One—Statics," McGraw-Hill Inc., New York, 1956.

Bibliography

- R.L. Daughtery and A.C. Ingersoll, "Fluid Mechanics Engineering Applications," Kogakisha Co., Tokyo, 1954.
- M. Jakob, "Heat Transfer," Vol. 1, John Wiley & Sons Inc., New York, 1956.
- V.M. Faires, "Thermodynamics," The Macmillan Co., New York, 1957.
- C.H. Gilmour, "Chemical Engineering Progress," 54-10, pp. 77-79, September 1958.
- E. Eckert and R. Drake Jr., "Heat and Mass Transfer," McGraw-Hill Inc., New York, 1959.
- N. Zuber, "Hydrodynamics Aspects of Boiling Heat Transfer," Ph.D. dissertation, UCLA, June 1959.
- P. Berenson, "Transition Boiling Heat Transfer from a Horizontal Surface," AICHE paper No. 18, ASME-AICHE Heat Transfer Conference, Buffalo, N.Y., August 1960.
- W. Geidt, "Principles of Engineering Heat Transfer," D. Van Nostrand, New York, 1961.
- J.R. Baum and R.J. Jimenez, "Integrated Circuit Thermal Study," Motorola Inc., Scottsdale, Ariz.

The authors



Robert R. Weirather designs amplifiers in Motorola Inc.'s antenna and microwave group, but was loaned to the firm's Semiconductor Products division to take part in liquid-cooling experiments. He is working for a master's degree in electrical engineering at Arizona State University.



Tiong C. Go is a senior engineer in the Semiconductor Products division. He researches and develops equipment for laboratory, test and production use. Go joined Motorola in 1965, a year after receiving his master's degree in mechanical engineering at Stanford University.

Parylene proves itself

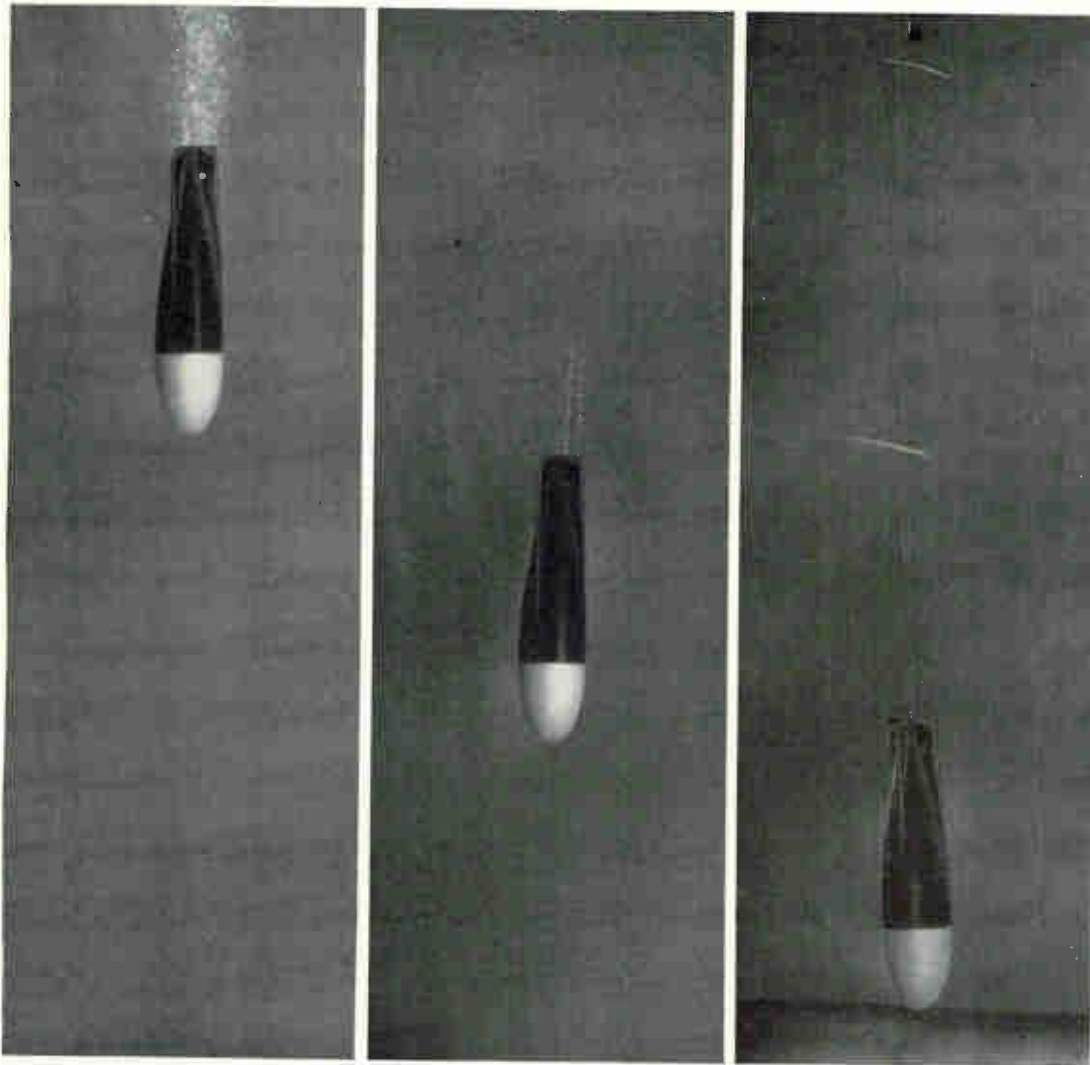

at 250 fathoms.



The Sippican Expendable Bathythermograph System accurately and rapidly measures and records the temperature of ocean waters down to depths of 1,500 feet. Heart of the system is an 8-inch probe, that carries, as its temperature-sensing element, a miniature-sized thermistor, shown on the left.

The protective coating for the thermistor had to be extremely thin (0.5 mil), yet had to be formed as a uniform, continuous, adherent layer, even around sharp corners.

Only BAKELITE parylene was able to meet these critical requirements and also provide the necessary dielectric and corrosion-preventing properties. The Sippican Corporation coated the thermistors under a parylene license from Union Carbide Corporation.

The ability of parylene to be vacuum-deposited in uniform micro-thin coatings is unmatched. True conformal coatings can be as thin as 0.002 mil or as thick as 3 mils or more...and they

won't bridge, run, sag, bloom, blister, wrinkle or blush! As a conformal coating, parylene is a primary dielectric, an excellent moisture barrier, resists softening at high temperatures and its chemical resistance is outstanding.

With all of these special properties, parylene is recommended as conformal coatings on discrete components or high density circuitry, for fast responding sensing probes, photo-cells or memory units.

This plastic is already used as ultra-thin pellicles for such applications as beam splitters in optical instruments and windows for nuclear radiation measuring devices.

Thin coatings of BAKELITE parylene can even be used to increase the over-all heat transfer coefficient of desalination condenser tubes by promoting dropwise condensation.

Possibly your product could benefit from this new plastic. For more information, write to Dept. E-4, Union Carbide Corporation, Plastics Division, 270 Park Avenue, New York, N. Y. 10017. BAKELITE is a registered trade mark of Union Carbide Corporation.



Be a hero — design something with our new conductive-film pendulum pot—

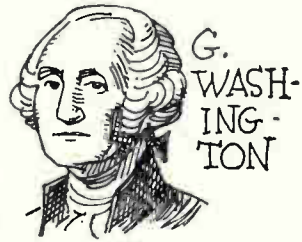

(and win your very own certificate of heroism).

Strong point of our new transducer is infinite resolution in both linear and nonlinear functions. Trigonometric, logarithmic, or any empirical functions can be generated to provide a smooth transition of a mathematical characteristic. This unique versatility makes it easy to win your certificate of heroism. Here are a few more specs to help you along.

The transducer consists of a pendulous high-density mass vertically suspended from an ultralow-torque bearing system. Hermetically sealed silicone fluids of varied viscosities mean you can use practically any damping ratio you like. What's more, your design element can be of deposited conductive material or of wire, wound in sizes down to .0003 inches.

Our ability to trim the resistive element down *after* manufacturing means, too, that your design can include a high order of accuracy conformity—up to .05%! And you needn't worry about striction because it's kept at a minimum with Litton's smooth track and light wiper pressure.

We've already thought of a few of the more obvious applications, but let's see what you can come up with. We'll send your certificate by return mail, and if yours is one of the 50 best ideas we'll publish it in our next IDEA BOOK.

LITTON INDUSTRIES 
POTENTIOMETER DIVISION

If your present supplier can't solve your potentiometer problem, try us. For single-turn and multiturn, linear and functional, wirewound and conductive film, ganged or unitized with servo modules—Litton begins where others leave off.

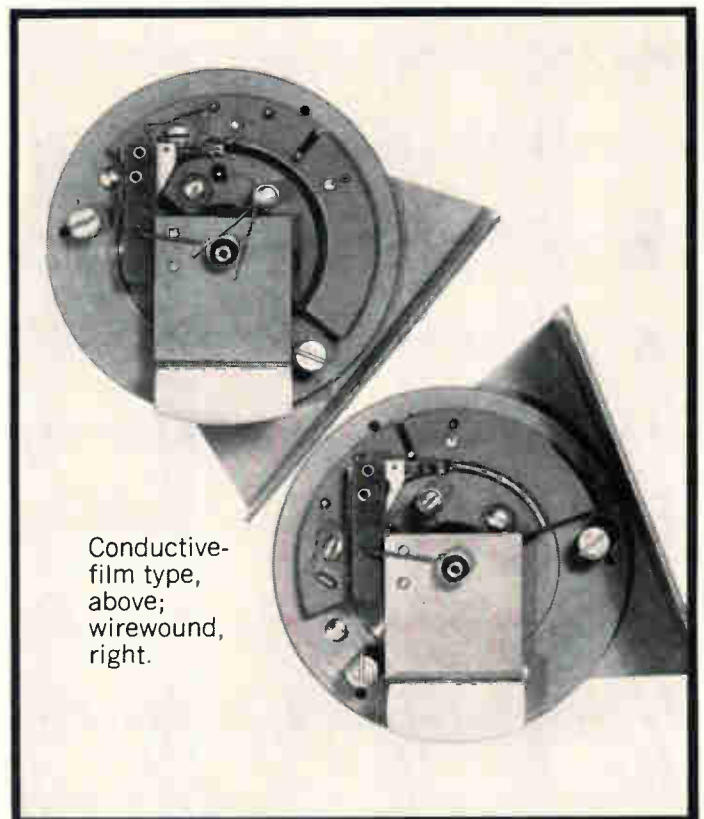

Conductive-film type, above; wirewound, right.

Litton Industries, Potentiometer Division
226 East Third Street, Mt. Vernon, New York 10550

- My idea for an application is attached. Send my hero certificate.
- I have an idea, but need more data first. Send specs.

Name _____ Title _____

Company _____

Address _____

City _____ State _____ Zip _____

New Tally 500 series photoelectric tape readers work up to 1000 characters per second.

That's not unique.

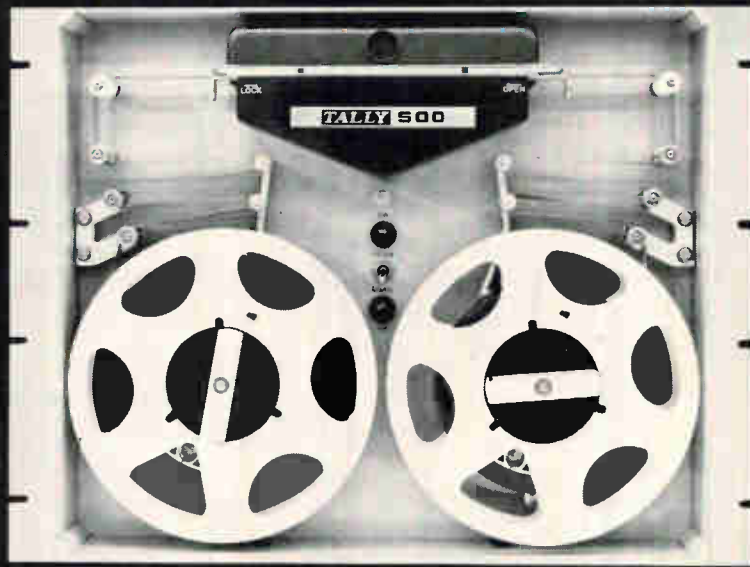

But working without pinch rollers, friction brakes, clutches, or solenoids – that is!

There's no point in Number 1 introducing just another "me too" product. Just to give you an idea of how good the new line is, in a recent life test, one photoelectric reader ran for 15,000 hours at maximum speed without a failure. You can see why we say these new readers represent genuine "state of the art" achievement. Adding them to the Tally line rounds out the broadest line of perforated tape equipment on the market today.

The 500R, 500RF, and 500T.

These three readers operate at up to 200 characters per second asynchronously (stop on character), up to 500 char/sec in the synchronous or free running mode (stop before next character), and 1000 char/sec in the wind/search mode. All feature printed motor direct capstan drive, and bi-directional reading and winding. The Model 500R (recess mounted) and the Model 500RF (flush mounted) are reader and spooler com-

binations, while the Model 500T comes without the reel servo system. For tape handling only, two spoolers using printed circuit motors and proportional reel servo are offered, one with 8 inch reels, the other with 10½ inch reels.

MIL-SPEC reader, Model 500RM and "ruggedized" reader, Model 500RF, 10

Fully militarized, the Model 500RM is the first high speed reader that meets all applicable military specifications without exception. Featuring the same basic design as other Series 500 photoelectric readers, this unit will work in environments of -40°F to +145°F, in humidities of 100%, and take more than 15 g's shock. Pertinent RFI specs are met. MTBF is 5,000 hours. Expected life is 10,000 hours minimum.

Where severe environmental conditions are not encountered, the Model 500 RF/10 will perform with the same accuracy and life for about half the cost. Reading speeds for both readers are



Model 500 RM

150 char/sec asynchronously, 500 char/sec synchronously, and 1000 char/sec wind/search.

Full disclosure.

For all the facts, call your full service Tally sales engineer (see EEM), or write Ken Crawford, Tally Corporation, 1310 Mercer Street, Seattle, Washington 98109. In the U.K. and Europe, address Tally Europe, Ltd., Radnor House, 1272 London Road, London, S.W. 16, England.

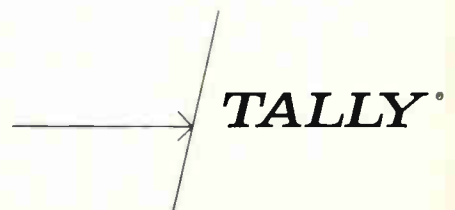

If you want the best connectors money can buy

start with this catalog first!



CONDENSED CATALOG

- * printed circuit
- * removable contacts
- * center screwlock
- * microminiature...
subminiature...
and miniature
rack and panel
- * power
- * terminal blocks
- * special designs

ELECTRONIC CONNECTORS FOR
COMMERCIAL & MILITARY APPLICATIONS



CONTINENTAL CONNECTOR CORPORATION

WOODSIDE, LONG ISLAND, NEW YORK 11377

*Write
for it
today.*

This booklet gives capsule reviews of specifications and general information on Continental's precision electronic connectors. Check your requirements against the most complete and reliable product lines for printed circuitry and rack and panel interconnection applications. Each connector series meets the critical standards of design and application engineers in both commercial and military systems including computers, electronic data processing, communications, aerospace, telephone and other intricate electronic equipment.

For the Sales Representative Nearest You, See Our Listings in EEM and VSMF Directories.

CONTINENTAL CONNECTORS

CONTINENTAL CONNECTOR CORPORATION ■ WOODSIDE, NEW YORK 11377



0.020" of Hipernom[®] shields like .030" of the magnetic alloy you're probably using.

Hipernom meets the requirements of Federal Standard No. 222

It can keep your costs competitive in the 1970's.

Westinghouse Hipernom's high permeability lets you use thinner, lighter shielding against magnetic fields from DC to 10,000 Hz. That means easier fabrication, less material per shield. So if you use magnetic shielding materials, be sure to use Hipernom. Its premium performance gives you the shielding you need at the lowest possible

cost. And cuts needless weight from your products. Along with Hipernom, you get the services of the largest group of metallurgists specializing in magnetics. For 50 years, Westinghouse research has led in this field. You get the benefit. Want specific details? Call Bob Carroll at 412-459-9400.

Free 36-page book on magnetic shielding. It's a complete seminar in practical, easy-to-use form... tells you everything you must know to design and evaluate magnetic shielding. The only book of its kind. For your free copy, write for "Shielding Book." Address Westinghouse Metals Division, Box 868, Pittsburgh, Pennsylvania 15230.

You can be sure if it's Westinghouse

J-05014

Circle 135 on reader service card



The Hughes/NASA Syncom stands still at 6875 mph to talk to a billion people.

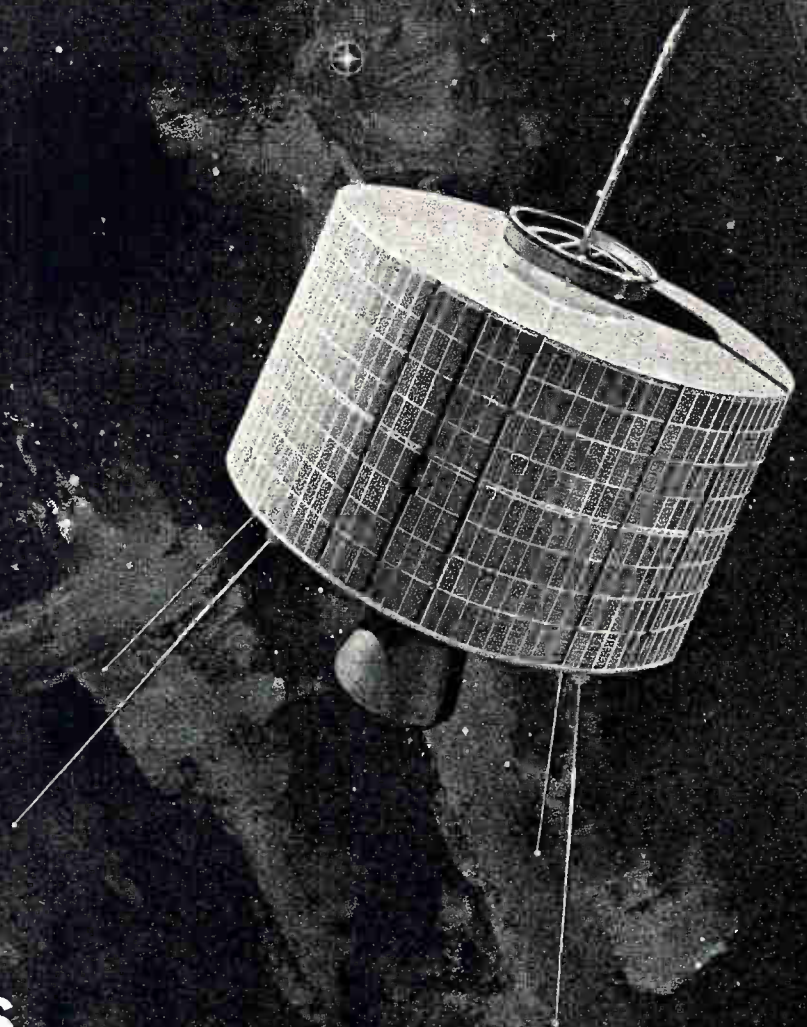

CIRCUIT DESIGNERS... is your appointment in space with Hughes?

Today, Hughes is one of the nation's most active aerospace/electronics firms: Projects include: F-111B PHOENIX Guided Missile System, TOW Anti-Tank Missile, SURVEYOR Lunar Spacecraft, SYNCOM, POLARIS, VATE, Hard Point Defense and others.

This vigor will assist the qualified engineers and scientists towards more and better opportunities for both professional and personal growth.

Many immediate openings exist. The engineers selected for these positions will be assigned to the following design tasks: the development of high power airborne radar transmitters, the design of which involves use

of the most advanced components; the design of low noise radar receivers using parametric amplifiers; solid state masers and other advanced microwave components; radar data processing circuit design, including range and speed trackers, crystal filter circuitry and a variety of display circuits; high efficiency power supplies for airborne and space electronic systems; telemetering and command circuits for space vehicles, timing, control and display circuits for the Hughes COLIDAR (Coherent Light Detection and Ranging).

If you are interested and believe that you can contribute, make your appointment today.

For immediate consideration, please airmail your resume to:

Mr. Robert A. Martin
Head of Employment
Hughes Aerospace Divisions
11940 W. Jefferson Blvd.
Culver City 7, California

Creating a new world with electronics

HUGHES

HUGHES AIRCRAFT COMPANY

AEROSPACE DIVISIONS

An equal opportunity employer.

U. S. CITIZENSHIP REQUIRED



BETTER QUALITY AND RELIABILITY THROUGH CONTROL

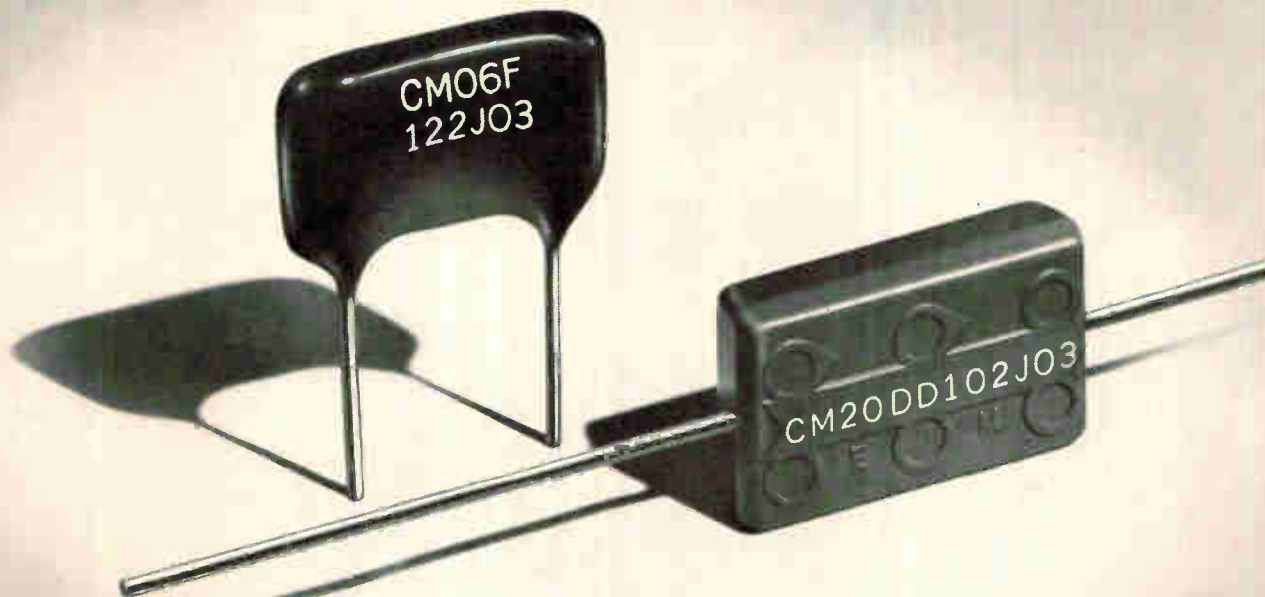

Shown 2½ x Actual Size

Capacitor Problems That Require A Lot Of Self-Control...Chemically Speaking

Problem 1: How to make sure the silver paste composition used for electrodes provides the best results for each electrical parameter in a given capacitor design?

Problem 2: How to improve the recognized moisture reliability of our dipped mica capacitors without adversely affecting life reliability?

Problem 3: How to upgrade the reliability of molded mica capacitors to equal that of dipped mica capacitors so designers can take advantage of body uniformity and axial lead design?

Solution: Chemical self-control! To do this we operate our own chemical manufacturing plant where we formulate silver pastes, phenolic dipping compounds, and epoxy molding compounds — all under strict controls.

Result: Dipped mica capacitors and molded mica capacitors of equally high reliability that operate up to 150°C. Send for technical literature and always insist on El-Menco brand capacitors . . . your assurance of better quality and reliability through control.

THE ELECTRO MOTIVE MFG. CO., INC.

WILLIMANTIC, CONNECTICUT 06226

Dipped Mica • Molded Mica • Silvered Mica Films • Mica Trimmers & Padders
Mylar-Paper Dipped • Paper Dipped • Mylar Dipped • Tubular Paper

Exclusive Supplier to Jobbers and Distributors
in the U. S. and Canada:
ARCO ELECTRONICS, INC., Community Drive.
Great Neck, L. I., New York

West Coast Manufacturers contact:
COLLINS & HYDE CO., 900 N. San Antonio Rd.,
Los Altos, California 94022
1250 E. Artesia Avenue, Long Beach, California

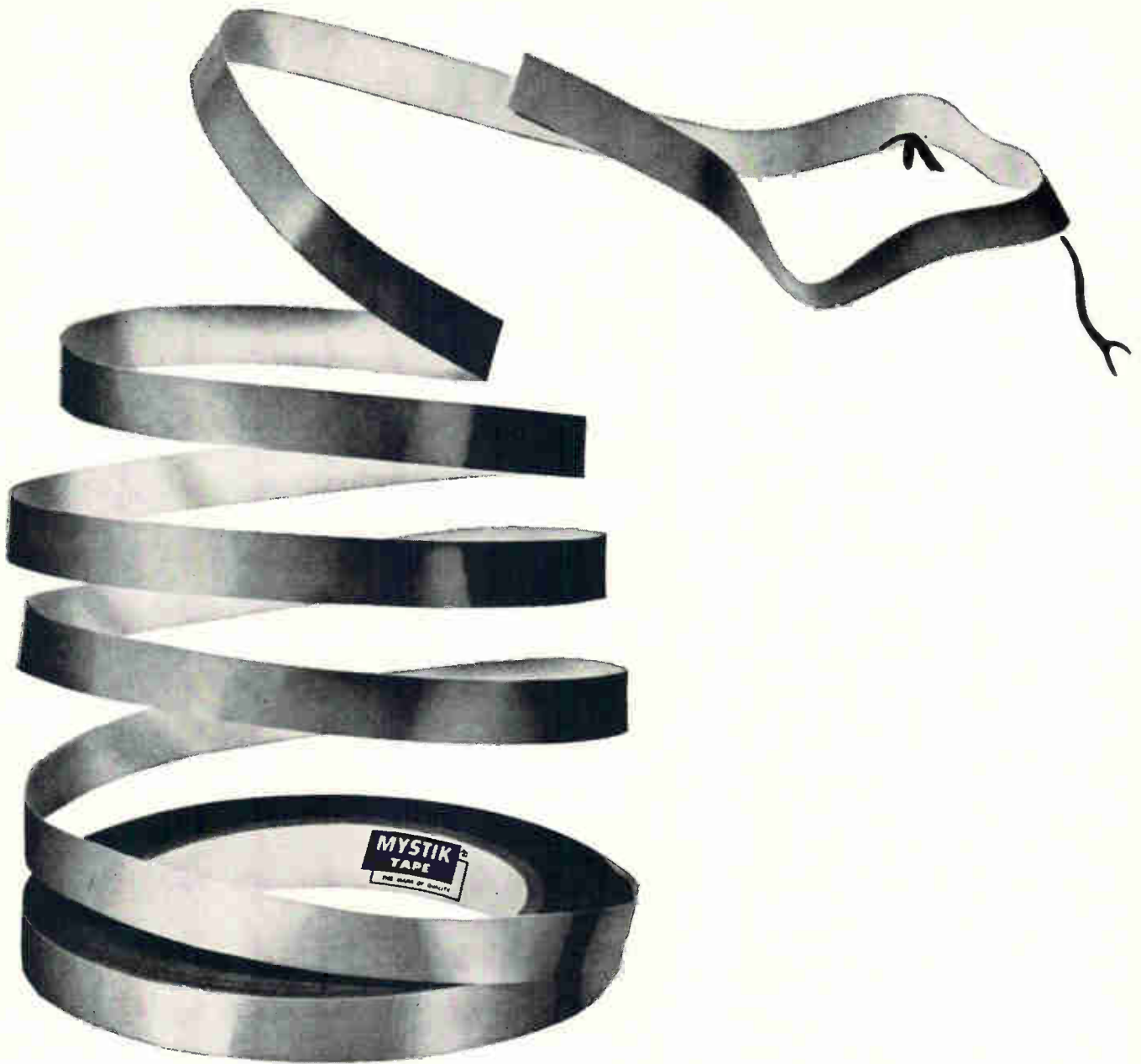

Reduce friction and keep cool with Mystik Teflon® Tapes

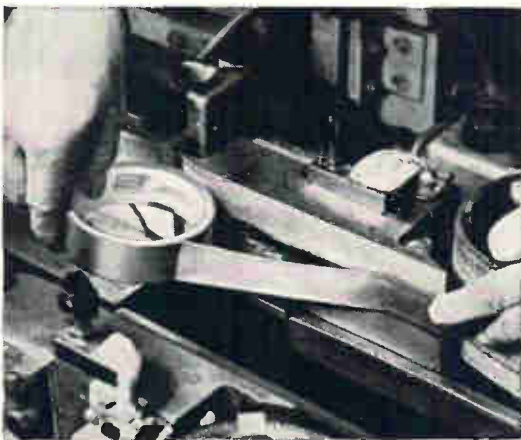

Mystik's Teflon tapes combine the advantages of TFE Teflon film with a silicone pressure-sensitive adhesive. As a result, they offer high dielectric strength, low coefficient of friction, and high performance within a temperature range from -100°F to $+450^{\circ}\text{F}$.

These remarkable tapes are particularly useful in reducing friction on high speed equipment and as insulators of electrical apparatus, but they have many other applications in the electrical and electronic industry.

Of course, Mystik Teflon Tapes represent only a few of the high quality paper, film, and glass cloth tapes available for special applications. For assistance in selecting the best ones for your needs, contact your local Mystik distributor. He's listed in the Yellow Pages under "Tape" or write The Borden Chemical Co., Mystik Tape Div., 1700 Winnetka Avenue, Northfield, Illinois 60093.



**BORDEN
CHEMICAL**

This integrating DVM still offers better performance than any other of its kind.

Measure low-level signals even in the presence of extreme noise with Hewlett-Packard's 2401C Integrating Digital Voltmeter. It has a floating and guarded input for minimizing the effects of common mode noise; and integration averages out all noise superimposed on the signal.

But the 2401 DVM could do that when it was first introduced. Since then there have been two new models and many additional features to keep the 2401 the industry's most useful bench and system DVM.

Here's why:

5 ranges, 100 mV, 1 V and the 3 usuals; 300% over-ranging on the 4 most sensitive ranges, 6th digit for overrange display; integration through zero; full programmability; BCD output for systems use; independent internal calibrate source stable to 0.006% / 6 mo.; 300 kHz frequency counting ability; optional autoranger with 34 msec maximum change time.

If this isn't enough, a full repertoire of options and compatible systems instruments is available to satisfy your measurement needs.

Price: still \$3950.

Call your local Hewlett-Packard field engineer or write direct to Dymec Division of Hewlett-Packard, 395 Page Mill Rd., Palo Alto, California 94306, Tel. (415) 326-1755; Europe: 54 Route des Acacias, Geneva.

HEWLETT
PACKARD  DYMEC
DIVISION

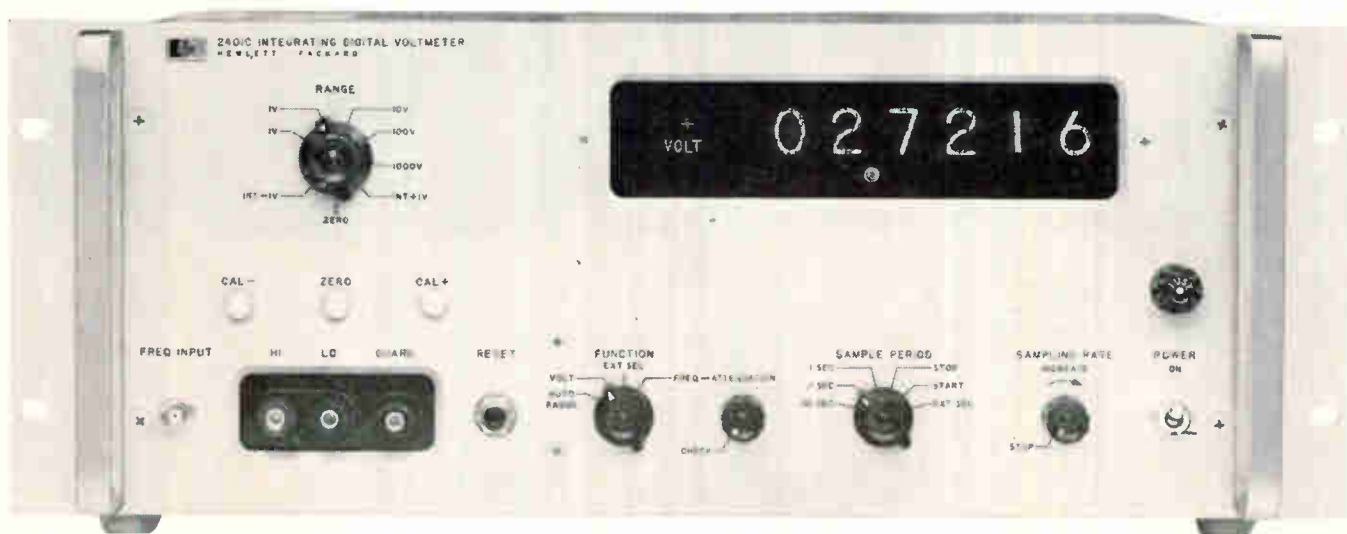



**If you want to see
as well as these eyes,
use the MTI Image Orth**

Nocturnal animals see well in the dark. MTI Image Orthicon television cameras see almost as well. We're specialists in low light level television equipment. In fact, the largest manufacturer in the world. And our equipment will pick up an

image in near total darkness. A pin hole of light is more than enough. Or more specifically, at 1×10^{-5} foot candles of ambient light (approaching total darkness).

This is but one research application. The possibilities in all fields

are endless, as research is discovering every day. If you have need — call us. We'll be there to help . . . quickly with quality.



mti MARYLAND TELECOMMUNICATIONS, INC.

York & Video Roads, Cockeysville, Md. 301-666-2727 World's largest manufacturer of low light level television cameras.



We could say these
mechanical filters are the best filters
available for the 60-600kHz range

And we will. Because they are.

Collins mechanical filters are the best frequency filtering devices available for the 60-600kHz range. They're *smaller* and *less expensive* than most other filters covering that portion of the spectrum. Hundreds of designs are available from stock with 60-db to 6-db shape factors as low as 1.2 to 1. They tolerate extreme temperature change

and long, continuous service without ageing, breakdown, or drift. They offer the greatest combination of selectivity, simplicity, compactness, and reliability ever developed in a filter. For more information or a descriptive brochure, contact Collins Components Sales, 19700 Jamboree Road, Newport Beach, California 92663. Ph (714) 833-0600.

COMMUNICATION / COMPUTATION / CONTROL



COLLINS RADIO COMPANY / DALLAS, TEXAS • CEDAR RAPIDS, IOWA • NEWPORT BEACH, CALIFORNIA • TORONTO, ONTARIO
Bangkok • Beirut • Frankfurt • Hong Kong • Kuala Lumpur • Los Angeles • London • Melbourne • Mexico City • New York • Paris • Rome • Washington • Wellington

HONEYWELL IN FLORIDA

offers exceptional career opportunities in our newly-created
Advanced Communications Laboratory.

Engineers and Scientists

CLIP THIS COUPON

IT MAY BECOME YOUR PASSPORT TO NEW WORLDS OF OPPORTUNITY.

Mr. F. G. Keese, Honeywell, 13350 U.S. Highway 19,
St. Petersburg, Florida 33733

Let's talk about the future.

Name _____

Address _____

City _____ State _____

Degree(s) _____

Field(s) of experience _____

Specific job interest _____

Present Salary \$ _____ U. S. Citizen Yes _____ No _____

Here are the areas of opportunity awaiting you in sunny Florida:

- Digital Communications
- RF and Telephone Transmissions
- Satellite Communications
- Advanced Navigation Techniques
- Hardware Development

Look over the specific job opportunities below:

Communications Systems Engineers

Advanced degree and significant experience in communications systems. Should be able to perform conceptual work on systems involving message handling, coding and decoding, radio frequency transmissions, and on-line computer or signal processing elements.

Receiver Development Engineers HF, VHF, UHF

Experienced circuit designers familiar with front ends, phase-locked oscillators, synthesizers, balanced mixers, filter design and state-of-the-art solid state techniques. Familiarity with ultra stable signal sources and the Doppler shift from satellites and high-speed aircraft desirable.

Synthesizer Development Engineers

Minimum of four years experience in synthesizer design. Must be familiar with past and present techniques. Requirement the development of next-generation equipment: utilizing micro-miniature and thin-film techniques.

RF Amplifier Design Engineers

Minimum of two years experience in broadband solid state amplifier design. Audio through UHF applications. Must be familiar with impedance transformation networks and stability criteria.

IF and Audio Design Engineers

Minimum of two years experience in solid state design with applications in Receivers and Exciters.

If your particular job interest is not mentioned here, but your talents fall in the general area of Design, Project Leadership, Systems Analysis and support functions, we'd like to talk with you about other important assignments at Honeywell in Florida, Junior through Engineering Specialist levels.

Clip and mail the coupon today. We'd like to talk to you about your future. We promise a prompt, confidential reply and probably an invitation to visit our facilities, meet our people and discover for yourself the many advantages of working and living here on Florida's west coast.

HONEYWELL ENGINEERS ARE DOING THINGS IN FLORIDA

Honeywell

AN EQUAL OPPORTUNITY EMPLOYER

To investigate professional openings in other Honeywell facilities,
send resume to F. F. Laing, Honeywell, Minneapolis, Minnesota 55408.



Lockheed's 417.



Lockheed makes the portable portable. At 18 pounds, including its self-contained batteries, the 417 recorder comes in at 50 pounds less than any comparable recorder. The 417 measures up in more ways than one. □ It starts off with a price tag as low as \$7000. It operates on 110/220 VAC/DC, with a power consumption that goes up to 10 watts. It has an exclusive, rugged low-mass inertial capstan drive for precision operation under

vibration in any position. It has phase-locked servomotor control; a simplified maintenance-free transport mechanism, and a frequency response of 100 kc direct 10 kc FM; and, scaling in at only 14" x 15" x 6", it can even fit under an airplane seat. □ We believe the 417 is the best portable recorder on the market. But check it out for yourself. □ Just ask for the Lightweight, one of a family of recorders for undersea, land, air and space applications.

The Lightweight.

LOCKHEED ELECTRONICS COMPANY

CARBON FILM RESISTORS

CERAMIC CAPACITORS

PIHER*

CARBON POTENTIOMETERS

SILICON TRANSISTORS



TUDELA FACTORY



BADALONA FACTORY

A wide range of reliable products and types allows us to meet your requirements.
Large and up to date facilities and mass production quantities guarantee:

- CONSTANT QUALITY
- SHORT DELIVERY TIME
- LOWER PRICES THAN INTERNATIONAL LEVELS



Riera Cañado, s/n. Apartado 53. Phone 280 03 06. - Telex 05792 Badalona (Spain)

STOCKING REPRESENTATIVES IN:

U. S. A. - Canada - Great Britain - France - Germany - Australia - Italy - Portugal - Netherland - Belgium
Finland - Sweden - Norway - Denmark - Colombia - Uruguay - Republic South Africa - Switzerland.

* Write for technical catalog

WHAT IS O/E/N?

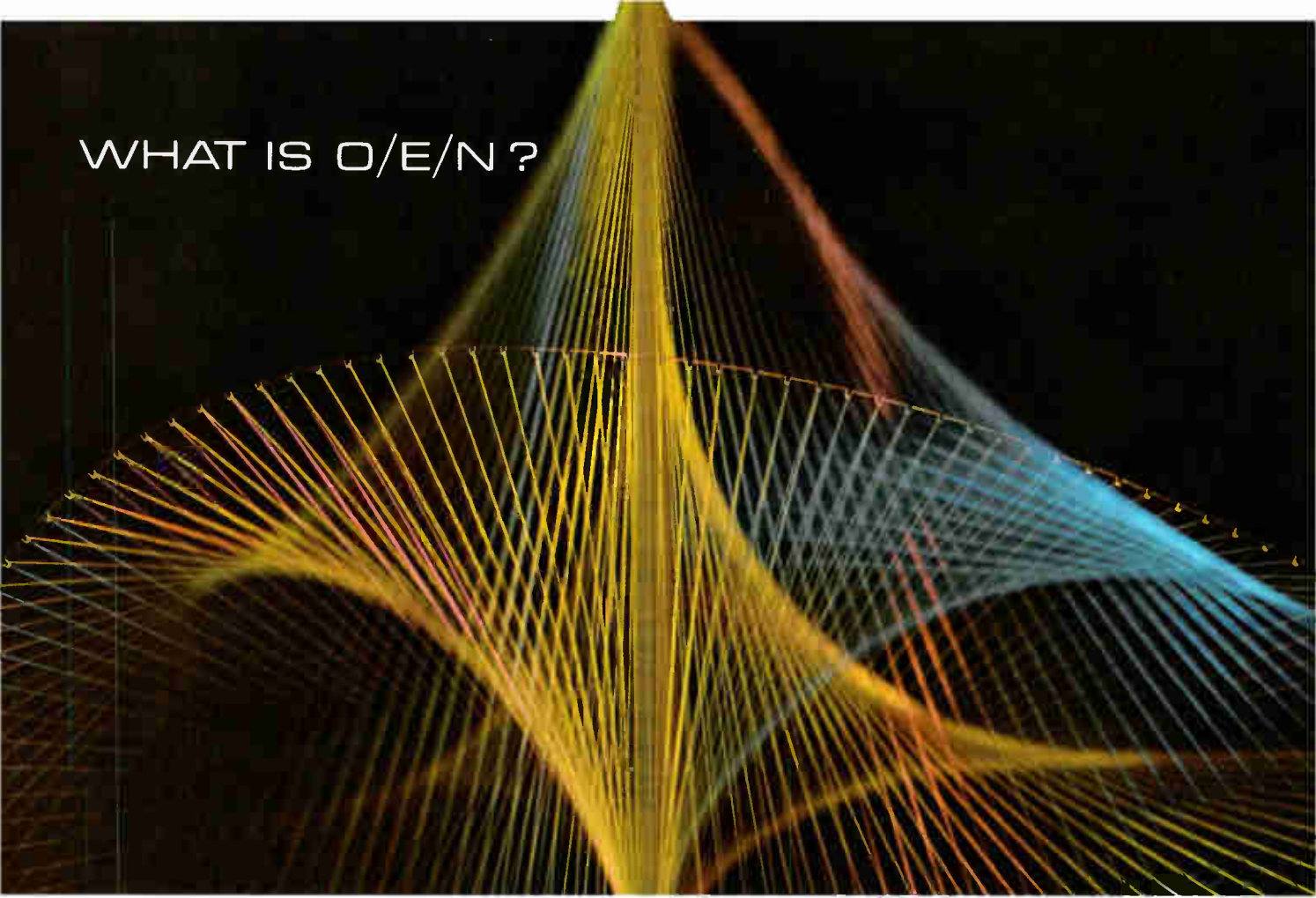

O/E/N IS QUALITY COMPONENTS



OAK MANUFACTURING CO.

... for over 35 years the leader in rotary switches, pioneer of many new advances including double-wiping contacts. Oak is also a leader in pushbutton, lever, slide and snap switches; rotary solenoids and choppers. Oak FM, VHF & UHF television tuners can be found in most major brand name sets.



MARCO-OAK

... serves our pushbutton world by showing "what's going on." Customers rely on Marco-Oak lighted pushbutton and matching indicator lights for applications far more complex than car radios. They're used in such applications as computers, missile ground controls, aircraft, utility and industrial instrument panels, TV broadcasting.



MCCOY ELECTRONICS CO.

... makes quartz crystals and assemblies to keep radio transmitters and receivers "on the beam." Such precise frequency control requires exacting manufacturing techniques—thickness accurate to .000001", cutting to 1/300 of 1° of angle accuracy, hermetic seals for protection. McCoy crystals are the highest quality available and perform in severe environments.



HART MANUFACTURING CO.

... "turns things on" with relays for household and commercial appliances, high-current relays for industry, and miniaturized relays for missiles and computers. Also thermostats, rotary and snap-in toggle switches, pilot lights. The complementary Phillips-Advance line of relays serves the electronics and communications industries.

O/E/N produces quality components...our customers build them into circuitry. We're their main source for an ever-widening variety of products. The one common denominator is engineering excellence, built into components produced by every O/E/N subsidiary or division described here. Write for Facilities and Capabilities brochure.



O/E/N

OAK ELECTRO/NETICS CORP
CORPORATE OFFICE
CRYSTAL LAKE, ILLINOIS 60014

THIS IS SIGMA'S NEW SOLID-STATE DATACEL[®]

An opto-electronic
switching device that
provides input-output
circuit isolation.

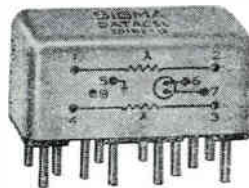

Solid-state and opto-electronic switching benefits are combined in low-cost Sigma Series 301 Databcels.

Electrically Isolated Input-Output Circuits: Light-beam coupling to 1, 2 or 4 photocells provides isolation resistance on the order of 10^9 ohms and smooth turn-on, turn-off.

AC-DC Capability: Both input and output circuits can handle either AC or DC signals. Cell loads may range from millivolt to 250-volt levels.

Application Versatility: Functions include high isolation interface switching, logic switching (and/or gate, inverter, latch circuits), audio switching, multiplexing, data sampling, feedback gain control, noiseless potentiometer.

Compact Construction: 1, 2 and 4 pole versions

all designed for high-density printed-circuit packaging. Also socket conversion to solder terminal mounting. In addition each unit visually indicates its on-off state to aid system trouble-shooting.

We'd like to give you a new solid-state Sigma Databcel—or any of our standard relays. It's the best way we know to prove what we say about Sigma performance. Just circle our reader service number on the reader service card. We'll send you the new Sigma catalog and a "free" request form. Return the form to us and your Sigma representative will see that you get the sample you need.

Need fast delivery? Opto-electronic Databcels are available off-the-shelf from your Sigma distributor. Call him today.

SIGMA DIVISION  SIGMA INSTRUMENTS INC
Assured Reliability With Advanced Design / Braintree, Mass. 02185
Sigma Instruments (Canada) Ltd., P.O. Box 43, Toronto 18

Where can you get quick delivery on 930 DTL?

Order TI Series 15930 DTL from WEATHERFORD!

We can fill your requirements for 930 DTL today! We carry full warehouse stocks of all types of TI's Series 15930 (military) and Series 15830 (industrial) integrated circuits for immediate delivery.

These devices are direct equivalents . . . pin-for-pin and spec-for-spec . . . of competitive types. All circuits are equivalent in every parameter to other 930 DTL circuits and may be used interchangeably with other makes on a mixed system basis.

Series 15930 DTL circuits are produced by the industry's largest and most advanced semiconductor manufacturing facility to fulfill your largest requirements.

We stock them in depth so you won't have to wait for delivery. Call us!

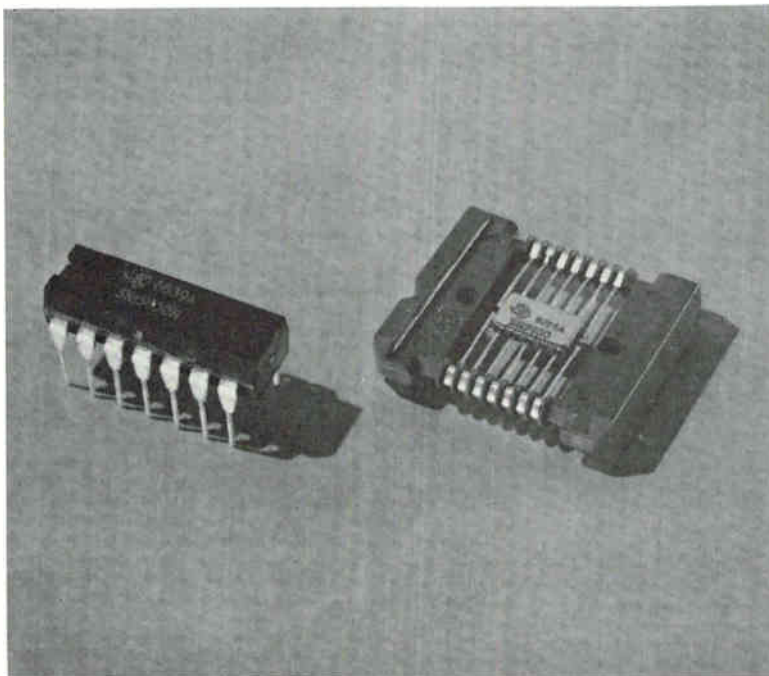

R. V. WEATHERFORD CO.

DISTRIBUTORS OF ELECTRONIC COMPONENTS AND EQUIPMENT

ANAHEIM, CALIFORNIA
1651 State College Blvd.
714-532-6741
714-547-7521

GLENDALE, CALIFORNIA
6921 San Fernando Road
213-849-3451

PALO ALTO, CALIFORNIA
3240 Hillview Drive
Stanford Industrial Park
415-321-5373

SALES OFFICES
Albuquerque, N.M.
505-298-5593
Phoenix, Arizona
602-272-7144

Pomona, California
714-966-8461 714-623-1261
San Diego, California
714-278-7400

NOW WITH CUSTOMIZED COMPONENTS
WEATHERFORD
SERVICE
PLUS 

THE NEW GENERATION



SILVERLINE^{T.M.*}

a new, superior line of Clifton Synchros

- Higher Accuracy. 5' standard
- Outstanding Repeatability of Calibration Pattern
- Stability of Calibration over Temp.
- 150°C Standard Operating Temp.

Keeping pace with the developing aerospace field, Clifton announces SILVERLINE, a new, superior line of standard synchros. □

These units, a natural evolution from our present line of quality synchros, embody certain new manufacturing techniques and space age materials. The result is a standard synchro which outperforms pres-

ent synchros in four distinct ways shown above. □ SILVERLINE synchros are in the field now. Call your local Clifton Sales Office for price, delivery and further information.

cppe **CLIFTON** 
DIVISION OF LITTON INDUSTRIES

*Trademark of Clifton Division of Litton Industries

Circle 148 on reader service card

Probing the News

Electronics markets

Bloom's gone from 1967's rosy outlook

Softness in consumer markets, a shift in Government outlays slows boom; industry starts to prune year's sales projections

Barely four months ago, growth-conditioned executives in the electronics industry were virtually unanimous in their belief that the boom would continue in 1967. Electronics' markets survey forecast a 9.4% boost in sales.

Now, however, with the first-quarter results in, these same executives are having second thoughts. Although there's no recession, or even a slump, gaps have shown up to turn the great expectations of year-end 1966 into a more realistic appraisal of 1967.

The high level of expenditures for Vietnam has kept most military electronics markets close to or ahead of estimates, and space outlays are holding their own. But a slowdown in the five-year expansion of the economy has softened certain civilian outlets. In particular, a shift in consumers' buying patterns has hurt such profitable big-ticket items as monochrome and color television sets. Similarly, the auto makers' winter of discontent during which new car sales fell over 20% from year-earlier levels has taken a toll from Detroit-oriented electronics concerns. Uncertainties also beset industrial electronics and instrument firms.

Despite what at first appears to be a dismal picture, indications are that 1967 will still be a good year. Available evidence suggests that the selective "minislide" will be arrested by the end of the third-quarter—a little later than hoped by most—and that the business trend will turn upward thereafter. Such recent Government actions as the proposed restoration of the 7% investment tax credit and the Federal Reserve Board's lowering of the rediscount rate to member

Selected consumer electronics markets
(millions of dollars)

	1st quarter 1967	2nd quarter 1967	3rd quarter 1967	4th quarter 1967	Total 1967
TV receivers, b&w	110.0	82.5	154.0	203.5	550.0
TV receivers, color	256.5	216.0	395.0	472.5	1,340.0
Home & portable radios	39.5	25.1	50.3	64.7	179.6
Auto radios	40.5	52.1	26.1	40.5	159.2
Phonographs, portable	33.6	55.4	60.8	68.7	218.5
Hi-fi sets & components	16.0	13.4	25.2	29.4	84.0
Kits (except toys)	13.1	12.0	8.6	16.5	50.2
Musical instruments, electronic	25.6	23.6	20.7	28.5	98.4

Selected electronics components markets
(millions of dollars)

	1st quarter 1967	2nd quarter 1967	3rd quarter 1967	4th quarter 1967	Total 1967
Resistors, fixed	44.7	49.5	53.4	55.4	203.0
Potentiometers	40.0	42.0	42.9	46.1	171.0
Capacitors, electrolytic	46.4	47.2	52.9	55.4	201.9
Capacitors, other	57.1	57.4	61.2	62.5	238.2
TV yokes & flybacks	6.5	6.5	7.2	8.7	28.9
Tubes, receiving	62.4	68.2	80.0	77.1	287.7
Tubes, picture CRT, b&w	29.9	26.3	36.5	43.7	136.4
Tubes, picture, CRT, color	106.6	119.5	160.0	202.5	588.6
Transistors, silicon	69.8	75.1	81.0	85.8	311.7
Transistors, germanium	35.8	32.6	40.5	49.4	158.3
Diodes, silicon	53.4	55.6	49.0	64.5	222.5
Diodes, germanium	7.5	7.8	7.2	8.8	31.3
Silicon controlled rectifiers	12.6	13.2	13.7	14.3	53.8
Loudspeakers	24.0	27.2	29.3	24.0	104.5
Magnetic tape	46.8	47.7	45.8	50.5	190.8
Integrated circuits, monolithic	49.3	53.8	58.0	62.9	224.0
Thick films	5.7	6.1	6.7	7.5	26.0
Thin films	2.6	2.8	3.0	3.2	11.6
Power supplies, lab type	11.1	12.2	12.9	10.3	46.5
Power supplies, OEM type	19.8	22.0	20.2	19.2	81.2

NEW! VACTEC Photocell-Lamp Control Module

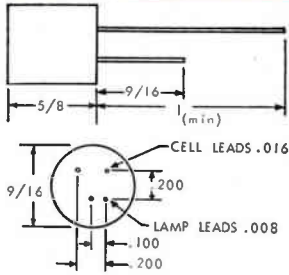

The first of a complete line designed for improved, noiseless volume and tone controls in transistorized amplifiers. Perfect for guitars, organs, musical instruments, radio, TV and the like.

Combines a proven dependable Vactec photocell with an extremely long-life incandescent lamp. Complete low-cost module in a unique epoxy sealed metal enclosure. Leads are spaced on standard .100" centers to simplify circuit board mounting.

Six and 10-volt units now available. Special characteristic designs on request.

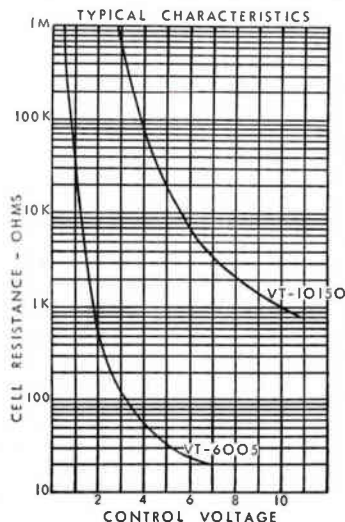

For details, write requesting Bulletin OC-1.



VACTEC, INC.

2423 Northline Ind. Blvd.
Maryland Hts., Mo. 63042 AC 314, 432-4200

See Vactec's listing in EBG under "Semiconductors," and in EEM, Sec. 3700.

Selected instruments markets (millions of dollars)

	1st quarter 1967	2nd quarter 1967	3rd quarter 1967	4th quarter 1967	Total 1967
Oscilloscopes	30.4	30.2	30.0	32.2	122.8
Signal generators	6.7	5.8	6.0	5.5	24.0
Sweep generators	3.2	3.5	3.3	2.8	12.8
Counters	9.4	10.0	7.5	11.4	38.3
Digital voltmeters	7.0	7.0	7.3	7.3	28.6
Components testers	6.2	5.5	5.5	4.7	21.9

banks should furnish additional momentum to the recovery.

I. The reluctant consumer

Any industry registering a better than 25% sales gain for the first quarter—as color tv set makers did—would normally be overjoyed. But producers expected to do twice as well and made their manufacturing and marketing plans accordingly. As a result, a lot of spanking new capacity, added in anticipation of a continuing bonanza, will be standing profitlessly idle. Sales predictions of 7 to 8 million units have been trimmed to a more realistic level of about 6 million.

If the demand for color is dull, the market for black-and-white sets is bleak. So far this year, black-and-white sets are off by 30%—about 16% below earlier estimates.

Such staple consumer items as radios, phonographs, and tape recorders are holding up well in the makers' difficulties, sales of auto-fidelity components are making gains. However, reflecting the car makers' difficulties, sales of automobile radios are running 26% below expectations.

Think small. Tv marketing men are taking some comfort in the sales curve of small-screen sets (up to 15-inch screen). J.L. Myers, marketing manager of the General Electric Co.'s personal television department, says sales are off only 8% and are beginning to turn upward. With summer approaching, Myers is looking for a boom.

S.R. Herkes, marketing vice president at Motorola Inc.'s Consumer Products division, is optimistic beyond 1967. "We may even have bigger years in black and white than we have had in the past," he says. "Transistorization will bring the price down to \$49.95 by 1970. And at that price, tv sets will be an impulse purchase."

Portable color tv will also get more attention, accounting for about 10% of total sales this year, predicts GE's Myers. General Electric already has three 10-inch color sets on the market, two of which were introduced this year. And last month, the Radio Corp. of America entered the field with a 14-inch set. By the end of the year, there should be as many as 10 manufacturers in the portable color field.

Selected communications equipment markets (millions of dollars)

	1st quarter 1967	2nd quarter 1967	3rd quarter 1967	4th quarter 1967	Total 1967
Land mobile	42.5	42.5	42.5	42.5	170.0
Radar	15.5	17.0	16.0	15.0	63.5
Airborne & ground links	44.5	50.0	56.5	39.4	190.4
Broadcast equipment	20.9	41.9	53.2	45.1	161.1
Citizens band equipment	8.8	9.7	10.8	10.7	40.0
Telemetry	45.5	46.0	42.2	52.6	186.3

Now that the color market has toned down a bit, manufacturing of home entertainment products may bring some of the developments that were in a state of "suspended animation" to bear upon next year's tv and stereo sets. But a caution light on costs has been lit.

Says William Buschmann, vice president for marketing at the Sylvania Electric Products Co., a subsidiary of the General Telephone & Electronics Co.: "Anything that adds a dollar to the price of a tv set presents a problem in sheer economics."

One such innovation could be a new 1,200-volt silicon transistor introduced last month at the IEEF exhibition by the Delco Radio division of the General Motors Corp. The device can switch the 3,800-volt-ampere load line needed to operate a 25-inch color set horizontal deflection system. Another new entry could be voltage-variable capacitors for tuning black-and-white and color tv sets from the International Telephone and Telegraph Corp.'s Semiconductor division.

II. Bits and pieces

When an important market like color tv receivers fails to grow as expected, the impact upon components suppliers can be severe. Color tv tubes, resistors, capacitors, and other discrete devices have been hard hit, resulting in a lag in sales.

In another sector of the components field, silicon transistors are taking a real beating as a result of price deterioration and slackening demand. Expected to rack up \$480.4 million in sales during 1967, these devices are now running at an annual rate of only \$311.7 million. At the Dickson Electronics Co., demand for solid-state tantalum capacitors dipped during the first quarter. But sales coordinator Milton Jesman attributes the slide to a more competitive pricing situation and prior stockpiling of devices by computer makers.

Components companies serving military markets report volume was right on target during the first three months of the year. However, marketing officials at these firms show signs of nervousness about the immediate future. Dan Schwadron, senior sales engineer at Bourns

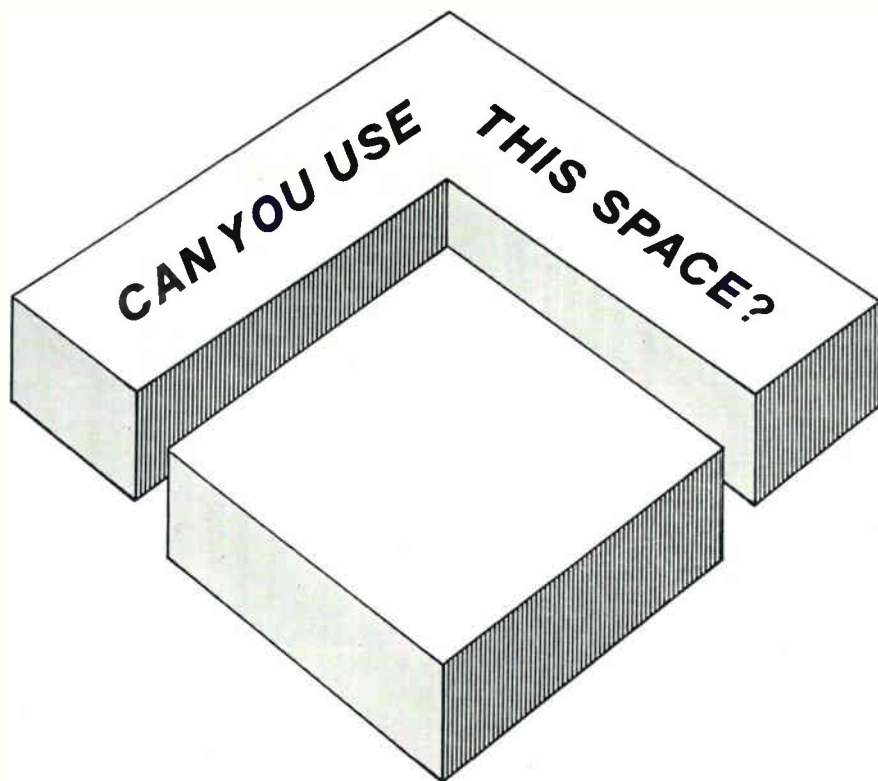

The new VK[®] Ceramic Capacitor can save it for you



The new VK[®] Ceramic Capacitor—containing CK06 capacitance values (1000-10,000 pf) in a CK05-size case (.2" x .2" x .1")—is built to increase volumetric efficiency.

In fact, this new capacitor uses less than half the space

of a CK06 (.009 cu. in. vs. .004 cu. in.) and gives the design engineer the same high capacitance values, plus a superior temperature characteristic well within $\pm 15\%$ (over the temperature range of -55°C to $+125^{\circ}\text{C}$). So select the new VK[®] Ceramic Capacitor—you'll find you have more space for other vital components.

For complete information, write for Data Sheet C17.

Vitramon[®]

VITRAMON, INCORPORATED
BOX 544
BRIDGEPORT, CONN. 06601

In Greater Europe Contact:
VITRAMON EUROPE
Wooburn Green, Bucks, England

DO YOU MAKE THESE FIVE COMMON MISTAKES IN EVALUATING CAREER GROWTH OPPORTUNITIES?

1. Do you consider only the largest companies in your particular field? Size of opportunity is not necessarily proportional to size of company. Many medium size companies, such as ECI, offer faster achievement of professional recognition and personal satisfaction than do the "industry giants."
2. Do you fail to consider breadth of product/customer base? It's difficult to achieve career stability in a company that is closely tied to a narrow range of products and technologies and which sells them to a limited number of customers. You'll do better at ECI, where major projects in VHF/UHF communications, multiplex, space instrumentation, microelectronics, systems integration and advanced communications techniques are in progress simultaneously. ECI's broad customer base includes Army, Navy, Air Force, Marine Corps, NASA and foreign governments.
3. Do you consider joining a company which has insufficient R&D programs? Lack of aggressive R&D could mean future trouble for the company . . . and you. ECI has a wide range of Company and customer-funded development programs, particularly in the promising fields of microelectronics, telemetry, space instrumentation and digital switching systems.
4. Are you overly impressed with "boom" growth conditions? Growth that's too fast can point to future instability. Look for a record like ECI's, where years of stable, predictable growth demonstrate management's ability for both sound planning and successful execution.
5. Do you settle for less-than-optimum living conditions in the name of opportunity? You needn't! In addition to all the foregoing advantages, a career at ECI will let you and your family enjoy life to the fullest in St. Petersburg, Florida. This segment of Florida's Gulf Coast offers an unequalled combination of sunshine, beaches, golf, boating, and fishing plus cultural, educational and professional engineering opportunity.

RF ENGINEERS SYSTEMS INTEGRATION ENGINEERS INDUSTRIAL ENGINEERS

Make a new career evaluation today! Investigate the immediate and attractive opportunities at ECI by sending your resume, in confidence, to K. S. Nipper, Director of Professional Placement, Electronic Communications, Inc., Box 12248E, St. Petersburg, Florida 33733. (An equal opportunity employer.)



St. Petersburg Division
Electronic Communications, Inc.

Inc. points out that while hardware outlays are up, military spending for research is down—a situation that will adversely affect the sales of components for instrumentation systems and other laboratory equipment. Carryover orders from last year are almost exhausted, says Schwadron, and no new bookings are in sight.

Problem areas. At Westinghouse Electric Corp.'s Semiconductor division, marketing manager John Morris notes that February sales were just about the same or a little higher than last year, but fell by 5% to 10% in March. Westinghouse had anticipated a 35% growth rate in 1967.

The softness at Westinghouse shows up in parcels of products. For example, diodes for use in color tv receivers and industrial equipment are not doing as well as expected. Division manager Don Gunther is still hoping the industry will build 7 million sets. But if sales slide to less than 6 million, the division's sales performance will be very disappointing for 1967.

Sales of large silicon-controlled rectifiers for use in speed controls of locomotives are also very slow. Gunther attributes this to the loss of the investment credit which curtailed railroad's capital-spending plans more sharply than was the case in other industries. On the plus side of the ledger, sales of power transistors and thyristors (silicon-controlled rectifiers) smaller than railroad size are still outstripping production capacity.

IC picture. For the past year and a half, the "monkey has been on the integrated circuit manufacturers' back," from the point of his being unable to fill orders, says a source at the Signetics Corp., a subsidiary of the Corning Glass Works. The consensus is that most added capacity now being installed will be on line by summer—and the result could be some softening due to a reduction of backlogs.

Sylvania continues to see an IC market of about \$230 million in 1967. For Sylvania, first-quarter sales have been on target with its estimates, says Roger Swanson, semiconductor marketing manager. Orders have been "a bit lighter in the consumer area than anticipated," but such business is only a negligible percentage of the total.

The largest manufacturer of diodes in the world, IRT's Semiconductor division, sees its markets "holding on target." Robert Hostage, manager of market research and planning for semiconductor operations, notes that while his division holds 30% of the germanium diode market and enjoys a better than 10% penetration of the entire diode market, over 90% of IRT devices are sold for computers. In that area, sales have gone largely according to plan. The softening in the entertainment products market has not seriously affected IRT's diode business, and only about 2.5% of sales are to the auto market—mostly germanium units for radios.

III. Instrumentation

With few exceptions, the 1967 instrumentation outlook is gloomy and most sources concede that sales are lagging behind the original forecasts.

Alan B. Dallas, manager of instrument marketing for Honeywell Inc.'s Test Instruments division, says, "1967 will not be a disastrous year but it won't be the growth year predicted last July." According to Dallas, many instrument manufacturers are faced with increased inventories and are offering off-the-shelf deliveries.

Because test instrument sales are tightly linked to research and development, many companies are reeling from the diversion of Government funds to production. Many have had to make major readjustments. Some, including the Consolidated Electrodynamics Corp., a subsidiary of the Bell & Howell Co., have even had major layoffs.

Others haven't been as seriously affected. Honeywell Inc., for instance, has experienced lower sales of its larger oscillographs designed for research and development applications. At the same time, the company is selling more apparatus for use by less skilled personnel. "But," says Dallas, "the increase in the one line does not offset the loss in volume in the other." The reorientation of Government spending has also lowered sales of the more complex signal and sweep generators, and even the digital voltmeter market has been affected.

Gains in industrial instrumentation have caused marketing man-

control / alarm shortcut

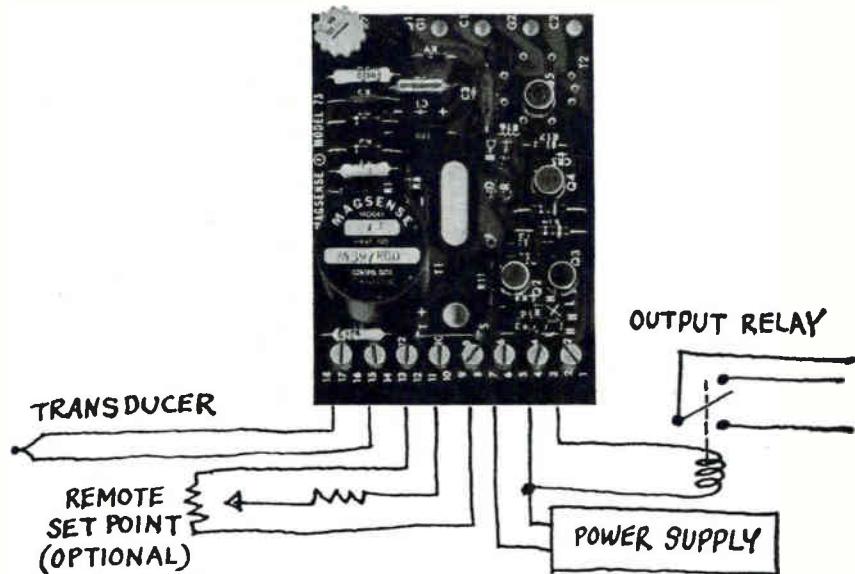

MAGSENSE®

control / alarm for temperature, pressure, speed, flow

Here's a fast, easy way to design a solid-state control/alarm circuit you can depend on. Just connect sensor, load and power source to the standard MAGSENSE model that meets your specific requirements. That's it. Your circuit is complete. You'll save time and money by using MAGSENSE, and you'll be taking advantage of accuracy and reliability proven in hundreds of temperature, pressure, speed, position, liquid level and flow applications.

All 11 Magsense models offer 100-billion power gain and accept inputs as low as 1 microamp or 10 microvolts *directly* without preamplification. Continuous overload capability is 1,000 times nominal full-scale input without damage. Trip point is unaffected by common mode voltages as high as 110 VAC, 60 Hz because input is full floating with respect to the

output circuit.

Single or dual setpoints and hysteresis are easily adjusted internally or remotely. You can specify latching, non-latching or pulse control/alarm action. Non-latching and pulse units have adjustable differential gap and proportional band capabilities.

Transducer excitation voltage is available from all MAGSENSE units, and cold junction and copper compensation are standard in models for thermocouple applications.

Priced from \$35 in quantity, all MAGSENSE modules are available from stock.

For data sheets or a quote, contact MAGSENSE Sales, Dept. 117, La Jolla Division, Control Data Corporation, 4455 Eastgate Mall, La Jolla, California 92037. For immediate action, phone (714) 453-2500.

LA JOLLA DIVISION

CONTROL DATA

CORPORATION

4455 Eastgate Mall, La Jolla, Calif

HOW SMALL CAN A MICROWAVE COUPLER GET?

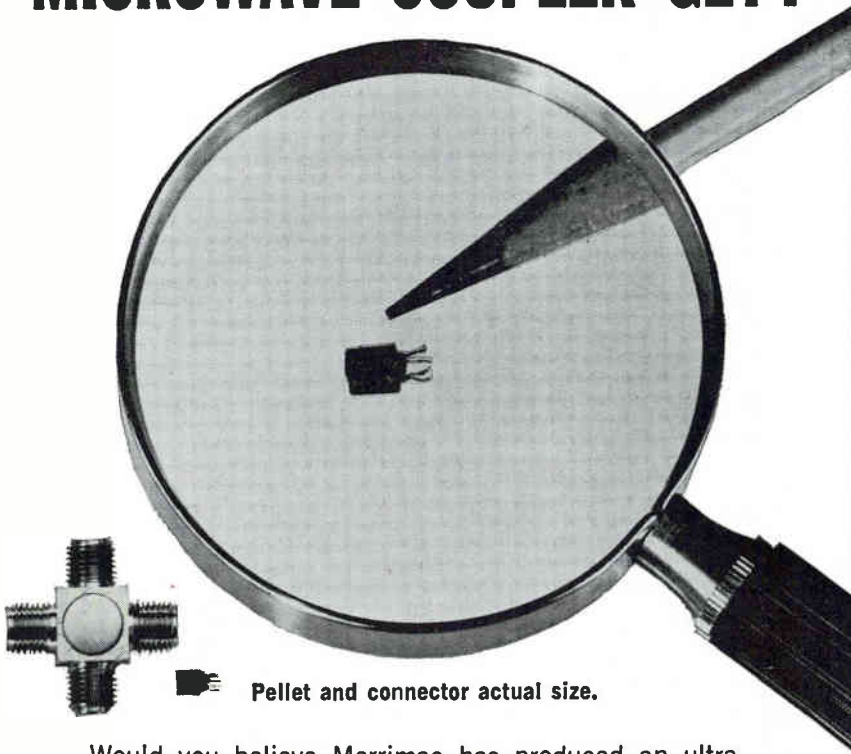

Pellet and connector actual size.

Would you believe Merrimac has produced an ultra-miniature microwave quadrature hybrid coupler $\frac{1}{8}$ inch in diameter and $\frac{3}{16}$ inch long? Size reduction was made possible by using a novel lumped element synthesis (U. S. Patents applied for). The Model QHU-2 is intended primarily for use with printed circuit boards and is highly suitable for aircraft and space applications. The pellet can be provided in a miniature connector housing, designated Model QHM-2. The new hybrid coupler, with or without connector, is presently available in the 2.1-to-2.3 GHz frequency range. Merrimac also can provide, on request, couplers at frequencies within 1-to-4 GHz. Inquiries on special requirements are invited.

Applications include image rejection mixers, phase comparators, phase shifters, attenuators, single sideband modulators, solid state power amplifiers, discriminator networks and power dividers.

Models QHU-2 and QHM-2 exhibit more than 23 db isolation with VSWR of 1.2:1; impedance 50 ohms. Other specifications include: Bandwidth 10%, phase quadrature $90^\circ \pm 3^\circ$; output equality ± 0.3 db; insertion loss typically less than 0.3 db; and power 5 watts average.

For further information, write or phone:



MERRIMAC RESEARCH AND DEVELOPMENT, INC.
41 FAIRFIELD PLACE, WEST CALDWELL, N. J. 07007 • 201-228-3890

agers to view this segment of the instrumentation market with some optimism. [See "Instrument makers are measuring up to systems engineering standards," page 161.] Most feel that the reinstatement of the 7% tax credit will boost sales in this area. But as Keith Williams, manager of oscilloscope marketing at Tektronix Inc., puts it, the effect of the restoration will be more psychological than anything else.

Bright side. Component test equipment is enjoying an excellent year. The Instrumentation division of the Fairchild Camera & Instrumentation Corp. indicates automatic transistor and integrated-circuit tester sales are ahead of forecast. Similarly, the automatic component test systems recently introduced by the General Radio Co. are enhancing the company's total volume.

But the market for machine tools also reflects the economy's softness. Although deliveries for the first two months of 1967 are some 10% ahead of the comparable period a year ago, new orders have suffered a sharp decline of about 25%.

This drop may not affect sales until 1968, however, because of the close to 11-month backlog of orders with which manufacturers began 1967. On the whole, deliveries for 1967 should be about the same as last year, according to a spokesman at the Bendix Corp.'s Industrial Controls division.

Because an increasing percentage of machine tools are being sold for numerically controlled applications, manufacturers of the controllers will see their volume rise during the year—up to \$100 million says Bendix. Last year 20% of all metal-cutting tools sold had numerical control. This year this percentage could reach 25%.

Restoration of the 7% investment tax credit by the Federal Government would certainly be the biggest stimulant to an increase in numerical-control tool sales, according to James Gray, executive vice president of the Tool Builders' Association. The suspension of this credit last October had an almost immediate effect on all kinds of capital equipment manufacturers. By December, new orders for machine tools were already starting to drop.

INNOVATION IS THE PULSE OF PROGRESS



Karl Wilhelm Scheele was an apprentice pharmacist at age 14. In the mid 18th century, pharmacists prepared their own drugs and often did much chemical experimentation. It was Scheele who actually first prepared oxygen three years before Priestley and studied nitrogen before Rutherford. Writing a description of his experiments, he sent it to a publisher who delayed so long in printing the book that by the time it appeared, Rutherford and Priestley had reported their experiments and received all the credit.

In 1957 Raychem pioneered a series of innovations in the field of radiation chemistry. Among the first was heat shrinkable tubing which has since become an accepted device throughout the aerospace, communication and appliance industries. Today Raychem continues to be the world leader in the development of commercially irradiated products.

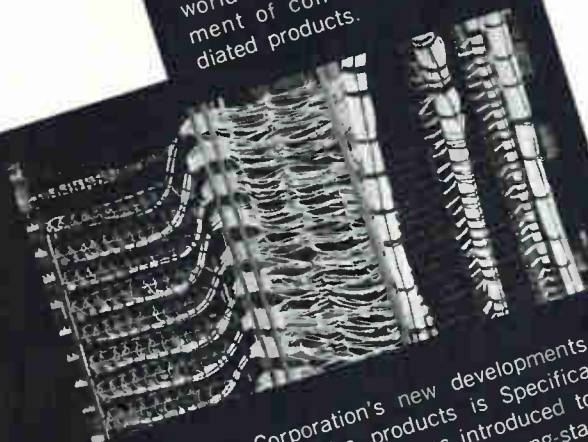

Among Raychem Corporation's new developments in irradiated cross-linked wire products is Specification "44" Wire and Cable. This wire was introduced to the aircraft and aerospace industry to fill its long-standing need for high temperature stability in a small-size, light weight wire. It is now in widespread use on many of the most advanced electric and electronic systems.



RAYCHEM
CORPORATION

300 CONSTITUTION DRIVE • MENLO PARK, CALIFORNIA

WHO PINNED A MEDAL ON THIS TINY TRW CAPACITOR?



...nearly everybody!

For your next design where there's too little room for components and *no room for compromise*...turn to "tiny but tough" TRW Type 608 Mylar* capacitors.

Excellent electrical characteristics and exceptionally small size make the Type 608 ultra-miniature a good capacitor for exacting military and instrument applications. Add the remarkable record of space-proven reliability and TRW Type 608 becomes a great capacitor!

Look at these outstanding features!

- 50% smaller than MIL-C-27287
- 4½ lb lead pull capability
- Mylar-foil, tape-wrapped construction
- Exceeds characteristics of many larger units
- MIL-C-27287 performance
- 50V and 100V, .001 to 2.0 mfd
- Temp. range -55 to +85°C; to 125°C with derating
- Tolerance to ±1% available

Product information is available from TRW Capacitor Division, TRW INC., Box 1000, Ogallala, Nebraska. Phone (308) 284-3611. TWX: 910-620-0321. *DuPont's trademark for polyester film.

TRW®

Safeguarding time-sharing privacy —an all-out war on data snooping

The problem of unauthorized access to proprietary files spurs development of tighter protection systems for users

Recognizing that time-sharing could also mean unauthorized data-sharing, the computer industry is coming to grips with the gnawing problem of safeguarding privacy in multiaccess processors. So important is the privacy-snooping dilemma that it has been put in the spotlight at the Spring Joint Computer Conference opening this week in Atlantic City, N.J.

The problem became a national issue last summer when Congress held hearings on the proposed national data bank. Backers wanted to collect information from such Federal agencies as the Census Bureau and the Internal Revenue Service and store it in one computerized repository. But opponents, fearing that user-agencies would have unrestricted access to data regardless of whether they had filed it, succeeded in getting the enabling legislation killed in committee—at least for this session.

Snooping fear. The problem of privacy in a commercial or industrial application centers on the prevention of unauthorized access—whether inadvertant or intentional—to proprietary computer files. Destruction of data by other data stored in the wrong place is a problem, as are tapped telephone lines carrying subscribers' data between terminals and the computer.

As far as Government agencies are concerned, privacy is a security problem that is compounded by varying classification levels. Although no Government unit has as yet entrusted classified data to a time-shared computer system, the Air Force has taken the first step [Electronics, March 20, p. 26].

I. By the numbers

Time-sharing systems offer a variety of safeguards against un-

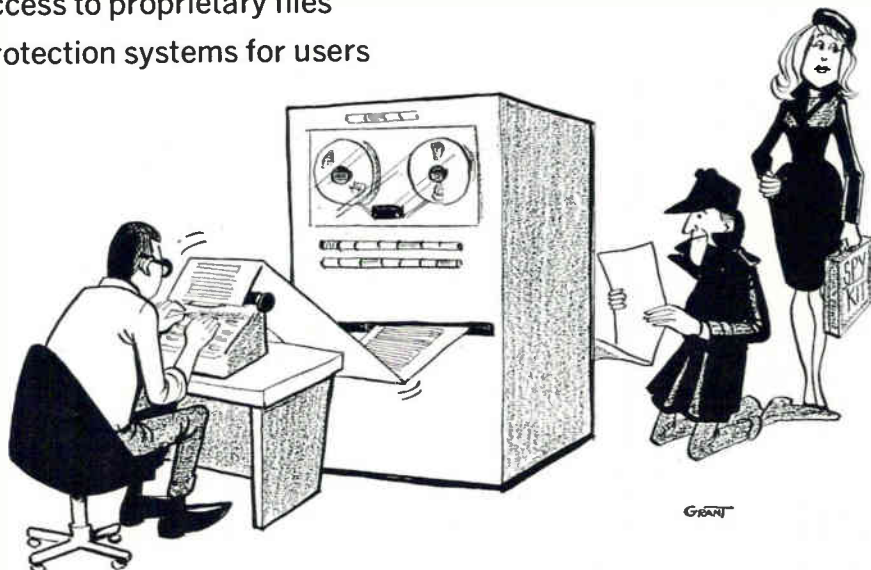

authorized access. In common with other systems, Control Data Corp.'s 6000 computer series relies on software backed by the hardware organization. Two kinds of files—private and public—are kept in the system. When a user sets up a new private file, he tags it with a confidential key or password. Thereafter, access is restricted to those who can submit the proper identification.

Programs available to anyone, like compilers to translate programs written in Fortran and other languages into machine language, are kept in the public file.

"There's no such thing as a hardware lockout," says Robert Korsch, an applications analyst at Control Data. "Any hardware you install to protect the files must be under software control." Keeping protection schemes in the software has the advantage of flexibility. Software can be changed simply by punching out new cards and feeding them into the computer.

Hard stuff. Despite Korsch's doubts, Honeywell Inc. has developed a hardware approach for its H-8200 time-shared computer. Keys for up to nine blocks in the memory and nine input-output assignments

are kept in hardware registers. As in Control Data's machines, these keys must match keys supplied by the user for access to private files for reading or writing. Taking advantage of a read-only memory that is unique in the H-8200, the comparison is performed in hardware. [For more on Honeywell's read-only memory, see page 56.]

II. Customers always write

Clients of Allen-Babcock Computing Inc., a Los Angeles-based time-sharing service, are restricted to Fortran, Cobol, and PL/1 languages. Since they can't modify the supervisory program with these languages, users can't bypass the memory protection system.

At Project MAC (for machine-aided cognition) at the Massachusetts Institute of Technology, there are no language restrictions and skillful users can modify the supervisor from remote terminals. According to James D. Babcock, Allen-Babcock's president, this is one reason why Project MAC has been having privacy problems.

Another Allen-Babcock method of preventing invasion of privacy is what Babcock calls an "early cutoff." Any user is allowed as

NEW! DIGITAL PANEL METERS
0.1% ACCURACY

ABBEE ELECTRONICS CORP.

- 1 0 2 1 =

press turn

Shown $\frac{3}{4}$ actual size

DIGIMETER
MODEL DM-25

\$260

OEM discounts available

For every application where a conventional panel meter is inadequate

- AC or DC measurements
- Single or multiple ranges
- 1 μ A to 1,000 A. full scale
- 10 mV to 10,000 V. full scale
- Other functions & ranges to order

Send for detailed literature



2 Sixth St., New Hyde Park, L. I., N. Y. 11044
516 CH 8-8060

Circle 238 on reader service card

UNIVERSAL CALIBRATOR
Model MC-10

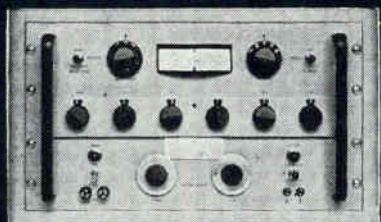

Fast, accurate calibration of panel meters, multimeters, oscilloscopes, vvm's, other measuring instruments. Full accuracy without correction curves. Meter indicates directly the % Error in device under test. All solid-state. Meets MIL specs for temperature, humidity, vibration, shock, RFI.

AC & DC VOLTAGE: $\pm 0.2\%$, 0-1000 volts in 1 millivolt steps, 0-20 mA load
AC & DC CURRENT: $\pm 0.2\%$, 0-1 ampere in 1 microamp steps, 0-1 volt burden
RESISTANCE: $\pm 0.1\%$, 0-1,000,000 ohms in 1 ohm steps

Send for detailed literature



2 Sixth St., New Hyde Park, L. I., N. Y. 11044
516 CH 8-8060

158 Circle 158 on reader service card

... a user can restrict access to his files to certain times of the day ...

much memory space as he needs—for which he is charged. But anyone trying to corner more than 20 blocks at a time is automatically cut off. "He can dial in again immediately," says Babcock. "But when he does, we are on with him, watching everything he does. If we didn't do something like this, a user could go on grabbing more blocks of memory and crowd everything else out, taking over the whole system."

Systems go. In some time-shared facilities, the central processor must be in a particular status before a user can get into the system. When the General Electric Co.'s 645 computer is in the slave mode, the machine can't execute privileged instructions—like input-output commands. If a privileged instruction should appear in a program, the computer automatically transfers control to the monitor program that operates in the master mode. The offending user is disconnected. If a user requires a privileged operation, he can set up the necessary information in his own restricted portion of memory and request the master mode to take over. Similar restrictions exist in other time-shared systems.

The International Business Machines Corp.'s System 360 computer has two modes called problem state and supervisor state, corresponding in some respects to GE's slave and master modes.

III. What's ahead

Major efforts at devising new safeguards are being made at MIT. Edward L. Glaser, an associate professor of electrical engineering, heads the design group responsible for protection of privacy in Multics, a computer-utility project being developed jointly by Project MAC and the Bell Telephone Laboratories.

"In Multics," says Glaser, "various parts of the file have different conditions of access and different levels of privilege." The user must specify all of these—including his name, problem number, account to which charged, and password—to get into the system. But he is re-

stricted to his particular section. If he manages to get into somebody else's section by accident or intent he is blocked from wandering through the entire file by a programmable partitioning system.

Whatever a user does is automatically recorded and can be audited later, just as transactions in a bank can be examined by bank examiners. The protection system cannot be changed on-line and the auditing procedure must be performed off-line by two or three people.

Despite the safeguards, Multics' security system will still have one weak spot—the public telephone system, which can be tapped. Because of this, individuals using the system over such lines will be barred from certain files.

General Electric has experimented with telephone line scramblers—similar to those used on military communications lines—for one of its in-house systems. "They offer some security for transmitted data but they aren't foolproof," says Louis F. Cimino, manager of computer operations at GE's Missiles and Space division in Valley Forge, Pa.

Word changes. An additional level of sophistication in the use of passwords is suggested by Brian W. Pollard, manager of product planning at the Radio Corp. of America's Electronic Data Processing division. "Passwords can be easily changed," he says. "Suppose a file were set up in such a way that a different password was required each time the file was used. Only the person authorized to use the file would know that it had been used, and he would know the sequence of passwords, so that he should have no trouble. Anyone else who perhaps learns the sequence wouldn't know which one to use at any particular time, and trying them all on a random basis would be easily detectable."

To an extent, General Electric leaves protection up to the client. A user can put in as many levels of security as he wants, depending on the degrees of privacy required for his data. At Allen-Babcock, a

series of keys or passwords is necessary to get into the system. But a user can restrict access to his files to certain times of day or provide other safeguards. If a client's employees are permitted access only during normal business hours, the system can be programmed to turn down anyone trying to get into the system outside these hours.

This approach does have disadvantages: "The name of the game is response time," says Gerald Galler, product manager for GE's 600 line. "The more verification you require of a legitimate user, the longer it takes to get information out of the system. You can overdo it."

Joel Erdwinn, senior staff scientist at Computer Sciences Corp., a software house in El Segundo, Calif., acknowledges that a privacy problem exists in time-shared systems. But, he says, protection against accidental release or destruction of data is adequate for most industrial users. Spying is another story. "No one has ever convinced the military that a time-shared system can be guarded," he says. "And the military is probably right."

Erdwinn looks for improvement at remote terminals. The executive system, entailing a series of routines which must be performed before data is released, is particularly effective, he says. Encrypting equipment at the data printout terminal provides another safeguard. But such procedures are costly, requiring vaults and guards to protect the code manuals.

Memorable. Walter Bower, president of the Data Products Corp.'s subsidiary, Informatics Inc., a software firm in Sherman Oaks, Calif., regards security in time-shared systems as "essentially a people problem." He concedes there are technical difficulties in both hardware and software design but considers them tractable. But Bower sees one area in which provision for security could alter the design of time-shared computers—memory size.

He anticipates a day when 10% of a computer's memory will be devoted to routines needed to qualify users requesting information. In some applications, according to Bower, the figure could be as high as 20%.

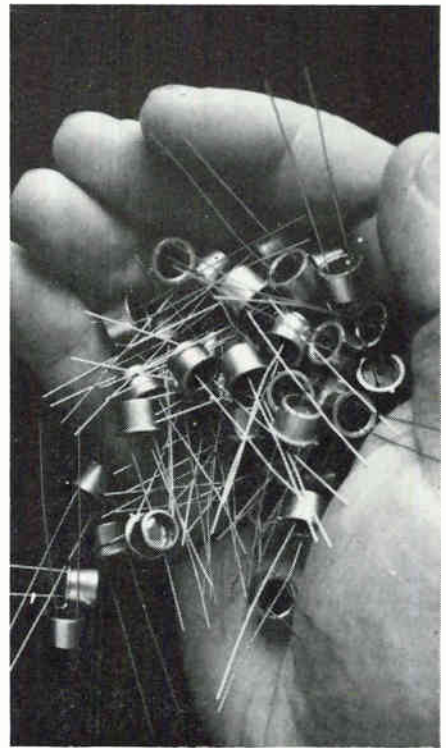
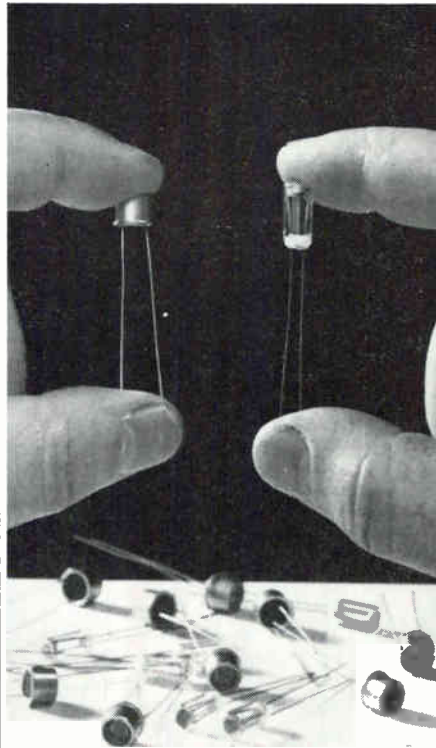

Need thirty different photocells? Or thousands exactly alike?

In either case, specify "Raytheon." Raytheon now offers standard and special types with cadmium sulfide or selenide sensors, TO-5 case or glass vial packaging, and a wide range of operating characteristics. These photocells are interchangeable with competitive types, available to MIL specifications, priced from 90¢ to \$1.60 in production quantities.

All Raytheon photocells feature: rugged mechanical construction, small size, light weight. Low noise, completely ohmic light-dependent vari-

able resistors, their characteristics and high voltage capabilities ensure fast switching, temperature stability and linear response to illumination.

Wide range of characteristics. Our CK1201, for example, features 150 ohms resistance at 100 ft. candles, rise-fall time of 3 and 60 ms, 75 mw power dissipation (maximum). And our CK1266 features 2500 ohms resistance at 100 ft. candles, rise-fall time of 1.5 and .6 seconds, and power dissipation of 100 mw maximum.

Send reader service card for data on the complete line of standard Raytheon photocells. Or tell us about your special requirements.
Raytheon Company, Components Division, Quincy, Mass. 02169.

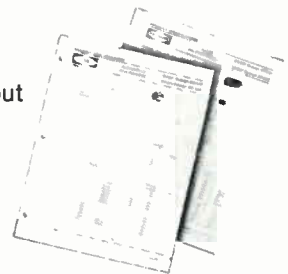

Industrial Components Operation — A single source for Circuit Modules/Control Knobs/Display Devices/Filters/Hybrid Thick-Film Circuits/Industrial Tubes/Optoelectronic Devices/Panel Hardware

Measurement of Complex Impedance with the HP 8405A Vector Voltmeter

The measurement of complex impedance in the 1 to 1000 MHz range using slotted line or bridges has always been a time-consuming and cumbersome process, particularly when determining phase angle. Now, with the HP 8405A Vector Voltmeter, faster and simpler techniques are possible.

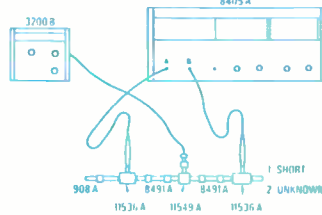

Below 100 MHz, the method illustrated above is especially convenient. Signal power is equally split, and the voltage drop across the unknown impedance is compared against the drop across the known. Results are easily entered on the Smith Chart for rapid determination of impedance.

From 100 MHz to 1 GHz, impedance is measured in the form of Reflection Coefficient, using a new, extremely wideband dual directional coupler as in the set-up shown below. The 8405A Vector Voltmeter measures incident and reflected voltage and their phase

angle, allowing quick entry into the Smith Chart.

Free Application Data

Application Note 77-3 discusses "Measurement of Complex Impedance". For your copy write Hewlett-Packard, 1501 Page Mill Road, Palo Alto, Calif. 94304; Europe: 54 Route des Acacias, Geneva.

You can appreciate the wide-range of the 8405A from these brief specifications; match them to your measurement requirements. And call your HP field engineer for complete information on this wideband, 2-channel RF millivoltmeter-phasemeter.

Major Specifications, HP 8405A Vector Voltmeter

Frequency Range is 1 to 1000 MHz in 21 overlapping octave bands; automatic tuning within each band.

Voltage Range for Channel A (synchronizing channel), 300 μ V to 1 V rms (5-500 MHz), 500 μ V to 1 V rms (500-1000 MHz), 1.5 mV to 1 V rms (1-5 MHz).

Voltage Range for Channel B (input to Channel A required), 100 μ V to 1 V rms, full scale. Full-scale meter ranges from 100 μ V to 1 V in 10 dB steps. Both channels can be extended to 10 V rms with 11576A 10:1 Divider.

Phase Range of 360° indicated on zero-center meter with end-scale ranges of $\pm 180^\circ$, $\pm 60^\circ$, $\pm 18^\circ$, $\pm 6^\circ$. Phase meter OFFSET of $\pm 180^\circ$ in 10° steps permits use of $\pm 6^\circ$ range for 0.1° phase resolution at any phase angle.

Price: \$2500.



**A NEW
TIME-SAVING
TECHNIQUE**

HEWLETT **hp** PACKARD

Instrument makers are measuring up to systems engineering standards

Availability of low-cost computers coincides with the emergence of a market for fast and accurate gear to test complex circuitry

By Carl Moskowitz

Instrumentation editor

Since the phrase "systems engineering" entered the lexicon of instrument men six short months ago, the once staid instrument field has undergone a startling change. Manufacturers no longer think in terms of single, special-purpose units; they are developing and selling complex, computer-based packages capable of providing a wealth of test data almost instantaneously.

"Before long, instrument systems will be as common in the engineering laboratory as the slide rule is today," says Richard Anderson, manager of the network analyzer section at the Hewlett-Packard Co.'s Microwave Laboratory.

Necessity was the stepmother of the computerized instrumentation systems now making their debut. Conventional test apparatus could no longer cope with the complexities of recording, reducing, and analyzing data for intricate new circuits and devices. But it was the availability of efficient, low-cost computers that really triggered the stampede into systems that make a myriad of measurements and provide results in real time [Electronics, Feb. 20, p. 203].

Old hat. Instrument "systems" are not new. Engineers have often "tied" groups of instruments to speed testing and data recording without sacrificing accuracy. But such jury-rigged packages, connected by mazes of cables, were limited in scope because they were adapted from existing equipment. Little attention had been paid to the problems of interface. These rigs also lacked the computational capacity to perform data reduction

and analysis.

Computerized systems eliminate the inaccuracies of point-by-point measurements. By furnishing continuous data during experiments, they also reduce the waste in time, energy, and money in repeating steps and calculations to collect missing information. Even home-grown instrument systems, when combined with a computer, offer this advantage. A perfect example is the system built by the U.S. Coast Guard and placed aboard the cutter Evergreen. Designed to measure ocean currents and to plot and temperature charts, the system includes the Digital Equipment

Corp.'s PDP-8/S computer. Because the computer enables immediate calculations of the output data, data gaps can be prevented.

I. Selling points

"An engineer's talent should really be used for design," says H-P's John Cardoza, a product manager. "But he has to spend too much time getting data." Since an instrument system can handle 90% to 95% of measurements like amplitude, phase, gain, and impedance, engineers and designers can be freed from purely clerical chores.

Because an instrument system



Down cold. General Radio's automatic capacitance bridge permits faster cryogenic tests than are possible with conventional instrumentation.

WITH **KH** ALL-SILICON
R-C OSCILLATORS
YOU GET MORE
THAN ADJUSTABLE
FREQUENCY!

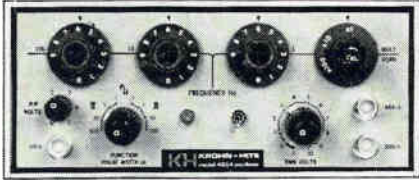

MODEL 4004, one of the new K-H all-silicon Variable R-C Oscillators, provides continuously adjustable frequency over the range of 0.001 Hz to 100 kHz. Programmed units also available.

A stable low-distortion signal source is essential for today's complex electronic measurements. You get unsurpassed signal stability and purity in K-H's new line of all-silicon broad band variable R-C Oscillators. Amplitude stability is described, below. Distortion is plotted.

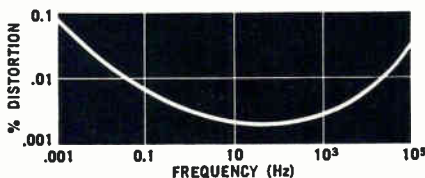

TYPICAL HARMONIC DISTORTION PLOT of K-H Series 4000 R-C Variable Frequency Oscillators.

Stability and signal purity are only two examples of the extra value you get from these modern Krohn-Hite electronic instruments. Other values increase user confidence further by providing simpler, faster and lower-cost operation.

Excellent Amplitude Stability: 0.01%, cycle-to-cycle; 0.01% per hour.

Sine- and Square-Wave Outputs: Pure sine-wave output — no diode-shaped approximations to produce step-function or waveform discontinuities. Square-wave rise and fall times less than 20 nanoseconds.

Quadrature Outputs: Sine and cosine outputs remain within $\pm 1^\circ$ of quadrature. Ideal as driver for polyphase variable power sources or simulators for rotary or linear encoders.

There's more in K-H Data Sheet 4000.

Write for a copy.

KH KROHN-HITE CORPORATION
580 Massachusetts Avenue, Cambridge, Mass. 02139
Telephone: 617/491-3211

enables the designer to work with a precise mathematical model of a device rather than a theoretical model, circuit design can be speeded. By putting the system through its paces, the computer can calculate such things as optimum gain and the proper terminations for the design of the real model. This brings computer-aided design to the engineer at the bench. However, some design work requires large, specially programed computers.

A computerized instrumentation system yields a more accurate picture of device characteristics than is possible with discrete readings. Data gaps exist between the measured points with discrete readings; thus, while a plotted curve might be fairly smooth, there would still be uncertainty about what occurs between the points. But a computerized system can sweep through a range, analyzing every possible point. The resultant curve might reveal discontinuities not disclosed by the point-by-point technique.

Self-help. Shortening the experiment and eliminating the time lost between getting the data and reviewing the analysis also speeds design work. At Hewlett-Packard, engineers test semiconductors for certain circuits under a variety of conditions—frequency, bias, load, and temperature, for example—to obtain a characteristic profile. Data is accumulated by the engineers with pad and pencil and then entered on punch cards for analysis on a time-shared computer at Stanford University, Palo Alto, Calif. Results are available about 24 hours later.

The same tests are now being performed with an experimental computerized instrument system and the results are immediately available. In fact, the system permits the changing of circuit parameters while a device is under test, and the results can be studied almost instantaneously.

Teaching machines. Anderson sees instrument systems of this type playing a dual role. Besides serving as a design tool, the system can also be used to teach design techniques to neophyte engineers just out of college. "The experience can be put on punched tape and programed into the computer's

memory for the time that another engineer may seek the solution to that particular type of design problem," says Anderson.

Computerized systems also speed design work by permitting more flexibility in test setups and by removing any ambiguities that may exist from measurement to measurement. For instance, a microwave setup with a coaxial coupler that samples signals traveling in a transmission line has a measurement ambiguity from test to test. The computer can store data taken prior to the tests or before each measurement and apply it to the results to make necessary corrections. Because the system calibrates itself, test setups do not have to be painstakingly built to minimize errors.

II. Building bridges

Two years ago, the General Radio Co. developed an automatic capacitance bridge that selects the range, balances capacitance and loss simultaneously, generates a coded digital output, and displays measured values—all in about a half-second. The bridge—the instrument that launched the firm into the automatic systems field—has increased the speed of capacitance measurements by more than 12 times. In one application, at Electronics Associates Inc., it is coupled to a computer and measures capacitors as they are temperature cycled; output data are the temperature coefficients of the capacitors. Electronics Associates reports errors have been reduced to less than 1% at a rate of almost 100,000 measurements per week.

General Radio is now developing a more complex system which will utilize a computer, in this case Digital Equipment's PDP-8/S. The new equipment—based on the capacitance bridge—will make more measurements and solve equations. The computer will signal which measurement to make and will determine whether more measurements are necessary.

Cost-yield tradeoffs. According to Harold T. McAleer, engineer in charge of General Radio's systems group, instrument systems can be used to increase the yield of discrete components at today's costs or maintain today's yields at lower costs. For instance, with General Radio's capacitance bridge, limit

408 - Minute kitchen, rooms, 1 with sink, Recessed 4081.
 409 - Sleeping room, References, \$10 month.
 410 - Ro. Dini. - Dressing, heat, bath, dining, bus, and sanitation, references. 409-644.
 411 - Silo. - Sleeping room, Ind. Private. Ref. 409-644.
 412 - Sleeping room, refrigerator, heat, air. Convenient. References. 409-644.
 413 - Room for rent from shopping center. 409-644.
 414 - Single room, refrigerator, with sun, room, air, heat, adults, References. 409-644.
 415 - Rent. Large v. Mosambique employed. 409-644.
 416 - Mississipi. Sleeps, honey bath, tiled, carpet, References. 409-644.
 417 - Affordable, bedroom, completely private, convenient, References. Any is 409-644.

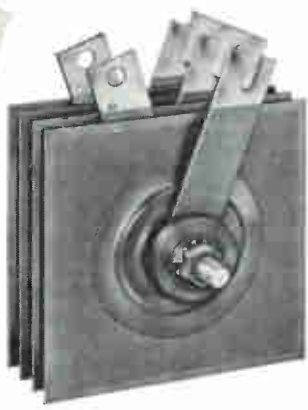

421 - Small, well, 2 bedrooms, References, \$10-6013.
 422 - LIJELY - Warm, refrigerator, stove, References, \$10 week. 409-644.
 423 - Liberty - Clean, modern, References, Bus. 20.
 424 - ELLIOTT - Large, private bath, modern, near Parkway, local, References. 21-607.
 425 - SRENCVILLE - Large, modern, excellent transport, in woman, reasonable, References. 409-644.
 426 - Labanon - Semi-golf, residential, References. 409-644.
 427 - Labanon - Good, fully furnished, with air, convenient to buses, I.C.
 428 - RITCHE - Front, shower, References, convenient, 409-644.
 429 - CLARK - 2-room, private, convenient, everything.
 430 - 1115 Avenue - Single, private bath, entrance, References. 409-644.
 431 - ROYCE - 5620, attractive, sleeping, convenient, References, 409-644.

Space To Let!

When you use Uni-Sel Selenium Rectifiers....

Profit in space-saving with smaller physical sizes operating at higher current density...

Profit in reduced cost with 45-volt quadruple density Uni-Sel...

Profit with Higher Temperature Capability, 50% ratings at 70°C ambients.

More information? Send coupon...

Send catalog data about 241
 Syntron Uni-Sel Rectifiers
 Name/Title _____
 Company _____
 Street _____
 City, State _____ Zip _____



Just out!
 New catalog with full information on Silicon Diodes and Assemblies.



SYNTRON COMPANY
 241 LEXINGTON AVE. • HOMER CITY, PA. 15748
 TELEPHONE 412-479-8011
 Sales Representatives Coast-to-Coast

67R9

HOW YOU CAN READ, PLOT, OR SCALE CURVES WITHOUT CALCULATION

The Gerber Variable Scale is based on a precision extensible spring, calibrated in hundredths. You can read curve amplitudes and frequencies directly, multiply by scale factors, plot with correction factors or other constants included, interpolate, normalize, etc. . . . eliminate routine calculations. Accurate to 0.05% in full scale of ten inches. Partially shown below (actual size) plotting curve from original.

FREE Application Manual

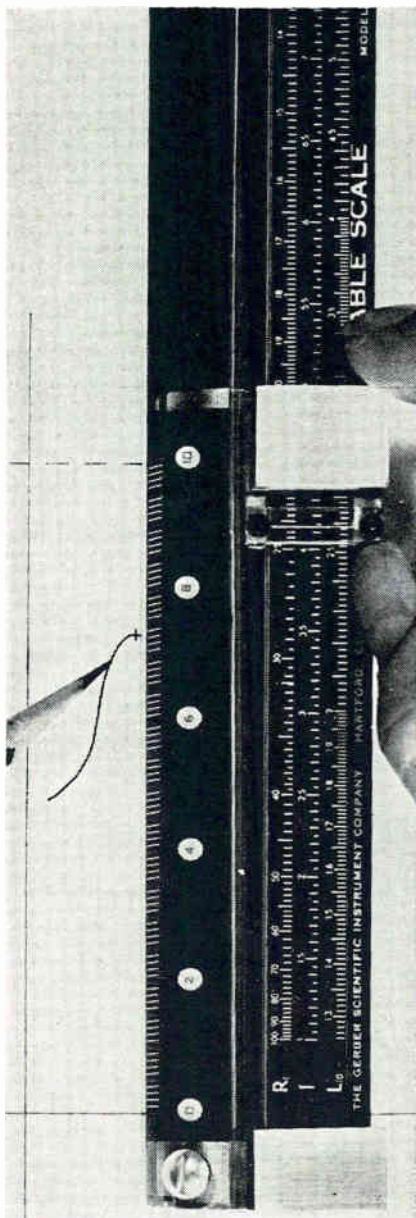

GERBER SCIENTIFIC INSTRUMENT CO., INC.
P. O. Box 305, Hartford, Connecticut

comparators, and a bin sorter, capacitors manufactured to a tolerance of 10% can be automatically tested and sorted by grades. This system can measure and sort up to 120 capacitors a minute.

Instrument systems increase accuracy as well as speed: Julie Research Laboratories Inc. has developed automatic resistance-measuring apparatus that measures to an accuracy of 40 parts per million. Julie's system is based on the company's Ratiometric technique where the unknown is compared to a nominal value. In the automatic system, the comparison unit is a digital ratiometer that records the deviation from the nominal value. A programable standard resistor sets up the nominal value for comparison to the unknown. "This permits resistance measurements to be made to standards laboratory accuracies even within a production environment," says Loeb Julie, the company's president.

Changing image. Instrument systems are changing the character of many manufacturers. As recently as two years ago, a systems engineer at an instrument company would have been out of place. Now companies like General Radio not only have systems engineers, but also systems divisions. Almost every major instrument maker has developed and sells some type of measuring system capable of working with computers.

Hewlett-Packard has systems groups in all divisions, each concerned with devising systems to solve measurement problems within specific areas. One of the most noticeable results of this change is that the company now makes computers that are designed specifically to interface with measurement instruments.

In many ways, the Digital Equipment and Hewlett-Packard computers are alike: both have expandable core memories with about 4,000-word capacity; both are built with integrated circuits and easily adapted to measurement and analysis tasks. But unlike Digital Equipment's general-purpose PDP-8/S, H-P's 2116A machine accommodates test instruments within the input-output structure instead of with coding or interfacing equipment. The various classes of instruments and the priorities the com-

puter should give to the signals from different instruments are taken care of by plug-in cards in the input-output section, thus tailoring the computer to the specific measurement system.

III. Changing of the guard

Product lines are also changing. General Radio, for example, now sells digital-to-analog converters, limit comparators, scanners, and other conditioning, handling, and processing devices.

Progress in instrument systems may, however, be impeded by the incompatibility that exists between the major building blocks supplied by different companies. Both Hewlett-Packard and General Radio equipment require all instruments to be designed with binary-coded decimal outputs and to be programable. But characteristics like logic levels and codes may differ. Standardization would put an end to these discrepancies. But no move has as yet been made in this direction.

Shifting markets. To be marketable, of course, instrument systems must be economical. Development of digital computers priced from \$10,000 to \$20,000 has made this possible. According to Bill Landis, marketing manager for the PDP-8/S at Digital Equipment, the new economics opened previously barred instrumentation markets to computers. His firm projected new computer sales at 200 per year, but the machine is now moving at a rate about three or four times the original estimate.

Digital Equipment is now eyeing the test systems market itself. John MacKen of the company's digital test systems group, indicates that a \$10,000 computer is priced low enough for computer-based memory testers to find wide use—even as a design tool. These systems would enable design engineers to make maximum-minimum parameter searches, automatic distribution plot analysis, and Shmoo plotting [Electronics, July 25, 1966, p. 127].

And eventually, companies like Digital Equipment may be competing with their customers, the instrument manufacturers, for the same business in the same manner as the instrument maker is encroaching on the computer maker's territory.

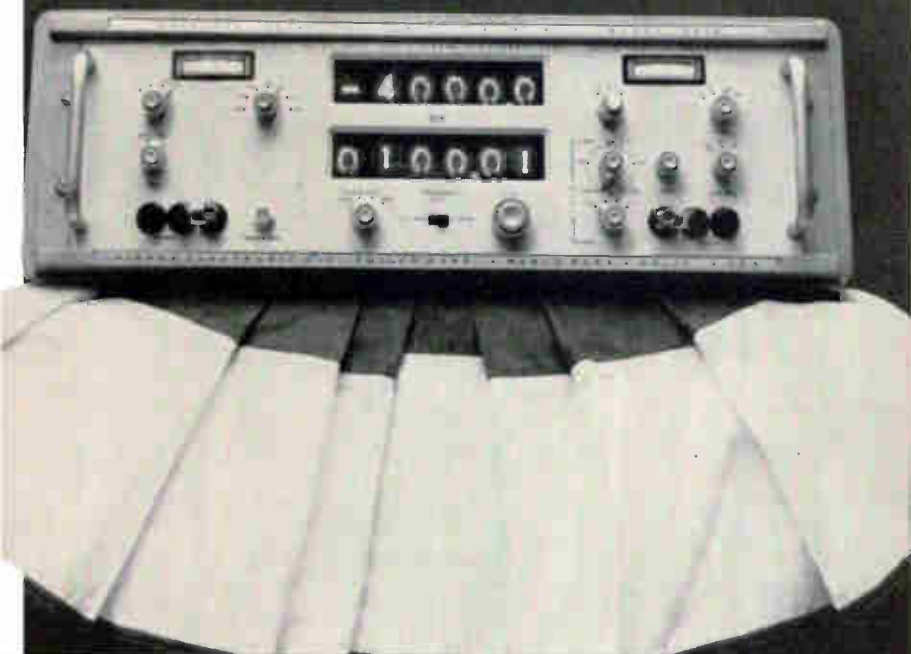

The day Sierra announced this...

Delay distortion became a new issue in the maintenance campaign when data crossed paths with your carrier system. To insure clear, coherent communications, you need all the inside information you can get about each individual transmission circuit. Unknown envelope delay, in particular, can easily garble those well-ordered bit formations into a meaningless shower of babble.

Sierra's new Model 340B helps keep your system tuned to peak performance. It measures delay from 300 Hz to 110 kHz, permitting measurements both on 4-kHz voice circuits and on circuits utilizing group frequencies (60–108 kHz). You have a built-in choice of three measuring modes: end-to-end, loop-back, or end-to-end with return reference path.

Model 340B opens a new frontier of speed and simplicity with such features as:

- Single delay range covering $-20,000$ to $+20,000$ μsec
- Direct digital readout with resolution of 0.1 μsec or 1.0 μsec

A second digital readout indicates carrier frequency to the nearest 10 Hz. Electronic sweeping and a built-in 1-MHz frequency counter (± 1 digit, ± 1 Hz accuracy) round out a solid list of performance features. Price, with one modulation frequency: \$4,750.

For the campaign literature, write Sierra/Philco, 3885 Bohannon Drive, Menlo Park, California 94025.



other ways of measuring envelope delay on carrier circuits became as dated as this



PHILCO-FORD CORPORATION
Sierra Electronic Operation
Menlo Park, California • 94025

Only from Lambda — New 7-inch, broadest line of .015% regulated

All convection cooled

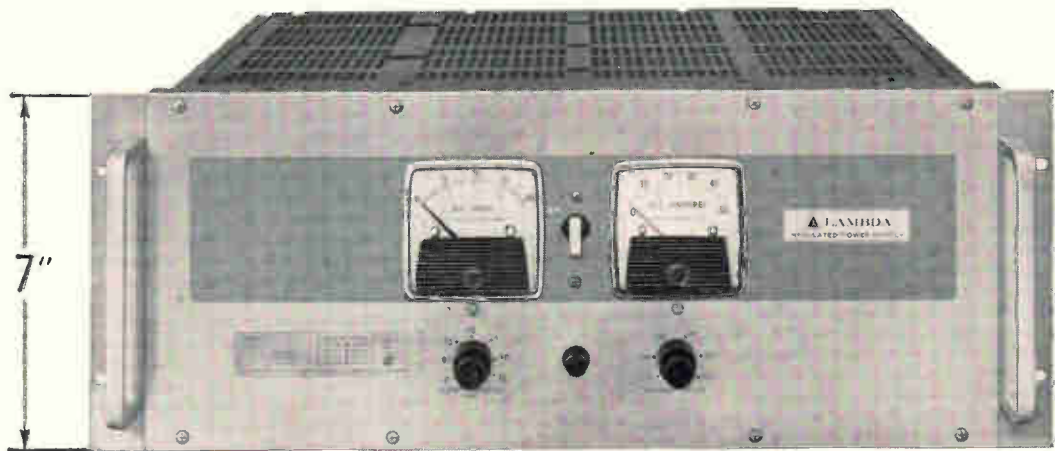

FULL RACK—7" LK SERIES

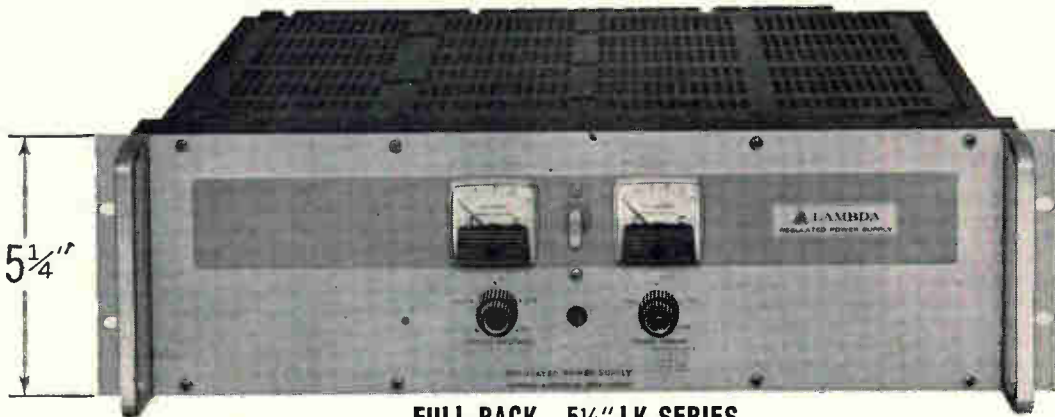

FULL RACK—5 1/4" LK SERIES

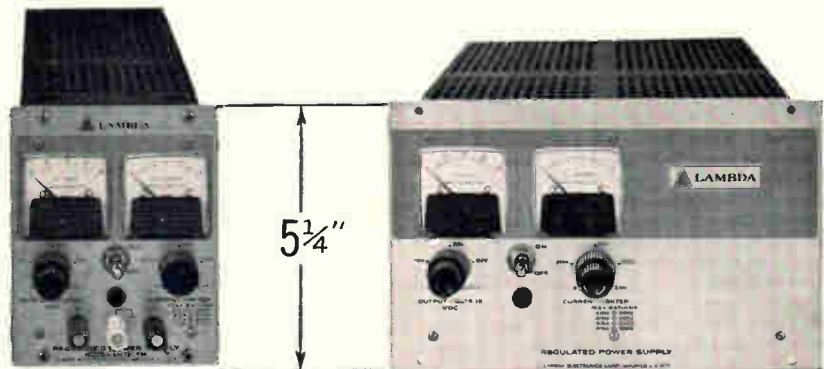

1/4 RACK—LH SERIES

HALF RACK—LK SERIES
LH SERIES



high current models in the all-silicon power supplies

For test equipment and lab use—rack or bench
 From 1/2 to 66 amps, 0-10, 0-20, 0-40, 0-60, 0-120 VDC
 Full five year guarantee on materials and labor

Features and Data

- Convection Cooled
- Remote Programming
- Remote Sensing
- Regulation—.015% or 1 MV (Line or Load)
- Temp. Coef. .015%/°C
- Transformer—designed to MIL-T-27 Grade 6
- Completely Protected—Short circuit proof—Continuously adjustable Automatic current limiting
- Constant I./Constant V. by automatic crossover
- Series/Parallel Operation

- No Voltage Spikes or Overshoot on "turn on", "turn off" or power failure
- Meet Mil. Environment Specs.
 Vibration: MIL-T-4807A
 Shock: MIL-E-4907A Proc. 1 & 2
 Humidity: MIL-STD-810 Meth. 507
 Temp Shock: MIL-E-5272C (ASG) Proc. 1
 Altitude: MIL-E-4970A (ASG) Proc. 1
 Marking: MIL-STD-130
 Quality: MIL-Q-9858

- Ripple—
 LK models—500 μ V RMS
 LH models—250 μ V RMS, 1 MV P-P
- Wide Input Voltage and Frequency Range—
 Models LK360-362FM: 200-250 VAC, 47-63 cps
 Other LK models: 105-132 VAC, 47-63 cps
 LH models: 105-135 VAC, 45-480 cps.
- LH models meet RFI Spec.—Mil-I-16910
- Rack Adapters
 LRA-1—5 $\frac{1}{4}$ " Height x 16 $\frac{1}{2}$ " Depth (For use with chassis slides) Price \$60.00
 LRA-2—5 $\frac{1}{4}$ " Height Price \$25.00

3 Full-rack Models — Size 7" x 19" x 18 $\frac{1}{2}$ "

Model ²	Voltage Range	CURRENT RANGE AT AMBIENT OF: ¹				Price ²
		40°C	50°C	60°C	71°C	
LK 360 FM	0-20VDC	0-66A	0-59A	0-50A	0-40A	\$995
LK 361 FM	0-36VDC	0-48A	0-43A	0-36A	0-30A	950
LK 362 FM	0-60VDC	0-25A	0-24A	0-22A	0-19A	995

11 Half-rack Models — Size 5 $\frac{3}{16}$ " x 8 $\frac{3}{8}$ " x 15 $\frac{1}{2}$ "

Model ²	Voltage Range	CURRENT RANGE AT AMBIENT OF: ¹				Price ²
		30°C	50°C	60°C	71°C	
LH 119	0-10VDC	0- 9.0A	0- 8.0A	0- 6.9A	0-5.8A	\$289
LH 122	0-20VDC	0- 5.7A	0- 4.7A	0- 4.0A	0-3.3A	260
LH 125	0-40VDC	0- 3.0A	0- 2.7A	0- 2.3A	0-1.9A	269
LH 128	0-60VDC	0- 2.4A	0- 2.1A	0- 1.8A	0-1.5A	315
LH 131	0-120VDC	0- 1.2A	0- 0.9A	0- 0.8A	0-0.6A	320

3 Full-rack Models — Size 5 $\frac{1}{4}$ " x 19" x 16 $\frac{1}{2}$ "

Model ²	Voltage Range	CURRENT RANGE AT AMBIENT OF: ¹				Price ²
		40°C	50°C	60°C	71°C	
LK 350	0-20VDC	0-35A	0-31A	0-26A	0-20A	\$675
LK 351	0-36VDC	0-25A	0-23A	0-20A	0-15A	640
LK 352	0-60VDC	0-15A	0-14A	0-12.5A	0-10A	650

Model ²	Voltage Range	CURRENT RANGE AT AMBIENT OF: ¹				Price ²
		40°C	50°C	60°C	71°C	
LK 340	0-20VDC	0- 8.0A	0- 7.0A	0- 6.1A	0-4.9A	\$330
LK 341	0-20VDC	0-13.5A	0-11.0A	0-10.0A	0-7.7A	385
LK 342	0-36VDC	0- 5.2A	0- 5.0A	0- 4.5A	0-3.7A	335
LK 343	0-36VDC	0- 9.0A	0- 8.5A	0- 7.6A	0-6.1A	395
LK 344	0-60VDC	0- 4.0A	0- 3.5A	0- 3.0A	0-2.5A	340
LK 345	0-60VDC	0- 6.0A	0- 5.2A	0- 4.5A	0-4.0A	395

5 Quarter-rack Models — Size 5 $\frac{3}{16}$ " x 4 $\frac{3}{16}$ " x 15 $\frac{1}{2}$ "

Model ²	Voltage Range	CURRENT RANGE AT AMBIENT OF: ¹				Price ²
		30°C	50°C	60°C	71°C	
LH 118	0-10VDC	0-4.0A	0-3.5A	0-2.9A	0-2.3A	\$175
LH 121	0-20VDC	0-2.4A	0-2.2A	0-1.8A	0-1.5A	159
LH 124	0-40VDC	0-1.3A	0-1.1A	0-0.9A	0-0.7A	154
LH 127	0-60VDC	0-0.9A	0-0.7A	0-0.6A	0-0.5A	184
LH 130	0-120VDC	0-0.50A	0-0.40A	0-0.35A	0-0.25A	225

¹ Current rating applies over entire voltage range.
² Prices are for non-metered models (except for models LK360FM thru LK362FM which are not available without meters). For metered models, add suffix (FM) and add \$25 to price of LH models; add \$30 to price of LK models.
³ Overvoltage Protection: add suffix (OV) to model number and add \$60 to the price of LH models; add \$70 to price of half-rack LK models; add \$90 to price of 5 $\frac{1}{4}$ " full-rack LK models; add \$120 to price of 7" full-rack LK models.
⁴ Chassis Slides for full rack models: Add suffix (CS) to model number and add \$60 to the price.

SEND FOR NEW
 LAMBDA CATALOG



LAMBDA ELECTRONICS CORP.
 515 BROAD HOLLOW ROAD • MELVILLE, L.I., NEW YORK 11746 • (516) 694-4200

A  SUBSIDIARY

SAVE

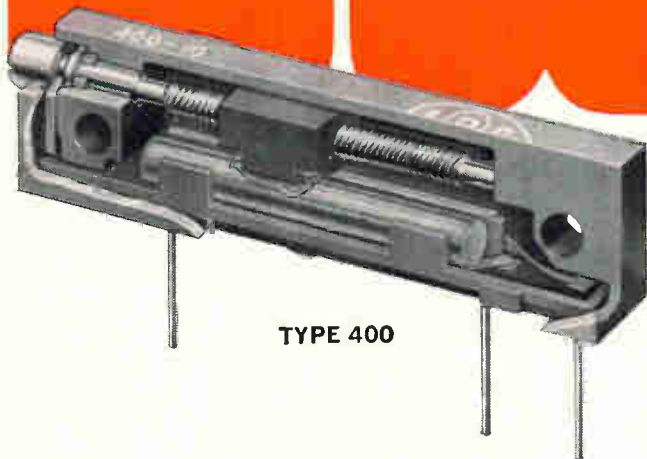

TYPE 400

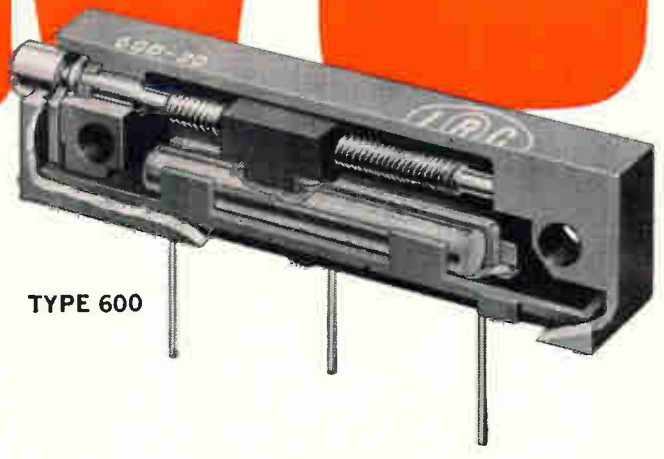

TYPE 600

Military quality at industrial prices

IRC wirewound rectangular trimmers save space and dollars

IRC's CIRCUITRIM potentiometers offer MIL characteristics at the same price as industrial types. Benefit by upgraded performance and reliability for your industrial needs and impressive savings for your MIL applications.

Both series are designed to perform under environmental requirements of MIL-R-27208. Molded diallyl phthalate cases are rugged, light and practical for use in any military or high grade industrial application. A one-piece, corrosion-resistant shaft and specially designed wiper block system isolate electrical elements and assure "set-and-forget" stability.

The 600 series is designed to MIL-Style RT-11 and is offered with staggered P.C. pins or teflon insulated leads. The 400 series is designed to MIL-Style RT-12 with P.C. pins in-line or teflon insulated leads. It is also available in a thin-line version of RT-11 (Type 400-20) with staggered P.C. pins which offer 30% space savings and complete interchangeability on pre-printed boards.

These low-cost MIL-type units are the result of IRC's years of experience in building high-quality trimmers. Samples available

from local sales offices. For prices and data, write: IRC, Inc., 401 N. Broad St., Philadelphia, Pa. 19108.

ONLY IRC OFFERS ALL 4 POPULAR STYLES
Wirewound or infinite resolution elements



CAPSULE SPECIFICATIONS

	TYPE 400	TYPE 600
MIL STYLE	RT-12*	RT-11
POWER	1 W @ 70°C	1 W @ 70°C
TOLERANCE	± 5%	± 5%
RESISTANCE	10Ω to 50KΩ	10Ω to 50KΩ
TEMPERATURE	-55°C to 150°C	-55°C to 150°C

*Plus thin-line version of RT-11 (Staggered P.C. pins)



Water takes the heat off thyristors

Labyrinth bath boosts power dissipation of conventional as well as 'hockey puck' silicon controlled rectifiers

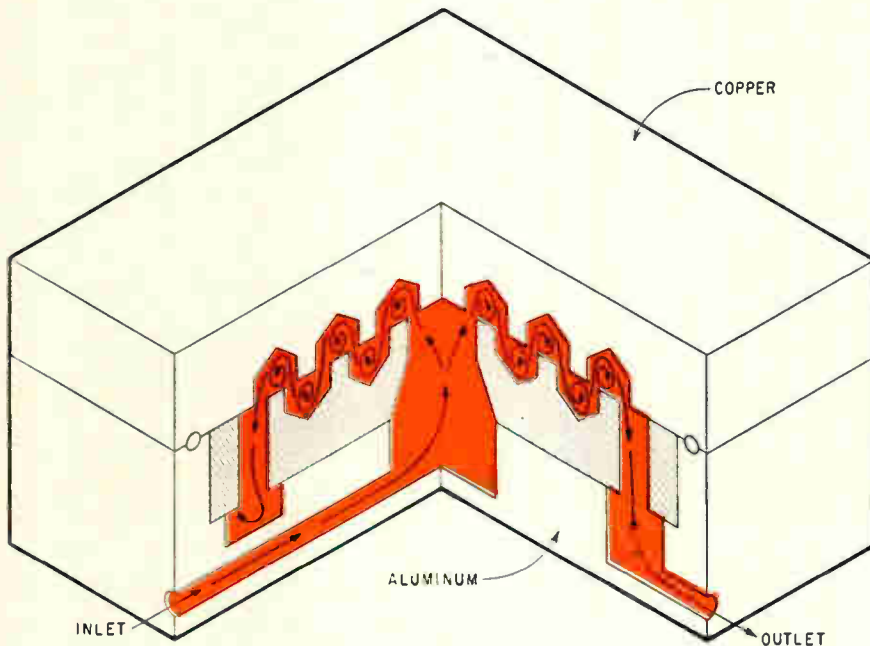

ly consists of three parts: an aluminum body, a machined insert, and a copper counter-body. The insert, now made of stainless steel, can be copper, aluminum, or even plastic, its developers say, and it could be cast instead of machined to reduce cost.

Water is pumped into the center of the block directly below the silicon wafer and circulates radially through the labyrinth, creating low velocity eddy currents. A collector ring circles the labyrinth and a resilient O-ring seals the halves.

The labyrinth was designed so that it can be used on either side of a "hockey puck" or disk-cell type thyristor, as well as with a conventional stud mounted thyristor. The hockey puck type enables the removal of heat from both sides of the silicon wafer simultaneously. A pair of these operating as an a-c switch can handle 1,200 amperes root mean square.

The first device to use the new labyrinth is the type 224, a conventional single-sided thyristor. It can carry currents of 630 amperes rms compared with 400 amperes for the

New water cooling methods may be the solution to the gnawing problem of power dissipation when high currents are demanded of thyristors. A cooling labyrinth has been designed that promises to boost the current-carrying capability of the

silicon wafer—the heart of the thyristor or silicon controlled rectifier.

Developed by the Westinghouse Electric Corp. with the aid of a computer, the labyrinth—through which water is pumped—can be clamped to a thyristor. The assem-

New products in this issue

- 169 Water takes the heat off thyristors
- 170 Versatile receiver scrimps on power
- Components**
- 172 Plastic connectors make airtight case
- 172 Protective containers for delicate parts
- 173 Square commercial trimmer
- 174 Stable photochopper modules
- 175 Electromagnetic relay
- 176 Tv diode rated at 18 kv
- 177 Braked servomotor
- Semiconductors**
- 178 H-v transistor sweeps color tv
- 178 Silicon transistors resist radiation
- 179 High-power avalanche rectifiers

- Instruments**
- 180 Pulse delay has 1-nsec resolution
- 180 Signal generator runs on battery power
- 181 Current indicator also integrates
- 182 Squaring transducer operates to 1 Mhz
- 182 Vibration analyzer has dual role
- 183 A-c microvoltmeter rejects noise
- 184 Peak voltage sensor
- 185 Three-in-one digital meter
- 187 Digital multimeter tracks two ways
- 189 Pressure transducer
- Subassemblies**
- 190 Tracing curves by the numbers
- 190 Binary code switch
- 191 Power amplifier
- 192 Core memory systems

- 193 Vlf signal source
- 194 Military inverter
- Microwave**
- 196 Coaxial package lifts transistor power
- 196 Bandpass filters at 12 Ghz
- 197 Air-cooled loads handle high power
- Production equipment**
- 198 Transistor labeling machine
- 198 Production-line wire stripper
- 198 Die bonder for film devices
- 199 P-c board router
- Materials**
- 201 Silicone sheet blocks microwaves
- 201 Polyurethane pots and encapsulates
- 201 Low-temperature-curing epoxy resin

New Products

air-cooled type 229. Westinghouse has conducted tests of the hockey puck version cooled from both sides using the labyrinth and reports results "quite close to the full current carrying capability inherent in the silicon wafer." The only way to beat these results, says one Westinghouse engineer, is to use Freon-cooled systems.

Westinghouse hasn't decided whether to market the hockey puck

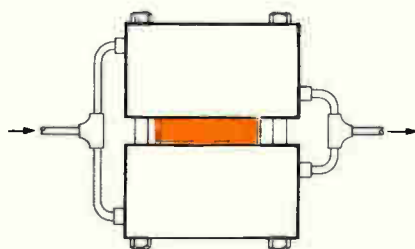

thyristor and associated labyrinth coolers as a package. Instead, it may encourage customers to buy its thyristors and put together their own coolers using the labyrinth approach. In the meantime, the water-cooled 224 is available at prices ranging from \$135 to \$755 depending on voltage ratings (50 to 1,400 volts) on a four-to-six week delivery.

Specifications

Package	One-sided stud, water-cooled labyrinth
Water flow	1.5 gal. per minute
Current ratings	
Half wave average	400 amps
Rms	630 amps
Half cycle surge	5500 amps
Voltage ratings	
Forward and reverse	50-1,400 v
Price	\$135-\$755 in 1-24 quantities

The Westinghouse Electric Corp., Pittsburgh, Pa. [349]

Versatile receiver scrimps on power



A bantamweight champion of versatility, the all-purpose receiver developed by Defense Electronics Inc. is also penurious with battery power. So miserly is the GPR-20 on battery drain that it can operate on land, sea, or air for 250 hours on its power supply of 10 standard flashlight cells. This frees the unit, which weighs less than 10 pounds, from the fetters of an a-c line cord, and enables it to perform an extraordinary number of sophisticated jobs in the field as well as in the laboratory.

With an all solid state lineup of

40 silicon transistors, 11 silicon diodes, and 40 germanium diodes, the receiver operates over a frequency range of 55 to 260 Mhz, and can detect amplitude and frequency modulation, continuous wave, and pulse transmissions. This flexibility qualifies it for applications in telemetry, communications, spectrum analysis, medical instrumentation, radio frequency interference investigations, and surveillance.

According to Ray Rosenberg, president of DEI, the portability of the GPR-20 is important in rugged field applications like quick-look telemetry and surveillance. "Getting the receiver off the power line makes it immune to power surges," he says, "and eliminates the noise of gasoline generators. Furthermore, it isn't necessary to lug gasoline into the remote and rugged terrain where these receivers may be used."

Rosenberg claims that the receiver will do more with less size and weight than any other receiver designed for the same class of applications—and at low cost, too: \$1,250.

Design features that give the receiver unique performance characteristics include an f-m demodulator with a high capture ratio that assures locking onto the strongest signal in a multipath distortion environment, and a stretched pulse audio monitor, which elongates pulse inputs, allowing detection of high speed pulse codes that might otherwise slip by during a surveillance frequency sweep. Measuring $3\frac{3}{4} \times 11\frac{1}{8} \times 11\frac{1}{8}$ inches, the receiver has a noise figure of only 5.5 decibels maximum below 200 Mhz, and 6.5 db maximum above that range. Local oscillator stability is less than 100 hz per minute after a 30 minute warmup.

Bandwidth and phase response make it suitable for tv reception without modification. With a facsimile printer, the unit can be slightly modified to receive satellite weather photos.

The GPR-20 is housed in a splash-resistant case with carrying handle, and has a built-in telescoping antenna that can be swiveled for either horizontal or vertical polarization. Two front panel meters provide indication for tuning, relative signal strength, and battery condition. The unit has a calculated mean time between failures of 25,000 hours.

Specifications

Tuning range	55-260 Mhz
i-f bandwidth	1 Mhz [f-m, a-m, pulse, c-w]; 10 khz [a-m, c-w] other i-f bandwidths available on special order.
Video response	20 hz to 500 khz into 600 ohms
Antenna-conducted local oscillator radiation	Less than 15 μ v
Image rejection	40 db min., below 150 Mhz 30 db min., above 150 Mhz
F-m distortion	Less than 1% with 1 khz modulation rate, 200 khz peak deviation
A-m distortion	Less than 3% for 50% modulation with 1 khz modulation rate and r-f input from <10 μ v to 50 mv
Options	Standard 19-inch rack adapter, carrying case including headphones and tool kit, 115/230 volt 50-400 hz plug-in power supply
Price	\$1,250
Delivery	30-45 days

Defense Electronics Inc., Brookville, Maryland. [350]

ulano is the leading manufacturer
of screen process stencil film

...any kind!



*In screen processing
of complex printed circuitry ...
there's no margin for error!
That's why Ulano offers
a complete line of
Screen Process Stencil Films
especially designed for
the Electronics Industry.*

ulano^{T.M.}

610 DEAN STREET, BROOKLYN, N. Y. 11238

NEW YORK • CALIFORNIA • CHICAGO • ZURICH

In Europe: ULANO A. G., Untere Heslibachstrasse 22, Kusnacht 8700, Switzerland

*For free working samples, write today
on your letterhead for Kit No. 5848*

Circle 171 on reader service card

Need fast action on servo amplifiers?

Try Bulova first! Chances are, we can solve your problem better and faster than anyone else. Here's why:

1. We have the most complete line of Servo Amplifiers in the business—hundreds of standard designs to solve your problems! From 3.5 to 40 watts output power; 60 and 400 Hz.

2. Bulova Servo Amplifiers are engineered to reduce the number of components, producing low cost, high quality, trouble-free units. This frees you to concentrate on systems, rather than components.



3. High-density packaging—down to just 0.3 cu. in.! For example, Model S21220101: A 3.5 watt Servo Amplifier with gains of up to 5000—in the smallest package of its type on the market!

Another example:

The smallest package ever for a stable solid state servo amplifier producing 40 watts of output power! Need a unit fast to put into a breadboard or prototype? We can probably supply it, meeting most military specs (MIL-E-5272, MIL-E-5400, MIL-I-26600, etc.) You'll get assembly by personnel trained and certified by NASA, if desired. You'll get amplifiers built for 10,000 hours of operating life! And perhaps equally important, you'll get the unit you need fast!



Write today for your free copy of our 8-page Bulletin No. 10, containing complete specifications and ordering information. Also ask about our Resolver Amplifiers, Demodulators, Quadrature Reject and AGC Amplifiers. Address: Dept. E-24.

Try Bulova First!

SERVO PRODUCTS

ELECTRONICS DIVISION
OF BULOVA WATCH COMPANY, INC.

61-20 WOODSIDE AVENUE
WOODSIDE, N.Y. 11377, (212) DE 5-6000

New Components and Hardware

Plastic connectors make airtight case

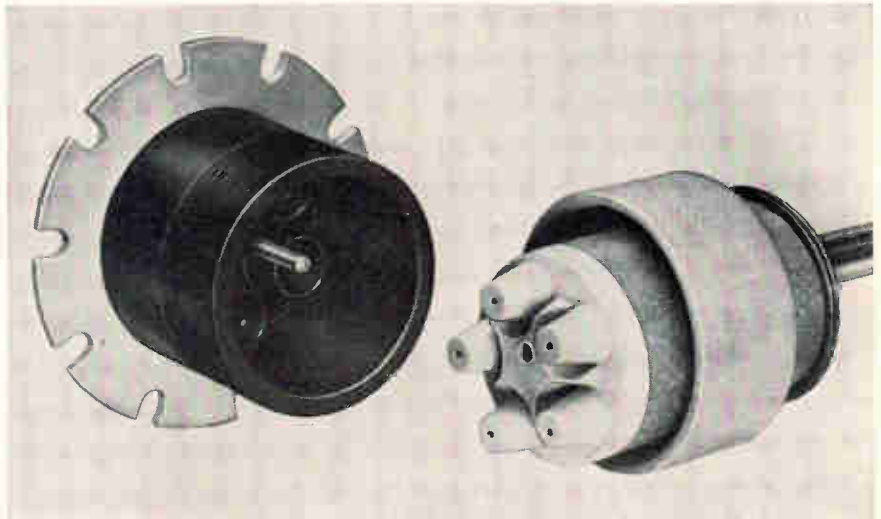

There's still a good bit of controversy about the hermeticity of plastic packages [Electronics, March 20, p. 25]. Most of the attention has been focused on semiconductor device packages, but now a line of high-voltage connectors is being introduced that features hermeticity with a plastic to metal seal. The connectors use a high-temperature plastic dielectric which the manufacturer claims can stand up under wide temperature fluctuations that often adversely affect units using glass or ceramic insulators. The connector's application, rather than the dielectric, thus determines the choice of optimum contact material. For example, copper alloys, which permit the incorporation of high-conductivity contacts, can be used instead of such special metals as Kovar.

Built by the Capitron division of AMP Inc., Elizabethtown, Pa., the connectors are designed to maintain a hermetic seal when cycled from -55°C to $+125^{\circ}\text{C}$. When tested with a helium mass spectrometer, they show no leakage; sensitivity ranges from 1×10^{-7} to 1×10^{-9} cubic centimeters per second.

Capitron is convinced its bonding process sidesteps a number of the difficulties involved in making connectors with conventional dielectrics to military specifications.

Glass, the company says, is vulnerable to heat-cracking during soldering operations and it can also shiver if contact pins are bent or straightened. An alternative, ceramic, is more resistant to cracking and provides stronger bonds to metal than is the case with glass. But ceramic's high costs may outweigh these advantages, and any special geometry that may be required in the device will lengthen fabrication lead times.

As a result of the ability of its plastic dielectric to be fused with a wide variety of metals, Capitron says, the choice of materials for a connector's outer shell is not limited by the insulation. In fact, the outer shell can be eliminated for "O" ring mounting. Threaded holes can be molded directly in the insulator—a feature that would be impracticable with glass or ceramic.

Capitron Division, AMP Inc., Elizabethtown, Pa. 17022. [351]

Protective containers with finned end caps

Designing a package for delicate, expensive electronic parts has for years been a problem to manufacturers. Now a series of simple, shockproof, low-cost, transparent

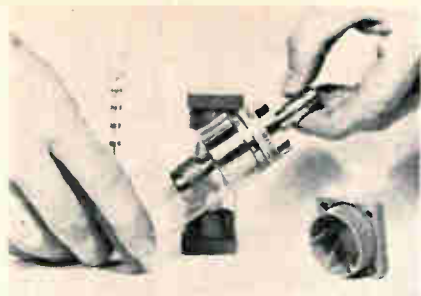

containers provides lightweight protection for such items.

Key to the effectiveness of the new container is the specially designed injection molded polyethylene end cap, the inner part of which has fins that grip the enclosed part tightly. If the container is dropped, the shock is absorbed by the flexible end closures and dissipated over the surface of their rims. The end closures can be color-coded for product identification.

The manufacturer is also making available a cutting machine for users wishing to produce their own package lengths. Standard 6-foot lengths of tubing can be quickly and economically cut into specified lengths.

At present, the acetate tubing is available with outside diameters of from 1/4 to 1 1/4 in. in 1/4-in. increments. End closures come with corresponding o-d's. Wall thicknesses are 0.020 in. for the 1/4-in.-diameter tube, 0.025 in. for the 1/2- and 3/4-in.-diameter tube, and 0.030 in. for the 1- and 1 1/4-in. diameter.

Tiros Plastics Corp., 543 Tarrytown Road, White Plains, N.Y. [352]

Commercial trimmer in square design

The first commercial trimmer in a square configuration is claimed for a wirewound 3/8 in. trimming potentiometer. Its p-c pins fit the cards of any standard 3/8 in. or 1/2 in. square trimmer. It also offers a 0.200 in. trimmer height for low card spacing applications.

Because of this geometric design, the model 3600 trimmer permits a longer mandrel than that of rectangular units and, therefore, offers up to 131% better resolution than that offered by the best 3/4 in. rectangular trimmer, the company re-

A BIG PUSH, PULL, TWIST OR TURN, IN A SMALL SPACE

Ledex solenoids can help you get a lot of work done in places where you don't have much room. We make both push/pull and rotary solenoids in a wide variety of shapes and sizes to solve just about any actuating problem you have.

PUSH/PULL

Our push/pull solenoids are designed for fast response and high force-to-size. Generally, the flat face is best for big loads and short strokes, and the conical gives you more force with longer strokes. Here's a performance comparison for a Ledex size 5 (1 7/8" dia. x 1 1/16"):



Conical

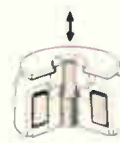

Flat Face

STROKE	FORCE flat-face plunger, 90 watts, 1/10 duty	FORCE conical plunger, 90 watts, 1/10 duty
.020 inch	96 pounds	35 pounds
.120 inch	12 pounds	27 pounds

ROTARY

Ledex rotary solenoids are known best for their shock resistant ability and high torque-to-size rotary motion. For example, with a load that must be moved through a 25 arc, our smallest rotary solenoid (1" dia. x 5/8") snaps 1.1 pound-inches, and our largest (3 3/8" dia. x 2 5/16") moves a hefty 117 pound-inches.

Because Ledex rotary solenoids have a relatively flat output torque curve, they are often used to move linear loads. They are also used for linear loads when shock conditions exist or when stroke length is beyond the efficient range of push/pull solenoids.



Standard Solenoid.
Life to 10 million
actuations.



Endurance Engineered.
Life to 100 million
actuations.



Call Ledex when you need a lot of power in a small space to push, pull, turn, twist, step, index, hammer, punch or trigger. For a quick start on your prototype, choose from over 350 different stock model designs. Or, send details and we'll custom design a space-saving solenoid for you.



LEDEX INC., 123 WEBSTER STREET, DAYTON, OHIO 45402
Custom Circuitry & Controls

phone (513) 224-9891

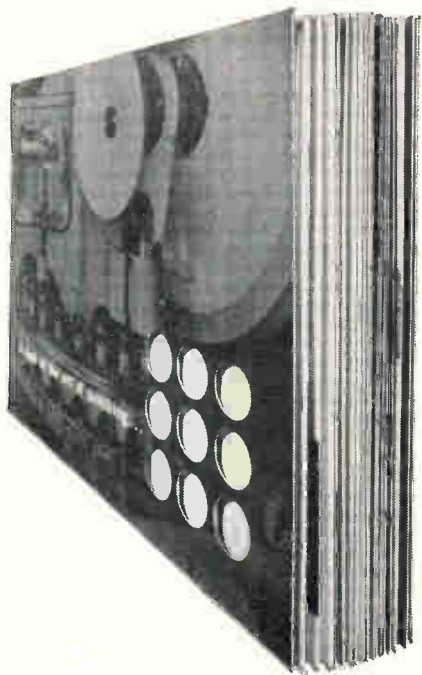

44 brand new pages of helpful punching information

- Six basic punching concepts
- Turret punch presses
- Stylus operated turret punch presses
- OBI punch presses
- Single station punch presses
- New horn punch presses
- Adjustable punch and die sets
- All shapes and sizes of punches and dies
- Template layout machines

Complete information! Illustrations, descriptions, specifications and prices. Ask your distributor for the new 44-page Di-Acro punching catalog or write us.



DI-ACRO

division of



434W EIGHTH AVENUE
LAKE CITY, MINNESOTA 55041

New Components

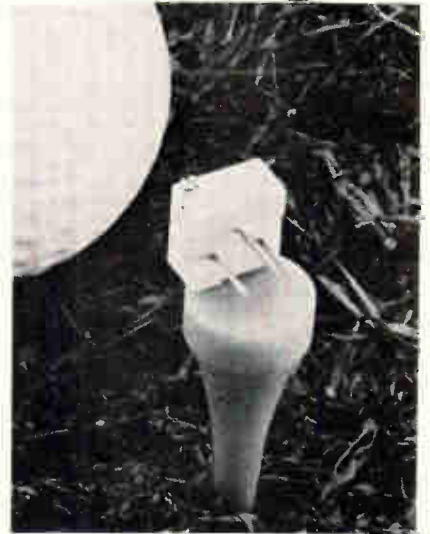

ports. Because the wire is wound on a small diameter mandrel, the new design offers up to 85% better resolution than that specified by MIL-R-27208B, RT24.

Resistance values are available from 100 to 20,000 ohms. Power rating is 0.5 w at 40°C. Operating in a temperature range from -65° to +125°C, the new trimmers feature silver-brazed terminations, gold-plated terminals and a damage-proof clutch. The model 3600 trimmers are production-priced at less than \$2 each.

Amphenol Corp., Amphenol Controls Division, 120 S. Main St., Janesville, Wis. 53545. [353]

Temperature-stable photochopper modules

Stable high efficiency over a wide temperature range is the specialty of a line of photochopper modules. Designated CM-1 and CM-2, the devices utilize high-speed cadmium-sulfide photocells with low temperature coefficient for applications to 1,000 hz.

The modules consist of two photocells illuminated by a neon glow lamp. Model CM-1 has a nominal input impedance of 300 kilohms at 60 hz. The CM-2 has a nominal input impedance of 10,000 kilohms at 60 hz. Input impedance is claimed to be unusually stable over a temperature range from -25° to +75°C, and efficiency

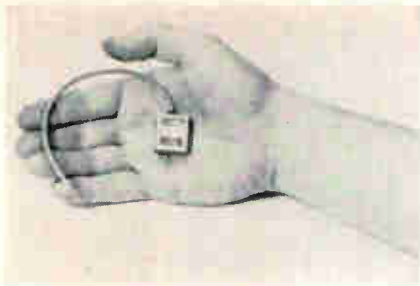

varies less than 5% over this range from the value at 25°C. Typical module conversion efficiency is 99% at 60 hz and 25 C.

Low driving power, low micro-volt noise, and low offset are other features of the modules. Offset is less than 1 μ V. Life, which is limited only by the life of the neon lamp, exceeds 10,000 hours and can reach 50,000 hours when lamp supply voltage is high and average current is low.

Internal offset effects due to electrostatic coupling between lamp and cells have been eliminated by internal shielding, and a shielded lamp lead is included. Thermal offset has been minimized by design and selection of materials including Sealmet leads.

The extremely low inherent noise and offset voltages of the modules allow for use in spst modulator-demodulator configuration where low cost is a prime consideration. They may also be used in spdt configuration for maximum efficiency and output voltage.

Clairex Corp., 1239 Broadway, New York City 10001. [354]

Electromagnetic relay handles high currents

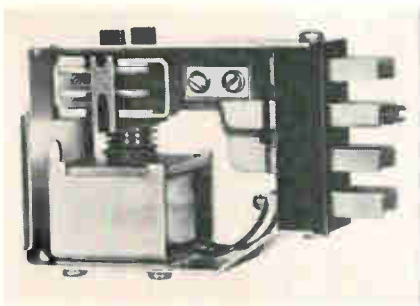

Problems of heavy current loads are expected to be answered by a plug-in, dpdt, double break relay. The LA57 electromagnetic relay can handle 15-amp tungsten lamp

1/100TH SECOND STOP CLOCK!

RAPID • ACCURATE • DIGITAL READOUT



THE HSI SERIES 42 PLANETGEAR® STOP CLOCK makes it possible to measure, integrate or totalize with high accuracy and reliability. Average error over 10 or more readings is less than 5 ms. Well under this figure for integrating. Instant start-stop motor plus patented Planetgear low-torque transfer provide 5 exclusive features . . .

- No pre-start or stabilizing
- Memory lock for power loss
- No spurious counts due to line transients
- Quiet operation
- Extremely long life

Series 42 has large 5/16" high figures, 6 drum display, manual or electrical reset.

**HSI PLANETGEAR TRANSFER . . .
YOUR BEST BET IN THE LONG RUN!**

Send for HSI Bulletin 42-3



HAYDON SWITCH & INSTRUMENT, INC.

Where Optimum Performance Is Standard

1500 Meriden Road, Waterbury, Conn. 06720/Area Code (203) 756-7441

talk algebra, log, trig.

or talk price.

mathatron 4280 talks your language.



Name familiar but you can't remember the face? The insides of this new Mathatron computer calculator are different, too. Log, antilog, sine, cosine, and arctan are performed at the touch of a button. Storage 4000 bits. Simplified program control. And the price-performance ratio is higher than any other computer/calculator. Starts at \$6990.

Of course, Mathatron 4280 has all the features that made the original Mathatron famous. You tap in algebraic problems and decimal numbers just the way you write them — parentheses, powers-of-10 exponents, decimal points, and square root. Electronic circuits compute answers accurate to 8 digits plus a 2-digit power-of-10 exponent and sign.

Tape printer output is a permanent record. Punched tape input is a great time and error saver for re-insertion of frequently used programs. Optional Teletype provides alpha-numeric page-printed output, paper tape reader, and paper tape punch.

A companion like Mathatron 4280 can save hours of a technical man's day. To get acquainted, ask us to send the brochure.

mathatron 4280: Formula memory 480 steps • Addressable number storage, 42 registers; 82 if Formula storage is reduced • Number range $\pm 10^{-12}$ to 10^{+58} • Speed 100 accumulations per second • Basic operators: plus, minus, times, divided by, left paren, right paren, square root, exponent, log, antilog, sine, cosine, arctan.



MATHATRONICS

a division of Barry Wright Corporation



241 Crescent Street, Waltham, Massachusetts 02154, Telephone: 617-893-1630

New Components

loads as well as resistive loads up to 50 amps, at 120 v a-c. The compact ($3\frac{1}{4} \times 1\frac{1}{8} \times 2\frac{1}{4}$ in.) unit's simplicity of design, the manufacturer says, is the key to its long-life capabilities. Tests indicate a minimum life of 2,000,000 operations under its fully rated 15-amp tungsten lamp load.

In addition, the relay rapidly and thoroughly dissipates high temperature build-up due to repetitive make-and-break operations. Carefully controlled over-travel reduces bounce and increases contact life.

Another feature of the LA57 is the plunger type solenoid. It supplies higher contact force (50 grams minimum), to help carry heavy currents with minimum heat and the lowest possible voltage drop. The solid bus members and associated jacks eliminate solder connections in the current carrying components of the relay. A safe manual-type method to pulse the movable contact system is also incorporated. Buttons on top of the relay are depressed for quick circuit checks.

The LA57 is directly interchangeable with the LAS57 relay currently used in many of the company's vehicular traffic signal controllers.

E.W. Bliss Co., Eagle Signal Division, 736 Federal St., Davenport, Iowa [355]

Television diode rated at 18 kv

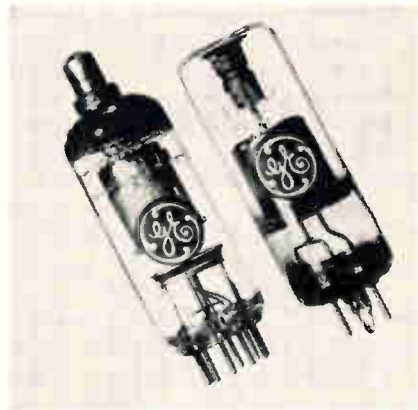

Designed as a rectifier tube for the high-voltage power supplies of black-and-white tv receivers, the miniature, double-ended 1BL2

diode has a two-pin base and features an inexpensive recessed anode connector that holds corona to a minimum.

The anode connector is supported in cantilever fashion by the tube glass. The diode is conservatively rated at 18 kv.

General Electric Co., Owensboro, Ky. [356]

Braked servomotor withstands shock



High torque-to-inertia ratio is offered in a 400-hz braked servomotor. Consisting of a size 15 servomotor and a friction brake controlled by an electromagnet, this component, designated CTO-1711 006, can maintain a constant reference position in a servosystem subjected to shock and vibration extremes. In operation, the brake element, when deenergized, effectively stops and holds the motor's rotor and shaft at a desired position.

Weighing 8.5 oz. the braked motor is equipped with a pinion shaft and has color-coded leads. Motor characteristics include: phase 1 and phase 2 voltage, 115 v; starting voltage, 3 v; stall torque, 1.45 in.-oz; no load speed, 5,000 rpm; power input, 6.1 w; current input, 110 ma; effective resistance, 2,200 ohms; d-c resistance, 154 ohms; rotor inertia, 3.6 gm cm²; theoretical acceleration, 30,200 rad/sec²; time constant, 0.017 sec.

Brake characteristics include: torque, 4 in.-oz; excitation voltage, 18 to 29 v d-c; input power, 5 w; resistance, 168 ohms; response time, 0.021 sec. Measuring slightly more than 2 in. in over-all length, the component's brake element has a diameter of less than 1 in.

General Precision Inc., Aerospace Group, 1150 McBride Ave., Little Falls, N.J. 07424. [357]

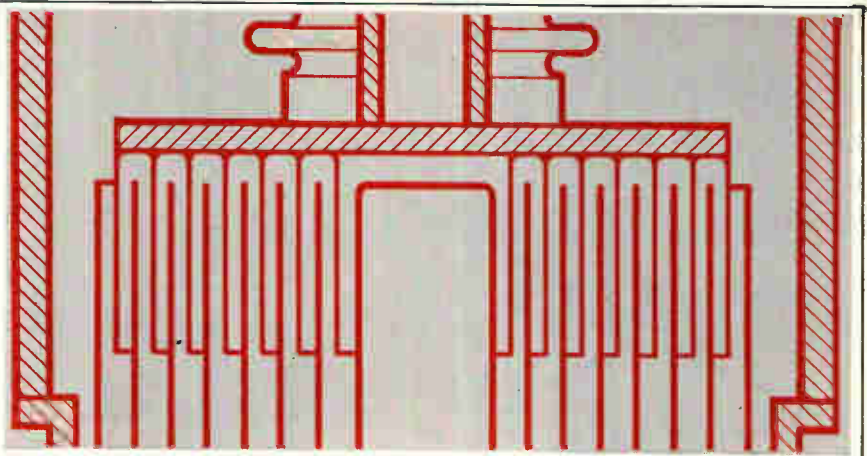

Why do Jennings vacuum capacitors meet every requirement? There's nothing to it

Ultra high vacuum dielectric combined with Jennings exclusive capacitor design is the answer. This combination has been a major factor in the development of modern transmitters. New vacuum capacitor designs from Jennings will contribute even more to the advancement of transmitter design. They can also help solve some of your immediate problems.

Jennings has hundreds of standard fixed and variable vacuum capacitors in a wide variety of capacity, voltage, and current levels. In all probability the capacitor you need has already been designed, field tested, and proven reliable. If it hasn't you couldn't find a more experienced company than Jennings to design a new one.

USL-500



Capacity Range: 5-500 pF
Peak Test Voltage: 5 KV
RF Current: 40 Amps RMS
Height: 5-3/4"
Width: 2-3/8"

CFHP-1000



Capacity: 1000 pF
Peak Test Voltage: 45 KV
RF Current: 215 Amps RMS
Height: 5-1 2"
Width: 5-1 2"

CVCC-2500



Capacity Range: 25-2500 pF
Peak Test Voltage: 7 KV
RF Current: 75 Amps RMS
Vibration: 5G to 500 cps
(with less than 3 pF capacity shift)

CVDD-500



Capacity Range: 20-500 pF
Peak Test Voltage: 15 KV
RF Current: 80 Amps RMS
Height: 7-1 2"
Width: 3-3 4"

For complete information on ITT Jennings vacuum capacitors, write for our new catalog No. 101. ITT Jennings, a subsidiary of International Telephone and Telegraph Corporation, 970 McLaughlin Avenue, San Jose, California 95108.

JENNINGS ITT

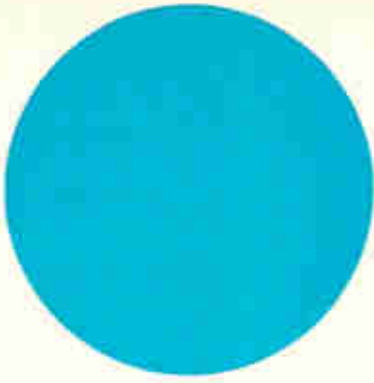

Atlas will put the blue bead anywhere you want it . . .



But the real value is the extra testing we do to save you trouble later. The point is, most manufacturers of custom hermetically-sealed headers don't have the extensive test facilities that Atlas has . . . altitude, temperature, and humidity cycling chambers as well as Helium Mass Spectrometers for leak detection, and metallographic equipment for taking high-magnification photographs of glass-to-metal interfaces or plating thickness cross-sections.

These in-house test facilities allow Atlas to make . . . and test . . . your custom headers to your specs (or MIL specs, if you prefer), so that the rejects are weeded out before you get them. And when we say that a header with terminals spaced at 1/4 inch will withstand 900 volts at 70,000 feet without flashover . . . WE CAN PROVE IT!

Call our marketing department today. Or send for more detailed technical information.

ATLAS
CHEMICAL INDUSTRIES, INC.
Aerospace Components Division
Valley Forge, Pa. 19481

New Semiconductors

High-voltage transistor sweeps color tv

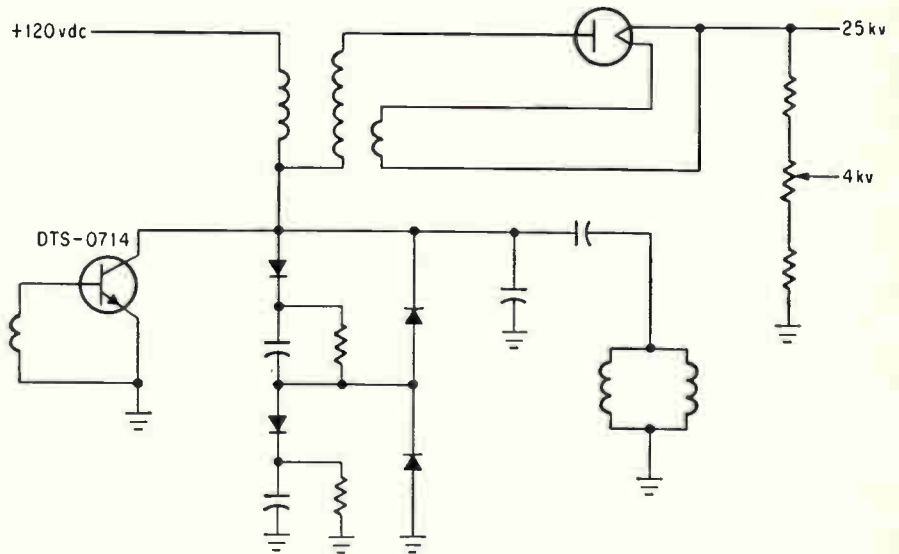

A silicon transistor has been developed that can withstand a retrace voltage pulse above 1,000 volts generated in the horizontal deflection system of a large-screen television set. The Delco Radio division of the General Motors Corp. is now demonstrating a modified 25-inch Zenith color set in which the new 1,200-volt transistor can switch the 3,800 volt-ampere load line of the horizontal deflection system (see circuit).

Previously, a vacuum tube or a pair of lower-voltage DTS-402 transistors operating in series were needed to do the job (present production sets use only tubes, though some manufacturers have been evaluating the 402 transistors). A series resistance-capacitance network connected between a center tap on the primary winding of the flyback transformer and the midpoint between the two series-connected DTS-402's would be required to force the equal sharing of the 1,050-volt retrace pulse by the two transistors. The DTS-402 is rated at 700 volts.

In the circuit shown, the 1,050-volt pulse is transformed in the flyback transformer to 25 kilovolts for the ultor anode of the picture tube. The horizontal transistor switches about 4 amperes; it's protected during fault-arcing conditions by a

peak rectifier network consisting of the two diode and RC networks connected across it. This could be replaced by a single, higher-voltage diode-and-RC combination.

The 1,200-volt silicon transistor, type DTS-0714, is a triple-diffused mesa device in a strip-mounted epoxy package. Limited samples will be available this month.

Specifications

Type	DTS-0714
V_{CEX}	1,200 V
V_{CE0}	750 V
Linear current gain N_{FE} at 2.5 amperes	10 min.
Reverse voltage V_{EBO}	5 V
Thermal resistance	1.2°C/watt
Package	Strip-mounted epoxy

General Motors Corp., Delco Radio division, Kokomo, Ind. [361]

Silicon transistors resist radiation

Three npn transistors operate in environments subjected to neutron bombardment where radiation levels may reach 3×10^{14} nvt (the time integral of neutron flux). The units are silicon epitaxial planar types designated NS9726 and silicon epitaxial planar power transistors designated NS9608 and NS9609. Case sizes are TO-18, TO-60, and TO-61, respectively.

Operating and storage tempera-

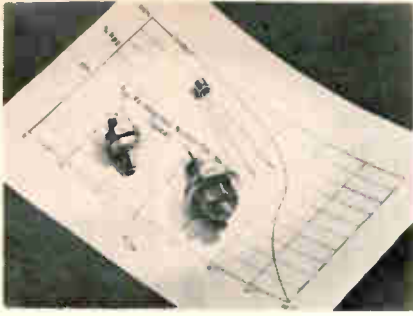

tures for all three are -65° to $+200^{\circ}\text{C}$. Total device dissipation at 25°C case temperature is 1.2 w for the NS9726, 12 w for the NS9608, and 25 w for the NS9609. National Semiconductor Corp., Danbury, Conn., 06810. [362]

Avalanche rectifiers deliver high power

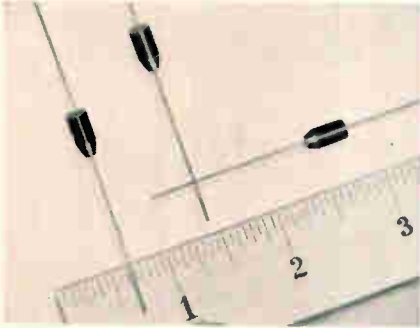

Four tiny (0.07 cu. in.) avalanche rectifiers in a single phase bridge will deliver as much as 2 kw at 50°C ambient temperature.

Three different versions have maximum recurrent peak inverse voltage ratings of 1,500, 2,000, and 2,500 v respectively. At 25°C , types F-15 and F-20 are rated at 1 amp d-c and 30 amps surge. Type F-25 is rated at 500 ma d-c and 20 amps surge. The devices can be operated at temperatures up to 140°C , at which point they are derated to 10% of their 25°C current rating.

Applications for the rectifiers include amateur equipment, ultrasonic generators, test equipment, oscilloscopes, medical equipment, spot welders, television monitors, and transmitters.

Prices for the avalanche units are reportedly the lowest for comparable ratings. Type F-20 is priced at \$1.50 in single quantity, and 73 cents in maximum quantities.

Sarkes Tarzian Inc., 415 North College Ave., Bloomington, Ind. 47401 [363]

You can buy a sample now of this new General Electric solid state lamp!



This is the SSL-1, actual size. It's a 2- to 5-volt solid state light source that emits 40 footlamberts of visible light end on @ 50 ma. Turns on and off at the rate of 10,000 cycles per second. Resists shock and vibration better than any filament lamp. Lasts indefinitely with no loss in efficiency!

SSL-1 is a remarkable new development of General Electric Miniature Lamp research. You'll want to consider it in your business, wherever tiny tough lamps are required. As an indicator or photo cell driver, it has hundreds of applications in computers, missiles, telephone equipment and aircraft, to name a few.

ORDER SAMPLES TODAY

Perhaps the SSL-1 can help save space, improve performance, reduce maintenance cost in *your* product. It's easy enough to find out: SSL-1 lamps are available now at just \$9.50 each. Order today. Just fill in the coupon and mail it with your check or money order. (Or contact your regular GE lamp representative.) Your calibrated SSL-1 will come to you cradled in styrofoam, protected in a rigid plastic box.

Need more data? Send for free technical bulletin #3-7041. It's yours for the asking.

Miniature Lamp Department

GENERAL  ELECTRIC

TO: General Electric Company
Miniature Lamp Department
P.O. Box 2422, Nela Park, Cleveland, Ohio 44112
Attn: J. D. McMullen

Please send me _____ new GE SSL-1 lamp(s) at \$9.50 ea.

Total enclosed \$ _____

Name _____

Company _____

Address _____

City _____ State _____ Zip _____

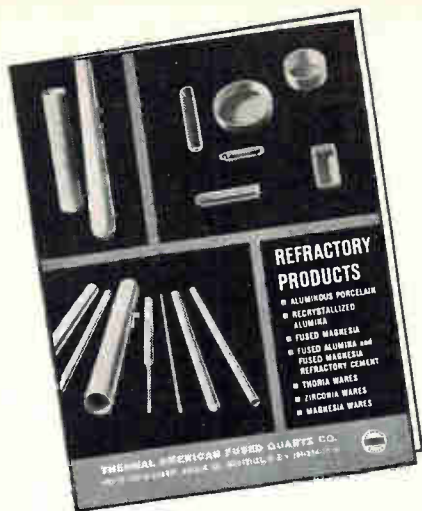

FREE SELECTOR CHART FOR REFRACTORIES

This Free New Selector Chart / Brochure describes a line of crystalline oxide refractory and insulating ware for use by industry and laboratories. These new products are designed for high resistance to heat, low reaction with metals and chemicals, low porosity and high thermal conductivity. The Selector Chart provides instant technical, mechanical and application data for apparatus made of Aluminous Porcelain, Recrystallized Alumina, Thoria, Zirconia and Magnesia. Write for your copy today.

57



**THERMAL AMERICAN
FUSED QUARTZ CO.**

RT. 202 & CHANGE BRIDGE RD.
MONTVILLE, NEW JERSEY
ZIP CODE 07045

New Instruments

Pulse delay has 1-nsec resolution



An all-solid-state unit capable of delaying pulses up to 3 microseconds with a resolution of better than 1 nanosecond has been introduced by MCG Electronics. Two or more of these pulse-delay lines can be connected in series to increase delay times.

According to the manufacturer the best previous digital pulse-delay unit costs twice as much as the new unit and has but a 10-nsec pulse-resolution capability.

The new instrument, model VPD-100, can be used in the laboratory or at production test facilities. Connected to a pulse generator, it can act as a reference delay line for pulse jitter studies, or as a quick means of calibrating other delay lines and oscilloscope time bases.

The delay time is controlled by switching between five fixed lumped-constant delay lines and a variable delay line connected in series. Each fixed delay retards the pulse for 0.5 microseconds; the variable delay line delays the pulse from 0 to 750 nsec.

The variable delay line's input pulses are conditioned by integrated-circuit NAND gates, which were chosen for this task because they switch rapidly and are relatively insensitive to pulse shape. Also, the NAND gates' output is constant in amplitude and rectangular in shape.

The undelayed pulses from a signal generator are used as triggers to switch the NAND gates on and off. The variable delay line's initial input pulse switches the first gate from logic 0 to logic 1 and the output of the first gate switches a sec-

ond gate. The 2.5-volt signal from the second gate feeds the lumped-constant delay line and triggers the third and fourth NAND gates at the unit's output. Each succeeding input pulse switches the gates in like manner.

During its passage through the VPD-100's internal delay lines, the signal from the second NAND gate is attenuated by almost half and its shape degraded, so the third and fourth NAND gates at the output are used to regenerate the original 2.5-volt rectangular wave.

The rise and fall times of the output pulse are only 10-nsec, regardless of pulse width. A 3- μ sec rectangular pulse through an ordinary lumped-constant delay line will have a rise and fall time of about 300 nsec, 10% of the pulse width.

Specifications

Pulse input	
Amplitude	2 to 5 v
Pulse repetition rate	1 Mhz at 25% duty cycle
Pulse output	
Pulse delay	50 nsec to 3 μ sec
Resolution	1 nsec
Amplitude	2.5 v into 150-ohm load
Pulse rise and fall times	Less than 15 nsec
Supply voltage	115 v a-c
Size	10 1/2 x 8 x 8 in.
Weight	6 lbs
Panel connectors	BNC

MCG Electronics, 11-22 Joselson Ave., Bay Shore, N.Y. [371]

Signal generator runs on battery power



A solid state standard signal generator is claimed by the manufacturer to be the only one available

which can be operated from either internal battery or the 115-v a-c line. This suits it for use in the field or in screen rooms when complete isolation from the power line is desired.

The SG-S3B covers 50 khz through 54 Mhz in six bands, with a seventh bandswitch position in which it is crystal controlled at 1 Mhz. The output is accurately calibrated from 0.6 μ v to 0.16 v, ± 2 db. Frequency calibration is 1% or better. Modulation is variable from zero to 50% from an internal 400-hz oscillator or by an external signal.

Price is \$295. Delivery is from stock.

Clemens Manufacturing Co., 630 S. Berry Road, St. Louis, Mo. 63122 [372]

Current indicator also integrates

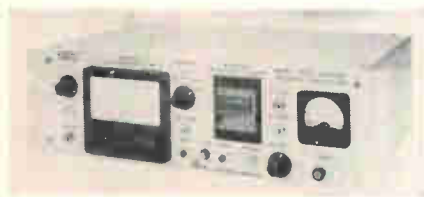

Accurate to within 1%, a self-calibrated, solid state instrument measures current flow and displays an integral digital value. The current indicator and integrator is suited for a variety of applications involving accurate integration of continuous current values. The unit features pushbutton start and stop controls that are adaptable for remote operation.

Sensitivity of the instrument can be varied from 0.1 milliamp to 0.3 nanoamp for either positive or negative current measurement. Individual current inputs are shown on the d-c indicator. The integral is displayed digitally and is calibrated by a 10-turn precision potentiometer. The instrument can be preset to terminate integration and control a wide range of auxiliary equipment. Both the indicating and integrating values are accurate to 1%. Calibration requires no external instrumentation and is achieved by internal current sources and front-panel calibration controls.

The new model A310C measures

Some dry facts about Moisture Monitors

If your job is to think about moisture in gases, liquids and solids — then you came to the right ad.

For we're talking about CEC Electrolytic Moisture Monitors—the most precise and reliable instruments now available for the trace measurement of ppm amounts of water.

The reason for their superiority is their exclusive brain, the CEC *Electrolytic Cell*. This unique cell has greater accuracy at low levels than any other, twice the life, and it cannot become shorted through prolonged storage or disuse. Furthermore, the Electrolytic Cell is potted for impact resistance and is replaceable in seconds without tools.

Additional advantages

CEC Moisture Monitors assure the fastest usable readings. From 15 minutes to one hour after initial sample stream hookup, accurate readings can be made from 1-1000 ppm. After that, a 63% response to moisture change occurs in 30 seconds or less.

CEC Moisture Monitors are advanced throughout. A specially manufactured flow controller, plus ingenious circuitry, assure more accurate and dependable performance at the lowest cost.

CEC Moisture Monitors are backed by greater experience. As the pioneer and leader in the field of moisture monitoring, CEC can guarantee users the right answers to application needs as well as the best instruments.

A moisture monitor for every purpose

The following instruments are representative of the full range of moisture monitors currently available from CEC.

26-303 Portable Laboratory Moisture Monitor. This is the finest laboratory-quality moisture monitor designed for industry.

26-304 Hydrogen Moisture Monitor. Especially designed for the continuous measurement of water in hydrogen- or oxygen-rich gas streams, it uses the error-proof CEC Delta Flow principle.

26-321A Solids Moisture Analyzer. This unit delivers the most conclusive results, and is the most trouble-free, easy-to-use instrument made for measuring water in solids.

For all the facts about the complete moisture monitor line, call your nearest CEC Field Office. Or write Consolidated ElectroDynamics, Pasadena, California 91109. A subsidiary of Bell & Howell. Bulletin Kit 345-X4.

Also available upon request—the booklet, "Moisture Monitor Hints," which covers moisture detection problems and how to solve them.

CEC
ANALYTICAL INSTRUMENTS
 **BELL & HOWELL**



Now Silk City Offers Complete Ceramic Production Facilities From Development Through Volume Production



Major Ceramic Services Offered By Silk City

PROTOTYPE DEVELOPMENT

In the development of precision prototypes for the electronic industry, we are equipped to offer multi-shaped parts and varied-ceramic formulations to meet every possible design and economy requirement. We produce precision ceramics that are machined from alumina, die formed, isostatic pressed, extruded, molded or cast. Materials range from high-aluminas through forsterite.

PRECISION MACHINING

Where the tolerance or surface finish is extremely critical, we are skilled and equipped to provide the necessary ceramic machining. We offer a complete range of grinding, polishing, lapping and ultrasonic machining.

METALIZING AND PLATING

We offer prototype development or volume production of metalized and plated ceramics for use in hermetic seals and other sub assemblies. Both high and low temperature metalizing are available. We prepare surfaces for customer brazing or numerous other sealing requirements.

SUB ASSEMBLIES

We produce complete sub assemblies to customer specifications, as well as provide a capability to design parts to meet your requirements. Final assembly includes brazing of ceramic to ceramic and metal to ceramic for either mechanical or hermetic seals.

SHORT PRODUCTION RUNS

After prototypes have been developed and approved, we are staffed and equipped to carry the item through to a test production run or fill initial stock orders. You are assured precision products that meet the highest quality standards.

VOLUME PRODUCTION

With the addition of our new plant in Hendersonville, North Carolina, we are now prepared to handle your full production requirements. Our present equipment will produce ceramic parts with diameters ranging from a fraction of an inch up to 15 inches.

We invite your inquiry!

SILK CITY INDUSTRIAL CERAMICS INCORPORATED

Subsidiary of Basic Incorporated

221 Seventh Avenue • Hawthorne, New Jersey 07507
Phone 201-427-4211



OFFERING A COMPLETE CERAMIC SERVICE FROM PROTOTYPE THROUGH PRODUCTION

New Instruments

19 in. wide x 5¼ in. high x 12 in. deep. Price is \$1,798 with present shipping being one to three weeks. Elcor, a division of Halliburton Co., 2431 Linden Lane, Silver Spring, Md., 20910 [373]

Squaring transducer operates to 1 Mhz

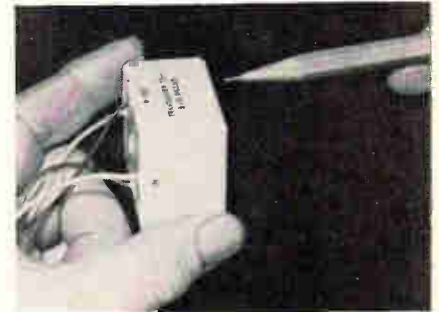

Requiring no power supply for activation, a solid-state, voltage-to-current analog squaring transducer serves as an accurate, low-energy, completely passive squaring device. Model TD-1 Transquare performs accurately for all input levels up to 200 mv. Operating frequency is d-c to 1 Mhz.

The unit is made up of stable, solid-state elements arranged and matched in a network so that the instantaneous output current is proportional to the square of the instantaneous input voltage. The transducer output, therefore, is nonlinear; its characteristic, a true parabola. The output is $\pm 0.1\%$ of theoretical squared-value.

The instrument is 1½ in. wide x 1 in. high x 1¼ in. deep. It has a center mounting hole for a No. 6 screw and four pigtail leads for input-output connections. The unit is available from stock. Price for small quantities is \$200 each. Greibach Instruments Corp., 315 North Ave., New Rochelle, N.Y. [374]

Vibration analyzer has a dual role

Measurements of vibration amplitude and frequency can be obtained with a single, lightweight, portable instrument. The unit de-



tests and measures vibration, shock, and impact in rotating members.

Model 642 and its accessories provide the information for detailed vibration analysis and in-place balancing of operating machinery. The unit also functions as a strobo tachometer. Vibration amplitudes as little as 10 millionths of an inch to as great as $\frac{3}{8}$ in. may be measured using the model 023 velocity pick-up.

The same meter and scaler used to indicate direct frequency also indicate vibration levels. A tunable wave filter provides narrow-band observation of vibration signals to isolate their components. Connectors are provided on the rear panel for attaching recording equipment, oscilloscopes and audio equipment. Reliance Electric and Engineering Co., 24701 Euclid Ave., Cleveland, Ohio 44117. [375]

A-c microvoltmeter rejects noise



Signals as small as 300 mv rms in the frequency range between 25 hz and 60 khz are measured with full-rated accuracy by an a-c microvoltmeter. The instrument has 13 sensitivity ranges, from 3- μ v full scale to 3-v full scale in a 1-3-10 sequence. It also measures signals in a frequency range between 5

Low Cost 4 DIGIT

400 SERIES INTEGRATING DC DIGITAL VOLTMETER

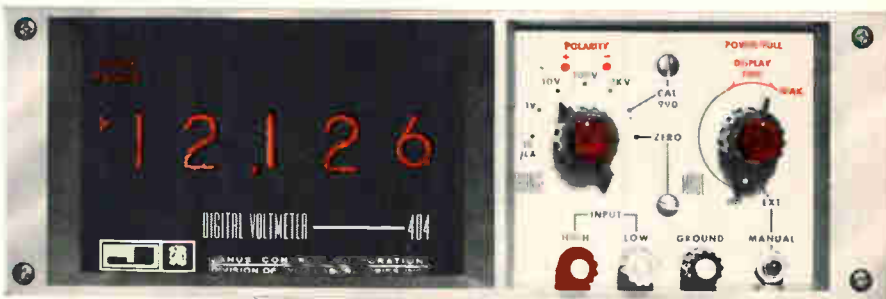

Extended Range Measurements: Fifth digit over-range.

Precise Measurements: With accuracies to 0.05%.

Input Flexibility: Four voltage ranges and a micro-current input for measuring in "Engineering Units" (psi, degrees, etc.)

System Compatibility: BCD Outputs and Remote Programming.

High Noise Rejection: Differential input and integration techniques provide common mode rejection greater than 120 db at 60 Hz.

Economical: 3 and 4 digit models range from \$349.50 to \$495.50.

These DVM's are not only **NEW**, they're **AVAILABLE** from Janus representatives from coast to coast!

CALL OR WRITE FOR A DEMONSTRATION.



296 NEWTON STREET • WALTHAM • MASSACHUSETTS 02154 • TEL: (617) 891-4700

SMART CIRCUITS know the difference!

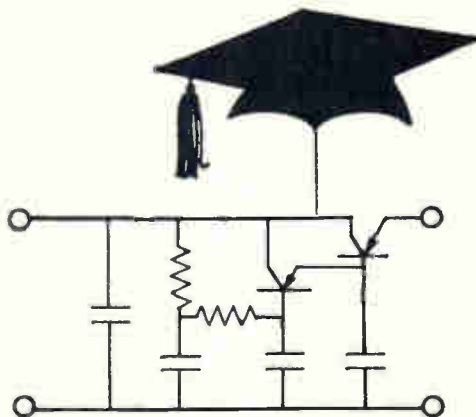

That's why Hopkins Capacitors come in such a wide selection of parameters.

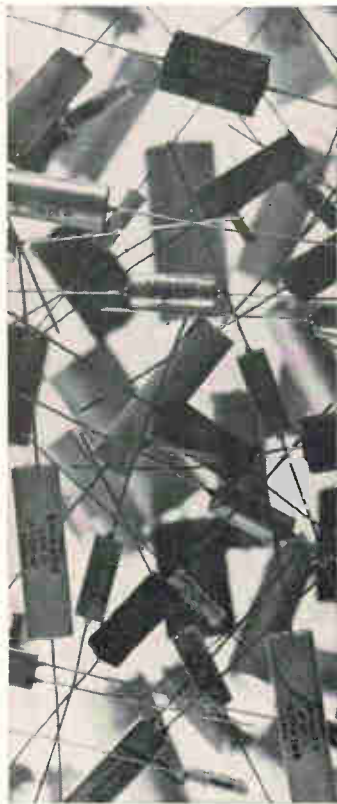

Some capacitors may be rejected by circuits as being incompatible with other components although they may seem to fit at first glance. As the circuit requirements become increasingly more stringent, smart designers often take a second look for capacitors with compatible characteristics to specify. To make your job easier, Hopkins makes a wide family of metallized dielectric capacitors—METALLIZED PAPER, METALLIZED MYLAR, HERMETICS, DUREZ COATED and WRAP & FILL—in hundreds of values, styles and sizes.

Whether you specify capacitors by capacitance, voltage, space, case style, price, polarity, temperature, tolerance, stability, resistance, or dissipation factor, check your HOPKINS catalog first—your circuit knows the difference.

Write for catalog.

HOPKINS
Engineering Company

Telephone: (213) 361-8691 • TWX 213-7645998 • Cable: HOP
12900 Foothill Blvd., P. O. Box 191, San Fernando, Calif. 91341
A Subsidiary of Maxson Electronics Corporation

New Instruments

and 25 hz with full-scale ranges of 30 μ v to 3 v. Basic accuracy is $\pm 3\%$ of full scale up to 60 khz, and $\pm 5\%$ of full scale above 60 khz. Input impedance is 10 megohms shunted by 20 picofarads.

The high sensitivity of model 3410A is made practical by its ability to tolerate large amounts of noise with the signal. Rms noise voltages up to 20 db above full scale do not affect the accuracy of the reading, even for signal levels that are only $\frac{1}{10}$ of full scale (40 db below noise that is 20 db above full scale).

The new microvoltmeter uses a phase-locked synchronous detector rather than narrow-band filters to separate the effects of noise from the signal. The detector is an electronic gate controlled by an oscillator phase-locked to the input signal. Alternate half cycles of the input signal are passed by the gate, and the output of the gate is smoothed by a low-pass filter to obtain a d-c voltage proportional to the average value of the input waveform. Since both the positive and the negative excursions of noise and other randomly varying signals pass through the gate when open, these average out to zero and do not affect the reading.

Price of the model 3410A is \$800, and delivery time is estimated at 60 days.
Hewlett-Packard Co., 1501 Page Mill Rd., Palo Alto, Calif., 94304. [376]

Peak voltage sensor has floating input



A peak voltage sensor to be used with solid state circuitry detects transients as short as 10 microseconds. The Memorette variable-threshold peak indicator has a completely floating input, making

it possible to monitor positive or negative levels from 50 millivolts to 50 volts at any point in the circuit. An external resistor extends the upper end of the range to the thousands of volts. Front-panel controls include a sensitivity adjustment, a reset control, and a memory readout.

The sensor is supplied with an internal mercury battery and both are warranted for one year of continuous duty. Cabinet dimensions are 2 x 2 x 1 inches. Source impedance is 20,000 ohms per volt; frequency response is d-c to 20 khz.

Price of the unit is \$44.50, with lower prices quoted for quantities. Delivery is 2 to 4 weeks. Rovi Instruments, 1643 Forest Drive, Annapolis, Md. 21403 [377]

Digital meter unites 3 instruments in 1



A general-purpose digital meter combines the features of three commonly used laboratory instruments in one compact, economical unit: a 100- μ V-resolution, d-c digital voltmeter, a greater than 1-Mhz multi-function electronic counter, and an electronic integrator. The extensive use of IC's and plug-in modules in the DM5000, along with circuit sharing, enhances maintainability, and accounts for the \$950 price.

No external plug-ins or adapters are required and simplified operation is assured by using a minimum number of controls. A long-life, four-digit, buffered Nixie display with illuminated legends indicates the units being measured, as well as over-range and polarity.

As a dvm, this instrument offers automatic polarity, five d-c voltage ranges from ± 100 mv to $\pm 1,000$ v, calibrated over-ranging to 40%, an accuracy of $\pm 0.1\%$, 100- μ V resolution, and an input impedance

Taylor's total reliability plan: Glass-Epoxy Copper-clad

in sheets, panels or punched blanks to your specifications and reliability requirements

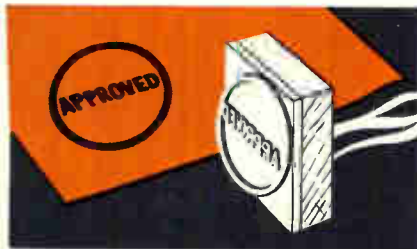

Accepted by an increasing number of major OEMs and commercial etchers who give their stamp of approval, because . . .



. . . they get highest quality level assurance from two fully-equipped copper-clad plants using white-glove techniques . . .



. . . in atmosphere-controlled white rooms, under extremely tight quality control procedures, to produce copper-clad . . .

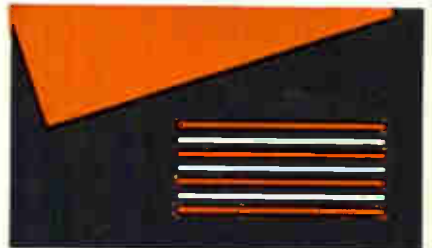

. . . to specifications and established reliability requirements in standard sheets, ultra-thin sheets and multi-layer prepress . . .



. . . then deliver when promised, or in an emergency, from plant or warehouse stocks in special packages.

Let us prove the advantages of Taylor's TOTAL RELIABILITY PLAN to you! Ask for a demonstration today. Write for a sample (give grade designation and copper combination) and Bulletin GB-2.



... your assurance
of quality

Taylor copper-clad

TAYLOR CORPORATION • Valley Forge, Pa. 19481

Phone: 215-666-0300 TWX: 215-666-0659

West Coast Plant: La Verne, Calif.

Also manufacturer of Taylor laminated plastics, Taylorite® vulcanized fibre and Tayloron® prepress

NEW SOLID STATE CYCL-FLEX® TIMER

CE300



**YOUR
BROADEST
SCOPE**

RENOWNED ELECTROMECHANICAL CYCL-FLEX TIMER

HP5

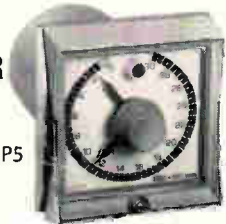

The Man from E.A.G.L.E.* offers you a range of accurately controlled Cycl-Flex time delays that run all the way from 1/20 second to 60 hours. These timers, housed in their now famous plug-in cases, may in fact be interchanged. The HP5 Cycl-Flex is a synchronous, motor driven, precision instrument providing accurate delay between control-circuit actuation in the operation of load circuits. Maximum settings range from 5 seconds to 60 hours with minimum settings from 1/6 second to 2 hours. The CE300 Cycl-Flex is a solid state timer that overlaps the HP5 in the lower time ranges. The 300 series offers dial ranges of 10 seconds and shorter, with minimum settings from 1/20 second to 1/2 second. Depending on contact load, average mechanical life is more than 10,000,000 operations.

Whether you need short time cycles at a fast repetitive rate, or longer but still precisely-controlled delays, the Cycl-Flex Series will give you exactly the right answer... for specifications, get our HP5 Series Bulletin 125 and our CE300 Series Bulletin 155. Write Eagle Signal Division, E. W. Bliss Company, 736 Federal Street, Davenport, Iowa 52808; or call (319) 324-1361.

BLISS



EAGLE SIGNAL

A DIVISION OF THE E. W. BLISS COMPANY

*E.A.G.L.E.—Engineering Assistance Given Locally—Effectively.

For information on CE 300 Timer circle reader service card number 500
For information on HP 5 Timer circle reader service card number 501

New Instruments

greater than 100 megohms on all ranges.

When functioning as an integrator, the DM5000 displays the digital value of the time integral of the analog input signal. Inhibit and reset functions are controlled by either front-panel switches or remotely by external voltage inputs. Three distinct counter modes are offered: rate, period, and count. Sensitivity, level, and coupling features permit operation with a variety of input waveforms.

In the rate mode, pulse rates or frequencies to greater than 1 Mhz are measured and displayed with a time base derived from a $\pm 0.005\%$ crystal-controlled clock. Four full-scale ranges are provided from 9.999 khz to 9.999 khz, corresponding to gate periods from 1 to 0.001 second.

In the period mode, pulse interval, pulse width, or period are displayed with a resolution of 10 nsec over full-scale ranges from 99.99 msec to 99.99 sec. Count range is from 0 to greater than 250 khz with a resolution of one part in 10^4 .

Technology Inc., 7400 Col. Glenn Highway, Dayton, Ohio 45431. [378]

Digital multimeter tracks two ways



D-c volts, d-c current, resistance, a-c volts, and d-c/d-c ratios can be measured by a new 5-digit digital multimeter. Bidirectional tracking logic gives fast and accurate measurements of small variations in critical parameters, such as those that occur when trimming or adjusting. A stable zener diode reference supply and a precision digital potentiometer assure maximum accuracy.

The push-button instrument offers automatic ranging on the d-c



INSTANT EAGLE RELAYS

Test Them Immediately...Get Production Quantities in Two Weeks!

That's right . . . Eagle challenges you to compare them with any relay on the market. NOW you can get immediate delivery on these general-purpose or medium-power relays. Test results prove they're the finest of their kind in the world. Eliminate your relay delivery problems. Call your "Man from E.A.G.L.E." . . . listed below. You'll find he has full details and specifications on Eagle relays.

YOUR "MAN FROM E.A.G.L.E."

Distributors

Burlingame, California 415-697-6244	Albuquerque, New Mexico 505-265-1020
Glendale, California 213-245-1172	Albany, New York 518-436-8536
Englewood, Colorado 303-781-0912	Depew, New York 716-684-5731
Hamden, Connecticut 203-288-9276	Endwell, New York 607-723-8743
Orlando, Florida 305-855-3964	Fairborn, Ohio 513-878-2631
Baltimore, Maryland 301-484-5400	Fairview Park, Ohio 216-333-4120
Newton Highlands, Mass. 617-969-7140	Dallas, Texas 214-363-1526
Minneapolis, Minnesota 612-922-7011	Houston, Texas 713-649-5756
Clifton, New Jersey 201-471-6090	Seattle, Washington 206-725-7800
Haddonfield, New Jersey 609-429-1526	

Representatives

Scottsdale, Arizona 602-947-4336	Hackensack, New Jersey 201-342-2602
Pasadena, California 213-681-4421	Latham, New York 518-785-5032
Jacksonville, Florida 305-388-7656	Rochester, New York 716-436-4410
Orlando, Florida 305-422-4295	Skaneateles, New York 315-685-6172
Roswell, Georgia 404-993-6498	Fairfield, Ohio 216-333-4120
Chicago, Illinois 312-775-5300	Havertown, Pennsylvania 215-528-6640
Chicago, Illinois 312-784-7314	Dallas, Texas 214-748-7788
Baltimore, Maryland 301-276-1505	Houston, Texas 713-224-9715
Norwood, Massachusetts 617-769-3600	Bellevue, Washington 206-454-5200
Minneapolis, Minnesota 612-922-0243	Charleston, West Virginia 304-342-2211
St. Louis, Missouri 314-428-5313	

BLISS



EAGLE SIGNAL

A DIVISION OF THE E. W. BLISS COMPANY

736 Federal Street, Davenport, Iowa



This is the vintage year for BURGUN-D™ connectors.

These sparkling new Mark IV D-Subminiatures are *low-cost* connectors with *rear release*, *crimp snap-in* contacts. They're intermateable and intermountable with existing D-Subminiatures. The wine-colored insulators we selected enhance the connector as well as your equipment.

Robust BURGUN-D Mark IV connectors operate in temperatures up to 250°F. They are ideal for plug-in module

applications, cable-to-cable and cable-to-panel installation, computers, business machines and many other commercial applications.

Value analysis will tell you they're low in price because of highly developed pin and socket contacts. The contacts are available in two sizes (which accommodate 18 through 24 AWG stranded wire) and may be ordered separately. Contacts are rear inserted and extracted with a simple expendable plastic tool that's shown above. Closed-entry

socket insulators correct any misalignment of pins during engagement.

Buy them off the shelf now along with a complete line of accessories from your nearest factory authorized distributor. For our new catalog, write to ITT Cannon Electric, a division of International Telephone and Telegraph Corporation, 3208 Humboldt Street, Los Angeles, California 90031.



CANNON **ITT**



HERE ARE YOUR AUTHORIZED CANNON DISTRIBUTORS

ALABAMA

Nelson Radio & Supply Company, Inc.
Mobile
Phone: (205) 479-1471

ALASKA

Alaskan Aircraft Equipment Supply, Inc.
Anchorage
Phone: (907) 322-3202

ARIZONA

Kimball Electronics, Inc.
Phoenix
Phone: (602) 264-4438

CALIFORNIA

ABC Connectors, Inc.
North Hollywood
Phone: (213) 875-0665,
765-8861, 963-1736

K-Tronics

Los Angeles
Phone: (213) 685-5888

Kierulff Electronics, Inc.

Palo Alto
Phone: (415) 968-6292

Liberty Electronics Corp.

Inglewood
Phone: (213) 678-8111

Richey Electronics, Inc.

North Hollywood
Phone: (213) 761-6133,
877-2651

San Delcor, Inc.

San Diego
Phone: (714) 274-3131,
276-2653

COLORADO

Waco Electronics
Denver
Phone: (303) 322-7708

CONNECTICUT

Connector Corporation of America
New Haven
Phone: (203) 624-0127

FLORIDA

Electro Air of Florida, Inc.
Orlando
Phone: (305) 241-5461

Industrial Electronics Associates, Inc.

Palm Beach Gardens
Phone: (305) 848-8686

GEORGIA

Electro Air Corp.
Atlanta
Phone: (404) 351-3545

HAWAII

Pacific Electronics
Honolulu
Phone: (808) 810-1111

Radio Television Corp. Ltd.

Honolulu
Phone: (808) 564-416,
502-901

ILLINOIS

Merquip Electronics, Inc.
Chicago
Phone: (312) 282-5400

Radio Distributing Company, Inc.

Chicago
Phone: (312) 379-2121

INDIANA

Radio Distributing Company
Indianapolis
Phone: (317) 637-5571

Radio Distributing Co., Inc.

South Bend
Phone: (219) 287-2911

LOUISIANA

Southern Radio Supply Company, Inc.
New Orleans
Phone: (504) 524-2345

MARYLAND

Radio Distributing Co.
Baltimore
Phone: (301) 377-6402,
377-4616

MASSACHUSETTS

Lafayette Industrial Electronics
Natick 01762
Phone: Boston
(617) 969-6100

Natick

(617) 875-1358

Schweber Electronics

Waltham
Phone: (617) 891-8484

MICHIGAN

Newark-Detroit Electronics, Inc.
Detroit
Phone: (313) 548-0250

MINNESOTA

Lev Bonn Co.
Minneapolis
Phone: (612) 339-9461

MISSISSIPPI

Ellington Electronic Supply, Inc.
Jackson
Phone: (601) 355-0561

MISSOURI

Electronic Components for Industry Co.
St. Louis
Phone: (314) 647-5505

MONTANA

Electronic Supply Company Billings
Phone: (406) 252-2197

NEW MEXICO

Waco Electronics, Inc.
Albuquerque
Phone: (505) 268-2409

NEW YORK

Progress Electronics Co., Inc.
Plainview, L. I.
Phone: (516) 433-1700

Schwaber Electronics

Westbury
Phone: (516) 334-7474

Stack Industrial Electronics, Inc.

Binghamton
Phone: (607) 723-6326

Summit Distributors, Inc.

Buffalo
Phone: (716) 884-3450

Time Electronic Sales

Great Neck, L. I.
Phone: (516) 487-0100

NORTH CAROLINA

Kirkman Electronics, Inc.
Winston-Salem
Phone: (919) 724-0541

OHIO

Hughes Peters, Inc.
Cincinnati
Phone: (513) 381-7625

Hughes Peters, Inc.

Columbus
Phone: (614) 294-5351

Radio Distributing Company, Inc.

Willoughby
Phone: (216) 946-0900

PENNSYLVANIA

Aercon, Inc.
Clifton Heights
Phone: (215) 622-2500

Philadelphia Electronics, Inc.

Philadelphia
Phone: (215) 568-7444

Radio Parts Co., Inc.

Pittsburgh
Phone: (412) 361-4600

TENNESSEE

Lavender Radio & TV Supply, Inc.
Memphis
Phone: (901) 276-2756

TEXAS

Hall-Mark Electronics Corp.
Dallas
Phone: (214) 231-2531

Harrison Equipment Co., Inc.

Houston
Phone: (713) 224-9131

McNicol, Inc.

El Paso
Phone: (915) 566-2936

Sterling Electronics, Inc.

Dallas
Phone: (214) 357-9131

Wholesale Electronic Supply, Inc.

Dallas
Phone: (214) 824-3001

UTAH

Kimball Electronics, Inc.
Salt Lake City
Phone: (801) 328-2075

New Instruments

voltage function (1 μ v to 1,000 volts); resistance measurements from 0.1 ohm to 100 megohms; a-c voltages from 1 mv to 1 kv; d-c/d-c voltage ratios with 100- μ v sensitivity; d-c currents from 0.1 na to 100 ma.

The 530 series is available in either rack or cabinet models. Price of the basic model is \$1,495; the complete package, \$2,750. Delivery takes three weeks after receipt of order.

Cohu Electronics Inc., Box 623, San Diego, Calif. 92112 [379]

Pressure transducer is small and rugged

Heavy-duty construction with low weight and small size are the features of a high-line differential pressure transducer. The instrument accurately measures small changes in differential line pressure with full line pressure overloads up to a maximum line pressure of 5,000 psi. The rugged transducer will operate in ranges of ± 30 , ± 75 , ± 150 , and ± 300 inches of water.

The high sensitivity of the PM393TC is achieved by use of a four-leg Wheatstone bridge transducer encased in a single-chamber cavity filled with silicone oil. Protection from pressure overload is provided by mechanical stops, thus permitting a maximum pressure differential of 5,000 psi without danger of damage to the instrument.

The transducer measures 3 in. in diameter and 2 in. in length. Weight is 4 lbs. Nonlinearity is less than 0.25% of full scale and hysteresis does not exceed 0.15% of full scale. Output is compatible with present day recorders and controllers.

All metal parts are stainless steel, which permits use with many fluids, including those incompatible with each other. No recalibration is necessary, allowing for easy remote installation.

Statham Instruments Inc., 12401 W. Olympic Blvd., Los Angeles, Calif., 90064 [380]

feeling the pinch

for qualified
electronics
technicians?

New electronics equipment demands technicians with a wide range of specialized skills. Men who understand the "why" of electronics... can install, maintain, troubleshoot and repair the electronics gear you're using today and will be using in years ahead.

Qualified electronics technicians are scarce. But with a Cleveland Institute of Electronics Training Program you can soon develop an ample supply by up-grading your present staff of technical personnel. CIE "AUTO-PROGRAMMED" Courses are fast, economical, effective. What's more, they can be readily "tailored" to your specific training needs. Hundreds of companies use them... thousands of men are enrolled. Get free details fast. Mail coupon today. Cleveland Institute of Electronics, Dept. E-28, 1776 E. 17th St., Cleveland, Ohio 44114.

SEND COUPON TODAY

Cleveland Institute of Electronics

Dept. E-28, 1776 E. 17th St., Cleveland, Ohio

Gentlemen: I am interested in learning more about your Electronics Home Study Programs. Please send complete information.

Name _____

Title _____

Company _____

Address _____

City _____ State _____ Zip _____

Accredited Member, National Home Study Council.

**nothing's
special
but the
delivery**



**special cables to solve
special problems are
an everyday job at
Columbia Wire. If
we don't have the
cable in stock for
immediate delivery
we have the knowledge
skill and facilities
for producing it fast.**

write for our fully-illustrated catalog



Columbia 
WIRE PRODUCTS COMPANY
2850 Irving Park Rd., Chicago, Ill. 60618

New Subassemblies and Systems

Tracing curves by the numbers

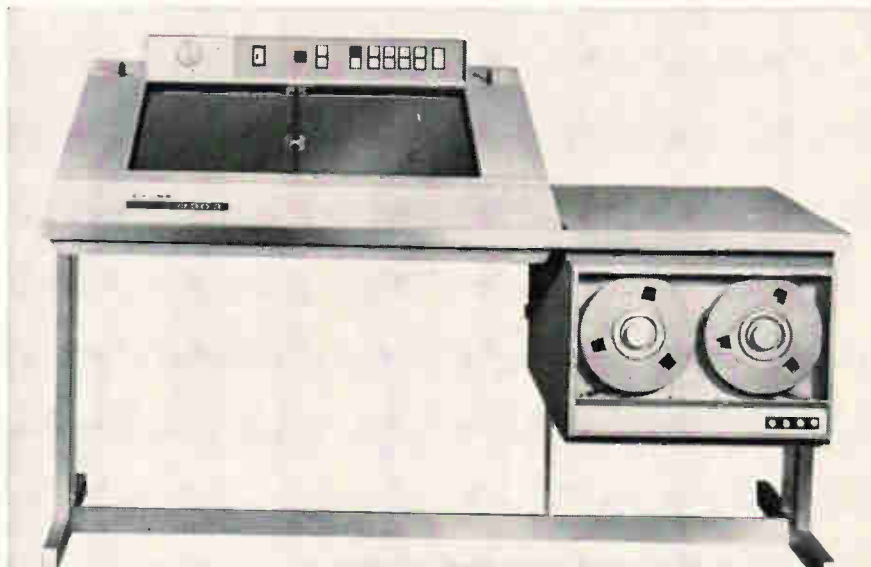

Working almost as an x-y recorder in reverse, a new graphical digitizing system allows an operator to trace curves with a stylus without worrying about outpacing the digital output recorder. Heart of the system, says the manufacturer, is "variable interval programed" digitizing.

Developed by the Calma Co., it is claimed to be the only analog graphical data digitizer capable of efficiently reducing both contour and point-to-point data directly to digital magnetic tape. Basically, the system adjusts the size of the sampling interval to the complexity of the curve being traced. On complex data, an operator will move the stylus slowly to record precisely the sharp peaks and changes in direction, but on straight sections can move the stylus quickly. In conventional systems, the operator has to abide by the speed capability of a magnetic tape recorder. He couldn't move the stylus quickly if he wanted to maintain resolution.

In the new system, points are read off the curve at intervals of 0.01 inch, digitized, and entered in a buffer storage. The points are sent out from storage to the magnetic tape at a rate of 250 points per second. Thus, at speeds up to 2.5 in. per second, the magnetic tape keeps pace. However, if the opera-

tor moves the stylus at a faster rate, the points are stored temporarily and taken out at wider intervals, but with the same resolution as at 0.01 in. intervals.

The effective recorded interval increases as the operator's tracing speed increases, stepping up 0.01 in. for each 2.5 in. per second increase in tracing speed. Maximum speed is 37.5 in. per second and maximum interval is 0.15 in.

Accessories are available to permit reduction of data from projected 16-mm, 35-mm, and 70-mm film images and to interface the digitizer, on-line, with an IBM 1130 computer.

Specifications

Tracing area	18 x 24 in.
Maximum tracing bed area	22 x 28 in.
Paper hold-down	Mechanical
Dimensions	58½ x 30 x 34 in.
Weight	400 lb.
Price	\$22,500

The Calma Co., 346 Mathew St., Santa Clara, Calif. 95050 [381]

Binary code switch has 2,040 contacts

A compact matrix for memory, programming, data, voice, and broadband switching applications contains 2,040 switching contacts in

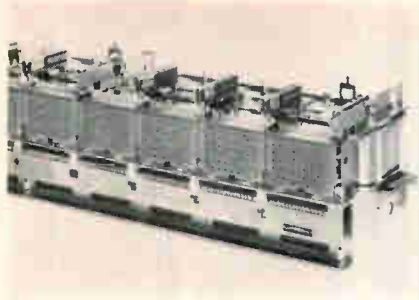

670 cubic inches. Binary operation with a wide range of input-output arrangements is provided. Palladium-silver contacts require no wetting voltage. Due to V-type positive-lock contacts, no sustaining power is needed. Power interruption will not affect the locked program.

The switch includes 10 modules, each with 17 multiple positions having 12 make-contacts per position (photo shows only five full modules, each with 204 contacts). Maximum power voltage is 56 v; minimum, 44 v. The code coils and the code-release vertical coils operate on 48 v d-c. The unit measures 25½ by 6 by 4½ in.

Price is \$600, with quantity discounts. Availability is 60 to 90 days. The Ericsson Corp., 100 Park Ave., New York, N.Y. 10017 [382]

Power amplifier spans 100 to 10,000 hz



Audio and ultrasonic testing is provided by a 5-kva power amplifier that has numerous applications in sonar calibration systems, high intensity acoustic systems, vibration test systems, and industrial process

"All right, Jeff, we'll buy your system, but you'll have to specify a more advanced X/Y recorder. We need greater versatility and more reliable operation on the job. Any ideas?"

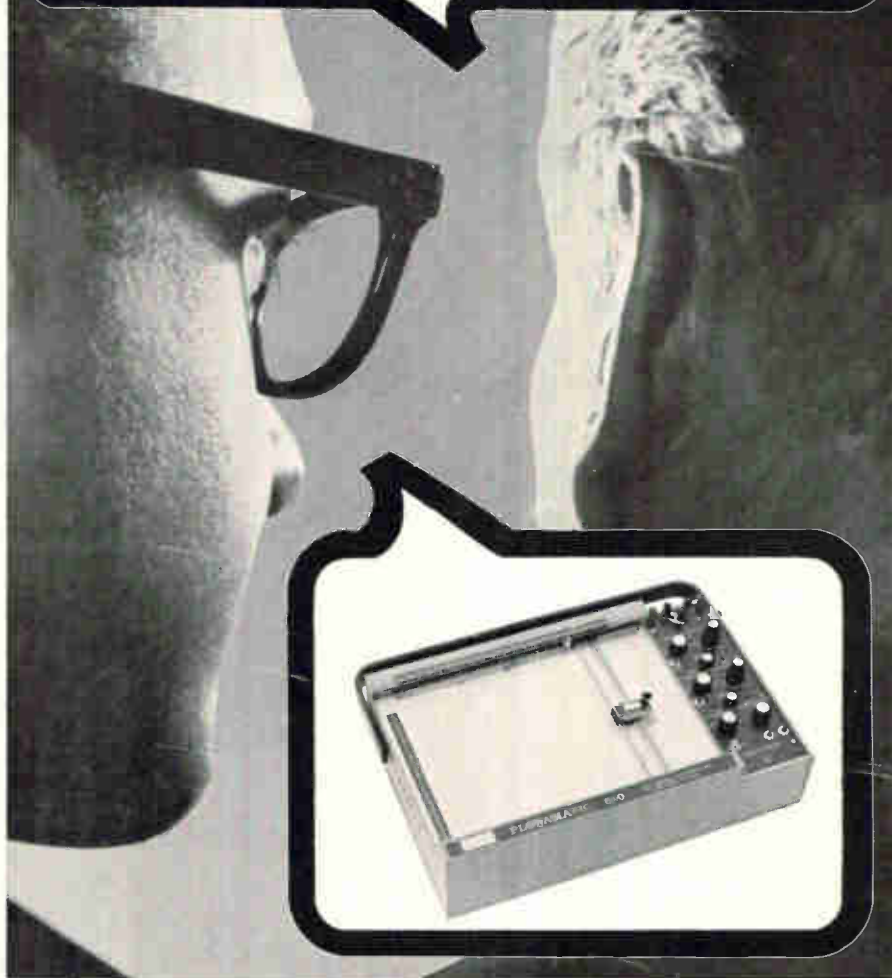

"If you like, Craig, I'll give you the system with the latest X/Y recorder on the market: The PLOTAMATIC built by Bolt Beranek and Newman's Data Equipment Division. Other users swear by them. The PLOTAMATIC has a paper hold-down system that always works, never gets dirty, and yet allows you to adjust the paper for proper alignment after it's mounted. Input resistance is greater than one megohm, independent of gain setting. Accuracy and input versatility are as good as anything on the market, and you don't have to buy time base if you don't want it. No high voltages to produce RFI problems, either. Just between us, Craig, I think our people are in a rut with those X/Y recorders we've been using. They use them out of habit, and aren't up on the latest the market has to offer."

BBN's PLOTAMATIC line includes a variety of 8½" x 11" and 11" x 17" X/Y recorders for virtually every application. Keep up with the market—write us for a catalog.



BOLT BERANEK AND NEWMAN INC
DATA EQUIPMENT DIVISION

2126 SOUTH LYON ST., SANTA ANA, CALIF. 92705 (714) 546-5300

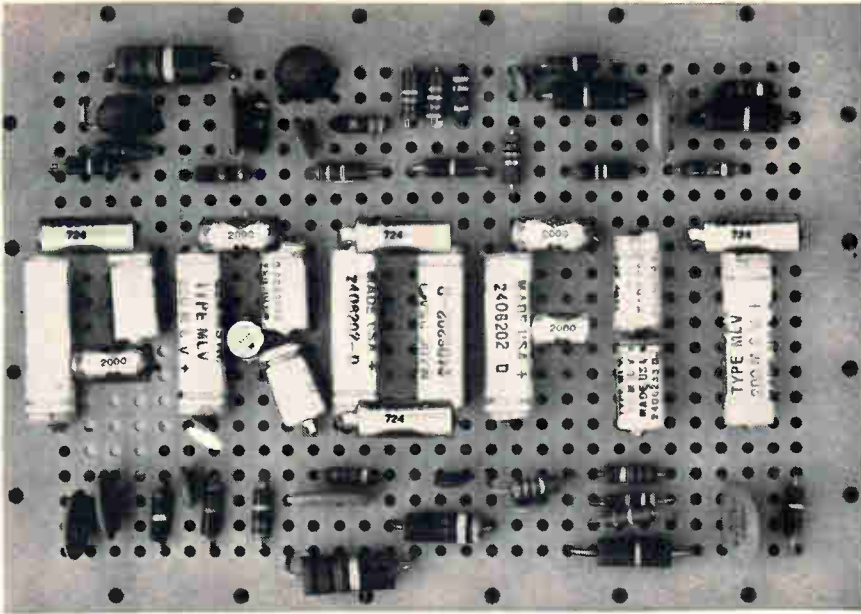

New Subassemblies

control. Measuring 24 x 24 x 45 in., including casters, the unit is rated for continuous duty over a frequency range of 100 to 10,000 hz.

Model B5K is suitable for operation with keyed input signals, and features responses of ± 0.5 db over the frequency range. Distortion in output waveform is less than 3% over the range.

Features include six output impedance taps ranging from 8 ohms to 1,152 ohms. The air-cooled amplifier delivers full rated output into load power factors between ± 0.1 and unity. The hinged front panel section provides test points for critical voltages.

CML Inc., subsidiary of Tenney Engineering Inc., 350 Leland Ave., Plainfield, N.J. 07062. [383]

where industry is never short-circuited...

Plug-in anywhere in Louisiana and you'll be able to take advantage of:

Louisiana's revolutionary **Right-To-Profit Laws**, which protect industry, large and small, from unfair taxation and excessive government regulation.

Louisiana's money-saving **plant financing programs**. Build the exact production facility you require, without tying up your capital in brick and mortar.

Louisiana's **manpower training program**. Louisiana offers industry a substantial pool of labor, both trained and trainable. Where training is necessary, we'll provide it at no cost to you.

For full information on these and other ways to profit in Louisiana, write to William T. Hackett, Department of Commerce and Industry, Room 214, Capitol Annex, Baton Rouge, Louisiana 70804.

LOUISIANA

The Right-To-Profit State

Compact, aerospace core memory systems

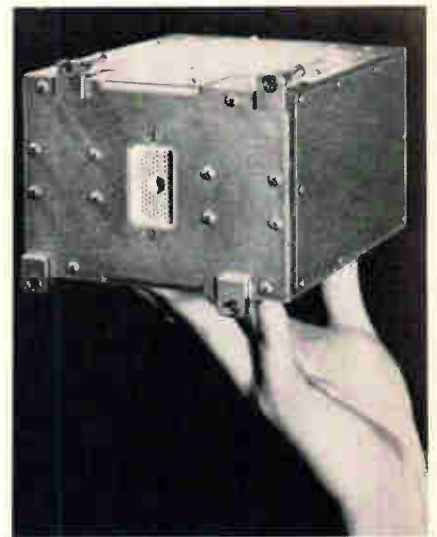

Designed to meet the high reliability requirements of military and aerospace computers, four new core memory systems feature small size and low weight and low power. Switch-core selection techniques eliminate a number of semiconductor components and allow a corresponding reduction in system prices.

The LCM710 provides a combination of coincident current addressing and linear select operation. This technique permits wide current and voltage tolerances and

high-speed performance, and it eliminates the necessity of drive current compensation at speeds of 4 μ sec or slower. These memories are available as complete systems or with modified electronics for specific applications. Standard expandable memory capacity is 256 to 4,096 words with up to 32 bits per word. Larger word and bit sizes can be provided.

These systems are effectively nonvolatile digital delay lines that have already found applications in the Y and R register memories of a specific aerospace computer. Plugging-in of additional sections of computer core storage to change the delay line length is convenient.

The systems can store both electrically alterable and fixed data in the same array. The basic storage matrix of these dual core units consists of a one-core-per-bit, two-wire-per-core arrangement. The same core simultaneously stores read-only and electrically alterable information through time sharing of the system's electronics. Standard expandable memory capacity is 512 to 8,192 words with up to 32 bits per word, with larger word and bit sizes available.

The LCM220 is a hard-wired read-only memory, utilizing very few semiconductor components. Unlike conventional hard-wired units, it can be readily filled without difficulty and easily modified with external fill equipment. Its expandable memory capacity is 256 to 4,096 words with up to 60 bits per word.

Litton Industries Inc., 9370 Santa Monica Blvd., Beverly Hills, Calif. 90213 [384]

Versatile and stable vlf signal source

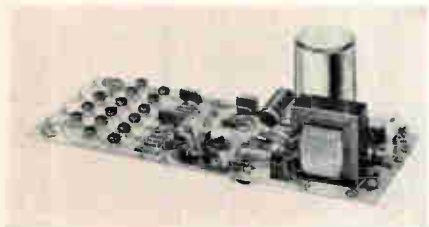

Inexpensive and highly versatile, a vlf signal source may be tailored to fit electrically and mechanically in a large number of applications

SOLID CARBIDE CIRCUIT BOARD DRILLS

*... for every circuit board
drilling need*

Precision to maintain location and hole size tolerances to close limits. Permits ultra high speed drilling at feeds up to 15 inches per minute. Design features include four facet point configuration and very fine flute finish. Drill point concentric to drill diameter within .0005".

STANDARD CIRCUIT BOARD DRILLS... Standard design with flute and shank same diameter. For use on any type production drilling from single board to high volume, stacked drilling tape controlled set-ups.

SERIES 125—1/8" SHANK DRILLS... Eliminate need for drill bushings when used with precision spindles and collets. Drill diameter to shank concentricity is within .0003". Common 1/8" shank for all drill sizes ends need for collet inventory for each size.

For complete information write for Bulletin C866.



THE METAL REMOVAL COMPANY

1859 West Columbia Avenue • Chicago, Illinois 60626
Manufacturing Plants Located in CHICAGO/LOS ANGELES/SAN JUAN

**MASTER TOOL AND WHEEL MAKERS FOR THE WORLD
END MILLS / DRILLS / REAMERS / BURS / SPECIAL TOOLING**

Circle 193 on reader service card

To order reprints: Fill in, cut out coupon below, insert in envelope and mail to: **Electronics Reprint Dept.,
330 W. 42nd Street, New York, N.Y. 10036**

Reprint order form

For listing of reprints available see the Reader Service Card.

U.S. Electronics Markets 1967

Send me reprints of Key no. R-08 at 50¢ each.

For reprints of previous special reports fill in below:

Send me reprints of Key No.(s) @ ¢ each.

(For prices, see Reader Service Card)

Name

Number of street

City, State, Zip code

...and
AIR PRODUCTS
 will give us
**RADIOACTIVE
 GASES,
 DOPING GASES,
 ULTRA-PURE
 HYDROGEN CHLORIDE
 ULTRA-PURE
 METHANE**



When you get back, write for "spec" sheets on the gases you need and our folder which points out the benefits of buying high-purity specialty gases from Air Products.



Air Products and Chemicals
 SPECIALTY GAS DEPT.
 Allentown, Pennsylvania INC.

194 Circle 194 on reader service card

New Subassemblies

where a precise timing signal or vlf frequency standard is required.

The module illustrated, model PC-6, has an output voltage of 60 hz $\pm 0.00001\%$, when operated from an input voltage of 108 to 130 v a-c, 50 or 60 hz nominal line frequency. Output voltage is a 50/50 duty cycle square wave rising from 0 to +4 v d-c, when connected for internal collector supply; or 0 to +30 v d-c, when the output amplifier is connected to an external supply.

This unit is available at any output frequency from 0.1 hz to 10 khz. Various packaging arrangements are available. Prices start at \$185 each, in lots of 50 or more. Some frequencies can be shipped in less than 3 weeks after receipt of the order.

Metric Engineering, a division of Green-ray Industries Inc., 5235 E. Simpson Road, Mechanicsburg, Pa. 17055. [385]

Military inverter is compact and rugged

Used to power any 400-hz device, a static inverter converts 28 v d-c to 400-hz sine-wave voltages of 115 or 26 v a-c. With continuous full load operation at 100°C, model S12D supplies an output power of 120 v-a.

Modular design techniques provide a compact unit of 6 x 4 x 4 in. which weighs less than 7.6 lbs. Hermetic sealing and full encapsulation allow the inverter to meet the environment of MIL-E-5272C at 100°C.

Regulation is 0.2% for input variations of 24 to 30 v d-c. Other features include complete isolation of inputs and outputs, and an output voltage adjustment range of 12% from the nominal output voltage. The module is also protected against short circuit conditions, input voltage transients, and reverse polarity damage.

Price is \$1,285. Normal delivery takes six weeks. Abbott Transistor Laboratories Inc., 5200 W. Jefferson Blvd., Los Angeles, Calif. 90016. [386]

The Best Of Boston

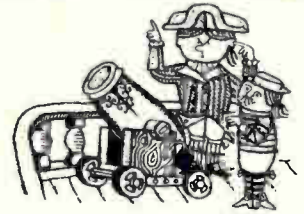

Decisions! Decisions!

The big ones are made where the best things happen Now as always at the grand-old, brand-new Boston Statler Hilton. Home of the New Trader Vic's! Phone any Hilton Reservation Service... for instant, confirmed accommodations.

The Statler Hilton

Circle 260 on reader service card

San-Esu poly varicon for FM. AM

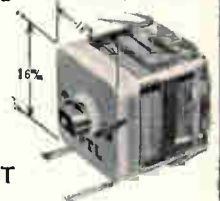

4X-16BET

Main Features:

- * Micro-miniature sized yet with large capacity, (2% \pm 1pF)
- * High reliability against temperature and humidity.
- * 4 Trimmers of AM, FM sections.
- * Good howling-proof.
- * Smooth rotation torque.
- * Excellent "Q" characteristics.

San-Esu is always contributing to cut your production costs through the precise delivery by mass-production under conditions of the rigid quality control.



For catalog, write to:

SAN-ESU ELECTRONICS CO., LTD.

1-2, 6-chome Nishi-oi-Shinagawa-ku, Tokyo, Japan
 Tel. Tokyo (783) 7311
 Cable: SANESVARICON TOKYO

Circle 261 on reader service card



Great editorial is something he takes home

(What a climate for selling!)

Electronics

A McGraw-Hill Market-Directed Publication
330 West 42nd Street, New York, N.Y. 10036



"NEW SHOCKPROOF PACKAGE GIVES US BIG SAVINGS"

That's what leading electronic component makers are saying about the Tiros System. People like Sage Laboratories and Ad-Yu Electronics have found the unique Tiros package to be perfect for delicate, expensive microwave hardware. Key to the effectiveness of the Tiros package is the specially designed injection-molded end caps with integral fins that grip the end of the enclosed part tightly. If the container is dropped, shock is absorbed by the end closures and dissipated over the surface of their rims. The end closures can be color matched and coded. Tiros is also offering a cutting machine for customers wishing to produce their own package lengths. Using the machine, standard 6-foot lengths of tubing can be quickly and economically cut into specified lengths. This solves the problem of having to maintain large inventories of various size packages. Tubing is available with outside diameters of from 1/4 inch to 1 1/4 inches. End closures come with corresponding outside diameters. Write for full details and our new folder. TIROS PLASTICS CORPORATION, 543 Tarrytown Road

• White Plains, N. Y. • 10607
• 914- WH 8-5457.



NEW! CUSTOM- ENGINEERED DIELECTRIC SLEEVES

Want to insulate an active component properly, economically and with an absolute seal? — We can do . . . with a custom-extruded dielectric sleeve! Ask us for details.



The NEW CHAMP

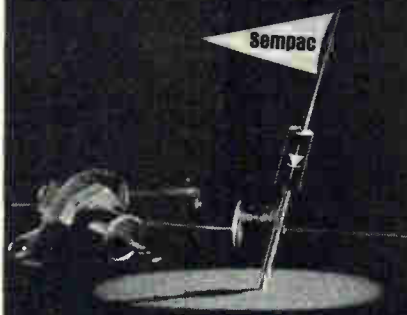

3 amp 55°C
No heat sink

6 amps if mounted
per MIL-STD-750A

Semtech's multi-purpose, high current, axial lead, silicon rectifiers are designed to eliminate packaging problems associated with lead mounted metal can and stud rectifiers.

Packaged in fully insulated "SEMPAC" cases the units are light weight, small (.375" long x .195" diameter), and easy to install.

Available in PIV ratings from 50 to 600 volts with a low reverse current of 10 μ A @ 25°C, an average rectified current of 3 amps at 55°C, NO HEAT SINKING required and a one cycle surge rating of 300 amps.

Equal area heat sinking is provided on both sides of the silicon junction with Tungstaloïd pins which match the thermal expansion characteristics of the silicon. The junction, Tungstaloïd pins, and solid silver (.04") leads are bonded

above 900°C. No solders are used in the construction of the rectifiers.

For more information contact your nearest representative and ask for Technical Bulletin No. E44. Economically priced, the units are available in large quantities.

SEMTECH CORPORATION

WESTERN OFFICE: 652 Mitchell Road, Newbury Park, California
(805) 498-2111 (213) 628-5392/TWX 805-499-7137
Central: 140 No. La Grange Road, La Grange, Ill. (312) 352-3227
Eastern: 71 West 23rd St. N.Y., (212) 989-7550/TWX 212-640-5060
European Sales: Bourns AG, Alpenstrasse 1,
6301 Zug, Switzerland (042) 4 82 72/73

New Microwave

Coaxial package lifts transistor power

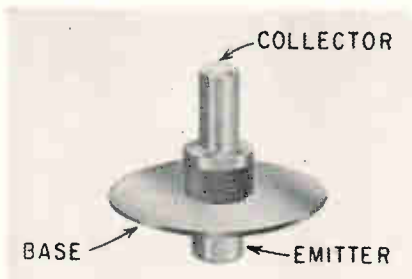

A new overlay transistor in a coaxial package takes 0.316 watt at its input and delivers a 2 gigahertz output of 1 watt. The manufacturer claims this is about 4 times the power previously available from commercial transistors operating at the same frequency. As an oscillator, the transistor has produced 1.5 watts at 1 Ghz.

The coaxial package reduces the device's parasitic inductances, which in turn minimizes degenerative feedback and thus increases power gain. An additional advantage of low inductance is that the transistor can be used in wideband circuits.

Designed by the Radio Corp. of America under a Signal Corps contract, the new unit—the TA7003—is being offered as a developmental transistor at a cost of \$90. Although it is RCA's first coaxially packaged transistor, it is not the first ever. The Fairchild Camera & Instrument Corp.'s Semiconductor division introduced a lower power coaxial transistor last year.

Hon Lee, an engineering leader at RCA's Somerville, N.J. plant, says that the coaxial package produces the minimum case inductance of any transistor package. "The inductance is less than 0.1 nanohenry and can't be measured," says Lee.

The TA-7003, an epitaxial silicon npn transistor, is an overlay design. The transistor chip has 16 emitter sites that are connected in parallel and operate with a common collector region. The overlay structure permits a substantial increase in emitter periphery, which allows higher current or power op-

eration. At the same time, the collector and emitter areas are smaller, which reduces the input and output capacitances and permits high frequency operation.

RCA will not divulge details on construction of the device except to say that the TA-7003's design incorporates very-low resistivity material, a thin epitaxial layer and narrow base widths.

The transistor produces its high power in coaxial air lines where it must be employed in a common-base circuit. A suitable line has a characteristic impedance of about 20 ohms and requires a 0.25 inch center conductor and 0.35 inch outer conductor. The transistor itself has an over-all length of 0.470 inch and its largest diameter—the flange that is the base lead—is 0.500 inch.

RCA says the TA-7003 will find use in L and S band equipment including telemetry, radar and electronic countermeasures equipment, and as a driver for varactors and microwave tubes. Various RCA divisions are already using the transistor in solid state circuits for the military.

The company is presently working on a higher power coaxial type transistor. Under an 18-month contract with the National Aeronautics and Space Administration, RCA is designing a unit that will produce 5 to 8 watts at 2.3 Ghz.

Specifications

As a 2 Ghz amplifier	
Minimum power output	1 watt
Gain with 0.316 w input	5 db
Minimum efficiency	30%
Collector-to-base voltage	28 v
Output capacitance	3.5 pf
Gain-bandwidth product, f_c	Over 2 Ghz
V_{CE}/I_c	55 v min.
Price	\$90

Commercial Engineering, Radio Corp. of America, Harrison, N.J. [3911]

Bandpass filters operate to 12 Ghz

Bandpass filters with center frequencies from 6 to 12 Ghz are slightly more than 2 in. long and

Solve Your Special Purpose Filter, Transformer, Inductor and other Wire Wound Component Problems at SIE!



Dresser SIE now offers a complete engineering and manufacturing service to fill all your needs for special purpose wire wound components for your ordnance, aircraft, aero space and seismic applications.

Send your specifications today to the address below for complete information.

DRESSER

SIE

INC.

INDUSTRIAL PRODUCTS GROUP
P.O. Box 2928/Houston, Texas 77001
one of the **DRESSER** Industries

Circle 256 on reader service card

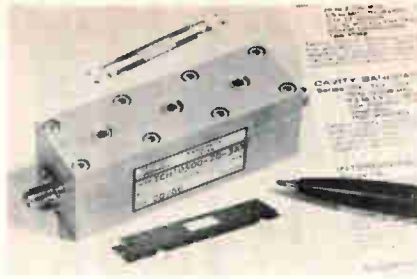

are capacity loaded, iris-coupled TM_{010} -mode cavities of 0.05-dB Chebyshev design. The devices are narrow band, with 3-dB bandwidths from 0.1% to 1%. Power capability, although high, is limited by the type of connector used on the filter.

Performance features are low insertion loss, high Q, and low vswr and ripple in the passband.

The filters, series TCU are available with a choice of two, three, or four sections and are constructed of precision bored aluminum blocks with a finish to minimize insertion loss.

Price is from \$195 to \$280 in single quantities.

Telonic Industries Inc., Box 277, Laguna Beach, Calif. [392]

Air-cooled loads handle high power

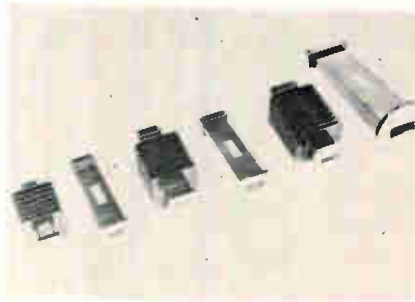

Twenty-one air-cooled dummy loads are lightweight devices, yet handle very high power levels. For example, the model LKuM1 weighs 4.8 oz and handles 25 w average power, while the model LCH100 weighs 3.6 lbs and handles 2,000 w of average power.

Available in finned or unfinned versions, the new loads are offered to operate over uhf, L, S, C, X, and K bands. The loads are used to terminate waveguide transmission systems, eliminating the need for additional cooling devices.

Prices start at \$150.

Raytheon Co., 130 Second Ave., Waltham, Mass. 02154. [393]

Circle 197 on reader service card→

how to tame a temperature problem



HYGRADE

POLYTUBE 463 CLASS F Fiberglass Sleeving

retains its flexibility and electrical properties in continuous operation at temperatures up to 155°C. Even after 1000 hours, it will not crack when bent 180° around a mandrel. Constructed of closely woven fiberglass, it is thoroughly impregnated and uniformly coated with modified acrylics, making it compatible with most wire enamels and encapsulants and resistant to oils, acids, alkalis, jet fluid, lox and water. Good resistance to abrasion and cut-through—non-wicking. Write for samples, data and prices.

MARKEL
SINCE 1922

L. FRANK MARKEL & SONS

Norristown, Pennsylvania 19404

INSULATING TUBINGS AND SLEEVINGS
HIGH TEMPERATURE WIRE AND CABLE

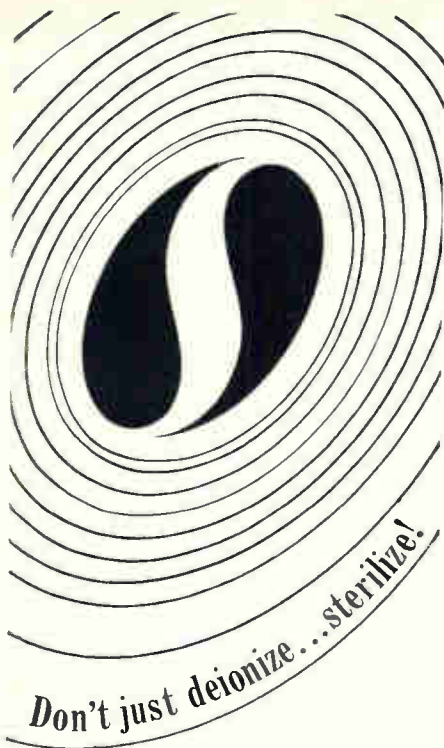

REDUCE QUALITY CONTROL PROBLEMS IN PROCESS WATER! REDUCE COSTLY DOWNTIME IN YOUR DEIONIZING SYSTEM!

A Steroline electronic sterilization unit uses potent ultraviolet rays to destroy organism such as algae, slimes, fungi, and diatoms in process water. It stops trouble-causing organic build-up in filters, ion exchangers and flow lines. Yet, chemical structure or pH of the water remains unchanged.

PUT STEROLINE'S ULTRAVIOLET ENERGY TO WORK FOR YOU...

- Reduce organic impurities in rinse water for improved product quality!
- Reduce pipe and filter cleaning to as seldom as once a year!

STEROLINE INSTALLS EASILY INTO YOUR PRESENT WATER SYSTEM!

Requires only two simple pipe connections and one electrical connection.

FOR MORE INFORMATION WRITE OR CALL

Steroline Systems Corp.

11809 (J) E. Slauson Avenue
Santa Fe Springs, California 90670
Telephone: (213) 698-8157 Cable: Sterline

New Production Equipment

High-speed printer labels transistors

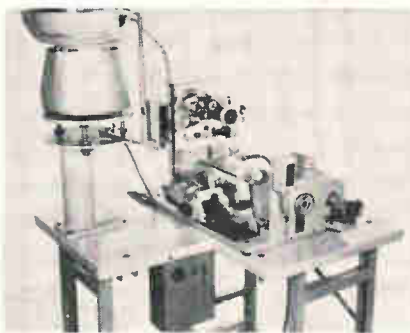

Up to 12,000 transistors an hour can be labeled by a machine designed to print the tops and sides of transistors in TO-5 and TO-18 cans and other configurations. Two transistors are printed with the completion of each cycle of the U-1166 machine.

Components are placed in a vibrating bowl which feeds and correctly positions them as their tops are printed. They then continue down a chute and are positioned to have their sides printed. The components are then automatically ejected.

The U-1166 employs two U-1146 printing heads which hold two sets of messages. Clean and legible imprints are obtained with accurate control of the inks.

Markem Machine Co., Keene, N.H. [401]

Bench wire stripper used on production lines

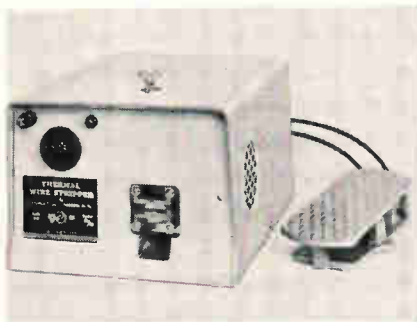

Any type of plastic covering, including Teflon insulation, can be removed by a bench wire stripper

designed for continuous use on production lines. Strip length on the model, BWS-100A, is adjustable up to 2½ in. The diameter adjustment is made at the top of case: correct setting of this locking nut prevents conductor damage. Electrode blades normally are drilled to correct wire size by the user, but drilled blades can be obtained from the factory.

The electrode jaws are air operated and are started by a pneumatic foot switch, leaving the operator's hands free for handling the wire.

A variable transformer controls the heat setting and a 55-cfm blower pushes the fumes out through a 2-in. rear exhaust. Fuse protection, pilot light, and off-on switch are front-panel mounted. Pneumatic foot switch and three-wire grounded line cord are standard.

The unit operates on 115 v a-c, 60 hz. Air required is 40 psi. The fiber glass case measures 12 x 10 x 7 in.

Price is \$315, and availability is immediate.

Contact inc., Elm Ave., Hudson, N.H. 03051. [402]

Ultrasonic die bonder for film devices

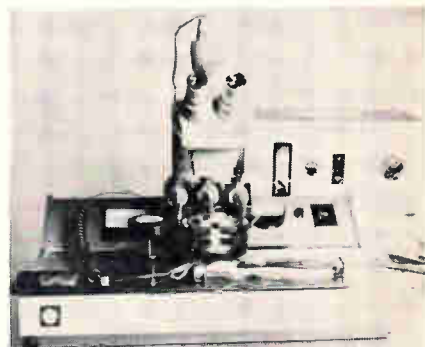

Thick and thin film devices are ultrasonically die-bonded by a multiple-head instrument. Incorporating three transducers, each with a different bonding tip, permits feeding of devices of different sizes.

Substrates are held on a heated vacuum chuck, flooded with form-

*for
maximal
performance
in critical
applications...*

**COAXITUBE
PRE-FAB PARTS
& ASSEMBLIES**

Orders of Coaxitube can be furnished cut to size, stripped, preformed to shape or assembled with connectors to meet your exact specifications. Semirigid construction assures the retention of shape and closely held tolerances. We'll gladly send data or quote your needs . . . no obligation.

© 1977

ing gas, and heated to eutectic temperature before the dice are ultrasonically scrubbed into the mating film. Dice are vacuum lifted into the bonding tips and edge-held to prevent damage to their critical areas.

Axion Corp., 6 Commerce Park, Danbury, Conn. 06810 [403]

**Rotating-pin router
for p-c boards**

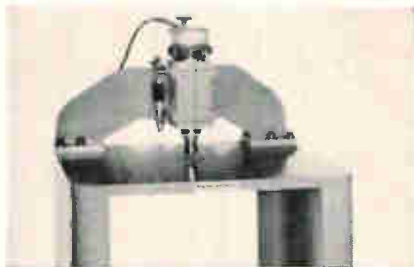

Continuous-duty printed-circuit board routing of materials from $\frac{1}{16}$ to $\frac{1}{2}$ in. thick as well as stack routing up to $\frac{1}{4}$ -in. thickness is accomplished with an accurate, heavy-duty machine. Several design features incorporated in the Model 9001 minimize template wear, increase positioning accuracy, and assure efficient cutting.

The position pin is set in the table in precision preloaded bearings, rather than rigidly mounted, so the pin rotates when the template moves against it and around the pin. Pin sizes range from $\frac{1}{16}$ - to $\frac{1}{2}$ -in. diameter to accommodate various router bits.

The entire vertical head assembly is lowered or raised by a foot-operated air valve, and remains in the up or down position. This allows cutting within the circuit board. An adjustable positive stop is provided in the down position to compensate for cutter bit length. The head moves vertically on 60° dovetails with preloaded gib adjustment to maintain accuracy.

An optional red light or audio warning signal can be incorporated to warn the operator if the feed rate is excessive.

Model 9001 has a 2-hp electric motor with variable speeds from 5,000 to 24,500 rpm and 2% speed regulation. Table dimensions are 20 x 30 in.

Digital Systems Inc., 1078 E. Edna Place, Covina, Calif. 91722. [404]

**PRECISION
Semi-rigid
COAXITUBE**

These high performance solid-jacketed cables offer broad frequency response, low attenuation, zero radiation and lowest possible VSWR. The splined, air-articulated types provide minimum attenuation and highest cutoff frequencies, eliminate periodicity phenomena, and insure phase stability in the order of 20 PPM/°C from 10°C to 40°C, and 35 PPM/°C from -40°C to +125°C. They also provide excellent external RF shielding. For critical applications in severe environments, your best decision is Precision.



PRECISION TUBE COMPANY, INC.
SPECIAL PRODUCTS DIVISION
North Wales, Pennsylvania 19454
Phone 215-699-4806 TWX 510-661-8427

Who's foolhardy enough to pay people to try to put his business out of business?

Some company called Poly-Scientific.

For years we've been in the slip-ring business. We make them in every size and shape. And to any parameter. So we like to think we're experts in the field. But we've often thought "Maybe something else would work better."

Recently, we decided to explore the idea.

With the help of our next-door neighbor, Virginia Tech, we set up a Scientific Advisory Board. Its mission: To think new processes, new materials, new products.

Four regular members— Ph.D.'s and professors who periodically meet with our own top people—make up the SAB. Each represents a separate scientific discipline. Often a visiting VIP sits in on the brainstorming sessions.

Naturally, some of their ideas get pretty far out—but we've already seen some practical benefits. Our new Captach Switch described on the opposite page is an example.

It's just one of the many useful ideas resulting from our Scientific Advisory Board. You'll be hearing about more in the future. If anybody puts us out of business—we're going to make sure it's us.

Care to have a foolhardy company like this working for you?

POLY-SCIENTIFIC 
A DIVISION OF LITTON INDUSTRIES

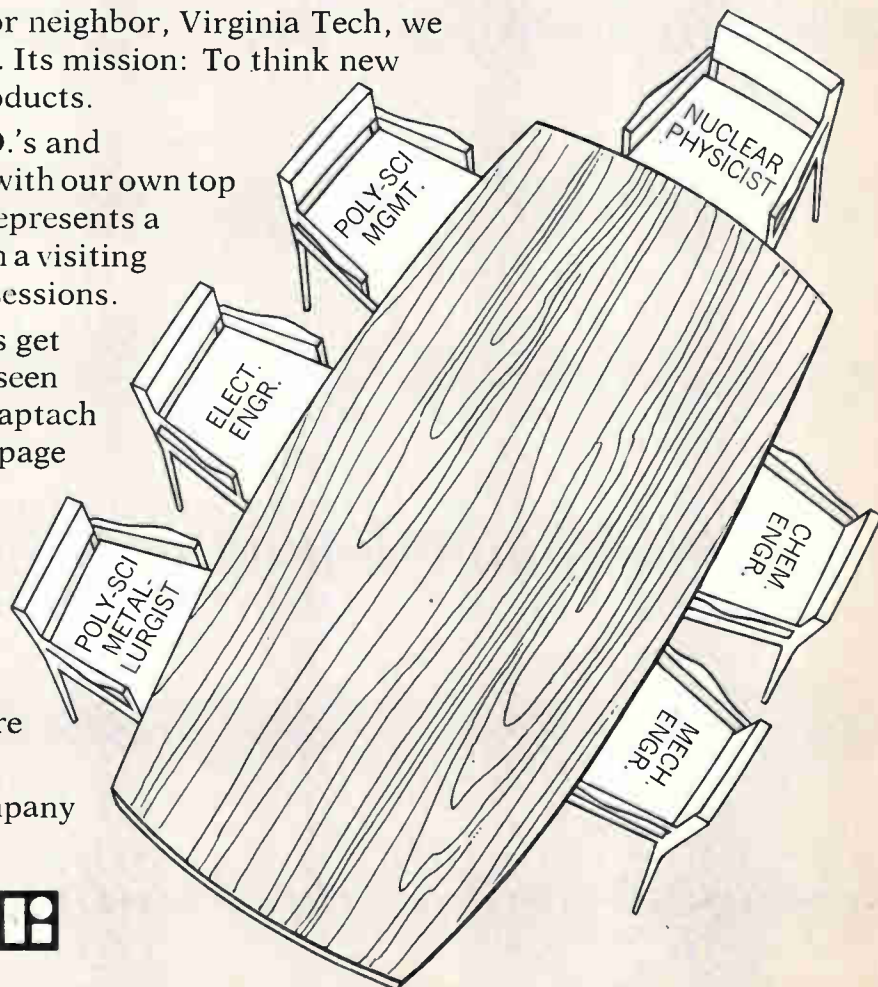

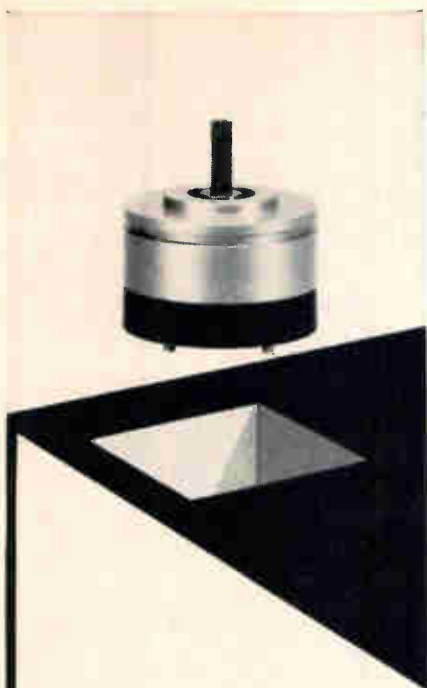

"BLACK BOX" components like our new mechanically driven, 24-contact Captach Switch exemplify our ability to meet complex rotary-switch requirements for shaft integrator systems of airborne computers.

The tiny unit (0.8" x 1.062" OD) features a 13-tooth pinion drive shaft (diametral pitch .120") extending 0.47" outside the housing. Other specs for this 0.9-oz. device include:

- Breakaway torque: 0.015 to 0.05 oz.-in.
- Continuous rotational speed: 0 to 3600 rpm
- Life: 10 million revolutions (min.)
- Shaft runout: 0.001 TIR
- Shaft end play: 0.0015 TIR
- Shaft radial play: 0.0008 TIR

Specify your design problem to Poly-Sci. We'll specify your solution. Mail coupon or call Robert Gardner at 703/552-3011. Or TWX 710-875-3692. On the West Coast, call Jim Swallow, at 213/887-3361.

Poly-Scientific Division ★ ★
Litton Industries
1111 N. Main St., Blacksburg, Va.

Tell me how Poly-Sci is qualified to solve my design problem.

Name _____

Title _____

Company _____

Address _____

City _____ State _____ Zip _____

New Materials

Silicone sheet blocks microwaves

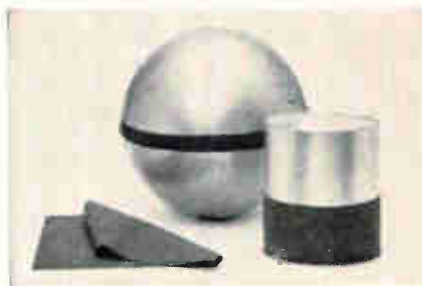

A high-loss, flexible silicone material, when bonded to a metal surface, prevents the flow of microwave currents. It reduces the backscatter or reflectivity of metal structures in cases where this is caused by surface currents. It can also be draped over objects to alter reflectivity characteristics. Radiation patterns of antennas can be modified by the application of Eccosorb cns, to elements, dishes, and horns.

In some microwave devices it may be used as a gasket material, since it is easily cut. This provides both a hermetic and a microwave-energy seal.

Since it is based on silicone rubber, the material is impervious to moisture, and can withstand temperatures up to 400°F.

Eccosorb cns is available 0.030 in. thick in 1 ft by 3 ft sheets. Greater lengths are available on special order. It can be easily bonded to itself to form large blankets. It weighs approximately ½ lb per sq ft. Price is in the \$10-per-sq-ft range.

Emerson & Cuming Inc., Canton, Mass. 02021 [406]

Polyurethane rubber pots and encapsulates

Silicone rubber can be replaced in many applications by a polyurethane rubber developed for potting and encapsulating pressure-sensitive components, especially glass components, such as diodes and resistors.

The comparatively low viscosity of HumiSeal 2B71 permits it to

penetrate dense electrical assembly packages. Dielectric strength of 1,500 volts per mil provides excellent protection in thin cast sections.

The hardness and elongation factor of 180% protect fully against shock and vibration.

The product is available clear or black.

Columbia Technical Corp., 24-30 Brooklyn-Queens Expressway West, Woodside, N.Y., 11377. [407]

Epoxy resin cures at low temperature



Pressure-sensitive components can be encapsulated with a black, semi-flexible epoxy resin, which has a low temperature curing cycle. Curing starts at 65°C and may range as high as 120°C. Gel time is 23 minutes at 121°C.

Called Scotchcast resin No. XR-5140, it is suitable for dipping and encapsulating transformers, coils, motors, modules, strain sensitive circuitry, and other electrical and electronic components. It is stable at high temperatures (155°C) with permanent flexibility for thermal and mechanical shock resistance. The material may be applied by dipping, spraying, extruding, or troweling.

Properties of XR5140 after heat aging at 130°C for 1,000 hours include: dielectric constant (100 hz, 23°C), 3.56; dissipation factor (100 hz, 23°C), 0.054; volume resistivity (ohm/cm), greater than 10¹⁵; electric strength (volts/mil, ¼-in. sample), 375; hardness (Shore D), 65. It passes standard thermal shock tests and resists moisture.

3M Co., 2501 Hudson Road, St. Paul, Minn. 55119. [408]

THINK RATS

... for electrical power.

Garrett-AiResearch Ram Air Turbine Systems (RATS) give you auxiliary electrical power from 150 watts to 30 kw.

Externally or internally stored RATS provide power on demand—full-time or intermittent loading—speed control within $\pm 5\%$ of the rated electrical frequency.

Think RATS for reliable electrical power for countermeasures, communications, control, guidance, weapons systems, and other aircraft and missile needs. Operate over a broad environmental range. Low weight. Low drag. Backed by AiResearch single-source responsibility and service.

For design and application data on RATS for electrical, hydraulic, pneumatic, and mechanical power, write: AiResearch Manufacturing Company, 9851 Sepulveda Blvd., Los Angeles, California 90009.

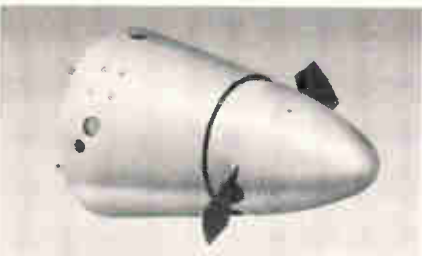
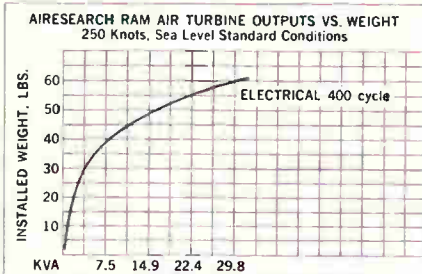

**AIRESEARCH
RAM AIR TURBINE
SYSTEMS**

New Books

Tunnel diodes

Analysis and Synthesis of Tunnel Diode Circuits
J. O. Scanlan
John Wiley & Sons, 274 pp., \$9.75

This is the second textbook of note to appear on the tunnel diode since the invention of this device nine years ago by Leo Esaki. Chow's 1964 book, "Principles of Tunnel Diode Circuits" (Wiley & Sons), gave a general treatment of the theory and applications of tunnel diodes, while this one is devoted exclusively to theoretical aspects of applications in high-frequency signal circuits.

The author does a creditable job of covering the underlying physics of tunnel diodes, starting from the foundations of quantum theory. Tunneling theory is illustrated by examples to give the reader insight into this concept. Semiconductor band structure, Fermi levels, density of states, degeneracy, and the WKB approximation—all essential to the understanding of tunnel diodes—are discussed in detail. Although the treatment of these subjects probably won't satisfy the physicist or device designer, it should prove valuable to the man to whom the book is primarily addressed—the circuit theorist.

A simple four-element equivalent circuit is developed based on both theoretical and practical arguments. Several equations are given that can be used to approximate the large signal voltage current characteristics of the tunnel diode. One improvement, perhaps, could have been the inclusion of numerical values of the electrical parameters for actual tunnel diodes.

The major portion of the book is devoted to tunnel diode amplifiers using principles of network synthesis in the treatment of broadband amplifiers. The treatment is entirely theoretical; it lacks discussion of both the practical performance limitations of microwave amplifiers and the hardware problems involved in their construction. Also omitted is any treatment of multi-diode amplifiers for improved linearity and dynamic range.

One chapter is devoted to oscil-

lators, mixers, converters, and detectors. While the mathematical treatment of these topics is comprehensive, the reader will have to search elsewhere for information on oscillator circuit configuration, oscillator stability, and theoretical treatment of back diode mixer detectors.

T.P. S

General Electric Co.
Syracuse, N.Y.

Looking back at the future

Communication Satellite Systems Technology
Edited by Richard B. Marsten
Academic Press, 1,051 pp., \$12

In 1945, Arthur C. Clarke proposed a global communications network that would bypass the effects of the ionosphere. He observed that a rocket traveling at five miles per second—"only twice as fast as those already in the design stage"—could put an artificial moon into orbit. A satellite, he said, placed 26,040 miles above the earth would be in stationary orbit; and thousands of such satellites, equipped with receiving and transmitting equipment, could relay signals over the entire world.

Clarke pinpointed the exact latitudes and longitudes for the satellites to best serve Europe, Africa, China and Oceania, and the Americas. He chose microwave carrier frequencies, suggested that the evidence necessary to prove that radio waves passing outer space might be obtained by exploring echoes from the moon. Applying the Federal Communications Commission's standard minimum signal strength of a frequency-modulated signal (50 millivolts per meter), he arrived at a power level of 1.2 kilowatts for broadcast service.

This amazingly accurate prophecy from the magazine *Wireless World* is reprinted as the prologue to this collection of papers from the May 1966 conference of the American Institute of Aeronautics and Astronautics.

As with any such compilation, papers now obsolete are placed

MAGNETIC INTERFERENCE STOPPED PERMANENTLY

by Netic Co-Netic Shields designed and fabricated by Magnetic Shielding Specialists

New shield designs meet the new shielding specifications... from a few gammas to several thousand gauss. Over 80% of all magnetic shield designs currently used were engineered and designed here. This design experience is at your service.

Sheet Stock also available.

Applications

Military Command & Control Systems • Strategic Systems • Tactical Systems • Computer Display Systems

Unique Features of Netic Co-Netic Shields

Provide permanently effective shielding • Insensitive to ordinary shock • Minimally retentive • Provide up to 80 db attenuation.

DELIVERY 3-4 WEEKS IN MDST INSTANCES

Request Short Form Catalog No. 67



Photomultiplier & CRT Shields



CRT Sectionalized Shields



Scan Converter Tube Shields



MAGNETIC SHIELD DIVISION

Perfection Mica Company

1322 N. ELSTON AVENUE, CHICAGO, ILLINOIS 60622

ORIGINATORS OF PERMANENTLY EFFECTIVE NETIC CO-NETIC MAGNETIC SHIELDING

Circle 243 on reader service card

FREE TECHNICAL MICA MANUAL K-6

gives electrical and physical data on all types of mica

No tooling cost on numerous fabricated parts of natural and built-up mica.

Pre-punched insulating wafers to electrically isolate transistors, diodes, etc. from heat sinks.

Corrugated mica to reduce handling and fabrication costs for thermal elements.

All grades of mica offered.

Immediate delivery from stock on many items.

PERFECTION MICA CO.

1322 No. Elston Ave.

Chicago, Illinois 60622

Phone: 312, EV 4-2122

Circle 244 on reader service card

NEW HEATHKIT® Solid-State High Impedance V-O-M

Kit \$80 Wired \$115

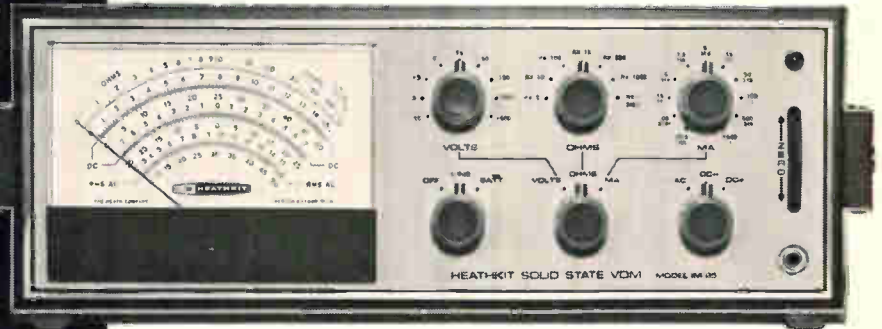

Never Before Has An Instrument With These Features and Performance Been Available At Less Than \$200

- 13 Silicon Transistors Plus 2 Field Effect Transistors
- 11 Megohm Input Impedance on DC
- 10 Megohm Input Impedance on AC
- 9 DC Voltage Ranges From 150 Millivolts Full Scale to 1500 Volts Full Scale... Accuracy $\pm 3\%$ Full Scale
- 9 AC Voltage Ranges From 150 Millivolts Full Scale to 1500 Volts Full Scale... Accuracy $\pm 5\%$ Full Scale
- 7 Resistance Ranges, 10 Ohms Center Scale x1, x10, x100, x1k, x10k, x100k, x1 meg... Measures From One Ohm to 1000 Megohms
- 11 Current Ranges From 15 Microamps Full Scale to 1.5 Amps Full Scale... Accuracy $\pm 4\%$ DC, $\pm 5\%$ AC
- AC Response to 100 kHz
- 6", 200 μ a Meter With Zero Center Scales For Positive and Negative Voltage Measurements Without Switching
- 1% Precision Resistors
- Separate Switch For Each Function Eliminates Constant Changing
- Ten-Turn Thumbwheel Zero Adjustment For Precision Settings
- Built-In 120/240 VAC, 50-60 Hz Power Supply Plus In-Cabinet Holders For Battery Supply During Portable Operation
- Easy Circuit Board Assembly
- New Heath Instrument Styling With "Unitized" Construction and Low Profile Appearance; Color Styled in Handsome Beige and Black

The first of an exciting new line of Heathkit test instruments, the IM-25 Solid-State V-O-M does all the measurement jobs normally required in tube or transistor circuits with the no-loading high impedance of a VTVM, the convenience and versatility of a VOM, and the accuracy and sensitivity of separate lab instruments. Whether you choose the factory assembled model or the new, easier-than-ever kit version, we believe you will find the IM-25 a significant step forward in design and value.

Kit IM-25, 10 lbs. (Available May) \$80.00
Assembled IMW-25, 10 lbs. (Available June) \$115.00

HEATH COMPANY, Dept. 520-28
Benton Harbor, Michigan 49022

Enclosed is \$ _____, plus shipping.

Please send model (s) _____

Please send FREE Heathkit Catalog.

Name _____ (Please Print)

Address _____

City _____ State _____ Zip _____

Prices & specifications subject to change without notice. TE-159

NOW...

Color-code and Teflon-wrap
in one operation with

Dilectrix "Fluorofilm"†

COLORED TEFLON* TAPES

FULLY SINTERED
FUSES TO ITSELF. UNFUSED TFE
OR TO FEP



- Minimal pigmented layer protectively encapsulated within normal PTFE laminations
- Lowest pigment content for highest electrical and physical properties
- Will not peel, crack, wear or fade
- Void and pinhole-free multilaminar construction
- Low shrinkage after fusion—greater surface coverage POUND FOR POUND
- Choice of TEN permanent, vibrant mil-spec colors
- AVAILABLE FROM STOCK in various thicknesses and widths, and in SPLICE-FREE lengths to 500 ft.

Dilectrix "Fluorofilm" color interlaminated tapes and films are *ideal* for color coding and wrap-insulation applications, or as a low-friction surfacing material. Several types are supplied in plain PTFE, pressure-sensitive, and one side weldable for wrapping circular or rectangular conductors using *standard* fusion heat-seal equipment. WRITE FOR BULLETIN 1066.

COLORS: White, Black, Grey, Yellow, Green, Blue, Purple, Red, Orange and Brown.

*DuPont trademark † Dilectrix trademark



CORPORATION

FARMINGDALE, NEW YORK 11735 • TEL: (516) 249-7800 • TWX: 694-1884

Advanced fabricators of Teflon—producers of multilaminar autodeposited Teflon tapes, films and sheets
Circle 246 on reader service card



NEW from Cramer



ADJUST-A-LOK STOOLS

Adjust to every worker like fine tools!

Cramer Adjust-A-Lok is immediately adjustable to any workers height. Just release the safety stop, and lift or lower. It can be done just that quick. Since fatigue is a critical factor in efficiency of seated workers, it's just good economics to provide tools that minimize fatigue. With Adjust-A-Lok every worker can find his own most comfortable and efficient level. 6 seat styles and 5 base types provide 30 available models. For more information: write V. P. Sales, Cramer Industries, Inc., 625 Adams, Kansas City, Kansas 66105.

Industrial supplier
inquiries invited



Cramer—The leader in style and quality.

Circle 247 on reader service card

The micro-miniature tuned-circuit package.

JFD TO-5 Enclosed MTLC Tuners

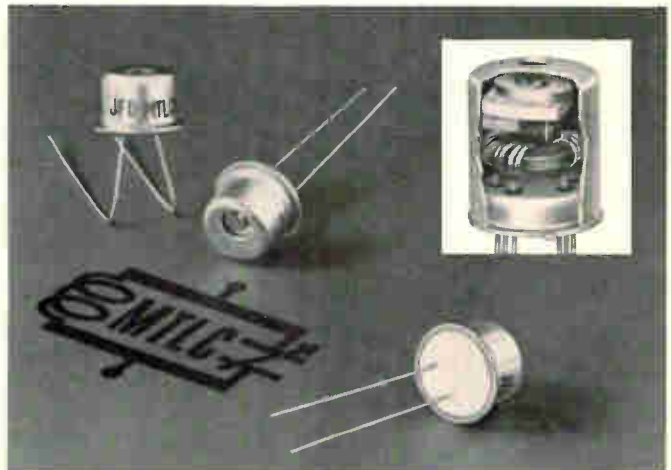

Capacitors shown enlarged 20%

JFD MTLC tuners enable circuit designers to shrink various LC circuits into TO-5 configurations completely compatible with today's miniaturized or hybrid circuitry. The tuning element is a subminiature variable ceramic capacitor measuring: .208 x .280 x .120 inch thick. These variable ceramic capacitors offer high capacitance plus a choice of wide Δ Cs in extra small, ultra stable units.

JFD builds these miniature circuits with high quality ferrite and iron inductor toroidal cores, providing maximum Q for any given frequency. Where necessary, special JFD Uniceram fixed capacitors are used with Modutrim units to yield lower center frequencies or to satisfy special circuit requirements.

Ten standard tunable LC networks are available for a wide range of applications. Variations of these standard units, or special designs, will satisfy most other requirements. Write for bulletin MTLC 65-2.



JFD ELECTRONICS CO. / COMPONENTS DIVISION 15th Avenue at 62nd Street
Brooklyn, N. Y. 11219 / Phone 212-331-1000 • Sales Offices—Arcadia, Calif.
Chi., Ill. / Balt., Md. / Saxonville, Mass. / Bklyn., N. Y. / New Hartford, N. Y.
Cinn., Ohio / Phila., Pa. / Pitts., Pa. / Paris, France / Azor, Israel

Circle 205 on reader service card

205



CALIBRATED VARIABLE COAXIAL ATTENUATORS

- DC-1.0 GHZ
- 0-30 DB
- ECONOMICAL
- PROMPT DELIVERY
- CHOICE OF BNC,
TNC, N, OR C



MODEL
D1196

Originated at RDC*, D1196 is the industry's first zero-loss, infinite resolution variable attenuator operating DC-to-microwave.

Inclusion of a special planetary 5:1 movement allows fine setting, smooth rotation and effectively provides a lock against movement under vibration.

Other variable attenuators covering 2.0-12.0 GHZ are available and are described in 1966 catalog section "VA."

*patent #3,192,493



5-YEAR WARRANTY on every RDC product! For the first time in the microwave industry, this additional assurance of reliability.

A Complete Source for Microwave Components

Send for complete information . . .



**RADAR DESIGN
CORPORATION**

510 PICKARD DR ■ SYRACUSE, N.Y. 13211
PHONE 315-424-4413

Technical Abstracts

Sound from light

Acoustic wave generation through electrostrictive mixing of two light beams

D. E. Caddes
Sylvania Electronic Systems—West,
Mountain View, Calif.
C.F. Quate and C.D.W. Wilkinson,
Stanford University, Palo Alto, Calif.

The difficulties these researchers experienced with ultrasonic transducers points up the major application of their work; the elimination of electro-mechanical transducers from acoustic propagation studies. They show that acoustic waves at high microwave frequencies can be generated by mixing two optical frequencies in a suitable crystal and taking the ultrasonic difference frequency. The acoustic wave is produced by an electrostrictive effect in which the electric field of the optical wave produces a strain in the crystal. Two optical waves will interact in the crystal, and generate many sum and difference acoustic frequencies, though only the difference frequency is used.

The method requires two optical waves slightly shifted in frequency. Two techniques have been used to obtain the frequency-shifted optical waves. In the first, ultrasound is generated with a conventional transducer and mixed with a light wave that is shifted in frequency by the acoustic frequency. The two optical waves are then focused on the electrostrictive material to generate the sound waves. Although this method only takes sound from one part of the laboratory and delivers it at another point—with some loss—it serves to demonstrate the electrostrictive mixing technique.

The second method for shifting an optical wave uses the output of a giant-pulse ruby laser to produce stimulated Brillouin scattering in a liquid, ethyl ether. This method doesn't require an injected sound wave. If the intensity of the radiation from the laser is high enough, the ethyl ether will be driven into coherent acoustic oscillations without external acoustic excitation.

The bandwidth of the generated sound could only be checked in 50-

megahertz steps since the researchers work only at the overtones of the piezoelectric zinc oxide transducer that is used as the detector. This coarse measurement indicates a spectral width of less than 150 Mhz at a 3.7-gigahertz center frequency. The transducer also has to be aligned to a tight tolerance to detect the ultrasound.

Presented at the Polytechnic Institute of Brooklyn Symposium on Modern Optics, New York, March 22-24.

Plugging leaks

Packaging for Electromagnetic Compatibility

Herman Jankowski
Apollo Support Department,
General Electric Co.,
Daytona Beach, Fla.

Equipment failure can result from adherence to the tried and supposedly true methods of preventing electromagnetic interference among the subsystems of a complex electronic system.

For example, bonding straps are commonly used to connect interference shields to a ground plane. However, a strap will always be resonant at some frequency, and if corrosion occurs at the junction with the ground plane, a nonlinear resistance may be created. The junction then becomes a mixer producing spurious frequencies. As a mixer, the junction is inefficient, but if the signals in the strap are large enough, the equipment can fail.

This is one of scores of electromagnetic compatibility problems—some old and some new to integrated circuits—that the author quickly reviews. He balances off the problems with dozens of ways—again, some old, some unusual—to stop electromagnetic leaks by paying closer attention to subsystem packaging, transmission lines, and system design.

One way the strap problem can be avoided, to continue the example given, is to use copper tubing as the ground conductor. Any stray magnetic fields will induce a circulating current in the copper, but the skin effect keeps this current on the outside of the tube. If the

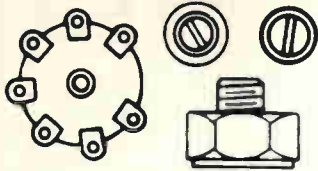

CHICOPEE MANUFACTURING CO. RESEARCH DIVISION MILLTOWN, NEW JERSEY	
TITLE:	
DRAWN BY:	DATE:
CHECKED BY:	SCALE:
APPROVED BY:	DWG. NO.:
PROJECT NO.:	

The second time you draw these (or any other repetitive element) you're wasting creative time!

Use STANPAT repetitive symbols for any diagram, spec, detail, title block . . . or any other detail you draw. It's like adding another draftsman to your staff. STANPAT will preprint your own symbol. You'll always have it ready for application to your drawings and tracings on any medium. It will be accurate, permanent, reproducible, and . . . most important . . . you will gain creative time!

STANPAT reproduces the drawing you need on top-quality tri-acetate sheets. You simply apply the STANPAT to your tracings whenever you need to, as often as you need to. Adherence is instant. Reproductions are crisp and clean, even when microfilming. There's never ghosting . . . no matter what tracing medium you use!

Send for literature and samples today.

faithfully serving the engineer and architect for a quarter of a century

STANPAT PRODUCTS INC.



Covert and Main Street, Dept. J4
Port Washington, N.Y. 11050
Telephone: 516 883-8400

Circle 248 on reader service card

169 REED RELAYS

IN STOCK for
immediate
delivery

Described in
Catalog 268

Available thru
MAGNECRAFT
DISTRIBUTORS
at factory prices

The greatest selection of Mercury-Wetted and Dry Reed Relays stocked by any manufacturer and 290 other stock Relays are described and priced in Stock Relay Catalog 268

The most complete Reed Relay information available anywhere is provided in the new 80-page DESIGNERS' Handbook & Catalog of Reed and Mercury-Wetted Contact Relays

Contact the MAGNECRAFT REPRESENTATIVE in your area or send for your free copies of Catalog 268 and the DESIGNERS' Handbook & Catalog NOW.

MAGNECRAFT Electric Co.

5575 N. Lynch, Chicago, Ill. 60630

Ph 312-282-5500

Circle 249 on reader service card

See, there's a Blackstone ultrasonic unit for every precision cleaning need:

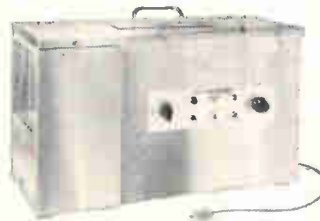

1. Blackstone VRO. Makes it easy to put vapor rinse and ultrasonic cleaning at every work-station. Requiring no water, drains or hood because of a built-in refrigeration system, the VRO runs on 110 volts, delivers 21,000 cycles, ± 1 Kc., controls particulate matter to 1 micron, and has jet spray plus solvent vapor rinsing. To assure long, trouble-free life, the lead zirconate titanate transducer is mechanically held by a retainer which is silver-brazed to the bottom of the 4" x 4" x 3" deep 316L stainless steel tank.



2. Blackstone HT Series. Provides the right combination of tank size, power output and temperature to meet daily "on-the-bench" cleaning needs. Tank sizes can be furnished with 72, 144 and 216 square inch cleaning area capacities. Power outputs can be 100, 200, 300 and 500 watts and can be controlled from 0 to 100% for maximum cleaning efficiency without affecting the part to be cleaned. Temperature is thermostatically controlled from ambient to 190°F.



3. Blackstone VR Series. Great where cleaning needs vary from day-to-day. Available with two ultrasonic tanks of either 5, 10 or 20 nominal gallon capacities, you can attack contaminants with a combination of solvents such as DuPont "Freon"® TF and "Freon"® T-WD602. Includes a third tank for vapor and spray rinsing. By changing sequences and solvent combinations, you can handle almost any cleaning problem on a moment's notice.

Give us a sample of your work. We'll process anything you're cleaning and make recommendations — at no charge, of course.



BLACKSTONE ULTRASONICS, INC.

1400 Howard Street • Sheffield, Pa.

Circle 207 on reader service card

207

NEW

ALSiMAG

Compact Ceramic Capacitor

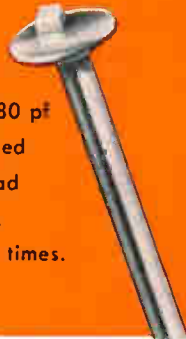

.020" sq 180 pF

Photographed
on the head
of a pin.

Enlarged 6 1/4 times.

Is your Real Estate Expensive?

Are you Cramped for
Capacitor Space?

Do you need Small Capacitors?

Is that your problem?

Then try our New

"Compact Ceramic Capacitor"!

Of course it's no coincidence that this compact ceramic capacitor contains all the characteristics considered certain to certify its use in ceramic circuits. Coming in various colors, capacitances, and compositions, the compact ceramic capacitor can coexist with other components under conditions that would challenge a competitor's capacitor to be compatible.

Concise close control and cognizance of current circuit conditions were combined to create this new ceramic component.

For comprehensive information, call us, quick!

Bulletin 674 sent on request.

American Lava Corporation **3M**
A DIVISION OF
Titanita Division
Chattanooga, Tennessee 37405
Sixty-Fifth Year of Ceramic Leadership

circuit is grounded on the inside surface, the ground current is isolated from the induced interference and no ground loops can occur. This technique has been used in the Apollo ground-support equipment. If the tubing method cannot be used the next best choice is a solid circular conductor.

If rectangular conductors must be used, the corners should be well rounded. Skin effect forces the current to the corners. Conductor resistance will be high in unrounded corners, due to the low effective cross-section of the conductor. Rounding the corners increases the effective cross section.

Twisted stranded line should never be used as a ground bus. The outer twisted conductors act as solenoids, causing the cable's reactance to increase as skin effect becomes significant. In a short time, the bus would be unable to conduct the ground current in sufficient quantity. Braided wire works up to about 1 Mhz, but isn't recommended for higher frequencies.

Presented at the Electronic Packaging Conference, Society of Automotive Engineers, New York, Feb. 14-16.

Won't help a bit

Performance of random-error-correcting in the switched telephone network
A.C. Franco and L.J. Saporta
Communications Systems Inc.,
Paramus, N.J.

Codes for correcting random errors in data transmissions over switched telephone networks can reduce block error rates, but they hardly make a dent in bit error rates.

Given a block size of 150 bits, of which 75 are assigned to the correction code, block errors could be reduced by a factor of 50, while bit errors—which occur in clusters in a switched phone network—may be pared by a factor of only 4.

After presenting the paper, the authors noted that codes designed to correct groups of errors don't have much effect on bit error rates, either. Systems that automatically cause the repeated transmission of a data block containing an error are often applied to screen out bit errors, but their use involves a tradeoff in equipment costs and transmission speed.

Presented at the 1967 International Convention of the Institute of Electrical and Electronics Engineers, New York, March 20-23.

spec
the
switch
to
fit
the
job!



Here's a 1/2" diameter rotary switch that lets you fit the switch to the job — not vice versa.

The new Daven series "X" will switch currents up to 2 amps. It's available in 1 to 4 poles per deck. Single pole decks have up to 12 positions shorting.

Write, phone or TWX for Bulletin SWSM 267. We build switches like no one else can.

DAVEN **M. CRAWFORD**
FEEDS ON

DIVISION OF THOMAS A. EDISON INDUSTRIES
GRENIER FIELD, MANCHESTER, N.H. 03103
(603) 669-0940 • TWX 603-623-4938
Circle 250 on reader service card

3 of a series

TRANSICOIL SOLVES SERVO PROBLEMS

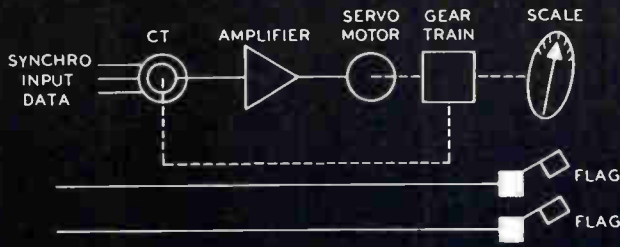

Transicoil radar height indicator

Transicoil designed this instrument for the APN-120 Radar Altimeter Set aboard A3J aircraft. It provides a visual display of altitude. In addition, two Weston meter movements warn of "OFF", "FAIL", and "OVERRIDE" conditions. ■ Altitude data transmitted from a CX in the radar altimeter is fed to a matching CT in this assembly. A miniaturized servo, using size 8 components and transistorized amplifier drives the CT to a null, and exhibits this output as a pointer position on an altitude scale. ■ Pictured above without case, the unit is hermetically sealed in a 3¼" instrument can per AN-5727. All wiring is terminated at AN connectors at the rear of the can. ■ Transicoil offers an unusual capability for combining servo components into operating servo systems. Write for our 16-page brochure, *SERVO ASSEMBLIES*. It describes many of our standard and special-purpose units.

Weston Instruments, Inc., Transicoil Division, Worcester, Pa. 19490.

WESTON® *prime source for precision . . . since 1888*

Circle 257 on reader service card

New 20 pg. Catalog makes it Easy to Select



the right Thermal or Magnetic Circuit Breakers

Write for your **FREE COPY**



WOOD ELECTRIC CORPORATION

244 Broad Street, Lynn, Mass. (617) LY8-5313

Circle 251 on reader service card



Packs a wide frequency range in small space

The Hewlett-Packard 3200B VHF Oscillator offers continuous coverage of frequencies from 10 to 500 MHz, yet takes up little space on the bench or in the rack. The 3200B provides $\pm 0.002\%$ frequency stability over a 5-minute period, a high RF output level, and an output attenuator. It is ideal as a general purpose source of CW signals and will also accept external pulse or amplitude modulation. The 3200B may be used with an accessory doubler probe to extend the frequency coverage to 1000 MHz. Size: 7½" wide, 6½" high and 13½" deep. Price \$525. For more complete information, contact your local Hewlett-Packard field engineer or write: Hewlett-Packard, Green Pond Road, Rockaway, New Jersey 07866.

HEWLETT  PACKARD

1074

Circle 209 on reader service card

209

*NEW FROM HATHAWAY

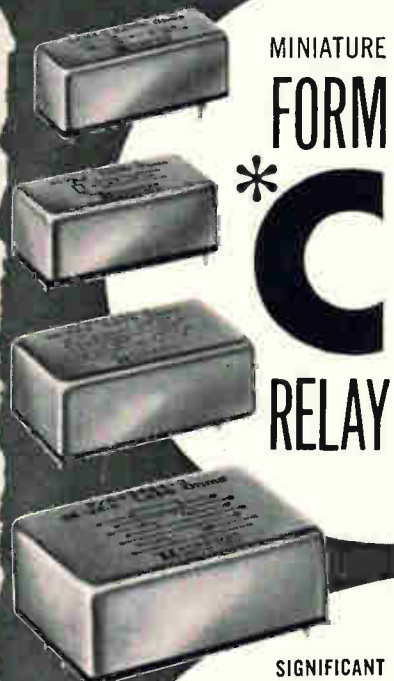

MINIATURE
FORM
*
C
RELAY

SIGNIFICANT
PERFORMANCE
GAINS ESTABLISHED BY
HATHAWAY'S CONTROLLED
REED PROCESS ARE:

- A pure, inert contact environment resulting in no "film" buildup on contacts eliminating contact resistance irregularities and recurring infant mortality on dry circuit loading.
- The Drireed actuation avoids failure mechanisms characteristic of electromechanical devices.
- Whatever the switching assignment, Hathaway Double Throw relays will do it better and more economically.

Hathaway Form C Relays are available in all Series—"J" AXIAL, "K" PRINTED CIRCUIT, "R" COMPUTER GRADE, "GP" GENERAL PURPOSE

For detail
information
call or write

HATHAWAY INSTRUMENTS, INC.
5250 EAST EVANS AVENUE
DENVER, COLORADO 80222
(303) 758-8301 • TWX 292-2935
Distributed Nationally by
COMPAR CORPORATION

New Literature

F-m/f-m telemetering system. Solid State Electronics Corp., 15321 Rayen St., Sepulveda, Calif. 91343, has available a bulletin describing the Model 5000 miniature f-m/f-m telemetering system designed for obtaining data from systems in a state of high acceleration or complex motion. Circle 420 on reader service card.

Precision potentiometers. Beckman Instruments Inc., 2500 Harbor Blvd., Fullerton, Calif. 92634, has released Data Sheet No. 661218 describing the Helipot Series 7260 precision potentiometers. [421]

Metalized polycarbonate capacitors. Film Capacitors Inc., 100 Eighth St., Passaic, N.J. Engineering bulletin No. 1501 gives complete technical information on type ME metalized polycarbonate capacitors. [422]

Decimal encoders. Theta Instrument Corp., 22 Spielman Rd., Fairfield, N.J. A four-page bulletin describes a complete line of shaft encoders with four-digit, decimally coded outputs. [423]

Strain-gauge instrumentation. B&K Instruments Inc., 5111 W. 164th St., Cleveland, Ohio 44142, has released a four-page brochure describing the Model 1516 strain-gauge apparatus, accessories, and related equipment. [424]

R-f terminations. Raytheon Co., 130 Second Ave., Waltham, Mass. 02154. A line of r-f terminations, ranging from convection-cooled to calorimetric waterloads, is described in the catalog, "Coaxial and Waveguide R-F Terminations." [425]

Small electrical counters. Kessler-Ellis Products Co., 46 Center Ave., Atlantic Highlands, N.J. 07716. Bulletin No. 9 covers a small three-digit predetermining impulse counter and a four-digit totalizing counter. [426]

Miniature noise generators. Signalite Inc., 1933 Heck Ave., Neptune N.J. 07753, has published a two-page illustrated bulletin on a standard line of 90° E-plane miniature noise generators. [427]

Tooling selector chart. Isochem Resins Co., Cook St., Lincoln, R.I. 02865. A selector chart contains a complete line of tooling resins with instructions. [428]

Phase-modulation choppers. Airpax Electronics Inc., Cambridge, Md. 21613. Bulletin C-121R covers the series PM chopper that uses a compact toroidal transformer to achieve high performance. [429]

Data communications equipment. Scientific Data Systems, 1649 17th St.,

Santa Monica, Calif. 90404. Brochure 64-33-11B gives detailed descriptions, specifications, and applications of a series of data communications equipment. [430]

Accelerometer. B&K Instruments Inc., 5111 W. 164th St., Cleveland, Ohio 44142, has released a specification sheet on the Model 4333 low-cost accelerometer that provides laboratory standard vibration measurements. [431]

Push-button switches. Centralab Electronics division, Globe-Union Inc., 5757 North Green Bay Ave., Milwaukee, Wis. 53201, has published Catalog PBS-1 describing an extensive new line of push-button switches. [432]

Electrochemical devices. Curtis Instruments Inc., 351 Lexington Ave., Mount Kisco, N.Y. 10549. A quick-reference catalog discusses Indachron elapsed time meters that utilize miniature ampere hour meters. Typical applications are given. [433]

Molded contour cables. Electrical Components division, Bendix Corp., Sidney, N.Y. 13838. Molded contour cables for space conscious designs are described in Bulletin SL-184. [434]

Dielectric materials charts. Emerson & Cuming Inc., Canton, Mass. 02021. Two color charts, for notebook or wall mounting, show the dielectric constant and loss tangent at microwave frequencies of a host of materials. [435]

Ceramic capacitors. Republic Electronics Corp., 176 E. 7th St., Paterson, N.J. 07524. Catalog C-1 gives complete technical data on the company's Mucon subminiature ceramic capacitor line. [436]

Digital multimeters. Fairchild Instrumentation division, Fairchild Camera and Instrument Corp., 475 Ellis St., Mountain View, Calif. 94040. A 12-page, illustrated brochure describes a line of four digital multimeters and their related plug-ins. [437]

Power relays. Solid State Electronics Corp., 15321 Rayen St., Sepulveda, Calif. 91343, has published a four-page application note covering the Series 10 Magnereed power relays. [438]

Microwave relay systems. Microwave Associates, Burlington, Mass. A short form catalog describes the MA-2A and MA-7A solid state, television microwave relay systems. [439]

X-Y recorders. Recorder division, Varian Associates, 611 Hansen Way, Palo Alto, Calif. 94303. A data sheet illustrates and describes, with complete specifications, the Series F-100 X-Y recorders. [440]

Super

SOLID CARBIDE CIRCUIT BOARD DRILLS AND ROUTERS

DESIGNED FOR PRECISION DRILLING AND ROUTING OF ALL CIRCUIT BOARD LAMINATES



CBU

A precision solid carbide circuit board drill designed with a 1/8" uniform shank for simplified chucking. Tapered webs for maximum strength. In wire gauge, fractional and metric diameters.

CB

The original solid carbide circuit board drill design with tapered web guaranteed to produce precision bur-free holes, as the CBU above, in single or stacked board operations where flute lengths permit. In wire gauge, fractional and metric diameters.

DIR

A diamond cut design solid carbide profile-router for plunge or outside profiling. The cross-hatch flute principle of this diamond-cut design provides many positive overlapping cutting edges to insure clean, sharp profiling with absolutely no delamination. In fractional size range.

Super circuit board drills and routers are guaranteed to perform efficiently in all circuit board laminates. Tolerances and concentricity are minimal to permit

exact locating or repositioning in N/C or conventional equipment. Literature No. EL-67-1 available at distributors and branches or directly from:



SUPER TOOL COMPANY SINCE 1927

A DIVISION OF UNIVERSAL AMERICAN CORPORATION

ELK RAPIDS, MICHIGAN 49629

PHONE (616) 264-8151

BRANCHES:

Chicago
5428 N. Milwaukee Ave.
Chicago, Illinois 60630

Detroit
Suite 508, Professional Bldg.
Eastland Center, Detroit, Mich. 48236

New York
350 Hudson St.
New York, New York 10014

Los Angeles
5908 E. Washington Blvd.
Los Angeles, California 90022

Circle 252 on reader service card

Electronics Engineers

We are now offering you responsible assignments in these applied nuclear research programs at our Livermore facility.

Plowshare—Peaceful Applications of Nuclear Explosives

Biomedical—Radiation Effects on the Biosphere

Sherwood—Controlled Thermonuclear Reaction

Whitney—Nuclear Weapons for National Defense

Space Reactors—Reactors for Power in Space

For more information, write to Mr. Dan McGee, Personnel Department,



Lawrence Radiation Laboratory
UNIVERSITY of CALIFORNIA

P. O. Box 808 18-47
Livermore, California 94550

An Equal Opportunity Employer • U.S. Citizenship Required

New from Helipot

First \$1¹⁰ cermet trimmer sealed for board washing

New Helitrim® Model 77:

only trimmer in its price class made fail-safe for solvent washing on the board... and offering essentially infinite resolution, 10 ohm — 2 megohm resistance range and 105°C. max. operating temp. No general purpose adjustment potentiometer has wider performance parameters. Directly interchangeable with competitive models 3067, 3068. \$1.10 in quantity — ask your Helipot rep for a free sample.



Beckman®

INSTRUMENTS, INC.
HELIPOT DIVISION
FULLERTON, CALIFORNIA • 92634

INTERNATIONAL BRANCHES: GENEVA, MUNICH, GLENROTHES, SCOTLAND, TOKYO, PARIS, CAPE TOWN, LONDON, MEXICO CITY

UP-TO-DATE TECHNOLOGY from McGRAW-HILL



1. RESIDUE ARITHMETIC AND ITS APPLICATION TO COMPUTER TECHNOLOGY. By NICHOLAS S. SZABO and RICHARD I. TANAKA. New. All the known work on residue arithmetic is thoroughly summarized here to make this information available for the first time in a single source. Engineering applications to computer technology are indicated, and the book will be of special value in both the industrial and academic branches of this field. The bibliography not only lists the literature in the field, but supplies authoritative comments on each reference cited.

224 pp., \$12.50.

2. INTEGRATED CIRCUIT TECHNOLOGY: Instrumentation and Techniques for Measurement, Process, and Failure Analysis. By SEYMOUR SCHWARTZ. New. Contributors from Westinghouse, Philco, Motorola, General Electric, RCA, North American Aviation/Autonetics, IBM, and NASA have written chapters for this book. Such new topics as integrated circuit encapsulation, scanning electronic beam methods for non-destructive testing, advanced cryoelectronics instrumentation and measurement, and the use of laminar flow work are thoroughly discussed.

325 pp., \$15.00.

3. GAS LASERS. By C. G. B. GARRETT. New. This most authoritative, up-to-date work on gas lasers emphasizes their behavior. This, when properly understood provides an understanding of the other lasers as well, and is so presented in this book. Symbols and definitions are listed; more involved equations are interpreted and explained.

192 pp., \$10.95.

4. THE PROGRAMMER'S ALGOL: A Complete Reference. By CHARLES P. LECHT. New. This programmer's reference to the classic ALGOL language is arranged alphabetically to give you easy, quick access to needed ALGOL terms. It also provides valuable insight into ALGOL's utilization possibilities by presenting each instruction as a series of variations, proceeding from the simplest to the most complex forms.

272 pp., \$8.95.

At Your Bookstore
or Direct from Publisher for

10 DAYS FREE EXAMINATION

McGRAW-HILL BOOK CO., Dept. 23-L-417
330 West 42nd Street, New York, N. Y. 10036
Send me the book(s) circled below for 10 days on approval. In 10 days I will remit for book(s) I keep, plus a few cents for delivery costs, and return other book(s) postpaid.

1 2 3 4

Name (print) _____

Address _____

City _____ State _____ Zip Code _____

For prices and terms outside U.S. write
McGraw-Hill Int'l. N.Y.C. 23-L-417

New Literature

Military resistors. Sprague Electric Co., North Adams, Mass. A guide to military resistors, designated ASP-364A, is primarily devoted to fixed types, but also includes a brief explanation of variable resistor types and style numbers in current military specifications. [441]

DTL design data. ITT Semiconductors division, International Telephone and Telegraph Corp., 3301 Electronics Way, West Palm Beach, Fla., has published a DTL design data book. It contains a description of the 930 series, its element characteristics, and a glossary of terms. [442]

Single crystals. Semi-Elements Inc., Saxonburg Blvd., Saxonburg, Pa. 16056. A four-page brochure lists a line of single crystals that are in continuous production and are available from stock, pure or doped. [443]

Electronic calculators. Wang Laboratories Inc., 836 North St., Tewksbury, Mass. 01876. An illustrated brochure contains features, specifications, and applications for the 300 series electronic calculators. [444]

Pulse instrumentation. E-H Research Laboratories Inc., 163 Adeline St., Oakland, Calif. 94607, offers a pulse instrumentation catalog that includes integrated test systems, plus a sophisticated line of system building blocks. [445]

Microminiature transformer. The Gudeman Co., 340 W. Huron St., Chicago, Ill. 60610. Engineering Bulletin MMT-1 gives complete technical information on a microminiature transformer that weighs 0.06 oz and measures 0.038 cu in. [446]

Transistors. Solitron Devices Inc., 1177 Blue Heron Blvd., Riviera Beach, Fla. A 28-page catalog describes a line of silicon and germanium transistors used for military, industrial, and commercial applications. [447]

Audio recorders. Ampex Corp., 401 Broadway, Redwood City, Calif. 94063. A six-page illustrated brochure lists features, specifications, and applications of the AG-440 series audio recorders. [448]

Printing calculator. Monroe International Inc., a division of Litton Industries, 550 Central Ave., Orange, N.J. 07051. A 10-page, color brochure (1174-A) describes the EPIC 3000 electronic printing calculator. [449]

Small parts production. Federal Tool Engineering Co., 1386 Pompton Ave., Cedar Grove, N.J. 07009. A fully illustrated, 16-page guide to automation equipment for the production of small electronic parts is available. [450]

New! From MESON! New!

ELECTRONIC TIME DELAY RELAY

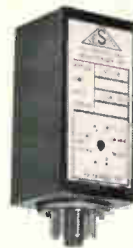

- High Accuracy, $\pm 10\%$
- Repeatability, $\pm 3\%$
- Fast recycling time — .05 sec. max.
- Input — 115 VAC
- Up to 180 sec. delay, fixed or variable with external variable resistor.

Only **\$6⁹¹** in 100 lots
IMMEDIATE DELIVERY!

Order one for test at \$8.80. Your
MONEY BACK if not satisfied!

MESON
ELECTRONICS CO. INC.
380 Cottage St., Rochester, N. Y. 14611
Phone (716) 235-7070

Circle 253 on reader service card

MICO

NEW MODEL 885 SEVEN RATIO WIDE-RANGE ENGRAVER

NO. 885

FOR LONG AND
MULTI-LINE WORK

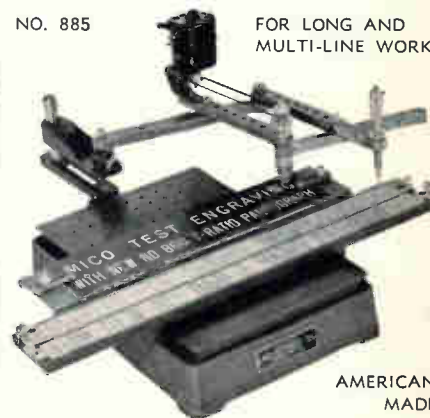

AMERICAN
MADE

- A time-saver for large plate work.
- Engraves 3" x 19" area in one set-up.
- Seven pantograph ratios—from 1:5:1 to 6:1.
- Choice of 3-ball-bearing spindle assemblies for 1/8", 3/16" or taper-shank cutters.
- HSS, COBALT and Solid Carbide Cutters.
- Single and multi-line copy carriers for holding, blanks 3/4" to 1/2" high.
- Accommodates Mico standard accessories.

Send for bulletins and prices

MICO INSTRUMENT CO.

77 Trowbridge St. Cambridge, Mass. 02138

Circle 213 on reader service card

Professionalism at Grumman ...is personal development programs

Grumman is not for everybody. Many technically proficient people are glad to put their degrees to work for just *plain money*, content to work their lives out, leaving their personal technological progress to the passing of the years.

At Grumman it's different. Here we take a keen interest in seeing that our engineers and scientists develop *personally*. We are sincerely interested in their *personal* progress within the company... that they keep abreast of the sweeping advances in technology, not because they can contribute more (although this is true), but more because it makes for greater individual progress and well-being. Job satisfaction, if you will. Let's look at these personal development programs.

Evening Scholarship Programs

Directly applicable to their work, these programs offer engineers and scientists financial assistance for graduate studies at the many institutions in the Long Island-New York area.

In-Plant Courses

Engineering courses, particularly those not available at neighboring institutions, to deepen technical knowledge to the specific needs of the engineering sections.

College-Industry Courses

Selective attendance for rapid technical updating on fundamentals, theoretical methods and design information. (One to two weeks' duration.)

Engineering Professional Development Program

Lasting for 2 years, participants are given, in 4 six-months' terms, an exposure to Grumman operations which broadens their technical knowledge, sharpens ability to make sound decisions, and raises their career potential.

Here then is a real opportunity to enhance career growth while working in programs that are in themselves conducive to career acceleration. Your attention is directed to the following immediately available positions.

Electronics Field Engineers—B.S. in Electronics or Physics with a minimum of 6 years experience desirable, but candidates demonstrating the equivalency will be considered. In-plant training will be provided. Must be experienced in one or more of the following areas: search & track radars, digital computers, inertial guidance systems & transistor theory & application.

Computer System Engineers—Engineers & Mathematicians with 1-5 years experience in the analysis, design and development of digital computer systems.

Programmers—Experienced in both general purpose and special purpose techniques, to work on complex systems for aerospace vehicles.

Digital Systems Engineers—BSEE with a minimum of 3 years experience in military digital and data processing equipment. Must be capable of performing a comprehensive analysis of digital equipment to establish support concepts and define support requirements.

EMC Systems Engineers—With ability to perform system analysis, state-of-the-art reviews, and develop advanced EMC techniques. Will be responsible for generating design data, control plans, test plans, directing tests, analyzing results, generating fixes, and preparing reports for systems in accordance with MIL-E-6051C. Familiarity with WR-27 and MIL-STD-449 is essential.

Radar Development Engineers—BSEE with a minimum of 3 years experience in the analysis, design and development of airborne radar systems. Should be capable of analyzing the radar system with end view of integrating the equipment into a complex space vehicle system. Will fully participate in laboratory and flight development program conducted in the finest facilities available in a professional atmosphere.

Technical Management Development

A series of lectures provides a course in management principles to group leaders who show technical management ability. This course, which explores corporate goals and procedures, is given by corporate and technical management, and by the faculties of colleges and universities.

Senior Engineers' Program

Intended to overcome the threat of technological obsolescence, individual disciplines are updated with regard to new scientific discoveries, new or expanded applications of long existing knowledge, and computer applications to problem solving.

Senior Management Development

Selected individuals within Grumman junior and middle management groups are nominated to attend management development programs such as the MIT Executive Development Program, the Program for Management Development or the Advanced Management Program at Harvard University.

ECM Subsystems Engineers—B.S. in E.E. or Physics with 2 to 6 years experience in design of ECM receivers &/or jammers or applicable radar communication background.

Communications Systems & Equipment Engineers—BSEE with a minimum of 2 years experience in Communication and Radio Navigation Hardware Engineering. Familiarization with the following equipments is desirable: H.F. (SSB), VHF/FM & AM, UHF/FM & AM, Voice & Data Link Communications Equipment, ADF, VOR, TACAN, Rada-Altimeter, and Doppler Navigation. Duties include: Systems integration, analysis of equipment design, circuit & component analysis, generation of equipment specifications, information and test procedures information, liaison with subcontractors & contractors; laboratory & vehicle system testing.

Antenna Design Engineers—BS in EE with a minimum of 3 years experience in antenna design. Background in classical electro magnetic theory and advanced math essential. Work consists of analysis and synthesis of antennas on current and advanced designs for space applications including the use of the IBM computer facilities to develop design techniques.

Instrumentation Application Engineers—BS in ME or Physics with a minimum of 2 years experience with transducers, recorders, data gathering systems, & interested in lab type work.

BS in ME, EE or Physics with a minimum of 2 years experience, to work with telemetry, digital systems & tape recorders as applied to Flight Test Development Programs.

BSEE with a minimum of 2 years experience in electronics circuit application with knowledge of digital techniques. Will operate analog & digital data acquisition systems.

Note: 1967 graduates looking to start a career in aerospace are invited to contact Grumman now!

To arrange an immediate interview, send comprehensive resume to: Mr. George E Kwak, Manager, Engineering Employment, Dept. GR-76



GRUMMAN
AIRCRAFT ENGINEERING CORPORATION
Bethpage • Long Island • New York, 11714

An Equal Opportunity Employer (M/F)

HIGH-POWER MICROWAVE GENERATION IN SOLIDS

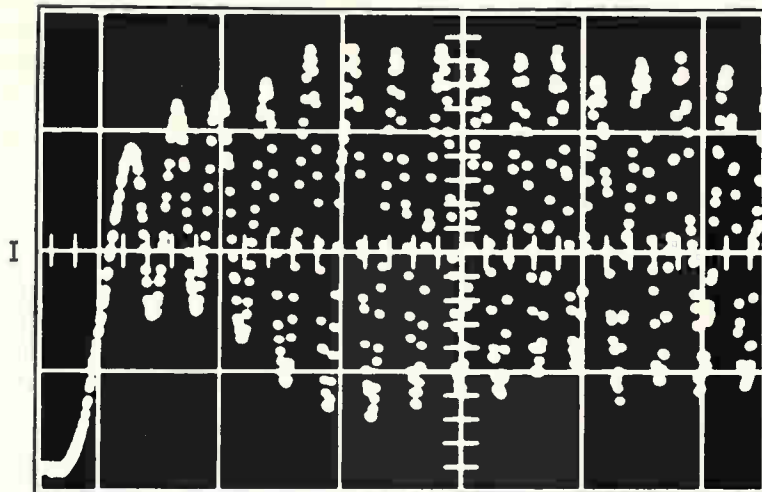

Pioneering research led to this first published observation of large amplitude current oscillations in Gunn-type gallium arsenide devices.*

*Reference: A. J. Shuskus & M. P. Shaw, "Current Instabilities in Gallium Arsenide", Proc. IEEE (Correspondence), Vol. 53, pp. 1804-1805, November 1965.

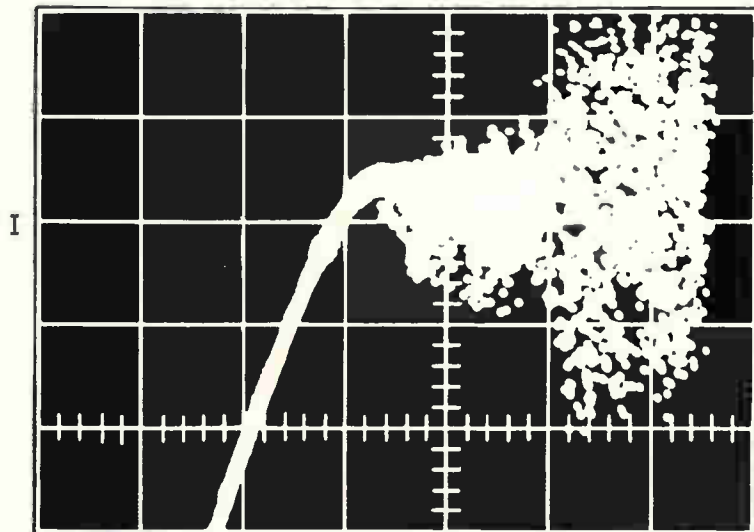

Extensive further studies produced these observations of both the Gunn transit-time and the large amplitude modes of oscillation. This large amplitude oscillation is now often called the Limited Space Charge Accumulation mode or LSA.**

**Reference: M. P. Shaw & A. J. Shuskus, "Current Instability Above the Gunn Threshold", Proc. IEEE (Correspondence), Vol. 54, pp. 1580-1581, November 1966.

If you have capability and interest in SOLID STATE RESEARCH (or would like reprints of the above papers), please write Mr. R. C. Ciriack, United Aircraft Research Laboratories, East Hartford, Conn. 06108. An equal opportunity employer.

United Aircraft Research Laboratories

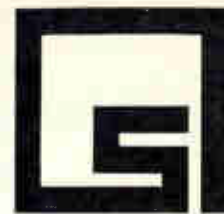

Semi-conductor
Integrated
Circuits

San Francisco Bay
Area Positions

PROCESS ENGINEERS

Responsibilities include the analysis of existing processes; determination of process improvement; relating electrical parametric variables with process variables; and to develop new fabrication processes which will result in the most efficient and optimum production yield of integrated circuits.

A BS or MS in Chemistry, Physics or EE is required, with 2 or more years experience in the above including a background in epitaxy, diffusion and photolithographic techniques.

Additional professional opportunities are available in the following areas:

PRODUCT ENGINEERING
DIGITAL CIRCUIT DESIGN
LINEAR CIRCUIT DESIGN
APPLICATIONS ENGINEERING

Write to Jim Lewis, Professional Placement

SIGNETICS

CORPORATION
811 E. Arques Ave.,
Sunnyvale, California

An Equal Opportunity Employer

YOU'RE H!RED

Do you need electronics engineers or technical management men? Electronics magazine is the way to recruit them. Electronics is designed specifically for the working engineer. 68,000 subscribers and an additional 133,000 pass-along readers turn to it to keep up with their industry. You can find the man that meets your qualifications with an advertisement in the Employment Opportunities Section.

For rates & information write: Electronics, a McGraw-Hill Publication. Classified Advertising Division, Post Office Box 12, New York 10036.

PROFESSIONAL SERVICES

Donald C. Harder, Inc.
Magnetic Component Engineers
Reactors—Transformers—Filters
Serving the Research Laboratory
2580 K Street, San Diego, Calif. 92102
Phone (714) 239-8021

THE TREND TOWARD ECONOMY—

The service of the consulting engineer is a real economy. With his knowledge of organization and production problems and his wide and varied experience, he can usually reveal the points of waste and inefficiency that are costing you money and suggest inexpensive means for their elimination.

engineers

Here is your opportunity to associate with a high calibre staff in its formative state. At our research center in Ithaca we are engaged in exploratory activities in aircraft and ocean instrumentation. Our job is to come up with new ideas and new designs for transducers, modules and subsystems using the latest techniques and components. We seek the help of talented and resourceful engineers (E.E. & M.E.) having up to ten years applicable experience.

Technical domain of this work will range through... Solid-state applications • Servo-mechanisms • Transducer design • Circuit design • Electromechanical design • Subsystems design & testing • Analog and digital techniques.

This is a real ground floor opportunity. Your opportunity also to live and work in the stimulating atmosphere of Ithaca, the educational, recreational and scenic center of the Finger Lakes region.

Inquiries will be treated in confidence. Send resume to: Mr. R. G. Thrasher, Dept. E

THE BENDIX CORPORATION
FLIGHT & ENGINE INSTRUMENTS DIVISION
RESEARCH CENTER, CORNELL RESEARCH PARK, ITHACA, N.Y. 14850



An Equal Opportunity Employer



SEARCHLIGHT SECTION

- CLASSIFIED ADVERTISING
- BUSINESS OPPORTUNITIES
- USED OR SURPLUS EQUIPMENT

SEARCHLIGHT EQUIPMENT LOCATING SERVICE

No cost or obligation

This service is designed to help you, the reader of Searchlight Section, to locate used or rebuilt equipment not currently advertised.

How to use: Check the ads in this Searchlight Section, to see if what you want is advertised. If not, print clearly the specifications of the equipment and/or components wanted on the coupon below, or on your own letterhead.

This is a service to our readers. This publication does not buy, sell or stock equipment or materials of any type. Your

requirements will be brought promptly to the attention of the used equipment dealers advertising in this section. You will receive replies directly from them.

Obviously, the list of such advertisers is limited by comparison with the over 68,000 subscribers to Electronics, all directly engaged in the electronics industry. A small 'Equipment Wanted' advertisement in the Searchlight Section will bring your needs to the attention of ALL who read Electronics. The cost is low... just \$28.75 per advertising inch— $\frac{3}{8}$ "x2-3/16".

Electronics, Searchlight Equipment Locating Service, P.O. Box 12, New York 10036

Please help us locate the following used equipment:

Name	Title	Company		
Street	City	State	Zip Code	

For Sale

VACUUM METALIZER or COATING SYSTEM

N.R.C. Type 3143B-42301. Chamber size 36" dia. X 6" long complete with diffusion pumps, mechanical pumps, gauges and power supplies. Overall dimensions 19" long, 8" 6" high. Used 3 months.

Also 2 G.E. 5 KW dielectric heaters. 45 megacycles.

INSTRUMENTS & MACHINES, INC.

1200 Grove St. Irvington, N.J. 07111

Telephone: (201) 371-7900

CIRCLE 966 ON READER SERVICE CARD

RADAR AUTO-TRACK & TELEMETRY ANTENNA PEDESTALS 3 & 10 CM. SCR 584 AUTOTRACK RADARS. M-33 RADAR TPS 1D SEARCH. APS-45 TPS-10D HT. FINDERS. WX RADARS. FPN-32GCA. APS-10 APS-15B APS-27 (AMTI) SEARCH. APN-102 DOPPLER. DOZENS MORE CARBON/IRON. PAVS. 25-41 23.6 MEGAWATT PULSE MODULATORS. GAVITLES. PULSE TRANSFORMERS. IF STRIPS. WAVEGUIDE. BENDS 200 MC. 1 KMC. 3 KMC. 6 KMC. 9 KMC. 24 KMC. RF PKGS.

RADIO RESEARCH INSTRUMENT CO.
550 5TH AVE., NEW YORK 36, N. Y. JU 6-4691

CIRCLE 967 ON READER SERVICE CARD

New VACUUM PENCIL

for picking up miniature parts

\$7.50 ea

See Hell Distributors available.

PHILIP FISHMAN COMPANY
7 CAMERON ST., WELLESLEY, MASSACHUSETTS

CIRCLE 968 ON READER SERVICE CARD

A black and white photograph of a hand holding a coiled HeliAx coaxial cable. The cable has a braided outer shield and a central conductor. Two connectors are visible: one is a standard SMA connector, and the other is a phase-adjustable connector with a sliding sleeve. The background is dark and textured.

ANDREW

Phase Stable

HELIAX[®] COAXIAL CABLES

- Repeatability Phase Tracking
- Electrical Length Stability
- Precise Phase Adjustment

For phase-sensitive applications, special HELIAX coaxial cables are available in three general classes. ■ HELIAX coaxial cables can be supplied phase stabilized to provide a repeating, or "stable", phase-temperature characteristic. ■ Phase compensated cables maintain relatively flat electrical length versus temperature characteristics over selected temperature ranges. Phase-temperature coefficients of better than 1 PPM/°F over 30°F operating range have been achieved. ■ Sets of cables with connectors attached are cut to equal electrical length within very close tolerances. Phase adjustable connectors offer fine adjustment in the field. Andrew Corporation, P. O. Box 42807, Chicago, Illinois, 60642.

IN EUROPE: Andrew Antenna Systems, Lochgelly, Fife, Great Britain

Andrew
CORPORATION
30 YEARS OF ENGINEERING INTEGRITY

17 66

Newsletter from Abroad

April 17, 1967

Tokyo putting out the welcome mat —but not for all

Expected to relieve some of the pressure from abroad, Japan's move to liberalize foreign investment won't be a bonanza for U.S. electronics firms. "It amounts to little more than window dressing and drum beating," says an American executive in Tokyo. It may lead to further liberalization, but few expect to see this affecting computers, integrated circuits, or other advanced electronics areas.

Cabinet approval of the plan is likely next month. The plan is based on an agreement between the Ministry of International Trade and Industry and Japan's Federation of Economic Organizations.

Ceiling on foreign holdings in existing companies, now 15%, will be raised to 20%. The limit for individuals will go up from 5% to 7%. Unchanged is the 10% ceiling on 19 industries covered by a U.S.-Japan treaty. To determine allowable foreign investment in new companies, three categories—A, B, and C—will be established. In A industries, foreign interests will be permitted to establish wholly owned subsidiaries; in B industries, foreign investment will be limited to 50%; and in C industries, foreign holdings will be regulated on a case-by-case basis. Companies wholly owned by foreigners will be barred from expanding into B and C industries. Indications are that electronics firms will be put into categories where complete foreign ownership is barred.

The plan is unlikely to affect the pending case of Texas Instruments. The U.S. has been putting diplomatic pressure on Japan for permission for the firm to set up a subsidiary [Electronics, April 3, p. 257].

Egalite for French components firms

Strong government backing appears to be in the offing for French semiconductor manufacturers. At last week's International Exhibition of Electronic Components in Paris, Marc Colonna, head of the Industry Ministry's influential Direction des Industries Mecaniques, Electriques, et Electroniques, disclosed that the de Gaulle administration is considering a national components plan. Presumably, the scheme would do for the French semiconductor industry what Plan-Calcul has done for the computer field: pressure companies to join forces and mount a national effort, largely underwritten by government money, to develop advanced devices bearing a made-in-France label. Electronics industry sources expect the components plan to be limited to integrated circuits at the outset.

Britain plans computer utility

Britain is taking its first step toward a computer public utility. Postmaster General Edward Short told the House of Commons of plans to have a nationwide computer grid operational by 1971; the system would be available to private industry as well as to the General Post Office. Short estimated the cost of the grid at \$34 million. He said computer time on the GPO's current machines will be available to private firms as soon as the enabling legislation he has introduced becomes law.

Russian scientists rap computer lag

Two influential Russians have proposed the centralization of all Soviet computer development efforts. "It is high time the whole thing was put on industrial lines," declare B. Petrov and A. Smirnov, members of the Soviet Academy of Sciences. Among hindrances to speedier development

Newsletter from Abroad

of new computers and computer-based work, they cite a scarcity of digital-reading instrumentation, a shortage of even such basic peripheral equipment as magnetic tape, a lack of coordination in compiling computer programs, and a shortage of research and production managers trained to use computers. [See related story on page 219.]

MOS road show to tour Europe

Applying a tried-in-the-U.S. method, an Italy-based subsidiary of the General Instruments Corp. will use a seminar tour to try to stimulate development of applications for metal oxide semiconductor integrated circuits in Europe. A group from General Instruments Europe headed by Marcello Corradetti, an IC specialist formerly with IBM, will describe MOS technology to school groups, engineers, and businessmen throughout Europe.

Some segments of European industry see a need for multiple sources of microcircuitry in the near future, and expect equipment makers there to jump from earlier work with germanium transistors to IC designs.

Summer debut seen for British color tv

It begins to look as if Britain will get its first color telecasts in late June or early July. The debut, on a single network, is officially scheduled for "late this year," but the British Broadcasting Corp. is already sending out test signals.

The color cameras for the BBC-2 network's telecasts will use Plum-bicon pickup tubes developed by Philips of the Netherlands. The BBC's research department has been working with two prototype cameras, one with three Plumbicons and the other with four.

Britain's Independent Television Authority is also gearing up for color, hoping—along with the BBC's other network—to get on the air with it by 1969.

Emerson in line for F-111 test job

The Emerson Electric Co. is said to be the front-runner in bidding for a contract to furnish computerized test sets for Britain's 50 F-111's. If Emerson gets the order, the planes' weapons system will be serviced with the U.S. firm's general-purpose automatic sets for a price believed to be about \$10 million. Emerson, whose test equipment is now in operation at several U.S. Air Force repair and supply depots, is competing against Elliott-Automation Ltd. for the British award.

Nippon automates step in producing thin-film IC's

Japan's Nippon Electric Co. has automated one stage of thin-film integrated-circuit production. Postcard-size ceramic wafers are fed continuously through a series of vacuum chambers, with the sputtering done in the central chamber. The wafers are afterwards fabricated into IC's by manual operations.

The process is similar to an earlier one developed at Western Electric.

Only resistors are being produced by this method currently. The unadjusted accuracy of the tantalum resistance elements on the wafer is about 5%; chemical techniques can improve this to about 0.05%.

The thin-film circuits are now being delivered for experimental electronic telephone exchanges and pulse-code modulation systems. They are also expected to be used in sense amplifiers for magnetic core readout, in test equipment, and in other relatively high-cost applications.

Great Britain

Trends and trials

Computer-based instrument systems are in their infancy, but their potentials for reliability prediction, device "signatures," and production trend alarms are emerging [see page 161].

Near Southampton in Southern England the Plessey Co. operates a computer-controlled reliability testing center which provides long-term measurements and also reliability trials of components.

A key part of Plessey's product assessment laboratories, the system tests thin-film circuits under varying environmental conditions.

Failure rates are being obtained from the performance of 5,840 circuit elements—some resistive, some capacitive—at their maximum ratings of power and temperature over a one-year period. Short-term tests, up to 10 weeks, are also being conducted on weekly samples of 96 elements under high-stress conditions.

These tests are designed to take more than 200,000 measurements in the first year, says Plessey. The system is linked to an on-line computer which measures and analyzes performance via data input and output, and controls the equipment as well. The computer is a PDP-8 made by the Digital Equipment Corp., with software using Fortran, symbolic assemblers, mathematical subroutines, utility, and maintenance programs.

To test thin-film circuits, Plessey researchers designed a series of identical enclosures which provide environmental stress for components mounted on interchangeable doors. Chambers are available to test for both dry heat, and humidity at a stabilized reference temperature of 20°C.



Components on trial for reliability characteristics are closely monitored and analyzed by computer in center of product test facility. Mounting frameworks for thin-film circuit modules are attached to the doors of test chambers at right.

Logging the data. The system, says Plessey, is basically a data-logging system. Component parameters are measured on digital instruments whose output is transferred to the computer for checking, calculation, and statistical analysis. Input to measuring instruments is by a special switch which is stepped under computer control. The outputs are printed format and punched tape.

Resistance measurements come as a percentage deviation of the unknown resistance from a preset standard value. Parameters of capacitive elements are provided by readings of both capacitance and dissipation. The system can also do d-c or a-c voltage measurements over a wide range.

In a reliability trial, the system measures component parameters and checks them simultaneously against prescribed limits, with subsequent statistical analysis. It can also act as a watchdog, with a

checkout program starting at preset intervals to monitor the life test equipment. Voltage and current levels in life test circuits and temperatures of the chambers are selected, measured, and tested against preset limits. An alarm goes off when a fault shows up.

Soviet Union

Corporate comrades

A few months ago, the Vilnius electric meter works in Lithuania voluntarily turned over 4,400 square feet of scarce production space to the Telyash meter plant for the manufacture of special instruments.

"If anyone had tried to tear that space away a couple of years earlier," says Vinzas Babilus, chief engineer and second-in-command at Vilnius, "we would have com-

plained to the (Communist) Party Central Committee."

The difference now is that both plants, plus five others in Lithuania, are subsidiaries of a common parent company and pool some of their profits. If the Vilnius experiment in cost-accounting works, it will probably be followed by similar amalgamations in other parts of the Soviet instrument and computer industry, which, on April 1, became the first entire industry to adopt the Communist version of a "profit" system. "Profitability" in this case is the difference between income and costs, excluding such gifts from the state as land, plant, and equipment.

The seven Lithuanian enterprises were combined last year into a single organization, called Sigma, which designs, produces, installs, and services computers and other equipment under contract to its customers.

Bureaucracy. The rest of the computer and instruments industry is still fragmented. Designers, producers and users operate in almost complete isolation from one another. Instead of acting on feedback gained from direct contacts with their customers, computer plants are subjected to a bewildering array of edicts from above and to sudden changes in orders from below. The products are distributed by 26 separate agencies.

Relations of distributors to manufacturers are entirely administrative. K. N. Rudnev, Minister of Instrument Building, Automation, and Control Systems, says distributors "have no material responsibility, no obligations to popularize our products or advertise them. Nor are they answerable materially for the correctness of the orders they place with us."

Sigma itself isn't free of bureaucratic red tape, but by maintaining contact with the customer from the design stage through installation and servicing, it has a better idea of what users want.

Sigma's participating organizations operate largely as they did before the amalgamation. But two new offices have been created: a service bureau to install and service computers and train operators, and

a headquarters to coordinate operations.

The "head office" is a venerable Gothic-style building on Communar Street in Vilnius. Here Algis B. Tchuplinscus directs a staff of 46 people and a "board of directors" made up of chiefs from each of the seven factories and each of the three design offices, as well as chairmen of trade-union committees.

Naked kings. The consolidation was the principal technical change, but not until the central office received financial powers was Tchuplinscus able to wield any real control over his sprawling empire. "Until then we were like naked kings," he says. "We were entitled to do everything by ourselves, but we had no money."

The system seems to be paying off handsomely in the seven factories. During the last six months of 1966, after amalgamation, output rose 21% from the first half pace and profit increased 40.7%.

However the three design bureaus haven't fared as well, apparently because the Russians haven't yet figured out how to charge for intangibles such as design and counsel.

Reforms are less sweeping in the other plants under Rudnev's ministry. There seem to be no Sigma-type amalgamations and no direct dealings with customers.

Last year, the 51 "reformed" enterprises, representing nearly 50% of the industry's production and 75% of its workers, boosted sales 16.4% and profit 41.6% from the 1965 level. But these figures are far from representative of the overall industry. The first plants reformed were generally those that had been operating well or where improvements could be easily made.

Computers ahoy

A system of 16 Minsk computers is helping to direct construction and deployment of the Soviet Union's 1,300 cargo vessels, according to Viktor G. Bakayev, the Soviet Minister of Merchant Marine.

He said each of 15 shipping dis-

tricts has a computer that feeds data into a central machine in Moscow.

Computers assist in construction scheduling and are linked by radio to shipboard equipment on every major Russian cargo vessel now afloat, the official said. By 1970, he added, there will be a "computer" aboard every Soviet cargo ship. He didn't say whether this would be an electronic machine, or a mechanical calculator, which Russians sometimes classify as a computer, but he clearly left the impression that he meant electronic equipment.

These computers, Bakayev said, will perform navigational tasks as well as helping to plan shipboard chores. They will substantially reduce the vessels' personnel requirements, he noted.

France

Maskless marvel

Now that France's long-heralded color-television tube has arrived, its developer is further heralding it as a big step toward all-solid-state receivers.

Concurrent with the Paris components show, but not at it, Compagnie Francaise de Television (CFT) unveiled the image tube, which the French call a successor to the Radio Corp. of America's shadow-mask tube.

CFT, which also developed the Secam color tv system, claims that the new 19-inch tube requires three times less power than the shadow-mask, a power requirement that may clear the way for solid state receivers. To emphasize the implications of the development, the firm also showed prototype transistor receivers at its Levallois plant, where the tube made its debut.

The new tube is also brighter and more rugged than the RCA device, according to Pierre Bonvalot, director of CFT's tube department.

Bigger models. A hundred tubes have been produced in a pilot run that began earlier this year at a plant owned by one of CFT's hold-

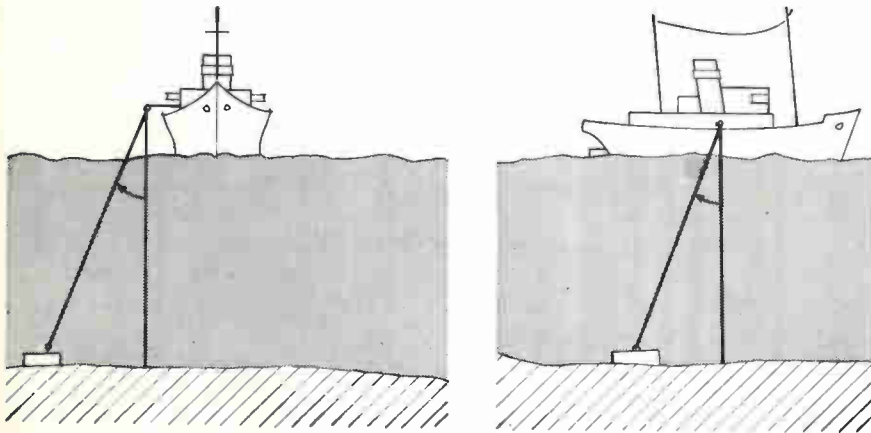
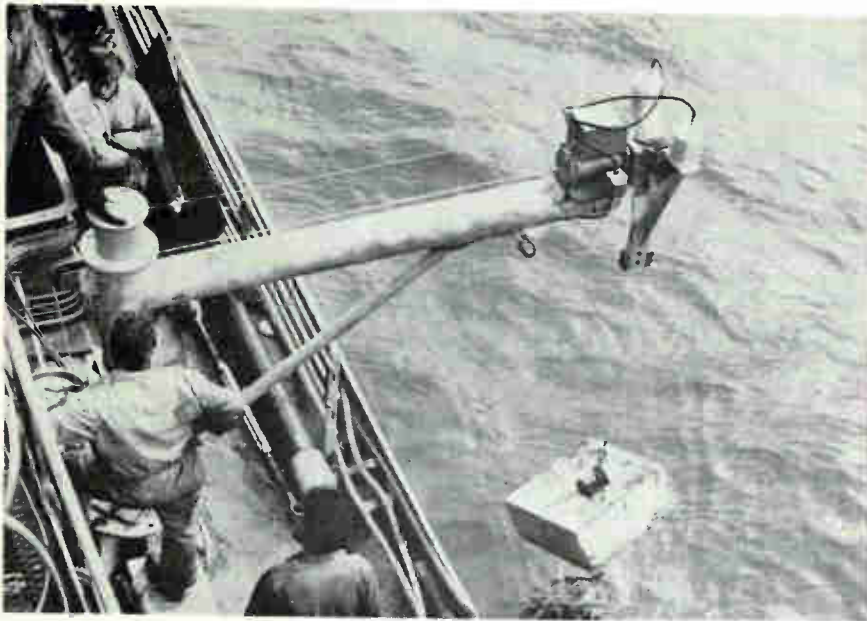

Research vessel Toucan tests anchorless anchoring system off Indonesia. Two inclinometers, one for backup, are on end of boom. Inclinometer measures angle changes and sends information to computer.

ers, CSF-Compagnie Generale de Telegraphie Sans Fil. Bonvalot says 2,000 to 3,000 of the tubes will be turned out this year, and full production will start next year.

More important, says Bonvalot, is CFT's decision to start work on a 23-inch model; this unit is slated for introduction this summer, and for full production in 1969, just when the French tv industry expects color sales to take off.

The CFT tube should be a big money maker, according to observers. So far, there's only been one contract—for a pilot production plant that CFT and CSF will help set up in the Soviet Union. Russia, the only major country besides France to buy the Secam system, thus seems destined to become France's

biggest tv customer.

Buyers sought. CFT, strictly a development company, won't produce the tube commercially. Besides seeking to sell manufacturing rights to French firms, CFT is actively hunting a U.S. customer. This buyer may well be RCA, insiders report; the two companies have declined to comment on this.

The essential difference between the RCA and CFT devices lies just behind their screens. Instead of a shadow mask, CFT uses a grill of 550 stainless steel wires strung vertically in parallel 75 millimeters apart. Bonvalot puts the transparency of the grill at 80%, four times greater than that of the RCA mask.

Because of the grill's construction, Bonvalot says, the new tube is

also more rugged. It's an integral part of the tube, strung tightly into the glass separating the screen from the bulb; the RCA shadow mask is hung on an interior frame.

Bonvalot asserts that the CFT tube provides far better contrast than the shadow-mask tube in a lighted room, and about equal contrast in a dark room. This level of contrast was achieved, he says, by improving the graphite deposit on the screen.

Anchors away

It's tough to "stay put" in the ocean. But precise positioning is essential for ships that lay cable, explore the ocean bottom, or track missiles and satellites.

Two French research vessels, one in the North Sea and the other off the coast of Indonesia, are testing a dynamic anchoring system designed to compensate for drift—without using anchors. The system was developed by Compagnie Francaise Thomson-Houston-Hotchkiss Brandt, working with the French Petroleum Institute.

The basic reference is a taut cable from the ship to a known position on the ocean bottom. Movements of the cable away from the vertical generate error signals to a computer.

Hold or steer. The system can also be used as an automatic pilot—without additional equipment—for river, harbor, and coastal navigation. Thomson-Houston says tests show the technique holds drifting to less than a meter and heading to less than 5° in 70-mile winds and 10-knot currents.

The system includes an analog computer and two omnidirectional auxiliary engines, one in the ship's bow and the other in the stern. Control sticks—one for each engine—permit manual operation without use of the computer. For semi-automatic operation, the control sticks can be set and the computer used to determine the power and direction of each engine; or, the course or position can be preset and the computer takes over to navigate or stabilize the vessel.

At anchor, the computer keeps

the auxiliary engines in continuous operation to enable the system to respond instantly to displacement. The computer manages this in calm seas by setting the engines' operation directly against each other.

Senses angle changes. A cable—at constant tension—is dropped from a boom on the ship's side to a fixed point at the sea's bottom. An inclinometer is attached to the boom. The inclinometer senses variations in the angle between the cable and an imaginary line directly beneath the inclinometer. It responds to movements on two axes: forward-reverse motion and transversal. A gyrocompass supplies data on a third axis: changes in heading.

The data, converted to volts representing degrees of position change, is amplified and cleared of noise—cable vibration and superfluous ship movement—in three operational power-amplifier and active-filter chains, one for each axis. Equations are fed to the computer, which compares them to the preset axes. From the differences, the computer determines the direction and thrust for the auxiliary engines. The engines are activated by signals sent from the computer to the engines' servomotors.

The entire operation can be monitored on a cathode-ray tube display located on the ship's bridge.

Although the system employs inclinometers for measuring, it can be adapted to most other aeronautical and nautical methods based on fixed reference points.

Japan

A new entry

With the introduction of its multipurpose NEAC 3100 computer, the Nippon Electric Co. opened the door for its entry into the control computer field.

Suitable for scientific calculations, process control, and message-switching applications, the new system uses Nippon's own diode-transistor-logic integrated circuits

—similar to those used in the company's Series 2200 computers. The number of IC packages in the computer varies from 2,500 to 4,000, depending on the installation.

Market potential. Besides using the computer in its own process-control installations, Nippon will market it to process instrumentation and control companies—including Yamatake Honeywell Inc., a joint Honeywell-Japanese venture, and the Hokushin Electric Co.

Japan's powerful Ministry of International Trade and Industry had prevented Yamatake Honeywell from importing technology to manufacture Honeywell's H-20 computer, now out of production. The move was designed to strengthen Japan's electronics industry by stemming the proliferation of computer manufacturers. Hokushin, however, has its own line of process-control computers, used in the company's installations, but it turns to other manufacturers' data processors when specified by its customers.

While putting the brakes on companies that don't belong to a select group of computer manufacturers, the ministry has also "administratively guided" Nippon Electric away from head-on competition with makers of process instrumentation and control systems.

Designation of the new computer for scientific and engineering computation means it can be registered with the Japan Electronic Computer Co., the government-sponsored agency that purchases computers from domestic manufacturers and rents them to users. The agency does not handle computers made only for control applications.

Time-Sharing. Although demand for data transmission switching applications is small, it is expected to increase soon. The 3100, when combined with a 2200 computer, can switch up to 36 lines at the input, thus providing a time-sharing capability.

The smallest system will sell for about \$40,000.

The 3100 is a word-oriented machine, with words measuring 18 bits plus one parity bit. Internal core memory varies from a mini-

mum of 2,048 words to 32,768 words. Memory cycle time is two microseconds. Computer add time is four microseconds, multiply time 20 microseconds, and divide time 24 microseconds.

West Germany

Plus-power laser

An argon⁺ laser emitting a continuous-power output of "about 100 watts"—almost double the previous high—has been developed at West Berlin's Technical University. The device emits in the blue region of the spectrum at about 0.4 microns.

The record output for this type device had been held by the Raytheon Co.'s Research division in Waltham, Mass., which achieved 53 watts more than a year ago.

A power input of 60 kilowatts is required for peak emission, says Hans Boersch, who, with G. Gerziger, heads the university's research staff that developed the new argon⁺—also called ionized-argon—laser. Efficiency is 0.16%.

Wall stabilization. A major problem confronting researchers in gas laser technology is protecting the discharge tube wall from the high-temperature plasma. This was overcome in the new laser by using a gas layer to insulate the tube walls. Argon or a mixture of argon and argon⁺ can be used, say the German researchers.

Earlier devices either used built-in water-cooled metal segments or confined the laser beam to a narrow sector by employing magnetic fields focused along the axis of the tube. The trouble with a magnetic field—in addition to limiting the laser emission—is that it's both cumbersome and expensive. Water-cooled segments have also proved undesirable.

Argon⁺ lasers are being investigated for applications in microwelding, materials processing, and communications. Boersch also believes the devices have potential in color holography and photosynthesis.

Stressing the heart

The beat-by-beat story of what happens to the human heart in the vastness of outer space may have dramatic impact, but doctors and scientists are still groping with down-to-earth mysteries of the heart—particularly under stress.

A portable electrocardiograph (EKG) remote transmission system has been developed by Fritz Hellige GmbH of Freiburg that can help study the heart under a variety of special conditions. It was used earlier this year to record the heart action of a chutist during a skydiving event near Colmar, France.

The system is also being used in hospitals to monitor patients' hearts during intensive care or rehabilitation periods.

Lightweight. The battery-operated transmitter weighs 17 ounces and can be carried in a jacket pocket. It has an output of 50 milliwatts and its range runs from 600 yards in congested city areas to 1.8 miles in open country. The unit operates at the low end of the 150-180-megahertz frequency range used in most European countries for telemetering.

Depending on receiver-recorder configuration, the Hellige system is priced in the \$1,500-\$2,500 range. Hellige is a subsidiary of Litton Industries Inc.

The transmitter consists of a cardiograph amplifier and the carrier frequency modulator. The heart-beat signal—derived from two electrode contacts—modulates the 1,300-hertz carrier frequency, which, in turn, modulates the transmitter's ultrahigh frequency, around 151 Mhz.

Quartz-stabilized. The receiver is fixed-tuned to the transmitter frequency and has a sensitivity of 1 microvolt. Noise suppression starts at 0.75 microvolts. Both transmitter and receiver frequencies are quartz-stabilized.

An output that can be fed to an oscilloscope or an oscillograph to display the EKG waveform is provided by the receiver.

The electrode contacts, made of a silver-silver chloride alloy, pick up muscle voltages that appear on the skin when the heart beats.



Cure for circuitry headaches

Solve your critical circuitry problems with two extraordinary new miniaturized ceramic capacitors — the product of Nytronics research and development in the continuing pursuit of excellence.

New NYT-CHIP, an ultra-stable chip capacitor, has such advantages as superior packaging flexibility and mounting versatility, particularly for outboard mounting on integrated, thick and thin film circuitry. Dimensions, with tinned terminals, 0.170" x 0.065" x 0.070", with capacitance range of 4.7 pf through 82 pf, and 0.280" x 0.195" x 0.070" for 100 pf to 4700 pf.

NYT-CAP, an ultra high stability ceramic capacitor series is packaged in a miniature molded epoxy tubular package 0.1" diameter by 0.250" in length, with capacitance range of 4.7 pf to 82 pf. The remainder of series in miniature, molded epoxy case 0.350" long by 0.250" wide by 0.1", with a range of 100 pf to 4700 pf.

Both NYT-CHIP and NYT-CAP have a temperature coefficient that does not exceed ± 40 ppm/ $^{\circ}$ C over temperature range of -55° C to $+125^{\circ}$ C, and working voltages of 200 D.C.

As a pioneer in the concept of standardization, Nytronics maintains large volume inventories of these two products, as well as of many other standardized high quality components: inductors, delay lines, and resistors. Write for complete engineering data.



NYTRONICS®

...for Precision Electronic Components

550 Springfield Ave., Berkeley Heights, N.J. 07922 ■ (201) 464-9300 ■ TWX: 710-984-7977

Electronics advertisers

April 17, 1967

■ Abbey Electronics Corp. Phillips/Alogna Assoc. Inc.	158	Corning Glass Works, Electronic Prod. Div. Rumrill Hoyt, Inc.	75	Hewlett-Packard, Dymec Div. Lennen & Newell, Inc.	139
Airborne Instruments Laboratory Campbell-Mithun, Inc.	59	Cramer Industries Bryan/Donald Adv.	205	■ Hewlett-Packard, Loveland Div. Tallant/Yates Adv., Inc.	2, 40
Alrpax Electronics, Inc. Welch, Mirabile & Co., Inc.	63	Cyclo-Tronics, Inc. Art Brown Writing Service	58	Hewlett-Packard, Microwave Div. Lennen & Newell, Inc.	160
■ Air Products & Chemicals, Inc. Arthur Falconer Assoc.	194	■ Dage Electric Co., Inc. Garrison, Jasper, Rose & Co.	42	■ Hewlett-Packard, F.L. Moseley Co., Div. Lennen & Newell, Inc.	1
Air Reduction Co., Inc., Speer Carbon Co. Div. Hazard Adv. Co., Inc.	53	■ Dale Electronics, Inc., Sub. of Lionel Corp.	60	Hewlett-Packard, Rockaway Div. Culver Adv., Inc.	209
Allen-Bradley Co. Fensholt Adv. Agency	43, 44	■ Daven, Inc. Weston Assoc., Inc.	208	Honeywell, Computer Control Div. Franklin P. Folts, Inc.	51
■ Amelco Semiconductor, Div. of Teledyne, Inc.	77	Di-Acro Corp., Div. of Houdaille Ind., Inc. Charles E. Brown Adv.	174	Honeywell, Micro Switch Div. Batten, Barton, Durstine & Osborn, Inc.	36, 37
■ American Lava Corp., Sub. of Minnesota Mining & Mfg. Co. Designers, Inc.	208	Digital Equipment Corp. Kalb & Schneider, Inc.	22	Honeywell, Inc. W.M. Zemp & Assoc., Inc.	142
■ Amphenol Corp., Connector Div. Marsteller, Inc.	20, 21	■ Dilectrix Corp. Flamm Adv.	205	Honeywell, PMD Div. Batten, Barton, Durstine & Osborn, Inc.	41
■ Andrew Corp. Fensholt Adv., Inc.	216	Dresser Sie, Inc. Erwin Wasey, Inc.	197	Honeywell, Test Instruments Div. Campbell Mithun, Inc.	17
Arnold Engineering Co. Burton Browne Adv.	74	■ Eagle Signal, Div. of Gamewell, Sub. of E.W. Bliss Co. Feeley Adv. Agcy.	186, 187	Hopkins Engineering Co. Ray Gage, Inc.	184
Atlas Chemical Industries, Inc., Aerospace Components Div. Harris D. McKinney, Inc.	178	■ Electro Motive Mfg. Co. Reynolds & Foster, Inc.	137	Hughes Aircraft Co. Foote, Cone & Belding, Inc.	136
Automatic Electric Co., Sub. of General Telephone & Electronics Corp. Tatham-Laird & Kudner, Inc.	18, 19	Electro Tec Corp. McClellan Assoc.	56	International Rectifier Corp. Botsford, Constantine & McCarty, Inc.	6
Basic, Inc., Silk City Industrial Ceramics Div. Carr Liggett Adv., Inc.	182	Electronic Communications, Inc. Neals & Hickok, Inc.	152	I R C, Inc. Gray & Rogers, Inc.	168
■ Beckman Instruments, Inc., Helipot Div. Hixson & Jorgensen, Inc.	211	Electronic Modules Corp. Ray Thompson & Assoc.	122	■ ITT Cannon Electric, Inc. West, Weir & Bartel, Inc.	188, 189
Bendix Corp., Electrical Components Div. MacManus, John & Adams, Inc.	46	■ Esterline Angus Instrument Co. Caldwell, Larkin & Sidener Van Riper, Inc.	82	■ ITT Jennings Mfg. Co. West, Weir & Bartel, Inc.	177
Blackstone Corp., Ultrasonics Div. Carr Liggett Adv., Inc.	207	Fairchild Semiconductor, Inc. Faust/Day, Inc.	12, 13	ITT Semiconductors Div. Neals & Hickok, Inc.	226
Bolt Beranek & Newman, Inc. Leland Oliver Co.	191	Fansteel Metallurgical Corp. Reincke, Meyer & Finn	76	Janus Control Corp. L.K. Frank Co., Inc.	183
Borden Chemical Co., Mystik Tape Ind. Div. Conahay & Lyon, Inc.	138	Fluke Mfg. Co., John Bonfield Assoc.	15	Jerrold Corp., Government & Industrial Div. Lescarbours Adv.	14
Bourns Inc., Trimpot Div. Lester Co., The	57	Garrett Corp., Airesearch Mfg. Div. J. Walter Thompson Co.	202	■ J F D Electronics Co., Components Div. Delphi Adv., Inc.	205
Bud Radio, Inc. Allied Adv. Agcy.	66	General Electric Co., Component Capsules Div. George R. Nelson, Inc.	79, 80	Krohn-Hite Corp. L.K. Frank Co., Inc.	162
Bulova Watch Co., Electronics Div. Frank Best Co., Inc.	172	General Electric Co., Miniature Lamp Div. Batten, Barton, Durstine & Osborn, Inc.	179	■ Lambda Electronics Corp. Michel Cather, Inc.	166, 167
■ Bussmann Mfg., Div. of McGraw Edison Co. Henderson Adv. Co.	67	General Electric Co., Polymer Prod. Operation Div. Ross Roy, Inc.	71	Lawrence Radiation Laboratories Hoefler Dieterich & Brown Adv.	211
■ CTS Corp. Burton Browne Adv.	73	General Radio Co. Horton, Church & Goff, Inc.	2nd Cover	Ledex, Inc. Yeck & Yeck, Inc.	173
Celanese Corporation of America, Celanese Plastics Div. West, Weir & Bartel, Inc.	45	Genisco Technology Corp., Electronic Components Div. Martin Klitten Co.	72	Licon, Div. of Illinois Tool Works, Inc. Waldie & Briggs, Inc.	68
■ Clairex Corp. Michel-Cather, Inc.	204	Gerber Scientific Instrument Co. John Howard & Assoc.	164	Litton Industries, Inc., Poly-Scientific Div. West, Weir & Bartel, Inc.	200, 201
Cleveland Institute of Electronics Foote, Cone & Belding, Rapp & Collins Div.	189	■ Guardian Electric Mfg. Co. K & A Advertising	65	Litton Industries, Inc., Potentiometer Div. West, Weir & Bartel, Inc.	132
■ Clifton Precision Products Co., Div. of Litton Industries Ivey Adv., Inc.	148	Hathaway Instruments, Inc. Eby & Everson, Inc.	210	Lockheed Electronics Co. McCann-Erickson, Inc.	143
Codex Corp. WestOn Assoc., Inc.	64	■ Haydon Switch & Instruments, Inc. Reynolds & Foster, Inc.	175	Louisiana, State of, Dept. of Commerce & Industry Bauerlein, Inc.	192
Collins Radio Co. John G. Barnett Adv. Agcy.	141	■ Heath Co., Sub. of Schlumberger Ltd. Advance Advertising	203	McGraw-Hill Book Co.	212
Columbia Wire Products Co. Sander Rodkin Adv. Agcy. Ltd.	190	Helnemann Electric Co. Thomas R. Sundheim, Inc.	100	■ Machlett Laboratories, Div. of Raytheon Co. Fuller, Smith & Ross, Inc.	9
Comcor, Inc., Sub. of Astrodata, Inc. Marketing Directions	69	Hewlett-Packard, Colorado Springs Div. Tallant/Yates Adv., Inc.	3rd Cover	■ Magnetic Shield, Div. of Perfection Mica Co. Burton Browne Adv.	203
Communication Electronics, Inc.	204			Magnecraft Electric Co. Allbright Assoc.	207
Consolidated Electrodynamics Corp., Sub. of Bell & Howell Hixson & Jorgensen, Inc.	181				
Consumers Power Co., Area Development McLain Adv., Inc.	78				
Continental Connector Corp. Dunwoodie Assoc.	134				
Control Data Corp., La Jolla Div. Barnes Champ Adv.	153				



Advertising sales staff

Frank E. LeBeau [212] 971-6464

Advertising sales manager

Wallis Clarke [212] 971-2187

Assistant to sales manager

Donald J. Austermann [212] 971-3139

Promotion Manager

Atlanta, Ga. 30309: Michael H. Miller, 1375

Peachtree St., N.E.

[404] TR 5-0523

Boston, Mass. 02116: William S. Hodgkinson

McGraw-Hill Building, Copley Square

[617] CO 2-1160

Chicago, Ill. 60611: Robert M. Denmead,

J. Bradley MacKimm, Ralph Hanning,

645 North Michigan Avenue,

[312] MO 4-5800

Cleveland, Ohio 44113: William J. Boyle, 55

Public Square, [216] SU 1-7000

Dallas, Texas 75201: Richard P. Poole, 1800

Republic National Bank Tower,

[214] RI 7-9721

Denver, Colo. 80202: Joseph C. Page, David

M. Watson, Tower Bldg., 1700 Broadway,

[303] 255-5484

Detroit, Michigan 48226: Ralph Hanning

856 Penobscot Building

[313] 962-1793

Houston, Texas 77002: Kenneth George,

2270 Humble Bldg., [713] CA 4-8381

Los Angeles, Calif. 90017: Ian C. Hill,

John G. Zisch, 1125 W. 6th St.,

[213] HU 2-5450

Minneapolis, Minn. 55402: J. Bradley

MacKimm, 1104 Northstar Center

[612] 332-7425

New York, N.Y. 10036

500 Fifth Avenue

Donald R. Furth [212] 971-3615

James R. Pierce [212] 971-3616

Stanley J. Kail, Jr. [212] 971-3617

Philadelphia, Pa. 19103:

Warren H. Gardner, Jeffrey M. Preston,

6 Penn Center Plaza,

[215] LO 8-6161

Pittsburgh, Pa. 15222: Warren H. Gardner,

4 Gateway Center, [412] 391-1314

Portland, Ore. 97204: James T. Hauptli,

218 Mohawk Building, 222 S.W. Morrison

Street, Phone [503] 223-5118

Rochester, N.Y. 14534: William J. Boyle,

9 Greylock Ridge, Pittsford, N.Y.

[716] 586-5040

St. Louis, Mo. 63105: Robert M. Denmead

The Clayton Tower, 7751 Carondelet Ave.

[314] PA 5-7285

San Francisco, Calif. 94111:

James T. Hauptli, 255 California Street,

[415] DO 2-4600

London W1: John W. Patten, Edwin S.

Murphy Jr., 34 Dover Street,

Hyde Park 1451

Milan: Robert M. Sidel

1 via Baracchini Phone: 86-90-656

Frankfurt Main: Gerd Hinske, Dieter

Rothenbach, Elsa-Brandstroem Str. 2

Phone: 72 01 81

Geneva: Michael R. Zeynel,

1, rue du Temple Phone: 31 95 60

Paris VIII: Denis Jacob, Kenneth Davey,

17 Avenue Matignon Phone: 359 6637

Tokyo: Nobuyuki Sato, 1, Kotohiracho

Shiba, Minato-Ku [502] 0656

Osaka: Ryoji Kobayashi 163, Umegae-cho

Kita-ku [362] 8771

Business department

Wallace C. Carmichael, Manager

[212] 971-3191

Stephen R. Weiss, Production Manager

[212] 971-2044

Thomas M. Egan,

Assistant Production Manager [212] 971-3140

Dorothy Carmesin, Contracts and Billings

[212] 971-2908

Circulation and research

Milton Drake, Manager [212] 971-3485

Isaac Siegel, Assistant Circulation Manager

[212] 971-6057

David Strasser, Assistant Research Manager

[212] 971-6058

Chloe D. Glover, Research Associate

[212] 971-6057

Electronics buyers' guide

George F. Werner, General Manager

[212] 971-2310

Regina Hera, Directory Manager

[212] 971-2544

Thomas M. Egan, Production Manager

[212] 971-3140

■ Markel & Sons, L. Frank	197
George Moll Adv., Inc.	
Maryland Telecommunications, Inc.	140
Ray E. Finn Adv.	
Mathatronics, Inc.	176
Kalb & Schneider, Inc.	
Merrimac Research & Development, Inc.	154
Masson, Reed & Walker, Inc.	
Meson Electronics Co., Inc.	212
Wolff Assoc., Inc.	
Metal Removal Co., The	193
Advertising Producers Assoc.	
Mico Instrument Co.	212
■ Microsons, Inc.	54
S. Gunnar Myrbeck & Co.	
■ Monsanto Co.	38, 39
Foote, Cone & Belding	
North Atlantic Industries, Inc.	10
Murray Heyert Assoc.	
Nytronics, Inc.	223
The Stukalin Adv. Agcy.	
Oak Electro/Netics Corp.	145
Buchen Adv., Inc.	
Ohmite Mfg. Co.	110
Fensholt Adv. Agcy.	
■ Pacific Measurements, Inc.	7
Jack Herrick Adv., Inc.	
Philco/Ford Co., Microelectronics Div.	24
Hofer, Dieterich & Brown, Inc.	
Piher, S.A. Publicitas, S.A.	144
Polaroid Corp.	55
Doyle Dane Bernbach, Inc.	
■ Precision Tube Co.	199
George Moll Adv., Inc.	
Radar Design Corp.	206
Barlow/Johnson, Inc.	
Radio Corporation of America	4th Cover
Al Paul Lefton Co.	
Rayclad Tubes, Inc.	155
Shafer Assoc.	
Raytheon Co., Components Div.	159
Fuller & Smith & Ross, Inc.	
Rohde & Schwarz Co.	109
Armand Richards Adv. Agcy.	
San-Esu Electronics Co. Ltd.	194
General Adv. Agcy.	
Semtech Corp.	196
Burress Adv.	
Sierra Electronics, Div. of Philco Ford	165
Hal Lawrence, Inc.	
Sigma Instruments, Inc.	146
Marschalk Co., Inc.	
■ Silicon Transistor Corp.	70
A.D. Adams Adv.	
Sorensen Operation, Raytheon Co.	11
James Adv., Inc.	
Sprague Electric Co., The	5, 8, 16
Harry P. Bridge Co.	
Stanpat Products, Inc.	207
Morton Advertising, Inc.	
Statler Hilton Hotel of Boston	194
Calkins & Holden Adv.	
Steroline Systems Corp.	198
Clinton E. Frank, Inc.	

Super Tool Co.	211
Varon Advertising	
Sylvania Electric Products, Inc.,	27-34
General Telephone & Electronics	
Tatham-Laird & Kudner, Inc.	
Syntron Co.	163
De Sales Adv., Inc.	
Tally Corp.	133
Bonfield Assoc., Inc.	
Taylor Corp.	185
Gray & Rogers, Inc.	
■ Tektronix, Inc.	121
Hugh Dwight Adv., Inc.	
Texas Instruments Incorporated	147
Semiconductor/Components	
Division	
Don L. Baxter, Incorporated	
Thermal American Fused Quartz	180
Kniep Assoc.	
Tiros Plastics Corp.	195
Feeley Adv. Agcy., Inc.	
TRW Capacitors	156
Fuller & Smith & Ross	
■ Tung Sol, Div. of Wagner Electric Corp.	81
E.M. Freystadt Assoc.	
Ulano & Co., J. Byrde, Richard & Pound, Inc.	171
Union Carbide Corp., Electronics Div.	35
J.M. Mathes, Inc.	
Union Carbide Corp., Plastics Div.	131
J.M. Mathes, Inc.	
■ Vactec, Inc.	150
Coleman & Assoc. Adv.	
Vitramon, Inc.	151
Ted Sommers, Inc.	
Westinghouse, Metals Div.	135
McCann/ITSM	
Weston Instruments, Inc.,	209
Transcoil Div.	
Arndt, Preston, Chapin, Lamb & Keen Inc.	
Wood Electric Co.	209
L.K. Frank Co., Inc.	

Classified Advertising

F.J. Eberle, Business Mgr.

PROFESSIONAL SERVICES 215

EMPLOYMENT OPPORTUNITIES 213-215

EQUIPMENT (Used or Surplus New) For Sale 215

ADVERTISERS INDEX

Bendix Corp. The Flight & Engine Instruments Div. 215

Fishman Co., Philip 215

Grumman Aircraft Corp. 213

Instruments & Machines Inc. 215

Radio Research Instrument Co. 215

Research Laboratories, Div. of UAC 214

Signetics Corp. 214

■ For more information on complete product line see advertisement in the latest Electronics Buyers' Guide

The Predictables.

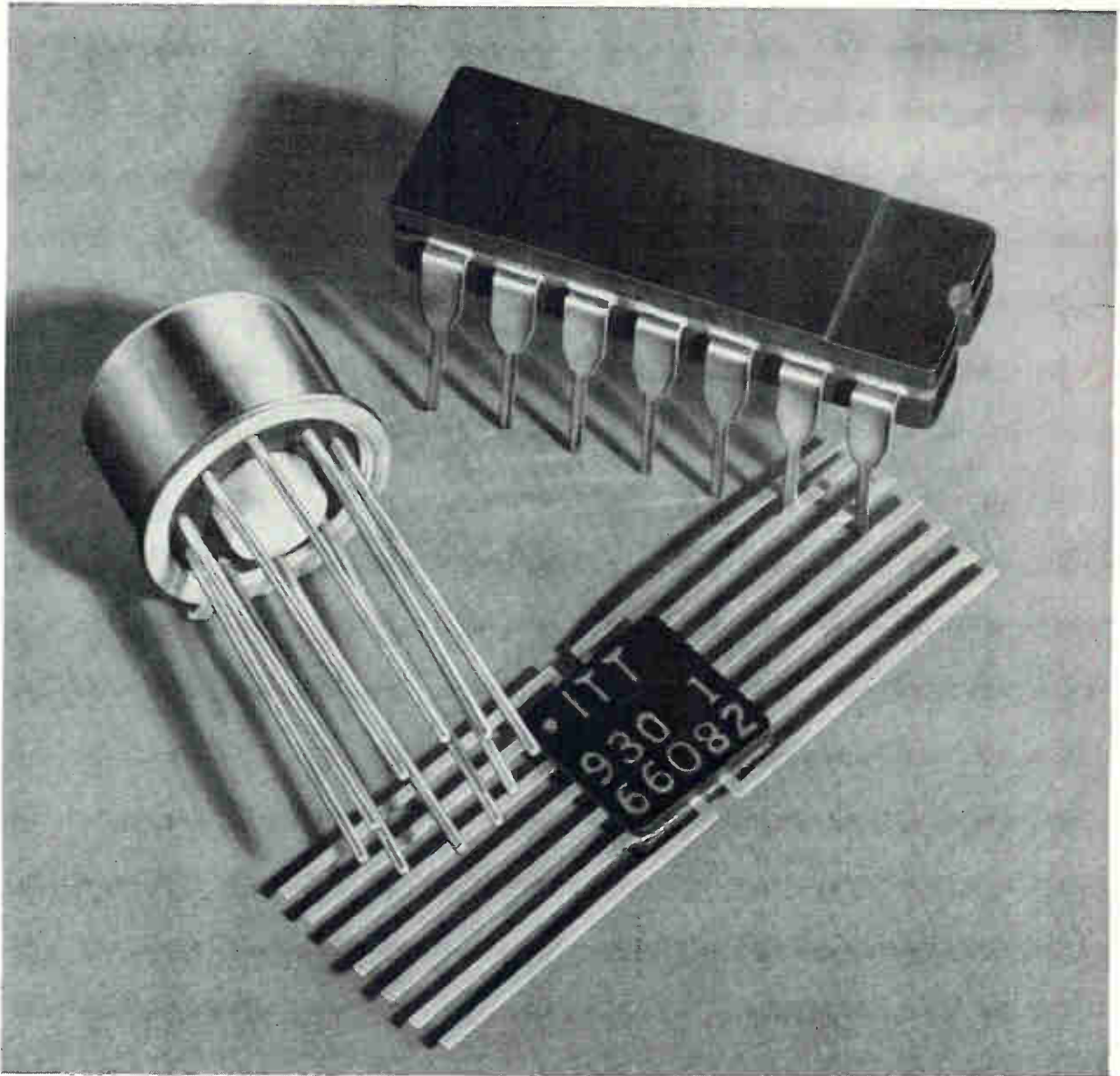

100% DC and dynamic testing verifies the performance of every circuit in ITT's full line of Series 930 DTL

When your order of ITT Series 930 DTL arrives, you can have absolute confidence in its performance. First of all, every circuit gets full DC and dynamic testing at 25°C, plus temperature cycling, centrifuge, and fine leak tests. Then there's 1% AQL testing at -55°C, +25°C and +125°C for 15 DC parameters and at +25°C for 2 dynamic parameters. If circuits flunk, we just don't ship them.

ITT's Series 930 "predictables" come in 15 circuit functions and three package styles. If you're tired of rejecting and returning DTL, try ordering it from ITT. It's available off-the-shelf from your distributor or direct from the factory through your ITT representative. ITT Semiconductors is a Division of International Telephone & Telegraph Corporation.

integrated circuits **ITT**

FACTORIES IN WEST PALM BEACH, FLORIDA; PALO ALTO, CALIFORNIA; LAWRENCE, MASSACHUSETTS; HARLOW AND FOOTSCRAY, ENGLAND; FREIBURG AND NURENBERG, GERMANY

Electronics reader service

Use these handy post cards for more detailed information on: products advertised, new products, new literature.

Circle the number on the Reader Service post card that corresponds to the number at the bottom of the advertisement, new product item, or new literature in which you are interested.

Please print clearly. All written information must be legible to be efficiently processed.

If someone has beaten you to the post cards, you may obtain the needed information by writing directly to the manufacturer, or by sending your name and address, plus the Reader Service number, to Electronics Reader Service department.

All inquiries from outside the U.S. that cannot reach Electronics before the expiration dates noted on the Reader Service post card, must be mailed directly to the manufacturer. The manufacturer assumes all responsibilities for responding to inquiries. Electronics merely provides and clears requests for information from inquirer to manufacturer.

Correct amount of postage must be affixed for all mailings from outside the U.S.

To subscribe to or to renew Electronics

Fill in the "For Subscriptions" area on the card if you desire to subscribe to or renew your present subscription to Electronics. Send no money. Electronics will bill you at the address indicated on the Reader Service post card.

Multi-product advertisements

For information on specific items in multi-product advertisements which do not have a specific Reader Service number indicated write directly to manufacturer for information on precise product in which you are interested.

Warning: The Post Office now requires your ZIP CODE on all mail. Please include your ZIP CODE number when filling out your reply card.

8 Please Print Clearly April 17, 1967 Card Expires June 17, 1967 **14**

Name _____ title _____

Company _____

Address _____

City _____ state _____ zip code _____

For Subscriptions
 new renewal
 3 years \$16.00
 1 year \$8.00

1	2	3	4	5	6	7	8	9	10	11	12	13	14	15	16	17	18	19	20	21	22	23	24	25	26	27	28	29	30	31	32	33	34	35	36	37	38	39	40	41	42	43	44	45	46	47	48	49	50	51	52	53	54	55	56	57	58	59	60	61	62	63	64	65	66	67	68	69	70	71	72	73	74	75	76	77	78	79	80	81	82	83	84	85	86	87	88	89	90	91	92	93	94	95	96	97	98	99	00																																																																																																																																																																																																																																																																																																																																																																																																																																																																																																																																																																																																																																																																																																																																																																																																																																																																																																																																																																																																																																																																																																																																																																																																																																																																																							
20	39	58	77	96	115	134	153	172	191	210	229	248	267	286	305	324	343	362	381	400	419	438	457	476	495	514	533	552	571	590	609	628	647	666	685	704	723	742	761	780	799	818	837	856	875	894	913	932	951	970	989	008	027	046	065	084	103	122	141	160	179	198	217	236	255	274	293	312	331	350	369	388	407	426	445	464	483	502	521	540	559	578	597	616	635	654	673	692	711	730	749	768	787	806	825	844	863	882	901	920	939	958	977	996	015	034	053	072	091	110	129	148	167	186	205	224	243	262	281	300	319	338	357	376	395	414	433	452	471	490	509	528	547	566	585	604	623	642	661	680	699	718	737	756	775	794	813	832	851	870	889	908	927	946	965	984	003	022	041	060	079	098	117	136	155	174	193	212	231	250	269	288	307	326	345	364	383	402	421	440	459	478	497	516	535	554	573	592	611	630	649	668	687	706	725	744	763	782	801	820	839	858	877	896	915	934	953	972	991	010	029	048	067	086	105	124	143	162	181	200	219	238	257	276	295	314	333	352	371	390	409	428	447	466	485	504	523	542	561	580	599	618	637	656	675	694	713	732	751	770	789	808	827	846	865	884	903	922	941	960	979	998	017	036	055	074	093	112	131	150	169	188	207	226	245	264	283	302	321	340	359	378	397	416	435	454	473	492	511	530	549	568	587	606	625	644	663	682	701	720	739	758	777	796	815	834	853	872	891	910	929	948	967	986	005	024	043	062	081	100	119	138	157	176	195	214	233	252	271	290	309	328	347	366	385	404	423	442	461	480	499	518	537	556	575	594	613	632	651	670	689	708	727	746	765	784	803	822	841	860	879	898	917	936	955	974	993	012	031	050	069	088	107	126	145	164	183	202	221	240	259	278	297	316	335	354	373	392	411	430	449	468	487	506	525	544	563	582	601	620	639	658	677	696	715	734	753	772	791	810	829	848	867	886	905	924	943	962	981	000	019	038	057	076	095	114	133	152	171	190	209	228	247	266	285	304	323	342	361	380	399	418	437	456	475	494	513	532	551	570	589	608	627	646	665	684	703	722	741	760	779	798	817	836	855	874	893	912	931	950	969	988	007	026	045	064	083	102	121	140	159	178	197	216	235	254	273	292	311	330	349	368	387	406	425	444	463	482	501	520	539	558	577	596	615	634	653	672	691	710	729	748	767	786	805	824	843	862	881	900	919	938	957	976	995	014	033	052	071	090	109	128	147	166	185	204	223	242	261	280	299	318	337	356	375	394	413	432	451	470	489	508	527	546	565	584	603	622	641	660	679	698	717	736	755	774	793	812	831	850	869	888	907	926	945	964	983	002	021	040	059	078	097	116	135	154	173	192	211	230	249	268	287	306	325	344	363	382	401	420	439	458	477	496	515	534	553	572	591	610	629	648	667	686	705	724	743	762	781	800	819	838	857	876	895	914	933	952	971	990	009	028	047	066	085	104	123	142	161	180	199	218	237	256	275	294	313	332	351	370	389	408	427	446	465	484	503	522	541	560	579	598	617	636	655	674	693	712	731	750	769	788	807	826	845	864	883	902	921	940	959	978	997	016	035	054	073	092	111	130	149	168	187	206	225	244	263	282	301	320	339	358	377	396	415	434	453	472	491	510	529	548	567	586	605	624	643	662	681	700	719	738	757	776	795	814	833	852	871	890	909	928	947	966	985	004	023	042	061	080	099	118	137	156	175	194	213	232	251	270	289	308	327	346	365	384	403	422	441	460	479	498	517	536	555	574	593	612	631	650	669	688	707	726	745	764	783	802	821	840	859	878	897	916	935	954	973	992	011	030	049	068	087	106	125	144	163	182	201	220	239	258	277	296	315	334	353	372	391	410	429	448	467	486	505	524	543	562	581	600	619	638	657	676	695	714	733	752	771	790	809	828	847	866	885	904	923	942	961	980	003	022	041	060	079	098	117	136	155	174	193	212	231	250	269	288	307	326	345	364	383	402	421	440	459	478	497	516	535	554	573	592	611	630	649	668	687	706	725	744	763	782	801	820	839	858	877	896	915	934	953	972	991	010	029	048	067	086	105	124	143	162	181	200	219	238	257	276	295	314	333	352	371	390	409	428	447	466	485	504	523	542	561	580	599	618	637	656	675	694	713	732	751	770	789	808	827	846	865	884	903	922	941	960	979	998	007	026	045	064	083	102	121	140	159	178	197	216	235	254	273	292	311	330	349	368	387	406	425	444	463	482	501	520	539	558	577	596	615	634	653	672	691	710	729	748	767	786	805	824	843	862	881	900	919	938	957	976	995	014	033	052	071	090	109	128	147	166	185	204	223	242	261	280	299	318	337	356	375	394	413	432	451	470	489	508	527	546	565	584	603	622	641	660	679	698	717	736	755	774	793	812	831	850	869	888	907	926	945	964	983	002	021	040	059	078	097	116	135	154	173	192	211	230	249	268	287	306	325	344	363	382	401	420	439	458	477	496	515	534	553	572	591	610	629	648	667	686	705	724	743	762	781	800	819	838	857	876	895	914	933	952	971	990	009	028	047	066	085	104	123	142	161	180	199	218	237	256	275	294	313	332	351	370	389	408	427	446	465	484	503	522	541	560	579	598	617	636	655	674	693	712	731	750	769	788	807	826	845	864	883	902	921	940	959	978	997	016	035	054	073	092	111	130	149	168	187	206	225	244	263	282	301	320	339	358	377	396	415	434	453	472	491	510	529	548	567	586	605	624	643	662	681	700	719	738	757	776	795	814	833	852	871	890	909	928	947	966	985	004	023	042	061	080	099	118	137	156	175	194	213	232	251	270	289	308	327	346	365	384	403	422	441	460	479	498	517	536	555	574	593	612	631	650	669	688	707	726	745	764	783	802	821	840	859	878	897	916	935	954	973	992	011	030	049	068	087	106	125	144	163	182	201	220	239	258	277	296	315	334	353	372	391	410	429	448	467	486	505	524	543	562	581	600	619	638	657	676	695	714	733	752	771	790	809	828	847	866	885	904	923	942	961	980	003	022	041	060	079	098	117	136	155	174	193	212	231	250	269	288	307	326	345	364	383	402	421	

Reprint service

All Electronics editorial matter available in reprint form:

For reprints of special reports and feature articles see list on right side of this page. Send your order to Electronics Reprint Department at the address indicated. To expedite mailing of your order for single reprints please send cash, check or money order with your order.

Bulk reprints of editorial matter can be ordered from current or past issues. The minimum quantity is 100 copies. The higher the quantity ordered, the more economical the cost per copy. Prices quoted on request.

Warning: The Post Office now requires your ZIP CODE on all mail. Please include your ZIP CODE number when filling out your reply card.

3

Business reply mail

No postage stamp necessary if mailed in the United States

Postage will be paid by

Electronics
Reader service department
Box 444
Hightstown, N. J. 08520

First class
 Permit no. 42
 Hightstown, N. J.



8 Please Print Clearly April 17, 1967 Card Expires June 17, 1967 14

Name _____ title _____
 Company _____
 Address _____
 City _____ state _____ zip code _____

For Subscriptions
 new renewal
 3 years \$16.00
 1 year \$8.00

1	20	39	58	77	96	115	134	153	172	191	210	229	248	267	286	305	324	343	362	381	400	419	438	457	476	495	514	533	552	571	590	609	628	647	666	685	704	723	742	761	780	799	818	837	856	875	894	913	932	951	970	989	1008	1027	1046	1065	1084	1103	1122	1141	1160	1179	1198	1217	1236	1255	1274	1293	1312	1331	1350	1369	1388	1407	1426	1445	1464	1483	1502	1521	1540	1559	1578	1597	1616	1635	1654	1673	1692	1711	1730	1749	1768	1787	1806	1825	1844	1863	1882	1901	1920	1939	1958	1977	1996	2015	2034	2053	2072	2091	2110	2129	2148	2167	2186	2205	2224	2243	2262	2281	2300	2319	2338	2357	2376	2395	2414	2433	2452	2471	2490	2509	2528	2547	2566	2585	2604	2623	2642	2661	2680	2699	2718	2737	2756	2775	2794	2813	2832	2851	2870	2889	2908	2927	2946	2965	2984	3003	3022	3041	3060	3079	3098	3117	3136	3155	3174	3193	3212	3231	3250	3269	3288	3307	3326	3345	3364	3383	3402	3421	3440	3459	3478	3497	3516	3535	3554	3573	3592	3611	3630	3649	3668	3687	3706	3725	3744	3763	3782	3801	3820	3839	3858	3877	3896	3915	3934	3953	3972	3991	4010	4029	4048	4067	4086	4105	4124	4143	4162	4181	4200	4219	4238	4257	4276	4295	4314	4333	4352	4371	4390	4409	4428	4447	4466	4485	4504	4523	4542	4561	4580	4599	4618	4637	4656	4675	4694	4713	4732	4751	4770	4789	4808	4827	4846	4865	4884	4903	4922	4941	4960	4979	4998	5017	5036	5055	5074	5093	5112	5131	5150	5169	5188	5207	5226	5245	5264	5283	5302	5321	5340	5359	5378	5397	5416	5435	5454	5473	5492	5511	5530	5549	5568	5587	5606	5625	5644	5663	5682	5701	5720	5739	5758	5777	5796	5815	5834	5853	5872	5891	5910	5929	5948	5967	5986	6005	6024	6043	6062	6081	6100	6119	6138	6157	6176	6195	6214	6233	6252	6271	6290	6309	6328	6347	6366	6385	6404	6423	6442	6461	6480	6499	6518	6537	6556	6575	6594	6613	6632	6651	6670	6689	6708	6727	6746	6765	6784	6803	6822	6841	6860	6879	6898	6917	6936	6955	6974	6993	7012	7031	7050	7069	7088	7107	7126	7145	7164	7183	7202	7221	7240	7259	7278	7297	7316	7335	7354	7373	7392	7411	7430	7449	7468	7487	7506	7525	7544	7563	7582	7601	7620	7639	7658	7677	7696	7715	7734	7753	7772	7791	7810	7829	7848	7867	7886	7905	7924	7943	7962	7981	8000	8019	8038	8057	8076	8095	8114	8133	8152	8171	8190	8209	8228	8247	8266	8285	8304	8323	8342	8361	8380	8399	8418	8437	8456	8475	8494	8513	8532	8551	8570	8589	8608	8627	8646	8665	8684	8703	8722	8741	8760	8779	8798	8817	8836	8855	8874	8893	8912	8931	8950	8969	8988	9007	9026	9045	9064	9083	9102	9121	9140	9159	9178	9197	9216	9235	9254	9273	9292	9311	9330	9349	9368	9387	9406	9425	9444	9463	9482	9501	9520	9539	9558	9577	9596	9615	9634	9653	9672	9691	9710	9729	9748	9767	9786	9805	9824	9843	9862	9881	9900	9919	9938	9957	9976	9995	10004	10013	10022	10031	10040	10049	10058	10067	10076	10085	10094	10103	10112	10121	10130	10139	10148	10157	10166	10175	10184	10193	10202	10211	10220	10229	10238	10247	10256	10265	10274	10283	10292	10301	10310	10319	10328	10337	10346	10355	10364	10373	10382	10391	10400	10409	10418	10427	10436	10445	10454	10463	10472	10481	10490	10499	10508	10517	10526	10535	10544	10553	10562	10571	10580	10589	10598	10607	10616	10625	10634	10643	10652	10661	10670	10679	10688	10697	10706	10715	10724	10733	10742	10751	10760	10769	10778	10787	10796	10805	10814	10823	10832	10841	10850	10859	10868	10877	10886	10895	10904	10913	10922	10931	10940	10949	10958	10967	10976	10985	10994	11003	11012	11021	11030	11039	11048	11057	11066	11075	11084	11093	11102	11111	11120	11129	11138	11147	11156	11165	11174	11183	11192	11201	11210	11219	11228	11237	11246	11255	11264	11273	11282	11291	11300	11309	11318	11327	11336	11345	11354	11363	11372	11381	11390	11399	11408	11417	11426	11435	11444	11453	11462	11471	11480	11489	11498	11507	11516	11525	11534	11543	11552	11561	11570	11579	11588	11597	11606	11615	11624	11633	11642	11651	11660	11669	11678	11687	11696	11705	11714	11723	11732	11741	11750	11759	11768	11777	11786	11795	11804	11813	11822	11831	11840	11849	11858	11867	11876	11885	11894	11903	11912	11921	11930	11939	11948	11957	11966	11975	11984	11993	12002	12011	12020	12029	12038	12047	12056	12065	12074	12083	12092	12101	12110	12119	12128	12137	12146	12155	12164	12173	12182	12191	12200	12209	12218	12227	12236	12245	12254	12263	12272	12281	12290	12299	12308	12317	12326	12335	12344	12353	12362	12371	12380	12389	12398	12407	12416	12425	12434	12443	12452	12461	12470	12479	12488	12497	12506	12515	12524	12533	12542	12551	12560	12569	12578	12587	12596	12605	12614	12623	12632	12641	12650	12659	12668	12677	12686	12695	12704	12713	12722	12731	12740	12749	12758	12767	12776	12785	12794	12803	12812	12821	12830	12839	12848	12857	12866	12875	12884	12893	12902	12911	12920	12929	12938	12947	12956	12965	12974	12983	12992	13001	13010	13019	13028	13037	13046	13055	13064	13073	13082	13091	13100	13109	13118	13127	13136	13145	13154	13163	13172	13181	13190	13199	13208	13217	13226	13235	13244	13253	13262	13271	13280	13289	13298	13307	13316	13325	13334	13343	13352	13361	13370	13379	13388	13397	13406	13415	13424	13433	13442	13451	13460	13469	13478	13487	13496	13505	13514	13523	13532	13541	13550	13559	13568	13577	13586	13595	13604	13613	13622	13631	13640	13649	13658	13667	13676	13685	13694	13703	13712	13721	13730	13739	13748	13757	13766	13775	13784	13793	13802	13811	13820	13829	13838	13847	13856	13865	13874	13883	13892	13901	13910	13919	13928	13937	13946	13955	13964	13973	13982	13991	14000	14009	14018	14027	14036	14045	14054	14063	14072	14081	14090	14099	14108	14117	14126	14135	14144	14153	14162	14171	14180	14189	14198	14207	14216	14225	14234	14243	14252	14261	14270	14279	14288	14297	14306	14315	14324	14333	14342	14351	14360	14369	14378	14387	14396	14405	14414	14423	14432	14441	14450	14459	14468	14477	14486	14495	14504	14513	14522	14531	14540	14549	14558	14567	14576	14585	14594	14603	14612	14621	14630	14639	14648	14657	14666	14675	14684	14693	14702	14711	14720	14729	14738	14747	14756	14765	14774	14783	14792	14801	14810	14819	14828	14837	14846	14855	14864	14873	14882	14891	14900	14909	14918	14927	14936	14945	14954	14963	14972	14981	14990	15000	15009	15018	15027	15036	15045	15054	15063	15072	15081	15090	15099	15108	15117	15126	15135	15144	15153	15162	15171	15180	15189	15198	15207	15216	15225	15234	15243	15252	15261	15270	15279	15288	15297	15306	15315	15324	15333	15342	15351	15360	15369	15378	15387	15396	15405	15414	15423	15432	15441	15450	15459	15468	15477	15486	15495	15504	15513	15522	15531	15540	15549	15558	15567	15576	15585	15594	15603	15612	15621	15630	15639	15648	15657	15666	15675	15684	15693	15702	15711	15720	15729	15738	15747	15756	15765	15774	15783	15792	15801	15810	15819	15828	15837	15846	15855	15864	15873	15882	15891	15900	15909	15918	15927	15936	15945	15954	15963	15972	15981	15990	16000	16009	16018	16027	16036	16045	16054	16063	16072	16081	16090
---	----	----	----	----	----	-----	-----	-----	-----	-----	-----	-----	-----	-----	-----	-----	-----	-----	-----	-----	-----	-----	-----	-----	-----	-----	-----	-----	-----	-----	-----	-----	-----	-----	-----	-----	-----	-----	-----	-----	-----	-----	-----	-----	-----	-----	-----	-----	-----	-----	-----	-----	------	------	------	------	------	------	------	------	------	------	------	------	------	------	------	------	------	------	------	------	------	------	------	------	------	------	------	------	------	------	------	------	------	------	------	------	------	------	------	------	------	------	------	------	------	------	------	------	------	------	------	------	------	------	------	------	------	------	------	------	------	------	------	------	------	------	------	------	------	------	------	------	------	------	------	------	------	------	------	------	------	------	------	------	------	------	------	------	------	------	------	------	------	------	------	------	------	------	------	------	------	------	------	------	------	------	------	------	------	------	------	------	------	------	------	------	------	------	------	------	------	------	------	------	------	------	------	------	------	------	------	------	------	------	------	------	------	------	------	------	------	------	------	------	------	------	------	------	------	------	------	------	------	------	------	------	------	------	------	------	------	------	------	------	------	------	------	------	------	------	------	------	------	------	------	------	------	------	------	------	------	------	------	------	------	------	------	------	------	------	------	------	------	------	------	------	------	------	------	------	------	------	------	------	------	------	------	------	------	------	------	------	------	------	------	------	------	------	------	------	------	------	------	------	------	------	------	------	------	------	------	------	------	------	------	------	------	------	------	------	------	------	------	------	------	------	------	------	------	------	------	------	------	------	------	------	------	------	------	------	------	------	------	------	------	------	------	------	------	------	------	------	------	------	------	------	------	------	------	------	------	------	------	------	------	------	------	------	------	------	------	------	------	------	------	------	------	------	------	------	------	------	------	------	------	------	------	------	------	------	------	------	------	------	------	------	------	------	------	------	------	------	------	------	------	------	------	------	------	------	------	------	------	------	------	------	------	------	------	------	------	------	------	------	------	------	------	------	------	------	------	------	------	------	------	------	------	------	------	------	------	------	------	------	------	------	------	------	------	------	------	------	------	------	------	------	------	------	------	------	------	------	------	------	------	------	------	------	------	------	------	------	------	------	------	------	------	------	------	------	------	------	------	------	------	------	------	------	------	------	------	------	------	------	------	------	------	------	------	------	------	------	------	------	------	------	------	------	------	------	------	------	------	------	------	------	------	------	------	------	------	------	------	------	------	------	------	------	------	------	------	------	------	------	------	------	------	------	------	------	------	------	------	------	------	------	------	------	------	------	------	------	------	------	-------	-------	-------	-------	-------	-------	-------	-------	-------	-------	-------	-------	-------	-------	-------	-------	-------	-------	-------	-------	-------	-------	-------	-------	-------	-------	-------	-------	-------	-------	-------	-------	-------	-------	-------	-------	-------	-------	-------	-------	-------	-------	-------	-------	-------	-------	-------	-------	-------	-------	-------	-------	-------	-------	-------	-------	-------	-------	-------	-------	-------	-------	-------	-------	-------	-------	-------	-------	-------	-------	-------	-------	-------	-------	-------	-------	-------	-------	-------	-------	-------	-------	-------	-------	-------	-------	-------	-------	-------	-------	-------	-------	-------	-------	-------	-------	-------	-------	-------	-------	-------	-------	-------	-------	-------	-------	-------	-------	-------	-------	-------	-------	-------	-------	-------	-------	-------	-------	-------	-------	-------	-------	-------	-------	-------	-------	-------	-------	-------	-------	-------	-------	-------	-------	-------	-------	-------	-------	-------	-------	-------	-------	-------	-------	-------	-------	-------	-------	-------	-------	-------	-------	-------	-------	-------	-------	-------	-------	-------	-------	-------	-------	-------	-------	-------	-------	-------	-------	-------	-------	-------	-------	-------	-------	-------	-------	-------	-------	-------	-------	-------	-------	-------	-------	-------	-------	-------	-------	-------	-------	-------	-------	-------	-------	-------	-------	-------	-------	-------	-------	-------	-------	-------	-------	-------	-------	-------	-------	-------	-------	-------	-------	-------	-------	-------	-------	-------	-------	-------	-------	-------	-------	-------	-------	-------	-------	-------	-------	-------	-------	-------	-------	-------	-------	-------	-------	-------	-------	-------	-------	-------	-------	-------	-------	-------	-------	-------	-------	-------	-------	-------	-------	-------	-------	-------	-------	-------	-------	-------	-------	-------	-------	-------	-------	-------	-------	-------	-------	-------	-------	-------	-------	-------	-------	-------	-------	-------	-------	-------	-------	-------	-------	-------	-------	-------	-------	-------	-------	-------	-------	-------	-------	-------	-------	-------	-------	-------	-------	-------	-------	-------	-------	-------	-------	-------	-------	-------	-------	-------	-------	-------	-------	-------	-------	-------	-------	-------	-------	-------	-------	-------	-------	-------	-------	-------	-------	-------	-------	-------	-------	-------	-------	-------	-------	-------	-------	-------	-------	-------	-------	-------	-------	-------	-------	-------	-------	-------	-------	-------	-------	-------	-------	-------	-------	-------	-------	-------	-------	-------	-------	-------	-------	-------	-------	-------	-------	-------	-------	-------	-------	-------	-------	-------	-------	-------	-------	-------	-------	-------	-------	-------	-------	-------	-------	-------	-------	-------	-------	-------	-------	-------	-------	-------	-------	-------	-------	-------	-------	-------	-------	-------	-------	-------	-------	-------	-------	-------	-------	-------	-------	-------	-------	-------	-------	-------	-------	-------	-------	-------	-------	-------	-------	-------	-------	-------	-------	-------	-------	-------	-------	-------	-------	-------	-------	-------	-------	-------	-------	-------	-------	-------	-------	-------	-------	-------	-------	-------	-------	-------	-------	-------	-------	-------	-------	-------	-------	-------	-------	-------	-------	-------	-------	-------	-------	-------	-------	-------	-------	-------	-------	-------	-------	-------	-------	-------	-------	-------	-------	-------	-------	-------	-------	-------	-------	-------	-------	-------	-------	-------	-------	-------	-------	-------	-------	-------	-------	-------	-------	-------	-------	-------	-------	-------	-------	-------	-------	-------	-------	-------	-------	-------	-------	-------	-------	-------	-------	-------	-------	-------	-------	-------	-------	-------	-------	-------	-------	-------	-------	-------	-------	-------	-------	-------	-------	-------	-------	-------	-------	-------	-------	-------	-------	-------	-------	-------	-------	-------	-------	-------	-------	-------	-------	-------	-------	-------	-------	-------	-------	-------	-------	-------	-------	-------	-------	-------	-------	-------	-------	-------	-------	-------	-------	-------	-------	-------	-------	-------	-------	-------	-------	-------	-------	-------	-------	-------	-------	-------	-------	-------	-------	-------	-------	-------	-------	-------	-------	-------	-------	-------	-------	-------	-------	-------	-------	-------	-------	-------	-------	-------	-------	-------	-------	-------	-------	-------	-------	-------	-------	-------	-------	-------	-------	-------	-------	-------	-------	-------	-------	-------	-------	-------	-------	-------	-------	-------	-------	-------	-------	-------	-------	-------	-------	-------	-------	-------	-------	-------	-------	-------	-------	-------	-------	-------	-------	-------	-------	-------	-------	-------	-------	-------	-------	-------	-------	-------	-------	-------	-------	-------	-------	-------	-------	-------	-------	-------	-------	-------

Put this new design window in your lab

New delayed sweep... magnifies... eliminates jitter for...

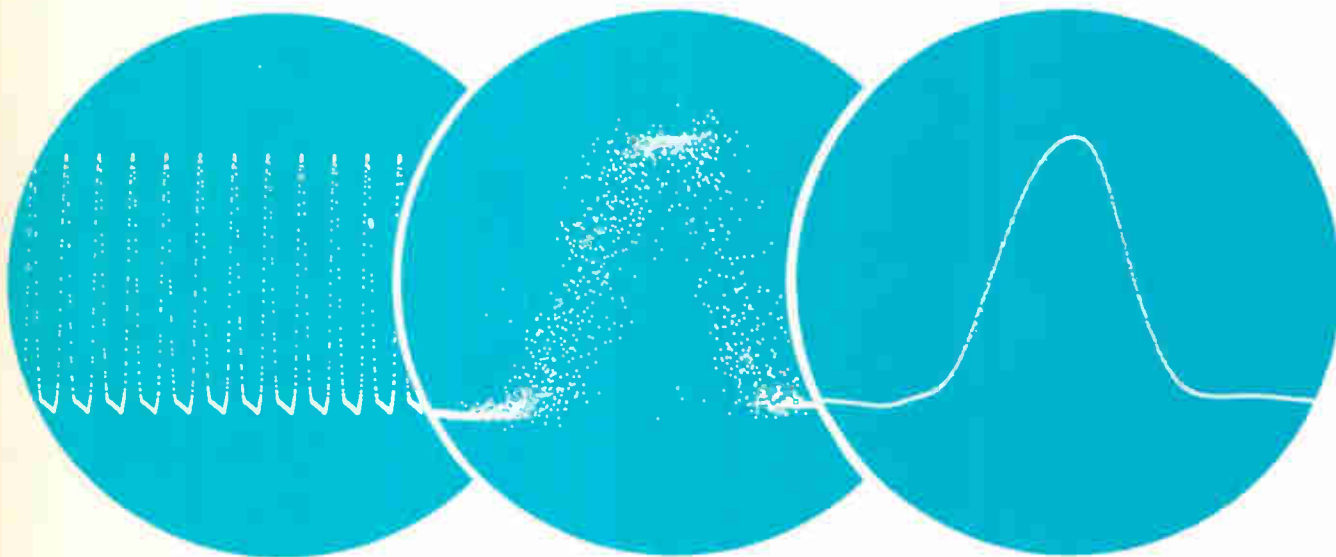

CLEAR DISPLAYS TO 1 GHz & BEYOND

Here is an analytical window that sheds new light on the characteristics of computer and other fast logic circuitry—anywhere, in fact, where complex waveforms or pulse trains are involved. Notice how it pulls the picture into focus.

Mainframe of this step-ahead sampling system is the hp 140A with standard CRT. For low rep-rate waveforms (5 kHz and below or long delay times) you get clear, steady displays with the "stop-action" variable persistence and storage features of the hp 141A mainframe. Solid-state sampling plug-ins include:

NEW 1425A TIME BASE & DELAY GENERATOR— first delayed sweep in sampling. You get sweep speeds from 10 psec/cm to 500 μ sec/cm, triggering to 1 GHz, delay times as long as 5 ms, automatic triggering, and a movable intensified dot making it easy to set up point of magnification. \$1600.

NEW 1410A DUAL-CHANNEL VERTICAL AMPLIFIER with 1 mv/cm sensitivity at 1 GHz. This plug-in gives you the convenience of high-impedance probes for circuit measurements, plus internal triggering for measurements in 50-ohm systems. \$1600.

Mainframe prices: 140A, \$595; 141A, \$1275.

For sampling through X band, the 1411A Dual-Channel 1 mv/cm Vertical Amplifier (\$700) functions with any of three remote samplers: 1430A with 28 psec

rise time for clean pulse response (\$3000), 1431A with 12.4 GHz bandwidth and low VSWR (\$3000), and the 1432A with 4 GHz bandwidth and 90 psec rise time (\$1000). With the versatile hp 140 Scope System, you get *better performance in any direction*: 20 MHz wide-band • TDR • high sensitivity with no drift • variable persistence and storage—and sampling.

For data on the new hp sampling scopes, write or call Hewlett-Packard, Palo Alto, Calif., 94304. Phone (415) 326-7000. In Europe, 54 Route des Acacias, Geneva.



HEWLETT  PACKARD
An extra measure of performance

087/20

From RCA Hometaxial-Base... The industry's most powerful plastic power transistors— Dissipation up to 83 Watts

TA7156

2N5037

TA7137

2N5034

Tomorrow's action needs are here today... as RCA, leader in silicon power, now introduces its famous Hometaxial-Base technology in plastic!

Eight transistors in all, RCA's new power program is the first to combine the low cost of plastic with brute power-handling ability—83 watts or 36 watts—each is an industry-high for plastic! And this power comes in your choice of package... a

straight-lead design for PC-board mounting or a bent-lead design compatible with standard TO-3 or TO-66 mounting techniques.

Performance is tops—RCA mounts the silicon chip directly onto a solid copper base for better current handling, thermal resistance, and dissipation capabilities. You get unsurpassed freedom from second breakdown... the inherent advantage of RCA Hometaxial-Base technology.

Put the cost and performance benefits of RCA plastic transistors in your circuits... they'll do the job for audio amplifiers and a broad range of industrial applications.

Call your RCA Representative for more information or write Commercial Engineering, Section IN4-3, Harrison, N. J. 07029.

Also available through your RCA distributor.

TYPE	PACKAGE	V _{CEK} (sus)	I _C	h _{FE}	θ _{J-C}	P _T @ 25°C
2N5036 2N5037	TO-3 equivalent P.C. type	60 V @ R _{θJ} = 100 ohms	8A	20-70 @ 3A	1.5 °C/W	83 W
2N5034 2N5035	TO-3 equivalent P.C. type	45 V @ R _{θJ} = 100 ohms	6A	20-70 @ 2.5A	1.5 °C/W	83 W
TA7155 TA2911	TO-66 equivalent P.C. type	60 V @ R _{θJ} = 100 ohms	4A	25-100 @ 0.5A	3.5 °C/W	36 W
TA7156 TA7137	TO-66 equivalent P.C. type	50 V @ R _{θJ} = -500 ohms	4A	20-120 @ 1A	3.5 °C/W	36 W

RCA Electronic Components and Devices



The Most Trusted Name in Electronics

Circle 902 on reader service card