

# Electronics®

Optoelectronics in memories: page 82

Designing with strip line, part II: page 90

Shifting to hybrid microcircuits: page 103

February 21, 1966

75 cents

A McGraw-Hill Publication

Below: Hybrid techniques produce a tiny  
stairstep voltage generator: page 110

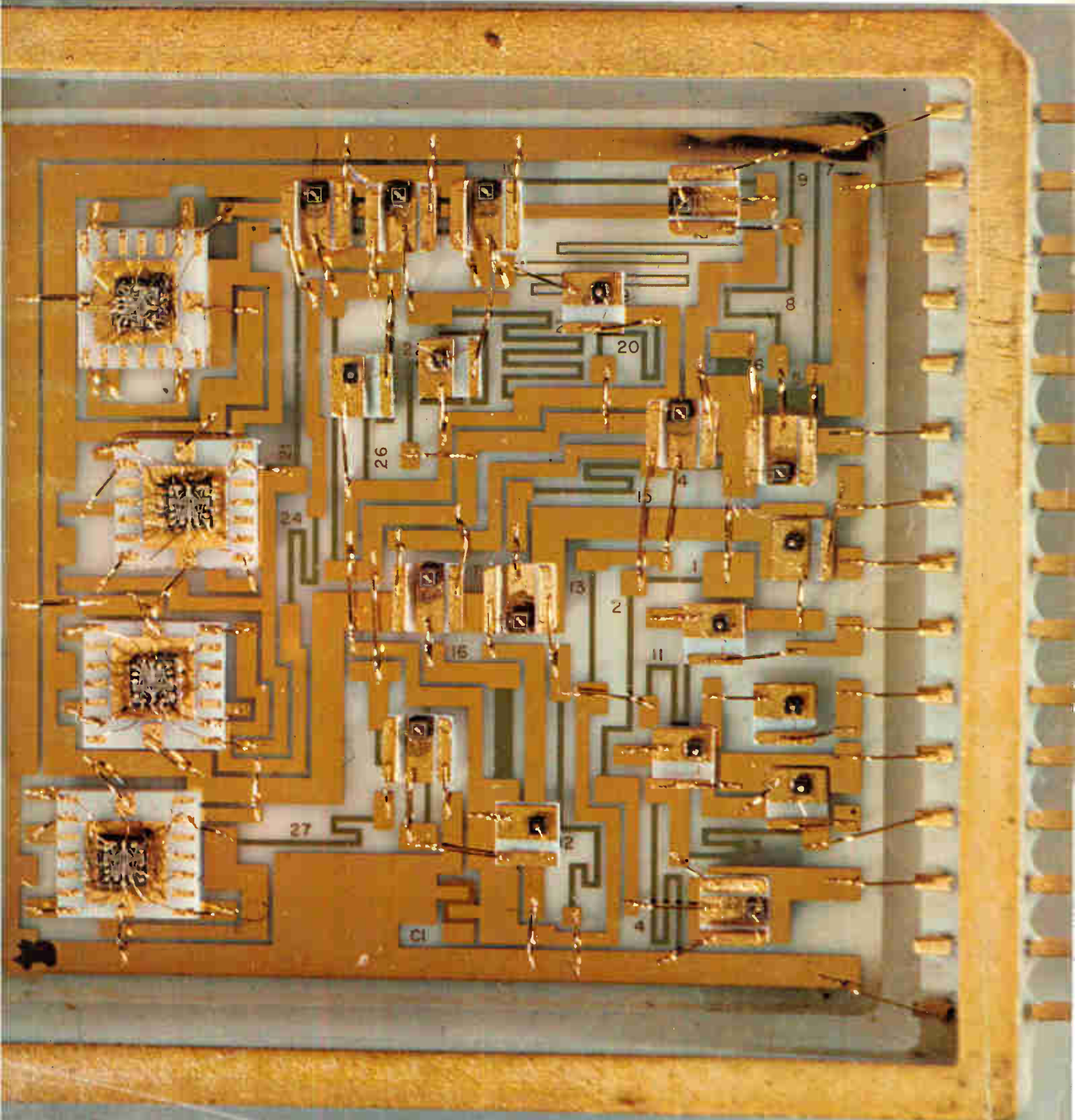



# The Coherent Tone Burst

## ... Has the Bandwidth Properties of a Pulse and the Tunability of a Pure Tone

The interrupted periodic wave produced by the GR Tone-Burst Generator is a most useful signal. Its measured, repeated ac transients can do what continuous waves and pulses cannot do.

The tone-burst signal is made up of a series of equally spaced energy bursts of equal duration, created by alternate passing and blocking of an external periodic signal — sine wave or otherwise. Each burst contains a precisely selected number of cycles of the periodic wave. Moreover, since the signal within one burst is coherent (phase-stable) with that in another burst, energy distribution within the frequency spectrum is precisely defined; thus, the tone-burst signal becomes an extremely useful test signal.

The frequency spectrum of a coherent tone-burst signal clearly shows how useful a signal it is, particularly for bandpass measurements. Unlike the single-line spectrum of the plain sine wave and the spectrum of the repetitive pulse (whose energy is tied to the origin and cannot be concentrated where you want it), the symmetrical spectrum of the coherent tone-burst signal can be shaped and placed

where it is needed. The tone burst's center frequency is simply that of the periodic wave from which the tone-burst signal is derived; consequently, the center frequency can be shifted easily. The tone burst's bandwidth can also be varied over an extremely wide range by adjustment of the number of cycles in the burst and the number of cycles between bursts. Thus, the test signal can be "tailored" and located in the frequency spectrum to fit your measurement needs exactly.

In a test, 31-cycle bursts of a 10-kc sine wave were used to measure the transient response of a circuit resonant above 10 kc/s. The upper trace of the oscillogram is that of the tone-burst signal; the lower trace shows the signal after it has passed through the circuit. Rise and fall times are easily measured on this trace, and overshoot and ringing are clearly visible.

The tone-burst generator is useful in many other applications including telemetry-signal simulation, sonar testing, and amplifier recovery-time measurements. For more information about this versatile instrument, write for the preprint "A Generator of AC Transients." Instrument Note IN-105, a detailed analysis of the Fourier frequency spectrum of tone-burst signals, is also available on request.

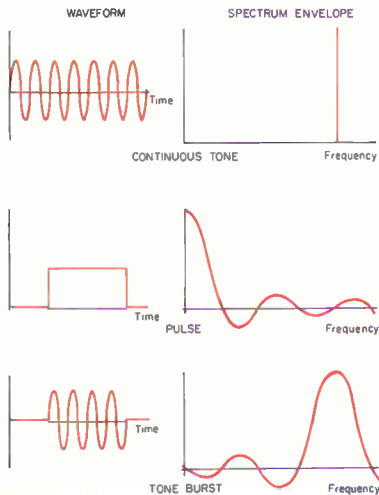
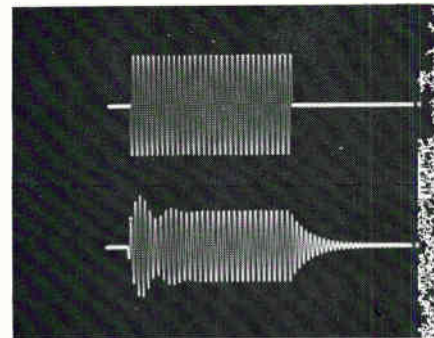

Type 1396-A Tone-Burst Generator . . .

a coherent gate for any waveform . . . produces tone-burst signals with the coherence necessary for accurate, reproducible measurements.

### CONDENSED SPECIFICATIONS

**Signal Input** (to be supplied by an external generator or oscillator);  
Frequency Range: DC to 500 kc/s.  
Maximum Voltage Level:  $\pm 7$  volts (5 volts, rms).

**Gate Timing:** Gate-open and -closed intervals can be independently set to 2, 4, 8, 16, 32, 64, or 128 cycles (periods) of timing signal. By means of a MINUS ONE switch, intervals can be set to 1, 3, 7, 15, 31, 63, or 127 cycles. The gate-closed intervals can also be timed in increments of one period of timing signal from 1 ms to 10 s.

**Gate-Open Output:** Maximum signal level is  $\pm 7$  volts (5 volts, rms).

**Gate-Closed Output:** Less than 140 millivolts, peak-to-peak ( $-40$  dB), with maximum signal input.

**Switching Transients:** Less than 140 millivolts, peak-to-peak ( $-40$  dB compared to maximum signal input).

**Size:** 8 by 5 $\frac{7}{8}$  by 7 $\frac{1}{2}$  inches, over-all.

**Price:** \$490 in U.S.A.

Write for Complete Information

## GENERAL RADIO COMPANY

WEST CONCORD, MASSACHUSETTS

IN CANADA: Toronto 247-2171, Montreal (Mt. Royal) 737-3673  
IN EUROPE: Zurich, Switzerland - London, England

BOSTON (W. Concord) 646-0550    NEW YORK, N. Y., 964-2722 (Ridgefield, N. J.) 943-3140    CHICAGO (Oak Park) 848-9400    PHILADELPHIA (Ft. Washington) 646-8030    WASHINGTON, D.C. (Rockville, Md.) 946-1600    SYRACUSE 454-9323    DALLAS FL 7-4031    SAN FRANCISCO (Los Altos) 948-8233    LOS ANGELES 469-6201    ORLANDO, FLA. 425-4671    CLEVELAND 886-0150

Circle 900 on reader service card

# INKLESS

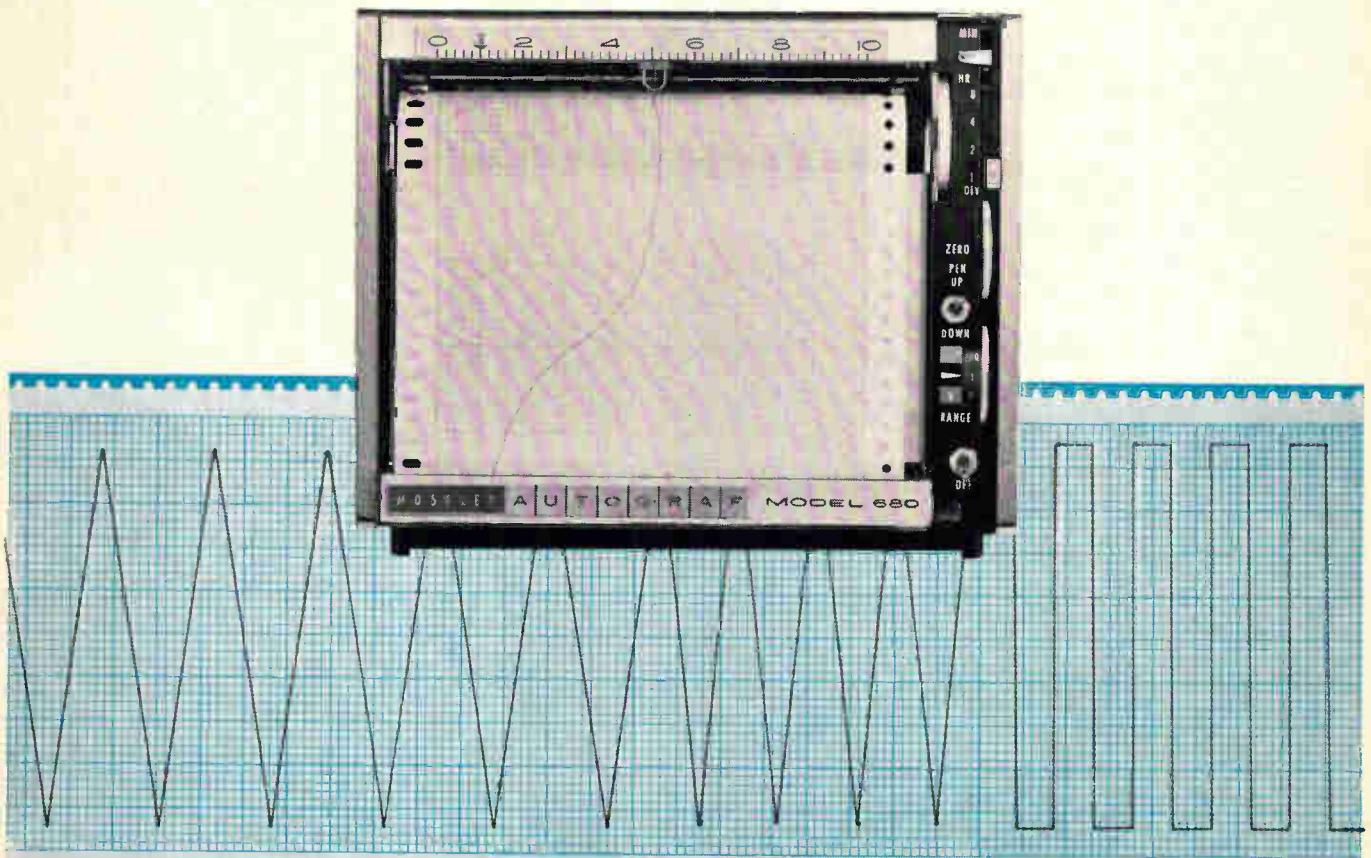

## NEW STRIP-CHART WRITING TECHNIQUE:

**Ends pen clogging, ink drying  
Gives clear, clean traces  
Provides new economy**

New Hewlett-Packard electrosensitive paper, available as a standard option on Moseley 680 and 7100 Series Strip-Chart Recorders, ends the problems associated with pen-and-ink writing techniques... at an economical price and without the disadvantages inherent in other available electric writing methods.

The Hewlett-Packard electrosensitive paper is a special electro-chemical coated chart paper. The coating is current sensitive, changing to a dark brown trace with application of voltage from the recorder stylus. The new technique eliminates the familiar arc method of electric writing on carbon-backed paper.

With Hewlett-Packard electric writing, you can use your strip-chart recorders for long-term, unattended monitoring, with increased performance at slow writing speeds, as well as at high writing speed. It is non-

pressure sensitive, so that you can't damage or obscure your recordings.

Here's another advance in recording capability from Hewlett-Packard. Call your Hewlett-Packard field engineer for information on converting your strip-chart recorder to maintenance-free electric writing. Or write for information: Hewlett-Packard, Palo Alto, California 94304, Tel. (415) 326-7000; Europe: 54 Route des Acacias, Geneva.

*Data subject to change without notice.*

**HEWLETT  
PACKARD**  **MOSELEY  
DIVISION**

Visit The Moseley Division of Hewlett-Packard at IEEE 3rd Floor New York Coliseum, March 21-24

1189

## Working within an increasingly congested spectrum

Equipment designers and system engineers, working in a spectrum that daily grows more crowded, find an ever-increasing need to identify, perfect and then document the spectrum signature of their equipment or system. Historically, signature gathering has been a time-consuming, expensive process. Worse than that, it's usually required at a critical stage of design work, when time is at a premium.

Modern spectrum analysis affords welcome relief, because acquisition of signatures has become virtually instantaneous, using the Hewlett-Packard 851B/8551A Spectrum Analyzer, in conjunction with the hp 196B Oscilloscope Camera.

Major innovations in spectrum analyzer design, incorporated in the 851B/8551A, not only save time, but also improve the definition of the signature "finger-print." These include calibrated spectrum widths to 2 gc, 60 db of calibrated display dynamic range, 4 gc image separation and flat response, free of spurious and residual signals.

Broadband signatures, with the 2 gc spectrum width, are instantaneous and calibrated, and the wide display dynamic range permits analysis of both weak and strong signals in the spectrum. Narrowband displays, useful, for example, in examining modulation, are equally simple with the 851B/8551A, which offers stable traces to 10 kc/cm, derived from a unique sampling phase-lock system within the spectrum analyzer.

Increased versatility . . . and resulting savings in time . . . guided the design philosophy behind the "open" front end of the hp spectrum analyzer. This "open" front end (no pre-selection), which accepts signals from 10 mc to 12.4 gc (to 40 gc with additional waveguide mixers), permits simplest adaptation to the greatest number of measurement requirements. This design technique provides for the use of economical accessory filters, where some form of pre-selection might be desired (i.e., low-pass or band-pass filters, such as the hp 360 Series or 8430 Series). Appropriate pre-amps also are applicable, where increased sensitivity is required. Extreme resolution of close-in signals (even those of greatly different amplitudes) can be achieved with the hp 8442A Crystal Filter.

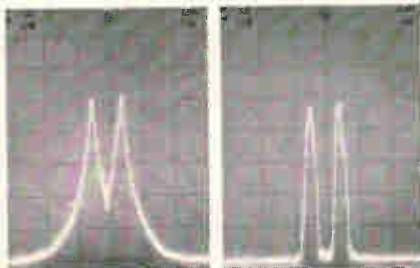

The increased resolution possible with the hp 8442A 1 kc filter is demonstrated here, with the normal 1 kc bandwidth display on the left, the display with the 8442A installed on the right; horizontal scale 10 kc/cm at 150 mc, vertical 10 db/cm.

## new uses for SPECTRUM ANALYSIS



Viewing of transients, often missed when slow-tuned receiver/recorder systems were used for time-consuming signature work, is preserved simply and economically with the 851B/8551A and the 196B Camera, as demonstrated here:

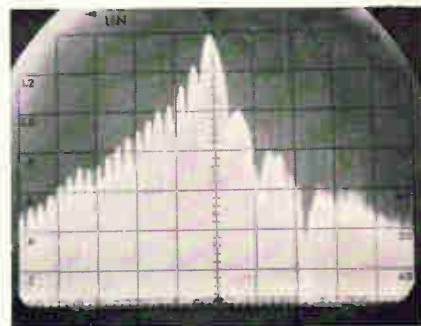

Spectrum signature of L-Band radar (horizontal 3 mc/cm, vertical 10 db/cm); 851B/8551A wide display dynamic range allows viewing of magnetron moding and transients 40-50 db below pulse main lobe.

The problems discussed here are typical of many others prevalent and growing in the congested spectrum. That's why the 851B/8551A is gaining in importance . . . and application . . . as a modern tool of spectrum analysis.

*A complete technical discussion of spectrum signature and other new or improved techniques of spectrum analysis is presented in Application Note 63A ("More on Spectrum Analysis"), a supplement to the earlier Application Note 63. You may get your copy, plus information on the 851B/8551A, from your hp field engineer. Or write directly to Hewlett-Packard, Palo Alto, California 94304, Tel. (415) 326-7000; Europe: 54 Route des Acacias, Geneva; Canada: 8270 Mayrand Street, Montreal.*

*Data subject to change without notice.*

See the Hewlett-Packard spectrum analyzer at IEEE, 3rd Floor, New York Coliseum, March 21-24.

**HEWLETT  PACKARD**

*An extra measure of quality*

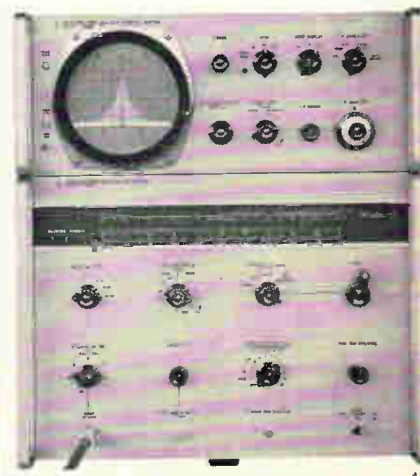

461

# Electronics

February 21, 1966  
Volume 39, Number 4

Page	4	Readers Comment
	8	People
	14	Meetings
	16	Meeting Preview
	23	Editorial
	25	Electronics Newsletter
	67	Washington Newsletter
	163	New Products
	223	New Books
	224	Technical Abstracts
	232	New Literature

## Electronics Review

Page	31	Scr's on wheels	36	Steerable parachutes
	32	Supermode laser	38	Military communi- cations
	33	Broadband antennas	40	Space computer
	34	Shadow mask	41	Electronics notes
	34	Tunnel radio		

## Probing the News

135	Microwave IC's: hybrid or monolithic?
146	Microwave power struggle
147	Trio of scientists
148	Field effect or bipolar arrays?
149	Two approaches to IC microwave design
150	New devices described
154	The quiet explosion around Washington

## Electronics Abroad

235	Messages from the moon	237	Weather eye
		237	Counterattack in IC's
236	Earthbound computers	238	Time to share
		239	Around the world
236	Color tv on tape		

## Technical Articles

### I. Design

<b>Optoelectronics</b>	82	<b>Storing data with light</b> Optical memory has the advantages of isolation, low dispersion, parallel propagation and high resolution Richard D. Stewart, General Electric Co.
<b>Circuit design</b>	87	<b>Designer's casebook</b> <ul style="list-style-type: none"><li>▪ Tunnel-diode pulser measures cable delay</li><li>▪ Fast pulse generators test digital circuit delay</li><li>▪ Simple mercury relay circuit develops single, clean pulse</li></ul>
<b>Microwave</b>	96	<b>Using strip transmission line to design microwave circuits, part II</b> Modulators, tunnel-diode amplifiers and antennas are small but good performers J.R. Dangi and K.P. Steele, Sylvania Electronic Systems

### II. Manufacturing

<b>Packaging</b>	103	<b>Converting to microelectronics</b> The change requires a new design and closer ties between design and manufacture Fred A. Plemenos, Raytheon Co.
		<b>Ceramic handles and ultrasonic bonders upgrade hybrid assembly (cover)</b> New method eliminates two of the major causes of failure in hybrid microcircuits W.L. Shockley and R.W. Weedfall, Collins Radio Co.
		<b>Modular arrays—the path to single-circuit systems</b> Analog subsystems are packaged so they contain large numbers of monolithic chips in one package H.T. Melcher, Honeywell Inc.

Title R registered  
U.S. Patent Office;  
© copyright 1966  
by McGraw-Hill, Inc.  
All rights reserved,  
including the right to  
reproduce the contents  
of this publication,  
in whole or in part.

# Electronics

**Editor:** Lewis H. Young

**Senior editors**

**Technical:** Samuel Weber

**News:** Kemp Anderson Jr.

**Senior associate editors:** John F. Mason, George Sideris

**Department editors**

**Advanced technology:** Joan Blum

**Avionics:** W.J. Evanzia

**Circuit design:** Michael Elia

**Computers:** Wallace B. Riley

**Consumer electronics:** Richard Lipkin

**Electronics review:** Stanley Zarowin

**Instrumentation:** Carl Moskowitz

**Manufacturing:** George Sideris

**Military electronics:** John F. Mason

**New products:** William P. O'Brien

**Solid state:** Jerome Eimbinder

**Space electronics:** Peter R. Sigmund

**Regional editors**

**Bonn:** John Gosch

**Boston:** Thomas Maguire, editor; Robin Carlson

**London:** Derek Barlow

**Los Angeles:** William B. Wallace, Walter Barney, editors; June Ranill

**San Francisco:** Laurence D. Shergalis, Edmond G. Addeo, editors; Mary Jo Jadin

**Tokyo:** Charles Cohen

**Copy editors**

Howard Rausch, Sally Powell, Kenneth Munn, James J. Moran

**Graphic design**

**Art director:** Saul Sussman

**Assistant art director:** Donna M. Griffiths

**Editorial production:** Ann Mella

**Production editor:** Arthur C. Miller

**Editorial secretaries:** Claire Benell, Mary D'Angelo, Lynn Emery, Lorraine Fabry, Kay Fontana, Lorraine Longo, Carolyn Michnowicz

**McGraw-Hill News Service**

**Director:** John Wilhelm; **Atlanta:** Fran Ridgway; **Chicago:** Reck Johnson;

**Cleveland:** Arthur Zimmerman; **Dallas:** Marvin Reid;

**Detroit:** N. Hunter; **Houston:** Ron Lovell; **Los Angeles:** Michael Murphy, Gerald Parkinson;

**San Francisco:** Margaret Ralston;

**Seattle:** Ray Bloomberg; **Washington:** Arthur L. Moore, Charles Gardner,

Herbert W. Cheshire, Seth Payne, Warren Burkett, Warren Kornberg

**McGraw-Hill World News Service**

**Bonn:** John Johnsrud; **Brussels:** Arthur Erikson; **London:** John Shinn;

**Mexico City:** Bruce Cross; **Milan:** Ronald Taggiasco;

**Moscow:** Donald Winston; **Paris:** Dan Smith;

**Rio de Janeiro:** Leslie Perry; **Tokyo:** Marvin Petal

**Circulation manager:** Hugh J. Quinn

**Reprints:** T.M. Egan

**Publisher:** C.C. Randolph

**Electronics:** February 21, 1966, Vol. 39, No. 4

Printed at 99 North Broadway, Albany, N.Y., 12207  
Second class postage paid at Albany, N.Y.

Subscriptions are solicited only from those actively engaged in the field of the publication. Position and company connection must be indicated on orders. Subscription prices: United States and Possessions and Canada, \$6.00 one year, \$9.00 two years, \$12.00 three years. All other countries \$20.00 one year. Single copies, United States and Possessions and Canada 75¢. Single copies all other countries \$1.50.

Published every other Monday by McGraw-Hill Inc. 330 West 42nd Street, New York, N.Y. 10036, Founder: James H. McGraw, 1860-1948. Corporate officers: Shelton Fisher, President; John J. Cooke, Secretary; John L. McGraw, Treasurer.

Subscribers: The Publisher, upon written request to our New York office from any subscriber, agrees to refund that part of the subscription price applying to copies not yet mailed. Please send change of address notices, subscription orders or complaints to Fulfillment Manager, Electronics, at the address below. Change of address notices should provide old as well as new address, including postal zone number if any. If possible, attach address label from recent issue. Allow one month for change to become effective.

Postmaster: Please send Form 3579 to Fulfillment Manager, Electronics, P.O. Box 430, Hightstown, New Jersey 08520

## Readers Comment

### Setting the record straight

To the Editor:

In the article "A record problem" [Dec. 27, 1965, pp. 39-40]. You correctly state that United Data Control, Inc. is one of two firms whose advanced design Flight Data Recorder is slated for future FAA testing. It is incorrect, however, to say that United Data Control, Inc. is a division of the Control Data Corp.

United Data Control, Inc., in South El Monte, California, is a subsidiary of the United Control Corp. Redmond, Washington.

Leo H. Cross

United Control Corp.  
Redmond, Wash.

### Repetition

To the Editor:

While reading Electronics [Dec. 13, 1965, p. 76] my attention was caught by a feature in the Designer's casebook—the improved one-shot circuit by Jozek Kalisz of Warsaw, Poland.

This circuit is very familiar to me since we have used it in the design of Philips circuit blocks since 1963.

Perhaps I have a suspicious mind, but I can't help wondering whether our data sheets have found their way to Poland.

Heinrich van Bruck  
N.V. Philips' Gloeilampenfabrieken  
Eindhoven, Netherlands

■ Or possibly it's another case of an engineer developing something which has been developed already.

### Patented transformer

To the Editor:

I read with interest the item, "D-c transformer? Yes—at—450° F" [Feb. 7, p. 25].

In particular, the following statements describing the transformer attracted my attention: "The bottom thin film is the primary and the top film is the secondary. If two thin films are deposited in either layer and connected in series, the transformation ratio becomes 2 to 1 or 1 to 2."

This is exactly the sort of super-

# New from Sprague!

**This Resistor has 5 Times the Resistance of a Conventional Metal-Film Resistor of Equal Size!**

**This Resistor is 21 Times Smaller than a Conventional Metal-Film Resistor with Equal Resistance Value!**

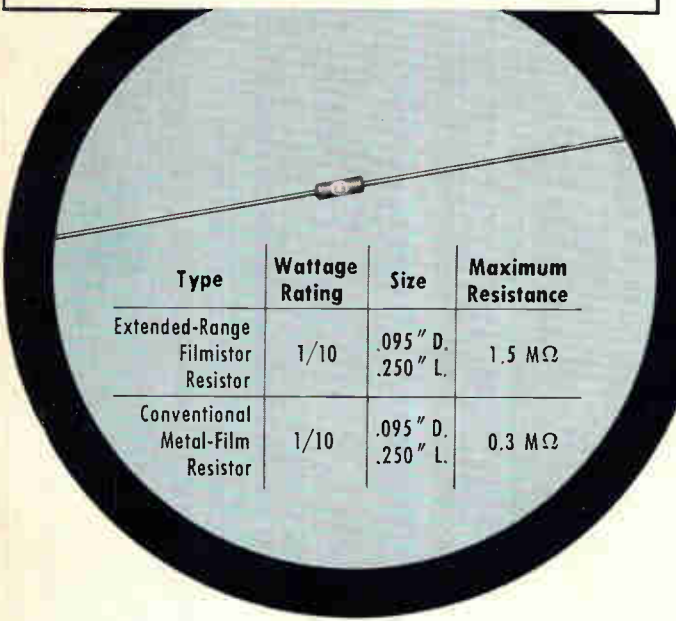

Type	Wattage Rating	Size	Maximum Resistance
Extended-Range Filmistor Resistor	1/10	.095" D. .250" L.	1.5 M $\Omega$
Conventional Metal-Film Resistor	1/10	.095" D. .250" L.	0.3 M $\Omega$

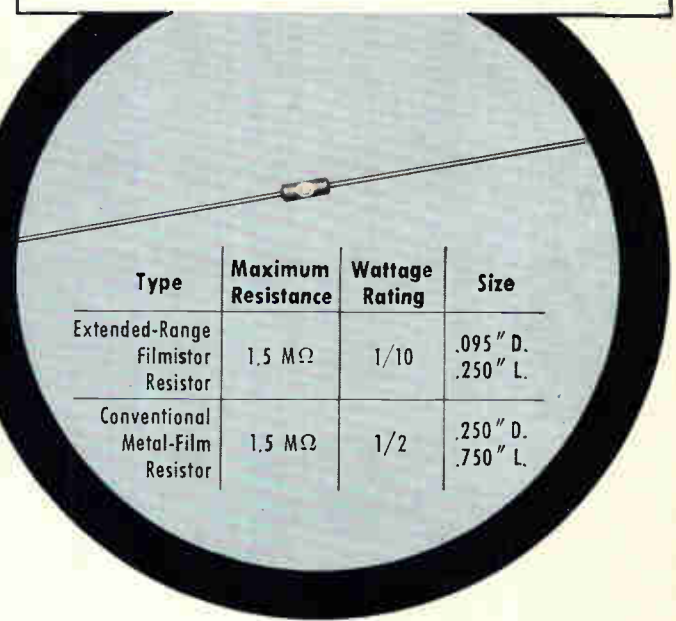

Type	Maximum Resistance	Wattage Rating	Size
Extended-Range Filmistor Resistor	1.5 M $\Omega$	1/10	.095" D. .250" L.
Conventional Metal-Film Resistor	1.5 M $\Omega$	1/2	.250" D. .750" L.

## Both Resistors are one and the same...they're Sprague's new **EXTENDED-RANGE FILMISTOR<sup>®</sup> METAL-FILM RESISTORS**

Substantial saving of space in all wattage ratings—1/20, 1/10, 1/8, 1/4, 1/2, and 1 watt—with absolutely **NO SACRIFICE IN STABILITY!**

New manufacturing techniques at Sprague Electric have made possible a major breakthrough in resistance limits for metal-film resistors. Extended-Range Filmistor Resistors now offer, in addition to accuracy . . . stability . . . reliability . . . extended resistance values in size reductions which were previously unobtainable. Size and weight advantages of Filmistor Resistors now make them the ideal selection for applications in high-impedance circuits, field-effect

transistor circuits, etc., where space is at a premium. Many designs which previously had to settle for the higher temperature coefficients of carbon-film resistors in order to obtain required resistance values can now utilize the low and controlled temperature coefficients of Filmistor Metal-Film Resistors.

Other key features are  $\pm 1\%$  standard resistance tolerance, low inherent noise level, negligible voltage coefficient of resistance, and tough molded case for protection against mechanical damage and humidity.

*For complete technical data, write for Engineering Bulletin 7025C to Technical Literature Service, Sprague Electric Company, 35 Marshall Street, North Adams, Massachusetts 01248.*

### SPRAGUE COMPONENTS

RESISTORS  
CAPACITORS  
TRANSISTORS  
THIN-FILM MICROCIRCUITS  
INTEGRATED MICROCIRCUITS

PULSE TRANSFORMERS  
INTERFERENCE FILTERS  
PULSE-FORMING NETWORKS  
TOROIDAL INDUCTORS  
ELECTRIC WAVE FILTERS

CERAMIC-BASE PRINTED NETWORKS  
PACKAGED COMPONENT ASSEMBLIES  
BOBBIN and TAPE WOUND MAGNETIC CORES  
SILICON RECTIFIER GATE CONTROLS  
FUNCTIONAL DIGITAL CIRCUITS

**SPRAGUE<sup>®</sup>**  
THE MARK OF RELIABILITY

\*Sprague<sup>®</sup> and <sup>®</sup> are registered trademarks of the Sprague Electric Co.

**Speed, up to 150 characters per second,  
bidirectional and asynchronous . . . fast front  
loading . . . new simplified read head with fewer  
parts for greater life and easier maintenance.**

## **NEW TALLY TAPE READERS GIVE YOU MORE BITS PER DOLLAR . . . LONGER**



Tally "R" series readers mark an important advance in the evolution of perforated tape technology. Offering a new combination of speed, price, and performance unmatched by any remotely comparable device, they are your best value today—and tomorrow.

Here are some of the reasons why. Because of edgeless guiding and a four point

starwheel, these readers read tape longer and more accurately—even out-of-tolerance tape. Tape wear is virtually eliminated by starwheel reading. You can comfortably expect tape life to exceed 1,000 passes on any Tally reader. "R" series readers will read any tape material without regard to color, thickness, or opacity. They will read 5, 6, 7, or 8 level tapes without modification or adjustment.

New "R" series readers are available in either 75 or 150 character per second versions. They are offered in table top console without reeling or standard rack

mount with or without integral reel tape handling.

Let us send you the details. Address Mr. Ken Crawford, Tally Corporation, 1310 Mercer Street, Seattle, Washington 98109, Phone: (206) MA 4-0760. TWX: (910) 444-2039. In the U.K. and Europe, address our man in London, H. Ulijohn, Tally Europe Ltd., Radnor House, 1272 London Road, London, S.W. 16, England, Phone: POLlards 9199.

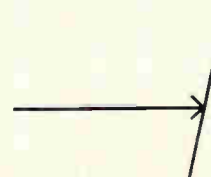

 **TALLY**



conductive transformer covered by my U. S. patent 3,124,679 applied for July 29, 1959, and issued Oct. 26, 1965.

R. K. Richards

Ames, Iowa

### Space veteran

To the Editor:

In the Dec. 27 issue [p. 26] you stated that "IT&T has built the first portable transceiver for use on a space mission." This is not true.

A Sperry Phoenix battery—powered uhf emergency beacon and transceiver has been a part of the personal survival pack of every Gemini astronaut to date and will be carried on all future Gemini flights. In addition it will be carried by all Apollo astronauts.

While it is intended primarily to facilitate the location and recovery of astronauts after landing or in the event of an emergency abort, it could be used in a space environment either connected to the spacecraft antenna or by utilizing the built in flexible steel antenna.

John Kosiek

Sperry Phoenix Co.  
Division of Sperry Rand Corp.  
Phoenix, Ariz.

### Japan's influence

To the Editor:

In the editorial of December 13, 1965, you mention that "nearly every U. S. consumer-products company uses Japanese devices—an impressive fact." To every U. S. manufacturer competing against Japanese devices, the fact is neither impressive nor surprising. The implication in your editorial and article is that their industry is no

longer built on cheap labor. The fact of the matter, however, is that Japanese labor (overhead as well as direct) is still three or four times as cheap as in the U. S. and this is still the principal reason U. S. consumer-products companies use their products.

The primary commodity being imported is cheap labor no matter how you camouflage it in print.

L. G. Mumford

Electronic Components Div.  
General Electric Co.  
Owensboro, Ky.

▪ Electronics was saying that Japanese companies are not relying solely on cheap labor these days because labor rates are rising rapidly and astute Japanese see the time when this advantage will be dissipated. The point of the editorial was that too few U. S. companies are taking advantage of two factors the Japanese fear: automation and the pace of technology. The editorial and the articles on Japanese technology also pointed out that the Japanese have been very clever with their product planning, striving to develop products that are not duplicated in the U. S.

### A 100° error

To the Editor:

In our article, "Diode sheds its costly package with beam-lead construction" [Jan. 24, p. 77], one fairly important error crept in. The article states on page 81 that the temperature of the 1,500-hour life test was 55°C. Actually, the temperature of the test was 155°C.

J. Earl Thomas Jr.

and Alan S. Esbitt

General Instrument Corp.  
Newark, N. J.

# collage

*A random collection of fact, opinion and miscellany... some of it a blatant attempt to peddle the products and capabilities of Motorola's Military Electronics Division.*

If this looks vaguely familiar it's because you've probably seen our humble little periodical that also bears the name, COLLAGE. In a bold effort to save a little time and a few bucks some genius in the Motorola hierarchy decided we ought to print a few of its less censorable items in high-class magazines like this.

## At the forefront etc. Department



Our Chicago Center has developed a solid-state light deflector composed of alternate crystals of electro-optical materials and birefringent calcite. It is capable of both matrix and continuous character generation, and can distribute information onto photosensitive media or display screens. As of press time, no one is quite sure if we are selling these things or just bragging. If you get nasty though, we may send a recent *Engineering Bulletin* that tells about it. We're also pretty big on high-speed non-impact printers, but that's a story all in itself that we'll save for a later day. For more information, write to our Chicago Center.

*Continued on page 149*

### SUBSCRIPTION SERVICE

Please include an Electronics Magazine address label to insure prompt service whenever you write us about your subscription.

Mail to: Fulfillment Manager  
Electronics  
P.O. Box 430  
Hightstown, N.J. 08520

To subscribe mail this form with your payment and check  new subscription  renew my present subscription

Subscription rates: in the U.S.: 1 year, \$6; two years, \$9; three years, \$12. Subscription rates for foreign countries available on request

### CHANGE OF ADDRESS

ATTACH LABEL HERE

If you are moving, please let us know five weeks before changing your address. Place magazine address label here, print your new address below.

name \_\_\_\_\_

address \_\_\_\_\_

city \_\_\_\_\_

state \_\_\_\_\_

zip code \_\_\_\_\_

# Where can you find the world's largest selection of HF antennas?

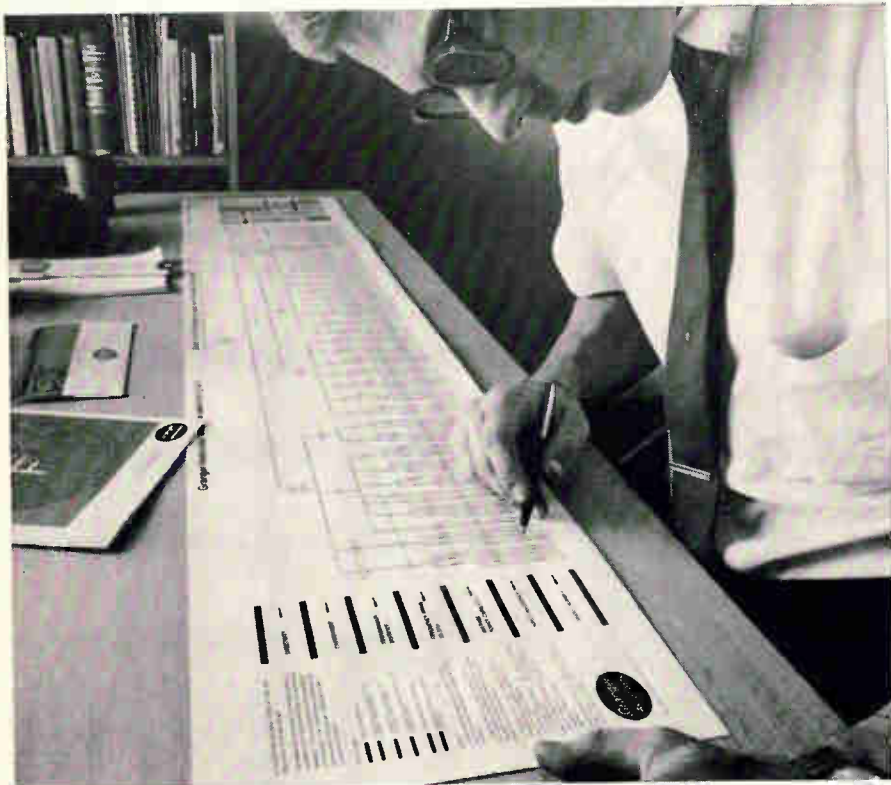

## Granger Associates has the answer

**now** The world's largest selection of HF antennas is spread out for your consideration on G/A's new Antenna Selection Chart — now free for the asking. You'll find 188 different antennas, all fully developed, proven and available. When you need an HF antenna, one of these standard models is likely to meet your requirements superbly.

This full-color chart helps you quickly locate the antenna you need. You simply trace your requirements for directivity, transmission distance, frequency range, power capacity, input impedance, and ability to withstand wind and ice.

The chart is only the beginning of the antenna service available from Granger Associates. If you wish, G/A will provide all services from the initial propagation analysis to final on-site testing.

CAREER OPPORTUNITIES FOR ENGINEERS IN ANTENNAS AND TRANSMISSION PRODUCTS

SEND THIS COUPON FOR FREE ANTENNA SELECTION CHART

Gentlemen:  
Please send me  
your HF antenna  
selection chart.

NAME \_\_\_\_\_

TITLE \_\_\_\_\_

ORGANIZATION \_\_\_\_\_

ADDRESS \_\_\_\_\_

ZIP \_\_\_\_\_

**Granger  
Associates**

73

Granger Associates, 1601 California Ave., Palo Alto, California 94304  
or  
Granger Associates Ltd./Russell Hse., Molesey Rd., Walton-on-Thames, Surrey, England

## People

When the Stewart-Warner Corp. decided to concentrate on digital circuits, one of its first moves was to name **John P. Gates**

manufacturing manager of its microcircuits division in Sunnyvale, Calif. Gates had been manager of digital integrated circuits at the Fairchild Camera & Instrument Corp.'s semiconductor division in Mountain View, Calif. He is the first member of a new staff with the assignment of gathering a larger share of the digital circuit market and forgetting about selling linear circuits or other custom designs. The new team replaces four recently released key employees [Electronics, Jan. 24, p. 26].



The first key employee released was William B. Hogle, formerly executive vice president and general manager; his wife, Frances Hogle, director of research and engineering; Tom Prosser, an expert in linear circuit design; and William Perrine, manufacturing manager.

According to Gates, the primary job now is to overcome production problems that have plagued Stewart-Warner. "We're trying to raise yields and lower costs, a perennial battle in this industry," he says. "Until we can do it, our 1966 plan to hit the digital circuit field in flatpacks and dual in-line packages is considerably hampered."

To help overcome the production problems, Stewart-Warner has transferred almost all of its engineering and research department to manufacturing operations. The company has also brought in Jack Coffey, formerly the Chicago-based sales manager, to become general manager of the microcircuits facility. By the end of this year, Stewart-Warner hopes to be able to compete more effectively with the leaders in the digital circuit field.

Gates was with Fairchild for three years. He has two master's degrees, one in electrical engineer-

# Power Tube Breakthrough Permits Nearly 100 to 1 Grid to Plate Current Division

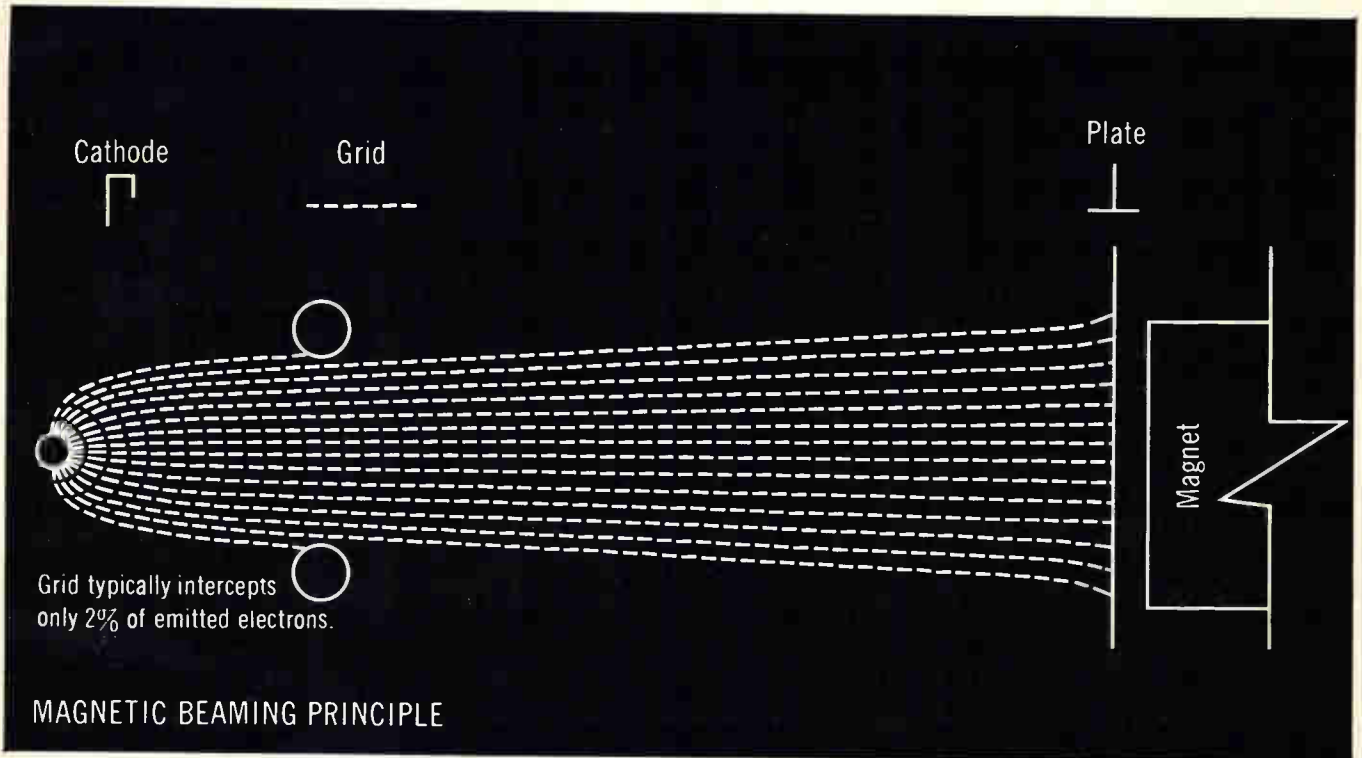

Machlett research has led to a new magnetic beaming principle for use in grided power tubes. This breakthrough in power tube design results in higher power gain, increased tube efficiency, and maximum double-sided cathode utilization. As shown above (in simplified single-sided form), a permanent magnet, placed external to the active tube elements, controls the electron trajectory from cathode to plate so that only a negligible amount of electrons are intercepted by the grid—typically 2% as opposed to 20% in conventional tubes. Grid dissipation is no longer the limiting factor in tube operation. Magnetic beaming is being applied to an expanding line of Machlett triodes and tetrodes. Whether you require high power/high voltage triodes or tetrodes, UHF planar triodes, X-ray tubes or vidicons, or if you need assistance in research or design development, write The Machlett Laboratories, Inc., Springdale, Conn. 06879



A SUBSIDIARY OF RAYTHEON COMPANY

**New from Sprague!**



# LOW COST DUET<sup>★</sup> 3N123 DUAL-EMITTER CHOPPER TRANSISTORS

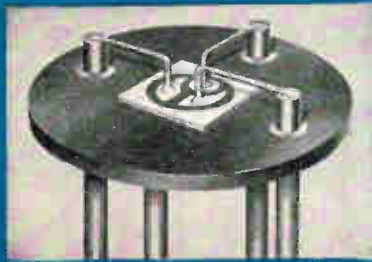

**CHECK THESE FEATURES!**

$BV_{EEO} > 25 \text{ VOLTS}$

$|V_o| < 250 \mu V$

$|\Delta V_o / T_A| < 2.3 \mu V \text{ per } ^\circ C$

$f_t > 6 \text{ mc}$

## HIGH VOLTAGE! RELIABLE PLANAR CONSTRUCTION!

Sprague offers more dual-emitter transistor types than any other source!

TYPE No	$BV_{EEO}$ (volts)	$V_o$ ( $\mu V$ )	TYPE No.	$BV_{EEO}$ (volts)	$V_o$ ( $\mu V$ )	TYPE No.	$BV_{EEO}$ (volts)	$V_o$ ( $\mu V$ )	TYPE No.	$BV_{EEO}$ (volts)	$V_o$ ( $\mu V$ )	TYPE No.	$BV_{EEO}$ (volts)	$V_o$ ( $\mu V$ )
3N90	30	50	3N95	50	200	3N104	20	50	3N109	50	150	3N116	12	200
3N91	30	100	3N100	10	50	3N105	15	250	3N110	30	30	3N117	20	50
3N92	30	200	3N101	30	50	3N106	30	250	3N111	30	150	3N118	20	100
3N93	50	50	3N102	40	50	3N107	50	250	3N114	12	50	3N119	20	200
3N94	50	100	3N103	50	50	3N108	50	30	3N115	12	100	3N123	25	250

\*1120000

For complete information, write to Technical Literature Service,  
Sprague Electric Co., 35 Marshall St., North Adams, Mass. 01248

**SPRAGUE COMPONENTS**

- TRANSISTORS
- CAPACITORS
- RESISTORS
- THIN-FILM MICROCIRCUITS
- INTEGRATED CIRCUITS
- INTERFERENCE FILTERS
- PACKAGED COMPONENT ASSEMBLIES
- FUNCTIONAL DIGITAL CIRCUITS
- MAGNETIC COMPONENTS
- PULSE TRANSFORMERS
- CERAMIC-BASE PRINTED NETWORKS
- PULSE-FORMING NETWORKS

455-0155R1



'Sprague' and '(S)' are registered trademarks of the Sprague Electric Co.

**People**

ing from Stanford University and the other in business administration from Santa Clara University.

"When I first started in oceanographic research 14 years ago, I had to worry about keeping wires dry. We've gone a long way since then. Now, with many of these basic problems solved and with larger budgets to work with, we can turn to the theoretical aspects of collecting data from the ocean." Speaking is **Edward W. Johnson**, the new manager of product administration for the Ocean Systems Group of Litton Industries, Inc.'s Ainecom division in Silver Springs, Md.

Johnson's job is the development of instruments for gathering information about the world beneath the waves. "The day will come," he speculates, "when a worldwide network of instruments will be deployed to collect data about the undersea environment."

Currently, Johnson is working on one part of that possible network: deep-moored buoys. Under a Navy contract, Litton is developing instrument packages that can be submerged in 15,000 feet of water. The underwater capsules will be able to collect such data as temperature and pressure and telemeter it to data-collection bases.

The trend now, he explains, is the conversion of analog data-collection systems to digital systems, because digital information can be transmitted and analyzed more easily.

**Starts with fish.** Johnson became involved in oceanography through his studies of biology and chemistry at Shepherd College; he received a master's degree from the University of Maryland. His hope was to become a fish-conservation expert with the federal government. "But there simply weren't any jobs available," he explains, so he took a post with the Navy's Oceanographic Office and learned about instruments. Among his many assignments with the Navy was the development of automatic weather stations in the Arctic.

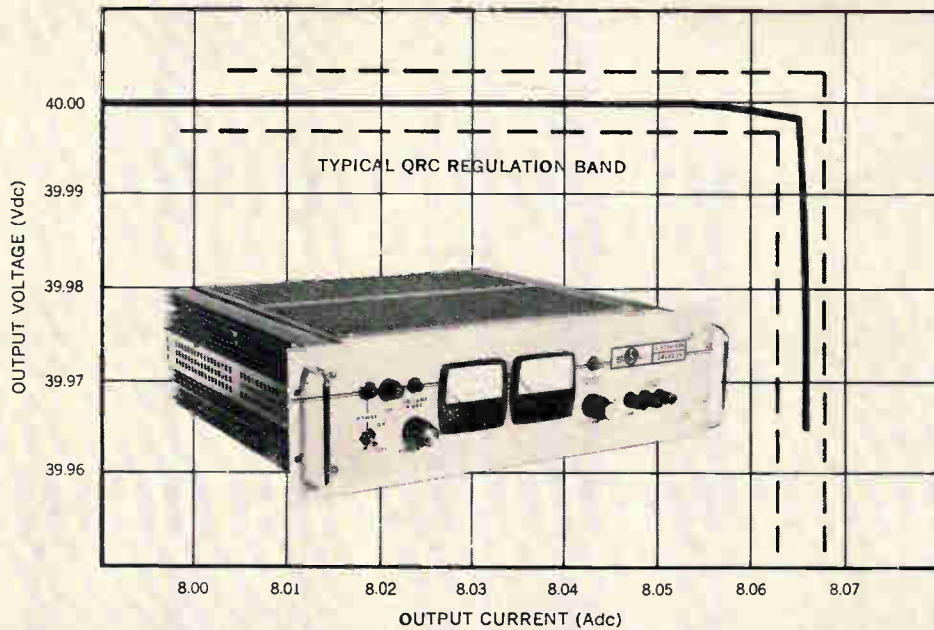

Automatic crossover between constant voltage and constant current modes

# Power Supply Specs That Set The Standard.

The Sorensen QRC series—wide range, transistorized power supplies—provide constant voltage/constant current regulation so sharp the units operate without ever leaving the specified regulation band. Voltage regulation is  $\pm .005\%$  for line and load combined. The QRC's are provided with front panel dial set adjustment of voltage and current limits, as well as voltage/current mode indicator lights. Other design features include: Low ripple...1 mV rms • No turn-on/turn-off overshoots • Re-

mote sensing and programming • Series/parallel operation • Input voltage 105-125 or 201-239 Vac, 50-400 c/s • Easily replaceable plug-in control boards • High efficiency and compact packaging. All Sorensen power supplies conform to proposed NEMA standards. For QRC details, or other standard/custom power supplies, AC line regulators or frequency changers, contact your local Sorensen rep, or write: Sorensen, A Unit of Raytheon Company, South Norwalk, Connecticut 06856.

#### ELECTRICAL & MECHANICAL SPECIFICATIONS

MODEL NUMBER	OUTPUT VOLTAGE RANGE (Vdc)	CURRENT OUTPUT RANGE (Adc)	VOLTAGE REGULATION (LINE & LOAD COMBINED)	RIPPLE VOLTAGE (rms)	CURRENT REGULATION	RIPPLE CURRENT (rms)	RACK HEIGHT (INCHES)	PRICE
QRC20-08	0-20	0-8	$\pm .005\%$ or $\pm 1$ mv	1 mv	$\pm .05\%$ or $\pm 4$ ma	2 ma	3½	\$410.00
QRC20-15	0-20	0-15	$\pm .005\%$ or $\pm 1$ mv	1 mv	$\pm .05\%$ or $\pm 8$ ma	4 ma	5¼	525.00
QRC20-30	0-20	0-30	$\pm .005\%$ or $\pm 1$ mv	1 mv	$\pm .05\%$ or $\pm 16$ ma	8 ma	7	700.00
QRC40-4	0-40	0-4	$\pm .005\%$ or $\pm 1$ mv	1 mv	$\pm .05\%$ or $\pm 2$ ma	1 ma	5¼†	315.00
QRC40-8	0-40	0-8	$\pm .005\%$ or $\pm 1$ mv	1 mv	$\pm .05\%$ or $\pm 4$ ma	2 ma	3½	450.00
QRC40-15	0-40	0-15	$\pm .005\%$ or $\pm 1$ mv	1 mv	$\pm .05\%$ or $\pm 8$ ma	4 ma	5¼	575.00
QRC40-30	0-40	0-30	$\pm .005\%$ or $\pm 1$ mv	1 mv	$\pm .05\%$ or $\pm 16$ ma	8 ma	7	775.00

†Half rack



A UNIT OF RAYTHEON COMPANY

Circle 11 on reader service card

# This is Siemens

Never before has electrical engineering covered such a wide field as today. This extends from the thin magnetic films of high-speed memories to the mammoth dimensions of modern turbine generators. Electrical systems operate with submillimeter waves only a thousandth of a millimeter in length as well as low-frequency waves up to several kilometers in length. Research has penetrated into a subtemperature region only a few degrees above absolute zero. For its plasma investigations it generates temperatures approaching that of the sun. Reactor technology harnesses the inmost forces of the atomic nucleus. Communications satellites circle the earth.

These extreme achievements give an idea of the broad range of our activities, which extend all the way from the study of first principles to the ultimate development of new products. That is why the Siemens Group keeps 15,000 of its employees assigned to R&D projects alone. The results of their efforts are of concrete benefit to all of our customers: every system that leaves our factories and every system we install reflects the sum total of the experience acquired and evaluated daily at our R&D laboratories.



Components Plant, Munich

# Siemens Polystyrene "Styroflex" Capacitors

## "Mica" properties at "paper" prices

**Unique properties of Polystyrene** and the method of manufacture developed by Siemens (The polystyrene is stretched and stabilized in the stretched condition before winding. After winding, special heat treatment shrinks the film, forming a hard, stable body.) results in low cost STYROFLEX capacitors which offer:

**Reliability:** 1) against voltage breakdown (assured by tests on each unit at 3.3 times rated voltage). 2) in the microvolt range (assured by positive welded contacts between foil and leads).

**Stability** against change in capacitance over long periods of time is one result of the solidity and hardness of the capacitors... produced by the special film shrinking manufacturing process.

**Low Self-Inductance:** values as low as for extended-foil construction.

**Low Dissipation Factor:** usually even lower than for mica capacitors, making them especially suitable for filter circuits.

**High Resistance to Humidity:** polystyrene has the lowest water absorption coefficient of all capacitor dielectric materials.

**Highest Insulation Resistance:** higher than for any other kind of dielectric.

**Immediate Shipment:** substantial stocks are held in White Plains, N. Y.

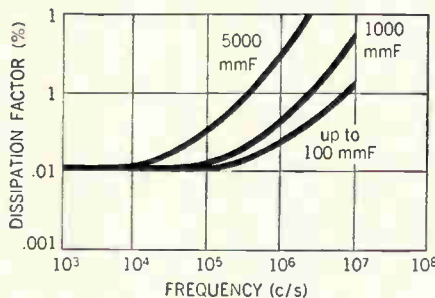
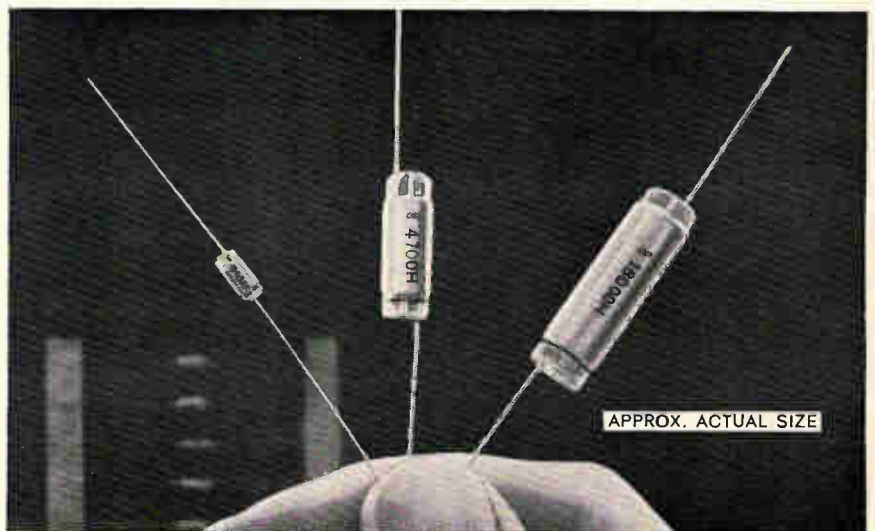

**Low dissipation factor** (usually even lower than for mica capacitors) is provided by Styroflex capacitors... making them specially suitable for filter circuits.

SIEMENS AMERICA INCORPORATED  
Components Division  
230 Ferris Avenue, White Plains, N. Y.

In Canada:  
SIEMENS CANADA LIMITED  
407 McGill Street, Montreal 1, P. Q.

# most versatile rf sweep generator



## JERROLD 900B

■ Sweep widths from  
10kc to 400mc

■ Frequency range  
500kc to 1,200mc

Here is the ultimate instrument for all your IF, VHF, and UHF sweep requirements. Famous for its stability and built-in convenience: Crystal-controlled harmonic markers; variable-gain dc or ac-coupled scope preamplifier; precision turret attenuator from zero to 50db in 10db steps. Write for complete technical data.

\$1,980.00 f.o.b. Phila.

**JERROLD**  
JERROLD  
ELECTRONICS  
CORPORATION

Government & Industrial Division  
Philadelphia, Pa. 19132  
Export: Rocke International, New York, N.Y. 10016

**SWEEP GENERATORS • AMPLIFIERS  
PRECISION ATTENUATORS • COMPARATORS**

## Meetings

**International Fair for Electronics, Automation and Instruments, Danish Electronics Industry;** Exhibition Hall, Copenhagen, Denmark, Feb. 25-March 6.

**Joint Industry Military Government Packaging and Transportation Symposium, National Security Industrial Association;** Sheraton Park Hotel, Washington, Feb. 28-March 2.

**Conference on Nondestructive Testing, Society for Nondestructive Testing;** Biltmore Hotel, Los Angeles, March 7-10.

**Symposium on Manufacturing In-Process Control and Measuring Techniques, Air Force Materials Laboratory and Motorola Semiconductor Products Division;** Hiway House, Phoenix, Ariz., March 9-11.

**International ISA Aerospace Instrumentation Symposium, ISA, College of Aeronautics; College of Aeronautics, Cranfield, England,** March 21-24.

**International Convention and Exhibition of the IEEE; New York Hilton Hotel and the Coliseum, New York,** March 21-25.

**Microwave Measurement Symposium, Weinschel Engineering Co.; Essex House Hotel, New York,** March 21-24.

**Seminar on Computers and Automation in Europe, Lomond Systems, Inc.; Washington, and European tour, March 21-April 7.**

**National Association of Broadcasters Convention, NAB; Conrad Hilton Hotel, Chicago,** March 27-30.

**International Conference on Electronic Switching, Union of International Technical Associations, Societe Francaise des Electroniciens et des Radioelectriciens; UNESCO Conference Hall, Paris, France,** March 28-31.

**Digital Electronics Seminar, RCA Institutes, Inc.; Hotel New Yorker, New York,** March 28-April 1.

**Automatic Control in Electricity Supply Meeting, IEE; Renold Building, Manchester College, England, March 29-31.**

**Conference on Analysis and Synthesis of Networks, IEEE-NTG; Stuttgart, West Germany,** March 31-April 1.

**Industrial Engineering Conference, AIIE; Hotel Pontchartrain, Detroit,** March 31-April 1.

**Advanced Seminar for Automatic Data Processing, International Computation Center; International Computation Center, Rome, April 6.**

**Symposium on Electron and Laser Beam Technology, IEEE, University of Michigan; Ann Arbor, Mich., April 6-8.\***

**Conference on Ground-Based Aeronomic Studies of the Lower Ionosphere, AFCRL, DRTE; Defense Research Telecommunications Establishment, Ottawa, Canada, April 11-15.**

**IEEE Region III Convention, IEEE; Mariotta Motor Inn, Atlanta, April 11-13.**

**Cleveland Electronics Conference, Cleveland section of IEEE; Engineering and Scientific Center, Cleveland, Apr. 12-14.**

## Call for papers

**Technical and Electronic Ceramic Manufacturers Exhibit and Seminar, Exhibition Management; New York Trade Show Building, Nov. 1-3. April 15 is deadline for submission of papers on the use of technical and electronic grade ceramic materials in the mechanical, chemical processing, aerospace and electronic industries to John J. McManus, President, Royal Worcester Industrial Ceramics, Inc., 11 E. 26th St., New York 10010.**

**IMEKO-Symposium on Microwave Measurement, Hungarian Scientific Society for Measurement and Automation; House of Engineering Societies, Budapest, Hungary, Oct. 12-24. April 30 is deadline for submission of three summaries of a paper on the theory and practice of microwave measurement, automation of microwave measurement techniques, or semi-conductors in microwave measurement to Prof. Dr. G. Almassy, Hungarian Scientific Society for Measurement and Automation, House of Engineering Societies, Budapest V. Szabasagter 17, Budapest.**

\* Meeting preview on page 16



Value equals performance divided by price. Our new Null Detector/Microvoltmeter satisfies the equation. The parameters:

- 100 & 10 megohm input impedances
- 1 microvolt to 1000 vdc ranges with  $\pm 2\%$  accuracy
- Input isolation  $10^{12}$  ohms
- takes up to 1200 vdc on any range
- grounded recorder output isolated from input
- rechargeable battery operation
- price: \$350, or \$395 with batteries.

Applications for the Fluke 845 Null Detector/Microvoltmeter include standardization of voltage dividers, intercomparison of standard cells, ratio measurements, voltage measurements with a dc calibrator, isolation amplifier and as a general purpose transistorized voltmeter. Other specifications include DC common mode rejection of better than 180 db; AC common mode rejection, 120 db; milspec shock and vibration requirements; size, 7" high x 8½" wide; two units fit a 19" rack. For details and a demonstration, call your Fluke engineering representative or write.



**FLUKE • Box 7428 • Seattle, Washington 98133 • Phone: (206) PR 6-1171 • TWX: (910) 449-2850**

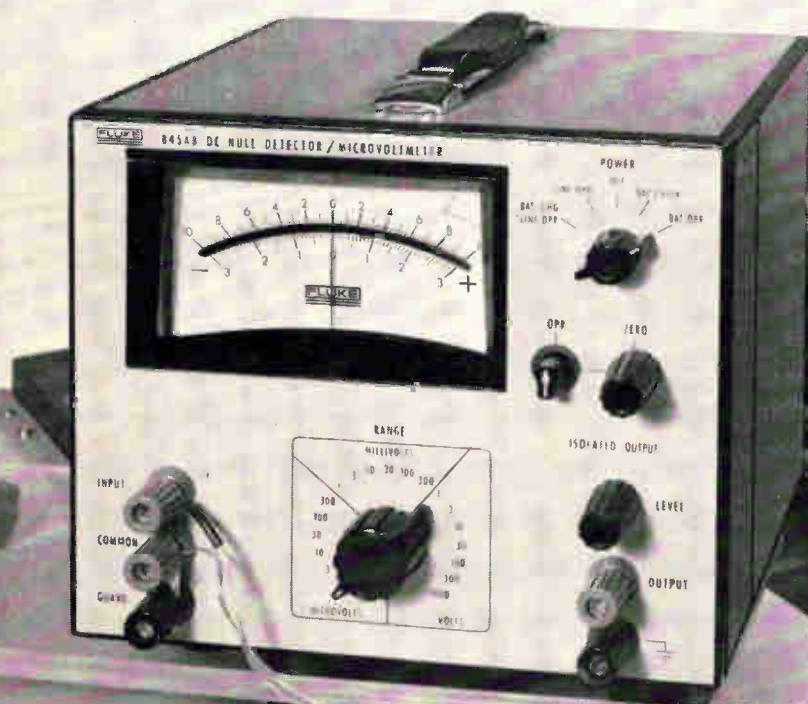

New Fluke Model 845AB  
checking out Rosa type resistors  
in oil bath.

# All from Sprague!

## ENERGY-STORAGE CAPACITORS for every type of discharge application

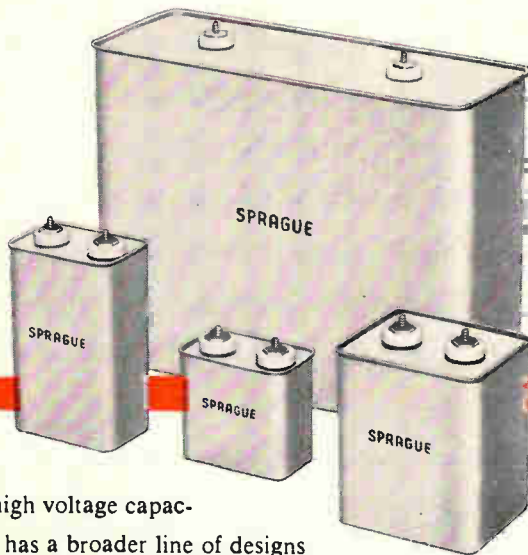

A pioneer in high voltage capacitors, Sprague has a broader line of designs for energy-storage applications than any other capacitor manufacturer. If your project involves lasers, masers, electronic photoflash, time-control circuits, exploding wire, thermonuclear fusion research, magnetization of permanent magnets, medical equipment, or similar discharge applications, Sprague can provide a capacitor to meet your specific needs.

### Light, Moderate, or Heavy Duty Capacitors

Available types range from small, light-weight units for aerospace applications such as satellites, missiles, etc., to heavy-duty capacitors for high-current/high-frequency oscillatory discharges.

### Broad Range of Electrical Ratings

Voltages from 2 kilovolts to 24 kilovolts. Energy ratings up to 6700 joules. Self-inductance as low as .0025 microhenry.

### Paper, Metallized Paper, and Paper/Film Design

Metallized capacitors intended for light-weight, space-saving applications . . . one-half the size, one-third the weight of conventional capacitors. Other available designs include castor oil impregnation for extremely long life (assuring a high number of discharges), and non-flammable synthetic askarel impregnation for applications where non-combustibility is a prerequisite.



### Energy-Storage Electrolytic Capacitors

A selected line of cylindrical types for industrial applications requiring maximum capacitance in minimum space.

For complete information or application engineering assistance on Sprague Energy-Storage Capacitors, write to Field Engineering Department, Sprague Electric Company, 35 Marshall St., North Adams, Mass. 01248.

### SPRAGUE COMPONENTS

CAPACITORS  
TRANSISTORS  
RESISTORS

THIN-FILM MICROCIRCUITS  
INTEGRATED CIRCUITS  
INTERFERENCE FILTERS

45C-5172

PACKAGED COMPONENT ASSEMBLIES  
FUNCTIONAL DIGITAL CIRCUITS  
MAGNETIC COMPONENTS  
PULSE TRANSFORMERS  
CERAMIC-BASE PRINTED NETWORKS  
PULSE-FORMING NETWORKS

**SPRAGUE**<sup>®</sup>  
THE MARK OF RELIABILITY

\*Sprague and  are registered trademarks of the Sprague Electric Co.

## Meeting preview

### Holography and lasers

The eighth annual symposium on electron and laser-beam technology will open April 6 with a discussion of holography at the University of Michigan, at Ann Arbor. The university will sponsor the three-day conference with the Institute of Electrical and Electronics Engineers (IEEE).

Professor Dennis Gabor of Imperial College, London, will review holography and discuss its application. Michigan's Professor Emmett Leith will consider application of holography to the measurement of differentiation and its use for projecting images through irregular mediums. He will tell of imaging through opaque objects and on three-dimensional media in laboratory experiments.

Professor George Stroke, of Michigan University, will discuss the theoretical and experimental foundations of holography. He will describe his discovery of a new type of reflection observed with white-light holograms.

Prof. Stroke, who coined the word "holography," has written the first book on the subject, "Introduction to Holography," published February 9 by American Press. Included in the book are three papers by Prof. Gabor, who is the inventor of holography. Stroke's paper at the symposium will consider existing applications and from them project future uses and ramifications of holography. Stroke and Leith are considered in the forefront of research in this field in America.

Concluding sessions will deal with laser beam applications. Professors J. A. Jenny, D. M. Rank and Peter Franken, of Michigan, have been asked to discuss "Airborne Investigation of Clear Air Turbulence with Laser Radar." Klaus D. Mielenz of the National Bureau of Standards, Washington, will speak on "Lasers and their Application to Length Measurement."

In addition to the papers, discussions are planned on the production of the laser beam and its use in industry, machinery, construction and fabrication research.

# In some businesses it pays to be slow

**That's right, slow.** You just don't need that hot .5  $\mu$ sec or 2  $\mu$ sec memory you've been dreaming about if your digital applications are data transmission, process control, data display or any of hundreds of other commercial and military applications.

It costs a lot of money to make fast stacks and add the electronics that will keep them honest. We know. We make them. For businesses that need them.

But what plenty of businesses need is wide operating margins, low cost and reliability. What you get with slower memories.

Take our 8  $\mu$ sec core memory systems. They may be fast enough to do the job you need done.

And they have wide operating margins over a broad range of environmental conditions.

(Our FX-12 system shown here has wide oper-

 **FERROXCUBE CORPORATION OF AMERICA**  
Saugerties, New York

ating margins over a 0° to +65°C temperature range even with a 10% variation in dc input voltages.)

You save money (about 50% in fact) because with slower memories we're able to use fewer components. Less critical components. And our production and testing techniques are simpler.

We're ready to support everything we've said through actual

demonstration. We do it every day. We know more about memory system construction than anyone else in the business, and are prepared to deliver new concepts in design, packaging and organization.

Send for our Bulletin 3003, and tell us about the application you have in mind. Just a few lines on your company letterhead will do. **Think slow. But act fast.**

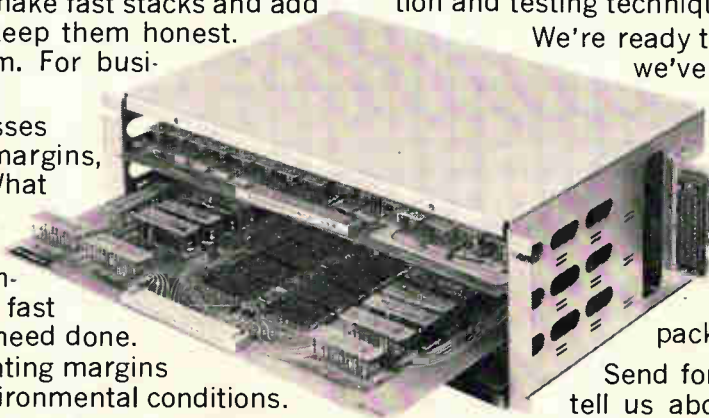

# What Kind of Panel Meter Do You Need ?

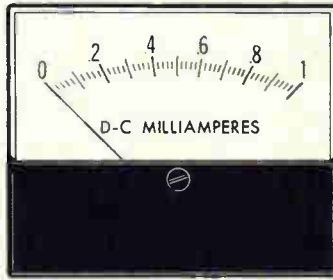

**crisp, classic  
Horizon Line?**

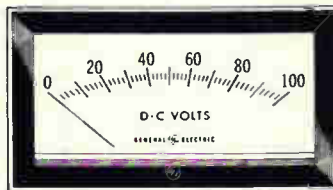

**trim, built-in  
Horizon Line?**

Built-in or front-mounted, General Electric HORIZON LINE® panel meters add quiet sophistication that accents, never dominates your electronic equipment. Check these distinctive HORIZON LINE features: smart, low-profile; clean, soft line; fine-precision markings. All ratings are available in 2½", 3½", and 4½".

**distinctive  
Big Look?**

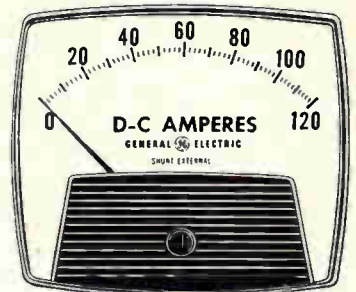

Add bold, exciting, truly distinctive styling to your electronic equipment with General Electric BIG LOOK® panel meters. Panelboards take on added flair with such BIG LOOK features as . . . big, bold numerals, uncluttered display, tapered pointer, stylish shape, plus many others. All ratings are available in 1½", 2½", 3½", 4½".

Besides saving you valuable panel space, General Electric slim-line Type 185 EDGEWISE panel meters add exceptional styling and readability to your electronic equipment. These 2¼" Type 185 EDGEWISE panel meters can be mounted individually or in space-saving clusters of two, three, or more. All ratings are available for vertical or horizontal mounting, with or without bezels.

## smart, slim edgewise?

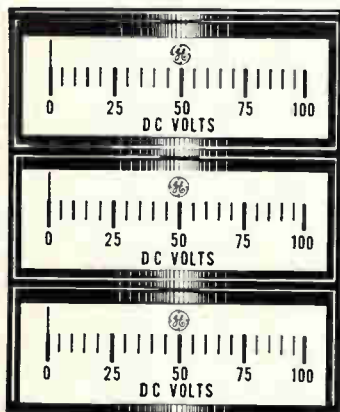

## style-matched time meters?



Distinctive BIG LOOK styling is yours with General Electric BIG LOOK elapsed time meters. These "look-alike" time meters combine to give your equipment uniformity and beauty. G-E elapsed time meters measure either hours or minutes with or without a reset knob. All ratings are available in 2½" and 3½".

## bright, bold meter relay?

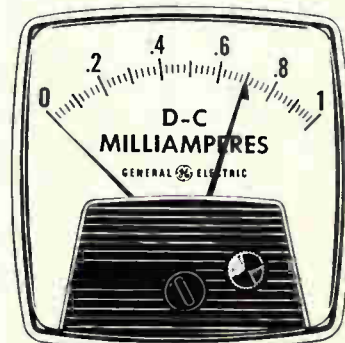

Add years ahead BIG LOOK styling to your equipment with General Electric Type 195 contactless meter relays, featuring a totally new, solid-state, light-sensitive switch for the ultimate in control simplicity and readability. "Piggyback" control modules make for faster, easier installation. Companion pyrometers are also offered. All ratings are available in three sizes (2½", 3½", 4½") with single or double setpoints.

## You can get it...from General Electric's full line

And, of course, General Electric's full line of panel meters is unmatched for accuracy and reliability. They're as near as your dependable G-E electronic distributor or sales office. You get fast delivery, too. For free descriptive bulletins describing G.E.'s full line of panel meters, write General Electric Co., Section 592-25A, Schenectady, New York 12305.

**GENERAL ELECTRIC**

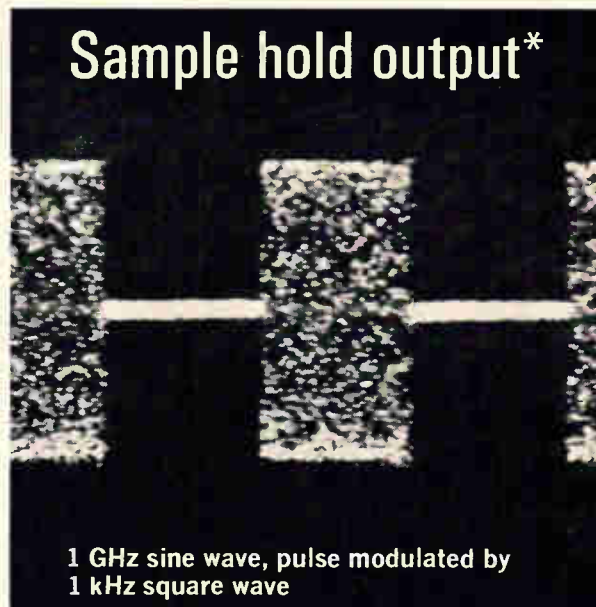
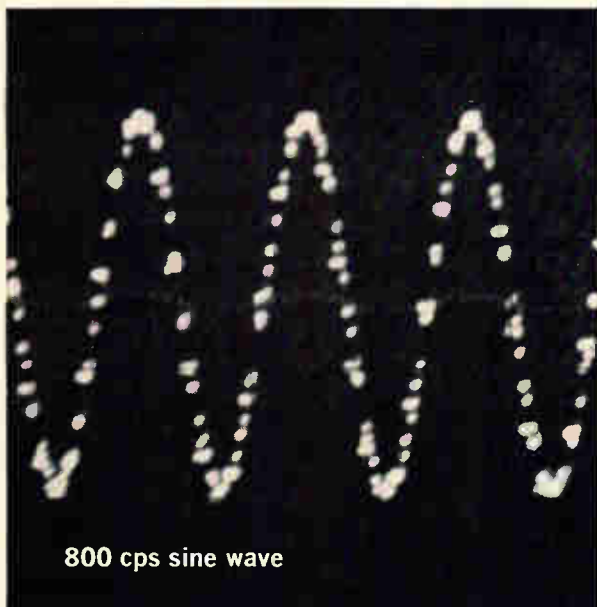

# Sampling RF Voltmeter!

## *hp 3406A Broadband Sampling Voltmeter*

Unique sampling technique has been applied to an analog meter to permit economical, broadband measurements.

The 3406A is an average-responding voltmeter that provides more accuracy and sensitivity than is presently available from any other type.

Peak and true rms measurements can be made using the "sample hold" output. Many other uses include retrieval of AM carrier envelopes, power and noise measurements.

Extra features, such as the front-panel calibrator and the pushbutton probe (which allows retention of a reading), are among some of the many reasons why you should call your Hewlett-Packard field engineer. Or write for full specifications and a description of this state-of-the-art sampling technique to Hewlett-Packard, Palo Alto, Calif. 94304. Tel. (415) 326-7000; Europe: 54 Route des Acacias, Geneva.

\*Measured with a low-frequency scope.

*Complete accessories available*

See it at IEEE  
3rd floor New York Coliseum  
March 21-24

**HEWLETT**  **PACKARD**  
An extra measure of quality

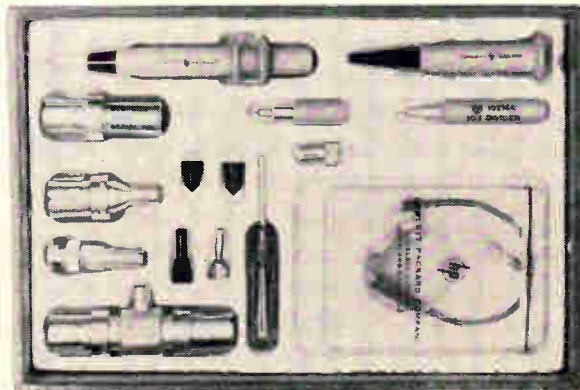

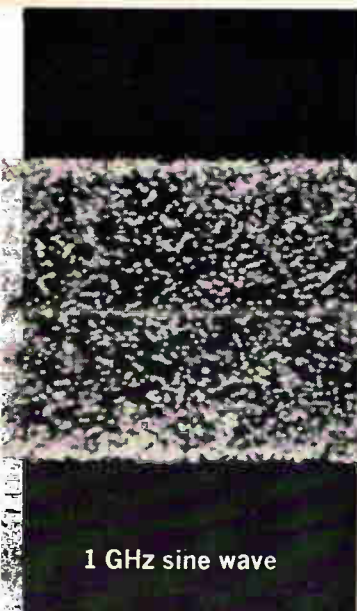

1 GHz sine wave

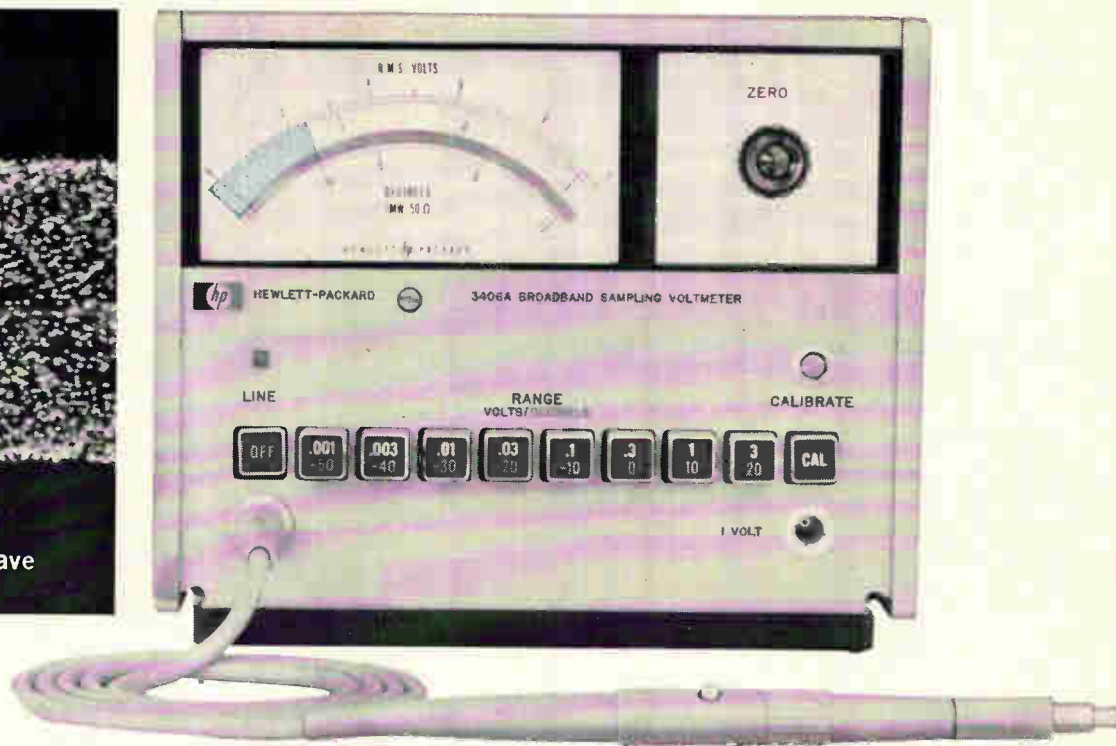

measure **1 MV to 3 V,**  
**10 kHz to 1 GHz!**

**The first rf voltmeter to give:**

- 50  $\mu$ V readings with 20  $\mu$ v resolution
- $\pm 5\%$  measurements at 700 MHz (usable to 2 GHz)
- Linear scale on all ranges
- Recorder and sample hold outputs \*
- Probe with measurement retention
- Price—only \$650

### Specifications, hp 3406A

<b>Voltage range:</b>	1 mv to 3 v full scale, 8 ranges; db -50 to +20 dbm (0 dbm=1 mw in 50 ohms); absolute average-reading instrument calibrated to rms of sine wave
<b>Frequency range:</b>	10 kHz to 1 GHz, useful sensitivity 1000 Hz to beyond 2 GHz
<b>Full-scale accuracy:</b>	$\pm 3\%$ , 10 kHz to 100 MHz; $\pm 5\%$ , 100 MHz to 700 MHz; $\pm 8\%$ , 700 MHz to 1 GHz
<b>Input impedance:</b>	100,000 ohms at 100 kHz, capacity approximately 2 pf (input capacity and resistance depend on accessory tip used)
<b>Outputs:</b>	dc recorder, 1.2 ma into 1 K ohms at full scale, proportional to meter deflection; ac, sample-hold output—ac signal statistically equivalent to measured signal (on ranges 0.01 v and above)

<b>Meter scales:</b>	linear voltage, 0 to 1 and 0 to 3; db, -12 to +3; individually calibrated taut-band meter
<b>Dimensions:</b>	6½" high, 8¾" wide, 11½" deep (165 x 225 x 292 mm); 8 lbs
<b>Accessory furnished:</b>	11072A Isolator Tip
<b>Accessories available:</b>	11064A Basic Probe Kit (\$100)— 11063A 50 Ohm "T" 10214A 10:1 Divider Tip 10218A BNC Adapter (0950-0090) 50 Ohm Termination 11071A Probe Kit (\$185) consists of above, plus— 11073A Pen Type Probe 10219A Type 874A Adapter 10220A Microdot Adapter 11035A Probe Tip Kit

*Data subject to change without notice. Prices f.o.b. factory.*

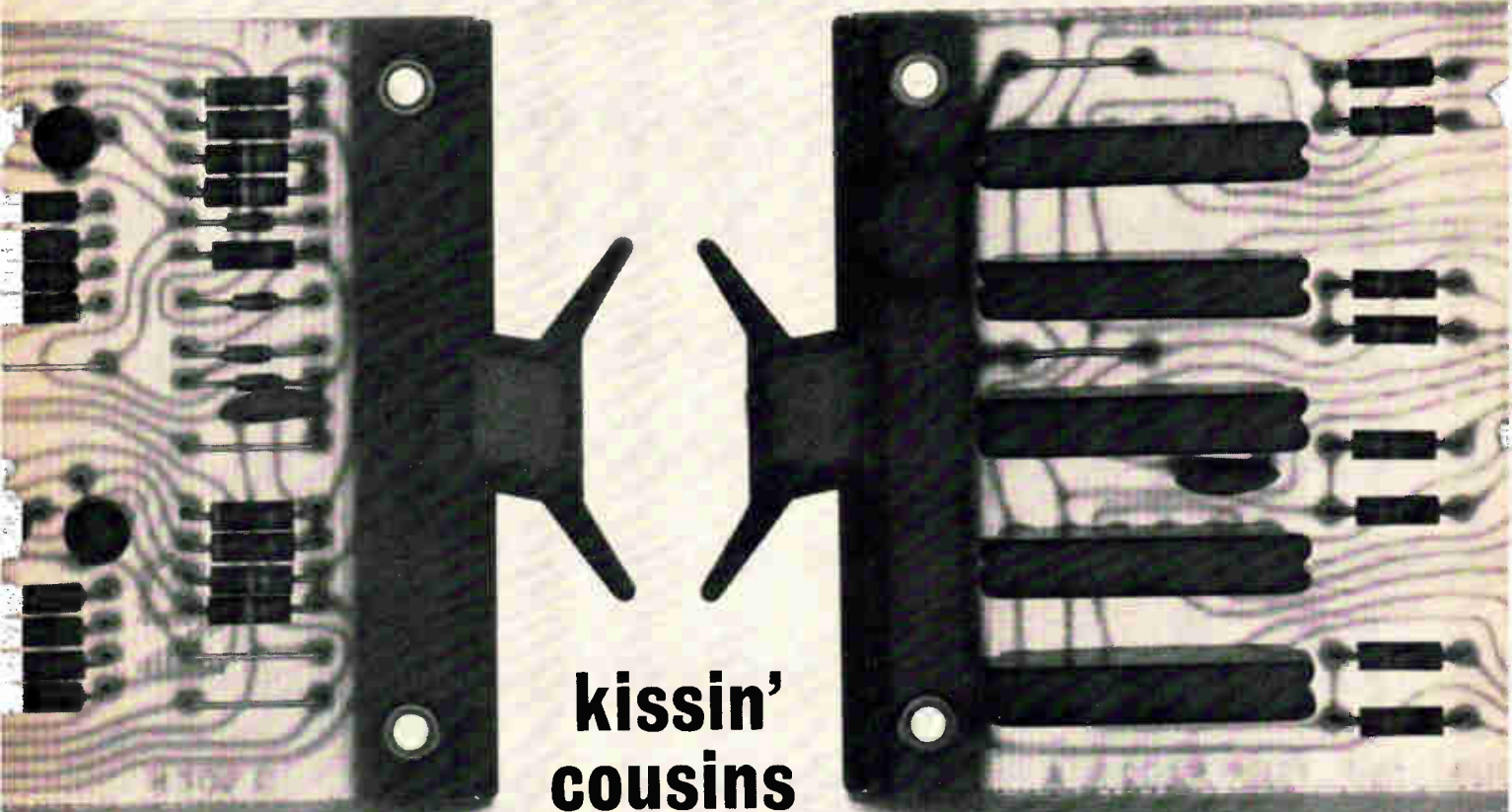

## kissin' cousins

These two digital modules are directly related to 99 other standard Flip Chip™ modules. They are related electrically, physically, and logically, and they all carry the same 10-year guarantee.

Together with their kinfolk, they can be arranged to make an up counter, a down counter, a shift register, a jam transfer buffer, a high speed parallel adder, an analog to digital converter, or a vice versa.

Or a signal multiplexer, a typewriter driver, a Gray to binary converter, a vice versa, a paper tape punch control, a reader control, a pseudo random sequence generator, a data acquisition system, or an interface between peripherals and a real time computer.

Sometimes it pays to have a big family.

Write for a catalog.

# DIGITAL

MOOULES • COMPUTERS

DIGITAL EQUIPMENT CORPORATION, Maynard, Massachusetts 01754. Telephone: (617) 897-8821 • Cambridge, Mass. • Washington, D. C. • Parsippany, N. J. • Rochester, N.Y. • Philadelphia • Huntsville • Orlando • Pittsburgh • Chicago • Denver • Ann Arbor • Los Angeles • Palo Alto • Seattle • Carleton Place and Toronto, Ont. • Reading, England • Paris, France • Munich and Cologne, Germany • Sydney and West Perth, Australia • Modules distributed also through Allied Radio



---

Editorial

---

## Electronics for neglected G.I.

By the end of the year, the United States will have more than 400,000 men in Vietnam—unless a miracle occurs to end the fighting and that seems less likely every day. Just equipping a force that size for combat means a substantial increase in business for the electronics firms supplying ground communications and electronics for the soldiers and aircraft. Some suppliers have already added extra work shifts to meet suddenly accelerated delivery times and new orders with rush shipment dates.

But supplying equipment already designed is only a part of the task electronics firms face. The type of warfare in Vietnam demands a generation of new electronics equipment—far better communications gear for work in a jungle; easier-to-use, lighter communications that more field soldiers can carry, and better surveillance radar to spot an enemy on the ground.

A great number of the electronics projects for ground forces have remained locked up in reports because the Pentagon has not taken much interest in them [see story on p. 38].

For most of the past 15 years, the Defense Department has concentrated on strategic weapons—intercontinental bombers or missiles, giant electronic warning systems, complex command and control systems and antisubmarine-warfare systems. The United States' defense posture was geared to face a hostile Soviet Union whose strategic arsenal was building up just as rapidly. As late as 1960, a president of the United States was elected campaigning about a "missile gap."

Circumstances and history have changed. With both U. S. and Soviet forces equipped with enough armaments to destroy the world (though, how many times can the world be destroyed?), the two governments have adopted a more conciliatory pose: the deadly strategic weapons are

holstered. In the kind of "little war" being fought in Vietnam, the big weapon is almost useless. In a battlefield without a front line there is no place for ICBM's. The U. S.'s efficient radar warning lines and command and control systems have little to do against the dozen or so fighter planes of North Vietnam's puny air force. In a land war against an enemy whose Navy consists of small patrol boats, antisubmarine warfare is as unnecessary as an overcoat in the jungle.

For many years, the Pentagon offered one excuse for not pushing improvements in military electronics for ground forces. Defense brass claimed that solid state components weren't good enough, powerful enough or reliable enough to replace the faithful tubed equipment. And some military experts were burned pursuing fads in components that never lived up to expectations, like the tunnel diode and molecular electronics.

Certainly solid state components no longer are an obstacle (and haven't been for several years). Transistors can handle powers of several hundred watts; their reliability is far superior to tubes; and their availability is unquestioned.

In addition, many new components exist that military communications equipment could use to great advantage: overlay transistors, field-effect transistors, varactor diodes and silicon-controlled switches.

Other developments have great potential for communications and radar gear. Strip transmission line can reduce the amount of plumbing and hardware in microwave equipment by as much as 90%—and cut the power dissipated to that extent. And microelectronics are being used in prototype microwave equipment.

One reason strip transmission line has not been used more widely is that engineers have not had enough data on its performance. Now this kind of information is available [see the references on p. 100] and the onus for application rests with the engineer.

Another development is microelectronics for microwave applications [p. 138]. Here is one place that hybrid microcircuits seem to be outstripping monolithics.

Such components should lead not only to modernized communications and radar equipment but also to some radically new products. What comes out of all this is limited only by an engineer's ingenuity and knowledge.

# CLIFTON

## Steps in to the Stepper Motor field



### CLIFTON STEPPER MOTORS

SIZE	8	8	10	10	11	11	8	8	8	11
LENGTH (M.F.)	0.770	0.770	0.770	0.770	1.215	1.215	1.062	1.112	0.770	1.215
WEIGHT (OZ.)	1.0	1.0	1.6	1.6	3.2	3.2	1.5	1.5	1.0	3.2
INERTIA (GM-CM <sup>2</sup> )	0.19	0.19	0.19	0.19	0.77	0.37	0.18	0.45	0.19	0.77
INDEX ANGLE	90° ±3°	90° ±3°	90° ±3°	90° ±3°	90° ±3°	15° ±1°	90° ±3°	90° ±3°	45° ±2°	45° ±2°
TYPE	PM 2Ø	PM 2Ø	PM 2Ø	PM 2Ø	PM 2Ø	VR 3Ø	PM 2Ø	PM 2Ø	PM 2Ø	PM 2Ø
RATED D.C. VOLT.	28V	28V	28V	28V	28V	28V	28V	28V	28V	28V
RESISTANCE (OHMS/PHASE)	460	300	300	300	300	150	300	300	135 per PHASE	130 per PHASE
NO LOAD RESPONSE RATE PULSE/SEC	250	320	350	330	220	600	360	280	600	440
NO LOAD SLEW RATE PULSE/SEC	510	930	700	610	265	1600	375	650	2700	1200
HOLDING TORQUE OZ-IN ONE PHASE	0.37	0.35	0.50	0.53	1.1	0.60	0.80	0.58	0.60	1.5
DETENT, OZ-IN ZERO INPUT	0.12	0.05	0.05	0.13	0.24	—	0.17	0.10	0.05	0.12
TYPE NUMBER	MSA-8-A-1	MSA-8-A-2	MSA-10-A-1	MSA-10-A-2	MSA-11-A-1	RSA-11-A-1	MSM-8-A-1	MSL-8-A-1	MSA-8-A-3	MSA-11-A-2

EXCITATION MODE: TWO PHASES PARALLELED ALTERNATELY.

After careful testing and having already had units in end-use equipment in the field, we are now ready to announce a full line of size 8, 10 & 11 stepper motors and the controllers that go with them.

Steppers are gaining popularity rapidly in digital systems because of their quick response, high resolution, and many other distinct advantages over the con-

ventional servo motor.

We'd like to step in to your stepper motor picture with Clifton Precision quality, reliability and application knowledge.

Clifton Precision Products, Division of Litton Industries, Clifton Heights, Pa., Colorado Springs, Colo. Area 215 622-1000; TWX 215 623-6068.

Flash! Clifton has just opened a new synchro plant in Fall River, Mass.

**cppe** **CLIFTON** **PRECISION PRODUCTS**  
DIVISION OF LITTON INDUSTRIES



---

# Electronics Newsletter

---

February 21, 1966

## Japanese develop millimeter diode

Japanese researchers were eclipsed by their American counterparts in the development of the transistor, but they are making up for it with the development of new diodes. These include the Esaki diode, the Kita diode [Electronics, Dec. 13, 1965, p. 99], and now the Mizuno diode. The Mizuno diode, made of germanium, has a highly doped junction and generates millimeter oscillations when biased in the reverse breakdown region.

The diode was developed by a group led by Hiroyuki Mizuno at Matsushita Electronics Corp.'s research laboratory. Matsushita is a joint venture of Matsushita Electric Industrial Co. of Japan and Philips Gloeilampenfabrieken NV of the Netherlands.

In experiments, the Mizuno diode has been operated between 10 and 90 gigacycles at power outputs of up to 10 milliwatts peak. So far, the devices have been operated in a pulsed mode. The major obstacle to continuous-wave operation is heat dissipation.

The Mizuno diode differs from Bell Telephone Laboratories' microwave diode [Electronics Nov. 1, 1965, p. 24]. Bell's diode is made from silicon and its operation is based on avalanching of carriers. The Mizuno diode's oscillation is associated with tunneling of carriers from the valence band to the conduction band. Its oscillation frequency increases as the thickness of the junction depletion region decreases, which corresponds to increased doping.

## NASA may use satellite's network for tracking

Satellites may replace many ground stations in the National Aeronautics and Space Administration's manned spaceflight tracking network in the early 1970's.

NASA recently received industry proposals for studies of an Orbiting Data Relay Network, composed of two or more satellites, which would receive voice and data directly from orbiting spacecraft for relay to the Mission Control Center in Houston.

The satellites would save the space agency a considerable amount of money; it now costs NASA about \$200 million a year just to staff and operate its ground tracking sites.

Each of the satellites is expected to carry an electronically steerable 30-foot antenna. From synchronous orbit 22,300 feet above the equator, tracking satellites could receive signals from many orbiting spacecraft and from returning interplanetary spacecraft.

A contract for a six-month study of the proposed network is expected to be awarded in April.

## Electron beams cure paint fast

The Ford Motor Co. has developed a fast way of curing paint with an electron beam. The conventional paint-curing process, using heat, takes about 10 minutes in 150°F ovens; the electron-beam method takes three seconds at room temperature. Aside from the speed, the new curing process—effective for use on wood, plastic and rubber—provides better bonding of paint to surface. Ford says its special paint, cured by a broad beam of electrons, remains bonded to the surface despite immersion in boiling water for up to 15 minutes; ordinary paint cured with heat can't withstand such a test.

---

# Electronics Newsletter

---

## 'Buy America' resists challenge

The Defense Department's "buy America" policy has been unsuccessfully challenged by the General Accounting Office, which oversees the Government's buying practices. The Pentagon won out, with support from the President's Cabinet Committee on Balance of Payments, in what may prove a "buy America" precedent.

The controversy arose over the Air Force's \$9.5-million award in 1965 to Page Electronics Engineers, Inc., for an undersea cable communications system in the Southwest Pacific. The GAO claimed that Page's bid was \$2.3 million above the \$7.2 million bid by the Federal Electric Corp. for components from a British affiliate. But the GAO pointed out that Page was planning to use German components in the system and that the total balance-of-payments saving was only \$1.3 million, compared with the \$2.3 million higher price. Federal Electric is a subsidiary of the General Telephone and Telegraph Corp.

Under terms of the "buy America" policy, the Pentagon has been following this guideline: The difference between the bids must be at least 50% greater than the balance-of-payments savings to warrant accepting the lower bid from a foreign company. But the Cabinet committee ruled that it isn't always possible to separate domestic and foreign costs and that administrative costs figure heavily in setting final costs. So, they rejected the GAO argument.

## Satellite-to-home broadcast proposals sought by NASA

NASA is about to take the first step in its proposal to develop satellites that beam television broadcasts directly to home receivers. It now plans to request proposals from industry for studies of technical requirements for communications satellites.

The space agency has already received proposals for studies of a voice broadcast satellite and plans to let one or more study contracts this fiscal year [Electronics, Dec. 13, 1965, p. 25]. The same satellite may ultimately be used for both direct tv and voice broadcast.

## FCC extends jurisdiction over all CATV

The Federal Communications Commission has adopted a plan to regulate all forms of community antenna television (CATV). The plan should spur CATV's growth in smaller cities and rural areas but retard its development in the nation's 100 largest cities. Also, the FCC asked Congress to clarify and confirm its jurisdiction of CATV, and to clarify the place of CATV in the general broadcast community.

In action taken last week the commission:

- Assumed jurisdiction over cable-transmitted CATV as well as microwave-transmitted CATV.
- Will require a full-scale hearing and FCC approval prior to operation of a new CATV system in any of the nation's 100 largest tv markets.
- Granted CATV pretty much a free hand in other markets.

## Addenda

NASA is testing an auxiliary magnetic-tape memory that would allow astronauts on future Gemini flights to load new programs on their computers. Now, a single program is loaded before a flight, and the astronauts are unable to change it. . . . The Radio Corp. of America, which says its orders for computers are running 68% ahead of last year's, plans a \$3-million expansion of a computer-assembly plant in Palm Beach, Fla. RCA will increase the size of the plant by 75%.

PRESIDENT

DIRECTOR OF  
RELIABILITY

**What electronic component company  
has a corporate structure like this?**

PRESIDENT

DIRECTOR OF  
RELIABILITY



Our Corporate Director of Reliability reports directly to our President. Unusual for a components company? Yes. But out of this kind of management awareness of the importance of reliability have come practical advances for you. A case in point: IRC has amassed the industry's largest body of resistor reliability data—over 500,000,000 unit hours of testing without a failure. And IRC is the first to publish prices for standard metal films at three reliability levels. Other optimum economical levels of reliability—from precision films to carbon composition resistors, from multi-turn to trimming potentiometers, from signal to control semiconductors—are available to match your cost and performance needs. Address your questions regarding reliability to our Director of Reliability. It will get top management attention. IRC, Inc., Philadelphia, Pa. 19108

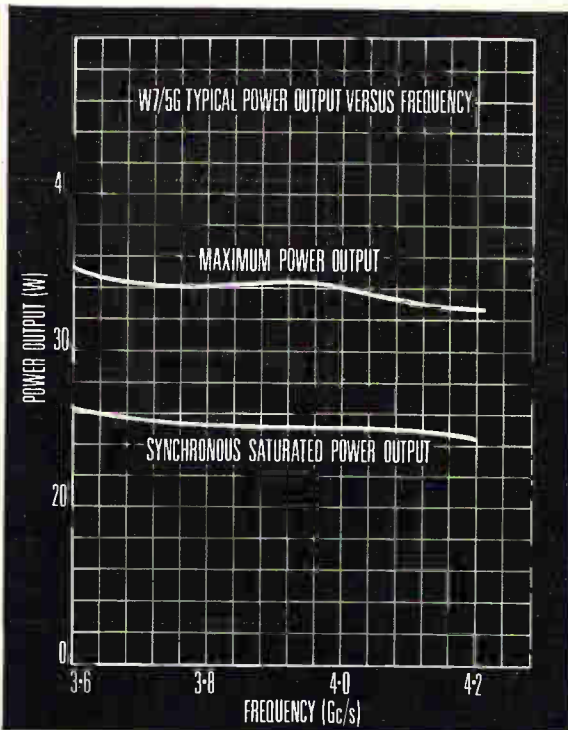
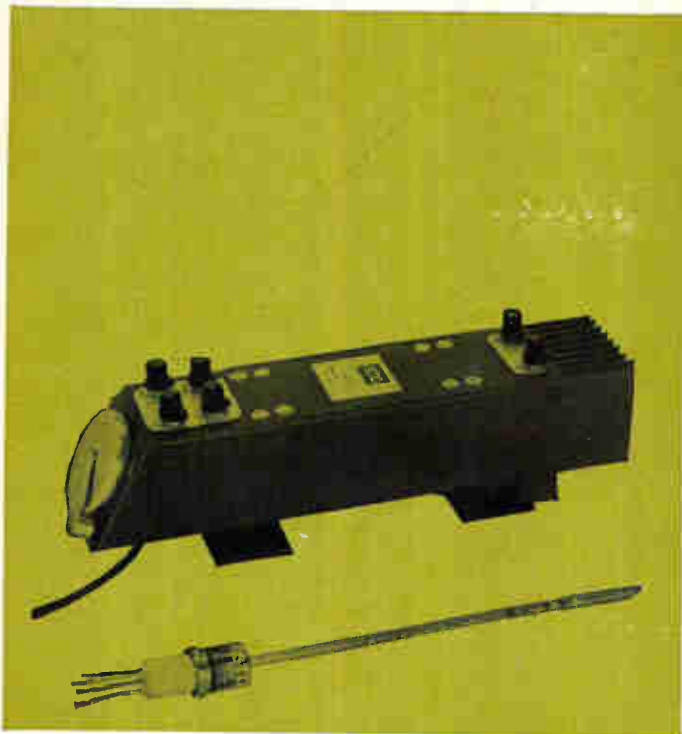

## New 30W TWT for the 4Gc/s communications band

STC's new, low-voltage travelling-wave amplifier tube, Type W7/5G, has been designed for use in 1800 channel radio communications links in the 3.6 to 4.2 Gc/s frequency range. It has a typical gain of 43 dB at a working output of 20W. (30W saturated output). This means that, in an existing system which incorporates a tube with a 40 dB gain and an output of 10W, the tube can be replaced by the W7/5G to produce twice the previous output for the same drive power.

The tube operates in a robust periodic permanent magnet mount, Type WM110A. Incorporated in the mount are r.f. input and output waveguide connections (a choice of WG12A or WR229 is offered), mechanical alignment, deflection and matching adjustments; tube ejection control at either end of the mount, a convection cooler and facilities for easy field replacement of tubes.

USA enquiries to:  
 ITT Electron Tube Division,  
 Box 100, Easton, Pennsylvania.  
 Other countries contact:  
 STC Valve Division, Brixham  
 Road, Paignton, Devon, England.

**Standard Telephones and Cables Limited**

Subsidiary of International Telephone and Telegraph Corporation



**45 db at 60 Mc**  
**25 db at 160 Mc**  
**2.5mw power output**

# Philco Microelectronics announces the PA7600 broadband amplifier!

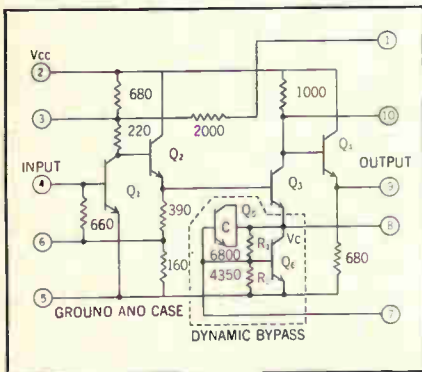

This is a new planar epitaxial monolithic silicon integrated microcircuit—a broadband amplifier that represents a significant advance in gain-bandwidth coupled with useful power output. Developed by Philco Microelectronics the PA7600 amplifier offers you externally adjustable gain and bandwidth combinations—such as 45 db gain out to 60 Mc or 25 db gain to 160 Mc.

An examination of the gain vs. frequency curves (measured with 50 ohm source and load) also suggests the desirable bandpass flatness ( $\pm 1$  db). And

the Voltage vs. Load Resistance curve reveals a 2.5 mw power output—more than adequate to drive, say, a detector.

In addition to this remarkable set of parameters—the Philco PA7600 maintains its operating point and gain characteristics stable over the full military temperature range ( $-55^{\circ}$  to  $125^{\circ}\text{C}$ ).

It operates with a single power supply. It is AGC-able.

It requires a minimum of external components.

And the Philco PA7600 is available in

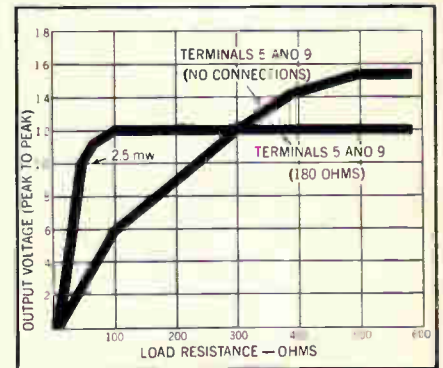
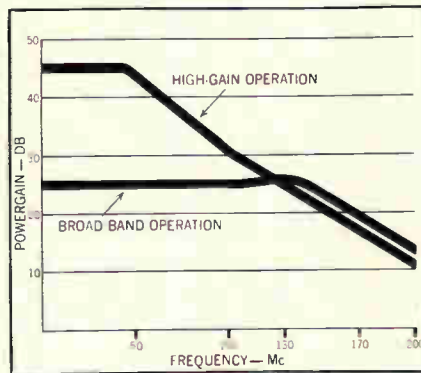

a TO5 package.

We are, frankly, excited about the potential of this new device—about the design possibilities it opens for you in such fields as broadband video amplifiers, RF and IF amplifiers through VHF, oscillators and the like.

And we look upon it as yet another first from Philco—extending the frontiers of Microelectronic technology.

For additional information on the Philco PA7600, write, wire or call Philco Microelectronics Marketing Department (215-855-4681).

MICROELECTRONICS OPERATION  
**PHILCO**  
 A SUBSIDIARY OF *Ford Motor Company*  
 LANSDALE DIVISION • LANSDALE, PA.  
 In Canada, Don Mills Road, Don Mills, Ontario, Canada



# Electronics Review

## Industrial electronics

### Scr's on wheels

Automotive engineers have long dreamed of developing practical electric trucks and cars powered by a-c motors. Electric vehicles are cheaper to operate, more precisely controlled and easier to build. The major obstacle to their design, however, has been the lack of a lightweight, reliable switching device that could handle high current.

Now, with the development of high-powered silicon controlled rectifiers, that barrier has been removed, and the Army has moved quickly to exploit the scr. Last month, the Army's Tank-Automotive Center in Detroit unveiled a 2½-ton, six-wheel test truck that runs on electricity. The truck's six wheels are powered by a-c motors [Electronics, May 17, 1965, p. 17].

**Saving fuel.** The truck's drive system, designed and built by Lear Siegler, Inc.'s Power Equipment division in Cleveland, uses a fre-

quency converter to control the speed of a squirrel-cage induction motor. Electricity is generated by an alternator powered by the truck's gasoline engine. Lear Siegler says the test truck consumes about 20% less fuel than a comparable truck powered directly by an internal-combustion engine.

The frequency converter—a cycloconverter—changes the three-phase a-c input of the alternators to output power of a controlled frequency that is below that of the input frequency. The change in electrical frequency, in turn, adjusts the speed of the six electric motors. The cycloconverter contains three sets of scr's and control circuitry; each of the cycloconverter's three parts fabricates one phase of the electrical output.

The combination of an induction motor and frequency control to regulate the speed of the electric motor has several advantages.

- This type of a-c motor, in contrast to a d-c motor, lacks commutators and brushes, making it more reliable.

- By controlling speed through

frequency changes, rather than voltage-level changes, the motor is able to maintain high torque levels even when it's revolving slowly; thus the electric motor provides high power even when it's turning as slow as one revolution per minute.

- Also, the motor's speed can be controlled to within 1 rpm.

Most of the truck's speed controls are automatically handled by a small computer. For example, when the driver steps on the "gas," he is directly controlling a reference frequency to which the output frequency of the cycloconverter is slaved. So, by depressing the pedal, the driver signals the cycloconverter to boost the output frequency, which in turn speeds up the electric motors. This action causes another change: when the wheels of the truck speed up, a tachometer on each wheel signals the computer that the wheels are coming up to the speed ordered by the driver; that speed is related to the reference frequency. The electric motor stops accelerating when the reference frequency and

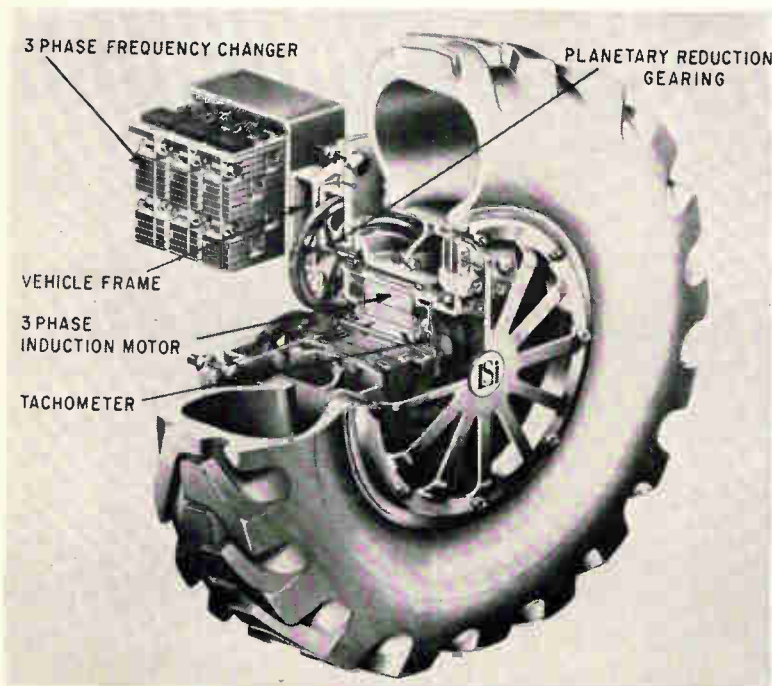

Electrically driven truck, developed for the Army by Lear Siegler, Inc., uses a frequency-control device to regulate speed of electric motors. Each of the six wheels has its own motor. The 2½-ton truck is said to consume about 20% less fuel than a comparable truck driven directly by a gasoline engine.

the tachometer frequency match. A signal is fed to the computer, which then orders the gasoline engine to accelerate; an increase in engine speed results in an increase in alternator speed and an increase in electrical output.

The computer plays another role: it maintains the speed of the gasoline engine so that it operates only at the most economical levels for the several power settings.

**Full power.** The scr's in the cycloconverter are arranged as a full-wave bridge, so power from each of the input phases supplies a portion of the power for each of the output phases. The scr's in the positive group supply the power during the positive half-cycle and the negative group during the negative half-cycle. Since the scr's are fast-acting switches, it's possible to successfully select the appropriate portions of each phase of the input and add these to produce a lower frequency wave at the output. The output can then be made to closely approximate the frequency that's wanted for a particular engine speed. The three-phase output is obtained by using three groups of scr bridges and timing the output wave fabrication process so that the successive waves lag behind each other by 120 electrical degrees. The output frequency is determined by the length of time the positive and negative groups are each allowed to carry current.

Six control circuits generate the appropriate gating signal to the scr's. Each circuit contains five monolithic integrated circuits, three diodes and two output transistors; all of the devices are thermally bonded to a thin-film network of resistors and interconnections.

**No turn-off.** The control circuit is impedance matched to the scr gate by a firing module. The module contains two miniature pulse transformers with a passive resistor-diode network to provide the proper turn-on of the scr's. No special turn-off circuits are required because the scr's in the cycloconverter are turned off by natural commutation.

The final control unit is the

single module that generates the blanking logic for the negative and positive groups of controlled rectifiers. The circuit samples the current delivered by each scr group and holds the nonconducting group off until the last conducting group is turned off. This eliminates any possibility of currents being conducted from group to group.

Thirteen control modules for each single-phase converter are mounted on, and interconnected by, a multilayer printed-circuit board. The board is mounted on top of a heat sink containing the scr's. Three single-phase assemblies are put together to control the three phases of the squirrel-cage motor.

Lear Siegler plans refinements in the design. For example, the engineers plan to use the tachometer signal from each wheel to determine when a wheel is slipping; in such a case, the computer could turn off power to that wheel, directing it only to the wheels that have traction.

The design has applications beyond the automotive field. It could, for example, be used to accurately turn gun turrets or large dish antennas, where precision movements are vital.

Although the test vehicle currently depends on a gasoline engine for electricity, an engineering team at Fort Belvoir, Va., is experimenting with hydrocarbon-air fuel cells as power sources. Such a power source could be the forerunner of a breed of vehicles that are quiet and exhaust-free.

---

### Advanced technology

---

#### Doing it with mirrors

The state of the laser art was advanced two steps last year when researchers at Sylvania Electric Products, Inc., produced a frequency-modulated beam and then used this laser to achieve a single-frequency output containing the energy of all the modes of the original laser [Electronics, March

22, 1965, p. 33]. The single-frequency laser, or supermode laser, was created by using a phase modulator in the f-m output beam—outside the laser cavity—and driving the f-m output 180° out of phase.

**Eliminates modulator.** Now, the same lab that built the supermode laser, Sylvania's Electronic Systems division in Mountain View, Calif., has achieved the same single-frequency output—collecting the total power of all the oscillating modes—but without the cumbersome external modulator and its required power supply.

The result is a supermode laser that is more economical and easier to operate than the first-generation design; in addition, there is no need to worry about the efficiency of the crystal materials commonly used in the external phase modulator.

The new technique was developed by Burton J. McMurtry, who's director of the lab that performed the work, and Stephen Harris, a Sylvania consultant who first conceived of the new laser. Sylvania is a subsidiary of the General Telephone & Electronics Corp.

What McMurtry and Harris did was to replace an active element with a passive element. The researchers found that all of the laser's power could be transmitted through two properly spaced mirrors at certain frequencies, rather than through the external phase modulator.

Ordinarily, a mirror will reflect most of the light, absorb a small part and transmit only a small part. A second mirror, it would seem, would transmit a small part of the light being transmitted by the first.

Not true, the Sylvania people determined. When the two mirrors are spaced so that the distance between them is an integral number of half wavelengths, the resulting phase relationship of the light between the mirrors produces total transmission of the original laser light, and thus the total power from the laser oscillations. This achieves the same result as the supermode laser, but without the previously required external phase

modulator, which was used to "demodulate" the f-m output and convert all the energy of the original laser modes into a single frequency, or supermode.

**Higher power.** Using the double-mirror technique (or a frequency-selective transmission etalon) can ultimately lead to higher and higher power outputs at a given laser frequency because the two mirrors have a passband that allows only one frequency to get out of the laser.

The experimental laser was a conventional neon-helium gas unit, modified to use a potassium dihydrogen phosphate (KDP) crystal inside the laser cavity in the optical path. This crystal changes the index of refraction and causes a change in the optical length of the cavity. The laser operates at 6328 angstroms with an output power of more than 50 milliwatts, a thousand times the output of the original supermode laser.

Sylvania scientists hope to achieve 10 times that much single-frequency power soon with an argon laser.

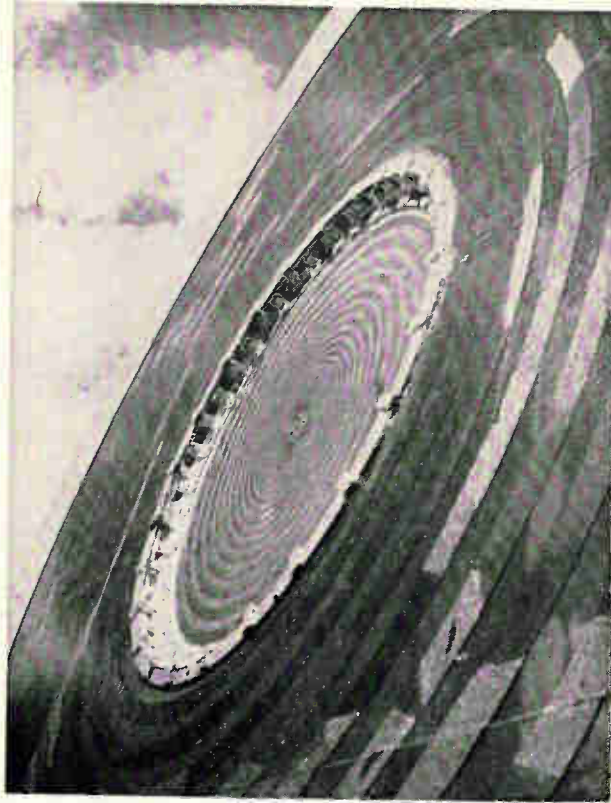

Monopulse feed, consisting of two spiral antenna—one inside the other—operates over a 4-to-1 frequency band with a sharp gain in boresight accuracy. The antenna was developed by Radiation Systems, Inc.

## Antennas

### Broadband but accurate

Monopulse antenna systems, which use many tuned feeds to operate over a wide frequency range, have one basic drawback: boresight error—the angular error between the axis of the antenna and the center of the radiated beam. The triple-feed antenna that's used by the National Aeronautical and Space Administration to track the Tiros weather satellite, for example, has a boresight error of about  $\pm 15$  milliradians because not all the feeds can be positioned exactly in the dish's focal point. At a distance of 100 miles, for example, a boresight error of 15 milliradians can cause a tracking error of 1.5 miles. NASA is now testing two antenna systems, designed and built by the Radiation Systems, Inc., of Alexandria, Va., using novel single-

feed designs that cut this error to only  $\pm 0.8$  milliradians—an improvement of more than 15 to 1 over multiple-feed designs that are used by NASA.

An antenna that has a bore sight

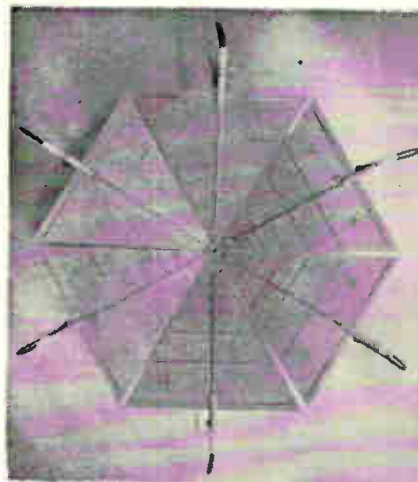

Array of 16-log periodic dipoles can pick up frequencies over a 17-to-1 frequency band. New antenna feed will be used in a 85-foot antenna for satellite tracking and data collection.

error of only 0.8 milliradians would be able to track a 100-mile high satellite to within 0.1 mile of its actual position.

One feed, which is scheduled to become operational shortly at Wallops Island, Va., picks up a 4-to-1 band of frequencies; the other, which is about a year away from operational testing, has a bandwidth of 17 to 1. In addition, both antennas can pick up all frequencies within their band; with multiple-tuned feeds, only the discrete frequencies for which the feeds are tuned can be received. Both feeds were designed for 85-foot parabolic dishes for tracking and data acquisition.

**Wide band.** The 4-to-1 feed operates from 136 to 400 megacycles while the 17-to-1 feed is effective between 130 and 2,300 Mc—the entire range of NASA's satellite-tracking and data-acquisition network.

Work on the 4-to-1 feed was a hurry-up job to meet the needs of Tiros, which became operational this month [Electronics, Jan. 10, p.

43]. The 17-to-1 design will probably replace the 3-to-1 feed and may eventually be installed in NASA's worldwide network of tracking antennas.

The 3-to-1 feed is a four-arm spiral printed on a glass fiber dielectric. It's eight feet in diameter, the largest printed spiral feed ever constructed. The cavity on which it is mounted is 17¼ inches deep. Two sets of spirals are used, one inside the other; the smaller spiral has a diameter of about 2.6 feet.

The 17-to-1 feed is also eight feet in diameter and consists of a radial arrangement of eight-log periodic dipoles printed on a flat dielectric sheet.

**Other pulses.** Aside from large bandwidths and small boresight errors, the feeds provide two other pluses: smaller sidelobes and the ability to simultaneously receive both right- and left-hand polarization.

A four-decibel reduction in sidelobe level is achieved by accurate positioning of the feed and illumination of the dish. The ability to pick up both senses of polarization eliminates feed-line switching networks, which introduce phase errors and degrade boresight accuracy. Also, antenna gain is boosted by as much as three decibels when both polarizations are transmitted by the target because there's no polarization loss.

## Consumer electronics

### A second source

For more than a decade, a little-known manufacturer—the Buckbee Mears Co. of St. Paul, Minn.—has held a tight grip on the market for a key part in color television tubes: the shadow mask. Although it has granted licenses to two companies—the Radio Corp. of America and Sylvania Electric Products, Inc.—the pair has produced shadow masks only for in-house use. As a result, six of the eight producers of color-tv tubes have looked to Buckbee Mears as the sole source of the vital part. Next month, however, the situation will change: Sylvania has announced it will triple its mask-production facilities at its Towanda, Pa., plant and offer the masks for sale on the open market.

**A helping hand.** As in the earlier licensing agreements, Buckbee Mears will install the manufacturing equipment and train the production line workers for Sylvania, which is a subsidiary of the General Telephone & Electronics Corp.

Buckbee Mears is also planning ahead. It has announced a major expansion to boost mask production by 100% next month. Says the company's executive vice president, Norman C. Mears: "We've

been doubling production every six months for the last few years."

A quick look at the skyrocketing sales of color tv sets indicates the size of the mask market: in 1965, the industry estimated sales of 2.7 million sets; this year, sales are forecast at 4.5 million; and in 1967, volume is expected to exceed 8 million.

The shadow mask is a thin sheet of steel perforated with up to 440,000 tiny cone-shaped holes. The holes are photographically imprinted on the steel and then etched out chemically. The holes pinpoint the three beams emitted by the electron gun in the picture tube, and direct them at the phosphor screen.

### No fade-out

Commuters driving through the Caldecott Tunnel near San Francisco recently had a surprise—not only didn't their car radios fade out, as radios always do in tunnels, but on some stations the volume even increased.

The reason: a new system developed by TRG West of Menlo Park, Calif., a division of TRG, Inc., picks up the entire a-m broadcast band and reradiates it through a cable inside the half-mile tunnel.

**Keep in touch.** The idea of transmitting radio signals in tunnels isn't new. For example, a communications system is currently being installed in New York subway tunnels so trainmen can keep in touch with dispatchers and police; and in some long auto tunnels, cables provide emergency radio communications. But the TRG system is the first system that relays the entire a-m radio band solely for the convenience of motorists.

The TRG system is already being considered for underpasses in Washington, D. C., and Monterey, Calif.

In the Caldecott Tunnel, which passes under a mountain between Oakland and Walnut Creek, California highway engineers tried various schemes for eliminating radio fade-out, but none was very successful. First, they took a wire and



Production line for the manufacture of shadow masks, a key element in color television tubes.

# A PROBLEM SOLVER RECTIFIER... FOR FREQUENCIES TO 100 KC

INTERESTED?

Read on and learn how fast recovery rectifiers helped one designer

## CASE HISTORY

George had a problem--the bridge rectifiers in a 30 KC static inverter power supply were running much too hot. This perplexed him since the bridge output current of 1 Amp was within the rating of these rectifiers, 1N3189s. Although crowded for space, George decided to try larger stud mounted 1N1124As. No help! They also ran hot and in addition reduced output voltage and operating efficiency.

What George needed was a fast recovery rectifier to eliminate the severe reverse recovery losses at this frequency. Such losses cause conventional diodes to overheat and drop their output voltage. The solution... UNITRODE UTR22s which have recovery times of 100 nanoseconds in the standard 1 Amp to 30 volt test circuit. In contrast the 1N3189 has a typical recovery time of 2 microseconds; a stud mounted 1N1124A is even slower.

In addition, George picked up some other bonuses--much smaller size, lighter weight, higher thermal efficiency and increased reliability because of the unique Unitrode monolithic construction.

P. S. Note the Unitrode 50 watt surge zeners (the same small size as the UTR 22) used to protect the expensive power transistors from burnout due to voltage spikes.

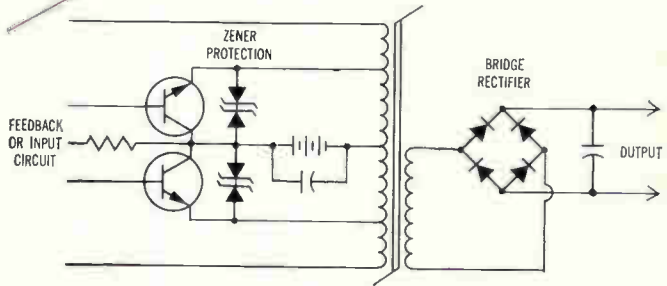
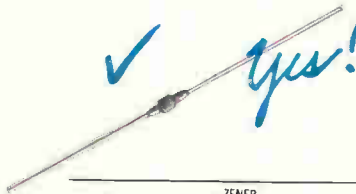
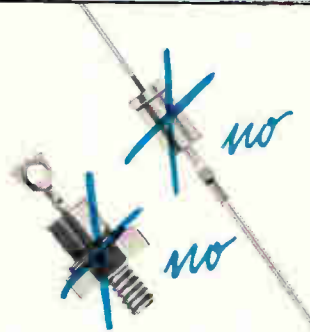

## YOU CAN HELP YOUR DESIGNS TOO.

Contact the factory, call your local COMPAR office, or circle the reader service number on this magazine's reply card. All will insure your receiving data sheets and samples of Unitrode Fast Recovery Rectifiers (including the new 50 nanosecond UTX series) plus information on other Unitrode devices immediately.

REPRESENTATIVES IN PRINCIPAL CITIES THROUGHOUT THE WORLD

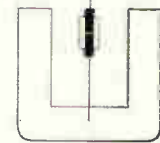

**UNITRODE®**  
"better always/by design"

UNITRODE CORPORATION  
580 Pleasant Street, Watertown,  
Mass. 02172 Telephone (617) 926-0404  
TWX (710) 327-1296

suspended it by insulators through the length of the tunnel with one end of the wire jutting out at the tunnel's mouth.

The scheme was ineffective; car radios still faded at intervals in the tunnel.

The next step was to place a wideband amplifier with a whip antenna at the mouth of the tunnel after connecting the amplifier to a cable that stretched through the tunnel.

This plan also failed, because of several matching problems in the system.

**Sought help.** The highway engineers then turned to TRG, and the project's engineer, Richard Hilbers, developed the system that's being used now. The trick, says Hilbers, was to solve the matching problem between the antenna and a specially designed amplifier and between the amplifier and the tunnel's cable.

A nine-foot whip antenna, mounted in an area of good signal reception, was coupled to the amplifier through a wideband antenna coupler. The amplifier, a solid state unit that covers the range from 530 to 1602 kilocycles, has a power output of five watts. It was designed with a large dynamic range, because of the wide variation between strong and weak stations, and with low intermodulation distortion.

The Caldecott Tunnel has three bores, one for each lane of traffic. In a recent test only two bores were strung with wire. Now that the system has been proved effective, the third bore also will be wired. Three identical outputs will be provided from the amplifier to feed the three cables.

Each of the cables will be terminated in a 300-ohm resistor to prevent standing waves inside the tunnel.

Thus, the strength of signal received by the auto radio will be independent of the car's distance from the mouth of the tunnel.

The entire electronic system, not counting the price of the number 6 copper wire that's strung in the tunnel, costs about \$1,500, TRG says.

## Military electronics

### Steerable parachutes

The Army and the Air Force are showing increasing interest in electrically steerable parachutes and wing-like structures as a way of accurately dropping airlifted supplies to troops engaged in anti-guerrilla warfare. Several new concepts, all of which utilize guidance devices to keep supplies from falling into enemy hands or going astray in difficult terrain, are being tested or evaluated. The new field looks so promising that the two services, joined by the Navy, have agreed on the parameters of a standard guidance and control package. Their aim is to avoid a proliferation of electronic systems with different frequencies and modes of operations.

The frequency, of course, is a tightly kept secret—to keep the enemy from guiding the parachutes to his own use. The services are now working microminiaturization features into the designs.

**Standard package.** A variety of electronics systems are now used on the different types of parachutes being studied or tested. But a switch to a standard package would be required if any of the air-drop devices is procured for operational use.

All of the systems have a ground transmitter that sends signals to a control unit on the parachute. It, in turn, operates servomechanisms that manipulate steering cords on the parachutes.

The Air Force already has run more than 60 tests in this country and in the Bavarian Alps on a flexible wing-like structure known as the Para-Sail homing cargo-delivery system. Along with a 2,000-pound payload, it carries a 15-pound control unit. The ground transmitter weighs 30 pounds.

A larger version of this system, with an electronics package developed by the Sierra Corp., was eventually rejected by the National Aeronautics and Space Administration to guide the Gemini space capsule down once it reentered the atmosphere. The electronics gear

of the Air Force version was developed by the Avionics Laboratory and Systems Engineering Group at Wright-Patterson Air Force Base, Ohio.

The Air Force is also testing a steerable "cloverleaf" parachute, which consists of three joined canopies. It uses the same guidance mechanism as the Para-Sail.

The Army is testing a radio-controlled Regalo wing, which inflates after it is dropped from an aircraft. This chute, which can support 500 pounds, was originally developed by NASA. The Ryan Aeronautical Co. developed its guidance package.

**The Batwing.** Both the Army and Air Force are also interested in a bat-like wing developed for civilian sky divers by Barish Associates, Inc. It has such a slow rate of descent—five feet per second, compared with 20 feet per second for the standard parachute—that it lands a man on his feet. Both services are exploring the possibility of adapting it for guided cargo drops. They are also interested in another concept that is still in the exploratory stage—the Notre Dame wing. This is a series of cloth cells that look like vertical wind socks. When the wind fills them out, they form a steerable honeycomb wing. Both parachutes could be equipped with electronic controls, the military says.

The Canoga Electronics Corp. has developed a different control device for parachutes that does not attempt to guide them, yet deprives the enemy of their cargo if they stray off course. The Air Force is beginning tests this month of what Canoga calls the "chute popper."

It consists of a tiny control box carried by a ground observer who watches as supplies are dumped from an airplane. With the Canoga system, the parachute does not open initially. It keeps falling until the observer is sure it will drop into friendly territory. If it looks as though it will, he sends a signal to a receiver, which forces the parachute open at 500 to 1,000 feet above the ground.

If it appears the parachute is drifting into enemy territory, the

# COMPONENT COMMENTS

*From Speer*

**Are our new custom resistor networks the missing link your precision circuits have been waiting for?**

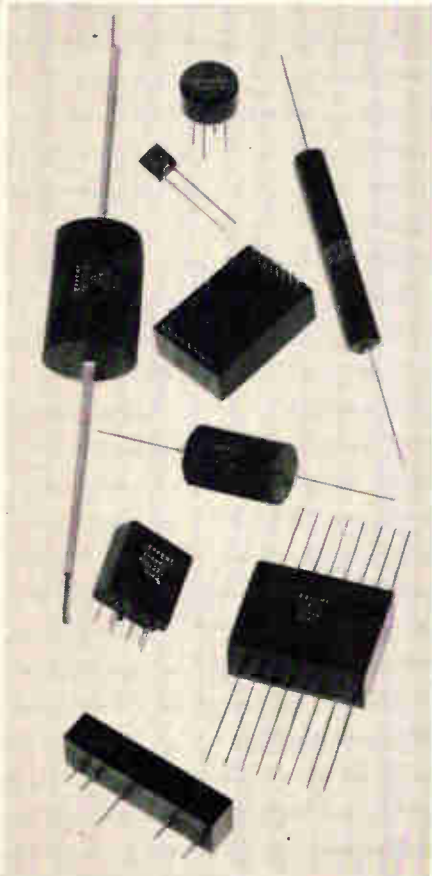

We suspect that they are—since they're a direct descendant of our Jeffers Electronics Division's *standard* JXP resistor.

What we did first was to recognize that the advantages (price, delivery, and performance) of the highly stable

JXP metal film resistive elements used in the standard line were also applicable to custom network and packaging assemblies. Therefore, we established an engineering staff and production facilities to handle design and manufacture of complex resistive element combinations and to package them according to your custom requirements.

In the meantime, the state of the art of producing the JXP type of metal film resistive element advanced. Specifically, we developed the ability to calibrate resistive elements to tolerances as low as 0.01% with characteristics of very low temperature coefficient of resistance and compatible stability.

What's more, we can design these packages to meet any network application—ladder, analog-digital, voltage divider, function generation, summing amplifier, pulse sampling—you name it.

Our custom packaged networks and assemblies offer broad environmental capabilities. And thanks to the marvels of modern technology performance, they will meet all your requirements at the lowest possible cost on the shortest delivery schedule known for this type of product.

Doesn't this indicate that our new custom packaged resistor networks are worth investigating further? You can do this at the IEEE Show. Or you can get more information by merely mailing us the coupon.

**Explore our new custom resistor networks at the IEEE Show**

Come to the Jeffers/Speer Booth (4M32) at the Coliseum. You'll see

both our new networks and our standard JXP. (Not to mention that work horse of the electronics industry—the Speer carbon composition resistor.)

If you can't make it to the Show, send us the coupon and we'll tell you more about our new networks. You'll find that they make quite a package!

**Visit with our Technical Service Engineers**

Take a little time out to visit our Technical Service Engineers at Booth 4M32 at the Coliseum. They are well acquainted with networks, especially in regard to resistors (as they should be), because of contributions made by them and other members of our technical staff to specifications during development of our networks.

**SPEER**® Carbon Co.

JEFFERS ELECTRONICS DIVISION  
**SPEER CARBON COMPANY**  
DuBois, Pennsylvania 15801

Speer Carbon Co. is a Division of  
Air Reduction Company, Inc.

Rush more information on your new custom resistor networks.

Name \_\_\_\_\_

Title \_\_\_\_\_

Company \_\_\_\_\_

Address \_\_\_\_\_

City \_\_\_\_\_ State \_\_\_\_\_ Zip \_\_\_\_\_

# This new DVM from Trymetrics proves—



Models 103—104—105  
Single range plug-in heads  
10V, 1V, 100mV

Models 300A—400A—500A  
3, 4 and 5 automatic  
range plug-ins; 0.1—1000VDC

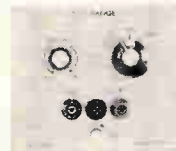

Models 300M—  
400M—500M  
3, 4 and 5 manual  
range plug-ins;  
0.1—1000VDC

## Check these Trymetrics features:

- Full 4 digit resolution. ■ Accuracy  $\pm 0.01\%$  of reading  $\pm 1$  count. Automatic polarity and overscale indicator. ■ High common mode rejection. ■ Complete range of plug-in heads for optimum flexibility. All silicon solid state circuitry. ■ Operation up to  $50^\circ\text{C}$ . ■ Sampling speeds up to (10) samples/second. ■ Sensitivity to  $10\ \mu\text{V}$ . ■ BCD or decimal printer output. ■ Crystal controlled oscillator guarantees ultra stable voltage-to-time conversion system.

## Check this Trymetrics price:

Model 4000 DVM \$770 with Model 103 10V Range Plug-In. For complete information and prices, write to:

**TRYMETRICS**  
Corporation  
204 Babylon Tpke., Roosevelt, L.I., N.Y.  
Phone 516-378-5020 Zip 11575

## Electronics Review

observer does nothing and the chute falls unopened, its cargo demolished by the impact.

**Finding the supplies.** Canoga is also working on a locator beacon that will send out signals on a secret frequency if the parachute has dropped close to target but is hidden by dense foliage. The Canoga system has drawbacks when it comes to handling multiple drops. Only one parachute can be deployed at one time if a single frequency is used, and if more than one chute is dropped, all respond to the same command. The alternative is to use more than one frequency. The Air Force is confident that in the case of steerable parachutes, multiple drops can be guided on a single frequency, but has not conducted a multiple-drop test yet. In principle, all the parachutes should home in on the guidance signal, and the time lag between drops should keep them from colliding.

### Lack of communication

It has taken a war in Vietnam to point up the inadequacies of close air support for American ground troops. Among the shortcomings, the most glaring has been the inability of the Army and Air Force to communicate with each other directly at the battlefield because of a radio incompatibility.

A recently released report by a House Armed Services subcommittee termed this incompatibility "appalling . . . incredible . . . a fiasco." The subcommittee also criticized the Air Force for never having developed an airplane specifically tailored for the ground-support mission. And the Congress also criticized the Defense Department for wavering too long before deciding to develop and procure a specialized counter-insurgency (COIN) plane.

**Better late than . . .** What the subcommittee didn't point out is that corrective action—however belated—is being taken.

The communications problem between ground units and supporting aircraft arose because Army and Air Force radios differ in both

frequency range and modulation mode. The Army chose frequency-modulated ultrahigh frequency sets because it must concentrate many radios in a battlefield and must limit their power and range to reduce interference. The Air Force settled on amplitude-modulated very-high frequency sets because it requires longer-range communications.

As a result, an Army ground unit cannot talk directly to airborne controllers who fly overhead and mark targets when air strikes are requested or to other air controllers who perform the same mission on the ground. Messages are relayed from the platoon or company back to Air Force liaison at headquarters, then transmitted on an Air Force radio.

**An unusual war.** In a normal war, this time lag could be tolerated. Tanks and heavy artillery could pound the target until an air strike arrived. But Vietnam is not a normal war; mobility requirements are so great that slow tanks and bulky artillery are scarcely used.

Yet the investment of both services in their communications equipment is so great that it would cost hundreds of millions of dollars for a changeover, not to mention the time loss.

To close the communications gap, the Defense Department forced a compromise. Air controllers—whether airborne or on the ground—now carry duplicate sets of equipment, which have been redesigned and repackaged so they weigh no more than the original sets.

In addition, the Army's PRC-10 has been supplemented by the PRC-25, a radio of greater power and range, which has been rushed to Vietnam. This set has greater capability for reaching air controllers.

**Ignore the soldier.** The subcommittee said that while it lauded the Air Force "for its accomplishments in the strategic field, in the field of air superiority, in its interceptor capabilities and in its improved airlift . . . we feel that in its magnificent accomplishments in the wide blue yonder it has tended to ignore





It's a steal.

We're not trying to keep you from seeing a better deal when you buy. We're just trying to help you see the value of the quality and reliability of the Wavetek Model 110. It's a complete laboratory of signal sources all by itself. It's portable. Just 7 lbs. light. Goes anywhere you need it. And it's rugged. Wavetek portables installed in trucks, ships and airplanes have taken all kinds of rough treatment and continued to function according to specs. The standard ac-powered version sells for \$395. If you want added portability, spend another \$50 and get the Model 110R. It has ni-cad batteries with a built-in recharger. And our new voltage-controlled generator (VCG), the Model 111, goes for only \$545.

**WAVETEK**  
8159 Engineer Rd., San Diego, Calif. 92121  
 3000 Bern 9, Seidenweg 17, Switzerland

## Another steal.

We decided that function generators didn't have to sell for \$550 or more.

The new 110 is more than just a function generator. It's a precision source of sine, square and triangle waveforms.

It operates at servo, audio and video frequencies with six (6) simultaneous outputs.

Actually, the 110 is a complete laboratory of signal sources all by itself.

Like most Wavetek function generators, the 110 is portable. Just 7 lbs. light. Goes anywhere you

\$50 and get the Model 110R. It has ni-cad batteries with a built-in recharger. And our new voltage-controlled generator (VCG), the Model 111, goes for only \$545.



So we designed the most versatile function generator yet, the Model 110, to sell for just \$395.

You're probably thinking we skimped on quality or cut something out in order to do this.

We didn't.

In fact, we've improved the quality. And we've added versatility that our earlier instruments didn't have.

We've been working toward this goal since we designed the first portable, broad-frequency-range function generator more than three years ago.



need it.

And it's rugged. Wavetek portables installed in trucks, ships and airplanes have taken all kinds of rough treatment and continued to function according to specs.

The standard ac-powered version sells for \$395. If you want added portability, spend another

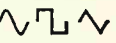
- 0.005 Hz to 1 MHz 
- 30v p-p into 600Ω
- 10v p-p into 50Ω
- 6 simultaneous outputs
- Clean HF waveforms
- 0.5% sine distortion
- Flat frequency response
- Calibrated outputs
- 5 nSec. rise and fall time
- All silicon
- 0°C to 55°C operation

At any of these prices, you'll be getting more signals per dollar than with any oscillator or function generator on the market today.

Talk about a steal!



**WAVETEK**  
 8159 Engineer Rd., San Diego, Calif., Tel. 279-2200  
 3000 Bern 9, Seidenweg 17, Switzerland

the foot soldier on the dirty brown under."

The subcommittee also charged that although the Air Force has the responsibility of providing close support for the Army, it has never developed a plane solely for the mission, nor is it doing so, the subcommittee said. Instead, it insists on multipurpose planes—capable of air-to-air combat as well as air-to-ground combat—and on supersonic speed rather than the slower speed more suitable to ground support, said the report.

Whatever the merits of this argument, the Air Force will get a new subsonic plane built solely for the close-support role under the new defense budget. Ironically, the aircraft is a Navy plane—Ling-Temco-Vought, Inc.'s A-7—and it will replace another Navy plane being used by the Air Force in Vietnam, the Douglas Aircraft Co.'s old prop-driven A-1. In addition, the Air Force made the A-7 decision somewhat reluctantly, under pressure from the Pentagon and the Army.

**Close support.** The subcommittee also pointed out that the Air Force had to get spotter planes it needed for close support in Vietnam from the Army and is not producing any planes with the same capabilities for attacking ground targets at night or in adverse weather as the Grumman Aircraft Engineering Corp.'s A-6, another Navy plane. The possibility of an Air Force purchase of the A-6 is under study.

As for the COIN, the subcommittee charges that both the Defense Department and the Air Force dragged their feet. COIN is a reconnaissance plane with long-loiter capability that can also deliver attacks against ground targets not heavily fortified.

The Marine Corps established a requirement for COIN in 1962. But the Air Force did not ask for the plane until last September, and the Defense Department did not decide on procurement until November, when the new budget was drawn up.

North American Aviation, Inc., is developing COIN, which made its first flight in July and is still being evaluated.

## Computers

### Setting the pattern

Thirteen electronics companies are vying for a National Aeronautics and Space Administration contract to develop a spaceborne multiprocessing system that may set the pattern for onboard computers in space missions after the Apollo project to land men on the moon by 1969.

Conspicuous by its absence from the list is the giant of the industry, the International Business Machines Corp.

An award is expected to be made this week in Cambridge, Mass., by NASA's Electronics Research Center.

**Proposal made.** Technical proposals for development of the computer were submitted by the Autonetics division of North American Aviation, Inc.; the Burroughs Corp.; General Electric Co.; Goodyear Aerospace Corp.; Hughes Aircraft Co.; Radio Corp. of America; Raytheon Co.; Stanford Research Institute; Teledyne Systems Co., a subsidiary of Teledyne, Inc.; the Univac division of Sperry Rand Corp.; Westinghouse Electric Corp.; Sylvania Electric Products, Inc., a subsidiary of General Telephone & Electronics Corp.; and Honeywell Inc.

Under a one-year contract, the successful bidder will develop new hardware and software techniques of multiprocessing geared to the requirements of long-range space missions. At various stages of a mission, the computer will have to reallocate its modular resources to monitor prelaunch and inflight checkouts, supervise communications and telemetry, monitor control and stabilization, allocate spaceship power, trigger flight displays, perform guidance and navigation, monitor astronaut performance and life-support subsystems and process scientific measurements.

**Just in case.** In addition, the computer will have to be prepared for unpredictable situations: it must be able to reconfigure its modules and reallocate its chan-

nels during the mission. Also, it will have to take care of an unforeseen failure of some subsystem, including itself, and this reallocation must give priority to critical phases of the mission.

"The computer will not be adaptive in the sense that the human brain is, but it will mark a first move in that direction," says Thomas E. Burke, acting chief of the Computer Research Laboratory at the NASA center. "This multiprocessing capability will be a critical one for future space missions," he says.

The development contract probably will involve, for the first time in the space program, extensive use of computer-aided design. NASA is funding several such studies, including one at the Massachusetts Institute of Technology [Electronics, Feb. 7, p. 39].

"Present-day approaches to the synthesis of computers follow largely the design techniques developed for commercial electronic data-processing equipment," says Burke. "In the Apollo guidance and navigation computer, progress has been made on automating the module interconnections while providing a basic framework for accommodating changes and modifications. Present techniques, however, do not provide for close interaction between the computer and the designer before hardware commitments. New approaches are needed to allow the synthesis of advanced computer designs, which use advanced components and circuitry, including threshold network elements. More powerful computer aids will allow significant time and dollar savings during the initial phases of spaceborne computer developments."

**Saving time.** Burke says extensive pre-design simulation and modeling can reduce design time and thus permit the use of the latest technology. It can also pinpoint restraints dictated by varying environmental conditions. Simulation, Burke adds, allows a better use of semiconductor chip technology. Computer-aided design can spell out and test functions, then allocate these functions to one or more chips.

Computer-aided design will also minimize the problem of accommodating changes after initial design has been frozen. "A huge investment of manpower is needed to do this manually—and error can be introduced," says Burke.

"Simulation will be important in tracking down errors in programming," he adds. "There are too many variables to track them down one by one as a human programmer does."

## Electronics notes

▪ **Pilgrim's progress.** The National Aeronautics and Space Administration is expected to approve the development of a new scientific

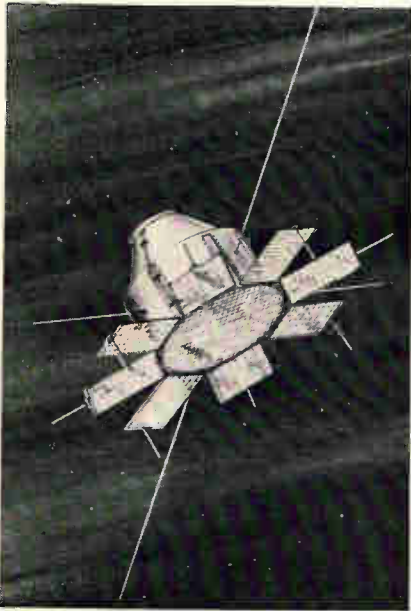

satellite, called Pilgrim, which will study solar flares. The craft will probably be launched either late in 1968 or early in 1969. The 170-pound satellite will make extensive use of integrated circuits. Pilgrim will carry three spectrometers that will receive in the range from 0.25 to 16 megacycles. The satellite will be launched into an elliptical earth orbit that will extend as far as 6,000 miles into space.

▪ **C-5A subcontracts.** The Lockheed Aircraft Corp.'s Georgia division has awarded the first two multimillion-dollar subcontracts for the Air Force's C-5A cargo plane. The Norden division of the United Air-

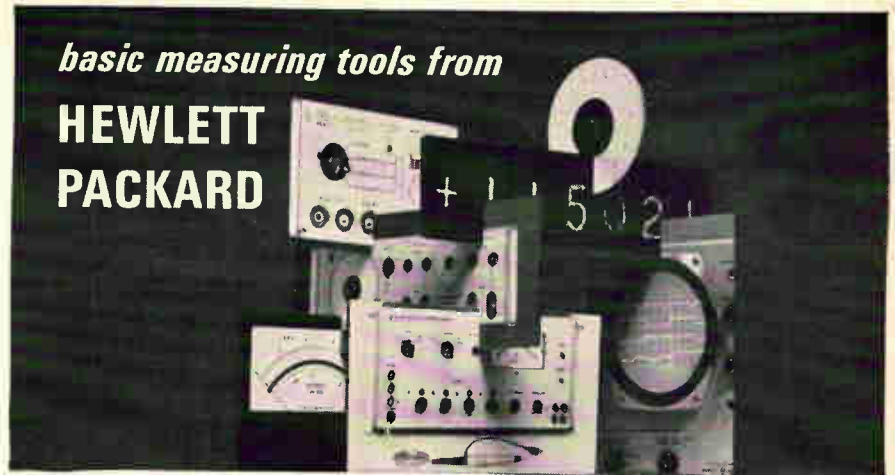

*basic measuring tools from*

**HEWLETT  
PACKARD**

## Field-proven hp 651A Test Oscillator

Accurate test signals, 10 Hz (cps) to 10 MHz (mc)  
Typically 10 ppm short-term stability  
Long-term frequency stability  $\pm 0.02\%$ , amplitude stability  $\pm 0.1\%$   
1% accurate 90 db output attenuator  
50-, 600-ohm output impedances (optional 75 $\Omega$ )

### Use it for:

Response testing, narrow- or wide-band  
Test signal source with low distortion in presence of shock, vibration or hf radiation  
Measuring filter transmission characteristics, tuned circuit response  
Telephone carrier measurements  
Bridge measurements  
Video amplifier tests  
Voltmeter calibration  
Amplifier loop gain plots  
Receiver alignment  
Network gain/loss measurements

Here's a high-performance solid-state source of low-distortion test signals for a wide variety of uses. Performance-proven in the field. Wide frequency range, continuously variable across six bands. Low hum and noise. Voltmeter output monitor calibrated in v and db, highly accurate output attenuator with output isolation achieved through power amplifier. Price: Only \$590.

Ask your hp field engineer for a demonstration of this basic measuring instrument. Or write for complete information to Hewlett-Packard, Palo Alto, California 94304, Tel. (415) 326-7000; Europe: 54 Route des Acacias, Geneva.

Data subject to change without notice. Price f.o.b. factory.

**HEWLETT**  **PACKARD**  
An extra measure of quality

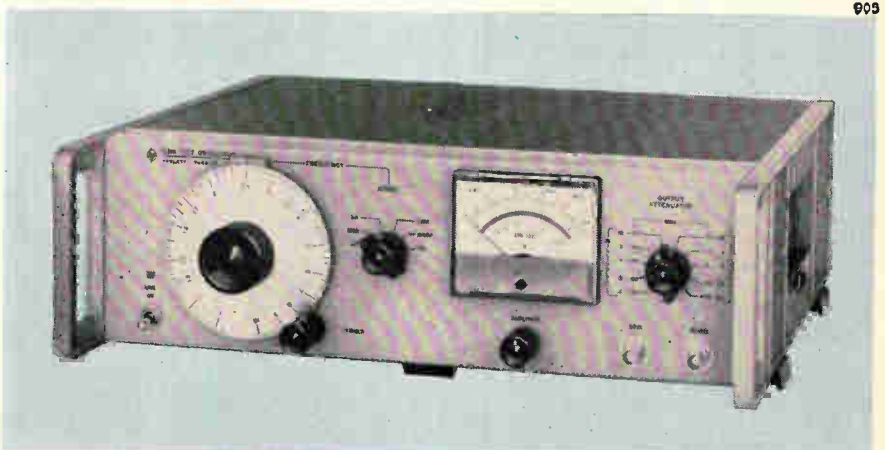

# ANTENNA and TOWER INSULATORS by LAPP

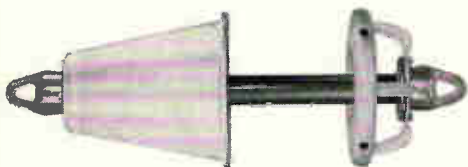
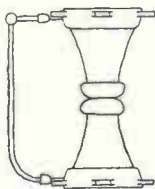
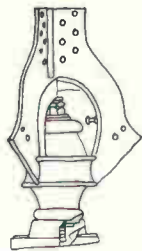

## Electronics notes

craft Corp. received a contract for multimode radar equipment that will exceed \$18 million. And the Nortronics division of the Northrop Corp. won an order for doppler-inertial navigation gear that will top \$20 million. The radar will provide high-resolution ground mapping and will warn pilots of bad weather ahead. It will also contain automatic low-level terrain-following equipment.

▪ **Beacon for crash clues.** A tiny, solid state acoustic beacon to help air crash investigators find a flight recorder underwater is about to undergo testing by the Federal Aviation Agency. The device was developed for the FAA by the DuKane Corp. The FAA—looking for a means of locating the information-packed flight recorder in relatively shallow water—asked only for a radio transmitting device with a range of 1,000 yards and a life of 48 hours. The transmitter is activated when contact with water shorts two terminals. If the device is effective, the FAA could require them on commercial aviation flight recorders and on the new pilot voice recorders that airliners will be required to carry beginning later this year.

▪ **New symbol.** The National Academy of Engineering, created in December, 1964, has adopted an official seal—a silhouette of a Roman viaduct. Explaining the design, Augustus B. Kinzel, president of the organization, says: "It represents an important historical achievement of the engineering profession. It's also meant to symbolize engineering as a bridge between science and society."



▪ **IBM and computer tape.** The Japanese government has approved an agreement permitting the Sony Corp. to export its know-how and patent rights covering the production of magnetic tape to the International Business Machines Corp. in the United States. The agreement marks IBM's move to manufacture its own magnetic tape; it currently buys tape from outside suppliers.

Lapp insulators support most of the world's large radio towers, both self-supporting and guyed masts. Lapp has designed and built base insulators from 80,000 lbs. to 9,000,000 lbs. ultimate strength. Lapp strain insulators have been made from 1200 lbs. to 620,000 lbs. ultimate strength. □ Lapp is also a dependable supplier of entrance, spreader and stand-off insulators for transmission lines. Other Lapp insulators and our gas filled capacitors are used in transmitters and coupling networks. □ Difficult insulating problems are welcome here at Lapp. We've been solving them for almost a half century. Write Lapp Radio Specialties Division, Lapp Insulator Co., Inc., 241 Sumner St., LeRoy, N. Y. 14482.

# Lapp



## ULANO EUROPEAN TECHNICAL CENTER FOR GRAPHIC ARTS

Ulano's technical center in Switzerland is headed by the very capable Mr. Henri Kunz. He is qualified by his many years of experience in the Screen Process and Graphic Arts fields. Demonstrations and technical seminars are held in many languages throughout the year. Complete laboratory facilities have been installed to provide demonstrations of the complete Ulano line. Large stocks of all famous Ulano films are available for immediate delivery to all parts of the world.

You are invited to contact Mr. Henri Kunz at ULANO A.G., Untere, Heslibachstrasse No. 22, Kusnacht 8700, Switzerland, Telephone 905959. It is our pleasure to serve you.



**DO YOU USE  
SCREEN PROCESSING  
IN THE PRODUCTION OF  
COMPLEX  
PRINTED  
CIRCUITRY?**

**TWO NEW PRESENSITIZED FILMS TO  
SPEED PRODUCTION - LOWER COSTS**

*Ulano*



Write today on  
your letterhead  
for free Special  
Sample Kit 5248

### HI-FI RED

#### HEAVY-DUTY INDUSTRY PROVED

Presensitized photo film used by many leading electronic firms for clean, sharp, tough, durable, almost indestructible screens of unmatched quality. Adheres tightly to wire, silk, nylon and dacron.

### PREP®

#### PRESENSITIZED FOTO FILM

.002 Polyester support guarantees good register. Does not require a dark room. Very good resolution—suitable for halftones. Excellent adhesion to silk, nylon, dacron and metal mesh. Tough, strong emulsion—good for machine printing and long runs.

## J. ULANO & COMPANY, INC.

610 Dean Street, Brooklyn, N. Y. 11238, U.S.A.

Cable address: "Ulanofilm"

In Europe: ULANO A.G., Untere, Heslibachstrasse No. 22  
Kusnacht, Zurich, Switzerland

## HERE'S HOW...



**LITHOGRAPHERS, ENGRAVERS, ARTISTS, SCREEN PROCESSORS ALL USE  
THESE FAMOUS MASKING FILMS TO SEPARATE COLOR, ELIMINATE  
OPAQUING, PREPARE DROPOUTS, SAVE TIME, REDUCE JOB COSTS**

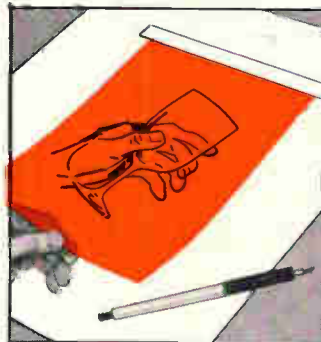

Cut a piece of the desired film large enough to cover area to be masked. Tape it down firmly at the top with dull-side up.



With sharp blade, outline the areas to be masked. Do not cut through the backing sheet. The Ulano Swivel Knife does the job quickly, easily.



Using the tip of the blade, lift up a corner of the film thus separating it from the backing sheet.

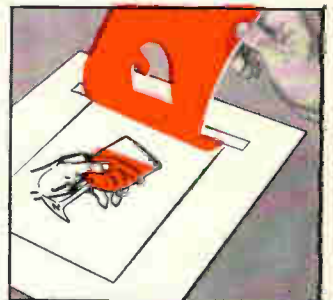

Now carefully peel off the film. Your art work is now separated with the "second color" on a clear Mylar overlay ready for camera and in perfect register.

**Ulano** T.M.

**RUBYLITH T.M. • AMBERLITH T.M.**

HAND CUT MASKING FILMS FOR THE GRAPHIC ARTS

ULANO RUBYLITH . . . a revolutionary knife cut red film is laminated to a stable transparent plastic backing sheet. The red film is "light safe" so that when contacted to a sensitized emulsion and exposed to a suitable light source, light passes through the cut-out portions only . . . not through the red film. ■ The mylar\* backing is absolutely stable . . . insures perfect register. ■ Special effects such

as crayon tones, paste ups, benday sheets, and opaquing are easily combined with versatile ULANO RUBYLITH. \*T.M. Dupont Polyester Film

ULANO AMBERLITH . . . a companion to Rubyolith serves as a color separation medium used as the master on camera copy board to secure negatives or positives.

Available in Rolls and Sheets

**ulano**

610 DEAN ST., BROOKLYN, N. Y. 11238

NEW YORK • CHICAGO • ZURICH



Write today on your letterhead for  
free Special Sample Kit 5348

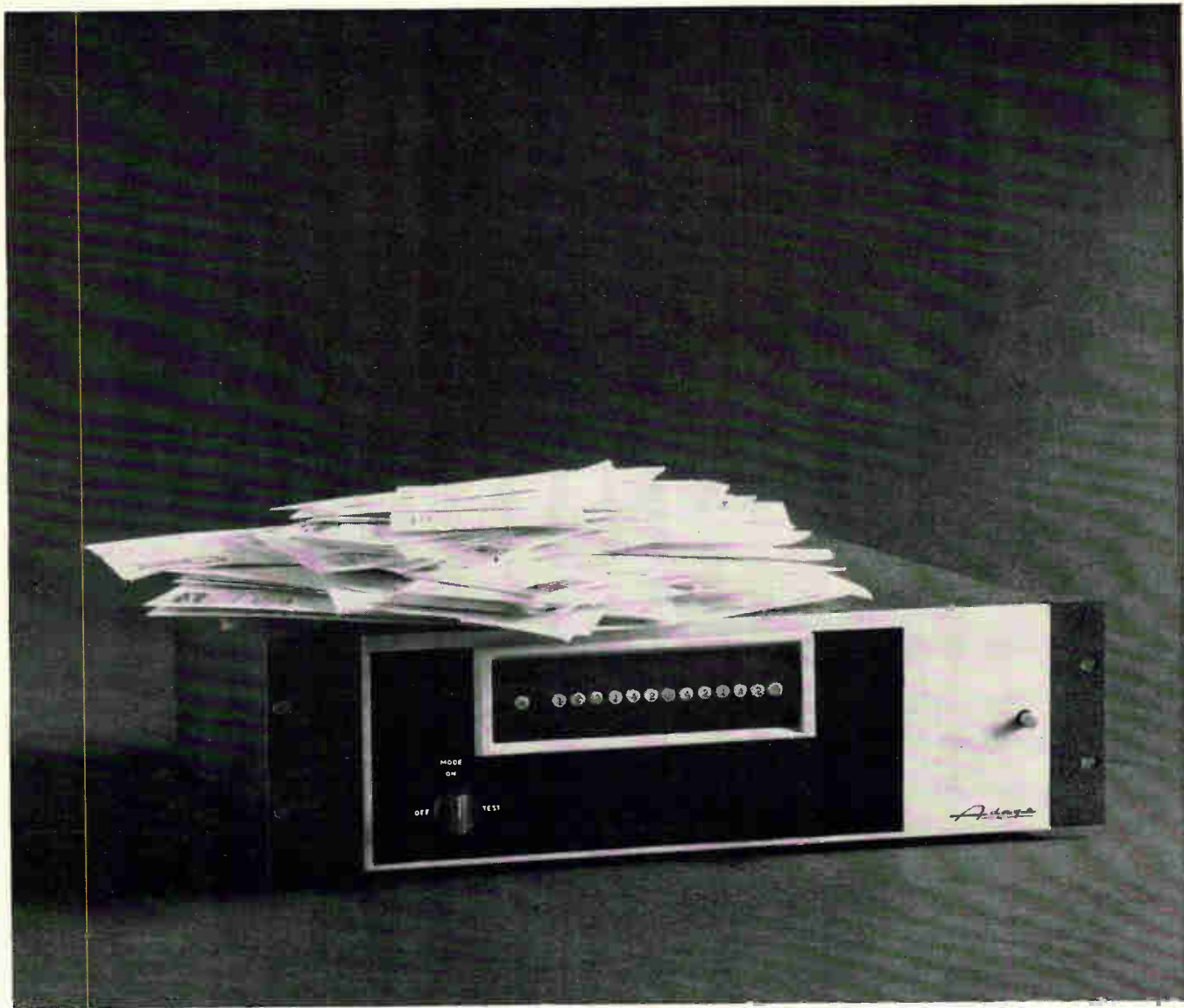

## A complete 14-bit A-to-D conversion in under 4 $\mu$ sec... that's something to write about!

We're delighted with the overwhelming number of inquiries we've received about our two new additions to the Adage VOLDICON™ line of voltage digitizers.

The high-speed, high-resolution VT13-AB and ultra high-speed VT7-AB are based on a novel design combining techniques of successive approximation and parallel threshold decoding. The VT13-AB ac-

complishes a 14-bit analog-to-digital conversion in less than 4 microseconds. The 8-bit VT7-AB performs a complete conversion in under 800 nanoseconds.

A full line of data systems components, including other A-to-D converters, D-to-A converters, multiplexers, operational amplifiers, and digital logic, is available from Adage, Inc. These components use

all-solid-state circuitry and are designed and tested to meet the most demanding requirements for accuracy and reliability.

Why not add your inquiry to the many we've already received? We would be pleased to send you a technical brochure on the VT13-AB and VT7-AB. Call or write I. R. Schwartz, Vice President 783-1100, area code 617.

*Adage, Inc. welcomes employment inquiries from professional engineers.*

**Adage**  
INC

1079 Commonwealth Avenue  Boston, Massachusetts 02215

This is a **MULTIVERTER**<sup>®</sup>. An integrated circuit Multiplexer, Sample and Hold Amplifier and Analog-to-Digital Converter in a single chassis. You can buy one from Raytheon Computer and nowhere else. 



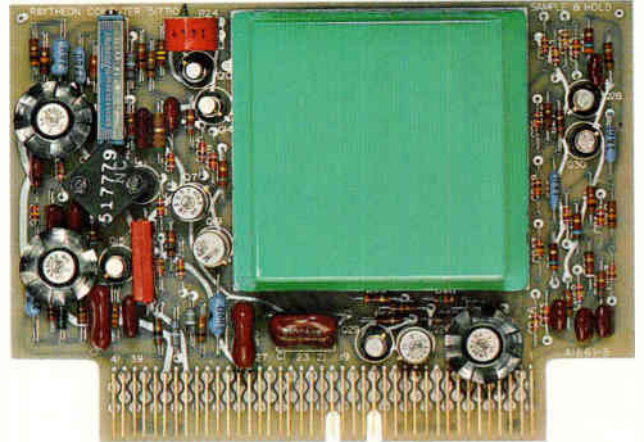
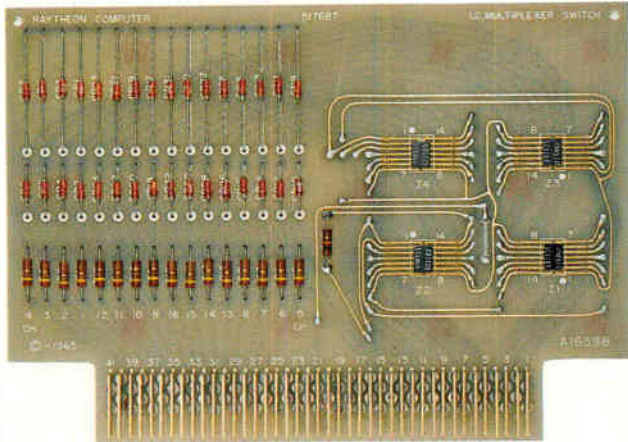

## MULTIVERTER FEATURES

### Complete Front-End System in Single 5¼" Drawer

- Multiplexer
- Sample and Hold Amplifier
- A/D Converter
- Power Supplies

### Integrated Circuit Multiplexer with 96-channel capacity

- Plug-in expandability in 8-channel increments
- Circuits packaged 16 channels/circuit card

### High Input Impedance

- 100 megohms for selected channel
- 1000 megohms for unselected channels

### High Performance—Total System to within 0.02%

- Linearity within 0.01% ± LSB
- Drift, 0.01% typical

### High System Throughput Rates

- 51KC at 12 bits
- 28KC at 15 bits

### High Performance Sample and Hold Amplifier

- Aperture time less than 50 nanoseconds
- Settling time (0.01%) less than 4.0 microseconds for full scale input

### Temperature Stability within 10 ppm/°C

- Five proportional controlled ovens
- Reference Oven Stability—±0.1°C

### Built-in Systems Timing and Control

- Single pulse operation for timing
- Sample and Hold internally controlled
- All sub-system interconnections made internally

### Four Standard Operating Modes

- Sequential
- Random Address
- Digitize Only
- Manual

### System Isolation

- Transformer Coupling
- Isolated Transistor Junctions
- Reversed Biased Diodes

### Low Cost—Approximately 30% less than conventional equipment

## Technical representatives and company sales offices:

**Alabama**, Fact-Tronics, P.O. Box 1135, Huntsville, (205) 539-7193; **Raytheon Computer**, Holiday Office Center, Suite 47, Huntsville, (205) 881-2844; **Arizona**, Barnhill Assoc., 30 Pima Plaza, Office 20, Scottsdale, (602) 949-0132; **California**, Home & Western Regional Office, Raytheon Computer, 2700 South Fairview Street, Santa Ana, (714) 546-7160; **Williams & Hedge, Inc.**, 4341 West Commonwealth, Fullerton, (714) 521-7410; **Williams, Hedge & Martin, Inc.**, Suite 308, Fayette Townhouse, 2675 Fayette Drive, Mt. View; **Colorado**, Barnhill Assoc., 1170 So. Sheridan Blvd., Denver, (303) 934-5505; **Connecticut**, Eltron Engr. Sales, 2341 Whitney Avenue, Hamden, (203) AT 8-9276; **Florida**, Fact-Tronics, P.O. Box 3202, Orlando, (305) GA 3-7069; **Georgia**, Fact-Tronics, 254 East Paces Ferry Road, Atlanta, (205) WX-4000; **Illinois**, Pivan Engineering, 3535 West Peterson Avenue, Chicago, (312) KE 9-4838; **Indiana**, Pivan Engineering, 10447 North College Avenue, Indianapolis, (317) VI 6-5805; **Iowa**, Pivan Engineering, P.O. Box 1274, Cedar Rapids, (319) 365-6635; **Maryland**, L. G. White & Co., 880 Bonifant Street, Silver Spring, (301) JU 5-3141; **Massachusetts**, Eltron Engr. Sales, 246 Walnut Street, Newtonville, (617) DE 2-6975; **Raytheon Company**, Bedford Laboratory, P.O. Box 508, Bedford, (617) 274-7100; **Michigan**, WKM Associates, Inc., 1474 East Outer

Drive, Detroit, (313) 892-2500; **Minnesota**, Pivan Engineering, 3203 North Highway 100, Minneapolis, (612) 537-5626; **New Jersey & Met. New York**, Kenneth E. Hughes Co., Inc., 2035 Lemoine Avenue, Fort Lee, (201) 944-1600; **New York**, DB Associates, Inc., 3307 Erie Boulevard East, DeWitt (Syracuse), (315) 446-0220; **DB Associates, Inc.**, 22 Biscayne Drive, Lancaster, (716) TF 5-6186; **New Mexico**, Barnhill, Assoc., 319 A Wyoming, N.E., Albuquerque, (505) 265-7766; **North Carolina**, L. G. White & Co., P.O. Box 2356, Winston-Salem, (919) 725-3612; **Ohio**, WKM Associates, Inc., 6741 Ridge Road, Cleveland, (216) 885-5616; **WKM Associates, Inc.**, 6085 Far Hills Avenue, Dayton, (513) 298-7203; **Pennsylvania**, L. G. White & Co., 100 N. Essex Avenue, Narberth, (215) MO 4-6505; **WKM Associates, Inc.**, 90 Clairton Boulevard, Pittsburgh, (412) 892-2953; **Texas**, Carey-Wolf Co., 3327 Winthrop Avenue, Ft. Worth, (817) PE 8-1702; **Carey-Wolf Co.**, 2510 Broad Street, Houston, (713) MI 3-2114; **Raytheon Computer**, 204 East Main, Arlington, (817) CR 5-5361; **Washington**, The Thorson Co., 1767 15th Avenue, So., Seattle, (206) EA 5-5000; **Washington, D.C.**, Eastern Regional Office, Raytheon Computer, 4217 Wheeler Avenue, Alexandria, Va., (703) 836-7616; **Wisconsin**, Pivan Engineering, P.O. Box 437, Waukesha, (414) 547-5131.

**RAYTHEON**

RAYTHEON COMPUTER, 2700 SOUTH FAIRVIEW STREET, SANTA ANA, CALIFORNIA 92704



# Start Designing Now with Integrated Circuits — the Easiest, Fastest, Most Economical Way



## Get a TI Designer's Kit from R. V. WEATHERFORD

Here's everything you need to get a headstart in modern logic design — newest Series 73 modified DTL integrated circuits, test sockets, applications circuits, complete device data — all for much less than the price of the items if purchased separately.

In your Texas Instruments Series 73 Designer's Kit you'll receive:

- Eight digital integrated circuits in hermetically sealed flat packs — representing 24 separate circuit functions (flip-flops, gates, dual EXCLUSIVE-OR, and "one shot").
- Six breadboarding sockets. Each integrated circuit is mounted in its own *Mech-Pak*™ carrier for quick, easy transfer from socket to socket to accomplish various circuit functions.
- A mechanical sample of TI's new 16-pin plug-in flat pack. This is an optional package for Series 73 circuits, specially designed for fast insertion and flow-soldering.
- Applications Guide including sample assemblies that can be built with kit components.
- 28-page data brochure describing electrical and mechanical details of Series 73 integrated circuits.
- Catalog of TI's full line of more than 125 digital and linear integrated circuits.

Demonstrate for yourself the many economies and the high performance inherent in integrated-circuit design. Start now to design and breadboard integrated-circuit assemblies such as counters, shift registers, adders, and . . . well the rest is up to you. Order your kit today.



## R. V. WEATHERFORD CO.

DISTRIBUTORS OF ELECTRONIC COMPONENTS AND EQUIPMENT

GLENDALE 1, CALIFORNIA: 6921 San Fernando Road, VI 9-3451  
ANAHEIM, CALIFORNIA: 1651 State College Blvd., KI 7-7521  
PALO ALTO, CALIFORNIA: 3240 Hillview Drive, Stanford Industrial Park, DA 1-5373

AUTHORIZED  
**DISTRIBUTOR** 



**Match these specifications against your requirements.  
Then contact Sigma or your distributor.**

<b>Series 11:</b>	Contact rating 1 ampere. Unenclosed, screw mounted, solder or printed-circuit terminals, all UL-listed (E28610 Yellow Card). Choice of 3 physical types, 11 coil resistances, 2 adjustments, 3 DC or 2 AC coil voltages.
<b>Series 59:</b>	Contact rating 2 amperes. Unenclosed, screw mounted, solder terminals; or metal dust cover, 8-pin plug. Choice of 3 DC coil voltages.
<b>Series 65:</b>	Contact rating 1 ampere. Unenclosed, screw mounted, solder terminals, or terminals for printed circuit mounting. Choice of 3 DC coil voltages.

New Sigma Series 59 and 65 relays now join the popular Series 11 to provide a broader range of low-cost SPDT relays for general purpose switching. Each of these small, one-ounce relays provides optimum operation for controlling light industrial and commercial loads. All are immediately available from stock at low prices.

How low in cost? Take the new Series 65. These DC relays are available in quantity at less than a dollar. They are specifically designed for simple, reliable on-off switching.

New Sigma Series 59 relays are built for gradually changing signals as well as on-off operation. This is made possible by the unique construction of these DC relays which use a snap-switch instead of conventional contacts.

Sigma Series 11 relays are available in both AC and DC versions. They are UL-listed and combine low price and high sensitivity with the ability to respond to gradually changing and on-off DC.

The new Sigma Series 59 and 65 relays and the Series 11 are suitable for applications ranging from vending machines and alarm systems to industrial controls. Use them wherever there is need for small, low-cost, highly dependable relays.

**FREE CATALOG:** Send today for the new Sigma Preferred Standard and Stock Relay Catalog and up-to-date stock list. They will help you select the relay types immediately available in quantity from your distributor or Sigma direct.

**SIGMA DIVISION**  **SIGMA INSTRUMENTS INC**  
*Assured Reliability With Advanced Design / Braintree, Mass. 02185*

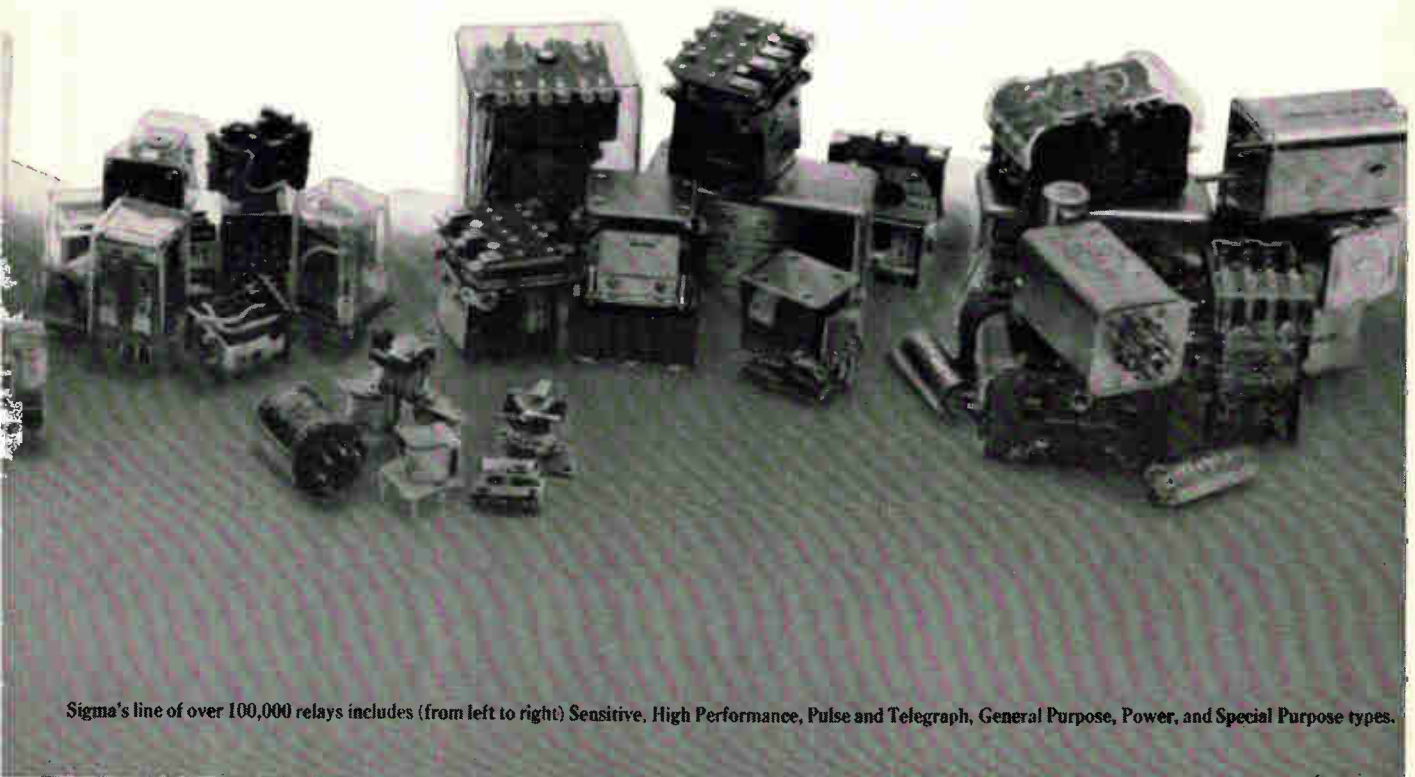

Sigma's line of over 100,000 relays includes (from left to right) Sensitive, High Performance, Pulse and Telegraph, General Purpose, Power, and Special Purpose types.

## How to have a low cost, reliable anticoincidence circuit ...with Clareed Control

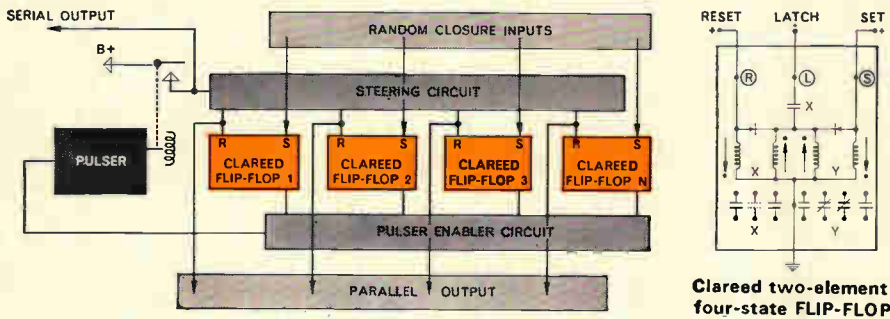

This simple anticoincidence circuit can be used for counting random multiple events through a common input ...or to receive multiple inputs and to read out logic from a system so as not to permit simultaneous action.

For example, the block diagram is typical of an industrial control counting function. Random input signals are transmitted to Clareed Flip Flop Counting Modules (see schematic, left), where signals are stored. Pulser operates through ladder steering circuit, which resets any or all flip-flops, and creates outputs in a numerically progressive order if inputs arrive simultaneously. If inputs do not arrive simultaneously, outputs are issued in the order received. Additional Clareed logic can be incorporated to assure first-in, first-out system response.

As indicated, outputs can be taken from the store state either serially for accumulation, or in parallel for other logic functions.

## A simple, dependable way to control set limits of a system ...with Clareed Control

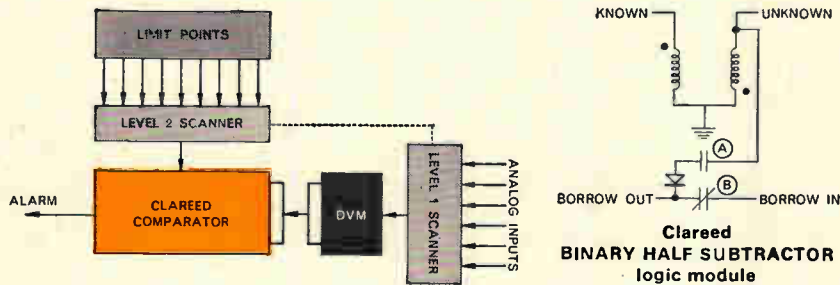

line or ambient transients would make solid state circuitry prohibitively expensive.

Unknown value analog signals from field sensing devices are picked up by the Level One Scanner, which sends them to the DVM for conversion to digital signals. The DVM transmits the digital signals as input to the digital comparator where the unknown DVM value is subtracted from the known limit value, which is switched to the comparator by level two of the scanner. If the unknown value is greater than the known value, an alarm output is produced. When both high and low limit alarms are required, dual logic elements are used in the comparator and a third level scanner is required.

The basic logic element used in the comparator is a Clareed Binary Half Subtractor (see schematic, left). Two Clareed switches, (one of which is polarity sensitive due to addition of a bias magnet), a diode and a bifilar coil make up the assembly. One element is required for each binary digit.

If the unknown input is greater than the known input, the "A" switch closes and a borrow out is produced. If the known and unknown are equal, neither switch operates and no borrow output is produced. In this case a borrow input from a lesser significant digit is transmitted through to the borrow out. If the known input is greater than the unknown, both the "A" and "B" switch operate. In this case, a borrow input does not transmit through to the borrow out. The borrow input and outputs from significant digits are series connected to the alarm output.

The system shown represents one of the most versatile and economical means of controlling set operating limits in such supervisory control functions as heating, air conditioning or process control. This system, designed around Clareed logic elements, permits either random or sequential scan of 100 control points per second. It is ideally suited for "long line" sensing, where required buffering against

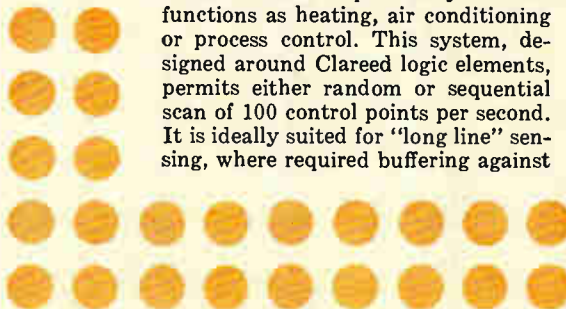

# ...and you get this optimum performance with **CLAREED® CONTROL MODULES**

You can optimize system performance with these, and many other Clareed Control counting, selection and logic circuits. Specifying pre-packaged Clareed Control Modules will assure that your system will operate dependably...to its design characteristics...over its planned life. Here's how:

- Your system is not subject to inadvertent switching by ambient or line transients...no elaborate buffering required
- You get inherent reliability. Sealed-in-glass switches are maintenance-free; are not subject to environmental contamination or mis-adjustment.
- Your Clareed system is completely compatible with industrial environment and service conditions

*and, besides...*

- You'll save on cost over solid state for most applications
- You need only one power source...24 vdc  $\pm$  5%
- Your outputs are isolated contacts capable of handling low level to 50 va dc or ac power loads
- You'll realize ample switching speeds...up to 250 bits per second

Whether your system requires a simple counting circuit, or a complex logic function...and if you are now using electromechanical or solid state switching devices...it will pay you to look at Clareed Control.

**Proven Clareed Control solutions span many different application areas, including counters, scanners, digital clocks, shift registers, logic arrays, and non-volatile memories. Write for Clareed Control Application Manuals, C. P. Clare & Co. Group 02N4, 3101 Pratt Boulevard, Chicago, Illinois 60645.**

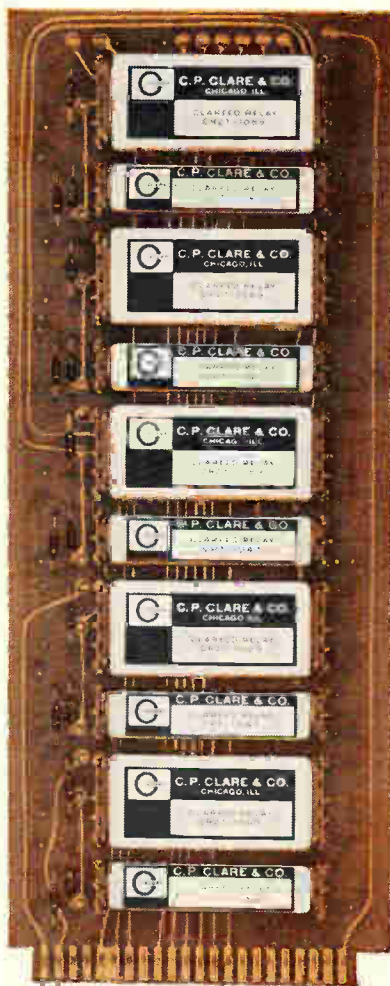

Typical Clareed five-stage anticoincidence module

For complete information  
contact your nearest  
CLARE Sales Engineer.

CALL—NEEDHAM (Mass.): (617) 444-4200  
• GREAT NECK, L. I. (N. Y.): (516) 466-2100 • SYRACUSE: (315) 422-0347 • PHILADELPHIA: (215) 386-3385 • BALTIMORE: (202) 393-1337 • ORLANDO: (305) 424-9508 • CHICAGO: (312) 262-7700 • MINNEAPOLIS: (612) 920-3125 • CLEVELAND: (216) 221-9030 • XENIA (Ohio): (513) 426-5485 • CINCINNATI: (513) 891-3827 • COLUMBUS (Ohio): (614) 486-4046 • MISSION (Kansas): (913) 722-2441 • DALLAS: (214) 741-4411 • HOUSTON: (713) 528-3811 • SEATTLE: (206) 725-9700 • SAN FRANCISCO: (415) 982-7932 • VAN NUYS (Calif.): (213) 787-2510 • TORONTO, CANADA: C. P. Clare Canada Ltd. • TOKYO, JAPAN: Westrex Co., Orient • IN EUROPE: C. P. Clare International N. V. TONGEREN, BELGIUM • WATFORD, ENGLAND • MUNICH, GERMANY



# NEWS!

## AMELCO & CRYSTALONICS SEMICONDUCTOR DEVICES ARE AVAILABLE FROM A SINGLE SOURCE!

- PNP and NPN Small Signal Transistors
- Low Noise PNP and NPN Transistors
- Low Level Switching Transistors
- N Channel Silicon FETs
- PNP Power Transistors
- Varactor Diodes
- Integrated Choppers
- Analog Gates
- Hybrid Analog and Digital Circuits
- Integrated Circuits, Analog and Digital
- PNP, NPN and FET Differential Amplifiers



**this AMELCO FET  
combines low  $R_{ON}$ ,  
low  $I_{D(OFF)}$ , and low  $C_{DG}$   
better than  
ever before...**

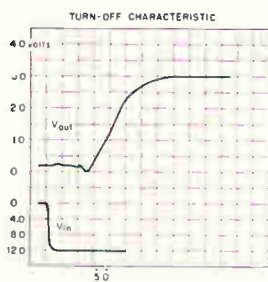

### CHECK THESE KEY SPECIFICATIONS:

$R_{ON}$	30 MAX	$t_{OFF}$	40 nsec MAX
$I_{D(OFF)}$	200 $\mu$ a MAX	$V_p$	10 V MAX
$C_{DG}$	5 pf MAX	IDSS	30 ma MIN
$t_{ON}$	25 nsec MAX	BVDG0	40 V MIN

**AMELCO  
SEMICONDUCTOR**

DIVISION OF TELEDYNE, INC.  
1300 TERRA BELLA AVENUE • MOUNTAIN VIEW, CALIFORNIA  
Mail Address: P. O. Box 1030, Mountain View, California  
Phone: (415) 968-9241 / TWX: (415) 969-9112 / Telex: 033-914

Now being mass produced, this FET switch is available from Amelco Distributor stock for only \$12.30, in quantities of 100 or more.

Get full information today!

Amelco's new 2N4091 FET switch offers extra high speed with the highest switching ratio ever available in a standard device. If you are working with multiplexing, commutating, analog switching or DC chopping, consider these facts . . .  $R_{ON}$  is 30 ohms max., the lowest of any FET on the market with  $C_{DG}$  of less than 5 pf;  $I_b$  (on)/ $I_b$  (off) ratio is better than  $10^8$ . Designers may now consider FET devices where previously the requirement for very low on resistance demanded use of bipolar transistors. In addition, applications presently using FETs can benefit from this improved performance.

For complete data on any of these products, contact your nearest Sales Office or Representative.

### FIELD OFFICES

#### SOUTHWEST

Suite 213, 8621 Bellanca Avenue  
Los Angeles, California 90045  
(213) 678-3146

#### NORTHWEST

P. O. Box 1030  
1300 Terra Bella Avenue  
Mountain View, California  
(415) 968-9241

#### EAST

P. O. Box 2091  
Peterson, New Jersey 07509  
(201) 696-4747

P. O. Box 366  
Kimberton, Pa. 19442  
(215) 885-1755

#### NORTHEAST

543 High Street  
Westwood, Massachusetts  
(617) 326-6600

711 Magnolia Avenue  
Orlando, Florida 32803  
(305) 423-5833

#### MIDWEST

650 West Algonquin Road  
Des Plaines, Illinois  
(312) 439-3250

3020 Woodlark Lane  
St. Paul, Minnesota  
(612) 646-1161

#### EXPORT

Write or wire collect  
TWX: (415) 969-9122 to  
Mountain View, California  
for nearest agent.

### SALES REPRESENTATIVES:

#### CALIFORNIA

Black & Strong, Inc.  
3840 Crenshaw Blvd.  
Los Angeles 8, California  
(213) 295-7751

#### IOWA

Engineering Services Co.  
1026 3rd Avenue, S. E.  
Cedar Rapids, Iowa  
(319) 366-1591

#### MARYLAND

Daniel & Company  
6 East Pennsylvania Avenue  
Lawson, Maryland 21204  
(301) 825-3330

#### MICHIGAN

W. R. Hummon & Associates  
20274 Stout Street  
Detroit, Michigan  
(313) 538-5704

#### MISSOURI

Engineering Service Co.  
6717 Vernon Avenue  
St. Louis, Missouri  
(314) 726-2233

#### NEW JERSEY

Graydon/Sherman, Inc.  
22 Fairfield Drive  
Morristown, New Jersey  
(201) 538-9246

#### NEW YORK

Gemini Electronics, Inc.  
45 North Station Plaza  
Great Neck, Long Island, New York  
(516) 482-4446

Graydon/Sherman, Inc.  
Old Farm Road  
Fayetteville, New York  
(315) 637-6765

#### OHIO

Electronic Sales  
1494 W. Clifton Blvd.  
Lakewood 7, Ohio  
(216) 228-1777

Gibson Electronics Marketing Co.  
2801 Far Hills Avenue  
Far Oaks Bldg., Room 110  
Dayton 40, Ohio  
(513) 298-7683

#### TEXAS

W. Pat Fralia Co.  
P. O. Box 12625  
6100 Camp Bowie Blvd.  
Fort Worth, Texas  
(817) 738-2394  
(214) TA 7-1233 - Dallas

#### WASHINGTON

Harry Levinson Co.  
1211 East Denny Way  
Seattle 22, Washington  
(206) 323-5100



# new CRYSTALONICS FOTOFETs<sup>®</sup>... an order of magnitude more sensitive!

FOTOFETs are a new type of solid-state photo-device offering high impedance voltage operation, high speed, and high sensitivity. Available from stock at \$28.50 (FF 600), \$22.50 (FF 400), and \$16.00 (FF 102) in one to 99 quantities.

FOTOFETs increase system sensitivity 10 times and speed vs. sensitivity 4 times over conventional photo-transistors. And, sensitivity is externally adjustable with gate resistance to meet variable light input levels and critical operating range requirements. FOTOFETs improve performance and simplify circuitry in present electro-optic applications and make new ones practical. Use them in photo-choppers, card readers, photo-switches, infrared instrumentation, laser detection, photo-coupled analog and digital circuits, and servo systems. Spectral response is compatible with both infrared and visible light detection.

Find out more by writing for Application Note ANF-8. <sup>®</sup>FOTOFET is a trade name of Crystallonics.

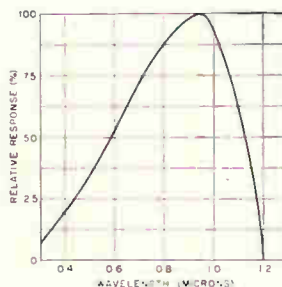

### CHECK THESE KEY SPECIFICATIONS:

Sensitivity:<sup>\*</sup>

FF 600	800 $\mu$ A/F.C.	$t_r$	50 nsec
FF 400	30 $\mu$ A/F.C.	Peak Response	0.95 $\mu$
FF 102	8 $\mu$ A/F.C.	Dark Current	
$t_r$	30 nsec	(Gate)	50 pA

<sup>\*</sup>Adjustable over  $10^6$  range with gate bias resistor.

## Crystallonics

DIVISION OF TELEDYNE, INC.

147 SHERMAN STREET • CAMBRIDGE 40, MASSACHUSETTS  
Telephone: 617-491-1670 TWX: 617-499-9156

Circle 55 on reader service card

# 10 gram guard



## Reverse-voltage defense is just one more reason for G-E tantalum foil

Forget about a surprise reverse with G-E tantalum foil capacitors. They're designed to take it. And reverse-voltage defense is just one reason for using G-E tantalum foil. Here are three others:

**PROVED IN-CIRCUIT RELIABILITY:** They've been proved—and improved—for over 17 years. More than 20 million have been successfully applied. G-E tantalum foil earned a 0.00023 reliability record (per 1000 hours) on Minuteman reliability tests,

based on the Minuteman acceleration factor.

**NO CATASTROPHIC FAILURES:** Low impedance circuits and catastrophic failures are no problem with G-E tantalum foils. They're self healing. **LONG SHELF LIFE:** We're up to the 14 year mark . . . with less than a 5% capacitance change at 25C. That's shelf life!

G-E tantalum foil capacitors are available in ratings up to 450VDC, 0.15 to 3500uf, —55 to 85 or 125C. They're

virtually risk-proof. And may cost more. But isn't a proved line your best defense?

For all the facts on G-E tantalum foil reliability, write for Reliability Report, Section 430-25, General Electric Co., Schenectady, N. Y. 12305.

ELECTRONIC COMPONENTS DIVISION

**GENERAL  ELECTRIC**



# FAIRCHILD PHOTO DEVICES

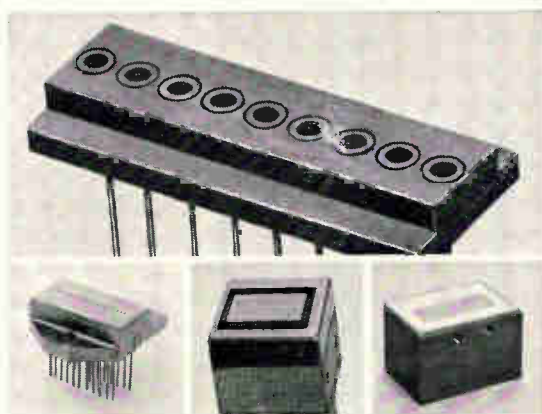

#### FEATURES:

- High sensitivity
- Flat lens (no aiming required)
- Welded hermetic case withstands temperatures up to 200°C
- Power dissipation up to 75mW
- Fairchild Planar reliability
- Low price

Fairchild photo devices are available as transistors (FPM 100) or as diodes (FPM 200). Large junction area assures high sensitivity. Flat window design enhances the reliability and flexibility of the device. Since the flat lens always looks straight ahead, the array designer can recess the lens or bring it out flush with the mounting to control the area of sensitivity. In either case no aiming is required and performance is predictable. Cross talk and other error producing features are easily controlled or eliminated.

#### DISCRETE AND MONOLITHIC PACKAGING

Fairchild photo devices are ideal for applications such as card and tape readers, curve followers, character recognition, position indicators, optical logic, and photo memory readout. Array assemblies are available, suitable for reading all card and tape codes. Monolithic arrays for high density data and/or military environments are also available.

For more information and complete specifications contact the nearest Fairchild sales office or write for our data sheets.

**FAIRCHILD**  
SEMICONDUCTOR

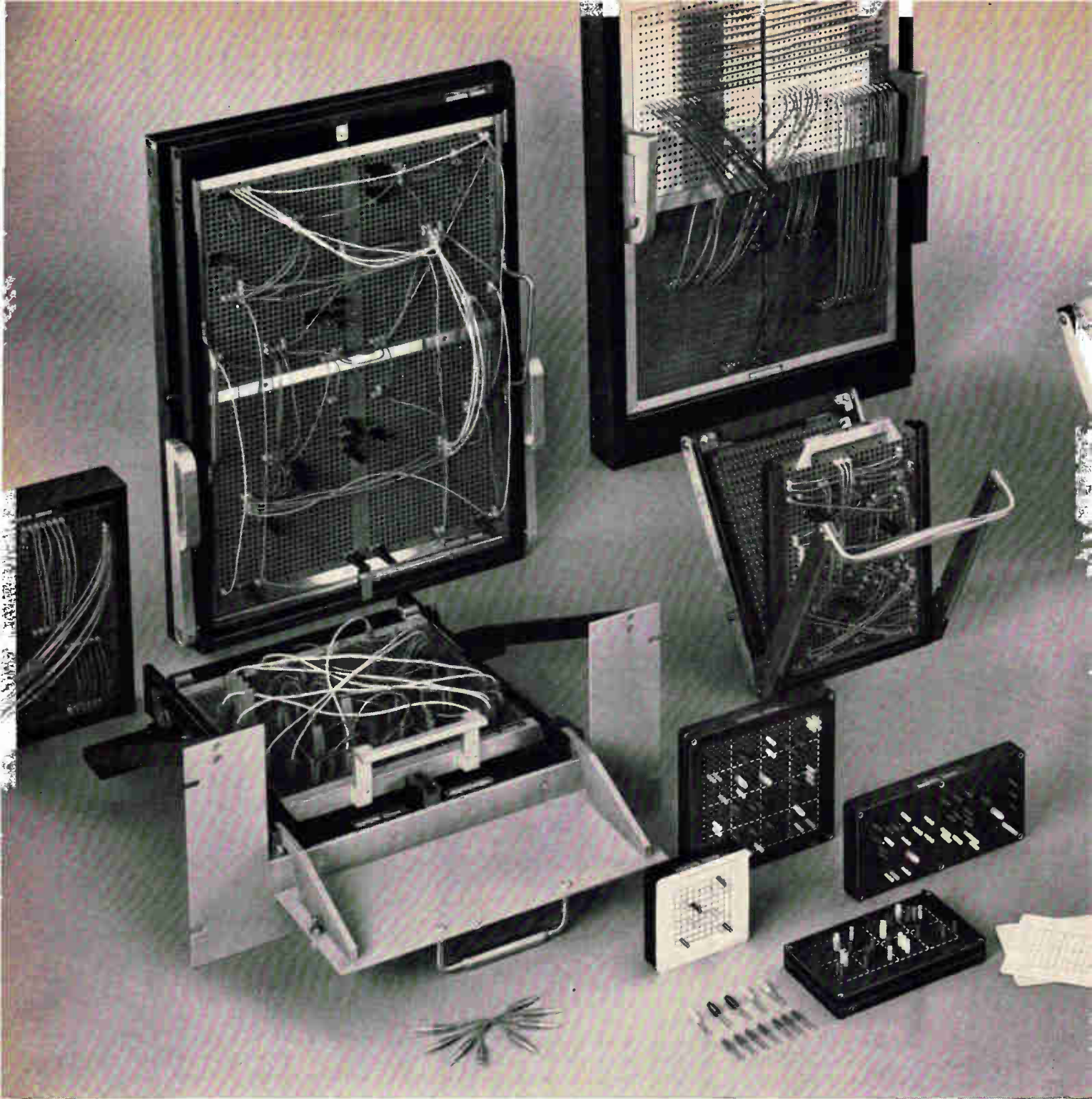

## Get your program here...

Circle 58 on reader service card

Presenting a full line of precision-engineered programming devices to satisfy requirements in batch mixing equipment, checkout and ground support equipment, simulators and trainers, data acquisition systems, and test equipment. No need to look high and low—AMP's line encompasses all types and sizes available anywhere. Highest quality gold over nickel plating, exclusive double-wiping action contacts, versatile rear bay wiring, rugged construction and unique design are some of the features which give these A-MP★ products their outstanding reliability.

From the easy-to-use matrix pinboard systems to complex coaxial patch-cord systems, one of the obvious features is flexibility. No effort has been spared to assure that every A-MP programming product demonstrates convenience in use, 100% reliability, and the longest possible service. These facts are not idle claims. They are fully substantiated by testing and performance.

Whenever programming has a role in your system, be certain of truly superior performance by choosing one of AMP's programming products. To make your own critical appraisal of any of the above devices, write today for complete information.

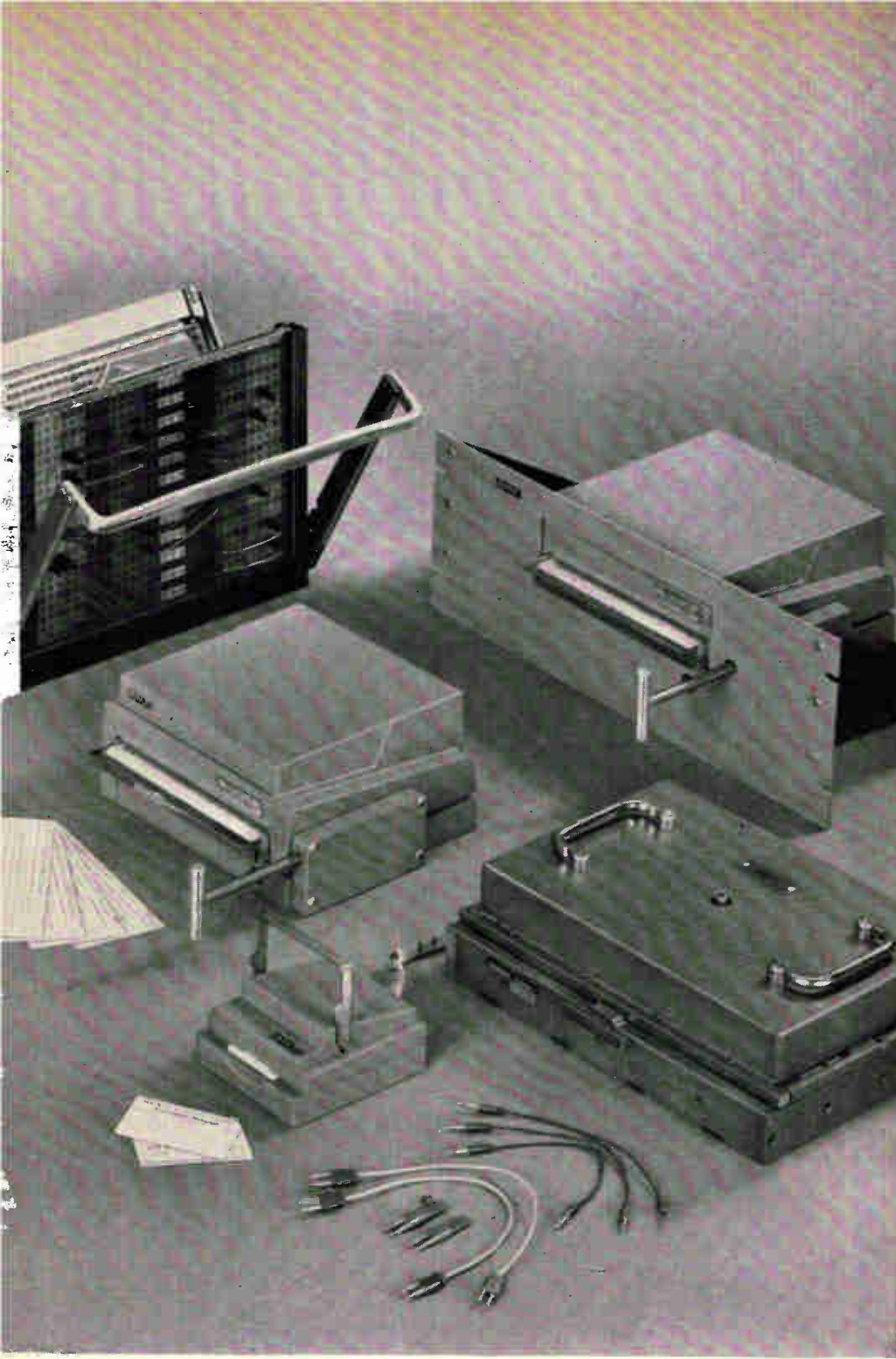

Rocket test data is programmed with AMP's Patchcord Programming System.

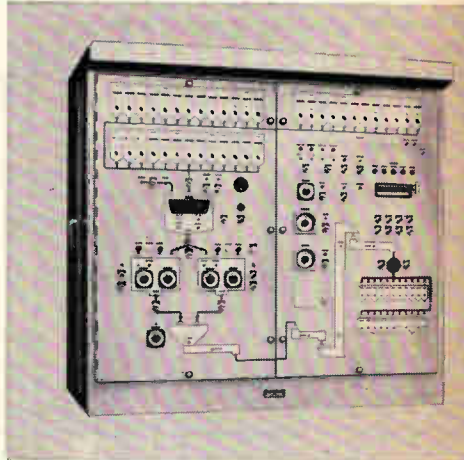

Standard punched cards, read by A-MP Card Reader, operate this batch mixing equipment.



Sequence programmer uses AMP's Matrix Pinboard with interchangeable program templates.

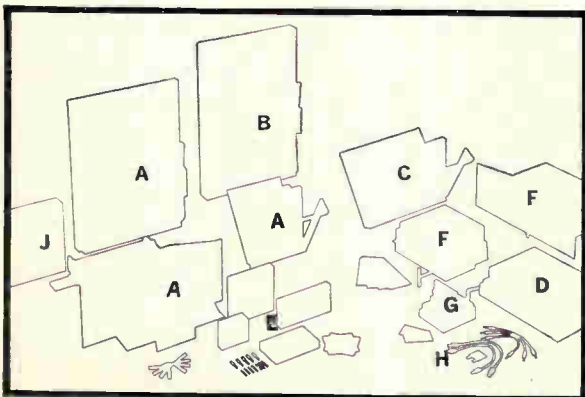

- a. Universal Patchcord Programming Systems (both rack and panel mounted)
- b. Coaxial Patchcord Programming Systems
- c. Shielded Patchcord Programming Systems
- d. Anti-vibration Patchcord Programming Systems
- e. Pinboard Programming Systems (Universal and Matrix types)
- f. Manual Card Readers (both desk-top and rack mount)
- g. Credit Card Reader
- h. Cords, shunts, squids, cards, etc.
- j. Universal Fixed Patchcord Panel

**AMP**  
INCORPORATED  
Harrisburg, Pennsylvania

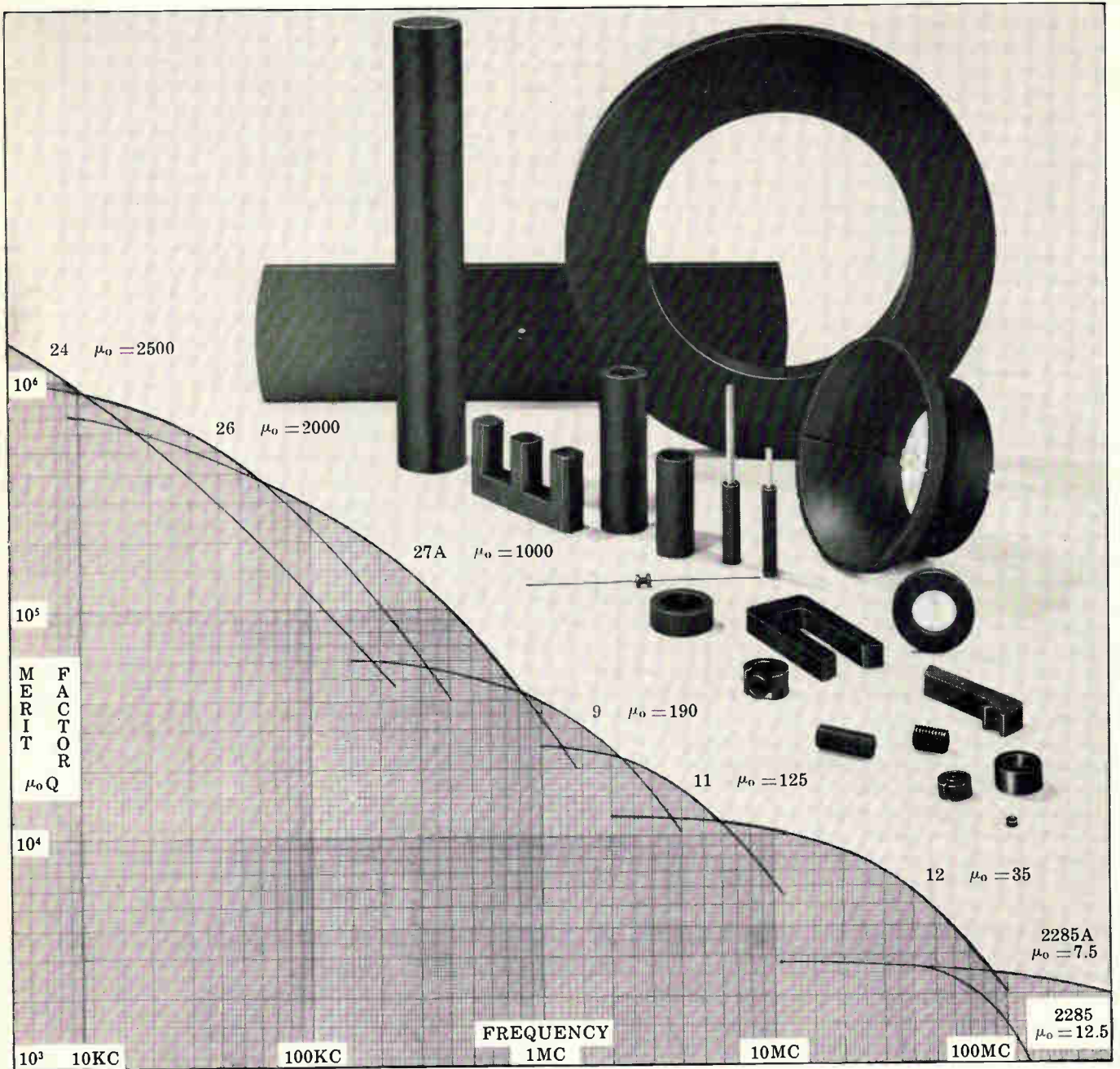

## CERAMAG® FERRITE PARTS ARE CONSISTENT

Stackpole offers over 30 grades of Ceramag® material. More are being developed continually. Such up-to-the-minute technology permits you to specify Ceramag® on every new application. Discover the unique advantages of the versatile Ceramag® ferrites: complete moldability to virtually any shape, and the important savings over steel alloys for low frequency applications. When high permeability is an important factor, Ceramag® is the answer.

Hundreds of Ceramag® parts are already tooled as toroids, cup cores, insert cores, transformer cores, deflection yokes and rectangular solids. Special tooling is also available.

Stackpole is a name long associated with quality components in the electronic field. Only the closest attention to every production detail can result in the kind of product uniformity available with Ceramag® ferrites. As one of our customers

put it, "Your ferrite cores are more consistent from order to order than any of your competitors."

If you are about to select a ferromagnetic material for a new application, or if you are dissatisfied with the performance and service of your present ferrite supplier, why not investigate Stackpole's Ceramag®? To discover how you can save and still insure superior performance, write for our Bulletin 1-A, Stackpole Carbon Company, Electronic Components Division, St. Marys, Pennsylvania 15857. Phone: 814-781-8521 — TWX: 510-693-4511.



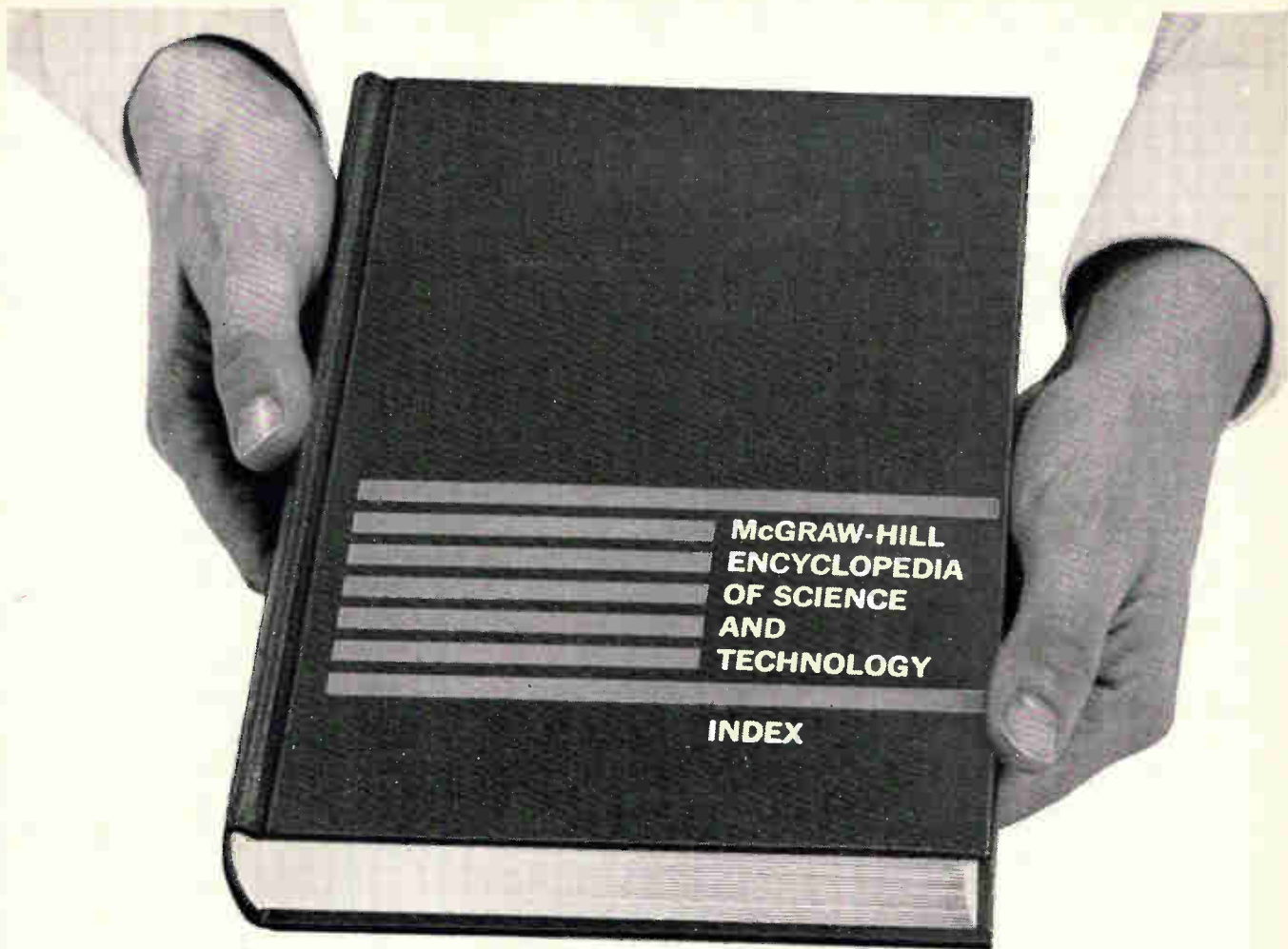

*New!* **Your key to every scientific and engineering problem**

**Announcing the new, revised edition of the reference work which *Scientific American* called, "A first-class tool without substitute."** The extraordinary volume you see here puts at your fingertips the latest information on over 100,000 subjects in every engineering and scientific field. It is the heart of a unique *Information Center* in encyclopedia form developed by McGraw-Hill. For concise, authoritative answers to specific questions that come up on the job...for consultation when your work leads you into areas outside your specialty...for keeping abreast of new developments over the whole spectrum of today's exploding technology...there has never been anything like this ready-reference tool.

More than 2,000 respected leaders of science and industry have pooled their knowledge and experience to create this *Information Center*. Here you will find every theory, concept, term...every significant new discovery and application...every major problem currently under study...precisely classified and described in 15 volumes of amazing usefulness. For a free illustrated Prospectus with complete details, simply mail the coupon. There is no obligation, of course. McGraw-Hill Encyclopedia of Science and Technology, 331 West 41st Street, New York, N. Y. 10036.

McGraw-Hill  
Encyclopedia of

**science and  
technology**



331 West 41 Street, New York, N. Y. 10036

Please send your free illustrated Prospectus with full details of this new *Information Center* for engineers and scientists. I understand there is no obligation.

Name \_\_\_\_\_

Address \_\_\_\_\_

City \_\_\_\_\_

State \_\_\_\_\_ Zone or  
Zip No. \_\_\_\_\_

Profession \_\_\_\_\_

BN-101

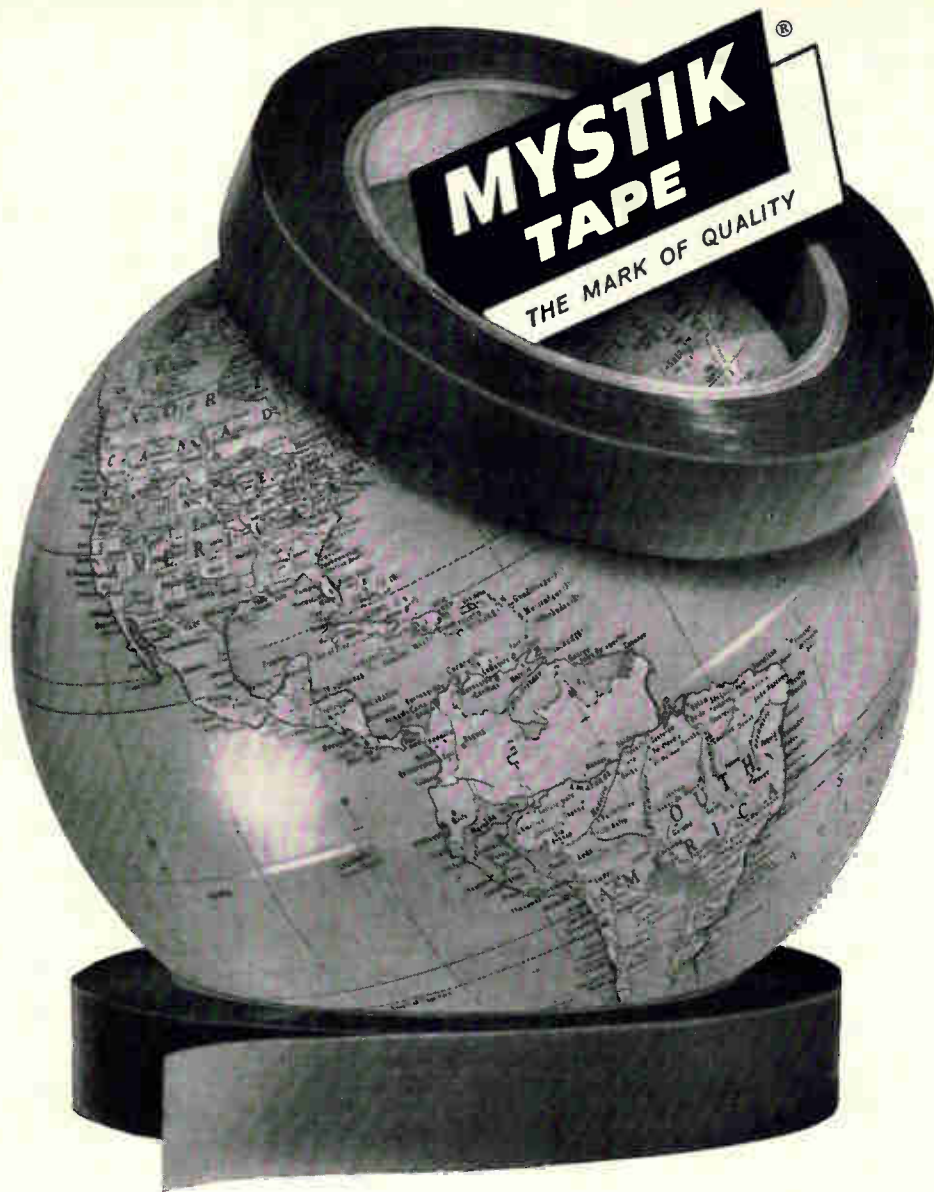

## No matter where your product goes . . .



When it comes to tape, you'll find Mystik just right for a world of applications and some that are *out* of this world. You can seal your product, hold it, package, mask, insulate, protect, or print on it with one or more of Mystik's 125 different pressure-sensitive tapes.

Whether your adhesive needs are as basic as cutting costs and improving product performance or as complex as solving space age environment problems, you can count on Mystik as your single tape source. Mystik assures you superior quality, reliability and high performance standards—all at competitive prices.

See for yourself how you can improve products with Mystik Tape. Let your Mystik distributor help you select the best *Mark of Quality* tapes for your requirements. He's in the Yellow Pages under Tape. Or write The Borden Chemical Co., Mystik Tape Div., 1700 Winnetka Ave., Northfield, Ill. 60093



**BORDEN  
CHEMICAL**

Helipot's side-adjust  
Helitrim® cermet  
trimmer—world's  
smallest—costs as little  
as \$1.50 in quantity.



Helipot's side-adjust  
Helitrim® cermet  
trimmer—world's  
smallest—costs as little  
as \$1.50 in quantity.



Helipot's side-adjust  
Helitrim® cermet  
trimmer—world's  
smallest—costs as little  
as \$1.50 in quantity.



Helipot's side-adjust  
Helitrim® cermet  
trimmer—world's  
smallest—costs as little  
as \$1.50 in quantity.



The Model 62PA side-adjust is a new easy-access cermet trimmer with these quality features: virtually infinite resolution; excellent high frequency characteristics; and standard resistance from 10 ohms to 1 megohm. Its rugged cermet resistance element gives you long, trouble-free life and freedom from sudden failure. Inside its plastic case is a sealed metal housing identical to the popular 1/4" top-adjust Model 62P.

Focus in on delivery advantages, too... immediate stock availability. Call your Helipot sales rep for full specs.

**Beckman®**

INSTRUMENTS, INC.  
HELIPOT DIVISION  
FULLERTON, CALIFORNIA • 92634

INTERNATIONAL SUBSIDIARIES: GENEVA; MUNICH; GLENROTHES, SCOTLAND; TOKYO; PARIS; CAPETOWN; LONDON

**If you're working with 0.100 to 20 amps,  
our new Series JA circuit breaker  
will save you space, weight, and money  
over this other OEM model**



The hydraulic-magnetic breaker shown above has long been the most popular OEM type on the market. But now the big buy is the little Heinemann Series JA that you see down below.

The JA is one-third smaller in volume than the other breaker. And one-third lighter in weight.

And it costs less.

On a standard series-trip model you save about ten percent. On special-function models (relay-trip, shunt-trip, etc.) you save even more.

The JA is also easier to install. Its round boss eliminates the need for the

square-cornered panel cutout the other breaker requires. Drill or punch a few holes and you're all set.

"Universal" terminals further expedite things. The JA will accept quick-on or soldered connections directly or, with snap-on adapters, screw-type connections. Whatever method you're tooled for is "go."

The JA is better looking, too. It comes with a neat white switch handle, and you can, as an option, dress it up with snap-on color-coding boss caps.

In performance capabilities, the JA

is thoroughbred Heinemann all the way. That means precisely calibrated, temperature-stable trip-points and nominal current rating. Choice of time-delay or instantaneous overload response characteristics. And a number of unique functional options.

The smaller, lighter, less expensive, better-looking Series JA circuit breaker is available in single- and multi-pole models rated for standard maximum voltages of 250 vac, 60 or 400 cycles, or 50 vdc. Our new Bulletin 3350 will give you detailed technical data. Write us for a copy.

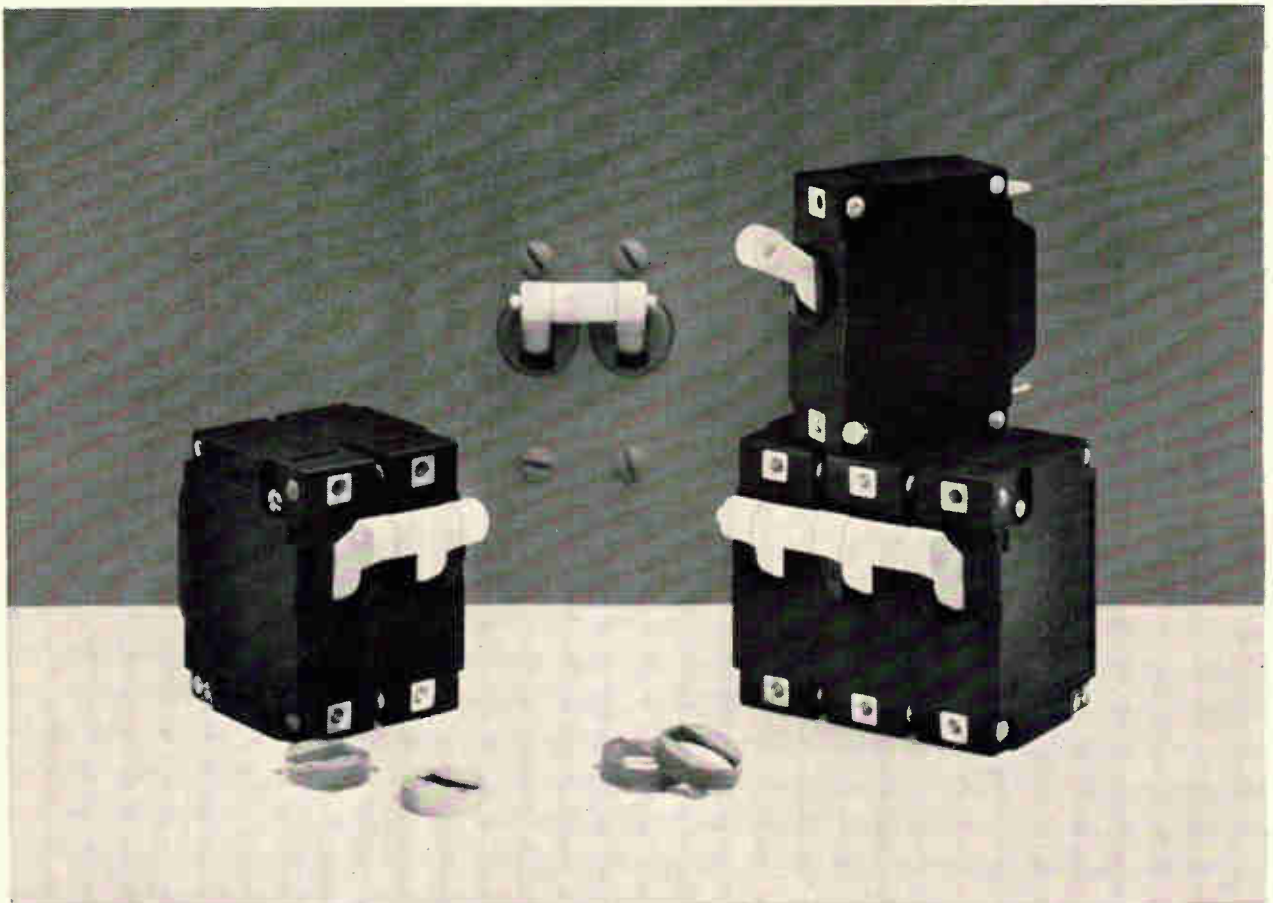

**HEINEMANN ELECTRIC COMPANY**

2600 Brunswick Pike, Trenton, New Jersey 08602

SA3243



PLACE SERVO-SET POTENTIOMETERS IN A COMPUTER?



THAT'S RIGHT!

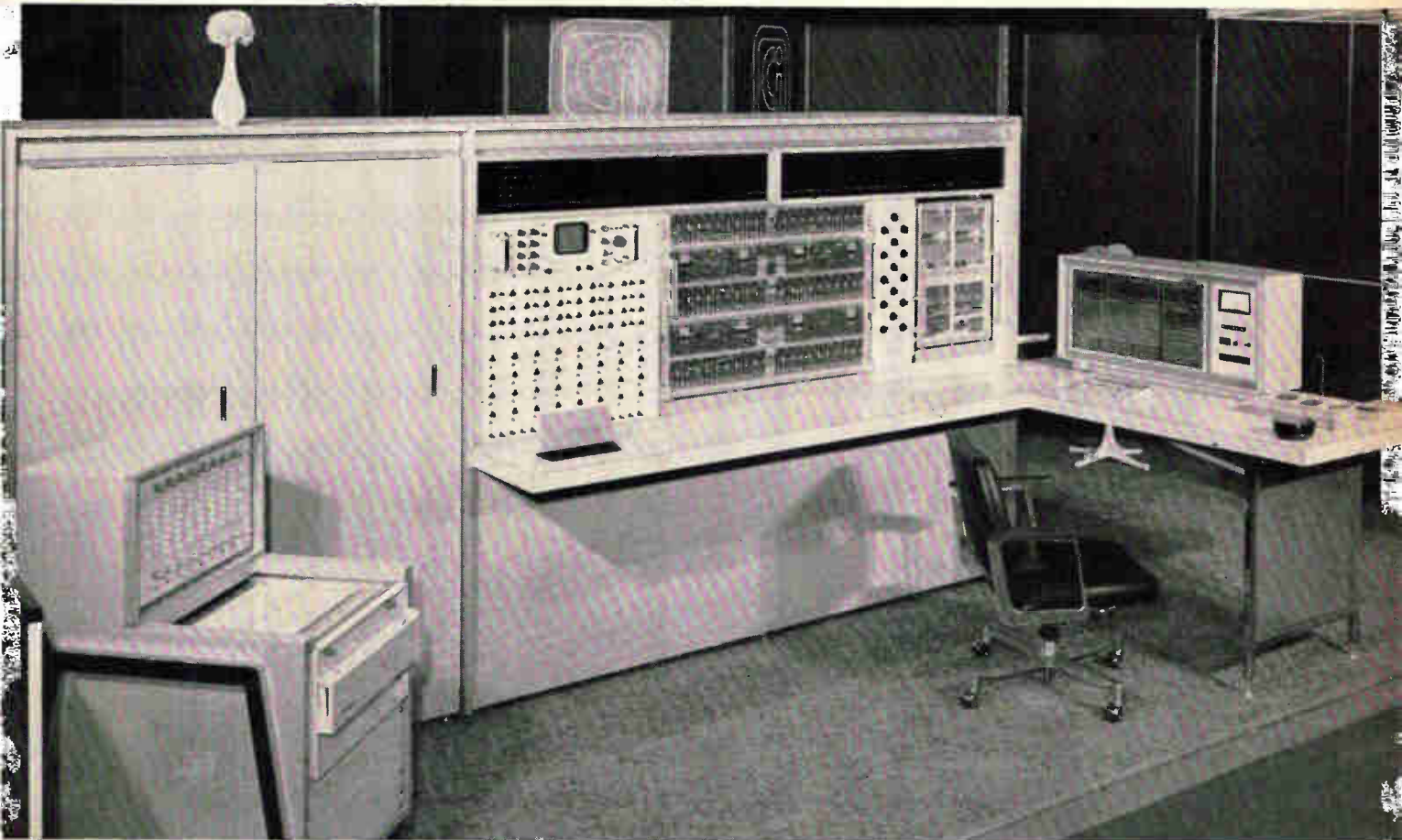

1965 Fall Joint Computer Conference

IT MUST REDUCE SET-UP TIME?

CONSIDERABLY!



AN INDUSTRY FIRST...THE COMCOR Ci-196 DIGITAL ATTENUATOR... ONE HUNDRED CAN BE SET UP IN LESS THAN 2 SECONDS! Completely solid-state in design, it replaces the servo-set



potentiometers in a computer system. In COMCOR's Ci-5000 Analog/Hybrid Computer (shown above) in which it was initially installed, the Ci-196 drastically reduced set-up time—previously each potentiometer setting took one second plus. Learn more about this amazing subsystem; contact your COMCOR representative or phone, wire or write COMCOR direct.



**COMCOR**

A SUBSIDIARY OF ASTRODATA, INC.

1335 SOUTH CLAUDINA STREET / ANAHEIM, CALIFORNIA 92803

Circle 65 on reader service card

# New Dale commercial wirewounds...**priced right!**

*Dale expands with new silicone coated resistors to replace & outperform vitreous enamel*



- **Expanded Commercial Line** provides direct replacements for the full range of vitreous enamel styles and sizes. You pay no more—less in many cases
- **Proven Reliability:** Over 1,800,000 unit test hours prove maximum HL failure rate to be .05% per 1,000 hours (full power, 25°C; failure defined as 3% Δ R, 60% confidence level)
- **Superior Stability:** Multi-layer silicone coating provides lower T.C. ( $\pm 30$  ppm). Standard tolerance  $\pm 5\%$ . Precision tolerances available.

Write for ■ **New Commercial Resistor Brochure** ■ **Complete Resistor Catalog A**

## BUY NEW MODELS...NEW SIZES...FROM THIS COMPLETE COMMERCIAL WIREWOUND LINE!

TYPE	APPLICATION	APPLICABLE MIL SPEC AND TYPES	WATTAGE RATING	RESISTANCE RANGE	CORE SIZES	TOLERANCE
<b>CW</b> Axial Lead	Axial leads. For applications requiring high performance at low cost	MIL-R-26 RW-57, 58, 59	4.25-13 watts	.1 ohm to 273K ohms	Body Dia. .188 to .375" Body Length .500 to 1.781" Leads 1.5 to 2"	$\pm 5\%$
<b>HL</b> Tubular	Silicone-coated general purpose wirewound resistor. A direct replacement in both cost and performance for vitreous enamel types.	MIL-R-26C RW-29, 30, 31, 32, 33, 35, 36, 37, 38, 47	5-225 watts	.1 ohm to 1.3 Megohms	O.D. ¼ to 1½" Length 1-10½"	$\pm 5\%$ (10% below 1 ohm)
<b>NHL</b> Non-Inductive	High frequency circuits and applications requiring low inductive effect and minimum distributed capacity	None	5-225 watts	1 ohm to 90K ohms	O.D. ¼ to 1½" Length 1-10½"	$\pm 5\%$
<b>HL</b> Flat	For limited space requiring high power-to-size ratio. Vertical or horizontal stacking.	MIL-R-26C RW-20 thru RW-24	24-95 watts	.1 ohm to 150K ohms	Length 1¼ to 6"	$\pm 5\%$ (10% below 1 ohm)
<b>HLM</b> Miniature Flat	For limited space, high power-to-size requirements particularly in high vibration areas.	None	10-20 watts	.1 ohm to 51K ohms	Length ¾ to 2-1/16"	$\pm 5\%$ (10% below 1 ohm)
<b>HLA</b> Adjustable	For resistance or voltage adjustment	MIL-R-19365C RX-29, 32, 33, 35, 36, 37, 38, 47	12-225 watts	1 ohm to 100K ohms	O.D. 5/16 to 1½" Length 1½ to 10½"	$\pm 5\%$ (10% below 1 ohm)
<b>HLT</b> Tapped	For voltage divider networks	None	11-225 watts	.1 ohm to 1.1 Megohms	O.D. 5/16 to 1½" Length 1½ to 10½"	$\pm 10\%$ each section ( $\pm 10\%$ total)
<b>HLW</b> Tubular	General application where terminal wires are required for direct electrical connection	None	5-20 watts	.1 ohm to 80K ohms	O.D. ¼ to 7/16" Length 1 to 2"	$\pm 5\%$ (10% below 1 ohm)



**DALE ELECTRONICS, INC.**  
1300 28th Avenue, Columbus, Nebraska



---

# Washington Newsletter

---

February 21, 1966

## Navy pushes automation for new ships

The first major Navy ship with extensive automation of its propulsion controls is scheduled to be started this year and will join the fleet in 1969. The Navy's Bureau of Ships has approved contract design plans for a group of the \$28-million attack cargo ships (AKA), but hasn't yet selected the prime contractor.

The AKA's will employ:

- Remote control of main engines from the bridge.
- Central control consoles in the engine room for automatic monitoring and controlling of engineering functions.
- Automatic alarms to signal failure of any part.
- And remote activation of back-up components in the event of a malfunction.

Plans are also under way for the development of other ships with automated engine controls:

- A pair of destroyers to be armed with guided missiles, scheduled for the fiscal 1967 shipbuilding program.
- And a fleet of automated fast deployment cargo ships (FDL). This new type of cargo ship will be purchased in a single package, a procedure that the Air Force initiated in buying airplanes [Electronics, Nov. 15, 1965 p. 73].

Under the plan, several companies will compete for the design and development contract, then a single contract will be written covering follow-on construction, maintenance and repair.

## Broader aid plan set for firms hurt by imports

The Administration is about to ask Congress to cushion the damaging impact on manufacturers and their employees hurt when low United States tariffs stimulate competition from imports. As it stands, the law allows the government to help companies move into new lines of business and to retrain employees. But the requirements for proof of injury from imports are so difficult to meet that every application—including one from workers at an Ohio transistor-radio plant of the Philco Corp.—has been turned down.

Under the proposal, companies would still have to prove damage from foreign competition, but they no longer would have to prove that imports are the sole cause of their trouble.

## 2 Apollo satellites adding 280 channels

The two synchronous-altitude satellites that the Communications Satellite Corp. will loft this fall for the Apollo moon program will have an additional 280 channels for commercial transoceanic communications. The Atlantic satellite will have an additional 100 channels; the Pacific satellite, an extra 180 channels.

The military is negotiating with Comsat for a large block of commercial channels that would be available over the Pacific. Commercial service among the mainland United States, Hawaii, Australia and Japan is expected to start shortly after the Pacific satellite becomes operational.

Negotiations are also under way for Comsat to put a 42-foot portable ground station in the Philippines to link the islands with the U. S. by the

---

# Washington Newsletter

---

end of this year. Thailand may be another country similarly linked to the U. S.

The growing demand for a Pacific satellite may require Comsat to launch a second communication craft in that area.

## Decision due soon on 3-R's satellite

A White House committee headed by Leonard Marks, chief of the U. S. Information Agency, has submitted its recommendations to President Johnson on the use of satellites for a mass education program in backward nations [Electronics, Jan. 10, p. 57]. A White House decision to proceed with the program is expected shortly.

## FCC may rule on Puerto Rican ground station

A decision on who will own a proposed satellite ground station in Puerto Rico may have to be made by the Federal Communication Commission. The International Telephone & Telegraph Corp., which announced last fall that it wanted to build such a station, last week asked the FCC to defer a ruling on its bid.

The company is waiting to see what the Communications Satellite Corp. does about presenting a proposal of its own to build a station in Puerto Rico.

Last year, in an interim decision, the FCC said Comsat should own all ground stations in the United States. Should there be competitive bids for the station in Puerto Rico, as now seems likely, the FCC may alter its decision on ground-station ownership—a possibility of great interest to companies like ITT.

On another matter, Comsat may shift its plans for a station in the Southeastern U. S.; it had planned to put the station in West Virginia, but now is considering building it in a more southerly state—possibly Georgia.

## Standards on way for federal buying of computer gear

Federal agencies shortly may be required to buy only paper computer tape that meets new criteria of the National Bureau of Standards (NBS). The standard is the first of many to be recommended by the NBS. The Budget Bureau is expected to approve the standards shortly.

Next in line will be standards for punched cards and magnetic tape. More complex standards for such hardware components as printers, keyboards, displays and other supplementary computer equipment, as well as languages and other software, are also planned. "We won't be able to force manufacturers to meet our standards," says an official. "But if they want to sell to the federal government, they don't seem to have much choice."

The government's current annual budget for computers totals \$3 billion. The proposed NBS standard for paper tape is the same as that established by the American Standards Association's code for information exchangers.

Adoption of the standard is expected to be made gradually.

"There are problems with equipment that's already been manufactured for other taped coding; it'll be a matter of phasing those out and bringing the new ones in," an official says.

# Why specify Mallory wet slug tantalum capacitors?

## Four reasons:

- most microfarad-volts per unit volume
- lowest DC leakage
- maximum freedom from catastrophic failure
- highest voltage and temperature ratings

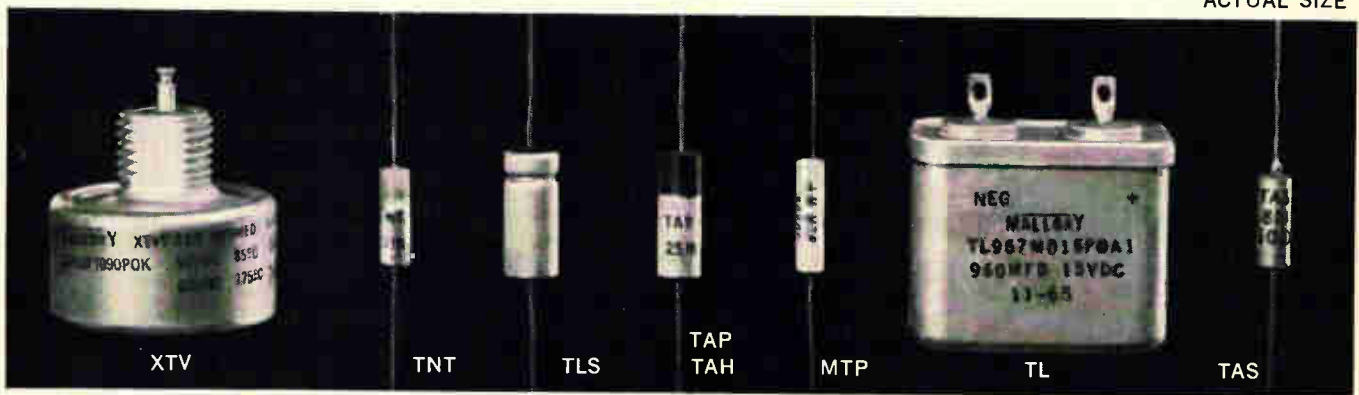

Compare these characteristics:

Mallory Wet Slug Types

Solid Electrolyte

	Mallory XTV	Mallory TNT	Mallory TLS	Mallory TAP/TAH	Mallory MTP	Mallory TL	Mallory TAS
Mfd-volts/in <sup>3</sup>	42,600	52,200	62,500	83,900	178,000	25,600	37,200
Max. DC Wkg. Voltage, 85°C	630V	50V	125V	90V	60V	150V	100V
Max. DC Leakage at highest mfd and voltage, ua/CV	.0052	.0050	.00064	.0026	.00071	.00026	.010
Failure mode	----- Degradational -----						Catastrophic
Temp. range	-55°C +200°C	-55°C +85°C	-55°C +125°C	-55°C +85°C/ +125°C	-55°C +85°C	-55°C +125°C	-55°C +125°C
Weight: grams/mfd-volt	.0018	.0021	.0015	.0012	.00067	.0024	.0024

Next time you need a capacitor for high-reliability applications, consider Mallory wet-slug tantalum capacitors. We'll recommend the best type for you: we make them all—wet

slug, solid and foil—and can recommend without bias. Write or call Mallory Capacitor Company, a division of P. R. Mallory & Co. Inc., Indianapolis, Indiana 46206.

**50<sup>th</sup>**  
ANNIVERSARY

**MALLORY**



# QUICK

**name the one switch that gives you all these features:**

- hermetically sealed
- up to 45 amp. capacity or micro amp.
- no contact bounce
- no operating noise
- minimum operating force
- long life
- no moving contacts
- temperature resistance to +300°F or -65°F



Pulse switch assures split-second pulse regardless of operating speed



Metal or plastic enclosures protect against damage



Subminiature switch less than one inch long



Low Cost—SPST



Ultra-sensitive switch makes or breaks on a 9 minute tilt angle



2 Isolated circuits in a single switch



Heavy duty—mercury to mercury contact

You are right! It is a mercury switch. Actually, mercury switches have more unusual combinations of features than any other type of switch. They are easy to use and low cost, too.

The point is, you can often do it better with a mercury switch than you may think—especially when you have a complete line from which to choose. The broad MICRO SWITCH line includes types such as:

- SPST, SPDT or 2-CKT contact arrangement.
- Light loads—1 amp or less.
- Medium loads—1 to 8 amps.
- Heavy loads—8 to 45 amps.

For some interesting ideas and suggestions, contact a MICRO SWITCH Branch Office (see Yellow Pages under "Switches, Electric"). Or write for the industry's most complete catalog of mercury switches.

## MICRO SWITCH

FREEPORT, ILLINOIS 61033

A DIVISION OF HONEYWELL

HONEYWELL IS WORLDWIDE—Sales and Service offices in all principal cities of the world. Manufacturing in Brazil, Canada, France, Germany, Japan, Mexico, Netherlands, United Kingdom, United States.



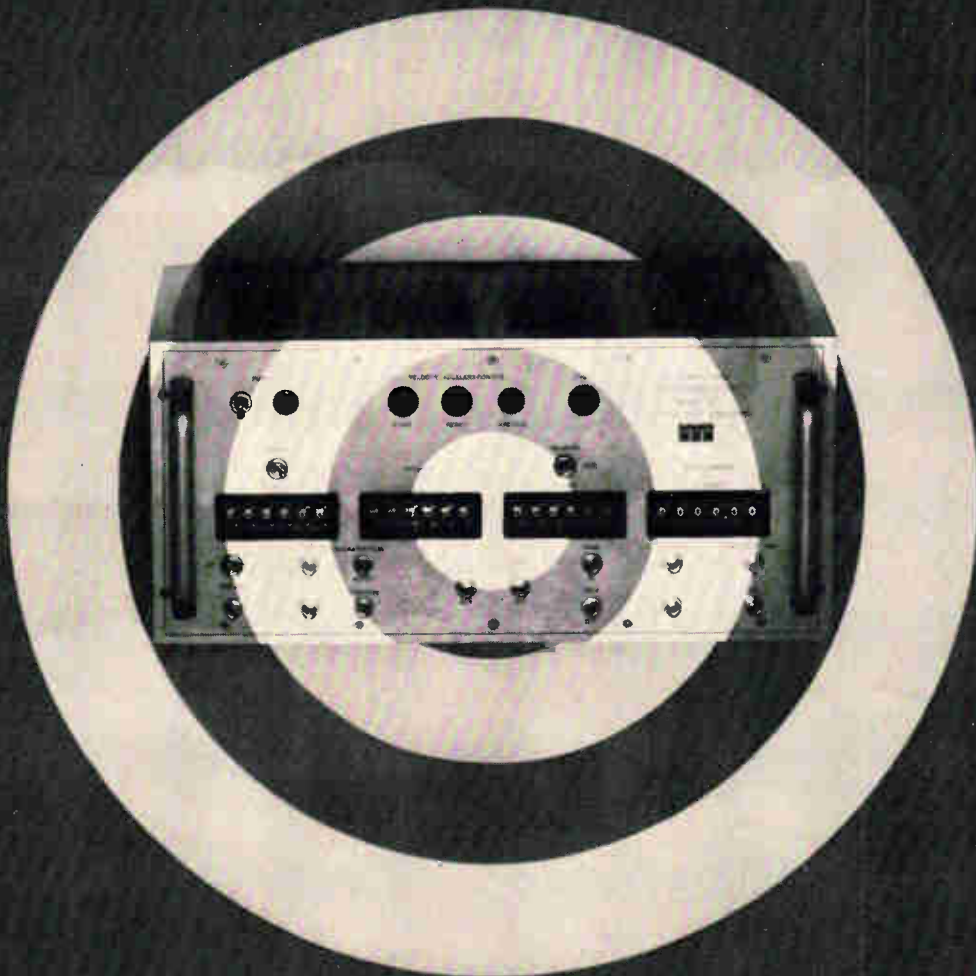

## We make enemies

Simulated enemies are available in a compact package labeled the RUTHERFORD S1 Dynamic Range Simulator. It is the most accurate, reliable, stable video target simulator ever developed. With it you can evaluate, check, and calibrate range, range rate, target tracking, and tracking memory of the most sophisticated weapons control and tracking systems. Forget the limitations and problems built into old-fashioned analog simulators.

Check these parameters: Target Range in one-foot increments from 0 to 1 million feet. Target Velocity

from 0 to 100,000 ft/sec in 0.1 ft/sec increments. Target Acceleration from 0 to 10,000 ft/sec/sec with 0.01 ft/sec/sec resolution. Check all the specs. They meet or exceed the rigid performance requirements of any known weapons control system or tracking system used for air traffic control, satellite surveillance, etc. The Rutherford S1 is an example of

the advanced design that has established Rutherford as the leader in pulse and time delay instrumentation. Other sophisticated instruments will soon be developed by the new CMC/Rutherford team. Our intent is to give you a wide range of instruments that are always the best quality and best buy.

So join the Rutherford Rampage (a division of the CMC Crusade) and write today for the complete specs on the S1. Learn how you can earn your own glorious Crusading Engineers medal with special Rutherford stripe. You'll look so handsome!



12982 Bradley • San Fernando, California • Phone (213) 772-6321 • TWX 213-647-5170

THE RUTHERFORD DIVISION OF CMC IS A LEADING DESIGNER AND MANUFACTURER OF PULSE GENERATORS, TIME DELAY GENERATORS, AND DYNAMIC RANGE SIMULATORS.



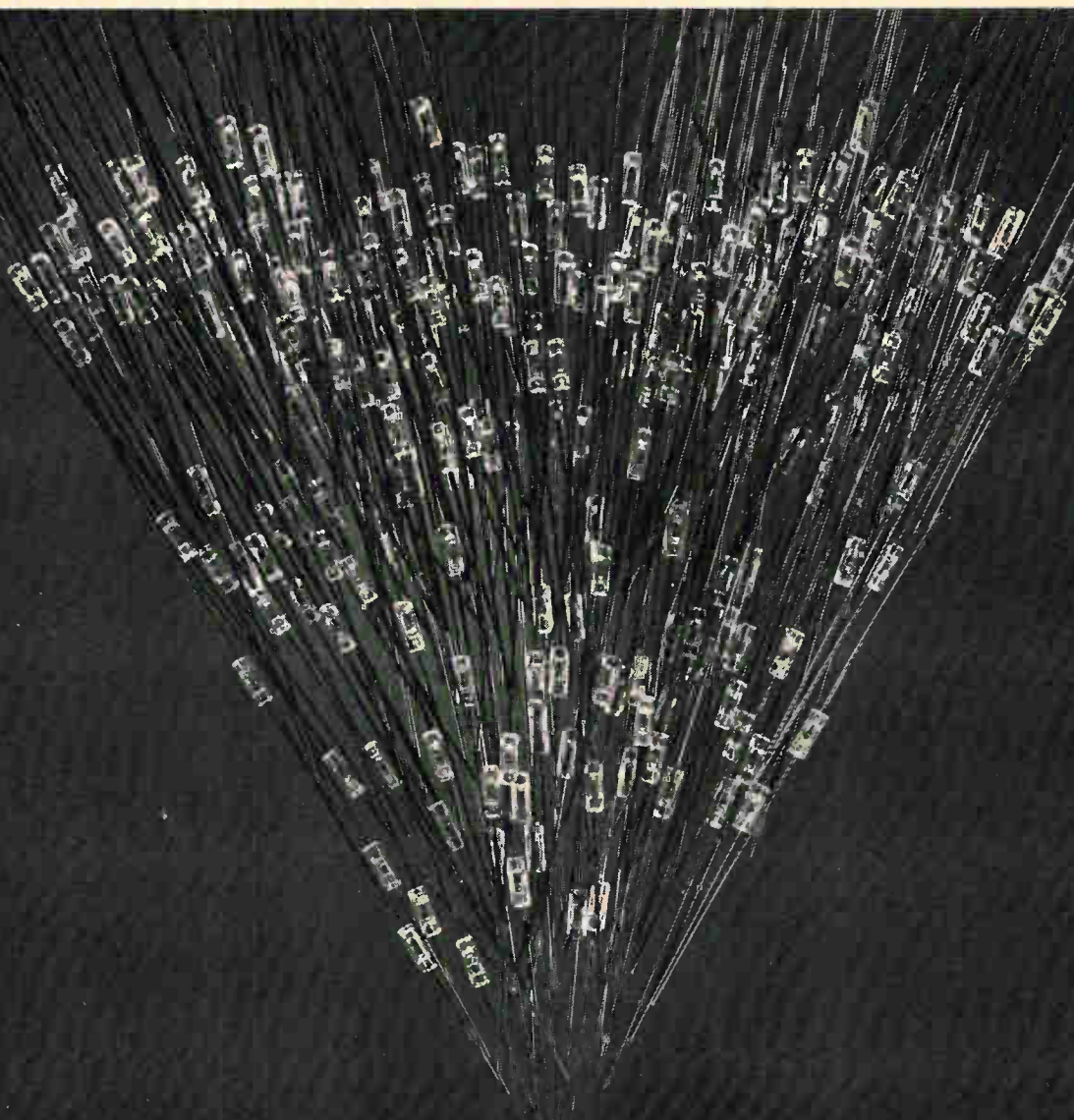

15  15

## Monolithic Diode Matrix

**Now available in any configuration from 5x5 to 15x15.**  
Another microelectronics breakthrough from Radiation Incorporated. New matrix, pictured actual size, is equivalent to 225 general-purpose planar diodes.



**RADIATION  
INCORPORATED**

For data sheets, price and delivery information, write: Radiation Incorporated, Physical Electronics Division, Dept. EL-02, Melbourne, Florida 32902. Phone: (305) 723-1511.  
Sales offices: 650 North Sepulveda Blvd., Suite 622, El Segundo, Cal., (213) 772-6371 • 600 Old Country Road, Suite 438, Garden City, N.Y., (516) 747-3730  
See this and other Radiation products at Booths 2B34-36, IEEE Show

Circle 73 on reader service card



**IBM needed a compact battery that could power amplifying circuits—and drive a motor, too.**

**Mallory made it.**

## What can we do for you?

No one had ever asked a primary battery to do so much. It had to be light—the new model "IBM Executary®" all-purpose dictating unit weighs only 28 ounces. It had to resist extremes of temperature. And it had to maintain near constant voltage for amplifying at the same time it was putting out steady current to drive the magnetic recording belt. Any appreciable variation of either voltage or current during the battery's operating life would produce distortion in the recording belt. IBM brought their specifications to Mallory. Mallory engineered the battery—a new mercury battery with a unique anode design. Its drop-off in voltage is low even when the battery is operating under heavy current drains. Low temperature performance is excellent. And because the basic battery system is mercuric oxide—potassium hydroxide—zinc, battery size and weight are kept to a minimum while delivering maximum performance and life. But this is only one of the extraordinary uses for Mallory Mercury Cells...

### Reliability of Mercury cells brought to new heights



The X-ray photograph shows Mallory mercury cells implanted in a human being. They're part of an amazing device, the cardiac pacemaker, used to stimulate partially or completely blocked hearts. Because this device—and its batteries—must withstand the environmental conditions imposed by the body on foreign materials for up to five years, a new order of reliability and uniformity had to be created. Mallory did so with the Certified Cell Program—step-by-step quality control of materials and production techniques. Structural improvement is made where indicated and confirmed by tests in comparison with existing types. Thus the program not only brings high reliability, but the level

of reliability continually rises with experience.

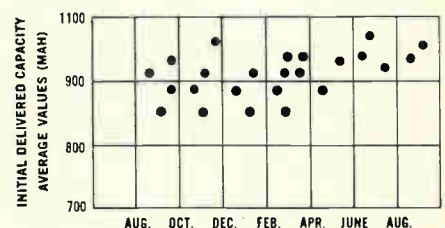

Control chart of test averages of delivered capacity over a year's time. Data represents sample groups taken from a run of 22,000 cells. (Minimum acceptable capacity—800 MAH)

Mallory is currently producing over 100 batteries of all sizes and capacities. And if we're not actually producing the battery you need, we'll be happy to work with you in designing a new one. Please write us at the Application Engineering Department, Mallory Battery Company, a division of P. R. Mallory & Co. Inc., South Broadway, Tarrytown, New York. Or call us at 914-591-7000.

It's good business to do business with Mallory

**MALLORY**

**50<sup>th</sup>**  
ANNIVERSARY

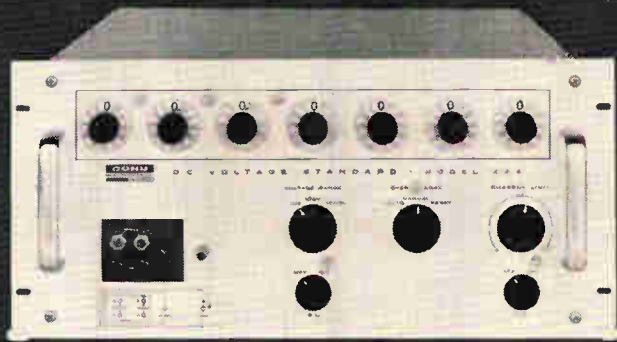

## Meet the DC voltage standard with:

# STABILITY WITHIN 15 PPM

... for 7 days, 25 ppm for 6 months.  
Recorded stability history available.

# 0.003% ACCURACY

... ensured by temperature-controlled precision  
Zener reference.

# IMMEDIATE DELIVERY

... the COHU Model 326 is off-the-shelf ... like the  
entire family of COHU DC voltage standards.

... and voltages from 0 to 1222.2221 in 3 ranges;  
steps as small as 1  $\mu$ v.

Price: \$2490.00 F.O.B. San Diego,  
additional export charge.



Box 623  
San Diego, Calif. 92112  
Phone 714-277-6700



# DC-to-30 MHz performance AND THE versatility of 20 plug-ins with split-screen storage



## Type 549

**split screen permits simultaneous operation as a storage and conventional oscilloscope**

Split-screen storage offers a distinct advantage to the user in waveform-comparison applications — by permitting quick comparison of dynamic signals appearing on one half of the crt with a reference trace stored on the other half, or the Type 549 can be used for full screen storage or full screen conventional displays.

### SAMPLING AND STORAGE

The storage capacity of the Type 549 provides easy-to-study displays—and with a Type 1S1 Plug-In adds new convenience to sampling applications. With this new dc-to-1 GHz sampling unit, you need no pretriggers or external delay lines—the 1S1 has internal triggering with a built-in delay line. The Type 549/1S1 combination gives a stored display that is steady and, because more samples can be displayed, there is high resolution of the sampled information.

### storage features:

**Unparalleled Writing Speed** — up to 5 cm/ $\mu$ s, with enhancement.

**2 Independent 3x10 cm Display Areas** — with separate upper half and lower half controls.

**Bistable Storage.**

**Automatic Erase** — with selectable viewing times from 0.5 seconds to 5 seconds. Erase can be selected for recurrent or after-sweep operation.

**Erase-and-Reset** — with push-button control for erasing display and rearming single sweep. Erase-and-Reset can be controlled remotely, if desired.

### other features:

**Precision Sweep Delay** — from 1 microsecond to 10 seconds.

**Wide Sweep Range** — 5 s/cm to 0.1  $\mu$ s/cm (Time Base A) and 1 s/cm to 2  $\mu$ s/cm (Time Base B). 5X Magnifier extends fastest sweeps to 20 ns/cm (Time Base A) and to 0.4  $\mu$ s/cm (Time Base B).

**Single Sweep** — manually, automatically, or remotely.

**Full-Passband Triggering** — with flexible, easy-to-use facilities.

**Simplified Trigger Logic** — with lever control of trigger functions.

**Size and Weight** — dimensions are 17" high x 13" wide x 24" deep; net weight is  $\approx$  67 lbs.

Type 549 Oscilloscope . . . . . \$2375 (without plug-ins)

The plug-in units range in price from \$145 (B high-gain unit, K fast-rise unit) to \$1100 (1S1 sampling unit, illustrated).

U.S. Sales Prices f.o.b. Beaverton, Oregon

**For more information call your Tektronix Field Engineer.**

**Tektronix, Inc.**



# Signal conditioning is a push-in with these input couplers

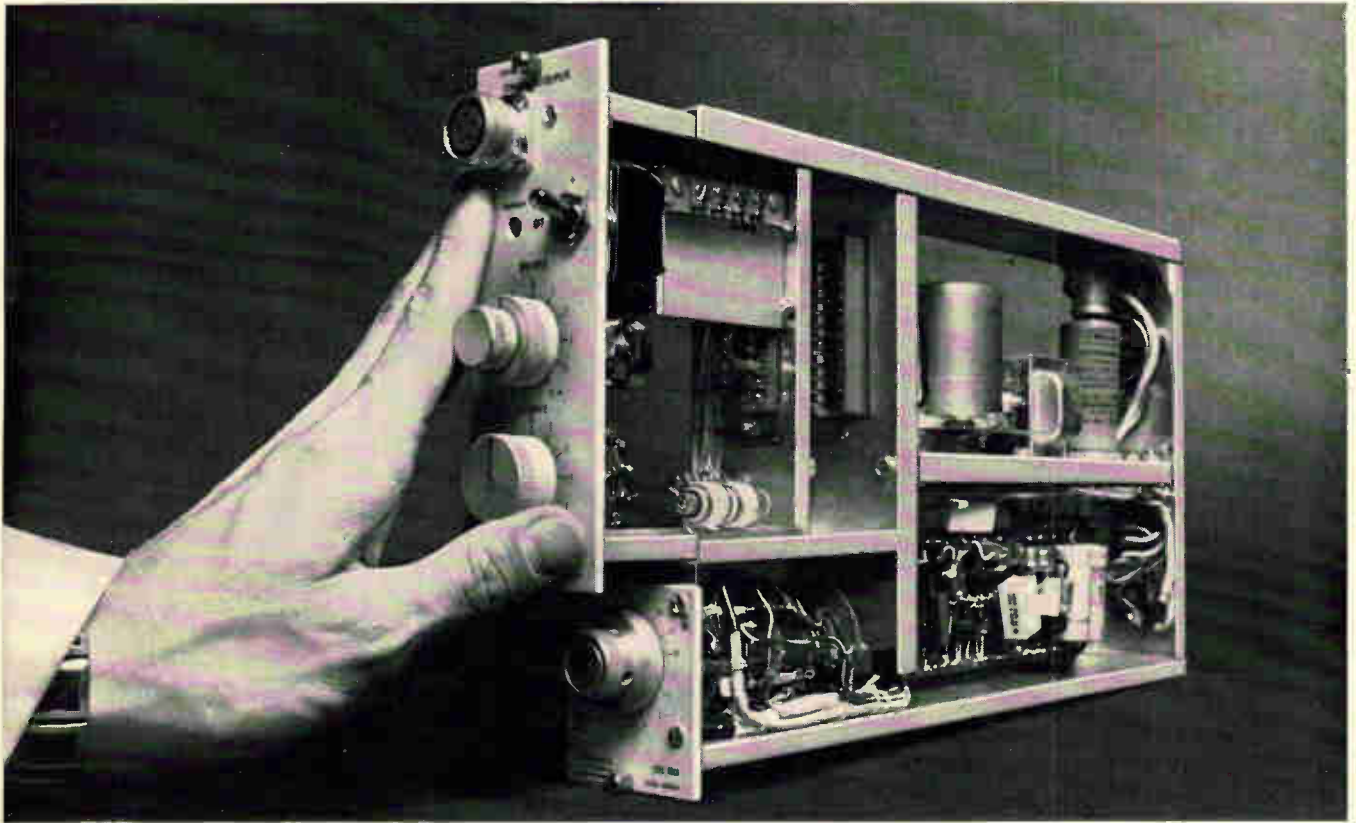
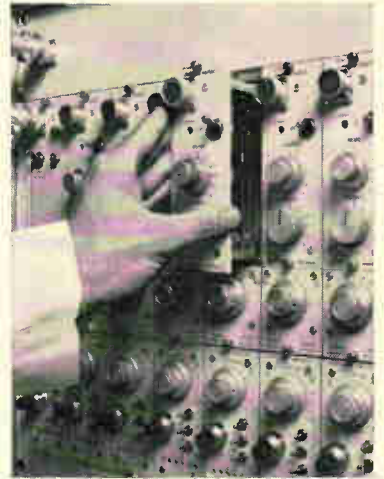

Record directly . . . strain . . . pressure . . . displacement . . . temperature . . . or any other phenomena that can be transduced into an electrical signal. The Beckman 9800 Series Input Couplers (over 30 of them) plug directly into the preamplifier in the Dynograph® Recorder, averting heavy expenditures for specialized amplifier systems when your application needs change.

Low-cost versatility . . . a simple change of couplers adapts the recorder to your particular requirement. They provide all the signal conditioning required for recording, including computation, demodulation, rectification, etc. Additionally, they supply the excitation and calibration signals necessary for many types of transducers . . . such as strain gage and reluctance gage.

Your Dynograph Recorder, with no complicated and expensive amplifier system changes, can readily meet your recording requirements today . . . and tomorrow.

For further information, including application, price and delivery, contact your local Offner Division Sales Engineering Representative . . . or write direct.

**Beckman®**

INSTRUMENTS, INC.

OFFNER DIVISION

SCHILLER PARK, ILLINOIS 60176

INTERNATIONAL SUBSIDIARIES: GENEVA; MUNICH; GLENROTHES, SCOTLAND; TOKYO; PARIS; CAPE TOWN; LONDON

# WHAT ONE INSTRUMENT...

*can be used to accurately test the frequency response of quartz crystals,* meeting the rigid requirements of stability, flatness, adjustability and frequency identification necessary for this precise operation?

*can measure the dynamic impedance of a power supply at any frequency from 20 Hz to 3000 MHz,* or at several frequencies in that range, providing an instantaneous oscilloscope presentation of the supply's impedance characteristics?

*can provide complete frequency transmission characteristics of telephone or other transmission lines* for equalizing operations, materially reducing testing time, supplying total frequency coverage, and eliminating correlation errors between first and last test readings?

What instrument that does all this can also determine filter passbands, compare input characteristics with phase/amplitude transmission, test relative inputs and outputs of an RF network, and perform many test functions in the lab or in production that by other methods took too much time and supplied incomplete data?

The answer is Telonic's **SM-2000 SWEEP GENERATOR**, a basic control unit that accepts 22 different plug-in oscillator heads covering 20 Hz to 3000 MHz in both wide and narrow frequency segments for a wide variety of applications. It is the most time-saving, versatile instrument you'll find on any test bench.

**MORE APPLICATIONS-**On request, Telonic will be glad to send you an Application File Folder covering all techniques mentioned here in detail, in addition to many other applications for swept frequency measurements. Your request also places your name automatically on our mailing list to receive further application notes for the file.



**Telonic** INDUSTRIES INC.  
60 North First Avenue, Beech Grove, Indiana  
Tel: (317) 787-3231 TWX: 810-341-3202

International Leader in Swept Frequency Instrumentation.  
Representatives in all major cities in the U.S.  
and throughout the world.

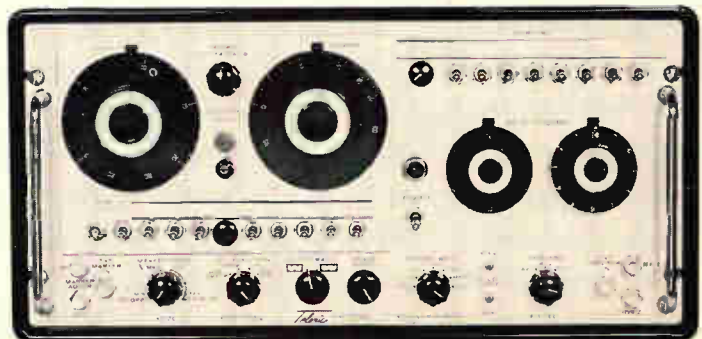
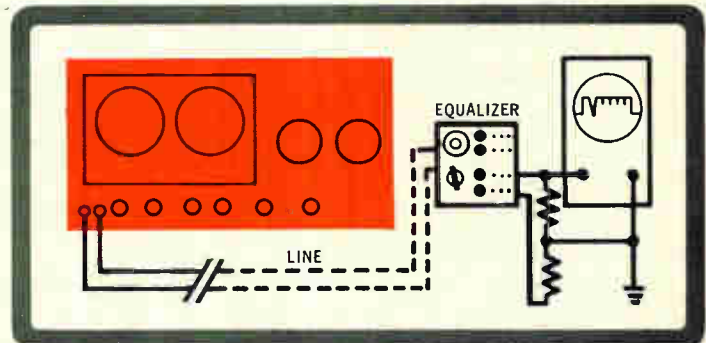
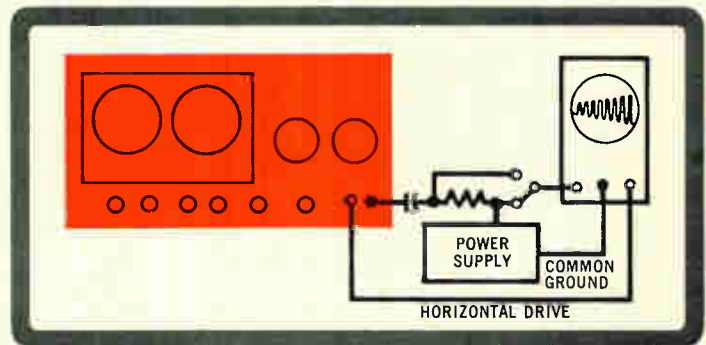
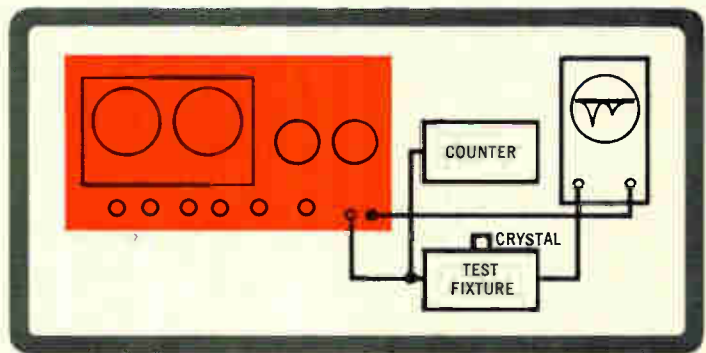

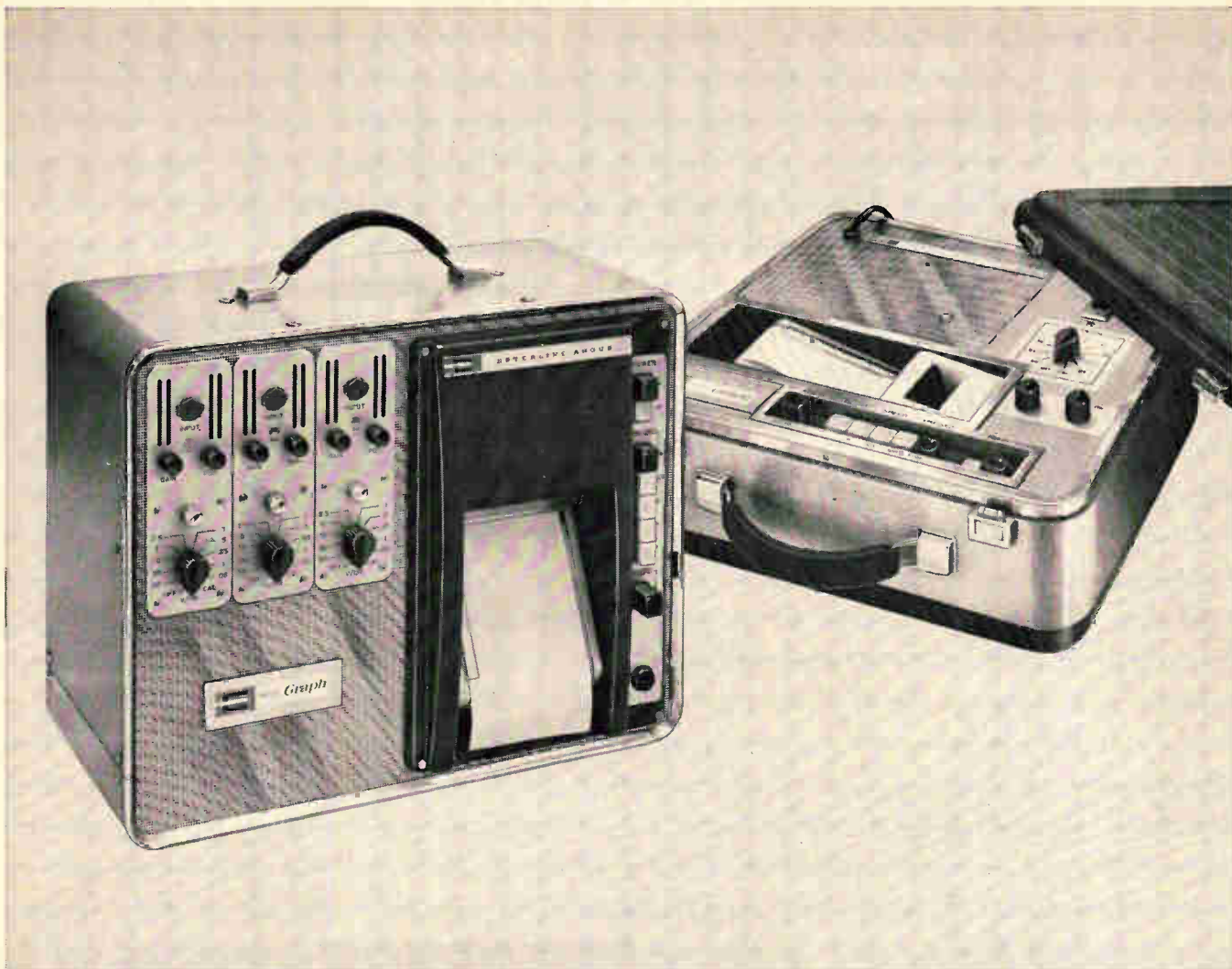

90 cps full scale response  
+  
3 channels } = your best Oscillo Graph buy

Take your choice—the only Three-channel Portable Oscillo Graph available, or Two or One-channel Oscillo Graphs.

All feature exceptional frequency response . . . flat to 90 cps at 30 mm peak-to-peak. It's down only 3 db at 125 cps. Other features:

- Balanced differential amplifier in modular form for Two and Three-channel Recorders. Same amplifier is built into the Single-channel Recorder.
- Four push-button controlled chart speeds—1, 5, 20 and 100 mm per second.
- Stylus motor uses no permanent magnets. Eliminates the clutter of brushes, slip rings, armature leads and linkages found in other stylus drive mechanisms.

Like cabinet model Esterline Angus Oscillo Graphs, portables employ the exclusive inkless, heatless Direct-Carbon-Transfer writing method. Advantages of D-C-T?

- Finest trace provides greatest resolution. 0.005 inch trace occupies only 1/2% of full scale. Competitive oscillographs produce a trace which is three times wider.
- No pens to clog or ink to splatter.
- Chart paper at half the cost of heat sensitive paper.
- No stylus temperature adjustments to bother with.
- Chart requires no special handling and is unaffected by light, humidity or temperature.

For trouble-free writing, economy and unequalled response, investigate Esterline Angus Oscillo Graph Recorders.

Write for colorful Series "O" catalog.

ESTERLINE ANGUS INSTRUMENT COMPANY, INC.  
Box 24000 E • Indianapolis, Indiana 46224

# ESTERLINE ANGUS



*Excellence in instrumentation for over 60 years*



# Technical Articles

---

**Storing data with light:**  
page 82

Optical memory has the advantages of electrical isolation, low dispersion, parallel propagation and high resolution. It also has a potential for compactness. Though such designs are not yet in production, engineers confidently predict that optical memories are for the next generation of data-processing equipment.

**Using strip transmission line to design microwave circuits, part II:**  
page 90

In this article, the authors continue the discussion started in the February 7 issue of microwave components designed with strip transmission line to include modulators, tunnel-diode amplifiers and phased array antennas. For the future, semiconductor material may be used as the dielectric of strip line, allowing diodes to be an integral part of the line material itself—creating a new category of monolithic integrated circuits.

**The packaging revolution, part VI:**  
Page 103

The series on packaging integrated circuits continues with a three-part examination of the problems in converting to hybrid microcircuits:

I. **Converting to microelectronics:** Redesign is inevitable. The relationship between design and fabrication is much closer when integrated circuits are used.

## Electronics



II. **Ceramic handles and ultrasonic bonders upgrade hybrid assembly.** Two common causes of failure of hybrid microcircuits are eliminated. For the cover, photographer Richard Saunders caught the delicate colors of a staircase voltage generator built by this method at Collins Radio. On a single ceramic substrate, the generator contains 4 integrated circuits, 8 transistors, 9

diodes, 27 resistors and 1 capacitor.

III. **Modular arrays, the path to single-circuit systems.** With a new combination of hybrid-circuit and sealing techniques, analog subsystems can be built with large numbers of monolithic circuit chips in one package.

---

**Coming  
March 7**

- Product development at the IEEE show
- Industrial applications of microwaves
- Thin film circuits made in East Germany
- Signal-powered circuits

# Storing data with light

Optical memory has the advantages of electrical isolation, low dispersion, parallel propagation and high resolution, and shows promise for next-generation data processing

By Richard D. Stewart

General Electric Co., Syracuse, N.Y.

**Improvement of memory systems** is more than a simple matter of increasing circuit speed. Such problems as interconnection length and crosstalk also must be overcome.<sup>1</sup> Optical memory systems, in addition to their potential for compactness, have four inherent advantages over conventional systems that eliminate these and other problems.

These advantages are:

- Electrical isolation, making possible non-destructive parallel readout and thus higher speed, because no recycling is needed.
- Low dispersion, allowing long transmission paths.
- Parallel propagation that increases the information density and allows a number of nearby parallel signal paths to be operated without crosstalk.
- High-resolution masks capable of resolving many bits of information because of the very short wavelength of light.

The term memory, or storage, describes everything from nanosecond-access tunnel-diode memories to millisecond-access magnetic drums, from densities of a million bits per square centimeter on

microfilm to 10 bits per square centimeter on punched cards.<sup>2</sup> With this latitude in requirements, it is not surprising that many optoelectronic systems are being studied.

## Beam-modulation method

The most familiar method of optical memory operation may be described as beam modulation, shown on the opposite page. With beam modulation, information is stored in a variable-density mask, and is read out by passing a uniform optical beam through the mask. A photosensitive detector converts the optical information signals to equivalent electrical signals. Transparent and opaque areas in the mask represent stored 1 and 0 bits. Several beam-modulation techniques will be briefly discussed in this article. They are important because they are the only forms of optical memory actively operational outside of the laboratory.

The direct approach to beam modulation is the conventional silver-halide photographic disk. Although this device has the disadvantage of operating only as a permanent memory—data is not alterable—its extremely high density makes it very valuable. Resolutions of greater than 1,000 lines per millimeter are not unreasonable for photographic emulsions; three-inch diameter disks with capacities of 90,000 bits have been used.<sup>3</sup> Multichannel optical code disks can resolve angles of one second of arc.

Reversible films have also been developed that can be directly substituted for the photographic mask. With these films, data can be added, erased or changed. Photochromic film,<sup>4</sup> for example, is darkened by exposure to ultraviolet radiation and is used the same way as the photographic negative. An image can be placed on the film either by exposing the entire field at one time or by scanning the field with the ultraviolet beam.<sup>5</sup> Exposure to

This article, one of a series on optoelectronics, discusses four ways of recording and reading back memory data optically: beam modulation, beam deflection, bistable light emitters and optical delay lines. Previous articles described new optoelectronic components and the application of optoelectronics to logic and display. These articles appeared in *Electronics* on Nov. 1, 1965, p. 58; Nov. 15, p. 98, and Nov. 29, p. 56.

### The author



Richard D. Stewart is a member of the Optoelectronic and Solid State Devices Group in the Electronics Laboratory of the General Electric Co. He joined GE in 1959 and has worked on solid state image converters, memory techniques and display techniques.

radiation at near-infrared wavelengths will erase the film. Photochromic film has a potentially greater resolution than conventional microfilm, because individual molecules in the sensitive layer react to light, as opposed to crystals in silver halide emulsions.

### New optical films

A new film, known only as RS (for recording system), has recently been announced by the Itek Corp.<sup>6</sup> Containing particles smaller than one micron, RS can be applied by conventional paper coating equipment onto almost any substrate. The material, which is not photosensitive during deposition, is sensitized by a nonchemical process while on the substrate. Conventional photographic exposure with relatively intense sources produces a latent image, which is developed by wet chemical processing. The material has been proposed for a high-density, read-only memory with a capacity of 250 million bits on a disk 10 inches in diameter. The film can be resensitized after development without destroying the original image. Thus, a memory could be repeatedly enlarged with data added in blank areas.

Another film for a memory system is Kalvar.<sup>7</sup> Unlike conventional photographic media, Kalvar is optically masked by scattering of the incident light with photosensitive crystals distributed in an amorphous binder. Ultraviolet radiation decomposes the crystals and exerts pressure on the binder. Subsequent heat treatment causes a recrystallization where the exposed crystallites contact the binder. Changes in the index of refraction along these recrystallization boundaries produce pronounced light scattering. The average size of these scattering sites is 0.5 to 2.0 microns. Because of the thermal setting process, the film is not reusable.

In another method of beam modulation—photoplastic recording<sup>8</sup>—a light-sensitive film is electrostatically charged. The charge dissipates through the film when the film is illuminated. After heating, the unlit areas, which retain the charge, cause a depression in the film because of electrostatic forces. The image is thus recorded by surface ripples, rather than by light and dark areas. To project this image into the detector array, special optics are required. By selective heating, any part of the image can be erased and rewritten.

### Other modulation methods

In each of these techniques, the original data input is a light beam, usually not in real time. An alternative technique uses an electron beam to control the mask density. An example is thermoplastic recording,<sup>9</sup> which is similar to photoplastic recording except that the thermoplastic film is charged directly by an electron beam. But this technique has one serious disadvantage: the electron-gun system must be enclosed in a vacuum.

The cathode-ray storage tube may be considered another form of beam-modulated storage.<sup>10, 11, 12</sup>

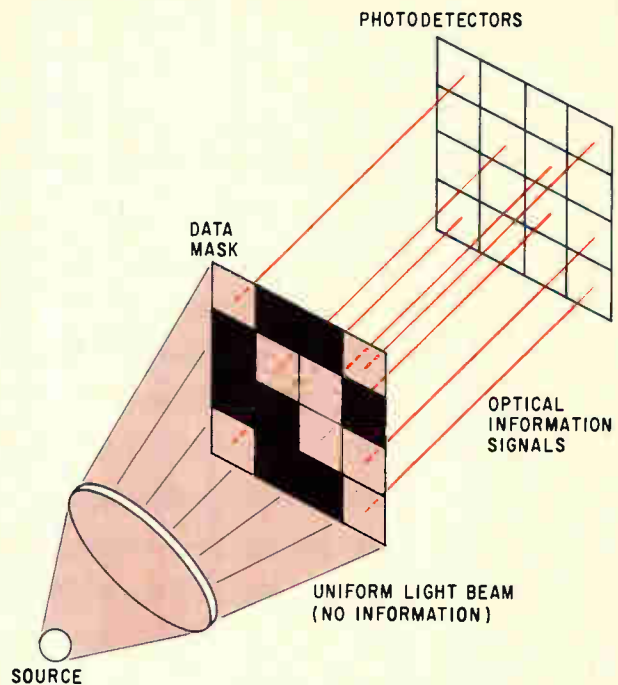

Light-beam modulation is the simplest technique for storing optoelectronic data. The mask is a photographic film containing the data; the array of detectors senses the data when the mask is uniformly illuminated.

This storage system, which is as much electro-optic as optoelectronic, was used in the first electronic telephone exchange.

Optical fibers have also been used in beam-modulation memories. The fibers replace the optical paths shown in the diagram above. A single emitter can illuminate a bundle of fibers. The bundle fans out to an entire column of positions in a closely packed mask; there are as many emitters as there are columns. Also, a single detector reacts to light from a bundle of fibers fanning in from an entire row of positions in the mask. So a single emitter and a single detector can sample a single position in the mask; an  $m$  by  $n$  mask with  $mn$  positions requires only  $m$  emitters and  $n$  detectors, a total of  $m + n$ . In conventional lens systems, this fanning out would mean excessive optical losses.

For instance, one memory scheme<sup>13</sup> has 250 channels, each operating at 10 kc, in an area 40 centimeters square. This gives a total capacity of  $2.5 \times 10^6$  bits, and a density of about  $10^4$  bits per square inch. This density limit is imposed by the photomultiplier detectors; the limit of the fibers or the mask is much higher.

Many kinds of light sources can be used with fiber optic memories, such as sources of intrinsic electroluminescence, and forward-biased (injection) and reverse-biased (avalanche) pn junctions.

Although pn-junction devices have very fast response time—on the order of 10 nanoseconds—electroluminescent devices are slow because of a much longer phosphorescent decay time. This problem can be overcome by exciting the row and

column drive lines of an electroluminescent matrix with different frequencies.<sup>14</sup> The light output of the electroluminescent cell fluctuates at twice the driver frequency, allowing a tuned filter on the detector output to differentiate between the driven output and the phosphorescent afterglow. Also, at the intersection of the excited row and column, the selected element follows the difference frequency  $2(f_1 - f_2)$  while the remaining elements in that row and column fluctuate at either  $2f_1$  or  $2f_2$ . A 128-by-128 matrix of electroluminescent devices operating in this mode had an access time of 100 microseconds.

Pn light emitters are useful in this type of memory. Optical fibers eliminate close spacing, so individually mounted diodes can be used. Coupling between the pn emitters and a solid state detector was described in a previous article. [Electronics, Nov. 1, 1965, p. 58.]

### Beam-deflection technique

A memory technique, still in the early development stage, is shown in the diagram below. The method is based on the ability of an electro-optic crystal to deflect an optical beam. The crystal's index of refraction varies with the strength of an electric field applied transverse to the beam of light. In operation, an incident horizontally polarized continuous beam is variably deflected in proportion to the variable index of the crystal's refraction. In the diagram, two crystals are shown producing a two-dimensional scan. A range of 100 spot diameters is predicted, but has not yet been attained.<sup>15</sup>

A digital indexed light deflector based on rotation in an electro-optic crystal when an electric field is applied parallel to the beam of light, and on birefringence, or double refraction, was built at

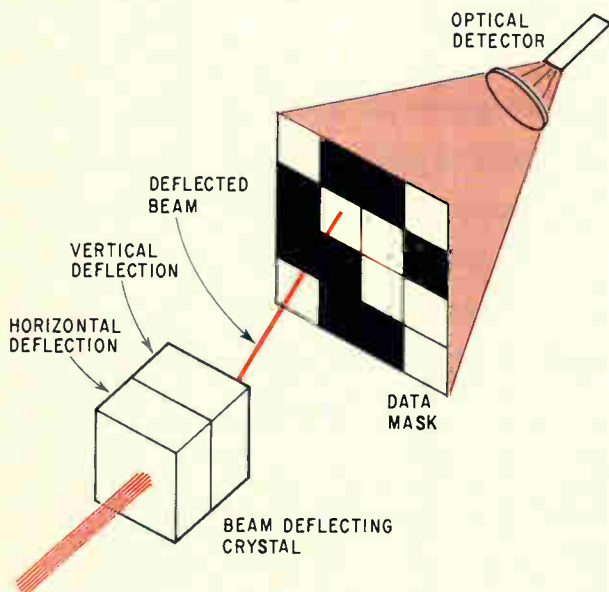

**Optical beam deflection.** Two electro-optic crystals deflect a beam of light to some point on a mask; the amount of deflection is a function of an applied electric field. The optical detector produces a signal that indicates whether that point is clear or dark.

the International Business Machines Corp.<sup>16</sup> A beam of unpolarized light perpendicularly incident on a birefringent crystal emerges as two beams, polarized at right angles. Both rays leave the crystal in a direction parallel to the input beam's direction but displaced from each other by an amount determined by the length of the crystal. A polarized light beam will either go straight through the crystal, or be deflected and rotated, depending on its incident direction of polarization. By selectively diverting the beam through crystals of different thicknesses, varying deflections are obtained. By placing an electro-optic crystal in front of the birefringent crystal, the input polarization can be varied. Digital control then is possible with a chain of electro-optic crystals such as potassium dihydrogen phosphate (KDP) and birefringent crystals such as calcite. The calcite crystals become progressively thicker in ratios of 1 to 2 to 4 to 8; this permits any integral deflection of the light beam by activating the appropriate electro-optic layers. A memory system based on this scanning technique has a mask in the path of the deflected beam, which is quite narrow. The presence or absence of light reaching a detector element behind the mask indicates a stored 1 or 0.

### Delay-line memories

A very high-speed memory could be built if the concept of the acoustic delay line were applied to an optical system. In acoustic delay lines, electrical signals representing the information to be stored are converted into a series of acoustic waves which propagate through a long wire or other medium and are reconverted to electrical signals. Data is stored in the line for the transit time through the wire. In an optical system using this principle, a high-speed sequential memory could be attained. The exceptionally long optical path length that would be required in such a memory is still the main technical problem to be overcome.

A possible solution to this problem has been suggested in work reported by Bell Telephone Laboratories, Inc.<sup>17</sup> Two mirrors 10 feet apart are aligned to reflect a laser beam back and forth more than 1,000 times. This highly collimated (parallel) beam can be modulated to contain as many as 10,000 bits. These bits are then available at the output—one every nanosecond. By controlling the angles and frequency of the entering light, several beams could be reflected back and forth simultaneously, permitting one mirror system to store several sets of information.

Another recently reported delay line memory takes advantage of the transmission time of an electron beam in a specially designed tube.<sup>18</sup> This electro-optical tube contains an output gate that is closed for the normal storage mode, causing standing waves in which up to 10,000 bits can oscillate on a single beam. When the gate is opened, data can be read out onto the phosphor screen. There can be up to 100 beams in a single tube, which could lead to a million-bit memory.

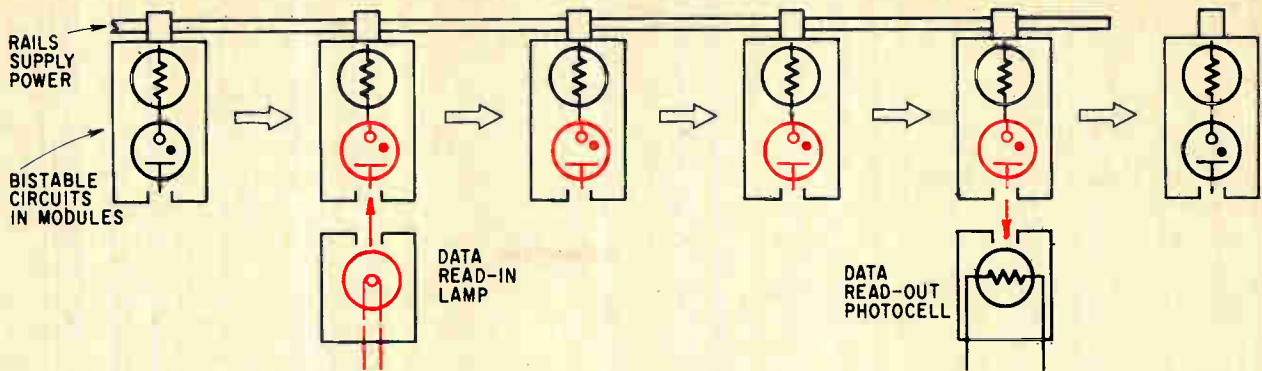

**Assembly line uses bistable optoelectronic element.** Each module travels along the line with a unit being assembled. Light bulbs beside the line indicate conditions at each assembly station. When a module passes a glowing light bulb, its bistable circuit turns on and its neon bulb glows. Later the module passes a photocell beside the line, which "sees" the glowing neon and produces a signal for the nearest assembly station. Modules are turned off when they run off the end of the rail at the end of the assembly line.

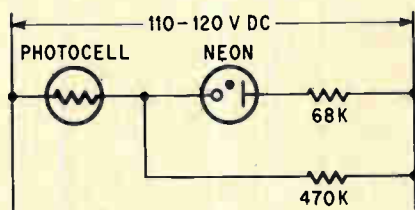

**Bistable optoelectronic memory element.** When the photocell is dark, its resistance is high and the neon lamp does not glow. When an external source illuminates the photocell, the cell's resistance drops, the neon lamp glows, and this glow keeps the photocell resistance down after the external source disappears. Power must be removed or the neon must be masked to return the circuit to its high-impedance state.

### Bistable light emitters

Perhaps the only true optoelectronic memories are those built of bistable optical elements, which combine electrical and optical signals to perform switching. One such element, shown directly above, uses optical feedback and has a negative-resistance characteristic that gives it bistable operation. With a neon bulb as the light-emitting component, these circuits operate in the millisecond range. A similar circuit can be designed with a single-crystal gallium-arsenide light-emitting diode, either alone or in parallel with a tunnel diode. The circuit, with a silicon photodiode as a detector, responds to 0.1-microsecond pulses at a one-megacycle rate.<sup>19</sup> Light-emitting tunnel diodes have also been made, although they have more excess current than do commercial tunnel diodes.

The negative-resistance characteristic of a bistable optical element is in the diagram on page 86, with a load line that intersects the characteristic curve at the stable operating points A and B. The high-impedance point A corresponds to operation of the circuit in the dark, when the photoconductor has extremely high resistance and the light emitter, in series, cannot fire. When an external light source lowers the resistance of the photoconductor, the light emitter turns on. If its light output illuminates the photoconductive cell, then the circuit will be stable and the neon bulb will remain on, even after the external light source has been removed. This state is represented by point B on the load line. Data is erased by removing the power; the circuit then reverts to the high-impedance state.

This rather simple bistable element is as much a logic element as a memory element. By combining

a series of bistable neon-photoconductor (neon-PC) or electroluminescent-photoconductor (EL-PC) elements, an optoelectronic shift register can be constructed.<sup>20</sup>

These elements have been described for a data recorder in a manufacturing assembly line.<sup>21</sup> Each unit being assembled is accompanied by a module containing a neon-PC circuit like the one shown in the diagram at the top of this page. At certain points along the line, light bulbs are turned on and off manually or automatically, depending on conditions. When a module passes a light bulb that has been turned on, the circuit in the module switches to the low-impedance state, and the neon bulb in the circuit glows. Farther along the assembly line, a photocell senses that the neon bulb is glowing and produces a corresponding signal. The circuit turns off when the module runs off the end of the power bus, thus removing the power from the circuit.

### Matrix memories

A number of bistable light-emitting elements may be assembled into a memory as a matrix. In one arrangement, shown on page 86, each bistable circuit represents one bit in the memory. In this arrangement, the bistable elements are turned on by voltage pulses instead of by external light sources. Simultaneous pulses on one row and one column drive line can select the element at the intersection of those lines and turn it on or off. Optical feedback makes the element remain on after the selecting pulse falls. This is a linear select method like that used in some magnetic core memories.

A photosensor array reads data from the memory. Since each photosensor element corresponds to one

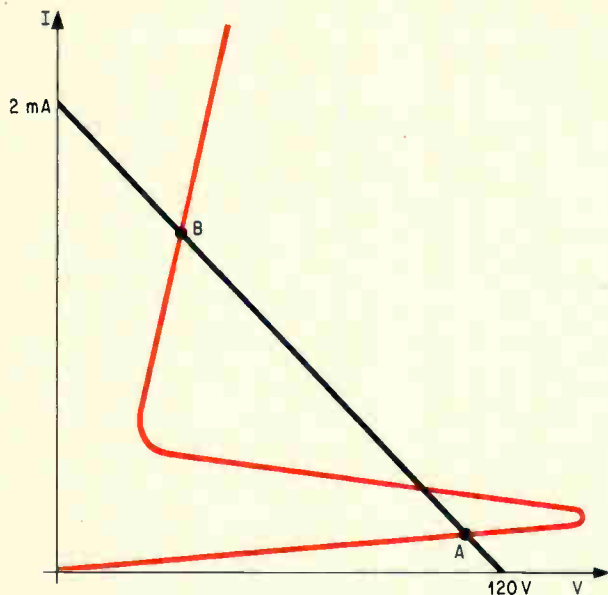

Characteristic curve and load line for a bistable optoelectronic memory element containing a photocell and neon, as shown on page 85. The straight line joins the points of zero current and zero voltage, and intersects the curve at its stable points.

emitter, the impedance level of each row-column intersection indicates the state of the corresponding emitter. Photodetectors that can be used include solid state, such as cadmium-selenide, lead-sulfide or silicon detectors, photodiodes, photo-transistors, photomultipliers; and a wide variety of electron-tube devices, such as vidicons, image orthicons, image intensifiers, and image dissectors.

Nondestructive readout is a significant advantage of this memory design, made possible because the bistable light-emitting elements are electrically isolated from the detector output signals. Another advantage is simultaneous reading and writing into this memory, again possible because the electrical circuits for reading and writing are completely isolated—an example of asynchronous operation.

The optoelectronic matrix memory can also be used in data correlation which compares the contents of one or more memory locations, or of the entire memory, with a predetermined set of data. The data is in a mask interposed between the emitter and detector arrays. Two masks are required: one transmits all desired signals and the other transmits all undesired signals. The latter transmits no signals if only the desired data is present in the memory. The masks are complementary—one is a negative of the other—unless only a part of the memory is compared, or unless the memory contains optional or "don't-care" data. This operation differs significantly from light-beam modulation in which the initial optical signals contain no data.

The similarities among logic, switching, memory and display are important to the development of optoelectronic devices and applications. Any one component or technique that can provide all of these computer functions will represent a significant step forward.

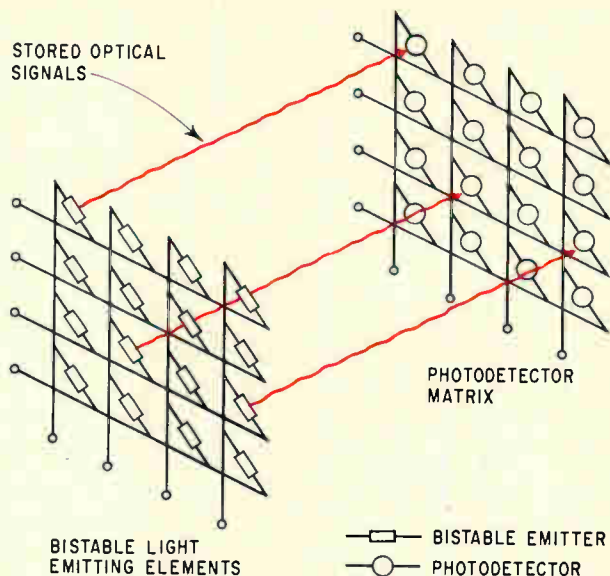

Memory matrix is built with bistable optoelectronic elements. The bistable elements are in matrix at left; the right-hand matrix is an array of detectors that determine the states of the bistable elements on command. Colored lines show light paths from emitter to detector.

## References

1. T.E. Bray and G.B. Jacobs, "State-of-the-Art of the Optical Logic Element," Symposium on Optical and Electro-optical Information Processing Technology, 1964.
2. Marvin Camras, "Information Storage Density," IEEE Spectrum, Vol. 2, Nov. 7, p. 98, July, 1965.
3. F.P. DeNegri, "Permanent optical memories for compact system," Electronics, p. 64, April 20, 1964.
4. S.D. Stookey, "Photochromic Glass," Data Systems Design, Vol. 1, p. 41, September, 1964.
5. C.O. Carlson, D.A. Grafton, and A.S. Tauber, "The Photochromic Micro-Image Memory," Symposium on Large Capacity Memory Techniques for Computer Systems, 1961.
6. "Many tricks in Itek's new bag," Business Week, p. 60, Jan. 30, 1965.
7. R.T. Nieset, "Kalvar," Data Systems Design, Vol. 1, p. 43, September, 1964.
8. Joseph Gaynor, "Photoplastic Recording," Data Systems Design, Vol. 1, p. 45, September, 1964.
9. W.E. Glen, "Thermoplastic Recording," J. Applied Physics, Vol. 30, p. 1,870, December, 1959.
10. W.R. Daniels, "Storage Tubes," Wireless World, p. 250, June, 1963.
11. C.W. Hoover, Jr., "An Experimental Flying Spot Store for Electronics Switching," Bell Laboratories Record, p. 470, December, 1959.
12. T.S. Greenwood, "A Barrier-Grid Tube Memory," Bell Laboratories Record, p. 470, December, 1959.
13. G.R. Hoffman and D.C. Jeffreys, "A Computer Fixed Store using Light Pulses for Readout," Journal of the British Institution of Radio Engineers, p. 99, February, 1963.
14. G.R. Hoffman and P.L. Jones, "An Electroluminescent Fixed Store for a Digital Computer," Proceedings Institution of Electrical Engineers, March, 1962.
15. V.J. Fowler, C.F. Buhner and L.R. Bloom, "Electro-Optic Light-Beam Deflector," Proceedings of the IEEE, February, 1964, p. 193.
16. W. Kulche, T.J. Harris, K. Kossanek and E. Max, "A Fast Digital-Indexed Light Deflector," IBM Journal of Research and Development, p. 64, January, 1964.
17. "Two-Mile Laser Beam Folded into Ten Feet," Bell Labs Record, Vol. 43, No. 7, p. 306, July-August, 1965.
18. A.D. Berg and R.W. Smith, "A Possible Electron Image Information Store," Advisory Group for Aerospace Research and Development, Opto-Electronic Components and Devices Conference, Paris, September, 1965.
19. B.T. French, "Utilization of Light Emission from GaAs Tunnel Diodes to Perform Computer Functions," Symposium on Optical and Electro-Optical Information Processing Technology, 1964.
20. T.E. Bray, "An Electro-Optical Shift Register," IRE Transactions on Electronic Computers, Vol. EC-8, p. 113, June, 1959.
21. B.E. Palmer, "Data Storage Technique Utilizing Neon-Photocell Units," Automation, p. 64, October, 1963.

# Designer's casebook

Designer's casebook is a regular feature in Electronics. Readers are invited to submit novel circuit ideas, packaging schemes, or other unusual solutions to design problems. Descriptions should be short. We'll pay \$50 for each item published.

## Tunnel-diode pulser measures cable delay

By Peter J. Kindlmann

Yale University, New Haven, Conn.

**A technique** for determining the propagation delay time of a cable on the basis of frequency, rather than time, results in increased accuracy. In this technique, a pulse generated by a tunnel diode travels along the line and is reflected by the open end. The reflected pulse retriggers the tunnel diode and the process is repeated. The result is a series of pulses at a constant repetition rate that can be measured accurately. The circuit for performing this measurement, shown below, is designed for use with the 50-ohm cable.

In the standard time-measuring procedure, a pulse is transmitted along an open-circuited cable. The cable's propagation delay is determined by

measuring the length of time it takes the pulse to travel along the cable, reflect from the end and return to the input. Calibrated oscilloscope sweep circuits or interval timers are used to determine the time between the transmitted and reflected pulses. Because of instabilities in the sweep circuit or low resolution in the interval timers, however, this method is usually inadequate for high precision work.

The testing cycle in the new technique is started by pushing switch  $S_2$  to its alternate position at  $R_9$ . This discharges capacitor  $C_5$ , which triggers tunnel diode  $D_2$ . A negative pulse developed at  $D_2$  is differentiated and applied to tunnel diode  $D_1$  through diode  $D_3$ . Tunnel diode  $D_1$  is part of a conventional univibrator circuit that is biased by resistor  $R_3$  slightly below the circuit's threshold for free-running operation.  $D_1$  is triggered and generates a pulse that travels along the cable. After reflection from the open end, the pulse returns along the cable, triggers  $D_1$ , and the process is repeated. The resulting oscillation is amplified in  $Q_1$ , which produces negative pulses that are 0.5 volt in amplitude and 20 nanoseconds wide. The pulses

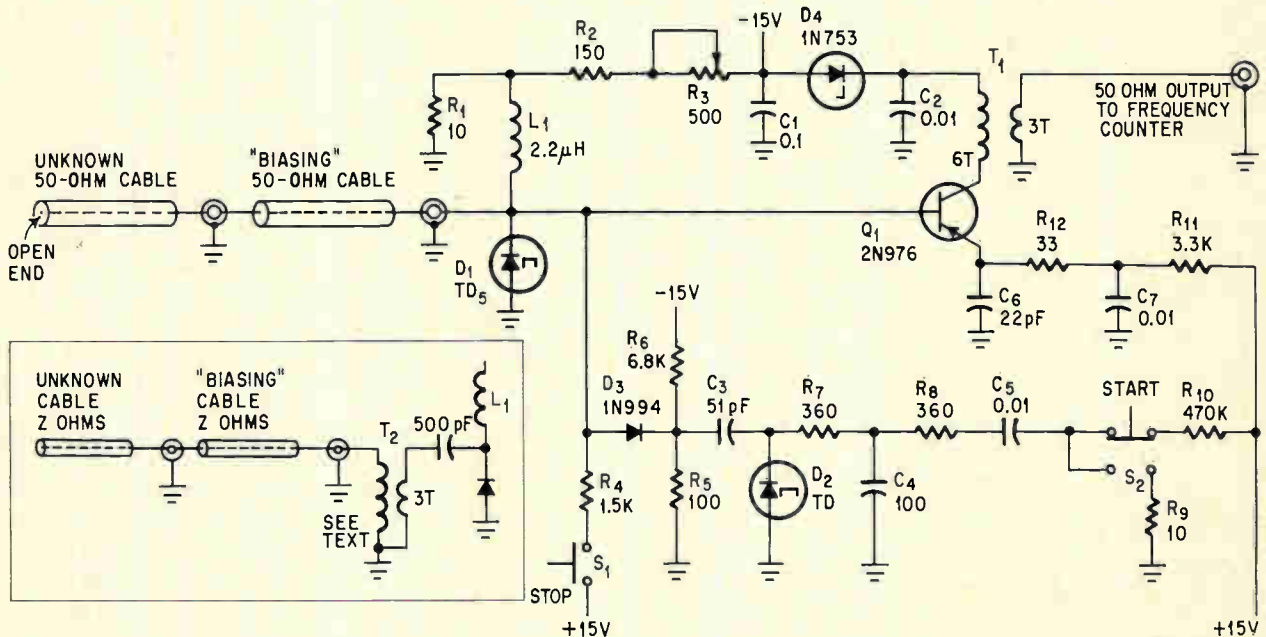

Propagation delay time of the cable is measured by a frequency counter, which receives its triggering pulses from  $Q_1$ . Tunnel diode  $D_1$  generates these pulses and also the pulses to be transmitted along the biasing and unknown line. The insert shows an additional transformer that is required if the cables do not have 50-ohm impedances.

generated by  $Q_1$  appear at the output of transformer  $T_1$  triggering a frequency counter.

The measurement is made in two steps. First, the frequency associated with a low-loss, "biasing" cable is measured. For proper operation the biasing cable should have a minimum propagation delay of 25 nanoseconds. Then the unknown cable is connected in series with the biasing cable and the testing cycle is repeated. The delay time of the cable is one half the difference in periods of the measured frequencies. This measuring procedure eliminates the need to know the regeneration time of  $D_1$  because the regeneration time contributes equally to both measurement steps, and cancels out in the subtraction.

In making the measurement, it is important that  $D_1$  is triggered only once at the start of each part of the test. Otherwise, multiple pulses will be developed and the counter will read erroneously. A stop button,  $S_1$ , is provided to stop the pulse reflection process before changing cables.

As an example of the circuit's stability, a Textronix 60-nanosecond delay box was used as a biasing cable and an adapter—General Radio-to-female BNC—was used as the unknown sample. The adapter's delay measured  $0.190 \pm 0.003$  nanoseconds. Much longer delays can be measured with picosecond accuracy.

Attenuation in the cable is one of the limitations

in measurement accuracy. As long as the pulse is not attenuated more than 10 db on its round trip, the circuit will operate satisfactorily. If the attenuation is greater, the triggering point of  $D_1$  is shifted, by some fraction of the pulse rise time—usually about 0.5 nanosecond—resulting in a less accurate measurement. However, in high-quality cable, 10 db of attenuation corresponds to propagation delays of about 500 nanoseconds or more, or to physical lengths ranging from 250 to 500 feet. So accurate measurements can still be made for considerable lengths of cable. For extremely long lengths, in which cable attenuation is a problem, an identical circuit may be connected to the open end to produce an amplified reflected pulse.

In the circuit, transformer  $T_1$  is a 2-to-1 stepdown transformer wound on a small ferrite bead such as Ferroxcube type 396T-125-3C3. Both the primary and secondary are wound with number 30 varnish-insulated wire.

If cables with impedances other than 50 ohms are to be measured, an impedance transformer such as the one in the diagram insert on page 87 is required. This transformer is constructed like  $T_1$  except that the primary must have  $3\sqrt{Z/50}$  turns, where  $Z$  is the new impedance of the line. Both the biasing cable and the unknown cable should have the same impedance to minimize multiple pulse reflections.

## Fast pulse generator tests digital circuit delay

By Clive P. Hohberger

Case Institute of Technology, Cleveland

**Fast, high-current pulses** are frequently needed for measuring delay in high-speed digital circuits. To be useful, the pulses must be spaced far enough apart so that phase and amplitude distortion does not result in overlapping. A ratio of pulse duration,  $t_d$ , to the interval between pulses,  $t_i$ , of about 1-to-5 or 1-to-10 is desirable.

The circuit on page 89 generates negative pulses with an amplitude range from -2 to -12 volts and with rise and fall times of 30 nanoseconds or less. Pulse amplitude is a function of the supply voltage,  $V_s$ .

Values of  $t_i$  and  $t_d$  depend on the transistor selected for  $Q_1$ . The spacing interval,  $t_i$ , is about 400 to 500 ns at -2 volts and increases linearly with

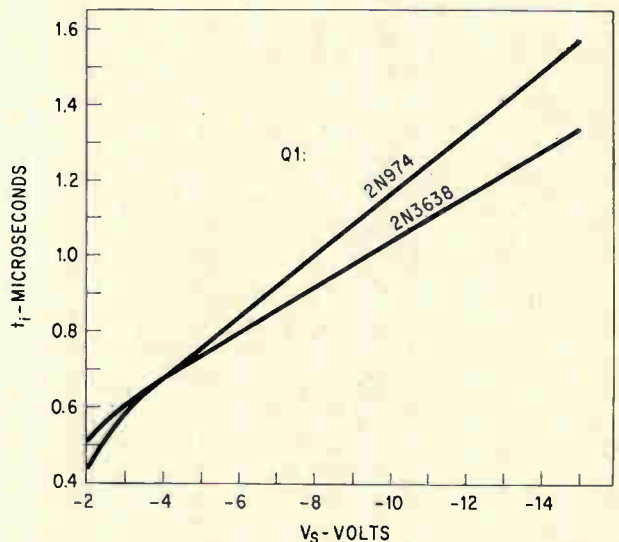

Interval between pulses,  $t_i$ , is a function of the transistor selected for  $Q_1$  as well as of the supply voltage  $V_s$ . The curves show typical data for two different transistors operating into a 150-ohm, 50-picofarad load. The value of  $t_i$  starts at approximately 475 nanoseconds and increases linearly at about 70 nanoseconds per volt.



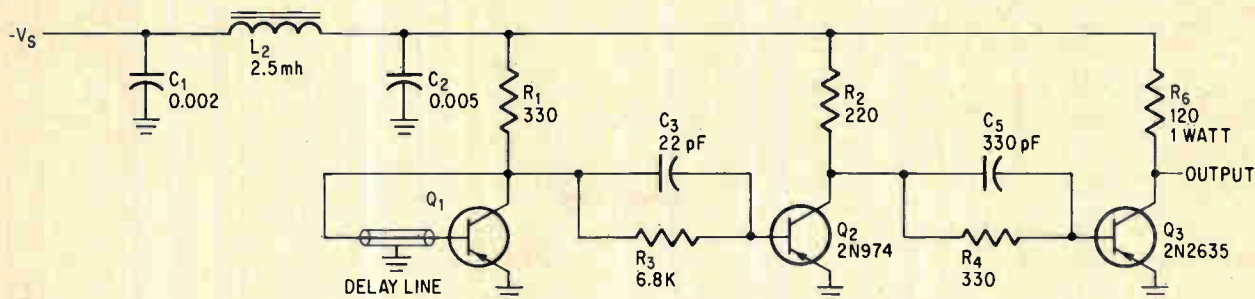

Pulse generator provides high-current pulses of constant width whose amplitude and spacing interval,  $t_i$ , varies with the magnitude of the supply voltage  $V_s$ . The delay line in the oscillator circuit is 20 feet of subminiature coaxial cable.

$V_s$  as shown by the graph on the facing page.

With reference to the values of  $t_d$  the type 2N974 transistor provides a 100-nsec pulse and the type 2N3638 provides a wider, square pulse of 150 nsec. Therefore, except at low values of  $V_s$ , the ratio,  $t_d/t_i$  is smaller than 1-to-5.

$Q_1$  is connected in a delay-line oscillator circuit. The delay line consists of 20 feet of type RG-174/U subminiature coaxial cable whose outer conducting shield is grounded only at the midpoint of the cable. The oscillator's waveform would normally be symmetrical with a period of about 300 to 400 nsec. However because the turn-off time of  $Q_1$  is 100 to 150 nsec, and because it is heavily loaded and has a large base overdrive, the output is the desired asymmetric rectangular pulse.

$Q_2$  is a high-speed, germanium mesa transistor

operating as a high-gain saturated pulse amplifier to provide the output drive for  $Q_3$ . Even when  $V_s$  is  $-12$  volts and the output current is large, the average dissipation of  $Q_3$  is well below its rating of 150 milliwatts. A square pulse is obtained at the output for resistive loads as low as 68 ohms and for moderate capacitive loads that are often encountered in computer circuits. The decoupling network consisting of  $C_1$ ,  $C_2$  and  $L_1$  reduces the noise that would otherwise be introduced in the power supply by  $Q_3$ .

The entire generator, including a battery supply, can easily be put into a box 3 x 4 x 5 inches for convenient use in the field. A positive pulse version of this circuit can be obtained by changing the polarity of  $V_s$  and substituting n-p-n transistors with characteristics similar to the p-n-p transistors.

## Simple mercury relay circuit develops single clean pulse

By Wayne King

Scientific Data Systems, Inc., Santa Monica, Calif.

In digital circuitry, a switch-closure that provides a single, clean, short pulse is often desired. The circuit at right develops such a pulse by using the make-before-break characteristics of mercury-wetted relays with type-D contacts. Positive or negative pulses are obtained, depending on the polarity of the supply voltage,  $E$ .

When switch  $S_1$  is closed, the movable arm of the relay travels from its normally closed position to its normally open position. For a brief period, both positions are bridged and a pulse appears at the output. Since, in the relay, the capillary action of the mercury closes the circuit between the movable and fixed contacts, there is no contact bounce

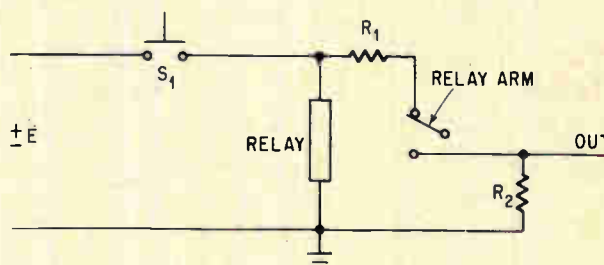

Make-before-break contacts on the mercury-wetted relay provide a clean output pulse whenever switch  $S_1$  is closed.

and the output pulse has no undesirable spikes.

The pulse width is a function of relay operating time. In one particular case, the operate-time specification of the relay was 6 milliseconds and a 4-millisecond pulse was obtained.

In this circuit, resistors  $R_1$  and  $R_2$  are adjusted to provide the desired amplitude and power.  $S_1$  may be any ordinary momentary-contact switch. Because of the time constant in the relay, any bounce in the contacts of  $S_1$  will not be detected in the output pulse.

# Using strip transmission line to design microwave circuits, part II

It results in tunnel-diode amplifiers, modulators and antennas that are small but have excellent characteristics. Second article in a series

By J. Richard Dangl and Kenneth P. Steele

Sylvania Electronic Systems, Williamsville, N.Y.

**Strip transmission line**—a guide for microwave energy—can be used to design circuits that are smaller and have better mechanical and electrical characteristics than those designed with waveguide and coaxial cable. Another advantage over waveguide and coax is that passive circuits can be formed inexpensively with the photographic techniques common in making printed circuits. These techniques apply in designing such passive circuits as antenna arrays and the coupling elements in balanced modulators.

Active circuits are built by inserting semiconductor components within the line. A tunnel diode amplifier represents an active circuit in which the etching techniques used in construction of the line inexpensively add resonator circuits that increase the bandwidth and selectivity and improve

the stability characteristics of the amplifier.

As in any design, it is necessary to understand the practical problems which are always present. Here an engineer must consider spurious responses, etching accuracy, and high-power limitations.

## I. Modulators in strip line

A single sideband suppressed carrier (SSBSC)<sup>1</sup> modulator shown at the right is an example of a complex S-band microwave circuit easily realized in strip transmission line. The size reduction over that of a waveguide modulator is especially impressive at S band (1,550-5,200 Mc) where waveguide dimensions are quite large.

The strip line modulator consists of four diode mounts, four 3-decibel directional couplers, and interconnecting transmission lines—all mounted on a board 3½ inches square. The entire circuit except for the varactor diodes and connectors are fabricated with strip transmission line.

The circuit contains two balanced modulators, each of which produces a double sideband suppressed carrier (DSBSC) signal at the output of its port 3. A summation circuit combines the two DSBSC signals in proper phase to cancel one set of sidebands and reinforce the other. Two outputs of the summation circuit are the upper and the lower sideband.

This technique of obtaining SSBSC, called the phasing method, is based upon the input modulation and r-f carrier of one balanced modulator's being in phase quadrature with the corresponding inputs of the other balanced modulator. In the circuit the modulation components are placed in

### The authors



J. Richard Dangl, the microwave department manager, graduated from the Massachusetts Institute of Technology in 1947. He specializes in semiconductor applications for the uhf, microwave and millimeter frequency-bands.



Kenneth P. Steele, a research engineer at Sylvania, has for the past seven years been engaged in the design and development of high power, solid state microwave signal sources. One of his prime responsibilities is the development of new multipliers.

quadrature by using an external phasing network; the quadrature carrier components are obtained by passing the r-f input through a power divider, or 3-decibel coupler, which provides equal amplitude signals at its output and introduces the required 90-degree phase shift between the signals.

Operation of the circuit is expressed by the following trigonometric expressions for balanced modulator 1. In the equations,  $a_n$  represents signal flow into the directional coupler ports,  $b_n$  represents signal flow out of the ports, and subscript  $n$  indicates the modulation port of interest.

$$a_1 = \cos \omega_c t, \text{ where } \omega_c \text{ is the carrier radian frequency}$$

$$a_2 = \frac{1}{\sqrt{2}} \sin \omega_c t \cos \omega_m t, \text{ where } \omega_m \text{ is the modulating radian frequency}$$

$$a_3 = 0$$

$$a_4 = \frac{-1}{\sqrt{2}} \sin \omega_c t \cos \omega_m t$$

$$b_3 = j\frac{1}{2}[\sin(\omega_c t + \omega_m t) + \sin(\omega_c t - \omega_m t)]$$

The two sinusoidal components of  $b_3$  represent the upper and lower sidebands of the SSBSC signal from modulator 1. The output of the second modulator contains a corresponding expression

$$b_3' = j\frac{1}{2}[\sin(\omega_c t - \omega_m t) - \sin(\omega_c t + \omega_m t)]$$

where the  $j$  term results from the 90° phase shift through the directional coupler.

When  $b_3$  and  $b_3'$  are applied to the input of the 3-db hybrid summation network, the outputs of the network are

$$b_{1s} = \sin(\omega_c t - \omega_m t) \text{ and } b_{3s} = \sin(\omega_c t + \omega_m t)$$

where  $b_{1s}$  and  $b_{3s}$  are the lower and upper sidebands.

The actual unit appears at the left in the photograph on page 92. Mounted on the unit is the phase-shifting circuit for the modulation input. At the right are two dielectric boards on which are etched the center conductor configurations for the strip transmission line. Placed face-to-face, these boards form the strip transmission line sandwich. Solid copper coatings on the reverse sides of the board form the ground planes.

Copper horseshoe-shaped patterns introduce shunt capacitance to the ground plane. These capacitors suppress higher modes generated by discontinuities at the connectors.

When the boards are mated, sections of the center conductor overlap, forming the 3-db couplers. Thin mica sheets between the sections prevent short-circuits and adjust the coupling.

At a 600-mw power output at 2,250 Mc, the carrier is suppressed 37 db below the undesired side-

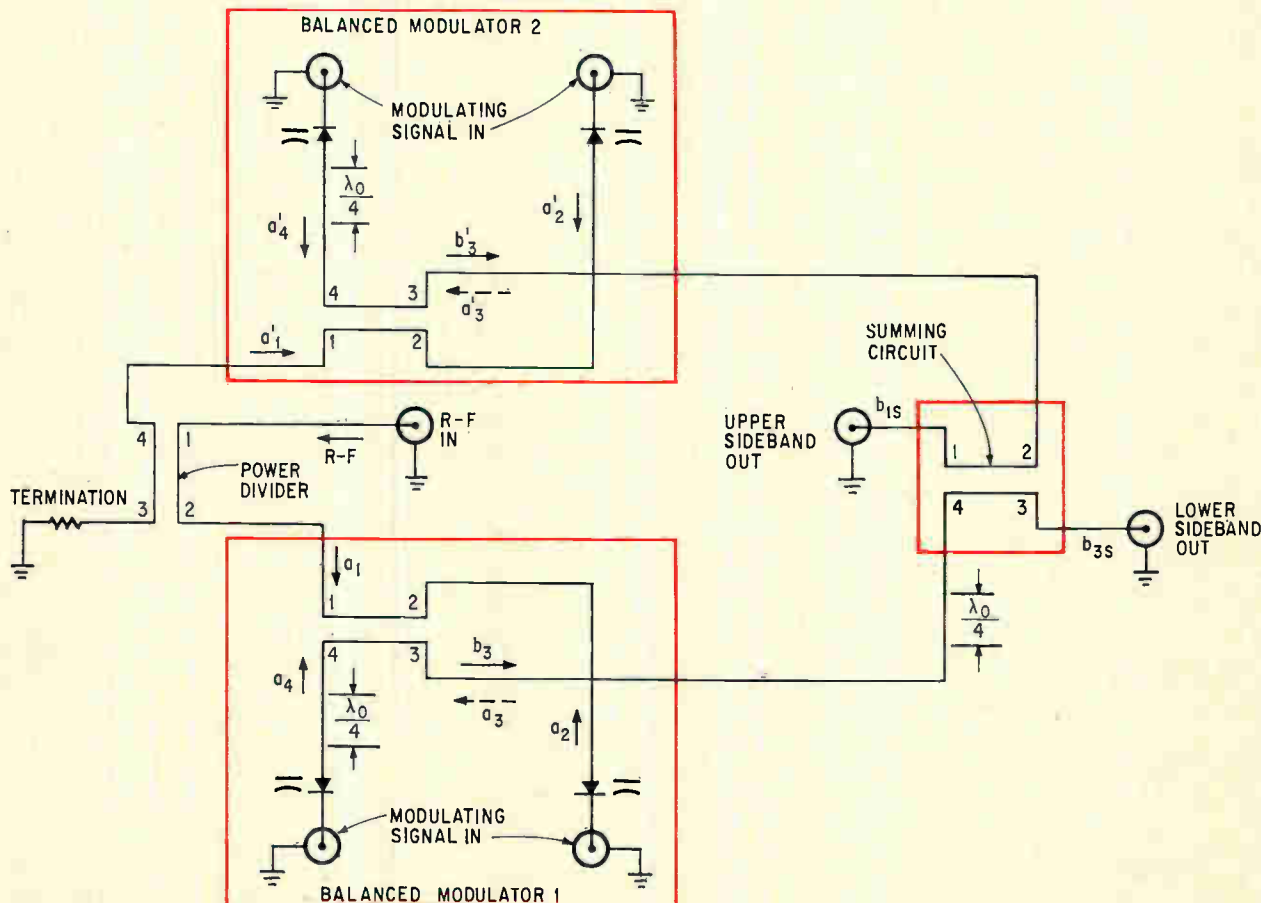

**Balanced modulator circuit** employs four 3-decibel couplers formed from strip transmission line. If port 3 is terminated, as in the power divider, then energy flowing into port 1 will divide equally between ports 2 and 4 and no energy will flow toward port 3. The electric fields at ports 2 and 4 will be in phase quadrature.

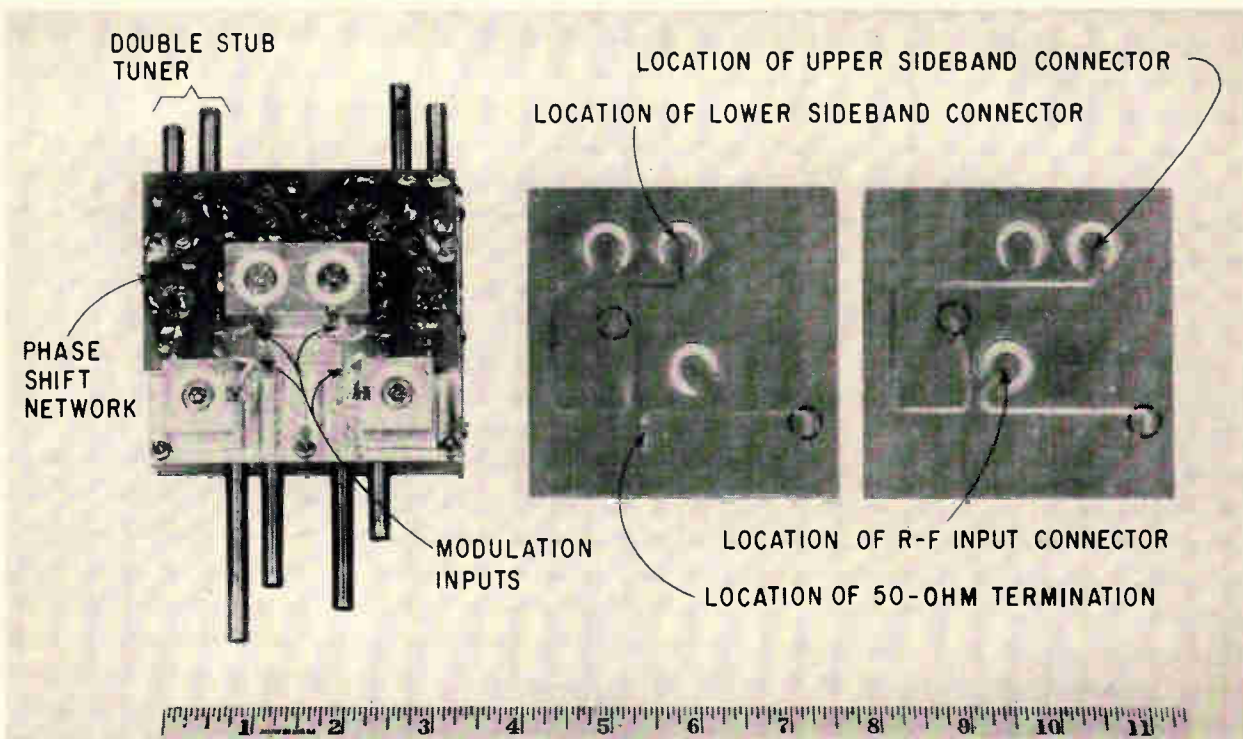

Miniaturization that can be achieved with strip transmission line is illustrated by this single sideband suppressed carrier. Mounted on top of the unit are a printed circuit board—used for phasing the input modulating signals—and four varactor diodes. Metal bars extending from the unit are double stub tuners used for matching the impedances of the diodes to the circuit. R-F connectors are mounted on the reverse side of the unit. The two boards on the right show the center conductor configurations on the upper right and lower dielectric sheets which form the strip transmission line circuit. Horseshoe-shaped elements short out higher modes generated by discontinuities at the connectors. Dashed circles indicate the locations of the varactor diodes.

band. No additional output filtering is required. By adjusting the tuning slugs, the modulator may be tuned over a bandwidth of approximately 9% of the center frequency. At any frequency within this tuning range, the 3-db bandwidth is 180 Mc. Within a 70-Mc bandwidth, the carrier and undesired sideband are suppressed by at least 20 db.

## II. Tunnel diode amplifiers

**Tunnel diodes** are often used at microwave frequencies in low-noise amplifiers. Noise figures from 3.5 to 6 db and gains ranging from 12 to 20 db are attainable, depending upon the diode and the frequency. Gain of the amplifier is governed by the diode negative resistance and the load impedance. The noise figure is a function of the negative diode resistance, series resistance, resistive cutoff frequency  $f_{RO}$ , and the operating temperature of the diode.<sup>2</sup> The resistive cutoff frequency—the frequency at which the input resistance of the diode goes to zero—is given by

$$f_{RO} = \frac{\sqrt{\frac{R}{R_s} - 1}}{2\pi RC_D}$$

where  $R$  is the negative resistance of the diode,

$R_s$  is a series resistance which includes the spreading and contact resistances and  $C_D$  represents the diode's barrier capacitance which is in shunt with the negative resistance.

Strip transmission line results in very rugged and compact tunnel diode circuits. The diodes can be imbedded in the dielectric material and provided with simple connections to the center conductors. With short line lengths, parasitic inductance is held to a minimum. Usually, the circuits are combined with other components in complete strip transmission line packages.

At Sylvania several types of tunnel diode amplifiers have been designed with strip transmission line. Circulator-coupled reflection amplifiers, in which circulators separate source from load, have satisfactory electrical and mechanical characteristics. The amplifier, with the circulator and its ferrite magnet imbedded in the strip transmission line material, forms a compact structure.

Such amplifiers often use a shunt diode configuration in which the diode is tuned by a parallel inductive stub. The stub may be either less than a quarter wavelength long and short-circuited or it may be open-circuited, greater than a quarter wavelength long and capacitively loaded.

An attractive feature of the tunnel diode is its potentially large bandwidth. To realize this potential, several methods have been developed. Some circuits that will be described have been built only

in coaxial line, but the design concepts apply to strip transmission line.

One broadband technique uses the circulator-coupled reflection amplifier circuit with a capacitively loaded shunt stub,<sup>2</sup> as shown in the diagram at the right. To increase the bandwidth of the amplifier, the reactive component of the circulator admittance is utilized. Plotted on a Smith chart, the circulator's susceptance varies with frequency in the direction opposite from the shunt-stub's susceptance. The dimensions  $S_1$  and  $S_2$  are chosen so that the residual susceptance of the diode is cancelled over a wide bandwidth. In this circuit  $C_c$  couples r-f while blocking d-c. The bias resistor for the diode is placed across the transmission line at a voltage node to decrease ohmic losses. The bias resistance—the shunt portion of the bias divider—is chosen so that when the diode reactance is cancelled by the stub's inductance, the line is matched to its characteristic impedance.

The bias resistor also serves as a stabilizer, limiting the possibility of oscillations outside the circulator passband. It does so by presenting a positive conductance to the tunnel diode. Implied is that the circulator rather than the tunnel diode generally limits the passband of the circuit. Outside its passband, the circulator's reactance produces a high-voltage standing-wave ratio at the diode, which can make the diode oscillate.

Another approach to maintaining large bandwidth is to use a separate stabilizing circuit to provide a positive conductance to ensure that the gain of the amplifier is less than unity outside the desired passband. In this way the stabilizing network is designed specifically for preventing oscillations and is not involved in biasing the amplifier.

An excellent example of stabilization is the amplifier, in the schematic below, which is shown with a stabilizer network comprising  $B_{ST}$  and  $G_{ST}$ .<sup>3</sup> To provide increased bandwidth this amplifier also employs a series resonator,  $X_s$ , and the usual shunt resonator,  $B_p$ , for tuning the diode.

Two alternate stabilization circuits, which may

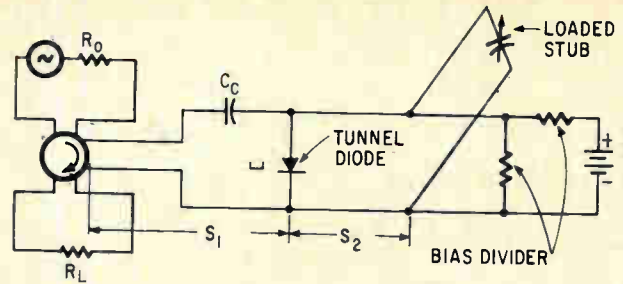

Tunnel diode amplifier uses a circulator to couple the energy in and out of the circuit.

be made a part of the amplifier, are shown at the bottom of the diagram below. The shunt stabilizing circuit at the left is applicable for diodes that have resistive cutoff frequencies,  $f_{RO}$ , up to about  $3f_0$ , where  $f_0$  is the center frequency of the amplifier. For diodes with higher cutoff frequencies, such as  $f_{RO} = 5f_0$ , the capacitance-loaded stabilizing circuit at the right is preferable, because the shorter line length increases the frequency at which the conductance disappears. An additional constraint in selecting the parameters of the stabilizing circuits is that at the band edge, the diode admittance should not change significantly.

A stabilized amplifier<sup>4</sup> which uses a directional, or traveling-wave filter, is shown at the top of page 94. A directional filter consists of two quarter-wave directional couplers included in a loop which is one wavelength long at the amplifier's center frequency,  $f_0$ . The idealized frequency response at the bottom of the diagram shows the attenuation between ports 1 and 3 and ports 1 and 2 as a function of frequency. At  $f_0$  the path between ports 1 and 2 exhibits low attenuation and ports 3 and 4 are isolated from the diode. In the passband, therefore, the input is coupled to the diode through the circulator and the filter, and the tunnel diode output is reflected back to the load through the circulator and the filter. Outside the filter passband, the tunnel diode is terminated by the resistance at port 4. The resistor at port 3 serves as an absorb-

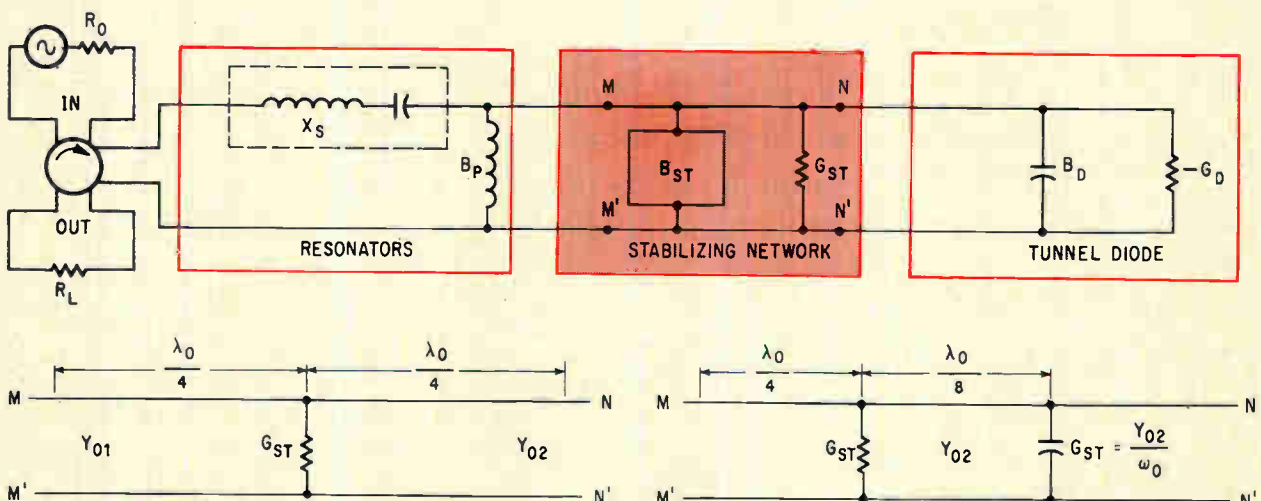

To prevent oscillations outside the circulator passband, the tunnel diode circuit includes a stabilizing network, consisting of  $B_{ST}$  and  $G_{ST}$ . Typical stabilizing circuits shown below are the shunt, left, and the capacity-loaded types.

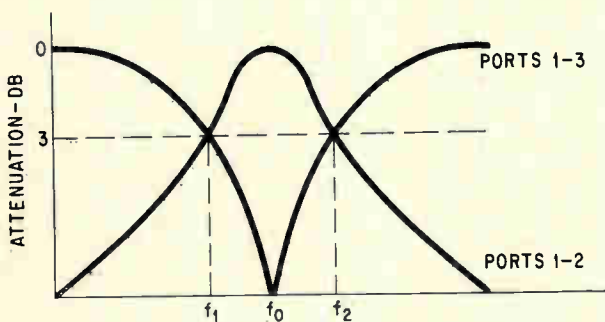
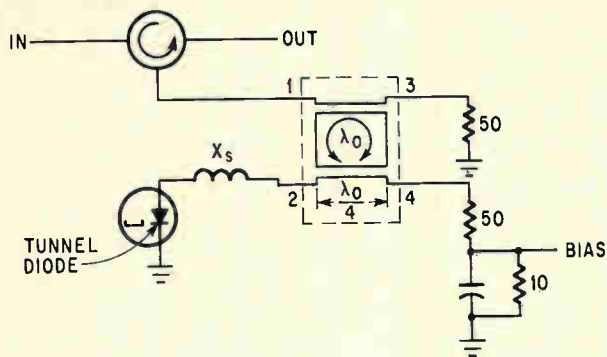

Traveling-wave filter consisting of two quarter-wave directional couplers arranged in a resonant loop, also stabilizes a tunnel diode circuit. The idealized response of the filter appears below the schematic. Since the filter is symmetrical, the curves also represent the attenuation between ports 2 and 4, and between ports 3 and 4.

ing load for a signal within the circulator passband, but outside the filter passband.

The bandwidth of a tunnel diode amplifier also may be increased by adding series and shunt resonant circuits. The design technique is outlined in the panel at the right and is applicable also to other negative-resistance reflective devices such as parametric amplifiers and masers.<sup>5</sup>

A tunnel diode amplifier usually is tuned with a shunt inductance. Addition of a single series resonator  $X_s$  improves the 3-dB bandwidth by as much as 50% and provides a more uniform frequency response. Calculated bandwidth for a circuit with a shunt tuning inductance and series resonator—referred to as the  $n = 2$  case, where  $n$  equals the number of resonated circuits—is approximately 26% of the center frequency. Adding an additional shunt resonator— $n$  equals 3—increases the bandwidth to 41.6%. The addition of another series resonator— $n$  equals 4—increases the bandwidth to 48.1%.

The technique may also be applied to parametric amplifiers.<sup>6</sup> Normally, these are designed in series diode configurations, because they result in greater bandwidth than does the shunt. The stabilizing resonator is placed in parallel with the diode. Unfortunately, because the parametric amplifier uses a time-varying capacitor, the design technique for computing the resonator parameters is not as accurate for the parametric amplifier as it is for the tunnel diode reflective amplifier. However, the method is adequate for the first breadboard design.

### Broadbanding tunnel diode circuits

The difficulties in broadbanding microwave circuits include: 1. realization of the lumped circuit design values in an equivalent distributed constant network, 2. problems inherent in designing multiple-resonator circuits at microwave frequencies and 3. cost of the required structures. The last problem has been eased by the relatively inexpensive method of etching the circuits in strip transmission line, while the first two problems have been solved by modern filter theory.<sup>7,8</sup>

An example of the technique for broadbanding a circuit is the one developed by Getsinger for increasing the bandwidth of a tunnel diode amplifier.<sup>5</sup> In this technique, the frequency response of the tunnel diode is determined by experiment or from an equivalent circuit such as illustrated in the diagram at the top of the next page.

The gain curve of the tunnel diode amplifier determines  $G_{max}$  and  $G_{max}/2$  expressed in decibels.  $G_{max}$  and  $G_{max}/2$  in turn establish the frequencies  $f_o$ ,  $f'$  and  $f''$ .

The frequency response is then used to determine the values of the elements in a simplified bandpass circuit that will produce the same response as the original circuit. The values of  $C_1$ ,  $L_1$  and  $R_D'$  in the simplified circuit are determined using the following expressions:

$$U = \frac{f'' - f'}{f_o} \quad (1)$$

$$K_o = 10^{G_{max}/20} \quad (2)$$

$$b_1 R_D' = \frac{2\sqrt{K_o}}{U(K_o - 1)} \quad (3)$$

$$R_D' = \frac{R_o}{r_o} \quad (4)$$

$$C_1 = \frac{b_1}{\omega_o} \quad (5)$$

$$L_1 = \frac{1}{(\omega_o)^2 C_1} \quad (6)$$

where

$U$  = the normalized bandwidth of the narrowband circuit

$K_o$  = the gain ratio

$b_1 R_D'$  = the normalized slope parameter of resonator

$R_D'$  = is the magnitude of the negative resistance in the simplified circuit

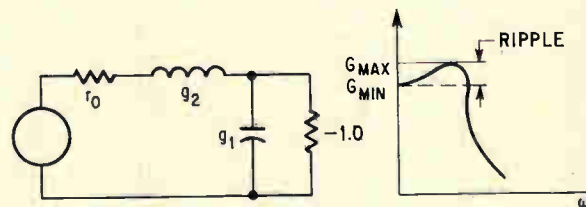

Prototype circuit that is related to the simplified tunnel diode circuit is broadbanded by the addition of the series element  $g_2$ .

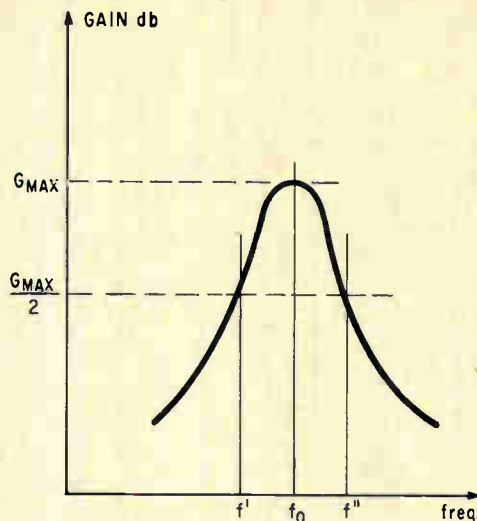
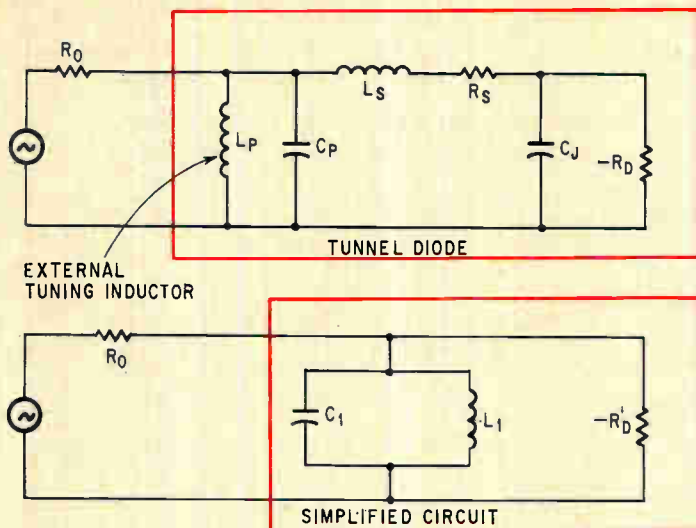

Equivalent circuit of tunnel diode amplifier includes junction capacitance  $C_j$ , negative resistance  $R_D$ , series spreading resistance  $R_s$ , series lead inductance  $L_s$ , shunt package capacitance  $C_p$ , and shunt inductor  $L_p$ , which tunes the diode. The frequency response of the circuit has the typical form shown at the right. By proper choice of the values of the shunt elements,  $C_1$ ,  $L_1$  and  $R_D'$ , the simplified circuit at the bottom of the diagram can be made to have an almost identical frequency response.

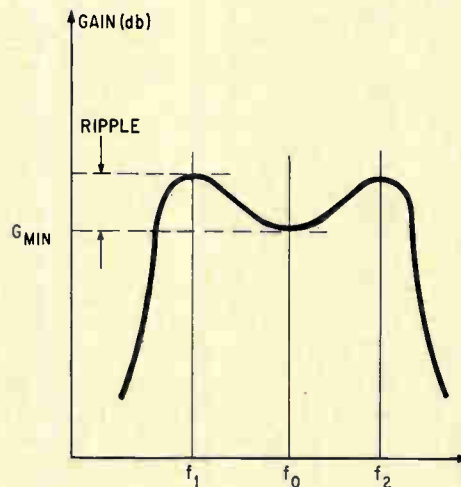
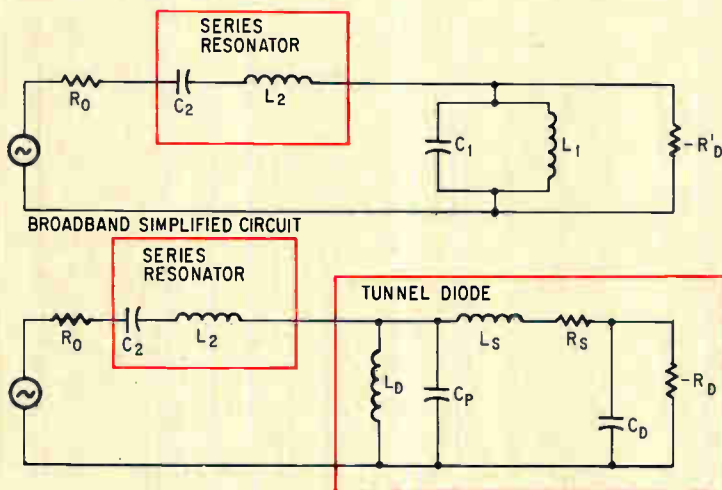

Broadband tunnel diode circuit is realized by determining the values of  $C_2$  and  $L_2$  in the simplified circuit at the top of the diagram. These values are used to broadband the actual circuit shown at the bottom of the diagram.

- $b_1$  = the slope parameter of resonator  $L_1$ - $C_1$  which is evaluated from equation 1 through 4
- $r_o$  = is the normalized generator resistance and is obtained in terms of  $G_{max}$  from figure six of reference 5.
- $R_o$  = the source resistance (50 ohms)
- $\omega_o$  = radian frequency at  $f_o$

band version of the simplified circuit as in the circuit above, which shows the addition of a series resonator consisting of  $L_2$  and  $C_2$ . This series resonator also broadbands the actual tunnel diode amplifier as in the circuit at the bottom of the diagram.

The new fractional bandwidth, is determined from the expression

$$\omega = \frac{g_1}{b_1 R'_D}$$

and the band edges are determined from

$$\omega_2 - \omega_1 = \omega \omega_o \quad \text{and} \quad \omega_o = \sqrt{\omega_1 \omega_2}$$

where  $\omega_1$  and  $\omega_2$  are the radian frequencies corresponding to  $f_1$  and  $f_2$ .

$L_2$  and  $C_2$  are determined from

$$L_2 = \frac{g_2 R}{\omega \omega_o} \quad \text{and} \quad C_2 = \frac{1}{(\omega_o)^2 L_2}$$

The simplified circuit is directly related to a low-pass prototype shown at the left.

Values of  $G_{min}$  and ripple in the frequency response of the desired broadband curve of the prototype circuit must be specified by the designer. With specified values of  $G_{min}$  and ripple, the parameters,  $g_1$  and  $g_2$  of the prototype circuit, are selected from the tables in reference 5. This broadband, low-prototype is now related back to a broad-

### III. Phased array antennas

**Strip transmission line** is ideal for phased array antennas. Such arrays—consisting of large numbers of antenna elements—when made from coaxial or waveguide components are often costly and unwieldy. In a strip transmission line antenna, many dipole elements can be etched simultaneously on a sheet of dielectric material. If an interlaced pattern of dipoles is used, a single etching will produce both receiving and transmitting arrays, and the dimensions of a complete pair of arrays will be reduced by a factor of one-half.

For satellite communications, retrodirective arrays fabricated of printed circuit antennas and strip transmission line circuits have the advantages of light weight and reliability. In the basic passive retrodirective array, the antenna elements and interconnecting transmission lines are so phased that any received signal is reradiated back along the path taken by signal transmitted from the ground. As a result, the satellite's signal is always directed toward the ground station. Thus, high-gain, narrow beam antennas may be used on the satellite in place of the usual omnidirectional antennas.

In active retrodirective array (ARA), as shown in the simplified drawing below, a tunnel diode amplifier is placed between receiving and transmitting elements in each line to increase the radiated power. A mixer is also included in the line to offset the frequency for increased isolation and to provide modulation if desired. Amplifiers and mixers are all constructed from strip transmission line, forming an extremely compact and rugged package. Such arrays have been developed by Sylvania on several programs.<sup>9, 10</sup>

One experimental ARA array operates at S band, with transmitting and receiving frequencies offset by 150 Mc and an r-f bandwidth of 120 Mc. The array gain is 14 db and the total scan angle is greater than 70°.

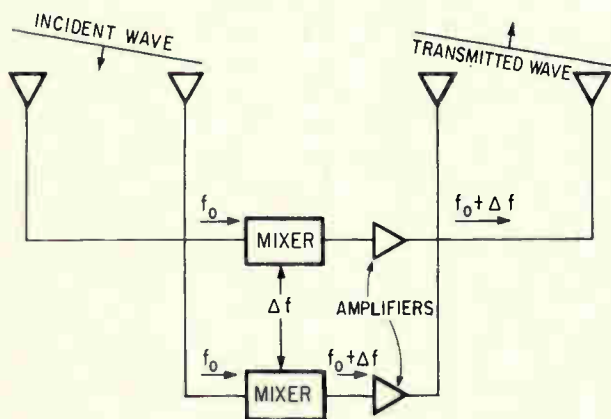

Active retrodirective array receives an incident signal and transmits it back in the same direction. In this highly simplified sketch only two antennas are shown in the receiving and transmitting arrays. The circuits in the interconnecting lines change the frequency of the received signal before it is retransmitted.

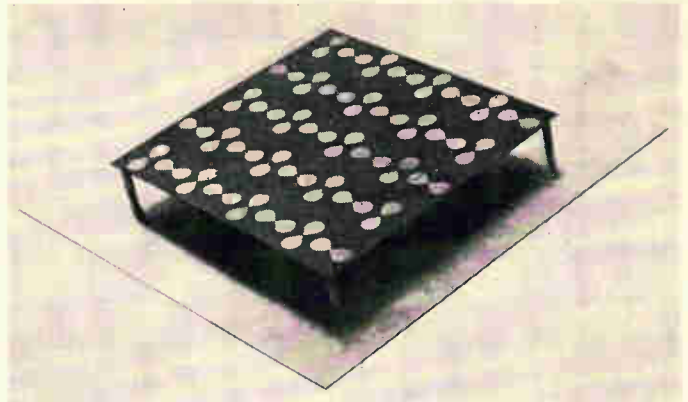

Experimental printed antenna array for satellite communications consists of an interlaced pattern of dipole antennas that increases isolation between receiver and transmitter. The dipole shape increases their bandwidth.

An interlaced pattern of orthogonal dipole elements as in the photograph shown above forms the antenna array. One set of orthogonal element functions as the receiving array; the other set as the transmitting array. Centers of the dipoles in either array are located at the vertices of an equilateral triangle. This reduces the number of elements needed for a specified array gain and increases the spacing between elements to reduce mutual coupling.

Isolation between the two arrays is dependent on the symmetry and mutual orthogonality of the individual elements. Accurate positioning of these elements is also necessary to obtain the desired radiation patterns. Using standard etching techniques, antennas elements on two-inch centers may be positioned within  $\pm 4$  minutes of exact orthogonality. This positioning accuracy is superior to the accuracy of most other methods of fabricating multiple-dipole arrays, and the cost is much less because no mechanical adjustments are necessary. Furthermore, the rigidity of the printed array prevents dynamic errors introduced by vibration and shock.

In this configuration, the isolation between orthogonal elements is between 40 to 50 db. Between parallel elements the isolation, which is determined by the spacing, is approximately 30 db.

#### Antenna balun

Antenna arrays normally require a balun—a device for transforming the unbalanced input of a receiver or transmitter to the balanced input of the antenna element. For the ARA antenna, the baluns were strip transmission lines similar to the one designed by Bower and Wolfe and illustrated on page 97.<sup>11</sup> The top and bottom views indicate the simplicity of the balun's construction.

Here, the unbalanced input consists of a thin conductor etched on the bottom side of the dielectric sheet. The copper on top of the dielectric serves as a ground plane for the unbalanced input conductor. A balanced output for a dipole antenna appears at the terminals marked x and x' as shown



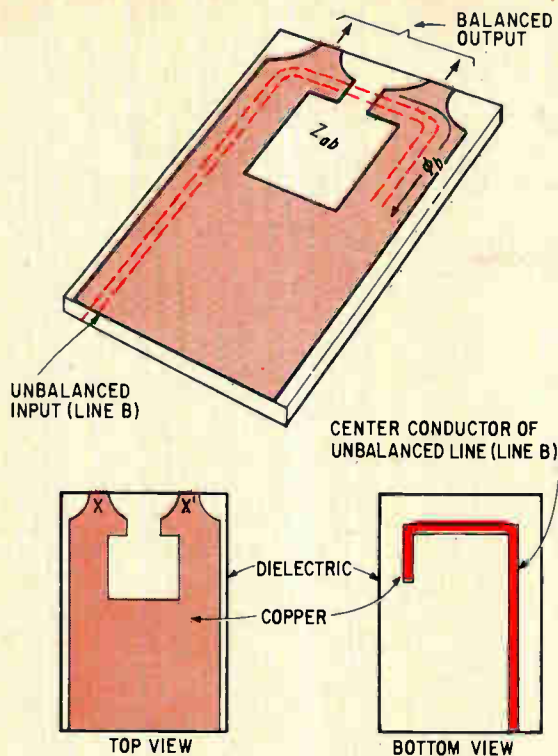

**Balanced-to-unbalanced line (balun) transformer** couples energy from the input to the antenna terminals. In this wideband strip transmission line version, line B is the unbalanced input. Balanced outputs are taken at points X and X'. For line B, the copper conductor on the other side of the board serves as a ground plane.

above in the top view of the dielectric sheet.

Length,  $\phi_b$ , in the balun is about a quarter wavelength at the midband frequency. For proper transformation it is required that  $Z_b = R^2/Z_{ab}$  where  $Z_{ab}$  is the impedance of the wide parallel line (normally made as large as possible),  $R$  is the load resistance, which in this case is the antenna input resistance, and  $Z_b$  is the characteristic impedance of the unbalanced input line.

## IV. General design factors

**Some spurious effects** in strip transmission line equipment appear as undesired lines in the output spectrum or as r-f interference. A less obvious effect is a decrease in efficiency resulting from unwanted spurious modes.

At least three physical parameters affect the generation of spurious modes: ground-plane spacing, center conductor width, and transverse discontinuities.<sup>12, 13</sup>

Spacing between ground planes must be held to less than  $\lambda/2$  where  $\lambda$  is the wavelength in the dielectric; if this isn't done, the signal travels along the ground plane rather than along the center conductor. If the width of the center conductor is greater than a half-wavelength, high-order modes will occur, producing a voltage node at the center

of the conductor and maximums at either edge. These modes will tend to travel through the dielectric material, rather than being constrained to follow the center conductor, as is the principal TEM mode.

A third restriction involving both ground-plane spacing and center conductor width requires that the mean path encircling the conductor (in a plane perpendicular to the centerline of the conductor) be less than  $\lambda$ . The frequency at which this path length is equal to  $\lambda$  is the cutoff frequency of the transmission line.

Spurious modes caused by transverse discontinuities, which occur whenever there is a transition from coaxial to strip line, or where the diodes are inserted in the line, can be suppressed by inserting shorting screws or eyelets between the two ground planes. The circulator in the photograph on page 98 illustrates the use of such screws in the vicinity of the right-angle connector. The spacing between these shorting elements should be less than  $\lambda/2$ . Shorting elements should also be located near resonant elements, such as filters, that tend to radiate. For high-Q circuits of this type, the spacing between shorting elements should be about  $\lambda/6$ . To prevent end-launched radiation, the ground-plane spacing should be less than  $\lambda/4$  and all circuitry should be restricted a distance of at least  $\lambda/4$  from the edge of the strip transmission line. Conducting material, left unetched around the edge of the strip transmission line board, or shielding material placed around the periphery, also helps prevent spurious radiation.

### Phase variations

In general, when phase-sensitive circuits are used, care must be taken to keep lines as short as possible, and to provide adequate bandwidth so that operation on the filter passband skirts is avoided. To maintain a constant guide wavelength, dielectrics which are homogeneous and have low temperature coefficients of expansion are required.

In production runs of circuits using semiconductors, phase variations are more controllable if the device junctions are taken as reference planes and dimensions are controlled with respect to these planes. To compensate for phase variations that are caused by production or material variations, several types of manual phase shifters or line-stretchers are available in strip transmission line designs.

Since the electrical length of a transmission line is proportional to  $\sqrt{\epsilon_r}$ , the relative dielectric constant of the material is a governing factor. Polyolefin dielectrics are now available with  $\epsilon_r$  held to an accuracy of  $2.32 \pm 0.005$  or 0.2%.

### Maximum frequency

The principal frequency limitation of strip transmission line is determined by dielectric losses. Low-loss dielectric material has extended the operational frequency range to beyond 10 Gc.

A figure of merit for a strip transmission line is

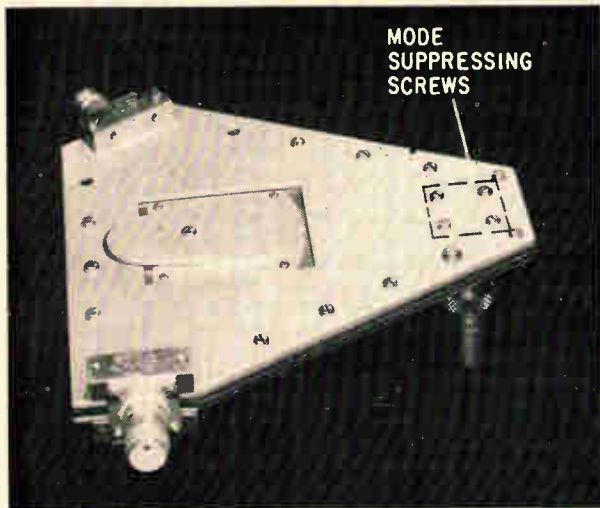

Circulator for C-band (5,000 to 6,500 Mc) illustrates the use of shorting screws for both mode suppression and for shielding the unit.

its quality factor,  $Q$ . At the same frequency the line with a high  $Q$  exhibits lower losses than a line with lower  $Q$ .

The advantage of low-loss polyolefin dielectric over a glass-based dielectric such as Teflon-fiber glass is indicated by the differences in their  $Q$ .<sup>14</sup> At 10 Gc, the unloaded  $Q$  of polyolefin is approximately 1,500 as opposed to approximately 400 for the Teflon-fiber glass. At lower microwave frequencies, the  $Q$ 's are much closer together with values 700 and 300, respectively, at 1.0 Gc.

The higher  $Q$  of polyolefin has permitted the fabrication of multiple-resonator filters with actual characteristics very close to the design values. Representative bandpass filters constructed by Sylvania for use in the microwave region have exhibited a minimum insertion loss of 0.5 to 1.0 db. An S-band filter using five sections had an insertion loss of less than 1 db.

#### Maximum power

A number of factors determine the power handling capabilities of strip transmission line circuits. In semiconductor circuits the allowable temperature of the semiconductor junction is limited, and usually requires an adequate heat sink.

Another factor is the temperature at which the dielectric material deforms. For irradiated polyolefin, deformation occurs in the temperature range 90° to 100°C. The allowable center conductor temperature is another factor. The average power-handling capability for a 1/8-inch thick sandwich of Rexolite 1422, a cross-linked polystyrene, is approximately 290 watts at 2,000 Mc and 110 watts at 9,000 Mc.<sup>15</sup> This is based on allowable temperature rise at the center conductor of 39°C, taking into account the thermal conducting properties of the strip transmission line's dielectric material.

The peak power-handling capability is a function of high-voltage breakdown. Breakdown first occurs along the narrow edge of the center conductor at

the air space left after the metal has been etched away. For Rexolite 1422, the peak power rating (assuming a 2:1 safety factor) is calculated to be 25 kilowatts for a 1/8-inch thick sandwich.

#### Etching accuracy

When materials with dielectric constants of 2 or 3 are to be used at frequencies from L to X band (390 Mc to 10,900 Mc), a drawing scale ranging from four times to ten times the actual size of the circuit is required. As an example, a drawing for the center conductor configuration of a varactor tripler appears in the photograph at the right. The drawing is reduced to the desired size by photographic methods.

The photograph below shows the reduced film being used to expose the strip line pattern on the board. This procedure holds dimensional errors within a range of 0.001 to 0.002 inch, adequate for most circuits. However, since the tolerances required vary inversely as  $\sqrt{\epsilon_1}$ , lines designed with high dielectric constant material require that the drawings be 12 to 30 times the circuit size. If critical narrow-band circuits are involved, drawing-scales may be even higher.

In parallel-coupled lines, two parameters affected



Reduced size negative is used to expose a light-sensitive coating on the copper clad dielectric. After spraying with a suitable etch, only sections of copper corresponding to the center conductor configuration will remain.

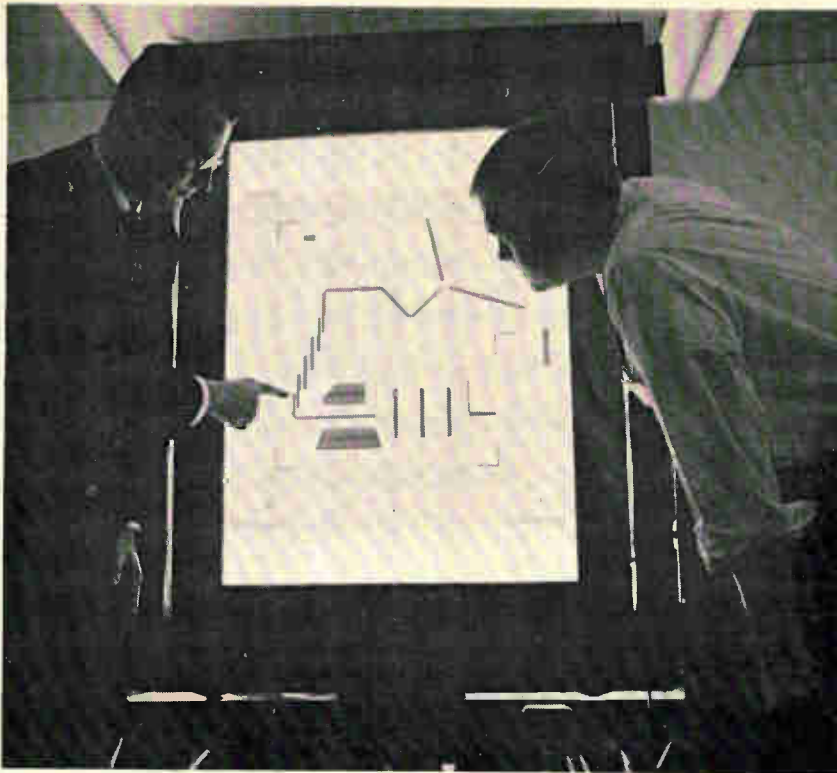

**Maintaining dimensional accuracy** requires that the master drawing for the strip line's center conductor configuration be drawn at an enlarged scale. For the varactor tripler circuit shown in the photograph, the drawing is about five times the size of the actual unit. The author is pointing to a bandpass filter circuit in which the narrowest spacing between elements is only 0.005 inch in the actual circuit.

by the accuracy of etching are the characteristic impedance,  $Z_0$ , which depends on conductor width, and the coupling factor. In fact, the critical dimension in a high-frequency design is often the minimum spacing which can be maintained with etching in a parallel-coupled bandpass filter.

#### Multiple layer assembly

The ideal geometry for strip transmission line assemblies is a large area and little depth. This permits etching of many elements on a single surface. Not only is this economical, but it reduces the number of interconnections and therefore reduces the cumulative vswr's associated with connectors. Unfortunately, most equipment is packaged in box-like containers, so that stacking of two or more layers of strip transmission line is necessary.

Stacking poses a problem of mechanical stability. Dielectric materials should be rigid as possible, with uniform thickness. Soft dielectrics require rigid metal pressure plates and an adequate number of fasteners to hold the pieces securely. Double registration conductors ease the problem of tilt or voids at the mating surfaces. Double registration implies that the center conductor pattern is etched on both boards which form the strip transmission line. This results in a thicker center conductor which is easier to mate.

Care must be taken that center conductor and ground plane connections are firmly made. A variety of methods such as butt joints, spring fingers, and springs, are used to connect the center conductor. Permanent connections can be made by soldering or welding if the conductor bonding temperature is not exceeded and the sections of the device do not have to be disassembled.

Interconnection between layers may also be made by bringing the center conductors out to coaxial end launchers at the ends of the boards and interconnecting these with coaxial cable. The interconnection method finally decided upon depends primarily upon the space available and the degree of vibration and shock anticipated.

#### Testing

Most strip transmission line circuits are inherently broadband and have low spurious levels. Broadband spectrum analyzers, sweep signal generators, and power bridges or calorimeters are necessary for testing them. Testing varactor multiplier circuits, for instance, involves checking unwanted harmonics and spurious frequencies, which may be either very close to or far from the desired output frequency. Both a wide spectral window and good close-in definition are required of the spectrum analyzer. Wide dynamic range, low internal spurious output and high sensitivity are also important for testing low spurious devices.

The time domain reflectometer<sup>16</sup> is also a valuable aid in transmission line design. Reflected waveforms indicate the impedance characteristics and location of discontinuities. Such equipment can detect reflections 80 db down from the main signal, corresponding to a vswr of less than 1.0002.

The  $Q$  and the relative dielectric constant of the strip transmission line material must often be determined. A practical method is to fabricate a sample resonant section from the material to be tested and to measure the frequency-response curve and resonant frequency of the section. The  $Q$  and dissipation factor of the material is obtained from the frequency response, and  $\epsilon_r$ , the relative dielectric

constant, can be computed from the frequency and dimensions of the sample. Applicable mechanical tests of material include foil peel strength, warpage, dimensional accuracy, and coefficient of linear expansion.

Also necessary in the laboratory as auxiliary test accessories are strip transmission line connectors or launchers. End-launchers or connectors permit connections to test equipment and interconnections between breadboard components.  $V_{swr}$ 's of less than 1.05, over a band of a few gigacycles, are obtainable in commercial launchers. Lower  $v_{swr}$ 's are obtainable over narrower frequency bands.

## V. Future trends in circuitry

Developments in strip transmission line circuitry will include the incorporation of transistors into distributed parameter circuits. Microwave transistors are available, which provide powers of 1 watt in the 1-Gc to 2-Gc frequency range. A 6-Gc transistor is under development which will be capable of supplying 10 Mw at 20% efficiency.<sup>17</sup> Output power at microwave frequencies can be increased by summing the output of several low-power transistors, as Sylvania engineers have already done at ultrahigh frequencies. Summing techniques are directly applicable to strip transmission line circuits.

As the ability to utilize and sum the outputs of transistors is improved, varactor multipliers will have to be designed to take advantage of the increased power. With the more refined synthesis techniques now available and better definitions of the varactor model, it is possible to design optimum multiple configurations. The resulting circuits are complicated, but they can be economically fabricated in strip transmission line.

Another promising development is the use of semiconductor material for the dielectric of strip line, allowing diodes or transistors to be an integral part of the line material itself. An X-band hybrid or coupler circuit employing semiconductor material for the dielectric covers an area of about  $0.1 \times 0.1$  square inch. A balanced mixer using this coupler is being developed.<sup>18</sup> Also under development is a transistor and varactor diode built on the same dielectric substrate. The device is expected to have a 5-watt continuous wave output and 50% efficiency in S band. Because of the high dielectric constant material used in these devices, linear dimensions are very small and, as a result, high resistivities do not cause excessive losses.

Perhaps the most challenging field for strip transmission line circuitry is the development of solid state frequency sources using the Gunn effect and Read devices, that permit the direct conversion from d-c power to microwave power. In contrast to transistors whose operation depends on the junctions between semiconductor materials, a Gunn device depends on the transfer of electrons within the energy bands of bulk material such as gallium

arsenide (GaAs) or indium phosphide (InP). Gunn oscillators<sup>19</sup> have supplied a c-w output of 15.5 mw at 4.35 Gc and a pulsed output of 190 watts at 1.1 Gc and 1.83 watts at 4.96 Gc.<sup>20, 21</sup> The Read device, a junction diode made by diffusion of gallium and arsenic into high-resistivity silicon, generates microwave signals by a combination of avalanche and transit-time effects.<sup>22</sup> As an oscillator, it has a potential power output of 5 watts at 5 Gc.<sup>23</sup>

Since the Gunn and Read devices are only in the research stage, their evolution into reproducible monolithic strip transmission line circuits is far in the future. In the meantime, these devices will probably be embedded into strip transmission lines made with high temperature, ceramic material so that increased power levels may be obtained.

## References

1. J. Bartnik "Telemetry Solid State Microwave Transmitter," Technical Documentary Report, Contract No. AF33(616)-7433, Sylvania Electronic Systems, Williamsville, N.Y., April, 1962.
2. D. Gallagher, "A Microwave Tunnel Diode Amplifier," *Microwave Journal*, February, 1965, pp. 62-68.
3. J. Lepoff, "The Design of Broadband Tunnel Diode Amplifiers," TM EDL-M583, Oct. 21, 1963, prepared under Contract DA36-039-AMC-00088(E), Sylvania Electronic Defense Laboratories.
4. T.P. Miles and D.C. Cox, "A Microwave Tunnel-Diode Amplifier in Strip Line," 1965 International Solid-State Circuits Conference, Univ. of Pennsylvania, pp. 24-25.
5. W.J. Getsinger, "Prototype for Use in Broadbanding Reflection Amplifiers," *IEEE Transactions on Microwave Theory and Techniques*, Vol. MTT-11, November, 1963, pp. 486-497.
6. G.L. Matthaei, "A Study of the Optimum Design of Wide-Band Parametric Amplifiers and Up-Converters," *IRE Transactions on Microwave Theory and Techniques*, Vol. MTT-9, January, 1961, pp. 23-38.
7. S.B. Cohn, "Parallel-Coupled Transmission-Line Resonator Filters," *IRE Transactions on Microwave Theory and Techniques*, Vol. MTT-6, April, 1958, pp. 223-231.
8. G.L. Matthaei, "Direct-Coupled Bandpass Filters with Quarter-Wave Resonators," 158 IRE National Convention Record, Vol. 6, Part 1, pp. 98-111.
9. E.M. Davis, "Some Considerations for a Steerable Satellite Phased-Array Antenna," *IEEE International Convention*, New York, N.Y., March, 1965.
10. S. Andre, D. Leonard, "An Active Retrodirective Array for Satellite Communications," *IEEE Transactions*, AP-12, March, 1964, pp. 181-186.
11. R. Bower and J.J. Wolfe, "A Printed Circuit Balun for Use with Spiral Antennas," *IEEE Transactions*, MTT-8, May, 1960, pp. 319-324.
12. H.S. Keen, "Scientific Report on Study of Strip Transmission Lines, AIL Report No. 2830-2, Contract No. AF19(604)-780 December, 1955.
13. E. Fubini, W. Fromm, and H. Keen, "New Techniques for High-Q Strip Microwave Components," *IRE Convention Record, Part 8—Communications and Microwaves*, March, 1954, pp. 91-103.
14. S.B. Cohn, "New Thoughts on Strip Line," *The Microwave Journal*, July, 1962, pp. 13-18.
15. N.R. Wild, et al., "Handbook of TRI-PLATE," Sanders Associates, Inc., Nashua, N.H., 1956.
16. B.M. Oliver, "Time Domain Reflectometry," *Hewlett Packard Journal*, Hewlett Packard Co., Palo Alto, Calif., February, 1965.
17. "Engineering Services on Transistors," Report No. 8, June, 1965, Contract No. DA36-039-AMC-02227(E), Western Electric Company, New York, N.Y.
18. Tom M. Hylltin and Gerald J. Kelly "Interim Engineering Report Number 2—Molecular Electronics for Radar Applications," Texas Instruments Incorporated, Report TI-03-65-40, Contract No. AF33(615)-1993 April, 1965.
19. J.B. Gunn "Instabilities of Current in III-V Semiconductors," *IBM Journal of Research and Development*, April, 1964, pp. 141-159.
20. B.W. Hakki, J.C., "C-W Microwave Oscillations in GaAs," *Proceedings of IEEE Correspondence*, January, 1965, p. 80.
21. D.G. Dow and C.H. Mosher "Properties of Devices Using the Gunn Effect at High Pulse Power," 1963 23rd Conference on Electron Device Research, University of Illinois, Urbana, Ill.
22. C.A. Lee, R.L. Batdorf, W. Weigmann and G. Kaminsky, "The Read Diode; an Avalanche, Transit Time, Negative Resistance Oscillator," 1965 International Solid State Circuits Conference, Univ. of Pennsylvania, pp. 28-29.
23. W.T. Read, "A Proposed High Frequency Negative Resistance Diode," *Bell System Technical Journal*, March, 1958, pp. 401-446.



Here's the right integrated circuit if you want very stable switching voltage

We call it the Silicon Bilateral Switch. You'll find it just about eliminates power output fluctuations caused by temperature effects on the triggering voltage. The switching voltage of this new device is virtually unaffected by temperature. What's more, G.E.'s new SBS has extremely low switching voltage—a mere 10 volts. Use G-E SBS's to trigger SCR's and bi-directional thyristors (Triac's). They're available in unilateral form as well as bilateral form. Circle **Number 90** for more details.

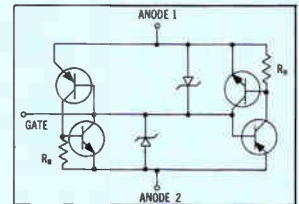

Silicon Bilateral Switch Equivalent Circuit

G-E thermistor probes solve many design problems

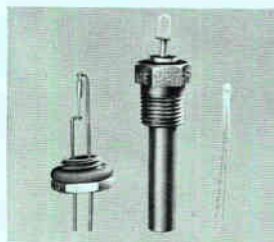

Here's the answer if thermistor probes are your problem:

- **G-E H-series probes** give you trigger-fast response in a truly rugged, hermetically sealed unit . . . operate up to 400C in air, gas and non-conductive liquids.
- **G-E 1/4" diameter probes** range from 50 to 100,000 ohms resistance, Grade 1 through 4 materials.
- **G-E bead probes** are designed to fit into nearly any circuit package. Easy-to-mount and operable up to 400C, you can even use them in liquid media. Circle magazine inquiry card **Number 91**.

New bonded heater-cathodes for planar ceramic triodes

Now you can meet all these design goals: ■ faster warmup . . . 3 to 5 seconds without heater over-voltage ■ tolerance to extreme mechanical environments . . . up to 50 g's RMS ■ extremely low microphonic output . . . quietest of any known tube design ■ improved life, reliability . . . heater temperature is sharply reduced ■ predictable thermal transfer between heater and cathode . . . permits precise control of cathode temperature through heater-voltage control ■ circuit simplicity . . . indirectly-heated cathode needs no special heater circuitry or voltage. This new heater-cathode technique can be applied to all recent tube designs. Circle **Number 92** on the magazine inquiry card.

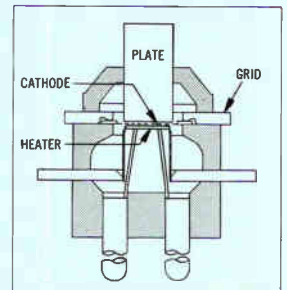

More and still more G-E economy transistors

Switch to the low-cost way to solid state. Try the famous planar passivated economy line. Try new G-E 2N3973-76 transistors for example. They're tops for medium speed industrial switching and large signal RF amplifiers. And they feature excellent  $h_{FE}$  holdup at collector currents between 0.1mA and 500mA. Or try our new 2N3858A and 2N3859A transistors . . . excellent as high voltage, high gain amplifiers. Circle inquiry card **Number 93**.

Want high-level color demodulation?



The 6AG10 compactron

This little G-E 6AG10 compactron gives full color fidelity . . . actually does the work of 2 miniature demodulators, or of 2 pentodes and 3 triodes. The 6AG10 puts out 3 "color-difference" signals directly to 3 cathode-ray-tube guns. Here, unquestionably, is your lowest-cost way to full-color-fidelity demodulation. And best of all, it's a COMPACTRON. Ask your G-E engineer/salesman for our new "Compactrons for Color TV" Brochure or circle **Number 94** on the magazine inquiry card.





Solid-state  
light-sensitive switch  
controls G.E.'s  
meter relays



GE-Type 195 meter relay  
with single setpoint

Contactless pass-through control action—that's the advantage you get with these solid-state meter relays. Completely self-contained control action is initiated by a light-sensitive switch directly controlling the load relay. No troublesome pointer contacts. No external amplifiers, power supplies or load relays. No mechanical interference with meter movement. Pointer travel is unrestricted across the entire scale. You get continuous indication above and below the setpoints. And you get all this in a distinctive, easy-to-read BIG LOOK meter package. Ask for Publication GEA-8014 or circle magazine inquiry card **Number 95**.

PREDICTION:  
Crystal-can relays out.  
150-grid  
relay family in.

G-E low-profile 150 Grid-space relays set the trend for things to come in relay applications. Available now in 2-pole and 4-pole arrangements (and a latching version's due this year, too) these small devices have 150-mil terminal spacing, are only 0.32" high. This growing family of new relays offers you the best in space-saving ability with all the performance required from a mil-spec relay. Circle **Number 96**.

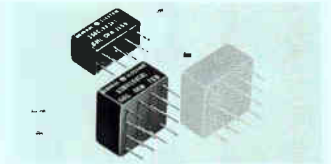

Family will soon include  
new latching version

Give critical components  
the protection  
they deserve



Triggered Vacuum Gap

Divert system and component faults through a General Electric triggered vacuum gap. Nothing else will do the job as well. TVG's trigger remarkably easily, just as low pressure gas gaps do. Yet TVG's are gas-free. Their voltage holdoff capabilities won't degenerate. They are also free from adverse atmosphere damage, adaptable to any environment, and will protect against faults ranging from 10 to 100% of their rated voltage. Circle **Number 97** for more information on all 5 available models.

Try this new  
ramp-and-pedestal  
precision temperature  
regulator

At maximum gain setting, this low cost circuit controls load power over its entire range by a mere 3°C change in thermistor temperature. What's more its feedback control network is stabilized by the circuit's adjustable gain. How's it work? Ask your G-E engineer/salesman for Application Information Publication 671.1 and cost details. Or circle magazine inquiry card **Number 98**.

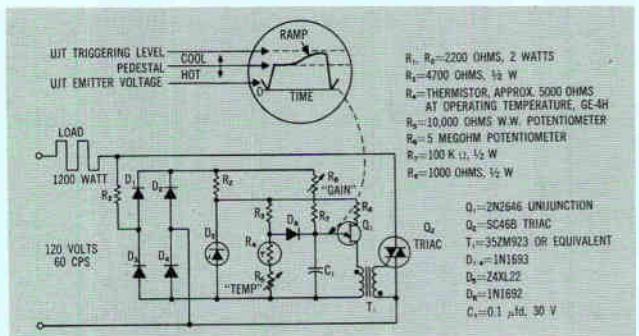

8 different case sizes  
now for  
Black Hawk capacitors

And each capacitor size has 5 different voltages to choose from—50, 100, 200, 400 or 600 VDC. Black Hawk capacitors are molded to give you a hard, moisture-resistant shell around the capacitor roll. Each one you use has strong welded leads, extended foil construction, and very precise dimensions ( $\pm 0.005$ ). Circle **Number 99** on the magazine inquiry card for all the facts.



Featuring  
molded  
encapsulation

WE MAY NOT OFFER EVERYTHING YOU WANT FROM ONE COMPONENTS  
SUPPLIER. BUT WE DO COME A LITTLE CLOSER THAN ANYONE ELSE.

285-12

GENERAL ELECTRIC

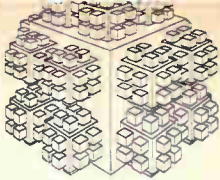

# The packaging revolution, part VI: converting to microelectronics

Redesign is inevitable and frequently drastic, but design headaches can be avoided and economies effected if the various techniques for fabricating and packaging integrated circuits are understood

By Fred A. Plemenos

Space and Information Systems Division, Raytheon Co., Sudbury, Mass.

**Engineers who try to build** an integrated circuit from the schematic of a discrete-component circuit usually run into trouble. Invariably, they can't make an economical IC version that will work, without a change in circuit design. The relationships between design and fabrication are much closer in IC's than in discrete component circuits and they impose new ground rules for circuit design, fabrication and packaging.

For example, one reason that the lag-lead filter circuit that is discussed on page 105 can be built economically as a hybrid circuit is that the high-value, precision resistors, customary in such analog circuitry, were designed out of the IC version. To convert the filter to an IC, switching functions akin to digital circuitry were substituted for linear circuitry.

The filter's resistor network can be built as a vacuum-deposited thin-film circuit or as a screen-printed thick-film circuit resembling the thick-film circuit shown above. With adequate redesign an estimated 85% to 90% of all linear circuits for analog functions can be built as thick-film hybrids. In some cases, redesign and fabrication can be simplified by incorporating a monolithic silicon IC in the hybrid structure, as in the case of the sense amplifier shown on page 105.

Although the design transition is often difficult in analog circuitry, it can be reasonably straightforward in digital circuitry once the system design and packaging is altered to accommodate the smaller size, lower noise immunity and voltage levels, and other characteristics of IC's. Unlike analog functions, digital functions are highly stand-

This article and the two that follow on pages 110 and 115 are part of Electronics' continuing series on integrated-circuit system packaging. They examine the problems of making and packaging IC's from three viewpoints: selecting the type of IC most suited to the system, assembling hybrid circuits and fabricating hybrid subsystems and systems.

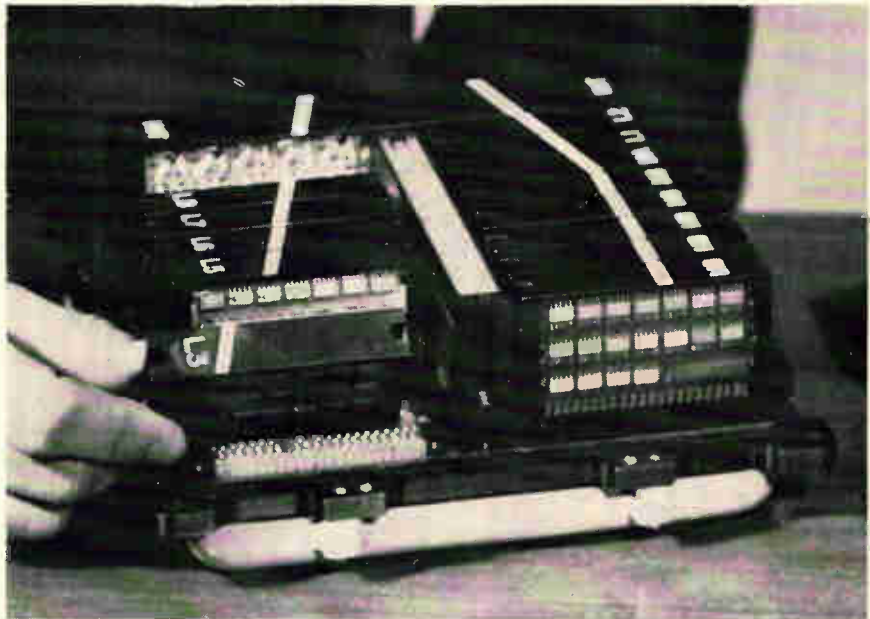

Miniature digital differential analyzer for missile-guidance and other digital-control applications is the Raytheon Co.'s M3X. High-density welded modules contain integrated-circuit components  $\frac{1}{4}$  by  $\frac{1}{8}$  inch. High-density welded discrete components are used in the interface modules in the rear part of the analyzer.

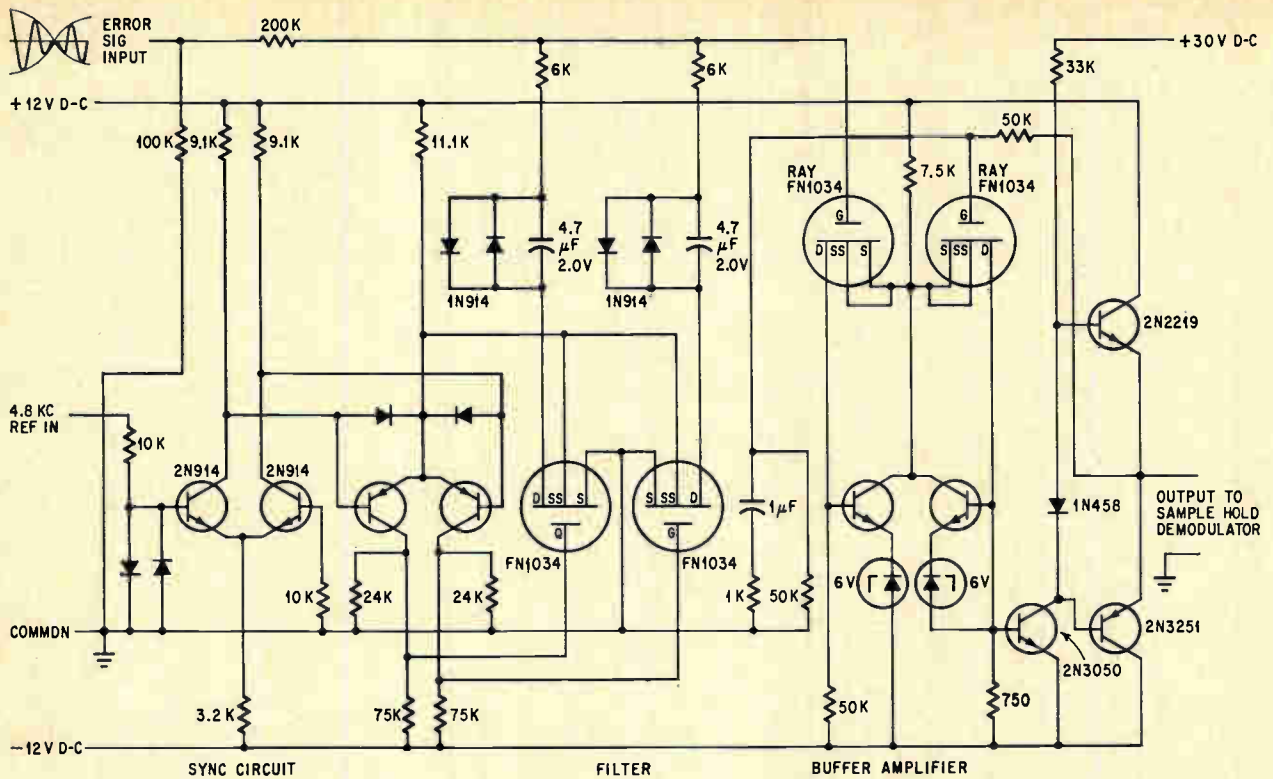

Greater circuit complexity often reduces size and weight by eliminating bulky components. This circuit, produced as a hybrid, is a servo frequency compensator based on switching rather than linear operation.

ardized and most digital applications can be filled by off-the-shelf logic circuits.

However, these general guidelines are often inadequate. Engineers responsible for converting conventional equipment to microelectronic equipment have found there is no universal answer to the question: What is the best way to make and package the IC's? In each case, a number of alternate techniques should be considered.

Theoretically, a circuit such as the lag-lead filter could be made by any of the various hybrid and monolithic techniques. In practice, the choice is limited by circuit quantity and cost, and the limits which each technique imposes on circuit power, voltage, frequency and precision.

### Analog redesign

The redesign and fabrication of linear circuits for analog functions is usually a do-it-yourself project. Redesign is almost always drastic—and inescapable. It is possible to reduce the new system's dependence on linear circuitry by converting some analog functions to digital ones, but even basically digital systems, such as a computer, require linear circuits for power supplies, memory drive and sense amplifiers, and for input-output to sensors that are primarily analog.

The few off-the-shelf monolithic linear IC's that are available are still costly and limited in performance. This is a natural consequence of the specialization of most analog functions; it seems impossible for the industry to standardize on basic linear building-block circuits.

A challenging design task is eliminating large

components or reducing their size and numbers. Large capacitors, inductors and transformers won't fit in a hybrid circuit and can't be made in monolithic IC's. Two successful redesign practices are to substitute active filters for large inductance-capacitance filters and to replace linear circuits with switching circuits.

These redesign principles are employed in the synchronous lag-lead filter that is shown in the schematic above. The circuit performs frequency compensation in a servo system by operating on the modulation envelope of an amplitude-modulated, suppressed-carrier signal. The diode pairs which prevent saturation of the circuit also limit the voltage across the 4.7-microfarad capacitors; thus these capacitors can be miniature types readily attached to the film circuit along with the semiconductor devices. The resistors and the component interconnections are thick or thin films.

Often, a combination of IC forms is best. The special-purpose sense amplifier at the right is made of a standard monolithic linear circuit (Fairchild 702 differential amplifier) plus a hybrid circuit. The IC flatpack, the diode and another flatpack containing the dual transistor are soldered to an encapsulated thick film resistor network. The network is protected by a coating of diallylphthalate plastic which leaves the solder pads (terminals) of the network exposed.

### Film-type hybrid circuits

The IC form most popular for linear circuits is the film-type hybrid. There are two major forms: thin film and thick film. In the last year, the thick-



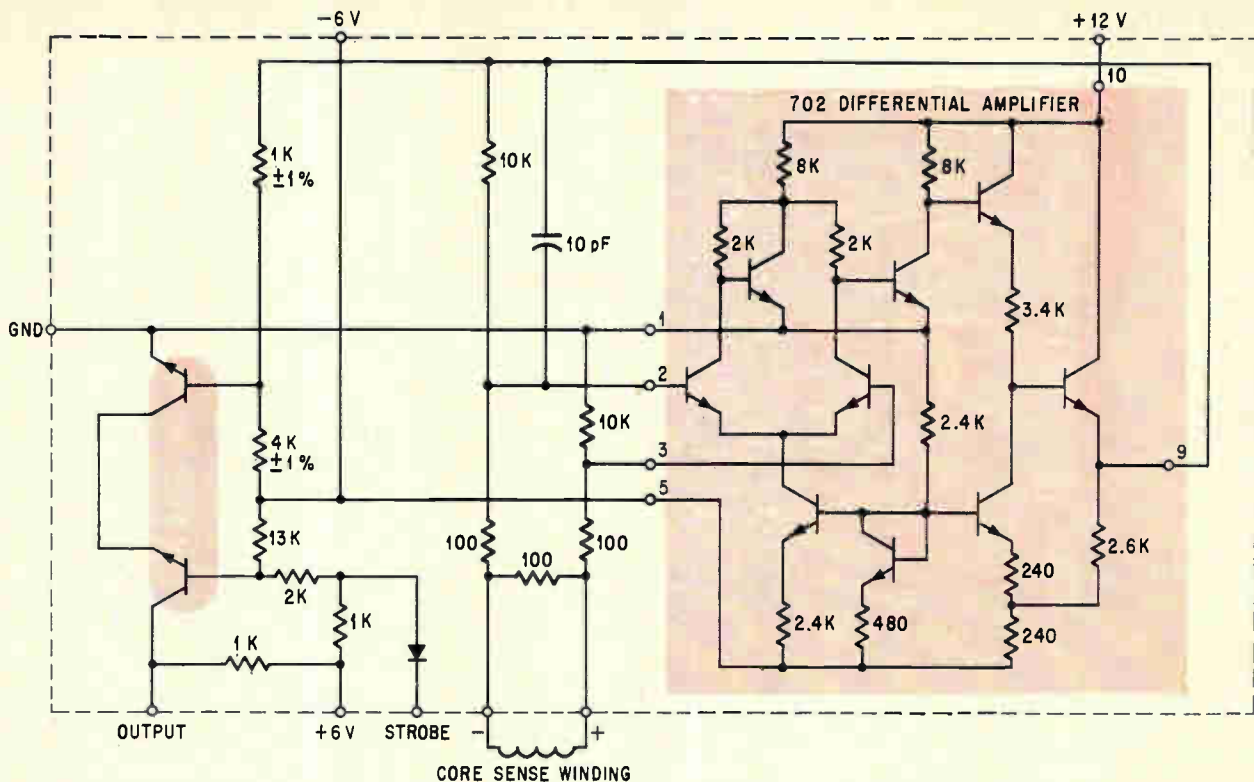

Sense amplifier is built with a monolithic circuit and a transistor, both in flatpacks (colored areas), that are attached to a passive network made by the thick-film process. The hybrid-circuit assembly is shown at the top of page 106.

film IC's have become the dominant hybrid form because of improvements in substrate and printing materials. The thick-film approach promises to break up the logjam of specialization and high cost that has retarded the use of analog integrated circuits.

Thick-film circuits are made by screen-printing special inks on a ceramic substrate. Generally only resistors and interconnections are printed, although it is possible to make capacitors and inductors. Semiconductor devices and high-value, high-precision or variable capacitors and resistors or small inductors are attached to the substrate, usually by soldering. The resistors can be printed to tolerances of 5% or 10% and trimmed to closer tolerances.

Thin-film circuits are similar, but the films are vacuum-deposited through masks, or deposited and shaped by etching. Film thickness is generally less than a micron, compared to a mil or more for thick films. [The two articles that follow, on pages 110 and 115, detail thin-film techniques]. Both methods impose few restrictions on the choice of active devices. Either type can have thermally conductive ceramics as substrates, allowing power dissipations of tens of watts, compared with milliwatts for monolithic IC's.

The pertinent electrical difference between thin and thick films is the difference in resistor stability. A typical thin-film resistor has a temperature coefficient of resistivity of 50 to 100 parts per million per degree centigrade. The temperature coefficient of a thick-film resistor is typically 200 to 300 parts per

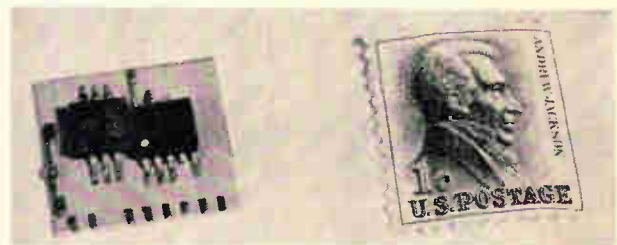

Sense amplifier, which is described by the schematic above, is smaller than postage stamp.

million; its voltage coefficient is small and the resistance value changes continuously as the resistor ages while the circuit is in operation.

When the circuit must have stable, precision resistors, the designer should specify thin-film or discrete resistors. Otherwise, he can generally save money by employing thick films. The printing process is more economical than vacuum processing and the thick-film circuits are better able to withstand assembly procedures such as soldering of component leads.

The thick-film process can be used instead of thin-film if the circuit can be designed so that resistor tolerances are broad. The lag-lead filter discussed above was designed with low-value, 5 to 10% resistors so it could be made by either thin or thick-film methods. The thick-film resistors are mechanically trimmed to 2%, an easy step which allows a considerable margin for the slight changes in value which may occur during long-term aging.

(continued on next page)

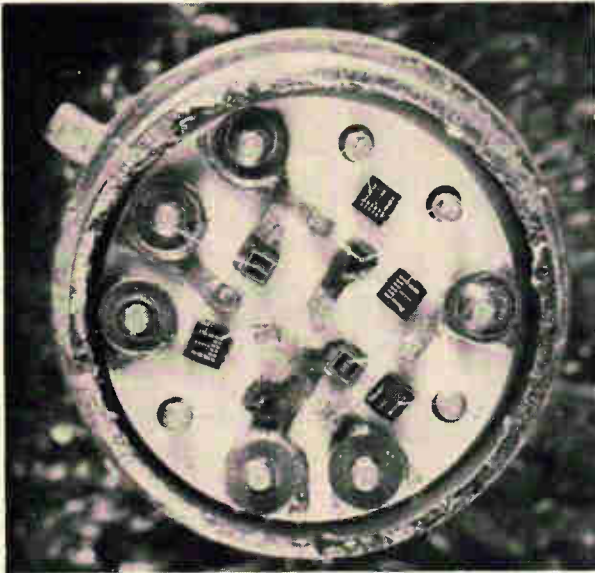

Multiple-chip hybrid circuit can contain a wider variety of semiconductor components than the usual monolithic circuit, but isn't much bigger when packaged. This chip-and-wire circuit is assembled on a transistor header.

### Single or multiple chip?

One would think that the semiconductor industry could produce monolithic linear IC's with the facility that it mass-produces monolithic logic circuits. But linear specialization has prevented manufacturers from applying the cost effectiveness of volume production. Development costs are high in comparison with production volume; several designs and processes may have to be tried before the circuit is adequate. The only important linear monolithic circuits available off-the-shelf are differential amplifiers and video amplifiers.

Technical limitations have also retarded linear monolithics. The range of voltage, frequency and power dissipation is too narrow for many analog functions. Semiconductor resistors are neither pre-

cise nor stable enough for most applications.

Another single-chip form of IC that is conceptually attractive for linear IC's is the compatible approach illustrated below. The circuits are made by diffusing active devices into the silicon crystal and depositing film resistors atop the silicon's oxide coating. Most of the monolithic process advantages are retained, while the resistors are more precise and stable than the diffused resistors of conventional monolithic IC's.

But the compatible circuits also have their practical limitations. The small size of the silicon substrate restricts total resistance value and power dissipation, relegating the technique to special applications.

Part of the gap between hybrids and monolithics is bridged by the multiple-chip form of IC at the left. These are made by interconnecting device chips with bonded lead wires, after mounting the chips on a package header. Since separate devices are used, they can be made by different processes and selected for optimum characteristics. The devices are generally diffused silicon, but monolithic IC's, ceramic capacitor bodies, thin-film resistors and miniature inductors can be put into the structure.

Multiple-chip IC's can be made as small as packaged monolithic or compatible IC's. They can dissipate more power than monolithics because the separation of the chips on the header relieves thermal problems. This versatility allows linear circuits to be made as chip hybrids. However, film circuits are usually preferred because the film substrates are roomier, allowing more room for passive components. The film circuits cost less, too, because the device interconnections are printed.

Actually, most multichip circuits are digital. The main attraction in switching and logic applications, compared with monolithic IC's, is the higher power, freer choice of components and physical isolation of the components. Isolation overcomes the speed limitations which parasitic capacitances

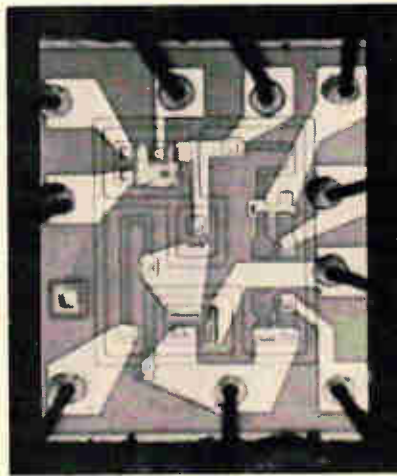
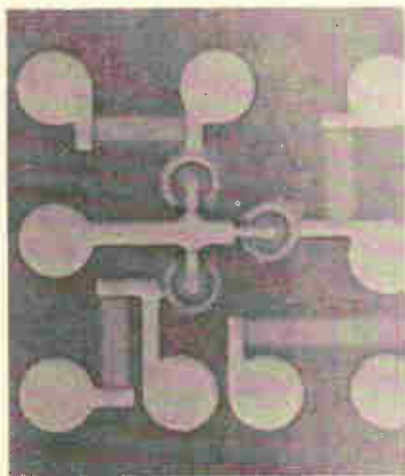

Three forms of monolithic circuits (left to right): a compatible circuit which has four film resistors (the faint bars) atop the silicon crystal in which the active devices are grown; a conventional IC with bipolar transistors and resistors diffused into the silicon; a metal-oxide-semiconductor circuit built primarily of field effect transistors.

impose on most monolithic IC's. However, monolithics cost less and are more reliable because there are fewer wire connections.

### Digital monolithic circuits

Although much has already been written about digital monolithic IC's, a few points related to fabrication and packaging are worth repeating.

Monolithics are the first choice for most digital applications, rather than hybrids, because of the

low costs of mass production, smaller size and higher reliability resulting from the lesser number of discrete connections. Compatible, hybrid or multichip IC's may be used when small quantities of special circuits are needed or when the required speed, noise immunity or radiation tolerance is unavailable in conventional monolithic IC's.

The monolithic IC's are easy to buy and apply. Several manufacturers sell families of circuits with matched characteristics. The five major functional

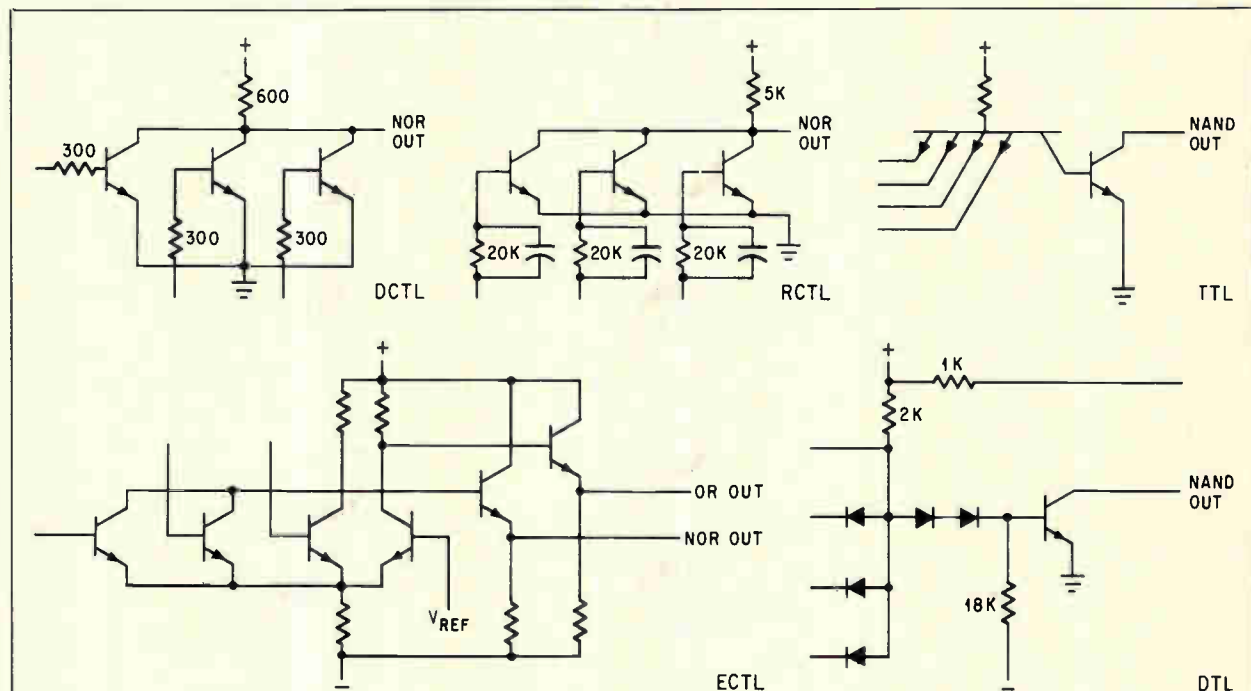

### Logic-circuit selection

Five functional forms of logic circuits, each with several variations, are available as monolithic IC's. The choice for a specific application depends not only on performance characteristics, but also on cost, the type of package the manufacturer uses, and whether his circuit family includes triggered flip-flops, drivers and other needed circuits as well as logic gates.

The characteristics of the different logic types are detailed in manufacturers' literature and in previous reports, for example, *Electronics*, Oct. 4, 1963, p. 23, so the selection factors will only be summarized here. The five types are:

- **Direct-coupled transistor logic.** DCTL circuits are the easiest to make, since the resistors are low in value. But they suffer from current hogging (the elements may draw unequal power, adversely affecting fan-out of the previous stage), relatively high power dissipation

and only fair noise immunity. Newer DCTL circuits with faster transistors and higher-value resistors dissipate only 3 milliwatts at 3 volts and have propagation delays of about 25 nanoseconds.

- **Resistor-capacitor transistor logic.** RCTL's high-value resistors provide good logic-voltage levels, but operating rates are generally limited to several hundred kilocycles under worst-case loading and temperature conditions. These circuits are good for low-speed applications because their slowness makes them less susceptible to noise.

- **Transistor-transistor logic.** TTL speeds are higher than DCTL, but noise immunity is only fair and the inverse beta of the coupling transistor must be kept low to prevent current hogging.

- **Emitter-coupled transistor logic.** Unlike the other forms of

logic, ECTL functions in a non-saturating mode and therefore is exceptionally fast. Some circuits attain switching speeds of 2 nanoseconds or less. However, noise immunity is only fair and an extra power supply, for a reference voltage, is required.

- **Diode-transistor logic.** DTL is a low-power circuit that can operate as fast as 20 nanoseconds. Series diodes in the base circuit give it good noise immunity. Fan-in can be raised conveniently by adding external diodes.

Although DTL circuits are more complex to fabricate than the other forms, DTL has no significant disadvantages. It is the only form available from all major manufacturers and is widely accepted. Some DTL families are available from more than one company—for example, Raytheon is a second-source producer for the Westinghouse Electric Corp.'s DTL line.

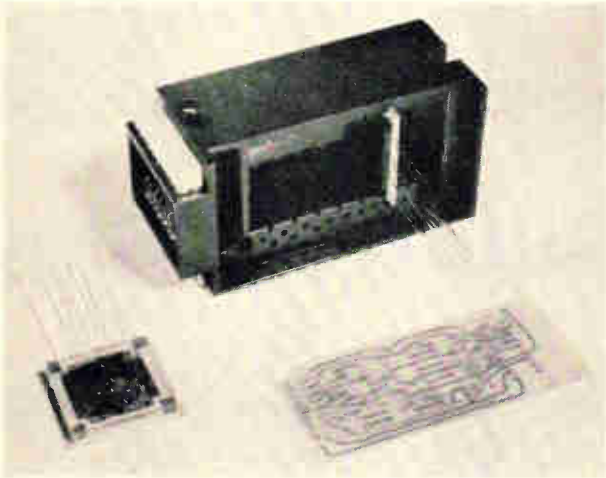
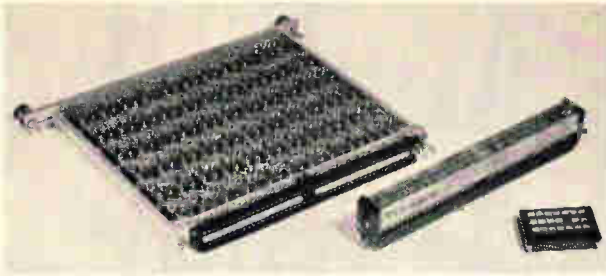

Monolithic and hybrid integrated circuits are blended by the system packaging of the Raytheon M3X computer, seen in the photo above. Each of the digital modules has about 42 flatpacks—84 three-input NOR gates—interconnected by a welded-foil matrix. A digital model is contrasted at the upper left with earlier discrete-component modules that contain 66 gates each. At the lower left is a hybrid-circuit module. Twice the size of the digital module, it heat-sinks the film circuits. This type of hybrid module will also accept discrete power components.

isolating the circuit elements. One method is to isolate them with silicon dioxide barriers, a second is to make the barriers of polycrystalline silicon with high resistivity and a third is to etch away the silicon between devices, leaving the elements held together with metal conductors. In essence, a monolithic equivalent of a multiple-chip hybrid circuit is produced.

A relatively new form of monolithic IC, also shown on page 107, is the MOS FET [Electronics, Oct. 4, 1965, p. 84]. Made with metal-oxide-semiconductor thin-film transistors, they are majority-carrier devices that have characteristics similar to

those of a pentode vacuum tube. Their characteristics overcome parasitic and isolation problems, enabling large numbers of MOS FET's to be used in a single circuit. Entire logic or memory functions, such as full adders or shift registers, can be performed on a single chip of silicon.

#### Voltage and noise

Digital IC's operate at lower voltages than discrete-component circuits. System power dissipation is lowered, but the penalty is less noise immunity. Noise thresholds are as low as 300 millivolts, making shielding and grounding more im-

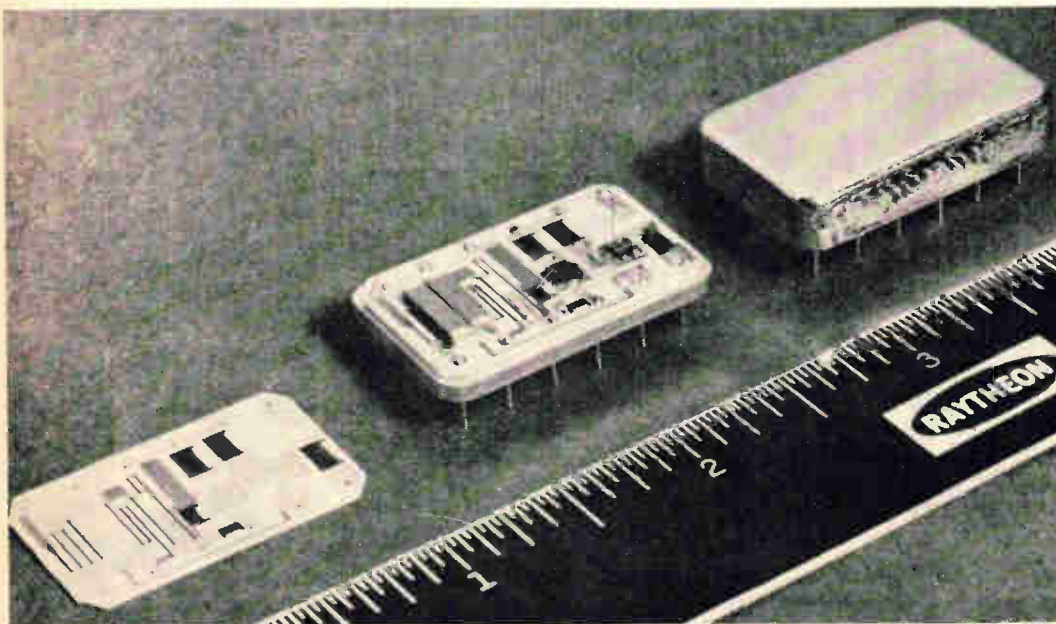

Thick-film hybrid integrated circuits are made by screen-printing resistors and conductors on a ceramic plate (left), then attaching discrete components and packaging. Most analog functions can be made in such circuits.

portant in overall system performance than differences in circuit performance.

Most monolithic digital circuits operate over a voltage range of  $\pm 40\%$ ; that is, the range is 2.5 to 5.5 volts for a system with a nominal voltage of 4 volts. Comparable figures for discrete-component logic are 10 volts nominal and a range of 6 to 14 volts.

Although the allowable variation of  $\pm 1.5$  volts for IC's seems restrictive, most power supplies can better these requirements by a wide margin. One suitable type of regulated power supply is a pulse-width-modulated, d-c to d-c converter: It can supply  $4.0 \pm 0.1$  volts at 7 amperes when the input voltage varies between 12 and 50 volts. Its efficiency is near 85%, which means that a small price is paid in power dissipation for the converter. This price is outweighed by the advantages of having the digital-system supply regulated and isolated from the main system supply.

However, if the designer finds that he cannot afford the converter's size, weight, cost and power penalty, he will have to select his IC's on the basis of how well they can operate at voltage levels available from the system's main power supply.

Although noise generated within the digital system can be controlled by appropriate grounding, decoupling and separation of high-level and low-level signals, a shield around the system is the only sure barrier against malfunctions caused by external radio-frequency interference (rfi). Shielding can be provided without serious weight penalties when IC's are used because the system package is small.

An experiment conducted at Raytheon on a digital computer indicates that monolithic logic systems are 100 times less likely to malfunction due to rfi when they are packaged in a shielded housing.

The computer was subjected to rfi generated in an anechoic chamber by a transmitter, to determine the rfi conditions which could cause the computer to malfunction. The transmitter's peak pulse power was 1 kilowatt, its frequency range 500 to 3,000 megacycles per second, and its nominal pulse width 1 microsecond. The pulse repetition rate was varied to synchronize or delay the pulse with respect to the internal synchronization of the computer. Incident power was measured in milliwatts per square centimeter with a power-density meter.

If the computer malfunctioned at one value of incident power while it was unshielded, the same type of malfunction would not occur after the computer was shielded until the rfi power became more than 100 times greater. These experiments were used to evaluate different designs for the shielded housing.

### Hybrid system packaging

The module shown at the left is an example of hybrid packaging. To provide a good thermal path to the module housing, the substrates are backed with metal plates that slide into grooves in the housing and are bonded to the module, where they are interconnected with a double-sided printed cir-

cuit board. The housing design permits discrete components to be added at the bottom of the module and power transistors to be mounted at the end.

This packaging design accommodates all the compromises necessary to microminiaturize an analog subsystem.

The hybrid analog module described above is compatible with those used for the digital functions of Raytheon's M3X digital differential analyzer shown on the opposite page. This computer, designed for ballistic missile guidance, is only six inches square and about two inches high. It has a 17-bit word length and a 12-word solid-state memory. Power dissipation is less than five watts.

The smaller modules are eight logic modules and six flip-flop memory modules, each of which contains up to 42 flatpacks. The logic and control functions are performed by approximately 600 NOR/NAND gates. The flatpack leads are welded to foil-type interconnections and the modules are interconnected in the bottom of the housing with machine-wrapped wiring [Electronics, Nov. 1, 1965, p. 75].

Such systems are the computer industry's reward for the impetus it has given the mass production and development of monolithic IC's. Aerospace and military computer applications that were difficult or impossible to fill, because of size, weight and reliability problems, are now practical. Even a large, general-purpose computer with up to 5,000 logic gates can now be cut down to a size easily carried by an aircraft or space vehicle. As a result, most military and space systems now being designed will employ integrated circuits.

### State of the art

There are four phases in the development of a technology: development of basic elements, applications engineering, development of fabrication and packaging techniques, and adaptation or conversion of production facilities.

Digital IC's have just about completed the first three phases. Although there is still much development work ahead, systems are now being produced. Few production lines have been fully established; the main production effort will come during 1966.

By comparison, analog IC's are still primarily in the applications engineering phase, even though they are in production for a number of systems. The experience gained with digital IC's should materially shorten the time it will take for analog IC's to be widely used in nondigital systems.

### The author



Fred A. Piemenos used to work on radar systems and displays, but his main interests since 1960 have been the Polaris missile and Apollo space computer programs. He manages the electronic equipment department at Raytheon's Space and Information Systems Design Center in Sudbury.

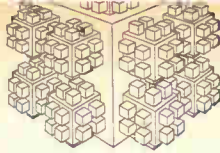

# Ceramic handles and ultrasonic bonders upgrade hybrid assembly

Cold-bonding the leads and mounting the chips on ceramic eliminates two causes of hybrid integrated-circuit failure—heating and handling the semiconductor devices and integrated circuits during assembly

By William L. Shockley and Richard W. Weedfall

Collins Radio Co., Dallas

**The main cause** of hybrid-circuit rejects—component damage or degradation caused by prevailing methods of attaching active semiconductor devices and integrated circuits to thin-film networks—is virtually eliminated by two recent improvements in methods of bonding leads to active devices.

One is premounting the active-device chips onto tiny, individual ceramic bases, called channels. This returns the critical chip-bonding steps to the device manufacturer's plants, where they can be handled more safely. The assembler bonds leads to the channels, not the chips.

The second is ultrasonic bonding of the leads that connect the devices and the passive networks. Strong bonds are made without heating the network and running the risk of permanently altering passive-component values. The method can be used to bond leads directly to chips, but it is more effective when bonds are made to the channels.

## The authors



William L. Shockley, who established a microminiaturization laboratory at the Collins Radio Co., now heads a solid state research and development department at Collins' Dallas facility. He has a master's degree in electrical engineering from Southern Methodist University and is a senior member of the IEEE.



Richard W. Weedfall, a research and development engineer in Shockley's department, has designed filters and oscillators for frequency synthesizers and has supervised the design of portions of a high-frequency scan receiver. Also a graduate of SMU, Weedfall has specialized in thin-film projects four years.

Several thousand circuits similar to the circuits shown on page 9 and on the cover of this issue have been made with channel-mounted devices. Compared with previous methods of making high-reliability circuits, assembly costs are lower and rejects fewer.

Both techniques are compatible with a third technique which shows promise of coming into general use, the face-down bonding of leadless inverted devices (LID's) directly to the passive network. At present, lead bonding and other device-attachment steps represent about half the cost of hybrid-circuit fabrication. Our studies indicate that LID's can reduce assembly time about 75%.

These techniques are applicable to most types of hybrid circuits. At Collins, they are primarily used for tantalum-film circuits. The tantalum film is deposited by the process popularly known as sputtering. The process flow and the deposition system are shown at the bottom of page 111. The advantage of this method is that the same basic processes which make high-value, precision resistors also make medium and low-value capacitors. The portions of the film used as resistors are anodized to thin the film and thus raise the resistance to the exact value required. Fully anodizing the areas of the film reserved for capacitors converts the tantalum metal into a capacitor dielectric, tantalum pentoxide. Photoetching processes shape the passive components and the conductors.

## Ceramic channels

The ceramic channels were developed by Collins with the cooperation of device producers after a long, often frustrating series of attempts to iron out difficulties in device procurement, testing, protection and assembly. The channels are shown on page 10.

The transistor channel is a U-shaped section

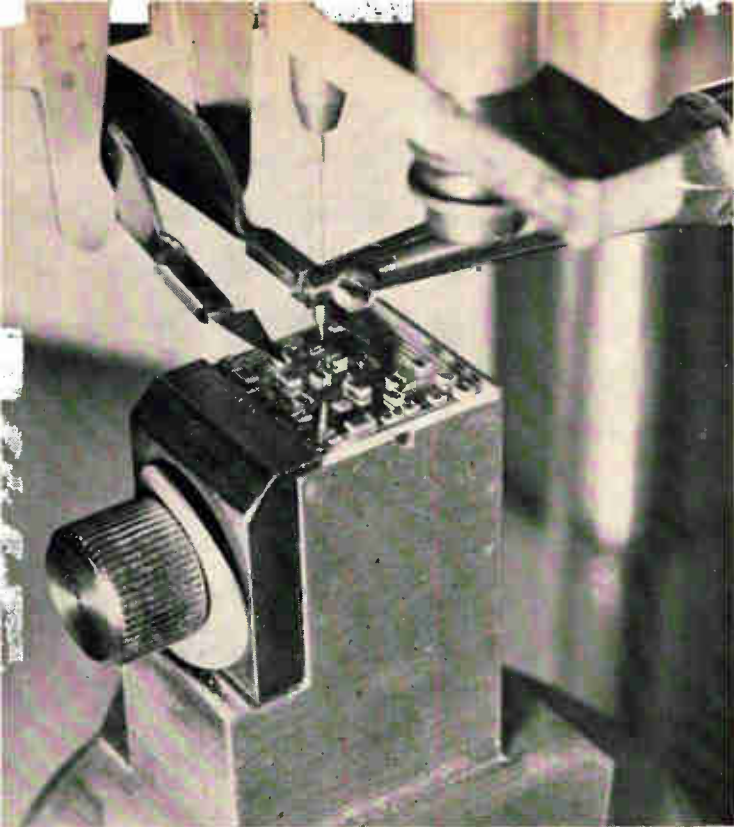

Ultrasonic bonder attaches gold leads to chip mounts and to thin-film conductors on the hybrid-circuit substrate. The close-up photograph at the left shows the bonding tip poised above a transistor mounted on a ceramic channel.

of alumina ceramic. The bottom of the channel and the tops of the two ridges are metallized and thickly plated with 200 microinches of gold. The device manufacturer bonds the silicon die, or basic chip, to the channel bottom by gold-silicon eutectic alloying. This forms the connection to the transistor collector. The base and emitter connections are made by conventional thermo-compression ball-bonding of lead wires to the thin-film contacts on top of the chip and to the gold plate on the channel.

During circuit assembly, the channel is used to handle the device, align it on the thin-film pattern and attach it with epoxy adhesive. The electrical connections are made by bonding gold wire to the plating on the channel and to thin-film conductors.

The mounting for a diode is similar, except that the ceramic is flat and only two trips are gold plated. The die is alloyed to one strip and the other connection is a lead wire bonded to the opposite strip. This idea has been extended to the flat-plate form for monolithic integrated circuits.

Since the device manufacturer controls the chip-bonding process, he is willing to guarantee device performance. The refusal of such guarantees when the bonding is done by circuit assemblers has caused many disputes between device vendors and buyers.

An important assembly advantage of the channels is that they facilitate ultrasonic

bonding and make for a more rugged and compact circuit than other semiconductor packages.

Ultrasonic bonds are made by pressing a lead wire against another surface. The pressure is applied by the tip of a transducer that is vibrating at about 60 kilocycles per second. The mechanical force and scrubbing action cause molecular mingling of the two surfaces, forming a bond.

Since the channels are far stronger and bigger than the chips, thicker wires and greater bonding forces can be employed. Gold wires, two or three mils in diameter (0.002 or 0.003 inch), are used. These leads are two or three times as thick as normal chip leads, increasing lead strength four to nine times. The leads can also be double- or triple-bonded to the plating, for added bond strength,

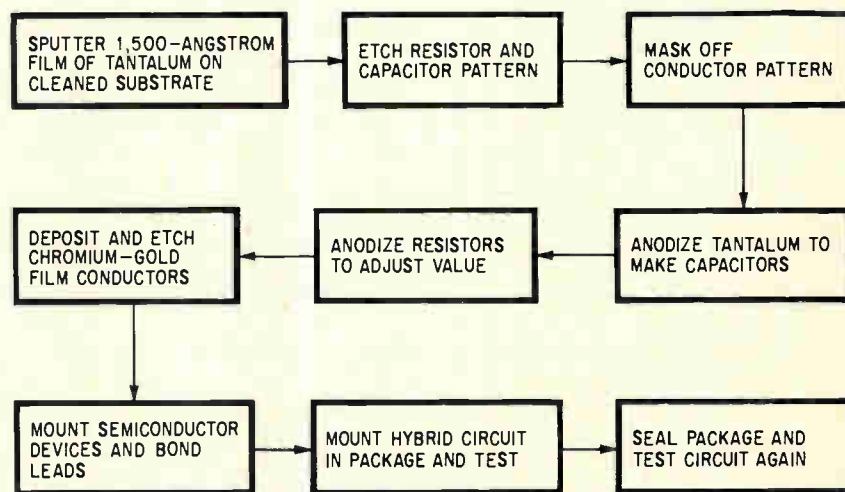

Process and assembly sequence for hybrid integrated circuit based on tantalum thin-film networks. The tantalum, deposited by cathodic sputtering with argon, makes both resistors and capacitors. Collins Radio Co. sputters the tantalum in a conveyor-fed deposition system.

## Dice mounted on ceramic bases are easier to assemble

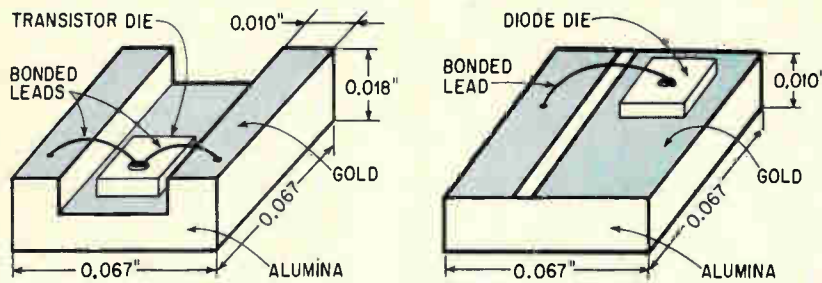

Transistor mount, seen in the left-hand sketch and in the photograph at right, is a U-shaped channel of alumina. During circuit assembly, wires are bonded to the gold-plate (color). The diode mount (sketch at right) is flat.

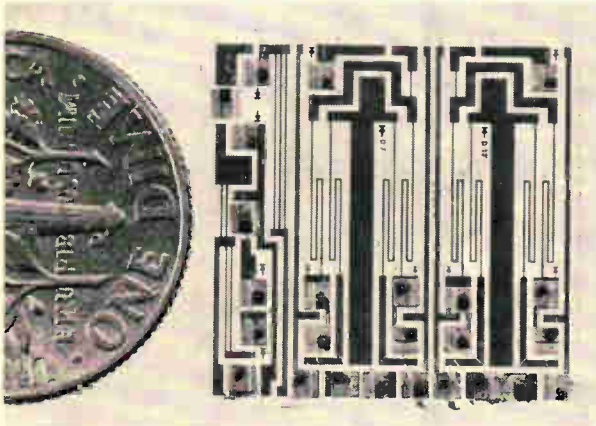
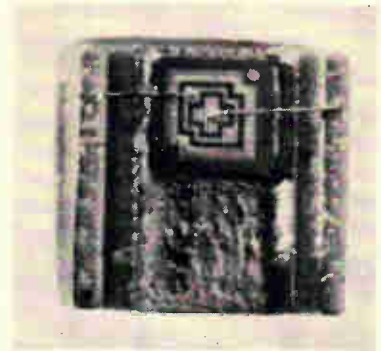

Ceramic mounting for monolithic integrated circuit. The circuit on the cover, a stairstep-voltage generator for a frequency synthesizer, contains four such circuits.

There are two transistors, mounted on ceramic channels, in the lower portion of this hybrid circuit. All the other active devices are diodes premounted on ceramic.

since bonds can be made to the channel at any location on the plating. The assembler does not have to place one bond at precisely the right location on the chip because of the larger wire and bonding areas, nor does he have to cope with other chip-bonding problems. Centrifuge tests at 20,000 g's have proven the reliability of the bonds.

Circuit layout is simplified because the ceramic body is an electrical (though not thermal) insulator. Thin-film conductors can run under the channels. This cannot be done if the chips are alloyed to the conductor or mounted on a conventional metal tab; also the wire lead must looped from the chip junction over the tab and the lead-to-tab clearance must be enough to prevent shorting when the assembly is subjected to shock and vibration. The height of the channel allows the leads to bridge the gap between two channels, or between a channel and a conductor, while an intervening conductor safely passes under the bridge. These methods reduce the number of wires and bonds needed and help make the circuit more compact and rugged.

One layout rule that Collins follows is that device leads cannot have random orientations—that is, run every which way over the substrate. Whenever possible, leads all run in the X direction or the Y direction. The bonder operator only has to move the bonding tool along the X and Y axes in an orderly progression, lessening operator training time and speeding assembly. The added length and symmetry of the bonding areas and the insulating properties of the channels, compared

with chip bonding, make it easier to apply this rule.

Another advantage, which reduces assembly reject rates due to electrically inadequate devices, is that the device or circuit manufacturer can use the channel as a miniature test fixture, to cull devices with inadequate high-frequency performance. H-f or high-speed-switching tests usually cannot be made effectively unless the device has leads, or is tested in the circuit assembly.

Testing of leadless chips is generally restricted to a few direct-current characteristics, measured with the aid of needle-like probes. The channel also allows chip bonds to be electrically checked before a device is committed to the hybrid assembly, an important benefit when the devices are monolithic circuits, because of the large number of bonds.

### Baring the chips

One strong reason for favoring unpackaged chips is that earlier attempts at microminiature semiconductor packaging have proven inadequate.

One of the first of these, shown at the right, consisted of a device chip bonded to a broad, gold-plated lead and coated with epoxy. Soldering the leads to the thin-film was difficult and the solder joints were bulky. Next, the die was mounted on a Kovar tab and three wire leads were brought through the epoxy.

The epoxy-coated devices often failed at low temperature during thermal shock tests. The lead bonds to the chips failed, apparently because the



packaging materials were poorly matched in thermal expansion. Substituting gold-plated steel for the Kovar tab helped, but not enough to ensure reliability in critical applications.

Since the epoxy was apparently the culprit and since the circuits were to be sealed for environmental protection, circuit manufacturers began buying unencapsulated devices, like the tab-mounted transistor with three flying leads that is shown at the right. The flying leads—leads without mechanical support—were difficult to hold and bond to the thin films and were easily ripped loose from the die. Understandably, device manufacturers refused to be responsible for such damage.

The next attempt to close this Pandora's box was to buy leadless devices mounted on gold-plated tabs. The assembler bonded leads directly to the chip, forcing him to enter the semiconductor-bonding business and assume responsibility for device performance.

Many device manufacturers would guarantee only the simple d-c characteristics measurable with needle probes. The buyer's best recourse was to mount sample devices on transistor-can headers, test them and reject the entire shipment if a significant number of sample devices failed. If the shipment was acceptable, some circuits would be made with bad devices, but repair costs were somewhat offset by the low cost of the unpackaged devices.

Now, the devices mounted on the ceramic channels cost a bit more due to the lead bonding and tighter specifications on performance. But they cost less than packaged components, have no flying leads to break off and provide the assembly advantages already cited.

### Troubles with bonding

Lead-bonding problems followed a parallel course. Once he could buy metal-tab-mounted devices, the circuit assembler could abandon soldering for thermocompression bonding of the flying leads or for bonding leads directly to the chips.

But thermocompression bonding, despite its long and successful use in device manufacturing, is not ideally suited to hybrid-circuit assembly. The bonds are made by pressing fine gold wire against the film contacts on the chip and then on the thin-film terminals of the passive network. The problem is that for effective thermocompression bonding, the assembly has to be heated to almost 370°C.

A transistor manufacturer deals with a single chip on a package header, but the hybrid-circuit manufacturer may have to put 20 chips on a thin-film network and keep the network hot for 15 or 20 minutes. Often, the overheating is prolonged enough to change the values of the thin-film components—a result that defeats the purpose of using thin-film processes to get precise passive networks. Incidentally, this is also a good reason for not alloy-bonding silicon dice directly to the thin-films, which requires additional heating above 370°C.

*(continued on next page)*

### Pinhead-sized packages

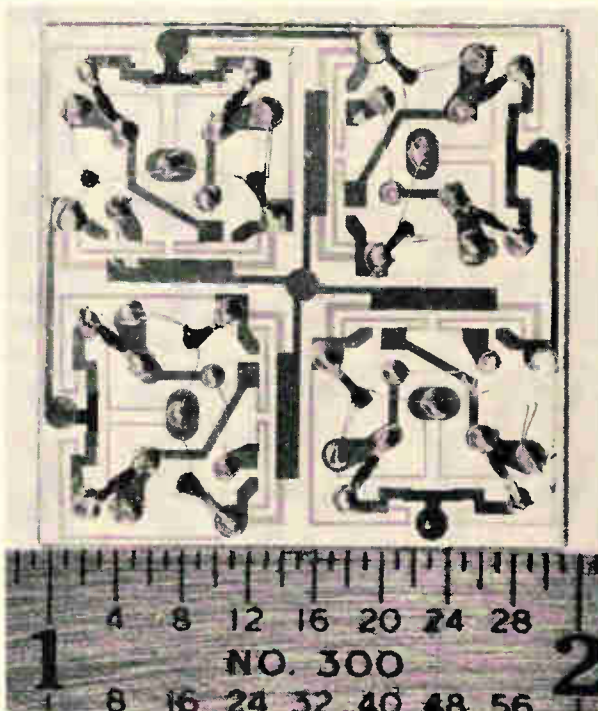

Broad leads of encapsulated devices were soldered to assemble this 1960 hybrid integrated circuit.



Mounting the silicon die on a small metal tab, attaching wire leads and encapsulating made the device smaller.



Omitting the encapsulation solved a thermal-stress problem but left the wire leads without support.



Tab mounting, without leads, requires the hybrid-circuit manufacturer to bond the wire leads to the silicon die.

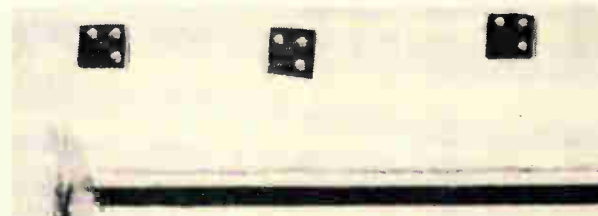

Leadless devices, designed for face-down mounting to film conductors, are latest form of active-device chips.

## Ultrasonic bonding

Ultrasonic bonding has been used for several years in device manufacturing. Because it is a cold process, it overcomes the thermal degradation problem, but little information is available on methods of obtaining reliable bonds in hybrid circuits.

Two years of development have gone into working out the bonding conditions needed to obtain consistently strong bonds. One of the most critical factors we found is the metallurgical specifications of the lead wire. For bonding leads directly to chips—the method used when devices on ceramic tabs aren't available—the wire is usually 1.3 mils in diameter. The most satisfactory wire for chip bonding seems to be 99.25% gold, 0.75% gallium. For 3-mil and larger wire, 99.99% gold is used. Wire elongation should be only 2 to 4%.

Even seemingly minor details, such as the way the wire is wound on a spool by the vendor, can be critical. One circuit manufacturer who had been getting good wire-to-film bonds suddenly found them weak. When the wire source was traced, it was discovered that the spools had been shaken up by an earthquake during shipment. The jostling disarranged the loops on the spool. When the de-reeling mechanism of the bonder drew the wire off the spool the pull required to free the crossed turns was excessive. The extra wire tension during bonding left the joints weak.

A common cause of weak bonds is unevenness in the height or flatness of the chip, awkward mounting on the tabs, or channels, or simply the use of devices from different manufacturers in the same hybrid circuit. The face of the bonding transducer's tip must be parallel to the chip face. Otherwise, the bond will be made by one edge of the tip, rather than the entire face. This makes the bond area smaller and the concentration of bonding pressure can excessively thin the wire and may damage or fracture the chip surface.

The first bonder bought by Collins had the transducer mounted on an arm that moved in a small radius to lower the tool on the bond location. The radius arm had to be lengthened and the pivot point moved further back, to ensure that the tip face would come down approximately parallel to every point on the different devices as well as the circuit substrates.

There is a further problem—the variation in the metals which different vendors use as contact films on their devices. The only solution is to work out the bonder's power, pressure and time settings for each film and adjust the bonder as required, or use several bonders for each circuit. With channel devices and 0.003-mil gold wire, these problems are minimized.

### The last straw

When all the problems of chip bonding seemed solved, we found that the ultrasonic vibration during bonding degraded some devices. One circuit called for a 2N2432 transistor, which acted as a switch to charge and discharge a resistor-capacitor

circuit. The network required a long time constant, so the leakage current of the transistor's base-emitter junction had to be less than 2 nanoamperes when the junction was reverse-biased. After bonding, three out of four transistors failed to meet the specification. A semiconductor manufacturer suggested that the cause of the failures was probably due to crystal dislocation in the base-emitter region.

There was no recourse from the device manufacturer. He pointed out that his guarantees did not include degradation caused by the buyer's bonding process.

This final problem sparked the development of the ceramic channel, which kept the bonder off the chip.

The channels also avoided the other problems. The bonds are now made on the gold plate, which is softer than the chip face, making tip pressure and parallelism less critical. The bonder can now be set to suit the thin-film conductors, which are also gold. To bond the 3-mil-diameter lead wires to the channel and the gold film, the bonder is set at a vibration frequency of 60 kilocycles, a tip pressure of 125 grams and a bonding time of 0.25 seconds. This produces bonds with an average pull strength of 16 grams.

Also, with the channels there are some thermal advantages (aside from the use of ultrasonic bonding instead of thermocompression bonding). The added mass of the ceramic under and around the chip and the added thickness of the channel lead wires makes for better heat-sinking of the active devices. A typical power rating of a channel device mounted on a substrate is half the rating of an equivalent device in a TO-5 package.

### Leadless inverted devices

Channel mounting is not the ultimate method of chip attachment. Face-bonding of leadless, inverted devices will probably be preferred in the future, particularly if automated assembly machinery is to be developed. However, only a limited variety of suitable "flip chips," like those at the bottom of page 113, are now available; it will take some time to establish the reliability of the technique; and there are numerous unsolved problems in face-bonding of single devices and integrated circuits [Electronics, June 28, 1965, p. 66 and p. 68, and Oct. 4, 1965, p. 102]. Besides, the circuit manufacturer will again have to do his own chip bonding.

However, these difficulties are offset by the basic attractiveness of leadless devices—no leads and fewer bonds to pose failure hazards, far lower assembly cost, more devices per unit area of substrate, no chip packaging or mounting cost, and so on.

Until enough proven leadless devices for complete circuits are available, the channel-mounted chips and monolithic circuits can supplement the LID's that are available. Both forms of devices can be connected with ultrasonic bonders. A substantial market exists for leadless inverted devices, and many manufacturers of hybrid-circuits eagerly await their sale.

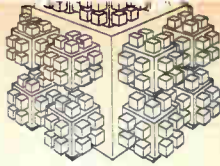

# Modular arrays—the path to single-circuit systems

New combination of hybrid-circuit and sealing techniques in analog subsystems provide the power, precision and small size needed to use large numbers of monolithic circuit chips in one package

By H.T. Melcher

Aeronautical Division, Military Products Group, Honeywell, Inc., Minneapolis

**Avionics systems** are made smaller and more reliable with integrated circuits, but every rose has its thorns. One drawback with IC's is the fact that system functions are increasing and the packaging engineer is required to cram more circuitry and power into a smaller case without lowering circuit precision or impeding circuit-design flexibility.

Such design conflicts are characteristic of analog circuits, which make up most avionics systems. A timely solution of the conflicts is the modular array of hybrid integrated circuits on the next page. It is a hermetically sealed subsystem building block for military and aerospace flight controls.

The construction allows the circuit designer to build many different analog functions with a few standard monolithic IC's, by tailoring the IC operating characteristics with precision thin-film resistors. The thin films are supplemented by power resistors and interconnections that are screen-printed on a ceramic base. The combination multiplies the power-handling capability of the circuit package by approximately five times.

This technique is expected to lead to the construction of large, sealed subsystems and eventually to single-module avionics systems built mostly of uncased monolithic chips. The array is an intermediate stage in the development of a new analog

packaging concept by the Microelectronics Group of Honeywell Inc.'s Aeronautical division.

At present, thin films that are vacuum-deposited on glass substrates are the primary base for the hybrid circuits. As other means of fabrication—ceramic or plastic-based, for example—prove acceptable, the array concept can include them.

Meanwhile, thin films are preferred because thin-film resistor networks are the most precise means of tailoring monolithic IC's. Such networks have resistance ratios that track tightly—the values of the resistors vary proportionally—over a wide temperature range. They are compatible in construction with monolithic IC's, since both are planar and extremely small in size. Batch processing makes the resistors economical and precise. The resistors are readily made to tolerances of 10% to 5%. Trimming gives resistor tolerances of 5% to 1% and extremely tight matching of ratios in the networks.

## Analog packaging conflicts

There are four major design conflicts in the packaging of microminiature analog systems.

The first conflict, the need to handle higher power in a smaller package, has been the main barrier to further miniaturization of analog systems. It is difficult to package circuit components more densely and not exceed the package's ability to dissipate the heat the components generate.

The use of two superimposed substrates hurdles this barrier. Resistors with values over 200 kilohms and high-power resistors are printed on the array's ceramic baseplate. Since the ceramic (96% alumina) has a higher thermal conductivity than glass, it acts as a heat sink for the thin-film network and also directly heat-sinks the power-handling resistors.

When glass alone is the resistor substrate, the

## The author



H. T. (Hank) Melcher has over-all responsibility for microelectronics applications in Honeywell, Inc.'s advanced systems. He is senior development engineer of the Microelectronics Group and has represented Honeywell on several industrial committees—most recently as chairman of the Aerospace Industries Association's microelectronics panel.

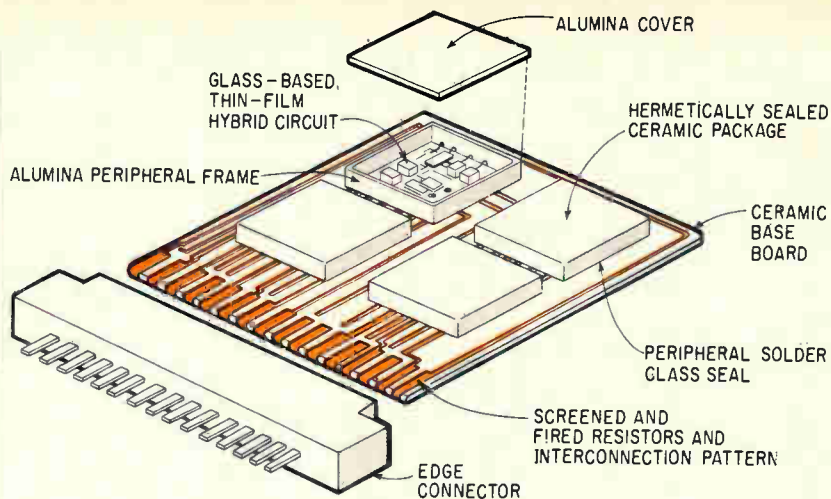

Modular hybrid-circuit array is built by sealing four ceramic frames to a ceramic base, putting thin-film circuits into the frames and then sealing the frames with ceramic covers. A base-frame assembly and an almost-completed array are seen in the photo. The circuits are interconnected with conductors (color, in drawing) that are screen-printed on the base along with power resistors and package leads.

allowable power rating, for an acceptable drift in resistor values, is four watts per square inch. That works out to an actual design maximum of about 0.4 to 0.8 watt, assuming the resistors occupy 10% to 20% of the substrate area. The remainder of the area is occupied by conductors and lands. Lands are thin-film areas to which other components are attached or electrically connected.

By the same rules of thumb, alumina allows 40 watts per square inch. In the glass and ceramic combination, maximum power is generally held to five watts per square inch of total base area—a rating at least five times as high as that of glass alone.

This also resolves a second conflict, the desirability of combining power circuitry and small-signal-processing circuits in the same package. The array, for example, allows the designer of autopilot circuitry to include the servo amplifier, a power circuit, in the same module. In this way, the array becomes a small but complete subsystem.

If the power output of the hybrid circuits is not sufficient, an alternate packaging structure may be used. Power-transistor chips can be attached directly to lands on the ceramic. Or, one or two of the sealed hybrid circuits can be left off so there is room on the ceramic base for connecting and heat-sinking transistors and other power components that are individually packaged.

Since the ceramic base forms one side of each hybrid-circuit package, it doesn't increase the size of those packages. Rather, it tends to reduce package size—multipackage assemblies are smaller because of the printed interconnections, components and package leads. The use of printed, rather than discrete components and leads, also reduces the number of wiring joints for an improvement in reliability.

The third conflict resolved is the desirability of physical symmetry in system packaging versus the

limited repetition of like functions within analog systems. Modularity, such as that obtained in digital systems through the use of standard plug-in units for repetitive functions, aids in system production and maintenance.

Although functional repetition is often absent in analog systems, the modular arrays help standardize the physical packaging format. Furthermore, they are better than conventional analog packaging for the newer systems that have a mix of analog and digital circuitry; many avionics systems already have some digital circuitry and others are being designed with digital signal processing.

Modular construction at the hybrid-circuit level also offers the advantages of larger functional units without exceeding the circuit area that is practical to fabricate and hermetically seal. The array shown has four inch-square thin-film circuits, at present a practical size for economic fabrication. However, the effective assembly and seal area is four square inches.

This is accomplished by running the ceramic-based interconnections through the package seals. Eliminating the conventional package feedthroughs, with their glass-to-metal seals, is another plus for reliability. Rupturing of feedthrough seals because of bending or strain on the flexible wire or ribbon leads is a major cause of failure of conventional, hermetically sealed packages. This failure mode doesn't exist in the ceramic-based array.

### Design flexibility

The fourth and final major conflict is the need for custom fabrication at low cost, an historic problem of analog design. Even basic, off-the-shelf linear circuits require tailoring to suit specific systems. Modification costs must be low today because the price competition is stiff in military avionics and production quantities are often small.

The array design does not affect the cost of the glass-based circuitry, nor impede the choice of

fabrication methods. Cost per function is lowered by the addition of screen printing. The printed high-value resistors are cheaper than equivalent thin-film or discrete resistors. The cost of printing the interconnections between packages is less than wiring individual packages. Packaging and sealing costs are also less, because the materials and methods are more economical than conventional packages with prefabricated feed-throughs.

Design flexibility is higher than in any other hybrid method studied. The circuit designer can choose screen-printed or deposited films, packaged or unpackaged discrete devices and monolithic IC's. Monolithic chips, which are much cheaper than packaged IC's, can be used freely because they will be operating in a sealed environment.

The use of chips means that the thin-film layout is no longer dictated by the size and lead spacing of attached packaged devices, like those in the earlier modules on the next page. The bonded wire leads of today's IC chips can be routed freely over the substrate. In the future, the chips may be face-bonded without leads directly to the thin-film conductors, eliminating the flying leads. Also, the larger area of the hermetic seals means that the designer can effectively put more chips into the package, further conserving substrate area and increasing the functional capacity of the module. Remember, he is now working at the sealed-sub-system level, rather than at the sealed-circuit level.

### Evolution of analog packaging

Since the Honeywell design is a response to the evolving problems, a brief review of analog packaging history will help explain why the design was developed.

In the past decade, packaging engineers have been challenged to devise increasingly more compact forms of packaging to counteract the escalation of avionics system functions. The great increases in the numbers of components and connections tended to make systems larger and less reliable. Wired chassis gave way to printed circuit boards which were then supplanted by welded cordwood modules and finally the pico module.

The increased density of standard components in cordwood modules posed power dissipation problems and prompted the design of lower-power circuitry assembled with miniature components in the pico module form. The pico module on the next page is a low-power demodulator-amplifier.

Ultimately, module size and component density were dictated by the amount of room that assemblers needed to weld the leads and interconnection ribbons of the pico modules. At this point, the packaging engineer could not prevent further increases in system size without a new technology.

Thin-film resistors touched off a radical departure from the time-honored discrete components. The film components reduced volume and eliminated large numbers of wires and joints. The resistance ratios in resistor networks tracked well over the military temperature ranges because the batch proc-

essing produced homogeneous sheets of resistor materials. A significant cost savings—25% less cost than pico modules—became possible.

### Problems with hybrids

Two earlier forms of hybrid modules are on the next page. One has a half-inch-square circuit on each side of an aluminum heat sink. The other has five circuits on each side. The circuits are individually mounted and interconnected by common module leads which pass through the heat-sink assembly and are insulated from it. This form of hybrid module is still made today.

These designs have two drawbacks. First, they are encapsulated with epoxy, not sealed. Second, they are limited in power to the four watts per square inch rating glass.

The epoxy mechanically protects the packaged devices attached to the thin-films, but the circuits

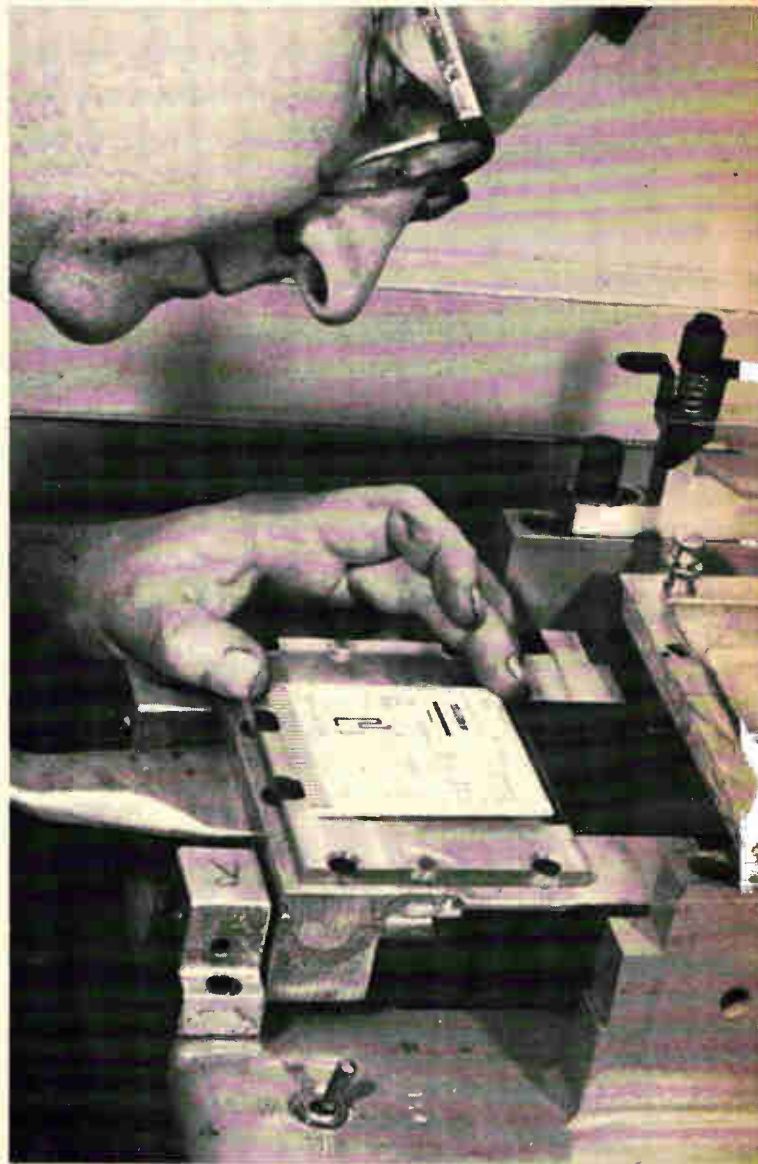

Ceramic bases are screen-printed by forcing resistive and conductive compounds through a patterned mesh of stainless steel. The light lines on the substrate are conductors and the dark lines are resistors.

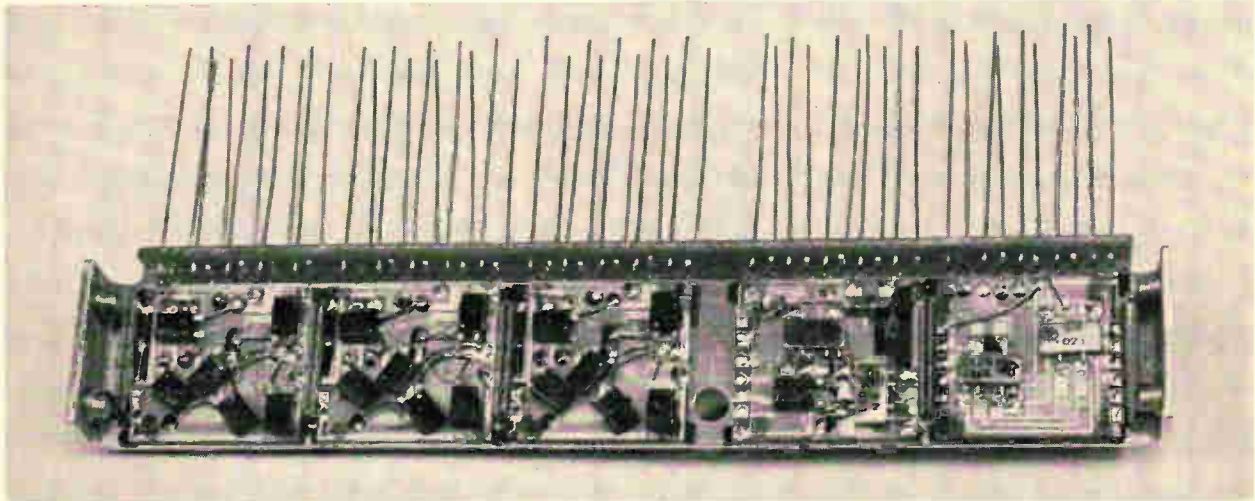
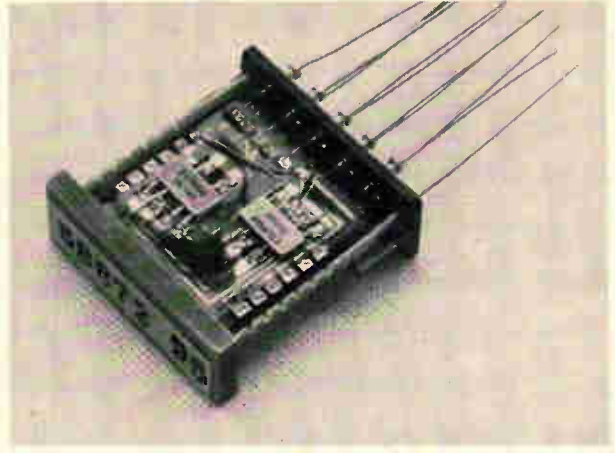
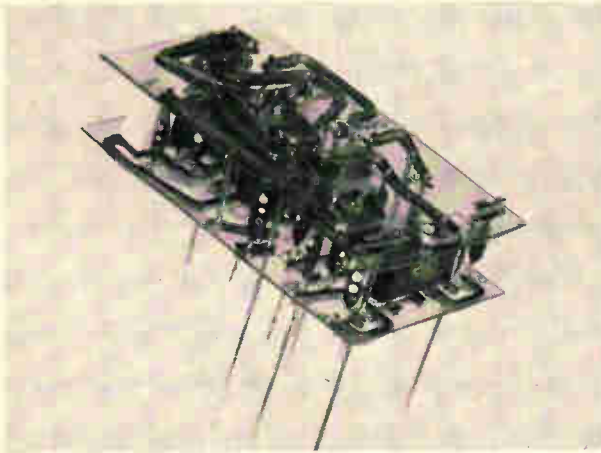

Three earlier stages in analog microminiaturization. At the top left is an inch-long pico module, made by welding, interconnection ribbons to the leads of flat-packaged transistor pairs, miniature resistors and solid tantalum capacitors. The other two modules are made of half-inch-square thin-film hybrid circuits, mounted on each side of an aluminum heat sink. The module at the top, right has two circuits. the lower one has 10 circuits. These modules were encapsulated, not hermetically sealed.

are only suitable for benign environments. Thin-film resistors must be hermetically sealed to remain stable in the adverse environments faced by most military and aerospace flight controls.

#### Sealed ceramic package

The power limit can be relieved by several methods of making resistors on ceramic, but the glass-based resistors are often the only type stable and precise enough for military avionics.

So the packaging engineer faced a dilemma: seal the entire module in a large, costly, prefabricated case, with the disadvantages already discussed; or individually seal the circuits or networks in a small case and use these as components of a conventional module or in a ceramic-based functional assembly. Such assemblies have been designed by Honeywell's Microelectronics Group. Circuit packages with solderable or weldable feedthrough leads could be mounted on ceramic bases like the bases of the present array. But that construction does not completely eliminate the problems of prefabricated packages and feedthrough seals.

Honeywell's first solution to those problems came on the single-circuit level with the package at the right. Like the modular array, it has printed resistors and conductors on the ceramic base and encloses the circuit in a sealed package made of 96% alumina. The inside of the frame is one inch square. An extensive investigation of ceramics and ceramic-metal (cermet) compounds for making conductors, resistors and seals preceded this design.

Package fabrication begins with printing and firing of the package base. The printing formulations are similar to those sold commercially for the production of screen-printed hybrid circuits. The top of the frame and the perimeter of the cover are metallized with refractory metals that are subsequently gold plated. The bottom of the frame is coated with solder glass, a type of glass used as a high-temperature sealant. When the frame is placed on the base and fired, the solder glass flows out and closes the gaps between the frame and base.

The thin-film circuit is preassembled. Chips and other discrete components are mechanically attached to the thin-film substrate with epoxy, solder or gold-silicon alloying, depending on the nature of

the device [see the two preceding articles for details on how hybrid IC's can be made]. The circuit is inserted in the frame and attached by soldering the glass substrate to the package base. The two substrates are electrically connected by gold-alloy ribbon that is thermocompression-bonded to the aligned land areas on the glass and ceramic.

The package is sealed with a square lid, after the cover perimeter has been pretinned by wave-soldering. A peripheral-contact heater is applied to the cover to remelt the solder, which readily wets the gold plate on the frame. No flux is used. The package base is mounted on a cold plate during this sealing operation, to keep the thin-film cool.

These soft-solder seals are another intermediate step in the full development of the packaging concept. Improved sealing equipment is being developed. It will seal two package frames simultaneously in a controlled atmosphere. The seals will be high-temperature brazes, eutectic alloys of gold and silicon or germanium that are stronger than solder. These alloys may eliminate the need to metallize the ceramic surfaces. Plans are to seal packages as large as 1½ inches square, by means of contact resistance heaters that will heat the seal area to around 400°C without heating the circuit over 150°C.

To make larger seals without overheating the circuit will require a highly localized method of heating the seal area. A technique such as infrared spot heating may be required.

### Sealed systems

The single-package fabrication and sealing technique have already been extended to the modular-array package. The arrays can be plugged into a motherboard to form a system. A planned and logical extension of the technique, pictured above, would be suitable for large subsystems and eventually single-module systems. The goal is to assemble up to 60 circuits, mostly monolithic chips, on a three-inch-square substrate. The system would be designed as a functional whole, rather than individual units. The potential of further savings in cost and weight, and further improvements in system performance and reliability are stimulating this development.

It is not practical to build such an assembly today. Equipment to make the required three-inch-square seals has not been developed. Nor have methods been established for preventing prohibitively costly reject rates during assembly of such large

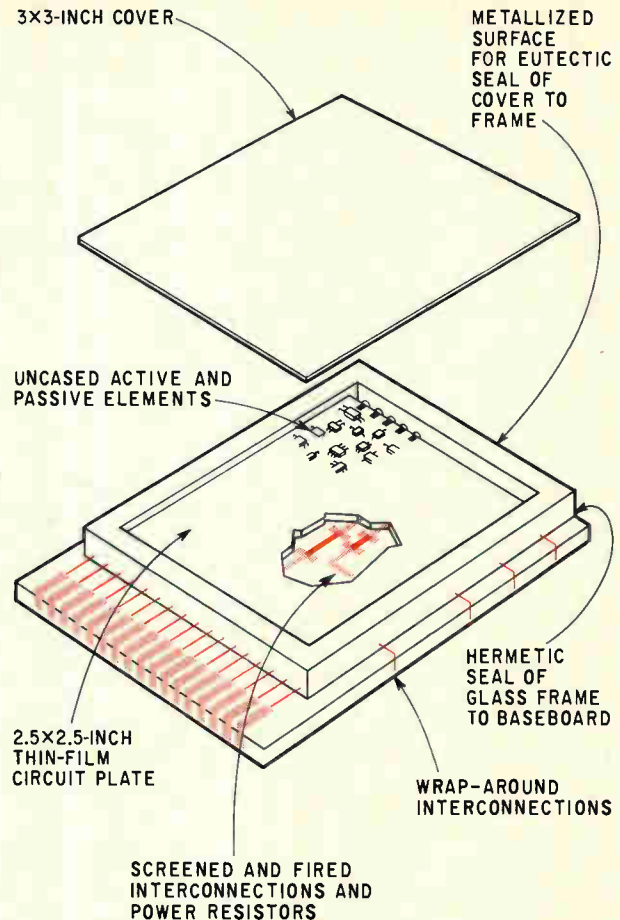

Package planned for large subsystems. Although nine times as large as the inch-square packages already developed, this package can be made the same way. Honeywell hopes to put 60 analog circuits into it.

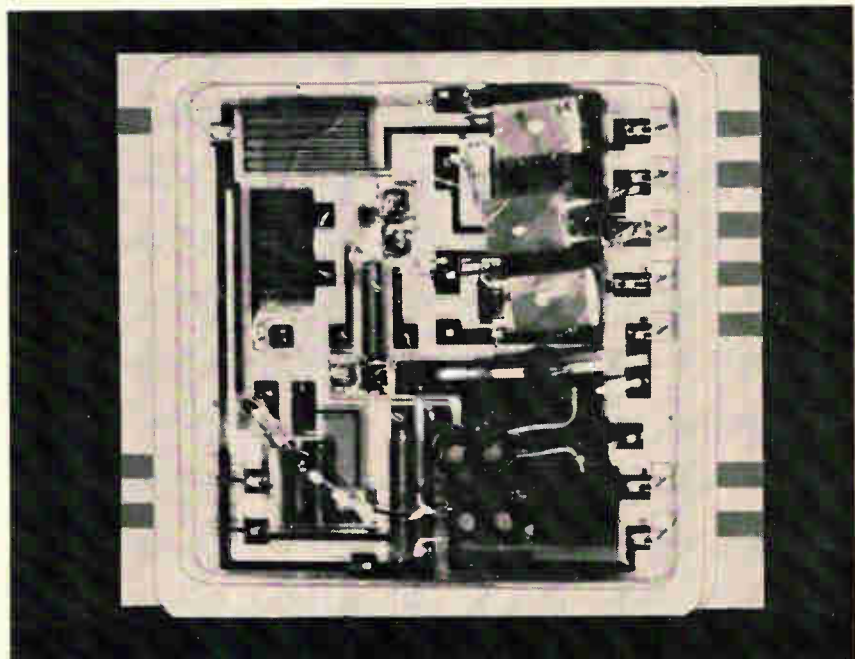

Predecessor of the modular array was this single circuit package. It also has power resistors and conductors printed on a ceramic base and a hermetically sealed ceramic frame that is an inch square.

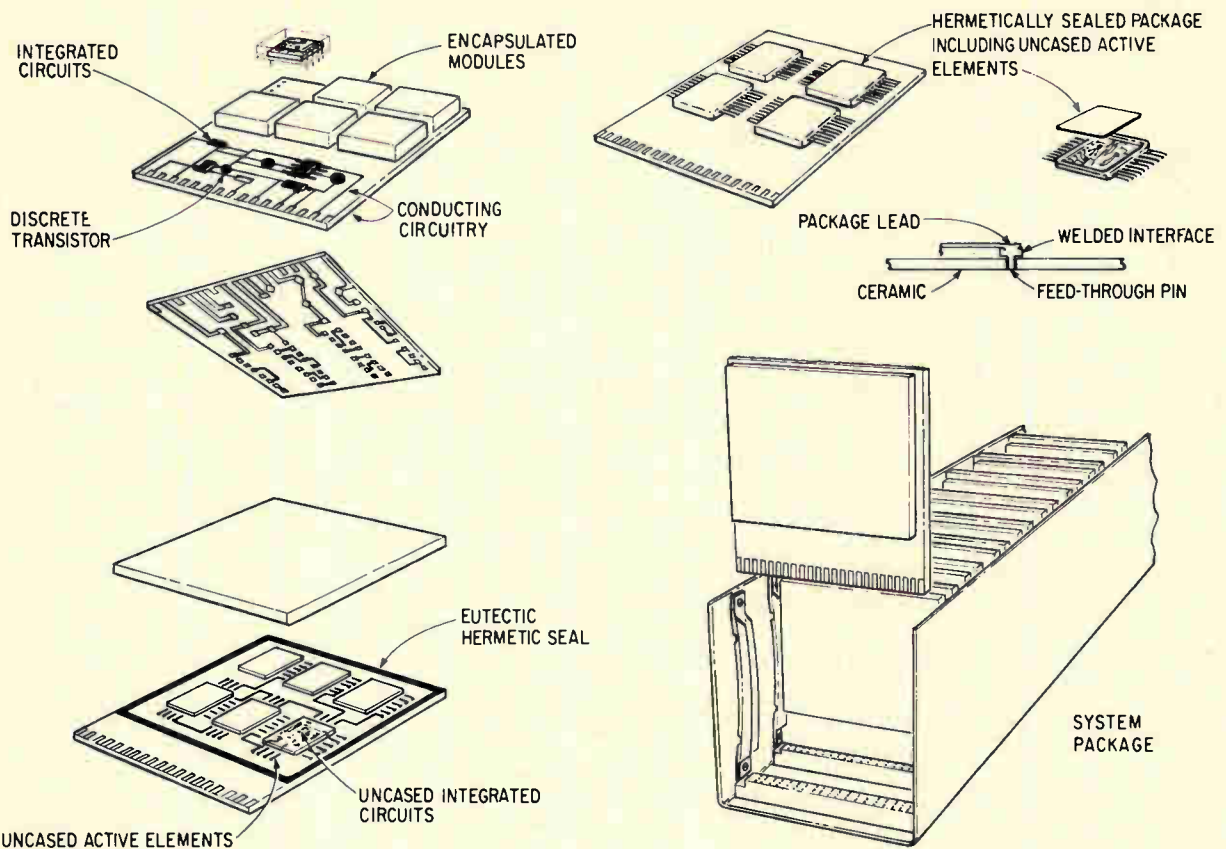

Alternate methods of making hybrid-circuit arrays are to plug sealed packages into a ceramic base (upper left), seal the circuits under one cover (lower left), or weld ribbon leads to feedthrough pins (upper right). The respective power ratings per square inch are 4 watts, 50 watts and 10 watts. Each type can fit into the system package shown.

hybrid circuits.

Thin-film deposition techniques are adequate. Honeywell can, at present, deposit and calibrate resistor networks  $2\frac{1}{2}$  inches square. This capability offers some interim techniques. For example, related networks can be deposited on a glass plate and be interconnected by extensions of their input-output land areas. Hybrid circuits can be assembled on such arrays to establish assembly capability and controls over causes of rejects.

Groups of individual circuits have been made on a  $2\frac{1}{2}$ -inch-square substrate, but they have to be cut apart for sealing.

Another intermediate technique for sealing the entire assembly is a clamshell-type of metal enclosure that is welded or soldered around the lips of the two half shells. The feed-through problem becomes minimal because only the subsystem's inputs and outputs are needed rather than those of all the individual circuits.

If a circuit on the large glass plate is faulty, the circuit can be electrically isolated by severing the interconnecting lands. A functional replacement can be overlayed on the substrate and electrically connected to the adjoining circuits with flying leads.

### Future possibilities

Glass will probably be used as the primary substrates of these arrays for at least several years, because of resistor needs and because of the preci-

sion conductor patterns required for future face-down bonding of monolithic-IC chips.

All-ceramic substrates with screened resistors can readily be substituted for the glass-ceramic combination if any one of several advances are made: if screening improves in precision and layout efficiency to near that of photoetched films; if new types of linear IC's make tailoring no longer critical; or if circuits are designed that do not require tailoring with outboard precision resistors.

If screen-printed resistors do become adequate, a chip-and-finger type of interconnection would become practical for analog systems. The interconnection wiring is etched from an aluminum film that was deposited or laminated on a plastic film. Holes are etched in the plastic at the locations where the ends of the film interconnections are to be bonded to the terminal lands—also aluminum—on the IC chips. The etching leaves the ends extended like fingers over the holes. The fingertips are then bonded to the chips. A similar type of assembly is now used by Honeywell to make digital subsystems.

Whether or not these possibilities prove acceptable, the developments to date have already filled out the packaging engineer's toolbox. He can raise circuit power, use unencapsulated devices and seal relatively large modules. He can expect to build single-module systems that eventually will be low enough in initial cost and reliable enough to be considered nonrepairable, throwaway items.



# Now that we're sure you like the low leakage of our solid tantalum capacitors.

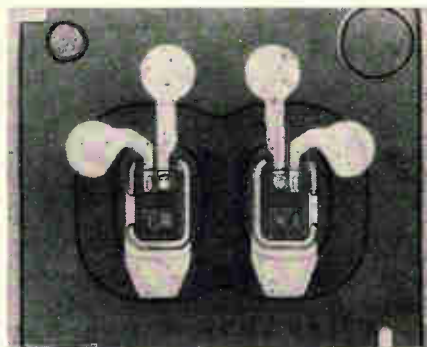

## Here's something else we think you'll like:

This totally new type of Monolithic Dielectric Isolation Dual Transistor features really close transistor matching: the UNION CARBIDE ELECTRONICS 2N4042-45 Series. Thanks to our new method of collector isolation, you can build differential amplifiers without any worry about thermal transients.

There's nothing miraculous about developments like this. Not if you're dedicated to research as we are. For it's through research that we continue to develop a growing family of products for electronics. Such as: one of the first

satisfactory semiconductor injection lasers; the largest U.S.-made line of single crystal products; and the best, most reliable, solid tantalum and film-foil capacitors you can find today.

You'll find many more innovations coming from us. All aimed at problems on the frontiers of electronics. All backed by the technology of Union Carbide.

For data on dual transistors, write for spec sheet #2N4044. Dept. E-23, Linde Division, Union Carbide Corporation, 270 Park Avenue, New York 10017.



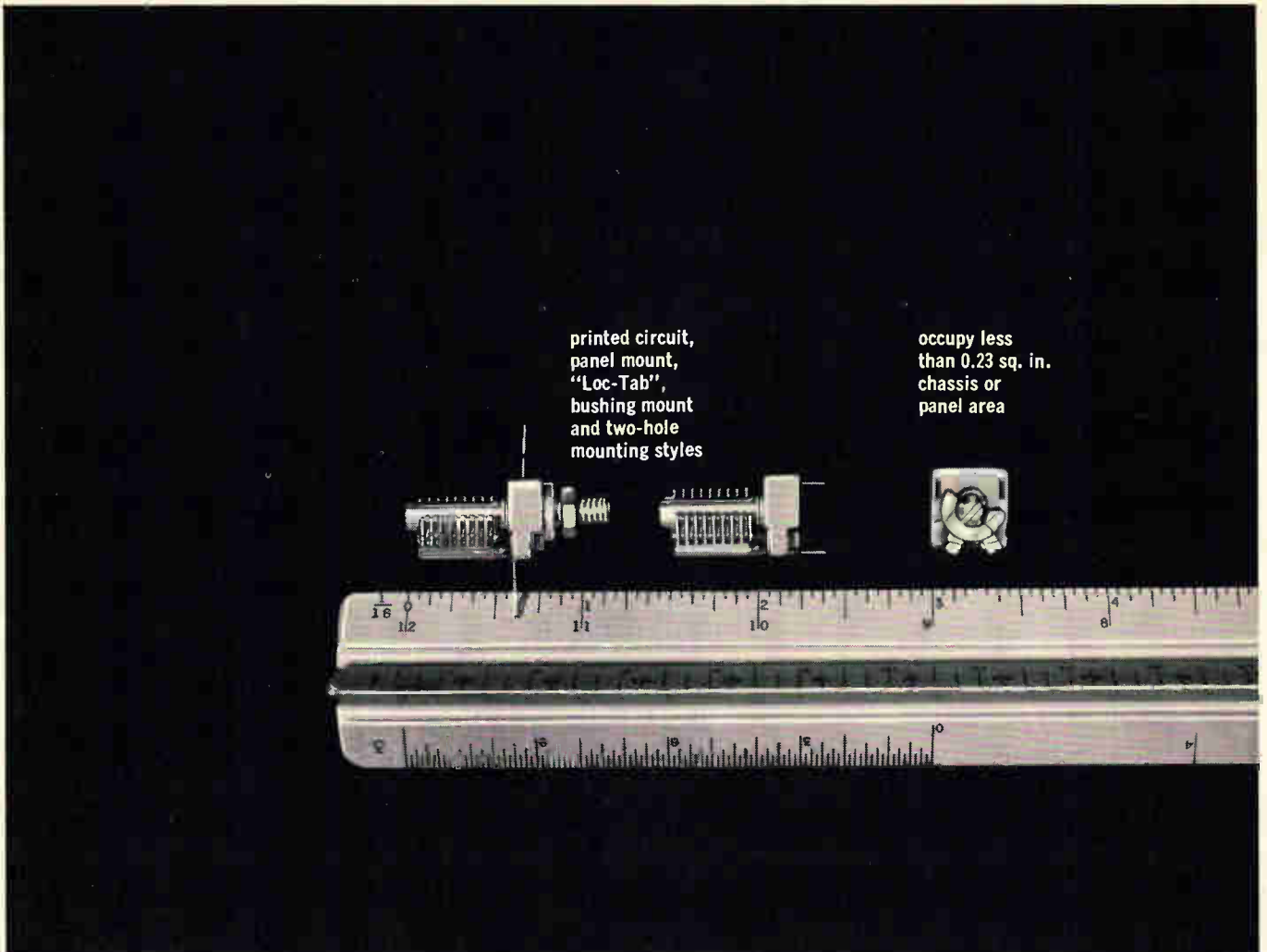

printed circuit,  
panel mount,  
"Loc-Tab",  
bushing mount  
and two-hole  
mounting styles

occupy less  
than 0.23 sq. in.  
chassis or  
panel area

## THESE TINY AIR VARIABLES SOLVE BIG DESIGN PROBLEMS!

Cut costs—improve performance—and save valuable space with these tiny sub-miniature air variable capacitors! "U" requires less than 0.2 square inch for chassis or panel mounting . . . types "UA" and "UB" require less than 0.23 square inch! Unique precision design with stators and rotors machined from one piece of solid brass, provides outstanding mechanical stability and uniformity. High "Q"—greater than 1500 at 1 Mc. High torque-to-mass ratio—2½ to 10 inch-ounces. Exceptionally low temperature coefficient—plus  $45 \pm 15$  PPM/°C. Provides absolute freedom from moisture entrapment found in trimmer capacitors of the enclosed or solid dielectric type. All metal parts silver-plated. Ceramic is Grade L-423 steatite, or better. Exceptionally uniform delta C and voltage characteristics. Choice of wide, double-pierced or printed circuit style terminals. Single-section models available in "Loc-Tab"; 2-Hole; Printed Circuit; and #10-32 Bushing Mount Types—Differential and Butterfly models available in Printed Circuit Types.

**TYPE "V" MINIATURES**—Slightly larger than the Type "U" series, the "V" miniatures offer all of the design, construction and performance features of the "U"s plus higher capacity with little increase in mounting area requirement. Available in Single Section types for printed circuit or panel mounting.



**"U-LC" TUNERS**—Combines precision machined Type "U" capacitor with air-wound, silver-plated inductor. Offers low cost, compact tuneable L-C circuit with excellent "Q" and temperature stability!



**DETAILED CATALOG AVAILABLE**—In addition to the variable capacitors described above, Johnson also manufactures other electronic components. For complete specifications and current prices, write for Components Catalog 984.



**E. F. JOHNSON COMPANY**

3332 TENTH AVE. S.W. • WASECA, MINNESOTA 56093

# Here's what insulation of MYLAR® meant in: ballast transformers...relays

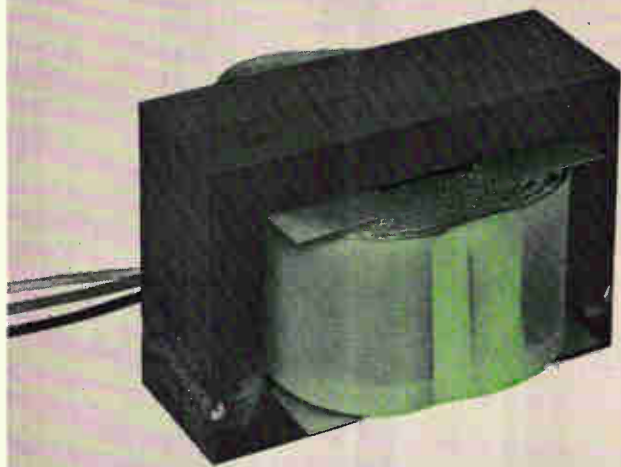

- tripled life of guarantee against failure
- upgraded rating to Class B



- 50% increase in thermal range
- smaller coil
- longer coil life

Whatever your insulation needs—motors, bus bars, capacitors, relays, transformers, wire and cable—chances are good you can benefit from the ability of MYLAR\* to:

- improve insulation performance
- lower costs
- provide greater design capability

This is because MYLAR offers you a unique combination of properties in thin, flexible film form. With MYLAR you can replace heavier, bulkier insulation materials to design smaller, lighter components which have greater insulation resistance.

For the same reason, it's possible to lower insulation costs because often less MYLAR is required for a given insulation value.

Also, the excellent working strength of MYLAR can mean lower reject rates and

faster production speeds for you.

## New "Fact File" available!

To get started on your evaluation of MYLAR, send for your copy of the "Fact File". This compact reference piece contains complete technical data, cost comparisons of MYLAR versus other insulation materials, film samples and information on several recent applications. Write Du Pont Co., Room 2796C, Wilmington, Delaware 19898. (In Canada: Du Pont of Canada Ltd., P.O. Box 660, Montreal, Que.)



\*DU PONT'S REGISTERED TRADEMARK FOR ITS POLYESTER FILM.

**17...**

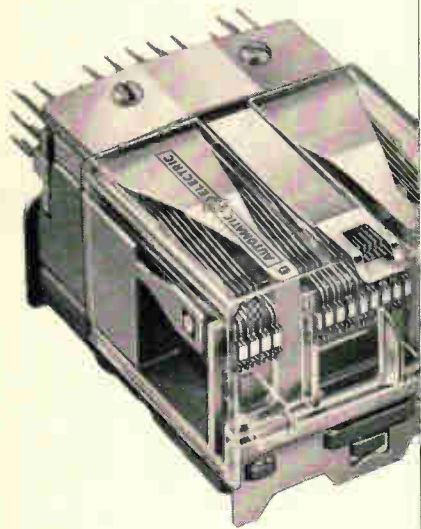

**34...**

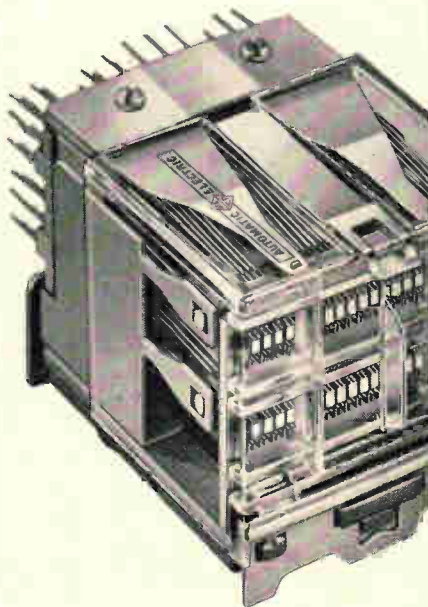

**51...shift  
or latch!**

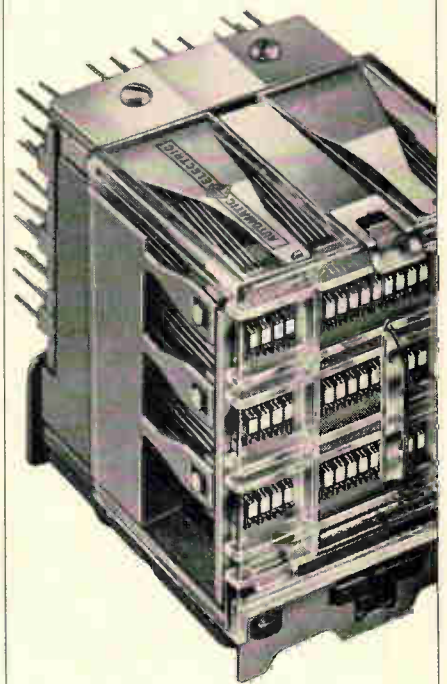

Assuring the simultaneous transfer of circuits in a multiple-relay group is one of the trickier problems faced by electrical and electronic engineers. AE's happy solution is the WQA Relay—the first industrial-control component specifically designed for uniform transfer of up to 51 circuits.

The modular construction of the WQA permits one, two or three rows of contact forms, each with a capacity for 17 circuit transfers. Unique, compact design saves valuable mounting space, replacing 4 or more "general-purpose" relays. Remarkably sensitive, even the largest pile-up requires less than 6 watts input. Continuing tests show a life expectancy of over 800 million operations without readjustment.

If you use latching relays, investigate the new WRM. It has

all WQA features plus a special one of its own. When pulsed on one winding, remanent magnetism keeps the WRM relay latched without power consumption until it is restored by a second pulse to its release winding.

For full information, ask for Circular 1957. Write the Director, Control Equipment Sales, Automatic Electric, Northlake, Illinois 60164.

***AUTOMATIC ELECTRIC***  
SUBSIDIARY OF  
**GENERAL TELEPHONE & ELECTRONICS GTE**

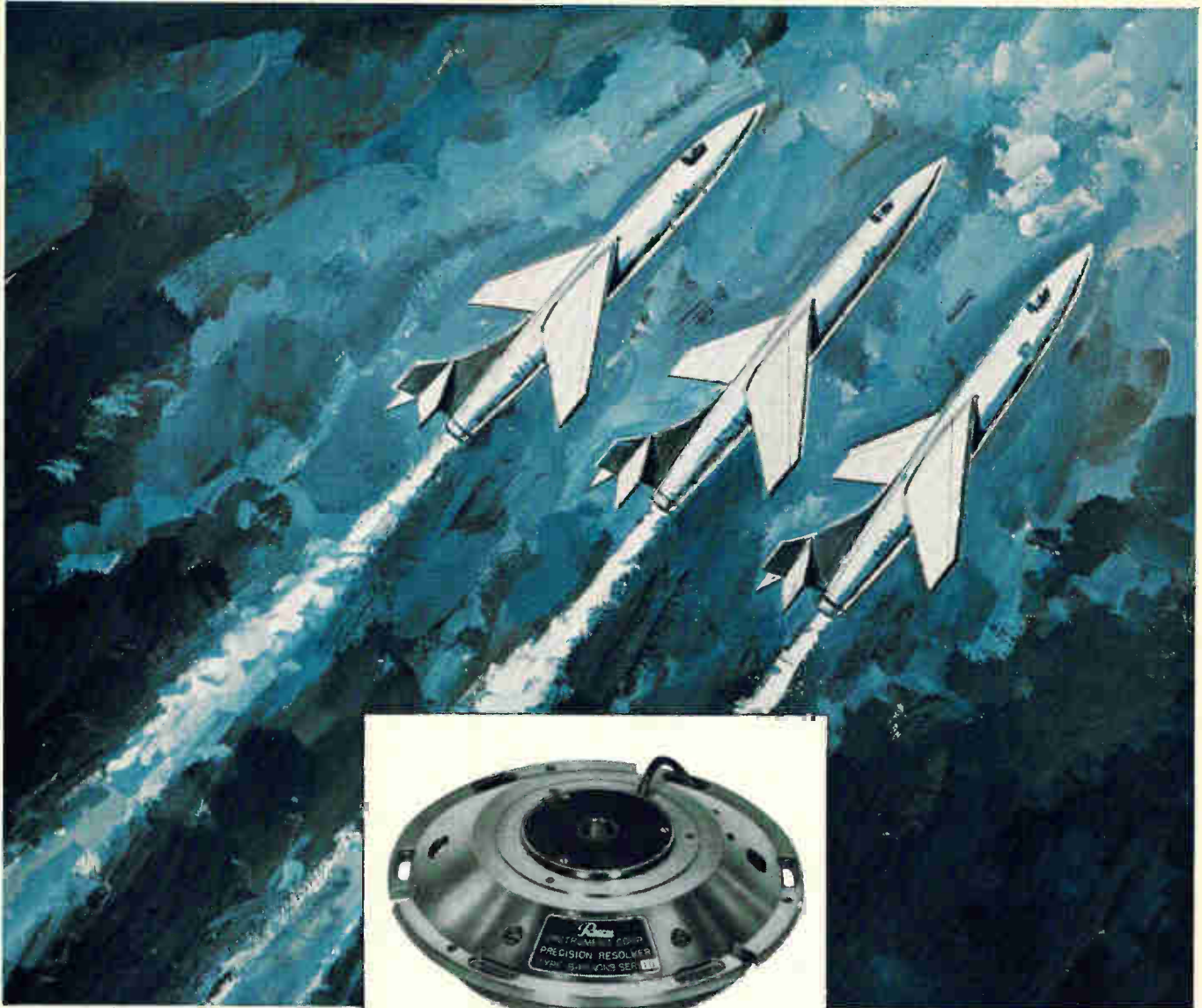

A Reeves Precision Pancake Resolver

## THIS SMALL PART plays a big role in your project

The Pancake Resolver is one of over a million Reeves components operating in almost every major government and industrial project in work today.

The actual Resolver shown above is a precise angle transmission element—naturally lending itself to high-accuracy angle digital encoding. It's one model in the fullest line of precision components you can find.

Our Pancake Resolvers and Synchros, for instance, give you 10-second accuracy with single speed data transmission. Multi-speed units if you need them, up to 64 speed with 5-seconds-of-arc accuracies. Beryllium or aluminum housings.

We're ready with precision resolvers and synchros, or gyros—any part you need, in any configuration you require. Single, dual or multi-speed accuracies to your desired seconds of arc, every type proven in use, with housings to suit your purpose, whether your work's in production or still on the

design drawing board.

The usefulness of Reeves full line of components is limited only by the aims of your project. Help assure your project's objectives by finding out about our components now. Write our Sales Dept., or call us at: 516-746-8100, Ext. 510.

**Reeves**®

**INSTRUMENT COMPANY**

Garden City, New York / Division Dynamics Corporation of America **DCA**

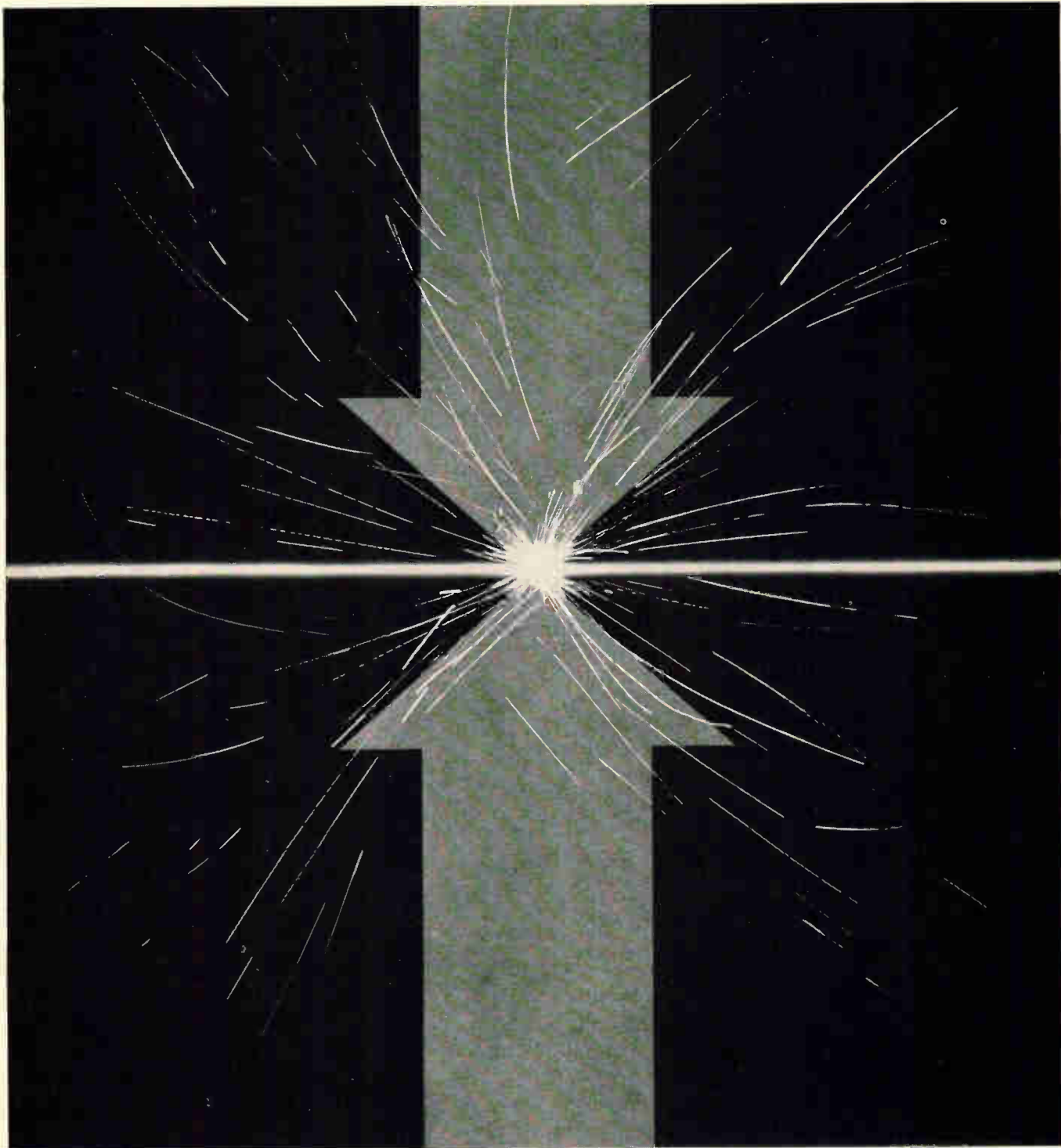

## A new magnitude of power in cw gas lasers

Perkin-Elmer presents a molecular gas laser generating 10 watts cw power at a wave-length of  $10.6\mu$ . This new continuous flow gas laser operates at unusually high efficiency. Available on 90 days'

delivery, the new Model 6200 Laser is priced at \$8,950, f.o.b. Norwalk, Conn. Write for details to Electronic Products Division, Perkin-Elmer Corp., 751 Main Avenue, Norwalk, Conn.

# PERKIN-ELMER



## A dour source of power

Happiness to some is sufficient lungpower to support a stirring skirl. To some members of the test engineering clan, it is stable power to support an RFI determination. Among the latter, many a dour face has brightened lately to performances given by Sierra's Model 470A power signal sources.

This powerful pair of Sierra sources delivers stable 55 to 80-watt power across frequency ranges of 200–500 mc and 470–1000 mc. Frequency stability is 0.005% per ten minutes below 500 mc; 0.002% per ten minutes above. Modulation can be provided from an internal 1 kc square wave, or from an external pulse source.

Other features include: 1) direct-reading, two-range wattmeter, 2) single-knob frequency tuning, 3) oscillator current metering, 4) automatic power tube protection under all load conditions, and 5) easy power tube changing (takes about two minutes). You can enjoy this highland performance at a thrifty lowland price of \$2,650 for each model.

The product bulletins come scot-free. Write to Sierra/Philco, 3885 Bohannon Drive, Menlo Park, California 94025.

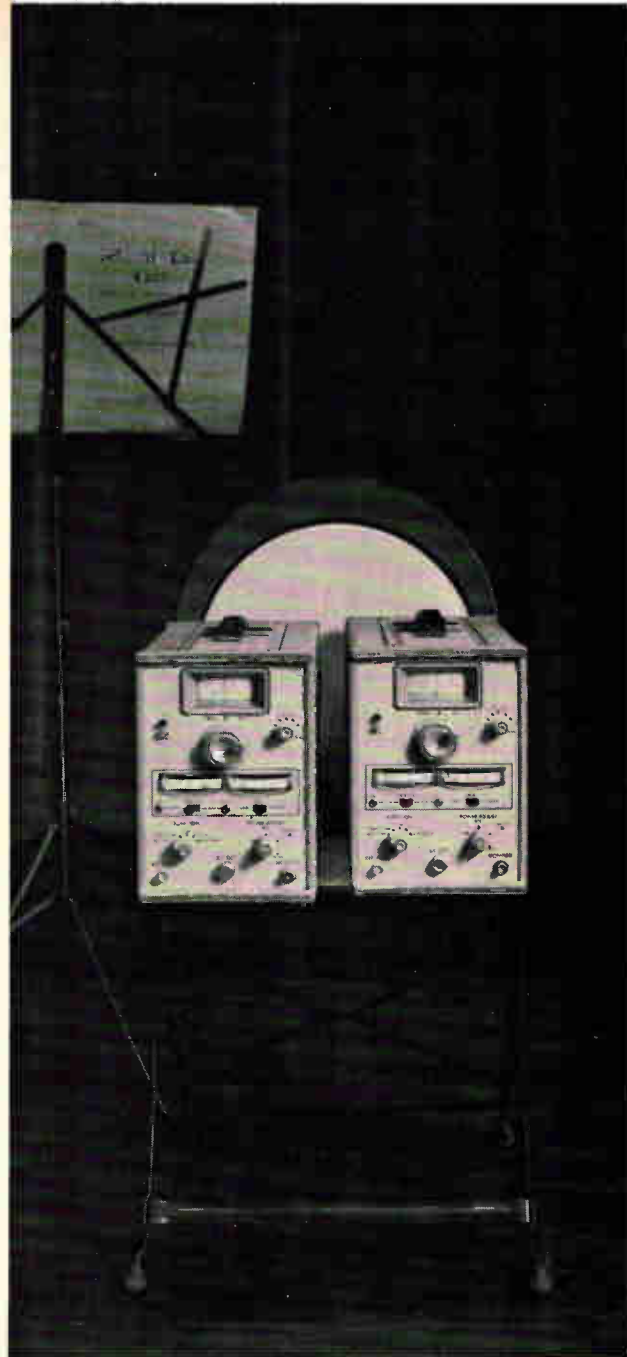

## A powerful pair from Sierra

**SIERRA ELECTRONIC DIV.**

OF

**PHILCO**

A SUBSIDIARY OF *Ford Motor Company*

Circle 127 on reader service card

# First universal portable spectrum analyzer

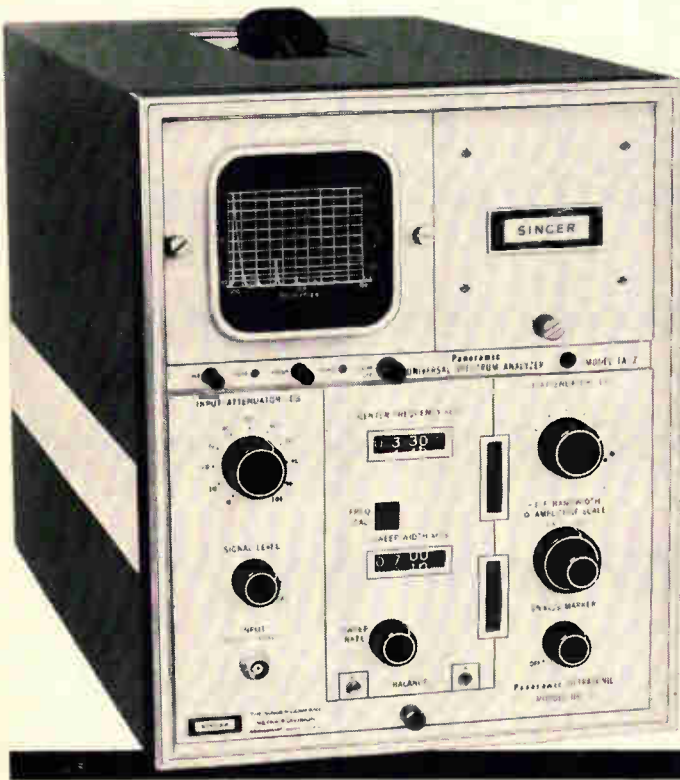

- BATTERY OR AC OPERATION!
- RUGGED ALL-TRANSISTORIZED!
- ALSO RACK MOUNT STYLE!

Panoramic swept band Spectrum Analyzer Model TA-2 combines solid-state dependability, compactness, light weight, battery operation, and modular plug-in construction to provide this first fully portable, truly universal spectrum analyzer.

The TA-2 Spectrum Analyzer provides directly calibrated level-vs-frequency analyses on the CRT display. Broadband "quick-look" and highly resolved narrow band scans are displayed. A common main frame and interchangeable plug-in modules are used. Precise dynamic on-location analyses can be made of vibration, noise, RFI, and communications signals.

Rugged, transistorized, and completely portable, the TA-2 operates from internal rechargeable battery or AC line. A minimum of four hours of battery operation between charges is obtained. Traces are bright enough for convenient outdoor use. All modules feature high sensitivity, excellent resolution, and sweep stability. Dy-

namic range extends to 60 db. Modular, highly reliable etched circuit-card construction provides minimum downtime.

Model RTA-5 rack mount version with 5" CRT and standard camera mount bezel accommodates the same plug-in modules for laboratory, plant, and systems installations.

**TA-2 features:** Light and compact—8<sup>3</sup>/<sub>4</sub>"w x 11" h x 18" d; approx. 40 lbs. with module ■ Calibrated, adjustable center frequency with digital readout ■ Linear and 40 db calibrated level scales ■ Interchangeable plug-in modules for present and future needs ■ Built-in markers for self-checking calibration ■ Simplified operation—few controls, many pre-set for optimum analysis ■ Future modular units will extend TA-2 and RTA-5 versatility.

For complete details and applications assistance, contact your nearest METRICS representative.



Available Modules	OFF THE SHELF DELIVERY			
	AR-1 (Sonic)	AL-2 (log-scan sonic)	UR-3 (Ultrasonic)	VR-4 (Video)
Frequency Range	20-35,000 cps	20-35,000 cps	100 cps-700 kc	1 kc-27.5 mc
Sweep Widths	0.2, 1, 5, 20 kc	0.2, 1, 5, 20 kc; 25-25,000 cps log	adjust. to 0-400 kc	adjust. to 0-5 mc
Resolution	Automatic optimum to 25 cps		adjust. to 100 cps	adjust. to 200 cps
Residual distortion	All unwanted products at least 60 db down			-50 db
Sensitivity	30 μv full scale deflection			

Motor vibration on 0-5 kc sweep. Resonant frequencies and amplitudes are easily read (log amplitude). Narrow band scans provide greater resolution and accuracy.

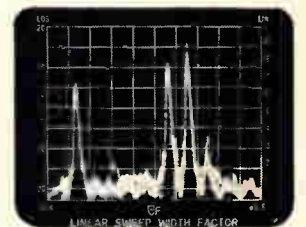

## THE SINGER COMPANY METRICS DIVISION

915 PEMBROKE ST., BRIDGEPORT, CONNECTICUT  
PHONE (203) 366-3201 • TWX 710-453-3483

Design and production of PANORAMIC • SENSITIVE RESEARCH • EMPIRE • GERTSCH Instruments for measurements

P-66-2B



## THIS IS DEUTSCH COUNTRY!



**Way out there where there ain't no air...** Deutsch hermetic plates ride herd on your space commands... minimize your mavericks in wide, w-i-d-e open spaces with use-proven Deutsch designs! **Hot, hot days and cold, cold nights?** Radiation and thermal shock can cause electrical stampedes, but not with Deutsch. Gold plating, Silicone interfaces, and total hermetic sealing head 'em up and move 'em out! Toting high-caliber receptacles, Deutsch spaceplates have a leak rate of less than .001 micron cu ft/hr at one atmosphere differential. **Show-down at the A-OK Corral!** Ranging through space, or bedded down in your vacuum chamber, Deutsch quality and 100% inspection give you Certified Grade A Prime performance! Tighter than a new holster, Deutsch spaceplates can shrug off LOX,

sneer at thin air, and gun down corona problems. **The Deutsch brand means pampered plugs!** No saddle-sore signals with the superior Silicone inserts used in Deutsch fully environmental mates. These miniature plugs with crimp type, insertable-removable contacts wrangle complete sealing around the rangiest of wires... won't let no air out, either! **Rough and tough environments a problem?** Head 'em off at the pass with Deutsch! You name it, we'll track it down.

*Need fast draw delivery? Round up your local Deutschman, pardner. Pronto!*

# DEUTSCH

ELECTRONIC COMPONENTS DIVISION • Municipal Airport • Banning, California

ADVANCED SPECIFICATION MINIATURE ELECTRICAL CONNECTORS



# Silicone greases solve unique problems of moisture, corrosion, temperature and contamination

Silicone greases have many unique properties that make them perform when other types of greases fail. Silicones are chemically inert and therefore compatible with most materials. They are also usable from  $-100^{\circ}\text{F}$  to  $450^{\circ}\text{F}$ , and maintain the same viscosity without solidifying or melting. They are hydrolytically stable and water repellent. Silicones also resist oxidation and gumming. And they exhibit low evaporation and bleed loss. Here are some examples of how industry takes advantage of these unique silicone properties:



Inert silicone grease fills joints of explosive separation system for space vehicles. Prevents entrance of liquid air if seals or bonds leak. Grease is easily applied.

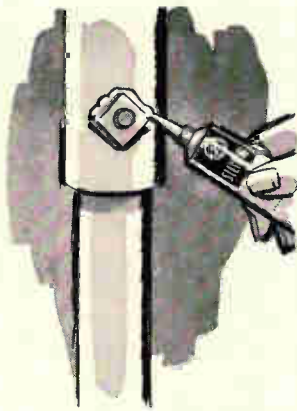

Outdoor lighting fixtures used galvanized bolts that corroded badly in a year. Thin coat of silicone grease resulted in zero corrosion, permitting bolts to be removed.

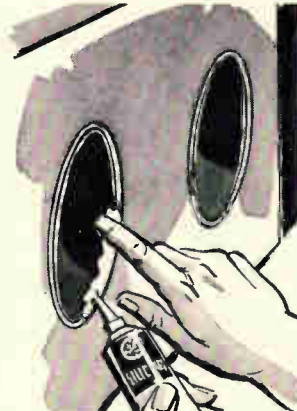

Grease film is applied to organic rubber O-rings on gloved box. Box must be leak-tight to prevent spread of radioactivity. O-ring life doubled, saving replacement work.



Rotor for a watt-hour meter is permanently lubricated with silicone grease. Six years and one million meters later, not one case of failure due to grease breakdown has occurred.



A small amount of silicone grease is used to fill connector plugs for down hole oil well equipment. Petroleum greases failed at  $400^{\circ}\text{F}$  and washed out. Silicones protect against salt water.



Silicone grease is applied to the cutouts in the thrust bearings of a turbo drill. The grease prevents adhesion to a rubber surface and also provides corrosion protection in service.

Silicone Products Department, Waterford, New York

**GENERAL  ELECTRIC**



Silicone Greases are available from these distributors:

- ALABAMA**  
ARGO and COMPANY  
7 — 18th St., SW, Birmingham
- ARIZONA**  
ELECTRICAL SPECIALTY COMPANY  
120 S. 29th St., Phoenix  
R. V. WEATHERFORD COMPANY  
9310 N. Central Ave., Phoenix
- CALIFORNIA**  
ELECTRICAL SPECIALTY COMPANY  
2820 E. 12th St., Los Angeles  
ELECTRICAL SPECIALTY COMPANY  
213 E. Harris Ave., S. San Francisco  
R. V. WEATHERFORD COMPANY  
6921 San Fernando Rd.  
Glendale 1  
R. V. WEATHERFORD COMPANY  
3240 Hillview Ave., Palo Alto
- COLORADO**  
ELECTRICAL SPECIALTY COMPANY  
2026 Arapahoe St., Denver 5
- CONNECTICUT**  
R. H. CARLSON COMPANY, INC.  
7 Bruce Park Ave., Greenwich
- DISTRICT OF COLUMBIA**  
READ PLASTICS, INC.  
317 Cedar St., NW, Washington 12
- FLORIDA**  
GULF SEMICONDUCTORS, INC.  
129 Almeria Ave., Coral Gables 34  
2733 Scarlet Rd., Winter Park
- ILLINOIS**  
FEDERAL INSULATION  
549 W. Randolph St., Chicago 7  
J. J. GLENN & COMPANY, INC.  
605 W. Washington Blvd.  
Chicago 7
- INDIANA**  
HYALINE PLASTICS CORPORATION  
1019 N. Capitol St., Indianapolis
- IOWA**  
PLASTIC SUPPLY INC.  
512 S.W. 9th St., Des Moines  
P.O. Box 1482
- KENTUCKY**  
GENERAL RUBBER & SUPPLY CO.  
3118 Preston Hwy.  
Louisville 40213
- MASSACHUSETTS**  
NORTHEAST CHEMICAL COMPANY  
581 Boylston St., Boston 16
- MICHIGAN**  
F. B. WRIGHT COMPANY, INC.  
9999 Mercier St., Dearborn
- MINNESOTA**  
D. A. SCHULTZ COMPANY  
801 S. E. 8th St., Minneapolis
- MISSOURI**  
D. A. JAMES COMPANY  
911 St. Charles St., St. Louis 1  
REGAL PLASTIC SUPPLY COMPANY  
1735 Main St., Kansas City
- NEBRASKA**  
REGAL PLASTIC SUPPLY COMPANY  
2324 Vinton St., Omaha
- NEW YORK**  
CHAMBERLIN RUBBER COMPANY  
455 E. Main St., Rochester 14604  
CHAMBERLIN RUBBER COMPANY  
210 Marcellus St., Syracuse 4  
PUNT, INC.  
160 Woodbine Ct., Box 99  
Floral Park
- OHIO**  
THE PHILPOTT RUBBER COMPANY  
2077 East 30th St., Cleveland 15  
PARKWAY PRODUCTS, INC.  
1230 W. 7th St., Cincinnati 45203
- OREGON**  
ELECTRICAL SPECIALTY COMPANY  
2360 N.W. Quimby St., Portland 10
- PENNSYLVANIA**  
SMITH OF PHILADELPHIA  
Second & Somerset St.  
Philadelphia 33  
SPECK-MARSHALL COMPANY  
P.O. Box 110, Nichol Ave.  
McKees Rocks 15136
- TEXAS**  
HOUSTON INDUSTRIAL SUPPLY CO.  
P.O. Box 52507, 1902 Bell Ave.  
Houston 52  
LAWRENCE ELECTRONIC COMPANY  
P.O. Box 20676, 3422 Cridelle,  
Dallas 20
- WASHINGTON**  
ELECTRICAL SPECIALTY COMPANY  
2442 First Ave., S., Seattle
- WISCONSIN**  
R. J. WITTENBURG COMPANY  
1338 W. Atkinson Ave.  
Milwaukee 53206

## The Greeks had a Word for it...

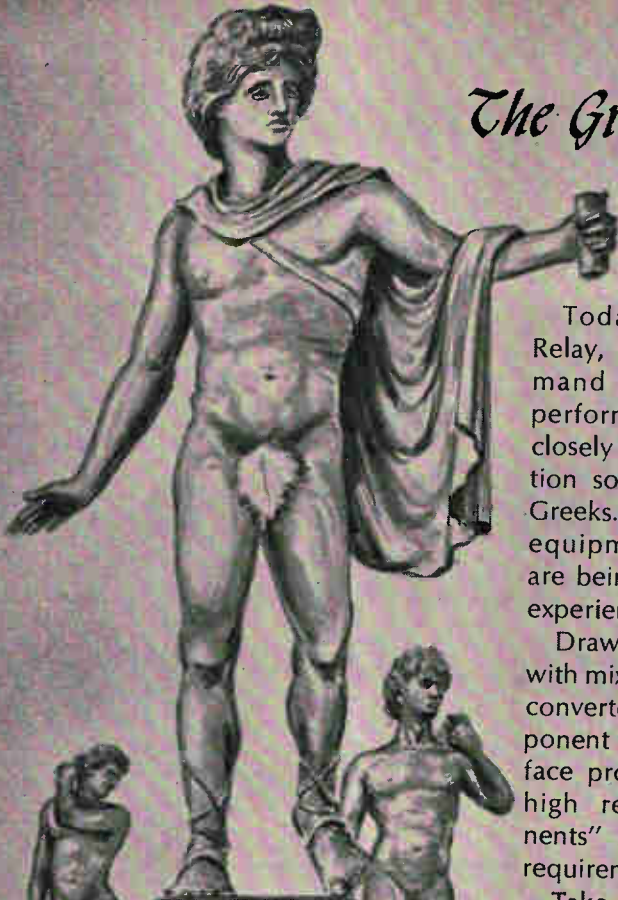

Today, projects like Apollo, Relay, Mistran and Gemini demand a degree of equipment performance and dependability closely approximating the perfection sought after by the ancient Greeks. In high reliability receiving equipment, these requirements are being successfully met by LEL experience and ingenuity.

Drawing on long experience with mixers, IF strips, RF amplifiers, converters, etc., LEL blends component functions, eliminates interface problems and produces the high reliability "super-components" needed for today's space requirements.

Take the S-Band receiver front-end shown above, for example. In a single 8 ounce package, occupying less than 15 cu. in. are preselector, frequency multiplier, balanced mixer and IF preamplifier. Overall, the package has an 8.5db noise figure, includes 5 cavities and is designed to assure high reliability telemetry data reception and voice communication from anything or anybody... anywhere.

If you've been looking moonward (or anywhere in that direction), our engineers probably have the right answers to your communications questions. Contact LEL today.

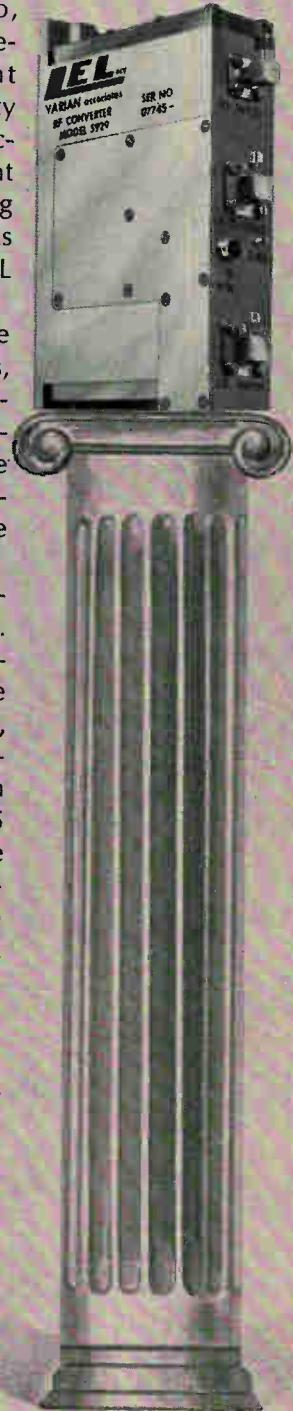

**LEL** DIVISION  
VARIAN associated

AKRON STREET COPIAGUE, L. I., NEW YORK 11726

(516) Amityville 4-2200 / (516) PYramid 9-8200 / TWX Code 516-691-5085

## No heat shrinkable tubing can do all this:

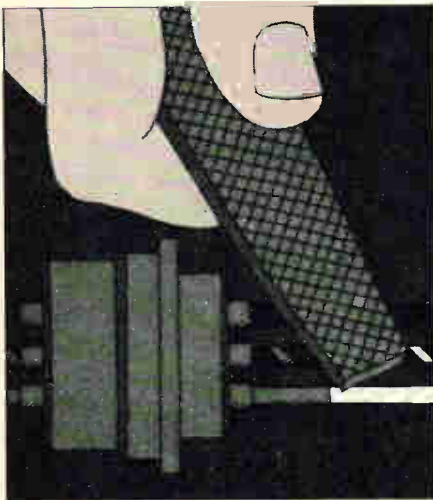

Resist abrasion and cut-through  
twice as well as others.

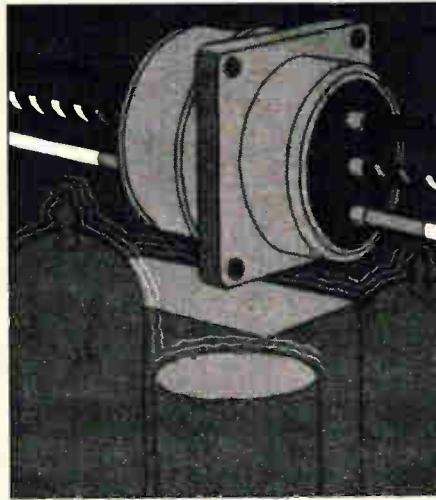

Resist heat shock  
up to 350°C.

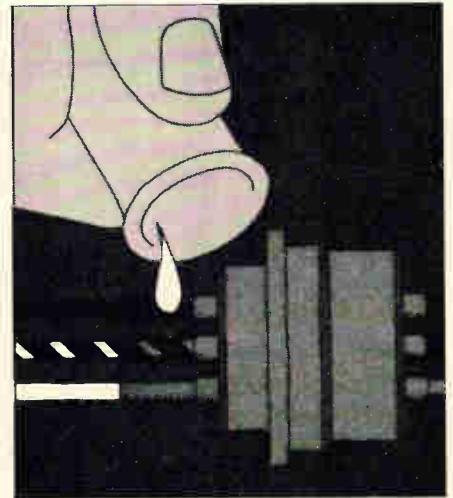

Resist practically  
all inorganic chemicals.

## Except this one.

Alpha's new FIT-350 heat shrinkable Kynar tubing is a tough, thin-wall transparent polyvinylidene fluoride that resists high temperature, abrasion, cut-through, solvents, and meets the standard of AMS-3632.

Specifically developed for high temperature operation, Alpha's FIT-350 withstands intermittent heat shocks up to 350°C, and operates continuously from -55° to +175°C. It resists abrasion twice as well as other fluorocarbon tubing in MIL-T-5438 tests.

It resists cut-through (4,300 pounds pressure was required to cut through Alpha FIT-350 versus 800 pounds for other types of tubing) and will not split even when

shrunk over sharp or irregular objects.

It resists practically all inorganic chemicals (even sulphuric acid up to 225°C) and is non-flammable.

Its tensile strength is 7300 psi at 77°C. (Even under exposure to 10 roentgens of gamma radiation, no effect on tensile strength was observed.)

It comes in ten sizes from .046" to 1.0" I.D. in standard packages of 4' and 6" lengths (or whatever you require).

For a free sample of Alpha FIT-350 Kynar heat shrinkable tubing and the latest engineering report and specifications, write us. Or call your Alpha Wire tubing distributor.

**Alpha Wire** 

Headquarters: Elizabeth, New Jersey 07207. A Division of Loral Corporation.

# SPERRY SEMICONDUCTOR

## RTL MICROLOGIC INTEGRATED CIRCUITS



in flat packs  
and low profile TO-5

### SPERRY A MAJOR I.C. SOURCE.

Since their development, RTL Micrologic Integrated Circuits have proven their advantages in many types of equipment. Sperry Semiconductor offers you a reliable source for the most commonly used types of RTL, Micrologic 900 to 927 in flat packs and low profile TO-5. Sperry Rand Corporation, through a cross-licensing agreement with Fairchild Camera and Instrument Corporation, is licensed to

produce RTL Micrologic Integrated Circuits which are **completely interchangeable** with Fairchild units. Fairchild trademarks  $\mu$ L,  $\mu$ Logic, and Micrologic are licensed to Sperry.

The Sperry Micronet-203 is a monolithic differential amplifier, also immediately available. Write for complete specifications. Keep in touch with  **SPERRY SEMICONDUCTOR, Norwalk, Connecticut 06852.**

# SPERRY

DIVISION OF  
SPERRY RAND  
CORPORATION

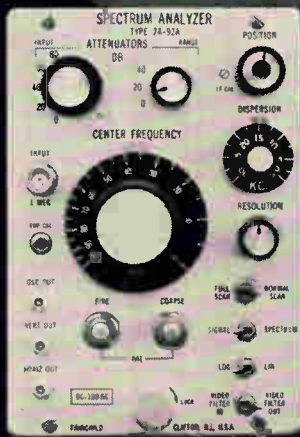
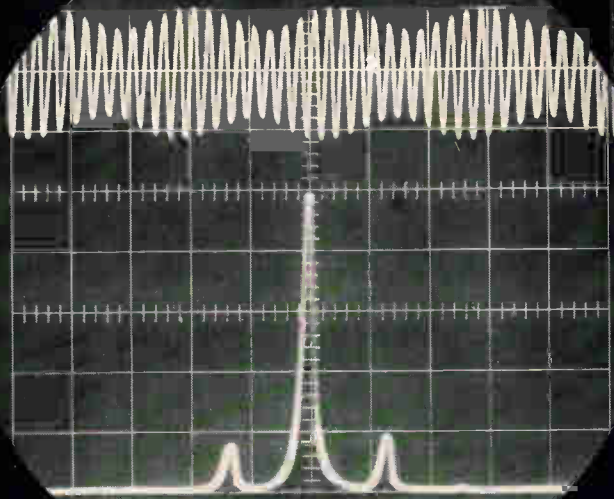

## These new plug-ins make your Fairchild scope a versatile spectrum analyzer

Four new spectrum analyzer plug-ins for Series 765H oscilloscopes give you unique measurement capabilities. These range from low frequency vibration analysis through noise density measurements to telemetry analysis, either on a swept or manually tuned basis. Manual tuning allows frequency measurement to an accuracy as high as three parts in  $10^9$ . Other applications include percentage modulation and deviation; oscillator analysis; distortion and spectral density measurement; sonar; VLF transmitter design and alignment. Specifically, these four plug-ins provide bandwidths from DC to 20, 100 and 500 kc, and from 1 kc to 2 mc. Prices range from \$820 to \$950. Available soon: additional units with bandwidth capability into the microwave region.

For additional versatility two analyzers in a Fairchild 777 dual beam scope permit two simultaneous displays on the same tube. Thus, in telemetry subcarrier oscillator analysis you can observe the complete subcarrier band together with any desired section of it. Or, with proper

choice of plugs-ins, both frequency domain (spectral display) and time domain (standard scope display) are presented simultaneously on the single CRT. No other spectrum analyzer offers these features. For informative Application Note No. 108 and specification, write Fairchild Instrumentation, 750 Bloomfield Avenue, Clifton, N.J.

**FAIRCHILD**  
INSTRUMENTATION

# Probing the News

---

Solid State

## Microwave IC's: hybrid or monolithic?

Hybrid microcircuits could provide relay stations that will last 100 years; monolithic IC's dominate the Air Force's search for a radar that won't fail

By Jerome Eimbinder

Solid State Editor

To supply the reliability urgently sought by users of microwave devices, designers have turned to integrated circuits; but there is no agreement on which type to use — hybrid or monolithic. Though the contest has just begun, the hybrid approach has jumped off to a fast lead. Strongest advocate of hybrid technology for microwave IC's is Bell Telephone Laboratories, the research arm of American Tele-

phone and Telegraph Co.

Pursuing the monolithic approach is Texas Instruments Incorporated in a big project under way for the Air Force.

The reason for the disagreement on approach lies in the uneven development of integrated circuits: IC's are widely operational in the lower frequencies — in scientific satellites, computer logic modules, navigation systems for aircraft, and

even desk top calculators—whereas IC's for the microwave region had encountered many difficulties and are only now being developed.

Until 1964, for example, high-frequency transistors, which are necessary for building a high-frequency IC, had not been built with the power-output capability required. And, a planar microwave-mixer diode — essential for both transmission and reception — did not exist.

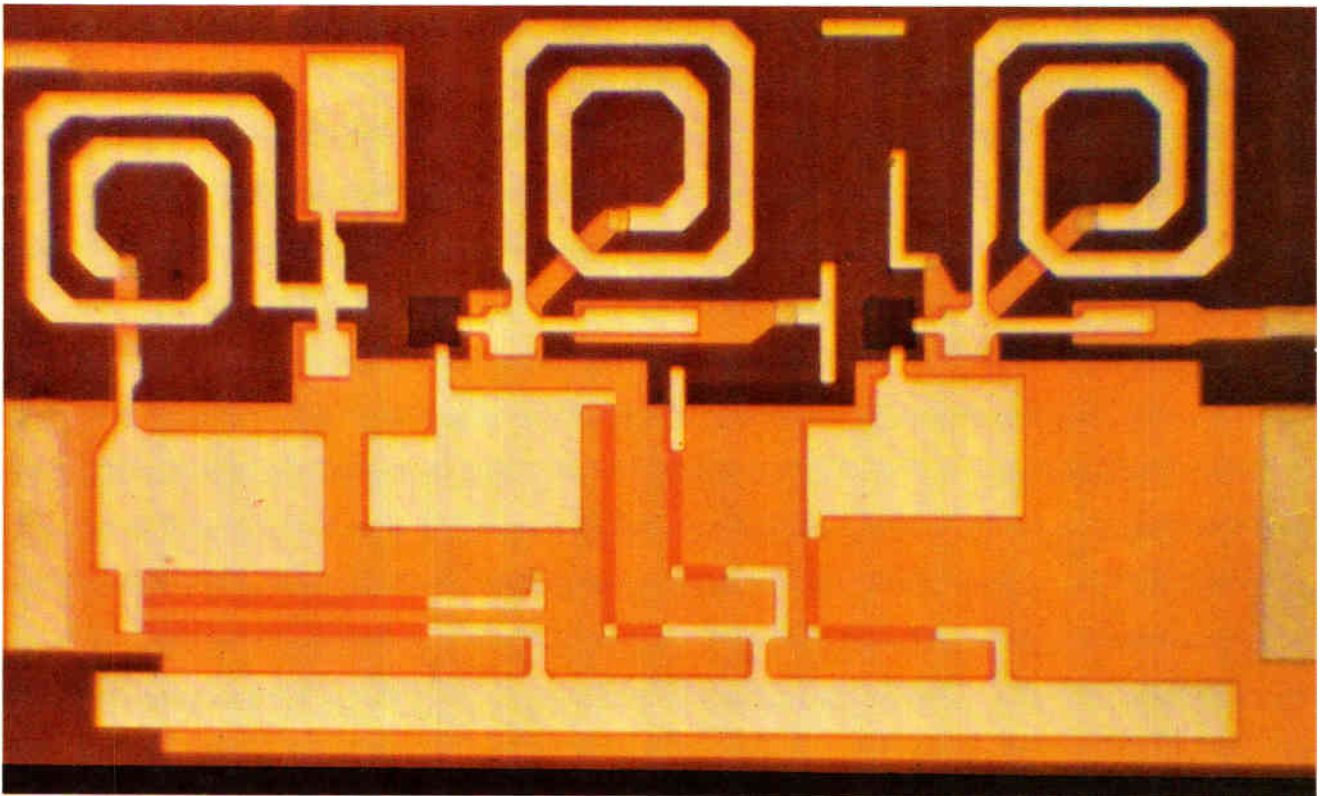

This 500-Mc, two-stage amplifier is the first of a series of monolithic microwave integrated circuits Texas Instruments Incorporated will develop for the Air Force's Project MERA, a new terrain-following radar system. The circuit shown has thin-film components on a silicon substrate and was built to accommodate silicon transistor chips. In the final version, however, the transistors will be diffused into the substrate.

## Bell builds microwave amplifier

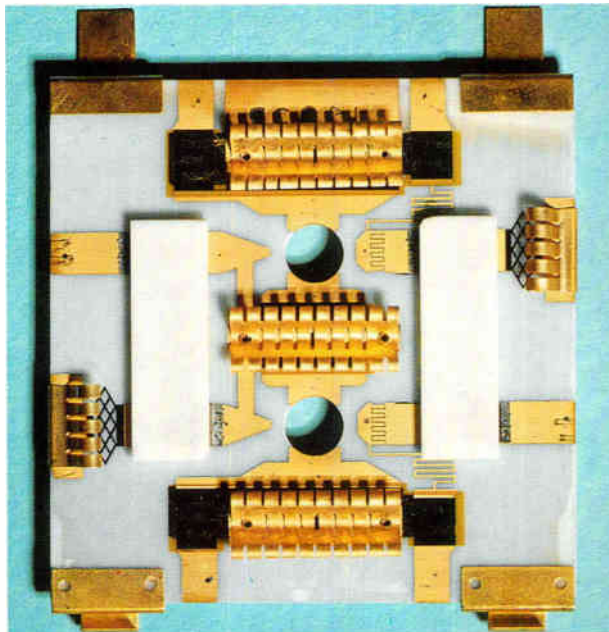

Evolution of Bell Telephone Laboratories' 3.5- to 4.5-Gc amplifier begins (upper right) with a plan ceramic substrate that is built up, step by step, from left to right, with components. The finished IC—except for transistors which are missing in this picture—(above) becomes one of the four IC's that make the completed amplifier (lower right).

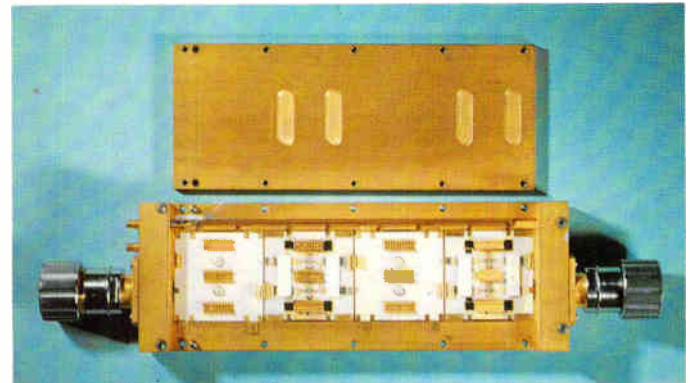
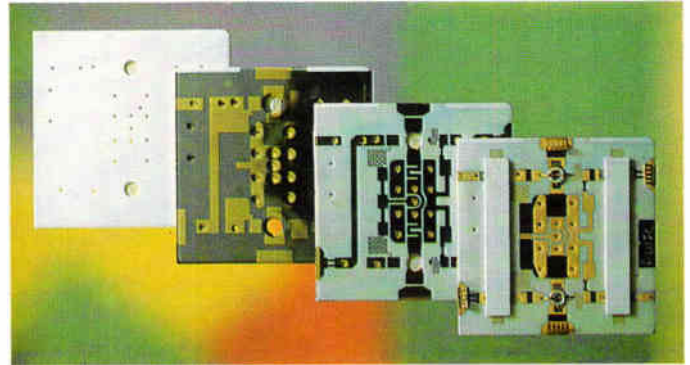

The Air Force believed that with enough effort and money, such problems could be solved. The rewards were big and worth working toward.

Now, work is well under way, and more funds are coming.

### I. The market

Most significant goal is reliability. The Air Force wants it for microwave airborne equipment — such as radar — that fails all too often at precisely the wrong time and grounds a plane for repairs. Arthur Uhlir, Jr., vice president and manager of Microwave Associates Inc.'s Semiconductor division, says phased-array radar, airborne and ground-based, will be the main market for microwave integrated circuits.

Communications companies, like American Telephone & Telegraph Co., want microwave IC's for unattended radio relay stations — many of which are on mountaintops or in other hard-to-reach places. AT&T would like IC's to last 100 years; however, company officials say, for the time being they will settle for 20.

"Another market possibility," Uhlir says, "is short-distance communications, where you don't want your transmission to carry beyond

a certain distance." This kind of equipment could be useful for taxis to avoid restrictive federal regulations as well as for ground troops working close to enemy lines.

Because of size and weight, Uhlir also foresees IC's being used extensively in aerospace navigation systems and in computers.

### II. Work under way

Texas Instruments Incorporated is working on a monolithic IC; Bell Telephone Laboratories is using a hybrid approach. These two techniques sum up the attack on the problem.

Bell is building its IC by putting germanium transistor chips and thin-film passive elements on a ceramic substrate. TI is diffusing

transistors and other active devices into a silicon substrate and is using the silicon as a base for thin-film components. It is also considering using the silicon as a dielectric material for transmission lines.

TI has two contracts that involve microwave IC's: one is for a phased-array, terrain-following radar — this is the Air Force project MERA (molecular electronics for radar applications); and the other for the National Aeronautics and Space Administration — the possible use of computers to design microwave IC's.

Two other government-sponsored projects are also under way: The Syracuse University Research Corp. is investigating various thin-film ferrite materials including yttrium iron garnet for use with microwave integrated circuits for the Air Force. Lincoln Laboratories of the Massachusetts Institute of Technology is studying hybrid microwave IC's under a contract with the Advanced Research Projects Agency of the Department of Defense.

### III. Future work

The Air Force plans to award two more contracts: one for an integrated circulator, the other for integrated phase-shifters and switches using ferrite thin films. A NASA

#### Broadband amplifier data

Characteristic	1-2 Gc. Amplifier	3.5-4.5 Gc. Amplifier
Stage power gain (db)	10	4
Bandwidth (Gc)	1	1
Noise figure (db)	3	6
Amplifier power gain (db)	40	16
Maximum VSWR, input and output	1.1	1.25
Power output (mw):		
Maximum	10	10
Undistorted	1	1



spokesman says that additional microwave IC studies through his agency are not far off.

The Army Electronic Command at Fort Monmouth, N.J., will soon award a study contract for evaluating the feasibility of building both monolithic and hybrid microwave IC's. The Army wants to know to what extent, if any, performance provided by tube equipment must be sacrificed by using microwave IC's and if subsystems for portable radar and portable radio-relay systems can be built with microwave-IC modules.

#### IV. Bell's hybrid approach

Bell Telephone Laboratories has made the deepest penetration by solid state amplifiers into the microwave region with a hybrid-IC amplifier that operates over a 3.5- to 4.5-Gc range. The wideband amplifier has four stages, provides a 16-db power gain and, according to Bell, equals or exceeds the performance of low-noise, traveling-wave-tube amplifiers designed for the same frequency range. The amplifier requires only a 6-volt, 100-milliampere supply — about 10% of the power needed for a traveling-wave-tube amplifier. In addition, accelerated, individual life testing of the circuit's components indicates a mean-time-between-failures for the amplifier of approximately 1 million hours. By comparison, the mean-time-between-failures for a traveling-wave-tube amplifier is only about 10,000 hours.

Each of the four amplifier stages is identical. About 20 components are used in each stage, including both distributed and lumped passive components and two planar germanium transistors. The resistors and capacitors are evaporated tantalum thin films. Thick films (copper-plated thin films) are used for the transmission lines. The square substrate is glazed ceramic and measures slightly less than two inches on a side.

"One of the important features of the amplifier," says Rudolf S. Engelbrecht, head of Bell's microwave integrated device department, "is that no tuning adjustments are required. The base capacitance and collector inductance," explains Engelbrecht, "are matched to the average characteristics of the transistor."

The 3.5- to 4.5-Gc amplifier is the



Bell's Paul Stark checks a 3.5- to 4.5-Gc hybrid IC during final assembly.

second microwave hybrid-IC amplifier developed by Bell. A 1- to 2-Gc amplifier was designed about a year ago. The essential characteristics of both four-stage amplifiers are shown in the table on page 136.

**Reliability.** Engineers at Bell give several reasons for the high reliability of the 3.5- to 4.5-Gc amplifier: rugged construction, reduced parasitics resulting from the elimination of many interconnections, optimized interconnections within the circuit because of freedom to change impedance levels, lack of stress on individual components because of the operating power level,

and even lack of handling damage because of the elimination of hand assembly.

Besides reliability, Bell is concerned with performance and cost in the design of microwave IC's for radio relay systems. Size for these ground-based systems is less important.

As a result, Bell is satisfied with the size reduction it achieved with ceramic substrates; for now, it sees no reason to strive for the further reduction that silicon monolithic microwave IC's would bring. The only change Bell is now contemplating in its hybrid IC's is a switch to beam-lead transistors and low-complexity (two to four components) beam-lead IC's.

Western Electric Co., however, which like Bell Labs is a part of the American Telephone & Telegraph Co., could change Bell's plans. Western Electric does a lot of military business which would require the smaller, silicon monolithic IC's. The 1- to 2-Gc (L-band) amplifier developed by Bell last year is now being manufactured by Western Electric for use in a phased-array radar system. Thus, it's conceivable that Western Electric's needs might influence Bell to change its position on silicon microwave monolithic IC's.

#### V. The monolithic approach

Of all the work on microwave IC's, the Air Force's project MERA, by Texas Instruments, is the most ambitious and is drawing the most attention. TI has set out to build a series of monolithic microwave IC's that, when put together, will form a

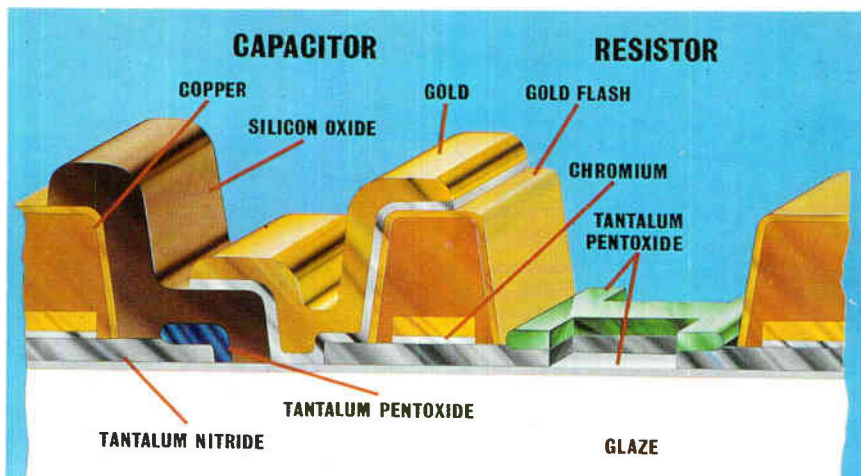

Thin-film resistors and capacitors can be seen in this cross-section of part of Bell's 3.5- to 4.5-Gc hybrid IC.

# GOOF-PROOF INTER-WIRING

Garlock Free-Flex® circuits minimize rework and trouble-shooting because it's impossible to hook them up wrong.

## LOOK

All Garlock Free-Flex circuits are flexible circuit assemblies . . . pre-engineered mechanically and electrically so all terminations naturally go on the right terminals . . . make it impossible to miss a connection.

Materials and configurations to meet your specifications and the Government's.

Write us for your copy of *Flexible Circuits in "Teflon" FEP Have Come of Age* reprinted from *The Journal of Teflon*, published by E. I. du Pont de Nemours and Company . . . and for the **FREE-FLEX** Circuitry Manual.

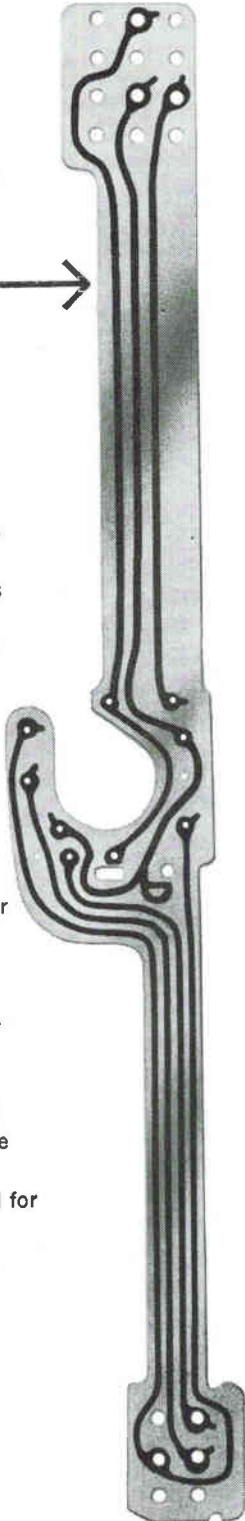

**GARLOCK**  
ELECTRONIC PRODUCTS  
GARLOCK INC.  
CHERRY HILL, N.J. 08034

## MERA radar uses IC modules

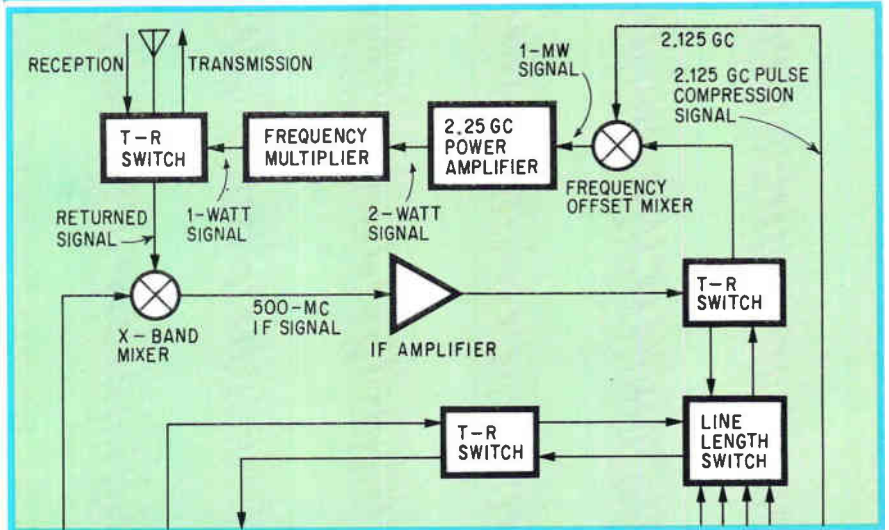
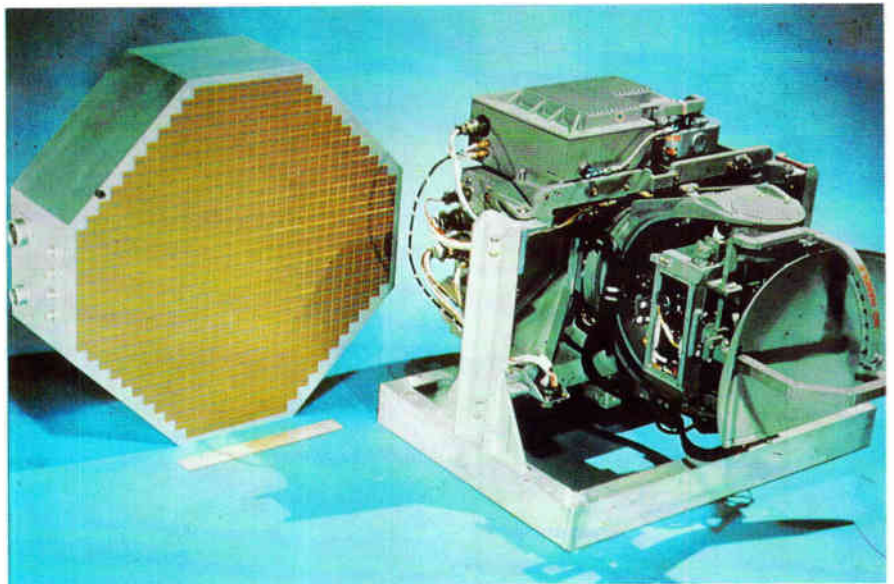

LOCAL OSCILLATOR  
8.5 GC

125 MC IF

PHASE CONTROL SIGNALS

New MERA terrain-following radar (left, above) with its three computers is much smaller than the AN/APQ-99 shown without its computers. MERA system uses 600 identical modules; each (shown in block diagram) emits a 1-watt, 9-Gc signal.

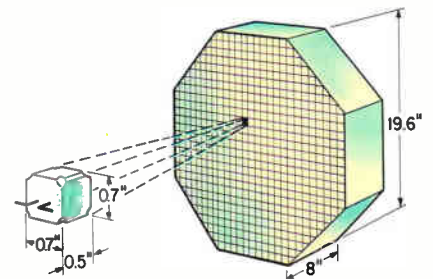

working, phased-array radar system. This has never been done before.

"MERA has great significance," says Richard D. Alberts, chief of the Molecular Electronics branch of the Air Force's Avionics Laboratory, at Wright-Patterson Air Force Base, Ohio. "It will be the first vehicle to demonstrate the feasibility of microwave integrated technology." Adds Alberts, "If the program is success-

ful, whole new areas for integrated circuits will be opened."

The Air Force is putting up 75% of the funds needed to carry out the \$3-million, 3-year MERA program. Texas Instruments is footing the remainder of the bill. Work on the contract started in late 1964.

Radar. The MERA program is developing a terrain-following radar system with additional capability

for ground mapping and air-to-ground range determination. Terrain-following radar enables a pilot to fly under the enemy's radar coverage. On his visual display, the pilot sees a diagonal line which is determined by his altitude and direction. He also sees a series of pips which depict the nature of the terrain ahead of the plane. If a pip touches the diagonal line, the pilot must pull up to avoid crashing.

The MERA system will do the same type of job the AN/APQ-99 terrain-following radar does, but with several notable improvements: MERA is expected to be 15 times more reliable, weigh half as much and take up half the space.

The space and weight advantages are particularly important because terrain-following radar is usually located in the nose of a jet fighter. The Air Force hopes that MERA will save money because its building-block construction lends itself readily to mass production.

MERA is by far the most ambitious and costly of the microwave integrated-circuit projects under way or contemplated. It calls for development of entirely new kinds of integrated circuits and it is using computers to design them.

MERA's monolithic integrated circuits will be the first to use varactor diodes, Schottky-barrier diodes, and p-i-n (p-material, intrinsic-material, n-material) diodes.

That this could be done was reported last year in a study Microwave Associates made for the Air Force. The study said that monolithic IC's were feasible but that interim developmental work using ceramic substrates would probably be necessary. In a sense, this is the procedure Texas Instruments is following. But, instead of building an operational series of hybrids before going on to build a series of monolithic IC's—as Microwave Associates had envisioned — TI is combining the two steps: it builds a hybrid ceramic substrate IC, evaluates and perfects it, then uses it as a model for a silicon monolithic circuit.

**Dissenters.** Motorola is not convinced that TI is on the right track. Some of its engineers believe TI's careful avoidance of distributed components at low microwave frequencies is a mistake.

Motorola engineers believe distributed components should be used

# this is a spring clip for a miniaturized computer

ACTUAL SIZE

we've drawn it, cut it, flared it, slotted and crimped it...and made hundreds of thousands just like it.



MAGNIFIED

If you use small metal parts from bar stock or molds ask yourself if they couldn't be made just as well, or better, with small diameter tubing. Capabilities for forming thin wall tubing into intricate shapes are highly developed at Uniform Tubes, as you can see from the product illustrated here. *Quality in Quantity* is our forte. We are the principal source in the United States for many thin wall tubular forms. You, too, can rely on Uniform Tubes for anything in metal tubing .005" to .625" O.D. Chances are we have specific experience in your field. Phone or write for prompt attention.

50



## UNIFORM TUBES, INC.

Collegeville, Pa. • (215) 489-7293 • TWX 510-660-6107

## NEW CHEMELEC® TFE SOCKETS FEATURE

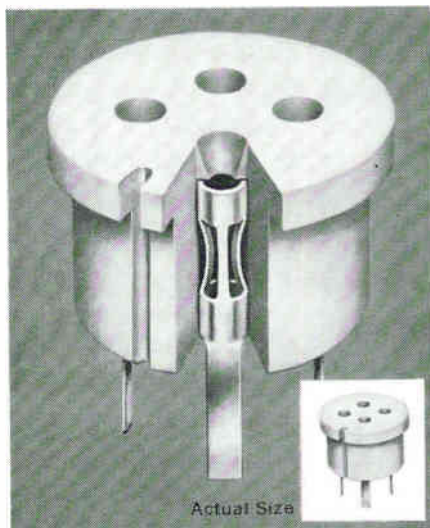

# THREE-LEAF CONTACTS FOR EXTRA RELIABILITY

Unique contact design gives Chemelec sockets their extra reliability: In each pin hole are three beryllium copper leaves that bow in toward the center. When a lead is inserted, the leaves deflect to let it slide in easily, but press firmly against it to assure good contact. A built-in barb prevents accidental pull-out of the contact assembly.

The design gives practically unlimited life . . . low contact resistance (less than .010 ohm) . . . and insertion force of less than 1 oz. per lead.

These low profile 1/4" high sockets of TFE fluorocarbon plastic—to MIL-M-55068—have orientation notches visible from above and below . . . tapered entry to guide leads in easily, quickly . . . and are available with flat, flat right-angle, or flexible mounting tabs, with 3 to 14 contacts in .100 to .250 pin circles.

For more information, write for Bulletin SPC-1.

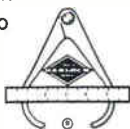

**GARLOCK**  
ELECTRONIC PRODUCTS

GARLOCK INC.

Cherry Hill, N.J. 08034 • Phone (609) 424-1470

Planar  
Schottky-  
barrier mixer  
diode, built by  
Microwave  
Associates,  
replaces the  
point-contact  
mixer diode.

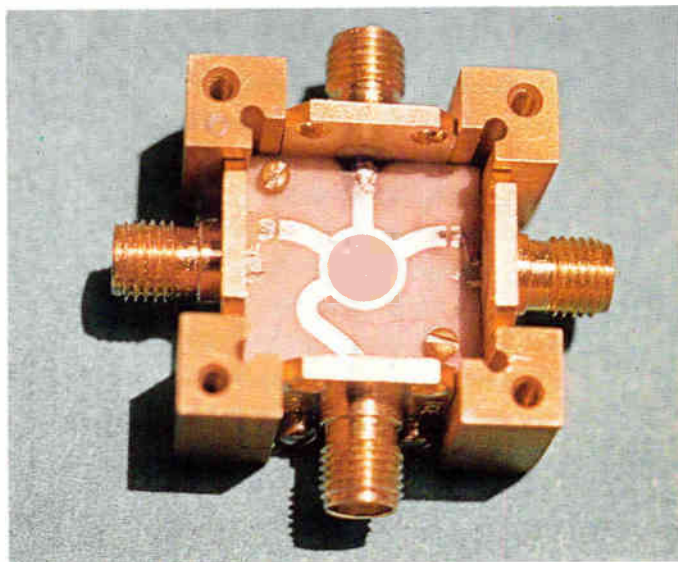

at all frequencies from 400 Mc up. Motorola has also lost its high hopes for thin films. It now feels that thick films, with high dielectric constants, of 60 or above, and thicknesses in the order of 0.1 mil, provide better results. Motorola is also dubious of the use of microstrip transmission lines. Texas Instruments uses them but Motorola prefers a symmetrical-plane strip line which it says has slightly better shielding and provides a slightly higher Q (quality factor) than microstrip does; its only disadvantage is that it costs a bit more to manufacture. Bell also uses strip-line construction on its transmission lines.

Microwave Associates has evaluated both the microstrip and strip-

line approaches and feels that microstrip will eventually win out. In some microstrip transmission lines such as those built with organic polymer material, a considerable portion of the electromagnetic field associated with the transmission is in the air above the dielectric. However, says Microwave Associates, the use of high-dielectric-constant silicon and alumina, and possibly glass and beryllia, will concentrate the electromagnetic field mainly within the dielectric.

**Troublemakers.** The MERA radar system will eliminate the two components that have been habitual troublemakers in terrain-following radar: the magnetron and the antenna's moving parts. These two

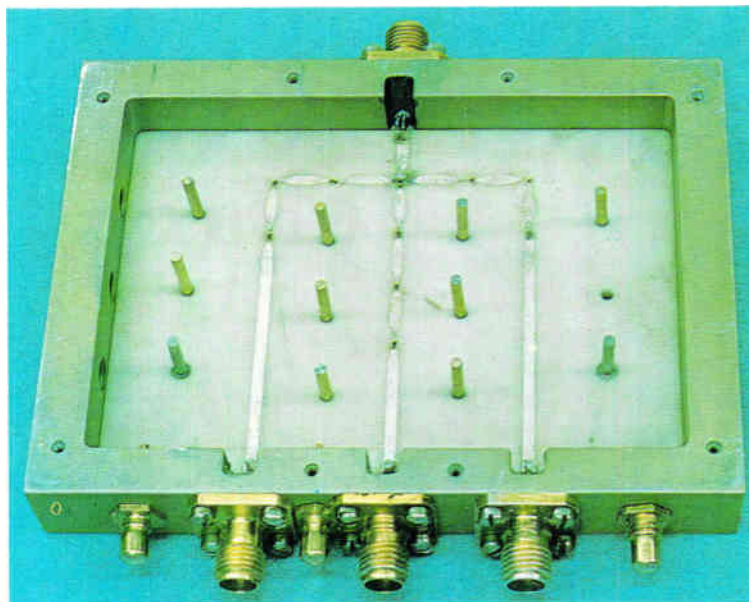

S-band (2- to 4-Gc) switch built by Microwave Associates uses alumina microstrip transmission lines. Diodes are the small black elements.

components in the AN/APQ-99 now cause 70% of the radar's failures.

An array of 600 identical modular blocks will replace the motor-driven parabolic-dish antenna. Each block will act as both transmitter and receiver. Varying the phase of the energy supplied to the individual blocks will produce scanning electronically.

At least seven IC's will be contained in each block. It hasn't been decided yet whether one, two or three chips will be used in the power amplifier. The blocks measure 0.7 by 0.7 inch and have a depth of 0.5 inch.

**MERA building block.** Each of the 600 building blocks will have nine sections or stages, as shown by the diagram on page 138. These sections are: four switches, two mixers, a frequency multiplier, a power amplifier and an intermediate-frequency amplifier. Integrated circuits will be used in all of the stages except for the line-length switch (phase shifter). Switching, signal generation and signal reception will take place within the block.

Two types of high-frequency switching circuits are used in the MERA building block: a phase-shift network (one is required) and a transmit-receive switch (three are required). The transmit-receive circuits alternately switch the system between the transmitting and receiving modes; the phase-shift switch controls the phase of each of the 600 individual signals processed.

At least four p-i-n diodes will be used for phase-shift control. The diodes will switch various lengths of microstrip transmission lines in and out of the signal-generation circuitry. Placing the microstrips on a wall of the building block is under investigation. Scanning instructions from the scan computer will control the diodes.

The transmit-receive circuit will employ two p-i-n diodes, such as those used in the phase shifter, and a control flip-flop circuit. Its function is to isolate the transmitting and receiving functions.

From three to five monolithic chips will handle the signal-generation functions. The signal-generation portion of the building block consists of a frequency offset mixer, an S-band amplifier, and a frequency multiplier.

In the frequency-offset mixer, the

# General Electric's newest little lamp is fast on its feet



G-E's Sub-Miniature Bi-Pin lamps will set new speed records for replacement in printed circuit, indicator and switching applications because they plug in from the front and stay there!

These tough little incandescents can perform the same functions as a midget flanged base, screw base, grooved base or wire terminal lamp. They'll save you money in manufacturing and assembly, too, by eliminating more expensive sockets. Bi-Pins in printed circuits, for example, can plug directly into a board. Their rugged plastic base adds long-life insurance by protecting the glass seal.

Five lamp types in the T 1 $\frac{1}{4}$  size (approx.  $\frac{7}{32}$ " diam.) are now available (smaller illustration above is actual size). Variations in design volts, amps, candlepower and design life give you the choice of more than 30 lamps in the T 1 $\frac{1}{4}$  size.

We'll send you complete specifications and drawings if you'll ask for Bulletin #3-5593. General Electric Co., Miniature Lamp Dept. M6-1, Nela Park, Cleveland, Ohio 44112.

*Progress Is Our Most Important Product*

**GENERAL  ELECTRIC**

## THIS IS A SPECTRA NOISE MEASUREMENT

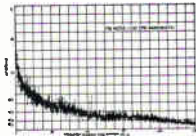

Spectra's exclusive Microwave Noise Measurement Service provides accurate measurements of customers' X-band sources from 8.5 Gc/s to 10.5 Gc/s.

## THIS IS A SPECTRA NOISE MEASURER

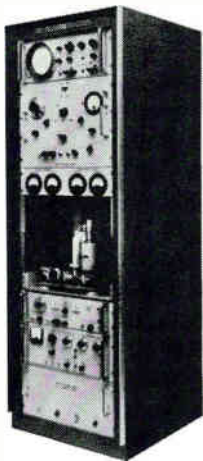

Spectra's SE-200 Series instruments are the only equipments that can give you the FM and AM noise content of conventional and solid state microwave sources — to accuracies of  $\pm 1\text{dB}$ .

## THIS IS A SPECTRA LEASING CONTRACT!



Spectra's Microwave Noise Measuring Instruments can now be leased for a monthly amount that's actually less than the salary of a good technician! Ask your Spectra representative to tell you the whole story — or write us today. It's exciting.

SPECTRA  ELECTRONICS

P.O. Box 85  
Los Altos, Calif. 94023 • (415) 948-4998

2.125-Gc signal supplied to the MERA building block is combined with a 125-Mc signal from the phase shifter. The resultant 2.25-Gc, 1-milliwatt signal then goes to the S-band power amplifier. An integrated circuit using Schottky barrier diodes is being developed as the frequency offset mixer.

The 1-milliwatt signal from the frequency offset mixer is boosted to two watts by the S-band (2.25-Gc) amplifier. This is double the power required at the transmit-receive switch since allowance must be made for power losses in the quadruple IC.

The transistors in the 2.25-Gc amplifier have sixty-five 0.2 mil by 3 mil interdigitated fingers. Transistors with 7, 15, 25, and 60 interdigitated fingers have also been evaluated but cannot supply the required power gain (33 db).

The thin-film capacitors, which have sputtered aluminum-oxide dielectric, have caused problems in building the 2.25-Gc amplifier. Originally, the capacitor dielectric was approximately 2,000 to 5,000 angstroms thick on metallization of approximately 100 microinches thick. The same thickness was used for the capacitor's top plate. This provided high capacitance per unit area and low series resistance. Unfortunately, the relatively heavy metallization cause many failures. To overcome this, the ratio of the dielectric material thickness to metal-plate thickness is being increased.

**The frequency multiplier.** This stage receives the 2 watts of input power from the 2.25-Gc power amplifier and delivers 1 watt of output power at 9 Gc. Both a four-varactor-diode with a passive filter and an eight-varactor-diode integrated circuit are being considered for the frequency quadrupling. Before the contract expires, the Air Force expects that a single diode will be developed for this function. Later, the Air Force anticipates development of a single Gunn-effect device with sufficient power to replace both the S-band amplifier and the frequency multiplier.

Two integrated circuits are used in the MERA signal-reception circuitry. The returning 9-Gs signal is fed to an X-band mixer and then the difference frequency from the mixer is delivered to a 500-Mc intermediate-frequency amplifier.

In the X-band mixer, the 9-Gc re-

turned signal is mixed with an 8.5-Gc signal to produce a 500-Mc difference frequency. This integrated circuit will include Schottky barrier diodes.

Microwave Associates helped hasten Schottky-barrier diodes into integrated circuits last year by building planar silicon and gallium arsenide Schottky diodes which had low noise figures at low microwave frequencies. The Schottky-barrier diodes eliminate the point-contact silicon microwave diodes currently in use as microwave mixers and detectors. Point-contact diodes are not compatible with monolithic technology because they require a carefully controlled pressure contact.

Texas Instruments has also successfully built prototype X-band mixer integrated circuits, company officials revealed at the Solid-State Circuits Conference in Philadelphia, February 9 to 11. The circuits used Schottky barrier devices capable of operating up to 12 Gc. They also contained microstrip transmission lines formed directly on the high-resistivity silicon substrate. Breakdown voltages for the Schottky diodes ranged from 2.5 to 6 volts. The circuit's over-all noise figure is 9 db at 9.375 Gc with a 30-Mc intermediate-frequency signal and 200 ohms of i-f impedance. Approximately 200 of these integrated circuits can be made on a single slice of silicon.

In the MERA system the 500-Mc difference frequency produced by the X-band mixer goes to the i-f amplifier, which is a two-stage, high-gain, low noise circuit. The signal is then amplified and delivered to pulse-compression circuitry located outside the building block. This 500-Mc i-f amplifier is the only one of the microwave integrated circuits being designed for the building block that is nearly completed. Even this circuit, which already meets minimum requirements, should be improved in the course of the contract, says the Air Force. The circuit provides 13 db of power gain but the Air Force would like 15 db.

The MERA system will also have three computers, each of which will be built with integrated circuits, probably of the large-array type. The computers will be a terrain-following computer, an air-to-ground ranging computer, and a scan computer.

If you could get a commutator that has  $\pm 0.1\%$  accuracy, weighs less than 10 ounces, measures less than 10.5 cu. in., has rates of 0 to 10,000 pps, accepts internal or random external clocking, includes isolation power supply, is extremely reliable, and costs no more than a lot of commutators that are not as good, wouldn't you use it?

Well, Vector has It in stock.

It's the Vector SC Series Subminiature Electronic Commutator, part of Vector's full line of FM, digital, and RF telemetry equipment. For more information write or call Vector, Division of United Aircraft Corporation, Southampton, Pennsylvania.

**Vector** DIVISION OF UNITED AIRCRAFT CORPORATION  
SOUTHAMPTON, PENNSYLVANIA

U  
A  
C



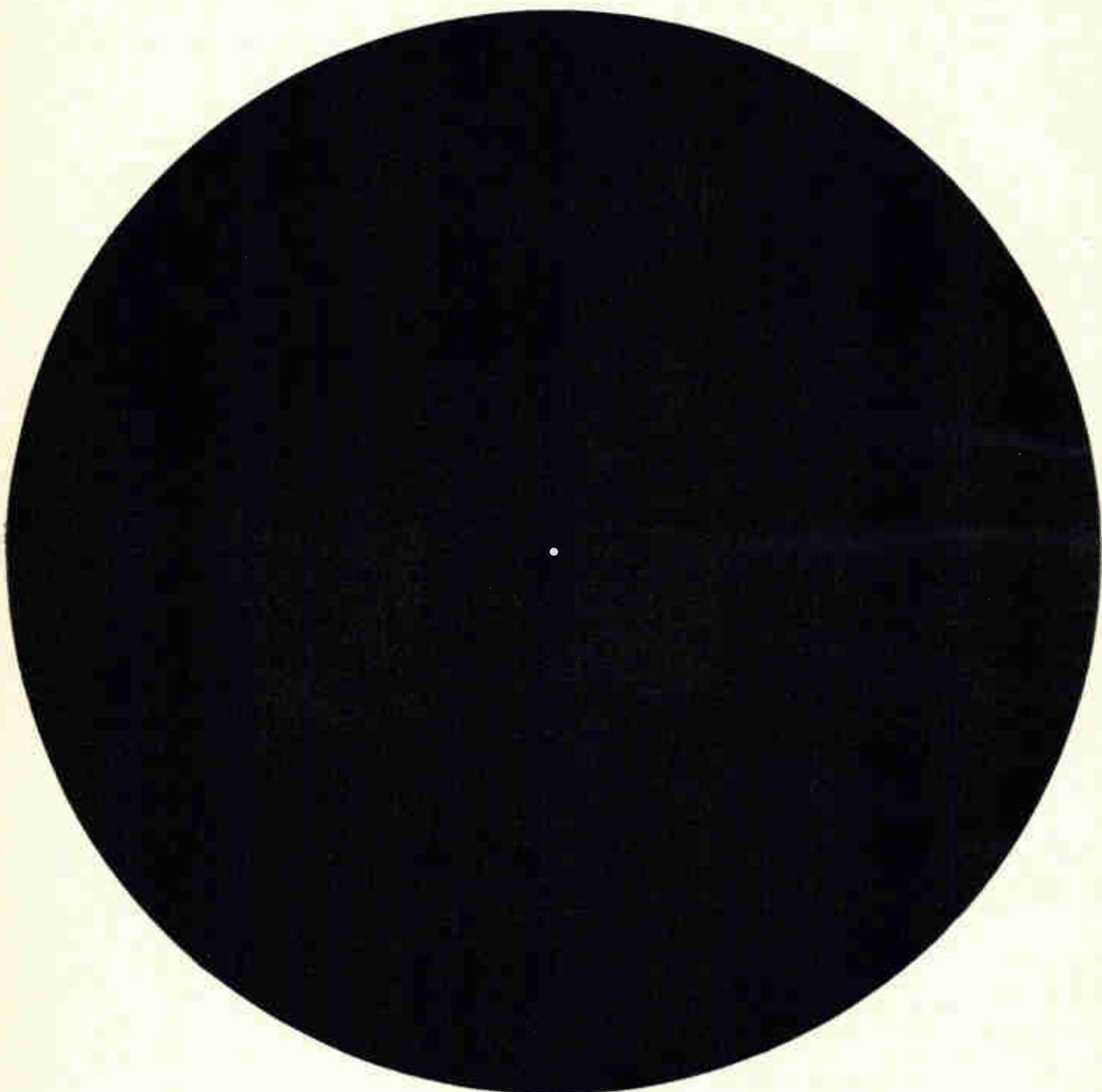

***The small pin hole in the center of this circle is more than enough light for MTI Image Orthicon Television Cameras.***

MTI is the world's largest manufacturer of low light level TV systems. This simply means that low light levels are our specialty. Specifically, at  $1 \times 10^{-5}$  foot candles of ambient light (approaching total darkness) MTI image Orthicon TV cameras will produce high resolution pictures. So the amount of light illustrated by the pin hole is more than enough.

There are hundreds of applications for MTI low light level equipment. Here are just a few: viewing nocturnal animals performing tasks, observing stars, examining small components such as transistors, diodes, capacitors and relays for minute flaws, and so on. In any application where low light levels are of prime importance, MTI can solve your problems.

Seven different line scan frequencies are available "off the shelf". Specific details available on request. If you have an application problem, call us. We can help.

**mti** MARYLAND TELECOMMUNICATIONS, INC.

York & Video Roads, Cockeysville, Maryland / Area code 301, 666-2727

WORLD'S LARGEST MANUFACTURER of low light level image Orthicon cameras





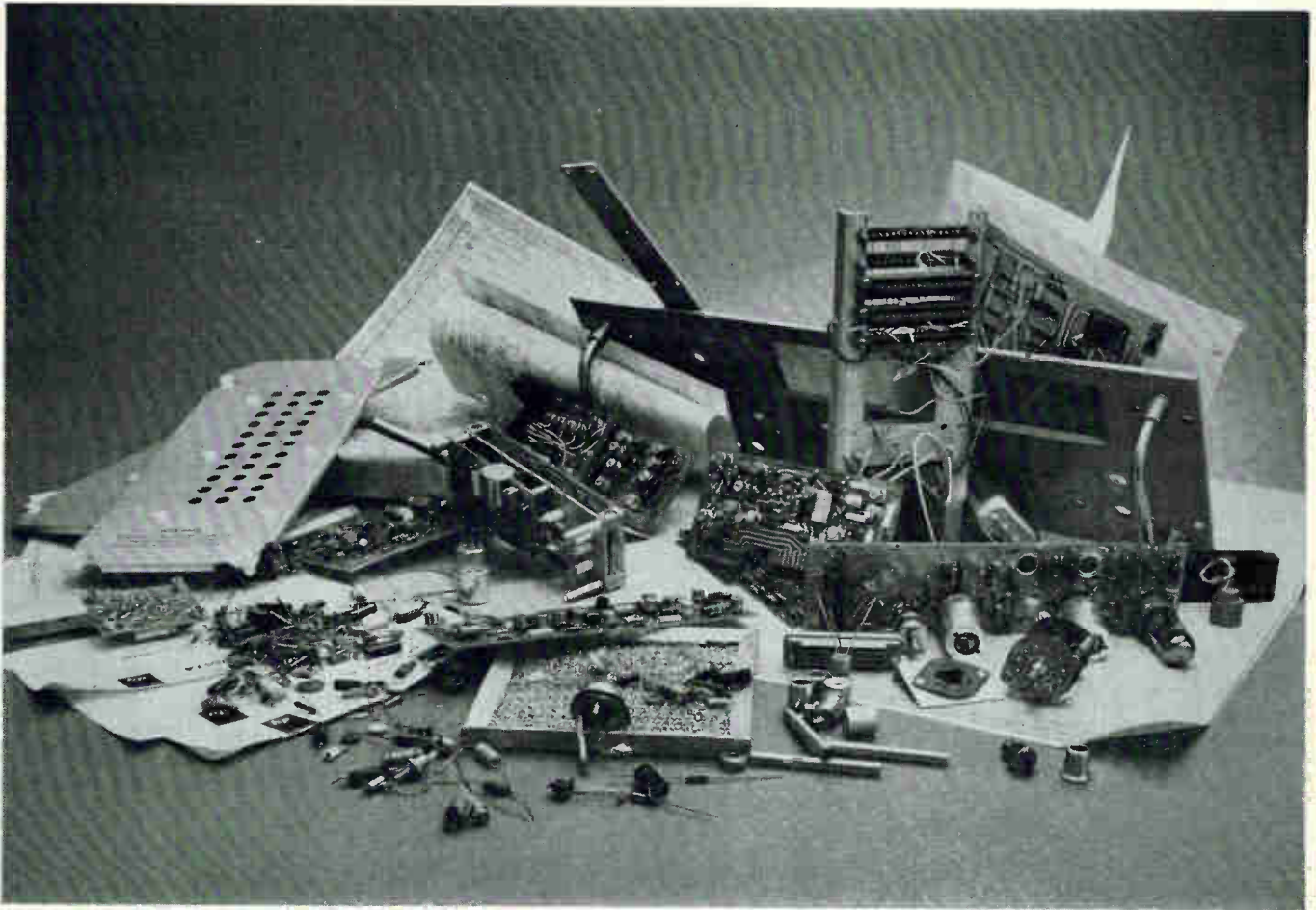

## 135 REASONS WHY

**The 2401C Integrating Digital Voltmeter is your best buy.** The Hewlett-Packard 2401C DVM keeps improving and improving. Just about everybody in the hp organization... engineers, test personnel, production line people... and, of course, marketing people, who know what you want and who want to offer it... keep making this instrument better.

That's why the 2401C has been changed 135 times since it became the world's first DVM to use the integrating principle... lets you make low-level measurements in the presence of extreme noise.

Some changes you've seen: A sixth digit to get maximum use out of the instrument's built-in 300% over-ranging capability. Optional autoranging at 6 msec per range, the fastest available. Integration around zero with a reversing counter... no zero foldover, even with positive/negative-going noise on the signal you want to measure. Improved accuracy of 0.01% of reading +0.005% of full scale  $\pm 1$  digit.

And a lot of changes you haven't seen: New, advanced components for increased performance and/or reliability. New engineering to keep the 2401C ahead in performance. New production techniques to keep the price in line (there has never been an increase in price). The 2401C offers tested and proved RFI performance. It has a Federal stock number for easy specification, too.

Nobody at Hewlett-Packard lets this DVM rest... it just keeps getting improved. That's why it's so far ahead. If you have a measurement problem, involved with getting accurate dc measurements (0.1-1000 v full scale) in the presence of a frustrating amount of noise, you shouldn't let the 2401C rest, either. You should have it on your bench. Your Hewlett-Packard field engineer will put it there... and put it through its paces. Or you can write for complete specs (though a lot of the 135 changes aren't spec'd) to Dymec Division of Hewlett-Packard, 395 Page Mill Road, Palo Alto, California 94306, Tel. (415) 326-1755; Europe: 54 Route des Acacias, Geneva.



**The machine costs \$3950. Ask for a demonstration.**  
*Data subject to change (135 so far) without notice.  
 Price f.o.b. factory.*

**HEWLETT  
 PACKARD**  **DYMEC  
 DIVISION**

860

# Microwave power struggle: Gunn vs. avalanche oscillators

Each solid state source has important technical advantages. The winner may also have the major share of a market already worth \$20 million

The future of solid state microwave seems to depend on two sources, each of which has been described as "about as different from transistors and tunnel diodes as klystrons were from vacuum-tube triodes."

The contrast was made at the International Solid State Circuits Conference in Philadelphia by Rudolf Engelbrecht, head of the microwave integrated device department at Bell Telephone Laboratories. At a panel discussion, he explained that oscillators of either type—Gunn or avalanche transit time—are "about the size of a grain of sand and are already producing 10 to 100 times more power than most advanced tunnel diodes or transistors at the same frequencies." Both types have already been operated as amplifiers, too.

The Gunn oscillator depends on a bulk negative resistance that occurs in n-type gallium arsenide when electrons transfer at high fields from high- to low-mobility valleys in the conduction band; this is sometimes called the transferred-electron effect. The Read diode and the related pn and p-i-n structures are called avalanche-transit time (ATT) devices; they consist of a narrow, high-field region where avalanche breakdown occurs, next to a medium field, or drift, region and they can be made of silicon or gallium arsenide.

## I. Advantages of each

Besides the technical interest, the scientists and engineers were attracted by the prospect of conflict. Richard Alberts, chief of the molecular electronics branch at Wright-Patterson Air Force Base, Ohio, said participants in the discussion expected an intramural squabble between Gunn oscillators and ATT diodes "to be decided in

the marketplace." To the winner could go the major share of the market for low power signal sources. The annual expenditure for reflex klystrons alone is about \$20 million.

Marion Hines, vice president and director of corporate research at Microwave Associates, Inc., said Read and similar structures might be disqualified from certain applications by relatively high noise. A typical noise figure for a Read-diode amplifier is 37 decibels at 7 megacycles per second. For a Gunn amplifier of 12-db gain, on the other hand, George Foyt at the Lincoln Laboratory at the Massa-

chusetts Institute of Technology has measured noise of only 18 db. Lower noise and high pulse powers are Gunn devices' main advantages.

"Unless someone comes up with a whole set of new ideas about these limitations due to noise" said Arthur Uhler of Microwave Associates, "applications of Read diodes and their derivatives may be limited."

The big advantage of ATT devices is their silicon structure. This makes them less expensive and easier to integrate into a silicon integrated circuit.

"Going for them are 10 years of

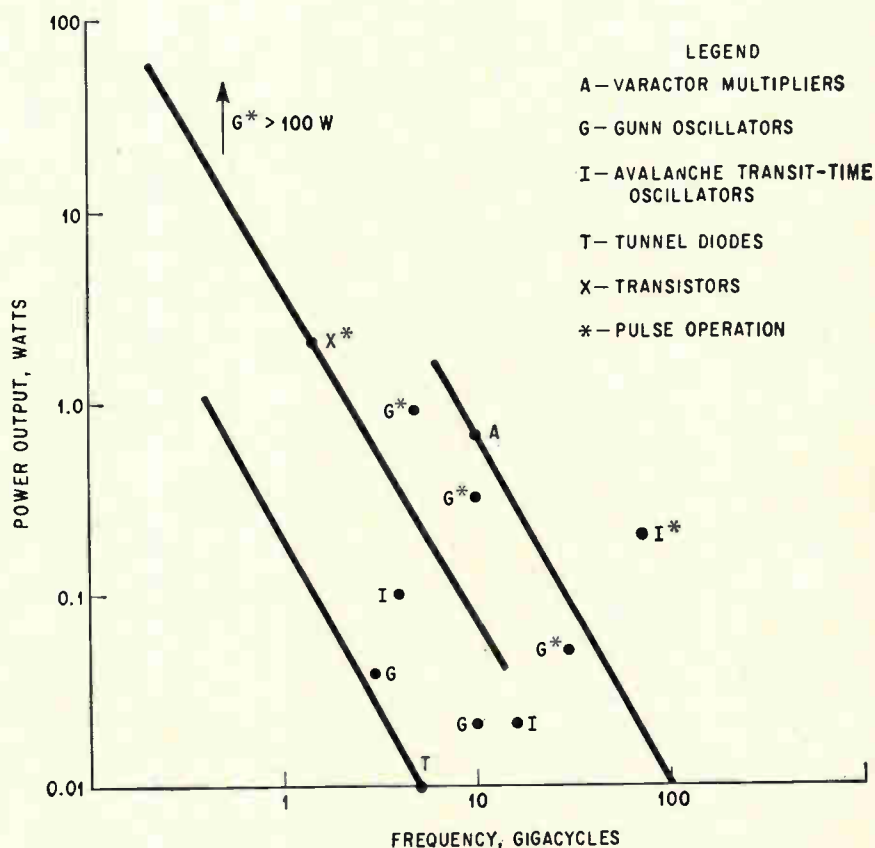

Output powers and frequencies obtainable from five kinds of solid-state microwave sources.

silicon transistor technology," explained Daniel Dow of Varian Associates. This has given ATT researchers a thorough knowledge of their material. In contrast, gallium arsenide—the material of which Gunn oscillators are made—is relatively unknown. But if all of its characteristics become understood in the next few years, the odds could favor Gunn devices.

One disadvantage of their structure, however, is that silicon microwave sources are junction devices; these could be more costly to produce than the junctionless Gunn oscillators of gallium arsenide, especially if a way is found to consistently pure material.

## II. ATT applications

Hines suggested some potential applications of ATT diodes and indicated the feasibility of each. He said that Read diodes cannot be used as local oscillators in pulsed and doppler radar systems and in f-m communications without special techniques. He considers Read diodes suitable as transmitter sources, except for f-m deviators (analog). He expects them to be unsuitable as low-noise amplifiers, and only partially useful as power amplifiers or phase-locked oscillators.

A summary of solid state power sources is on page 146. Not included in this January 1966 information are results from Frank Brand, deputy division chief of the Army Electronics Command's components laboratory at Fort Monmouth, N. J. (13.6 Gc, 25 to 30 mw for a gallium-arsenide ATT oscillator), and Mickey Uenohara's group on microwave parametric amplifiers and bulk-effect devices at Bell Telephone Laboratories (30 mw at 10 Gc, 20 mw at 14 Gc and 8 mw at 17.5 Gc) which they announced from the audience. These figures seem to represent the best performance of solid state microwave sources reported so far.

Although both types of devices are theoretically capable of about 30% efficiency, according to Dow; top values attained so far are 5% for ATT and 7% for Gunn oscillators; these figures are for continuous output. Pulse values for Gunn oscillators are already at 14%, or about one-half the theoretical estimates.

At the conference . . .

## . . . a trio of scientists

**One possible solution** to the problem of designing inductance into integrated circuits, says William E. Newell, is the use of a resonant-gate transistor [Electronics, Sept. 20, 1965, pp. 84-87]. The name stems from the fact that the resonator is the gate electrode of a surface field effect transistor.

"In this transistor, the output signal's frequency is controlled by a stable mechanical resonator that works like a tiny tuning fork," says Newell, who is manager of new devices and applications at the Westinghouse Electric Corp.'s research laboratories in Pittsburgh.

Thus far, resonant-gate transistors have been built that operate at frequencies to 60 kilocycles per second. Newell described the 60-kc devices during one of the technical sessions. Eventually, Westinghouse hopes to build a 455-kc, intermediate-frequency amplifier integrated circuit, incorporating a resonant-gate transistor. "Once that's done," Newell says, "we'll continue looking for ways to increase the frequency capability of resonant-gate transistors to one megacycle."

Newell plans to investigate new structures for single-resonant and double-resonant gate transistors. "We are going to look at split-beam resonators," resembling two parallel beams, says Newell. The investigation will be carried out, under Newell's guidance, by Harvey C. Nathanson and Robert A. Wickstrom, inventors of the resonant-gate transistor. Funds will be provided for continuation of the work by the Air Force.

Newell received a doctorate in electrical engineering from the Carnegie Institute of Technology in 1957 and taught for four years, including two years at the American University in Beirut, before joining Westinghouse.



Newell



De Loach



Engelbrecht

**The best-attended session** at the conference was a panel on bulk semiconductors, at which 700 engineers marveled at virtuoso performances by Rudolf Engelbrecht as moderator and by Bernard C. De Loach as font of information.

The large attendance was due partly to interest in these devices and partly to a well-circulated rumor that information about increased power was to be given by Bell Telephone Laboratories.

One scientist after another was called on to give illustrated descriptions of developments at their companies, but it was Engelbrecht and De Loach who dominated the presentation. As moderator, Engelbrecht, head of the microwave integrated device department, kept the discussion on the track with penetrating questions. De Loach, supervisor of the microwave semiconductor group, was stationed in the audience with pocketsful of slides, which he produced as needed.

Engelbrecht and his group have many irons in the fire. They are expanding the frequency capability of transistor amplifiers, and are working on Gunn-effect and avalanche transit-time devices. Engelbrecht said, "Now that we've built a 4.5-gigacycle integrated amplifier, the next one we'll probably tackle will be a 6-gigacycle hybrid-IC amplifier. This is the next frequency level that will be of interest to our radio-relay-station designers."

Concerning efforts with bulk-semiconductor devices, he said. "I can't predict just when we'll actually be using the devices in equipment, but I think it will be in the

# ASTRODATA

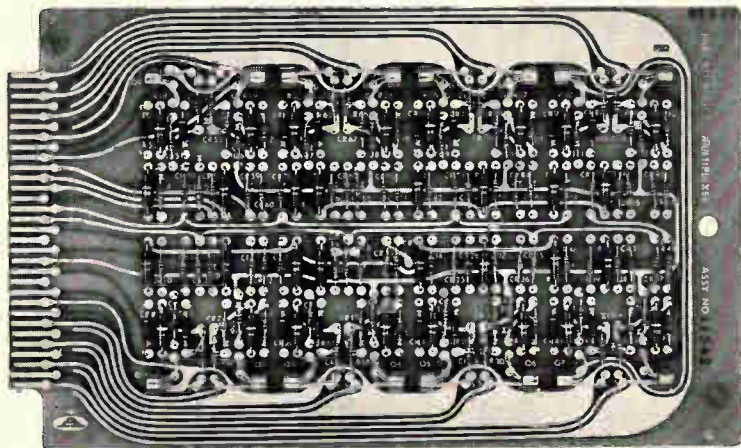

## STEP UP HIGH SPEED MULTIPLEXING WITH ASTRODATA'S NEW 970 SERIES

A new series of solid-state multiplexers now offers unexcelled performance in high speed, multi-channel applications. High reliability, low leakage, and virtually no offset voltage are assured by the use of improved Field-Effect Transistors in the switching element.

### SINGLE-ENDED INPUT - MODEL 970

The low-cost Model 970 provides up to 128 single-ended channels per module. Full scale input levels of  $\pm 1$  to  $\pm 10$  volts can be selected by a built-in, 4-position selector switch.

### DIFFERENTIAL INPUT - MODEL 975

Up to 128 differential inputs can be multiplexed in the general purpose Model 975. Both high and low signal lines are switched with Field-Effect Transistors. Gains of 2 to 20 can be selected allowing full scale input levels as low as  $\pm 0.5$  volt.

### THREE-WIRE INPUT - MODEL 976

Model 976 accepts multichannel signals which may originate from different ground sources. In addition to a differential FET switch, the shield of each input cable is switched to the multiplexer guard by a PNP silicon transistor. The shield switch effects high common mode rejection even when channel-to-channel common mode voltages are present.

### BRIEF SPECIFICATIONS

Stepping Rate ..... 0 to 20,000 channels per second  
Channel Selection ..... Random selection from external signals; or sequential scanning by internal programming  
Modular Expansion ..... Plug in as few as 8; expandable to 128 channels

*For more complete specifications or information, write or call:*



# ASTRODATA

P. O. Box 3003 ■ 240 E. Palais Road, Anaheim, California ■ 92803

relatively near future."

De Loach predicted that avalanche transit-time devices, rather than Gunn-effect, would be the microwave sources which would most extensively replace reflex klystrons.

## Field effect or bipolar arrays?

The keynote session at last year's Solid State Circuits Conference was on hybrid vs. monolithic integrated circuits. This year it was on large-scale integration (LSI) and the best approach, bipolar or unipolar. But this year, as last, the key questions were on cost and performance.

Interest was high in the development of large arrays, 100 functions or more, with the major manufacturers predicting they would be available within two years.

Jack S. Kilby of Texas Instruments Incorporated opened the discussion of large-scale integration by pointing out that a few years ago it could be proven mathematically that LSI was not possible. This analysis was erroneous for two reasons: today's high yields were not anticipated, and the ability to design high-performance logic circuits with loose component tolerances was unforeseen.

Joseph Logue of the International Business Machines Corp. brought up the argument of field effect devices versus bipolar devices, and said a clear-cut victory for either approach may never be achieved. This set the stage for a panel discussion exploring the subject and concluding only that whatever system predominates, a major effort toward standardization would be necessary. There was little agreement, however, between the field effect and bipolar advocates. Logue said there would probably be a place for field effect transistor IC's in small systems but that IC's built with bipolar transistors would predominate.

As for standardization, Edward A. Sack, chief engineer of the Westinghouse Electric Corp.'s molecular electronics division, called for a 48- or 64-lead standard case.

# Panel debates approaches to IC microwave design

**Debate continued** at the Philadelphia conference on whether hybrid or monolithic integrated circuits would best answer the needs of microwave designers. According to a panel on microwave circuits, the answer may not come for some time. (See related article on pp. 134 to 142.)

Only a few hybrid microwave integrated circuits, and no monolithic devices, have been built. Bell Telephone Laboratories has developed two amplifiers, and a few experimental hybrid models have been built by Microwave Associates, Inc., and Texas Instruments Incorporated. TI will deliver two monolithic IC's—a 500-Mc intermediate-frequency amplifier, and an X-band (9-gigacycle) mixer—to the Air Force in the next few months.

**Same story.** The backers of monolithic circuits cited the advantages of low cost, small size and high reliability. "It's really too early to compare hybrid and monolithic circuits at this time," said William Edwards of the Air Force's Molecular Electronics branch at Wright-Patterson Air Force Base, Ohio. But both Edwards and Arthur A. Uhlir Jr., vice president and manager of Microwave Associates' semiconductor division, maintained that in the long run monolithic circuits will win out. Uhlir declared that the monolithic approach lends itself more to automatic production techniques.

**Some problems.** While noting monolithics' advantages of size, weight and system flexibility, Frank A. Brand of the Army Electronics Command at Fort Monmouth, N. J., pointed out that they also had some disadvantages.

- Some sacrifices in performance result from tradeoffs between parameters.

- Once built, the circuits are inflexible, and no alterations or improvements can be made by the user.

- Some temperature instability is exhibited by both silicon and gallium arsenide substrates.

- Monolithic IC's are more subject to radiation damage than are hybrid IC's.

- The quality factors obtainable with monolithic IC's are lower than those obtainable with hybrids.

Hybrid circuits provide the designer with the factors he wants, such as "high performance, good bandwidth characteristics, good impedance matching, low noise, high-quality factors, good stability and high reliability," according to Rudolf S. Engelbrecht, head of integrated microwave work at Bell Labs. Size, he added, is not an overriding factor, since most microwave equipment is used on the ground.

**Another approach.** Engelbrecht suggested an approach combining hybrid and monolithic techniques. He pointed out that partial use of monolithic circuits in a hybrid system would eliminate the need to make critical interconnections by hand. He proposed a three-step design procedure for microwave circuits.

- Design the passive circuit using thin-film components just large enough to meet the performance and reliability requirements.

- Design the active devices adjacent to the critical passive components (short feedback loops, tunnel-diode stabilization networks and amplifier idler circuits) into the monolithic block.

- Attach the components built in previous steps at noncritical locations.

Although agreement on the ultimate success of microwave IC's was unanimous, there were some cautioning notes. Frank Haneman, section head of special systems and techniques in applied electronics at Airborne Instruments Laboratory, a division of Cutler-Hammer, Inc., said microwave circuits will offer an advantage, but won't arrive as fast as many people think. Future equipment using monolithic or hybrid integrated circuits will be more difficult to design and to breadboard than in current microwave equipment.

## collage

*More Motorola mishmash, continued from page 7*



Our Chicago Center proudly announces they've developed a new digital frequency synthesizer. It covers the frequency band of 30 mc to 70 mc in 5 kc steps and provides 90 db attenuation of spurious responses. But the BIG thing about the system is that it uses an ungodly number of *Motorola* MECL integrated circuits. Our Semiconductor Division must feel warm and good all over because we certainly aren't forced to buy their stuff. In fact, they tell us that "inside" business is usually the toughest to come by. It's like umpiring a ball game when your own child is playing. Or maybe it's more like dancing with your own sister... or with your own wife, for that matter. For more information write to our Chicago Center.

## A NOBEL PRIZE (or something) FOR GROVER

Can anyone use a couple hundred feet of coaxial cable that have been cunningly reduced to the dimensions of a .6 x .6 x .187 in. flat-pack? Well, that's what our Western Center's Grover Kennett has come up with using a few tricks like thin film capacitors, and he claims the delay time is comparable. Now if we can find a customer Grover will be recommended for the Nobel prize. If not, his resumé is available upon request. For more information, write to our Western Center.

*Continued on page 187*



## how to measure resolver or synchro position with 30 second repeatability

In both production test and ground checkout systems, North Atlantic's high performance Angle Position Indicators provide exceptional operator ease and precision in the measurement of synchro and resolver position. Features include digital readout in degrees and minutes, 30 second resolution, continuous rotation, plug-in solid-state amplifier and power supply modules. Due to the design flexibility of these units, they can be readily provided with a variety of features for specific requirements. Typical units in this line incorporate combinations of the following features:

- Single Synchro or Resolver Input
- Dual Synchro or Resolver Inputs
- Retransmit Synchro, Resolver, Potentiometer, or Encoder
- 2-Speed Synchro Input
- Multi-frequency Inputs
- DC Input
- 0-999 Counter

### BASIC SPECIFICATIONS

Range .....	0°-360° continuous rotation
Accuracy .....	6 minutes (standard)
Repeatability .....	30 seconds
Slew Speed .....	25°/second
Power .....	115 volts, 400 cps
Size .....	API-8025 .....
	API-8027 .....
	1 3/4" h x 9 1/2" w x 9" d
	3 1/2" h x 4 1/8" w x 9 3/4" d



Your local North Atlantic representative has complete data on the API line. Call him today or write direct for technical literature.

**NORTH ATLANTIC** industries, inc.  
TERMINAL DRIVE, PLAINVIEW, L. I., NEW YORK • Overbrook 1-8600

## New devices described at conference

Five new solid state devices were reported on at the conference. These included:

- A fast high-gain silicon photodiode, called a reach-through avalanche photodiode (RAPD). Reported by Heinz Ruegg of the Stanford Electronics Laboratories of Stanford, Calif., this is n-p-i-p construction to achieve a frequency response described as similar to that of p-i-n diodes. The carrier transit time was estimated at  $10^{-10}$  second. Ruegg said the diode could be used for the demodulation of microwave-modulated light and the detection of laser beams.

- A silicon needle transducer. This was suggested as a replacement for the steel, diamond and sapphire needles now being used in silicon transducers. Described by R. R. Stockard of the Research Triangle Institute of Durham, N. C., the device was said to have two advantages over existing silicon transistors: the alignment between the needle and the semiconductor surface it touches is less critical, and its sensitivity to change is greater. Silicon transducers are used to measure acceleration, force, pressure, stress, strain, and displacement.

- A resonant-gate transistor. This transistor has been described previously [Electronics, Sept. 20, 1961, pp. 84-87], but another geometry is being explored. The original geometry used an elevated cantilever beam attached to a circular contact at one end of the beam. The beam was 38 mils long; 3-ke devices using this geometry exhibit a Q of 150 and can be made in densities of 500 per square inch.

The new structure has circular contacts at both ends of the suspended beam. The beam is about 20 mils in length and values of Q up to 500 have been obtained for 60-ke devices made with the new geometry, according to author William E. Newell of the Westinghouse Electric Corp.

- A temperature-control inte-

## MORE AIRCRAFT UP TIME—LESS DOWN TIME

With **New** Automatic Wiring Analyzer

Keeping today's complex aircraft ready for action is a major challenge. Dalmo Victor is helping meet the challenge with the AN/USM-185\*, a mobile, versatile wiring analyzer that checks electrical integrity of oft-neglected aircraft wiring by automatically making error-free resistance, leakage and continuity tests. Though developed specifically for the F-105 and F4C, this analyzer can be used for **depot or field** maintenance to check out all present and future aircraft in all commands...all services.

Results of Air Force Project CAST and earlier related studies plus current operational command field tests that compare automatic and manual methods of checking aircraft wiring integrity indicate the true-significance of automatic wiring analyzers. For example, automatic equipment revealed marginal and faulty wiring normally not detected by manual means...test accuracy was significantly increased...and reduction in test times consistently averaged **minutes (vs. hours)**.

These studies also indicated that wiring age equals marginal wiring. Translated into more dramatic—but valid—terms, automatic wiring analyzers can contribute heavily to more aircraft up time, improved mission success and **saved aircraft**.

The USM-185 will make maximum contributions in these areas. With the simplest tape programming yet devised, the USM-185 is designed to automatically make go/no-go tests on a 5,000 point harness in only 36 minutes. Maximum test capacity is 40,000 points. Operational versatility is provided with automatic, semi-automatic, "manual" and self-programming operating modes. The central data processor is expandable for **functional versatility**. Self-test features ensure dependability and maintainability. When required, the USM-185 is readily adapted to card programming.

For more information, contact Dalmo Victor's Automatic Test Equipment Product Manager today.

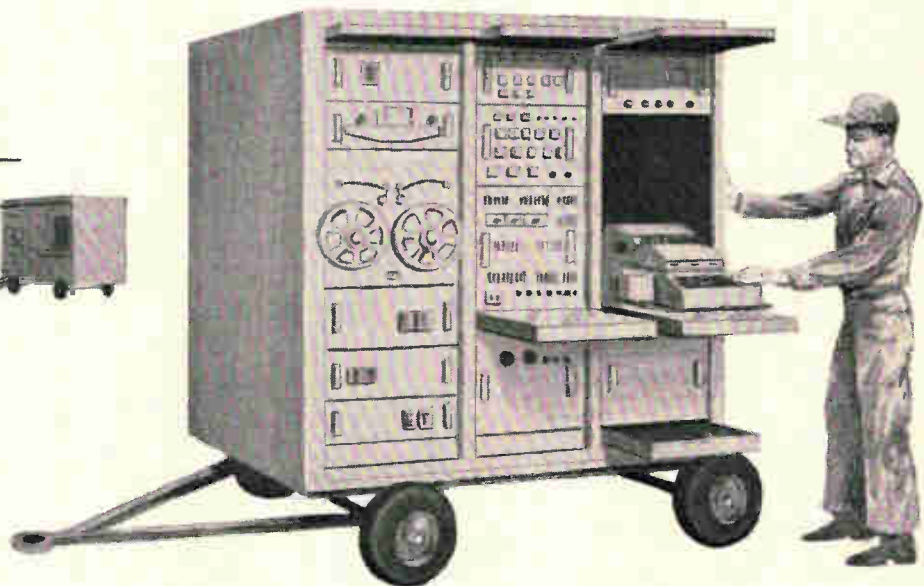
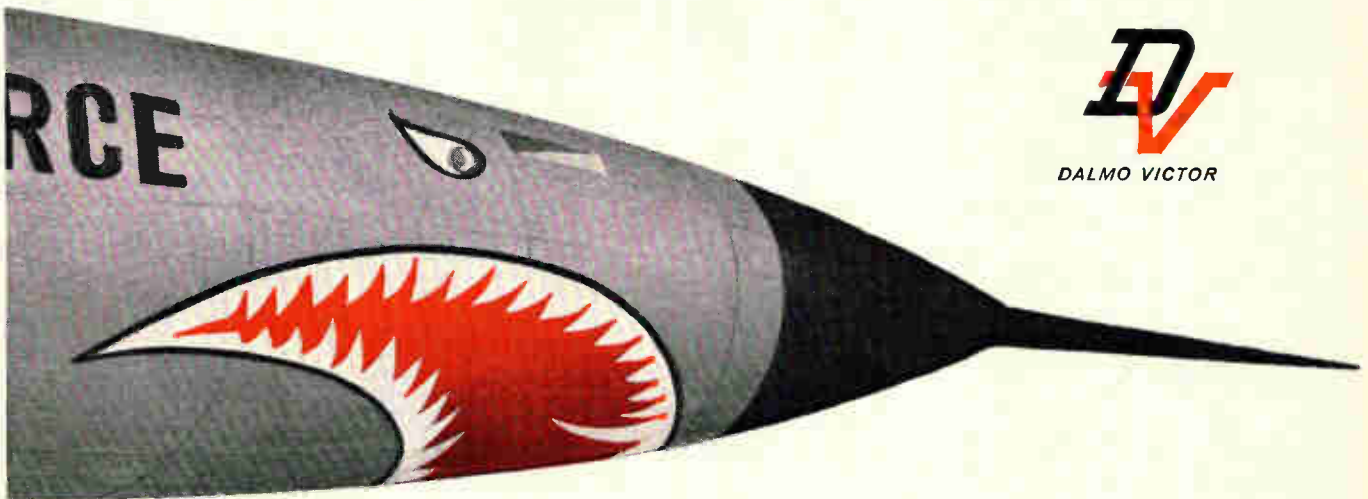

\*AN/USM-185, completely militarized automatic wiring analyzer produced by Dalmo Victor under contract to the Aeronautical Systems Division, Air Force Systems Command, USAF, Wright-Patterson AFB, Ohio. This analyzer meets or exceeds requirements of MIL-T-38218A, MIL-T-21200 and MIL-R-26667. Contract terms call for delivery of the first unit early this summer.

**DALMO VICTOR**

1515 INDUSTRIAL WAY • BELMONT, CALIFORNIA 94002  
TELEPHONE: 415/591-1414 TWX: 910/376-4400

A **textron** DIVISION



## Is the Spectrol Model 140 really so great ?

### No, it just acts that way!

This precision pot is priced like a trimmer, and yet it outperforms many higher priced models.

Here's a half-inch, single-turn, precision potentiometer with rear terminals for optimum packaging density...a new type mechanical stop that provides exceptionally high stop strength...and a unique wiper design that assures positive contact under severe conditions of shock and vibration per MIL-R-12934. Also, here's a miniature pot with high "specability!" From our standard data sheet, you can choose from more than 100 mechanical and electrical options, in addition to resistance ratings from 50 ohms to 70K ohms.

On second thought maybe it really is so great! Why don't you find out for yourself? You'll find the standard Model 140 (with stops) stocked at your local distributor. Want more data? Send for the 140 data sheet and ask for our new Short Form Catalog, too. The Model 140 comes from a great family.

**spectrol**

Spectrol Electronics Corporation  
17070 East Gale Avenue  
City of Industry, Calif. 91745

grated circuit. This multifunction circuit can be used as a temperature sensor, temperature control, voltage reference, voltage comparator, voltage-to-frequency converter, voltage-to-pulse-width converter, operational amplifier and selective filter. The circuit can sense changes in temperature and use heat as an input signal. Thomas F. Prosser, the designer, said that the functions of the circuit could be varied by using different masks and by changing pin connections. Prosser is with General Micro-electronics, Inc., in Santa Clara, Calif.

▪ An n-channel metal-nitride-semiconductor field effect transistor. This is a companion piece for the p-channel enhancement metal-nitride-semiconductor FET recently announced by the Sperry Rand Corp.'s Research Center in Sudbury, Mass. [Electronics, Jan. 10, p. 156]. Both devices, according to H. A. Richard Wegener, do not exhibit long-term instability. This instability is a serious drawback of metal-oxide-semiconductor FET's, said Wegener.

Wegener reported that up to 10 times the number of MOS devices could be put on the same size chip by using metal-nitride-semiconductor construction. He also said that devices built with nitride had higher breakdown voltages than devices built with dioxide insulation. He said p-channel devices have been built with an 80-volt drain-to-source voltage at 10 microamperes as well as n-channel devices with a 45-volt rating at 10 microamperes.

In two examples illustrating the stability of the nitride devices, Wegener described how Sperry coated half of a silicon slice with dioxide and the other half with nitride. After bathing the slice in sodium chloride, the changes in the electrical characteristics of the dioxide-coated devices were much greater than the changes in the nitride-coated devices. In the second example, Wegener said that after four weeks of storage at 300°C, a group of metal-nitride-semiconductor devices exhibited no changes in leakage characteristics and transconductance improved slightly. Nitride thicknesses for the device were approximately 1,000 angstroms.





## SERENDIPITY IS A \$985 INTEGRATING DIGITAL VOLTMETER

What makes the VIDAR 500 a rare and worthwhile find is not its price alone. It is the combination of low price and performance features that include:

Five full-scale ranges from  $\pm 100$  mv to  $\pm 1000$  volts

Three significant digit display (over-ranging adds a fourth from one to three times full scale)

Accuracy better than  $\pm 0.05\%$  of reading  $\pm 1$  digit

Up to nine readings per second

Variety of plug-in options

Built in voltage-to-frequency converter produces pulses at a rate precisely proportional to the input voltage. A precision electronic counter counts the pulses over a fixed time interval and displays an integral or average value. This technique virtually eliminates errors caused by noise superimposed on the data signal.

Used as a frequency counter, the

VIDAR 500 ranges from 10 cps to 200 kc with a four digit display and selectable gate times of 0.1 and 1.0 seconds.

You can own a VIDAR 500 Integrating Digital Voltmeter for \$985! Send today for the complete performance data. Your copy awaits you at: 77 Ortega Ave., Mountain View, Calif.

# VIDAR CORPORATION

Circle 153 on reader service card

# The quiet explosion around Washington

Private R&D companies have doubled in number since 1957. They supply, among other things, custom engineering operational hardware, and appraisals of military projects

By Warren Burkett  
Washington News Bureau

**Washington**, whose only major industry is the federal government, has quietly been spawning a private research-and-development complex that employs 27,000 people. Since 1957, the number of private R&D companies around Washington has nearly doubled, from 123 to 232, and 97 of them have been formed since 1960.

These firms are attracted to Washington by the government R&D funds and the opportunity for frequent personal contact with the men in government who do the buying. Also handy is the manpower market of government people with technical knowledge and contacts, who can be lured away by private industry. Explaining Washington's main appeal, Jacob Rabinow, president of Rabinow Electronics, Inc., in Rockville, Md., says: "Washington is where the money grows. The government is the largest buyer of our commodity—research and development—so Washington naturally tends to be a center for this work."

Rabinow previously worked for the government in R&D. After leaving the Army's Harry L. Diamond Ordnance Laboratory in Washington, he founded his own company in 1954. Control Data Corp. purchased the company last year and Rabinow is continuing as president of the wholly-owned subsidiary.

Rabinow is not unique; many of the founders of small R&D companies are former government researchers. Bruno Weinschel, president of his Weinschel Engineering

Corp. in Kensington, Md., also worked for the Harry L. Diamond Ordnance Laboratory; Arthur Varella, vice president of Radiation Systems, Inc., was with the Naval Ordnance Laboratory in White Oak, Md.; Edward Weiss of the Matrix Corp. was employed at the

Aberdeen Proving Grounds, Md.  
**I. Spurs to growth**

Besides the fact that the government is the major user of R&D, several recent events have spurred the boomlet of private R&D firms around Washington. One impetus

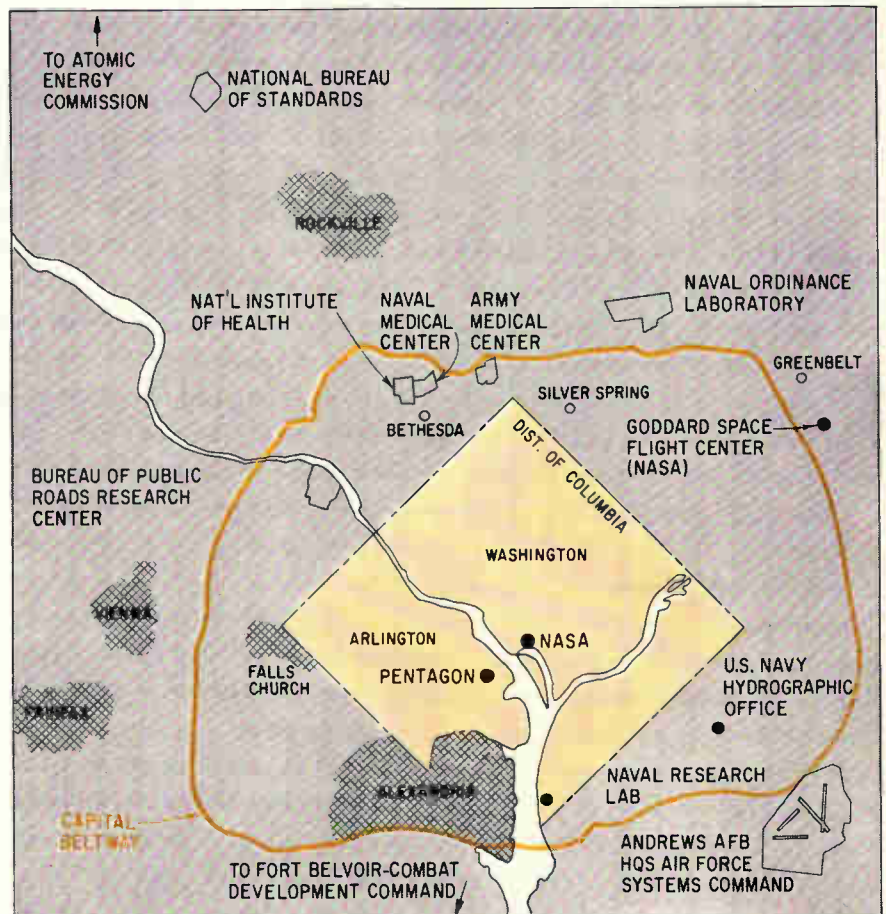

**Capital Beltway**—U.S. 495—circles the District of Columbia 10 miles from its center and has become a prime attractor of R&D industry. The high-speed freeway passes near the major federal R&D markets.



VA-244  
SERIES

## WARRANTY TRIPLED TO 15,000 HOURS



VA-259  
SERIES

### Two Varian klystrons in the 4.4 to 8.5 Gc range cut your warranty cost-per-operating-hour by a full *two-thirds*.

Originally warranted for 5,000 hours, the VA-244 and VA-259 klystrons have demonstrated a remarkably long life-expectancy. In the past two years, reports from users around the world, as well as results from our own laboratory Life Tests, indicate that the operating life of these tubes is far in excess of 15,000 hours. Therefore, we have tripled the warranty to

15,000 hours on both the VA-244 and VA-259 reflex klystrons.

For more complete information, write Palo Alto Tube Division, Executive Offices, 611 Hansen Way, Palo Alto, California. In Europe, write Varian A.G., Zug, Switzerland.





## MOLD LARGER PROFITS

ENCAPSULATE THE  
NEW AUTOMATED WAY  
WITH...

## HYFLO®

EPOXY MOLDING  
POWDERS

HYFLO® Epoxy Molding Powders are used to economically produce a wide variety of large or miniaturized complex, intricately shaped components, with the advantages of extreme toughness, low coefficient of expansion, flame-out properties, high dielectric strength, environmental protection and attractive appearance. They are designed for the automated transfer and compression molding of electrical-electronic components and are particularly economical when used on production runs.

HYFLO® Epoxy Molding Powders are stable, one component compounds which eliminate the need to mix and oven cure. Their physical and electrical properties are equal to or better than existing liquid epoxy systems.

*Write, wire or call for application engineering assistance... request Bulletin E-500 or EMP-2.*

was the increased outlay of R&D funds initiated during the Kennedy and Johnson administrations following cutbacks in federal research funds in 1960. Also, Defense Secretary Robert S. McNamara initiated a policy of demanding more documentary evidence in Pentagon proposals to a degree never before expected or demanded.

Military men found they needed the critical advice of independent R&D people to evaluate proposals. The private companies provided local advice and sometimes custom engineering for the writing of practical R&D contract proposals. Some companies also manufacture operational hardware.

**Problem solver.** Radiation Systems, Inc., of Alexandria, Va., got off the ground solving problems for skeptical government administrators. From providing advice on the potentialities of various antenna systems, the company moved into custom engineering and became a major contractor on the Navy's Shrike missile. It also developed and sells its own broadband (17 to 1 ratio) microwave antenna systems.

Another factor strengthening the position of the Washington R&D companies has been the increasing pressure put on Pentagon people to anticipate problems and initiate solutions. "You have to be able to sit down and help an official solve some of his problems," says J. Paul Walsh, chairman of the Matrix Corp., which is opening a high-speed, time-sharing data link capable of handling 40,000 characters a second. The link will connect Washington and New York with the Matrix 7094 computer in Farmingdale, L.I.

### II. Doing well

With few exceptions, all the private R&D companies are doing well—the old-timers as well as those which have emerged over the past few years. Radiation Systems, for example, will move its company and \$3 million worth of contracts from the National Aeronautics and Space Administration, Navy and National Security Agency from the banks of the Potomac River in crowded Alexandria to a 200-man plant in the Westgate Industrial Park in McLean, Va.

**Prime attractor.** The park is lo-

PROGRESSIVE PRODUCTS  
**HYSOL**  
THRU CHEMICAL RESEARCH

HYSOL CORPORATION • OLEAN, NEW YORK  
LOS ANGELES, CALIFORNIA / LONDON, ENGLAND

cated near the new Capital Beltway—U.S. 495. The Beltway is becoming a prime attractor of R&D industry, and has already influenced the moving of more than a dozen companies. The high-speed freeway circles the District of Columbia 10 miles from its center; it passes through wooded Virginia and Maryland suburban real estate ripe for industrial development. The land is relatively inexpensive and the smokeless R&D industry is almost the only kind of industrial development tolerated by the tough zoning boards in the residential suburbs.

More important, however, the Beltway is near more than a dozen government laboratories, the sources of money for electronics contracts.

From the Beltway, company representatives can swing northwest, past Rockville, Md., to the Atomic Energy Commission and the new National Bureau of Standards Laboratories at Gaithersburg, Md. The new plant for IBM's Federal Systems division is also going up near the Beltway in the Gaithersburg area. On beyond Germantown lies the U. S. Army Biological Laboratories at Fort Detrick, Md.

Beltway connections with the George Washington Memorial Parkway carry contract-hunters downtown to the mother lode of research dollars: the Pentagon, the National Aeronautics and Space Administration headquarters, the Department of Commerce, the Department of Health, Education and Welfare and Congress.

Small size generally characterizes the electronics-oriented Washington R&D organizations, reflecting their newness. About 60% of them have 50 employees or fewer. Only five have more than 1,000 people: the Atlantic Research Corp.; Melpar, Inc.; Vitro Laboratories, a division of the Vitro Corp. of America; the International Business Machines Corp.'s Federal Systems division; and the Johns Hopkins Applied Physics Laboratory.

### III. Problems

Working in Washington has its problems. Washington bankers aren't as attuned to the needs of R&D companies as are banks in other areas, says Walsh. Matrix has finally established a good fi-

# VACUUM+ CERAMIC

RF10A



RJ2A



RJ1A



#### JENNINGS TYPE

Operating Voltage (16 mc)  
Test Voltage (60 cycle)  
Continuous Current (16 mc)  
Interrupting Rating  
(dc resistive loads)  
Weight (oz.)

#### RF10A

10 KV Peak  
20 KV Peak  
30 Amps RMS  
50 KW  
(up to 5 amps or 10 KV)  
16

#### RJ2A

8 KV Peak  
18 KV Peak  
15 Amps RMS  
1 KW  
(up to 1 amp or 1 KV)  
3

#### RJ1A

2 KV Peak  
5 KV Peak  
7 Amps RMS  
1

Vacuum plus ceramic adds up to a new line of Jennings vacuum relays that brings you (1) High voltage hot switching capability (2) Highest RF current carrying ratings (3) Shock resistance (4) Small size and light weight (5) Greater reliability (6) Low unchanging contact resistance.

These new relays eliminate the necessity to redesign circuits in order to avoid difficult switching problems. Now small lightweight systems can be designed in the sure knowledge that the new Jennings vacuum relays offer as much as or more reliability and high performance than any other component in the circuit.

The RF10A relay features high power dc interrupting capability up to 50 KW.

The RJ2A and RJ1A are essentially rf relays capable of withstanding high voltage and carrying high rf currents. Even so the RJ2A will interrupt a rather remarkable 1 amp at 1000 volts for many thousands of operations.

Jennings also offers many glass vacuum relays, each designed to provide maximum performance to the particular segment of the electronic field for which they were created.

Our new catalog 102 describing our complete line of vacuum relays is available at your request.

Jennings Radio Manufacturing Corporation — Subsidiary of International Telephone and Telegraph Corporation, 970 McLaughlin Avenue, P. O. Box 1278 San Jose, California 95108.

ITT Jennings

# You just discovered how super/reg<sup>®</sup> pin-pointed regulation eliminates your worries about cross-talk and line losses in DC power systems.

Typical super/reg zener impedances of 2 to 8 milliohms — lowest ever yet achieved — makes possible .01% regulation and .5mv ripple.

Its unique "third" terminal lets you trim the output voltage a full  $\pm 10\%$  from nominal, with no derating or degradation.

.01%/°C temperature compensation at high power levels; thermal stability 100-times greater than that of the standard zener.

Zener voltages from 3.9 to 56V.

Full 3-ampere steady-state rating up to 75 watts.

A super/reg diode breaks the zener barrier by means of its "synthesized" construction: embodies a sensing bridge, operational amplifier,

thermally compensated zener diode, in standard TO-36 case.

Looks, mounts like any other diode. Performance-proven reliability; patent pending design. Designed for MIL applications.

Write or call for complete data and application bulletins.

Semi-conductor Division, Trio Laboratories, Inc., Plainview, L.I., N.Y. (516) OV-1-0400.

TWX: (510) 221-1861.



© 1966. TRIO LABORATORIES, INC. • ORIGINAL CONCEPTS IN INSTRUMENTATION



This is the super/reg<sup>®</sup> synthesized zener diode.  
See us at IEEE Booths 3G06 and 3G08

nancial arrangement with a bank in Arlington, Va., but the company was forced to go to the West Coast for its first development money. Walsh says. "The banks around here just didn't need the business; they knew the booming real estate developments would borrow all the money they could supply," he explains.

Also, trained professional and technical people are in as short supply in Washington as anywhere else, with a spot always open for the exceptionally qualified.

**The future.** C.G. Gullede, president of Dynalectron Corp. in Washington, says Washington needs one important element to keep its budding electronics and research industry growing: better graduate schools.

"Washington needs an institution whose graduate schools in the sciences and technology can take their places in quality and reputation with the Massachusetts Institute of Technology and the California Institute of Technology, to name only two," says Gullede. The lack of any such university around Washington makes it difficult to recruit "bright young men because they are naturally interested in pursuing their advanced educations toward graduate degrees in the sciences and prefer working in Massachusetts or California," Gullede contends.

**Others disagree.** But other federal and private R&D people disagree with Gullede about the lack of good universities. American University, George Washington University and Catholic University are three good area schools, says John Wheeler of the Harry Diamond Laboratory. Bill Herman of the U.S. Combat Development Center feels local educational standards are adequate. Rabinow, a graduate of the City College of New York, says it makes no difference what college an employee attended, "it's what he can do that is important."

With bigger and bigger federal budgets and an emphasis not only on military needs but Great Society goals as well—mass transportation, urban renewal, health and welfare and so on—more and more companies engaged in R&D will look to Washington as a base of operation.



# FASTER DESIGN DECISIONS with the help of the new CENTRALAB POTENTIOMETER CATALOG

This unique engineering reference provides you with basic design information you won't find elsewhere. A section on the factors involved in noise control and a special article on attenuator design typify the valuable data assembled for your convenience. A materials analysis and evaluation section supplies application data to help you decide the best material, plating and construction for ease, contact, insulation and hardware. A glossary of terms is included to clarify your design communications.

Of course, the new Centralab Potentiometer Catalog gives detailed electrical, physical, and mechanical specifications on all Centralab potentiometers and variable resistors. It describes the advantages and limitations of each type and provides comparative pricing information to help you decide which is best for your application.

*You can get your copy of this valuable publication by writing to Centralab, The Electronics Division of Globe-Union Inc., P.O. Box 591, Milwaukee, Wisconsin, 53201.*

**Rating ranges**—Devices rated at 1/20, 1/10, 1/5, 1/4, 1/2 and 2 watts are described.

**Tapers**—Graphs quickly show you the tapers available for each type.

**Mountings, shafts, terminals**—Easy to read, illustrated tables show the wide range of hardware options you can obtain—without tooling costs.

**Switches**—AC line switches are listed for most types as well as rotary, slide, or push types, for line and low voltage applications.

#### NEED PROTOTYPE QUANTITIES FAST?—

Most Centralab potentiometers are available in a wide choice of resistance ranges and tapers from Centralab Distributors—from stock. These units are listed in the catalog as locally available for immediate delivery.

**FOR ADDITIONAL INFORMATION  
CIRCLE NUMBER 203**



**DIVISION OF GLOBE-UNION INC.**



## Quality in Depth

Through Centralab Research and Development the products illustrated on these pages have been made available to the electronic industry.

**For Immediate Delivery . . .**

many of these products are stocked in quantity by Centralab's nationwide network of industrial distributors.

*For additional information on any of these product groups, circle the number indicated below, on the publication inquiry service card.*

**Switches—No. 201    Integrated Circuits—No. 204  
Capacitors—No. 202    Technical Ceramics—No. 205**



*Centralab...your partner in progress*

P. O. Box 591, Milwaukee, Wisconsin 53201  
In Canada: Centralab Canada Ltd., P.O. Box 400, Ajax, Ont.



# ON YOUR MARK...



**Kay 154: 50 KHz to 100 MHz**  
**Kay 159: 1 MHz to 300 MHz**

**PM 7650 Plug-in:  
Pulse Markers**  
**0.5 to 100 MHz**

**PM 7660 Plug-in:  
Harmonic & CW Markers**  
**1 to 300 MHz**

These solid-state sweep and marker generators cover the range in a single sweep; provide a continuously-variable narrow sweep.

Performance characteristics include line-lock, cw, manual and variable sweep rates, and external input.

PM 7650 and PM 7660 plug-in marker heads offer up to eight optional, individually-switched crystal plug-in markers per head.

A variable birdie marker provision is standard. All plug-in marker heads may be changed or added as required.

External modulation from dc up to more than 15 KHz, a built-in detector and switched attenuator are standard features. Sweep high-to-low or low-to-high.

*For literature and prices write:*

**KAY ELECTRIC COMPANY**  
 Pine Brook, Morris County, New Jersey • (201) 227-2000

## Wide-Sweep Generator

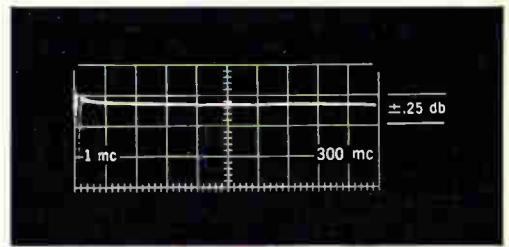

Full 300 MHz Wide Video Sweep

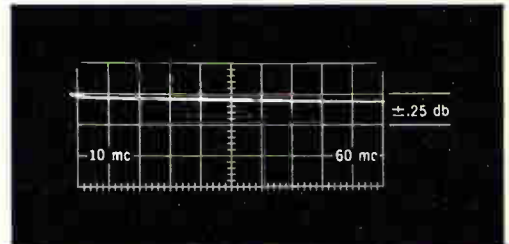

Programmable, Voltage Controlled Oscillator

## Marker Generator

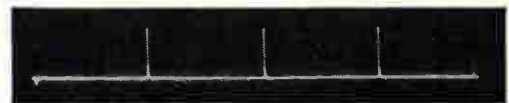

Pulse-Type Markers



Harmonic (or Comb) Birdie Markers



Single-Freq. Type Birdie Markers

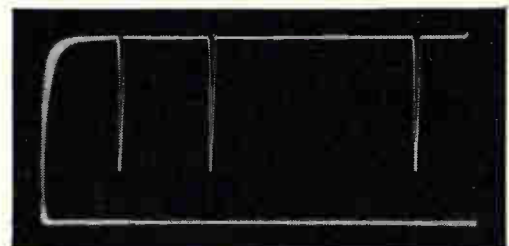

Detected Turn-Off Markers

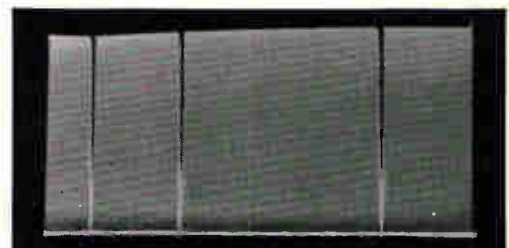

Undetected Turn-Off Markers

Visit Kay at the IEEE Show, Booths 3C11 - 3C17

Circle 161 on reader service card

# IS A PHOTO-CHOPPER BETTER?

PART NINE of a series on the state of the chopper art

Maybe. Us engineer types never get a decent clear cut decision. Still, if the Old Man said don't use them damn choppers maybe you'd better go photo-chopper. If you just ignore the neon bulbs you could say all solid state and get away with it.

It's like this. You'll get 1500 to 2500 ohms conducting resistance if you leave the neon lamp on. If you switch it at 60 cycles you get maybe 20 K. Dark resistance gets pretty good, about  $10^9$ .

The response time is not so hot. The flaw is turn-off time. The cells turn on quick and off slow. You use two, which helps, one in series with the load, one in shunt.

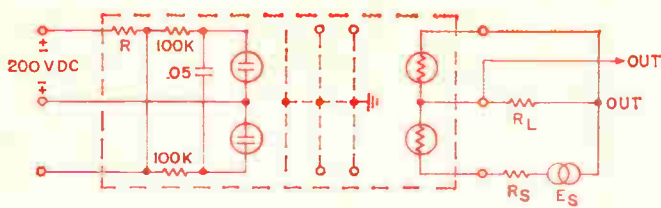

Type 5514 in a modulator circuit

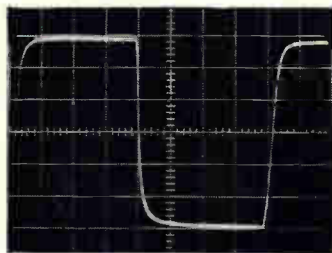

Output waveform  
60 cycle square wave drive

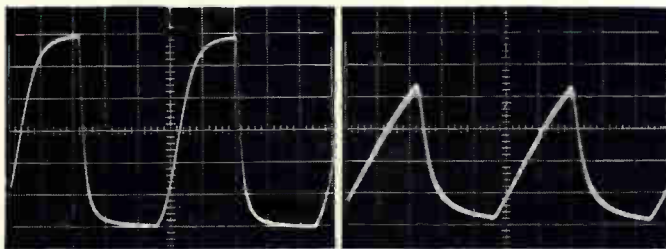

Output waveform  
400 cycle square wave drive

Output waveform  
1000 cycle square wave drive

You really need a square wave drive for best performance. Or you can supply DC at about 200 volts and get the neon bulbs to operate as relaxation oscillators. That's Airpax part 5514. The chopping rate will vary directly as the DC voltage.

So — sorry about that. It's still your headache. The life seems pretty good, we dunno how good yet, but it's probably up to the neon bulb if the photo-resistors are any good.

We will cheerfully sell you a couple thousand.

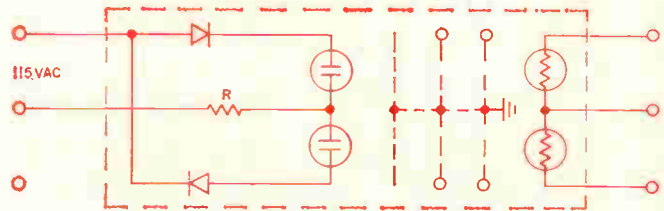
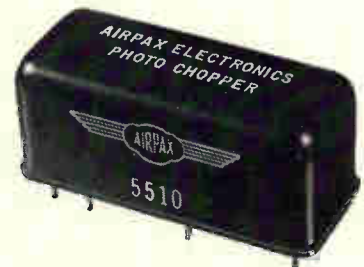

Internal schematic of AC Drive Type 5510,  
60 to 400 cps. R = Limiting resistor.

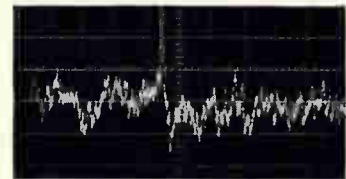

3 microvolt RMS, 50 microvolt  
peak noise across 1 megohm.

PEAK EFFICIENCY VS. FREQUENCY

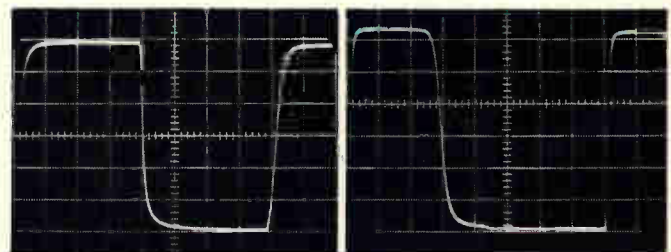
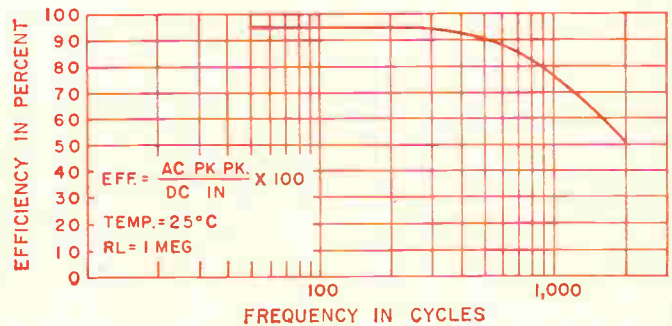

60 cps square wave drive  
showing maximum efficiency.

60 cps sine wave drive  
showing reduced time efficiency.

**AIRPAX ELECTRONICS** incorporated CAMBRIDGE DIVISION, Cambridge, Maryland

Phone: 301 228-4600 • TWX: 301-228-3558 • TELEX: 8-7715

# Flatpacks take another header

Mount for integrated-circuit packages  
crimps contacts to the ribbon leads

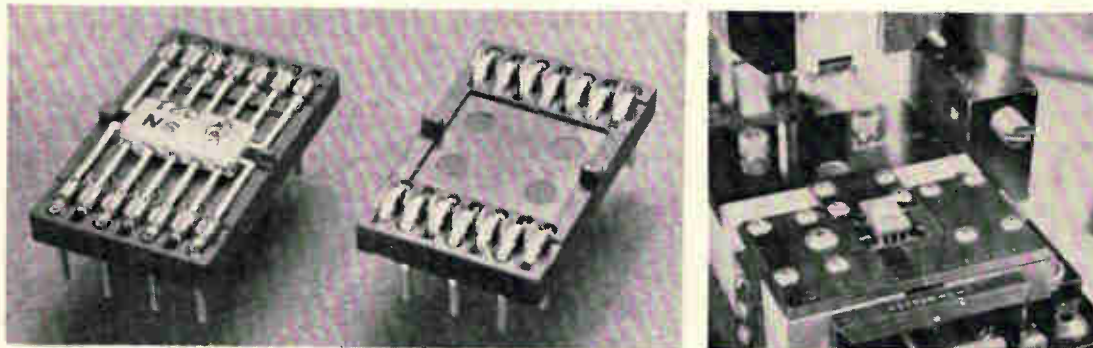

Crimping machine, simultaneously squeezes 14 barrel-shaped contacts around a flatpack's 14 leads. The process takes less time than is required to solder or weld flatpack leads.

A society for the preservation of integrated-circuit flatpacks is urgently needed. Once the darling of the microelectronics industry, the flatpack is in danger of being wiped out by those who prefer to use uncased IC chips, IC arrays, or ungainly plug-in packages.

But, the fourth and most prolific of the anti-flatpack schools are the mounters who try to convert the flatpack into something it isn't—a relatively large and husky piece of assembly hardware. They put the flatpacks onto carriers or into cavernous modules, which can then be plugged into wiring panels. The latest and cruelest blow by the mounters is a header assembly that costs \$2 to \$5. A guy really has to hate flatpacks to pay more for a mount than for many types of IC's.

The header is a new product of AMP Incorporated, a company dedicated to the preservation of crimped contacts. Crimping is a method of making electrical connections by squeezing a contact around a lead. Untold millions of uncrimped contacts are being used in microelectronics equipment because flatpack leads have been soldered or welded.

AMP figured out a way to crimp all 14 leads of a flatpack simultaneously in seconds—less time than it takes to solder or weld flatpack leads. Then AMP proceeded to build a mount under the crimps.

Not content with that, the company attacked the flatpack's best friend, the multilayer printed circuit board. Many manufacturers interconnect flatpacks with multilayer boards.

The new headers plug into a receptacle that in turn plugs into conventional wiring panels or into simple two-sided circuit boards—one side carrying a sheet-copper power plane and the other a ground plane. The pins of the receptacle are 5/8-inch-long, rectangular wiring posts, which permits all the flatpacks on a panel to be interconnected with old-fashioned wires. AMP recommends its own numerically controlled Termi-Point machines for the wiring job, but concedes it can be done just as well by the Wire-Wrap machine of its competitor, Gardner-Denver Co.

For customers who insist on multilayer boards, AMP will soon introduce a receptacle that has long, round pins that can be soldered into the round plated-through holes of the boards.

Richard O'Neil, the engineer responsible for the header, expects it to make an immediate hit with military system manufacturers who are more concerned with assembly and maintenance costs than with building smaller assemblies. "One of our customers," he says, "has been spending 14 hours to mount 90 flatpacks on a panel. We think he can do it our way in one hour."

The time saving will result, he says, from performing the crimping and panel-wiring as rapid sub-assembly operations. Besides, he adds, the header can be used as a test and breadboarding fixture and for replacing circuits that fail in the field. The header and receptacle are equipped with a series of keying and coding aids which assure that the right header will always be plugged the right way into the proper receptacle.

However, O'Neil admits that the \$2 to \$5 price (which depends on coding requirements and quantities ordered) may be too high for commercial-equipment manufacturers. So he has designed a 50-cent version of the header that does not require a receptacle. The crimps are made to the tops of the wiring posts. This version will be ready for sale in a month or so.

### Specifications

Header dimensions	0.61 by 0.38 inch
Mounted assembly height	0.35 inch
Header-receptacle keying	any combination of six positions
Flatpack lead spacing	0.05-inch centers
Wiring post spacing	0.1 and 0.125-inch centers
Post dimensions	0.625 by 0.022 by 0.036 inch
Crimping machine rate	100 to 150 an hour (including hand-loading time)

AMP Incorporated, Harrisburg, Pa.  
Circle 350 on reader service card

## Low-frequency filters offer 1% bandwidth

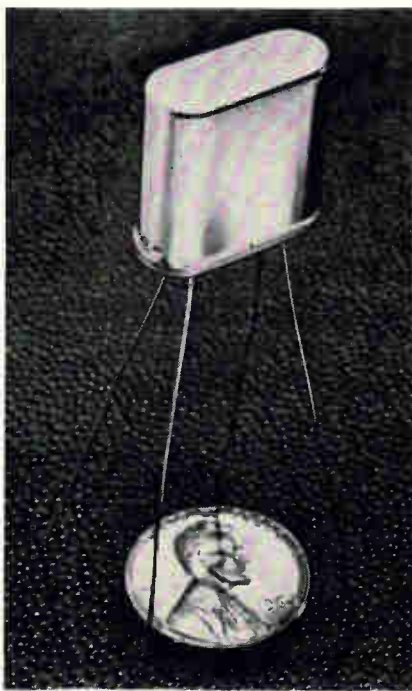

A line of ceramic filters for frequencies from 9 to 50 kilocycles per second offers narrow bandwidth and reasonably low insertion loss in a small package. Weighing only 1/4 ounce, the filters' three-decibel bandwidths are 1% of the center frequency, and their mid-band insertion loss is less than 3 db. The filters are packaged in a hermetically sealed crystal can, type HC-6/U, which measures 3/4 by 5/16 by 3/4 inches. The manufacturer, the Piezoelectric division of the Clevite Corp., claims that this is the first ceramic filter offered in this frequency range.

The filters were developed for a military communication system that must continue operating after an atomic attack; the atmosphere would be heavily ionized requiring very low frequencies—3 to 30 kc—for reliable communications and signaling. In commercial applications, the filters may be used for tone signaling systems that remotely actuate switches or electronic circuits, for selecting harmonics of crystal controlled oscillators, and for other applications requiring narrow-band filtering.

The ceramic filter's 1% band-

width is broader than that of a crystal filter, but narrower than that of a lumped-element filter. At 13% of the filter's center frequency, its response is down 20 decibels. One side of the response curve continues to drop gradually to 35 db, while the other side rapidly drops to 45 db and then returns to 35 db. By reversing the connections of the output leads, the 45-db point may be placed above or below the center frequency; it can also be moved closer to the passband by adding external capacitance.

Input and output impedances are equal, but their values are dependent on the center frequency selected. As an example, the impedance is 56,000 ohms at 10 kc, 47,000 ohms at 20 kc, 33,000 ohms at 30 kc and 22,000 ohms at 50 kc.

Over five years, aging of the ceramic element will result in less than a 0.25% increase in the center frequency, the manufacturer says. As a function of temperature, the center frequency will vary less than 0.3% from -40° to 85°C.

### Specifications

Designation	Split-ring, low-frequency filter
Type	U
Frequency range	9 to 50 kc
3-db bandwidth	1%
20-db bandwidth	13%
Input-output impedance (ohms)	
10 kc	56,000
50 kc	22,000
Midband insertion loss	3 db
Package	HC-6/U crystal can
Dimensions	3/4 by 5/16 by 3/4 in.
Weight	1/4 oz.
Lead spacing	0.120 by 0.372 in.
Price (1 to 25 pieces)	\$25

Piezoelectric Division, Clevite Corp., Bedford, Ohio [351]

## Wire-wound resistors feature high stability



A series of precision wire-wound resistors offers 0.0025% absolute

**IF**  
you use,  
need or  
specify  
**DC POWER**  
you'll want  
this new  
**TRYGON**  
**POWER**  
**SUPPLY**  
**HANDBOOK**

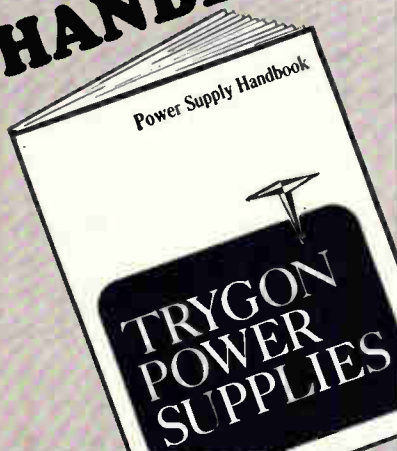

TRYGON Electronics, Inc.  
Roosevelt, L.I., N.Y. 11575

Gentlemen:  
Please RUSH me your newly published  
HANDBOOK—Free.

Name .....

Title .....

Company .....

Address .....

City .....State.....Zip.....

tolerance at 25° C with 0.0025% stability for three years. Series A is available with indicated commercial wattage ratings from 0.12 to 1 watt based on a maximum ambient temperature of 125° C derated to zero watts at +145° C. Resistance ranges from 1,000 ohms to 1 megohm. Tolerances of 1% through 0.0025% are available on most types and resistance values. Temperature coefficient is ±10 ppm/° C standard from +10° to +85° C. Sizes range from 0.250 in. by 0.500 in. to 0.500 in. by 2.00 in.

Where either resistance matching or accurate voltage division is required over long periods of time—for a-to-d converters, analog computers, differential voltmeters and guidance computers—the series A resistors are said to offer the ideal solution. These resistors are for use in room temperature environment. Kelvin, 5907 Noble Ave., Van Nuys, Calif. [352]

## Prop-axial blowers provide high airflow



Type PAX-3-DC prop-axial blowers provide high airflow (60 cfm at 0 in. H<sub>2</sub>O) from a small, lightweight package. Size is 3.250 in. diameter x 1.75 in. maximum depth and weight is 6.5 oz. The blower is powered by a standard SS motor; current drain is 0.28 amp at 28 v d-c and 60 cfm free air. Stainless-steel shaft, ball bearings, encapsulated armature, and black anodized housing and blade provide environmental protection. Nineteen standard SS motors provide a wide variety of performance from 6 to 50 v d-c.

Airflow direction is reversible by mounting from servo rings at either end of the unit. Terminals at the

## Why pay custom prices for conductive plastic pots?

Our off-the-shelf ECONOPOTS™, the industry's only standard conductive plastic precision potentiometers, provide multimillion-cycle rotational life and infinite resolution for as little as \$11.55!

Nearly every other industry has been able to standardize and take advantage of mass production. Why not the precision potentiometer industry?

Why not? This question marked the genesis of our ECONOPOT™ concept. We surveyed thousands of precision pot requirements, found definite common denominators, and designed 18 precision conductive plastic models that meet these common needs. The inherent efficiencies of standardization and automation enable us to offer these 18 models from stock at a small fraction of the prices usually paid for precision pots of this quality.

### HERE'S ALL THE INFORMATION YOU NEED TO ORDER ECONOPOTS™

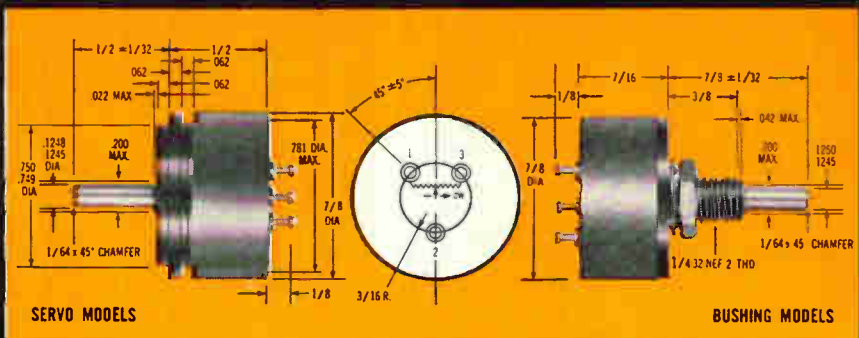

MODEL NO.	MOUNT	LINEARITY	TOTAL RESISTANCE	INTRO. PRICE
-----------	-------	-----------	------------------	--------------

78ESA102	Servo	1%	1K	\$13.60
78ESA502	Servo	1%	5K	13.60
78ESA103	Servo	1%	10K	13.60
78ESB102	Servo	0.5%	1K	16.45
78ESB502	Servo	0.5%	5K	16.45
78ESB103	Servo	0.5%	10K	16.45
78ESC102	Servo	0.25%	1K	19.55
78ESC502	Servo	0.25%	5K	19.55
78ESC103	Servo	0.25%	10K	19.55
78EBA102	Bushing	1%	1K	11.55
78EBA502	Bushing	1%	5K	11.55
78EBA103	Bushing	1%	10K	11.55
78EBB102	Bushing	0.5%	1K	14.40
78EBB502	Bushing	0.5%	5K	14.40
78EBB103	Bushing	0.5%	10K	14.40
78EBC102	Bushing	0.25%	1K	17.50
78EBC502	Bushing	0.25%	5K	17.50
78EBC103	Bushing	0.25%	10K	17.50

Prices subject to change without notice

### SPECIFICATIONS

PARAMETER	VALUE
Electrical angle	340° ±5°
Noise	100 ohms maximum
Rotational life	> 10,000,000 shaft revolutions
Resolution	infinite
Power Rating	1.25 watts at 70°C, derated to 0 at 125°C
Temperature Coefficient of resistance	±200 ppm/°C nominal
Resistance Tolerance	±10%
Starting Torque	<0.5 oz-in

ECONOPOT meets all requirements of MIL-R-12934D

For as little as \$11.55, you can evaluate an ECONOPOT!

For fast service, airmail the coupon. For same-day service, call us collect.

FREE ON REQUEST . . .  
4-page technical catalog plus a 25-page comprehensive report of reliability evaluation tests conducted on ECONOPOTS. Report includes results of tests for mechanical strength and high speed rotational life; and resistance to shock, vibration, humidity, solder heating, and temperature shock.

ECONOPOT  
TEST  
REPORT

Same-day processing on requests via coupon

**nej** new england instrument company

**new england instrument company**

Kendall Lane • Natick, Mass.  
Tel: 617-655-1411 TWX: 617-875-4261

If your purchasing procedures permit, NEI will honor this signed coupon as a purchase order

- Ship—units of Mod. \_\_\_\_\_ at \$ \_\_\_\_\_ ea
- Ship—units of Mod. \_\_\_\_\_ at \$ \_\_\_\_\_ ea
- Send free copy of 29-page ECONOPOT Catalog and Environmental Test Report
- Send technical literature on all NEI products & capabilities

NAME: \_\_\_\_\_

COMPANY: \_\_\_\_\_

ADDRESS: \_\_\_\_\_

CITY: \_\_\_\_\_ STATE: \_\_\_\_\_ ZIP: \_\_\_\_\_

SIGNATURE: \_\_\_\_\_



Need to say a lot  
in a little space?

(or make markings  
more **durable**...or  
more **economical**...  
or at **higher rates**?)

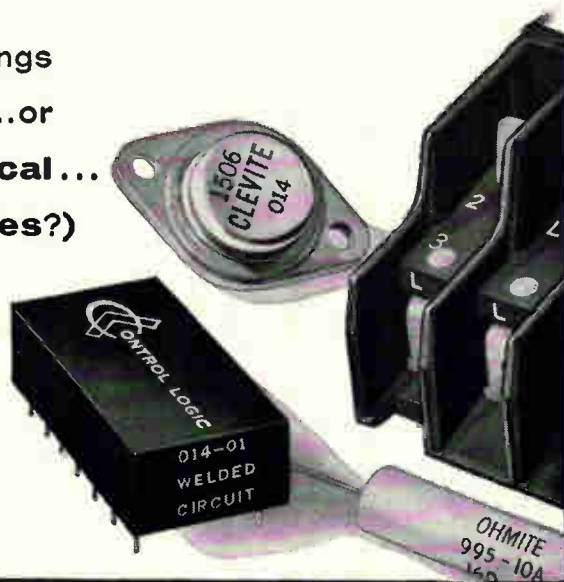

## We can show you how

We can show you how to identify products so they will resist extreme amounts of handling, abrasion, many solvents and other atmospheric conditions . . . or how to sequentially number and identify components with savings of more than \$50 per 1000 . . . or how to print trademark, type number, value and date code on 90 units a minute . . . or how to produce an imprint that remains readable after 1000 hours at 200°C. . . or get 10 digits and 2 letters in a micro-circuit area of 0.090" — or 21 characters on a TO-5 case with interchangeable type number and date code . . . or save 75 cents of every dollar you now spend on buying, applying, inventorying and discarding obsolete preprinted labels.

The answers are in proven Markem machines, type and specialty inks, which daily produce better product or package identification by reducing costs, smoothing production control and increasing customer acceptance. And while Markem machines, type and inks are helping to produce better products through more complete and lasting identification, they frequently pay for themselves in the savings they make possible. Tell us what *you* make, what it must say, and for how long: we'll give you a specific recommendation and cost estimate right away. Write Electrical Division, Markem Machine Co., 305 Congress St., Keene, New Hampshire 03431.

# MARKEM

## New Components

motor or on the blower housing are standard. Leads can be provided.

Globe Industries, Inc., 2275 Stanley Ave., Dayton, Ohio, 45404. [353]

## Coaxial connector with rfi filter

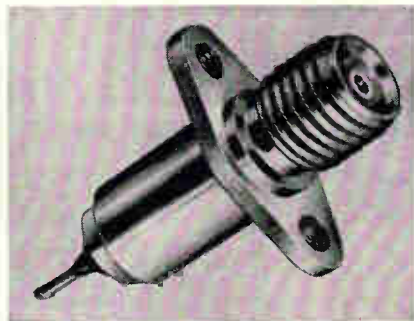

A subminiature coaxial connector has been developed with an integral low-pass rfi filter. The filter of the panel receptacle rejects passage of rfi signals by 10 db at 10 Mc, to 50 db down at 100 Mc through 2 Gc. The elements of the filter are hermetically sealed for added reliability, and the filter also provides the necessary shielded cable termination.

The impedance of the CX connector series is matched for 50 ohms, and the vswr exhibited is less than 1.25 up to 6 Gc. The connectors incorporate the manufacturer's Micropin and Microsocket contacts, which are terminated using crimp assembly techniques. ITT Cannon Electric, 3208 Humboldt St., Los Angeles, Calif., 90031. [354]

## Centrifugal blowers for hot-spot cooling

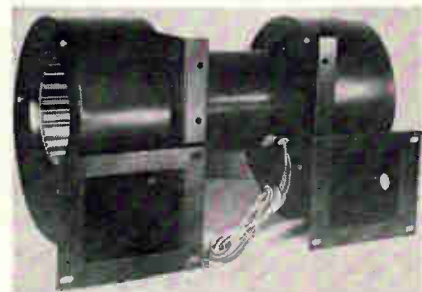

A line of single and dual centrifugal blowers includes 15 long-life

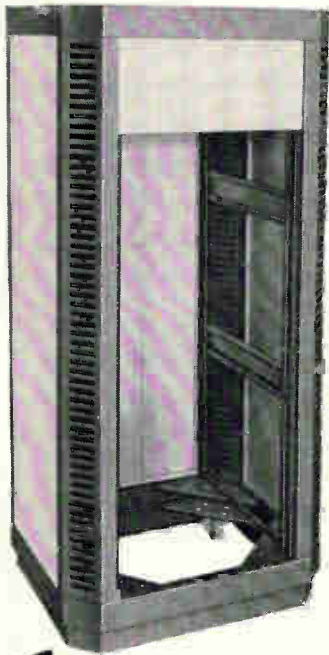

# WHAT SIZE HOUSING



Zephyr 8 Rack  
82 1/2" x 24" x 27 1/2"

Minibox  
1 1/2" x 2 1/8" x 2 3/4"

## Are these the ways you measure size?

### Greatest variety

From the smallest box to the largest cabinet rack and a multitude of sizes in between, Bud makes the most comprehensive line of sheet metal enclosures.

### Largest capability

112,000 square feet of floor space and every necessary production tool make it possible to fabricate thousands of sizes and types every day.

### Best service

A network of 400 authorized distributors stock Bud products for immediate delivery. They are backed-up by the largest factory inventory in the industry.

### Widest acceptance

More engineers prefer Bud products over all other similar products. They have said so in several surveys.

### Most "know-how"

Bud designers know every essential of creating housings for the electronic industry. Their services are available for the building of special enclosures.

Write us for catalog 166C.

INCHES	ALUM.		STEEL		ALUM.		STEEL		ALUM.		STEEL		
	THICK.	WEIGHT	THICK.	WEIGHT	THICK.	WEIGHT	THICK.	WEIGHT	THICK.	WEIGHT	THICK.	WEIGHT	
5	.1819	2092	.1144	1445	.13	0720	.0897	11	.0483	.0538	.0285	.0329	
6	.1820	1943	.1119	1345	.14	.0611	.0747	12	.0483	.0478	.0234	.0239	
7	.1443	1793	.11	.0907	.1196	.15	.0511	.0673	14	.0359	.0418	.0226	.0263
8	.1285	1644	.12	.0808	.1046	16	.0508	.0598	18	.0320	.0358	.0201	.0239

This attractive scale indicates the thickness of steel and aluminum gauges as well as their weights per square foot, It's FREE, write for it on your letterhead.



**BUD RADIO, INC.**  
WILLOUGHBY, OHIO

# TIRED OF FIGHTING THE NOISE BUGS?



PAT. PEND.

## this module counts them out!

Do transient noise spikes foul up your pulse waveforms? Well . . . there's no need to put up with it any longer. With NAVCOR's Digital Logic Modules, you can count on 2.5v input noise immunity at 1mc to 5mc frequencies.

And you can depend on getting a lot more from NAVCOR. Take a look at these specs . . .

- Honest 1mc speed through use of parallel logic.
- Up to 120 binary counter stages at 1mc clock rate in parallel operation . . . and all outputs settle within 150ns after the count pulse.
- Minimum of 8 allowable stages of amplified logic between two flip flops, at 1mc clock rate.
- No external clamp supply required. Zener regulator incorporated on each module.
- 100ns maximum rise and fall times.
- Complete ground shielding and input ringing clamps minimize backplane debugging expense.

Sound good? There's more . . . including the low prices. Mail the coupon for the full story.

## NAVIGATION COMPUTER CORPORATION

Dept. EL-022 • Norristown, Pennsylvania • 215-666-6531  
DISTRICT / Seabrook, Maryland • 301-577-2010  
OFFICES / Garden Grove, California • 714-839-0232

# NAVCOR®

Valley Forge Industrial Park  
Norristown, Pennsylvania

SURE DOES SOUND GOOD! Please send me all the data and prices on your Digital Logic Modules.

Name \_\_\_\_\_

Title \_\_\_\_\_

Company \_\_\_\_\_

Address \_\_\_\_\_

City \_\_\_\_\_

State \_\_\_\_\_ Zip \_\_\_\_\_

Dept. EL-022

Depend on white-glove Tayloring!

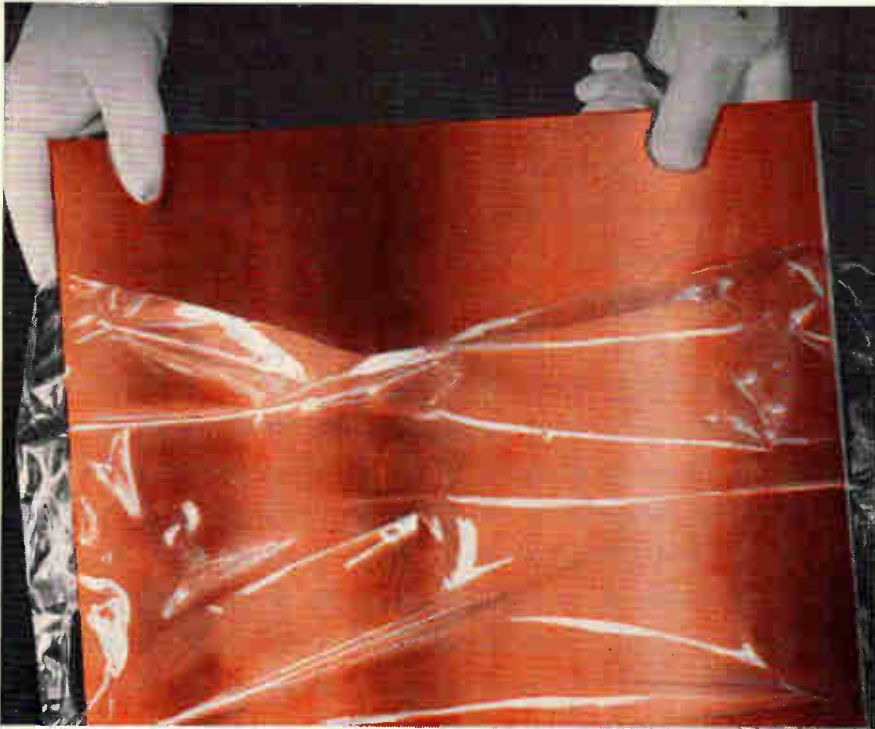

## Five compelling reasons for changing to Taylor copper-clad now

- Superior solderability
- Excellent printability
- Consistent uniformity
- Surface that accepts all acid resists
- Ready availability

The first three reasons are the results of white-glove handling, atmosphere-controlled white rooms, careful processing, and an extremely tight quality control system (governed by MIL-Q-9858—toughest spec in general use). The fourth is assured by a specially developed surface finish. The fifth is guaranteed by two fully equipped copper-clad facilities—one at Valley Forge, Pa., the other at La Verne, Calif.

We'll be happy to supply samples of Taylor copper-clad for test in your plant. Write today, describing your process and the type of copper-clad you use. And be sure to ask, too, for a copy of Bulletin 8-1B.

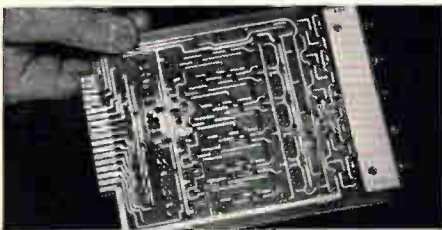

Typical high-fidelity, high-reliability printed circuit etched on Taylor copper-clad material. Courtesy of Navigation Computer Corporation, Valley Forge Industrial Park, Norristown, Pa.

# Taylor copper-clad

TAYLOR CORPORATION • Valley Forge, Pa. 19481

Phone: 215-666-0300

West Coast Plant: La Verne, Calif.

Also manufacturer of Taylor laminated plastics, Taylorite® vulcanized fibre

## New Components

models that provide air deliveries from 10 to 1,000 cfm for direct-connection mounting in cabinets, computers, consoles or systems to solve localized high-temperature problems. The blowers can also be used for general-purpose cooling, exhaust, pressurization of equipment, dust, fume or gas removal, drying, evaporation, etc. Motor and blower can rotate to blast in any direction. Motors may be mounted on right or left side of blower and are available in clockwise or counter-clockwise rotations.

They are compact—the smallest occupies a 3¾-inch cube—heavy duty, 115 v, 50/60 cps motors; 1,500 or 3,300 rpm ball bearing.

Volume discount prices apply. McLean Engineering Laboratories, P.O. Box 228, Princeton, N.J. [355]

## Square trimming pots with high resistances



A new line of miniature square trimming potentiometers is the first ½-in.-square trimmer ever to offer resistances as high as 100,000 ohms in the standard package, according to Conelco Components.

Series 07 trimmer also features positive humidity sealing, high reliability, and a greatly reduced number of parts. A key design feature is the small trimmer's cog-wheel drive mechanism which replaces six parts or functions common to most other square trimming potentiometers.

The 31-turn series 07 has standard resistance ranges from 50 to 100,000 ohms, an operating temperature range to +185°C, and is rated at 1 watt at 85°C.

Terminal configurations include side printed-circuit pins 90° and



# Uniring<sup>®</sup> grounds a shielded cable in less time than it takes to heat a soldering iron.

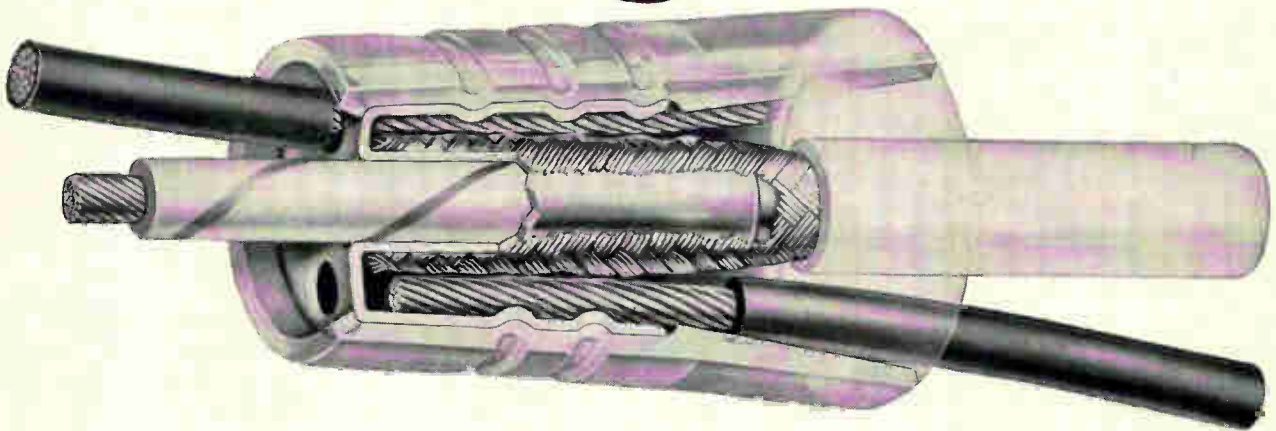

Uniring combines inner and outer ferrules in unitized construction. Simply insert a stripped conductor and tap wire, then crimp. One crimp does it. No heat. No burnt cables.

Result: A vibration-resistant, noise-free connection that is mechanically and electrically stable. A uniform connection that takes virtually no time to make.

Uniring terminations are color coded for fool-proof size selection. And the insulated Uniring employs a nylon sleeve that's flared for fast, easy insertion of the shielding braid and tap. (These connectors are also available uninsulated.) No other type of connector is as fast, as reliable, or as low in cost to use. Time and labor savings offered

by the compression method of grounding and terminating shielded cable are recognized by the military and referred to in MIL-E-16400 and MIL-I-983. Burndy Uniring terminations conform in all details to MIL-F-21608 (dated 1/5/59). Send today for a free sample and catalog.

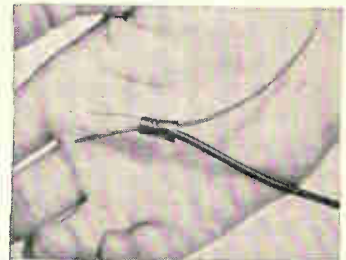

**BURNDY**

Norwalk  Connecticut

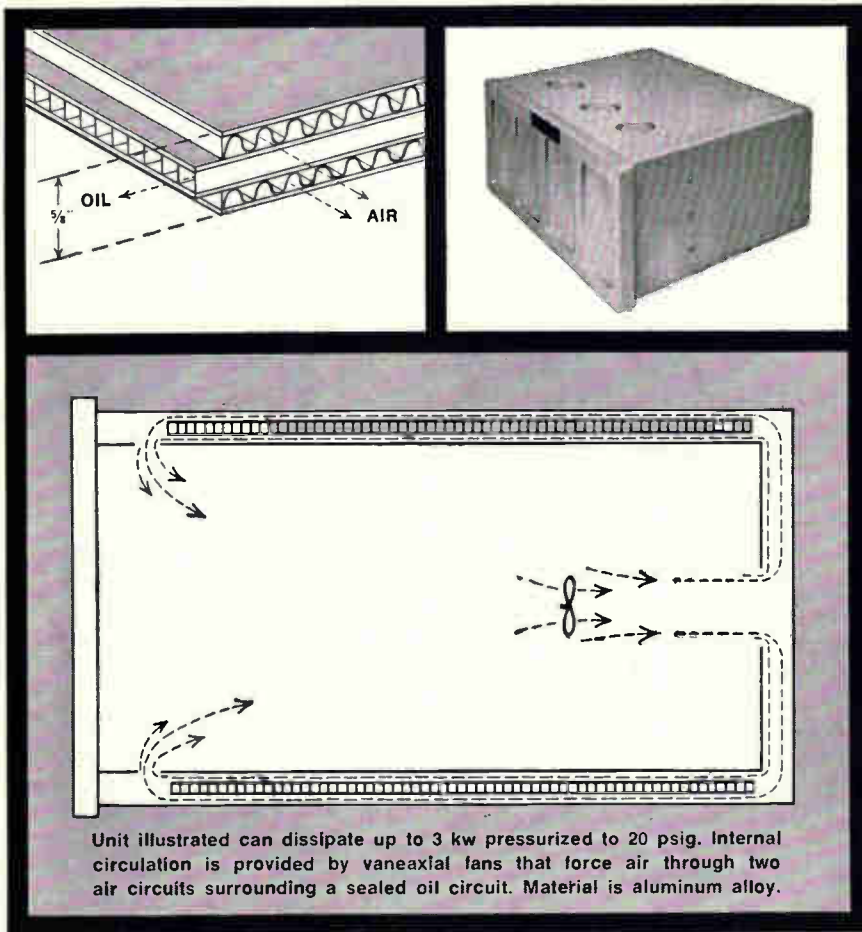

Unit illustrated can dissipate up to 3 kw pressurized to 20 psig. Internal circulation is provided by vaneaxial fans that force air through two air circuits surrounding a sealed oil circuit. Material is aluminum alloy.



## **STRUCTURAL heat exchangers cool electronics**

This new kind of electronics enclosure can help solve cooling problems in higher power level circuits—especially where you must pack the maximum electronics into minimum space. A typical exchanger measures 24" x 18" x 12" and forms a **pressurized** housing for a high-powered radar modulator, a low frequency transmitter, or a power supply.

Walls are only  $\frac{5}{8}$ " thick but contain two air circuits straddling a sealed oil cooling circuit. Janitrol precision engineering, coupled with new methods of forming and brazing foil-thin sheets, makes it possible to fabricate leak-proof housings.

Janitrol can fabricate thin-wall cooled housings to your specifications using thoroughly proven techniques. For details about our capability write to Janitrol Aero Division, Midland-Ross Corporation, 4200 Surface Rd., Columbus, Ohio.



**JANITROL AERO DIVISION  
Midland-Ross Corporation**

### **New Components**

180° from the shaft, printed-circuit pins from the base, and insulated stranded leads. Center taps are available in any terminal configuration. Prices, in quantity, start at \$3. Conelco Components, 465 W. Fifth St., San Bernardino, Calif., 92401. [356]

### **Miniature p-c-type transistor socket**

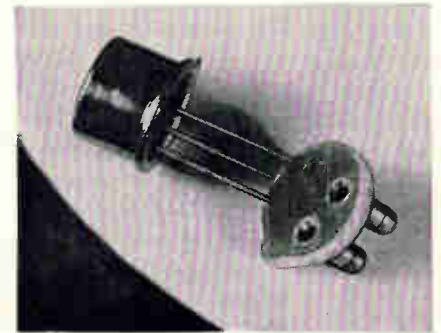

Part EX-736 socket solders directly into the printed circuit board and accepts the TO-60 outline package. Mounted height above the board is  $\frac{3}{16}$  in. maximum. Overall height is 0.218 in.; diameter, 0.370 in. maximum.

Rugged, machined, heat-treated, beryllium-copper contacts with silver/hard-gold finish are used throughout. Insulator is G-10 glass epoxy laminate with individual contacts securely staked into it; it will withstand a pull-out force of 25 lb minimum. Operating temperature range of the insulator is 150°C continuous.

The high-reliability socket is particularly suited for airborne or severe service applications. Robinson Nugent, Inc., 802 E. 8th St., New Albany, Ind., 47150. [357]

### **Tight feed-throughs for sealed enclosures**

Electrical equipment designed for function inside sealed enclosures, like those of nuclear reactors, need especially tight electrical feed-throughs for their power supply, control and instrumentation signals. The feed-throughs should withstand high temperatures and pressures as well as emissions from

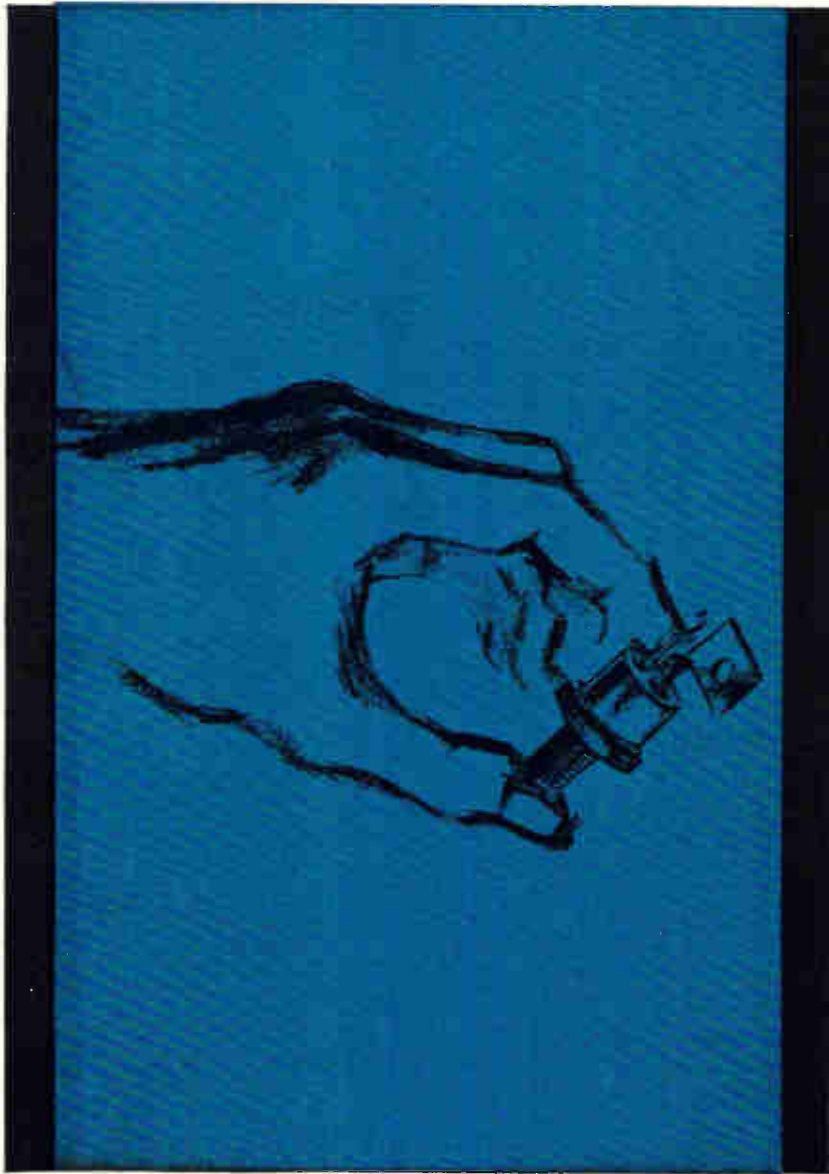

# “MONSTER”

## 300 WATTS-70 AMPS SILICON POWER TRANSISTOR

From Silicon Transistor Corporation come power and current capabilities never achieved before in silicon transistors. The 2N3149, 2N3150 and 2N3151 series, in the 1-1/16" double-ended stud package. Designed specifically for military applications where space and weight limitations are critical. Extremely low saturation voltage— $\leq 1.5$  V @  $I_c=50$  amps—makes available new high levels of efficiency in power inverters and high power regulated supplies. Allowable power dissipation of 300 watts @  $T_c=50^\circ$  C;  $BV_{ceo}$  from 80 volts to 150 volts; and  $h_{FE} \geq 10$  @  $I_c=50$  amps. As a customer service, Silicon Transistor Corporation supplies custom-designed types to meet specific requirements. For more information, contact:

EAST GATE BLVD., GARDEN CITY, NEW YORK 11532, 516 Pioneer 2-4100. TWX 510-222-8258

**REGIONAL OFFICES:**

CHICAGO, ILL. 60625, 5555 NORTH LINCOLN AVE., 312-271-0366-7, TWX 910-221-1304

LOS ALTOS, CALIF. 94022, 1 FIRST ST., 415-941-2842.



**ATTEND**  
SILICON TRANSISTOR CORP.'S  
SEMICONDUCTOR  
APPLICATIONS  
TRAIN MARCH 21-23  
NEW YORK AMERICANA

**SILICON  
TRANSISTOR  
CORPORATION**

**KLIXON**  
PRECISION CONTROLS

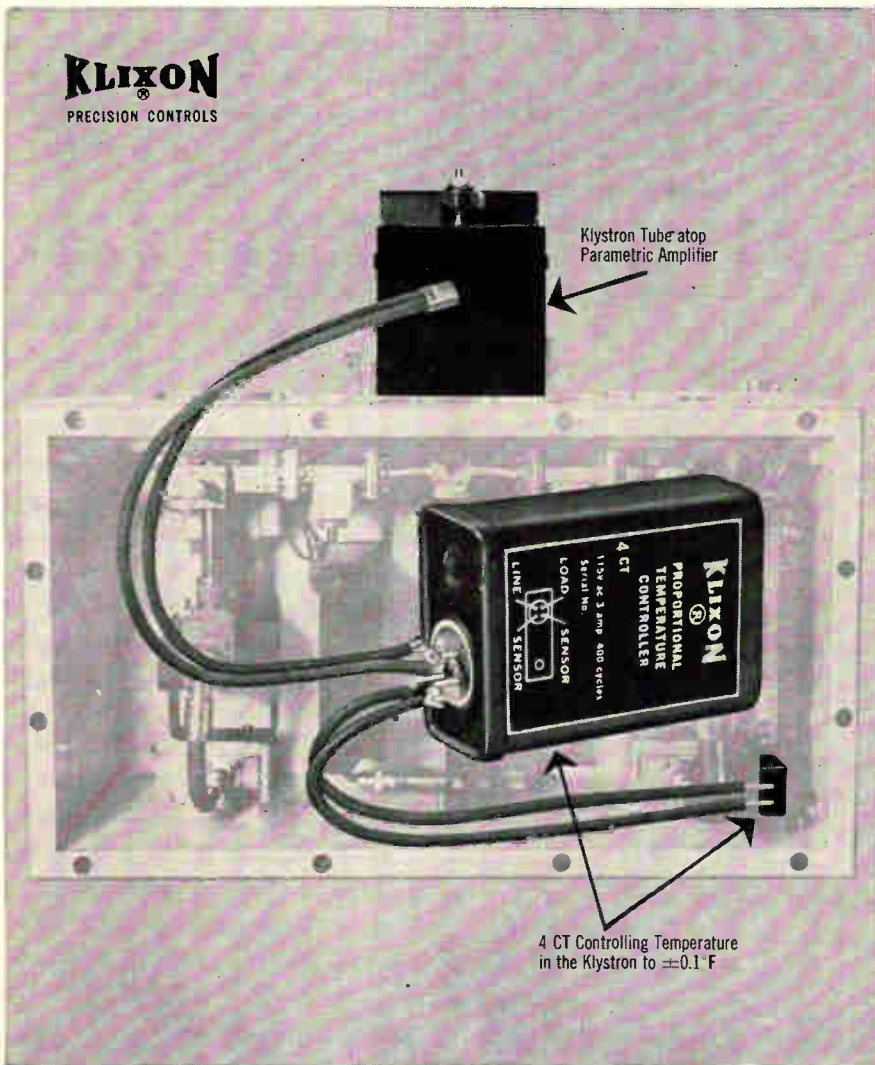

**When the demand  
is for  $\pm 0.1^\circ\text{F}$  accuracy...**

## **RELY ON T<sup>2</sup> FOR TEMPERATURE CONTROL**

No other device so small can match the performance of the new KLIXON® 4CT Solid State Proportional Temperature Controller in electronic systems that demand stabilized temperatures.

This 70-gram package utilizes a magnetic amplifier and a silicon controlled rectifier to supply proportionally controlled power from zero to maximum output of 350 watts at 150°F. A thermistor sensor (surface element or immersion probe) provides the control signal. Since there are no moving parts, reliability is high. In fact, the 4CT passes all applicable environmental tests of MIL STD 202. For example: 20G vibration, 100G shock, 50G acceleration.

Adjustable over 75°F, this rugged controller is available with 3 amp capacity for 60 cycle or 400 cycle, 115 v-ac circuits. Calibration range is -65°F to 600°F. Response time is within one cycle of line frequency. For complete information about the KLIXON 4CT Proportional Temperature Controller, write for Bulletin PRET-10. We'll also send you the "Tunnel of Horrors" booklet telling how we test our EHR (extra high reliability) thermostats.

**KLIXON**  
CONTROL PLANTS IN  
Attleboro, Mass • Versailles, Ky.  
Richmond Hill, Ontario  
Holland • Italy • Australia  
Argentina • Brazil • Mexico



**METALS & CONTROLS INC.**  
5002 FOREST ST., ATTELBORO, MASS.  
A CORPORATE DIVISION OF  
**TEXAS INSTRUMENTS**  
INCORPORATED

## **New Components**

radioactive particles.

Four such parts are being manufactured to comply with the types of electrical circuit feed requirements (low or medium voltage, controls and instrumentation signals, special wires for electronic measurements, etc.).

These feed-throughs are supplied at both ends of the crossed wall with hermetic flanges and, depending upon requirement, with an electrical connection-box or a multiple-phase connector. They are intended for pressures up to 25 kg/cm<sup>2</sup> and temperatures up to 200°C. Their biological protection against radiation is equivalent to the one in the sealed enclosure and, therefore, they do not reduce the mechanical resistance of this enclosure.

The feed-throughs can be used in any sealed nuclear or non-nuclear equipment, should it be in metal, concrete or any other material, since their lengths can be adapted to every specific purpose. ACEC, Charleroi, Belgium. [358]

## **Vacuum thermocouples in a matched set**



A matched set of two standard pattern model MP1S.7 vacuum thermocouples is available for use in true rms voltmeters or for converting digital voltmeters to measure true rms. Matching for temperature and tracking effects is better than 0.5% over a 50°C range, accurate for frequencies from a few cps to 10 Mc.

When used with a suitable amplifier the true rms of the input a-c current will be proportional to the d-c output current within 0.25%.

Characteristics of the individual model MP1S.7 couples are as follows: heater current, 5 ma; heater resistance, 90 ohms  $\pm 10\%$ ; couple output, 7 mv  $\pm 12\%$ ; and couple resistance, 8 ohms  $\pm 10\%$ .

Price is \$24.95 per pair for small quantities.

Best Electronics division, Harry Levinson Co., 1211 E. Denny Way, Seattle, Wash., 98122. [359]

## Metal film resistors only 40 mils square

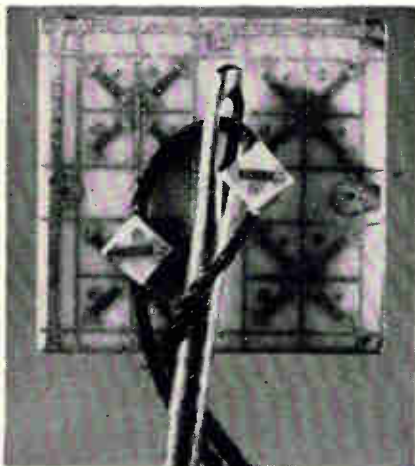

A needle and thread are shown to contrast the relative size of a 40-mil square, microminiature metal film resistor. The resistors, for mounting in TO cans or flatpacks, measure 0.04 in. by 0.04 in. by 0.01 in. As many as 36 resistors can be made simultaneously on a single substrate, and later sliced for production use (a substrate with 16 resistors is shown in background of photo).

The manufacturer also provides materials and equipment—on a lease or sale basis—and instructions to manufacture these resistors in a customer's plant. Resistor terminals can be soldered or welded. The back of the board is gold plated to facilitate attachment to the header. The resistor's initial tolerance is  $\pm 10\%$  and the temperature coefficient of resistance is  $\pm 100$  ppm per  $^{\circ}\text{C}$  over a range of  $-55^{\circ}$  to  $150^{\circ}\text{C}$ . Change in resistance due to load life condition is  $\pm 0.5\%$  per 1,000 hours. Power rating is 4 mv at  $125^{\circ}\text{C}$ . Resistance range is 100 ohms to 2,000 ohms.

Prototype quantities are available at \$4 each.

Electronic Films, Inc., 9 Third Ave., Burlington, Mass. [360]

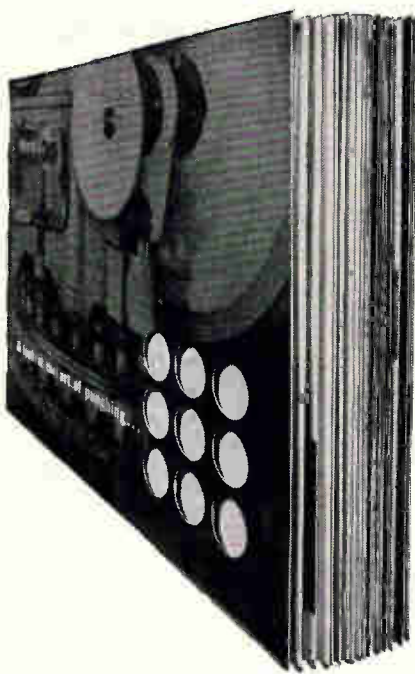

# 44 brand new pages of helpful punching information

- Six basic punching concepts
- Turret punch presses
- Stylus operated turret punch presses
- OBI punch presses
- Single station punch presses
- New horn punch presses
- Adjustable punch and die sets
- All shapes and sizes of punches and dies
- Template layout machines

Complete information! Illustrations, descriptions, specifications and prices. Ask your distributor for the new 44-page Di-Acro punching catalog or write us.



## DI-ACRO

A Division of Houdaille Industries, Inc.

452 Eighth Ave., Lake City, Minn. 55041

# 460 BASIC PRECISION SWITCHES

...at  
**Control Switch!**



**Sub-subminiature SPDT.** So tiny they mount side-by-side four to the inch! 7½ amp capacity, exceptional shock and vibration resistance. 25,000 operations min. For super-sensitive applications. T Series.



**Subminiature SPDT.** Stack, or gang mount in minimum space. Low movement differential and operating force for precision control in critical applications. For compact equipment where dependability is vital. E4 Series.

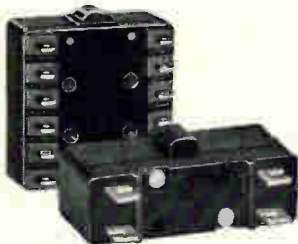

**Industrial switches.** Compact, highest reliability for tough jobs. Types include: Series G, 40 amp SP; Series D, 4-circuit DP for 3-phase motor control (not shown), Series K, 6-circuit, 3-Pole for motor reversing.



**Environment-free miniature switches.** Completely protected, ultra-compact package 1½" x ¾" x 1½" thick. Many variations in characteristics and terminals available, including high temperature models to 350F. EF-100 Series.

Available through leading electronic parts distributors.

**CONTROLS  
COMPANY**  
OF AMERICA

CONTROL SWITCH DIVISION  
1420 Delmar Drive, Folcroft, Pennsylvania 19032

## New Semiconductors

### Economy power transistors of silicon



An economy line of silicon power transistors has been introduced by the Bendix Corp. The line consists of 27 kinds of n-p-n diffused-mesa transistors for amplifying, regulating and switching. A company spokesman says the silicon line will be competitive in price with germanium devices, but will operate at higher temperature.

Each device will carry a minimum number of ratings for a particular application; customers won't have to pay for specifications they don't need, Bendix says. The devices carry power ratings from 60 to 120 watts, voltage ratings from 40 to 100 volts, and current ratings from 6 to 15 amperes. Prices range from \$1.70 to \$2.65.

The devices are designated B170000 through B170026. Selections from the H170000 through B170008 group are also available for d-c current gain at 500 milliamperes and 4 volts. Each transistor is painted a color which indicates the current gain: black for 20 to 35, brown for 35 to 50, red for 45 to 70, orange from 60 to 90 and yellow for 80 to 120. B170000 through B170008 are intended for class B amplifier service. The sharpest drop in base-to-emitter voltage at 500 milliamperes is 1.2 volts for all nine amplifier transistors.

The B17009 through B170017, intended for regulator applications, carry only a 2-volt rating for emitter-to-base voltage with the collector open. This rating is 5 volts for the other 18 types in the new series. The regulator transistors are available with saturation voltages as low as 0.4 volt at a collector current of one ampere.

The B170018 through B170026

are intended for use in power-switching applications. Three of the devices—the B170018, B170021 and B170024—have rise time of four microseconds, storage time of 0.3 microsecond and fall time of 0.5 microsecond. The remaining six types in the switching-transistor series are not as fast.

All 27 types are supplied in the TO-3 metal package. A mounting kit is also available that includes a socket, collector insulator and mounting-hole bushings.

#### Specifications

Collector-to-emitter voltage	40 to 100 v
Collector-to-base voltage	50 to 100 v
Collector dissipation	60 to 120 w
Thermal resistance	1.5°C per watt
Collector current	6 to 15 amp
Base current	3 to 7 amp
Emitter-to-base voltage	2 to 5 v
Storage temperature	-65° to +200°C
Price in 100-unit quantities	\$1.70 to \$2.65
Availability	Immediate
Bendix Corp., Holmdel, N.J. [361]	

### Voltage-adjustable synthesized diodes



Five new Super/Reg zener diodes in the 75 TE series are announced, with zener voltages of 3.9, 4.7, 5.6, 6.8 and 8.2 v d-c. The synthesized diodes are assembled from military-grade ultraminiaturized circuit components, and are mounted in standard TO-36 corrosion-resistant, hermetically-sealed cases. Connections are the same as for a standard zener diode, with the addition of a

**You need**

**1**

**very special switch.**

---

**Control Switch has**

**167,921**

**very special switches.**

---

**How can you beat odds like that?**

---

We'll get even more specific.

These 167,921 very special switches include pushbutton, basic precision, toggle, leaf and lever, interlock and limit, lighted panel, hermetically-sealed and environment-free switches.

Another specific. They're good ones . . . for equipment, systems, products that must reflect the integrity of the maker.

Doesn't it seem like a waste of time to pore through catalogs from umpteen suppliers when you're so sure of getting what you want through one of our distributors, one of our salesmen, or through us?

Send for any or all of the catalogs listed at the right. If you get them all, you'll have a *real* switch reference file!

Here's the list. Check numbers on the Reader Service Card corresponding to those on the left below for the catalogs you want.

- #481 *Condensed Switch Catalog 100*
- #482 *Basic Snap-Action Switch Catalog 110*
- #483 *Toggle Catalog 180*
- #484 *Indicator Light Catalog 120*
- #485 *Hermetic Switch Catalog 130*
- #486 *Switchlite Catalog 220*
- #487 *Pushbutton Catalog 190*



CONTROL SWITCH DIVISION  
1420 Delmar Drive, Folcroft, Pennsylvania 19032

*P.S. For an idea of what we have in basic precision switches alone, see our ad on the facing page.*

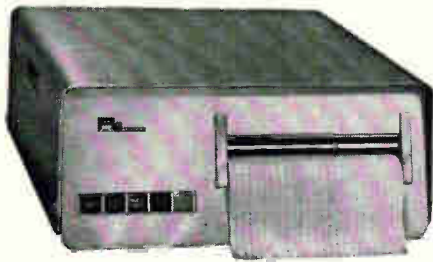

the DIGITAL PRINTER — DataPrinter



the METER PROTECTORS



the POWER SUPPLIES and TESTERS for Transistor or Components...



REO division of SPECTRA-STRIP CORP. has the capabilities.

Did you know the DataPrinter is the only read-out and print-out digital printer complete with electronic interface? And a basic price of \$350.00 plus \$115.00 per column... see how compact... also the service features of the printer's interchangeability of plug-in modules... Reo's DataPrinter can be customized to fit your requirements.

### REO DIVISION CAPABILITIES

REO Offers Highly Specialized Talents in Data Handling and Instrumentation to both Military and Commercial Industry — Proven Experience of REO's Professional Engineering Staff — Integrated with Production "Know How" — Offers Outstanding Reliability to Military and Commercial Customers in all Areas of Design, Studies and Production.

DEVELOPMENT Digital/Analog Data Handling Systems — Signal Conditioning Systems & Equipment — Commercial & Military Products — Infrared Systems & Products — Telemetry Range Systems & Equipment — Integrated Circuits — Radar Peripheral Equipments — Oceanographic Data Systems and Sensors — Commercial Data Systems — Instrumentation Electronic Assembly — Packaging — Industrial Data Systems.

ASSEMBLY & PRODUCTION Electronic Assembly & Fabrication — Wiring — Testing — Packaging — Integrated Circuit Assembly.

Plan to investigate the Reo's Product line today. For more information on the above products send for bulletin No. SSRD 101... we welcome inquiries for custom requirements. Call or write:



EXCELLENCE IN ENGINEERING

SPECTRA-STRIP CORP.

P. O. Box 415, Garden Grove, California 92642  
Tel: (714) 537-4530 • TWX: (714) 530-0313

## New Semiconductors

third terminal which may optionally be used for voltage adjustment.

The third terminal permits the user to set the zener voltage at any desired value within  $\pm 10\%$  of the nominal (two-terminal) value by external connection of a  $\frac{1}{8}$ -watt resistor of appropriate value between this terminal and the anode (to decrease the voltage) or cathode (to increase the voltage).

The diode has a maximum zener current rating of 3 amps, thus providing nominal power dissipation rating of 12 through 25 w. Maximum junction temperature is  $175^{\circ}\text{C}$ , thermal derating is  $2^{\circ}\text{C}$  per watt, and case temperature operating range is  $-55^{\circ}$  to  $+125^{\circ}\text{C}$ .

The lower zener impedance (6 to 15 milliohms design maximum; typically, half of these values) varies by only a few milliohms over the entire operating range, so that regulation at the 10-ma level is comparable to that at the 3-amp level.

Sample units are obtainable at \$59.50 per unit (all types); quantity discounts are available.

Semiconductor division, Trio Laboratories, Inc., 80 Dupont St., Plainview, L.I., N.Y. [362]

## Power transistors offer low saturation



A family of low-saturation germanium power transistors has collector currents ranging from 150 amps to 200 amps. They were designed specifically for high-efficiency conversion of the low-voltage output of fuel and solar cells, thermionic and thermoelectric generators, single-cell batteries, and other 0.5 v to 2.5 v power sources to a more



# Blackstone's new vapor rinse series for big, bulky assemblies.

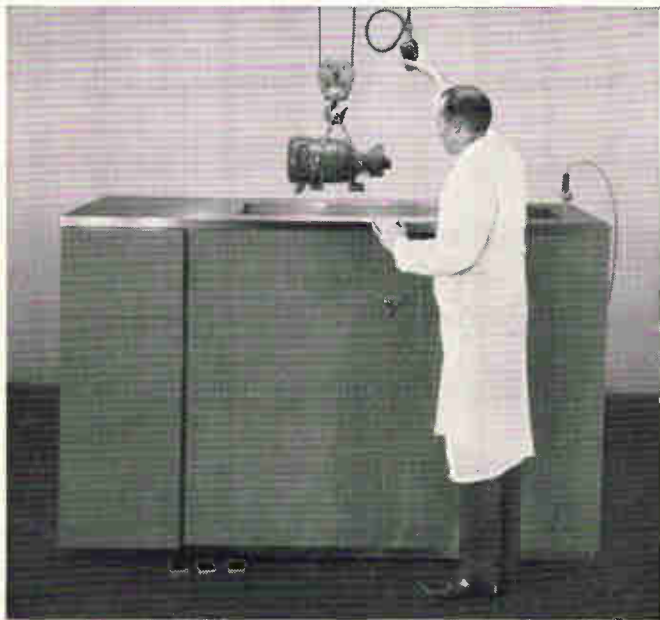

[like motors, for instance.]

Now get both ultrasonic scrubbing and vapor rinsing for large, hard-to-clean assemblies with this entirely new Blackstone cleaner.

Available with ultrasonic and vapor rinse tanks in sizes from 12" x 12" x 9" to 24" x 18" x 19", and designed for use with DuPont "Freon"® cleaning solvents, the Large VR features continuous filtration and two control systems. A foot switch controls ultrasonic wash, spray and rinse cycles. The photoelectric control may be used on pre-set ultrasonic cycles for repeated cleaning of like parts.

And consider these other Blackstone features:

- **Rounded-corner 316L Stainless steel tanks**—for easy maintenance and corrosion resistance.
- **Solid-state generator**—providing manual power control from 0 to 100%, a Blackstone exclusive.
- **Automatic timer control**—enabling pre-set wash, spray and rinse sequencing.
- **Vapor tank contamination indicator (optional)**—permits positive control over contamination build-up.
- **Hand-operated spray wand (optional)**—for manual spraying of the cleaned part.



AUTHORIZED SALES AGENT

**BLACKSTONE ULTRASONICS, INC.**

1400 Howard St. • Sheffield, Pa.

Circle 489 on reader service card

CALL ON  
**hurst-POWER**  
FOR YOUR APPLICATION

NEW **hurst** 600 IN. OZ.  
HYSTERESIS REVERSIBLE SYNCHRONOUS  
**INSTRUMENT MOTOR**



MODEL GA

- HEAVY DUTY GEARING
- NO LUBRICATION REQUIRED
- CAN BE STALLED WITHOUT OVERHEATING

For long life and higher torque applications. Offers instrument manufacturers high performance and economy. Starting torque is uniform; smoothly, rapidly accelerates into synchronization. Capacitor included.



MODEL EA

**150 IN. OZ. OF TORQUE**  
**AT 1 RPM (Unidirectional) (EA)**

Open frame, shaded pole, extremely cool running. Bronze bearings, brass gears, hardened steel pinions and wheel shafts, stainless steel output shaft. For dependable, low-cost timing applications. Wide range of speeds.

**120 IN. OZ. OF TORQUE**  
**AT 1 RPM (Reversible) (DA)**

Timing accuracy both clockwise and counterclockwise. SPDT switching. Case 2½" diam., 1¾" long. Will not overheat. Capacitor included.

**100 IN. OZ. OF TORQUE**  
**AT 1 RPM (Reversible) (CA)**

Features 1200 rpm rotor speed for quiet performance. Extremely versatile (animated displays, program instruments, outdoor advertising, etc.) Wide range of output speeds. Will not overheat. Capacitor included.

**RATED 40 IN. OZ. OF TORQUE**  
**AT 1 RPM (Unidirectional) (SM)**

For tough jobs demanding accurate timing. Excellent shock and vibration resistance. Starts instantly at full torque. Will not overheat. Wide range of output speeds.

**40 IN. OZ. OF TORQUE**  
**AT 1 RPM (Unidirectional) (PC-SM)**

**120 IN. OZ. OF TORQUE**  
**AT 1 RPM (Reversible) (PC-DA)**

Both are positive clutch and instantaneous brake motors. For extremely fast starts and stops. Motor runs continuously with clutch and brake controlled by switching actuator only. Clutch starts output shaft within 20 milliseconds; brake stops output shaft within 1/5° at 1 rpm; with 12° at 60 rpm. Motor on AC voltage; actuator AC or DC. Either can be supplied in any voltage combination when motor is AC. Will not overheat.

**100 IN. OZ. OF TORQUE**  
**AT 1 RPM (Reversible) (AR-DA)**

**40 IN. OZ. OF TORQUE**  
**AT 1 RPM (Unidirectional) (AR-SM)**

Automatic reset. Planetary-type clutch operates directly upon output shaft. When de-energized, shaft is manual or automatic reset. Addition of external return spring to output shaft provides automatic reset on either model. Motor on AC voltage; actuator on AC or DC. Either can be supplied in any voltage combination when motor is AC. Will not overheat. Capacitor included.



MODEL SM



MODEL PC-SM MODEL AR-DA  
MODEL PC-DA MODEL AR-SM

STANDARD SPEEDS STOCKED BY  
YOUR HURST DISTRIBUTOR

**hurst**  
MFG. CORP. • PRINCETON, INDIANA

Circle 177 on reader service card

177



# New, low-cost Philbrick Operational Amplifiers



Philbrick has always produced a wide variety of cool, reliable, solid state operational amplifiers for measurement, computing, control, data processing and testing. They provide premium performance and are priced accordingly. Their specified operating temperature exceeds  $-25^{\circ}$  to  $+85^{\circ}\text{C}$ . Now Philbrick also offers economical equivalents of many of the most popular types in a utility grade, at substantially reduced prices. Savings generally exceed 50%. Yet, these utility grade amplifiers have identical performance with their premium grade equivalents within a limited temperature range, usually  $0^{\circ}$  to  $60^{\circ}\text{C}$ , but operate over the full range. And they too carry a two-year warranty. For a chart giving detailed comparative specifications of more than 60 Philbrick Operational Amplifier types write, wire or phone: Philbrick Researches, 22F Allied Drive at Route 128, Dedham, Massachusetts. Telephone (617) 329-1600.

## Engineering Representatives

Ala.: Huntsville (205) 536-8393, Mobile (205) 954-9298; Ariz.: Phoenix (602) 265-3629; Cal.: Los Angeles (213) 937-0780, Palo Alto (415) 326-9800, San Diego (714) 222-1121; Colo.: Denver (303) 733-3701; Conn.: West Hartford (203) 233-5503, Greenwich (203) 661-5140; Fla.: Ft. Lauderdale (305) 564-8000, Orlando (305) 425-5505; Ill.: Chicago (312) 676-1100, (312) 676-1101; Ind.: Indianapolis (317) 356-4249; La.: New Orleans (504) 242-5575; Md.: Baltimore (301) 727-1999; Mass.: Wakefield (617) 245-5100; Mich.: Detroit (313) 838-7324; Minn.: Minneapolis (612) 545-4481; Mo.: St. Louis (314) 741-3779; N. M.: Albuquerque (505) 268-3941; N. Y.: Buffalo (716) 835-6186, DeWitt (315) 446-0220, Valley Stream (516) 561-7791; N. C.: Winston-Salem (919) 725-5384, (919) 725-5385; Ohio: Dayton (513) 298-9964, Westlake (216) 871-8000; Okla.: Tulsa (918) 627-6199; Pa.: Philadelphia (215) 277-0559, Pittsburgh (412) 371-1231; Tex.: Dallas (214) 526-8316, Houston (713) 781-1441; Utah: Salt Lake City (801) 466-4924; Va.: Alexandria (703) 836-1800; Wash.: Seattle (206) 723-3320.

EXPORT: N.Y.: New York (212) 246-2133.

CANADA: Quebec: Montreal (514) 482-9750, Ontario: Toronto (416) 789-4325.

ELECTRONIC ANALOG COMPUTING EQUIPMENT for MODELLING, MEASURING, MANIPULATING and MUCH ELSE



PHILBRICK



## NEW Miniature High Q Air Capacitors!

- SIZE: .220" dia. 15/32" length
- Q @ 100 mc: >5000
- CAPACITANCE RANGE: 0.4 — 6 pf
- NON-MAGNETIC

New miniature series features high quality materials and workmanship typical of all Johanson Variable Air Capacitors.



*Johanson* **MANUFACTURING CORPORATION**  
400 Rockaway Valley Road, Boonton, N. J. Phone (201) DEerfield 4-2676

Circle 490 on reader service card

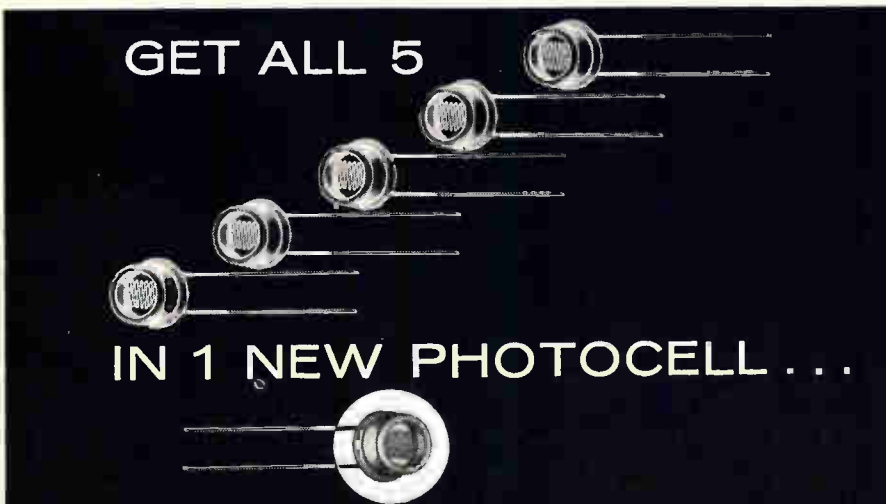

## GET ALL 5 IN 1 NEW PHOTOCELL ...

Now, the 5 best characteristics of CdSe and CdS are combined in 1 new Clairex CdS photosensitive material, the type "5H".

1. High speed (1-2 millisecond response)
2. Low temperature coefficient (0.5%/°C)
3. Low memory (15 X lower than CdSe)
4. High linearity (slope of 0.9 from 0.1 to 100 FC)
5. Uniform color temperature response (100% - 106%, 2854°K-6700°K)

Detailed information on type "5H" photocells plus the new Clairex 16 page Designers' Manual free on request.

# CLAIREX

"The LIGHT Touch in Automation and Control"

1239 Broadway, New York, N. Y. 10001, 212 MU 4-0940

## New Semiconductors

prices start at \$19 each for small quantities.

National Semiconductors, Ltd., 2150 Ward St., Montreal 9, Canada. [364]

## Tunnel diode chip can switch at 5 nsec



A tunnel diode chip measuring only 0.040 in. square is capable of switching at 5 nanoseconds. Chip tunnel diodes operate in the 60 to 700 mv range and have peak currents of 0.47 through 10 ma.

The CTD 100-400 series chip is said to be ideal for use in computers. It is subject to very little environmental degradation, and is suited to use in airborne computers which are subjected to extremes of shock and vibration.

Hoffman Electronics Corp., 4501 North Arden Drive, El Monte, Calif. [365]

## MOS shift register costs 52 cents per function

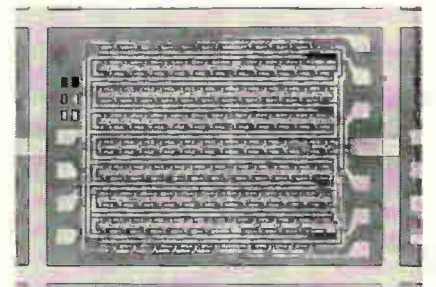

The 90-bit (dual 45-bit) dynamic shift register, MEM-4020, operates in computer memory systems at a clock frequency up to 1 Mc. One of the most complex digital-integrated circuits available commercially, this new device contains 542 MOS (metal-oxide silicon) transistors on a silicon chip only 58

mils by 80 mils.

The unit is priced at \$46.80 in 50 to 99 quantities and \$81 in sample quantities of 1 to 9. The \$46.80 price is equivalent to a cost of only 8½ cents per MOS transistor, or 52 cents per bit function, compared with a list price of at least \$15 for each of the 90 conventional bipolar microelectronic J-K flip-flops it replaces.

The shift register can operate either in parallel, to provide two 45-bit delays, or in series to provide a total of 90.

General Instrument Corp., 600 West John St., Hicksville, N.Y. [366]

## Npn power transistors in TO-8 package

Two families of npn silicon power transistors are available in the TO-8 package: a 5-amp series and a 10-amp series. The manufacturer says both transistor families feature excellent dissipation capabilities, low saturation voltages (0.5 v at  $I_C = 1$  amp on the 5-amp series, and 0.5 v at  $I_C = 5$  amp on the 10-amp series); 3 gain ranges (20 to 60, 40 to 120, and 100 minimum); and typical frequency of 20 Mc. Voltages for both families range from 40 v to 80 v ( $BV_{CEO}$ ).

The 5-amp series are identified as the MHT4611 to MHT4619 and range in price from \$12 to \$30 for quantities of 100.

The 10-amp series is identified as the MHT7511 to MHT7519 and range in price from \$16 to \$32 for 100 of them.

Soliton Devices, Inc., Transistor Division, 1177 Blue Heron Blvd., Riviera Beach, Fla., 33404. [367]

## Full-wave bridges have avalanche rectifiers



Compact full-wave bridges are available with silicon rectifiers which have avalanche characteris-

# 150 db Common Mode Rejection SHIELDED TRANSFORMERS

by **JAMES**

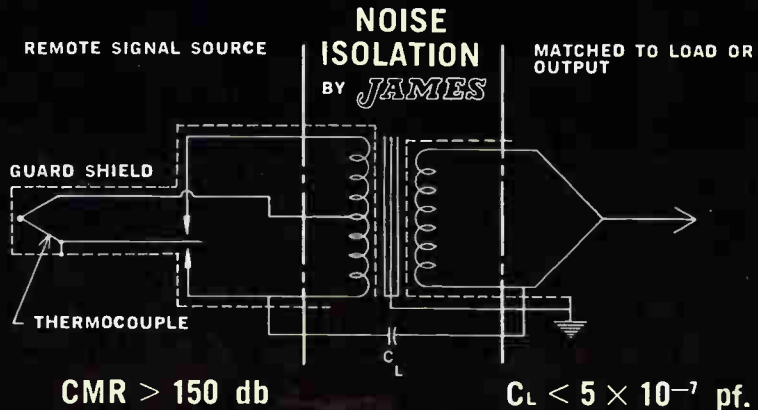

## SIGNAL-GUARD TRANSFORMERS

Low and Medium Frequency (DC to 100 KC) response

Designed for use in analog acquisition and computation equipment use. Signal Guard provides isolation, voltage comparison, impedance matching, and common mode rejection.

## DATA-GUARD TRANSFORMERS

High Frequency Signal (1 kc—20 mc)

Designed and shielded to isolate and terminate high frequency signal data in the form of pulses, AM and FM modulated carriers, multiplexed signals, and other low to high frequency data.

## ELECTRO-GUARD TRANSFORMERS

Power (1 watt to 100 VA)

Electrostatically shielded for use in signal conditioners, bridge supplies, and Zener reference supplies to isolate circuits from noise transients and undesirable common mode voltages commonly carried on electrical power lines.

Write for complete technical details and specifications.

KEY SUPPLIER  
OF COMPUTER  
CONTROLS

# JAMES

ELECTRONICS INC.

4050 North Rockwell • Chicago, Illinois 60618 • 312-463-6500 • TWX 312-222-0745



## Rejection to 100 DB with Fairchild's Tuneable Filters 14 KC to 1000 MC in five separate, shielded units

- The TRF Series tuneable rejection filters cover the range from 14 KC to 1 GC by means of five individual precision units, each having a typical rejection capability of 100 DB for a signal within its range. And **NO** interchangeable plug-in coils!
- Individual pass band for each of the five filters encompasses the complete range from DC to 1 GC, with typical insertion loss less than 3 DB outside the notch. Spurious filter response is 15 DB or less.
- At 20 DB down the band rejection width is approximately 20% of the notch center frequency, while at 60 DB down the width is approximately 0.2%.
- Filters can be obtained individually, or as a complete set. Each comes in its own well-shielded housing for use in laboratory or field measurements involving RFI/EMC instruments, or for other applications requiring rejection of interfering signals.
- For complete technical information, contact:

**FAIRCHILD**

**ELECTRO-METRICS CORPORATION**  
A SUBSIDIARY OF FAIRCHILD CAMERA AND INSTRUMENT CORPORATION

88 CHURCH ST., AMSTERDAM, NEW YORK 12011

Circle 491 on reader service card



## telephone quality handsets

There is no higher standard for handsets. Specify famous Stromberg-Carlson . . . known to telephony since 1894.

Both models shown incorporate push-to-talk switches and high-gain receivers and transmitters.

No. 33 lightweight handset is furnished with a rocker bar switch.

No. 35 comes with a button switch, or with both the button and rocker bar switches.

Write for complete technical data.

**STROMBERG-CARLSON**

*A Subsidiary of General Dynamics*

114 Carlson Road • Rochester, N.Y. 14603

182 Circle 182 on reader service card

## New Semiconductors

tics. The manufacturer says these avalanche characteristics protect the rectifiers from damage by reverse voltage transients, yet the rectifiers cost no more than units without this protection.

Model S-6211 assemblies are available with peak inverse voltages of 200 to 800, covering a wide range of applications. A 2-amp, d-c current rating is common to all models. Neither voltage nor current derating is required to 75°C.

The rectifier assembly mounts on either chassis or panel with only a single number six screw, measures only 3/4 in. by 3/4 in. by 3/8 in. (excluding terminals) and is sealed for protection against adverse environments.

Sarkes Tarzian Semiconductor Division, 415 North College Ave., Bloomington, Ind. [368]

## Planar, npn-type silicon transistor

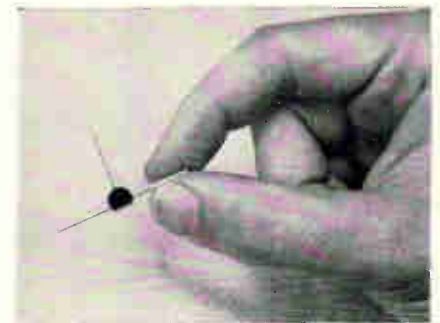

The VX-3375 silicon planar npn transistor provides 5 watts at 500 Mc, with maximum junction dissipation of 11 watts through its beryllium oxide base.

This epitaxial device has low induction ribbon leads, low parasitic capacitance, low junction-to-case thermal resistance and a beryllium oxide base readily solderable to a dissipator. In a lumped-element test circuit, the transistor delivers 6 db gain at 500 Mc, yielding a 5-watt output at 53% efficiency. The unit has operated in co-ax circuits with outputs greater than 100 mw at 2 Gc.

Price is \$60 each in quantities of 100.

Vector Solid State Laboratories, Vector Division of United Aircraft Corp., Southampton, Pa. [369]

Electronics | February 21, 1966

# 24 STANDARD MODELS . . .

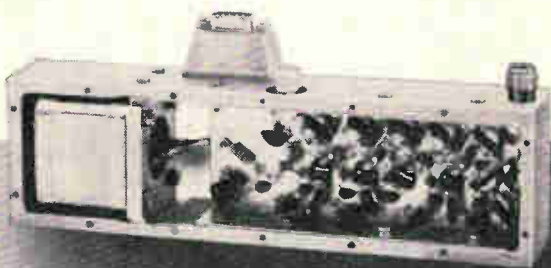

## RHG OCTAVE AMPLIFIERS

### FEATURING

- Noise figures to 2.5 db • Solid State Reliability • Low input and output VSWR
- RFI and Weatherproof housing • Octave coverage to 1000 MHz • With or without power supply

### FOR EXAMPLE

Model B505	
Frequency:	200 - 400 MHz
Gain:	20 db (min.)
Noise Figure:	< 4 db over band
Input and Output Impedance:	50 ohms
Input and Output VSWR:	2:1 typical over band
Price:	\$495

Utilizing RHG's broad background in low noise pre-amplification, an additional **43 CUSTOM DESIGNS** have been produced. The solution to your problem may be on file in our library now.

For specials, test our ONE-DAY-QUOTE Service. For standards, see complete listing in EEM Section 3400.

# RHG

RHG ELECTRONICS LABORATORY, INC.

94 Milbar Blvd., Farmingdale, N.Y. 11735  
(516) 694-3100

MICROWAVE FM and AM RECEIVERS ■ MICROWAVE MIXER PREAMPS  
LINEAR and LOG IF AMPLIFIERS ■ RF and OCTAVE AMPLIFIERS

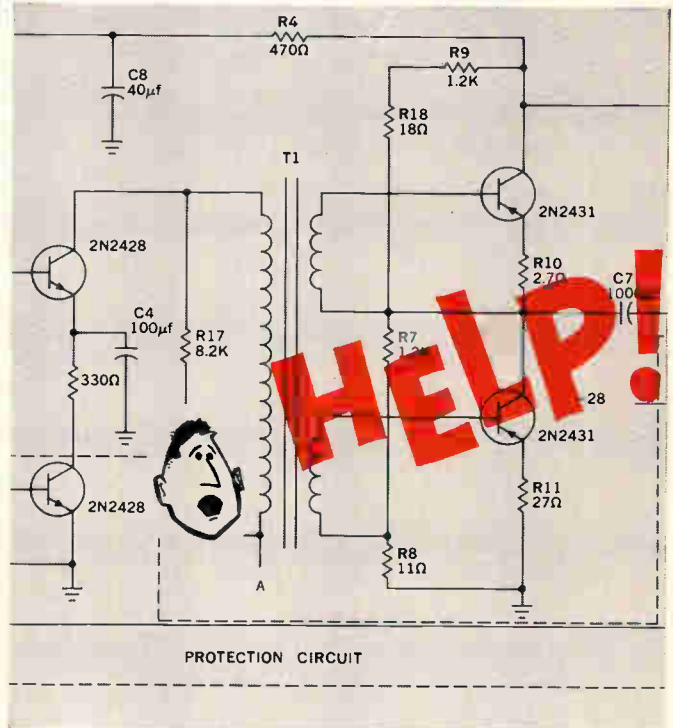

Drafting room backlog piling up? Cost of engineering drawings and technical documentation soaring? Mergenthaler has an answer to these problems.

In recent months, aggressive managers have been looking at The Diagrammer, a practical approach to automating drafting. The demonstrations they attended showed:

- A 400% time saving over manual drafting.
- "Better than inked" quality; ideally suited to microfilming.
- Ease of operation—minimum operator training.
- Matchless flexibility—adapts to most types of drawings.
- Low initial cost—ease of maintenance.

Interested? A call or a note on your letterhead will bring the help you need: the full story of The Diagrammer.

For full information on the  
**Mergenthaler Diagrammer**,  
call or write:

Charles L. Houpt, Manager  
Advanced Systems Marketing  
Mergenthaler Linotype Company  
29 Ryerson Street  
Brooklyn, New York 11205  
Telephone: (212) UL 5-0300



Mergenthaler

## THE DIAGRAMMER

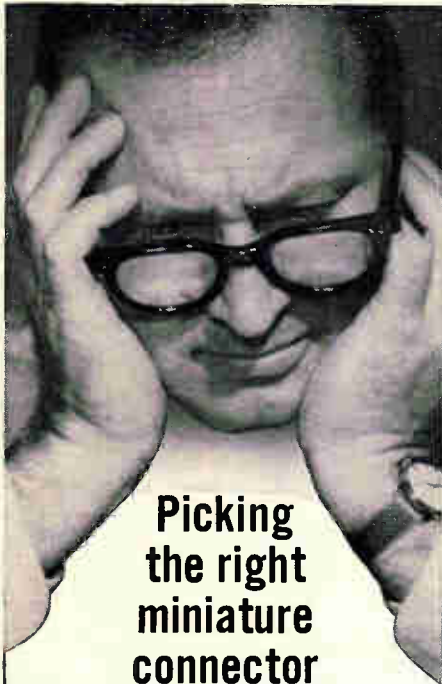

## Picking the right miniature connector is a small problem

It's not hard to locate a miniature connector small enough to meet tight space specs. Lots of people make them. There is a small problem, though, in finding the quality you need at the price you'd like to pay.



That's why business is booming at Transitron's Precision Connector Division. We design and produce miniature and subminiature connectors to exceed — not merely meet specifications. They are built to outlast the equipment you mount them on. Precision fabrication, knowledgeable design, the finest materials provide a combination that can't be surpassed by any manufacturer. Yet in quantity they cost no more than units that will barely squeeze by incoming inspection.

Send today for our new condensed catalog covering a complete line of miniature and subminiature connectors, as well as printed circuit connectors and many other types. And if you need a custom connector design, we're your source. Just give us the facts.



Precision Connector Division  
**Transitron**  
electronic corporation  
Wakefield, Massachusetts

## New Instruments

### Low-cost synchronizer stabilizes frequency



Engineers are often unwilling or unable to pay the high price for ultrastable signal generators which produce the signals for testing radio receivers and doppler radar systems. But now, The Hewlett-Packard Co.'s synchronizer provides two of the company's signal generators with a frequency stability approaching that found in frequency synthesizers, and at about 10% of the cost. Designed to work with H-P's model 606B and 608F signal generators, the synchronizer's phase-locking circuits stabilize test signals to 455 megacycles within 2 parts in  $10^7$  over a 10-minute period. This performance can be improved with an external frequency source that is more stable than the internal one because the synchronizing stability is limited only by this reference. The company says this stability is at least 250 times better than in standard generators operating in this frequency range.

Unlike other synchronizers, the model 8708A achieves frequency stability at any frequency from 50 kc to 455 Mc, because it is not restricted to phase-locking at multiples of the reference frequency. This instrument has an ultrafine frequency vernier which tunes the internal reference oscillator over a range of  $\pm 0.25\%$  and permits frequency settings to 2 parts in  $10^7$ . In this way, applications requiring high stability and precise settings — such as testing closely spaced

communications channels or high-Q filters—are easily handled.

The 8708A synchronizer is easy to use; phase lock is established automatically and no manual search is required. As soon as the equipment is connected and the frequency range is set by the operator, the automatic search in the 8708A locates the signal and locks on to it. The search is then disabled. If the signal generator output drifts from its setting, the synchronizer puts out a d-c signal which rebias the varactors in the generators to reestablish the desired frequency.

If the frequency generator setting is changed, there will be no change in its output frequency unless it is tuned beyond the hold-in range at one lock point. The automatic search establishes lock at the next point. These lock points are multiples of the 20-Mc internal reference. To change the generator frequencies continuously, the frequency vernier must be used. The range of the vernier, 0.5%, is considerably wider than the interval between discrete lock points.

An external 20-Mc frequency reference can replace the self-contained reference. However, in this case, the resultant stability is that of the external reference. An external reference also results in only discrete lock points unless the reference is frequency tunable  $\pm 0.25\%$  around 20 Mc. With a fixed reference, the interval be-



tween lock points varies from 62.5 cycles at 50 kc to 500 kc above 210 Mc.

#### Specifications

Frequency range	50 kc to 500 Mc
Input signal level (signal to be stabilized)	50 kc to 20 Mc: 0.25 to 5 volts peak-to-peak 10 to 500 Mc: 300 mv rms, $\pm 3$ db
Internal frequency reference stability	Short term: $5 \times 10^{-9}$ /minute with temperature: $2 \times 10^{-7}/10$ minutes Long term: $2 \times 10^{-6}$ day with temperature $2 \times 10^{-7}/^{\circ}\text{C}$ to $55^{\circ}\text{C}$ with line voltage: $2 \times 10^{-7}/10\%$ line voltage change
Power	115/230 volts $\pm 10\%$ , 50 to 400 cps, approximately 48 watts
Price	\$1,800

Hewlett-Packard Co., 1501 Page Mill Road, Palo Alto, Calif. [371]

### Spectrum analyzer is a real-time unit

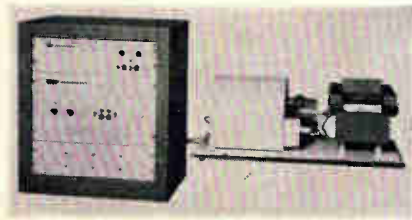

A real-time spectrum analyzer now being offered uses 100, 250 or 500 magnetostrictive filters to achieve narrow-bandwidth analysis of transient or repetitive events in a range to 100 kc. The magnetostrictive filter design is said to be especially stable and reliable under wide temperature variations and under severe mechanical conditions.

The series 100 Rayspan instrument is especially designed for laboratory and investigative operation in radar and sonar doppler effects; seismic, oceanographic and geophysical events; telemetry; and medical signals. In its 500-filter mode the analyzer can provide up to 100,000 samplings per second, obtained through capacitive commutation. All spectral data are preserved for scope presentation and/or for chart or other type of recording or display.

The analyzer is applicable in a wide dynamic range of 50 db, with individual filter bandwidths controllable to 3 db (3 to 120 cps). Threshold signals as small as 0.250 mv may be used, but maximum 6-v output requires input of at least

## Ballantine Model 440 Micropotentiometer

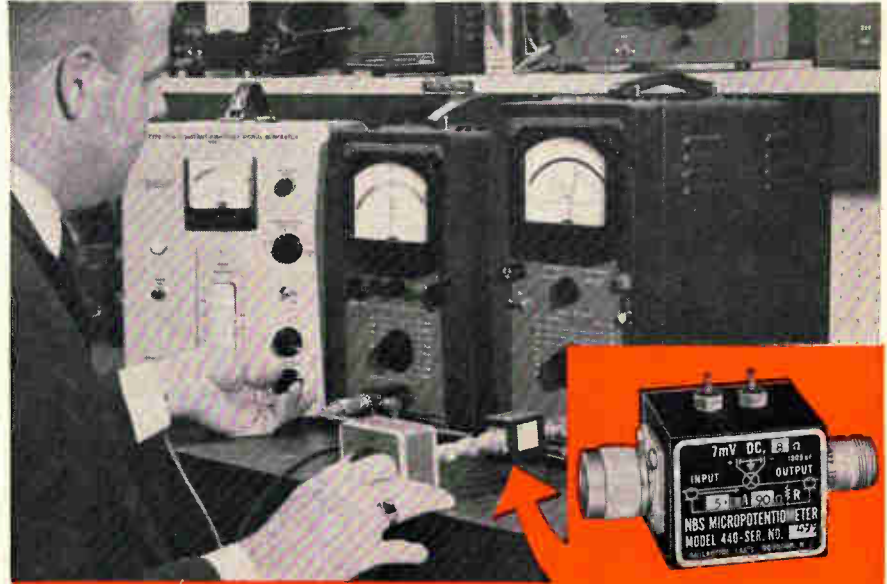

Model 440 Micropotentiometer being used to calibrate voltmeter on right

## Calibrate your ac Voltmeters, Signal Generators & 'Scopes to 900 MHz

Ballantine's Model 440 Micropotentiometer provides a precisely determined voltage at its output terminal when 0 to 900 MHz current is fed into the input terminal. The input current flows through a UHF-type thermocouple to a radial resistor of known constant value. The voltage developed across this resistor becomes the standard which is used to calibrate electronic voltmeters, oscilloscopes, and other voltage-sensing devices.

#### USEFUL FEATURES:

*Is simplest and most accurate method known to —*

1. measure relative frequency responses of ac voltmeters and oscilloscopes.
2. measure absolute accuracy of ac voltmeters and oscilloscopes.
3. measure absolute accuracy of output of signal generators.

Model 440 units are available for use from 15 microvolts to 1.5 volts.  
Price: \$175 per resistor, plus \$75 per thermocouple housing assembly.

#### OTHER USEFUL BALLANTINE REFERENCE STANDARDS

##### Model 393 HF (High Frequency) Transfer Voltmeter

Measures accurately ac voltages of 1 to 100 V at frequencies from 25 Hz to 30 MHz. Accuracy is better than 0.1% up to 10 MHz and better than 0.5% to 30 MHz even without application of calibration data. Price: \$1270 with six probes.

##### Model 390 A-T (Attenuator-Thermoelement) Voltmeter

Laboratory standard device consisting of an adjustable waveguide-below-cut-off attenuator feeding a UHF vacuum thermocouple for measuring voltages from 0.5 V to 300 V (depending on frequency) from 1,000 MHz to 10 MHz. Price: \$2250

Write for brochures giving complete details

— Since 1932 —



**BALLANTINE LABORATORIES INC.**  
Boonton, New Jersey

CHECK WITH BALLANTINE FIRST FOR DC AND AC ELECTRONIC VOLTMETERS/AMMETERS/OHMETERS, REGARDLESS OF YOUR REQUIREMENTS. WE HAVE A LARGE LINE, WITH ADDITIONS EACH YEAR. ALSO AC/DC LINEAR CONVERTERS, AC/DC CALIBRATORS, WIDE BAND AMPLIFIERS, DIRECT-READING CAPACITANCE METERS, AND A LINE OF LABORATORY VOLTAGE STANDARDS FOR 0 TO 1,000 MHz.

## TAPE PUNCH

LIST PRICE

**\$695.**

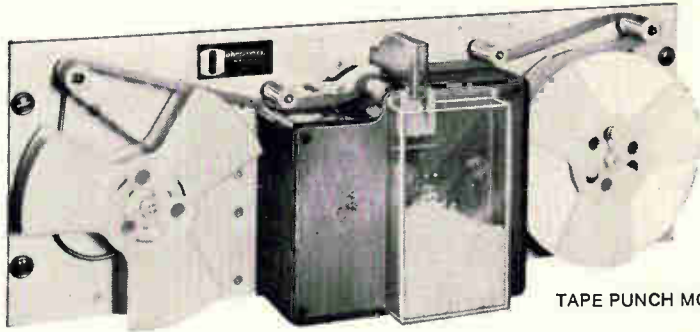

TAPE PUNCH MODEL 110R

Here is what the Series 110 Punch will do for you:

Punches at 30 characters per second asynchronously

Punches 5 to 8 channel paper or mylar tape

Two adjustable cam switches for interlocking with connected equipment

Reversing electro-magnet for backspacing of tape  
24 or 48 volt vdc

Contacts on electro-magnets for error checking, pulse stretching or holding for multi-punch operation

Can inhibit punching in event of error

One year warranty

Standard 19" panel mount

Impossible to punch elongated hole

If you need more information, please contact us.

other **ohr-tronics** products:

SERIES 119 tape readers

SERIES 117 encoding keyboards

SYSTEM 80 for inventory control

TAPE PREPARATION SYSTEMS

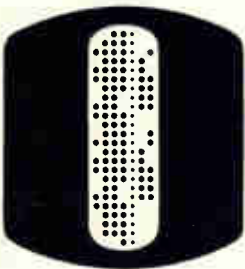

## ohr-tronics INC.

Dept. 6B

Time & Life Bldg. / 111 West 50th St. / New York, N. Y. 10020 / 212 CO 5-3067 / 212-581-3570 / twx #201 391-5118

Manufacturing and Engineering: Montvale / New Jersey

in Great Britain: Hodford House / High Street / Hounslow / Middlesex / England / HUDson 0777

Circle 492 on reader service card

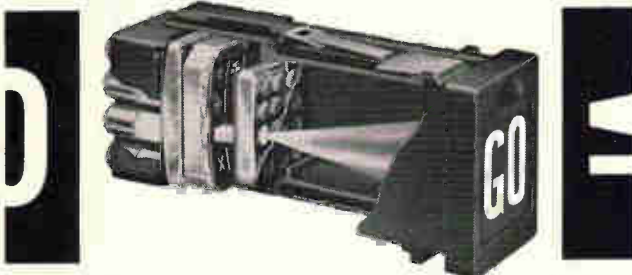

Send today for complete information on the only readout that works like a rear-projector, uses film to display anything (even colors!), gives you 12 message positions all in a single plane, and plugs in and out from the front for quick lamp replacement. All that and it's only 1½" x 1-1/16"! Just think what its bigger brothers can do...

**INDUSTRIAL ELECTRONIC ENGINEERS, INC.**  
7720 Lemona Avenue • Van Nuys, California  
Phone: (213) 787-0311 • TWX (213) 781-8115  
Representatives in Principal Cities

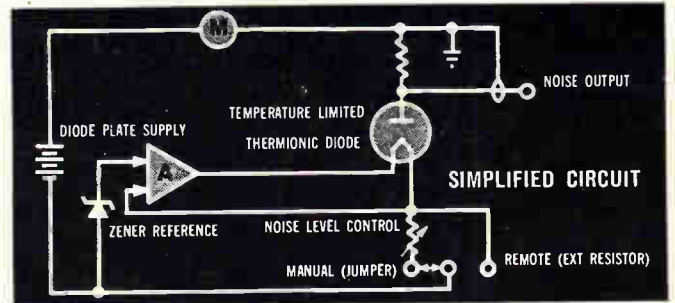

## PRECISION RANDOM NOISE VLF-UHF

- **SERVO-STABILIZED OUTPUT:** compensated for drift over temperature, line voltage, noise tube aging.
- **STABILITY:** 0.05 db after 11 msec warmup.
- **ACCURACY:** ±0.1 db to 200 MHz.
- **Model NS-L:** 100 Hz - 500 MHz. Output absolutely free of line noise harmonic contamination at VLF. Only generator on the market with precision VLF capability.
- **Model NS-B:** 1 MHz - 500 MHz.
- **Model NS-H:** 1 MHz - 2000 MHz.

Other products by ARI: Laboratory RF Measurements Equipment, Precision Frequency and Timing Instrumentation.



**AEROSPACE RESEARCH, INC.**  
130 Lincoln St., Boston, Mass. 02135  
(617) 254-7200



Great editorial  
is something  
he takes  
home

(What a climate for selling!)

**Electronics** 

A McGraw-Hill Market-Directed Publication  
330 West 42nd Street, New York, N. Y. 10036

## New Instruments

50 mv. At maximum attenuator setting, signals up to 50 v can be handled.

As furnished, the series 100 includes a beat-frequency oscillator to translate inputs to the resonance frequencies of the filters. External mixers can extend the over-all frequency range of the instrument if necessary.

The instrument is solid state throughout, and contains its own 115-v a-c power supply. Acton Laboratories, Inc., subsidiary of Bowmar Instrument Corp., 531 Main St., Acton, Mass. [372]

## Monitoring receiver spans 25 to 900 Mc



A vhf-uhf monitoring receiver is available covering the frequency range of 25 to 900 Mc with three r-f plug-in units. Type ESE is a versatile multipurpose unit for monitoring radio reception, radio interference and laboratory measurements. It contains the circuitry of a selective microvoltmeter with built-in r-f preselection. It permits input voltage measurements from 1  $\mu$ v to 1 v, and a built-in attenuator, adjustable in 10-db steps, allows the measurement range to be extended to a maximum of 120 db. The indication range of the meter is 20 db in the lin. position and 40 and 60 db in the log. position.

Type ESU is equipped with a standardizing oscillator ganged with the tuning control enabling calibration of the instrument at any test frequency. The voltage of this oscillator is made available with a fixed level of 90 db above 1  $\mu$ v (31.6 mv) at a special output, and the ESU can thus be used as a transmission test set.

The unit is provided with outputs for i-f recorder, headphones, loudspeaker, and two selectable bandwidths, bfo, switch-selected

## collage

More Motorola mishmash,  
continued from page 149



## AROD is not a Biblical name

AROD is "Govtalk" for Airborne Range and Orbit Determination, and our Western Center is building about 2 million dollars worth for NASA's Marshall Space Flight Center. This system has a few tricky nuances that are allowing our boys to show some fancy footwork in applying integrated electronics to real live hardware. AROD reverses normal design techniques by putting doppler equipment in the space vehicle and the usually vehicle-mounted transponder on the ground. There are some very good reasons for this reversal, not just an innate perversity on the part of Marshall scientists. If we could afford a few more columns, we'd tell you all about it.

For more information, write to our Western Center.

## BUY SOME TODAY!

Our hard-nosed sales force can't accuse us of being wishy-washy, by McGeorge. So right now, give one of them a call and buy something . . . or at least tell him your whole office is in hysterics over that last technical proposal he delivered. Also, we'd be overjoyed to send you reams of literature about things like digital communications, radar, microwaves, transponders, command receivers and microelectronic, integrated circuit anything.



**MOTOROLA**  
Military Electronics Division

Chicago Center  
1450 N. Cicero Ave., Chicago, Illinois  
Western Center  
8201 E. McDowell Rd., Scottsdale, Arizona

# 99% Fewer Cavities With Cinch-Graphik

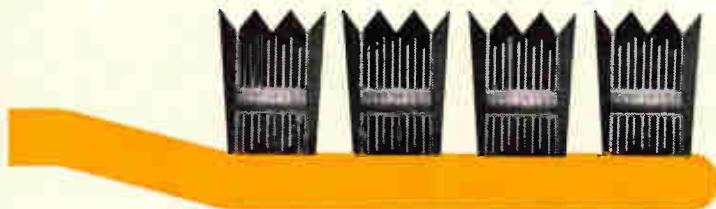

10X MICROPHOTOS OF MULTILAYER THRU-HOLE CROSS-SECTIONS

Cinch-Graphik's advanced multilayer production techniques eliminate voids in thru-hole plating and intra-layer lamination. This is why Cinch-Graphik circuits have greater electrical reliability (complete interface bond between plated thru-hole and individual circuit layers), better final assembly quality (good component contact) and increased physical integrity (no delamination under wave soldering). For a brighter smile, use Cinch-Graphik multilayer circuitry. Write for our illustrated brochure.



200 South Turnbull Canyon Road, City of Industry (Los Angeles), Calif. 91744 • Phone (213) ED 3-1201. Offices in 22 Principal Cities throughout United States, Canada, England and Australia listed under Cinch Mfg. Co. or United-Carr Incorporated • Cinch • Cinch-Monadnock • Howard B. Jones • Ucinite • Palnut

## New Instruments

afc, and a-m and f-m operation. Calibrated antennas for field intensity measurements are also available.

The three plug-in units cover 25 to 230 Mc, 160 to 470 Mc, and 460 to 900 Mc respectively.

The receiver has been designed for both a-c and battery operation (12 v d-c).

Rohde & Schwarz, 111 Lexington Ave., Passaic, N.J. [373]

## Impedance bridge features versatility

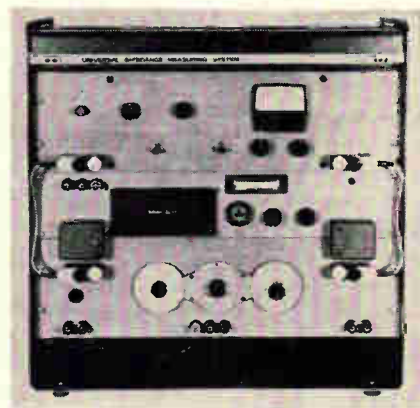

Model 292 universal impedance measuring system provides for precise measurements of resistance, conductance, capacitance and inductance. For capacitors and inductors, it also measures the dissipation factor and storage factors.

The modern design permits a conservative accuracy rating of  $\pm 0.05\%$  for resistance and conductance,  $\pm 0.01\%$  for inductance and capacitance. Comparative five-figure measurements can be made using the 120,005 divisions of dial resolution provided by the Dekadial decade dials.

The 292 system is designed for maximum versatility. Terminals are provided so that ranges may be extended and special circuit connections can be made. Four-terminal resistance connections can be used to increase the accuracy of low resistance measurements. Three-terminal connections can be used to remove the effects of stray shunt circuits when measuring high resistance, inductance or low capaci-

tance. D-c bias can be applied when making inductance and capacitance measurements.

The system features the model 290A impedance bridge, the model 803 d-c generator-detector, and the model 860A a-c generator-detector. These generator-detector units are specially designed as companions to the 290A bridge and provide performance compatible with the high resolution and accuracy of the bridge. Model 292 system complete sells for \$1,285. Delivery is from stock to 30 days.

Electro Scientific Industries, 13900 N.W. Science Park Drive, Portland, Ore. [374]

## Instrument measures thermoelectric power

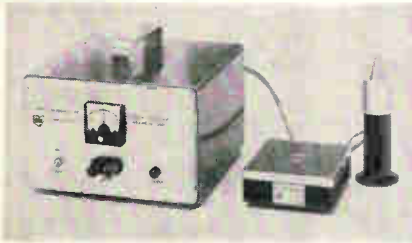

The model S-1 Secbeck coefficient measuring unit is said to replace the inaccurate soldering iron-galvanometer technique with a quality instrument providing reliable, quantitative determination of the type and magnitude of the thermoelectric power of semiconducting materials. The unit is said to provide the basic accuracy and convenience advantageous in materials research, device research, device design, general laboratory evaluation, or for quality control purposes.

High accuracy and repeatability of measurements results from the proven thermodynamic design and the utilization of a differential solid-state sensing and control system which maintains a 10°C temperature differential across the sample to better than 1% during measurement on typical samples. The 10° differential across the sample permits easy, direct read-out of the thermoelectric power. The output may be monitored by a potentiometer or precision recorder when extreme accuracy is desired, or a standard laboratory millivoltmeter may be used where its accuracy is

Circle 189 on reader service card →



Series 2201 for airborne applications. 1" diameter. Less than 3" long. Weighs less than 3.50 ounces. Hysteresis error less than 0.05% FSO. End point non-linearity less than 0.1% FSO. Wide operating temperature range from -100°F to +300°F.

Series 2102 for general purpose differential pressure measurement. Extremely rugged, high proof pressure, field serviceable, completely "dry" construction (not fluid filled), zero shift with base pressure less than 1.0% FSO.

Series 2101 for ground support and test stand applications. Wide operating temperature range from -100°F to +300°F. Hysteresis error less than 0.05% FSO. End point non-linearity as low as 0.10% FSO. 1000 g's shock. Natural frequency over 20KC.

## NEWEST Teledyne® Pressure Transducers feature greater accuracy, lower cost, smaller size, ruggedness

Incorporating unique new sensing elements, these three new Taber TELEDYNE® pressure transducers offer the features that today's instrumentation engineers are seeking — greater accuracy, lower cost and smaller size, with ruggedness and reliability.

All three of these new instruments utilize four strain gages bonded in optimum orientation to the controlled-stress zones of a semi-floating beam element, resulting in minimum error.

While these are Taber's newest pressure measurement products, even now Taber's scientists and engineers are engaged in an aggressive, continuing research and development program aimed at providing even finer equipment at lower cost without sacrificing the premium quality for which Taber is famous.

For descriptive literature, write Aerospace Electronics Div., Taber Instrument Corp., Section 158, 107 Goundry St., N. Tonawanda, N. Y.



Pressure Transducers • Signal Conditioning and Readout Devices

# SPECTRA <sup>No.</sup><sub>1</sub>

**PROBLEM:** HOW TO GET EXTENDABLE HARNESSSES USING STANDARD WIRE, STANDARD CONNECTORS, AND CONSISTENTLY HIGH RELIABLE MILITARY AND COMMERCIAL SPECIFICATIONS?

**SOLUTION:** FLAT RIBBONIZED CABLE. Customized into compact harnesses, using any PVC insulated or jacketed conductors — AWG 14 to 30, and strandings of 7 to 105. Meets Mil. Specs.

Spectra-Strip specializes in the manufacture of customized harnesses made from ribbon-cable. More than 2000 satisfied customers have used our cabling. Only the highest quality workmanship is put into every harness. And above all else . . . consistency and reliability first!

Write today for further information to:



*Excellence in Engineered Wiring*

**SPECTRA-STRIP CORP.**

P. O. Box 415, Garden Grove, California 92642  
Tel: (714) 537-4530 • TWX: (714) 530-0313

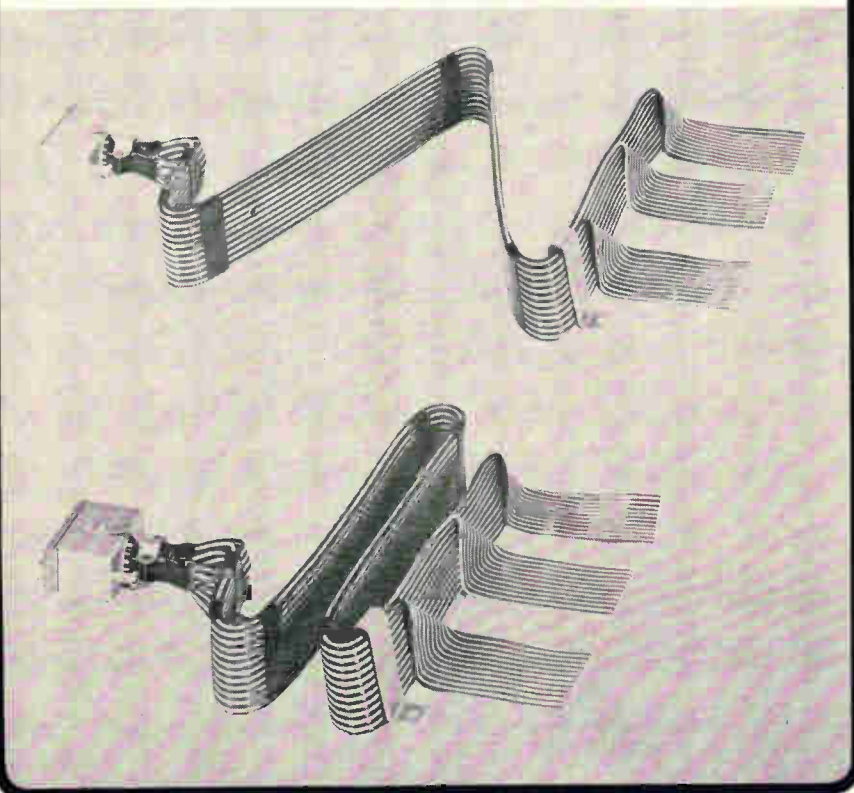

## New Instruments

sufficient for the particular determination.

According to the manufacturer, several years of laboratory experience have shown that an instrument of this design is useful for measuring thermoelectric power of semiconductors or semimetals in the range of a few microvolts per °C to several hundred microvolts per °C with either p-type or n-type materials. The data has been found extremely useful in materials and device optimization.

Model S-1 is a stock item and is available at \$910 each in small quantities.

Ohio Semitronics, Inc., 1205 Chesapeake Ave., Columbus, Ohio [375]

## Transient monitor features 10 channels

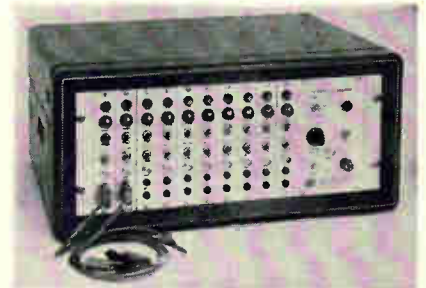

A reliable 10-channel transient monitor, Model TM-5100, is designed to monitor components such as relays, resistors, switches, connectors and transformers during shock and vibration for the detection of a momentary short or discontinuity in excess of a fixed pre-set period within the range of 5 to 100 microseconds. Other ranges are available.

The TM-5100 has a built-in bias capability which provides a maximum bias of 30 mv; 30  $\mu$ a for dry circuit testing. Accuracy of the monitor is 3% with internal calibrator, closer with external reference.

The all silicon transistor instrument consists of 11 easily removed modules thus allowing for great servicing flexibility. Price of the rack mounted TM-5100 is \$1,450. Add \$35 for cabinet.

Continental Testing Laboratories, 755 U.S. Highway 17-92, Fern Park, Fla. [376]

For career opportunities at  
Hamilton Standard,  
all systems are



Here is a company poised at the threshold of the most exciting era in its history. And our history goes back to beyond the Hamilton Standard equipment aboard the "Spirit of St. Louis." If you haven't been following our progress in recent years, you'll be surprised by our remarkably broad product range, and the state-of-the-art activity on so many technological fronts. This success and expansion creates excellent new openings offering responsibility and bonafide advancement opportunity. And just one leisurely ride through the beautiful Connecticut countryside will persuade you that this is THE area in which to LIVE and to raise a family. Some representative openings:

**SENIOR EXPERIMENTAL ENGINEER—ELECTRONICS—BSEE.** Should have experience in R&D testing of electronic control systems involving circuit or system design and/or transistor analog/digital circuit design. To plan, conduct and evaluate product development programs in field of electronic systems applicable to stabilization and navigation equipment, aircraft and missile flight controls, aircraft and rocket engine controls and other related systems.

**ELECTRONICS DESIGN ENGINEER**—Experience in discreet type or digital controls design. Oriented in both analytical and hardware phases of design activity involved in closed loop digital control systems. Product applications involve jet fuel controls, synchrophasers, cabin pressure controls and similar aircraft or aerospace closed loop systems. Requires BSEE or MSEE preferred.

**POWER SUPPLY ENGINEER**—BS in Electrical or Electronic Engineering with 4 to 6 years, design-development-test experience in power conversion generating systems. Will work with all levels of project engineers and customers. Will conceive and monitor all major electrical design for power supplies. Should be familiar with as many of the following as possible: Switching characteristics of transistors, silicon controlled rectifiers, four layer and turnol diodes, circuit applications of semiconductors, transformers, interstage and power voltage regulators, single and polyphase circuits, heat transfer, packaging, power generating specifications.

**ANALYTICAL ENGINEER—ELECTRONIC SYSTEMS,** to conduct analytical studies (stability, response, accuracy, etc.) of closed loop digital and analog control systems using a combination of control and digital techniques to completely define the required control mode and method of implementing small electronic control systems (2 or 3 loop systems involving speed, temperature and/or pressure).

**SR. ELECTRONIC ENGINEER, MICRO-ELECTRONIC CIRCUITRY**—Applicant will be responsible for the direction of a small scientific group engaged in the investigation of micro-electronics. PhD or equivalent with thesis in field of physics, physical chemistry or ceramics. Should, in addition, possess a minimum of 3 years direct laboratory experience in one of the following: thin films, development of materials of electronic interest, solid state devices, or process development in electronic components industry. In addition, candidate must have minimum of one year of supervisory experience.

**MECHANICAL DESIGN ENGINEER, ELECTRONIC PACKAGING**—BSME—to design and develop electronic-mechanical devices and applicable packages for industrial and aerospace product application (environmental controls, power supplies, stabilization equipment), develop packaging concepts; conduct structural and temperature development testing to determine concept feasibility and verify design calculations. Must be able to conduct own thermo and vibratory analyses.

**TO ARRANGE AN EARLY INTERVIEW,** please forward your resume, including present salary, to Mr. R. F. Harris, Personnel Department, Hamilton Standard, Windsor Locks, Connecticut.

**Hamilton  
Standard**

**U  
A**  
DIVISION OF UNITED AIRCRAFT CORPORATION

An Equal Opportunity Employer—M&F

# MANUAL Switching Simplified

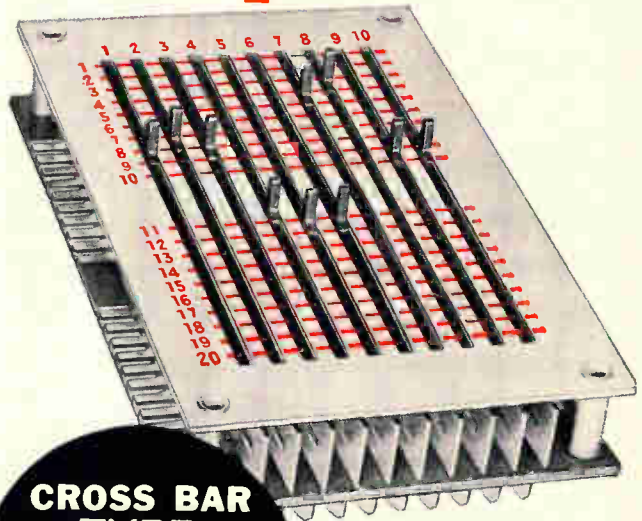

**CROSS BAR  
TYPE  
SELECTOR  
SWITCH**

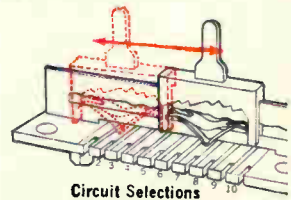

Ideal for:

- PROGRAMMING
- SELECTING
- CONNECTING

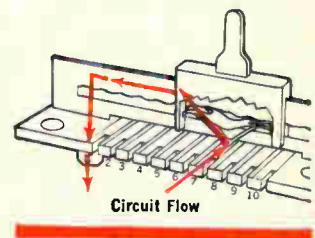

**Programming** repetitive data in computers.

**Selecting** different power supplies or resistance values in test equipment.

**Connecting** large groups of inputs into relatively few outputs in programming.

**Electrical capacity:**

1. Current carrying only (no make or break) 3 amp 125 V AC or DC
2. Make or break 1 amp 15 V DC, 150 m.a. 125 V AC



**The complete snap-action switch line!**



**Cherry Electrical Products Corporation**

P. O. Box 437-12—Highland Park, Ill.

IN CANADA: BARRY ELECTRIC, LTD., REXDALE, ONT.

# Problem Solvers

For precision clean manufacturing and research

White-Bench



Mobile Down-Flow Module



Convertible Laminar Flow Work Station



All our PROBLEM SOLVERS provide FED STD No. 209 Class 100 Absolute Filtered Air

For further information on these and other products contact:

**MATTHEWS** **mri**  
**RESEARCH, INC.**

4306 Wheeler Avenue  
Alexandria, Virginia (703) 548-1600

## New Subassemblies and Systems

### One-pound digitizer made with IC's



With monolithic integrated circuits, a miniature digitizer attains accuracy, resolution and speed that were previously available only in much larger instruments. With a package of less than 22 cubic inches, weighing less than one pound, it is now possible to transmit analog telemetry in high-speed digital form direct from airborne and space vehicles. Both military and industrial versions are available; the only difference is in the operating temperature specification.

The basic package is only 2½ by 2½ by 3¼ inches, and contains all the circuitry except the power supply. The circuits consist principally of monolithic Flatpacs in the digital section and discrete components in the analog section. The Flatpacs are mounted on multilayer boards that are individually pluggable for rapid maintenance and repair. The terminal interface for the entire unit is provided by a pair of aerospace quality subminiature connectors. The assembly is made vibration-proof and shock-proof by a resilient cushion mounted on the inside of the cover, into which each circuit board is placed.

The converter offers 14-bit resolution and a conversion rate of 4 microseconds per bit. Both series and parallel outputs are available simultaneously. Many options may be added to the standard 514 converter. These include:

- Slaving of the conversion process to an external clock.
- BCD, Gray or other codes for

the parallel output, substituted for the standard pure binary code.

- Higher input impedance, at or off null, by addition of an (internal) isolating amplifier.
- Crystal-controlled clock.
- NRZ output excursion for the pcm (serial) output, instead of the standard RZ excursion. Also pcm if desired.

The manufacturer says the price for either the militarized or industrial version is far below comparable competition.

#### Specifications

Resolution	14 bits
Accuracy	±0.01% from -55° to +95°C
Stability	±2 ppm/°C, -55° to +95°C
Sensitivity (full scale)	Standard: 0 to +5v; Optional: +2.5v to -2.5v or 0 to -5 volts (higher full-scale input ranges on special order)
Input impedance (at null)	2 megohms minimum
Output formats	14-bit binary Parallel Serial PCM, at bit rate
Output codes:	Binary, strobe output Parallel Serial Pulses, RZ and binary (optional: NRZ and/or BCD)
Conversion rate	4 μsec/bit, 56 μsec/conversion time
Operating environment	-55° to +95°C ambient (military version) 0° to 70°C ambient (industrial version)
Power requirements	+12v ±1% at 100 ma d-c -3.75v ±5% at 450 ma d-c -6v ±1% at 50 ma d-c (comparable power-supply module available)
Size	2½ by 2½ by 3¼ in.
Weight	Approximately 15 oz. net

RC-95 Inc., 9 East 38th St., New York, N.Y. [381]

### A/D converters use plug-in modules

Series 3030 analog/digital converters are solid state instruments for converting analog voltages to digital codes with an accuracy and long-term (three-month) stability of ±0.1%. Conversion rates from 50 cps to 40,000 cps are available. The outputs are 10 binary bits plus sign, or three decimal digits plus sign.

The instruments are designed for



# How we turned Joe into a Mysophobic.

The electrical industry wanted a cleaner film. So, from the first roll of Celanar Polyester Film, our policy has been "It's got to be the *cleanest* in the industry." We go to extremes, like making Joe—and everyone else who enters our hospital-clean production area at Greer, S.C.—first take a shower. A high-velocity shower of air that whisks away dust and lint particles. Only then may they enter the "White Room" where air filtration systems effectively trap dirt specks as tiny as 0.3 microns—infinitesimal as the point of a needle.

Cleanliness, of course, is not Celanar's only advantage in electrical applications. It is stronger, more uniform than the other polyester film. And it retains its strength well at elevated temperatures. Celanar film



has excellent aging characteristics, and it resists embrittlement. We lean over backwards, too, in supplying the roll lengths, widths and gauges most convenient to you. We guard Celanar during shipment with temperature recording flags, even impact recorders where necessary.

So, even if we did turn Joe into a mysophobic with an uncontrollable fear of dirt, we think you'll agree it was worth it.

Send for complete details about Celanar Polyester Film—and how we can help you make the best use of it. Celanese Plastics Company, Dept. 133-B, 744 Broad Street, Newark, N. J.

Celanese Plastics Company is a division of Celanese Corporation of America.  
Celanese® Celanar®



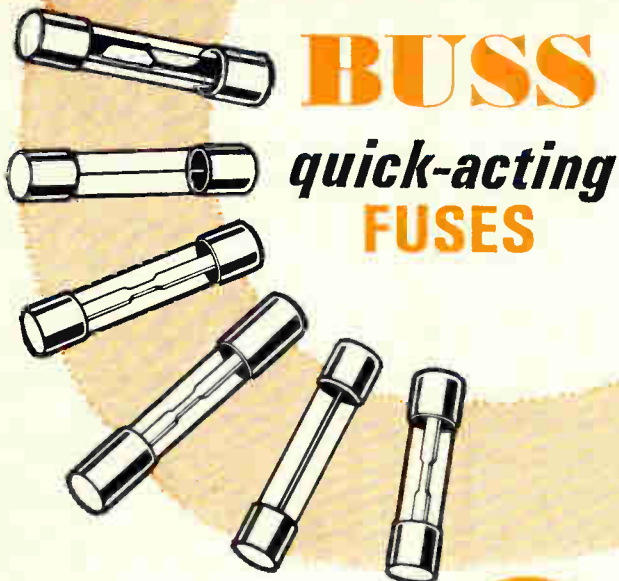

# BUSS

## quick-acting FUSES

"Quick-Acting" fuses for protection of sensitive instruments or delicate apparatus;—or normal acting fuses for protection where circuit is not subject to current transients or surges.

Write for  
BUSS  
Bulletin SFB

INSIST ON **BUSS**  
QUALITY

BUSSMANN MFG. DIVISION, McGraw-Edison Co., ST. LOUIS, MO. 63107

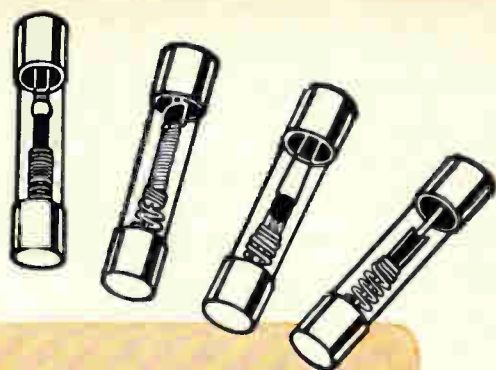

# FUSETRON

## dual-element Fuses

### slow blowing

Write for  
BUSS  
Bulletin SFB

"Slow blowing" fuses prevent needless outages by not opening on harmless overloads—yet provide safe, protection against short-circuits or dangerous overloads.

INSIST ON **BUSS**  
QUALITY

BUSSMANN MFG. DIVISION, McGraw-Edison Co., ST. LOUIS, MO. 63107

# BUSS: The Complete Line of Fuses and . . .

Circle 195 on reader service card

Circle 195 on reader service card

## Highest-quality copper-clad laminates for multi-layer printed circuits



Laminated plastics for multi-layer printed circuits have to be a special breed—very thin, made to exacting tolerances, uniform, free of voids and pinholes, suitable for etching and all soldering operations.

Synthane Thin Laminated grades G-10 and FR-4 are highest-quality fabric epoxy laminates. All produced under exacting clean room conditions. Write for leaflet. Synthane Corporation 36 River Road, 666-5011 (Area Code 215).

**SYNTHANE**  
CORPORATION  OAKS, PENNA.

Laminated Plastic Sheets, Rods,  
Tubes and Fabricated Parts



give...so more will live  
**HEART FUND**

## New Subassemblies

continuous operation without adjustment in industrial and scientific systems. Standard, solid-state plug-in modules are used to increase serviceability; the modules are also available for implementing custom logic designs.

Control Equipment Corp., 19 Kearney Road, Needham Heights, Mass. [382]

## Counter, light source reset automatically

Fast-moving objects can be counted by a compact, solid state system consisting of a photoelectric counter and a light source. In the counter is a solid state light sensitive cell, a specially designed optical lens system for maximum light accumulation, a sensitivity control, a six-digit

totalizing counter and silicon transistors. The totalizing counter, which is electromechanical and capable of counting-speeds up to 2,500 per minute, is equipped with a manual reset and will automatically reset when the total of 999,999 has been reached. The photoelectric counter is available in two models: TR2-05D energizes on a decrease in light; TR2-05L energizes on an increase in light.

The light source is available as model TR2-L, consisting of a specially designed lens system for maximum light transmission, a lamp and a transformer.

Both the counter and the light source operate off 120 v, 60 cps a-c. The enclosures for each unit measure 3 in. wide by 7<sup>5</sup>/<sub>8</sub> in. high by 3<sup>1</sup>/<sub>4</sub> in. deep. Each is mounted by means of a 1/2-in. standard male pipe thread.

Typical of the many hundreds of applications for this system are high-speed counting, totalizing and

production control.  
Photomation Inc., 280 Polaris Ave.,  
Mountain View, Calif. [383]

## P-c logic module for stepper motors

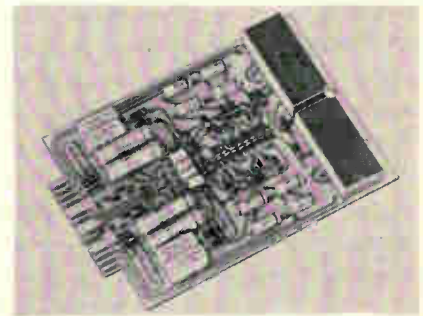

A printed-circuit module is announced for logic type stepper motors. Model designation is K85401.

The circuit accepts external pulses and programs them to the proper motor coils. Two pairs of transistors function as flip-flops

## Fuseholders of Unquestioned High Quality

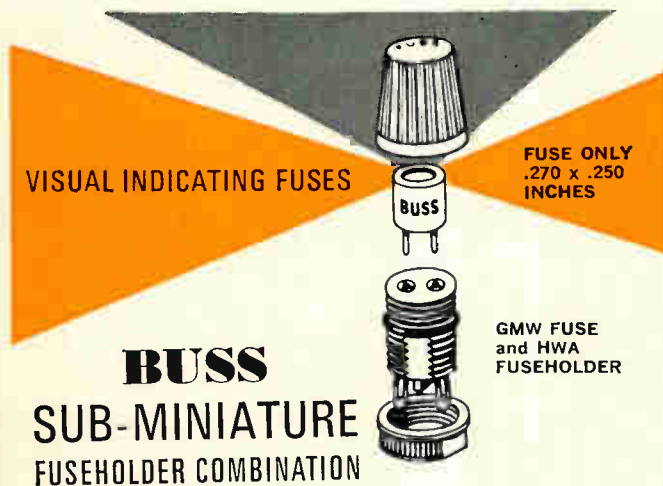

For space-tight applications. Fuse has window for inspection of element. Fuse may be used with or without holder.

Fuse held tight in holder by beryllium copper contacts assuring low resistance.

Holder can be used with or without knob. Knob makes holder water-proof from front of panel.

Military type fuse FM01 meets all requirements of MIL-F-23419. Military type holder FHN42W meets all military requirements of MIL-F-19207A.

Write for BUSS Bulletin SFB

INSIST ON **BUSS**  
**QUALITY**

BUSSMANN MFG. DIVISION, McGraw-Edison Co., ST. LOUIS, MO. 63107

Circle 195 on reader service card

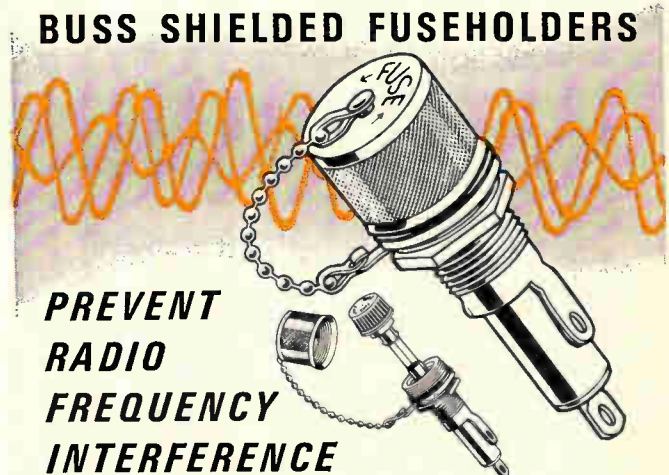

For use where fuse and fuseholder could pick up radio frequency radiation which interferes with circuit containing fuseholder—or other nearby circuits.

Fuseholder accomplishes both shielding and grounding.

Available to take two sizes of fuses—1/4 x 1 1/4" and 1/4 x 1" fuses.

Meet all requirements of both MIL-I-6181D and MIL-F-19207A.

Write for BUSS Bulletin SFH-12

INSIST ON **BUSS**  
**QUALITY**

BUSSMANN MFG. DIVISION, McGraw-Edison Co., ST. LOUIS, MO. 63107

Circle 195 on reader service card 195

New Member  
of the  
**QUALITY  
QUORUM**



*Bliley*  
TYPE  
**BK2 CRYSTALS**

Type BK2 was designed primarily for compact precision at 1 mc in high stability applications. A Koldweld sealed holder eliminates contamination due to heat and flux to assure optimum crystal performance. Typical parameters include:

- ▶ Maximum aging  $3 \times 10^{-8}$  per week
- ▶ Short term stability  $1 \times 10^{-8}$  per day
- ▶ Average Q 500,000

Type BK2 is also available on special order in range 900-1000 kc.

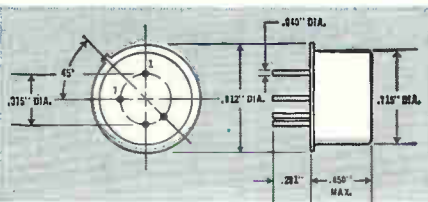

Request Bulletin 527B-S for complete information.

*Bliley* If you buy quality

**BLILEY ELECTRIC COMPANY**  
Union Station Bldg.  
Erie, Pennsylvania

## New Subassemblies

with diode gates to control the sequence. Diode suppressors are used to short-circuit inductive voltages generated on switching. Pulse shapers allow any form of signal input and will "clean up" pulses that are not essentially square. If pulses exhibiting 50  $\mu$ sec rise time are available, pulse shaper elements may be omitted.

If no pulse source is available, pulse generators can be supplied to meet specific requirements. Special controllers can also be furnished to permit selectable pulse rates. Technical data is given in Newsletter No. 120A.

The A.W. Haydon Co., 232 North Elm St., Waterbury, Conn., 06720. [384]

## Digital-to-analog converter card

A digital-to-analog circuit card operates to 100 kc. The GA-518 card converts four digital bits to an equivalent 10 volt analog-voltage swing which can be unipolar or bipolar. Accuracy is  $\pm 0.05\%$  over a temperature range from  $-55^\circ$  to  $+71^\circ$  C.

Up to three cards may be connected together to provide conversion of 10 binary bits or 3 BCD digits. Price is \$63.60 in quantities of 100.

Engineered Electronics Co., 1441 East Chestnut Ave., Santa Ana, Calif., 92702. [385]

## Multiple-channel solid-state preamp



A solid-state preamplifier has been added to the Nems-Clarke line of telemetry receiving equipment. The

# Rolled Metal Ribbon & Strips



(THINK OF CROSS FIRST)

## MAJOR MICROWAVE MANUFACTURERS DO!

Top manufacturers like Microwave Associates, Watkins-Johnson, Varian Associates and Raytheon use CROSS-rolled ribbons for their most finicky chores. That's because CROSS rolls molybdenum and tungsten down to tolerances of  $\pm .0001$ . CROSS is the **only** company to do so on a production basis.

CROSS rolls tantalum, columbium, zirconium, rhenium moly, titanium, vanadium, copper, nickel, alloys and standard metals. CROSS will roll strips to precise order, meet any demand for precision metals.

There's a good reason why top companies think of CROSS first—because if CROSS does it—it's right the first time! Join the top manufacturers who've found out how perfectly CROSS meets your most exacting metal requirements.

Phone or write today.

## H. CROSS CO.

363 Park Ave.  
Weehawken, N. J.  
201-UNION 3-1134

Circle 495 on reader service card  
Circle 197 on reader service card →



**HIGH Q**  
encapsulated

**HIGH Q**  
wafer

**HIGH K**  
encapsulated

## Now, JFD Uniceram® Fixed Capacitors Come THREE ways

**High Q** Uniceram High Q ceramic fixed capacitors offer a unique combination of small size, exceptional stability and a guaranteed minimum Q of 5000 . . . with up to ten times more capacitance per unit volume than competitive units . . . up to .206 mfd/in<sup>3</sup>.

**GLASS ENCAPSULATED**—105 models, with capacitance values from 0.5 to 3000 pf, provide the ultimate in High Q, reliability and stability. All models meet applicable requirements of MIL-C-11272B.

**WAFERS**—Uniceram High Q capacitors are also available as unencapsulated wafers with metalized edges. 88 low-cost units, with capacitance values from 0.5 to 3000 pf,

offer the same outstanding electrical properties. These wafers are ideally suited for hybrid integrated circuits, can be soldered directly to printed circuit boards or used as discrete components.

**High K ENCAPSULATED**—A High K series of Uniceram ceramic fixed capacitors with up to 1 mfd capacitance is also available. These glass encapsulated units meet applicable requirements of MIL-C-11015C. Volumetric efficiency . . . up to 48 mfd/in<sup>3</sup>.

**WAFERS**—Uniceram High K capacitors will soon be available as unencapsulated wafers, also.

**WRITE FOR CATALOG UNM 65-2**



Components Division  
JFD ELECTRONICS CORPORATION, 15th Ave. at 62nd St., Brooklyn, N. Y. 11219  
Tel: 212 DE 1-1000  
JFD NORTHEASTERN, Ruth Drive, P. O. Box 228, Marlboro, Mass. 07152  
JFD NEW YORK-NORTHERN, Damiano Pl., P. O. Box 96, New Hartford, N. Y. 13503  
JFD MID-ATLANTIC, P. O. Box 5055, Philadelphia, Pa. 19111  
JFD MID-ATLANTIC-MARYLAND, P. O. Box 7676, Baltimore, Md. 21207  
JFD MIDWESTERN, 6330 W. Hermione St., Chicago, Ill. 60646  
JFD MIDWESTERN-OHIO, P. O. Box 8086, Cincinnati, Ohio 45208  
JFD WESTERN, 9 Morlan Place, Arcadia, California 91006  
JFD ISRAEL LTD., Industrial Area B, Bldg. 23, Azor, Israel  
JFD ELECTRONICS, EUROPE S A, 7 Rue de Rocroy, Paris, 10, France

## Now twice as many



**Couch** 0.1 oz. rotary relays

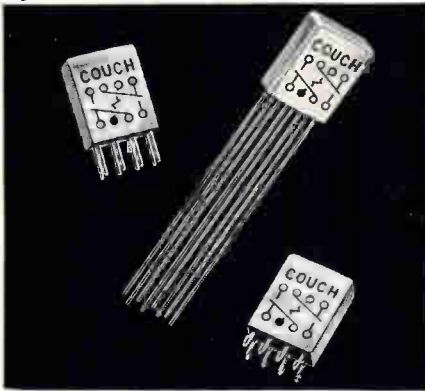

each available in 3 terminal styles . . .

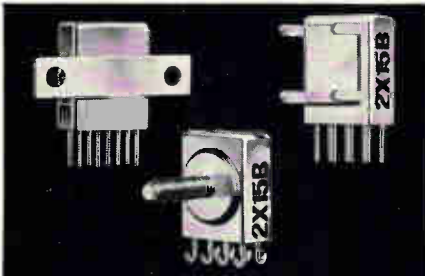

and in many mounting styles

We now offer a full line of SPDT relays, type 1X, to match our DPDT, type 2X, relay line. Except for coil data, specifications are identical for both types:

	2X	1X
Size	0.2" x .4" x .5"	same
Terminal Spacing	1/10" grid	same
Rating	0.5 amp @ 30 VDC	same
Coil Operating Power	150 mw	70 mw
Coil Resistance	60 to 4000 ohms	125 to 4000 ohms
Temperature	-65°C to +125°C	same
Vibration	20 G	same
Shock	75 G	same

Write for Data Sheets No. 9 and 10

RUGGED ROTARY RELAYS  Dynamically and Statically Balanced

## COUCH ORDNANCE INC.

3 Arlington Street, North Quincy 71, Mass., Area Code 617, CYPRESS 8-4147 A subsidiary of S. H. COUCH COMPANY, INC

## New Subassemblies

SSP-410 is available with center frequencies from 395 to 415 Mc. The 3-db bandwidth is 10 Mc.

The preamplifier is available in a one- to five-channel configuration with a power supply common to all channels. This unit is suited for tracking and diversity applications where a number of outputs are derived from the same antenna.

Performance data includes a nominal 3.5-db noise figure, an input/output vswr of 1.3:1, and a dynamic operating range up to -25 dbm. The entire assembly is weatherproofed, and each subunit is individually pressurized.

Vitro Electronics, a division of Vitro Corp. of America, 919 Jesup-Blair Drive, Silver Spring, Md. [386]

## Integrated-circuit decade counter

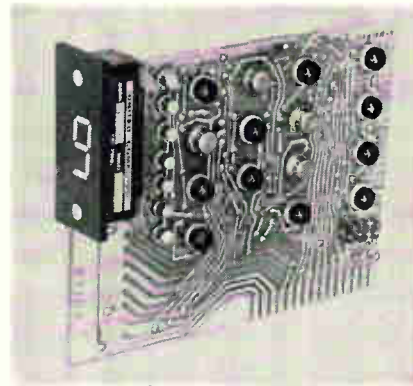

Model F1832 integrated-circuit decade counter features dual lamps in each display segment for maximum life and reliability. Electrical outputs include 10 line, BCD, and analog staircase. Frequency response exceeds 3 Mc. Fifteen integrated circuits provide maximum reliability. Optional single or dual preset knobs are offered for front panel mounting.

Display is in-plane 7 segment with 100,000-hour lamps. The decade has capability of being reset to any number from 0 to 9, rather than only to zero. Supply voltage is 3 to 4 v at 0.46 w for d-c logic, and 5 v a-c for lamps.

The counter operates over a temperature range of 0° to 72°C. Size is 1 in. wide by 4 in. high by 5

## Fiberfil High-Performance FRTP's In Action



Polycarbafil housing for Dictograph speaker is injection molded by Waterbury Co., Randolph, Vt. Nylafil switch housing, push-buttons and volume control wheel are molded by Hinchman Mfg. Co., Inc., Roselle, N. J.

## Polycarbafil® has toughness needed for new hospital speaker

### Impact strength important in speaker for hospital patients

The pillow speaker for individual hospital patients made by Dictograph Products, Danbury, Conn., must be able to withstand accidental dropping on the floor. Dictograph looked for a material that would have the impact resistance and toughness for this, plus rigidity, dimensional stability and low coefficient of thermal expansion. They chose Polycarbafil, fiberglass reinforced polycarbonate. Fiberglass reinforcement increases all of these properties.

In addition, Nylafil, fiberglass reinforced nylon, was chosen for push-buttons, volume control wheel and switch housing for its strength and wear resistance.

### Compare Physical Properties

Property	Unit	Unreinforced Polycarbonate	Polycarbafil G-50/20
Tensile Strength @ 73°F	PSI	8,000	18,500
Flexural Strength @ 73°F	PSI	13,500	25,000
Coef. Linear Thermal Expansion / °F.	In./In.	1.0x10 <sup>-5</sup>	1.02x10 <sup>-5</sup>
Heat Distortion Temp. @ 66 PSI	°F	285	308
Water Absorption 24 hrs.	%	0.15	0.11

Polycarbafil and Nylafil are only two of the full line of fiberglass reinforced thermoplastics pioneered and patented by Fiberfil. Only Fiberfil can give you complete technical data, practical experience and a full line of reinforced materials. Send for your free copy of the FRTP engineering manual. Fiberfil, Inc., Evansville, Indiana 47717.



Fiberglass Reinforced Thermoplastics®

Circle 496 on reader service card

Circle 199 on reader service card →

And it should be. We make, stock, and can deliver right now more different materials than any other manufacturer. Sixteen at last count. Including some nobody else makes.

They're all production items, not just laboratory samples. Whether you're ordering an old faithful like Alnico 5 or an exotic new one like Alnico 8, we've got both the know-how and the facilities to live up to our production promises.

Magnet shapes don't give us any trouble, either. We can often ship what you want right off the shelf. We catalog some 105 standard shapes and sizes in Alnico 2 and Alnico 5 alone. If you want something that's not in the catalog, or need design assistance, we have the country's leading magnetic engineers ready to consult with you.

If you're looking for prompt delivery of any type or shape of Alnico, turn to

the world's largest manufacturer of magnetic materials. That's us. You can get our catalogs by writing Mr. C. H. Repenn, Manager of Sales, the Indiana General Corporation, Magnet Division, Valparaiso, Indiana. In Canada write Indiana Steel Products of Canada, Ltd., Kitchener, Ontario.

**INDIANA GENERAL** 

**Shipping any type and shape  
of Alnico on time is duck soup for  
Indiana General**





At the NCR Electronics Division, you build your career on hardware—not hope. Advanced developments like CRAM and the NCR 315 RMC Rod Memory Computer—the first commercially available computer with an all-thin-film main memory—are a marketplace reality. (And bear in mind that the NCR marketplace consists of more than 120 countries!) If you want to combine career stability with go-ahead, on-line opportunity...if you want to earn a good living while enjoying the good Southern California life... look into the opportunities listed here.

## BUILD YOUR IN WORLD-WIDE BUSINESS AUTOMATION AT NCR, LOS ANGELES

### MAGNETIC RECORDING

Senior and intermediate positions for men with experience in advanced magnetic recording techniques. Knowledge of media, circuitry and magnetic head design necessary. Requires BS in engineering or physics.

### MEMORY DESIGN

Positions are available to perform memory design. Requires a BS in EE and previous experience with high speed applications of magnetic cores or thin films to memories. Must also be familiar with computer systems logic and hardware.

### PACKAGING

#### GROUP LEADER

To provide technical and administrative direction for electronic packaging of digital computers, including processors, memories, and peripherals. Requires a minimum of 6 years'

experience in electronic packaging and some previous supervisory experience. Must be knowledgeable of heat transfer and advanced manufacturing techniques. BS in engineering required.

### ADVANCED LEVEL

To perform advanced packaging of computer systems, including processors, memories and peripherals. Requires BS in engineering and thorough knowledge of packaging concepts as related to digital computers.

### INTERMEDIATE LEVEL

These positions entail layout and design of packaging for computer systems. Applicants must have previous experience with electronic computers or electromechanical devices. Background in miniaturization utilizing thin films and integrated circuits is desirable but not required. BS in engineering desirable.

### LOGIC DESIGN

For design of advanced integrated circuit computers. Requires BSEE and 2 to 5 years' experience in logic design; experience on processor and float-point design desirable.

### QUALITY ENGINEERS

Assignments will entail mechanical and electrical analyses with responsibilities for project testing and inspection specifications, including processes for automatic wirewrapping, cabling and electrical and mechanical assemblies. Requires BSEE or BSME and 3 years' related experience.

### PROGRAMMERS

#### SOFTWARE

Positions entail development of software for various computer input/output routines, operation systems and monitors. Applicants must

have previous programming experience with machine language on a large file computer.

### DESIGN AUTOMATION

Positions require 2 years' previous experience in programming. Good understanding of engineering and hardware problems desirable, BS degree in math, engineering or related field required.

### DIAGNOSTIC

Position entails the writing of diagnostic programs for checkout, acceptance test and field maintenance of EDP systems. Requires previous programming experience; college degree desirable.

### ADVANCED MECHANISMS SPECIALIST

For analysis and design of complex computer mechanisms. Must have knowledge of applied mechanics and high-level mathematical ability. PhD required.

### PROJECT ENGINEERING

#### COMPUTING SYSTEMS

Assignment will entail technical and administrative leadership of engineers involved in advanced digital computer system and logic design. Requires BSEE and 5 years' experience in logic design of digital computers. Must have system design capability and knowledge of peripheral equipment operation and interfacing. Previous team leader experience desirable.



**PERIPHERAL EQUIPMENT**

To direct engineers in the development of electromechanical magnetic files for digital computers. Requires BSEE and a minimum of 6 years' experience in electromechanical peripheral development, logical design and machine organization. Must have recent experience entailing project responsibility.

**SYSTEMS FORMULATION**

Positions available at all levels to study and formulate systems for commercial and industrial on-line computer applications, with emphasis on communications interface. Requires a minimum of two years' experience in specifying or programming real-time systems for banks, airlines or industry. A degree in engineering, business administration or related field is required.

**CIRCUIT DESIGN**

Intermediate- to senior-level positions are available for circuit designers who are experienced in analog or digital circuit design. Experience in power supply design, memory design, and micro-electronics desirable. BSEE required.

**ELECTRONIC PRODUCT ENGINEERING**

Assignments will entail design, checkout, documentation and liaison for digital computer systems. Requires BSEE and previous experience in these areas.

**RELIABILITY ENGINEERS**

Positions are available on an intermediate level in both mechanical and electrical reliability engineering to perform evaluation of electrical components, sub-assemblies and systems, as well as complex mechanical and electro-mechanical mechanisms. Also will be responsible for design reviews of new and existing

# FUTURE

EDP equipment. Requires BSEE and/or BSME with minimum of 2 years' experience in design or reliability engineering.

**ARRANGE NOW FOR AN INTERVIEW IN YOUR AREA**

Confidential interviews will be held soon in various parts of the country. Openings above are in Los Angeles. Additional openings in Dayton, Ohio, for mechanical, electrical and chemical engineers, physicists, chemists (MS or PhD level). Send resume immediately to Bill Holloway, Technical Placement, or call collect.

The National Cash Register Company



ELECTRONICS DIVISION  
2816 W. El Segundo Blvd., Hawthorne, Calif.  
Telephone: Area Code (213) 757-5111

An equal-opportunity employer

**New Subassemblies**

in. deep. Weight is 4 oz.  
United Computer Co., 4505 N. 16th St.,  
Phoenix, Ariz., 85016. [387]

**Universal amplifier  
for control functions**

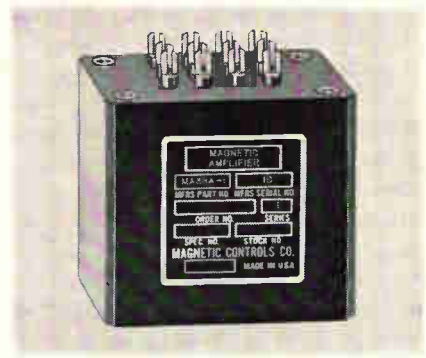

The MA-38A, a universal amplifier for control functions, can accept any current input for a control configuration. This versatile magnetic amplifier can accept a current-change input of as little as 1  $\mu$ a, providing an output of from 0.5 to 5 v d-c minimum to maximum. Designed to fit into industrial systems to detect changes in pressure, flow, strain, heat, weight and any other energy-changing variable, the unit also functions as a high-gain switching device in conjunction with a 400-ohm relay.

Used in connection with a reactor unit, the MA-38A can provide proportional temperature control of heater loads up to 130 w. All the temperature bridge circuit adjustments are external to the device and allow individual tailoring of the performance for individual system parameters.

Three control windings, two of which are identical, are used to provide control input signals. The third winding can be used as a reference bias or for feedback control.

Applications include edge-guide control, strain-guide amplification and control, photocell pickup, and any measurable force including velocity, flow, temperature or pressure.

Magnetic Controls Co., Systems division, 6414 Cambridge St., Minneapolis, Minn., 55426. [388]

**7 reasons why you should investigate**

**ELECTRONIC  
PARK  
in  
West Palm Beach  
FLORIDA**

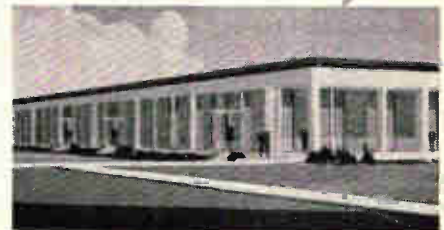

**Site of International Telephone and  
Telegraph Corporation's  
135,000-square-foot Semiconductor Plant**

- 1 Personnel Director's Delight.** Easier recruitment is proven. A blind ad to test location appeal to engineers and technicians proved Florida was favored 30 to 1 over another state.
- 2 Blue Chip Company Neighbors.** Electronic Park is the choice of ITT, and nearby in the Palm Beaches are RCA, Pratt-Whitney and Minneapolis-Honeywell plants.
- 3 Excellent Transportation.** Neighboring Palm Beach International Airport offers direct jet flights to major U.S. cities. Complete facilities for business aircraft. Deep-water port for Latin American trade.
- 4 New University.** Twenty miles south is the new Florida Atlantic University.
- 5 Climate Ideal.** Annual average temperature based on U.S. Weather Bureau observations is 74.5 degrees.
- 6 Recreation.** Just 4 miles to public Atlantic Beach. Waterways galore. A new 18-hole championship golf course and 600-acre sail club are under way just 1 1/2 miles from Electronic Park.
- 7 Location.** Two miles from downtown West Palm Beach, 70 miles north of Miami and 110 miles south of Cape Kennedy.

**SEND TODAY**

• Electronic Park  
• P.O. Box 1071E  
• West Palm Beach, Florida 33402  
• Gentlemen: Please forward in envelope marked CONFIDENTIAL literature about Electronic Park and the Palm Beaches to:  
• Name.....  
• Title.....  
• Firm Name.....  
• Street Address.....  
• City.....State.....Zip.....

# AMPERITE

## Thermostatic DELAY RELAYS

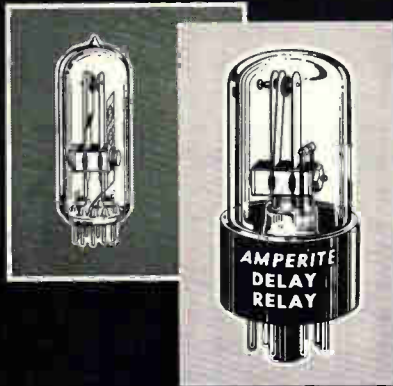

**Only a glass seal  
offers true hermetic sealing**  
... assuring maximum stability and life!

**Delays: 2 to 180 seconds** . . . Actuated by a heater, they operate on A.C., D.C., or Pulsating Current . . . Being hermetically sealed, they are not affected by altitude, moisture, or climate changes . . . SPST only—normally open or normally closed . . . Compensated for ambient temperature changes from  $-55^{\circ}$  to  $+80^{\circ}$  C. . . Heaters consume approximately 2 W. and may be operated continuously . . . The units are rugged, explosion-proof, long-lived, and—inexpensive!

TYPES: Standard Radio Octal, and 9-Pin Miniature.  
List Price, \$4.00

**PROBLEM? Send for Bulletin No. TR-81**

# AMPERITE

## BALLAST REGULATORS

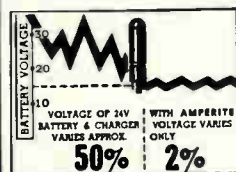

Hermetically sealed, they are not affected by changes in altitude, ambient temperature ( $-50^{\circ}$  to  $+70^{\circ}$  C.), or humidity . . . Rugged, light, compact, most inexpensive . . . List Price, \$3.00.

Write for 4-page Technical Bulletin No. AB-51

# AMPERITE

600 PALISADE AVE., UNION CITY, N.J.  
Telephone: 201 Union 4-9503  
In Canada: Atlas Radio Corp., Ltd.  
50 Wngold Ave., Toronto 10

## New Microwave

### Antenna pops up without motor power

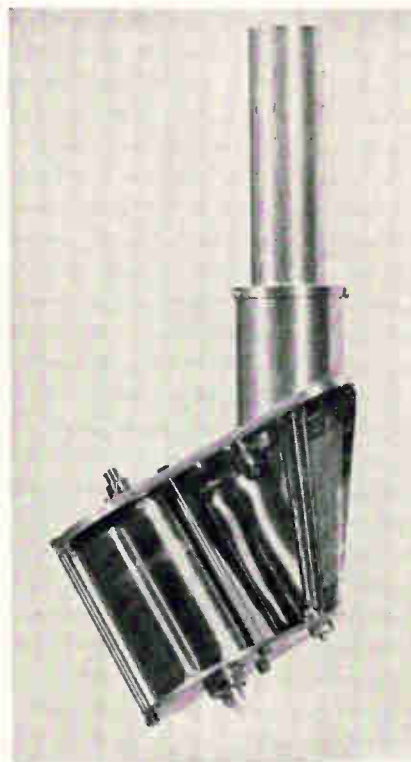

In tests, the antenna shows higher gain than do monopole antennas of equivalent length, because the antenna forms a long, thin helix; a thin layer of Mylar applied over the metal tape insulates the convolutions from each other.

However, for applications where a helical antenna is not desired, the company can supply the coil of tape with a conductive lubricant between the layers to form a monopole antenna.

Antennas 25 feet long were successfully tested for wind loading.

The company says the antenna costs less than other available retractable antennas. Price and delivery are available upon request.

#### Specifications

Tape thickness	0.001 to 0.005 inch
Tape width	Up to 4 inches
Antenna length	Up to 100 feet.
Fatigue life	Approximately 2,500 cycles of retraction and extension

Hunter Spring, Hatfield, Pa. [391]

An antenna that springs of its own power from a coil of metal tape has been developed by the Hunter Spring division of Ametek, Inc. Because it needs no motor to extend it, the antenna fits in less space than comparable equipment.

Hunter Spring says the antenna can be retracted by hand for portable communications equipment. Where no retraction is required, as for satellite transceivers or transceivers dropped from aircraft, antennas up to 100 feet can be provided by the company.

The metal tape of the coil, which can be either stainless steel or beryllium copper, is prestressed to form a tapered tubular antenna. The energy used to retract the antenna stores in the coil. When the tape is released, the stored energy pops the tape out, forming the antenna. To unleash the coil at a prescribed rate, a rotating drum with a damper mechanism can be provided. For automatic control, a driving motor can be connected to the drum.

### Rotary joint keeps insertion loss low



Model 345 is a d-c to 18 Gc contacting-junction rotary joint featuring these maximum specifications:

# Polaroid Land film makes you wait 10 seconds for an oscilloscope picture. The suspense can be unbearable.

We're sorry we can't do anything about that 10-second wait.

But if you can bear up under the strain, you'll get a sharply detailed, high-contrast, trace record.

You can study it, attach it to a report, send it as a test record along with a product shipment, or file it for future reference.

You also get a choice of four films for oscilloscope recording in pack, roll, and 4 x 5 formats.

The standard film has an ASA equivalent rating of 3000. And if you think that's fast, you haven't heard of our special film called Polaroid PolaScope Land film.

With an ASA equivalent rating of 10,000, it's the fastest thing in films. It can actually record a trace too fleeting for the human eye [for instance, a scintillation pulse with a rise time of less than 3 nanoseconds].

Of course, Polaroid Land films are as quick to point out a mistake as they are to point out a success.

If your trace shows an error, you know it right away. And you never go through the tedium of darkroom procedure only to find out that your blip was a blooper.

To use these films on your scope, you need a camera with a Polaroid Land Camera Back. Most manufacturers have them. Such as: Analab, Beattie-Coleman, BNK Associates, Fairchild, EG&G, General Atronics, Hewlett-Packard, and Tektronix.

You can get complete details by writing to one of these manufacturers or to Polaroid Corporation, Sales Department, Cambridge, Massachusetts 02139.

By the way, if 10 seconds fray your nerves, just imagine what it was like when Polaroid Land film made you wait 60 seconds to see your trace.

"Polaroid" and "PolaScope"®

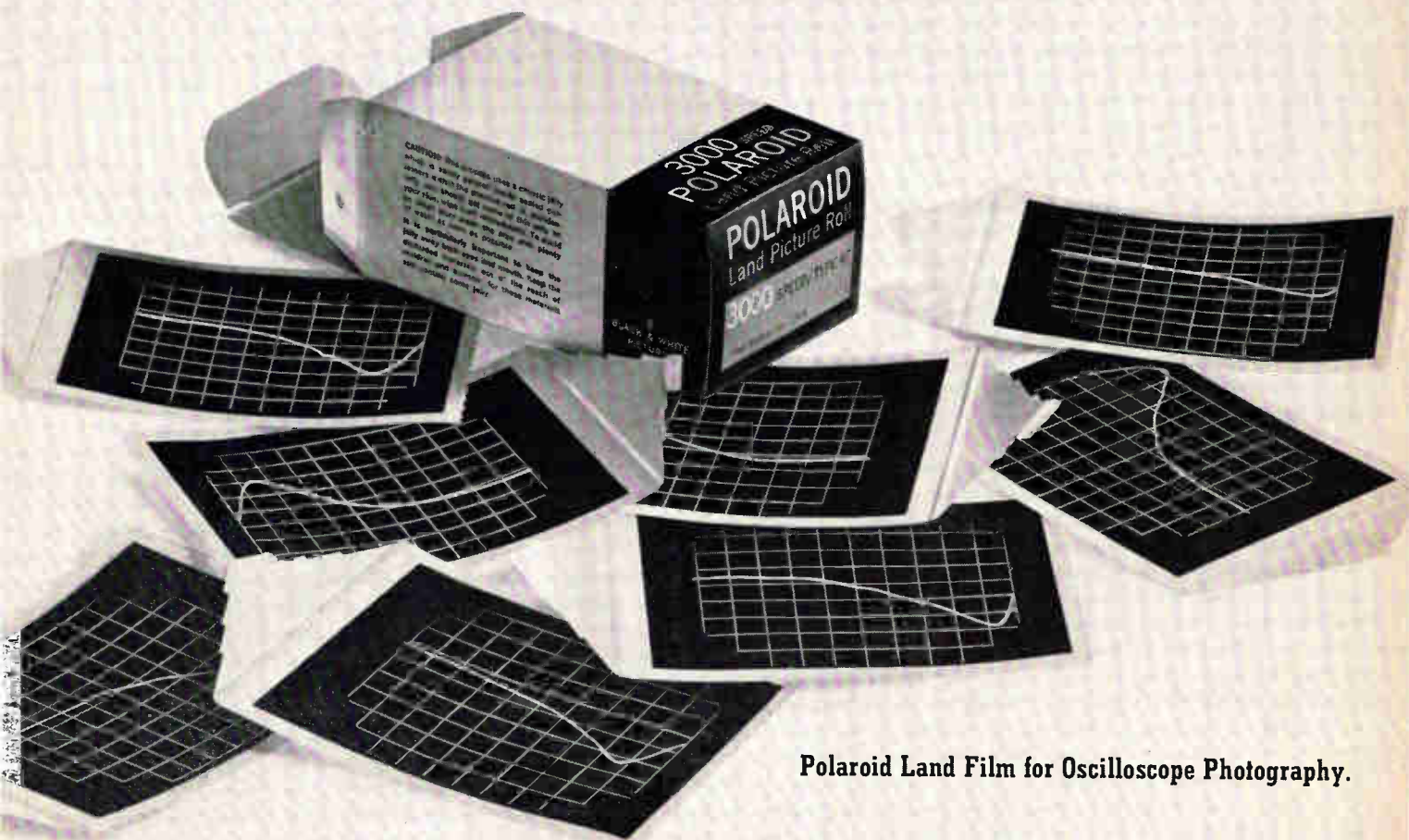

Polaroid Land Film for Oscilloscope Photography.

## Choice — not chance!

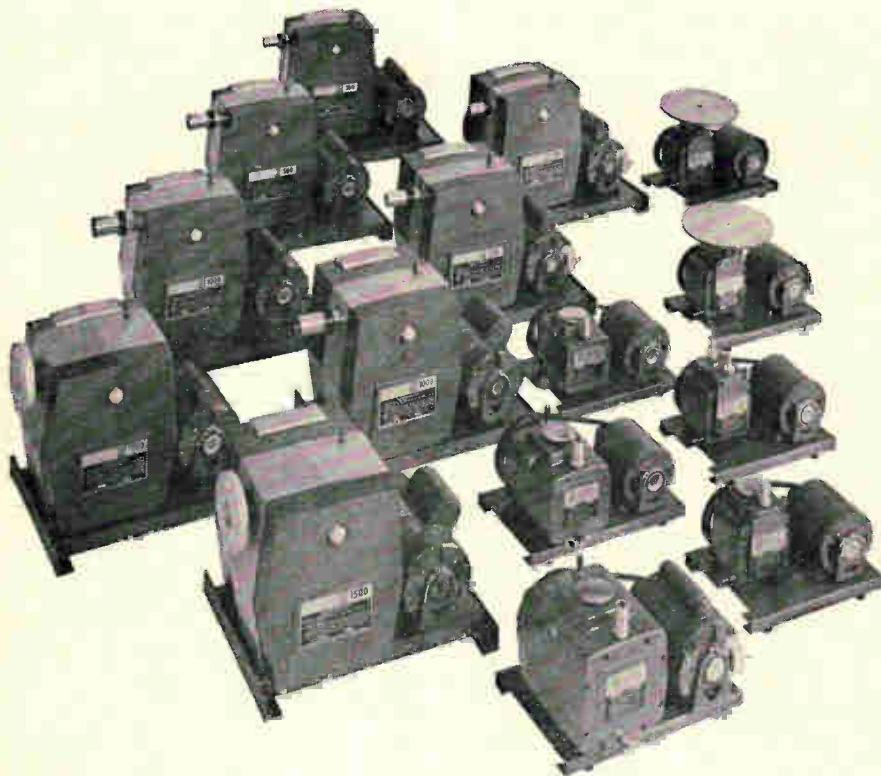

### New Precision High Vacuum Pumps are job-rated to meet your needs!

Now you can eliminate the guesswork—and save money, too! From this newest, most complete line of internal vane mechanical vacuum pumps on the market today you can select a model performance matched to your job. Take your choice of both single and two stage models in capacity ranges from 25 to 1500 liters/minute, at prices ranging from \$100 to \$1500. Guaranteed ultimate vacuum runs to 0.1 or 15 microns of mercury depending on model. And because Precision Pumps are more efficient at actual working pressures—up to a remarkable 79% at 1 micron—you not only get the job done faster, but can frequently use a smaller pump. Add handsome design, smaller size, quiet, vibration-free operation and you see why Precision is your best buy. Consult your Precision Scientific Distributor or write today for Bulletin 650.

Since 1920 • The finest in Quality Laboratory Apparatus



3737 W. Cortland Street, Chicago, Illinois 60647  
Local Offices in New York • Chicago • Los Angeles

## New Microwave

vswr of 1.30, insertion loss of 0.2 db, and wow of 0.1 db/360°. Unlike round rotary joints, which require special mounting flanges, this new rotary joint is square and is drilled and tapped for direct mounting.

The device measures 1.06 in. by 0.50 in. square in the body and weighs only 1 oz. Connectors mate with all standard miniature types.

Unit price is \$175 in small quantities. Deliveries are currently being made from stock.

Sage Laboratories, Inc., 3 Huron Drive, Natick, Mass., 01762. [392]

### Microwave oscillator spans 1.7 to 4.2 Gc



A triode cavity oscillator has been developed that is continuously tunable from 1.7 Gc to 4.2 Gc with a minimum output of 50 mw across the band.

The manufacturer says Model SC1201 produces less noise and incidental f-m than other oscillators covering similar frequencies and that power supply requirements are minimized to 150 v d-c at 15 ma and 6.3 v at 240 ma. Though originally intended as a local oscillator in wideband spectrum analyzers, the SC1201's many applications include wide-range receivers and signal generators.

RFD, Inc., 1501 W. Cass St., Tampa, Fla., 33606. [393]

### Megawatt circulator for X-band radar

Model CXH38 ferrite circulator, which covers the range from 8.5 to 9.6 Gc, is designed for X-band radar installations. It can accommodate peak power of 1 mw and average power of 10 kw. Isolation is 20 db minimum. Maximum in-

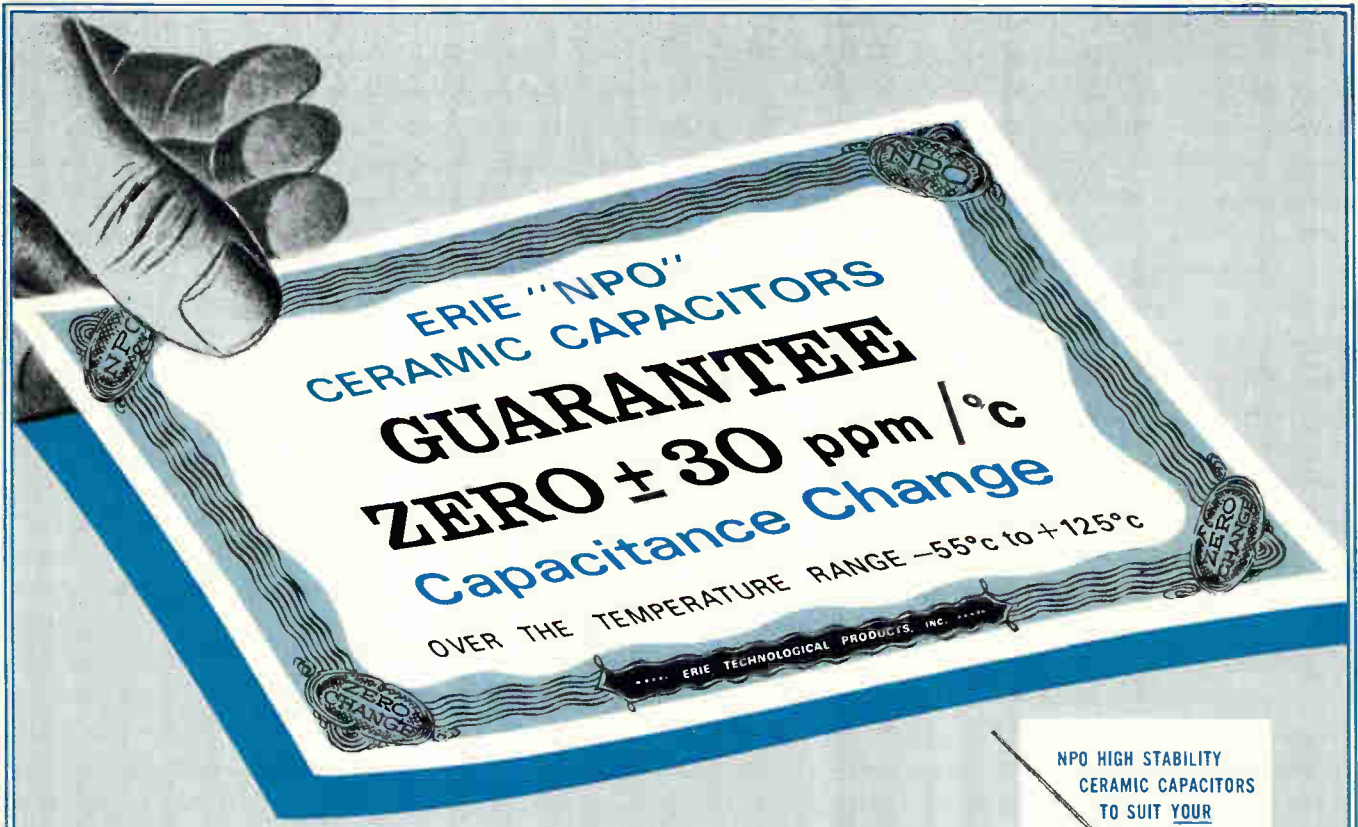

**ACKNOWLEDGED as the MOST TEMPERATURE STABLE MINIATURE CAPACITORS in the ELECTRONICS INDUSTRY . . . SUPERIOR to GLASS and MICA CAPACITORS**

If your circuits require capacitance stability, high Q, and close tolerance, there's only one line of miniature capacitors to consider . . . ERIE NPO High Stability Ceramic Capacitors. These ultra-stable ceramic dielectrics are considerably superior to glass and mica . . . for ERIE produces the most nearly perfect ceramic in the industry.

NPO (temperature coefficient) miniature capacitors are available in a variety of physical types as illustrated at right. Capacitance range and capacitance tolerance (as close as  $\pm 1\%$  or  $\pm .1$  pf.) to suit your circuit requirements. Units are conservatively rated . . . flash test 3 times WVDC, life test 2 times WVDC.

In addition to these NPO High Stability Ceramic Capacitors, Erie offers a full line of Temperature Compensating types (P100 through N5600) and General Purpose type capacitors . . . all produced from the most nearly perfect ceramic in the industry.

Write for information TODAY about Erie NPO High Stability Ceramic Capacitors. A helpful Erie Field Sales Engineer will be happy to discuss your specific requirements . . . no obligation of course.



**ERIE  
TECHNOLOGICAL  
PRODUCTS, INC.**



Erie, Pennsylvania

CAPACITANCE CHANGE VS. TEMPERATURE

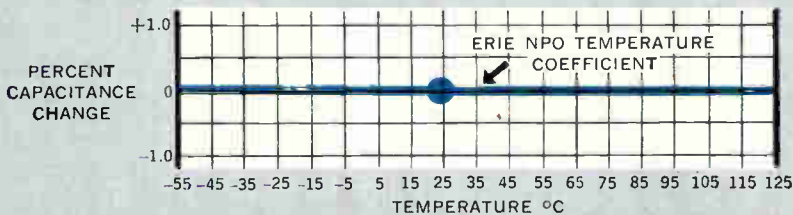

Another Series of Components in Erie's Project "ACTIVE" . . . Advanced Components Through Increased Volumetric Efficiency

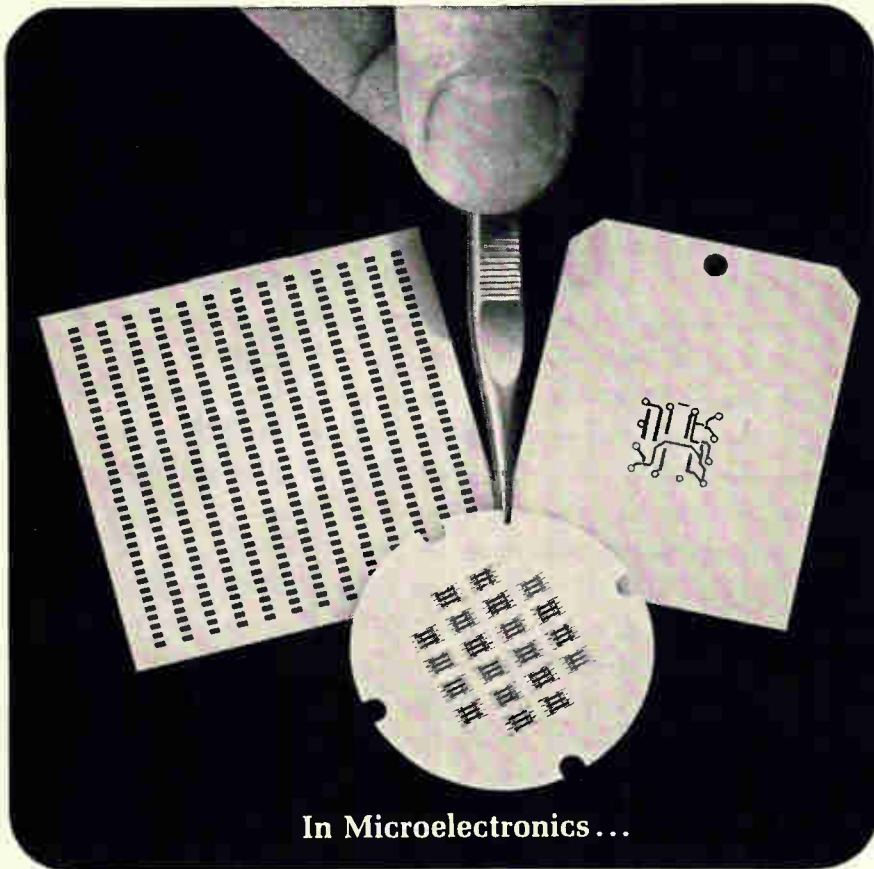

In Microelectronics...

## If the mask is Moly, the circuit is quality.

Shown actual size, these evaporation masks are used in vacuum deposition of microelectronic circuits. Molybdenum from General Electric, superior to any other masking material, delivers distinct advantages to producers of integrated microelectronic circuits.

Molybdenum's purity (99.9+ percent) and uniform, fine grain structure enable masks to be photoetched with outstanding precision and definition. Molybdenum's low coefficient of thermal expansion makes possible the reproduction of circuits on glass substrates with extremely close registry. Parallax problems are virtually eliminated because thinner foils can be used, since molybdenum is stiffer than any other available masking material. General Electric supplies molybdenum foil as thin as .0003 in. in widths up to 12 in.

General Electric molybdenum foil has uniform thickness and scratch-free, bright surface finish (2 RMS is typical).

Control of ripple and flatness minimizes resolution problems.

Write or call for more information or application assistance regarding any application of General Electric refractory metals in microelectronics: masks, substrate material, or evaporation boats and coils. General Electric Company, Lamp Metals & Components Department, 21800 Tungsten Road, Cleveland, Ohio 44117. Telephone: (216) 266-3490.

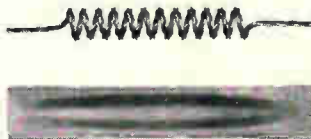

**GENERAL**  **ELECTRIC**

## New Microwave

sertion loss is 0.3 and vswr is 1.15.

The 13-lb, water-cooled unit is 21 in. long. Flanges are type CPR-112F connecting to RG-51U waveguide.

Raytheon Co., Special Microwave Devices Operation, 130 Second Ave., Waltham, Mass., 02154. [394]

## Tunnel-diode amplifier operates in X-band



A compact, lightweight tunnel-diode amplifier—the NC-5607—has been developed that measures only 6 in. by 3 in. by 1 in. and operates between 5.4 Gc and 5.9 Gc in the X-band with a gain of 15 db and a noise figure of 5 db.

The amplifier's compact size, light weight and excellent operating characteristics make it particularly well suited to retrofit installations in airborne responders and search radar equipment, says the manufacturer. Delivery is 45 to 60 days.

The MicroState Electronics Corp., 152 Floral Ave., Murray Hill, N.J. [395]

## Shielded magnetrons are voltage-tunable

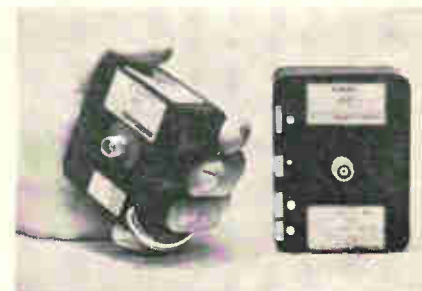

A line of magnetically shielded voltage-tunable magnetrons is shielded against the degaussing effects found in other permanent-

# Three Ways to Specify..

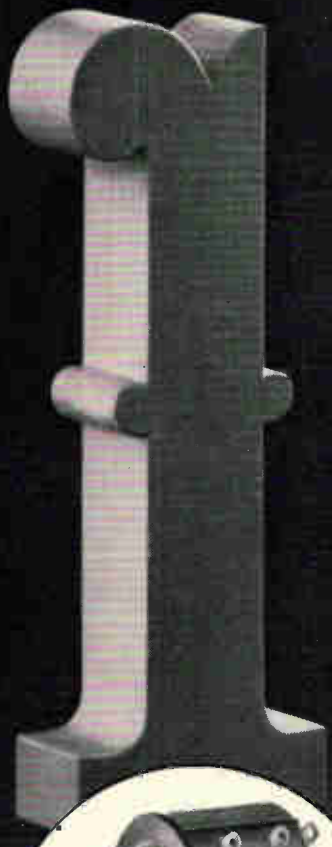

**FAIRCON**

**MULTI-TURNS**



**FAIRCON**

**TRIMMERS**

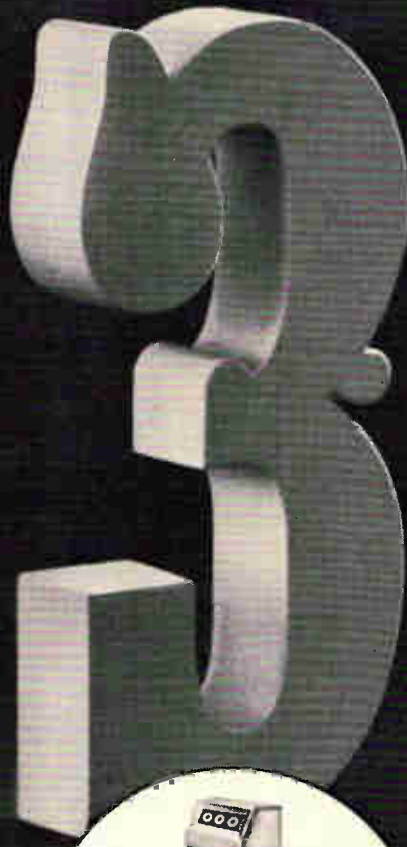

**FAIRCON**

**TURNS COUNTING  
DIALS**

## Quality Potentiometers

**FAIRCON**—the new name in industrial trimmers, multiturns and turns counting dials **GUARANTEED** by **FAIRCHILD**—with over 20 years experience in precision potentiometers.

**FAIRCON** potentiometers are built to meet or exceed MIL-R-27208 and most portions of the new High Reliability Specification MIL-R-39015... yet they cost **SURPRISINGLY LESS** than other high quality units. Write today for new short form catalog.

**FAIRCHILD**

**CONTROLS**

A DIVISION OF FAIRCHILD CAMERA AND INSTRUMENT CORPORATION

225 PARK AVENUE, HICKSVILLE, L. I., NEW YORK

TELEPHONE: (516) 938-5600 • TWX: (516) 433-9146

CABLE: FAIRCON-HICKSVILLE, NEW YORK, U. S. A.



CONSUMER ELECTRONIC OPPORTUNITIES  
TELEVISION RECEIVER DEPARTMENT

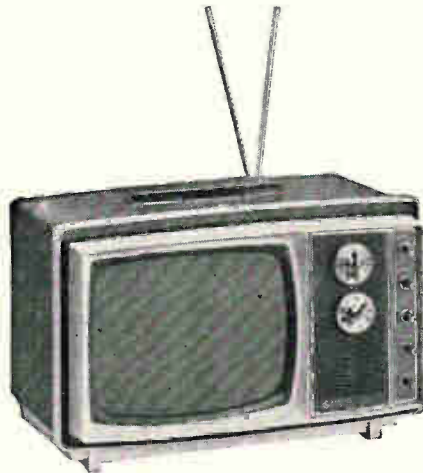

Our latest innovation: 11" Porta-color set with new G.E. picture tube.

TV/CRT ENGINEERS:

**Want to be part of our next innovation?  
We're going places. We can get you growing, too.**

■ Innovation means growth in this business. And our engineers—in circuit, set, CRT design and manufacturing engineering work in a climate that's aimed at producing the new and different approach—right now. Successful designs like the 12" personal portable; the 9" battery set; and our sensational low-cost Porta-color set are putting a steep pitch on our growth curve. Examples: expansion in our Electronics Park Headquarters operation; and a brand new facility now abuilding in Portsmouth, Va. We have other plans, too. You can figure in them—to your long-range personal profit. You can expect a full package of G.E. benefits, including our Savings and Security Plan; efficient work surroundings; a place in a diversified company with a history of 37 years in television research, design and production; and excellent local living conditions in Upstate New York or Eastern Virginia.

■ Investigate this partial list of openings now:

**SIGNAL CIRCUIT DESIGN:** conceive, develop and apply signal processing circuits to development of monochrome and color TV.

**MECHANICAL PRODUCT DESIGN:** requires 2-4 years' experience in consumer electro-mechanical product design and packaging.

**DEFLECTION CIRCUIT DESIGN:** develop deflection and convergence circuits for TV receivers. Requires experience in design of deflection yokes and related magnetic deflection components.

**COMPONENT DESIGN AND/OR APPLICATION:** conceive, design and apply electronic components for monochrome and color TV receivers. Needs 2-4 years' component design or application experience.

**TV QC, PROCESS CONTROL AND MFG. ENGINEERING:** establish, plan and attain QC programs. Apply QC principles to engineering design; develop plan; determine quality capabilities methods, testing, evaluating; analyze failure data; recommend action. BSEE plus QC or TV production.

**CRT DESIGN, MFG., PROCESS AND QUALITY CONTROL ENGINEERING:** Design and develop cathode ray tube products for both monochrome and color, including element, materials application, mfg. techniques, and QC. 2-10 years' related experience needed.

For more information, or to arrange a personal interview, send a resume of your experience in confidence to M. H. FitzGibbons, Manager, Professional Placement, Television Receiver Dept., Box 116, General Electric Co., Electronics Park, Syracuse, N. Y. 13201.

231-11

**New Microwave**

magnet devices, dynamic magnetic fields, and stray magnetic radiation. A unique circuit design allows the tubes to contact other ferromagnetic materials or components without degrading performance.

Other features include tuning linearity, high efficiency, and high-speed frequency modulation. The small-size, lightweight tube line is intended for use in radar receivers, telemetry systems, or other sophisticated electronic units subject to rigid high-density packaging limitations.

Tubes in the family cover the 50-mw to 75-watt power range, at frequencies from 250 to 3,200 Mc. Eimac Division of Varian Associates, 301 Industrial Way, San Carlos, Calif. [396]

**B-w oscillator provides 100 Gc**



A backward-wave oscillator, which provides frequencies up to 100 Gc, provides a new tool for system designers. Type SBF-4221 oscillator is capable of providing 20 mw over the 93-Gc to 98-Gc region.

Developed to meet a need for voltage-tuned signal sources in the 94-Gc atmospheric window, the device can be used for space communication and telemetry systems. Permanent magnet focusing and a new r-f circuit design have kept size and weight to a minimum. Single knob tuning eliminates tedious mechanical and voltage adjustments necessary for other oscillators.

Sperry Electronic Tube division, Gainesville, Fla. [397]

**GENERAL ELECTRIC**

AN EQUAL OPPORTUNITY EMPLOYER (M/F)



**IMAGINE  
No Friction  
& wear....**

That's because the moving system is suspended on metal bands under tension. Auto-Torque meters could last forever.

**LOOK! THE  
WORLD'S FIRST  
MACHINE MADE  
METER!**

**Save Money**

Quantity-order prices for volume buyers are actually below comparable pivot and jewel meters! Imagine!

**NEW HONEYWELL'S NO HAIR SPRING ON SCREWS**

**AUTO-TORQUE BAND TYPE METERS**

**More  
Reliable**

The rugged little mechanism is almost completely machine-made for greater reliability. This reliability is achieved by Auto-Torque's simplified design which has 50% fewer parts. And since they're machine made, Auto-Torque meters give you absolutely uniform quality and precision never before possible in conventional meters. You can just about say good-bye to service problems!

*Crisp Looking Cases*

Honeywell's MM and MS meters are the first to feature Auto-Torque. They're available in 1 1/2, 2 1/2, and 3 1/2-inch sizes. Auto-Torque meters will shortly be available in virtually all case styles.

**REVOLUTIONARY**

**SELF-SHIELDED MECHANISM**  
Auto-Torque meters can be mounted on any panel without special calibration; accuracy is unaffected by external fields!

- NO PIVOTS & JEWELS
- NO NUTS
- NO "STICKS"

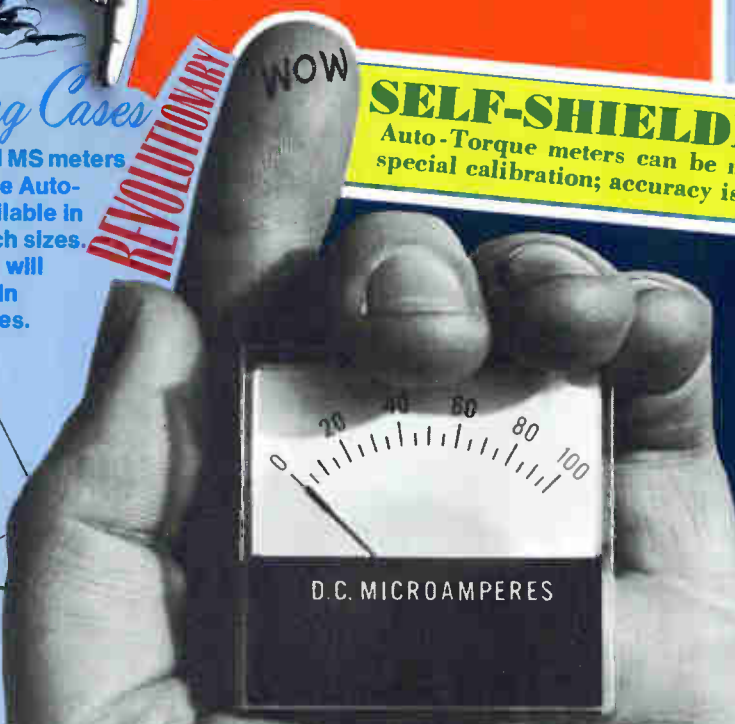

*Write*

For more news on this revolutionary Auto-Torque development write to Honeywell Precision Meter Division, Manchester, N.H. 03105

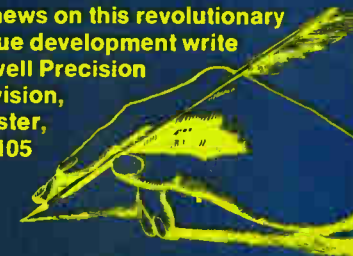

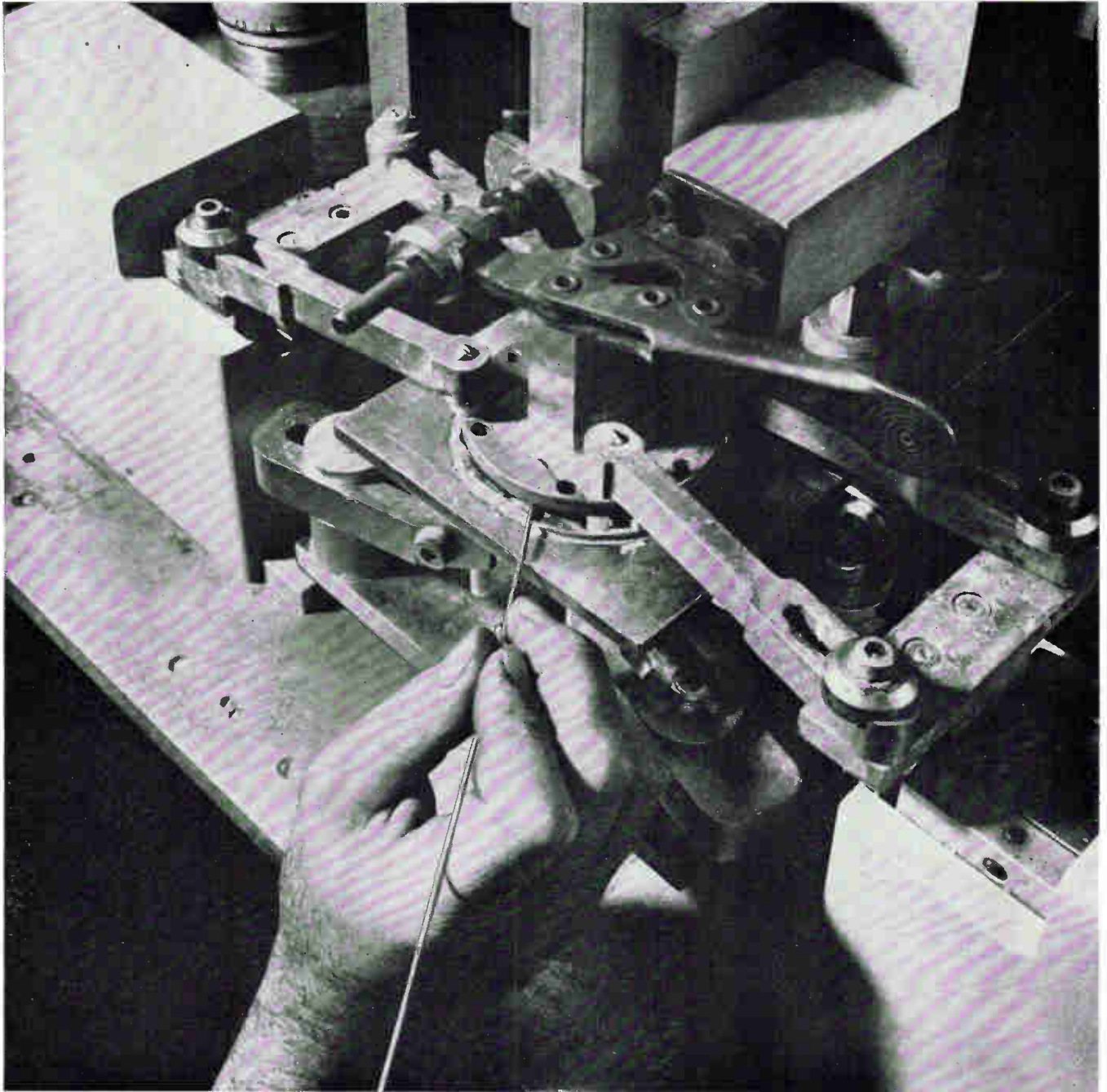

## **ENGELHARD Silvaloy 355** accomplishes void-free joint brazing in Hewlett-Packard waveguide tubing

Ordinarily, the standard 85% filling/15% void ratio is quite acceptable in joint brazing . . . even in critical aircraft applications.

But the Hewlett-Packard Company, Palo Alto, California, had something much more critical in mind when they approached Engelhard engineers. The task: to provide after machining a *completely void-free* joint on flange microwave tubing. The reason: any voids on the brazing of the completed joint would trap plating solutions . . . and these solutions would eventually corrode and ruin the waveguide.

For the answer, Hewlett-Packard brought the problem to Engelhard, one of the world's foremost specialists in the application of precious metals and brazing technology. Recommended was a system which employed Engelhard Silvaloy 355 silver brazing alloy and #1100 flux. As a result, the joints of Hewlett-Packard's waveguide tubing are now completely void-free . . . safe from the danger of corrosion.

For complete details on Silvaloy 355 and #1100 flux for a wide variety of brazing applications, write to the Technical Service Department today.

147A

## New Production Equipment

### Some other **ENGELHARD** products

#### **PLATINIZED TITANIUM ELECTRODES**

recent developments in platinized titanium electrodes allow optimization of configurations and coating types affecting many new applications in chemicals production and electroplating fields.

#### **PRECIOUS METAL CONTACTS**

in pure or alloyed forms of silver, platinum, palladium and gold provide unmatched resistance to atmospheric corrosion and electrical pitting. Engelhard will manufacture to specification or provide material in wire, rod or sheet form.

#### **RHODIUM PLATING**

of electrical and electronic parts offers outstanding protection against surface corrosion, reduces noise level of moving parts, and improves efficiency wherever a low-resistance, long-wearing, oxide-free component is required.

#### **TIN WIRE AND FOIL**

are produced by Engelhard's Baker Platinum Division to meet rigid electronic design requirements. Both extruded and Taylor Process tin wire are available in diameters as small as .001". Thin-gauge foil is supplied in sheets up to 8" x 18".

#### **SEMICONDUCTOR MATERIALS**

are supplied in a wide range of precious and base metals and their alloys. These include solid sheet, wire, tape, base tab materials and clad products. New materials are constantly under development. Technical assistance is available.

#### **LAMINATED CONTACT MATERIALS**

are produced in virtually any combination of precious metals and alloys with base metals and alloys. Types include edge, strip, inlay, spot, single or double-face laminations. Supplied in flat lengths, in strip, coil or fabricated forms.

### Micro solder system uses gravity loading



A precision implement for micro-soldering integrated circuits and other microcomponents in module assemblies features a highly precise and repeatable pressure system that uses gravity loading.

The use of gravity as an actuating force for the soldering head offers several advantages. A gravity-loaded head provides a gentle, constant electrode pressure, reducing the need for high temperatures or impact forces which could damage the components and circuitry or create spatter or blowout at the solder joint. Also, once the proper electrode pressure is determined and set through the use of adjustable weights, it will remain constant, predictable and repeatable.

The soldering head employs two independently suspended electrodes. Each electrode is free to seek the proper degree of contact pressure, independent of the opposing electrode. This independent determination of a constant electrode pressure creates conditions for controlled solder flow and total wetting of the parts at the solder joint even when the lead materials being bonded vary in over-all thick-

ness because of material or plating variations. Fluxes are not required and there is no need to preform or tin the leads.

The machine power supply consists of a solid state plug-in circuit board arrangement which controls 60-cycle a-c pulses up to 200-amp amplitude ranging from 1 cycle to 60 cycles. This broad a-c control capability even permits solder bonding of gold-plated leads in critical applications.

In actual production runs, savings in assembly time as high as 80% have been recorded with the new instrument.

Henes Mfg. Co., 4301 E. Madison St., Phoenix, Ariz. [401]

### Hot-gas micro-bonder joins components

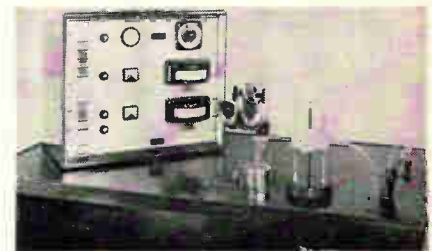

Type B400 micro-bonder utilizes a fine high-temperature gas jet for face-bonding semiconductor chips to metallic thin-film areas in microcircuits, attaching leads in electronic component manufacture, solder bonding wires to film circuit patterns or semiconductor devices, and the like.

The gas stream, such as nitrogen or nitrogen-hydrogen mixture, is heated electrically at a thermostatically controlled temperature of up to 400°C. The jet application can be controlled at preset durations up to 15 seconds. A pressure regulator and gauge control the gas flow rate. A series of interchangeable nozzles provide jet diameters ranging from 0.01 in. to 0.10 in. The larger diameter nozzles have a centrally located projecting pin to hold the component during bonding.

A thermostatically controlled, heated substage with micromanipulator position control supports the



# ASSEMBLE YOUR OWN ALL-TRANSISTOR *Schober* ELECTRONIC ORGAN



3 NEW MODELS  
Recital \$1500  
Console II \$850  
Spinet \$550

This is the all-new, all-transistor Schober

Recital Model... the most versatile electronic organ available today. Its 32 voices (plus amazing "Library of Stops"), 6 couplers and 5 pitch registers delight professional musicians... make learning easy for beginners. Comparable to ready-built organs selling from \$5000 to \$6000.

The pride and satisfaction of building one of these most pipe-like of electronic organs can now be yours... starting for as low as \$550. The Schober Spinet, only 39 1/4 inches wide, fits into the smallest living room. The new, all-transistor Schober Console II is the aristocrat of "home-size" organs... with two full 61-note manuals, 17 pedals, 22 stops and coupler, 3 pitch registers and authentic theatre voicing.

AND YOU SAVE 50% OR MORE BECAUSE YOU'RE BUYING DIRECTLY FROM THE MANUFACTURER AND PAYING ONLY FOR THE PARTS, NOT COSTLY LABOR.

It's easy to assemble a Schober Organ. No special skills or experience needed. No technical or musical knowledge either. Everything you need is furnished, including the know-how. You supply only simple hand tools and the time.

You can buy the organ section by section... so you needn't spend the whole amount at once.

You can begin playing in an hour, even if you've never played before—with the ingenious Pointer System, available from Schober.

Thousands of men and women—teenagers, too—have already assembled Schober Organs. We're proud to say that many who could afford to buy any organ have chosen Schober because they preferred it musically.

Send for our free Schober Booklet, describing in detail the exciting Schober Organs and optional accessories; it includes a free 7-inch "sampler" record so you can hear before you buy.

## THE Schober Organ CORPORATION

43 West 61st Street, New York, N.Y. 10023

Also available in Canada, Australia, Hong Kong, Mexico, Puerto Rico, and the United Kingdom

THE SCHOBER ORGAN CORP., DEPT. EL-8  
43 West 61st Street, New York, N.Y. 10023

Please send me FREE Schober Booklet and free 7-inch "sampler" record.

Enclosed find \$2.00 for 10-inch quality LP record of Schober Organ music. (\$2.00 refunded with purchase of first kit.)

Name \_\_\_\_\_

Address \_\_\_\_\_

City \_\_\_\_\_ State \_\_\_\_\_ Zip No. \_\_\_\_\_

## Production Equipment

components to be bonded. A vacuum facility in the substage retains the component during the operation, and a vacuum tweezer is provided for handling small pieces. The equipment includes a binocular microscope with variable intensity illumination.

For operation, the components to be joined are placed on the substage, for example, utilizing the vacuum tweezer, and the position is adjusted with the micromanipulator. With the gas heating head at the requisite distance, the temperature, duration and flow rate of the gas jet are preset and the bonding cycle is set in motion by a foot switch. No fluxes are normally required when a non-oxidizing gas is used.

Delivery in six weeks, and the price is approximately \$3,600. G.V. Planer Ltd., Windmill Road, Sunbury-on-Thames, Middlesex, England. [402]

## Optical masking in four steps



An automated, high-volume optical mask alignment and exposure system, the Model 500, requires only four easy steps to complete a load/align/expose/unload cycle. It will handle the smallest and most complex semiconductor devices to sub-micron accuracies.

The system can process 500 wafers per shift with its automatic wafer loading/unloading slide, automatic wafer prealignment—within 1° rotationally, 10 mils X and Y—and rapid, joystick fine-alignment. Model 500 also offers continuously adjustable alignment

# TRANSFORMER ELECTRONICS COMPANY

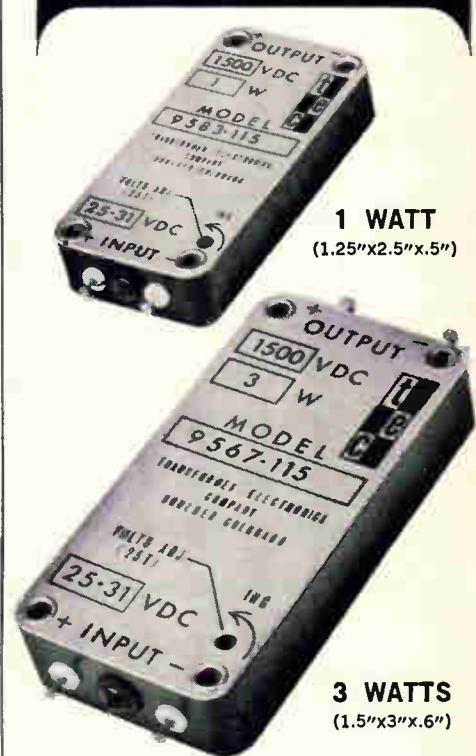

## MINIATURE REGULATED POWER SUPPLIES

Cost-Performance Optimized  
Reduces System Design Effort  
Meets Extreme Environments

### 9583 SERIES

1 Watt output power capability  
18 models—3 vdc to 3000 vdc  
25-31 vdc input

### 9567 SERIES

3 watt output power capability  
24 models—3 vdc to 5000 vdc  
25-31 vdc input



TRANSFORMER  
ELECTRONICS  
COMPANY

BOULDER INDUSTRIAL PARK  
BOULDER, COLORADO

TWX 303 443-2561 PHONE (303) 442-3837

POWER SUPPLIES • INVERTERS  
CONVERTERS • TRANSFORMERS

# If it's possible to make a crimp type connector smaller and lighter, Bendix does.

That's why you'll find Bendix® crimp-type JT Pancake connectors the smallest, lightest now available. They reduce connector length up to 50%, weight up to 60%.

We're able to offer you a wider-than-ever series in rapid, off-the-shelf fashion, too. Included are wall mount, box mount, jam nut, straight plug and 90°

plug. They're available in nine shell sizes—8 through 24, with standard temperature capabilities to 302°F. (Even high-temperature models to 392°F if need be.) And with over 28 different insert patterns, many of which are Pygmy® (Mil-C-26482) layouts.

Crimp-type Pancake connectors come in 16-, 20- and (Double Density) 24-con-

tact sizes, with up to 128 contacts in a single connector. And you'll even find they out-perform all others because of a host of new design features.

We still haven't mentioned the connector you need for your application? Try our extensive JT Hermetic or Solder types. Or contact us in Sidney, New York. Phone: (607) 563-9511.

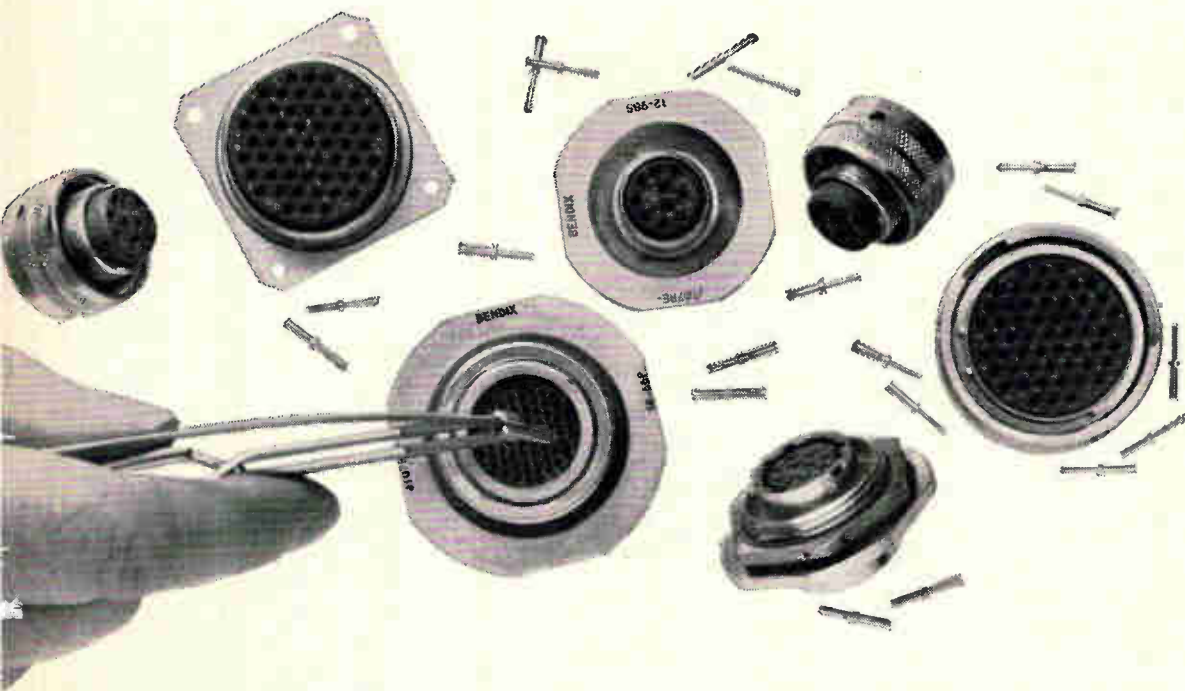

Scintilla Division



Circle 213 on reader service card

**Buy the BEST!**  
**Buy in KIT form!**



# MARK<sup>®</sup> TEN

**SCR** CAPACITIVE DISCHARGE  
IGNITION SYSTEM

ONLY \$29<sup>95</sup> PPD.!

Why settle for less in motor vehicle ignition systems when you can buy the very BEST from Delta, the originators, the leaders in capacitive discharge (SCR) systems. Delta pioneered this electronic marvel. Thousands have installed this remarkable electronic system. Now YOU can purchase at low, LOW cost, and in easy-to-build kit form, the king of them all, the DELTAKIT. Low price due simply to high production levels at no sacrifice in peerless Delta quality.

**Operate Any Motor Vehicle More Efficiently**

**Compare these proven benefits:**

- ▲ Up to 20% Increase in Gasoline Mileage
- ▲ Installs in Only 10 Minutes on any Car or Boat
- ▲ Spark Plugs Last 3 to 10 Times Longer
- ▲ Instant Starts in all Weather
- ▲ Dramatic Increase in Acceleration and General Performance
- ▲ Promotes More Complete Combustion

Literature and complete technical information sent by return mail.

**BETTER YET — ORDER TODAY!**



**DELTA PRODUCTS, INC.**

P.O. Box 1147 F • Grand Junction, Colo.  
Enclosed is \$\_\_\_\_\_, Ship prepaid.  
 Ship C.O.D.

Please send:

- Mark Tens (Assembled) @ \$44.95
- Mark Tens (Delta Kit) @ \$29.95

SPECIFY —  Positive  Negative  
 6 or  12 Volt

Car Year \_\_\_\_\_ Make \_\_\_\_\_  
Name \_\_\_\_\_  
Address \_\_\_\_\_  
City/State \_\_\_\_\_ Zip \_\_\_\_\_

DP 6-2

## Production Equipment

ratios from 10:1 to 50:1, true direction travel (even when ratios are changed), and automatic vacuum lock-down on disk-operated joystick. The system is supplied with a stage, control electronics, choice of 19 X to 1100 X split-field optics (95 X supplied as standard), 200-watt UV exposure source and power supply for \$8,750. Electroglas, Inc., 150 Constitution Drive, Menlo Park, Calif. [403]

## Roller coater adapted to small components



A small conveyor-fed roller coater is especially adapted to coating requirements in the electrical and electronic industries. The open-end roller coater is ideal for applying a coating of adhesive, sealant, insulating varnish, photosensitive materials, etc., to small electronic components.

The unit consists of a doctor roll, coating roll and back-up roll, all 3 in. in diameter. It will accommodate materials up to 2 in. thick. It spreads a thin, even film of coating material on any flat surface, wood, plastic or metal.

In one application, where a varnish is applied to the side of a tiny resistor, the coater reduced labor by two-thirds over the previous method of hand-painting. The machine coating also reduced spoilage and rejects. The roller coater for this type of application is equipped with a continuous belt conveyor and special rolls 3/4 in. wide. Metal guide fences insure the accurate feed of components to the rolls. The same machine can be used with rolls up to 4 in. wide. Union Tool Corp., Warsaw, Ind. [404]

## 6 BIT A TO D CONVERTER 15,000,000 CONVERSIONS PER SECOND

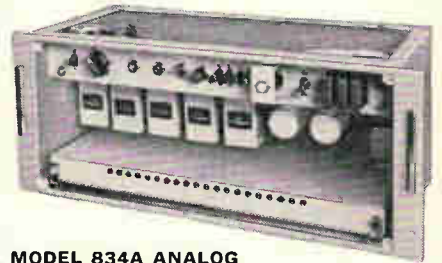

### MODEL 834A ANALOG TO DIGITAL CONVERTER

Well-suited for telemetering or process control  
Long life and high stability  
All solid state, silicon semi-conductors

#### SPECIFICATIONS

Method: successive comparison.  
Digital output: B.C.D. 12 bit parallel. Stability:  $\pm 0.2\%$ /6 months. Conversion time: approximately 240 $\mu$ s. Operating temperature:  $-10^{\circ}\text{C}$  to  $+50^{\circ}\text{C}$ . Width: 480 mm. Height: 199 mm. Depth: 225D m/m. AC Input: 100/110/220/240V  $\pm 10\%$  50 or 60 c/s.

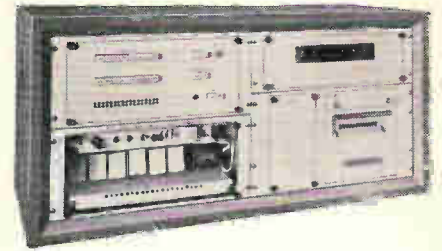

### MODEL 198C DATA LOGGING SYSTEM

All solid state  
Random access analog scanner  
High reliability and accuracy  
Operates over large temperature ranges  
Low cost

#### SPECIFICATIONS

Scanning capability: 16 channels. Scanning speed: up to 5 channels per second. Accuracy: 0.1%. Output: printing paper tape. Logging cycles: 10 seconds to 1 hour (specify on ordering). AC Input: 100/110/220/240V  $\pm 10\%$  50 or 60 cps (specify on ordering).



### MODEL 507C DIGITAL VOLTMETER

All solid state and high speed.

#### SPECIFICATIONS

Measuring range: (1) 0.001 to 1,599 volts  
(2) 0.01 to 15.99 volts  
(3) 0.1 to 159.9 volts  
(4) 1 to 1,599 volts

Accuracy: 0.1% of full scale. A/D conversion time: 600 $\mu$ s. Max. repetition rate: 1 kc. Reading mode auto: 100 c/s repetition rate.

#### Digital output:

4 digit decimal  $10^{\text{C}1}$ , parallel code connectable to the line printer Operating temperature: 0 to 40 $^{\circ}\text{C}$ . Width: 480 mm. Height: 199 mm. Depth: 350 mm. Weight: approx. 13 kg. AC Input: 100/110/220/240V 50 or 60 cps.

## CHUO ELECTRONICS CO., LTD.

No. 21 Motohongo-machi Hachioji-shi,  
Tokyo, Japan

Circle 497 on reader service card

Circle 215 on reader service card →

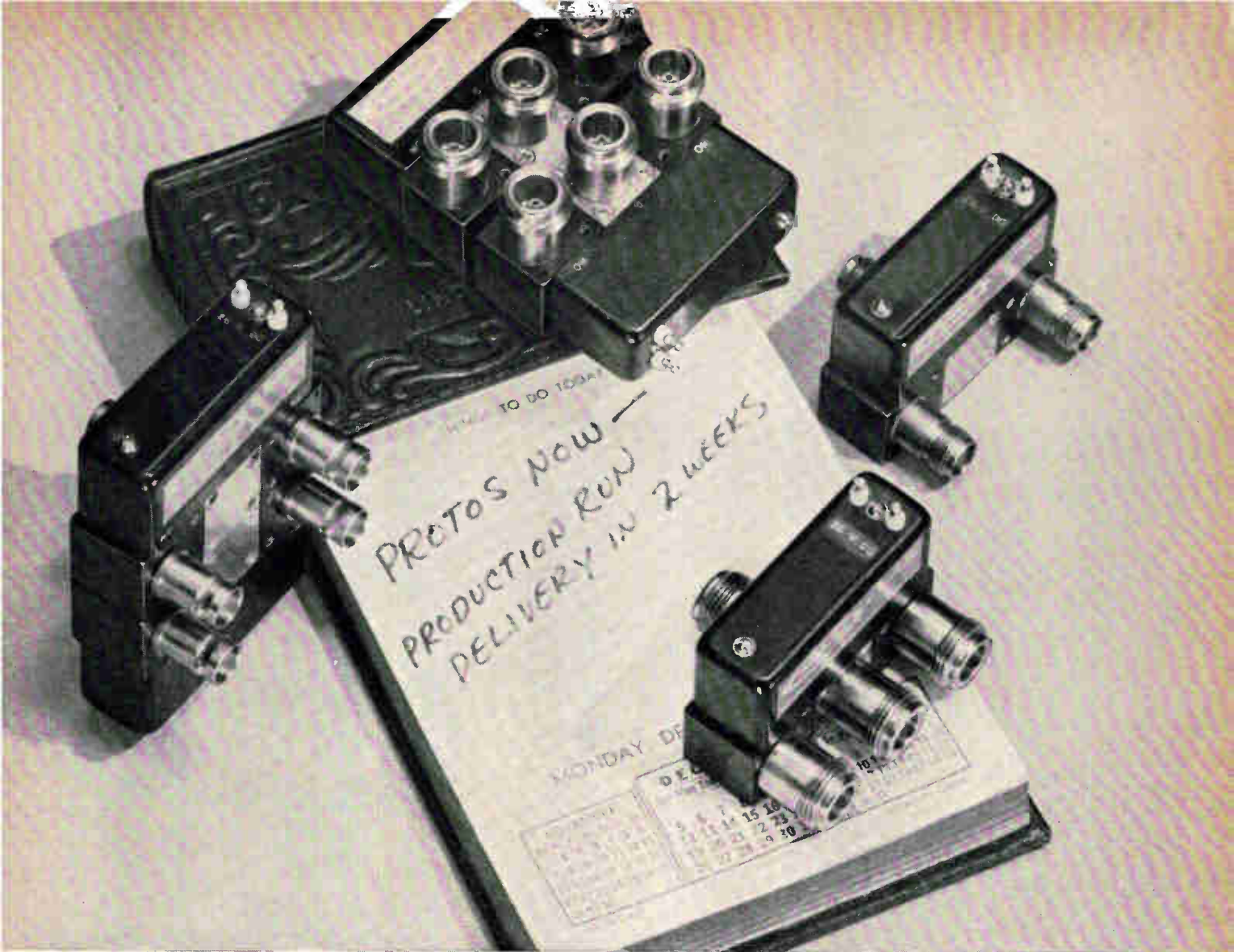

## ***New Amphenol design cuts RF switch delivery to 14 days***

Modular construction of Dynaform\* switches puts prototypes or production quantities in your hands as quickly as they can be assembled and shipped.

**OVER 300 VARIATIONS.** Amphenol Dynaform switches are built from 23 standard modules. From these come over 300 switch variations: SPDT, DPDT, and Transfer. Shorting, non-shorting or resistor terminations can be provided. A variety of coil voltages are available.

Connectors are BNC, TNC or

type N positioned for through-panel or above-chassis mounting.

**LIGHTER WEIGHT.** New aluminum construction cuts weight to less than one-half that of comparable RF switches.

Completely enclosed design makes Amphenol Dynaform switches dust-proof, too.

**FREQUENCY RANGE EXTENDED.** Electrical performance of the new Dynaform switch is better than any other blade-type RF switch. Usable frequency range

has been extended to 6 Gc. Cross-talk remains consistently low in all frequency ranges.

Designed and tested to exceed the requirements of classes B2b and B3b coaxial switches per Military Specification MIL-S-3928B.

**DELIVERY IN 2 WEEKS.** Order today and be prepared to install your custom design Dynaform in 14 days. Call your Amphenol Sales Engineer. Or write Amphenol RF Division, 33 E. Franklin St., Danbury, Connecticut.

\*Dynaform is a trademark of Amphenol Corporation.



**AMPHENOL RF DIVISION**  
AMPHENOL CORPORATION

Specify Amphenol . . . the leading name in cable, connectors, assemblies, RF switches, potentiometers, motors, microelectronics



with this catalog  
you can  
choose  
from  
62,000  
different  
power supplies...



Write for  
your copy today to  
Acopian Corp.  
Easton, Pennsylvania  
or telephone  
(215) 258-6149.



## New Materials

### Fused silica transmits ultraviolet light

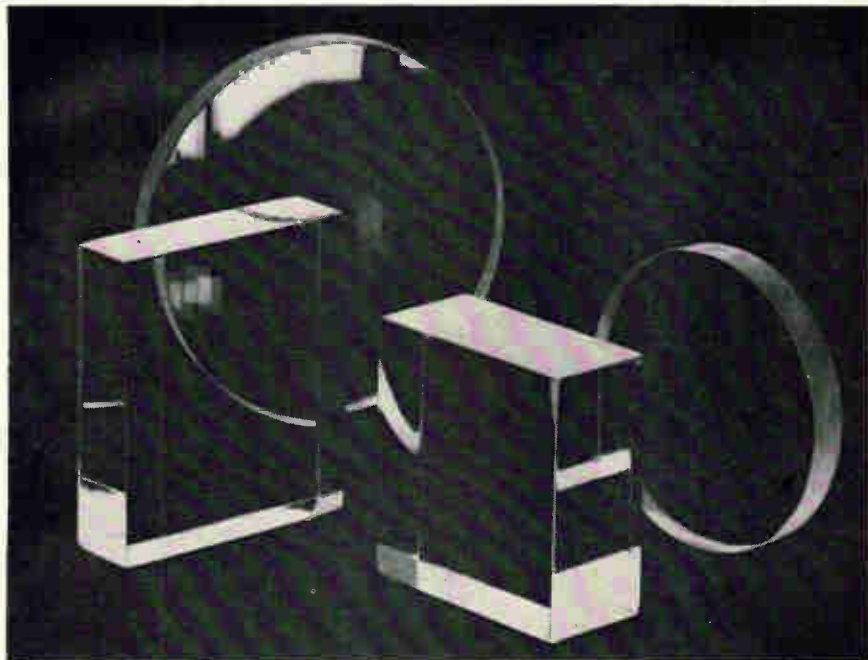

Fused-silica plates and disks of high optical quality for laser windows, prisms and lenses have 99.9% visible light transmission, and are resistant to darkening by gamma rays.

The development of the General Electric Co.'s type-151 fused silica was initiated in response to industry's demand for a silica with high optical quality, maximum light transmission—especially in the ultraviolet region—and minimum distortion. Developed by the Lamp Glass Department, the new material has excellent internal quality and homogeneity. Potential applications include laser windows, prisms for spectrometers, interferometer lenses, and instrument lenses for space. The largest market is expected to be in aerospace applications. The silica is free from bubbles that would impair its optical properties.

The material exhibits 99.9% transmission of the visible light spectrum and high transmission of ultraviolet, even below 1,800°K. It will not fluoresce up to 2,500°K and is resistant to darkening after exposure to gamma radiation—a feature that appeals to the aerospace industry.

Type 151 is annealed to less than 10 millimicrons per centimeter of

path difference. It meets the requirements of military specification G-174 for a grade A material in striations, and is available in ingots, plates, and discs up to 18 inches in diameter and 2 inches in height. Thicker sections are available in smaller diameters. Ground and polished pieces, such as prisms and lenses, are also available. Development of fused silica tubing and ribbon is now in progress.

#### Specifications

Light transmission	99.9% of visible light
Sizes	Up to 18-in. diameter, 2-in. height
Price	\$250 per lb.
Delivery	Standard sizes—immediate Special configurations—4 weeks

General Electric Co., Lamp Glass Department, 1133 East 152nd St., Cleveland, Ohio. [406]

### Urethane for potting is easy to handle

A urethane prepolymer called Conathane 2025 is primarily intended





*This little sample will help explain some...*

# New ideas for multi-layer circuitry

Formica's MLC system permits accurate registration of circuits, maximum packaging density, high-temperature stability, plus!

Many common multi-layer circuitry problems can be solved. Just ask your Formica rep to bring in his kit (with samples) detailing Formica's new MLC system. System's base laminate is FORMICA® brand copper clad laminated plastic, FR-45—documented reliability. Pre-preg has resin specifically developed for use with FR-45 . . . has inorganic additives which increase thermal conductivity of laminate; OKs use of thin

circuit lines, thin copper foil, dense packaging. And circuit pads hold tight for accurate registration . . . no slippage. Go ahead and weld or solder; bond holds. Reliable circuits . . . resin stays viscous (but not watery) to fill around all elements. Many tiny, closely-spaced holes to drill? Your Formica rep can tell you how. Also how you can use one laminate (instead of 4) for G-10, G-11, FR-4, FR-5 requirements. Write, Dept. ID-5.



Leadership through innovation • FORMICA CORPORATION • Cincinnati, Ohio 45232 subsidiary of

FORMICA® is our trademark for various products, including our brand of laminated plastic.



**you're an Electronic Engineer specializing in micro-electronic circuits, then you will gain by coming to Douglas.**

We're looking for Electronic Engineers with specialized background in circuit design. We're especially eager

to find men with automatic-pilot control hardware experience. We also have openings for men with micro-wave experience.

If these advanced programs interest you, and if you hold a BSEE or Master's degree with two to five years experience, then send your resume in confidence to C. R. MacDonald, Douglas Missile and Space Systems Division, 2700 Ocean Park Boulevard, Santa Monica, California.

*An equal opportunity employer*

**DOUGLAS**

MISSILE AND SPACE SYSTEMS DIVISION

## New Materials

for use in potting and encapsulation. Used with Conacure AH-22 chain extender, it will cure at room or elevated temperatures to a tough, flexible polyurethane elastomer. The system has low viscosity and can be processed at room temperature. It will produce void-free castings without the characteristic pinholes usually associated with conventional polyurethane systems.

The Shore A hardness of the cured system is 60-65, the tensile strength is 500 psi, and elongation is 100%. Shrinkage is less than 1 mil per inch during cure, and water absorption is 0.25% after 24-hour immersion. The color is a light, transparent amber.

Conathane 2025 and Conacure AH-22 can also be used as a protective coating for circuit boards. Conap, Inc., 184 E. Union St., Allegany, N.Y., 14706. [407]

## **Silicone elastomer is self-catalyzed**

A new self-catalyzed silicone elastomer, known as SSE, has been developed as a protective coating and encapsulant for semiconductor devices and for potting sensitive electronic components. It is designed to stabilize semiconductor surfaces and p-n junctions. It is particularly useful for high-voltage rectifiers, diodes, and circuit modules.

SSE is a high-viscosity silastomer, available in a prepolymerized state, ready for application. It cures quickly, simply by heating without the addition of catalyst. The cured product is a white, resilient, dielectric material that is highly protective, heat-stable, and waterproof. In addition, SSE serves as an excellent coating to obtain rapid dissipation of heat.

Cured SSE exhibits flexibility to  $-75^{\circ}\text{C}$ ; heat resistance up to  $300^{\circ}\text{C}$ ; bulk resistivity of  $5 \times 10^{14}$  ohm-cm; dielectric constant of 3.5 at 1 Mc; power factor of  $1.5 \times 10^{-3}$  at 1 Mc; and dielectric strength of 550 volts/mil.

The material is available from stock in 2.5-oz and 1-lb sizes,

Special Introductory Offer

**ANY THREE** FOR **\$1.00** ONLY VALUES UP TO \$38.75

To new members of the  
**HALL OF SCIENCE Book Club**



1. NATURAL LANGUAGE AND THE COMPUTER by P. Garvin (List Price, \$12.75)



2. BEYOND TIME by Michel Siffre (List Price, \$5.95)



3. MASERS AND LASERS by M. Brotherton (List Price, \$8.50)



4. TOMORROW'S WEAPONS by J. Rothschild (List Price, \$6.95)



5. ASSAULT ON THE UNKNOWN by W. Sullivan (List Price, \$8.50)



6. FROM DREAM TO DISCOVERY by Hans Selye (List Price, \$6.95)



7. COMPUTERS AND THOUGHT by A. Feigenbaum and J. Feldman (List Price, \$7.95)



8. EXPLORING THE UNIVERSE ed. by L. Young (List Price, \$7.95)



9. RUSSIAN SCIENCE IN THE 21st CENTURY by S. Gousheva and M. Vassilief (List Price, \$4.95)



10. THE MACHINERY OF THE BRAIN by D. Woodrige (List Price, \$5.95)



11. COMPUTABILITY AND UNSOLVABILITY by M. Davis (List Price, \$8.95)



12. THE AGE OF ELECTRONICS ed. by C. Overhage (List Price, \$7.95)



13. PEACETIME USES OF OUTER SPACE ed. by S. Ramo (List Price, \$6.95)



14. INTRODUCTION TO THE UTILIZATION OF SOLAR ENERGY, ed. by A. Zarem and D. Erway (List Price, \$14.00)



15. LOGIC MACHINES AND DIAGRAMS by M. Gardner (List Price, \$5.00)



16. MATHEMATICAL METHODS OF OPERATIONS RESEARCH by T. Saaty (List Price, \$12.00)



17. AN INTRODUCTION TO SCIENTIFIC RESEARCH by E. Wilson (List Price, \$7.95)



18. THE SCIENCE OF LIFE ed. by G. Taylor (List Price, \$9.95)

## Now – build your own home science library at low cost – and keep pace with today's major scientific events

Select any three of the above titles FOR JUST A DOLLAR! Choose from Masers and Lasers, Tomorrow's Weapons, Assault on the Unknown, and fifteen other important titles . . . your introduction to membership in *The Hall of Science Book Club*.

If you want to keep alert to the pace and impact of science's breakthroughs – and do so economically – here's the solution to your problem. *The Hall of Science Book Club* was organized for you to bring a new value in reading and reference service. All books are chosen on the basis of their practical, popular, and professional appeal, and geared to add new dimensions to your understanding of the ideas, discoveries, and achievements of science.

How the Club operates. Periodically you will receive free of charge the Club's official announcement, as issued. This will give advance notice of the next month's feature selection, as well as a number of alternate choices available. If you want the featured book, you do nothing; it will be mailed to you. If you want an alternate . . . or if you want no book at all that month, simply return the card conveniently provided for this purpose.

We ask you to agree only to take three books in a year. Certainly out of the large number of books offered during this time there will be at least three you would buy anyway. By joining the Club you save yourself the bother of searching and shopping, and save in cost

about 15 per cent from publishers' prices. Send no money now. Just indicate any four books you want – three for only \$1.00 and one as your first Club selection – in the coupon below. Take advantage of this offer *now*, and get four books for less than the regular price of one.

### Mail to HALL OF SCIENCE Book Club

330 West 42nd Street, New York, N.Y. 10036

Please enroll me as a member and send the 4 books indicated below. You will bill me for my first selection at the special club price and \$1 for my three new membership books, plus local tax where applicable, and a few additional cents for delivery costs (The Club assumes this charge on prepaid orders). As a member, I agree to buy as few as 3 more Selections during the next 12 months.

My Three Books for \$1.00

My First Selection

Name \_\_\_\_\_ (please print)

Address \_\_\_\_\_

City \_\_\_\_\_ State \_\_\_\_\_ Zip \_\_\_\_\_

(This offer good in United States only).

L221X

# NEW MILLIVOLT-TO-CURRENT TRANSMITTER GIVES 0.1% ACCURACY FOR ONLY \$145<sup>00</sup>!

ALL SOLID STATE • NO CHOPPERS  
TEN-YEAR MAINTENANCE-FREE LIFE EXPECTANCY  
NO RANGE CARDS NEEDED



Model 311  
cover removed

Here's the finest millivolt-to-current transmitter you can buy! It's one of the new Acromag 310 Series Millivolt and Thermocouple Transmitters. When adjusted for 0-10 millivolt DC input Model 311 gives you 4-20 milliampere output with 0.1% accuracy! Many modifications. List price with enclosure \$145.00. Standards from stock.

Request Technical Data 31 . . . .

**ACROMAG**  
INCORPORATED

15360 Telegraph Road • Detroit, Michigan 48239  
Phone (313) 538-4242 • Teletype (313) 583-4536

Makers of Precision Instrumentation and Controls



Circle 498 on reader service card

As a prime source . . .

WE HAVE

**INDIUM**

WE ARE THE PIONEERS IN PROCESSING

**INDIUM**

WE ARE THE ORIGINAL FABRICATORS OF

**INDIUM**

WE KNOW HOW TO USE

**INDIUM**

- Indium metal and alloys—standard and high purity grades • Indium pellets • Indium wire
- Indium foil • Indium oxide all purities • Indium plating solutions • Indium salts • Indium powders
- Indium ribbon • Indium spheres • Gallium



**SOLDER KIT 13** Indalloy solders and 5 fluxes plus full instructions and an Indium test chart. \$16.50. Write Dept. E1.

We welcome your inquiries

**INDIUM**

Corporation of America  
1676 Lincoln Avenue  
Dept. E1 • Utica, New York

Since 1934 . . . pioneers in the Development and Applications of Indium for Industry

Transformer for

**MICROPHONE**



**Q+Q**

YOUR assurance of best quality  
and quantity . . . . .

The secret 2-Q's  
behind

every Nishimura products



**Nishimura Musen-Denki Co., Ltd.**

21, Owada-cho, Shibuya-ku,  
Tokyo, Japan

Circle 499 on reader service card

## New Materials

priced at \$4 and \$20 respectively. Liberal discounts are offered in production quantities.

Transene Co., 121 Conant St., Danvers, Mass. [408]

## High-dielectric potting compound

A 3,000-volt-per-mil potting compound now being offered was originally developed for missile application. The modified epoxy, designed for transformer encapsulation, has a dielectric strength across a 1- to 3-mil thickness greater than 3,000 volts per mil and across a 1/8-in. slab greater than 1,600 volts per mil.

This compound affords maximum physical protection under the most severe environmental conditions. Because of the high dielectric strength, high physical strength, low moisture absorption and broad temperature range, unit size and weight can be drastically reduced while increasing system reliability. G-L Electronics, a division of G-L Industries, Inc., 300 Harvard Ave., Westville, N.J., 08093. [409]

## Flame-retardant polypropylene resins

A series of flame retardant polypropylene resins have been announced for use in a wide range of electrical and electronic applications. The new molding and extrusion resins, developed by Novamont Corp., are said to be the first to receive an Underwriters' Laboratories temperature rating of 95°C.

The Moplen type CR flame-retardant polypropylene resins deliver continuous high-temperature insulation for a minimum service life of at least 55 months at a continuous elevated temperature of 95°C as specified by the UL rating.

Moplen type CR imparts unusual nonburning and nondripping properties as well as high dielectric strength, low dielectric constant and dissipation factor, and superior chemical resistance. Chemore Corp., 100 E. 42nd St., New York, N.Y., 10017. [410]

# Give us 30 minutes of your time

# and we'll give you 2 years of IBM's

How? By using IRIS — IBM's Recruitment Information System — to help you find a new career . . . with IBM.

IRIS could find you a position with IBM that matches your unique talents in a matter of minutes. But if there's nothing open right now, that won't stop IRIS. It keeps right on searching. For two solid years.

All you have to do is fill out the IRIS Data-Pak. That takes about 30 minutes. IRIS takes it from there.

IRIS is tuned to openings in marketing, finance, manufacturing, research and development throughout IBM — from recent college graduates to the most highly experienced professionals. And IRIS may even *widen* your job opportunities. By instantly matching our openings to your unique experience and preferences.

IRIS could even find a new kind of job for you — a job requiring completely new mixes of personal experience — experience you have that may now be going unused and unrewarded.

With IRIS, whenever the computer singles out a job that appears right for you, IBM's experienced staffing people are alerted. They check carefully to be certain that the opening meets your professional goals and offers advancement potential. If it does, you'll be notified immediately of the opportunity. Then arrangements for a personal interview will be made.

Until then, your file remains "on top" and available when an opportunity comes along.

There are plenty of opportunities for professionals with college degrees and appropriate experience. We need qualified Electrical Engineers, Mechanical Engineers, Industrial Engineers and Plant Engineers.

We need qualified professionals in all phases of Development, Manufacturing, Programming, Space Systems and Research.

And there are other immediate openings, too. For Facilities Engineers, Statisticians, Systems Analysts and Sales Engineers.

Once your Data-Pak is returned to IBM and acknowledged, you'll know you're getting a clear shot at developing opportunities throughout IBM — the leader in the major growth industry: information processing and control. You'll know you could have the opportunity of a lifetime — the opportunity to work for an exciting company that offers stability and real growth potential. And more importantly, all the accompanying personal rewards.

So, even if you're not contemplating a move right now, let IRIS put your resume "on top" for hundreds of exciting opportunities at IBM.

Who knows what career challenge the next two years — and IRIS — could bring?

IBM is an Equal Opportunity Employer

SEND FOR YOUR IRIS DATA-PAK NOW!

-----  
Coleman Mandelblit, Dept. 55404  
Professional Staffing  
IBM Corporate Headquarters  
Armonk, New York 10504

**IBM**<sup>®</sup>

I am interested in career opportunities with IBM.  
Please send me the IRIS Data-Pak.

\_\_\_\_\_  
Name

\_\_\_\_\_  
Address

\_\_\_\_\_  
City

\_\_\_\_\_  
State

\_\_\_\_\_  
Zip Code

\_\_\_\_\_  
Degree

\_\_\_\_\_  
Present Job Title



# boost yields

New \$11,950 data logger permits faster, more accurate analysis of process variables



**RADIATION  
INCORPORATED**

PRODUCTS DIVISION • DEPT. EL-02 • P.O. BOX 220 • MELBOURNE, FLORIDA 32902 • PHONE: (305) 727-3711

Circle 500 on reader service card

Now you can step up yields through critical analysis of process variables. The new Radiation data logger converts analog data to computer compatible digital tapes—permits high speed analysis at substantially lower cost than ever before.

The new Radiation Model 5015 Data Logger is a self-contained system which offers: Input channels—16 analog inputs  $\pm 5.12v$ , full scale; expandable to 64. System accuracy\*— $\pm 0.025\%$  full scale, 12-bit resolution. Word rate—to 500 wps, synchronous; to 100 wps, asynchronous. Tape format—gapped, binary IBM-compatible, 200 bits/inch, 7 track. Adjustable record length.

Optional multiplexer capability: 32 input channels, add \$1,350; 48 inputs, add \$2,700; 64 channels, add \$4,050. Also available for rack mounting.

Radiation's digital applications engineers will be glad to discuss your special applications. Write or phone for details.

\*Mean square error

**GLOBE**

**commercial d.c.  
motors: 1 1/4" dia.**



TYPE CMM GEARMOTOR



TYPE CLL MOTOR



Globe Type CMM and CLL motors are commercial versions of experience proven Type MM and LL MIL-spec motors, carefully re-designed to offer compact size and military performance at a modest price. Outputs are 1/100 hp, 8-18,000 rpm (Type CMM) and 1/75 hp, 6-15,000 rpm (Type CLL). 6 to 75 v.d.c.

Both Type CMM and Type CLL motors are available with a planetary geartrain offering 83 ratios from 4:1 to 46,656:1 with torques from 3.0 to 1000 oz. in. Request Bulletin CMM-CLL.

Globe Industries, Inc., 2275 Stanley Avenue, Dayton, Ohio 45404, U.S.A., Tel.: 513 222-3741

## KNOW with an **AEROCOM** MODULATION MONITOR

AEROCOM's Model 906 Modulation Monitor is used for continuous monitoring of percentage of modulation of an AM transmitter operating on Low, Medium, High, and Very High frequencies.



### This AEROCOM unit

- Measures percentage of Modulation on either positive or negative peaks.
- Monitors modulation level. Covers carrier frequency range from 200 kc. to 160 mc.
- Handles transmitter power up to one kilowatt. Adjustment provided to meet different carrier powers.
- No power supply required (passive).

Detector unit is installed and left in transmission line and connected to meter panel with RG 58/U coaxial cable. This monitor is available for rack mounting (Model 906-R) and as a portable unit (Model 906-C) in self-contained case.

Additional data on request

WORLD WIDE



SINCE 1946

3090 S.W. 37th Avenue

Miami, Florida 33133

## New Books

### Digital differential analyzers

Digital Differential Analyzers  
F.V. Mayorov  
Edited by Yaohan Chu  
American Elsevier Publishing Co.,  
382 pp., \$15

Translated from Russian, this is probably the first book devoted entirely to digital differential analyzers.

Practicing engineers will probably find the most value in the first third of the book. It opens with a discussion of computer number systems and codes, register organization, and timing for incremental integrators and for servo integrators. Excellent examples and descriptions are given of the incremental counting process, clearly showing the sign-coding requirements and movement of data in the Y and S registers. One serious shortcoming, however, is the discussion of integrator scaling; it is too brief and difficult to follow.

Coverage of algorithms and computer solutions for various algebraic and trigonometric functions is very adequate. Solutions of coordinate transformations and sets of algebraic equations are also presented well. In addition to describing the algorithms for the basic operations, the author also provides setups for inverse trigonometric functions, hyperbolic, Bessel and elliptical functions, among others.

About 70 pages are devoted to descriptions of the organization of three types of DDA's: a serial binary computer, a serial decimal computer and a parallel computer. For these three computers, the descriptions of the integrating units are particularly clear and complete. However, some diagrams showing the test information are insufficiently detailed and too difficult to follow.

Approximately 40% of the book is devoted to descriptions of computer circuitry, memory devices and analog-to-digital converters. Most of the topics considered are not unique to DDA technology and have, therefore, generally been described elsewhere, usually in more mathematical detail. In many in-

stances, the examples provided are not representative of the most common technologies in general use in this country. Some of the circuits, for example, do not follow usual practices for transformer coupling. In many instances the circuits and techniques described are outdated and approaches in use now are entirely neglected. Angular and voltage-incremental digital encoding techniques, which are particularly suitable for DDA's and have received widespread use, are omitted from the discussion.

Perhaps the most serious failing is the omission of information on the error-propagation properties of the DDA. As a result, no basis is provided for the selection of binary or ternary incremental coding or determination of the appropriate mathematical integration-approximation technique to provide the necessary problem accuracy for the various algorithms. Thus this book cannot, by itself, serve as a guide to the designing of a DDA.

The book closes with a discussion of DDA applications. This section contains a short comparison of incremental and arithmetic computers, followed by a detailed discussion of the use of a DDA for machine-tool control. This chapter would have served a more valuable purpose had it presented the criteria for selecting between arithmetic and incremental computers.

The organization of the book lacks coherence because the discussions of basic computer organization, circuits and hardware elements are interwoven. This reduces the effectiveness of the descriptions of these areas.

Little prior knowledge of DDA's is necessary to understand this book. A short section on the operation of switching transistors is provided for readers unfamiliar with them.

The book is useful as a reference for engineers engaged in the design of DDA's; however, except for its presentation of incremental data flow and DDA algorithms, it cannot be considered comprehensive for the practicing engineer. The discussion of errors is insufficient to provide a basis for designing computers.

Robert L. Gordon  
Sperry Gyroscope Co.  
Great Neck, N.Y.

## SINCLAIR'S YAGI ANTENNAS

### RUGGED RELIABILITY... WHEN IT COUNTS!

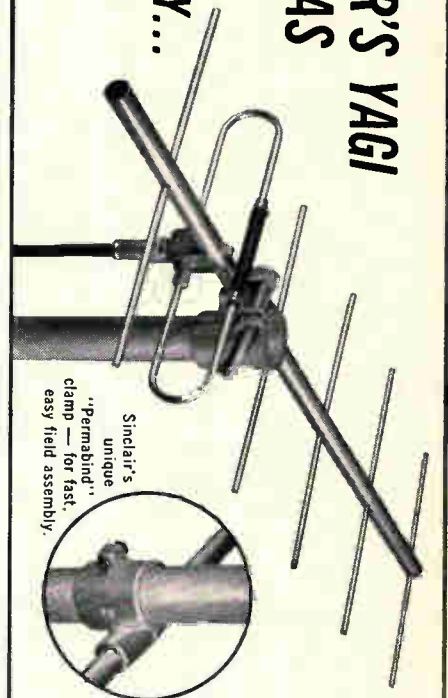

Sure, most UHF-VHF yagi antennas function effectively — when the weather's good! It's when the wind starts to howl and the weather turns from bad to worse that the unmatched rugged reliability of a Sinclair Yagi really counts. Every standard Sinclair yagi is designed to withstand 110 mph winds with a 1/2" radial ice coating. An integral part of this rugged construction is Sinclair's unique "PermaBind" clamp that makes for fast, permanent field assembly.

Standard Sinclair yagis are available in a wide frequency range from 30Mc. to 470Mc. . . . gains from 6.5db to 17.0db . . . power ratings up to one Kw. Send coupon today for complete FREE literature and prices.

**SINCLAIR RADIO LABORATORIES, INC.**  
523 FILLMORE AVENUE DEPT. 101 TONAWANDA, NEW YORK

### FREE LITERATURE

TO: SINCLAIR RADIO LABORATORIES, INC.  
Dept. 101 523 Fillmore Avenue  
Tonawanda, New York 14152

Name: \_\_\_\_\_  
Title: \_\_\_\_\_  
Company: \_\_\_\_\_  
Address: \_\_\_\_\_  
City: \_\_\_\_\_  
State: \_\_\_\_\_ Zip: \_\_\_\_\_

What's in it for you when  
you order **SILICON  
SLICES** and **EPITAXIAL  
SLICES** from the nation's  
Number 1 specialist?

**CONSISTENT  
QUALITY,  
CONSISTENT  
ECONOMY,  
FASTEST  
DELIVERY**

And the most complete line in Crystals and Slices...as sliced, lapped, etched, polished, diced and epitaxial in N/N+, P/P+, multilayer, oxidized. Top source for Germanium, too.

You can safely (and profitably) lower your own inventory when you order from Semimetals.

Try us and see for yourself.



172 Spruce Street

Westbury, L.I., N.Y. 516-333-8400

## Technical Abstracts

### Photoetched delay line

An M-type backward-wave oscillator with photocopied delay line

R. Mannelte, B. Shaw and F. Henry  
Raytheon Co., Waltham, Mass.

To reduce the weight of an M-type backward-wave oscillator used in airborne applications, a delay line photoetched on a lightweight ceramic substrate has been developed as a substitute for the massive metal structures presently employed. A typical M-type bwo combines the crossed field characteristics of the magnetron with the slow-wave interaction of a traveling-wave tube. A delay line or slow-wave structure is required in these tubes to reduce the velocity of the radio-frequency field to that of the electron beam, allowing r-f energy to be coupled from the beam.

A conventional slow-wave structure is made from two carefully machined crowns that are formed either by using a hardened, precision ground mandrel pressed into a solid copper slug or by pressing fingers made of refractory material into a copper ring. The devices are heavy, difficult to machine and expensive to manufacture.

In the new line, a thin layer of copper is bonded to a cylindrically shaped ceramic substrate made of beryllia, and the delay line structure is formed by standard printed circuit techniques. A linear form of the line is shown in the photograph below. Advantages of the photoetching technique include low weight, greater resistance to shock and vibration, lower manufacturing costs, and reduced tube size. In addition, the photoetching technique maintains excellent dimensional accuracies allowing the de-



Photoetched slow-wave structures are formed by etching away some of the copper bonded to the beryllia substrate.

sign of small, closely toleranced, slow-wave structures for tubes operating near X-band. It also permits the design of complicated slow-wave structures that are difficult, if not impossible, to build by machining techniques.

A 50-watt, C-band (5,000 to 6,500 Mc), M-type conduction cooled bwo was built using a photoetched delay line. The tube performed satisfactorily except for a problem with sputtering of the sole material. In an M-type bwo, the electron beam is confined between the delay line and a copper cylinder called a sole. In sputtering, copper atoms are dislodged from the sole material by positive ions formed when the electron beam ionizes residual gases in the tube. In the new tube, sputtered material short-circuits the delay line, resulting in reduced tube life. Sputtering also occurs in tubes using conventional delay lines, but there the dislodged atoms merely coat the structure or pass through it without affecting its operation.

In the new tube, the sputtering problem is reduced by coating the sole with a 50- to 100-angstrom layer of alumina—a nonconducting, low-sputtering material. This is expected to increase tube life to 400 or 500 hours as compared to two hours for an uncoated, copper sole. In one test with an alumina-coated sole, the tube operated satisfactorily for 30 hours before an internal short, not related to sputtering, caused a failure.

A major problem in building the delay line is to provide a proper bond between the beryllia and copper material that is to be deposited on it. Conventional metalizing and brazing techniques are unsuitable because they form a thick, 0.0002 inch interface between the materials that severely attenuates r-f waves. A novel technique was developed in which a 200-angstrom layer of evaporated copper oxide is first deposited and then coated with 0.002 to 0.003 inch of copper. The operation is performed at a controlled temperature and pressure atmosphere. The lines can be cycled to temperatures in excess of 600°C without any



# "ROOM AT THE TOP"

## Here are growth opportunities in Communications with TRW Systems in Los Angeles and Houston

There is "room at the top" for your special talents on America's major missile and space programs with TRW Systems' Communication Laboratory in either Los Angeles or Houston. From the beginning of communications via space, this group has played a pre-eminent role in developing communications systems for the nation's major missile and space programs. Major achievements include the first unified carrier tracking, telemetry and command system and the first PCM telemetry system for space. Now is the time for you to investigate these opportunities with this outstanding professional organization.

### MAJOR PROGRAMS . . .

- Apollo spacecraft systems
- Advanced Minuteman systems
- Mars mission and spacecraft studies
- Nuclear Detection (Vela) Satellites
- Pioneer interplanetary spacecraft
- Weather satellite systems
- Standardized tracking, telemetry and command system (SGLS)
- Advanced space probes
- Lunar telemetry systems
- Communication satellite systems

### Senior Communication Engineers

For design, analysis and management of communication systems and evaluation of scientific and military applications of communication techniques for aircraft, spacecraft and underwater craft use. BSEE, MSEE or PhD.

### Communication Equipment Design Engineers

Several years' experience in design and analysis in the following fields: RF filters, diplexers, antennas, phased arrays, feeds, solid-state transmitters, receivers, phase-lock loop techniques, cavity techniques, strip line, very wide and very narrow band circuits, circuit engineering, and modulation techniques. BSEE or MSEE.

### Communication System Analysis Engineers

Conceptual design, analysis and synthesis of wide variety of digital and analog communication systems, employing coding, modulation, and statistical communication theory. Systems include integrated coherent-carrier systems, phase lock demodulation (restrictive/non-restrictive), communication satellites and deep space probes. MSEE or PhD.

### Signal Processing Engineers

Design and development of sophisticated communication systems and components. Signal conditioners, analog and digital encoding and decoding, modulation tracking and carrier tracking phase lock loops, and multiphase modulation are involved in tracking, telemetry and command equipment which includes but is not limited to space applications. BSEE or MSEE.

### Telemetry Circuit Design Engineers

To design a wide variety of analog and digital signal processing circuits for spacecraft digital telemetry equipment. Experience should relate to the design of analog-to-digital converters, analog and digital multiplexers, logic and data storage. Familiarity with micro-electronics desirable. BSEE or MSEE.

### Telemetry System Engineers

Experienced in the functional and logical design of analog and digital telemetry systems. Familiarity with design, development, application and evaluation of spacecraft instrumentation systems. Experienced in the design of data systems to interface with a wide variety of data sources including scientific experiments, and engineering measurements.

*Please submit resume and salary history in confidence to R. J. Brown, TRW Professional Placement, Dept. L-22, One Space Park, Redondo Beach, California 90278. TRW is an equal opportunity employer, male and female.*

# TRW SYSTEMS

# Life before the PVB



**"Before the PVB, we would have needed many expensive instruments to do the same jobs!"**

Sam Yoshikawa wanted a resistance bridge for the Instrumentation and Calibration Lab he supervises for Signetics Corporation of Sunnyvale, California. We asked him why he chose our Model 300PVB (Portametric Voltmeter Bridge). His answer: "The PVB gives us a lot more measuring capability than we bargained for. We use it principally as a high-accuracy resistance bridge, to calibrate decade boxes in the lab, and for other resistance measurements.

"But it also packs eight other measurement functions into one compact, portable case. So the boys in the Electronic Maintenance Department often take it over there to calibrate their test equipment. And the instrumentation group use it as a design tool in the development of our automatic test equipment.

"In fact, the PVB is so versatile we can hardly keep it in the lab. We sure got a lot of test and calibration equipment in this one \$750 instrument."

ESI, 13900 NW Science Park Drive, Portland, Oregon (97229)



In a single battery-operated unit, the PVB combines the functions of a potentiometric voltmeter, voltage source, ammeter, guarded Kelvin double bridge, resistance comparison bridge, ratiometer and electronic null detector. Accuracy:  $\pm 0.02\%$  of reading or 1 switch step on virtually all ranges.

**esi**

Electro Scientific Industries

## Technical Abstracts

apparent damage to the bond.

The dispersion and coupling impedance of the photoetched delay line is comparable to that of a conventional delay line. Its insertion loss in the band between 4,700 to 5,300 Mc is 3 to 4 db; although slightly higher than conventional delay lines it does not seriously affect tube operation.

Presented at the International Electron Devices Meeting, Washington, Oct. 20-22, 1965

### Space data

The data management analyzer, a laboratory tool for data compression analysis  
J.A. Bryan and J.W. Stumpe,  
Radiation, Inc.

Data compression is becoming more essential as the length of space missions, and the amount of data to be transmitted to earth, increases. Until now, satellites have been able to transmit information with considerable redundancy, but space vehicles on longer missions—to Mars and other planets—will have to transmit on much narrower bands because their available power will be limited.

At Radiation, Inc., Melbourne, Fla., a laboratory model of an adaptive data system is being used to analyze both analog and digital space data in an attempt to eliminate redundancy. In the laboratory, a flow of data can be sampled much faster than on a space vehicle where power restrictions impose slower transmission and sampling rates. Lab equipment can determine, theoretically, the most efficient procedures, and allows the study of the relationships between redundancy and other factors such as the spectral characteristics of the data.

The lab system, consisting of a desk-high rack of equipment including two special purpose computers developed by the company, can handle 64,000 bits per second. Analyzing automatic picture taking (APT) data from the Nimbus weather satellite, it showed that a 10-to-1 sample reduction was possible without compromising picture quality. That is, each picture could be transmitted in 100,000 samples

# NORTON Magnetic Tape Heads

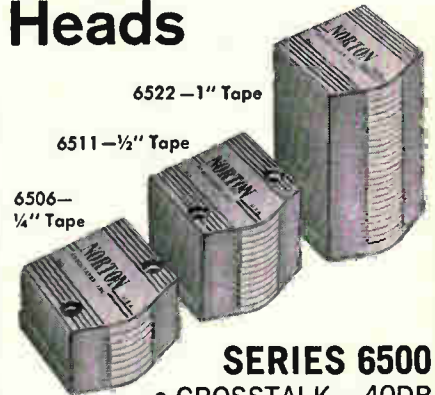

6522—1" Tape

6511—1/2" Tape

6506—  
1/4" Tape

## SERIES 6500

- CROSSTALK—40DB
- +75°C Temperature Operation

Send now for complete technical literature.

**NORTON**  
ASSOCIATES, INC.  
240 Old Country Road, Hicksville, N. Y.

Circle 502 on reader service card

## High torque, Self-shielded



AI-2 (actual size)

### moving coil mechanism

Versatile mechanisms for critical indicating and control systems have "On-off", "+, -", "Go-no go", null, left-right, or scale indicators. High torque, self-shielded core magnet design permits grouping of functions in small panel space. Moving coil weighs 100 mg less and provides at least 10% more torque than best previously available mechanism of this type. Wide choice of sensitivities; synchro or standard mounting.

**AMMON**

AMMON INSTRUMENTS, INC.  
345 Kelley Street, Manchester, N. H. 03105

Circle 503 on reader service card

## Can you advance the precision of digital guidance in space?

Our Guidance and Controls Division, which is contributing to such major contracts as Polaris, Phoenix, Surveyor and VATE, is continuing its expansion into areas which will present the greatest challenge for the foreseeable future — advanced aerospace guidance and navigation digital computers and advanced interceptor computers. Openings exist in a wide variety of disciplines in Laboratories which are responsible for advanced technology, preliminary design and applications, and digital circuitry and components. All of these require accredited degrees and a demonstrable capacity to do creative design or analysis. Although experience is required for most of the positions, several are open to recent graduates. Opportunities are immediately available for:

**Preliminary Design Engineers:** Experience in Digital Systems Applications Engineering, Logical Design, Memory Design (solid state, ferrite or drum) Electro-mechanical Design Engineering, or Physical Product Design—cold plate coating, thermal analysis, packaging trade-off studies—would be particularly helpful.

**Automatic Test Program Analysts:** Systems test, in-flight self test, time-sharing or maintenance depot experience would be directly applicable to our opening. A basic understanding of the mathematics involved with circuitry and computers or weapons systems analysis would be of particular value.

**Circuit Design Engineers:** Duties would involve the design of logic circuits, many forms of input output devices, high reliability low power circuits for spacecraft VHF and UHF counters.

**Systems Integration Engineers:** Experience is required in such areas as system integration, system checkout,

test equipment design, test specification and procedure writing.

There are several openings also for Mechanical Engineers, Physicists, Reliability Engineers and Mathematicians who have acquired specialized, professional experience which is directly applicable to the design or analysis of aerospace digital systems.



All of these assignments require an accredited technical degree, U.S. citizenship and related professional experience.

Please forward resume to:

**MR. ROBERT A. MARTIN**  
Head of Employment  
Hughes Aerospace Divisions  
11940 W. Jefferson Blvd.  
Culver City 6, Calif.

**HUGHES**

HUGHES AIRCRAFT COMPANY  
AEROSPACE DIVISIONS

An equal opportunity employer



# IT'S A FACT

America's principal defense contractors, computer builders, instrumentation manufacturers and electronic systems developers use more Metal Removal Company solid carbide circuit board drills and routers than all other makes combined.

For more information, may we send you our Catalogs D63 and E65 . . . and name of nearest distributor?



## SOLID CARBIDE CIRCUIT BOARD TOOLING

### THE METAL REMOVAL COMPANY

1859 West Columbia Avenue • Chicago, Illinois 60626

Plants Located in CHICAGO • LOS ANGELES • SAN JUAN

### MASTER TOOL AND WHEEL MAKERS FOR THE WORLD

Circle 253 on reader service card

instead of 1¼-million samples. In other studies, the lab gear confirmed that telemetry data rates from the Saturn booster could be reduced by a factor of 161-to-1 without loss, that medical data from Project Gemini astronauts could be reduced by 5.5-to-1, and that the cost of telephone circuits from Alaska could be substantially cut. Radiation has been using the equipment since last May.

Two projection techniques are employed. The zero, or "step," technique predicts future data along a slope established by two samples. If future samples fall within limits set by the slope they are considered to be redundant and are not transmitted.

In the second, or "fan," technique, two slopes are drawn between each new sample and the first sample, forming a "fan" of radial lines around each future sample. The fans are used to evaluate each successive sample to determine if it falls within a specified tolerance. The process was developed and patented by Radiation, Inc.

After reducing the data, the analyzer reproduces it by linear or first order interpolation which connects two nonredundant samples from the reducer with a straight line.

Peripheral equipment, which presents test results visually, includes a two-channel pen recorder for low-frequency displays. By switching, the input waveform can be recorded on one trace and one of several output waveforms on the second trace. A digital tape recorder is also available for further processing the data.

The big problem in designing such adaptive data systems for use in space vehicles is, of course, weight and available power. Radiation is working on a prototype of a one-channel space with 600 integrated circuit flatpacks, which would be about the size of a pack of cigarettes. It is anticipated that speed can be increased to 400,000 bits per second.

Presented at the 1965 International Space Electronics Symposium, Miami Beach, Fla., Nov. 2-4.

#### A REVOLUTIONARY NEW TWEEZER

#### SUPER FINE TWEEZERS FOR PRECISION WORK

It firmly grips and holds the most delicate objects. Object can't slip because of special diamond grip. Gripping points lined with diamond-powder (fine grit). The diamond particles are firmly welded to stainless steel metal. These tweezers are used for micro-fine work and micro surgery.



No. 774. Blades taper sharply from body to very fine points length 4¾ inches. Stainless steel — non magnetic. **\$10.00 each**



No. 777. Curved, superfine points length 4¾ inches. Stainless steel — non magnetic. **\$10.00 each**



No. 772. Angled superfine points — Points on 45° angle. Length 4¾ inches — Stainless steel — non-magnetic. **\$10.00 each**



No. 770. Blades taper gradually to very fine point — length 4¾ inches. Stainless steel — non magnetic. **\$8.50 each**

**DIAMOND COATED EMERY BOARD** — 7" over-all excellent for rapid finishing of fine parts — Diamond grit on both sides. **\$9.60 per dozen**

**I. KASSOY INC. 30 WEST 47 STREET, NEW YORK 10036, DIAMOND CLUB BLDG.**

WORLD'S LARGEST DISTRIBUTOR OF TWEEZERS | ASK FOR OUR EXTENSIVE TWEEZER CIRCULAR

# SEARCHLIGHT SECTION

## ELECTRIC MOTOR & BLOWER BARGAINS

Blowers • Cooling Fans • Heaters • Motors • Gear Motors • Gear Reducers Large Variety • Large Inventory

Send for Catalog

### ELECTRIC TRADING CO.

313-315 Canal St., N. Y., N. Y. 10013  
Dept. E-9 (212) CA6-0575

CIRCLE 956 ON READER SERVICE CARD

## FREE CATALOG

Electronic Test Equipment  
LAB MATERIAL - OPTICS  
Ham Gear - Components  
Semi-Conductors - Surplus

### GADGETEERS ELECTRONICS

5300 Vine St. Cincinnati, Ohio 45217

CIRCLE 952 ON READER SERVICE CARD

## free catalog

POTTING APPLICATORS  
MANUAL AND DISPOSABLE

6cc 12cc 30cc  
FOR POTTING, ENCAPSULATING, AND  
SEALING OF MINIATURE COMPONENTS

PHILIP FISHMAN COMPANY  
7 CAMERON ST., WELLESLEY 81, MASSACHUSETTS

CIRCLE 953 ON READER SERVICE CARD

## SURPLUS

Field Telephone Set Two-Way Telephone communication or signaling to multiple stations. Range, 2 miles. Utilizes standard connecting telephone line—Features: Local or remote control. Battery powered. AN/GRA-6

### MONMOUTH ELECTRIC CO., INC.

1805 Corliss Ave. Neptune, N. J.  
Phone—201-776-5300

CIRCLE 958 ON READER SERVICE CARD

RADAR AUTO-TRACK & TELEMETRY ANTENNA PEDESTALS 3 & 10 CM. SCR 584 AUTOTRACK RADARS. M 33 RADAR TPS-1D SEARCH. APS-45 TPS-100 HT. FINDERS. WX RADARS. FPN-32CA. APS-10 APS-15B APS-27 (AMTI) SEARCH. APN-102 DOPPLER. DOZENS MORE. CARCINOTRONS. PFN'S. 25.-5.-1.2-3-6 MEGAWATT PULSE MODULATORS. CAVITIES. PULSE TRANSFORMERS. IF STRIPS. WAVEGUIDE. BENDS 200 MC. 1 KMC. 3 KMC. 6 KMC. 9 KMC. 24 KMC. RF PKGS.

### RADIO RESEARCH INSTRUMENT CO.

550 5TH AVE., NEW YORK 36, N. Y. JU 6-4691

CIRCLE 954 ON READER SERVICE CARD

## SEMICONDUCTORS MAJOR BRANDS

INTEGRATED CIRCUITS • DIodes AMPs DARLINGTONS • POWER DIODES & TRANSISTORS • SPECIAL DEVICES

Write for Catalog S-1

SEMICONDUCTOR SALES OF CALIF.  
1063 Perry Annex Whittier, Calif.  
(213) 696-7544

CIRCLE 955 ON READER SERVICE CARD



1 MFD 25KV  
GE #44F10  
12"x8 1/2"x12 3/4  
(over top flange)  
SPECIAL  
\$29.50

## OIL FILLED CAPACITORS

- 1 MFD 16KV, G.E. 14F463  
1 1/2"x4"x13", 2 Ceramic Term. **\$29.50**
- 1 MFD 6000V, GE CAT #22F103G2  
CP70D1FP105V, 3/4 x 4 1/2 x 7 1/2  
2 Ceramic Terminals, Original Boxes  
10 for **\$39.50**.....**\$4.50 ea.**
- 1 MFD X 1 MFD 7500V 4"x8"x9 1/4",  
3 Ceramic Terminals.....**\$12.50**
- 5 MFD 7500V, GE CAT #26F393  
3 3/4 x 4 1/2 x 5 1/2, 2 Ceramic Terminals  
10 for **\$29.50**.....**\$3.50 ea.**

Prices subject to change without notice. Usual terms to rated Accounts—All others 25% Cash with order—Balance C.O.D. F.O.B. Bay Area. All items subject to prior sale. Minimum orders \$10.00.

## GENERAL SURPLUS ELECTRONICS

Building 1725 Oakland Airport,  
Oakland, California  
Telephone LO 2-1540

CIRCLE 951 ON READER SERVICE CARD

## EMPLOYMENT OPPORTUNITIES

THE MARKET-PLACE  
FOR ALL EMPLOYMENT NEEDS

Send new ads or inquiries to:

## ELECTRONICS

Class. Adv. Div., P.O. Box 12, N.Y. 10036

## ELECTRONIC COMMUNICATIONS SPECIALIST \$13,500—\$16,000

New York State is looking for persons with EE degree and experience in design & development of radio & TV equipment and circuitry or in the operation of electronic communications system using audio & video equipment.

Write: Dept. of Civil Service, R-201F, State Campus, Albany, N. Y. 12226

# DEQUITS BUYERS TURN TO THE SEARCHLIGHT SECTION IN ELECTRONICS NEQUILIS

## EMPLOYMENT

# Electronics

## OPPORTUNITIES

## QUALIFICATION FORM FOR POSITIONS AVAILABLE

### ATTENTION: ENGINEERS, SCIENTISTS, PHYSICISTS

This Qualification Form is designed to help you advance in the electronics industry. It is unique and compact. Designed with the assistance of professional personnel management, it isolates specific experience in electronics and deals only in essential background information. The advertisers listed here are seeking professional experience. Fill in the Qualification Form below.

**STRICTLY CONFIDENTIAL:** Your Qualification form will be handled as "Strictly Confidential" by Electronics. Our processing system is such that your form will be forwarded within 24 hours to the proper executives in the companies you select. You will be contacted at your home by the interested companies.

**WHAT TO DO.** (1.) Review the positions in the advertisements. (2.) Select those for which you qualify. (3.) Notice the key numbers. (4.) Circle the corresponding key number below the Qualification Form. (5.) Fill out the form completely. Please print clearly. (6.) Mail to: Classified Advtg. Div., Electronics, Box 12, N. Y. 10036.

COMPANY	Page #	KEY #
ATOMIC ENERGY OF CANADA LTD. Ontario, Canada	192*	1
ATOMIC PERSONNEL INC. Phila., Pa.	192*	2
BAUSCH & LOMB Rochester, N.Y.	191*	3
DOUGLAS AIRCRAFT CO., INC. Santa Monica, Calif.	218	4
ELDORADO ELECTRONICS Concord, Calif.	192*	5
ELECTRONIC COMMUNICATIONS INC. St. Petersburg, Fla.	192*	6

GENERAL ELECTRIC CO. Schenectady, N.Y.	208	7
GENERAL ELECTRIC CO. Syracuse, N.Y.	230	8
HAMILTON STANDARD DIV. United Aircraft Corp. Windsor Locks, Conn.	191	9
INTERNATIONAL BUSINESS MACHINES Armonk, N.Y.	221	10
NATIONAL CASH REGISTER Hawthorne, Calif.	200-201	11
NEW YORK STATE DEPARTMENT OF CIVIL SERVICE Albany, N.Y. 12226		12
PAN AMERICAN WORLD AIRWAYS INC. Cocoa Beach, Fla.	231	13
SPACE GENERAL CORP. El Monte, Calif.	191*	14
TRW SYSTEMS Redondo Beach, Calif.	225	15

\*These advertisements appeared in the Feb. 7th issue.

### PERSONAL BACKGROUND

Name .....  
Home Address .....  
City ..... Zone ..... State .....  
Home Telephone .....

### EDUCATION

Professional Degree(s) .....  
Major(s) .....  
University .....  
Date(s) .....

FIELDS OF EXPERIENCE (Please Check) 2/21/66  
 Aerospace  Medicine  
 Antennas  Microwave  
 ASW  Navigation

- |  |   |
|--|---|
| <input type="checkbox"/> Circuits            | <input type="checkbox"/> Operation Research |
| <input type="checkbox"/> Communications      | <input type="checkbox"/> Optics             |
| <input type="checkbox"/> Components          | <input type="checkbox"/> Packaging          |
| <input type="checkbox"/> Computers           | <input type="checkbox"/> Radar              |
| <input type="checkbox"/> ECM                 | <input type="checkbox"/> Radio-TV           |
| <input type="checkbox"/> Electron Tubes      | <input type="checkbox"/> Simulators         |
| <input type="checkbox"/> Engineering Writing | <input type="checkbox"/> Solid State        |
| <input type="checkbox"/> Fire Control        | <input type="checkbox"/> Telemetry          |
| <input type="checkbox"/> Human Factors       | <input type="checkbox"/> Transformers       |
| <input type="checkbox"/> Infrared            | <input type="checkbox"/> Other .....        |
| <input type="checkbox"/> Instrumentation     | <input type="checkbox"/> .....              |

### CATEGORY OF SPECIALIZATION

Please Indicate number of months  
experience on proper lines.

	Technical Experience (Months)	Super- visory Experience (Months)
RESEARCH (pure, fundamental, basic)	.....	.....
RESEARCH (Applied)	.....	.....
SYSTEMS (New Concepts)	.....	.....
DEVELOPMENT (Model)	.....	.....
DESIGN (Products)	.....	.....
MANUFACTURING (Product)	.....	.....
FIELD (Service)	.....	.....
SALES (Proposals & Products)	.....	.....

CIRCLE KEY NUMBERS OF ABOVE COMPANIES'  
POSITIONS THAT INTEREST YOU 1 2 3  
4 5 6 7 8 9 10 11 12 13 14 15



Engineering career opportunities

**Tie your career  
to the world's  
most advanced  
radar/sonar  
systems...  
at G.E.!**

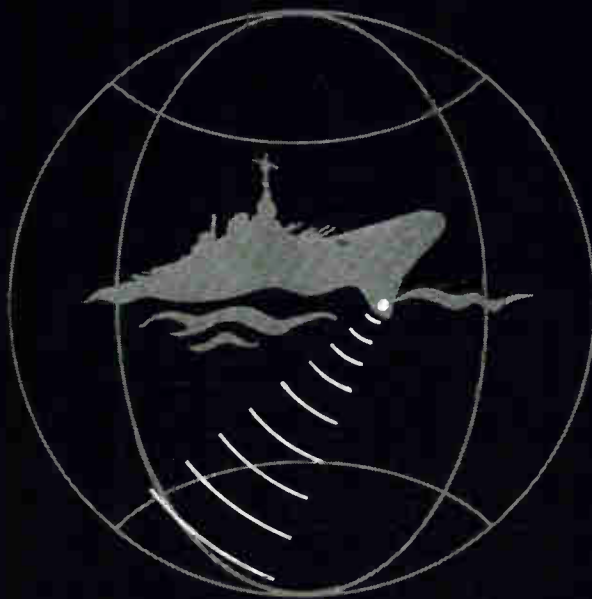

**Investigate your career now  
in missile-defense radar; ad-  
vanced sonar engineering at  
General Electric.**

G.E.'s Heavy Military Electronics Dept.—whose capabilities include the design, development and fabrication of the world's largest and most advanced ASW and radar systems—announces long-term career openings for continuing contributions to large military contracts.

HMED offers you stability based on its broad capability for handling large programs and the experience that goes with front-rank performance on this decade's most advanced projects. Your growth is tied to that of a lean, highly professional engineering group backed by top-flight facilities—both within HMED and throughout General Electric.

At G.E., you'll be treated as a professional who's expected to handle well-defined, delegated responsibility. In most instances you'll deal directly with your customer's organization.

You will be given every opportunity to develop yourself professionally through continuing Company-taught courses and advanced tuition-paid study at nearby Syracuse University. And, in the course of your work, you'll have access to information developed by other G.E. facilities throughout the country.

**WHY NOT MATCH YOUR EXPERIENCE AND CAREER DESIRES AGAINST THESE REQUIREMENTS?**

**SONAR:** Advanced Sonar Engineers; Array Beamformer and Signal Processing Development Engineers; Digital Logic Engineers; Sonar Solid-state Circuit Design; Transducer Development; Solid-state Transmitter Development; Pattern Recognition Analysis; Adaptive Filtering Research; Display Development; Propagation Analysis; Sonar Subsystem Development.

**RADAR:** Monitor and Control Analysis Engineers; Digital Control Eqpt. Engineers; Microwave Component Design Engineers; Consultant, Circuit Design and Development; Instrumentation Circuit Engineers; ME's for Signal Processing Modules; Consultant, Array Radar Subsystem Requirements.

**INVESTIGATE NOW!** For full information, send a résumé of your experience in confidence to J. L. Wool, Professional Placement, Heavy Military Electronics Dept., Section 127, General Electric Co., Court St., Syracuse, New York.

177-65

An Equal Opportunity Employer

**GENERAL  ELECTRIC**

# Most engineers are lucky to be in on a handful of space missions during a lifetime.

## In the next 5 years alone, you could help launch over 500

### like these:

GEMINI  
APOLLO  
MOL  
VOYAGER  
DISCOVERER  
BIOSATELLITE  
MARINER  
EXPLORER  
OAO  
OGO  
OSO  
PIONEER  
SERT  
SURVEYOR  
SMS  
SATURN 1-B & V  
TITAN III  
ATS  
MINUTEMAN  
PEGASUS  
IMP  
TIROS  
POSEIDON  
ETC.

#### Solving instrumentation problems like these:

**COMMUNICATIONS** Increase bandwidth and/or employ compaction techniques for expanded real-time bioastronautic, telemetry, and color TV data transmission...wideband data link using communication satellites.

**CW & PULSE RADAR** Improve sensitivity, reliability, and accuracy of GLOTRAC, MISTRAM and MIPIR...add multiple-slant-range measurement capability to down-range stations.

**TELEMETRY** Extend frequency coverage at all stations to 2300 mc...design a system which, upon command, will select the most important data from each station...replace obsolete telemetry equipment with modern receiving and recording stations...add automatic checkout and calibration.

**OPTICS** Add new fixed metric and tracking metric systems to cover increased launch activity...develop a new family of standard optical beacons for installation in missiles and space vehicles...new automatic optical calibration system...develop airborne optical systems equal in capability to ground telescopes.

**INFRARED** Add new high-resolution spectrometers for launch and re-entry coverage...new IR systems to extend mid-range coverage.

**RANGE SAFETY** Study and develop areas of explosive hazard assessment, including instrumentation to cover chemical fuel explosions and nuclear fuel excursions.

**INSTRUMENTATION & VEHICLE CONTROL** Add a 64-man central control at the Cape to direct operation of the entire range...new real-time dual-system computer facility (including 2 CDC 3600's) for failure-proof high-speed data handling.

**CORRELATION** Reduce time correlation uncertainty across the range to less than 10 microseconds...standardize the timing signal format on the Eastern Test Range to be compatible with other national ranges.

**FREQUENCY CONTROL & ANALYSIS** Monitor and control all electromagnetic radiation within the missile test area with a Spectrum Surveillance System...expand automatic interference control, spectrum signature collection, and quality analysis.

**METEOROLOGY** Improve cloud height and growth indication instrumentation...develop a system to measure atmospheric electrical potential and cloud movement.

**SHIP & AIRCRAFT INSTRUMENTATION** Improve the instrumentation to meet more stringent telemetry, navigation, tracking, communications, and data handling requirements...phase into operation new and/or modified tracking ships and aircraft.

**UNDERWATER SOUND** Refine the techniques employed to establish impact location points of nosecones and instrumentation cassetts.

**BIOASTRONAUTICS** Provide equipment to monitor and display physiological and environmental data to Air Force bioastronautic officers. Hook up this equipment into range computers and telemetry receiving sites.

#### In important technical and managerial positions like these:

Projecting program requirements and developing the advanced tracking system concepts required, including instrumentation, facilities, and logistic support.

Developing specifications for range instrumentation systems, evaluating bids from industry, monitoring development, fabrication, installation, and phasing of systems into operational status.

Planning, evaluating, and providing range support for all launches, coordinating all range support activities, providing data and command/destruct for range safety, and managing down-range island and ship stations.

Experience required in one or more of these areas: Pulse & CW radar / telemetry / infrared / data handling / communications / closed circuit TV / frequency analysis / command control / underwater sound / timing / shipboard instrumentation / meteorology.

Write to Manager, Professional Employment, Dept. 28B-3



## GUIDED MISSILES RANGE DIVISION

PAN AMERICAN WORLD AIRWAYS, INC.  
750 S. ORLANDO AVENUE, COCOA BEACH, FLORIDA  
An Equal Opportunity Employer M/F



## The shape of tomorrow, today

For more than 20 years, Ultra Carbon consistently has provided industry with advanced graphite technology. "F" purity graphite for the AEC ... semiconductor crystal crucibles, boats, headers and fixtures made from *Ultra purity* graphite—these are typical of our past contributions to the electronic industries.



ULTRA/FGP® flat glass packs for integrated circuits in 10 lead configuration are available from stock. For our catalog, write Ultra Carbon Corporation, Box 747, Bay City, Michigan 48709.

## New Literature

**Microwave packaging.** Bomac Division, Varian Associates, Salem Road, Beverly, Mass., has available a brochure describing the line of Bopac custom microwave packaging that solves interface problems, and relieves the systems designer of time-consuming search for compatible components.

Circle 420 on reader service card.

**Direct digital control.** Fischer & Porter Co., 522 Jacksonville Road, Warminster, Pa., 18974. Catalog 33 covers a multiple-channel time-shared digital system designed for the specific requirements of process control. [421]

**Microwave tubes.** Raytheon Co., Microwave and Power Tube Division, Waltham, Mass., has compiled a quick reference guide to principal specifications of more than 200 of the most widely used microwave tubes. [422]

**Circuit breakers.** Metals & Controls Inc., a corporate division of Texas Instruments Incorporated, 34 Forest St., Attleboro, Mass., 02703. Selection and application of precision circuit breakers are simplified by a new four-page bulletin describing the entire Klixon line. [423]

**R-f connectors.** Star-Tronics, Georgetown, Mass. An engineering data sheet deals with a line of subminiature and microminiature r-f connectors. [424]

**Aluminum knobs.** Atomite Electronics Corp., 119 Pleasant Ave., Roosevelt, L.I., N.Y., has published a brochure on aluminum control and instrument knobs that are custom designed and manufactured. [425]

**Self-locking fastener.** Robinson Vibration Shock Division, Robinson Technical Products Inc., Teterboro Air Terminal, Teterboro, N.J. Bulletin CS 65-7 describes self-locking fasteners designed for secure fastening and easy removal of mounted electronic equipment. [426]

**Telegraphy error corrector.** Codex Corp., 222 Arsenal St., Watertown, Mass., 02172. A detailed brochure covers the TD-12 solid state, compact telegraphy error corrector. [427]

**Solid state oscilloscope.** EMI Electronics Ltd., Hayes, Middlesex, England, offers a brochure describing the model 101 solid state oscilloscope, a portable, 3-inch general purpose unit. [428]

**Snap-action switches.** Cherry Electrical Products Corp., 1650 Old Deerfield Road, Highland Park, Ill., has available an article reprint giving a step-by-step description of how to find the right snap-action switch by the composite sketch method. [429]

**P-c production techniques.** Industrial Circuits Co., 99 Main Ave., East Paterson, N.J. Techniques for the production of printed circuits and assemblies for high reliability applications are detailed in a 12-page illustrated guide. [430]

**Pressure transducers.** ElectroSyn Technology Laboratories, Inc., 480 Neponset St., Canton, Mass., 02021. Bulletin 101 describes a line of miniature precision pressure transducers that utilize a 3-fluted straight Bourdon tube as the sensor. [431]

**Power supplies.** Trygon Electronics, Inc., 111 Pleasant Ave., Roosevelt, L.I., N.Y., 11575, has published a 52-page handbook, P965, which fully describes the company's complete line of standard power supplies and modules. [432]

**Laser metalworking systems.** Applied Lasers, Inc., 72 Maple St., Stoneham, Mass., 02180, offers an illustrated technical brochure describing a series of practical laser metalworking systems. [433]

**Solid state isolators.** Sperry Microwave Electronics Co., P.O. Box 1828, Clearwater, Fla. An illustrated, 8-page condensed catalog contains full information on 177 solid state isolator models available as a standard product line. [434]

**Bead thermistors.** Victory Engineering Corp., 122 Springfield Ave., Springfield, N.J., 07081, has published a technical bulletin on the type 33A9 glass-coated bead thermistors for microwave power measurement applications. [435]

**Magnetic pickups.** Airpax Electronics Inc., P.O. Box 8488, Fort Lauderdale, Fla., 33310. Bulletin F-8 discusses the application of magnetic pickups to tachometry, counting, positioning, motion study, timing, vibration measurement and synchronizing. [436]

**Data recording system.** Electronic Engineering Co. of California, 1601 East Chestnut Ave., Santa Ana, Calif., 92702. An eight-page brochure contains detailed information on the model 755 magnetic-tape data recording system. [437]

**Solid state multiplexers.** Astrodata, Inc., P.O. Box 3003, 240 E. Palais Road, Anaheim, Calif. A three-page brochure provides complete technical data on the series 970 solid state multiplexers. [438]

**Connectors.** Transitron Electronic Corp., Wakefield, Mass., has available a condensed catalog covering a complete line of standard and special-purpose connectors. [439]

**Photoetched lead frames.** Eburn Industrial Research Corp., 117 South Shore



Industrial Park, Hingham, Mass. Micro-circuit lead frames produced by photo-etching are described in technical data bulletin No. 11. [440]

**A-c standard.** Cohu Electronics, Inc., Box 623, San Diego, Calif., 92112. Technical data sheet 20-8 discusses the 601B a-c voltage standard with applications, specifications and block diagrams. [441]

**Pressure switches.** Cook Electric Co., Wirecom division, 2700 Southport Ave., Chicago, Ill., offers a booklet on custom set, diaphragm-type pressure switches that meet the high reliability requirements of original equipment manufacturers; they are economical and available for quick delivery for hydraulic or pneumatic applications. [442]

**Punched tape logger.** Fischer & Porter Co., 465 Jacksonville Road, Warminster, Pa., 18974, has published catalog 35-1545 describing a punched tape logger for automatic data processing. [443]

**Transistors and diodes.** General Instrument Corp., 600 W. John St., Hicksville, N.Y., 11802. Two new catalogs list and describe 145 types of germanium alloyed and diffused alloyed junction transistors and more than 200 types of germanium gold bonded diodes now available. [444]

**Digital systems capabilities.** The Foxboro Co., Foxboro, Mass. A 14-page brochure, bulletin L-17, illustrates the company's ability to accept total responsibility for design, fabrication and application of digital systems. [445]

**Mechanical differentials.** Globe Industries, Inc., 2275 Stanley Ave., Dayton, Ohio, 45404, offers bulletin D-500 giving information on a-c and d-c motor-driven mechanical differentials. [446]

**Mica insulating film & sheet.** Magnetic Shield division, Perfection Mica Co., 1322 N. Elston Ave., Chicago, Ill., 60622. Manual K-6 contains electrical and physical data on mica insulating film and sheet for the design engineer. [447]

**Resistance-to-current converters.** Instru-Lab, Inc., 1205 Lamar St., Dayton, Ohio, 45404, has issued a revised copy of its two-page data sheet 900-13 describing its Evenvolt resistance-to-current converters. The revision details additional input capability and wider output ranges. [448]

**Transmission line relationships.** PRD Electronics, Inc., 1200 Prospect Ave., Westbury, N.Y., 11590, offers Application Note No. 18, "Useful Tables and Graphs for Determining Transmission Line Relationships." [449]

**Laser safety handbook.** Martin Co., Orlando division, P.O. Box 5837, Orlando, Fla., has issued a booklet containing safety precautions for the casual laboratory visitor as well as detailed techniques and equations for establishing safe working environments for operating lasers. [450]

**We're into electronics  
up to our ears...**

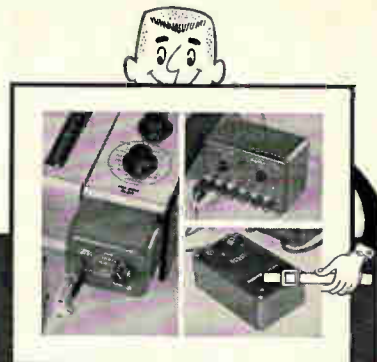

**that's why  
Bausch & Lomb V.O.M. Recorders  
ASSURE YOU  
outstanding performance!**

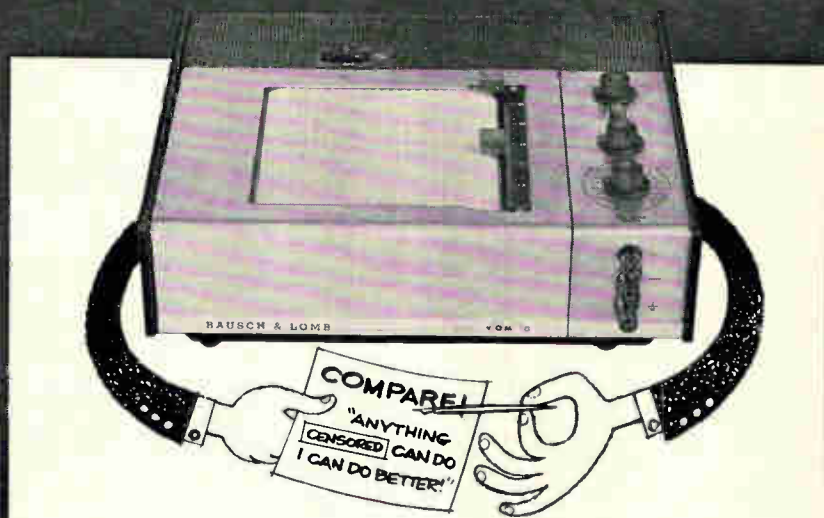

V.O.M. Recorders are backed by years of experience in engineering the most sophisticated electronic circuitry for a wide variety of precision scientific instruments. An entire division is devoted exclusively to the development and production of electronic products. Result? Outstanding performance and reliability... with exclusive important advantages for you at surprisingly low cost. Like recording multiple inputs... volts, ohms, milliamps... directly, without extra converters. Or the 5 chart speeds, and many more. People who buy them, like them and buy more. The V.O.M. Recorder in use is its own best salesman!

	V.O.M.-5	V.O.M.-6	V.O.M.-7	V.O.M.-8
Voltage range:	10 mv-500 v DC	2.5 mv-125 v DC	0.5 mv-10 v DC	Absorbance / Transmittance Measurement (voltage, current, resistance ranges same as V.O.M.-5)
Current range:	10 $\mu$ a-100 ma	2.5 $\mu$ a-25 ma	1 $\mu$ a-10 ma	
Resistance range:	1 ohm-100 K ohms	0.25 ohms-25 K ohms	1 ohm-100 K ohms	
Prices: (suggested list)	\$595 COMPLETE	\$700 COMPLETE	\$885 COMPLETE	\$900 COMPLETE

We also have the capability of designing special recorders... modified to handle whatever applications you wish. For complete information on our standard recorders and the many time-saving accessories available for them, write for Catalog 37-2068. Let us know if you are interested in modification for special needs. Bausch & Lomb, 62326 Bausch Street, Rochester, New York 14602.

**BAUSCH & LOMB**   
ELECTRONICS DIVISION

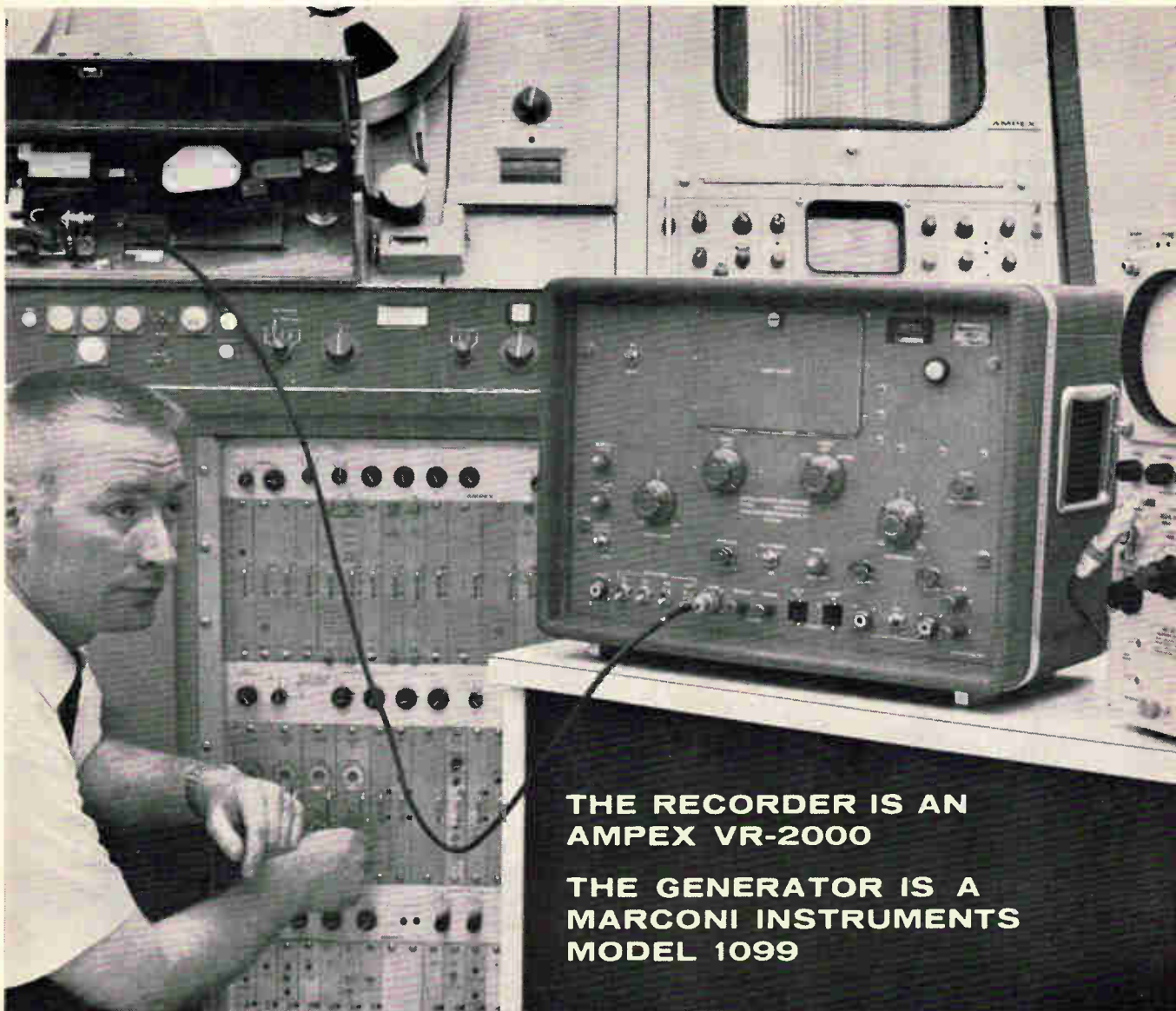

**THE RECORDER IS AN  
AMPEX VR-2000**

**THE GENERATOR IS A  
MARCONI INSTRUMENTS  
MODEL 1099**

## **Ampex uses the 1099 to align Color Video Heads and Amplifiers for Maximum Linearity**

Model 1099 sweeps from 0.1mc to 20mc with 1mc and 5 mc markers. Sweep is flat to 0.1dB with a maximum output of 3 volts p-p. The Sweep Generator uses special detector probes (supplied) to provide differential level, input/output, for exactly linearising networks and amplifiers and can discriminate to 0.02dB.



### **FOR YOUR TRANSMITTER -**

**Television Sideband Analyzer Model 2360 with  
UHF Adapter TM6936**

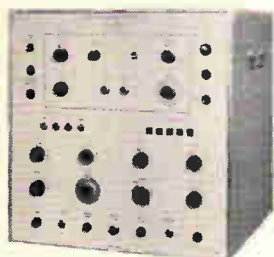

- tests channels 3 thru 83
- measures dynamic response of transmitter
- allows insertion of sync and blanking on internally generated sweep signal
- for steady state response use as sync mixer with external oscillator for trap setting etc.

*Write for your free copy of...*  
**MEASURING RESPONSE OF TV  
TRANSMITTERS**

# **MARCONI INSTRUMENTS**

DIVISION OF ENGLISH ELECTRIC CORPORATION  
111 CEDAR LANE, ENGLEWOOD, NEW JERSEY 07631  
(201) 567-0607

## Soviet Union

### Messages from the moon

With the transmission of pictures from the moon, Soviet scientists did more than surge at least three months ahead of the United States in the race to send men on the round trip. They also proved they had reduced America's biggest advantage in space: supremacy in electronic controls.

In steering Luna 9 to the moon, slowing it down from 6,000 miles an hour almost to a halt, then dropping it gently onto the moon from 10 feet up, the Russians demonstrated a high degree of expertise in computer technology and in telemetry. The maneuver, essential for a manned mission, is still to be perfected by the United States; it is the goal of the twice-delayed Surveyor program, whose first shot toward the moon is not expected before May.

**Timetable.** The Russians are expected to land several more stations on the moon this year. In the spring they plan to send into orbit a huge, manned space station, apparently equivalent to the manned Apollo that the United States expects to orbit early in 1967.

The Russians are expected to put stations onto the moon for longer periods this year, and in 1967 they are expected to land a mobile station.

As for a manned landing, however, Soviet scientists refuse to go on record with any prediction.

**Luna's progress.** Luna 9 was launched Jan. 31 into a parking orbit around the earth, but before it could complete one revolution it was kicked toward the moon by a final rocket stage. After the final stage was jettisoned, the station weighed 3,500 pounds. Nearly one-half of the weight—1,600 pounds—consisted of fuel for the braking rockets. The station itself weighed only about 220 pounds, consider-

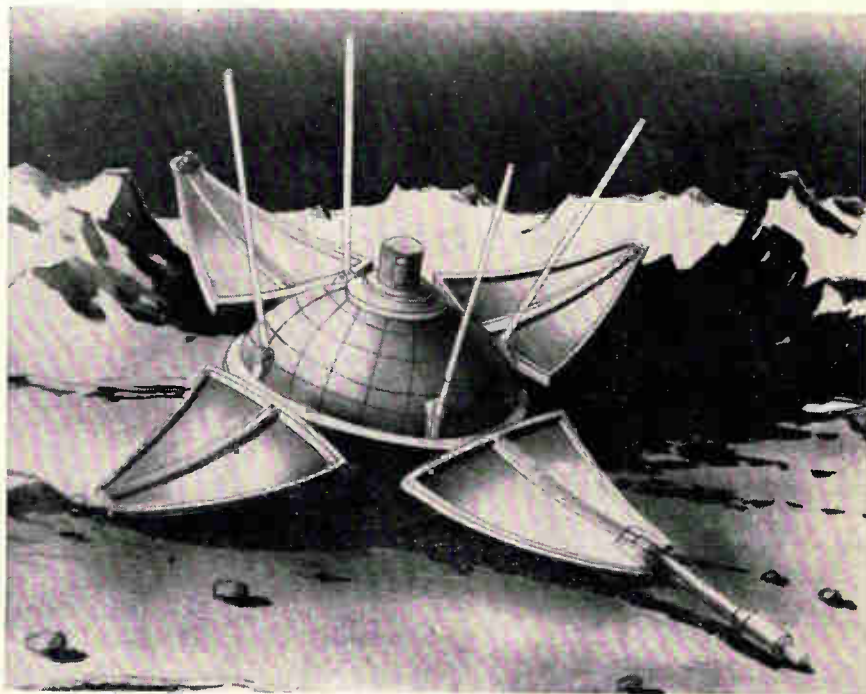

Luna 9, as conceived by Soviet artist, sprouts four antennas skyward after landing on the moon. Petal-like screens protect revolving tv camera.

ably less than the control package, whose exact weight was not disclosed by the Russians.

The original course would have missed the moon by 6,000 miles, but was corrected Feb. 1.

Between the time of the correction maneuver and the landing, the landing-control package aboard the spacecraft was fed information based on data gained from a computer center on earth. When all the information was in the ship's program, it was read back to earth for checking.

One delicate maneuver remained before landing: the ship had to be oriented with the moon's vertical axis. This was difficult because the ship was not moving directly toward the center of the moon, so that the vertical changed continuously with respect to the ship, requiring constant adjustments in orientation. This maneuver was made optically, using a gyroscope as a stabilizer.

Meanwhile, shipboard radar was making continuous measurements of Luna's altitude. The control cen-

ter on earth kept the ship on the lunar vertical for about an hour, then handed the task over to a shipboard computer seconds before the retrorockets were fired. The firing lasted 48 seconds; near the end of this period, four large petals folded out from the spherical station. The petals, made of light metal framing and covered with fine mesh, acted as stabilizers on the ground, also protecting the television camera and antennas from any dust that might be present on the moon's surface.

**On the moon.** Four minutes and 10 seconds after touchdown, Luna 9 established radio communication with earth. Its signals were picked up by six giant parabolic mirrors, mounted on towers several hundred feet high and moved by servomechanisms linked to a computer. The location of these receivers has not been disclosed; nor has the size, except that they make conventional radio telescopes look "Lilliputian," according to a Soviet journalist who has seen them. The antennas were connected to a re-

ceiving station 40 or 50 feet underground. This sensitive ground system was necessary because the transmitter's effective radiated power was less than one thousandth that of one on earth.

Luna's tv camera is said to be lightweight enough to be handled manually. It cannot be called a separate tv station, however, because the camera's circuitry is so closely meshed with telemetric equipment. The camera's main task was to examine small objects in its immediate vicinity, rather than long-range views. It photographed pebbles as small as 1 or 2 millimeters in diameter.

Mstislav Keldysh, chairman of the Soviet Academy of Sciences, says there was a bonus in the tv pictures because the spacecraft moved several inches between the second and third picture. The shift may have been caused by a deformation of the moon's surface or by uneven heating of the surface under the ship, causing buckling, he said. The movement may permit the Russians to build a three-dimensional picture of the moon.

**Experiments.** The most valuable information received from the moon consists of the tv pictures, but Luna 9 also made radiation measurements. The biggest discovery mentioned so far is the fact that the moon has background radioactivity which seems to be secondary radiation caused by bombardment by cosmic rays.

The biggest research task now, according to Moscow scientists, is to conduct further study of radiation around the moon. This should yield information about the moon's chemical composition, they say, and may also give some clues to its origin.

### Earthbound computers

Stung by charges that industry is misusing computers [Electronics Jan. 24, p. 187], the Soviet Union is experimenting with an organization patterned along American industrial lines and is considering tighter controls on the acquisition of electronic brains.

In the tiny republic of Lithuania,

the Soviet has combined several computer enterprises into a giant organization that will perform all functions, from designing the computer to building it to installing and servicing it. The amalgamation, to be called Sigma, will also consult with prospective users in the design of computing equipment.

In Leningrad, an influential scientist has urged the government to forbid an enterprise from buying a computer until it can prove an economic advantage and show sample software.

**Consolidation.** At present the Soviet computer industry is highly fragmented, with almost no communication between designer, producer and user. Computer operators are trained by institutes instead of by the manufacturers, and the machines are designed by other institutes instead of by the manufacturer, as in the United States.

From its headquarters in Vilnius, Sigma will administer several plants directly. It will also operate three design offices and a section engaged in installation and servicing of machines and in training of operators. The reorganization in Lithuania covers both process-control and business-data systems.

**Crackdown.** Tighter controls are advocated by L. Oganessian, a member of the Leningrad branch of the Academy of Sciences. He condemns a syndrome that he calls "the fashionable computer," in which a plant orders a computer for prestige reasons, then uses it improperly if at all.

In his own city of Leningrad, a survey of more than 100 computer installations showed recently that only 6 were operating at full capacity. More than 40 were working only one shift and several were not working at all, although some of these had been installed for as long as four years.

Oganessian blames the rigidity of operating procedures which, he says, makes it difficult for factory managers to change bookkeeping procedures to take advantage of computers. As a result, he says, most computers act as mechanized clerks, posting figures into ledgers according to procedures that were initiated in the 19th century.

## Japan

### Color tv on tape

A tape recorder for color television has been developed by the Sony Corp. for use in the home, but it will not be available until mid-1967. Akio Morita, executive vice president, says the color recorder will cost less than \$2,000 in the United States; black-and-white models, which were introduced last summer, can be converted to color for under \$1,000.

The two machines are very similar. To handle the additional information required for color, the half-inch tape is speeded up from 7.5 to 12 inches per second. Because the head's peripheral speed is much higher than the tape's speed, the color unit's helical tracks are nearly twice as wide as on the black-and-white recorder, permitting the addition of two recording heads to improve the signal-to-noise ratio. The color adapter fits into the part of the cabinet that now houses the nine-inch transistorized receiver. The black-and-white monitor would be of little use in the color recorder because a color receiver is needed for both recording and playback.

**Color compatible.** Compatibility of the two models is no accident, says Masaru Ibuka, president of Sony; it was one condition that had to be met before he ordered the black-and-white unit into production last year.

Because the color recorder uses tape one-half mil thick instead of one mil, a single reel will record for one hour despite the higher speed. In a prototype shown in Tokyo, resolution was about 250 lines and signal-to-noise ratio was better than 40 decibels.

To achieve the time-based stability necessary for an NTSC color recorder, Sony developed a recording signal which, it says, is different from any other major signal such as those used in Secam in France or in the PAL system in West Germany. During playback, the special Sony signal is transcoded to NTSC, the color-tv system used in Japan and in the United States.

Sony says its recorder can be adapted electrically to record any color signal, but in Europe this would also require mechanical modifications to both the color and the black-and-white recorders because of the different scanning rates in effect there. The revolving heads' scanning speed would have to be changed from 30 to 25 revolutions per second.

Initially Sony does not expect to offer a color camera for use with the recorder, so the machine will be limited to recording commercial telecasts. However, the company says it will offer a color tuner as an accessory for use when the best results are desired.

**Long lead time.** Why did Sony announce the color recorder so far ahead of the delivery date? The company gives two reasons:

- To reassure buyers of black-and-white machines that those recorders can be converted to color. Sony has sold more than 1,500 recorders in the U. S., Morita says, and does not want customers to worry about obsolescence.

- To try to influence standards committees to adopt Sony's specifications so the company can become dominant in the video-tape recorder field.

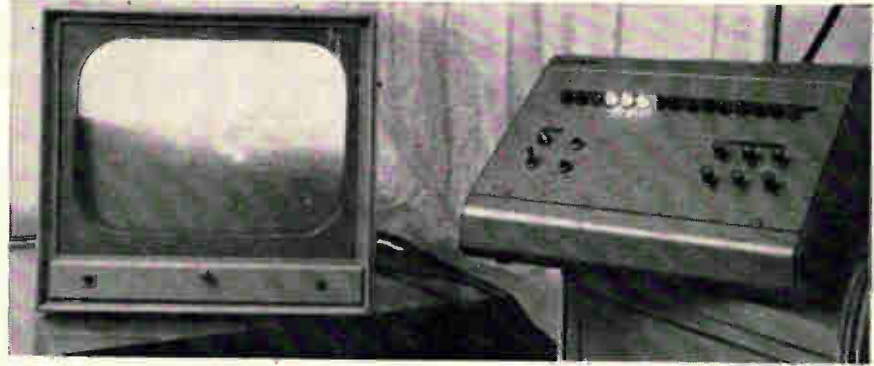

Remote reading of runway visibility is provided by instrument panel at right, which controls marker lights and the tv camera trained on them. Operator steps out the system until the farthest of three runway lights is invisible on the tv screen.

system, developed by Ateliers de Constructions Electriques de Charleroi (ACEC), is basically a closed-circuit tv whose camera has a remote-controlled zoom lens with the focal length ranging from 50 to 500 millimeters.

At present, the system takes remote readings of visibility on all runways at an airport. Eventually it could become part of a plane's instrument-landing-system display, providing digital readout in the cockpit of the visibility on the runway.

**Light after light.** In the Brussels installation, the camera is trained on a row of standard 200-watt marker lights, offset 75 meters from the edge of the runway. The lights are 50 meters apart over the first 500 meters, then at 100-meter intervals out to 1,200 meters.

If the entire row of lights—parallel to the regular runway lights—were lit continuously, it would confuse pilots coming in to land. So the weather-eye system powers only three adjacent visibility-reading lights at a time. Control circuits, which switch the marker lights on and off, are closed by contacts on the focusing-ring cam of the zoom lens. This link between lights and lens, together with a tilting mechanism, insures that the camera is focused on the three lamps that are lit.

To take a remote reading, the meteorologist works with a control panel and the tv receiver. He steps out the system, one light at a time, as long as three lights are clearly visible on the screen. The lights go on in a sequence of three—first,

second and third; then second, third and fourth; then third, fourth and fifth; and so on. When he reaches the visibility limit, the closest of the three lights will show brightly, the middle one will be barely perceptible and the farthest will not be visible. He can then read the visibility—the distance to the center light—directly off the control panel, which tells which three lamps are lighted.

A change in visibility shows up on the screen as a light becoming visible or fading out. The operator turns a light on or off to get a new reading.

For the systems that will follow the prototype, ACEC is planning some improvements. One would eliminate the receiver screen. The system would step automatically until the amplitude of the signal from the closest of the lighted lamps equalled the sum of the other two. At this point, stepping would stop and a visibility value would be displayed on a digital readout. The readout would also be relayed automatically to aircraft locked in on the airport's instrument-landing system.

## Belgium

### Weather eye

Airports the world over employ the services of a variety of electronic instruments, but the best estimates of visibility continue to be made with a pair of human eyes trained upon marker lights along the runways. On the long runways required for today's jet aircraft, an accurate reading in fog sometimes requires three men making simultaneous observations over the full length of a runway.

Meteorologists may soon have the help of a television weather-eye. Such a visibility-reading system is being tested at the Brussels Airport, and has attracted the attention of aviation officials from France, Italy and Luxemburg. The

## France

### Counterattack in IC's

In an attempt to prevent American domination of their domestic market, France's three major producers of integrated circuits are considering combining their research resources. One approach being dis-



## financeability

(low, low interest rates)

In WESTern PENNSylvania, you can obtain 100% financing of industrial plant space at average interest rates as low as 3¾%. This can result in savings of as much as \$84,632 on a 62,000-square-foot industrial plant. In addition, financing of industrial machinery and equipment and loans for working capital are readily available. This complete



financeability . . . plus a fair tax climate . . . pre-production training of a work force, usually at no cost to you . . . four-season livability . . . gives WESTern PENNSylvania a top combination of plant-location values.

### WEST PENN POWER

an operating unit of ALLEGHENY POWER SYSTEM

Area Development Department, Room 661  
WEST PENN POWER—Greensburg, Pa. 15602  
Phone: 412-837-3000

In strict confidence, I'd like to know more about WESTern PENNSylvania's:  Financing Plans  Fair Tax Climate  
 Pre-Production Training  Industrial Properties and Shell Buildings  
 Please have your Plant Location Specialist call.

Name \_\_\_\_\_  
Title \_\_\_\_\_  
Company \_\_\_\_\_  
Address \_\_\_\_\_  
City \_\_\_\_\_ State \_\_\_\_\_  
Code \_\_\_\_\_ Phone \_\_\_\_\_

cussed is outright merger. Another is an agreement whereby each French company would specialize in the development of a limited number of circuit types.

Companies taking part in the informal talks are La Radiotechnique, Sesco and Cossem. La Radiotechnique is controlled by Philips Gloeilampenfabrieken N.V. of the Netherlands; Sesco is owned 51% by the Compagnie Francaise Thomson-Houston and 49% by the General Electric Co.; Cossem is controlled by the Compagnie Générale de Télégraphie Sans Fil (CSF).

**American competition.** The most active American company in France is Texas Instruments Incorporated, which operates a semiconductor plant in Nice. The Fairchild Camera & Instrument Corp. has a foothold through its one-third interest in SGS Fairchild, Ltd., a British company with facilities in France. Another U.S. concern, Motorola, Inc., has requested permission to build a factory in France.

The French are worried about competition from these giant American corporations, each of them two or three years ahead of the French in semiconductor technology. American companies already receive most of the European orders for military and space applications, including orders from the Paris government.

The French strategy seems to be to hold on, as they did with transistors, until integrated-circuit technology becomes stable enough to justify big investments in production facilities. But Jean Marie, semiconductor product manager at La Radiotechnique, says, "The situation is worse with integrated circuits than it was with transistors." One reason is that the French are further behind in IC's than they were in transistor technology. Another difficulty is that the American companies now have European factories, which they lacked in the early days of transistors.

As might be expected, the three French concerns have begun IC production with logic devices. Marie says La Radiotechnique will produce at least 100,000 IC's this year; Antoine Laroche, marketing

manager at Sesco, says his company will make "many tens of thousands." Xavier Ameil, assistant director of CSF's physical-chemical research department, says Cossem will be producing IC's at a 100-a-day rate by June.

## West Germany

### Time to share

While its competitors were advancing their computer lines, Telefunken AG stayed so quiet that there was speculation that West Germany's second-largest electronics company might be bowing out of the computer business.

Last month the company put such rumors to rest. Telefunken disclosed details of a new digital machine, the TR 440, the first German-designed computer with time-sharing capability. With the TR 440, Telefunken hopes to increase its 1.7% share of the German computer market, which puts it in sixth place behind the International Business Machines Corp.—at 72%—the Univac division of the Sperry Rand Corp., Siemens & Halske AG, Zuse AG and Bull-General Electric, the joint venture of GE and the French Compagnie de Machines Bull.

The TR 440, being developed at Telefunken's 2,000-man data-processing equipment plant in Constance, near the Swiss border, is scheduled for delivery early next year. The cost of a medium-size installation—including peripheral equipment, remote data stations and external memory units—is about \$1.75 million.

**Built with IC's.** The TR 440, intended for commercial and scientific applications, has a central processor made with monolithic integrated circuits built at the company's semiconductor plant in Heilbronn.

To appeal to all kinds of customers, Telefunken will supply a repertoire of software, including program languages such as Algol, Fortran, Cobol 65, PL-1 and PERT. Besides multiprogramming, the TR 400's time-sharing capability is ex-

pected to find increased applications in Germany by next year. Time-sharing allows many users to carry on a dialogue with a computer at once, even remotely over telephone lines.

**Eleven times faster.** Telefunken says the TR 440 is 11 times faster than its predecessor, the TR 4, the only other machine with which the TR 440 is compatible. Of Telefunken's TR-4 line of computers, 13 are installed in Germany, two in the Netherlands and one in France, where it is being used for air-traffic control at the Eurocontrol center.

Using a 52-bit word, the TR 440 can add and subtract fixed-point numbers in 0.4 microsecond. With a floating decimal point, add or subtract time is 1.4 microseconds. Multiplication speed is 2.8 microseconds for both types of decimal points. Division speed is 12 microseconds, also with both types of decimal points.

The ferrite-core memory of 65,536 words, expandable to 262,144 words, has an average access time of 0.3 microsecond. The machine's cycle time is also 0.9 microsecond.

---

### Around the world

---

**Japan.** The Soviet Union is showing increasing interest in Japanese electronics. The Russians have arranged to buy \$32.4 million worth of electronic equipment there, including machinery for the manufacture of electronic products.

**Italy.** Italy seems to have written off France's Secam system of color television. The Ministry of Post and Telecommunications is testing the NTSC system used in the United States and the PAL approach taken in West Germany.

**Malaysia.** The government has been asked to tighten controls on banned radio and electrical equipment slipping into the country from Communist China. The prohibitions have been imposed to protect local industries against cheap imports, but Malaysia companies say Chinese goods are entering the country with Hong Kong labels.

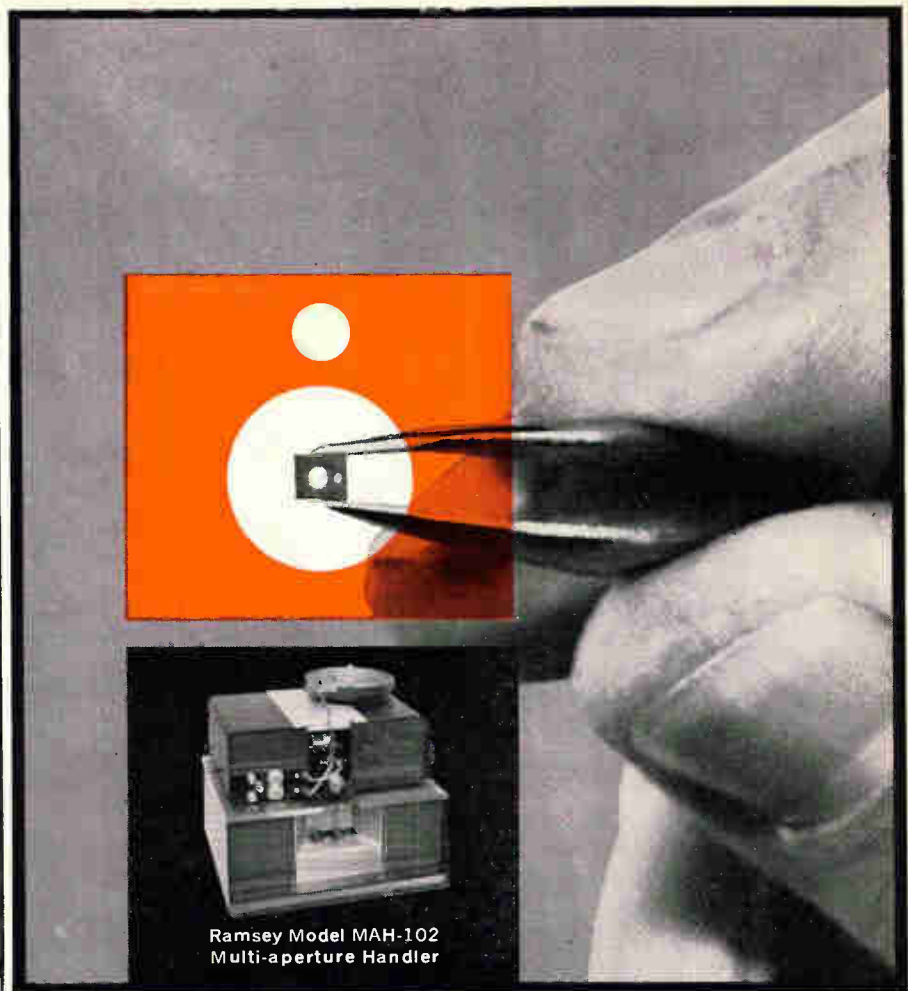

Ramsey Model MAH-102  
Multi-aperture Handler

## two-hole memory cores are no tougher to test than one-hole cores

Taking advantage of the non-destructive readout feature of two-hole cores used to be a problem. They were too tough and too expensive to handle and test. The lack of an automatic high speed core handler that could precisely orient and probe the different size holes necessitated manual testing on a sampling basis to keep costs down. It also kept reliability down. To make matters worse, the two-hole core required a more complex test program than the conventional one-hole ferrite. This meant applying limited tests in a number of successive passes through the test system. Again, time consuming and expensive. The Ramsey MAH-102 Handler and the Computer Test Model C-301 Automatic Memory Core Tester, however, have changed all that. Now, every two-hole core can be comprehensively and economically tested for 100% reliability at rates up to 12,000 cores per hour. We will be happy to give you details on how the system works.



COMPUTER TEST CORPORATION

CHERRY HILL, NEW JERSEY

# Electronics advertisers

February 21, 1966



■ AMP Incorporated Garceau, Hargrave & McCullough Inc.	58, 59	Cohu Electronics Erwin Wasey, Ruthrauff & Ryan Inc.	75	■ General Electric Company Miniature Lamp Dept Batten, Barton, Durstine & Osborn Inc.	141
Acromag Inc. Watkins Rogers Incorporated	220	Comcor Inc. Sub. of Astrodata Inc. Marketing Directions Inc.	65	■ General Electric Company Silicone Products Dept. Ross Roy Inc. Advertising	130
Acopian Corporation Mort Barish Associates Inc.	216	Computer Test Corporation James Lees Inc.	239	General Radio Company K. E. Morang Company	2nd Cover
Adage Incorporated Fuller, Smith & Ross Inc.	44	■ Controls Company of America The Harry P. Bridge Company	174, 175	□ Globe Industries Inc. Odiorne Industrial Adv. Inc.	222, OAS 3
Aerocom Grant Advertising Inc.	222	Couch Ordnance Inc. Culver Advertising Inc.	198	Granger Associates West Associates	8
Aerospace Research Inc. Sales Promotion Services	186	Cross Company, H. Milchar Adv. Inc.	196		
Airpax Electronics Inc. Welch Mirabile & Company Inc.	162	Crystalonics Inc. Impact Advertising Inc.	55		
Alpha Wire Corporation Div. of Loral Corp. Campbell Ewald Company	132				
Amelco Semiconductor Div. of Teledyne Inc.: Sturges & Associates	54	■ Dale Electronics Inc. Swanson, Sinkey, Ellis Inc.	66	Hamilton Standard Div. of United Aircraft Corp.	191
■ Ammom Instruments Inc. Culver Advertising Inc.	226	Dalmo Victor Company Pierce & Strain Advertising	151	Heinemann Electric Company Thomas R. Sundheim Incorporated	64
Amperite Company H. J. Gold Company	202	□ Delevan Electronics Corp. Clayton A. Stahlka Adv.	OAS 4	■ Hewlett Packard Company 1, 2, 20, 21, Lennen & Newell Inc.	41
Amphenol RF Div of Amphenol Corporation Marsteller Inc.	215	Delta Products Inc. Ball & Davidson Inc.	214	Honeywell Meter Division Batten, Barton, Durstine & Osborn Inc.	209
■ Astrodata Inc. Bonfield Associates Inc.	148	The Deutsch Company Jordan Farrell Inc.	129	■ Hughes Aircraft Company Foote, Cone & Belding	227
■ Automatic Electric Company Tatham-Laird & Kudner Inc.	124	Di-Acro Corporation Charles E. Brown Adv.	173	Hurst Mfg. Corporation Hathaway Adv. Agency & General Adv. Associates Inc.	177
		Digital Equipment Corporation Kalb & Schneider Inc.	22	■ Hysol Corporation Barber & Drullard Inc.	156
		Douglas Aircraft Company J. Walter Thompson Company	218		
■ Ballantine Laboratories Inc. Lang-Lawrence Advertising Inc.	185	■ DuPont de Nemours & Company Inc. E.I. Mylar Div. Batten, Barton, Durstine & Osborn Inc.	123	International Business Machines Benton & Bowles Inc.	221
Bausch & Lomb Inc. Wolff Associates Inc.	233	■ Dymec Div. of Hewlett Packard Lennen & Newell Inc.	145	Indium Corporation of America Inc. Darvoe, Breck & MacFarland Inc.	220
Beckman Instrument Inc. Helipot Div Hixson & Jorgensen Inc.	63			Indiana General Corporation The Griswold Eshleman Company	199
Beckman Instrument Inc. Offner Div Hixson & Jorgensen Inc.	78	Electro Scientific Industries Nadler & Larimer Inc.	226	Industrial Electronic Engineers Inc. Gumpertz, Bentley & Dolen Inc.	186
The Bendix Corporation Scintilla Div MacManus John & Adams Inc.	213	Emerson & Cuming Edwin F. Hall	241	□ Intertek Pema	OAS 2
Blackstone Ultrasonics Inc. Carr Liggett Adv. Inc.	177	Engelhard Industries Inc. Keyes, Martin & Company	210, 211	IRC Incorporated Gray & Rogers Inc.	27, 28
■ Biley Electric Company Barber & Drullard Inc.	196	Erie Technological Products Inc. Altman Hall Associates	205	ITT Jennings L. H. Waldron Advertising	157
Borden Chemical Company, Mystik Tape Division Robert Conahay Inc.	62	Esterline Angus Instrument Company Caldwell, Larkin & Sidener Van Riper Inc.	80		
■ Brush Instruments, Div. of Clevite Corp. Carr Liggett Adv. Inc.	3rd Cover			■ JFD Electronics Corp. Michel Cather Inc.	197
Bud Radio Inc. Allied Advertising Agency Inc.	167	■ Fairchild Controls Dunwoodie Associates Inc.	207	James Electronics Inc. Burton Browne Inc.	181
■ Burndy Corporation Ted Gravenson Inc.	169	Fairchild Electro-Metrics Corporation Herbert Lindauer Associates	182	Janitrol Aero Division Midland Ross Corp. Odiorne Industrial Advertising Inc.	170
■ Bussmann Mfg. Co. Div. of McGraw Edison Co. Henderson Advertising Company	194, 195	Fairchild Instrumentation The Wexton Company Inc.	134	Jerrold Electronics Corporation Irving Gould Advertising Inc.	14
		■ Fairchild Semiconductor Corp. Faust/Day Inc. Advertising	57	Johanson Mfg. Corporation Josephson, Cuffari & Company	180
Computer Measurements Company Charles Bowes Advertising Inc.	72	Ferroxcube Corporation of America De Garmo Inc.	17	Johnson & Company, E. F. Firestone Adv. Inc.	122
Celanese Corporation of America West, Weir & Bartel Inc.	193	Fiberfil Inc. Tri-State Advertising Inc.	198		
Centralab Electronics Strall Advertising Inc.	159, 160	Fluke Mfg. Co. John Bonfield Associates Inc.	15		
Cherry Electrical Products Corp. K & A Inc.	191	Formica Corporation Perry Brown Adv. Inc.	217		
Chuo Electronics Co. Ltd. Standard Advertising Inc.	214				
■ Cinch Graohik Div. of United Carr Fastener Co. Reach, McClinton & Company	188	Garlock Electronics Products Inc. Richardson, Thomas & Bushman Inc.	138, 140		
■ Clairex Corporation Michel Cather Inc.	180	■ General Electric Company George R. Nelson Inc.	18, 19, 56 101, 102, 208		
Clare & Company, C. P. Reincke, Meyer & Finn Adv.	52, 53	■ General Electric Company Lamp Metals & Components Dept. Dix & Eaton Inc.	206	■ For more information on complete product line see advertisement in the latest Elec- tronics Buyers' Guide	
■ Clifton Precision Products Div. of Litton Industries Ivey Advertising Inc.	24			□ Advertiser in Overseas Edition	

Executive, editorial, circulation and advertising offices: McGraw-Hill Building, 330 West 42nd Street, New York, N.Y., 10036. Telephone (212) 971-3333. Teletype TWX N.Y. 212 640-4646. Cable: McGrawhill. N.Y. Officers of the McGraw-Hill Publications: Joseph H. Allen, President; Vice Presidents: J. Elton Tuohig, Operations; John R. Callahan, Editorial; Ervin E. DeGraff, Circulation; Donald C. McGraw, Jr., Advertising Sales; Angelo R. Venezian, Marketing. Officers of the Corporation: Donald C. McGraw, Chairman of the Board; Shelton Fisher, President; L. Keith Goodrich, Hugh J. Kelly and Robert E. Slaughter, Executive Vice Presidents; John J. Cooke, Vice President and Secretary; John L. McGraw, Treasurer. Title R registered U.S. Patent Office; © copyright 1966 by McGraw-Hill, Inc. All rights reserved, including the right to reproduce the contents of this publication, in whole or in part.







## Adhesive Backed SHIELDMU

**FASTER TO APPLY**

high permeability  
magnetic shielding  
tape and foil with  
adhesive backing!

- protects your sensitive electronic and electrical components against electro-magnetic interference
- strips to expose an adhesive that grips components firmly
- eliminates taping and spot welding
- cuts with scissors to provide an easier way to form shields firmly in place
- offers 2 to 3 times more shielding efficiency than material currently available
- offers ductility without significant degradation of magnetic shielding properties
- is available in 4 levels of permeability performance

Write, wire or call your local electronic distributor. He has Adhesive Backed SHIELDMU packaged to meet your needs on spools and in individual sampler albums. Or, contact:

*Russell Industries, Inc.*

96 Station Plaza, Lynbrook, N. Y. 11563  
Phone: (516) 887-9000

Product of  
**MAGNETIC METALS COMPANY**  
also manufacturers of:

Transformer Laminations • Motor Laminations • Tape Wound Cores • Powdered Molybdenum Permalloy Cores • Electro-magnetic Shielding • Metallurgical Services • Custom Heat Treating • Photo Etched Precision Parts

Texas Instruments Incorporated Semiconductor Div. Don L. Baxter Inc.	47
Transformer Electronics Company Dacy Wolff & Associates	212
Transitron Electronics Corp. Larcom Randall Adv. Inc.	184
Trio Laboratories Inc. Zam & Kirshner Inc.	158
Trygon Electronics Inc. Wexton Company	38
Trymetrics Div. of Trygon Wexton Company	164

Ulano Company, J. Byrde, Richard & Pound Inc.	43
Ultra Carbon Corporation Church and Guisewite Inc.	232
■ Uniform Tubes Inc. Michener Company, The	139
Unitrode Corporation Electronic Marketing Assistance	35
Union Carbide Corporation J.M. Mathes Incorporation	121

Varian Associates Hoefler, Dieterich & Brown Inc.	155
Vector Div. of United Aircraft Cunningham & Walsh Inc.	143
Vidar Corporation Hal Lawrence Inc.	153
■ Vitro Corporation of America Buchen Advertising Inc.	178

Wavetek Chapman McQuiston Suzuki & Wright Advertising	39
West Penn Power Fuller & Smith & Ross Inc.	238

### Classified advertising

F.J. Eberle, Business Mgr.  
**EMPLOYMENT OPPORTUNITIES** 229-231

**EQUIPMENT**  
(Used or Surplus New)  
For Sale 229

### ADVERTISERS INDEX

Electric Trading Co.	229
Fishman, Co., P.	229
Gadgeteers Surplus Electronics Inc.	229
General Electric Co.	
Heavy Military Electronics Dept.	230
General Surplus Elect.	229
Monmouth Electric Co., Inc.	229
New York State Dept. of Civil Service	229
Pan American World Airways Inc.	231
Radio Research Instrument Co.	221
Semiconductor Sales of Calif.	221

■ For more information on complete product line see advertisement in the latest Electronics Buyers' Guide

□ Advertiser in Overseas Edition



### Advertising sales staff

**Gordon Jones [212] 971-2210**

Advertising sales manager

Atlanta, Ga. 30309: Gus H. Krimsier, Michael H. Miller, 1375 Peachtree St. N.E., [404] TR 5-0523

Boston, Mass. 02116: William S. Hodgkinson McGraw-Hill Building, Copley Square, [617] CO 2-1160

Chicago, Ill. 60611: Robert M. Denmead, J. Bradley MacKimm 645 North Michigan Avenue, [312] MO 4-5800

Cleveland, Ohio 44113: Paul T. Fegley, 55 Public Square, [216] SU 1-7000

Dallas, Texas 75201: Richard P. Poole, The Vaughn Building, 1712 Commerce Street, [214] RI 7-9721

Denver, Colo. 80202: Joseph C. Page, David M. Watson, Tower Bldg., 1700 Broadway, [303] 255-5484

Detroit, Michigan 48226: Paul T. Fegley 856 Penobscot Building [313] 962-1793

Houston, Texas 77002: Kenneth George, 2270 Humble Bldg., [713] CA 4-8381

Los Angeles, Calif. 90017: Ian C. Hill, John G. Zisch, 1125 W. 6th St., [213] HU 2-5450

Minneapolis, Minn. 55402: J. Bradley MacKimm 1104 Northstar Center (612) 332-7425

New York, N. Y. 10036: Donald R. Furth [212] 971-3615 Frank LeBeau [212] 971-3615 George F. Werner [212] 971-3615 500 Fifth Avenue

Philadelphia, Pa. 19103: William J. Boyle, Warren H. Gardner, 6 Penn Center Plaza, [215] LO 8-6161

Pittsburgh, Pa. 15222: Paul T. Fegley, 4 Gateway Center, (412) 391-1314

Portland, Ore. 97204: James T. Hauptli, Pacific Building, Yamhill Street, (503) CA3-5118

St. Louis, Mo. 63105: Robert M. Denmead The Clayton Tower, 7751 Carondelet Ave. [314] PA5-7285

San Francisco, Calif. 94111: James T. Hauptli, 255 California Street, [415] DO 2-4600

London W1: John W. Patten, Edwin S. Murphy Jr., 34 Dover Street, Hyde Park 1451

Milan: 1, via Baracchini Phone: 86-90-617 86-90-656

Frankfurt/Main: Gerd Hinske, 85 Westendstrasse Phone: 77 26 65 and 77 30 59

Geneva: Michael R. Zeynel, Joseph Wuensch, 1, rue du Temple Phone: 31 95 60

Paris VIII: Denis Jacob, 17 Avenue Maignon ALMA-0452

Tokyo: Nobuyuki Sato, 1, Kotohiracho Shiba, Minato-Ku (502) 0656

Osaka: Ryosi Kobayashi, 163, Umegee-cho, Kita-ku [362] 8771

Hugh J. Quinn: [212] 971-2335 Manager Electronics Buyers' Guide

David M. Tempest: [212] 971-3139 Promotion manager

Milton Drake: [212] 971-3485 Market research manager

Wallace C. Carmichael [212] 971-3191 Business manager

Theodore R. Geipel: [212] 971-2044 Production manager

# Electronics reader service

Use these handy post cards for more detailed information on: products advertised, new products, new literature.

Circle the number on the Reader Service post card that corresponds to the number at the bottom of the advertisement, new product item, or new literature in which you are interested.

Please print clearly. All written information must be legible to be efficiently processed.

If someone has beaten you to the post cards, you may obtain the needed information by writing directly to the manufacturer, or by sending your name and address, plus the Reader Service number, to Electronics Reader Service department.

All inquiries from outside the U.S. that cannot reach Electronics before the expiration dates noted on the Reader Service post card, must be mailed directly to the manufacturer. The manufacturer assumes all responsibilities for responding to inquiries. Electronics merely provides and clears requests for information from inquirer to manufacturer.

Correct amount of postage must be affixed for all mailings from outside the U.S.

## To subscribe to or to renew Electronics

Fill in the "For Subscriptions" area on the card if you desire to subscribe to or renew your present subscription to Electronics. Send no money. Electronics will bill you at the address indicated on the Reader Service post card.

## Multi-product advertisements

For information on specific items in multi-product advertisements which do not have a specific Reader Service number indicated write directly to manufacturer for information on precise product in which you are interested.

February 21, 1966 Card Expires April 21, 1966 14

4

Name \_\_\_\_\_ title \_\_\_\_\_

Company \_\_\_\_\_

Address \_\_\_\_\_

For Subscriptions  
 new  renewal  
 3 years \$12.00  
 1 year \$6.00

1 20 39 58 77 96 115 134 153 172 191 210 229 248 267 286 305 324 343 362 381 400 419 438 457 476 495 514 962  
 2 21 40 59 78 97 116 135 154 173 192 211 230 249 268 287 306 325 344 363 382 401 420 439 458 477 496 515 963  
 3 22 41 60 79 98 117 136 155 174 193 212 231 250 269 288 307 326 345 364 383 402 421 440 459 478 497 516 964  
 4 23 42 61 80 99 118 137 156 175 194 213 232 251 270 289 308 327 346 365 384 403 422 441 460 479 498 517 965  
 5 24 43 62 81 100 119 138 157 176 195 214 233 252 271 290 309 328 347 366 385 404 423 442 461 480 499 518 966  
 6 25 44 63 82 101 120 139 158 177 196 215 234 253 272 291 310 329 348 367 386 405 424 443 462 481 500 900 967  
 7 26 45 64 83 102 121 140 159 178 197 216 235 254 273 292 311 330 349 368 387 406 425 444 463 482 501 901 968  
 8 27 46 65 84 103 122 141 160 179 198 217 236 255 274 293 312 331 350 369 388 407 426 445 464 483 502 902 969  
 9 28 47 66 85 104 123 142 161 180 199 218 237 256 275 294 313 332 351 370 389 408 427 446 465 484 503 951 970  
 10 29 48 67 86 105 124 143 162 181 200 219 238 257 276 295 314 333 352 371 390 409 428 447 466 485 504 952 971  
 11 30 49 68 87 106 125 144 163 182 201 220 239 258 277 296 315 334 353 372 391 410 429 448 467 486 505 953 972  
 12 31 50 69 88 107 126 145 164 183 202 221 240 259 278 297 316 335 354 373 392 411 430 449 468 487 506 954 973  
 13 32 51 70 89 108 127 146 165 184 203 222 241 260 279 298 317 336 355 374 393 412 431 450 469 488 507 955 974  
 14 33 52 71 90 109 128 147 166 185 204 223 242 261 280 299 318 337 356 375 394 413 432 451 470 489 508 956 975  
 15 34 53 72 91 110 129 148 167 186 205 224 243 262 281 300 319 338 357 376 395 414 433 452 471 490 509 957 976  
 16 35 54 73 92 111 130 149 168 187 206 225 244 263 282 301 320 339 358 377 396 415 434 453 472 491 510 958 977  
 17 36 55 74 93 112 131 150 169 188 207 226 245 264 283 302 321 340 359 378 397 416 435 454 473 492 511 959 978  
 18 37 56 75 94 113 132 151 170 189 208 227 246 265 284 303 322 341 360 379 398 417 436 455 474 493 512 960 979  
 19 38 57 76 95 114 133 152 171 190 209 228 247 266 285 304 323 342 361 380 399 418 437 456 475 494 513 961 980

2

**Business reply mail**  
 No postage stamp necessary if mailed in the United States

Postage will be paid by

**Electronics  
 Reader service department  
 Box 444  
 Hightstown, N.J. 08520**

First class  
 Permit no. 42  
 Hightstown, N. J.

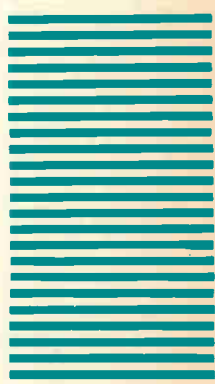

February 21, 1966 Card Expires April 21, 1966 14

4

Name \_\_\_\_\_ title \_\_\_\_\_

Company \_\_\_\_\_

Address \_\_\_\_\_

For Subscriptions  
 new  renewal  
 3 years \$12.00  
 1 year \$6.00

1 20 39 58 77 96 115 134 153 172 191 210 229 248 267 286 305 324 343 362 381 400 419 438 457 476 495 514 962  
 2 21 40 59 78 97 116 135 154 173 192 211 230 249 268 287 306 325 344 363 382 401 420 439 458 477 496 515 963  
 3 22 41 60 79 98 117 136 155 174 193 212 231 250 269 288 307 326 345 364 383 402 421 440 459 478 497 516 964  
 4 23 42 61 80 99 118 137 156 175 194 213 232 251 270 289 308 327 346 365 384 403 422 441 460 479 498 517 965  
 5 24 43 62 81 100 119 138 157 176 195 214 233 252 271 290 309 328 347 366 385 404 423 442 461 480 499 518 966  
 6 25 44 63 82 101 120 139 158 177 196 215 234 253 272 291 310 329 348 367 386 405 424 443 462 481 500 900 967  
 7 26 45 64 83 102 121 140 159 178 197 216 235 254 273 292 311 330 349 368 387 406 425 444 463 482 501 901 968  
 8 27 46 65 84 103 122 141 160 179 198 217 236 255 274 293 312 331 350 369 388 407 426 445 464 483 502 902 969  
 9 28 47 66 85 104 123 142 161 180 199 218 237 256 275 294 313 332 351 370 389 408 427 446 465 484 503 951 970  
 10 29 48 67 86 105 124 143 162 181 200 219 238 257 276 295 314 333 352 371 390 409 428 447 466 485 504 952 971  
 11 30 49 68 87 106 125 144 163 182 201 220 239 258 277 296 315 334 353 372 391 410 429 448 467 486 505 953 972  
 12 31 50 69 88 107 126 145 164 183 202 221 240 259 278 297 316 335 354 373 392 411 430 449 468 487 506 954 973  
 13 32 51 70 89 108 127 146 165 184 203 222 241 260 279 298 317 336 355 374 393 412 431 450 469 488 507 955 974  
 14 33 52 71 90 109 128 147 166 185 204 223 242 261 280 299 318 337 356 375 394 413 432 451 470 489 508 956 975  
 15 34 53 72 91 110 129 148 167 186 205 224 243 262 281 300 319 338 357 376 395 414 433 452 471 490 509 957 976  
 16 35 54 73 92 111 130 149 168 187 206 225 244 263 282 301 320 339 358 377 396 415 434 453 472 491 510 958 977  
 17 36 55 74 93 112 131 150 169 188 207 226 245 264 283 302 321 340 359 378 397 416 435 454 473 492 511 959 978  
 18 37 56 75 94 113 132 151 170 189 208 227 246 265 284 303 322 341 360 379 398 417 436 455 474 493 512 960 979  
 19 38 57 76 95 114 133 152 171 190 209 228 247 266 285 304 323 342 361 380 399 418 437 456 475 494 513 961 980

# Reprint service

All Electronics editorial matter available in reprint form:

For reprints of special reports and feature articles see list on right side of this page. Send your order to Electronics Reprint Department at the address indicated. To expedite mailing of your order for single reprints please send cash, check or money order with your order.

Bulk reprints of editorial matter can be ordered from current or past issues. The minimum quantity is 100 copies. The higher the quantity ordered, the more economical the cost per copy. Prices quoted on request.

To order reprints or for further information, please write to: **Electronics Reprint Department, 330 West 42nd Street, New York, N.Y. 10036.** Telephone: Area code 212 971-3140.

Prices for the below listed reprints unless otherwise specified are 1-10 copies 50¢ each; 11-24 copies 35¢ each; 25-99 copies 25¢ each; price for 100 or more is 20¢ each.

You may order any of the below listed reprints by key number.

- Key no. R-85 **U.S. Electronics Markets 1966** 24 page forecast report with 6 page foldout chart.
- Key no. R-84 **European Electronics Markets 1966.** 16 pages with 4 page foldout chart.
- Key no. R-83 **A Look At Japanese Electronics Technology.** 36 pages.
- Key no. R-82 **Time-Sharing Computers.** 20 pages.
- Key no. R-80 **The Packaging Revolution In Microelectronics** (2 Part series, 32 pages). \$1.00

- Key no. R-79 **MOS Integrated Circuits** 12 pages.
- Key no. R-78 **The Overlay Transistor** 15 pages.
- Key no. R-77 **Cold Cathode Tubes** (3 part series, 28 pages).
- Key no. R-76 **Automated Trains: Who's On The Right Track?** 16 pages.
- Key no. R-75 **Biotelemetry** [2 Part series 16 pages].
- Key no. R-74 **Unijunction Transistors,** 24 pages.
- Key no. R-73 **Communications on Gemini** 24 pages.

- Key no. R-71 **Experiments On Gemini** 28 pages.
- Key no. R-69 **1964 Complete Electronics Index** 40 pages. \$1.00
- Key no. R-68 **Designing Against Space Radiation,** 18 pages.

- Key no. R-66 **Field Effect Transistors, Part III** 16 pages.
- Key no. R-65 **Field Effect Transistors, Part II** 24 pages.
- Key no. R-64 **Field Effect Transistors, Part I** 24 pages.
- Key no. R-63 **Silicon Power Transistors** 8 pages. 25¢
- Key no. R-61 **Direct Digital Control in Industry,** 24 pages.
- Key no. R-60 **Transistor Heat Dissipators,** 32 pages.
- Key no. R-31 **1962 Electromagnetic Spectrum Chart,** [22" x 30" foldout chart]. \$1.00
- Key no. R-30 **Graphical Symbols For Electronic Diagrams,** [29" x 11" foldout chart].

3

**Business reply mail**  
No postage stamp necessary if mailed in the United States

Postage will be paid by

**Electronics**  
**Reader service department**  
**Box 444**  
**Hightstown, N. J. 08520**

First class  
Permit no. 42  
Hightstown, N. J.



4 February 21, 1966 Card Expires April 21, 1966 14

Name \_\_\_\_\_ title \_\_\_\_\_

Company \_\_\_\_\_

Address \_\_\_\_\_

For Subscriptions  
 new  renewal  
 3 years \$12.00  
 1 year \$6.00

1	20	39	58	77	96	115	134	153	172	191	210	229	248	267	286	305	324	343	362	381	400	419	438	457	476	495	514	962
2	21	40	59	78	97	116	135	154	173	192	211	230	249	268	287	306	325	344	363	382	401	420	439	458	477	496	515	963
3	22	41	60	79	98	117	136	155	174	193	212	231	250	269	288	307	326	345	364	383	402	421	440	459	478	497	516	964
4	23	42	61	80	99	118	137	156	175	194	213	232	251	270	289	308	327	346	365	384	403	422	441	460	479	498	517	965
5	24	43	62	81	100	119	138	157	176	195	214	233	252	271	290	309	328	347	366	385	404	423	442	461	480	499	518	966
6	25	44	63	82	101	120	139	158	177	196	215	234	253	272	291	310	329	348	367	386	405	424	443	462	481	500	900	967
7	26	45	64	83	102	121	140	159	178	197	216	235	254	273	292	311	330	349	368	387	406	425	444	463	482	501	901	968
8	27	46	65	84	103	122	141	160	179	198	217	236	255	274	293	312	331	350	369	388	407	426	445	464	483	502	902	969
9	28	47	66	85	104	123	142	161	180	199	218	237	256	275	294	313	332	351	370	389	408	427	446	465	484	503	951	970
10	29	48	67	86	105	124	143	162	181	200	219	238	257	276	295	314	333	352	371	390	409	428	447	466	485	504	952	971
11	30	49	68	87	106	125	144	163	182	201	220	239	258	277	296	315	334	353	372	391	410	429	448	467	486	505	953	972
12	31	50	69	88	107	126	145	164	183	202	221	240	259	278	297	316	335	354	373	392	411	430	449	468	487	506	954	973
13	32	51	70	89	108	127	146	165	184	203	222	241	260	279	298	317	336	355	374	393	412	431	450	469	488	507	955	974
14	33	52	71	90	109	128	147	166	185	204	223	242	261	280	299	318	337	356	375	394	413	432	451	470	489	508	956	975
15	34	53	72	91	110	129	148	167	186	205	224	243	262	281	300	319	338	357	376	395	414	433	452	471	490	509	957	976
16	35	54	73	92	111	130	149	168	187	206	225	244	263	282	301	320	339	358	377	396	415	434	453	472	491	510	958	977
17	36	55	74	93	112	131	150	169	188	207	226	245	264	283	302	321	340	359	378	397	416	435	454	473	492	511	959	978
18	37	56	75	94	113	132	151	170	189	208	227	246	265	284	303	322	341	360	379	398	417	436	455	474	493	512	960	979
19	38	57	76	95	114	133	152	171	190	209	228	247	266	285	304	323	342	361	380	399	418	437	456	475	494	513	961	980

1

**Business reply mail**  
No postage stamp necessary if mailed in the United States

Postage will be paid by

**Electronics**  
**Reader service department**  
**Box 444**  
**Hightstown, N.J. 08520**

First class  
Permit no. 42  
Hightstown, N. J.



For research labs and rolling mills and everything in between...

# The Incomparable Brush Mark 200.

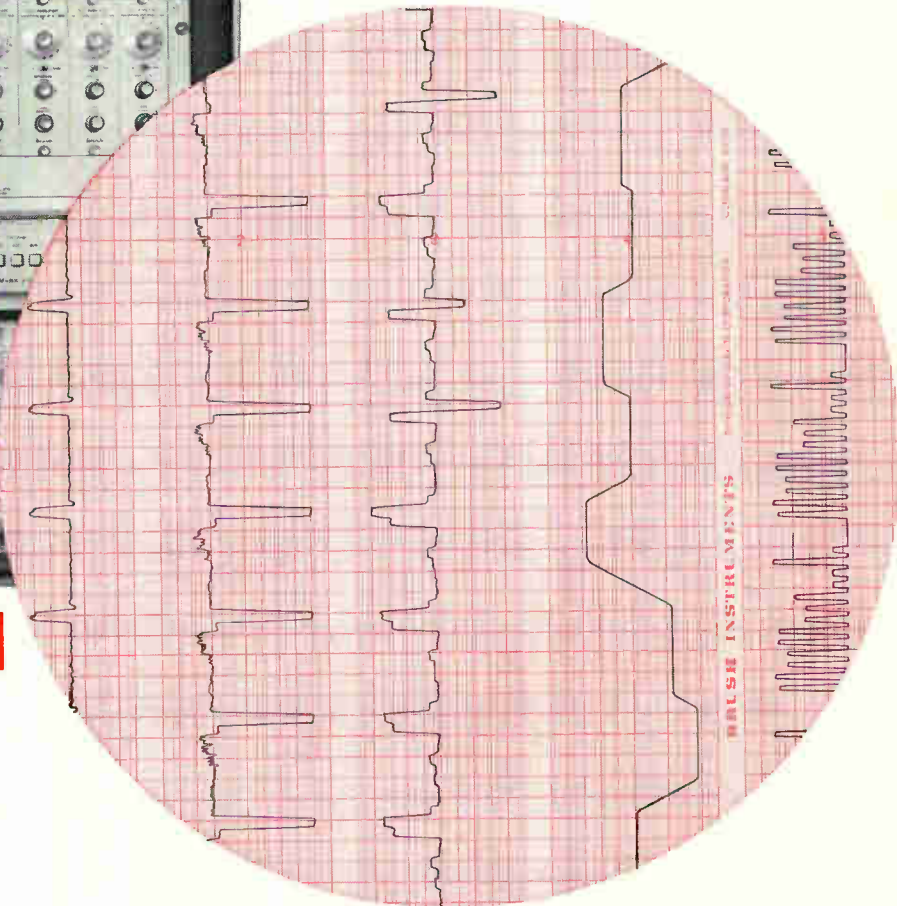
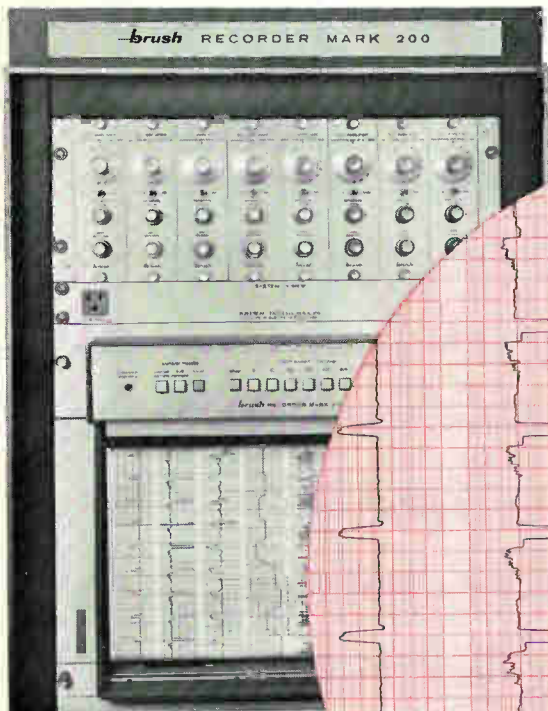

**The record  
speaks  
for itself!**

Look again.

Only one direct writing recording system in the world will give you such incredibly crisp traces: the Brush Mark 200. No wonder people call it "the finest ever built!"

That's what we had in mind when we designed it.

That's why Mark 200 Systems have a patented Hydrostatic Inking System that puts the trace *into* the paper . . . not just on it. And a unique, reliable pen position feed-

back system that delivers *total* system accuracy of better than  $\frac{1}{2}\%$ ! Plus a totally new pen linkage that assures *true* rectilinear writing.

But that's not all. Thanks to modular sub-systems, we can match a Mark 200 to your specific requirements *without* special engineering time and costs. Choice of three different penmotors . . . thirty-two pre-amplifiers . . . vertical or horizontal oscillographs. Any combination you want for any recording job

that comes along.

But words alone don't do the Mark 200 justice.

The only way to *really* appreciate a Mark 200 is to see one perform. And with well over 20,000 channels now operating across the country, a demonstration under actual field conditions is easy. Ask your Brush representative. Or write for our free booklet. Brush Instruments Division, Clevite Corporation, 37th and Perkins, Cleveland, Ohio 44114.

**brush** **CLEVITE**  
INSTRUMENTS DIVISION

Circle 901 on reader service card

# NO NO

**NEW  
RCA  
SILICON...  
2N4036—  
2N4037**

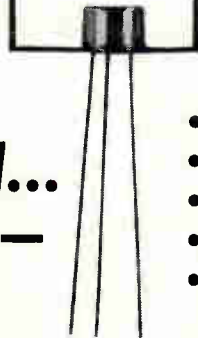

- audio output drivers
  - saturated switches
  - complementary core driver circuitry
  - low-level complementary audio output
  - series regulator pass transistor drivers
- available in production quantities for under a dollar\***

Now, meet your total circuit design needs with 2N4036 and 2N4037—new silicon p-n-p transistors from RCA in the popular TO-5 package. Geared toward applications requiring negative polarities, these two units are the first of a series of versatile p-n-p transistors designed to complement RCA's famous "universal" 2N2102 family.

RCA's 2N4036 and 2N4037 are new p-n-p epitaxial planar silicon transistors for simplifying circuitry. In many designs, you can now replace two n-p-n types with one p-n-p, or eliminate an inverter, transformer, or phase transformer stage.

Capable of delivering 1 watt free air, or 7 watts with heat sink at 25°C, these p-n-p transistors neatly fill the design gap for predriver/driver, medium power, and small signal applications with high heat dissipation capability. And for this performance, you can't beat the price—under a dollar in quantity.

See your RCA Representative for details on 2N4036 and 2N4037. For technical data sheets, write: RCA Commercial Engineering, Section 1N3-1, Harrison, N.J.

MAXIMUM RATINGS		
	2N4036	2N4037
$V_{CB0}$	—90V	—60V
$V_{CE0}$	—65V	—40V
$V_{EB0}$	—7V	—7V
$I_C$	—1.0A	—1.0A
$\theta_{J-C}$	25° C/W	25° C/W

\*\$.98 and \$.79 each for 2N4036 and 2N4037, respectively, in quantities of 1000 and up.

VISIT RCA AT IEEE. SEE WORLD PREMIERE OF "THE OVERLAY TRANSISTOR, THE CHALLENGE AND THE ANSWER." RCA BOOTHS 1F04-1F10, 1G03-1G11.



**Also Available from your RCA Distributor**

RCA Electronic Components and Devices

**The Most Trusted Name in Electronics**

Circle 902 on reader service card