

Electronics®

Getting the most out of feedback: page 66

Mechanizing to vie with Asian transistors: page 84

More on time sharing: page 93

January 24, 1966

75 cents

A McGraw-Hill Publication

Below: Mass-produced diode with beam-lead construction: page 77



ROLAND KISSLER
BOX 956
MOSES LAKE WASH



PULSE INSTRUMENTS



Type 1217-C



Type 1398-A



Type 1397-A

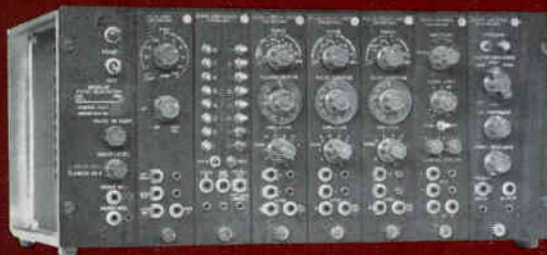

Type 1395-A

High Performance at Minimum Cost

Type 1217-C Unit Pulse Generator is a new model whose applications are many and varied, ranging all the way from testing high-speed computing circuits to physiological pulse simulation.

Pulse Repetition Frequency: controllable internally from 2.5 c/s to 1.2 Mc/s or externally from dc to 2.4 Mc/s.

Rise and Fall Times: 12 ns.

Pulse Duration: adjustable from 100 ns to 1.1 s.

Output: positive and negative 40-mA current pulses available simultaneously; adjustable to 40 V, peak. Positive and negative sync pulses and a delayed synchronizing pulse are also provided. Single pulses obtainable with the accessory Type 1217-P2 Single-Pulse Trigger (\$25).

Price: \$275 in U.S.A.

This generator requires an external power supply, such as GR's Type 1203 Unit Power Supply, \$65 in U.S.A.

Fast Rise and Fall Times

Type 1398-A Pulse Generator is basically a Type 1217-C Unit Pulse Generator (see above) with a self-contained power supply, higher output, and improved output-pulse characteristics. Rise and fall times are less than 5 ns, and the output consists of positive and negative 60-mA current pulses, providing 60 V across the 1-k Ω internal load impedance.

Price: \$535 in U.S.A.

Linear Amplifier with 1.2-Ampere Output

Type 1397-A Pulse Amplifier output pulses have typical rise and fall times of 50 ns when used with Types 1217-C or 1398-A Pulse Generators. Can also be used as a pulse shaper with rise and fall times continuously adjustable from 0.1 to 100 μ s.

Price: \$495 in U.S.A.

Produce Any Pulse You May Want

With the Type 1395-A Modular Pulse Generator, you can order only the pulse-generating capability you require. Five different modules are available, and as many as seven modules can be inserted in the main frame. Modules can be arranged in 38,400 different combinations.

Buy a main frame and as many modules as you need to custom-build your own pulse generator.

PRF Unit: provides internally generated repetition rates from 2.5 c/s to 1.2 Mc/s, from dc to 2 Mc/s when driven externally. Can use 7 per frame. Price: \$160 in U.S.A.

Pulse/Delay Unit: delays input pulses from 100 ns to 1 s and adjusts amplitude, polarity, and duration. Can use 7 per frame. Price: \$190 in U.S.A.

Pulse Shaper: adjusts rise and fall times from 100 ns to 10 ms, either individually or simultaneously. Limit of 3 per frame. Price: \$375 in U.S.A.

Power Amplifier: delivers 20-V pulses of either polarity into a 50-ohm load. Limit of one per frame. Price: \$270 in U.S.A.

Word Generator: produces binary words up to 16 bits long; as many as seven modules can be cascaded to provide 112-bit capability. Can use 7 per frame. Price: \$400 in U.S.A.

Main Frame: contains power supply and other circuits that are common to all modules. Price: \$575 in U.S.A. (without modules).

Write for Complete Information

GENERAL RADIO COMPANY
WEST CONCORD, MASSACHUSETTS

BOSTON • NEW YORK • CHICAGO • PHILADELPHIA • WASHINGTON, D.C. • SYRACUSE • DALLAS • SAN FRANCISCO • LOS ANGELES • ORLANDO • CLEVELAND — TORONTO • MONTREAL
GENERAL RADIO COMPANY (Overseas), ZURICH GENERAL RADIO COMPANY (U.K.) Ltd., BOURNE END, ENGLAND

Circle 900 on reader service card

0 kc.
 nts from 50 cps
 nts from 100 ohms
 rejection of all
 measurements.
 minimizes
 re, 200 3-wire
 its for group
 es input cabling
 for periodic data
 r go/no-go
 from diode

APPLICATION

Dymec Data Acquisition Systems are used to measure analog data derived from various sources, and to display a record of this information in digital form. To present the information in its most useful medium, systems are available with a choice of output recording media. For direct reading, by the operator, output on paper tape is provided. On-line recording, if the data is to be entered into a computer, may be recorded on punched paper tape, magnetic cards, or digital magnetic tape, as appropriate.

Data Acquisition Requirements?



...Just turn to an hp Data Sheet!

Feature	2013 Series (economy)	2010 Series (noise rejection)	2015 Series (speed, accuracy)	2017 Series (readout in engr. units)
Number of Input Channels	25 (2-wire) or 50 (1-wire) 2013 A-D	25 (3-wire) expandable to 100 2010A, B, E, H	25 (3-wire) expandable to 100 2015A, B, E, H	25 (3-wire) expandable to 100 2017A, B, E, H
	25 (3-wire) expandable to 100 2013 J-M	200 (3-wire) or 100 (6-wire) 2010C, D, F, J	200 (3-wire) or 100 (6-wire) 2015C, D, F, J	200 (3-wire) or 100 (6-wire) 2017C, D, F, J
Noise Rejection	NMR 30 dB at 60 c/s (filter)	inf. at 60 c/s (integrating)	inf. at 60 c/s	20 db min. all freqs. (integrating)
	ECMR	At least 105 dB all frequencies (f < 100 Hz)		
DC Voltage Range	10, 100, 1000 V. fs	0.1, 1, 10, 100, 1000 V. fs	1, 10, 100, 1000 V. fs	0.1, 1, 10, 100, 1000 V. fs
Resolution (mV/digit)	100 μV 10 μV with amplifier	1 μV standard 0.1 μV with amplifier	10 μV	1 μV standard 0.1 μV with amplifier
Accuracy (% rdg.)	.05%	.015%	.005%	.015%
Max. Speed, Readings/Sec. DC Volts	1.7 (4 digits)	18 (3 digits) 7 (4 digits) 1 (5 digits)	12 (5 digits)	18 (3 digits) 7 (4 digits) 1 (5 digits)
Optional Measurement Capability	AC voltage, resistance, dc current	AC voltage, resistance (frequency is standard)	AC voltage, resistance	AC voltage, resistance (frequency is standard)
Programming		standard with DY-2901A; add DY-2911C or DY-2560A with DY-2911		
Types of Output Recording	Printed strip, typewriter, punched tape, cards	Printed paper strip, perforated tape, punched card (IBM 526), magnetic tape		
Price Range (Basic System)	\$4495 - \$6000	\$8310 - \$18 550	\$8160 - \$18 400	\$10,960 - \$21,200

If you have a data acquisition application, just call your Hewlett-Packard field engineer for a solution... from a data sheet. Dymec Division offers 32 basic configurations of standard medium-speed systems, one of which is sure to solve the problem. They're completely spec'd, field proved, right off a production line (without special engineering)—and the economy of "off-the-shelf" delivery is passed along to you.

The four basic lines of systems are briefly specified in the chart. They differ primarily in the basic measuring instrument, and each series offers a wide variety of measuring parameters and an equally wide assortment of recorded outputs, including printed paper tape, perforated tape, punched card, magnetic tape and typewritten record.

For accurate measurement of low-level signals, especially in the presence of noise problems, look at the 2010 Series. For economical systems, offering a wide variety of voltmeter plug-in capabilities, the 2013 Series. High-speed, high-accuracy data acquisition can be solved by the 2015 Series, while data acquisition from transducers with readout in engineering units (i.e., psi, rpm, °C or F) at the time of measurement is possible with the 2017 Series.

Complete information is available (on data sheets) from your Hewlett-Packard field engineer. Or write Hewlett-Packard, Dymec Division, 395 Page Mill Road, Palo Alto, California 94306, Tel. (415) 326-1755; Europe: 54 Route des Acacias, Geneva.

Data subject to change without notice. Prices f.o.b. factory.



NEW

Hewlett-Packard Multi-function Meter

For Just
\$195

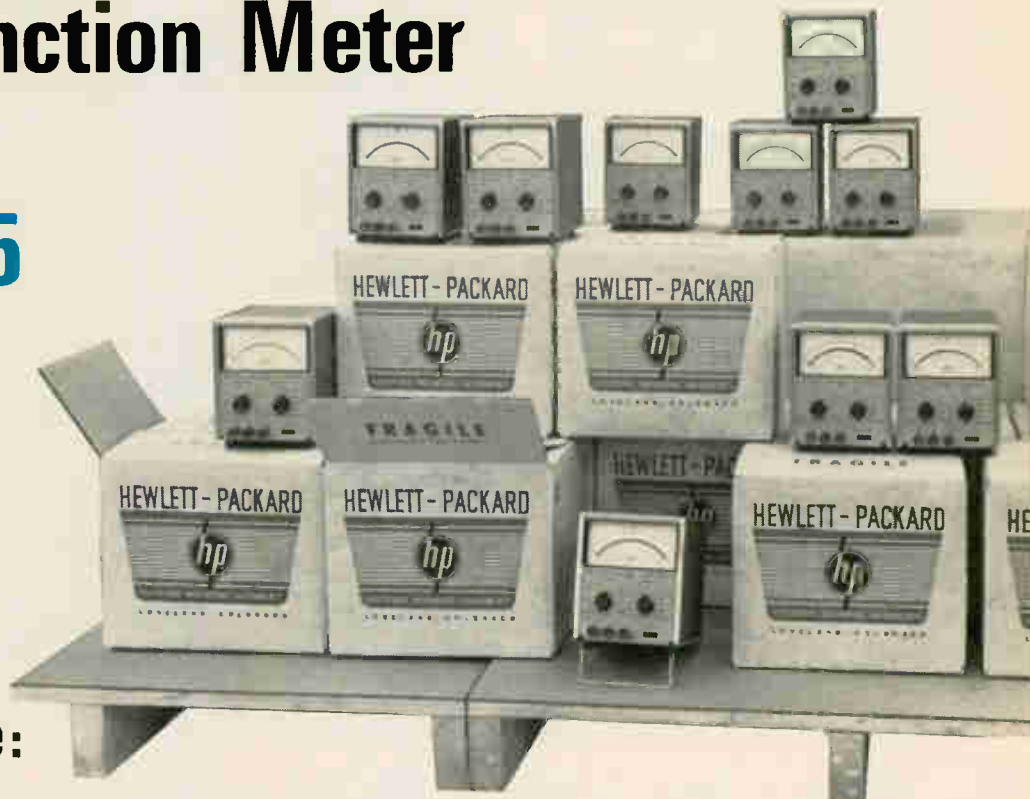

Accurately Measure:

DC Voltage ± 100 mv to ± 1000 v full scale ($\pm 2\%$ accuracy)

AC Voltage 10 mv to 300 v rms full scale, 10 Hz to 1 MHz ($\pm 2\%$ accuracy)

Resistance 10 ohms to 10 megohms center scale ($\pm 5\%$ of midscale reading accuracy)

Here's Hewlett-Packard quality in a low-cost, solid-state, battery-operated multi-function meter, the new hp 427A!

And you can get it for the lowest cost—check it against *any* comparable instrument!

Minimum zero drift. For dc measurements you get 1 mv resolution. The ac meter is average-responding, calibrated in rms volts. Only one zero set for dc and resistance measurements... no need to re-zero when switching from dc to ohms measurements... seldom "zero" on the 1 v range and above.

Long battery life. Basically battery operated (battery supplied), the 427A uses a dry-cell battery with a regulator; front-panel battery check provided, reads under load regardless of range switch setting. 300 hours' typical operation per battery. AC-battery operation, 115/230 v, 50-1000 cps, optional for \$35 additional.

Floating input. Performance is the story: Broad measuring capability, high accuracy, at low cost. Floating input, 10-megohm input impedance and common ter-

minals for ac and dc, high resolution with 9 ranges for dc coverage, 10 ranges for ac, 7 for resistance. Individually calibrated taut-band meter. Has overload protection for all functions.

Highest value. The hp 427A is a *real buy*... the best instrument of its type you can find... at a price that gives you the best available performance at the lowest available price (\$195). There's no other meter to match it.

If you *need* a demonstration, call your Hewlett-Packard field engineer. If you merely need to know complete performance specifications in order to get this low-cost measurement tool working for you, write Hewlett-Packard, Palo Alto, Calif. 94304, Tel. (415) 326-7000; Europe: 54 Route des Acacias, Geneva.

1051

HEWLETT  **PACKARD**
An extra measure of quality

Data subject to change without notice. Price f.o.b. factory.

Electronics

January 24, 1966
Volume 39, Number 2

Page	4	Readers Comment
	8	People
	14	Meetings
	16	Meeting Preview
	23	Editorial
	25	Electronics Newsletter
	45	Washington Newsletter
	141	New Products
	179	New Books
	180	Technical Abstracts
	185	New Literature

Electronics Review

Page	31	Bargain submersible	36	Frequency shift
	32	Symbolic victory	36	Green light for infrared?
	32	Fail-safe?		
	33	Jawohl for AOSO	38	Wired for talk
	34	Apollo's footprint	38	Superconductor forc
	34	Wire tester	40	Electronics notes

Probing the News

123	Rendezvous—first step on the long trip home
128	Sealab II went swimmingly
134	Clash of symbols

Electronics Abroad

187	The computer gap	190	Computers for Sofia
188	Betting on computers	190	Halting tv production
188	Boxcars check in	191	Around the world
189	Road to STARdom		

Technical Articles

I. Design

Circuit design	66	Getting the most out of feedback Information helps designers turn out better amplifiers and requires less adjustment of hardware Neale A. Zellmer, Lenkurt Electric Co.
Circuit design	73	Designer's casebook <ul style="list-style-type: none">■ Bias control and low parasitics shorten amplifier rise time■ Power supply reduces ripple by varying series resistance■ One-shot multivibrator with zero recovery time■ Fast-pulse amplifier drives 50-ohm load
Solid state	77	Beam-lead construction for diodes Mass production starts on a new, reliable diode that is its own package J.E. Thomas and Alan S. Esbitt, General Instrument Corp.

II. Manufacturing

Production	84	Belting out transistors on mechanized lines By strip bonding, General Electric has automated packaging of plastic encapsulated semiconductors George Sideris, Manufacturing editor
------------	----	---

III. Applications

Computers	93	Special Report: Time sharing; part II Better hospital care through time sharing Hospital computer system frees the staff for better patient care G.O. Barnett, Massachusetts General Hospital and J.H. Hughes, Bolt Beranek and Newman, Inc.
	97	Time-shared troubleshooter repairs computers Breakdowns are found and repaired while users continue to feed in programs Jesse T. Quatse, Carnegie Institute of Technology
	102	Fast-moving queue for better computer service A technique for small routine production jobs is more efficient than handling programs in parallel John A. Buckland, Sperry Rand Corp.

Electronics

Editor: Lewis H. Young

Senior editors

Technical: Samuel Weber

News: Kemp Anderson Jr.

Senior associate editors: John F. Mason, George Sideris

Department editors

Advanced technology: Joan Blum

Avionics: W.J. Evanzia

Circuit design: Michael Elia

Computers: Wallace B. Riley

Consumer electronics: Richard Lipkin

Electronics review: Stanley Zarowin

Instrumentation: Carl Moskowitz

Manufacturing: George Sideris

Military electronics: John F. Mason

New products: William P. O'Brien

Solid state: Jerome Eimbinder

Space electronics: Peter R. Sigmund

Regional editors

Bonn: John Gosch

Boston: Thomas Maguire, editor; Robin Carlson

London: Derek Barlow

Los Angeles: William B. Wallace, Walter Barney, editors; June Ranill

San Francisco: Laurence D. Shergalis, Edmond G. Addeo, editors; Mary Jo Jadin

Tokyo: Charles Cohen

Copy editors

Howard Rausch, Sally Powell, Kenneth Munn, James J. Moran

Graphic design

Art director: Saul Sussman

Assistant art director: Donna M. Griffiths

Editorial production: Ann Mella

Production editor: Arthur C. Miller

Editorial secretaries: Claire Benell, Mary D'Angelo, Lynn Emery, Lorraine Fabry, Kay Fontana, Lorraine Longo, Carolyn Michnowicz

McGraw-Hill News Service

Director: John Wilhelm; **Atlanta:** Fran Ridgway; **Chicago:** Reck Johnson;

Cleveland: Arthur Zimmerman; **Dallas:** Marvin Reid;

Detroit: N. Hunter; **Houston:** Ron Lovell; **Los Angeles:** Michael Murphy, Gerald Parkinson;

San Francisco: Margaret Ralston;

Seattle: Ray Bloomberg; **Washington:** Arthur L. Moore, Charles Gardner, Herbert W. Cheshire, Seth Payne, Warren Burkett, Warren Kornberg

McGraw-Hill World News Service

Bonn: John Johnsrud; **Brussels:** Arthur Erikson; **London:** John Shinn;

Mexico City: Bruce Cross; **Milan:** Ronald Taggiasco;

Moscow: Donald Winston; **Paris:** Dan Smith;

Rio de Janeiro: Leslie Perry; **Tokyo:** Marvin Petal

Circulation manager: Hugh J. Quinn

Reprints: T.M. Egan

Publisher: C.C. Randolph

Electronics: January 24, 1966, Vol. 39, No. 2

Printed at 99 North Broadway, Albany, N.Y., 12207
Second class postage paid at Albany, N.Y.

Subscriptions are solicited only from those actively engaged in the field of the publication. Position and company connection must be indicated on orders. Subscription prices: United States and Possessions and Canada, \$6.00 one year, \$9.00 two years, \$12.00 three years. All other countries: \$20.00 one year. Single copies, United States and Possessions and Canada 75¢. Single copies all other countries \$1.50.

Published every other Monday by McGraw-Hill Inc. 330 West 42nd Street, New York, N.Y. 10036. Founder: James H. McGraw, 1860-1948.

Subscribers: The Publisher, upon written request to our New York office from any subscriber, agrees to refund that part of the subscription price applying to copies not yet mailed. Please send change of address notices, subscription orders or complaints to Fulfillment Manager, Electronics, at the address below. Change of address notices should provide old as well as new address, including postal zone number if any. If possible, attach address label from recent issue. Allow one month for change to become effective.

Postmaster: Please send Form 3579 to Fulfillment Manager, Electronics, P.O. Box 430, Hightstown, New Jersey 08520

Readers Comment

Computers and calculators

To the Editor:

I read the comments [Nov. 15, p. 7] of Earl F. Gill about the definition of the Programma 101 Olivetti as the world's first desk-top computer. As director of the laboratory where the machine was designed, I would like to express an opinion.

Although other machines were on the scene before, I think the Programma 101 is the first machine that may be considered as a real computer, still having the dimensions and size of the classical monolithic desk calculators.

What is a computer? I agree upon the distinction from a desk calculator as reported in Electronics [Nov. 1, p. 32], though some features of the Programma 101 were not described exactly. In fact, this machine can accept automatic input of data (with the card) and can alter its own program automatically.

Therefore, it has all the characteristics of a general-purpose computer, according to the Electronics' definition. I feel it is also useful to quote here the definition of the term "computer" as given in the glossary of the British Standard (B.S.3527, p. 7): "Computer is any device capable of automatically accepting data, applying a sequence of processes to the data, and supplying the results of these processes. Note: the term computer is widely used as a synonym for stored program computer, and in this sense is contrasted with calculator."

The Programma 101 has all these characteristics, including an automatic medium for introduction of instructions and data (the magnetic card) and for the output of data (the strip of printed-paper and the card). This machine is therefore a computer.

The other machines on the market before the Programma 101 either do not have the foregoing characteristics or they cannot be called desk-top machines, since, to operate as a computer, they need other external devices (printer, card reader, etc.).

Hence the statement that the

Did You Know Sprague Makes 51 Types of Foil and Wet Tantalum Capacitors?

125 C FOIL-TYPE TUBULAR TANTALEX® CAPACITORS

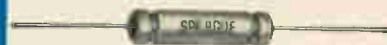

- Type 120D polarized plain-foil
- Type 121D non-polarized plain-foil
- Type 122D polarized etched-foil
- Type 123D non-polarized etched-foil

ASK FOR BULLETIN 3602C

Circle 337 on reader service card

FOIL-TYPE RECTANGULAR TANTALEX® CAPACITORS



- Type 300D polarized plain-foil
- Type 301D non-polarized plain-foil
- Type 302D polarized etched-foil
- Type 303D non-polarized etched-foil

ASK FOR BULLETIN 3650

Circle 338 on reader service card

FOIL-TYPE TANTALUM CAPACITORS TO MIL-C-3965C

- CL20, CL21 tubular 125 C polarized etched-foil
- CL22, CL23 tubular 125 C non-polar etched-foil
- CL24, CL25 tubular 85 C polarized etched-foil
- CL26, CL27 tubular 85 C non-polar etched-foil
- CL30, CL31 tubular 125 C polarized plain-foil
- CL32, CL33 tubular 125 C non-polar plain-foil
- CL34, CL35 tubular 85 C polarized plain-foil
- CL36, CL37 tubular 85 C non-polar plain-foil
- CL51 rectangular 85 C polarized plain-foil
- CL52 rectangular 85 C non-polar plain-foil
- CL53 rectangular 85 C polarized etched-foil
- CL54 rectangular 85 C non-polar etched-foil

Circle 339 on reader service card

85 C FOIL-TYPE TUBULAR TANTALEX® CAPACITORS



- Type 110D polarized plain-foil
- Type 111D non-polarized plain-foil
- Type 112D polarized etched-foil
- Type 113D non-polarized etched-foil

ASK FOR BULLETIN 3601C

Circle 340 on reader service card

SINTERED-ANODE TUBULAR TANTALEX® CAPACITORS



- Type 109D elastomer seal 85 C
- Type 130D elastomer seal 125 C
- Type 137D hermetic seal 125 C

ASK FOR BULLETINS 3700F, 3701B, 3703

Circle 341 on reader service card

SINTERED-ANODE CUP STYLE TANTALEX® CAPACITORS



- Type 131D 85 C industrial-type
- Type 132D 85 C vibration-proof
- Type 133D 125 C vibration-proof

ASK FOR BULLETINS 3710B, 3711

Circle 342 on reader service card

SINTERED-ANODE CYLINDRICAL TANTALEX® CAPACITORS



- Type 140D up to 175 C operation, 1/8" diam.
- Type 141D up to 175 C operation, 1/4" diam.

ASK FOR BULLETIN 3800

Circle 343 on reader service card

SINTERED-ANODE RECTANGULAR TANTALEX® CAPACITORS



- Type 200D negative terminal grounded
- Type 202D both terminals insulated

ASK FOR BULLETIN 3705A

Circle 344 on reader service card

SINTERED-ANODE TANTALUM CAPACITORS TO MIL-C-3965C

- CL14 cylindrical, 1/8" diam.
- CL16 cylindrical, 1/8" diam., threaded neck
- CL17 cylindrical, 1/4" diam.
- CL18 cylindrical, 1/2" diam., threaded neck
- CL44 cup style, uninsulated
- CL45 cup style, insulated
- CL55 rectangular, both terminals insulated
- CL64 tubular, uninsulated
- CL65 tubular, insulated

Circle 345 on reader service card

For comprehensive engineering bulletins on the capacitor types in which you are interested, write to:
Technical Literature Service
Sprague Electric Company
35 Marshall Street
North Adams, Mass. 01248

45C-3158

SPRAGUE®
THE MARK OF RELIABILITY

Sprague and "®" are registered trademarks of the Sprague Electric Co.

Coming from General Instrument...

The ULTIMATE DIODE

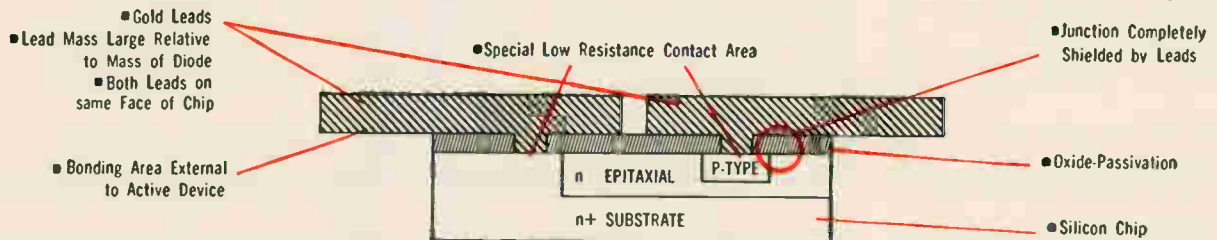

General Instrument's HERCULEADS™ beam-lead diode is a self-contained diode package with total environmental immunity—the smallest, discrete diode available—and it is virtually indestructible.

Ultimate in cost savings

The irreducible minimum in processing achieved via complete batch fabrication and self packaging offers minimum possible cost.

Ultimate in size

The HERCULEADS diode is the smallest available. Together with the leads which are uniquely integrated with the diode body, it measures less than 15x30 mils.

Ultimate in reliability

Most potential failure modes commonly associated with diodes, both electrical and mechanical, are eliminated. All bonding leads external to the active device permit simple, economic, high rel connections without the use of eutectics, aluminum or thermal wire bonding. And total surface passivation is assured because of HERCULEADS' unique design and metal-over-oxide construction.

Ultimate in versatility

Besides its use as a single, twin lead self-packaged device, the HERCULEADS diode is highly adaptable for use in module or stick arrays. Its design and construction make it ideal for automatic handling and positioning, and its pure gold cantilevered leads permit high reliability bonding. Electrical parameters available are comparable to those achieved in the most advanced single-plane devices presently in use.

HERCULEADS diodes are now being manufactured in developmental quantities and will be available shortly in packs of ten from your authorized General Instrument Distributor.

Write for full data and specifications.

GENERAL INSTRUMENT CORPORATION
SEMICONDUCTOR PRODUCTS GROUP

600 West John Street, Hicksville, New York



Programma 101 is the world's first desk-top computer seems to us completely correct.

Pier Giorgio Perotto

Olivetti
Ivrea, Italy

Feedback on feedback

To the Editor:

An interesting concept was discussed in the circuit design by Stephen B. Gray [Nov. 15, p. 108]. It should be noted that the assigned resistance ratio, r , must be $r = R_d/R_e$, if his expression for current gain is to follow. If $r = R_e/R_d$ as stated, then $h = B/(1+r)(1+B)$.

The feedback connection as presented is not the principal cause for modification of the transistor characteristics. The avalanching property of a transistor is dependent primarily upon the base circuit resistance (see sketch above). The curve tracer supplies a current base step from an equivalent Norton generator (high internal impedance). When the resistor R_d (1,000 ohms) is connected from base to ground as shown, the avalanche voltage increases toward BV_{ces} because of the decreased equivalent source impedance. As source impedance is reduced, R_d loses its influence on the three terminal circuits until, as $R_{gen} \ll R_d$, the avalanche voltage is controlled by R_{gen} and approaches BV_{ces} as $R_{gen} \rightarrow 0$.

When emitter degeneration is added, a portion of the collector supply voltage is absorbed across the emitter resistor, hence the emitter-collector terminals of the transistor actually operate at reduced voltage such that $V_{ce} = V_{cc} - I_e R_e$.

Incidentally, the results predicted by Gray can be obtained directly

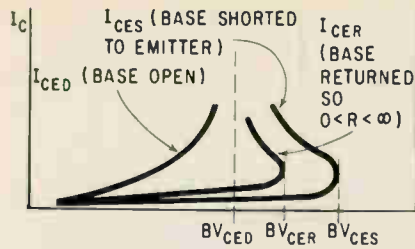

Effect of base-circuit resistance on the avalanching property of a transistor.

from conventional bias-stabilization techniques. The addition of the diode in series with the base emitter resistor, R_d , will introduce a degree of temperature compensation when the base circuit is designed with this effect in mind.

Harold T. Fristoe

Professor
School of Electrical Engineering
Oklahoma State University
Stillwater, Okla.

On circuit naming

To the Editor:

After reading the description of the Darlington circuit I wish to make the following suggestions:

The name Darlington should not be used when two (or more) transistors each have only one terminal in common; this case should be called a "direct-coupled" circuit rather than a Darlington circuit.

The circuit is a cascade of two direct-coupled emitter-follower stages. The novel feature is not to be found in the a-c small signal form but is in the static conditions where the author is balancing two base-emitter static voltages by using the particular combination of pnp and npn transistors.

Milton H. Crothers

University of Illinois
Urbana, Ill.

CRYSTAL FILTERS



BAND PASS FILTER

A filter of this type permits the transmission of a specified frequency band only. Fig. (1) shows a typical response curve. The information needed for the design of a bandpass filter is as follows:

- Center frequency of passband
- Permissible variation in passband attenuation.
- Minimum tolerance bandwidth.
- Maximum bandwidth at _____ db.
- Minimum attenuation in the stopband.
- Maximum insertion loss
- Load and source impedances.

Low pass and high pass filters are special types of bandpass filters where the pass band extends to zero or infinite frequency, respectively. Sideband filters have asymmetrical response curves and are characterized by the sharp attenuation rise on the carrier side and a more gradual rise on the opposite side.

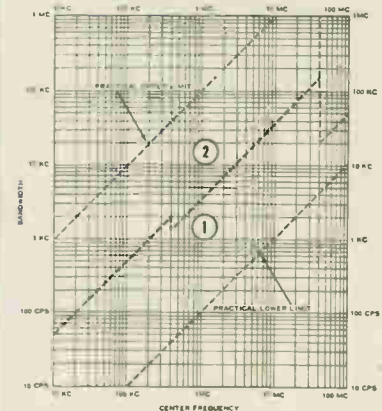

GUIDE TO PRACTICAL LIMITS

This chart is meant as a guide only and indicates the practical limits of crystal filters and discriminators. Filters within region (1) can be made with crystals and capacitors only and can, hence, be made in very small packages. Filters within region (2) must include inductors as well and are, therefore, slightly larger.

MICROSONICS INC.

A subsidiary of the
SANGAMO ELECTRIC CO.

60 Winter Street
Weymouth, Mass.

Area Code (617) 337-4200



DELAY LINES

QUARTZ CRYSTAL PRODUCTS

SUBSCRIPTION SERVICE

Please include an Electronics Magazine address label to insure prompt service whenever you write us about your subscription.

Mail to: Fulfillment Manager
Electronics
P.O. Box 430
Hightstown, N.J. 08520

To subscribe mail this form with your payment and check new subscription renew my present subscription

Subscription rates: in the U.S.: 1 year, \$6; two years, \$9; three years, \$12. Subscription rates for foreign countries available on request

CHANGE OF ADDRESS

ATTACH LABEL HERE

If you are moving, please let us know five weeks before changing your address. Place magazine address label here, print your new address below.

name _____

address _____

city _____

state _____

zip code _____

What high-performance HF antenna can you airlift to the field and erect in 2 hours?

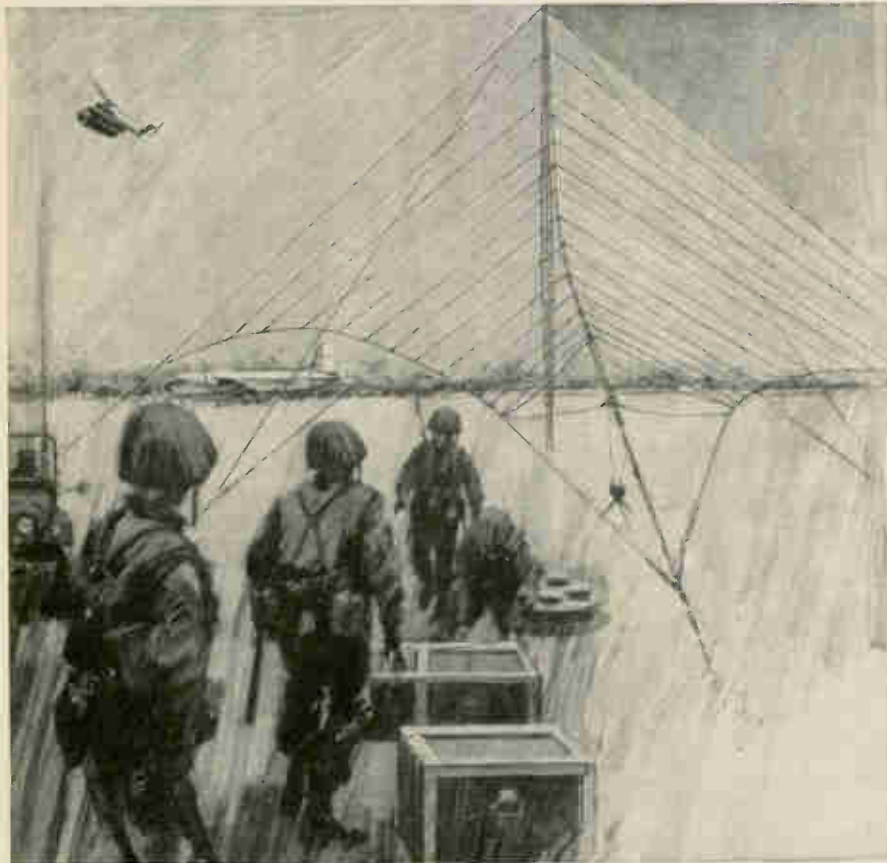

Granger Associates has the answer

now It's G/A's Model 747CA air-transportable HF antenna — which is only 10 feet long when packed, can be erected by five men in two hours, and stands up in 100-mph winds.

This antenna gets messages through when other transportable antennas don't. It does it by concentrating radiation at the elevation angle most likely to be best for the frequency used and the length of the circuit. Produces a useful gain of 10 to 13 db at any frequency from 4 to 30 Mc, with side lobes 14 db down.

Ordinary transportable antennas — like whips, dipoles and sloping V's — can't approach that kind of performance. The 747CA gives field stations an antenna fully comparable to a well-designed fixed-station antenna.

U.S. forces set up a Model 747CA in the Dominican Republic recently. Operated at only 1kw power, it delivered a better signal than an ordinary transportable antenna operated at 10 kw.

Send for complete technical data on Model 747CA.



747CA antenna packed for airlift

People

Henry W. Schrimpf's formal education ended with high school in Woodbridge, N. J. Nevertheless he has played a significant role since 1946 in the development of now classic techniques in the digital computer field. He recently joined LFE Electronics, a division of Laboratory for Electronics, Inc., of Boston, as assistant to the vice president.



His principal mission will be to lead the company into new commercial areas. "Today, the entree is via the digital world," comments Schrimpf. One of the most promising routes, LFE officials believe, is through a batch-fabricated matrix memory under development for several years.

Within 18 months, Schrimpf says, LFE will be putting this memory into a system which will demonstrate that the day of the really large memory has arrived. He says the memory will store 100 million bits and could eventually cost—in production volume—a tenth of a cent per bit.

Schrimpf graduated from high school during the Depression and went to work as an errand boy for the Prudential Insurance Co. of America. He later decided he wanted to be an electronics engineer, so he bought a few engineering books. "Then the roof fell in," says Schrimpf. "I realized it was like reading Sanskrit to study engineering without math."

'I'm an engineer.' So he took math courses offered by Prudential for actuaries, studied for 15 years on his own and became head of the insurance company's statistical department. Then he quit, declaring: "I'm an engineer."

He joined the Raytheon Co., became project engineer in development of the Racon computer, which became the Datamatic 1000, the first digital computer to incorporate a very high-speed input-output magnetic tape mechanism. Later, he helped develop the Honeywell 800, the first to use

**Granger
Associates**

68

AN EQUAL OPPORTUNITY EMPLOYER

1601 California Ave., Palo Alto, California / Telephone: 321-417 5/ TWX: 910-373-1291
Granger Associates Ltd., Walton-on-Thames, Surrey, England / Weybridge 44842

On the Flight Deck Highest DME Reliability Means Machlett UHF Planar Triodes

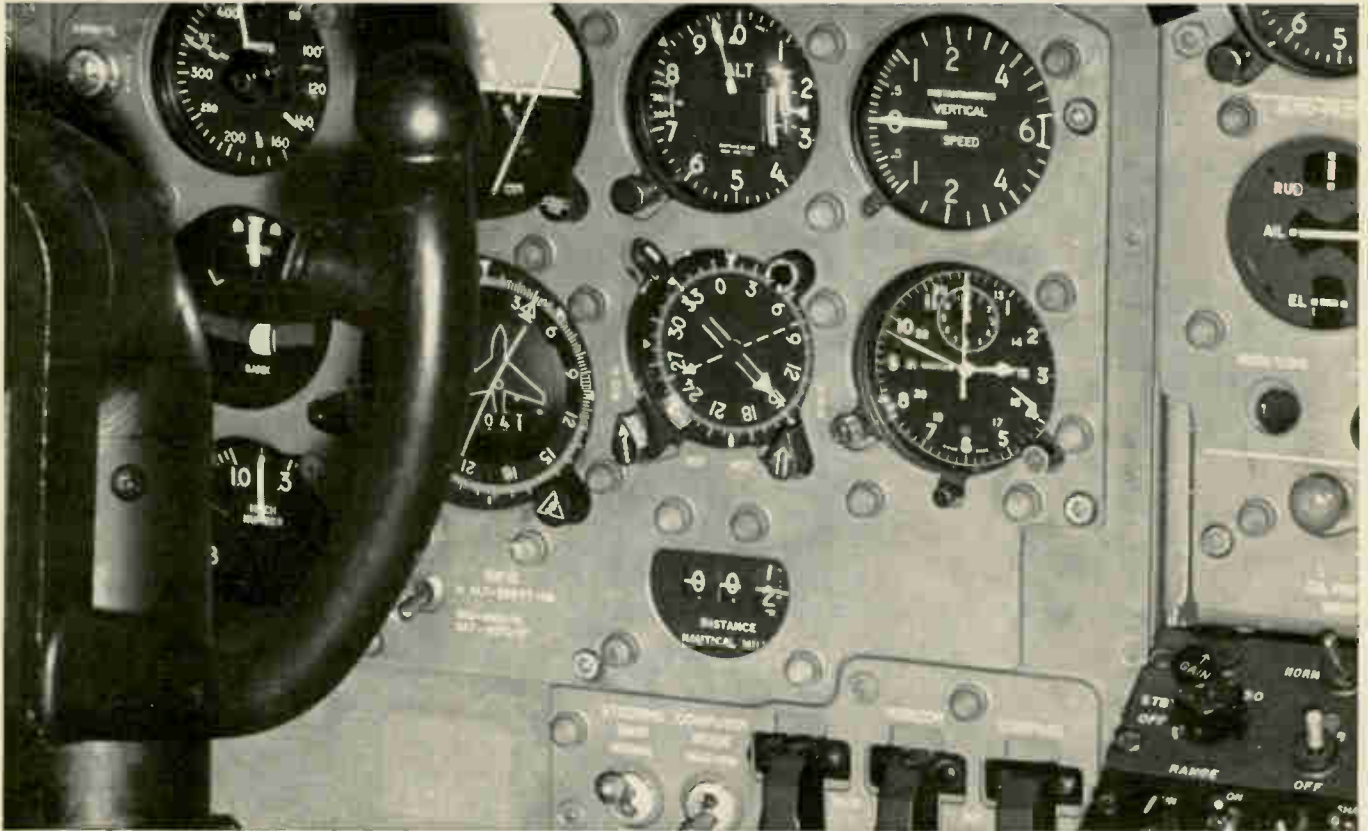

Consistently long, reliable operation at high output power has gained Machlett UHF planar triodes preferred acceptance among all the nation's major airlines. In new DME and transponder equipment or for replacement use, they are the choice. The demonstrated superiority of these tubes is further evidence of the capabilities available to you at Machlett. Whether you require high power/high voltage triodes or tetrodes, UHF planar triodes, X-ray tubes or vidicons, or if you wish research and design development assistance, write: The Machlett Laboratories, Inc., Springdale, Conn. 06879. An affiliate of Raytheon Company.

MACHLETT

ELECTRON TUBE SPECIALIST

**Did you
know
Sprague
makes...?**

**TRIGGER
TRANSFORMERS
FOR SCR
CIRCUITS**



A better, less-expensive way to trigger SCRs. Will accommodate large SCR gate impedance differences. 3-winding or 2-winding designs for full-wave or half-wave applications.

ASK FOR BULLETIN 40,225.2

Circle 326 on reader service card

**SILICONTROL®
SCR GATE DRIVES**



For balanced SCR firing in 3-phase a-c or d-c power control. Pulse rise time of 1 to 3 microseconds to meet requirements of high-current-rated SCRs.

ASK FOR BULLETIN 85,520A

Circle 327 on reader service card

**VOLTAGE-SENSITIVE
SWITCHES**

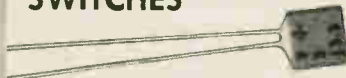

Unique semiconductor device which remains in the "open" state until a specified actuating voltage is reached. When "breakdown" voltage is applied, switch closes almost instantaneously, providing a low-impedance conductive path between terminals. Breakdown voltages from 7 to 200 V.

ASK FOR BULLETIN 93,000

Circle 328 on reader service card

**DYNACOR®
BOBBIN
CORES**



Logical flux values in popular physical sizes are stocked in production quantities for fast delivery. Value engineered for quality with economy.

ASK FOR BULLETIN SERIES 50,000

Circle 329 on reader service card

**INDISTOR®
R-L DELAY
NETWORKS**



Save space by replacing separate inductors and resistors. Guaranteed L/R ratio. Available in fully molded or epoxy-dipped cases.

**ASK FOR BULLETIN
SERIES 45,000**

Circle 330 on reader service card

**MOLDED-CASE
SHIELDED
R-F INDUCTORS**

Fully shielded, ultra-tiny, yet performance is comparable to that of larger units. Inductance values from 0.1 to 12,000 μ H. Molded for positive protection against humidity and handling. Meet requirements of MIL-C-15305.

**ASK FOR BULLETIN
SERIES
41,800**



Circle 331 on reader service card

For complete technical data on any of these products, write for applicable Engineering Bulletin(s) to Technical Literature Service, Sprague Electric Company, 35 Marshall Street, North Adams, Massachusetts 01248.

455C-1151

SPRAGUE®
THE MARK OF RELIABILITY

*Sprague® and ® are registered trademarks of the Sprague Electric Co.

People

parallel-processing traffic control.

Like many others, Schrimpf sees increased use of parallel-processing techniques as one of the main trends in computer development. "The amount of storage in a single memory unit is skyrocketing today," he says. "Many people want to get at that memory—and simultaneously."

IC's in computers. Schrimpf maintains that integrated circuits will take over the computer field completely within three or four years.

He sees the computer industry repeating the pattern of the radio industry—first a multitude of different designs, then gradual standardization until the day when computer design will be functionally identical in their general structures.

For years **William E. Osborne** has been convinced that the infrared detector, now in limited use by the military, has a much larger potential in commercial and consumer applications. But Osborne has lacked the financial support to put his belief to the test. Now, after joining Huggins Laboratories, Inc., of Sunnyvale, Calif.—an electronics company that makes, among other things, infrared instruments—Osborne will have the opportunity to exploit infrared's potential.



Osborne, whose title at Huggins is chief scientist, will be responsible for the development of infrared intrusion detectors—passive devices that detect the presence of a person. Beyond that, Osborne says, infrared devices could take a big share of the equipment market for computer-operated, traffic-control systems. Infrared detectors, he explains, could spot cars on highways and detect their direction and speed; the information would be fed to a computer, which would then select the best traffic-light arrangement for unsnarling traffic jams.



Get $\pm 0.2\%$ regulation with high voltage DC power

Unique combination of Sorensen's 1000 Series high voltage power supplies and ACR Series (SCR) line voltage regulators gives you $\pm 0.2\%$ output voltage regulation for $\pm 10\%$ line voltage variation.

This is just one of the customer-oriented benefits you get with the versatile 1000 Series...plus these other important features:

- 1 SELECTION OF 9 MODELS...cover range of 0 to 150KV and up to 750 W. (Other Series up to 400KV and 15,000 W.)
- 2 LINE REGULATION $\pm 1.5\%$ OR $\pm 0.2\%$ (optional)
- 3 LOW RIPPLE...0.01% (optional)
- 4 EASILY REVERSIBLE POLARITY
- 5 CONTINUOUSLY VARIABLE OUTPUT...coarse and fine controls
- 6 SOLID STATE HIGH VOLTAGE RECTIFIERS
- 7 FULLY METERED

THESE SAFETY DEVICES STANDARD ON ALL MODELS:

- On loss of input power, output power is automatically shorted.
- Meters and relays are protected against shorts by zener diodes.
- Series output resistor limits short circuit surges.
- Zero-Start Interlock assures zero output voltage at turn-on. Bypass is provided for special surge-on applications.
- Overcurrent cutoff adjustable from 20% to 120% of rated current.
- Overvoltage cutoff adjustable from 10% to 110% of rated output voltage.

For data on the 1000 Series and other Sorensen products, send for the "Controlled Power Catalog and Handbook." Write: Sorensen, A Unit of Raytheon Co., Richards Ave., South Norwalk, Conn. 06856. Or use Reader Service Card Number 200.

1000 SERIES DC POWER OUTPUT SPECIFICATIONS

MOEEL	1151*	1121*	1101*	1061*	1030-20	1020-30	1012-50	1006-100	1003-200
VOLTAGE	0-150KV	0-120KV	0-100KV	0-60KV	0-30KV	0-20KV	0-12KV	0-6KV	0-3KV
CURRENT	5 MA	5 MA	1.5 MA	10 MA	20 MA	30 MA	50 MA	100 MA	200 MA

*Furnished with separate high voltage section



Circle 11 on reader service card

**Planar II
is the purest
manufacturing
process ever
put into mass
production.**

**Fairchild
semiconductors
are the only
Planar II devices
you can buy.**

Planar is a patented Fairchild process.

most versatile rf sweep generator



JERROLD 900B

- Sweep widths from 10kc to 400mc
- Frequency range 500kc to 1,200mc

Here is the ultimate instrument for all your IF, VHF, and UHF sweep requirements. Famous for its stability and built-in convenience: Crystal-controlled harmonic markers; variable-gain dc or ac-coupled scope preamplifier; precision turret attenuator from zero to 50db in 10db steps. Write for complete technical data.

\$1,980.00 f.o.b. Phila.

JERROLD JERROLD
ELECTRONICS
CORPORATION

Government & Industrial Division
Philadelphia, Pa. 19132
Export: Rocke International, New York, N.Y. 10016

SWEEP GENERATORS • AMPLIFIERS
PRECISION ATTENUATORS • COMPARATORS

Meetings

American Society of Testing and Materials Spring Meeting, ASTM; Shoreham and Sheraton Park Hotels, Washington, D.C., Jan. 30-Feb. 4.

International Symposium on Information Theory, AFOSR, IEEE; University of California, Los Angeles, Jan. 31-Feb. 2.

Integrated Circuits Seminar, IEEE, Basic Sciences Committee; Stevens Institute of Technology, Hoboken, N.J., Feb. 2.

Western Radio and Television Conference, WRTA; Jack Tar Hotel, San Francisco, Feb. 2-4.

Winter Convention on Aerospace & Electronics Systems, IEEE; International Hotel, Los Angeles, Feb. 2-4.

International Salon of Electronic Components, Federation National des Industries Electroniques; Parc des Expositions, Paris, Feb. 3-8.

Solid State Circuits Conference, IEEE, University of Pennsylvania; Sheraton Hotel, Philadelphia, Feb. 9-11.

Association of Data Processing Service Meeting, ADAPSO; Stardust Motor Hotel, San Diego, Feb. 17-18.

National Meeting on Space Applications, Communications, and Environment, American Astronautical Society; San Diego, Calif., Feb. 21-23.*

Offshore Exploration Conference, OECON; Lafayette Hotel, Long Beach, Calif., Feb. 22-24.

Radioisotope Applications in Aerospace, AFSC and Atomic Energy Commission; Sheraton-Dayton Hotel, Dayton, Ohio, Feb. 22-24.

International Fair for Electronics, Automation and Instruments, Danish Electronics Industry; Exhibition Hall, Copenhagen, Denmark, Feb. 25-Mar. 6.

Conference on Nondestructive Testing, Society for Nondestructive Testing; B'tmore Hotel, Los Angeles, Mar. 7-10.

Symposium on Manufacturing In-Process Control and Measuring Techniques, Air Force Materials Laboratory and Motorola

Semiconductor Products Division; Hiway House, Phoenix, Ariz., March 9-11.

International ISA Aerospace Instrumentation Symposium, ISA, College of Aeronautics; College of Aeronautics, Cranfield, England, March 21-24.

International Convention and Exhibition of the IEEE; New York Hilton Hotel and the Coliseum, New York City, March 21-25.

Seminar on Computers and Automation in Europe, Lomond Systems, Inc.; Washington, D.C. and European tour, March 21-Apr.7.

National Association of Broadcasters Convention, NAB; Conrad Hilton Hotel, Chicago, March 27-30.

International Conference on Electronic Switching, Union of International Technical Associations, Societe Francaise des Electroniciens et des Radioelectriciens; UNESCO Conference Hall, Paris, France, March 28-31.

Automatic Control in Electricity Supply Meeting, IEE; Renold Building, Manchester College, England, March 29-31.

Call for papers

IEEE Communications Conference, University of Pennsylvania; Sheraton Hotel, Philadelphia, June 15-17. **March 4** is deadline for submission of a 35-word abstract and condensed version of papers on satellite systems, broadband distribution systems, microwave systems, analog and digital transmission systems, and aerospace communication systems to A. E. Joel Jr., Bell Telephone Laboratories, Inc., Room 2G-330, Holmdel, N. J., 07733.

Microelectronics Symposium, St. Louis Section of the IEEE; Colony Inn, Clayton, Mo., July 18-20. **March 4** is deadline for submission of three 100-word abstracts and three 350-word summaries on semiconductor films, thin-film devices, thick-film technology, and silicon monolithic techniques, to Dr. John W. Buttrey, Dept 952, McDonnell Aircraft Corp., P.O. Box 516, St. Louis, Mo., 63166.

* Meeting preview on page 16

Here's Lucky Item #13 in the Fluke '65 Pacesetter Line

Accuracy $\pm 0.0025\%$. Maximum meter resolution, 0.1 ppm. Fourteen pounds later you have the new solid-state Fluke 885 DC Differential Voltmeter, the first truly portable laboratory standard. Peak-to-peak reference stability is 15 ppm for 60 days. Use the Fluke 885 as an isolation amplifier. Grounded recorder output is so well isolated that a short-circuit at the output produces no voltmeter reading error. Ground loops are completely eliminated when the battery powered Model 885AB is used.

Other Specifications: Range 0 to 1100 Volts. Null sensitivity, 100 microvolts full scale. Line regulation better than 2 ppm. No zener oven, less than 30 seconds warm-up time. Cabinets can be half rack or full rack mounted with optional mounting kits. Price of the Model 885A line cord version is \$1,195. The battery powered Model 885AB is \$1,325.



FLUKE • Box 7428 • Seattle, Washington 98133 • Phone: (206) PR 6-1171 • TWX: (910) 449-2850

Model 885A reading precise voltage from Model 332A Voltage Calibrator on 10V range



Now from Sprague!

DIFFERENTIAL AMPLIFIERS IN FLAT PACKS!



2N3043 2N3044 2N3046
2N3047 2N3049 2N3050 2N3051
2N3052 2N3520 2N3524

PNP or NPN • BETA MATCHING to 10%

V_{BE} MATCHING to 3mV

VOLTAGE CAPABILITY to 60 VOLTS

TEMPERATURE COEFFICIENTS to $5\mu\text{V}/^\circ\text{C}$

ALSO AVAILABLE IN 6-LEAD TO-5 OUTLINE PACKAGES!

For complete information, write to Technical Literature Service, Sprague Electric Company, 35 Marshall Street, North Adams, Mass. 01248

SPRAGUE COMPONENTS

TRANSISTORS

CAPACITORS

RESISTORS

THIN-FILM MICROCIRCUITS

INTEGRATED CIRCUITS

INTERFERENCE FILTERS

455-9140

PACKAGED COMPONENT ASSEMBLIES

FUNCTIONAL DIGITAL CIRCUITS

MAGNETIC COMPONENTS

PULSE TRANSFORMERS

CERAMIC-BASE PRINTED NETWORKS

PULSE-FORMING NETWORKS



'Sprague' and '®' are registered trademarks of the Sprague Electric Co.

Meeting preview

AAS in San Diego

Space is far out in every sense of the term; it calls for the utmost in advanced technology and it is wildly expensive to penetrate. The national meeting of the American Astronautical Society at the El Cortez Hotel in San Diego, Calif., Feb. 21 to 23 will focus on the economic and political considerations that will affect space technology, and on the more immediate applications of space exploration. The topic of the meeting is "Practical Space Applications."

Morning sessions of the conference will be devoted to discussions of present and future technology, while afternoon sessions will be given to papers on economic and political-legal constraints.

Practical side. Charles Walli, assistant to program chairman Larry Cavanaugh of North American Aviation's Space and Information Systems division says "Eventually, the space program must have a practical side, and this conference is a start."

The AAS has made a distinction between near and far future applications; an example of the former is a paper on the Saturn/Apollo program to be given by William B. Taylor, director of Apollo applications for the National Aeronautics and Space Administration. More exotic and distant applications will be discussed by an impressive group of space experts.

Economics. Sherman Hislop of the Douglas Aircraft Corp. will give a paper on the economics of space explorations, and Samuel Lutz of the Hughes Aircraft Corp. Research Laboratories will talk about the economic aspects of an operational satellite system. Richard Colino, director of international arrangements for the Communications Satellite Corp. will present a case study of the political and legal problems of international satellite communications.

A summary of U.S. space program will end the meeting.

The most practical advice on space may come from a man who has been there—astronaut Scott Carpenter, who will be the luncheon speaker on the second day.

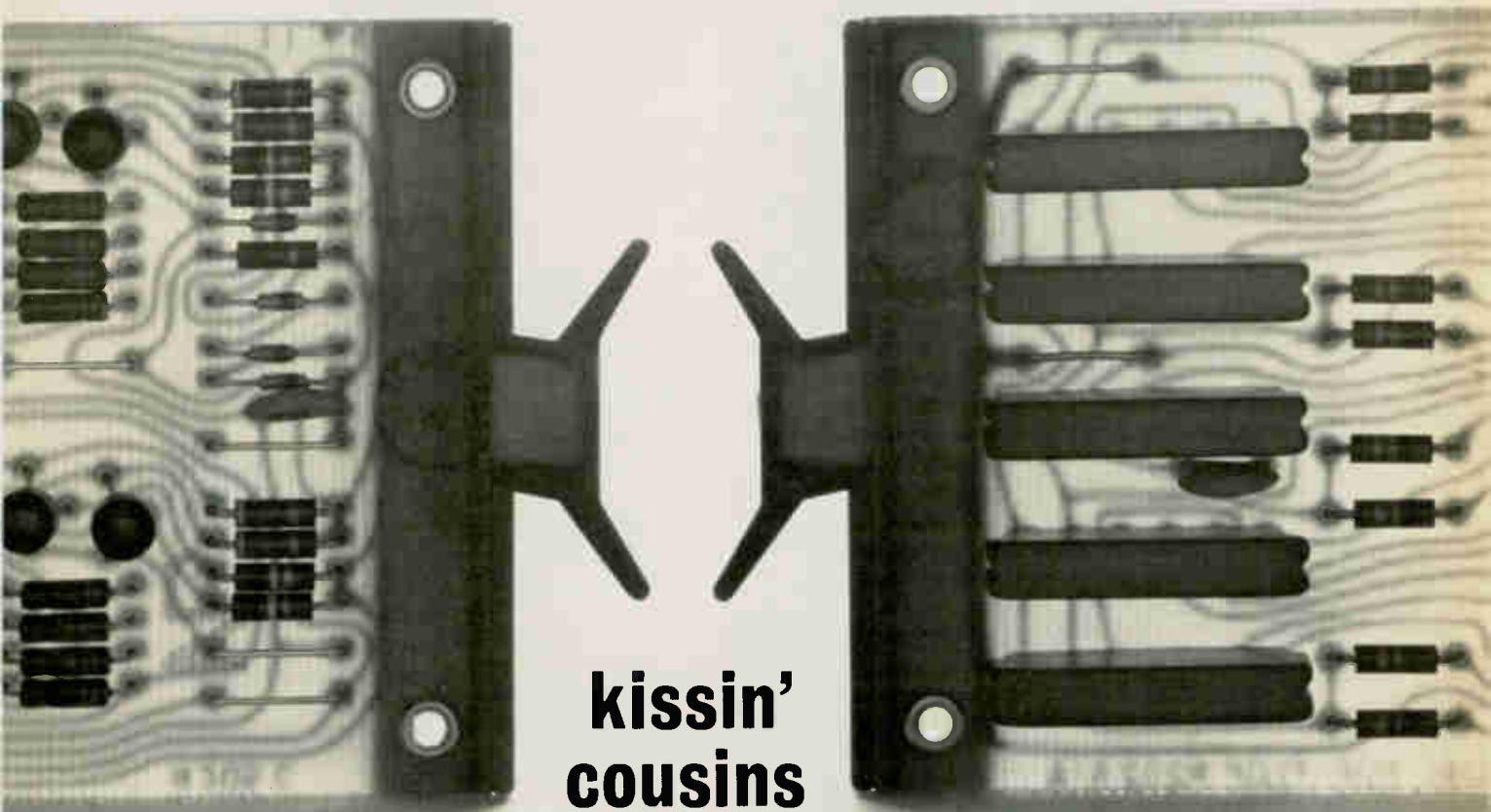

kissin' cousins

These two digital modules are directly related to 99 other standard Flip Chip™ modules. They are related electrically, physically, and logically, and they all carry the same 10-year guarantee.

Together with their kinfolk, they can be arranged to make an up counter, a down counter, a shift register, a jam transfer buffer, a high speed parallel adder, an analog to digital converter, or a vice versa.

Or a signal multiplexer, a typewriter driver, a Gray to binary converter, a vice versa, a paper tape punch control, a reader control, a pseudo random sequence generator, a data acquisition system, or an interface between peripherals and a real time computer.

Sometimes it pays to have a big family.

Write for a catalog.

DIGITAL

MODULES • COMPUTERS

DIGITAL EQUIPMENT CORPORATION • Maynard, Massachusetts 01754 • Telephone: (617) 897 8821 • Cambridge, Mass. • Washington, D. C. • Parsippany, N. J. • Rochester, N. Y. • Philadelphia • Huntsville • Orlando • Pittsburgh • Chicago • Denver • Ann Arbor • Los Angeles • Palo Alto • Seattle • Carleton Place and Toronto, Ont. • Reading, England • Paris, France • Munich and Cologne, Germany • Sydney and West Perth, Australia • Modules distributed also through Allied Radio

NEW MOTOROLA DEVICES GIVE THAT "SOMETHING EXTRA" To Your New Equipment Designs



Here are new semiconductor devices that put an added measure of performance in the designer's tool box — devices that make it possible to build those "temporarily shelved" designs that needed "just a little better device" to make them work.

Look them over . . . order evaluation units from your nearest Motorola semiconductor distributor . . . see how these new units solve your design headaches. Then, contact your local Motorola district representative for the quantities you'll need in production.

If you would like specific details about a particular device mentioned here, write to the Technical Information Center, Motorola Semiconductor Products Inc., Box 955, Phoenix, Arizona 85001.

NEW MOTOROLA VARIABLE THRESHOLD LOGIC SOLVES INTEGRATED CIRCUIT NOISE PROBLEMS!



MC650G — Dual 3-Input Gate

MC651F — Dual 4-Input Gate

MC652G/F — Gated R-S Flip-flop

- Noise immunity selectable from 2 to 5 volts
- 10-volt logic swing — allows direct interfacing without extra buffer stages
- Direct interfacing with conventional DTL circuits
- For applications up to 1 mc

A new circuit design approach for computers intended for industrial applications where high-noise environments create special problems for logic engineers.

MEDIUM and HIGH POWER SILICON TRANSISTORS for BOTH DRIVER and OUTPUT APPLICATIONS!

MEDIUM-POWER

(25 watts — P_o) 60 V and 80 V (TO-66)

NPN — Types 2N3766-2N3767

PNP — Types 2N3740-2N3741

HIGH-POWER

(150 watts — P_o) 60 V and 80 V (TO-3)

NPN — Types 2N3713-2N3716

PNP — Types 2N3789-2N3792



New high-performance, low-priced silicon power transistors now offered in complementary specifications to provide a new level of design flexibility.

HIGH-INPUT-IMPEDANCE MONOLITHIC INTEGRATED CIRCUIT OPERATIONAL AMPLIFIERS

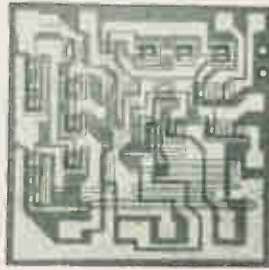
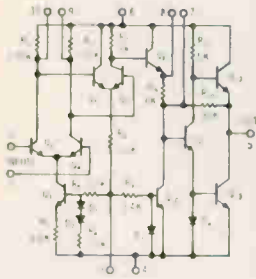

- Choice of input impedance levels
 - conventional input 20k ohms (MC1530)
 - Darlington input 2 megohm (MC1531)
- Drive a 1000 ohm load
- Open-loop gain of 6000/3500

Two new Motorola monolithic operational amplifiers offer a choice of conventional (MC1530) or Darlington (MC1531) inputs. The units feature high input impedance and superior output voltage swing.

TWO-IN-ONE UNIBLOC* DUAL SWITCHING DIODES

... priced lower than 2 individual diodes!

MSD6100

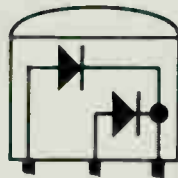

- High Voltage — $BV_R = 100V$ (min)
- Low Recovery Time — $t_{rr} = 4$ nsec (max)
- Low Diode Capacitance — 1.5 pF (max), $V_R = 0V$

An entirely new approach to diode pairs, the Motorola MSD6100 dual switching diode offers the common cathode configuration in the high reliability Motorola "Unibloc" plastic package.

HIGH-VOLTAGE SURMETIC* RECTIFIER SERIES (1000-3000 V)



- Low leakage currents @ rated PRV
- Packaged in high-reliability, silicone polymer encapsulation — types MR990 thru 994

A true inorganic glass surface passivation, a silicone plastic package, and conservative ratings give these high-voltage "Surmetic" rectifiers top reliability and performance.

NEW COMPACT, LOW-COST ELF* SCR LINE

8-AMPS (rms), MCR2304/5 and MCR2604/5 Series



MCR2304

- New low-silhouette packaging
- New low prices
- New welded, lug-type terminals

Economy, compactness, and mounting ease combine to highlight this "second generation" series of 8-amp SCR's from Motorola... permitting less costly, simpler circuit assembly and wiring.

NEW HIGH-POWER RF OUTPUT SILICON ANNULAR TRANSISTORS



... with your choice of voltage levels!

	12 VOLT SUPPLY	25 VOLT SUPPLY
4 Watts @ 175 mc (T0-39)	2N3924	2N3553
5 Watts @ 175 mc (102 pkg)	2N3925	2N3961
7 Watts @ 175 mc (T0-60)	2N3926	2N3375
12 Watts @ 175 mc (T0-60)	2N3927	2N3632 (13.5 W)

— All are triple diffused for larger safe area operation!

Choose either a 12 or 25 volt power supply, then pick the Motorola RF transistor that provides the required output. Use them as driver-output combinations, too!



MOTOROLA

Semiconductor Products Inc.

5005 EAST McDOWELL ROAD, PHOENIX, ARIZONA 85008

(602) 273-6900

*Trademark of Motorola Inc.

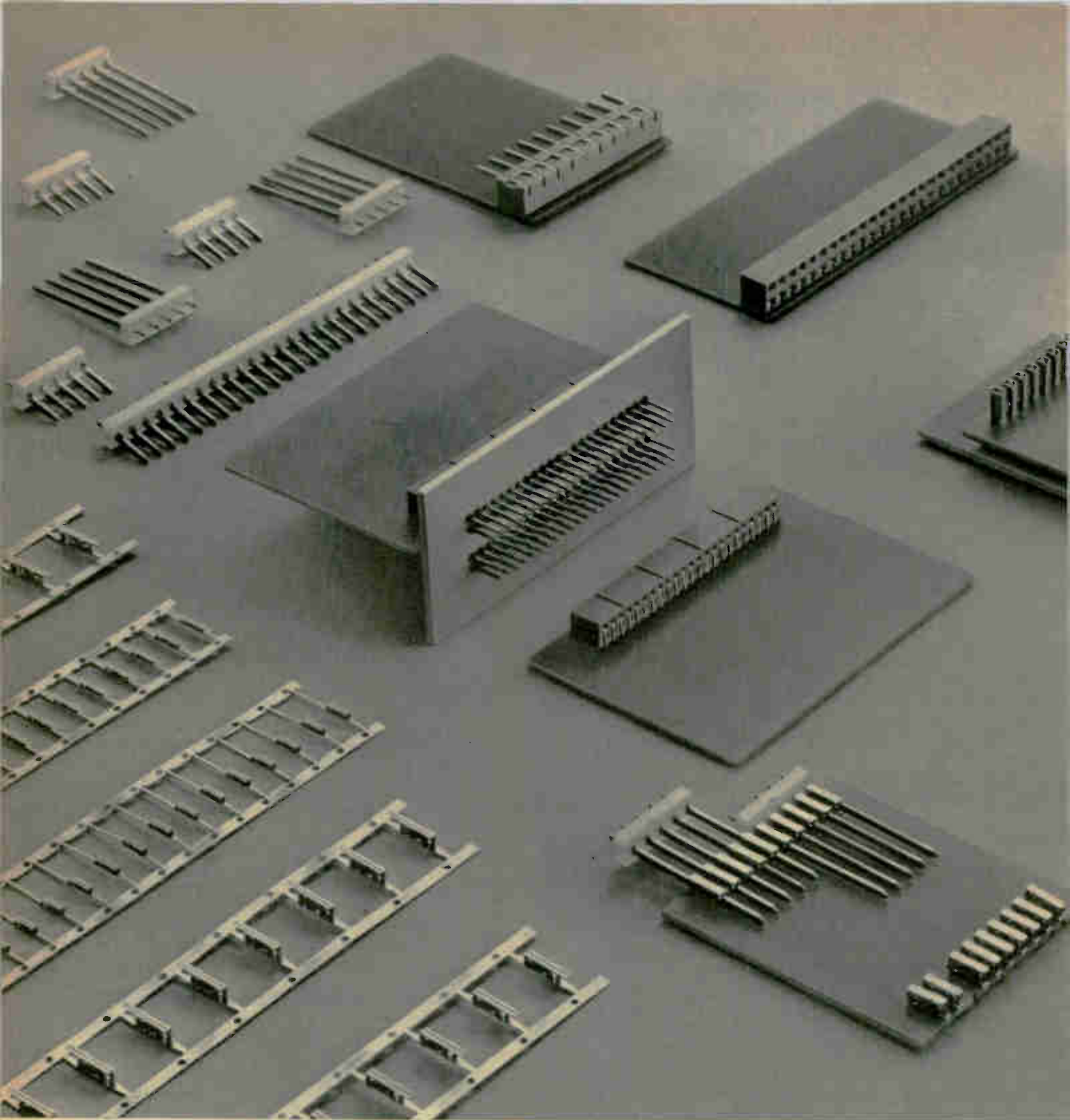

Go modular the easy way

This entirely new approach to modularization is the AMPMODU* Interconnection System. It permits almost unlimited design flexibility, high production speed, and economies resulting from automation and low per line cost.

Specifically designed for modular applications using printed circuit boards, it enables mounting module cards at 90° to a mother board, stacking them, or putting them end to end. The female contacts may be staked directly to a printed circuit board or enclosed in molded housings. Male contacts may be staked directly to a printed circuit board, used in nylon incremental connectors, or mounted with nylon bushings in aluminum grid plates. Two sizes of contacts are available: the standard size, which uses .031 x .062" posts for mounting on .156" centers, and the miniature size, which uses .025 x .025" posts for mounting as dense as .100". Electrical and mechanical efficiency are enhanced by the simplicity of the female contact design, which includes dual cantilever-beam springs for redundant contact action and anti-overstress devices to ensure reliability. The long life of the phosphor bronze contacts is a result of AMP's special gold plating. New modular ideas don't have to dead-end at the design stage. For information on how you might use the AMPMODU Interconnection System to modularize your product and lower your costs, write us today.

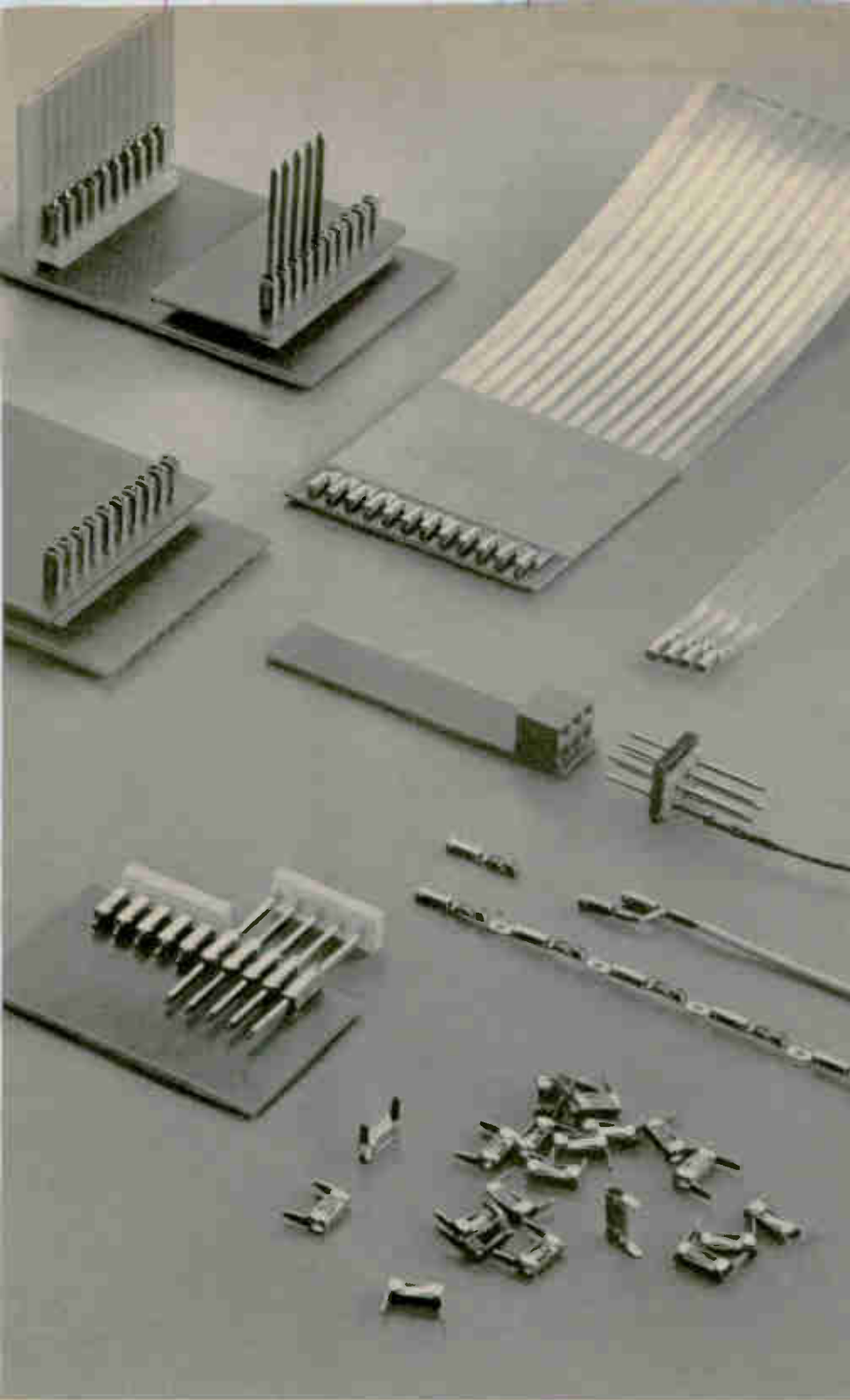

Automatic machines can stake contacts to printed circuit boards at rates of up to 1800 an hour

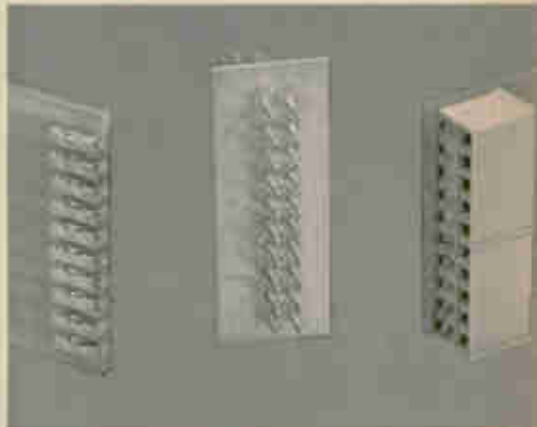

Miniature AMPMODU contacts may be mounted ten to the inch

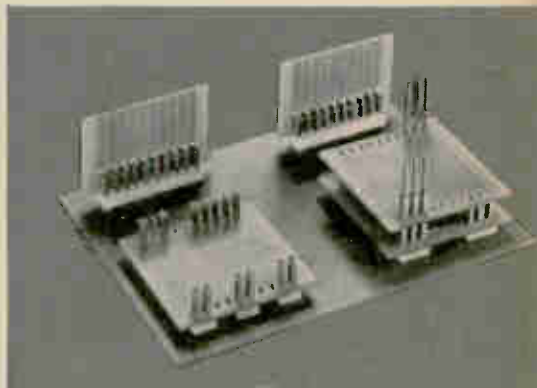

The AMPMODU female contacts may be mounted in one of three ways for modular connection versatility

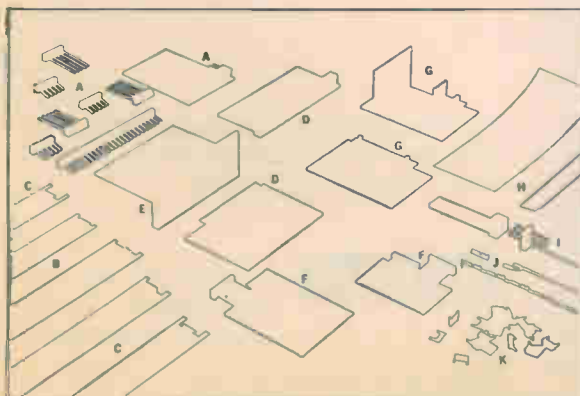

- A. AMPMODU Male Incremental Connectors
- B. Miniature AMPMODU Female Contacts in strip form
- C. Standard AMPMODU Female Contacts in strip form
- D. Miniature contacts in two-row housings
- E. Grid Plate Header
- F. Horizontally staked AMPMODU Contacts with incremental connectors
- G. Vertically staked AMPMODU Contacts
- H. Flexible tape cable AMPMODU Connectors
- I. Molded-in AMPMODU Pin Header and printed circuit board connector
- J. Miniature Crimp-Barrel AMPMODU Female Contacts
- K. Individual Standard AMPMODU Female Contacts

AMP
INCORPORATED
 Harrisburg, Pennsylvania

Helipot's side-adjust
Helitrim[®] cermet
trimmer—world's
smallest—costs as little
as \$1.50 in quantity.

Helipot's side-adjust
Helitrim[®] cermet
trimmer—world's
smallest—costs as little
as \$1.50 in quantity.



Helipot's side-adjust
Helitrim[®] cermet
trimmer—world's
smallest—costs as little
as \$1.50 in quantity.

Helipot's side-adjust
Helitrim[®] cermet
trimmer—world's
smallest—costs as little
as \$1.50 in quantity.

The Model 62PA side-adjust is a new easy-access cermet trimmer with these quality features: virtually infinite resolution; excellent high frequency characteristics; and standard resistance from 10 ohms to 1 meg-ohm. Its rugged cermet resistance element gives you long, trouble-free life and freedom from sudden failure. Inside its plastic case is a sealed metal housing identical to the popular ¼" top-adjust Model 62P.

Focus in on delivery advantages, too... immediate stock availability. Call your Helipot sales rep for full specs.

Beckman[®] INSTRUMENTS, INC.
HELIPOT DIVISION
FULLERTON, CALIFORNIA • 92634

INTERNATIONAL SUBSIDIARIES: GENEVA; MUNICH; GLENROTHES, SCOTLAND; TOKYO; PARIS; CAPETOWN; LONDON

Editorial

Help wanted. . . maybe

In the business sections of the big metropolitan Sunday papers, the pages read as they did in the golden fifties when the exploding electronics industry was begging for engineers. From a quick reading today, you might conclude that the United States is starving for engineers of all types. Clearly, the country is not. Despite the splurge of recruitment advertising in the Sunday papers, engineering employment is not as tight as it looks.

It is hard to believe that so many companies desperately need so many engineers today when 20 months ago many of them were laying off engineers as if the firms and the industry were going out of business. At the end of 1964, employment agencies estimated that nearly 20,000 engineers were walking the streets looking for work.

Nothing very spectacular has happened to the economy since then. True, the step-up in military spending for Vietnam has stimulated some business for companies that already specialized in military electronics; the boom in color television has created openings for a few more consumer-oriented engineers at appliance companies and at the component producers that supply them; and the nation's general prosperity has helped almost every electronics firm a little, but hardly enough to justify some of the prose that appears in these advertisements.

One advertisement declares: "Our company provides a real 'growth climate' for scientists, engineers and programmers. . . . Our diversification assures expansion in many areas." Yet informed readers will remember that this same company was a leader in layoffs 18 months ago when some of its military work phased out.

In another advertisement, the headline—"Our semiconductors set the standard in the business and the sales and staff curve has moved up consistently"—would surprise many of the company's former employees who were laid off within the past two years because of declining business.

Some of the companies that run the biggest, most strident ads have no openings for engineers at all. Others are trying to pirate one or two par-

ticular individuals and the ads are aimed at those top engineers only. Many average engineers never even get an acknowledgment of their answer to such ads.

Probably the most despicable practice is the running of recruitment advertisements to impress Wall Street. Back in the mid-fifties, when the financial community was enamored of technology, some money men evaluated the growth potential of companies by measuring the amount of recruiting the companies were doing. The bigger the ads, the better the potential. Today, most Wall Streeters no longer have a warm feeling for technologically based companies—the result of having been burned by investments that never paid off in new companies that ran on advanced technology—but some companies still place big recruitment advertisements to offset bad news in their annual financial reports.

Almost as contemptible is the company that advertises for a specialist with skills so narrow that he would have to be working only for a competitor doing the same limited work of the advertiser.

The hiring of the limited specialist stultifies companies that need to diversify and expand. What's more, it upsets the engineer employment market. Specialists who were hired six years ago were laid off two years ago. The experts being hired today are likely to be on employment agency lists in 1970 when companies will be looking for experts with different specialties.

Because companies demand narrow specialization, and engineers have tried to oblige by building up expertise in some strangely narrow areas, companies that discover they need engineers with broad experience cannot find them. One general manager of a microcircuit plant complained that he had been looking for 11 good engineers for almost a year without success. He added derisively, "We see a hundred humpty-dumpties a week, but not one good man with fundamental experience and creative ability."

A reader, commenting on the story on employment in the December 27 issue (p. 34), summed up the situation nicely. He wrote, "I wonder how a prospective employer can expect an engineer to have a specific rare skill when needed. Such a man can only come from a competitive company in the same field. The help-wanted ads have increased, but the answers to an honest letter seeking employment are zero. Employment agencies appear to be useless unless you have a very specific skill, recently developed, and seek more money in the same field in a job a thousand miles away. I wonder if personnel managers actually know what they need."

If they did, the electronics industry would change its approach to recruiting.

The Remarkable New Line of Clifton MOTORS and TACHOMETERS is important to YOU!

SERVO MOTORS



TEMPERATURE COMPENSATED MOTOR TACH

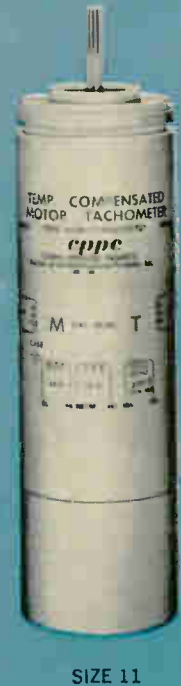

MOTOR TACHMETERS

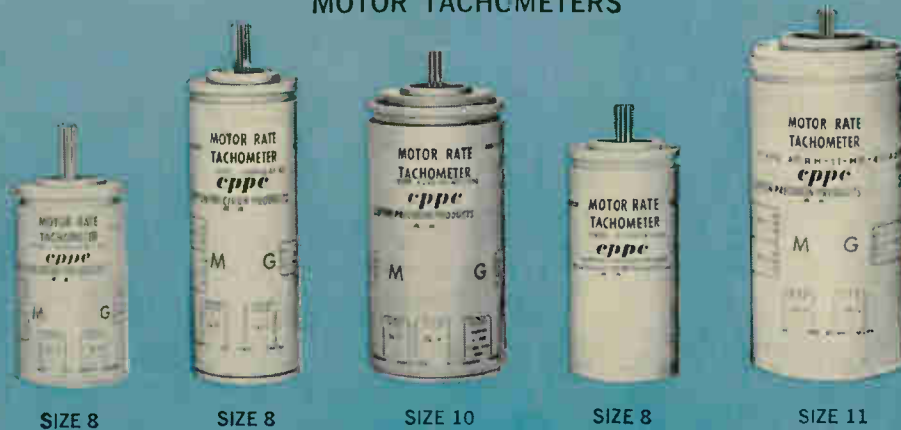

In this new line of motors and tachometers, Clifton has overcome to a significant degree, many limitations inherent in current servo motor designs.

For instance, the incompatibility of efficiency and a linear speed torque curve plagues servo motor users. We have designed a motor which will minimize this conflict. Efficiency has been improved by factors as large as 40% at no expense to speed torque linearity. Thus Clifton motors can give you: more torque for the same power input or same torque with less power consumption; better theoretical acceleration; a cooler more reliable motor with high capacity for being "over-driven" if necessary. These improvements have been achieved without degeneration of air gap or single phasing considerations.

Response time is another important area of improvement in our motors. Certain of our units are specially designed to reduce inertia and increase torque, thereby offering: decreased dead zone, increased slew rate, reduced velocity error.

A further refinement in our servo motors is: lower and more uniform starting voltages with levels as low as 1% of control phase voltage. This, of course, increases the dynamic range of a servo system.

In addition, our servo motors and tachometers are using less heat vulnerable materials such as: improved high temperature resistant magnetic wire; improved lubricant;

improved slot insulation; welded leads; flanged and shielded bearings; glass to metal seals, and high temperature resistant impregnation. As a result our motors can withstand temperatures considerably above the standard 125°C.

Motor Rate Tachometers

Because of the improved torque to inertia designs mentioned previously, no generator is necessary in situations where inherent self damping is sufficient. Smaller generators with less output, less length and less power consumption can now be used when needed. Synchro length *full drag cup* motor tachometers are now possible—a great saving in size and weight over the present long, heavy units.

In addition to a wide variety of off-the-shelf units, we custom design servo motors and tachometers with special requirements of torque, inertia, and temperature resistance. We are eager to serve your standard or custom needs. Clifton Precision Products, Division of Litton Industries, Clifton Heights, Pa., and Colorado Springs, Colo.

cppe

CLIFTON
PRECISION PRODUCTS
DIVISION OF LITTON INDUSTRIES



Electronics Newsletter

January 24, 1966

RCA testing silicon on sapphire for microwave IC's

A 500-megacycle linear-amplifier integrated circuit—using silicon on sapphire—is being built by the Radio Corp. of America to demonstrate the feasibility of silicon-on-sapphire construction for microwave integrated circuits.

RCA recently built a silicon-on-sapphire IC that is a two-transistor linear-amplifier capable of operating from 100 cycles per second to 4.2 Mc. The power gain for the circuit at 4.2 Mc is 23 decibels. The work was done for the Air Force. Both transistors are insulated-gate field-effect types. The thin-film resistors are chrome vanadium. Lanthanum titanate was used for the capacitors.

Printed circuit patent suits win new life

Two U.S. courts have allowed Technograph, Inc., to pursue the multi-million-dollar patent-infringement suits it has been waging for years over printed circuits. The company—through an Austrian-born engineer, Paul Eisler—holds patents which claim invention of printed circuits. Technograph seeks at least \$20 million from about 60 electronics companies and “many millions” from the U.S. government.

On Jan. 14 the Court of Claims in Washington ruled that Technograph could sue the government for royalties on circuit boards made by government contractors. Earlier, a Chicago appeals court ordered trial of suits against five private companies.

Eleven patents are at issue in the government suit—including two expired Eisler patents and one still in effect that covers electroplated circuit boards and multilayer boards. One of the other patents opens another area of battle and could move the patent fighting into the integrated-circuit area; it claims to cover etched thin-film circuits, a basic IC process.

Since 1959, Technograph has received over \$1.5 million in royalties.

Harvard, MIT scientists push radio observatory

A committee of scientists from Harvard and the Massachusetts Institute of Technology has requested government funds to study construction in New England of the world's largest radio astronomy observatory [Electronics, June 15, 1964, p. 27].

The group has asked the National Science Foundation to pay for an engineering-design study of a radio-radar astronomy observatory with a fully steerable antenna 300 to 500 feet in diameter.

The largest steerable U. S. dish is the 140-foot one at Green Bank, Va.

A new twist for laser beams

A scientist at the Radio Corp. of America has evidence that an analog of the Hall effect might be used to modulate and amplify laser beams. Kern Chang was able to change the polarity of laser radiation passing through gallium arsenide by applying a d-c magnetic field to the GaAs. The work was done under an Air Force Cambridge Research Laboratories contract.

The linearly polarized, 3.39-micron output from a helium-neon laser was trained on a wafer of the semiconductor material. When a pulsed d-c magnetic field—aligned perpendicularly to the light's polarization—was applied, the light transmitted through the wafer was twisted and it became nonpolarized and more intense.

Chang is now using a d-c electric field instead of a d-c magnetic field

Electronics Newsletter

to induce this effect. If the same effect can be achieved with an electric field, some of the energy from the field would be transferred to the light frequency, making modulation and amplification possible.

R&D funds shift as time sharing gets Pentagon nod

The Advanced Research Project Agency (ARPA), which is chartered as the Pentagon's research and development unit, is now beginning to steer some of the computer R&D funding away from time sharing and toward other areas: parallel processing and graphic input-output.

Time-shared computers are now beyond the experimental stage in the Defense Department and hardware for direct multiple access to computers is being designed into equipment for the National Military Command System and other military networks.

Philco buys GMe in surprise move

The Philco Corp. is buying, for an undisclosed price, the General Microelectronics Corp. of Santa Clara, Calif. GMe is currently a subsidiary of the Pyle-National Co.

Industry observers say that Philco's purchase of GMe is linked to the California company's expertise in the production of metal-oxide-semiconductor integrated circuits. There's speculation that Philco intends to shift GMe's business from commercial to military products.

GMe produces, among other things, office calculating machines for the Victor Comptometer Corp. Albert C. Buehler Jr., executive vice president of Victor, says the sale of GMe "wouldn't have the slightest effect on us—we have a 10-year-contract with them and it has nine years to run."

Computer-on-slice project to start

The Army intends to find the best way of building a computer-on-a-slice by having three contractors develop systems, according to Howard Steenberg, the project leader at Wright-Patterson Air Force Base [Electronics, Aug. 23, 1965, p. 40]. The contractors will be asked to work on different combinations of the two competing types of integrated circuits—those built with bipolar devices and those with metal-oxide-semiconductor (MOS) devices. In each case, none of the monolithic arrays that will make up the computer's logic and memory will have less than 100 circuits on each silicon chip.

Contracts are being negotiated with Texas Instruments Incorporated, the Radio Corp. of America and General Micro-electronics, Inc. TI will make both logic and memory of bipolar devices, RCA's system will have bipolar logic and MOS memory, and GMe will make both logic and memory MOS. TI will also interconnect the circuits of the array by a technique it calls discretionary wiring, which allows faulty circuits to be bypassed [Electronics, April 19, 1965, p. 36].

Top brass changes at Stewart-Warner

The Stewart-Warner Corp. is changing the executive lineup at one of its subsidiaries, Stewart-Warner Microcircuits, Inc. Jack Coffey, formerly with the Stewart-Warner Electronics division, has taken over as the subsidiary's general manager and executive vice president, and John P. Gates will become manager of engineering and manufacturing. Gates formerly was manager of digital integrated circuits at Fairchild Camera & Instrument Corp.'s Semiconductor division. Being replaced is William Hogle, executive vice president. The status of his wife, Frances Hogle, director of engineering and research, is still in doubt.



PLASTICOTE[®] WIRE & CABLE by **CHESTER**

CHESTER CABLE CORP.

A Subsidiary of Tennessee Corporation

CHESTER, NEW YORK

(See reverse side)

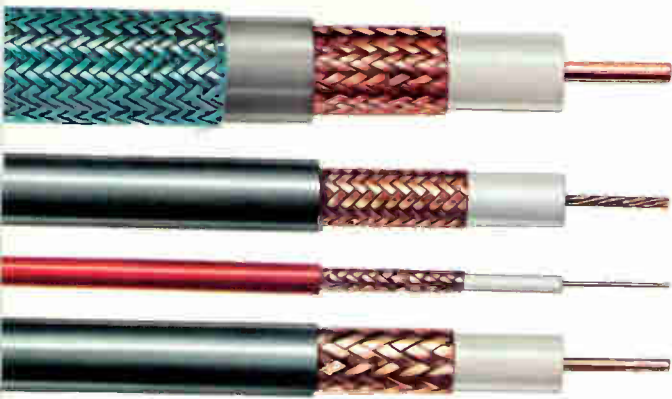

COAXIAL CABLE — Chester Cable Corp. offers a complete line of coaxial cable for military and commercial applications. Manufactured in accordance with MIL-C-17, JAN-C-17 and commercial specifications. Constructions include solid, air-spaced and foam dielectrics with conventional braid shields or flat copper tape shields, having PVC or polyethylene jackets. Custom designed constructions of triaxial cable and high frequency-high voltage cable are also available.

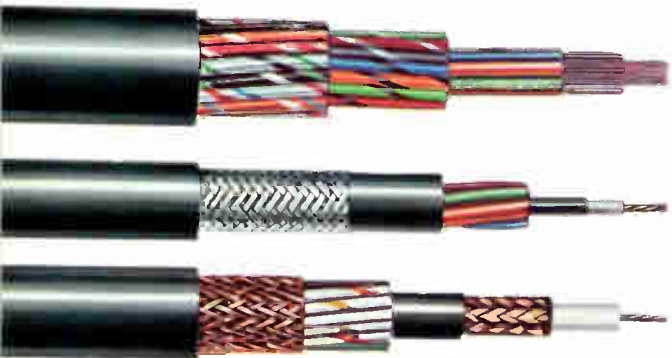

MULTI-CONDUCTOR CABLE — Wide range of custom designs available, manufactured in accordance with such industry standards as MIL specs., U/L, CSA, IPCEA, EIA, IMSA, ASTM, etc.

Chester Cable Corp. is a preferred source for quality electronic and electrical cable, insulated and jacketed with thermoplastic materials such as polyvinylchloride, polyethylene and nylon. Custom designs of shielded or unshielded cable include: Control Cable · TV Camera Cable · Missile Cable · Intercom Cable · Computer Cable · Special Hi-Voltage Cable and Parallel Bonded Ribbon Cable.



MIL-SPEC WIRE — Made in accordance with specifications MIL-W-16878 (Types B, C & D), MIL-W-76B (Types LW, MW & HW) and MIL-W-5086A for electronic systems. Available in single or multiple constructions, shielded or unshielded, with or without nylon or PVC jackets.



WIRE AND CORD FOR THE APPLIANCE INDUSTRY — U/L and CSA approved, 60°C — 80°C — 90°C — 105°C appliance wiring material — SVT, SJT, ST cord, SJTO & STO oil-resistant cord, SJT & ST oil-proof cord, SPT cord with or without individually insulated ground wire. Used for washers, dryers, refrigerating, air conditioning, vending, heating, X-ray and other electrical and electronic equipment.



RADIO AND TV CIRCUIT WIRE AND CABLE — U/L and CSA approved, 60°C — 80°C — 90°C — 105°C appliance and radio circuit wire, microphone cable, shielded and unshielded audio circuit wire, twin lead antenna wire, phonograph cable, parallel-bonded color convergence ckt. cable, braided hook-up wire, hi-anode wire, hot chassis lead, balun-coil wire, shielded constructions with spiral, braided, aluminum-Mylar tape and conductive materials; all available in Thrif-T-Bond® tinned over-coated conductors.

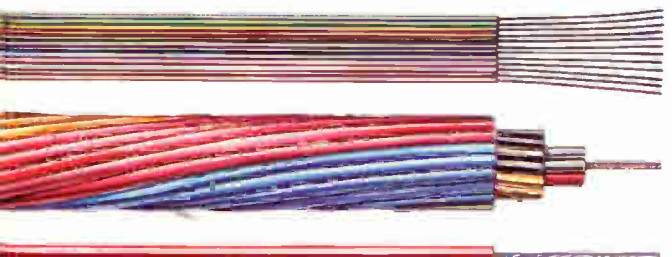

MISCELLANEOUS WIRE AND CABLE — Machine Tool Wire · Bus Drop Cable · Flexible Test Lead Wire · Municipal Signal Cable · Low Energy Circuit Control Cable · Station Control Cable · Inter-Office Communication and Signaling Cable · Deep-Well Submersible Water Pump Cable · Gas Tube Sign and Oil Burner Ignition Cable · Intercom Cable · Gasoline and Oil Resistant Wire · Computer Cable · Uninsulated Bus Wire · Parallel and Jacketed Cord · Braided Ground Strap, and special custom designed cable for your applications.



Write or phone for further information.

CHESTER CABLE CORP., A Subsidiary of Tennessee Corporation, CHESTER, NEW YORK 10918

Phone: 914 - 469-2141 · TWX: 914 - 469-7011

Printed in U.S.A.



TYPE OM to 115 v.d.c.,
3" dia. x 5½" long

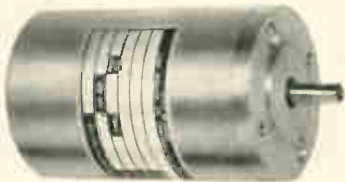

TYPE GRP to 115 v.d.c., 2¼" dia. x 3¾" long



TYPE BL to 115 v.d.c., 1½" dia. x 2¼" long



TYPE BD to 115 v.d.c., 1½" dia. x 2¼" long



TYPE LL to 75 v.d.c., 1¼" dia. x 2¾" long



TYPE JM to 115 v.d.c., 1¼" dia. x 2½" long



TYPE MM to 50 v.d.c., 1¼" dia. x 2½" long



TYPE HM to 75 v.d.c., 1" dia. x 1¾" long



TYPE SS to 50 v.d.c., ¾" dia. x 1¾" long



TYPE SD to 50 v.d.c., ¾" dia. x 1¾" long

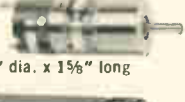

TYPE VT to 50 v.d.c., ¾" dia. x 1½" long



TYPE VS to 50 v.d.c., ¾" x ¾" x 1½" long

RELATIVE SIZE & DIMENSIONS

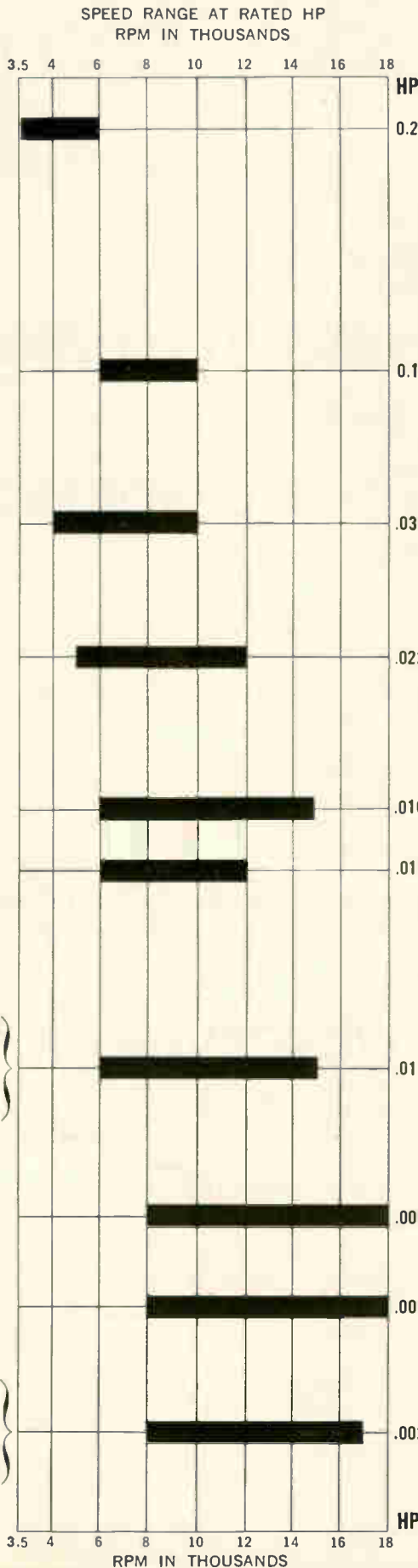

The MIL-spec D.C. motors you need are here!

If your MIL-spec d.c. motor needs fall within the parameters shown, a Globe high torque motor or gearmotor will fill the bill. Globe's complete line of compact permanent magnet and wound field motors plus integral planetary geartrains adds up to your best source for precision miniature motors. Request Bulletin A.

Globe Industries, Inc.
2275 Stanley Avenue
Dayton, Ohio 45404
Tel: 513 222-3741



ONLY PERMANENT MAGNET TYPES SHOWN. WOUND FIELD MOTORS AVAILABLE. GLOBE ALSO MAKES A.C. MOTORS, GEAR-MOTORS, AND BLOWERS.

A follow-up report on reliability from Philco Microelectronics:

As of **January 1, 1966**, a total of **5,040** Philco silicon monolithic integrated circuits* have accumulated over **27,000,000 unit hours** in simulated in-use operating life tests at **125°C**.

Average test-time/unit:
5,000 hours

Number of inoperable failures: **2**

For an observed failure rate
of **0.008% per 1,000 hours**.

*Microcircuits in life tests include DTL, TTL, MW/3, Milliwatt, Micrologic† integrated circuits.
†Trademark of Fairchild Camera and Instrument Corporation used under license.

 MICROELECTRONICS OPERATION
PHILCO
A SUBSIDIARY OF *Ford Motor Company*
LANSDALE DIVISION • LANSDALE, PA.
In Canada, Don Mills Road, Don Mills, Ontario, Canada

Oceanology

Light touch

In the Mojave Desert, where even a lake can be dry, the Navy is building a glass bubble in which two men will dive 20,000 feet beneath the ocean's surface. The craft's electronics will be controlled by a beam of light.

The project is a relatively small part of the Navy's Deep Submergence program. Engineers at the Naval Ordnance Test Station at China Lake, Calif., hope to come up with a bargain-basement-priced submersible that can be used for deep-sea research by keeping everything on the craft simple. Donald K. Moore, head of the station's Astrometric division, hopes to keep costs down to where the vehicle can be built for between \$8,000 and \$20,000.

There simply wouldn't be enough room inside the bubble for a lot of electronics and the two-man crew, so it was decided to house much of the electronics, plus other equipment, inside a plexiglass hull on which the bubble would sit. Then came the problem of regulating the electronics from inside the bubble. A glass sphere has the peculiar property of becoming stronger under pressure, but any surface break (such as a hole through which a cable could be drawn) weakens the structure. Moreover, leading wires through the ocean's depths raises the chances of short circuits from leaks in the wire's casing caused by the great pressure.

To avoid these problems the engineers turned to light, which can easily pass through the wall of the bubble, to modulate the electronics.

Light logic. The technique of modulating the electronics with light seemed the obvious, most practical solution to the tricky problem, says Moore.

Inside the bubble, the crew will carry the bare minimum of equip-



Model of glass bubble that will descend to the bottom of the sea. Unique light-modulating technique will be used to communicate between the deep-sea bubble and a separate electronics package.

ment: an environmental system to supply oxygen and remove carbon dioxide, a couple of flashlights, a very-high-frequency radio, a flashing light for a beacon and something that Moore calls "a control panel."

"I don't know what the control panel will be yet," he explains.

The hull will carry a depth sounder and meter, a scoop or suction device for collecting samples from the ocean floor, a velocity indicator (the sub will zip along at four knots), an inclinometer to show which way is up, two motors for propulsion, batteries or fuel cells, lights, instruments, displays and electronics.

The electronics will be limited to three kinds of circuits: a photo-detector amplifier, built on a single chip; logic and matching circuitry, (probably AND gates); and silicon controlled rectifier inverters for power switching.

Under control. The light source, either a light-emitting diode or a simple flashlight bulb, will be attached to the outside of the hull and focused through a lens onto an array of reflectors inside the

bubble. At the light source will be an array of photodiodes or phototransistors. Each photodiode on the hull would be matched with a reflector in the bubble. Hence, a single beam of light from the hull source would travel through the lens, into the bubble and hit the array of reflectors. The light that's reflected would no longer be a single beam; it would be broken up into a bundle of distinct beams by each of the reflectors. The bundle of light beams, then, would be reflected back to the hull and each separate beam would hit a corresponding photodiode. By covering or uncovering the appropriate reflector or group of reflectors—the men in the bubble will control the electronic devices in the hull.

The electronic components will operate in protective silicon oil. The China Lake station has a testing program under way to select components that will not change their characteristics under pressure; the chief difficulty is with capacitors, whose dielectrics can be deformed under pressure. Moore is also concerned with the effects

of frequent dives and surfacing.

The glass capsule, being built by the Corning Glass Works, is scheduled for delivery in about four months, Moore says.

It will take six to nine months of testing, both for the capsule and the controls, before the submersible is ready for manned operation, he explains.

Solid state

Symbolic victory

In any language, usage sets the standard. And in the language of electronic symbols, the manufacturers have set the standard for eight widely used solid state devices—ignoring the symbols of the Institute of Electrical and Electronic Engineers promulgated in 1957. So the IEEE, which would apparently rather switch than fight, is proposing to recognize formally the manufacturers' symbols, thus giving the engineering profession the option of using either of the two standards.

Manufacturers have been using their own symbols for controlled rectifiers, (pnpn and npnp types), gate turn-off switches (pnpn and npnp types), unidirectional breakdown diodes, bidirectional diodes, tunnel diodes and backward diodes. The producers claim their symbols are easier to draw and more descriptive. Also, some manufacturers claim that the standard symbols often don't fill their needs. For example, the symbol for the controlled rectifier is the same as that for the gate turn-off switch.

'... takes your choice.' Manufacturers will have little reason to change to the old IEEE-sponsored symbols now that their own have been recognized. The IEEE action will probably be reflected in textbooks because writers will undoubtedly change to the new symbols—which may ultimately become the sole standard—now that the IEEE has approved them.

[For a related story on possible symbol changes for the field effect transistor, see p. 134].

The IEEE's standards were based on the notion that all semiconductor devices were made up of combinations of n- and p-type semiconductor layers, intrinsic layers and ohmic contacts. Once graphic representations were established for these a standard symbol for any new device could be synthesized quickly on the basis of its construction. While this system satisfied the device physicists, many circuit engineers found the results confusing, especially since they resulted in the same symbols for different devices. In some cases, the new symbols bear some relation to the function of a device in a circuit.

Not unique. The practice of having more than one standard for a symbol is not unique for the IEEE. For instance, two symbols are recognized for the resistor—the zig-zag line and the rectangle.

The road to legitimacy does not end at the door of the IEEE. Before final approval can be attained, the proposal must go before the American Standards Association, which will consider it in the spring.

Since most companies support the change, no opposition of any consequence is expected.

Transportation

Fail-safe?

Weeks before its debut, Westinghouse Electric Corp.'s publicity men ground out stories about their new computer-operated transit system. A train was designed to zip around on a ribbon of concrete at 50 miles an hour, slow down for curves, stop at stations and, in the event of trouble, stop immediately. The evening before a demonstration for the press, the engineers were putting the system through a routine test. No one was in the train. Suddenly it ground to a halt—after crashing into a section of open track.

Embarrassed Westinghouse engineers confessed, after assessing the damage, that the fail-safe sys-

SEMICONDUCTOR DEVICE	PRESENT SYMBOL	PROPOSED ALTERNATE SYMBOL
CONTROLLED RECTIFIER, pnpn TYPE		
GATE TURN-OFF SWITCH, pnpn TYPE		
CONTROLLED RECTIFIER, npnp TYPE		
GATE TURN-OFF SWITCH, npnp TYPE		
UNIDIRECTIONAL BREAKDOWN DIODE		
BIDIRECTIONAL BREAKDOWN DIODE		
TUNNEL DIODE		
BACKWARD DIODE		

tem had failed.

A Westinghouse official speculated that a technician had left a temporary jumper wire on the train, preventing some device from bringing it to an emergency halt.

The Westinghouse demonstration transit expressway is controlled by a system that is like the one Westinghouse is testing near San Francisco, for the Bay Area Rapid Transit District [Electronics,



Computer-operated transit system developed by the Westinghouse Electric Corp.

July 26, 1965, p. 71]. The accident, which damaged the undercarriage of one car, occurred when the train struck a section of movable track that transfers cars from the main track to a siding. As that section moves out, another moves in to take its place.

Didn't work. The movable section stuck in the half-way position; the automatic control system was interlocked to stop any approaching train, but somehow that didn't work either.

Damage was not extensive because the train was approaching a station at low speed. There were no passengers or crew on the train at the time. The transit expressway system did open to the public on schedule two days later, but with only two cars operating instead of three.

The expressway is used for demonstration of a rapid transit system that Westinghouse is beginning to market. Trains of one to ten cars that resemble buses roll on rubber tires along concrete tracks 22 inches wide. Part of the Pittsburgh track is on the ground and part is elevated; Westinghouse says that tracks could be put in subway tun-

nels as well. Guide wheels on each car roll along the web of an I-beam between the concrete tracks; these guide wheels steer each axle and keep the cars from toppling off the track. Three-phase a-c power is supplied through rails on one side of the I-beam.

Loops of wire are strung along the inner vertical surface of one of the tracks in a square-wave pattern. Two audio frequencies gen-

erated on each train are picked up alternately by the top and bottom extremities of the square wave and transmitted to the control computer, a Westinghouse Prodac 510, at a wayside control station. The frequency of alternation tells the computer how fast the train is moving; the computer compares that speed with the speed the train should maintain and transmits a signal back to the train, again over the square wave loop, commanding a speed-up or a slow-down.

Space electronics

Jawohl for AOSO

The Advanced Orbiting Solar Observatory (AOSO) didn't look as if it would get off the ground—not in its target year of 1969, at least. The satellite was one of the casualties of the United States budget squeeze. From West Germany, however, has come an offer that may give AOSO the lift it needs—cash.

West Germany is said to have

earmarked several million dollars for international cooperation in space ventures—some of it for the AOSO mission.

The offer could be enough to encourage the National Aeronautics and Space Administration to squeeze a few more dollars out of its budget to save the \$160-million sun-research experiment. NASA hasn't yet made up its mind.

Seek projects. The offer followed by a few days President Johnson's statement to Chancellor Ludwig Erhard that international cooperation in space ventures should be stepped up. During the recent Johnson-Erhard talks, the President said he would send NASA administrator James E. Webb on a European tour to drum up cooperative projects.

The AOSO prime contractor is the Fairchild Hiller Corp. of Hagerstown, Md. Honeywell, Inc., and Texas Instruments Incorporated are the major subcontractors for systems aboard the NASA spacecraft.

European countries have long been eager to join in more space projects; they feel they are being left behind by the U. S., not only in satellite-launch technology, but in other industrial areas in which space technology is applied.

On to Europe. NASA's Webb will go to Europe shortly after the Congressional space-budget hearings [Electronics, Jan. 10, p. 26] in February. An advance team of experts from NASA may precede him to prepare the groundwork. Some discussions were held this month in Paris by Presidential Science Adviser Donald F. Hornig at the scientific ministers meeting of the Organization for Economic Cooperation and Development.

Hornig stopped in Germany and England on his way home for additional talks.

NASA has already launched scientific satellites for Canada, France and Great Britain and flown some foreign-built experiments on NASA satellites. More of both are planned.

Currently under way are programs to launch satellites for Italy and the European Space Research Organization.

While NASA doesn't have exact

cost figures, it estimates that foreign space participation has saved the U. S. \$1 million or more because all data from the satellites is available to the U. S.

Apollo's footprint

In space jargon, "footprint" means the probable area of splashdown for a missile or spacecraft at the end of a mission. In the Gemini series, the footprint measures only 40 by 200 miles; and the odds are against a landing outside it. The footprint for the Apollo moon capsule, however, measures 3,500 by 500 miles; and it's possible the craft will miss it entirely.



Network of specially equipped HC-130H's will be stationed throughout the world to track and recover Apollo spacecraft in the event it splashes down far from rescue ships.

To backup the present recovery system of helicopters and fixed-wing aircraft, the National Aeronautics and Space Administration is developing a worldwide network of 48-tracking planes to locate the incoming capsule, track it through the atmosphere, and provide assistance no matter where on earth it lands.

Skip back. The odds against a landing in the footprint are greater with Apollo than with Gemini. The slightest navigational error or trouble aboard the craft on the way back from the moon will cause it to miss its reentry zone above the atmosphere.

Even if it found the zone, at 25,000 miles an hour, space officials fear that a small error in the reentry angle would cause the capsule to "skip" off the top layer of atmosphere and reenter at another point—much the same as a flat

stone thrown across water skips along the surface.

Such a skip would put the final splashdown up to 1,500 miles away from the footprint. There simply aren't enough ground-based or ship-based tracking stations to adequately cover this much territory during reentry. A proposed network of such stations could track high-flying craft, but once the craft drops into the atmosphere, the range of a station would be limited by the horizon. The airborne network will fill the ground-station gap.

Print location. A fleet of Lockheed HC-130H's will carry the tracking gear, labeled AN/ARD 17. The Tech-Center division of the

Cook Electric Co. developed AN/ARD 17 to pick up S-band telemetry signals, automatically calculate a target's speed and bearing in relation to the plane, and print out the information.

The system's sensitivity, -129 decibels above 1 milliwatt (dbm) for S band, and -119 dbm at 225 to 300 megacycles, is better than that of earlier models, primarily because a rotating high-gain antenna is used in the new design. The unit can pick up signals coming from as far up as 6,000 miles and as far out as 1,000 miles.

NASA first considered the flying tracking stations back in the early 1960's, during the early Mercury missions. The system, used by the Air Force for a top-secret mission, was suggested to fill the ground-station gap. After a test with Mercury, NASA decided to use the technique, with modifica-

tions. It wasn't until Gemini 5, last year, that the first complete tracking model, developed to NASA's specifications, was ready for testing.

Avionics

Wire tester

A wire failure can ground a jet fighter for as long as 10 days while technicians with ohmmeters check through as many as 10,000 electrical wires in the plane's avionics systems. Because of this long and sometimes critical down time, the military is pushing automatic wire-checking systems.

A \$1.4-million contract, awarded by the Air Force Systems Command, has produced a tape-controlled system that cuts diagnosis on a jet fighter to an estimated four hours. The Dalmo-Victor Co. of Belmont, Calif., a division of Textron, Inc., developed the system, called USM-185, for the wiring harnesses of the F-4C and the F-105, but anticipates it will eventually check out the F-101, F-102, F-106 and the F-111 family of planes. The test can operate automatically or manually.

Quick check. Using an 80,000-contact random-access matrix of crossbar switches and microelectronic flatpacs, the system, which is in final development, will check leakage, continuity and resistance of all wiring within the aircraft. Each aircraft model will have its own taped program.

To meet the Air Force's requirement for mobility, the system will be housed in two trailers: one for the operator's console, the other for the test switch assembly.

The biggest part of the test job will be making all the connections. It will take three hours, for example, to make the 430 connections in the F-4C. The test cycle itself will take only about an hour.

Quick talk. Coded commands from either the tape resistor, the manual control panel, or both, are fed to decoders in the control logic. The control logic, like a telephone

HERE'S WHAT THIS 5 WATT ZENER DID FOR ONE COMPANY!

Reduced weight 93%
 Reduced size 90%
 Reduced cost 73%

IMPRESSIVE? Read on so you can achieve similar savings.

CASE HISTORY

This company has a design engineer-- let's call him Bill-- who had a problem. Line spikes were causing high base to emitter voltages that were destroying a transistor in the emitter-follower of Bill's solid state amplifier. Transistors with high base to collector voltages were both expensive and difficult to get.

The 24 volts of power for Bill's amplifier came from a high current, low voltage supply that also fed several other sub-assemblies. Bill found that when he inserted sufficient limiting impedance to protect the transistor, the circuit wouldn't operate satisfactorily.

What Bill needed was a line voltage transient clipper that would conduct high current during transient surges while having no steady state power consumption-- a 36-volt zener!! Now he had a choice-- a bulky 50 watt stud (1N3326), or an equally bulky 50 watt T03 (1N2885).

or

a Unitrode UZ5836, miniature axial leaded zener with a comparable surge rating. He chose the latter and saved in weight, size, and cost.

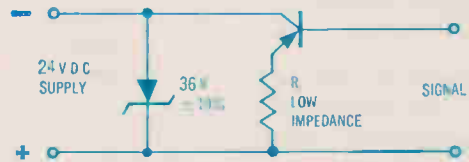

YOU CAN DO THE SAME. Contact the factory, call your local COMPAR office, or circle the reader service number on the magazine's reply card. All will insure your receiving data sheets and samples of Unitrode Zeners as well as information on other semiconductor devices immediately.



UNITRODE
 "better always by design"

580 Pleasant Street, Watertown,
 Mass. 02172 Telephone (617) 926-0404
 TWX (710) 327-1296

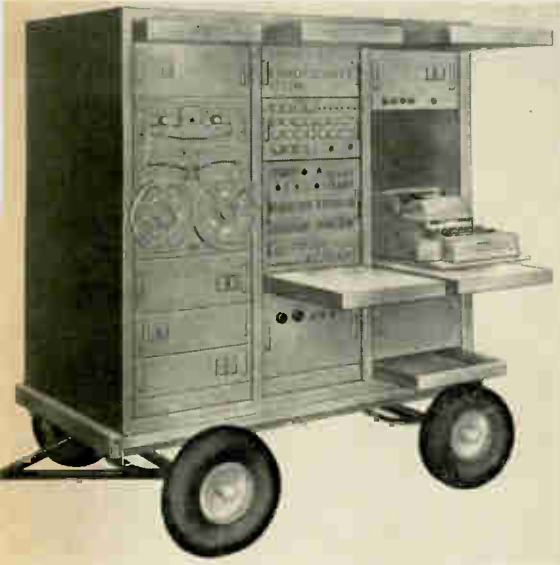

Mobile unit checks wiring in jet fighters, cutting test time from 10 days to four hours.

exchange, allows the input device to "talk" directly to the measure unit, the translator switching control logic and printout devices as required. The measure unit provides test results to both a visual display and printer-punch assembly. It also supplies a test advance control to the tape reader after a "go" result.

The unit operates in four modes: automatic, semiautomatic, manual and self-programming. In the automatic mode the test system sequentially performs the tape-programmed test and stops only when the operator interrupts it, when a "no-go" signal is generated or when an analyzer fault is detected.

Dalmo-Victor plans to study commercial applications of the unit, since it believes a model can be adapted or designed for any type of complex wiring system. The cost will vary, but the company estimates the average price at about \$70,000, depending on accessories and the type of test system required.

Avionics

Frequency shift

The Federal Aviation Agency has long maintained that satellite com-

munications would never become operational until the 1970's. But this would not be soon enough to satisfy the agency's demand that all over-the-ocean airliners be able to keep in constant touch with ground stations. Now, however, the agency has changed its mind: it believes a satellite network, serving the communications needs of the airlines, may be in operation no later than 1968.

Fill the gap. The decision delights the airlines but saddens the producers of radio equipment, because it means that the FAA will no longer push for the development and procurement of an interim communications systems—a system to fill the gap between the present unreliable high-frequency radios and the highly reliable very-high-frequency radios that would be used with satellites. The interim system, which the FAA has been pushing up till now, would use a suppressed, single-sideband h-f radio, which costs an estimated \$18,000 per plane.

The superiority of satellite-relayed vhf signals over any h-f system was never in dispute. Vhf provides a stronger, clearer signal and offers very high reliability. The Strategic Air Command, which obviously requires reliable worldwide communication links with its military craft, has been using the single-sideband h-f system for years and maintains it is adequately fulfilling the need—at least until a worldwide satellite system becomes operational.

The FAA is expected to make its policy shift official in March, when the U. S. will report to the International Telecommunications Union that it's opting for satellite communications. As recently as last November the FAA's position at the International Civil Aviation Organization conference was that single-sideband h-f should be used until satellites become operational.

Problems remain. The move to vhf-satellite communication is not without its problems, however. Propagation characteristics of satellite-relayed signals are still troublesome. Reflection of the signal from the ground or water creates

a multipath problem. And antennas for retrofit in present aircraft have not yet been perfected, although industry spokesmen say antennas have been developed for assembly-line installation in new planes.

Experiments with the National Aeronautics and Space Administration's Applications Technology Satellite-B may provide the answers, says Frank C. White, manager of communications and data processing for the Air Transport Association. The satellite is scheduled for launch late this year.

Last year in a Pacific Ocean flight, a Pan American World Airways cargo liner, using a Bendix Corp. receiver and a Boeing Co. antenna, sent and received the first successful ground-air communication by satellite.

Inspection

Green light for infrared?

A lot of people have talked about infrared testing but not too much has been done about it.

Now the techniques of infrared inspection of electronic devices and components may soon start moving out of the laboratory and onto the production line.

Two programs—one about to start and the other still in the planning stage—may presage industry-wide acceptance of infrared as a nondestructive assembly-line testing technique for electronic parts.

The program that's bound to have the biggest impact on spreading the word on infrared is the Lockheed Aircraft Corp.'s C-5A project, which may require that all electronic parts undergo infrared testing to insure extremely high reliability. With several hundred vendors vying for subcontracts, such a demand would represent overnight success for infrared testing. Lockheed is asking all potential subcontractors to provide two sets of bids: one with the cost of infrared testing and one without it.

For production. The second program is the Raytheon Co.'s Com-

COMPONENT COMMENTS *From Speer*

Has our traveling resistor show visited you yet?

We're referring to our new slide film presentation called "How a Speer Resistor Gets Its Stripes."

This lively 20-minute sound and color film follows a typical group of Speer composition resistors as they try to "shape up" to today's tougher MIL-R-39008 specs.

Starting with the first manufacturing steps, you'll see the

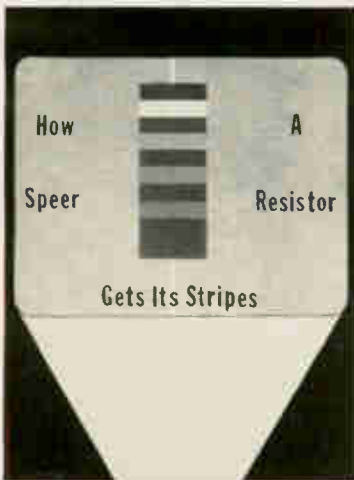

various tests that the raw materials have to pass. You'll see the exhaustive checks that accompany every step of resistor production. You'll see the latest electronic quality control and reliability equipment in action. And you'll see the proud moment when the resistors receive their insignia of uniformity and high quality—five colorful stripes.

If you're concerned with meeting military specifications, you'll want to arrange a free screening of this slide film. To do so, simply contact your nearest Speer representative. If you don't have his name, mail the coupon and we'll let you know where to reach him.

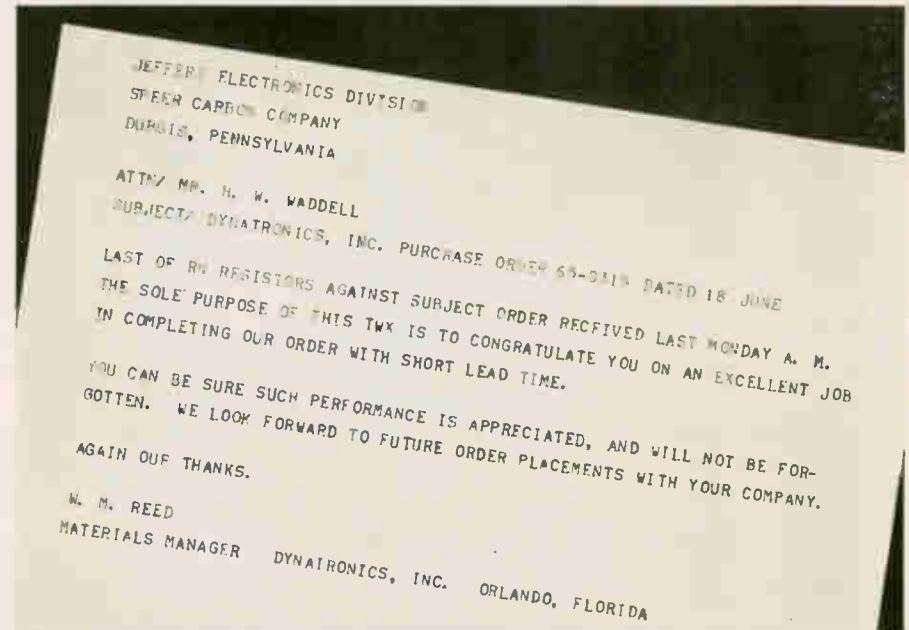

Fan letter. It seems that Dynatronics needed large quantities of .1% tolerance metal film resistors in a week. And only Jeffers Electronics would promise to meet their deadline. As you can see, we also kept that promise. Do we always deliver this fast? No. But even our normal delivery of standard JXP resistors is three times faster than the service you may be getting elsewhere.

If you're looking for the best temperature stability and least cost in a precision resistor, forget about its TC

We're as respectful of traditions as anyone. And we're well aware that the traditional determination of resistance-temperature stability is based upon resistance measured at two specified temperatures. (Otherwise known as "TC".)

We believe, however, that there is a more advantageous way to express resistor temperature stability—one that will prove less costly to you in situations where a high degree of stability is required.

We recommend instead a "design tolerance" or "total resistance deviation limit" expression of the stability of a precision resistor. For example, a resistor with an allowable total resistance deviation limit of 1,000 ppm over a given temperature range will satisfy the same circuit requirement as a resistor that is specified by a ± 5 ppm TC. Yet specifying a 1,000 ppm limit delivers a resistor that would cost only one third as much (and delivers it a lot faster, too).

We might mention our ultra-precise JXP metal film resistor at this point. It is available in tolerances that can meet

your *toughest* stability requirements.

A detailed discussion of our new stability determination method can be found in our article entitled "Specifying Resistance Temperature Stability." If you'd like a copy, simply mail the coupon.

JEFFERS ELECTRONICS DIVISION,
Speer Carbon Company
DuBois, Pennsylvania

Speer Carbon Co. is a Division of Air Reduction Company, Inc.

- Rush "Specifying Resistance Temperature Stability."
 Rush the name of my nearest Speer representative.

Name _____

Title _____

Company _____

Street _____

City _____

State _____ Zip _____

pare, an acronym for Console for Optical Measurement and Precise Analysis of Radiation from Electronics. In Compare, Raytheon will test production-line components for communications equipment with radiation-scanning instruments. Raytheon says this is the first time an infrared tester has ever been used on a production line for testing electronic circuits.

The reason. Why the move to infrared? Reliability engineers have discovered that circuits and components that passed production-line electrical and mechanical tests later failed an infrared test. A failure shows up during infrared scanning when a hot spot appears in the infrared photograph. The hot spot is an indication that heat is not being dissipated properly, providing a clue that the part contains a flaw or the design is poor.

During Lockheed's C-141 contract, for example, reliability engineers put both circuits and circuit boards through the infrared test. Photographs of the infrared scans provided thermal maps, so the engineers could pinpoint unusual hot spots, and eliminate them. They found that the resulting circuit redesign proved more reliable.

Similar investigation of infrared is under way at the Boeing Co.'s Microelectronics Laboratory in Kent, Wash. Boeing's engineers are using the technique for design verification by observing heat distribution patterns on thermographs and then redesigning to eliminate the heat traps and hot spots.

Pushes test. A major supplier of infrared equipment, the Barnes Engineering Co., is also looking for ways to make the testing technique more popular. Barnes has already been able to identify "signatures" for different kinds of microcircuit problems. With this information, a user can quickly identify the source of trouble and eliminate it.

At Raytheon, another testing technique, called recombination radiation, may prove to be yet another boost for infrared. In this technique, current is passed through the semiconductor being tested; the infrared instrument then measures the radiation emitted by

the semiconductor. This technique not only measures heat, but also the amount of electricity passing through the device. The scan is read as a current waveform on an oscilloscope.

A big supporter of this research is Raytheon's expert on infrared, Riccardo Vanzetti, who says the technique provides a direct measurement of the current passing through the semiconductor.

Although the technique is not yet perfected, it may provide an easy way to test a microcircuit. In conventional electronic testing, with such equipment as voltmeters and oscilloscopes, the probes are usually bigger than the circuit itself, so parts of the circuit can not be analyzed. But with recombination radiation, the infrared detector can be focused on a discrete spot such as a junction between two components.

Military electronics

Wired for talk

Long wire antennas, trailing thousands of feet behind the airborne command posts that are part of the Strategic Air Command's communications system, will be built by the Collins Radio Co. of Dallas under a \$3-million contract.

Although Collins seems to be reversing a trend—antennas are getting smaller and smaller as frequencies for airborne communications climb higher and higher—the explanation is simple. SAC's communications system, designated 487L [Electronics, Nov. 15, 1965, p. 164], must operate during and after a nuclear attack. Only very-low-frequency signals can cut through areas of atomic radiation, and only very long antennas can pick them up.

Remove and replace. SAC introduced its airborne command posts nearly five years ago. The trailing-wire antenna is part of the continuing development of the 487L system. Also under development is a 100-kilowatt solid state transmitter.

Its modular construction provides remove-and-replace maintenance, from major components down to the smallest amplifier unit.

The trailing-wire antenna consists of several thousand feet of high-strength, copper-wound steel less than one-sixth inch in diameter, with a 24-inch-diameter conical drogue chute attached to the end. The drogue holds the wire fairly taut and prevents it from whipping too violently.

If lightning strikes. Special safety devices will be built into the antenna to protect the crew, aircraft and communications equipment from lightning. In emergencies, the antenna can be controlled manually and it can be cut free of the plane.

The antenna contract was awarded to Collins by the Aeronautical Systems division, Wright-Patterson Air Force Base, Ohio, which is responsible for airborne equipment. The 487L program is managed by the Electronic Systems division, Hanscom Field, Mass. The prime contractor is the Westinghouse Electric Corp.; DECO, Inc., is providing the ground antenna subsystems; National Co., the receivers; and the National Cash Register Co., the teletypewriters and instruments.

Advanced technology

Superconductor force

A physicist at the Radio Corp. of America has demonstrated the existence of a force in superconductors that is analogous to the Magnus force in liquids and gases. Not only does this contribute to understanding the phenomenon of superconductivity, but it may lead to the development of a new class of tiny computer memories and electric generators without brushes or commutators. The force could also be valuable in new designs for d-c transformers and rectifiers.

The experiment by Judea Pearl an Israel-born scientist, demonstrated that the force—actually the movement of tiny whirlpools of

HERE IT IS!

The new low-priced DIGITAL VOLTMETER and RATIOMETER

- **COMPACT**
- **LIGHTWEIGHT**
- **VERSATILE**
- **ACCURATE**
- **RELIABLE**



developed by COHU ELECTRONICS and designated the model 511

CHECK THESE ABBREVIATED SPECIFICATIONS:

- 0.01% ACCURACY, ± 1 DIGIT
- 4 DIGITS RESOLUTION ON ALL RANGES
- AUTOMATIC POLARITY INDICATION
- 10 MANUAL RANGES, 1V TO 1000V, 1:1 TO 1000:1 RATIOS

- HIGH INPUT RESISTANCE
- SOLID-STATE REFERENCE AND CIRCUITRY
- BI-DIRECTIONAL, TRACKING LOGIC
- PRICE: \$995.00 F.O.B. San Diego. Additional export charge

Box 623, San Diego, California 92112 Phone 714-277-6700



for detailed specifications contact your nearest representative

ELGENCO Noise Generators

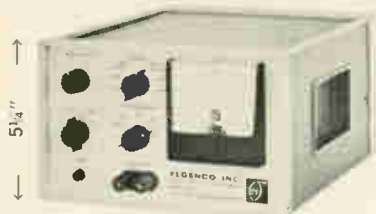

Model 610A

SOLID STATE NOISE GENERATORS

Model 602A 5 cps to 5 mc, 3 Ranges \$ 290
 Model 603A 5cps to 5 mc, 3 Ranges \$ 495
 Model 610A 5 cps to 5 mc, 8 Ranges \$1,175
 Series 624 (Fixed frequency) 5 cps to 500 kc
 \$245 to \$490. Write for details on frequency
 ranges and spectral flatness.



Model 312A

VACUUM TUBE NOISE GENERATORS

Model 301A DC to 40 cps \$1,995
 Model 311A Two outputs DC to
 40 cps and 10 cps to 20 kc \$2,395
 Model 312A Two outputs DC to
 120 cps and 10 cps to 20 kc \$2,495
 Model 321A DC to 120 cps \$2,095
 Model 331A 10 cps to 20 kc \$1,275

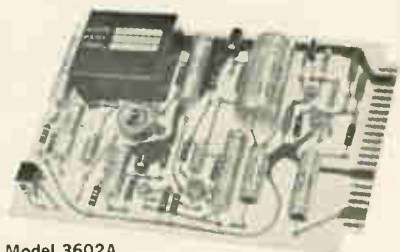

Model 3602A

NOISE GENERATOR CARDS

Series 3602, 3603, and 3606 \$144 to \$389
 Various frequency ranges and output flat-
 ness available. Size: 4 1/2" x 6 1/2" x 1". Write
 for details.

ENCAPSULATED NOISE SOURCE MODULES

Series 1602, 1603, and 1606 . . \$95 to \$340
 Various frequency ranges and output flat-
 ness available. Size: 1 3/4" x 1 1/2" x 3/4". Write
 for details.

ELGENCO INCORPORATED



1550 Euclid Street
 Santa Monica, California
 Phone: (213) 451-1635
 TWX: (213) 879-0091

For a more complete listing, write for
 our short form catalog.

Electronics Review

electrons which produces a small d-c voltage—could be controlled from outside the superconducting material.

To prove it. "Application of the force is long way off," Pearl explains. "Our job was to prove that it is there."

The newly identified force is an electronic analog to the Magnus force that causes a spinning object to move sideways as well as forward when thrown into the wind; the difference in the air pressure that develops between the two sides of the ball, due to the fact that one side is spinning in the direction of the wind and the other in opposition to it, causes the ball to move slightly sideways.

Physicists have observed that when a material is in its superconducting state (in this instance, type-2 superconducting material) an outside magnetic field cannot penetrate the material. If, however, the outside magnetic field is raised above a certain critical level, some lines of the magnetic field pass through the material, causing free

other inside the material, a voltage would be generated along the length of the superconductor.

Pearl's experiment demonstrated the existence of the whirlpools by actually measuring the tiny potential produced by the moving electrons and by controlling the movement of the whirlpools.

For the experiment, Pearl designed a structure consisting of a tube that housed a magnetized worm gear, wound with several turns of superconducting lead ribbon. The structure was brought to within a few degrees of absolute zero and the gear was turned, causing the magnetic lines emanating from it to follow the thread of the gear. In the process, the vortices were dragged across the superconducting ribbon. The result was a small d-c voltage at the ends of the ribbon.

When the direction of the gear was reversed, the polarity of the voltage was reversed, but not its magnitude.

Work on the Magnus force is being conducted by RCA in an effort to develop superconductors that could store information in computers. Pearl explained that, since the polarity of the current can be changed by reversing the motion of the vortices, bits of data conceivably could be stored on each vortex.



Magnus force in superconductors demonstrated by Judea Pearl, RCA physicist. The force may be the key to development of a new class of computer memories and brushless electric generators.

electronics within the material to form tiny vortices around the lines.

Controlling the whirlpool. Recently a Russian physicist theorized that if the whirlpools could be made to move from one side to an-

Electronics notes

▪ **Underwater range expanding.** The Bureau of Naval Weapons will triple the size of its underwater torpedo and submarine tracking range near St. Croix, Virgin Islands, this year. Under a million-dollar contract to be awarded about April 1, seven underwater hydrophone arrays will be added to the range, boosting its coverage to 15 from five square miles.

▪ **High-altitude danger?** The Air Force, the Federal Aviation Agency and the National Aeronautics and Space Administration are cooperating in a two-year study to determine if radiation poses a danger to people flying at altitudes of 40,000

to 80,000 feet for long periods. For the study, a proposed supersonic transport plane generally will fly at those altitudes to measure the radiation. A package of measuring instruments, including ionization chambers, linear energy transfer spectrometers, Geiger counters and various passive dosimeters, will be developed by Solid State Radiations, Inc., of Santa Monica, Calif.

▪ **Computer cop.** The General Electric Co. has developed a computer system for the Pennsylvania State Police. The computer, called the Datanet-30, is primarily for automatically switching messages transmitted over the statewide Teletype network. The computer also stores statistics on stolen cars, providing quick readout to help a policeman determine whether a vehicle under observation is stolen. The computer service will be expanded later for storing such information as criminal records and missing person files.

▪ **Laser for car safety.** Auto-safety engineers at the Martin Marietta Corp.'s Martin division have prepared plans for a "safety car" with a laser rangefinder to warn the driver of the approach of another vehicle or an obstacle. Some 27 mechanical and electronic safety devices have been proposed for the vehicle. Sketches of the safety car—said to cost a few hundred dollars more than conventional cars—were displayed at a conference of auto-safety officials in Iowa earlier this month.

▪ **Color tube plant.** The Radio Corp. of America has announced plans to build a \$26-million color television picture tube plant in Scranton, Pa. The manufacturing facility is part of RCA's \$195-million expansion and modernization program. The largest portion of this expenditure will be for expanding color-tv production facilities.

▪ **Computer checkout.** Electro-Optical Systems, Inc., a subsidiary of the Xerox Corp., has developed a digital computer system for production-line checkout of completely assembled commercial equipment. The system is being used initially to test the Xerox 2400, a high-speed document reproducer.

basic measuring tools from

**HEWLETT
PACKARD**

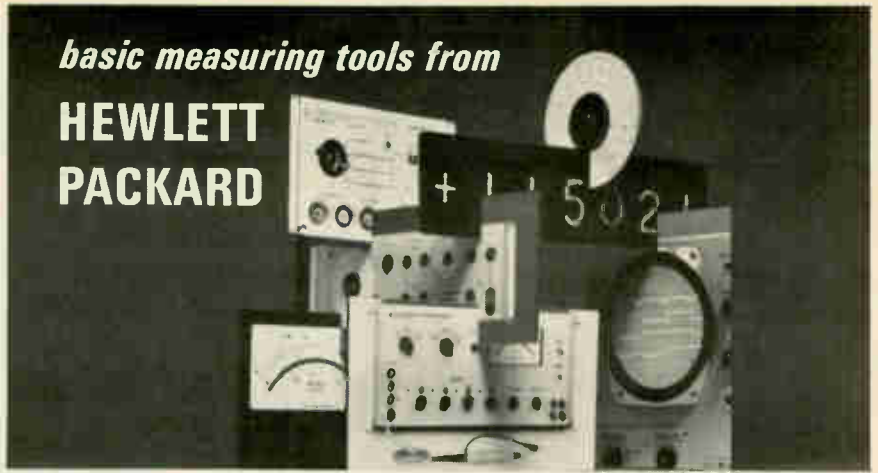

Field-proven hp 241A Pushbutton Oscillator

- Accurate, stable test signals for lab or production
- 4500 discrete frequency selections, 10 Hz (cps) to 1 MHz (mc), vernier overlap
- 3-digit pushbutton frequency resolution
- Frequency response flat $\pm 2\%$ over entire range
- Frequency accuracy within $\pm 1\%$
- Output -30 dbm to $+10$ dbm, 600 ohm output impedance
- Low hum and noise

Use it for:

- Production line and repetitive testing
- Calibrating ac-to-dc converters
- Response testing, narrow or wide band
- Low-distortion source in presence of shock, vibration, hf radiation
- Special versions for transmission line testing

In addition to the 241A, portable, solid-state oscillator, Hewlett-Packard offers the H30-241A (30 v, \$675) and H48-241A (48 v, \$650) battery-operated versions for transmission line testing, 100 Hz to 10 kHz. These versions offer balanced output, 600 and 900 ohm output terminals. The 241A itself is a true standard of the industry as a simple, fast, convenient source of test signals. \$490.

Call your Hewlett-Packard field engineer for a demonstration or write for full specifications of the model of your choice: Hewlett-Packard, Palo Alto, California 94304, Tel. (415) 326-7000; Europe: 54 Route des Acacias, Geneva.

*Data subject to change without notice.
Prices f.o.b. factory.*

HEWLETT  PACKARD
An extra measure of quality





THREE NEW RTV SILICONE RUBBER DEVELOPMENTS

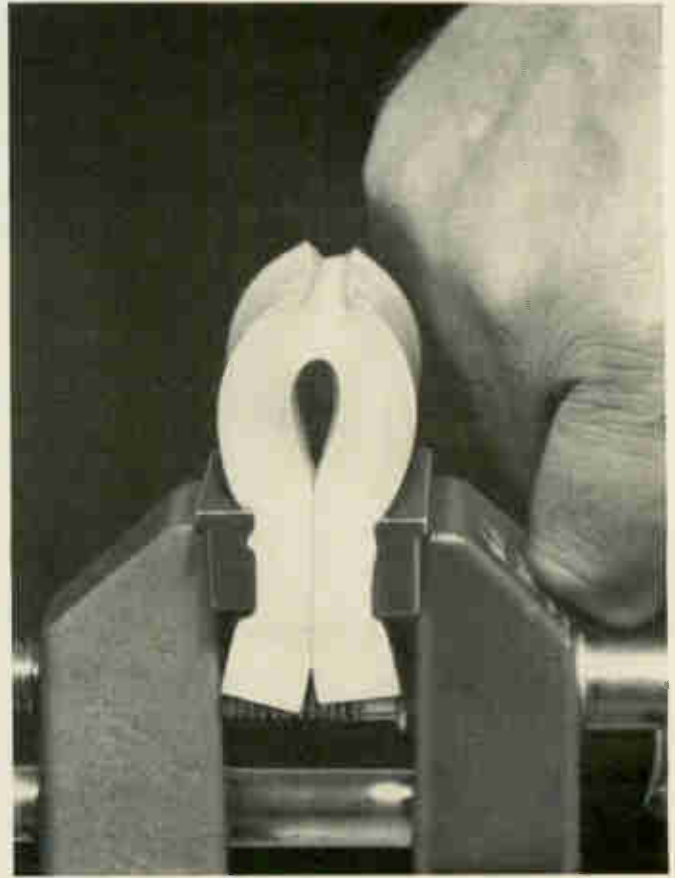
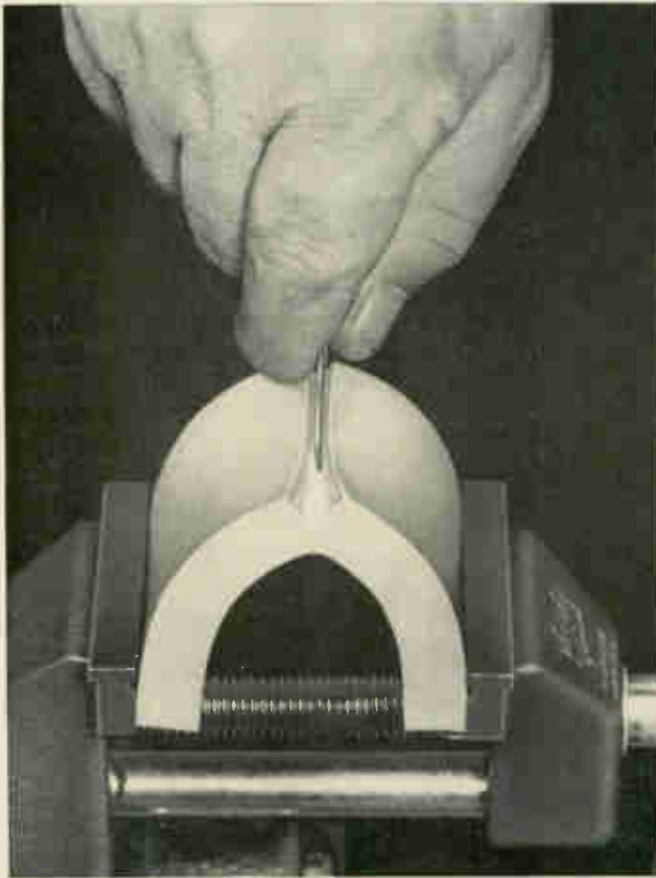

RTV-7 foam for shock and vibration damping at extreme temperatures

RTV-7 foams to five times its original volume to provide mechanical support. Even at temperatures as low as -65°F or as high as 350°F , it retains the flexibility needed to absorb severe shock and vibration . . . assures continuous protection for electronic components and electrical apparatus.

Mixed with a curing agent, RTV-7 liquid silicone rubber foams and cures on the spot. In 10 minutes flat. Density can be varied to meet specific requirements.



AUTHORIZED DISTRIBUTORS OF RTV INDUSTRIAL SEALANTS

ALABAMA
Argo & Company
Birmingham

ARIZONA
Electrical Specialty Co.
Phoenix

CALIFORNIA
Electrical Specialty Co.
Los Angeles
Electrical Specialty Co.
South San Francisco
R. V. Weatherford Co.
Glendale

COLORADO
Electrical Specialty Co.
Denver

CONNECTICUT
R. H. Carlson Co., Inc.
Greenwich

D. C.
Read Plastics, Inc.
Washington

FLORIDA
Gulf Semiconductors, Inc.
Coral Gables
Gulf Semiconductors, Inc.
Winter Park

ILLINOIS
Allied Radio Corp.
Chicago
Federal Insulation Corp.
Chicago
J. J. Glenn and Co., Inc.
Chicago

INDIANA
Hyaline Plastics Corp.
Indianapolis

IOWA
Plastic Supply, Inc.
Des Moines

KENTUCKY
General Rubber &
Supply Co.
Louisville

MASSACHUSETTS
Northeast Chemical Co.
Boston

MICHIGAN
F. B. Wright Co., Inc.
Dearborn

MICHIGAN (cont'd)
Ren Plastics Inc.
Lansing

MINNESOTA
D. A. Schultz Company
Minneapolis

MISSOURI
D. A. James Company
St. Louis
Regal Plastic Supply Co.
Kansas City

NEBRASKA
Regal Plastic Supply Co.
Omaha

NEW JERSEY
Smooth-on Mfg. Co.
Jersey City

NEW YORK
Punt, Inc.
Floral Park
Queen City Rubber Co.
Buffalo
Adhesive Products Corp.
New York
Chamberlin Rubber Co.
Rochester
Syracuse

OHIO
Philpott Rubber Co.
Cleveland
Parkway Products, Inc.
Cincinnati

OREGON
Electrical Specialty Co.
Portland

Ultra-high strength RTV-630: slash it, flex it double...it never tears

By far the toughest two-part RTV silicone rubber ever developed, General Electric's RTV-630 has a tear strength of 100 psi—die B. *That's more than twice the tear resistance of any other RTV.*

Three physical properties comparable to those of heat cured rubber are the basis for RTV-630's uncommon toughness.

- Hardness measures 55-70 durometer.
- Tensile strength registers as high as 850 psi.
- Elongation ranges between 300% and 400%.

The overall strength and durability of General Electric's newest RTV are complemented by its superior reversion resistance. By its rapid curing time. And by its outstanding thick section cure capabilities.

Tougher encapsulant and potting compound

Because of its great strength, RTV-630 can be used in thinner conformal coatings. It is also excellent for production line potting. RTV-630 is designed to protect electronic equipment against the worst environ-

ments of thermal shock, vibration, moisture, ozone, corona and temperatures from -65°C to 500°C .

Proved in mold applications and plastics processing

In multi-cavity molding of epoxy parts for electronic modules, RTV-630 molds lasted *twice as long* as molds made with conventional RTV's.

In thermoforming reinforced plastic parts for space vehicles, RTV-630 was successfully used as a male punch die. Subjected to 5000 psi at 350°F , it has performed more than *six times longer* than previously used materials without any visible signs of fatigue or deterioration.

7 common properties of all G-E RTV silicone rubbers

- Extreme temperature resistance.
- Room temperature cures.
- Chemical resistance.
- Ozone, weather and age resistance.
- Strong bonds.
- Excellent dielectric.
- Minimum shrinkage.



Ready-to-use RTV-102 cartridge pack speeds production line sealing

No catalyst, no mixing, no priming needed. RTV-102 sealant is ready to go, ready to speed sealing jobs. Provides tough, flexible rubber seals for radio chassis, terminal connectors, other electrical and electronic applications. Ideal for hard-to-reach spots. Sets in minutes. Cures in hours. Won't sag, shrink, crack, harden or peel.

General Electric's new cartridge pack comes with white (RTV-102) and translucent (RTV-108) compounds. In six and 12 ounce sizes for hand or air powered caulking guns.

PENNSYLVANIA
Smith of Philadelphia, Inc.
Philadelphia
Speck-Marshall Co.
McKees Rocks

TEXAS
Lawrence Electronic Co.
Dallas
Houston Industrial
Supply Co., Inc.
Houston

WASHINGTON
Electrical Specialty Co.
Seattle

WISCONSIN
R. J. Wittenburg Co.
Milwaukee

For complete information on these newest G-E RTV compounds, ask your nearest distributor as listed, or write to Section N1167R, Silicone Products Department, General Electric Company, Waterford, New York.

GENERAL  ELECTRIC

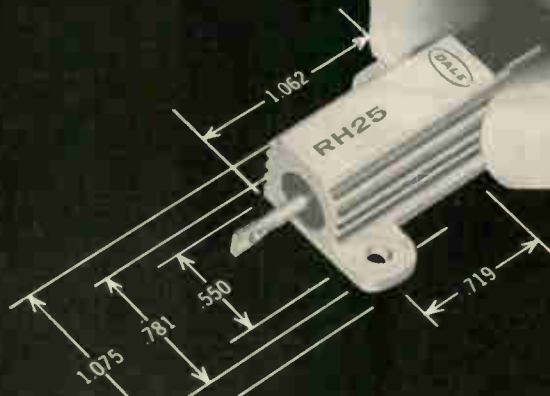
DALE**RELIABILITY**TOTAL CAPABILITY
IN PRECISION RESISTANCE

25 watt POWER in
15 watt Mil Size equals
10 watt DALE BONUS!

All new Dale RH Housed Wirewound design dissipates 25 watts from 15 watt Mil Size

This superior heat dissipation is typical of Dale's all-new RH line. It means extra design flexibility plus unprecedented stability when operated at MIL-R-18546C levels. It stems from: (1) New, specially conductive extruded aluminum housings; (2) A new Dale-developed molding compound which binds resistance unit and housing together in a homogeneous void-free mass with exceptional heat transfer ability.

COMPLETE HOUSED RESISTOR CAPABILITY

In addition to RH resistors, Dale produces PH Housed wirewounds for through-chassis mounting in 10, 25 and 100 watt sizes. Both RH and PH lines are available in non-inductive styles and with special mounting methods, terminals and other variations to suit your application.

RH RESISTOR SPECIFICATIONS

DALE TYPE	EQUIV. MIL. TYPE	DALE RATING*	MIL. RATING	RESISTANCE RANGE (OHMS)	STANDARD HEAT SINK
RH-5	—	7.5	—	.1 — 24K	4x6x2x.040 AL CHASSIS
RH-10	RE-65	12.5	10	.1 — 47K	
RH-25	RE-70	25	15	.1 — 95K	5x7x2x.040 AL CHASSIS
RH-50	RE-75	40	20	.1 — 273K	
RH-100	—	100	—	.1 — 50K	12x12x.125 AL PANEL
RH-250	RE-80	250	120	.1 — 75K	

ELECTRICAL & ENVIRONMENTAL SPECIFICATIONS

Tolerance: 3%, 1%, .5%, .25%, .10%, .05%

Load Life: 1% max. ΔR (RH-5-50) 3% max. ΔR (RH-100-250) in 1000-hour load life

Operating Temp: -55° C to +275° C

Overload: \pm .5% max. ΔR per MIL-R-18546C

*Power Rating based on 275° C max. internal hotspot temperature with resistor mounted on proper heat sink as specified by Mil. Spec.

WRITE FOR RESISTOR CATALOG A



DALE ELECTRONICS, INC.

1300 28th Avenue, Columbus, Nebraska

Also Sold by Dale Electronics Canada, Ltd., Toronto, Ontario, Canada



Washington Newsletter

January 24, 1966

Critics describe Johnson's message as juggling act

President Johnson's State of the Union message assured the American people that the war in Vietnam wouldn't slow the Great Society. To fulfill his pledge that spending on both programs would continue at an undiminished pace, Johnson may have to do some complicated budgetary maneuvering.

The President maintains that the increased amount for civilian programs—totaling some \$5.25 billion—would only cost the taxpayer \$600 million more in fiscal 1967 than a year ago. That figure is the result of some involved bookkeeping: Johnson expects economies in the Defense Department and other government agencies, plus the sale of some assets, to total about \$4.5 billion.

In addition, the President cited, among others, the mass transit program as an instance where he's pushing major domestic programs; but most of the funds for such programs won't be paid out of this budget—they'll come out of future budgets.

Because of fiscal 1967's tight budget, however, competition for non-priority programs, such as space, will come under closer scrutiny by the White House.

New NASA goal: nuclear power in space in '70's

The National Aeronautics and Space Administration is likely to get more funds to develop—possibly by the late 1970's—thermionic-nuclear power systems in the range of hundreds of kilowatts. NASA had been planning megawatt systems—but not until the 1980's.

Thermionic research and development by NASA, the Atomic Energy Commission and the Navy is highly classified, but NASA officials are enthusiastic about recent operating times of thousands of hours on thermionic diodes and other improvements in the technology.

A substantial boost in NASA's thermionics budget—now at about \$3 million—is expected for the year beginning July 1.

Industry seeks priority rulings

With military orders topping \$2 billion a month, the Commerce Department's Business and Defense Services Administration (BDSA) reports that it is being flooded with requests for priority rulings from manufacturers seeking to postpone delivery of civilian orders without being sued for breach of contract. The average of 65 requests a month BDSA customarily receives has almost tripled since August, and is still climbing.

Military priorities in electronics are affecting not only delivery of civilian products, but also military and other governmental orders. For example, manufacturers of combat radio equipment have been told that deliveries for Vietnam are to be placed ahead of deliveries for Polaris submarine missile programs and some space programs.

Manpower shortages worry Washington

With civilian electronics technicians needed at West Coast defense installations already in short supply, Labor Department officials will discuss measures to forestall a general manpower shortage below the professional level in critical industries. Manufacturers of electronic and electrical equipment, ordnance and aircraft will be called to Washington

Washington Newsletter

next month to confer with officials on the problem.

Shortages are expected to develop in all ranges, from semiprofessionals down to unskilled workers because the armed services will absorb most of the anticipated 1966 increase in the number of adult males who would be entering the work force.

New proposals may eliminate atom smasher

Budget squeezers and politicians, who together caused a delay in the decision to go ahead with the proposed 200-billion-electron-volt atom smasher, have opened the door to counterproposals that may kill it altogether. The Joint Congressional Committee on Atomic Energy, which will make a final decision this spring on the \$300-million high-energy physics installation, is intrigued by a new proposal to scuttle the 200-bev atom smasher for:

- An increase in the power of the existing 33-bev accelerator at the Brookhaven National Laboratory in New York to about 150 beV, at about half the cost of starting from scratch.

- Eliminating the 200-bev unit and building a 500-bev machine in the 1970's, probably also at Brookhaven.

Expanding the 33-bev accelerator would be cheaper, in part, because much of the electronic instrumentation and experimental equipment is already installed.

Scientists discount laser role in space

Radios, not lasers, will probably be the mode of communication for future deep space and interplanetary exploration, according to the policy-guiding space science panel of the National Academy of Sciences. But the group says that major changes will have to be made in ground-station designs before radios can handle the space job.

The panel recommends that radio dishes, from 85 to 120 feet in diameter, be mass produced and deployed in densely packed arrays.

Laser communication systems, the academy panel says, need considerable improvement before they can handle space communications. Because lasers are severely attenuated by the atmosphere, a laser transceiver would have to be stationed above the atmosphere to send and receive space messages efficiently. This, the panel explains, is impractical.

Comsat seeks more U.S. terminals

The Communications Satellite Corp. wants to build more ground stations in the United States. If it wins approval from the Federal Communications Commission it will build one station in the Southeast, reportedly in West Virginia, and another in Puerto Rico. Comsat is also said to want stations in Southern California and at major population centers.

Comsat's bid is a direct challenge to the International Telephone and Telegraph Corp.'s pending request before the FCC to build its own ground station in Puerto Rico.

In a related development, 40 or more countries have been invited to attend a 10-day seminar in Washington on satellite ground-station technology. The session would begin on May 16. The foreign representatives will probably be on the receiving end of hard sales pitches by companies building terminals.

How much reliability... how much capacitance... can you get in miniature size?

For your current high-reliability designs, evaluate the Mallory MTPH miniature wet slug tantalum capacitor. It's made in the same "white room" facilities that we use for making similar capacitors for Minuteman II, for Autonetics Division of North American Aviation.

Zero failures in 3.7 million unit-hours.

Reliability is documented by continuing 85°C tests at rated voltage. Results to date: zero short circuit or DC leakage degradation failures. Complete reliability testing and quality control programs to Minuteman specifications have been in operation on this product line for over 2 years in our plant.

High C-V ratings. Maximum ratings go up to 170,000 mfd.-volts per cubic inch... up to 5 times higher than solid tantalum types, up to 40% higher than other miniature wet slug models.

Small size. Three case sizes, 0.115" dia. by 0.400", 0.145" dia. by 0.590", 0.225" dia. by 0.775". Ideal for use with thin films and other microcircuits. Ratings from 450 mfd., 6 volts to 6.8 mfd., 50 volts.

For a review of our reliability data, write or call Mallory Capacitor Company, a division of P. R. Mallory & Co. Inc., Indianapolis, Indiana 46206.

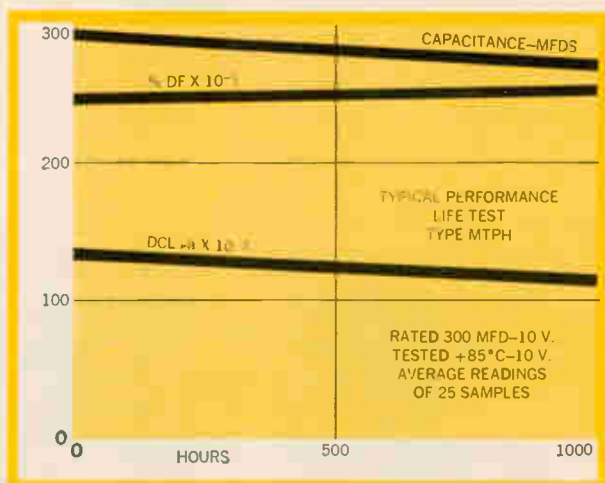
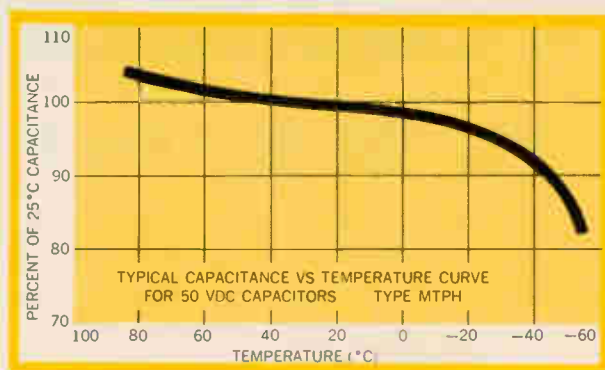

50th
ANNIVERSARY

MALLORY

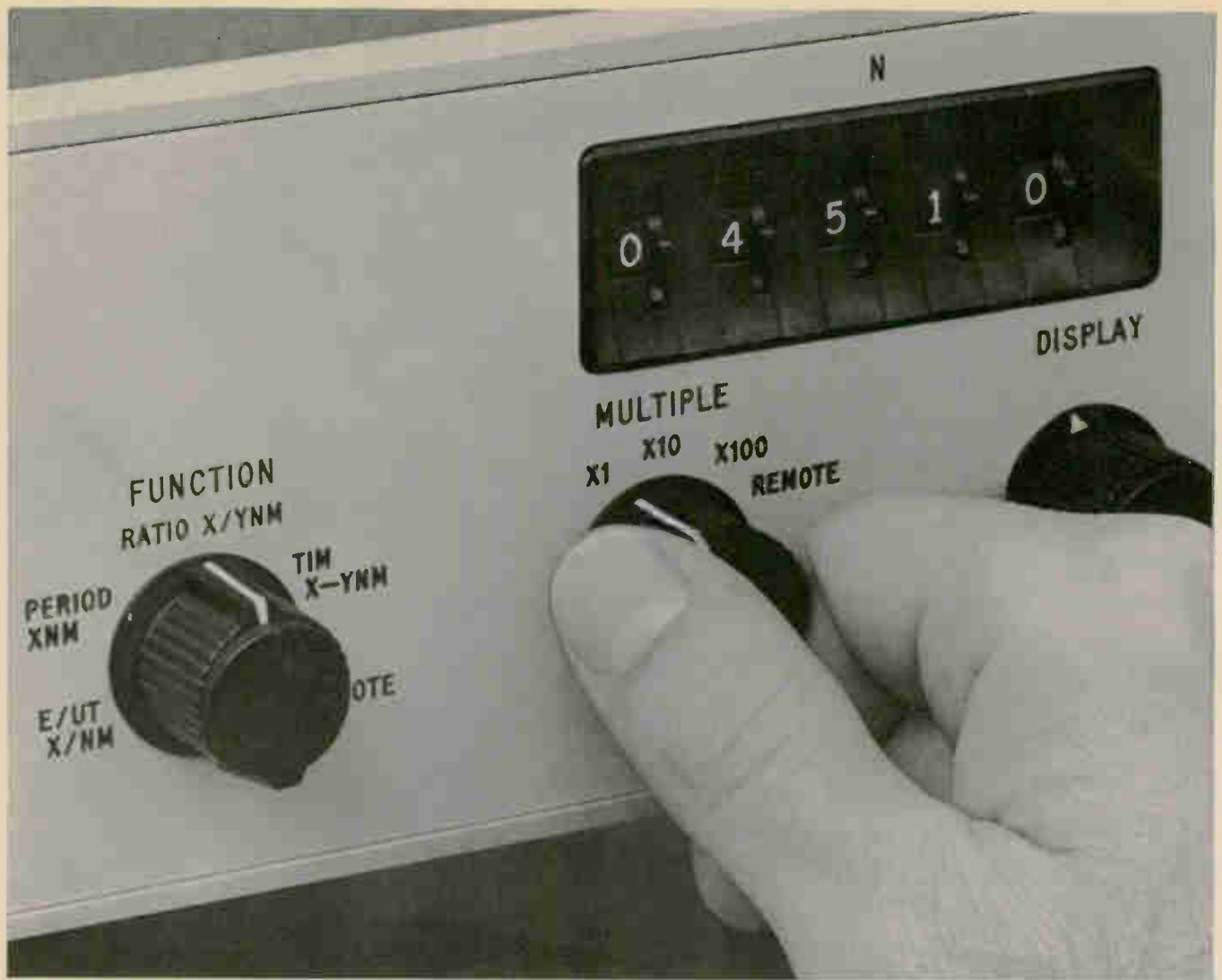

For the engineer who wants everything

The Beckman Model 6030 is the most versatile solid-state 2-mc Preset EPUT® & Timer available. This extraordinary all-in-one instrument gives you frequency, period, ratio, and time interval measurements... plus preset switches. And the universal 6030 will measure in rpm, gpm, etc., giving rationalization of engineering units. Pulse width, multiple pulse ratio, pulse repetition rate... all are no problem for the 6030. Neither are incremental multiple units, expansion of periods and time, expansion of frequency ratios... they're all yours in

the Model 6030 for only \$1,540. If you're an engineer who wants everything, get a Beckman Model 6030 Preset EPUT & Timer... and you've got it! Your Beckman Berkeley sales engineer has all the details. Call or write today.

Beckman®

INSTRUMENTS, INC.

BERKELEY DIVISION

RICHMOND, CALIFORNIA • 94804

INTERNATIONAL SUBSIDIARIES: GENEVA; MUNICH;
GLASCOW, SCOTLAND; TOKYO; PARIS; CAPE TOWN; LONDON



Integrated circuit digital modules with the highest guaranteed noise rejection: 1.5 volts on clock lines, 30 volts on data lines.

And that's not just a lot of noise from Raytheon Computer.

Why buy integrated circuit modules with inadequate protection against noise? Now, Raytheon Computer offers IC digital modules that are virtually impervious to system noise. These new ICs give you 1.5 volts guaranteed rejection on clock lines, 30 volts on data lines. And buffering provides 3 volt rejection on all outputs.

The new IC modules operate at 200KC and are compatible with the more than 100 existing Raytheon Computer discrete component digital modules for 200KC, 1MC, 5MC and 20MC frequencies. This means you can buy our lower-priced 200KC IC modules and not give up high frequency capability.

Raytheon IC modules are on the same compact 3¾ inch x 4¼ inch 35-pin boards as the discrete units and have compatible logic levels and power requirements. IC flatpacs are mounted with parallel gap soldering resulting in smaller, stronger joints which make encapsulation unnecessary. Logic density is as high as 24 flip-flops per board.

Write today for additional information. Ask for Data File M-115E.
Raytheon Computer, 2700 South Fairview Street, Santa Ana, California.

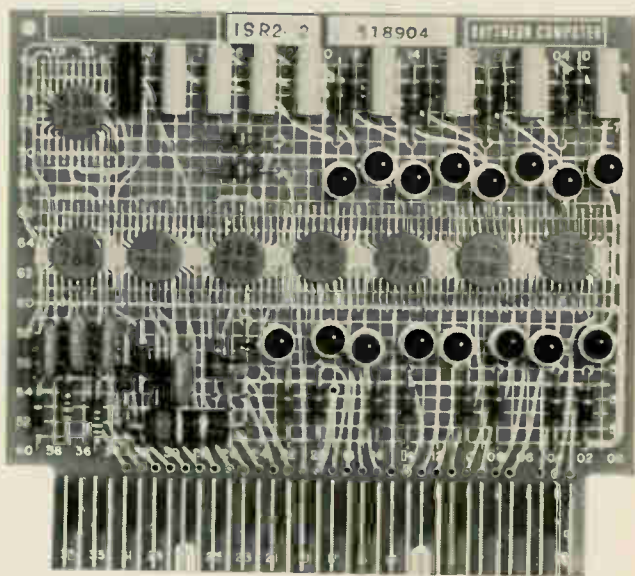

THESE NINE CIRCUITS AVAILABLE NOW

IDC1: Decade counter with one digit decoder and 10 line output. **IFF1**: Flip-flop 4 circuits universal. **IFF2**: Flip-flop, 12 circuits, buffer storage, parallel in, parallel out. **ISR1**: Shift Register, 8 bit and 4 bit, Serial in, Serial or Parallel out, T & F out of each Flip-flop. **ISR2**: Shift Register, 16 bit, Parallel or Serial in, Serial out, Parallel out for last 8 bits. **ISR3**: Shift Register, two 4 bit, Serial or Parallel in, Serial or Parallel out, T & F out of each FF. **ISR4**: Shift Register, two 14 bit, Reg. A Serial or Parallel in, Serial out, Reg. B Serial in or Parallel transfer from Reg. A, Serial out. **ISR5**: Shift Register, two 12 bit, Reg. A Serial or Parallel in, Serial out, Reg. B Serial in or Parallel transfer from Reg. A, Serial out. **IUC1**: Universal Counter, 2 decimal digits or two 4 bit binary counters, parallel preset input.

RAYTHEON

The performance of PRINTED MOTORS begins where ordinary motors leave off!



Precision Printed Motors—high performance printed armature servo motors in 10 standard sizes.



New Low Cost "U" Series — 4 models of printed armature motors at greatly reduced prices.



The Incredyne—cylindrical armature motor with the fastest possible speed of response.



Minertia Motors—low inertia, slotless armature dc motors in sizes up to 200 h.p.

Are you designing tomorrow's electromechanical systems with horse and buggy motors?

Maybe you're not aware of the recent revolution in the design of high performance actuators that has made the problems and limitations of traditional motors obsolete and unnecessary. Unique advantages offered by PMI's complete line of precision and industrial servo motors include:

- *Low inertia/high torque capability armatures give exceptionally fast speed of response.*
- *Wide speed ranges, typically 0 to 3000 rpm.*
- *Smooth, cogging-free torque, even at very low speeds; allows direct coupling of the motor to the load.*

- *Linear speed/torque characteristics, from no load to stall.*
- *Low mechanical and electrical time constants; armature inductance less than 100 microhenries.*
- *Low voltage/high current operation; allows simple, solid state control.*

For information on any or all of PMI's high performance actuators, call or write: Printed Motors, Inc., Glen Cove, New York, (516) OR 6-8000.



PRINTED MOTORS, INC.

GLEN COVE, NEW YORK

Engineering, Manufacturing and Sales by:

Photocircuits CORPORATION

HOW CAN JUST 200 RECTIFIERS REPLACE OVER 1000?

MOTOROLA PREFERRED SILICON RECTIFIER SELECTION GUIDE

... depicts the broadest line of quality rectifiers available

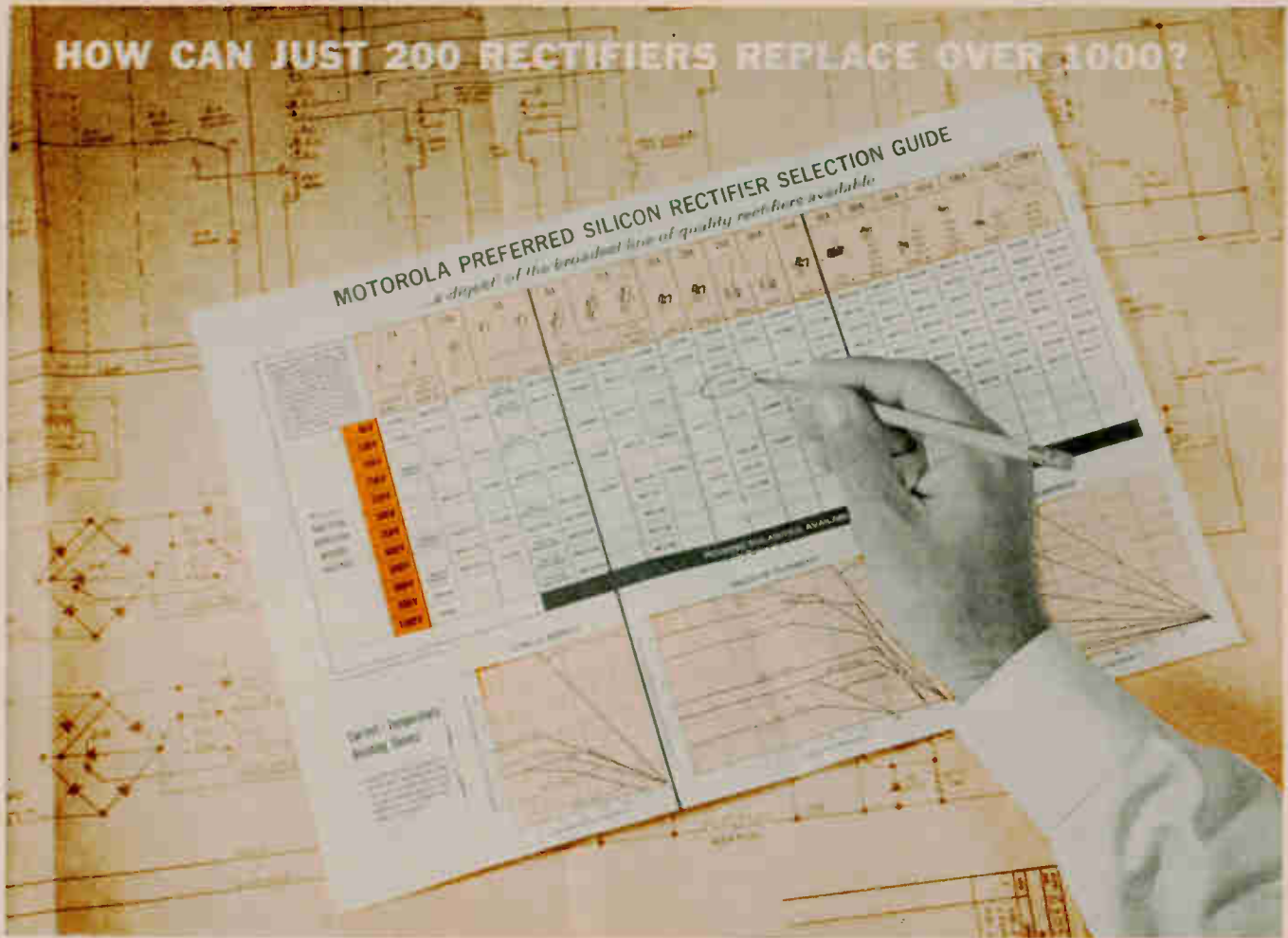

You'll find out by using Motorola's new Silicon Rectifier Selection Guide . . . a comprehensive profile of the most versatile rectifier line in the industry . . . 200 types that cover the complete spectrum of power requirements from 1 to 1000 Amps — 50 to 1000 Volts.

A RECTIFIER FOR EVERY APPLICATION ... EVERY POCKETBOOK!

Starting from the ■ Low Cost 1 Amp Surmetics® (1N4001 Series)—which have become the industry standards . . . featuring a full 1 Amp at 75° C, ambient ■ 3 Amp lead-mount types — with surge current ratings up to 300 Amps. ■ 12 Amp "universal" stud-mount series — so economically priced that they virtually replace *all* conventional "stud" types rated up to 12 Amps. ■ 15, 20, 25, 30 and 35 Amps units — featuring the world famous Motorola "press-fit" case design (25 and 30 Amp types) . . . All the way up to ■ High-current Multi-cells* from 50 to 1000 Amps!

No matter what your needs, you can now select the "just right" Motorola rectifier that most economically fits your particular current and voltage requirements.

SIMPLIFY PROCUREMENT TOO . . .

That "just right" rectifier you specify is from a standard, large volume line (the world's largest), built to satisfy your specific application as well as a broad scope of similar requirements.

Ask Your Distributor About Motorola Rectifiers!

*Trademark of Motorola Inc. †Patents Pending

Have your own miniature prototyping warehouse...

Order a Motorola Rectifier "Handylab" Kit™ — a wide assortment of popular usage rectifiers and molded-bridges covering current ratings from 1 to 35 Amps, 200-3000V (84 units in kit).



Total Value \$236.10 (incl. cabinet)

You Pay **\$94.50**
ONLY

Save — \$141.60

In Stock Now!
At Your Franchised
Motorola Distributor
... CALL HIM TODAY
FOR DETAILS!



MOTOROLA
Semiconductor
Products Inc.

BOX 955 • PHOENIX, ARIZONA 85001

The very broadness of narrow-band



(5 Kilocycles to 60 Megacycles)

And 3-Week Delivery at Competitive Prices!

By normal standards, many of Collins' narrow band crystal filters might be called "special design" units. But from the standpoint of price and delivery, they are standard items.

At competitive prices, prototypes can be delivered for customer evaluation within three weeks after receipt of order. This is made possible by computer-assisted design techniques and the use of standard, off-the-shelf components.

Collins capabilities include: Butterworth, Tchebycheff, Linear Phase, TBT, Elliptic Function, Band Reject and Prescribed Transfer Function in standard or predistorted designs, or in comb set configurations.

The filters are designed and built under the stringent engineering and manufacturing requirements that have made the Collins name synonymous with quality.

And one more very important point: After a filter is designed to your specifications, Collins has the capability to meet large production quantities on schedule.

Contact Collins today for details on how we can solve your crystal filter problems.

Call Collins Radio Company, Components Sales Department, 19700 Jamboree Rd., Newport Beach, California, phone: (714) 833-0600. Or call your nearby authorized Collins components sales representative.



Four reasons for using heat-shrinkable tubing of Kynar*! (1) It's two to three times tougher than any other shrinkable plastic tubing. (2) It's thermally stable... operates at 150°C, flexible at -65°C. (3) It shrinks 50% at 175°C. (4) It's UL approved for 600 volt rating at 150°C. And how can you use it? Here are just five of the many ways.

For corrosion protection—Resists chemicals and weathering at battery terminals.



For strain relief—Transfers flex stress away from joint; protects conductors.

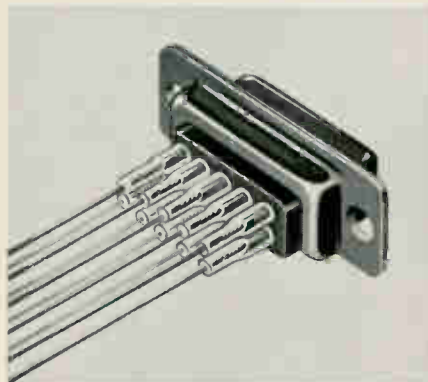

For insulation and mechanical protection—Capacitors, resistors, diodes.

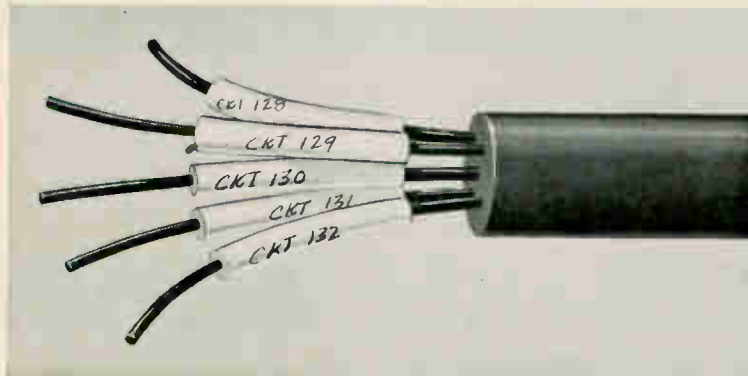
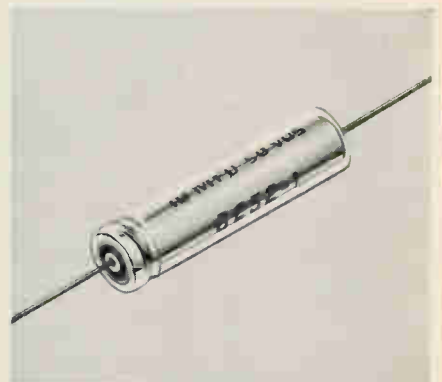

For identification—Eliminates the need for stocking colored or printed wire.

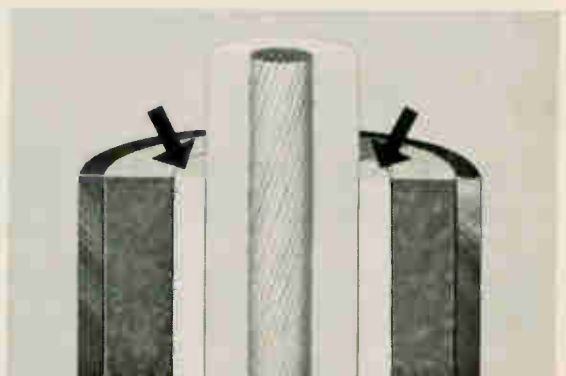

For sealing out moisture—Used over TFE insulation to bond with potting compounds.

If you are using or considering heat shrinkable tubing, investigate all the advantages of specifying Kynar. It's available in a range of diameters from Raychem Corporation as Thermofit** Kynar. For information, write Plastics Department, Pennsalt Chemicals Corporation, 3 Penn Center, Philadelphia, Pa. 19102.

Kynar... a fluoroplastic that's tough!

*Kynar is a registered trademark of Pennsalt Chemicals Corporation for its vinylidene fluoride resin

**Registered trademark of Raychem Corporation



new measure of scope performance:

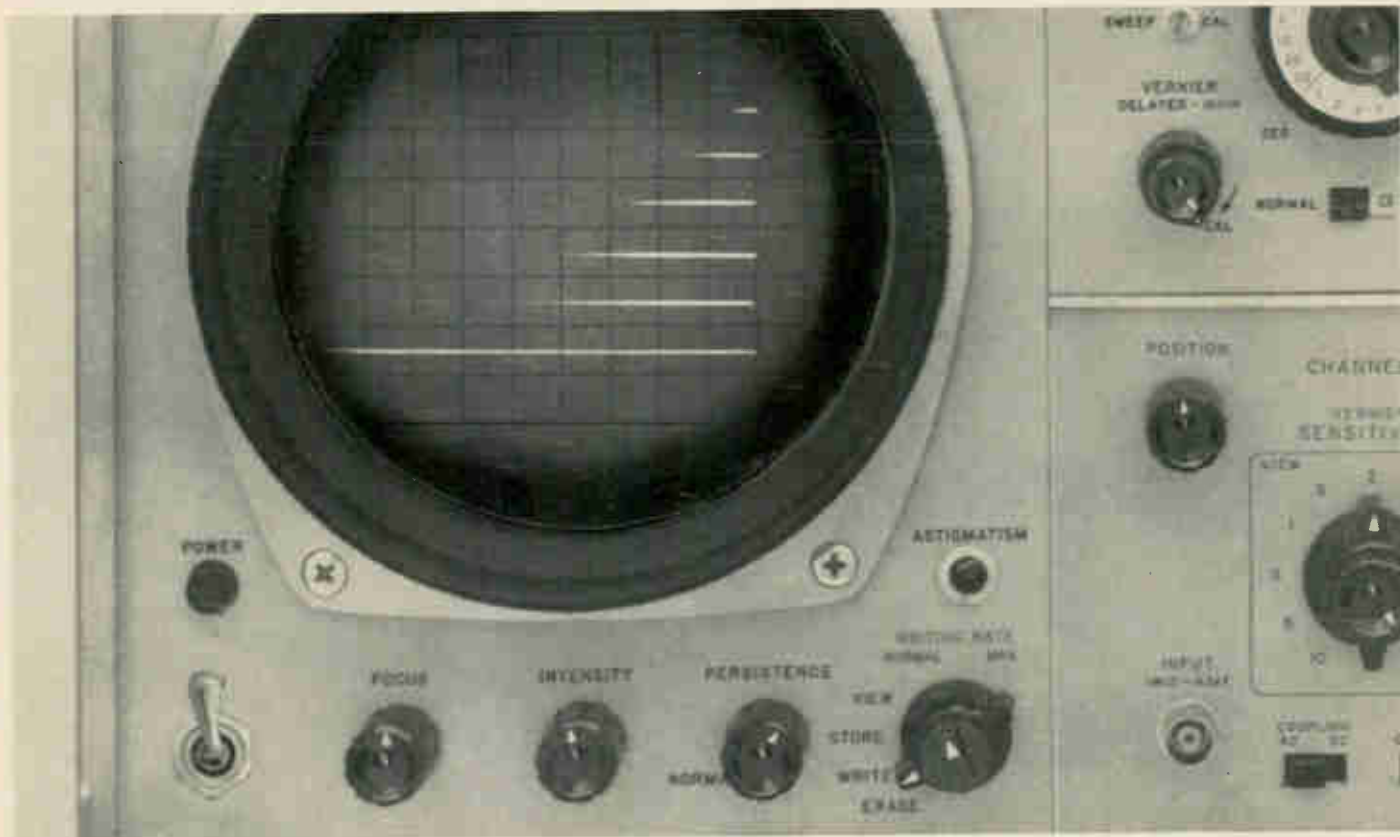

NEW **VARIABLE PERSISTENCE** for **EASY, FLICKER-FREE VIEWING** **OF ALL WAVEFORMS** . . . *on the new*

Hewlett-Packard 141A, also offering storage capability and all the versatility of a conventional, high-performance plug-in scope!

- variable persistence, 1/5 sec. to 1 min., to eliminate flicker for easy viewing of all types of waveforms
- trace storage up to an hour, giving you time to study signals, make better camera set-ups (or even avoid photography altogether); fast erase, fast 1 cm/ μ sec writing rate
- versatile conventional scope operation with plug-ins to match your need, each one value-priced
- all this, plus high-contrast picture, full year crt warranty on specs, no-parallax internal graticule, full 10 cm x 10 cm viewing area!

Variable persistence

Front-panel controls on the 141A scope permit continuous adjustment of persistence from 1/5 sec. to 1 min., eliminating annoying flicker on slow sweeps and fast signals with low rep rates. Easy viewing, too, for slowly moving waveforms, such as those from biochemical or medical phenomena. Just adjust so that the entire signal is on the screen, yet fades fast enough to avoid interference with the next signal.

Also, display several successive traces simultaneously, merely by adjusting the persistence control, superimposed or separated vertically.

Variable persistence also improves the resolution of signals viewed with the 1415A Time Domain Reflectometer Plug-in, for testing cables, connectors, strip lines, etc., where slow sweep speeds provide the best resolution, and with the 1416A Swept-Frequency Indicator Plug-in, where reflections and insertion losses are best resolved with slow sweeps.

Storage scope

Traces can be stored for up to an hour at diminished intensity, viewed at any time at full intensity with storage switch in View position, and even stored for days with the scope turned off. Study waveforms at your convenience, without using a camera. Even fast single-shot signals can be captured with fast 1 cm/ μ sec writing rate.

Storage also permits automatic integration of repetitive signals... lets you build up a dim trace until it is comfortable to view, easy to photograph or study.

Long life of your storage crt is guaranteed, too... a year's warranty at full specification with no degradation of performance.

Conventional Scope

Five vertical amplifier and two time base plug-ins, plus the two double-size special-purpose plug-ins, make the 141A as versatile as the popular hp 140A Plug-in Scope. The 141A with dual-channel 20 MHz bandwidth and time base with sweep delay, for example, costs only \$2450. A 100 μ V/cm 500 kHz system costs only \$1810.

The hp 141A Variable Persistence Storage Scope, without plug-ins, costs \$1275, price f.o.b. factory.

And every combination of scope and plug-ins gives

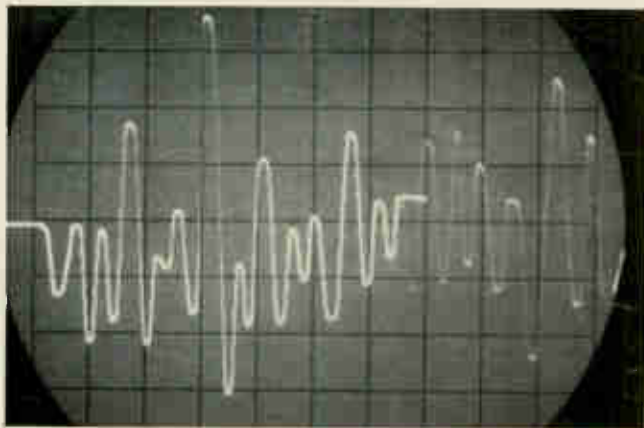

Here, the tail of the previous signal is fading as the succeeding signal advances across the crt, left to right.

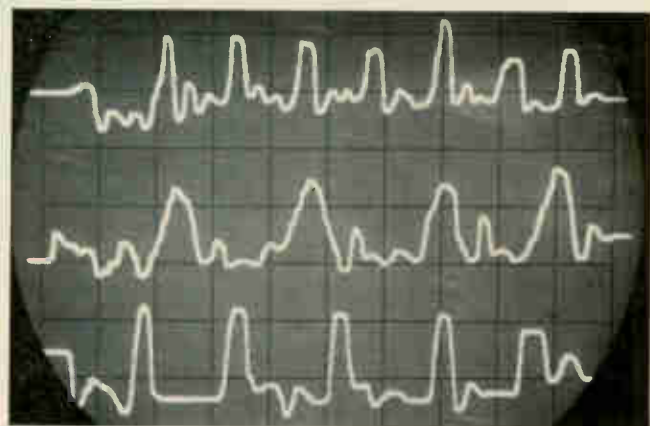

Three single-shot signals are stored here, will remain for an hour for study without the use of a camera.

you Hewlett-Packard design and manufacturing quality. Backed up, too, by your Hewlett-Packard field engineer, who can help solve your measurement problem with a scope or with other tools from the broad line of high-quality instrumentation he offers. Give him a call for complete information on the 141A. Or write for complete data: Hewlett-Packard, Palo Alto, California 94304, Tel. (415) 326-7000; Europe: 54 Route des Acacias, Geneva.

HEWLETT  **PACKARD**
An extra measure of quality



ACTUAL SIZE



See what the V3 switch can do for you now

The V3 switch, developed by MICRO SWITCH over 20 years ago, was the first precision snap-action switch to combine miniature size and high electrical capacity.

Through the years there have been many improvements and many new variations designed to satisfy specific customer requirements. Today there are over 500 standard designs available—offering you complete design freedom for a broad variety of applications. The adaptability of this switch to your requirement and its proven reliability over years of user acceptance make it a vital component in your equipment.

CHOOSE FROM THESE OPTIONS:

- Electrical ratings: UL and CSA listed for 10 or 15 amps, 125-250 vac; and gold contact designs for dry circuit use.
- Circuitry: SPDT, SPNO, SPNC.
- Operating Force: From 15 grams to 14 ounces.
- Differential Travel: .002 inch to .008 inch.
- Temperature Maximums: +185°, 400° and 600° F.
- Actuators: Auxiliary and Integral as shown below.
- Terminals: Variations as shown below.

For information on V3 switches and application assistance, contact a Branch Office or Distributor (see Yellow Pages, "Switches, Electric"). Or write for Catalog 50.

AUXILIARY ACTUATORS



INTEGRAL ACTUATORS



TERMINAL VARIATIONS



MICRO SWITCH
FREEPORT, ILLINOIS 61032
A DIVISION OF HONEYWELL

CHALLENGE US!

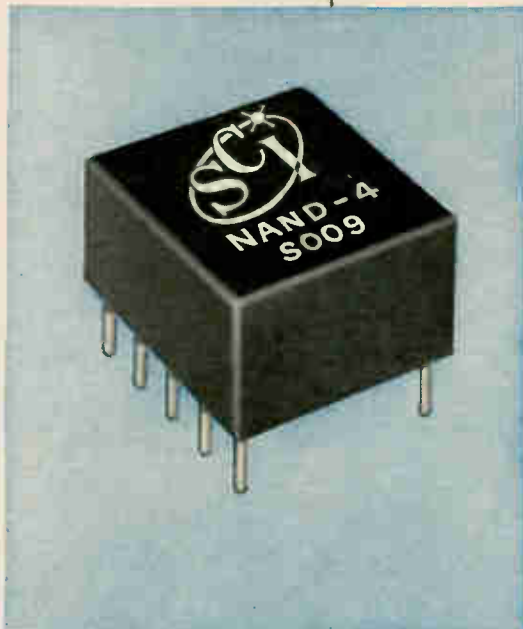

SPACE CRAFT, INC.

8620 SO. MEMORIAL PARKWAY
HUNTSVILLE, ALABAMA 35802

Gentlemen:

Consider yourselves challenged. Send me your short form specification sheet for custom-welded modules. I'll fill it out. Then you quote a price and give me whatever suggestions you may have for improving the module.

Name _____

Title _____

Company _____

Address _____

City _____ State _____ Zip _____

If you would like your system to have the reliability and size reduction advantages of custom welded modules but think you can't afford it, challenge us! Whether you need to design an all-new circuit, to adapt an existing design to welded packaging or to locate a qualified vendor for production quantities of your circuits, Space Craft will perform for you at surprisingly low cost. To call our hand, just use the coupon above.

SPACE CRAFT, INC.

8620 SO. MEMORIAL PARKWAY / HUNTSVILLE, ALABAMA 35802
TELEPHONE: (205) 881-1611 TWX: (510) 579-2234





new portable 50 MHz oscilloscope

- DUAL-TRACE DISPLAYS**
 20 mV/div through 10 V/div, dc-to- > 50 MHz.
 10 mV/div, dc-to- > 45 MHz.
 5 mV/div, dc-to- > 40 MHz.
 - SINGLE-TRACE DISPLAYS**
 1 mV/div, dc-to- > 25 MHz (channels cascaded).
 - X-Y OPERATION**
 5 mV/div through 10 V/div, dc-to- > 5 MHz.
 - OPERATING MODES**
 Channel 1 only; Channel 2 only (normal or inverted); Added Algebraically ($\geq 20:1$ CMRR up to 20 MHz, linear dynamic range $\geq 20X$ indicated sensitivity); Alternate; Chopped (500 kHz $\pm 20\%$ chopping rate).
 - SWEEP RATES**
 5 sec/div to 0.1 μ sec/div (Time Base A), 0.5 sec/div to 0.1 μ sec/div (Time Base B), with 10X magnifier extending fastest sweep rates to 10 nsec/div.
 - SINGLE SWEEP**
 Time Base A.
 - PRECISION SWEEP DELAY**
 50 sec to 1 μ sec.
 - DISPLAY FEATURES**
 4-inch rectangular tube; 6 x 10 div display area (1 div/0.8 cm); internal, illuminated graticule; 10 kV accelerating potential; P31 phosphor.
 - TRIGGER SYSTEM**
 To 50 MHz, from Channel 1 or combined signals (both sweeps). Trigger modes include AC, AC LF REJ, AC HF REJ, DC, AUTO. Trigger sources include INT, LINE, EXT, EXT $\div 10$.
 - POWER REQUIREMENTS**
 96-127, 103-137, 192-254, or 206-274 V ac (≈ 100 W) 45 to 440 Hz.
 - MECHANICAL FEATURES**
 Net weight is ≈ 28 lbs. including panel cover; shipping weight is ≈ 36 lbs. Overall height including feet is 7 $\frac{1}{4}$ " ; overall width including handle is 12 $\frac{1}{2}$ " ; overall length including rear feet and front cover is 20 $\frac{1}{2}$ " , including rear feet and extended carrying handle is 22 $\frac{3}{8}$ " . Carrying handle may be set in any one of a number of positions for viewing convenience. Feet on rear provide for vertical operation.
 - ENVIRONMENTAL FEATURES**
 Ruggedly designed to operate reliably under environmental conditions encountered in portable use.
- Type 453 Oscilloscope . . . \$1950
 Rack Mount Type R453 . . . \$2035
U.S. Delivery Prices; Fig. 6, Specifications, Catalog



A compact, high-performance oscilloscope, the Type 453 operates almost anywhere, and under severe environmental conditions—giving sharp bright displays. The Type 453 offers dual-trace and sweep-delay for accurate and reliable measurements over the dc-to-50 MHz range.

For a demonstration, call your Tektronix field engineer.
Tektronix, Inc.

It seems like only yesterday

that **phase-lock frequency control** was so new that it was a status symbol to have a "phase-lock-box" in your lab. Crude and tricky as those early designs were, they gave you more-or-less **tunable crystal stabilization** of just about any UHF/SHF oscillator...and they made wonderful "conversation pieces", too. Nowadays, ordinary phase-lock is old-hat—to be "one-up", you must own a **POLARAD** Model 3815—the "Rolls-Royce" of **Continuously Tunable Phase-Lock Frequency Controls**.

Then you can "spec-drop" with confidence, for the Model 3815 has at least an order of magnitude higher stability and resolution than any other design; and it will stabilize a wider range of signal generators, signal sources, oscillators, klystrons, BWO's and receivers, too—not only all 27 **POLARAD Instrumentation Modules**, from 950MC to 12.4GC,

but just about anybody's **stabilizable signal circuit**. Best of all, you can own this "Rolls" for about what you'd pay for that funny-shaped foreign compact. Call us for a free test drive—(212) EX 2-4500—and move up to a 3815.



Model 3815 Frequency Stabilizer
Continuously Tunable

HIGHEST STABILITY—Proportional oven, unique circuitry!

averaging time	stability
1 millisecond	1 part/10 ⁹
100 milliseconds	4 parts/10 ⁹
1 hour	1 part/10 ⁸

HIGHEST RESOLUTION—Continuous tuning (no "spots") 0.95 to 12.4 GC, discrete coverage down to 500 MC. (Usable to 21 GC with Polarad Models 1709 and 1710.)

HIGHEST SENSITIVITY

L Band—30 dbm X Band—10 dbm

WIDEST RANGE OF STABILIZATION—Stabilizes reflex klystrons, voltage-tuned magnetrons (VTM) or backward wave oscillators (BWO) with either helix or cathode grounded. Isolation: ± 3000 VDC to ground. Control output: 0-40 MA, ± 15 V. Discriminator bandwidth: 6 MC. Modulation sensitivity: 0.12 to 8 MC/Volt.



World Leader in
Microwave
Instrumentation

POLARAD

ELECTRONIC INSTRUMENTS

A Division of Polarad Electronics Corporation
34-02 QUEENS BOULEVARD
LONG ISLAND CITY, NEW YORK 11101

Circle 59 on reader service card

Analog write-out for real time systems

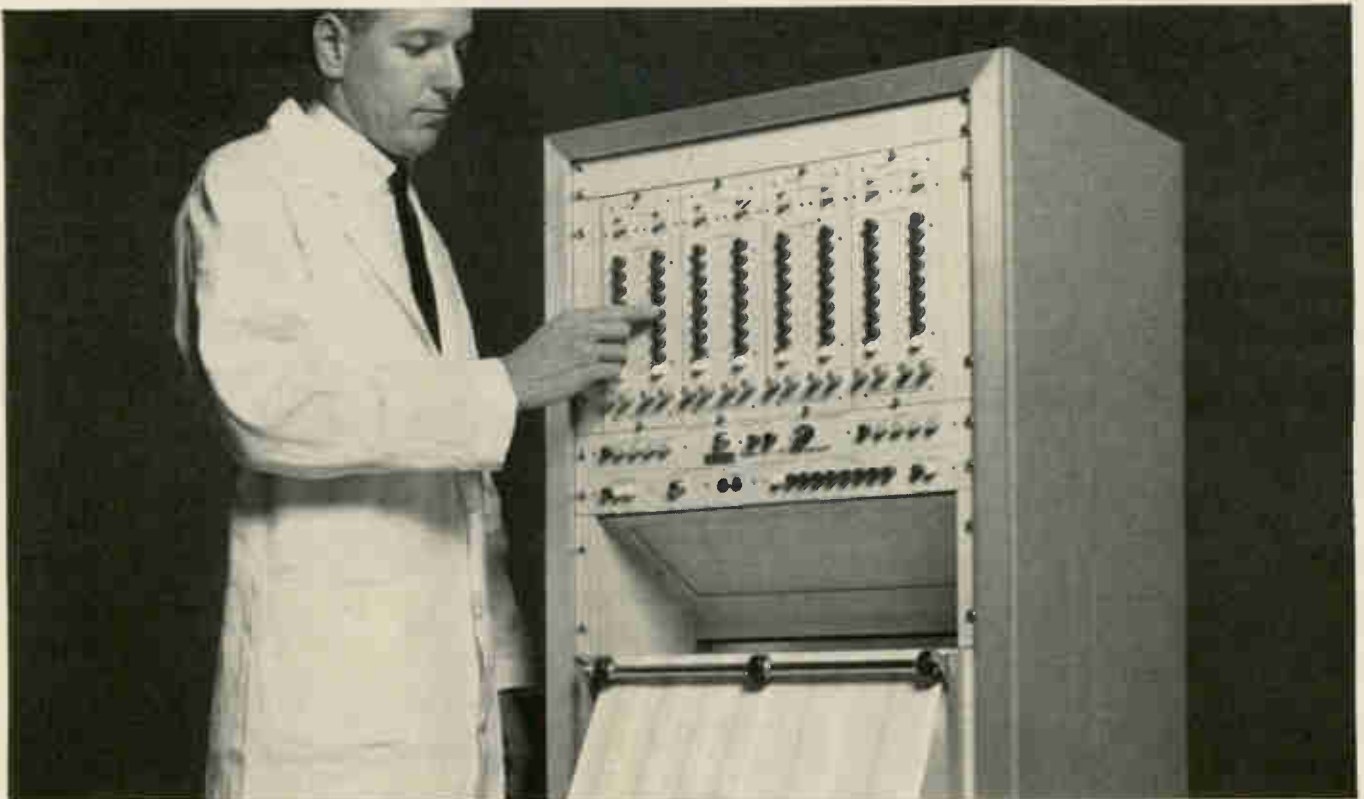
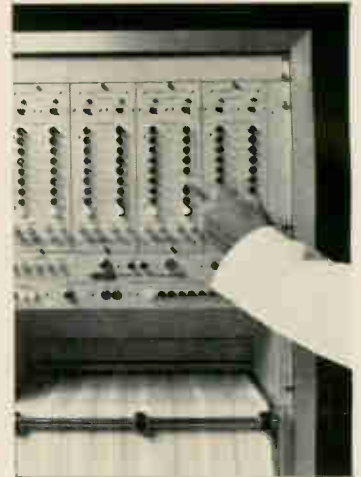

The pressurized-ink rectilinear Type SC-II Dynograph® Recorder is the ultimate in direct-writing recorders... all modular solid-state and human engineered... for your analog computer, telemetry, or special instrument systems. The easy-to-read high contrast records are permanent, reproducible, and continuous with constant line width.

Tracing linearity of $\pm 0.25\%$, full scale, is *locked in* at the stylus tip by an exclusive pen-positioning system. Straight-edge design guarantees absolute pen alignment with all channels and the time base of the chart paper. The system accuracy is further preserved by the *zero-weave* Dynograph paper drive which prevents base line distortions caused by lateral weave.

All level and function controls are quickly and accurately selectable by push buttons. Applications versatility of the Type SC-II is enhanced by the availability of either horizontal or vertical paper drives, as well as a separate mobile

chart drive console that accommodates up to 12 analog channels. The modular components can be supplied in any of three standard enclosures, or mounted directly into any standard 19" rack where they occupy less than 37" of panel space.

For the full rundown on this advanced, versatile, all solid-state recorder... and how it can help you... contact your local Offner Division Sales Engineering Representative, or write direct.

Beckman®

INSTRUMENTS, INC.

OFFNER DIVISION

SCHILLER PARK, ILLINOIS 60176

INTERNATIONAL SUBSIDIARIES: GENEVA; MUNICH; GLENROTHES, SCOTLAND; TOKYO; PARIS; CAPE TOWN; LONDON

**Been looking at all those OTHER oscillators?
Now—take a long, hard look
at the completely different
SD-104 LINEAR/LOG SWEEP OSCILLATOR**



Tired of the continuous monitoring of output normally necessary when making frequency-response tests? Work in the range of .005 cps to 50 kc? Then here's why—point by point—you will find the SD-104 Linear/Log Sweep Oscillator superior to every other instrument on the market today . . .

- Continuously variable, completely electronic linear and log sweep rates
- Unequalled accuracy in frequency indication and resolution through automatic range switching of the front panel meter
- Exceptionally flat frequency response
- Uninterrupted and automatic sweeps over a full three-decade range
- Eight simultaneous outputs, including extremely accurate DC analog output voltages, permitting DIRECT plotting of data on X-Y recorders without frequency or log converters

Plus

special capabilities and options, including . . .

- Continuously variable phase output, 0-360°
- Fixed-phase outputs of 0°, 90°, 180°, 270°
- Phase locking and frequency tracking
- Combined linear-log sweep
- External programming (analog or digital)
- Stepped-frequency operation

DEMONSTRATIONS? YOU BET! Every one of our Reps—from coast to coast—has a demo unit ready to set up at your convenience. Just call or write.

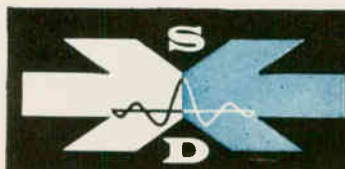

SPECTRAL DYNAMICS CORPORATION OF SAN DIEGO

POST OFFICE BOX 671 SAN DIEGO, CALIFORNIA 92112, TELEPHONE 714-278-2501

Why is this
Esterline Angus
24 Point Recorder
better than other
brands?

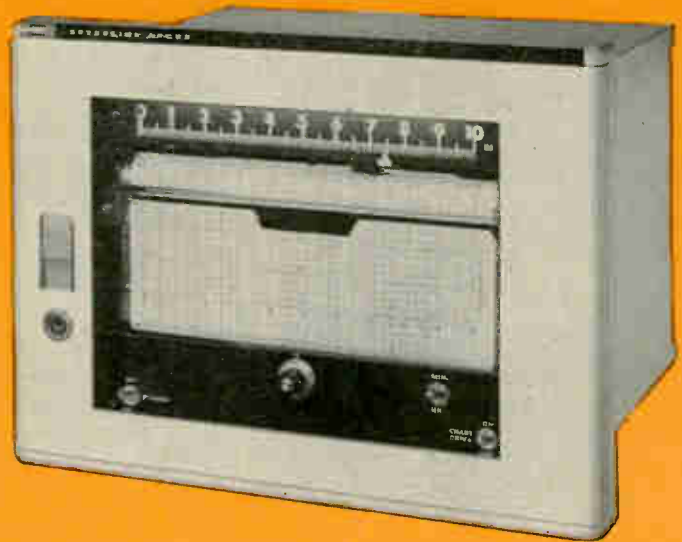

for 10 good reasons*

X's indicate standard features at no extra cost	Esterline Angus	Brands (Names available on request)			
		A	B	C	D
List price \$1450 or lower	X			X	
Solid state amplifier	X		X		
50,000 ohm off balance input impedance or better	X				
Stray rejection: longitudinal 60 cycles AC, 1,000 times span or 120 volts	X		X		
Accuracy $\pm 1/4\%$ span or $\pm 3 1/2$ microvolts or better	X		X		
Manual point advance. Dial in any point without disturbing synchronization	X				
Permanently sealed slidewire requires no cleaning	X				
5 chart speeds	X				
Choice of 8 print frequencies from $1 1/2$ to 60 seconds per point	X				
Tilt out writing platen and chart tear-off bar	X				

*Discover additional reasons for specifying Esterline Angus Multipoint Recorders including optional electrical programmed printing which permits point skipping as fast as $1/4$ second. Write for Series "E" Catalog.

Esterline Angus Instrument Company, Inc.
Box 24000E • Indianapolis, Indiana 46224

*Excellence in
instrumentation for
over 60 years*



ESTERLINE ANGUS

Technical Articles

**Getting the most
out of feedback:
page 66**

Feedback circuits are usually designed by calculating component values on the basis of an ideal circuit, then juggling decade boxes when the actual circuit fails to live up to expectations. This author suggests that better designs are possible when the engineer understands all types of feedback and how they affect amplifier stability.

**Diode sheds its costly
package with beam-lead
construction:
page 77**



A few years ago when the Bell Telephone Laboratories first announced the development of beam-lead construction for semiconductors—the use of gold-plated cantilevered leads—almost everybody felt the approach offered great promise. Now a company has applied it with startling results to mass-produce a diode. The new device has no external package but is protected from the environment by a silicon dioxide coating. On the cover is a close-up of a chip full of diodes, just before it is processed into separate devices. The picture was taken by coauthor J. Earl Thomas at the General Instrument Corp. plant in Newark, N. J.

**Belting out transistors
on continuous lines:
page 84**

One answer to competition from Asia's cheap labor is to automate production. Here's how one company packages semiconductors automatically, to produce low-cost transistors that can compete head-on with imports.

**More on time sharing:
page 93**

In the second part of a special report are more insights into time-sharing digital computers:

- I. How a hospital uses time sharing
- II. How a time-shared troubleshooter repairs computers on-line
- III. Fast-moving queue for better service

**Coming
February 7**

- Stripline circuits simplify microwave gear
- Computer-controlled telemetry stations
- Superconducting devices
- New spectrum analyzer

Getting the most out of feedback

Understanding all the possible types of feedback, and how each affects amplifier performance, can help the circuit designer solve stability problems with ease

By Neale A. Zellmer

Advanced Development Dept., Lenkurt Electric Co., San Carlos, Calif.

Feedback circuits are usually designed by calculating component values on the basis of an ideal circuit. When the circuit fails to perform as desired, the designer juggles decade boxes until he finds the correct values.

The problem is that most classical analyses of circuits with feedback assume the use of strictly voltage-operated devices having infinite input impedance and zero output impedance. In reality, most amplifiers have finite input and output impedance and should be considered power amplifiers. For example, amplifiers in telephone systems are designed to match line impedances and furnish power gain rather than voltage.

For efficient transfer of power it is desirable to design feedback circuits with capability of adjusting and holding the impedance match. Other parameters affected by feedback include gain, noise and distortion. All of these must be considered in the design of any practical amplifier.

Types of feedback

A practical analysis may begin with a simplified diagram of a typical realizable unstabilized amplifier as shown on page 67. Voltage e_{in} is now a function of the amplifier's input impedance. Effective unstabilized gain, A , is a function of the am-

plifier's input impedance, forward gain, μ , output impedance and load impedance. Conventionally, stabilized voltage gain is considered a function of forward gain and percent feedback, and is written

$$G = \frac{\mu}{1 + \mu\beta} \quad (1)$$

There are several well-known techniques for selecting some percentage of the output signal and feeding it back to the input. The most common one, referred to as voltage feedback, derives the feedback signal by tapping off in parallel with the load. As implied by its name, the feedback signal is proportional to output voltage. It is also possible to derive feedback by tapping off in series with the load; the feedback voltage is proportional to the output current and is thus commonly called current feedback. A third technique, a combination of the other two, will be considered later.

Effects on gain and impedance

With negative feedback, where the feedback voltage is 180° out of phase with the input, gain is reduced. How other parameters, such as input and output impedance, linearity, and stability are affected is less obvious. Assuming ideal midband conditions, several relatively simple equations provide an intuitive basis for predicting amplifier characteristics.

It is convenient to consider first the effects of negative feedback upon gain and output impedance. With voltage feedback as shown in the three-part diagram on page 67, stabilized gain is

$$G = \frac{-\mu}{R_o + R_L + \mu\beta R_L} \quad (2)$$

and output impedance is

$$Z_o = \frac{R_o}{1 + \mu\beta} \quad (3)$$

The author



Neale Zellmer, a senior staff engineer for advanced development, heads Lenkurt's carrier system and techniques section. He currently is applying micro-electronic techniques to communication equipment and is making pertinent system studies into telephone transmission equipment channel loading and its dynamic characteristics.

Stabilized gain with current feedback, as illustrated, is

$$G = \frac{-\mu}{\frac{R_o + R_m + R_L}{R_L} + \mu \frac{R_m}{R_L}} \quad (4)$$

Solving for power out, differentiating with respect to R_L , equating to zero, and solving for output impedance gives

$$Z_o = R_o + (1 + \mu) R_m \quad (5)$$

Since both β and R_m/R_L represent the feedback ratio and R_m is usually much smaller than $(R_o + R_L)$, equations 2 and 4 show that equal amounts of either voltage or current feedback will result in approximately the same degree of stabilization.

Assuming R_o is much greater than R_m , equations 2 and 4 reduce to

$$G \cong \frac{\mu}{1 + \frac{R_o}{R_L} + \mu\beta}$$

$$\text{If } A \cong \frac{-\mu}{1 + \frac{R_o}{R_L}}$$

the degree of gain stabilization may be determined by taking partial derivatives of A and G with respect to μ and R_o , and then solving for incremental changes of stabilized gain in terms of the incremental change in unstabilized gain, from which

$$\Delta G = \Delta A \frac{1}{[1 + \mu\beta/(1 + R_o/R_L)]^2} \quad \left. \begin{array}{l} R_o \text{ remaining} \\ \text{constant} \end{array} \right\} \quad (7)$$

and

$$\Delta G = \Delta A \frac{1}{[1 + \mu\beta/(1 + R_o/R_L)]^2} \quad \left. \begin{array}{l} \mu \text{ remaining} \\ \text{constant} \end{array} \right\} \quad (8)$$

As $\mu\beta$ is usually much larger than $(1 + R_o/R_L)$, ΔG is approximately equal to $\Delta A/\mu\beta$, showing that the degree of gain stabilization is relatively independent of the type of feedback. Furthermore, the degree of stabilization is independent of active

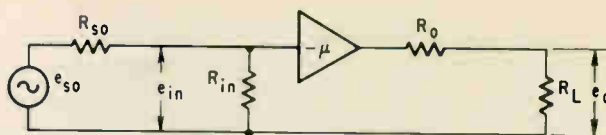

In typical unstabilized amplifier, gain, input and output impedance are subject to vagaries of the parameters of the active devices.

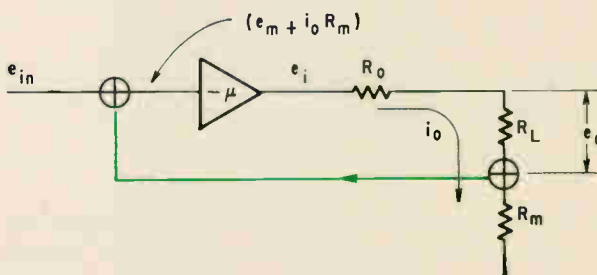
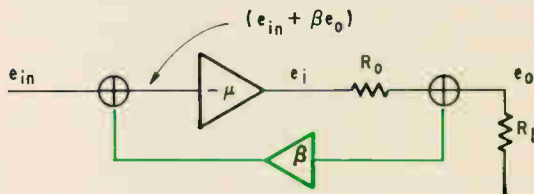

(6)

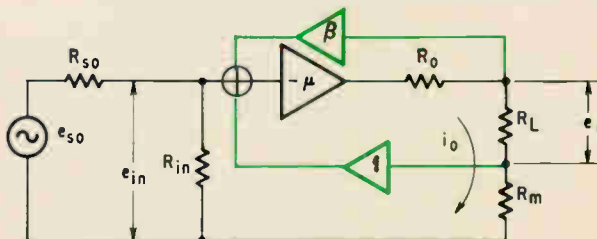

With voltage feedback, top, where the feedback voltage is proportional to the output voltage, output impedance is lowered. Current feedback, middle diagram, where feedback voltage is proportional to output current, raises output impedance. A combination of voltage and current feedback, lower diagram, allows the output impedance to be stabilized at almost any reasonable value. Feedback paths are shown in color.

device parameter variation as long as the feedback circuits are stable.

How to choose

The selection of the type of feedback emerges as an impedance problem. It is noted that voltage feedback lowers the output impedance (Eq. 3), while current feedback raises the output impedance (Eq. 5). Thus, the designer must determine if one type of feedback tends to stabilize the output impedance more than the other.

By partial differentiation of equations 3 and 5, it can be shown that in percentages, neither voltage nor current feedback alone improves impedance stability.

Combining voltage and current feedback

One way to stabilize output impedance is to first reduce its value with voltage feedback and then add

Definition of symbols

A	=effective unstabilized gain
B	=percent of voltage feedback
B_s	=percent of series feedback
e_{in}	=amplifier input voltage
e_u	=undesired signal
e_o	=amplifier output voltage
e_{so}	=source voltage
G	=stabilized voltage gain
g_o	=transfer conductance for shunt feedback
g_m	=equivalent transconductance of amplifier's forward gain
k	=transmission loss in current feedback loop
k_i	=reciprocal of forward-loop current gain
μ	=unstabilized forward voltage gain
P_o	=power out
R_{in}	=input impedance of amplifier with no feedback
R_m	=feedback transfer impedance for current feedback
R_L	=load impedance
R_o	=output impedance of amplifier with gain μ , and no feedback
R_{so}	=source impedance
Z_{in}	=effective input impedance of stabilized amplifier
Z_o	=effective output impedance of stabilized amplifier

a resistor to obtain the final desired value. Alternatively, the output impedance can be made very large with current feedback and the final value obtained by shunting it with a resistor. Either of these methods will tend to mask variations in forward gain, μ , or the original output impedance, R_o . However, both have the immediate disadvantage of wasting half the output power.

A more sophisticated way to control impedance is to combine the two methods. In the bottom diagram on page 67, the stabilized voltage gain is

$$G = \frac{-\mu R_L}{R_o + R_m(1 + \mu) + R_L(1 + \mu\beta)} \quad (9)$$

and output power is

$$P_o = \frac{(\mu e_{in})^2 R_L}{R_o + R_m(1 + \mu) + R_L(1 + \mu\beta)} \quad (10)$$

Effective output impedance when $\mu R_m/R_L$ and $\mu\beta$ are much greater than 1 is

$$Z_o \cong \frac{R_o}{\mu\beta} + \frac{R_m}{\beta} \quad (11)$$

If R_m/β is greater than $R_o/\mu\beta$, then the output impedance will be controlled largely by the passive feedback networks and be quite stable. If R_m/β is much greater than $R_o/\mu\beta$, then

$$Z_o = \frac{R_m}{\beta} \quad (12)$$

Equation 9 may be rewritten

$$G = \frac{-\mu}{1 + \frac{R_o}{R_L} + \mu \left(\beta + \frac{R_m}{R_L} \right)} \quad (13)$$

Note the similarity between equations 13 and 2. Effectively, the combined feedback is equal to the sum of the two types of feedback. If equation 12 is rewritten in the form

$$Z_o = \left(\frac{1}{\beta} + \frac{R_m}{R_L} \right) R_L$$

it is obvious that Z_o can be made to match R_L by making the current feedback ratio equal to the voltage feedback ratio. (That is, if $\beta = R_m/R_L$, then $Z_o = R_L$.)

This is true only if $R_o/(1 + \mu\beta)$ is very small and the transmission network from the current feedback point is lossless. In the more practical case, where $R_o/(1 + \mu\beta)$ may be appreciable and a transmission

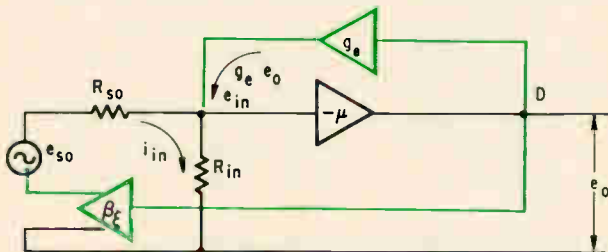

Combination of shunt and series feedback stabilizes input impedance. Increasing shunt feedback lowers input impedance while increasing series feedback raises it.

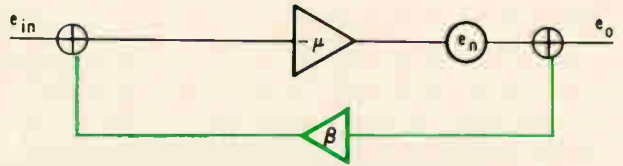
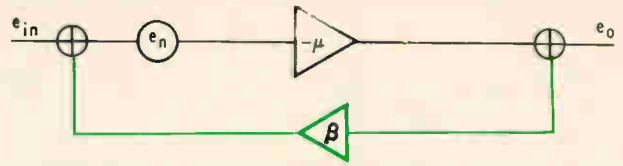

Noise or distortion appearing at the input of an amplifier, top, cannot be corrected with feedback. However, noise or distortion generated at an intermediate stage, bottom diagram, can be reduced with properly applied feedback.

loss, k , is present, equations 11 and 13 must be modified. If k can be adjusted to approximate $(1 - R_o/\mu R_L)$ and β and R_m/R_L remain equal, the output impedance will still match R_L , but the gain will be

$$G = \frac{-\mu}{R_o(1 - \beta) + 2(1 + \mu\beta)} \quad (14)$$

Injecting feedback at amplifier input

Just as there are two basic ways of providing feedback from an amplifier's output, there are two ways of injecting the feedback at the input. The figure shown below is a functional diagram of an amplifier with the two different methods of injecting feedback at the input.

The top loop, g_e , injects a current proportional to the feedback voltage in parallel with the input current. This type of injection is normally referred to as parallel or shunt injection. Series injection, is illustrated by the bottom loop, β_s , which injects a voltage in series with the input voltage. Point D represents a current or voltage node, or a summation point, for a combination of voltage and current feedback.

To analyze the effect of each type of feedback injection upon gain and input impedance, it is only necessary to write and solve the nodal equations for the input circuits.

Solving for stabilized voltage gain

$$G = - \frac{\mu R_{in}}{R_{so}(1 + \mu g_e R_{in}) + R_{in}(1 + \mu\beta_s)} \quad (15)$$

By inspection, $g_e R_{in}$ represents the degree of shunt feedback, while β_s represents the degree of series feedback.

Solving for Z_{in}

$$Z_{in} = \frac{(1 + \mu\beta_s) R_{in}}{1 + \mu g_e R_{in}} \quad (16)$$

Equation 16 shows that shunt injection lowers input impedance, while series injection raises input

impedance. If $\mu\beta_s > 1$ and $\mu g_o R_{in} > 1$, equation 16 reduces to $Z_{in} = \beta_s/g_o$, pointing up the fact that the stabilized input impedance of an amplifier can be made relatively independent of the unstabilized input impedance and gain with a combination of series and shunt injection. If the percentages of series and shunt feedback are made equal, the input impedance will equal the unstabilized amplifier's nominal input impedance.

Noise and distortion

Under certain conditions, negative feedback can be used to reduce extraneously generated signals. Two important sources of extraneous signals must be considered: first, distortion or noise generated at the input terminals; and second, noise that is present only at the output terminals.

The uppermost diagram on the top of page 68 shows an amplifier with a generator of an undesired signal, e_n , at the input. By inspection,

$$e_o = \frac{-\mu(e_{in} + e_n)}{1 + \mu\beta} \quad (17)$$

indicating that any noise or distortion generated at the input of the amplifier will not be reduced relative to the desired signal by feedback.

The lower section of the diagram shows an amplifier with noise in the output, but none at the input. Again by inspection,

$$e_o = -Ge_{in} + \frac{e_n}{1 + \mu\beta} \quad (18)$$

In typical circuits the amount of stabilized gain, G , is independent of the amount of feedback applied. Under these conditions the unstabilized forward gain must be increased 1 decibel for each additional db of feedback applied and $e_n/(1 + \mu\beta)$ will be reduced by 1 db relative to the desired signal level for each additional db of feedback.

Effect of feedback on phase shift

Another important consideration in amplifier design, especially near the corner frequencies (3 db rolloff points), is the effect of negative feedback on over-all phase shift. Assuming an amplifier with a forward voltage gain of $-\mu \angle \phi$ and a feedback loop with transmission characteristics of $\beta \angle \phi$, a stabilized gain G/α results. Mathematically,

$$\frac{1}{G \angle \alpha} = - \frac{1}{\mu \angle \theta} - \beta \angle \phi \quad (19)$$

Converting to rectangular coordinates, equating real and imaginary parts, and solving for α

$$\alpha = \arctan \left[\frac{1 - \mu\beta \frac{\sin \phi}{\sin \theta}}{1 + \mu\beta \frac{\cos \phi}{\cos \theta}} \right] \quad (20)$$

Normally, the phase shift in the feedback loop will be small; that is, $\phi \cong 0$. Then if $\mu\beta \gg \cos \theta$,

$$\alpha \cong \frac{\theta}{\mu\beta} \quad (21)$$

However, the feedback loop can be designed such that $\mu\beta \sin \phi > \sin \theta$ and $\mu\beta \cos \phi > \cos \theta$, then $\alpha \cong -\phi$; or if ϕ can be made equal to θ , $\alpha = -\theta$.

In general, where resistive feedback networks are used, feedback tends to reduce the inband phase shift of an amplifier to very small values. The effectiveness of feedback in reducing phase shift points up the advantage of using local feedback loops around each stage to shape the gain curves of an amplifier before applying over-all loop feedback.

Bridge feedback

The balanced bridge configuration, (see schematic below) is a convenient technique for balancing two types of feedback at either the input or the output. This circuit provides excellent isolation between output and input.

Generally, conventional bridge feedback requires both input and output transformers. It is possible to save components by using hybrid transformers to furnish the bridge action as shown in the diagram.

All the bridge and hybrid configurations have

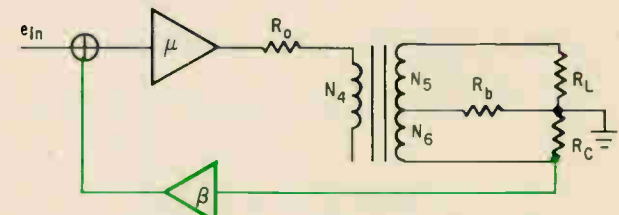
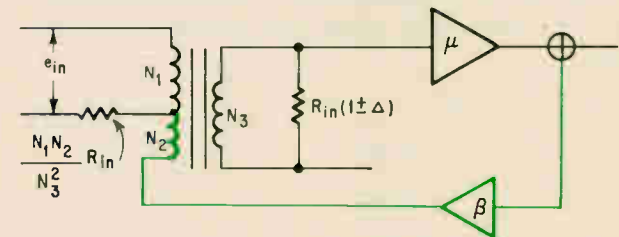
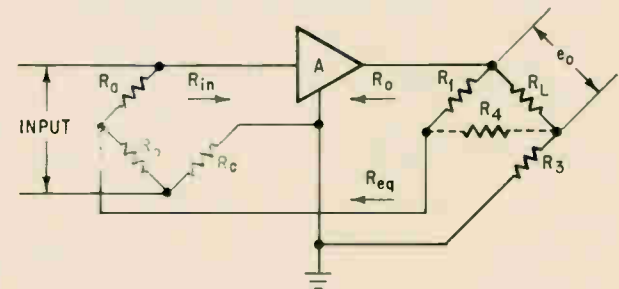

In bridge feedback amplifier with resistive bridges at both input and output, top, the input impedance, output impedance and gain may be adjusted and stabilized by a factor $(1 + \mu\beta)$. At center, the input bridge has been replaced with a hybrid transformer to simplify the circuit. The penalty, however, is that it becomes more difficult to obtain loop stability. The output bridge may also be replaced with a hybrid transformer, lower diagram, but loop stability is also sacrificed.

the same general advantage: they tend to control and stabilize not only gain and distortion, but also input and output impedances. In general, they reduce any variation in these four parameters in an unstabilized amplifier by the factor $(1 + \mu\beta)$.

The degree of success attainable depends upon the conditions that must be met. It should be remembered that transformers in feedback loops tend to contribute both low- and high-frequency phase shift and tend to aggravate the high- and low-frequency stability problem.

The configuration represents the more conventional approach to bridge feedback. The input impedance can be shown to equal the series resistance of $(R_a + R_b)$ in parallel with the series resistance of $(R_{in} + R_c)$ plus a small increment that approximately equals the change from its nominal value of R_{in} divided by $(1 + \mu\beta)$. If $(1 + \mu\beta)$ is large, this increment is usually negligible.

If the equivalent resistance R_{eq} is defined as the parallel resistance of $(R_a + R_{in})$ and $(R_b + R_c)$, then R_{eq} is the fourth and terminating leg of the output bridge. If $R_{eq}R_L = R_1R_3$, then R_4 controls the output impedance without affecting stabilized gain by adjusting the transmission loss k .

If, as is quite common, $R_a = R_b = R_c = R_{in}$ and R_L is large with respect to R_3 , then $\beta \cong$

$$\frac{R_{in}}{2(R_1 + R_{in})} \text{ and } G \cong 2 \left(\frac{R_1 + R_{in}}{R_{in}} \right) \quad (22)$$

$$\text{and } Z_{in} = R_a \quad (23)$$

Similarly, the configuration in which the input bridge has been replaced with a hybrid transformer may be analyzed to show that nominal stabilized gain

$$G = \frac{\mu}{\frac{N_1 + N_2}{N_3} + \mu\beta} \quad (24)$$

and

$$Z_{in} = \frac{N_1(N_1 + N_2)}{N_3^2} R_{in} \quad (25)$$

where R_{in} = nominal input impedance of the unstabilized amplifier.

Where the output bridge is replaced by a hybrid transformer,

$$G = \frac{N_5}{N_6} \cdot \frac{1}{\beta}; \text{ if } \mu\beta \frac{N_6}{N_5} > 1, \beta = 1,$$

$$G \cong \frac{N_5}{N_6} \quad (26)$$

$$\text{If } R_b = \frac{N_4}{N_5 + N_6} R_L,$$

(the usual value for the balancing resistor on a

properly terminated hybrid transformer) and if

$$\mu\beta R_c > \frac{N_5}{N_6} R_o, \text{ then}$$

$$Z_o \cong R_L \quad (27)$$

Practical design

The results of the foregoing analyses of various bridge feedback networks can now be applied to the design of a practical amplifier. The amplifier to be designed is based upon the configuration at the top of p. 71, a basic bootstrap configuration. The load is to be a properly terminated 2-winding transformer. This configuration can be reduced to an equivalent bridge circuit, in which the emitter resistor R_2 has become the fourth and terminating leg of the output bridge.

In a practical design it is a good idea to derive approximate design equations. The first step is to establish the gain. In this case, by examination of the bridge circuit $e_o = e_2 - e_3$. When the bridge is balanced, $R_1R_3 = R_2R_4$, and $e_1 = e_3$. Since e_o is independent of R_4 , e_o also equals $e_2 - e_1$. Dividing by $e_1 = e_2R_2/(R_1 + R_2)$, it follows that with proper impedance termination,

$$\frac{e_2}{e_1} = 1 + \frac{R_1}{R_2}$$

But stabilized voltage gain G equals e_o/e_{in} and by inspection $e_1 \cong e_{in}$. Therefore $G \cong e_o/e_1$ and since $R_1/R_2 = R_1/R_3$, it follows that

$$G \cong \frac{R_1}{R_2} = \frac{R_L}{R_3} \quad (28)$$

Adjusting output impedance

If R_L approaches infinity (output open-circuited) and since R_4 is typically very small with respect to R_1 , e_o still approximately equals $(e_2 - e_1)$, but e_1 will have changed. It can be shown that under open-circuit conditions

$$\frac{e_2}{e_1} = 1 + \frac{R_1(R_2 + R_3 + R_4)}{R_2(R_3 + R_4)} \quad (29)$$

With R_L equal to infinity, open-circuit gain is equal to $R_1(R_2 + R_3 + R_1)/R_2(R_3 + R_4)$. If $(R_2 + R_3 + R_1) = 2(R_3 + R_4)$, the open-circuit gain would equal $2G$, and heuristically the output impedance Z_o would equal R_L . That is if $Z_o = R_L$,

$$R_4 \cong R_2 - R_3 \quad (30)$$

Equations 29 and 30 can be confirmed by rigorous analysis. If G is less than 100, the analysis shows that equation 30 must be modified slightly to

$$R_4 \cong \frac{G}{G - 1} (R_2 - R_3) \quad (31)$$

In other words, equation 28 shows that the ratios

$$\frac{R_1}{R_2} \text{ or } \frac{R_L}{R_3}$$

control gain, and R_4 controls output impedance.

Using the corrected value for R_4 from equation

31, it can be shown that Z_o will be modified very little by changes in gain in a practical two-stage amplifier. Where transconductance gain would typically fall between the limits of 500 and 50,000, output impedance will vary less than 2% due to variations in the gain of transistors.

The equivalent circuit of the proposed amplifier shown at right was based on assumptions that introduced a small error in the calculation for the value of R_2 . This effect can be shown by referring to the schematic, at the right of the output bridge alone with the impedance controlling resistor R_4 removed. The factor k_i approximately equals the reciprocal of the forward loop current gain following the first stage. The value of R_2 required to balance the bridge is

$$R_2 = \frac{R_1 R_3}{R_L} \frac{1}{1 + k_i \left(1 + \frac{R_1}{R_L}\right)} \quad (32)$$

Thus, R_2 will necessarily be somewhat smaller than calculated by equation 28.

There exists a very useful modification of the bootstrap circuit in which the input stage is a differential amplifier. Basically, the second half of the differential amplifier acts as an impedance transfer device in the feedback loop, thereby materially increasing the efficiency of both the feedback loop and the total amplifier.

A differential bootstrap amplifier configuration with bridge-type feedback is shown below. R_2 becomes the parallel combination of R_2' and R_2'' , which raises the impedance level of the feedback loop by an order of magnitude. This has at least two advantages: the input stage does not materially load the feedback loop; and the feedback loop does not load the amplifier.

Experimental results

An experimental thick-film audio amplifier was designed with a gain of 36 db with a 65-milliwatt breakpoint (point where sine wave distortion begins) and 600-ohm input and output impedances. Practical limitations dictated that, if at all possible, the power dissipated should be under one-half watt. As the application required transformer coupling to the load, the collector quiescent current path was established through the external transformer.

The amplifier schematic shown at the top of p. 72 resulted from this approach. Equations 31 and 32 were confirmed by the fact that R_1 had to be adjusted upward from 33 ohms to 36 ohms and R_2 had to be adjusted to 47 ohms instead of 55 ohms.

The measured gain was 36 db from 200 cps to 100 kc. Low-frequency rolloff is due to the output transformer, and the increase in output impedance at high frequency is caused by parallel resonance of output transformer in this range. High-frequency response is dependent upon both the output transistor and output transformer. Both low- and high-frequency characteristics could be improved by

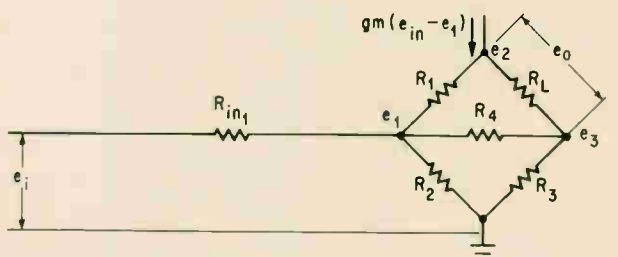
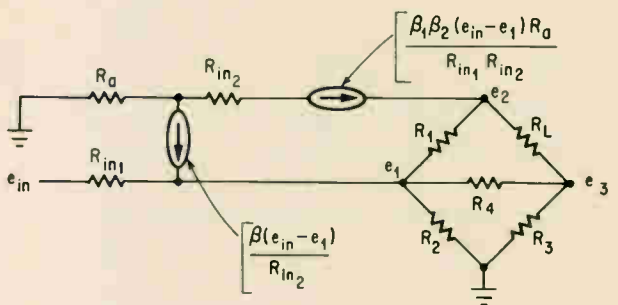
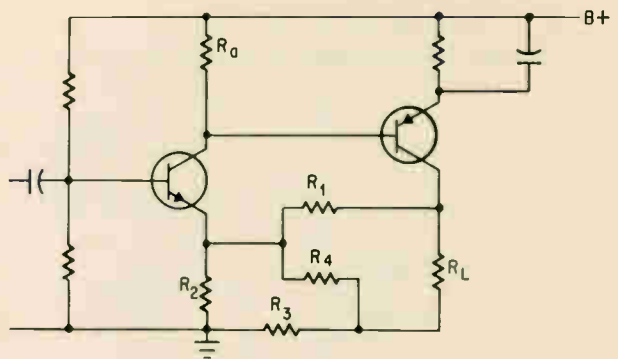

Proposed amplifier, simplified schematic at the top, uses bridge feedback at the output of a bootstrap amplifier. In the equivalent circuit of the amplifier, the transistors have been replaced with idealized constant-current generators with discrete impedance defined by $R_{in1} = r_{in1} + (\beta_1 + 1)r_{e1}$ and $R_{in2} = r_{in2} + (\beta_2 + 1)r_{e2}$. It is also assumed that R_4 is larger than R_{in2} . By assuming that the drop across R_{in1} is negligible, the circuit may be further simplified as shown at the bottom. In this case, it is assumed that

$$\frac{(\beta_1 + 1)(e_{in} - e_1)}{R_{in1}} \text{ is smaller than } \frac{e_2 - e_1}{R_1}$$

and g_m is defined as $\frac{\beta_1 \beta_2 R_a}{R_{in1} R_{in2}}$.

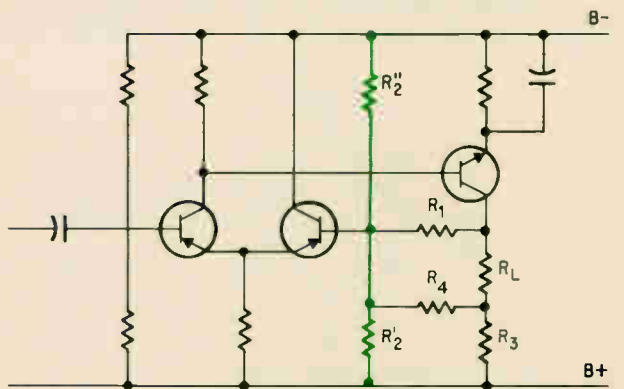

With additional grounded collector stage in the feedback circuit, the input stage becomes a differential amplifier with improved efficiency.

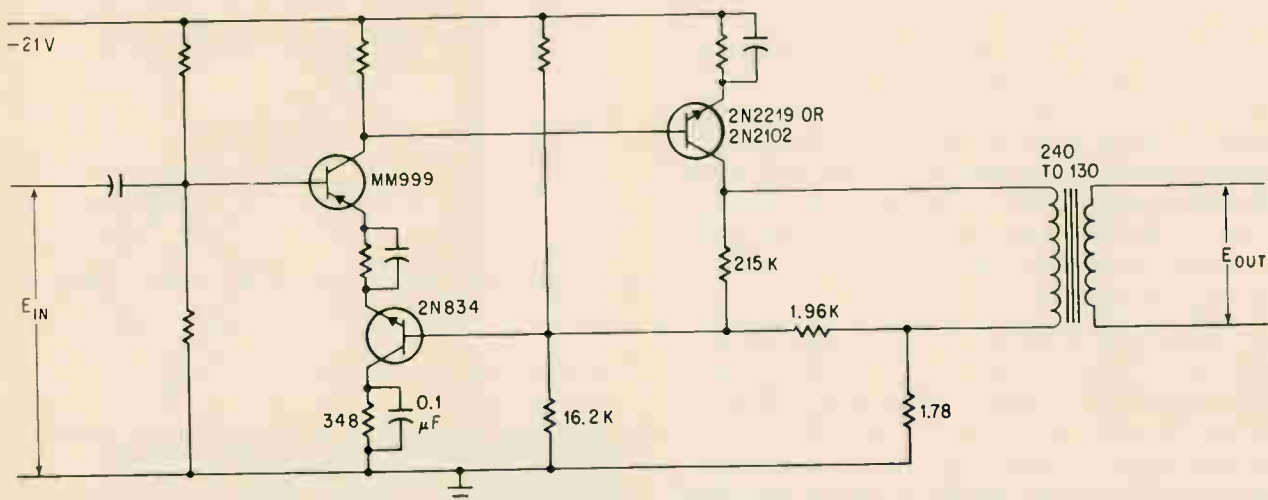
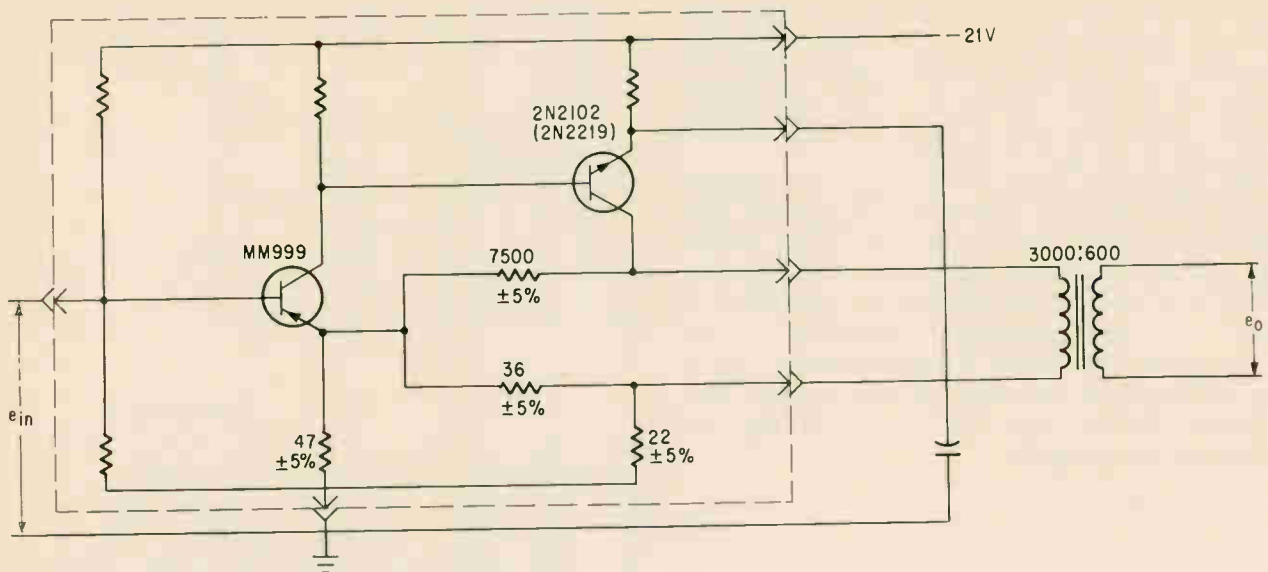

Audio amplifier design, top, has the desired dynamic characteristics for a channel amplifier in telephone frequency multiplex equipment. The differential bootstrap amplifier, lower diagram, uses bridge feedback and is used as a broadband amplifier for handling a group of channels.

improving characteristics of the output transformer. Output impedance is essentially flat and independent of transistor variations at midband. Distortion followed theoretical slopes below the breakpoint, thus assuring reproducible units in production.

A broadband differential bootstrap amplifier with bridge feedback was evaluated by designing an

amplifier suitable for baseband amplification. Tentative design targets were 40-db gain; 0.5 watt breakpoint; distortion more than 60 db down at nominal operating level of 25 milliwatts, over a frequency spectrum of 30 to 300 kc. The only major adjustment to the original calculated design values was the requirement to raise the value of the impedance control resistor from 1470 to 1960 ohms.

The dynamic operating characteristics were measured with both a 2N2102 and a 2N2219 as the output transistor. The 2N2219 transistor is recommended since gain vs frequency is flatter, the output impedance is under better control, and distortion is 1 to 2 db lower than with the 2N2102.

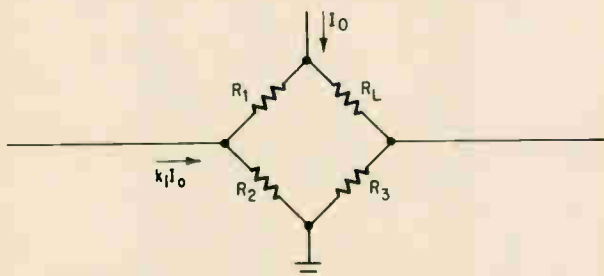

If the emitter current of the first stage is appreciable with respect to the output current, the effective value of R_2 in the bridge is increased by a factor $(1 + k_i)$ where k_i equals the ratio of the emitter current to the output current.

Bibliography

- Black, H.S., "Stabilized Feedback Amplifiers." Electrical Engineering, 1934.
- Millman, J. and Seely, S., Electronics, McGraw-Hill Book Co., Inc., 1941, pp. 606-618.
- Bode, H.W., Network Analysis and Feedback Amplifier Design, D. Van Nostrand Company, Inc., 1945.
- Applied Electronics, Members of Massachusetts Institute of Technology Electrical Engineering Department Staff, John Wiley & Sons, Inc., 1947, pp. 525-539.

Designer's casebook

Designer's casebook is a regular feature in Electronics. Readers are invited to submit novel circuit ideas, packaging schemes, or other unusual solutions to design problems. Descriptions should be short. We'll pay \$50 for each item published.

Bias control and low parasitics shorten amplifier rise time

By D.D. McLeod

United Kingdom Atomic Energy Authority,
Aldermaston, England

The pulse amplifier at the right achieves fast rise time by precise bias control at transistor Q_2 without introducing parasitics in the input signal line.

The circuit meets the following two design requirements. First, the input stage must be biased to provide the highest gain-bandwidth product, f_T . At this frequency, the current gain β of the transistor is unity. The typical f_T characteristics shown below are a family of constant contours, which are a function of collector voltage and current. To establish transistor operation at a particular value of f_T , the current and the voltage at the transistor terminals must be stabilized.

Secondly, the circuit must be arranged to minimize parasitics such as stray capacitance and series lead inductance. As an example, in a grounded emitter stage the input signal should not go through a decoupling capacitor to reach ground. In addition, the number of bias resistors connected to the base of the signal input transistor should be kept to a minimum.

Transistor Q_2 is a high-frequency type and is used as the fast-rise-time amplifier. The transadmittance of this stage is approximately $1/R_6$. Resistance R_6 and the parallel compensating capacitor C_4 are the only extra series components in the signal channel. Only a single resistor, R_3 , is used to maintain the collector current of Q_2 at the required level. As a result the shunt parasitic capacitance is very small.

Q_1 is a low-frequency transistor which operates as a d-c amplifier to bias Q_2 . Resistance R_3 in Q_1 's collector isolates the signal circuit from the bias circuit. The decoupling network, consisting of C_1 and R_2 , allows other stabilized stages similar to Q_1 and Q_2 to be connected to the same zener.

The stabilization of voltage and current at Q_2 may be analyzed in the following manner:

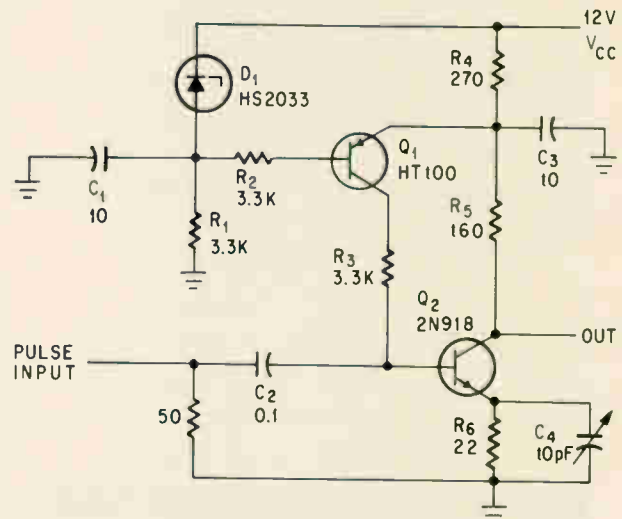

Fast-rise-time pulse amplifier uses a low-frequency transistor Q_1 to stabilize the bias of Q_2 without requiring many components, which might add parasitic reactances at the base of Q_2 . The circuit is biased to provide a high value of gain-bandwidth product.

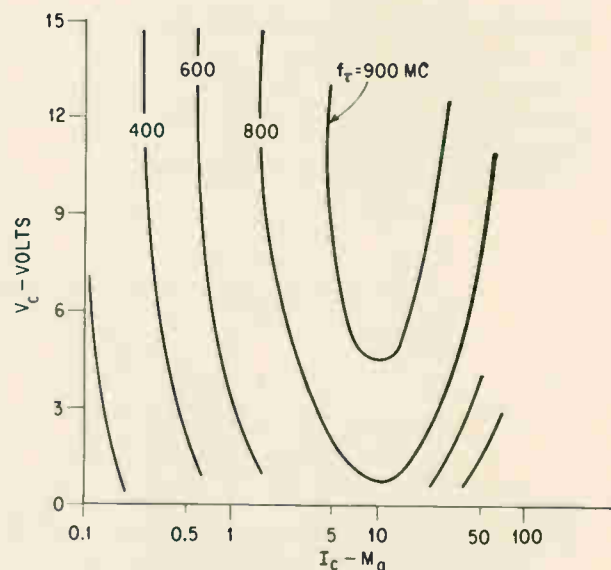

Curves of constant gain-bandwidth product for transistor Q_2 are given as a function of the voltage and current at the collector. Since a fast rise time requires a large bandwidth, the transistor stage must operate at the largest value of f_T .

Assuming that the d-c emitter current of Q_1 is much smaller than the collector current of Q_2 , then base current I_{b1} of Q_1 is approximately

$$I_{b1} = \frac{(V_z - V_{eb1}) - I_{c2} R_4}{R_{in}} \quad (1)$$

where V_z = the zener-diode voltage = 3.3 volts
 V_{eb1} = is the base-to-emitter voltage drop
 I_{c2} = is the collector current in Q_2
 R_{in} = the input impedance of $Q_1 + R_2 = 5,000$ ohms when $I_{e1} = 100 \mu\text{amps}$
 I_{e1} = emitter current of Q_1

Since the collector current of Q_1 is the base current I_{b2} of transistor Q_2 then:

$$I_{c2} = \beta_2 I_{b2} = \beta_2 \beta_1 I_{b1} \quad (2)$$

where β_1 and β_2 are the current gains of transistors Q_1 and Q_2 , respectively.

Substituting equation 2 into 1:

$$I_{c2} = \frac{V_z - V_{eb1}}{R_{in}/\beta_1 \beta_2 + R_4} \quad (3)$$

For the values of resistance and current gain used in this circuit, the first term in the denominator is very small compared to R_4 and may be ignored. Hence, the collector current is relatively independent of the transistor parameters and may be considered stabilized.

The collector voltage of Q_2 is

$$V_{c2} = V_{cc} - (V_z - V_{eb1}) \frac{R_4 + R_5}{R_4} \quad (4)$$

Since the supply voltage is assumed stabilized, equation 4 indicates that the collector voltage is also relatively independent of transistor parameters. Equation 4 also indicates that the value of V_{c2} may be established by the collector supply, V_{cc} . Collector current, I_{c2} , is set independently by V_z and R_4 and allows a particular f_T contour to be selected.

Evaluation of equations 3 and 4 show that

$$I_{c2} = 10 \text{ ma.}$$

$$V_{c2} = 5.7 \text{ volts.}$$

These values bias Q_2 on the maximum f_T contour.

Power supply reduces ripple by varying series resistance

By Richard E. Risely*

Motorola Co., Riverside, Calif.

Reduced ripple and good regulation is obtained in the inexpensive, regulated supply shown below. Costing less than \$15, the circuit is useful for industrial or commercial applications that require high performance at low cost.

* Now with The Marquardt Corp., Pomona, Calif.

A conventional full-wave rectifier, D_1 and D_2 , followed by a capacitor filter supplies power to the regulator circuit. A portion of the a-c ripple appearing across C_1 and C_2 is fed to the base of Q_1 through C_3 and R_1 . Transistor Q_1 inverts this ripple voltage, and applies it to the bases of the series regulator transistors Q_3 and Q_4 .

Because of the phase relationship between the ripple at the bases and at the collectors the combined series resistance of Q_3 and Q_4 is decreased or increased, depending on whether the ripple voltage at the collectors is going more positive or more negative, respectively, than -12V . The change in resistance compensates for the change in voltage level caused by the ripple. As a result the amplitude

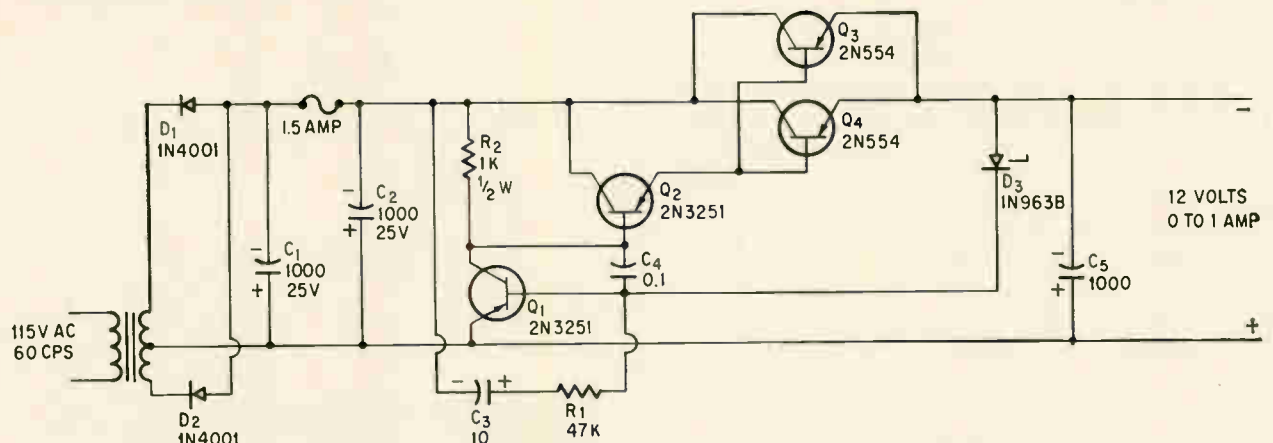

Low cost d-c supply reduces the ripple at the output by controlling the d-c resistance of series regulator transistors Q_3 and Q_4 with the ripple voltage.

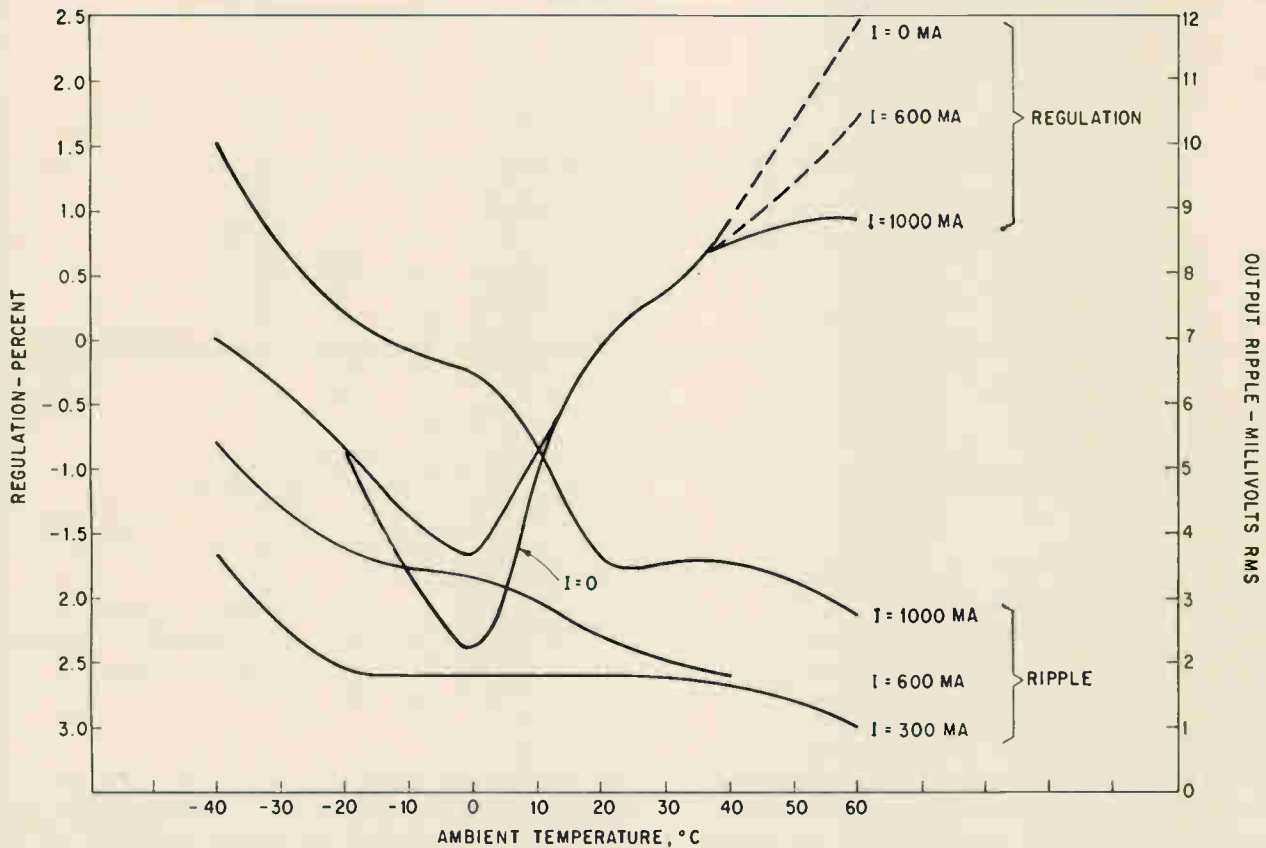

Load regulation and ripple are shown as a function of temperature. Over a temperature range from 15° C to 35° C the regulation is better than 0.1%.

of the ripple at the output is reduced and held below 10 millivolts root mean square over a wide temperature range.

As in an ordinary supply, the regulator also maintains the d-c output level, by sensing the changes in the output voltage through zener diode, D_3 , and controlling the resistance of the regulating

transistors. At room temperatures, the output voltage will not vary by more than 0.1% if the load current is varied from 0 to 1 amperes. However, because no temperature compensation is used the regulation varies 2% over a temperature range from -40°C to 60°C . Curves above show the ripple and load regulation.

One-shot multivibrator with zero recovery time

By Peter T. Rux
Monmouth, Ore.

This monostable multivibrator circuit is useful for converting digital data in an RZ format (return to zero) to NRZ (non-return to zero). The one-shot shown on page 76 effectively achieves zero recovery time by using the energy in the input capacitor to

recharge the timing capacitor C_2 . Recovery takes place during the trigger input.

A 20-nanosecond positive trigger pulse will turn Q_1 on, lower its collector 5 volts, and hold the base at -4 volts for 20 nanoseconds. During this time, Q_3 is off, but Q_2 has been turned on by Q_1 and the energy in C_2 has charged C_1 to 4 volts. When the trigger drops to zero, D_3 is reverse-biased and C_2 begins discharging through R_4 and R_5 until the base of Q_3 is 0.6 volt positive. This turns Q_3 back on and resets the multivibrator.

D_2 and the combination of R_1 and D_1 provide a low impedance path to recharge C_1 rapidly to 5 volts when the trigger ends and Q_1 turns off. If C_1 were not recharged completely between trigger pulses, arrival of the next trigger would not lower

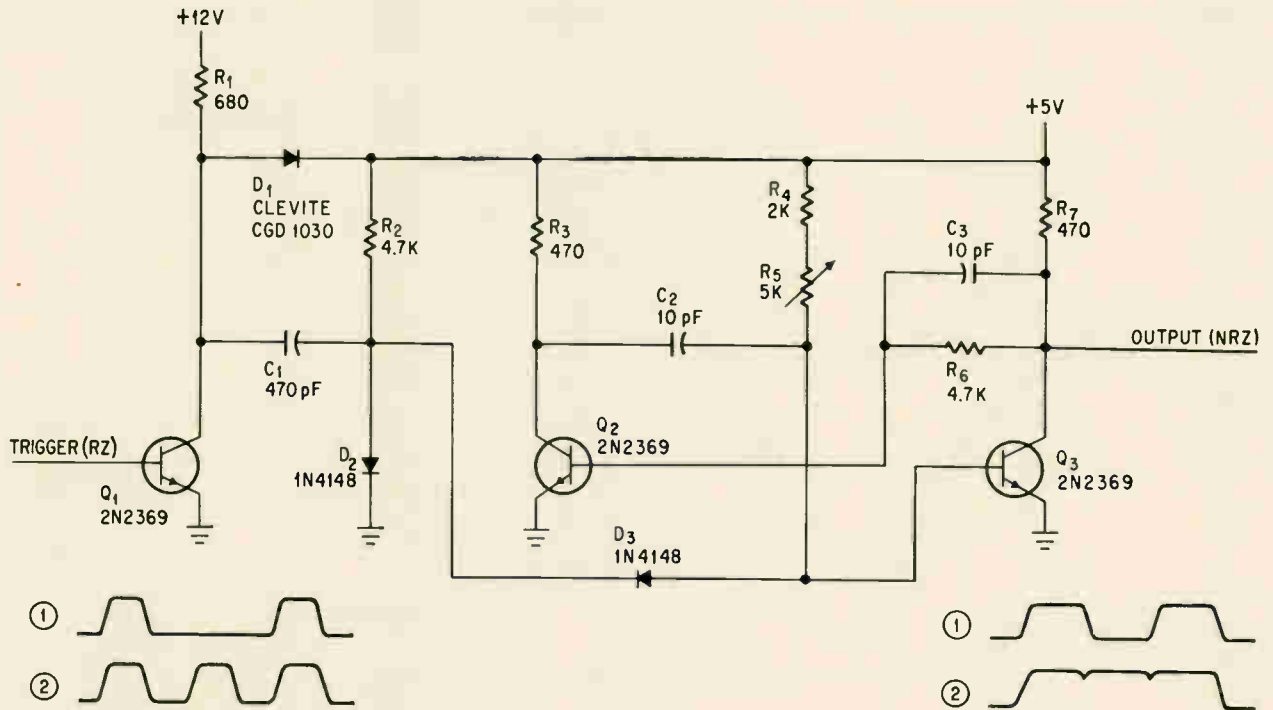

Adjustment of R_5 determines reset time of Q_3 .

the base of Q_3 completely to -4 volts; this shortens the one-shot's timing cycle. Because C_1 is large, its voltage remains fairly constant over the trigger pulse period.

For RZ to NRZ conversion, R_5 can be adjusted so that Q_3 begins to reset just as a new trigger pulse arrives. The effect of this adjustment is shown at the bottom of the schematic.

Fast-pulse amplifier drives 50-ohm load

By E. J. Kennedy

Oak Ridge National Laboratory, Oak Ridge, Tenn.

The linearity and rise time of most fast pulse amplifiers are degraded when driving a 50-ohm load. The circuit at the right possesses excellent characteristics when used as a current driver. One big advantage of the circuit is that one transistor is always on (Q_1 for a negative input and Q_2 for a positive input) resulting in equal output drive for positive and negative input signals. Most emitter-follower configurations that were studied, including the well-known White emitter-follower circuit, lacked both equal-polarity drive and fast rise-time.

The output pulse response of the circuit is similar for both positive and negative input signals. A feedthrough spike at the beginning and at the end of the output pulse is due to the input signal feeding through the collector-base capacitance of

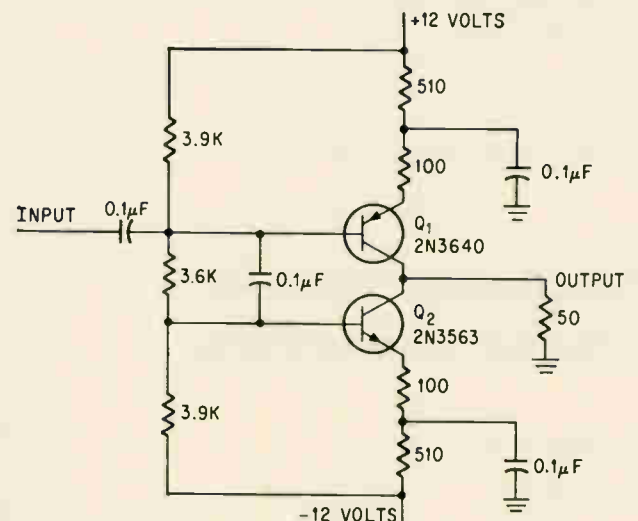

Equal-amplitude positive and negative output pulse can be achieved with this 50-ohm driver circuit.

Q_1 and Q_2 . A 10% overshoot on the edges of the pulse can be eliminated by inserting a small inductance in series with the emitters of Q_1 and Q_2 .

Measured output voltage drift was approximately $0.25 \text{ Mc}/^\circ\text{C}$ from 25° to 50°C .

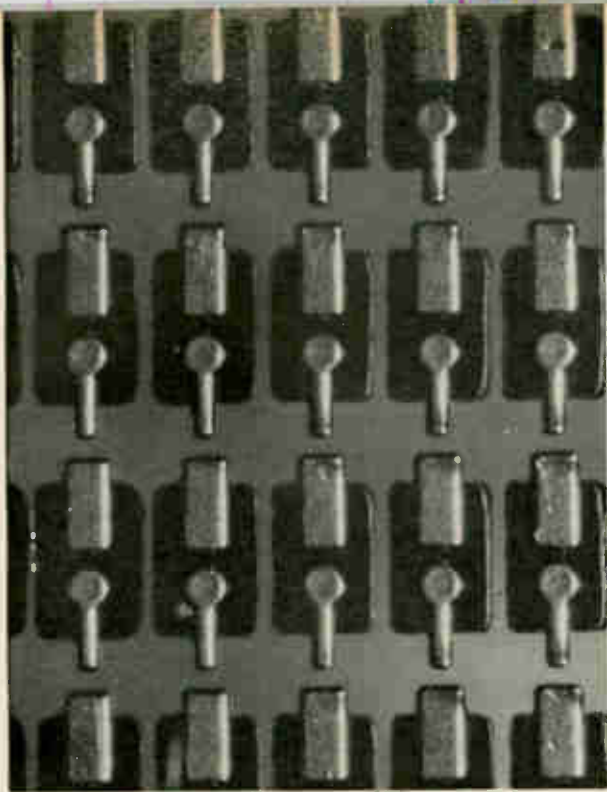

Each diode on this wafer—seen from above—weighs 100 micrograms. Diodes are manufactured by a batch process; assembly in equipment is readily automated.

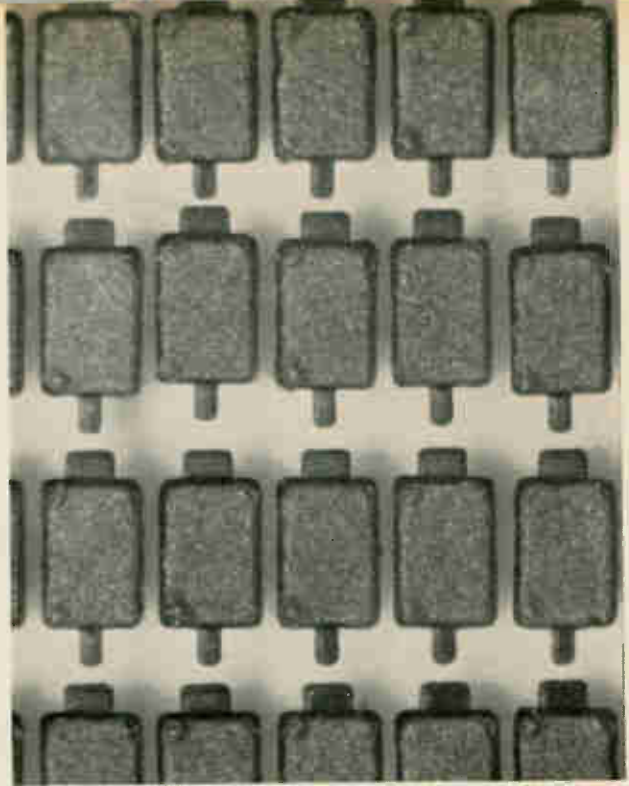

Diodes viewed from the bottom after separation. Each silicon chip measures 14 by 20 mils. For forward conduction, positive bias is applied to smaller terminals.

Solid state

Diode sheds its costly package with beam-lead construction

Silicon-dioxide insulation and corrosion-resistance gold leads provide protection without packaging. Production technique permits batch processing of silicon chips only 14 by 20 mils

By J. Earl Thomas Jr. and Alan S. Esbitt

General Instrument Corp., Newark, N.J.

A highly reliable diode, which requires no package and yet is completely protected from the environment, is being produced commercially. Because it is made with cantilevered gold leads, it is called a beam-lead diode [Electronics, Nov. 16, 1964, p. 114]. It is the first commercial product to incorporate the beam lead.

Its rugged construction, together with silicon-dioxide insulation throughout and a layer of metal shielding over the junction, assure high reliability. And the absence of a package permits low cost. The diode can be fabricated with almost any desired electrical characteristics and the manufacturing technique permits batch processing of sili-

con chips only 14 by 20 mils.

The General Instrument Corp. is manufacturing the diffused silicon diode under the trade name Herculeads. The company has a licensing agreement with Bell Telephone Laboratories, Inc., the research arm of the American Telephone & Telegraph Co. The beam-lead technique was invented by M. P. Lepselter¹ of Bell Labs.

The beam-lead diode consists of a diffused silicon pellet to which two relatively massive, electroformed gold bonding leads are attached, as shown in the drawing at the right. The lead connected to the silicon chip is wide to improve heat dissipation and the other lead is kept narrow to minimize electrical capacitance. The automatic handling equipment takes advantage of the size difference between the leads to line up the diode.

The total amount of gold used is so small that its cost is not an important factor in light of its advantages.

Fabrication of the diode

The manufacturer of the diode begins with an epitaxial n-type silicon wafer with a 1¼-inch diameter. Each wafer can produce about 1,600 diodes. First the wafers are oxidized, then p-type and n-type layers are deposited by diffusion through openings (windows) in the oxide layer. The procedure is similar to making planar transistors and monolithic integrated circuits. After the diffusion steps are completed, openings are made in the silicon dioxide where the ohmic contacts will be placed as shown by (A) in the diagram on page 79.

Next, a thin layer of a noble metal, such as palladium, platinum, silver or molybdenum, is deposited on the wafer. Then the wafer is heated to a critical temperature. The metal in contact with the silicon forms a low-resistance metallic compound (ohmic contact), but the heat does not affect the metal in contact with silicon dioxide. The metal on top of the dioxide is removed, leaving only bare silicon dioxide (B).

A thin layer of metal serving as an adherent bond, such as chromium or titanium, is deposited on the wafer. Apparently the metal chemically converts a fraction of the silicon dioxide to silicon. Next, a thick layer of noble metal is deposited on the wafer to provide the surface required for electroforming (C). This layer is the surface for the photoresist material.

Photoresist material is applied to the wafer, and the areas for the gold leads are defined. Two gold layers, each about 0.5 mil thick, are then deposited by electroplating in the open regions defined by the photoresist material (D).

Next, the photoresist material and the metal not protected by the gold are removed from the top surface. This completes the surface processing (E).

The dicing mask is then applied to the reverse side of the wafer and the areas for the individual chips are defined (F). All the silicon above the masked area is removed; this separates the diodes (G) and completes the processing.

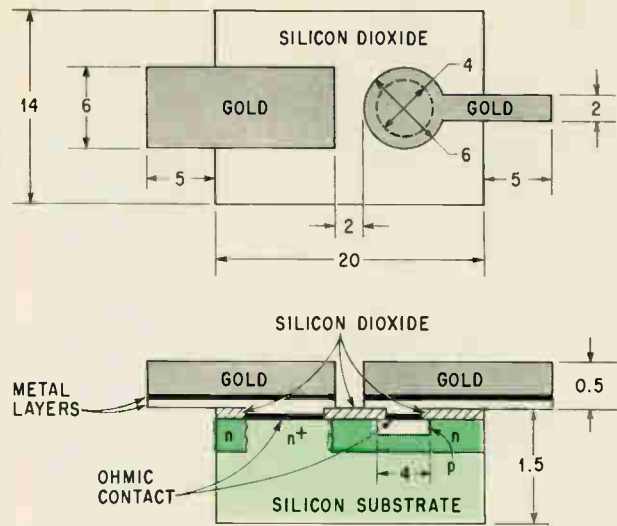

ALL DIMENSIONS IN MILS

Beam-lead diode gets its name from the gold leads which are shaped like beams. They are used for bonding to the circuit substrates. The construction eliminates solder or eutectic bonding to the chip or the circuit substrate, and expensive package materials.

Further advantages of beam-lead method

The beam-lead process offers many advantages besides reliability and economy, not only in the manufactured diodes, but of other devices such as transistors or integrated circuits. Because soldering and eutectic bonding are not needed, the process uses no plastic, solder or other materials unable to withstand high temperatures. Also eliminated are the expensive sodium-free glass and nonferrous metals—commonly required for glass-to-metal sealed diode packages—and aluminum. When aluminum is bonded to silicon, a failure known as purple plague can occur.

The small differences between the coefficients of expansion of the materials used are not significant enough to make thermal shock a serious factor. Differential expansion between the diode and the substrate, resulting from temperature variations, is compensated for by slight bending or stretching of the leads, which have the ductility of drawn gold wire.

The combination of metals used in the beam-lead diode do not form brittle or high-resistance alloys. And the shielding effect of the beam lead eliminates the degradation that sometimes appears in other package designs, caused by sodium contamination in the silicon with simultaneous exposure to reverse bias and high temperature.

What's in a name?

Privately, the engineers who developed the new beam-lead diode at the General Instrument Corp. call it a "Charlie Chaplin" diode. The engineers say the lead configuration resembles the famous heel-to-heel stance the comedian used in his portrayal of the little tramp. Company management, however, named the diode Herculeads for commercial use.

The structural design allows both batch fabrication of the diode and automated assembly of modules or printed boards. The large number of diodes used in the electronics industry dictates that new diode designs be tailored for automation.

The body of the Herculeads diode is only 14 by 20 mils; the distance from one lead tip to the other is only 30 mils. By comparison, a diode conforming to the Jecdec DO-7 outline dimensions has a body diameter of about 100 mils and is about 250 mils long, excluding the leads.

Automated production

In array applications, beam-lead diodes can be bonded face down directly to the circuit substrate. Face bonding [Electronics, Jan. 28, 1965, p. 68] protects the semiconductor device, eliminates lead wires, and is particularly suitable for automation. One disadvantage for conventional integrated circuits is the inability to inspect the bonds; this problem is avoided in beam-lead devices because the bonds are made beyond the silicon chip near the lead edges where they can be seen.

In the automated manufacture of the diode, batch processing is used from start to finish and almost any geometric arrangement of leads, chip shape and junction is possible. Because of the beam-lead diode's short cantilever structure, distortion of the leads during this automatic handling is negligible. Variations in the manufacturing process can be made quickly at low cost, usually by changing the photographic masks.

The diode geometry shown with this article is only one of several that have been developed.

Electrical characteristics

Herculeads diodes will be offered for sale with reverse breakdown ratings ranging from 30 to 300 volts. Beam-lead diodes with the electrical characteristics of any silicon diode can be made this way. A set of typical electrical specifications and a voltage current characteristic for the 45-volt diode is shown on page 81.

The typical reverse recovery time of four nanoseconds can be lowered still more by gold doping in the silicon to introduce recombination centers. A further reduction of recovery time can also be achieved by decreasing the size of the diode junction.

Bonding at room temperature

When the diode is to be bonded to lands or pads in a circuit, the maximum separation between bonding areas should be equal to the length of the silicon pellet—about 20 mils for the diodes described in this article—for good contact.

The gold leads can be satisfactorily bonded at room temperature with sufficient force to slightly deform the lead. Parallel-gap resistance heating and ultrasonic welding are excellent techniques for attaching the leads to land areas.

Preventing charge migration

In many semiconductor devices, operation at

Beam-lead diode production steps

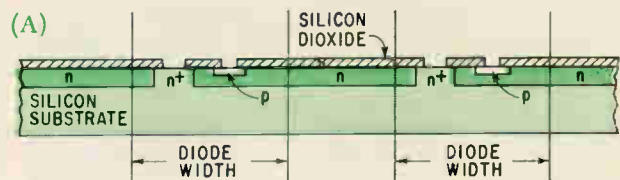

WINDOWS MADE

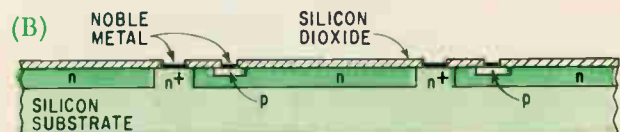

OHMIC CONTACTS FORMED

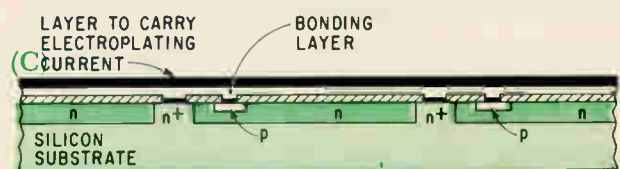

PREPARED FOR MASKING

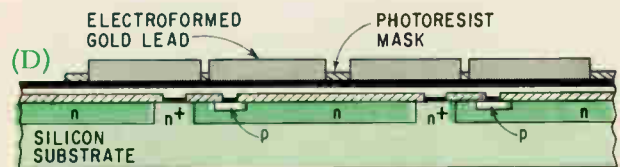

GOLD LEADS DEPOSITED

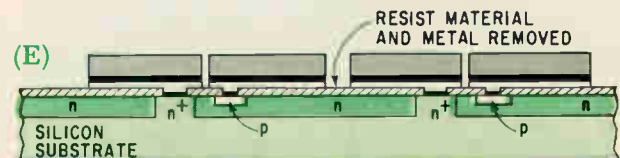

TOP SURFACE COMPLETED

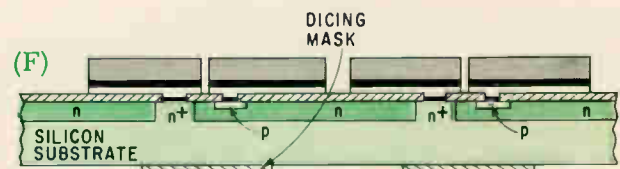

DICING MASK APPLIED



COMPLETED DIODES

Step-by-step views of the wafer during fabrication of beam-lead diodes. A wafer 1 1/4 inches in diameter can produce 1,600 diodes. Top view defines areas of wafer that are used for diodes. Remaining area between diodes is waste.



Research engineer Harry Bajars times the wafer metal bonding-layer deposition, accomplished by sputtering from a sheet cathode in a chamber containing argon.

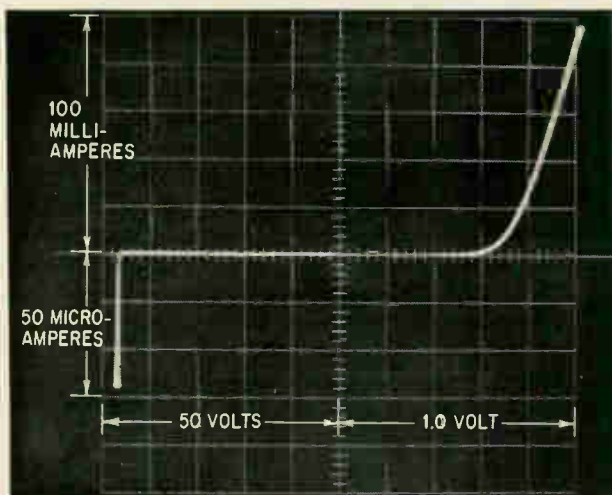

Sharp reverse-voltage breakdown for the beam-lead diode is shown by the trace at left. The trace at the right is for forward conduction. Scope calibration for the reverse quadrant is 10 μ /div. horizontal, 10μ a/div. vertical; for the forward quadrant, 0.2 v/div. horizontal, 20ma/div. Almost any standard silicon diode characteristic can be duplicated in a beam-lead device.

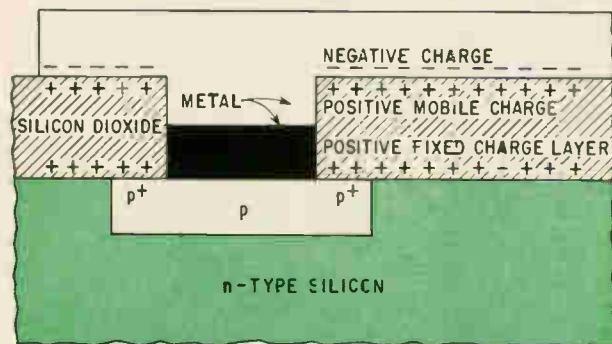

Metal shielding employed in the beam-lead structure nullifies the effects of positive charge migration. A check of 20 units after 1,500 hours of elevated-temperature operation showed no drift in the key characteristics.

high voltage and high temperature causes migration of electrical charges over the surface or in the interior of the silicon dioxide. This results in gradual changes in the electrical characteristics of the device. Humidity and radiation are two of the many causes which lead to charge migration. Characteristics adversely affected by charge migration include breakdown voltage, reverse saturation current, and junction capacitance. But migration can be prevented in the manufacturing process.

It becomes relatively easy to control the charge in the interior of the silicon dioxide because that charge always turns out to be positive.² Part of this positive charge appears to be a stationary layer located within a few atom layers of the silicon-silicon dioxide interface. The remaining portion of the internal positive charge is mobile. It is generally believed that the mobile portion of the positive charge results from contamination of the oxide by sodium, although there is some evidence that hydrogen ions are also involved.³

The positive charge in the oxide attracts mobile electrons in the silicon to the surface. The excess electron density will equal the positive charge density in the oxide. The surface of the silicon will then have a heavier electron concentration than the bulk of the silicon as a result of the normal n-type doping. Thus, electrical breakdown will occur on the surface at a voltage much lower than the normal bulk breakdown voltage of the diffused junction. For example, a junction designed to withstand 100 volts might actually break down with only 10 volts.

These difficulties can be overcome by reducing the mobile charge density, by attracting the mobile charge away from the silicon, and by nullifying the effect of the fixed charge layer. The first objective can be achieved by careful processing. The second and third objectives are accomplished by placing a metal layer in contact with the silicon dioxide layer. This metal layer completely bridges the junction and surrounding n-type semiconductor material, as in the illustration at the left.

The metal layer is electrically connected to the p-type region and thus, when biased, will be negative with respect to the silicon substrate. Under these conditions, at high temperature, positive mobile charges in the dioxide are attracted away from the silicon and toward the metal; thus, electrons in the metal and not in the silicon are attracted by the positive charge layer. The mobile charge thus becomes ineffectual. In addition, the electric field created by the biased metal layer overcomes the net electric field at the surface of the silicon and mobile electrons in the silicon are repelled from the surface. The effect of this process is to make the surface of the silicon seem less n-doped than the bulk silicon.⁴ Breakdown probably still occurs at the surface, but at a voltage nearly equal to the bulk breakdown voltage.

The harmful effects of charge migration on the outer surface of the silicon dioxide are also eliminated by the metal layer. Without the layer, such charges would change the electrical potential of the

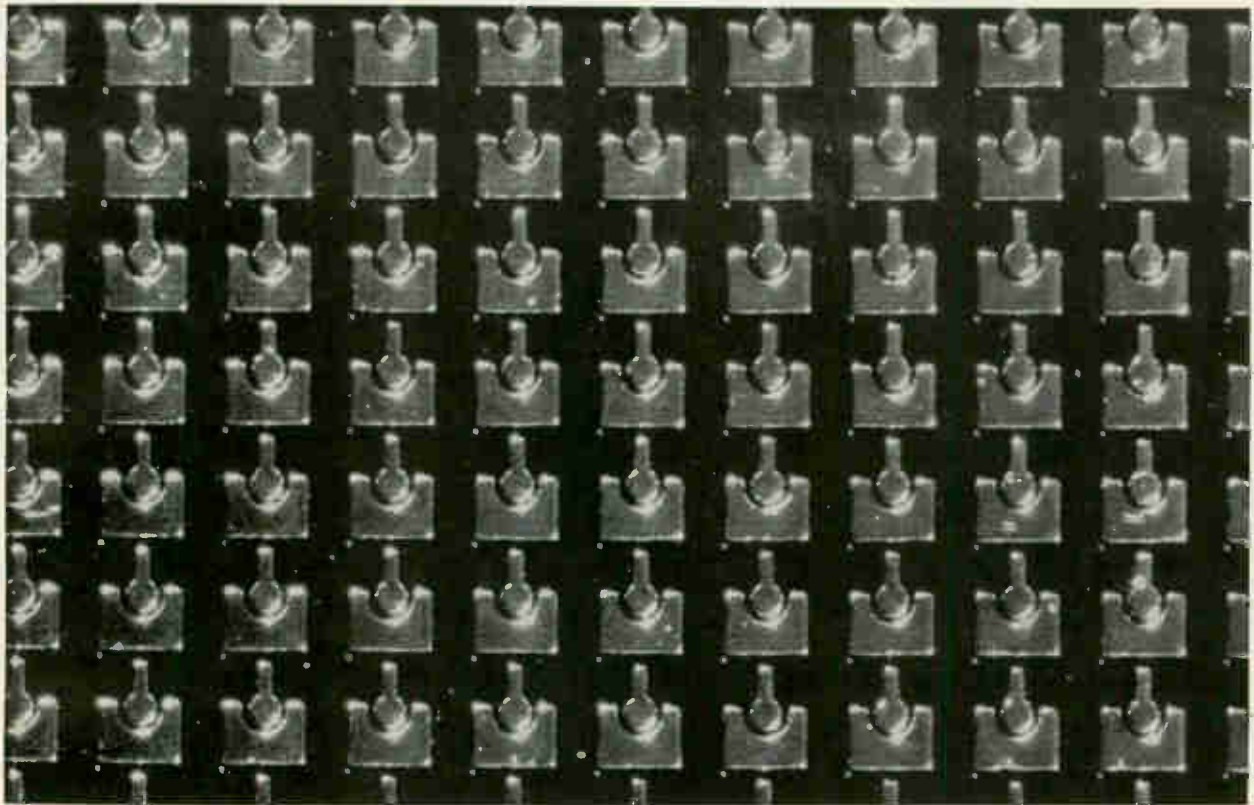

Tanks on parade? No, this is an enlargement of a wafer section showing an alternate construction for the beam-lead diode. The electrical characteristics from this construction match those of the diode described in this article. The diode leads are two mils apart.

outer oxide surface and cause drifts in diode characteristics from undesirable "field effects." With the metal layer, the surface of the oxide becomes equipotential and the effects of charges on the outer surface are nullified.

No failures in 1,500 hours

Twenty units have been tested for 1,500 hours at 55°C with a reverse voltage of 30 volts applied. No failures occurred; more significantly, there were no detectable changes in forward voltage drop, reverse leakage current or breakdown voltage for the 20 units. Additional units have been stored at temperatures up to 400°C without being damaged.

The strength of the bonds between the two gold beams and the silicon chip contributes to the diode's reliability. When force is applied to diodes bonded to a circuit board or module, the leads tear before the gold-to-silicon bonds give way. Beam-lead diode assemblies should withstand 100,000 g's of impact shock without rupturing the bonds or impairing electrical performance.

Electrical characteristics

Peak reverse voltage	45 volts
Reverse leakage current at 25 volts	0.8 na
Forward current at 1 volt	90 ma
Capacitance at zero bias	2.2 pf
Reverse recovery time, 10-ma forward current to 40 volts reverse voltage	4 nsec

References

1. M.P. Lepselter and R.W. McDonald, "Beam-lead Devices," IEEE Electron Devices Meeting, Washington, D.C., Oct. 29, 1964.
2. J.E. Thomas, Jr. and D.R. Young, "Space-Charge Model for Surface Potential Shifts in Silicon Passivated with Thin Insulating Layers," IBM Journal of Research and Development, Vol. 8, p. 368.
3. S.R. Hofstein, "An Investigation of Instability and Charge Motion in Metal-Silicon Oxide-Silicon Structures," to be published in IEEE Transactions on Electron Devices, February, 1966.
4. P.P. Castrucci and J.S. Logan, "Electrode Control of SiO₂ Passivated Planar Junctions," IBM Journal of Research and Development, Vol. 8, p. 394.

The authors



J. Earl Thomas Jr. joined the General Instrument Corp. in 1964 as a corporate new products manager and technical adviser to the president. Previously, he served as director of research and engineering for Sylvania Electric Products, Inc., and as solid state development manager at the International Business Machines Corp.'s components division.



Alan S. Esbitt, who holds a doctorate degree in physical chemistry from Harvard University, is the director of research at General Instrument's Applied Research Laboratory. He heads the company's developmental program for beam-lead devices, and is also responsible for thin-film and materials processing research.

A design advance

Broadest line of standard silicon modular power supplies for fixed voltage applications

UP TO 60 VDC • UP TO 90 AMPS

Features and Data

Meet Mil. Environment Specs.

RFI—MIL-I-16910

Vibration: MIL-T-4807A

Shock: MIL-E-4970A • Proc 1 & 2

Humidity: MIL-STD-810 • Meth. 507

Temp. Shock: MIL-E-5272C • (ASG) Proc. 1

Altitude: MIL-E-4970A • (ASG) Proc. 1

Marking: MIL-STD-130

Quality: MIL-Q-9858

Convection cooled—no heat sinking or forced air required

Wide input voltage and frequency range—105-132 VAC, 45-440 cps

Regulation (line) 0.05% plus 4mV
(load) 0.03% plus 3mV

Ripple and Noise—1mV rms, 3mV p to p

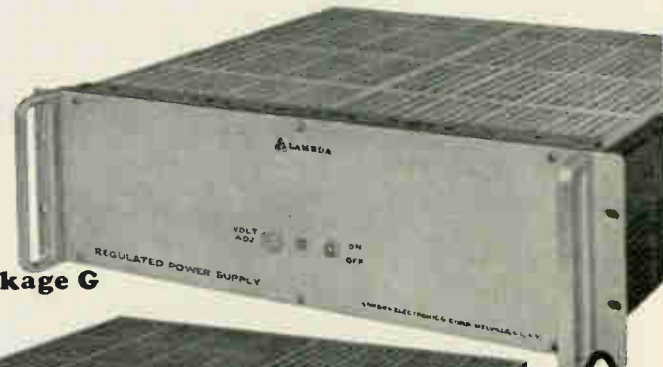

Package G



Package F



Package E



Package D



Package C



Package B



Package A



RACK ADAPTERS



LRA-5—3½" height by 2⅞" depth.
Mounts up to 4 A package sizes;
3 B or C package sizes; or 2 A and 1 B or
C package sizes. Price \$35.00

LRA-4—3½" height by 14" depth.
(For use with chassis slides)
Mounts up to 4 A package sizes; 3 B or C
package sizes; or 2 A and 1 B or C
package sizes. Price \$55.00

LRA-3—5¼" height by 2⅞" depth.
Mounts up to 4 A, B or C package sizes;
2 D or 2 E packages sizes; or 2 A, B or C
and 1 D or 1 E package sizes. Price \$35.00

LRA-6—5¼" height by 14" depth.
(For use with chassis slides)
Mounts up to 4 A, B or C package sizes;
2 D or 2 E packages sizes; or 2 A, B or C
and 1 D or 1 E package sizes. Price \$60.00

PATENTS PENDING

Circle 82 on reader service card



LAMBDA ELECTRONICS CORP.
515 BROAD HOLLOW ROAD • MELVILLE, L. I., NEW YORK • 516 MYRTLE 4-4200

from Lambda

Ordering Information

METERS— $3\frac{1}{2}$ " Metered panel MP-3 is used with rack adapters LRA-4, LRA-5 and packages A, B and C.

$5\frac{1}{4}$ " Metered panel MP-5 is used with rack adapters LRA-6, LRA-3 and packages A, B, C, D and E.

To order these accessory metered panels, specify panel number which MUST BE FOLLOWED BY THE MODEL NUMBER of the power supply with which it will be used.

Examples For Lambda Panel Model No. Metered Panels Model and Price
 MP-3 LM-B2 MP-3-LM-B2 \$40
 MP-5 LM-B2 MP-5-LM-B2 \$40

Note—F and G LM Packages are full rack power supplies available metered or non-metered. For metered

OVERVOLTAGE PROTECTION—Externally mounted adjustable crowbar type overvoltage protection accessory for use with A, B, C and D packages—\$25.

E, F and G packages available with built-in overvoltage protection. To order crowbar type overvoltage protection for E, F and G packages, add suffix OV to the model no. and \$60 to the E package price and \$90 to the F and G package price.

FIXED VOLTAGES—In addition to the fixed voltages listed, any fixed voltage is available up to 65 VDC at moderate surcharge.

models, add suffix M to the Model No. and \$30 to the non-metered price.

Package A $3\frac{1}{16}$ " x $3\frac{3}{4}$ " x $6\frac{1}{2}$ "



Accessory Metered Panels: \$40.00

Model	ADJ. VOLT. RANGE VDC	I MAX. AMPS ¹				Price
		40°C	50°C	60°C	71°C	
LM-201	0-7	0.85	0.75	0.70	0.55	\$ 79
LM-202	0-7	1.7	1.5	1.4	1.1	99
LM-203	0-14	0.45	0.40	0.38	0.28	79
LM-204	0-14	0.90	0.80	0.75	0.55	99
LM-205	0-32	0.25	0.23	0.20	0.15	79
LM-206	0-32	0.50	0.45	0.40	0.30	99
LM-207	0-60	0.13	0.12	0.11	0.08	89
LM-208	0-60	0.25	0.23	0.21	0.16	109

Package B $3\frac{1}{16}$ " x $4\frac{1}{16}$ " x $6\frac{1}{2}$ "



Accessory Metered Panels: \$40.00

Model	ADJ. VOLT. RANGE VDC	I MAX. AMPS ¹				Price
		40°C	50°C	60°C	71°C	
LM-217	8.5-14	2.1	1.9	1.7	1.3	\$119
LM-218	13-23	1.5	1.3	1.2	1.0	119
LM-219	22-32	1.2	1.1	1.0	0.80	119
LM-220	30-60	0.70	0.65	0.60	0.45	129
LM-B2	2-5%	3.4	3.0	2.3	1.4	119
LM-B3	3-5%	3.4	3.0	2.3	1.4	119
LM-B4	4-5%	3.4	3.0	2.3	1.4	119
LM-B4P5	4.5-5%	3.3	2.9	2.2	1.4	119
LM-B5	5-5%	3.3	2.9	2.2	1.4	119
LM-B6	6-5%	3.2	2.8	2.2	1.3	119
LM-B8	8-5%	3.0	2.7	2.2	1.3	119
LM-B9	9-5%	2.7	2.5	2.1	1.3	119
LM-B10	10-5%	2.6	2.4	2.1	1.3	119
LM-B12	12-5%	2.4	2.3	2.1	1.3	119
LM-B15	15-5%	2.1	1.9	1.7	1.2	119
LM-B18	18-5%	1.8	1.6	1.5	1.2	119
LM-B20	20-5%	1.6	1.4	1.3	1.1	119
LM-B24	24-5%	1.3	1.2	1.1	1.0	119
LM-B28	28-5%	1.2	1.1	1.0	0.90	119
LM-B36	36-5%	1.1	1.0	0.90	0.85	129
LM-B48	48-5%	0.90	0.85	0.80	0.75	129

Package C $3\frac{1}{16}$ " x $4\frac{1}{16}$ " x $9\frac{1}{2}$ "



Accessory Metered Panels: \$40.00

Model	ADJ. VOLT. RANGE VDC	I MAX. AMPS ¹				Price
		40°C	50°C	60°C	71°C	
LM-225	0-7	4.0	3.6	3.0	2.4	\$139
LM-226	8.5-14	3.3	3.0	2.5	2.0	139
LM-227	13-23	2.3	2.1	1.7	1.4	139
LM-228	22-32	2.0	1.8	1.5	1.2	139
LM-229	30-60	1.1	1.0	0.80	0.60	149
LM-C2	2-5%	4.9	4.2	3.5	2.4	139
LM-C3	3-5%	4.9	4.2	3.5	2.4	139
LM-C4	4-5%	4.9	4.2	3.5	2.4	139
LM-C4P5	4.5-5%	4.9	4.2	3.4	2.4	139
LM-C5	5-5%	4.8	4.1	3.3	2.4	139
LM-C6	6-5%	4.6	4.0	3.1	2.4	139
LM-C8	8-5%	4.4	3.8	3.0	2.0	139
LM-C9	9-5%	4.2	3.6	3.0	2.0	139
LM-C10	10-5%	4.0	3.5	2.9	2.0	139
LM-C12	12-5%	3.8	3.3	2.8	2.0	139
LM-C15	15-5%	3.4	3.2	2.7	1.8	139
LM-C18	18-5%	3.0	2.8	2.5	1.7	139
LM-C20	20-5%	2.9	2.7	2.4	1.7	139
LM-C24	24-5%	2.5	2.4	2.2	1.5	139
LM-C28	28-5%	2.3	2.1	2.0	1.4	139
LM-C36	36-5%	2.0	1.8	1.7	1.3	149
LM-C48	48-5%	1.6	1.4	1.3	1.0	149

Package D $4\frac{1}{16}$ " x $7\frac{1}{4}$ " x $9\frac{1}{2}$ "



Accessory Metered Panels: \$40.00

Model	ADJ. VOLT. RANGE VDC	I MAX. AMPS ¹				Price
		40°C	50°C	60°C	71°C	
LM-234	0-7	8.3	7.3	6.5	5.5	\$199
LM-235	8.5-14	7.7	6.8	6.0	4.8	199
LM-236	13-23	5.8	5.1	4.5	3.6	209
LM-237	22-32	5.0	4.4	3.9	3.1	219
LM-238	30-60	2.6	2.3	2.0	1.6	239
LM-D2	2-5%	13.1	11.3	9.2	6.2	199
LM-D3	3-5%	13.1	11.3	9.2	6.2	199
LM-D4	4-5%	13.1	11.3	9.2	6.2	199
LM-D4P5	4.5-5%	13.1	11.3	9.2	6.2	199
LM-D5	5-5%	12.6	10.8	9.2	6.1	199
LM-D6	6-5%	12.4	10.6	8.9	6.0	199
LM-D8	8-5%	12.2	10.3	8.8	5.9	199
LM-D9	9-5%	11.3	10.0	8.6	5.7	199
LM-D10	10-5%	10.8	9.7	8.5	5.7	199
LM-D12	12-5%	10.0	9.2	8.3	5.7	199
LM-D15	15-5%	9.0	8.4	7.9	5.3	209
LM-D18	18-5%	7.9	7.4	6.9	5.0	209
LM-D20	20-5%	7.4	6.9	6.5	4.9	209
LM-D24	24-5%	6.7	6.3	5.8	4.8	219
LM-D28	28-5%	6.0	5.6	5.2	4.7	219
LM-D36	36-5%	5.4	5.0	4.7	4.3	239
LM-D48	48-5%	4.1	3.9	3.6	3.1	239

Package E $4\frac{1}{16}$ " x $7\frac{1}{4}$ " x $11\frac{1}{2}$ "

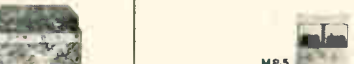

Accessory Metered Panels: \$40.00

Model	ADJ. VOLT. RANGE VDC	I MAX. AMPS ¹				Price
		40°C	50°C	60°C	71°C	
LM-E2	2-5%	18.0	16.0	15.0	10.0	\$269
LM-E3	3-5%	18.0	16.0	15.0	10.0	269
LM-E4	4-5%	17.0	16.0	15.0	10.0	269
LM-E4P5	4.5-5%	16.0	15.0	14.0	10.0	269
LM-E5	5-5%	16.0	15.0	13.0	10.0	269
LM-E6	6-5%	15.0	14.0	12.0	10.0	269
LM-E8	8-5%	14.0	13.0	12.0	9.5	269
LM-E9	9-5%	13.5	12.5	11.0	9.5	269
LM-E10	10-5%	13.0	12.0	10.0	9.2	269
LM-E12	12-5%	12.0	11.0	9.5	9.0	269
LM-E15	15-5%	11.0	10.0	9.0	8.5	269
LM-E18	18-5%	10.5	9.5	8.5	8.1	269
LM-E20	20-5%	10.0	9.0	8.3	7.7	269
LM-E24	24-5%	9.0	8.5	7.7	7.0	269
LM-E28	28-5%	8.5	8.0	7.3	6.6	269
LM-E36	36-5%	6.8	6.3	5.9	5.2	279
LM-E48	48-5%	5.0	4.6	4.3	3.9	299

Package F $3\frac{1}{2}$ " x 19 " x $16\frac{1}{2}$ "



For metered models, add suffix (M) to model number and \$30.00 to the price below

Model	ADJ. VOLT. RANGE VDC	I MAX. AMPS ¹				Price
		40°C	50°C	60°C	71°C	
LM-F2	2-5%	44.0	39.0	32.0	24.0	\$425
LM-F3	3-5%	44.0	39.0	32.0	24.0	425
LM-F4	4-5%	44.0	39.0	32.0	24.0	425
LM-F4P5	4.5-5%	44.0	39.0	32.0	24.0	425
LM-F5	5-5%	44.0	38.0	31.0	24.0	425
LM-F6	6-5%	43.0	37.0	30.0	23.0	425
LM-F8	8-5%	40.0	34.0	28.0	22.0	425
LM-F9	9-5%	38.0	32.0	26.0	21.0	425
LM-F10	10-5%	36.0	31.0	25.0	20.0	425
LM-F12	12-5%	30.0	26.0	21.0	16.0	425
LM-F15	15-5%	25.0	22.0	18.0	15.0	425
LM-F18	18-5%	23.0	20.0	17.0	13.0	395
LM-F20	20-5%	21.0	19.0	16.0	12.0	395
LM-F24	24-5%	18.0	16.0	13.0	10.0	380
LM-F28	28-5%	17.0	15.0	13.0	9.5	380
LM-F36	36-5%	13.0	11.0	10.0	7.5	395
LM-F48	48-5%	10.0	9.0	7.5	6.0	425

Package G $5\frac{1}{4}$ " x 19 " x $16\frac{1}{2}$ "



For metered models, add suffix (M) to model number and \$30.00 to the price below

Model	ADJ. VOLT. RANGE VDC	I MAX. AMPS ¹				Price
		40°C	50°C	60°C	71°C	
LM-G2	2-5%	90.0	83.0	62.0	43.0	\$575
LM-G3	3-5%	85.0	80.0	62.0	43.0	575
LM-G4	4-5%	77.0	71.0	61.0	43.0	575
LM-G4P5	4.5-5%	72.0	68.0	60.0	43.0	575
LM-G5	5-5%	68.0	64.0	59.0	43.0	575
LM-G6	6-5%	60.0	55.0	52.0	43.0	525
LM-G8	8-5%	59.0	54.0	48.0	39.0	525
LM-G9	9-5%	58.0	53.0	47.0	37.0	525
LM-G10	10-5%	56.0	52.0	44.0	35.0	525
LM-G12	12-5%	48.0	44.0	37.0	29.0	525
LM-G15	15-5%	39.0	37.0	31.0	24.0	525
LM-G18	18-5%	32.0	30.0	27.0	21.0	525
LM-G20	20-5%	30.0	28.0	25.0	20.0	525
LM-G24	24-5%	27.0	25.0	20.0	16.0	480
LM-G28	28-5%	25.0	23.0	19.0	15.0	480
LM-G36	36-5%	22.0	20.0	16.0	13.0	525
LM-G48	48-5%	17.0	14.0	12.0	9.0	575

¹ Current rating is from zero to I max. Current rating applies over entire output voltage range. Current rating applies for input voltage 105-132 VAC 55-65 cps. For operation at 45-55 cps and 360-440 cps derate current rating 10%.

Belting out plastic transistors on mechanized assembly lines

Strip-bonding transforms the packaging of semiconductor devices into a low-cost, continuous operation. Already adapted to transistors and rectifiers, the assembly-line method may soon be used for monolithic circuits

By George Sideris

Manufacturing Editor

A continuous-belt concept of manufacturing has enabled the General Electric Co. to triple its transistor production and to reduce the price to as low as 15 cents.

Essentially, GE converts silicon planar-device dice, or chips, into a continuous belt that flows through several mechanized production steps, diagramed on page 86, before the belt is cut apart into individual devices that are encapsulated in epoxy plastic. GE has sold more than 100 million of these "plastic" transistors.

The same basic method was adapted last summer to the production of 35-cent silicon controlled rectifiers. General Electric now plans to adapt it to the manufacture of low-cost power transistors.

Although the belt concept was adopted three years ago for the production of low-power transistors, details were kept secret until now. It was known that GE had substituted a molded-plastic package for a prefabricated metal package, but company engineers say the economies effected by this substitution are surpassed by those resulting from the strip assembly. The techniques were kept proprietary because of intense competition in the industrial and consumer electronics markets for low-cost transistors.

The belt method is simple and versatile, and can be adapted to the production of other semiconductor components. Although GE has not disclosed plans beyond the transistors and scr's, the concept seems suitable for mass-producing low-profile, microminiature transistors, special assemblies of transistors and diodes, and monolithic integrated circuits.

From the inside out

When GE set out in 1962 to mechanize transistor

production, its engineers redesigned the package so it could be built outward from the silicon chip, rather than putting the chip into a prefabricated package. First the chips are mounted on a metal strip, a belt-like structure that virtually eliminates the piece-by-piece handling of device parts; such handling has characterized semiconductor production for 15 years. The strip approach also permits the same production equipment to assemble different types of components.

Almost identical procedures and the same equipment produce more than 50 types of transistors at the main plant of GE's Semiconductor Products Dept. in Syracuse, N. Y. Modified equipment produces the controlled rectifiers at the department's plant in Auburn, N. Y.

GE says the strip approach solves most problems of parts-orientation and handling that often required either a large amount of hand assembly, or mechanization that required elaborate, expensive and obsolescence-prone equipment.

The GE production machines are relatively simple.

Starting the strip

The strip and a unique carrying and machine-loading tool—the magnetic drum shown in the photographs—transfer the parts during lead bonding, header-mounting, thermal aging, quality control inspection and other steps preceding final packaging.

For transistors, the strip is gold-plated Kovar foil about 50 mils wide. It is prepared for chip bonding with the machine shown on page 87.

The machine takes bare strip from the spool at the left, draws it through forming and welding stations, and rewinds it on the spool at the right.



Magnetic drum carries more than 1,000 transistor chips on a single strip of Kovar foil. It loads and unloads production machines, is a processing fixture and, as shown above, makes visual inspection of unpackaged devices a rapid procedure. The little studs on the drum's inner circumference are ferrite magnets which hold the strip.

At the forming station, a die makes a dimple in the strip at regular intervals. The dimple is an indexing guide for the other machines. Solder preforms of gold-antimony are welded midway between the dimples. The preforms, which are used later to bond the chips to the strip, are sheared from a 25-mil-wide foil of gold drawn from the spool above the welding station.

At a second machine (see p. 87), the chips are bonded to the strip. The strip is drawn off a spool and indexed so each preform pauses momentarily in front of the machine operator. Through a stereoscopic microscope she looks at chips loaded on a freely movable stage, whose underside is on a greased flat. She moves the stage with one hand, to align one chip at a time with an alignment reticle in the microscope. A vacuum-pickup needle, moving at the indexing rhythm, picks up the aligned chip and places it on the preform on the strip.

Meanwhile the strip has been moving over a heater, which raises the preform temperature to the level required to alloy-bond the bottom of the silicon chip to the gold preform. Then the strip moves on, the temperature is reduced to set the bond, and the strip is spirally wound on a magnetic drum.

Any side is up

To minimize the amount of chip orientation required during chip and lead bonding, the device's electrode patterns are made concentric whenever possible. All the standard designs now used by GE are pictured on page 89.

Three "nonoriented" configurations are shown in the left-hand row of photographs. The top design is primarily used for small-signal amplifiers operating at frequencies of audio to 30 megacycles per second; the center design is for high-speed switches;

OPERATING SEQUENCE

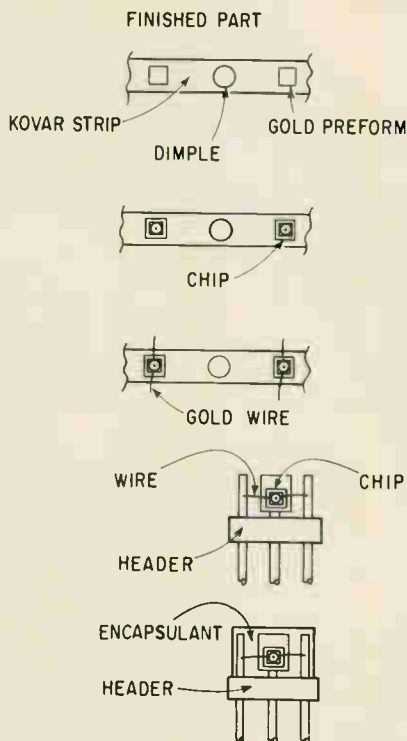

Strip preparation and packaging steps are (from top): formation of indexing dimple and welding gold-solder preform, bonding chip to strip with preform, bonding leads, welding tab to header and encapsulating transistor with epoxy.

and the bottom design is for high-frequency amplifiers and oscillators operating at up to 100 Mc. Thirty-four types of transistors are made with these designs—20 types with the first design alone.¹

Because these designs have no top or bottom, and no left side or right side, it is immaterial which edge or which corner of the chip faces the operator of the bonding machine.

The right-hand row of designs in the photographs on page 89 do require a specific orientation. All but the bottom design are used for high-frequency amplifiers and oscillators, up to 950 Mc. The bottom design is for large-signal amplifiers and medium-speed switches.

All-purpose magnetic drum

The magnetic drum has so many functions that some GE engineers call it the heart of the technique. It is a protective carrier, machine input and output, thermal processing fixture, inspection fixture as shown on the preceding page, and an aid to parts storage and inventory control. The strip on a fully wound drum carries more than 1,000 transistors.

The drum is made of Kovar for two reasons. First, using the same material as the strip prevents the physical stress to which the devices would be subject during thermal processing if the strip and drum expanded or contracted at different rates when heated and cooled. Second, because Kovar is a magnetic alloy of iron, nickel and cobalt, magnetizing the drum allows the strip to be held on the drum by magnetism alone. Mechanical hold-downs,

which would require more complicated tooling and could damage the devices, are unnecessary. The strip winds and unwinds easily, cannot fall off, and doesn't slide around; falling or sliding could damage the fine gold lead wires.

The magnetic force is supplied by the stud-like objects inside the drum. These are ferrite rod magnets arranged in a pattern corresponding to the spiral winding of the strip.

Bonding simplified

For conventional thermocompression bonding of base and emitter lead wires, the wire is fed through a capillary tube which also presses the wire end against the chip to make the bond. If the wire breaks—a frequent occurrence with one-mil gold wire—bonding must stop while the bonding tool is rethreaded. Also, the operator usually bonds one lead at a time to the chip and a package header, then cuts the wire and repeats the sequence. That requires eight motions by the machine or operator, and five positioning decisions. The sequence is as follows: orienting the header, placing and bonding the wire end on the chip electrode, placing and bonding wire on header pin, cutting, repeating and removing the header.

GE reduces these eight motions to seven simpler ones, and the five decisions to three, by establishing orientation beforehand and by cutting and positioning both wires simultaneously. Feeding, positioning and bonding are done with three different tools instead of one, but by a single operator.

The strip is fed to the bonding station from a magnetic drum in the bonding machine shown at the right. As the strip comes off the drum, it moves over the bonding stage and is rewound on the same drum.

As each chip comes into position on the bonding stage, the machine draws gold wire off a spool and grasps the wires with two pairs of tweezers. The wire is cut so that each pair of tweezers holds a small length of wire. The operator manipulates the tweezers so that the adjacent ends of the two wires drop downward and contact the base and emitter electrodes on the chip. A wedge-shaped thermocompression bonding tool, controlled by the operator, bonds the wire ends to the chip.

The motions performed automatically are: index strip, draw wire, grasp wire, cut wire. Manual motions are: depress wire, bond, bond. Operator decisions are: position wire ends, position bonder twice. The distance between the wire ends when they touch the chip can be adjusted by changing the tweezer rotation.

The strip-to-header weld

After aging, the strip is cut apart at the index dimples and the Kovar, which has now become the collector lead, is welded to the center pin as shown on page 90.

Headers usually have pins projecting slightly from a flat surface on which the device is mounted. GE's header has three long, straight pins made of

Chip and lead bonding machines

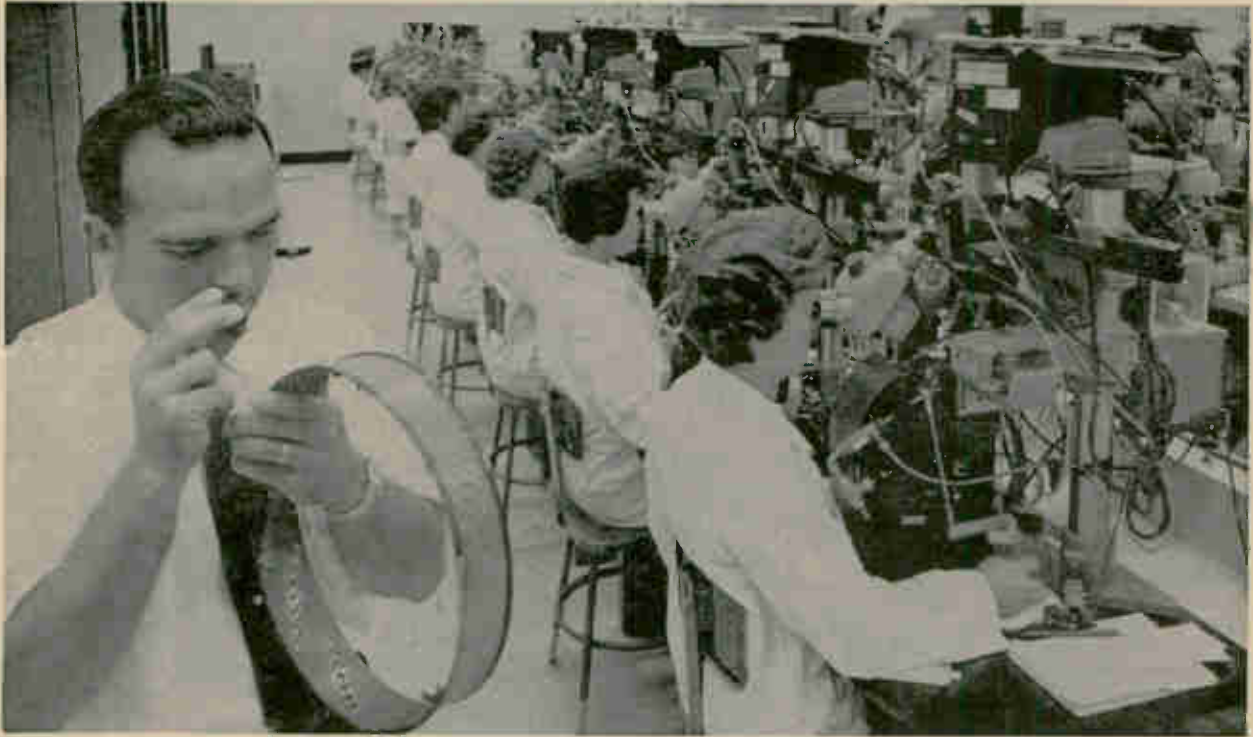

Drumfull of transistors is given a spot check (left) after lead bonding. The lead-bonding machines are at right



Leads, grasped by two pairs of tweezers, are placed on the chip and bonded by the tool above the tweezers.

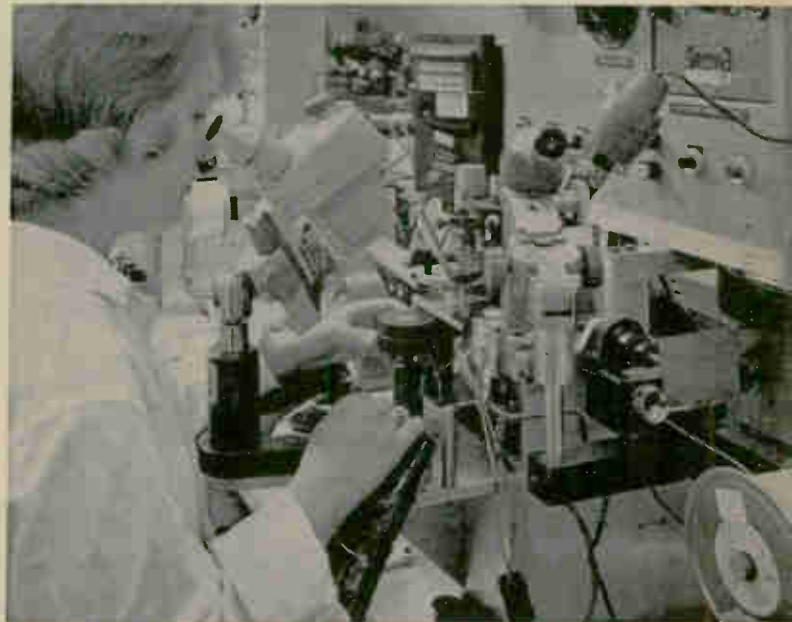

Chips are bonded to the strip at the machine above. The strip comes off the spool at right, is heated to alloy the gold on the strip and the underside of the silicon chip, and is wound on a magnetic drum. The photograph at the right is a close-up of the chip pickup.



Strip preparation machine draws Kovar from a spool, forms index dimples and welds on gold solder preforms. The welder is in front of the microscope.



tin-plated Dumet (copper-clad steel) wires fixed in an epoxy disk. The leads are lined up in a plane, an arrangement that extends the conveyor-belt concept through the finishing operations. The leads ride between stations in slotted tracks, such as the track between the header feed bowl and the welding station in the photo on page 90.

The welding machine draws the strip from a magnetic drum, welds it to the collector pin—the center pin—then shears the strip and passes the header on to thermocompression bonders. The bonders automatically form the gold leads against the base and emitter pins and bond them. The machine then loads the headers into a slotted fixture.

Transistor molding

For encapsulation, the headers are inserted manually into vulcanized rubber molds. The headers are placed upside down in D-shaped cavities, with the flat side behind the dice. The flat side is used for orientation during GE's finishing and testing, and during assembly of circuits in the user's plant.

The header leads are aligned and the molds inverted and placed in a molding fixture. Now the molds look like cupcake trays, with several rows of 20 cavities each. The cavities are filled, one row at a time, with liquid epoxy. Excess epoxy is cleared from the mold with a wiper blade and the epoxy is cured in an oven.

On the line that produces silicon controlled rectifiers the molding operation has been mechanized by a change to transfer molding; molding will also be mechanized for power-transistor production.

Testing and quality control

The transistors are tested and classified automatically. They are positioned in the test system by means of the flat side of the package body. The leads slide between three pairs of copper plates, which form the test contacts; this avoids the necessity of inserting the leads down into test sockets.

The package bodies are marked with type numbers and the customers' color codes. The marking machine can also form and trim the leads to duplicate the triangular lead arrangement of conventional TO-5 and TO-18 packages.

Before the final test, the transistors are subjected to three inspections and numerous sampling tests by the quality-control department. All dice are tested and inspected before the chips are bonded. After lead bonding, an inspector looks at the strips to detect misplaced or missing wires, missing chips, deformed chips or inadequate bonding (see photo on p. 85). Before encapsulation, the header assemblies are checked for similar defects, chip or header damage, and for shorted or open leads.

Machine and manual processes are monitored by having the quality-control staff check periodically on such conditions as weld strength, weld positions, preform-to-chip bonding, chip damage, lead alignment, and voids or other flaws in the encapsulation.

The quality-control procedures are more extensive than those followed in conventional manufacturing of transistors, because so much of the process is mechanized. In addition to the usual processing, electrical and environmental testing, the quality-control staff must provide data for continual control

Mechanization vs. cheap labor

The General Electric Co. developed its Economy Line transistors to meet price competition for the quality of devices desired by United States manufacturers of consumer and industrial electronics equipment.

In 1962 the price was being set by Japanese manufacturers, who had the advantage of low-cost assembly by hand. If production in the United States was to remain profitable, GE decided, either production would have to be mechanized, or packaging operations would have to be moved to an area of cheap labor, such as Hong Kong.

Why silicon was chosen

GE's manufacturing engineers decided to use known processes more efficiently. From this decision came the development of the strip method for making silicon planar devices; the method is described in this article.

Silicon was chosen over germanium—a popular material for low-cost devices—because silicon offered performance and production advantages. The silicon-planar chip con-

figurations were compatible with the conveyor-belt concept of bonding, and the protective coating—the passivation layer formed by oxidation of the silicon during planar processing—allowed the package to be formed of molded epoxy. The other materials of the package have been standard in component production for years.

The package's new design resulted from analysis of the labor costs in conventional transistor packaging. With this method, the chip was bonded to the base of a package header; the transistors had to be handled as individual units during subsequent processing and testing. The handling and orientation at each step required hand labor, or transfer mechanisms and tooling.

GE still uses people and machinery, but both have easier jobs that can be done more quickly because the orientation and transfer functions are built into the strip and package. The bonding-machine operators, for example, are concerned only with bonding, not header handling, and the machines only have to move a uniform strip, not devices whose geometry and orientation may vary.

Transistors by the pound

As a result, GE says, its transistor output has been boosted to double or triple the output of conventional manufacturing facilities. Production can be converted from one type of transistor to another by changing the type of device chips fed into the line; this allows large orders to be filled quickly without maintaining a big inventory of finished transistors.

These types of transistors are generally sold in large lots. In fact, GE has stopped counting out transistors to fill large orders; after a lot is approved by the quality-control department, the transistors are shipped in boxes, by the pound.

GE's transistors now go into most of the automobile radios produced in the United States, and into stereo phonographs, portable television sets, computers, communication and other equipment, the company says. The "plastic" transistors are also being considered for many military applications, according to GE, although most military specifications call for hermetically sealed devices that can withstand extreme temperature and humidity.

Chip patterns reduce bonding problems

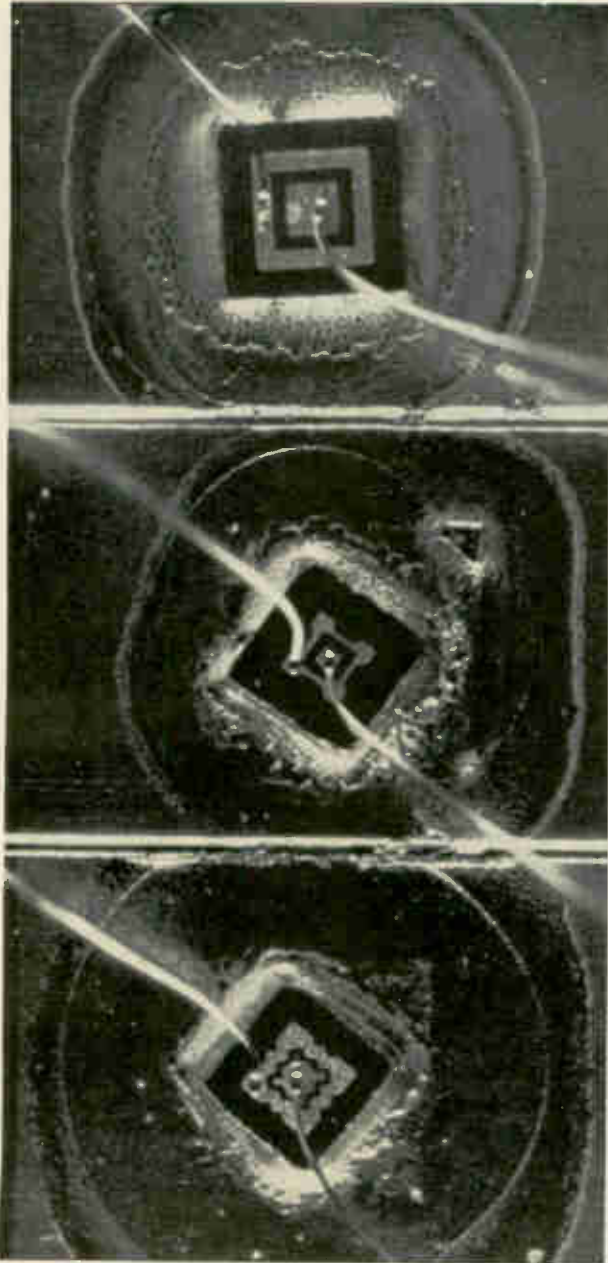

Chip geometries of the nonoriented type. Emitter leads are bonded to the center pattern; base leads can be bonded to any side of the outer square in the first design and to any of the outer corners in the second two designs.

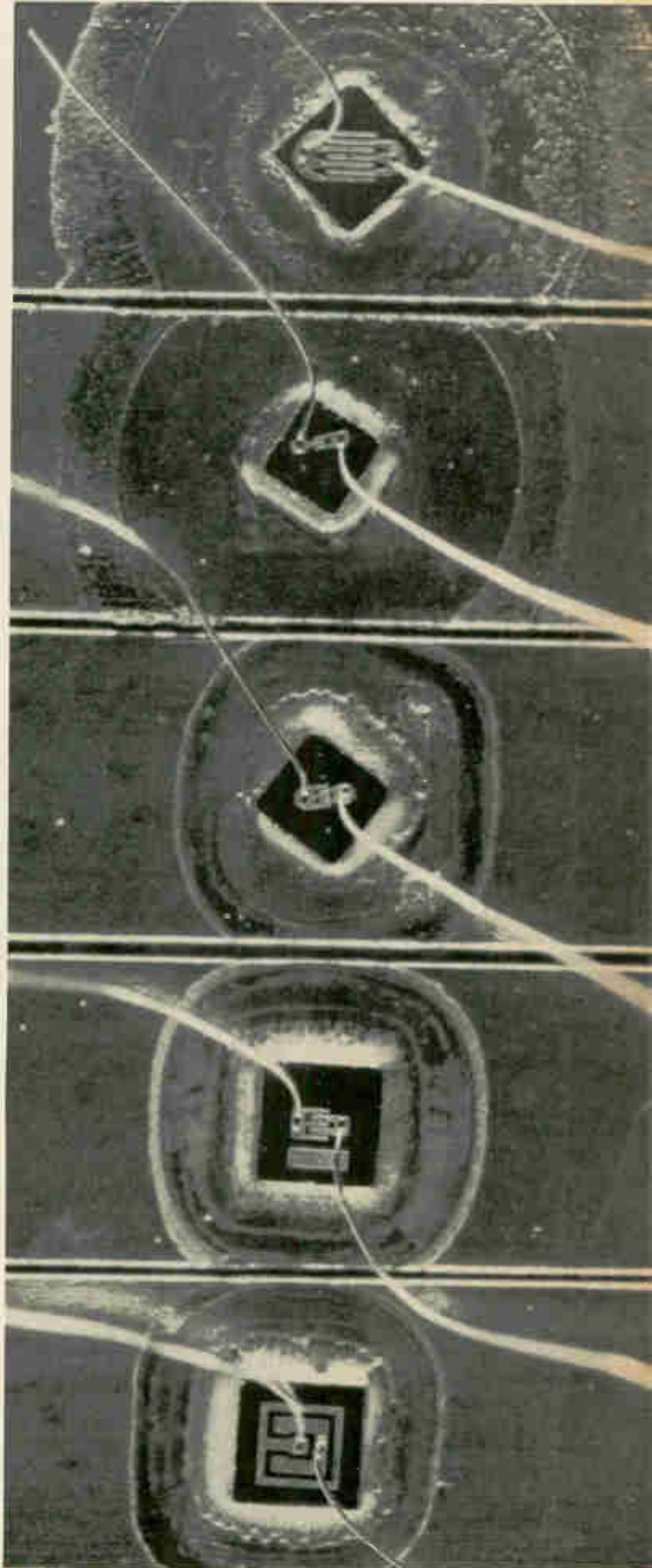

Chip designs at right require base leads at specific locations. In the first four patterns, the base electrode has one more finger than the emitter. In the bottom design, the emitter is C-shaped.

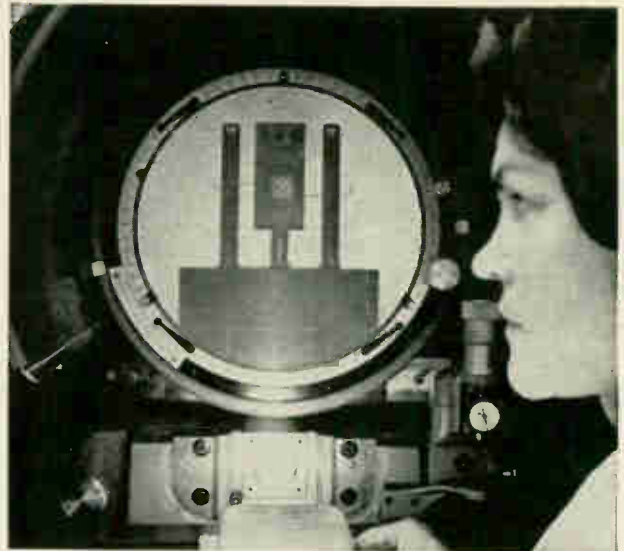
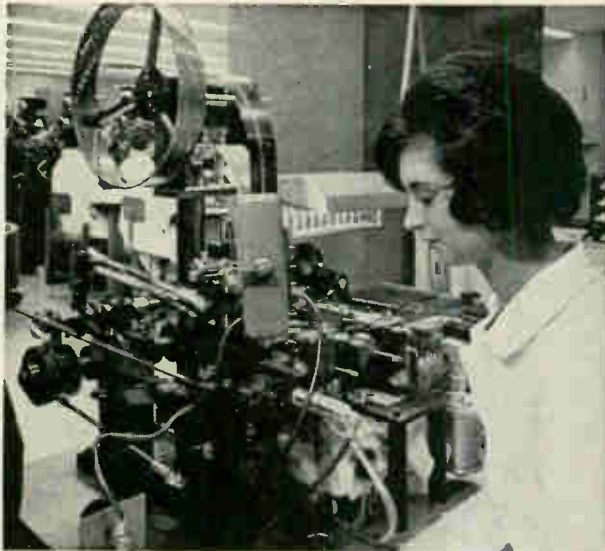

Welding machine draws the strip from a magnetic drum, cuts it into individual devices and bonds the Kovar foil and the gold leads to the package pins. At right is the assembly in one of the optical comparators that the quality-control department uses to check machine operation.

of the high-speed mechanized processes. The scrap barrels would fill quickly if physical and electrical properties were allowed to stray.

After the transistor, what?

For silicon controlled rectifiers [Electronics, July 26, 1965, p. 112], the strip is copper up to 40 mils thick instead of Kovar foil. The thick copper provides heat-sinking for the scr's, which have a power rating of 200 watts. The strip is blanked to form a lead frame like the one below.

The chip, heavily passivated with silicon dioxide, is mounted on the center lead, after which wire

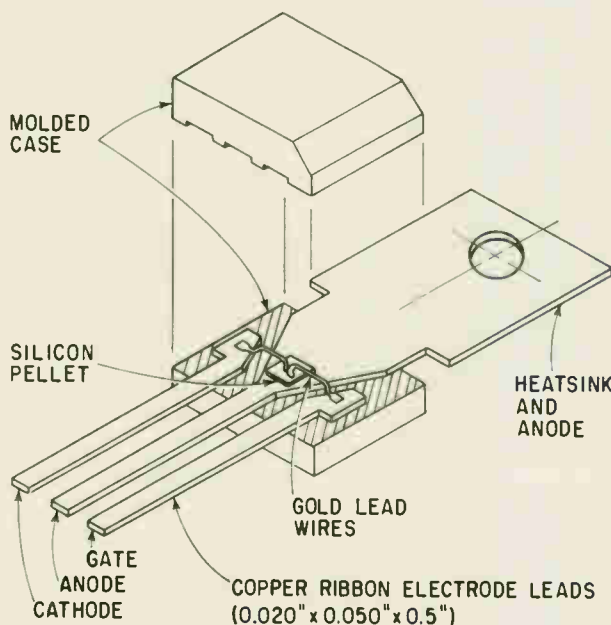

Package design for a silicon controlled rectifier. Sketch shows how chip is mounted on leads and encapsulated. Leads are preformed in copper strip, then sheared to cut the scr free after encapsulation. Over-all length of this scr is 1.3 inches. GE calls the chip a pellet.

leads are bonded to the chip and the two outer leads. The case is molded. To cut each scr from the strip, the three lead fingers are sheared and the top lead is sheared at both sides.

In the procedure planned for power transistors, the chips are mounted on a Kovar strip. But the Kovar is not welded to the collector pin of the package; it is bonded to a heavy copper heat sink that forms the base of the header. The heat sink is joined to the collector lead. Emitter and base wire leads are bonded, much the same as in the smaller transistors, to base and emitter leads which project through openings in the heat sink. This construction will enable the transistors to have a power rating of 4 watts at a case temperature of 70°C. The small transistors are rated at under one watt.

Further applications for strip assembly have not yet been developed. However, similar techniques presumably could be used to package monolithic integrated circuits if each IC chip were mounted on one finger of a blanked lead frame similar to the scr frame, but made of Kovar foil with additional lead fingers. A lead frame with three fingers would be suitable for low-profile transistors encapsulated in a small rectangle of epoxy; this configuration is favored when lead inductance and capacitance must be low.

A similar assembly method is already being used by a Japanese transistor company to make miniature, high-frequency transistors [Electronics, Dec. 13, 1965, p. 87]. Also, the Kovar strip now employed to make the regular transistors could probably be cut into lengths carrying several transistors or diodes, to make strings of transistors and diodes [Electronics, Sept. 6, 1965, p. 100].

Reference

1. "General Electric Economy Line Transistors," product brochure 40.01, 1965, General Electric Co. Semiconductor Products Dept., Electronics Park, Syracuse, N.Y.

Bendix “Pancake” connectors aren't half of what you can get from the other guy.

Bendix® Pancake connectors are less than half the size of other miniature cylindrical connectors now available. They'll reduce total connector length up to 50% and cut weight by as much as 60%. Our Double-Density models give you still further advantages by offering up to 128 contacts in a single connector. Whichever type you need, you'll find crimp or solder terminations available in 9 shell sizes—8 through 24. Over 6

multiple key shell types, too, with over 25 insert patterns, many of which are Pygmy® (Mil-C-26482) insert layouts. In addition, you can select from potted, grommetted and hermetic versions.

Our Pancake connectors are big on performance, also, boasting improved environmental sealing, increased resistance to contact pin bending, greater contact retention and temperature capabilities that range to 392°F. con-

tinuous operation. Even improved electrical characteristics through rigid, glass-filled epoxy inserts, as well as less chance of failure through fewer components and increased materials capability.

So before you decide to get in contact with the other guy, get in touch with us first.

The Bendix Corporation, Scintilla Division, Sidney, New York. Phone 607, 563-9511.



Scintilla Division



Circle 91 on reader service card



RESISTOR PROVING GROUND: RELIABILITY TESTING

Resistors are run under the most difficult operating conditions they might be expected to meet. Even after 1,000 hours under load, Stackpole resistors are well within the limitations of MIL-R-11 specs. This exemplifies the continual rigid testing that creates resistors of the highest quality and dependability.

Other tests are conducted to determine temperature/resistance characteristics. Perhaps you'd like to discuss this or other tests with us. Write or call: Don Kirkpatrick, Manager-Engineering, Electronic Components Division, Stackpole Carbon Company, St. Marys, Pa. Phone 814 834-1521. TWX 814 826-4808.





On the horizon: better hospital care through computer time-sharing

When the Hospital Computer Project becomes operational, it will free the medical staff at Massachusetts General Hospital for better patient care based on real-time research information.

By G. Octo Barnett, M.D., Massachusetts General Hospital, Boston, Mass.,
and John H. Hughes, Bolt Beranek and Newman Inc., Cambridge, Mass.

For the past three years, an active research program has been under way to develop a time-shared computer system that may revolutionize techniques of patient care and hospital administration. The new system, known as the Hospital Computer Project, is the prototype for a group of regional computer systems that will do the routine data processing, record handling and statistical research that now takes up much of the time of doctors, nurses and other highly skilled personnel. Not only will such a system free these people for the more urgent tasks connected with patient care, but it will also provide an invaluable adjunct to diagnosis, treatment and research.

The medical profession and the scientific community have applied new computers and new techniques of information technology to the statistical analysis of clinical observations, the gathering and processing of data directly from patients, and the quantitative study of physiological systems and conditions. However, despite spectacular progress in these areas, there has been little application of

on-line computers to the solution of problems surrounding the generation and use of the patients' records, or to medical research based on the accumulation of such data.

The broad goal of the Hospital Computer Project, a joint effort of Bolt Beranek and Newman Inc., and Massachusetts General Hospital, is to apply a time-shared computer with remote input-output devices to the rapid and accurate collecting, recording, transmitting, retrieving and summarizing of information about patients; to reduce the nurses' paper work; to arrange and consolidate information for the medical staff; and to develop a system that will store large amounts of complex medical information and also rapidly retrieve it for clinical research.

Another major goal is the design of a flexible system that can be used by a number of hospitals. Large metropolitan hospitals might afford to own their own computers, but smaller institutions could not. And more than 50% of the nation's total hospital beds are in hospitals with fewer than 200 beds each. Time-sharing a computer could reduce the cost to each hospital to an acceptable minimum, and would permit an interchange of information that should improve patient care.

If the goals of this project are to be achieved the medical staff must accept a time-shared computer system, with all of its psychological and sociological implications; it must understand the computer, and be able to communicate with it.

Because data on the care of patients and clinical research information will be fed to the computer, eventually it should be possible for a doctor to get real-time research results—that is, soon enough to aid in diagnosing and caring for a patient. He can

This article and the two that follow conclude the special report on computer time-sharing. Part I appeared in *Electronics*, Nov. 29, 1965.

The authors

G. Octo Barnett, M.D., is director of the Laboratory of Computer Science at the Massachusetts General Hospital in Boston.

John Hughes is associate director of the hospital computer project at Bolt Beranek and Newman, Inc. He is now sailing across the Atlantic Ocean in his ketch *Ensis II*.

```

CALL    MEDA

MEDIATION ORDER

9:56 AM 3/10/1965
1 TIME AND DATE
2 DOCTOR BROWN,R
3 PATIENT 4088 DOE,JOHN MR 1234567 M
4 ORDER
  4.1  RX, ACHROMYCIN, 500MG, PO, Q3H, I
      TETRACYCLINE HCL
      MAXIMUM SINGLE DOSE EXCEEDED
      DOSE ? 100MG
      RX, TETRACYCLINE HCL, 100MG, PO, Q3H, I
  4.2  RX, DIGITALIS, 0.2GM, PO, 10AM, I
      MAXIMUM SINGLE DOSE EXCEEDED
      DOSE ? *0.2GM
      RX, DIGITALIS, *0.2GM, PO, 10AM, I
  4.3
5 INITIALS CD

-THANK YOU-

```

Typical conversation between a doctor and the computer.

1. The computer prints out the time and date.
2. The computer asks the doctor's name, and the doctor identifies himself.
3. The doctor identifies the patient by number; the computer corroborates this by typing the patient's name and other data.
4. The computer requests the medication that the doctor is prescribing. As the doctor specifies each item, the computer questions any errors.
 - 4.1 Tetracycline HCL is the generic name for the drug that the doctor specified by its trade name; the computer questions the 500 milligram dose and allows the doctor to change it.
 - 4.2 The computer also questions the 0.2 gram dose of digitalis, but the doctor confirms this with the asterisk.
 - 4.3 The computer confirms each entry by typing back the corrected order in full.
5. The doctor signs off with this code and the conversation is finished.

ask, for instance, "What happened to the last 25 patients who had pneumonia and ulcers at the same time? Was drug X prescribed for any of them? If so, did it help them in any way?" Questions like these now require weeks of research and cannot be answered in time to help individual patients.

Interpretive communications

The system under development at Massachusetts General Hospital is called an interpretive communication system. The content of each message is analyzed by the computer and compared with previous messages. If the message contains information to be stored, the computer sorts out the data and stores each segment in the appropriate part of its bulk memory; if the message requests information, the computer retrieves the data and transmits it to the person requesting it.

Different kinds of messages might ask questions about patient care, request laboratory reports, set

up admission of new patients, and so on. The computer knows which kind of messages are likely to come from each terminal, and processes them or rejects them. For example, a doctor may use a terminal in his office to order medication for a patient. The computer asks for, then checks the doctor's name, the name of the drugs prescribed, permissible dosages, and so on. A sample print-out is shown in the diagram at the left.

If a terminal in the admissions office is used to transmit an order for a medication, the computer would reject the request, because the clerks in the admissions office are not authorized to order medication. On the other hand, if a laboratory terminal is used to enter information about a newly admitted patient, the system will accept the data, but with a warning that the terminal is being improperly used.

All the programs in the hospital system are used in the conversational mode. The dialogue begins when a user requests a specific program. Either the computer or the user will type a question and obtain a response. If the user is in doubt, he will ask the computer how to reply by typing the word "how?" and the computer will give instructions.

An unusual feature of the system is that it can work with either of two versions of the conversational-mode language, either long or short. For instance, two versions of the same request by the computer would be "Patient identification" and "Pt." A user familiar with the routine might prefer the short version.

In addition to routing messages, the system will organize messages, file them, and make them available on authorized request. Messages containing results, as opposed to messages asking questions, are automatically routed to the proper storage location where they contribute to the accumulation of statistics—for instance, on the treatment of patients with both pneumonia and ulcers.

If information entered is pertinent to other terminals, the computer will route it whether the user requests it or not. A grossly abnormal test result or a questionable drug order, for example, will be routed out of its normal sequence and sent to appropriate terminals.

The file structure is organized to store large quantities of medical information that can be used from day to day even though the information is constantly being changed. There are also provisions for an individual researcher to create new files compatible with the over-all file structure but with a format that suits his particular investigation.

Furthermore, since the system will be performing medical rather than computational tasks, its computer will make few demands of the users and require a minimum of training. A flexible, expandable system relies heavily on a set of generalized programs that provide necessary user services.

System hardware

The computer now being used in the Massachusetts General Hospital system is shown in the



Massachusetts General Hospital's computer system for medical record-keeping and research. The computer, installed at Bolt Beranek & Newman Inc.'s laboratory in Cambridge, is about seven miles from the hospital. The computer can be seen immediately behind the operator's panel to the right of the man at the teleprinter. Behind the computer are the memory banks; in the extreme rear is one corner of the drum storage unit; tape drives are visible at the right.

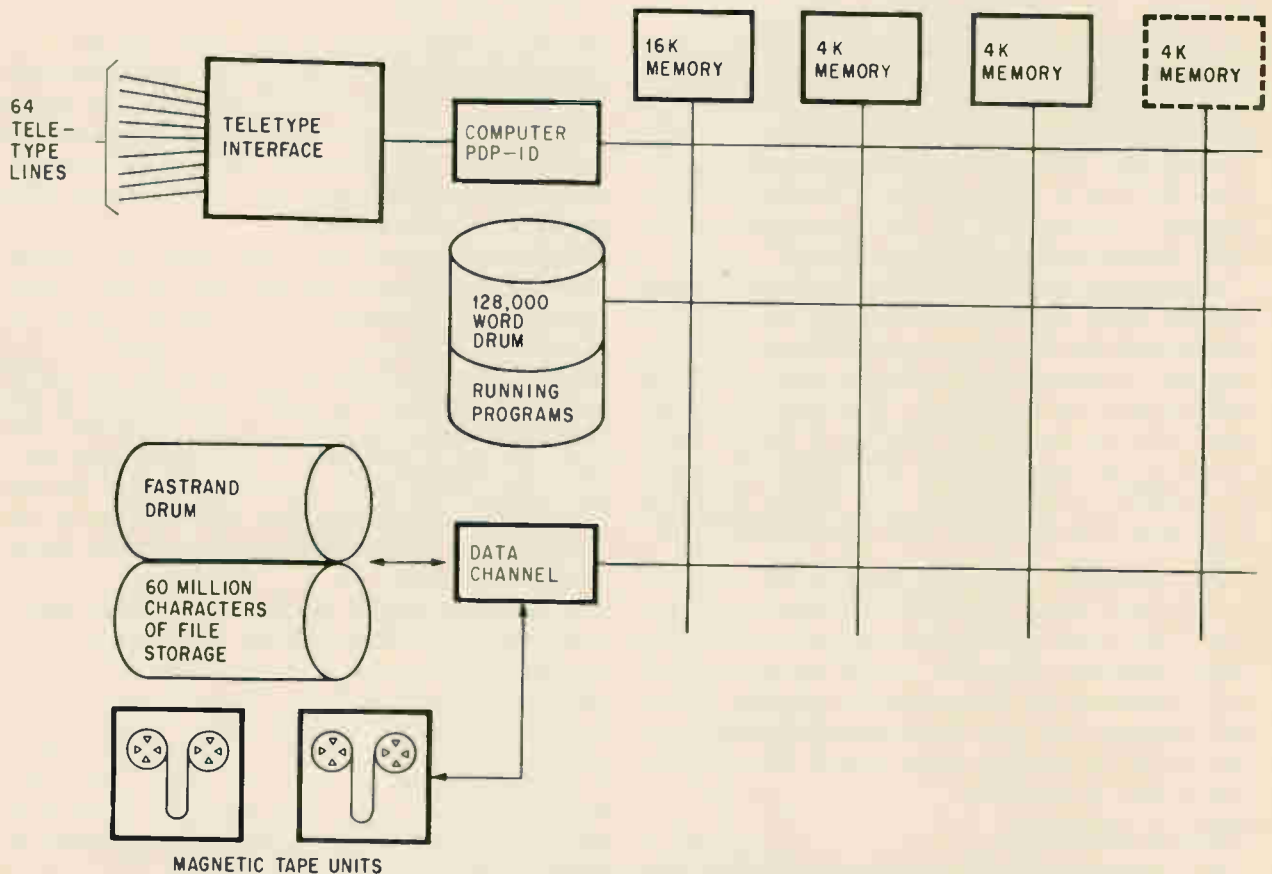

The computer system shown above is diagramed here. The dotted line indicates a 4,000-word memory that is within the capacity of the system but is not presently installed. All the 4,000-word memories can be expanded to 16,000 words. The single 16,000-word memory contains the supervisory program.

photograph above. The block diagram shows the computer's organization.

The Hospital Computer Project grew out of Simbug (for simplified debugging), a very early operating time-shared computer project developed at Bolt Beranek and Newman Inc. It used a Digital Equipment Corp. PDP-1 computer with which up to five users could debug programs simultaneously

from console typewriters. The basic PDP-1 comes with 4,096 words of memory and a single-channel interrupt system—that is, it can react to only one kind of external interrupt. For Simbug, a 16-channel interrupt system was added. One kind of interrupt is a signal from the drum that a requested program has been found. Another kind signals the arrival of a character from a teletypewriter, and so

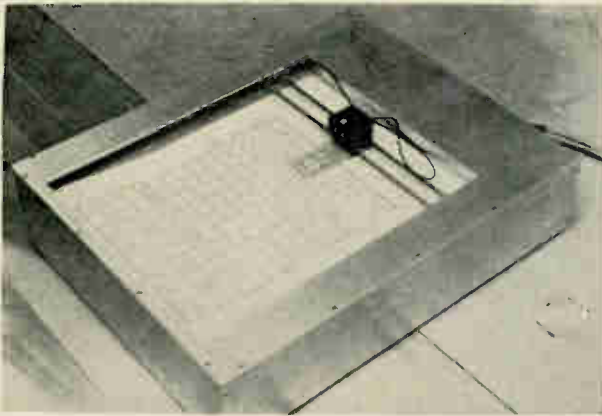

Prototype Datacoder terminal used with a teleprinter for quick and accurate input of repetitive data. Data is selected by placing the little window over the appropriate square and pressing the button on the slider. This transmits two Teletype characters that give the location of the window, thus indicating the item specified.

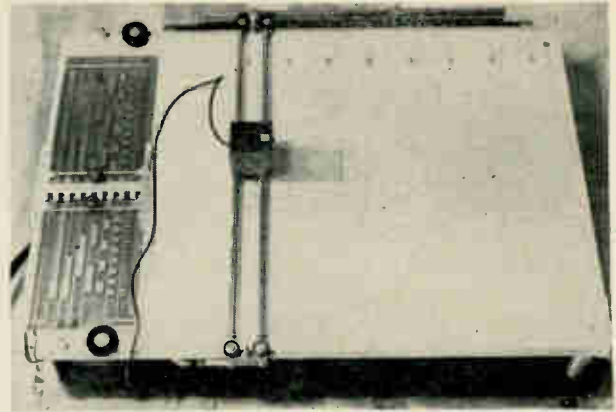

Datacoder terminal with the covers off. A sheet of grid paper with standard data marked in the squares is placed under the cursor. It is registered by the row of pegs at the top, which fit in holes in the paper. The printed conductor pattern at left translates the position of the cursor into an 8-bit binary code for transmission to the computer.

on. Simbug also required additional memory, logic to prevent user programs from interfering with the supervisory program or with each other, and a magnetic-drum storage unit for holding programs not in immediate execution. With the new central processor, an altered version of the PDP-1, most of the problems encountered by the prototype system built around Simbug have been solved.

A swapping drum is required in most time-shared systems with limited core capacity. The present system includes two drums: a high-speed drum for memory exchanges, and a lower-speed drum for bulk random access storage. The latter is a Fastrand built by the Univac division of Sperry Rand Corp.; it has approximately 60 million characters of available storage space, and fulfills the need for a large area in which to store medical information.

The computer can run in either of two modes—an executive mode where all commands are executed, and a user mode, where user commands that might adversely affect the system are intercepted for examination by the executive program. When this happens, the user loses control momentarily; the executive program may correct his error or advise him to try again.

Memory subdivision

An independent memory scheme divides the memory into four groups, each operating independently. Logically, memory is treated very much like a tape-drive or a card reader; the main arithmetic and control unit requests data from memory or stores data in memory. Memory control has also been given priority logic so that it will be accessible to more than one processor.

The present configuration includes one bank of 16,000 words, containing the executive program, and two 4,000-word banks for users. With the independent memory scheme, one user program may be swapped to or from the high-speed drum

into one of the smaller banks while another user program is running in the second bank. Since the computer is always running and always has access at least to the executive bank, it never has to wait for the swapping drum and can handle interrogations from communication lines at proper rates with single-character line buffers.

To meet the need for uninterrupted interchange between user memory and bulk storage, the system includes a data channel, which operates as an independent processor. With this channel, a user program in one of the small banks has access to bulk storage (the Fastrand) independent of the high-speed drum and the central processor. The data channel is activated by an input-output command from the central processor; it then obtains commands and transfers data directly through the memory buffer system independently of the central processor.

It cannot be known in advance in which bank a user's program will be running. Therefore a limited amount of program relocation hardware has been included, in the form of four registers, each holding two binary digits. Thus the user's program can always be written as if it were to be executed from a standard area in memory. Reference to that area by a user's program is automatically diverted by these registers to the area where the program actually resides.

Memory protection registers, which prevent access by users to that portion of memory containing the supervisory program, are also included in the system.

The central processor, in effect, acts as a switch that can connect a user program memory to the central processor itself, to the data channel or to the swapping drum.

Keyed or coded inputs

For the terminals, a Model 33 Teletype was chosen because its keyboard resembles that of a

standard typewriter. An input device, now being produced by the Data Equipment Corp. under the name of Datacoder 88, enters graphical or densely coded information.

The prototype Datacoder terminal shown in the photos on the opposite page operates with a Teletype. It sends two 8-bit characters in Teletype code designating the 8-bit x and y coordinates of a point indicated by the cursor, or indicator, when the transmit button is pressed. These coordinates are interpreted by the computer in terms of previously specified commonly used information.

Medication orders, for example, could be handled with the Datacoder terminal. A sheet of paper, divided into a rectangular grid with meanings assigned to each square in the grid, is placed in the Datacoder. One row of squares is assigned drug names like "penicillin," "digitalis," and so on. Another row calls for "1 cc.," "2 teaspoons," and other dosages. Still another specifies "once a day," "after meals," "before retiring," and so on. The doctor, who has written a prescription and wants it checked and recorded by the computer system, calls for the prescription program. This program

requests the drugs, dosages, times and all other pertinent data in turn, and the doctor responds by indicating the appropriate squares with the cursor and pressing the transmit button. Greater flexibility is gained by reserving a square to indicate that an entry will be typed in from the Teletype. The Datacoder can also be used for truly graphical input with a resolution of about 1 millimeter.

As the number of users increases, as the number of functions being implemented expands, and as data in the system accumulates, so demands upon the system will increase. The present hardware is only for research, and is not performing any service function in the hospital. However, the experience gained in examining hospital function, in specifying programs, in carrying out this feasibility research program will be very valuable in developing a computer system that will perform specific service functions.

Ultimately, smaller hospitals will time-share the Massachusetts General Hospital system, thus making the talents and experience of a great teaching hospital more readily available to institutions with more modest resources.

Time sharing



Time-shared troubleshooter repairs computers on-line

Breakdowns in big computers can be hunted down and repaired while users, unaware of any trouble, continue to feed programs through the system

By Jesse T. Quatse

Carnegie Institute of Technology, Pittsburgh, Pa.

A **burned-out transistor** or other minor failure can shut down a time-sharing computer system, leaving users all along the line with programs piling up or chopped off in midcalculation. With Strobes, an experimental maintenance system, a repair engineer can diagnose and repair a faulty part of a time-sharing system while users of the computer continue to work with the remaining equipment.

Strobes is the acronym for shared-time repair of big electronic systems. The repairman controls the computer from the standard console, in the

same way as the ordinary user. The repairman requests short diagnostic programs from the system's bulk storage, or enters programs from his console. They are executed, repeatedly and at regular intervals, without noticeably disturbing the other time-sharing users.

The repairman troubleshoots the system with a modified oscilloscope. While the diagnostic routine is running, the oscilloscope screen is unblanked by the Strobes program. While the standard programs are running, the screen is blanked, so that no dis-

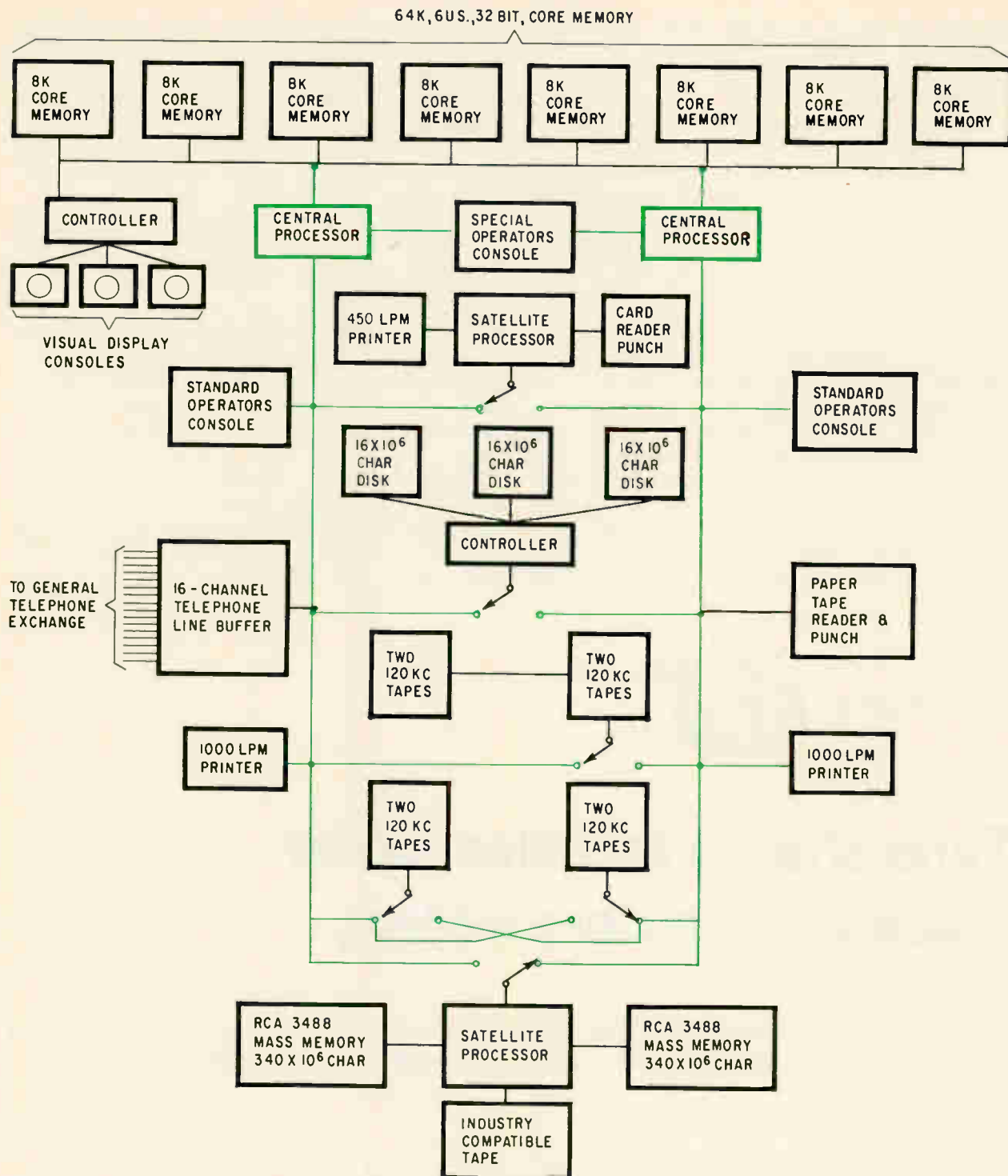

Dual computer system used for time sharing at Carnegie Tech. Two CDC G-20 computers are connected. The switches in the figure are program controlled. They allow the tapes, disks and satellite processors to be used with either of the two central processors.

play is generated by the standard user. This produces a stroboscopic effect in which the oscilloscope display is retraced only during the maintenance engineer's portion of the time-shared cycle. The diagnostic routines can be repeated fast enough to make the display appear flicker-free.

A Strobes program has been written at the Computation Center of the Carnegie Institute of Technology. It appears to be about 100 times more

efficient than conventional diagnostic techniques, in terms of machine time. Other computer systems, time-shared or not, can be modified to accommodate Strobes, which requires only multiprogramming the processor to run a small Strobes program with one or more user programs.

The diagnostic routines are short, in that the maintenance engineer's portion of the time-shared cycle is small compared to the standard user's

portion. They are made noniterative—that is, only one pass is made through a program when its turn comes to run (other programs often repeat small sequences of instructions over and over) and the computer time devoted to the diagnostic process is dramatically less than used in conventional diagnostic methods.

As an example, a diagnostic program that reads and writes data in a faulty memory location requires less than one millisecond of running time each cycle, including interrupt processing time. If the program is repeated at the rate of 15 runs per second, over-all system performance is degraded only by about 1.5%; that is, 66 out of every 67 milliseconds of machine time are still available for standard programs. Except for the loss of the memory module being repaired, the standard user is hardly aware of the repair process. Likewise, the maintenance engineer is not hindered by the background program.

Putting it together

At Carnegie Institute of Technology, Strobes depends upon a standard teleprinter, a clock, modifications to the central processors, and a modified Model 535A oscilloscope, made by Tektronix, Inc. The central processors are a pair of Control Data Corp. G-20 computers in a dual-processor computer system dubbed the G-21. It is connected to the general telephone network through 16 buffered channels. The teleprinter used by the maintenance engineer is one of 40 available to G-21 time-shared users. A time-shared connection is established at

the teleprinter by dialing the telephone number of the G-21. If at least one channel is free a recognition message is typed on the calling teleprinter. The user then types programs in the programming language of his choice. One such language is the special one used with Strobes.

The G-21 system is shown in the diagram on the opposite page. Of particular interest is the modular 64,000-word memory bank. Each 8,000-word module consists of two separately addressable 4,000-word core stacks. The distribution of circuits controlling memory access is itself highly redundant. In typical cases, faulty circuits for addressing the memory module would only degrade the system configuration from 64,000 to 60,000 during Strobes diagnostic processes. System redundancy is enhanced by the program-controlled line switches, shown as arrows in the diagram. Any of the switchable devices may be allocated to either processor upon program command.

The clock that controls the operation of Strobes generates a pulse 60 times a second. Since each pulse adds one to a binary counter that is reset to zero each midnight, the counter effectively shows the time of day. The counter makes three rates of interrupt available: 60, 15, or 1 pulse a second. A switch on the oscilloscope selects one of the three. Operation is flicker-free at 60 interrupts a second, and nearly so at 15. The one-per-second interrupt rate is an idle state used where signal monitoring may be required without high quality display.

The central processor modifications are shown in the diagram below. One of the three signals from

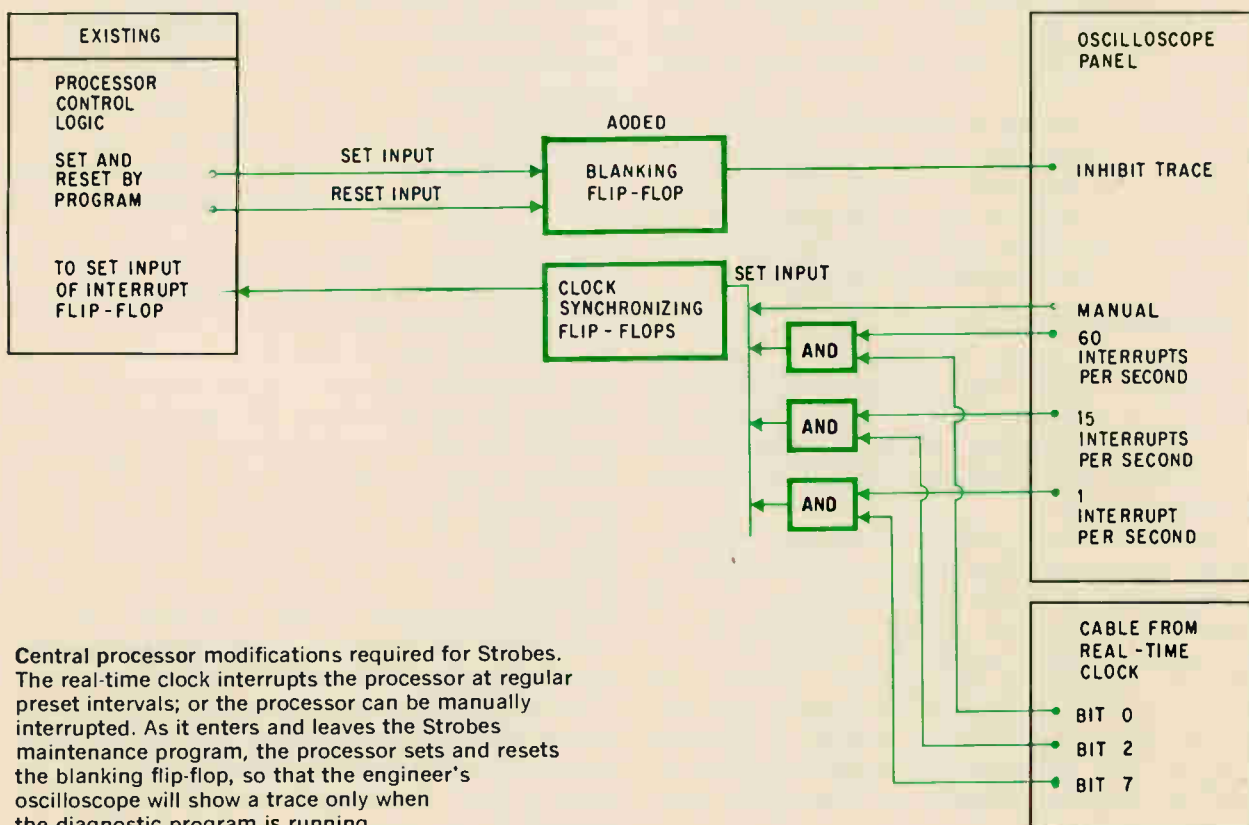

Central processor modifications required for Strobes. The real-time clock interrupts the processor at regular preset intervals; or the processor can be manually interrupted. As it enters and leaves the Strobes maintenance program, the processor sets and resets the blanking flip-flop, so that the engineer's oscilloscope will show a trace only when the diagnostic program is running.

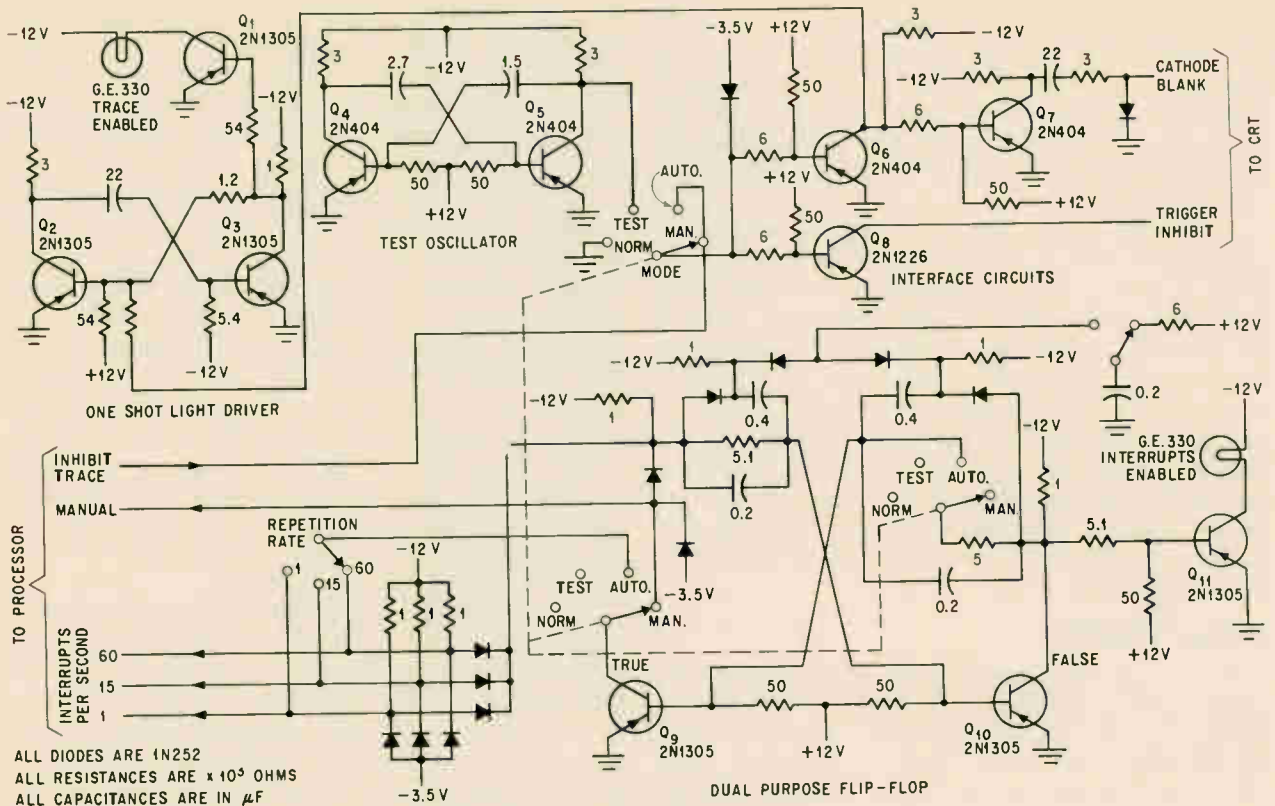

Oscilloscope modifications required for Strobes. These circuits are mounted on a circuit board housed in the preamplifier storage bay on the oscilloscope cart; only the two leads at the upper right are connected to the oscilloscope itself.

the clock or a signal from a push button is gated by the selector switch into clock synchronizing flip-flops. Manually generated interrupts bypass the clock gates. The gated and synchronized real-time pulse interrupts the processor, causing it to stop running the program then in control and to start the Strobes program.

During the running of the Strobes monitor, the diagnostic routine sets and resets the blanking flip-flop when the clock is controlling the interrupts. Circuits added to the oscilloscope blank the cathode-ray tube beam and disable the oscilloscope trigger when the blanking flip-flop is turned on.

Changing the scope

Modifications to the oscilloscope are shown in the diagram above. The two leads to the oscilloscope are connected at the points indicated. All other circuits are attached to a control panel, which is housed in the preamplifier storage bay on the oscilloscope cart.

The mode switch selects one of four operating modes. In the normal position the interface circuits are disabled and oscilloscope operation is normal regardless of the state of the blanking flip-flop in the computer. The test position connects a one-kilocycle oscillator to the interface circuits; with this oscillator cathode-ray-tube blanking and trigger disabling can be tested without a processor program. The automatic and manual positions enable the Strobes programs to control the oscilloscope display.

The "trace enabled" indicator distinguishes a zero-signal trace from an inhibited trace. It is driven by a monostable multivibrator that is turned on whenever the cathode of the crt is unblanked and stays on about a second—long enough to permit the light from the indicator to be seen. If the engineer sees no trace on his oscilloscope but the indicator is on, then he knows he has no signal. If there is no trace and the indicator is off, then the trace is inhibited; in that case either the Strobes circuits are not working or some switch has been left in the wrong position.

The dual-purpose flip-flop operates as either a bistable or a monostable circuit, corresponding to the automatic and manual modes, respectively. In the automatic mode, transistors Q_9 and Q_{10} are cross-connected through resistive networks, each collector to the other base. The flip-flop is turned on with the enable push-button switch. When the flip-flop is on, the output of transistor Q_9 conditions one of the AND gates in the diagram on page 99, through the repetition-rate selector switch. When the mode-selector switch is moved from automatic to any other position, the cross-connection from the output of Q_9 is disconnected—momentarily if the switch is moved to manual—turning the flip-flop off and disabling all interrupts.

In the manual mode, the output of Q_9 is connected directly to the synchronizing flip-flop in the processor and resistively cross-connected to the base of Q_{10} . The output of Q_{10} is capacitively coupled to the base of Q_6 so that the flip-flop is

monostable. When the enable button is pressed, the flip-flop turns on momentarily, then off again, generating a single interrupt pulse to the processor. The photo at the right shows the complete circuit.

Strobes' effect on performance

The effect of degradation of system performance during stroboscopic diagnosis is not easily related to the cost of shutting down the computer. The loss of a redundant unit or subunit may or may not be noticeable, depending upon what kinds of programs are being run. In general, those programs which do not use the faulty unit run as if the entire system were operative; whereas programs which depend upon use of the faulty unit cannot run at all. These dependent programs must wait until the faulty unit is returned to operational status. This queuing of unserviceable programs corresponds to the queuing normally encountered when the entire system is preempted by the maintenance engineer. However, with Strobes each program has a higher probability of running than of being queued. The net result is better system reliability.

Strobes also produces an over-all increase in system throughput—the total amount of work done by the system. The application of Strobes to routine preventive maintenance procedures can increase the computer time available daily by as much as two or three hours. Preventive maintenance can be distributed throughout the day so that the standard user is denied the service of no more than one or two units at a time.

Computer users who depend upon conversational access to the computer, or who use it to monitor events in real time, would benefit mostly from Strobes' ability to maintain and repair the computer without shutting it down. With conventional repair procedures, when the system is "down", users are helpless.

Finding the bug

If the maintenance engineer is called upon to locate a "bug" in one of the memory modules, he calls the G-21 through the computer room teleprinter and logs in with the standard identification procedure required of all time-sharing users. He then requests all procedures in the program library relevant to the faulty memory module and reserves the module for his exclusive use. After a brief pause, in which the requested routines are prepared for use, the computer types a message to inform the maintenance engineer that the conversational mode has been established. The "conversation" between the engineer and the computer then begins.

The maintenance engineer puts the system in the stroboscopic mode and then calls for, or writes, an appropriate program. He supplies the starting address and other data that the program will require, and then begins troubleshooting with his oscilloscope; he looks for waveforms showing that some part of the memory is not functioning properly.

If he wishes to disengage Strobes from the sys-

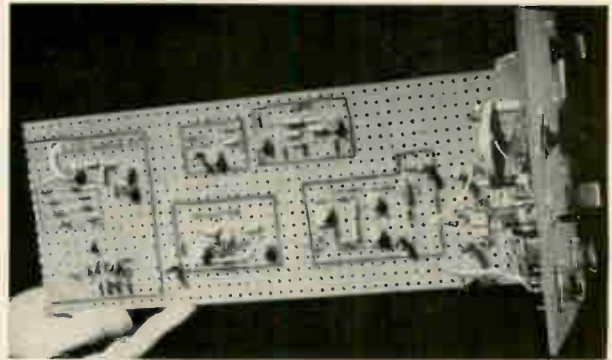

Oscilloscope circuits on circuit board. At the right is the control panel. When in use, this board is mounted on the oscilloscope cart and connected to the oscilloscope with two wires. An external cable brings signals and power from the central processor.

tem for any reason, he can do this without destroying the program. Normal computer operation, to the extent that the presence of the bug permits, resumes at the 100% performance level.

When returning to the troubleshooting task, the maintenance engineer must log in once again. Troubleshooting with the oscilloscope resumes, using the Strobes program, and other diagnostic routines written or taken from the program library as needed.

When the faulty component is found, it can be replaced without disturbing the rest of the system because power can be shut off in the faulty module alone. When power is restored to the memory module, an acceptance routine tests the module. When the routine reports faultless operation, the maintenance engineer removes Strobes from the system.

This example absorbs an estimated 2% of running time in the stroboscopic mode. The maintenance engineer succeeds in tracing the symptoms to the faulty unit, replacing the component, and putting the unit back on the air, all without shutting down the system.

Bibliography

- Hurley, Richard B., "Transistor Logic Circuits," Chapter 12, John Wiley and Sons, New York, 1961.
- Quatse, Jesse T., "Strobes: Shared Time Repair of Big Electronic Systems," Proceedings, Fall Joint Computer Conference, 1965; Spartan Books, Washington, D. C., p. 1065.
- Quatse, Jesse T., "Design of the G-21 Multi-Processor System," Computation Center, Carnegie Institute of Technology, Pittsburgh, Pa., 1965.

The author



Jesse T. Quatse is manager of engineering development in the Computation Center at the Carnegie Institute of Technology.



Fast-moving queue for better computer service

For small, routine production jobs, high-speed processing of programs, one at a time, and fast turn-around time is more efficient than handling programs in parallel

By John A. Buckland

Univac Division, Sperry Rand Corp., New York City

The time-sharing systems described in other articles of this series are fine for long research programs or debugging problems, but inefficient for many routine production jobs. A better way of permitting many people to use the computer simultaneously and get answers quickly is to reduce the turn-around time drastically in conventional processing and to let the computer run off programs one at a time, at high speed. This technique provides more efficient use of memory and has other advantages.

In the fast-turn-around system, the remote terminals are small general-purpose computers, which communicate with a large central processor over telephone lines through a magnetic drum buffer. The user feeds punched cards into the remote terminal, and these cards are transmitted to the magnetic drum. The central processor takes the program from the drum, executes it completely, and returns the results to the drum. The results are then transmitted to the remote terminal where they are either printed out or punched into another deck of cards. Queuing is the same as in a conventional batch-processing system, but the turn-around time is minutes instead of hours. Programs with long running times are submitted in the conventional

way for overnight processing, instead of tying up the time-shared system.

Time sharing of this kind is called job-demand batch processing. A remote entry to the central unit is completely under the control of the remote operator, subject to the central executive system. There is computer-to-computer conversation but not man-to-computer conversation.

Job-demand batch processing is in operation at the Univac Data Processing Centers of the Sperry Rand Corp., and at several customer installations. These installations have Univac 1107 computers as the central processor and Univac 1004 card processors as remote terminals. A typical Univac 1107 computer has a ferrite-core memory with a capacity of over 65,000 words of 36 bits each, operating with a cycle time of 4 microseconds; it also has a 128-word thin-film control memory. In time-sharing, the 1107 uses a magnetic drum with a capacity of 4.7-million characters, and an access time of 17 milliseconds.

The Univac 1004 card processor uses a program wired into an easily replaceable plugboard so programs on several different plugboards can be quickly interchanged. In addition, the computer has a core memory that holds 961 alphanumeric characters as data for programed calculations. In time sharing, the user's program is entered, then transmitted to the Univac 1107 under the control of the plugboard, which regards the user's program as data.

Full computing power

These Univac systems give each user full access to the entire core memory and arithmetic unit while his job is running; however, he cannot interrupt and modify his program. He sets up the job on the remote console exactly as he would on the

The author



John Buckland is national manager of technical support for the Univac Data Processing Centers. He was previously supervisor of mathematical methods for the Shell Oil Co.



On-line real-time system for controlling reservations for Eastern Air Lines. The computer is a pair of Univac 490's in Charlotte, N.C., serving 657 inquiry stations in 42 cities; the system also serves two other airlines

central computer. His program is expected to be in running order when it is loaded, thereby improving production efficiency. The data-control rules are the same as in any batch-processing installation.

After the central processor executes one program it immediately goes to work on another. Many peripheral operations, such as loading new programs and writing program results, proceed concurrently.

One of Univac's customers is the Oil and Gas Conservation Board in Calgary, Canada. Fortran decks are loaded on the 1004 in Calgary and the programs are run on demand in a time-sharing Univac 1107 system 1,600 miles away in the Univac Data Processing Center in Phoenix, Ariz. The results are printed out on the Univac 1004 in Calgary only a few minutes after the cards are loaded.

During a time-sharing demonstration in June, 1965, a program entered in a Univac 1004 in New York was computed on a Univac 1107 in Oslo, Norway, via international data-transmission cables. Then, in quick succession, Fortran programs were run on computers in Los Angeles, Phoenix, Huntsville, St. Paul, Cleveland and Mineola, L. I. None

of the computers had to "stand by."

The Univac 490 series of real-time computers can also be used as multiple remote-console computers with time-shared job control. One 490 installation, at the Westinghouse Electric Corp. near Pittsburgh, began operation in 1962 and has since handled a mixture of time-shared programs at multiple priority levels plus message switching from multiple teletypewriter entries.

The examples of time sharing which have been cited are based on multiple remote consoles of various types, connected by telephone to general-purpose computers with large, random-access drum memories. The programs are loaded in symbolic language or in Fortran, Algol or Cobol problem-oriented languages.

Limited time-sharing techniques

Four other ways, also considered time sharing, of slicing up the available time on a computer are: sequential scanning of remote entries; multiple remote entries for a special purpose; multiple remote consoles with "conversational" or personal-demand control; and multiprocessing, or multiple remote consoles with varied controls over multiple central

MULTIPLE REMOTE CONSOLES WITH JOB DEMAND CONTROL

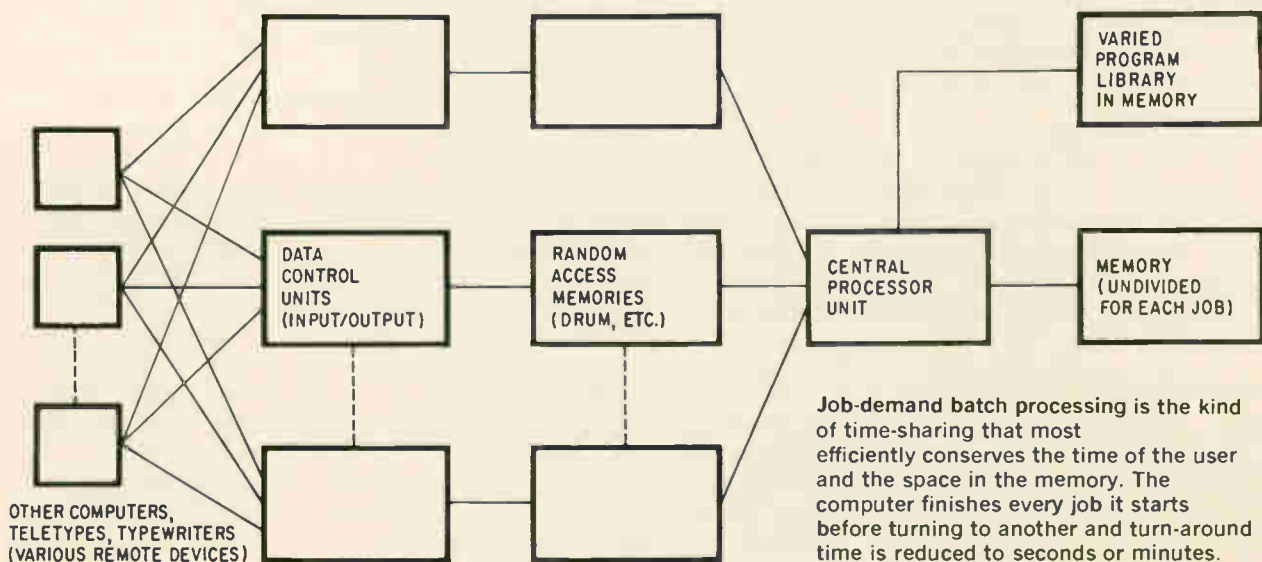

Job-demand batch processing is the kind of time-sharing that most efficiently conserves the time of the user and the space in the memory. The computer finishes every job it starts before turning to another and turn-around time is reduced to seconds or minutes.

MULTIPROCESSING

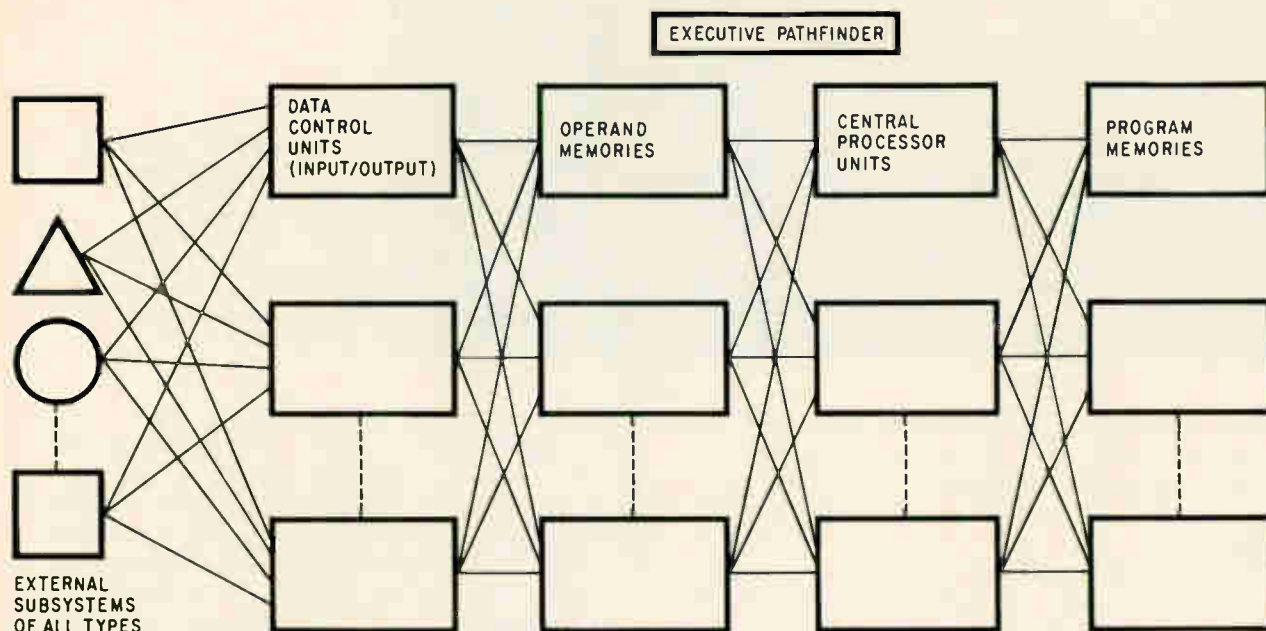

Multiprocessors are the time-shared computers of the future because several programs can be executed simultaneously and the system can be reconfigured to meet the demands of the moment.

processors.

The simplest way to cut up computer time, which can be used with any computer that has communications attachments, is sequential scanning of remote entries by a message-switching unit. The time available on the computer is divided into segments during which commands from stations can be executed in order. If done rapidly, the service by the computer appears full and uninterrupted to the user, but it is really divided. Such systems are usually used for limited numbers of programs with low cost input devices. Normally the messages are buffered and do not have direct access.

On-line real-time service, or service on demand for specific predetermined programs, is also time sharing. On-line means that the computer can be called directly from the remote station. Real-time means that data can be accepted, processed and updated in the same interval in which the transaction is taking place. The business operation controls the computer; the computer does not set the business pace.

An example of this system is an airline reservation network in which hundreds of inquiry stations throughout the country need answers to reservation queries in seconds and there are too many stations to be scanned sequentially. Eastern Air Lines has obtained highly reliable performance from a system running on a Univac 490 for over 3½ years.

More conversation

The success of Project MAC at the Massachusetts Institute of Technology and of comparable systems at the Rand Corp. and at the Systems Development Corp., has encouraged several universities to develop similar time-sharing systems in which the

user instructs the computer from a remote teletypewriter console. He waits for replies on the teletypewriter, then alters, or adds to his program. And he can call for routines already in the computer. Such a system provides flexibility for the research person and console-debugging for the programmer but it ties up the technical person. He is the only one who can "converse" with the computer at the teletypewriter for a considerable time. Additionally, the system has been wasteful of machine time and memory capacity. The conversational mode system has been called a combination desk calculator and stored program computer, but conversational mode is not a good way to handle production computation jobs, although it's fine for debugging small programs and for certain information-retrieval jobs.

Time sharing with a multiprocessor has been partly tested, and is the next step in the future of commercial time sharing. Multiprocessing describes computing systems with multiple processors and multiple large-memory units that can be used in any combination with multiple input-output units.

Multiprocessors will not be time shared in the sense of rapid sequential use of facilities, but will perform true simultaneous computation with interaction and dynamic reassignments of all facilities.

Two distinct types of multiprocessors are being developed: one consists of large equal-size computers in the dynamic system; in the other, several smaller computers for multiplexing, monitoring the work, and light computing surround one or two larger computers that do the heavy work.

In any event, the future is bright for several varieties of multiprocessors that offer economy and computing power.

**We're glad
so many of you like our
high-performance field
effect transistors.**

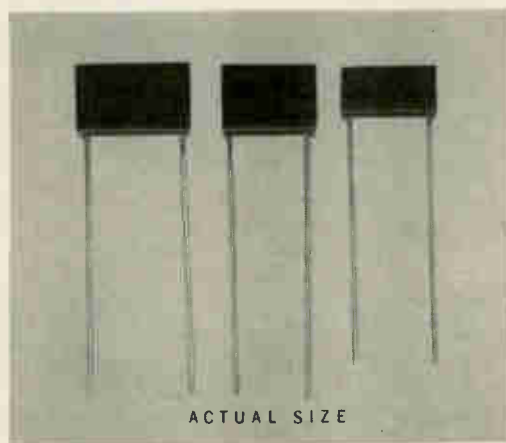

**We think you'll
like our stable new film
capacitors, too.**

KEMET Flat-Kap film-foil capacitors have such an effective dielectric they're 99.9+% stable, yet up to 95% smaller than other film types.

But FET's and Flat-Kaps are only two of the products designed for today's fast-shifting market. We're also committed to leadership in such areas as advanced laser systems... a family of single crystals and crys-

tal products... integrated and modular circuits... solid tantalum capacitors. They're all aimed at problems on the frontiers of electronics. All backed by the technology of Union Carbide.

For data on new film capacitors, write for Bulletin #22, Dept. E-14, Linde Division, Union Carbide Corporation, 270 Park Avenue, New York 10017.



KEMET is a registered trade mark of Union Carbide Corporation.

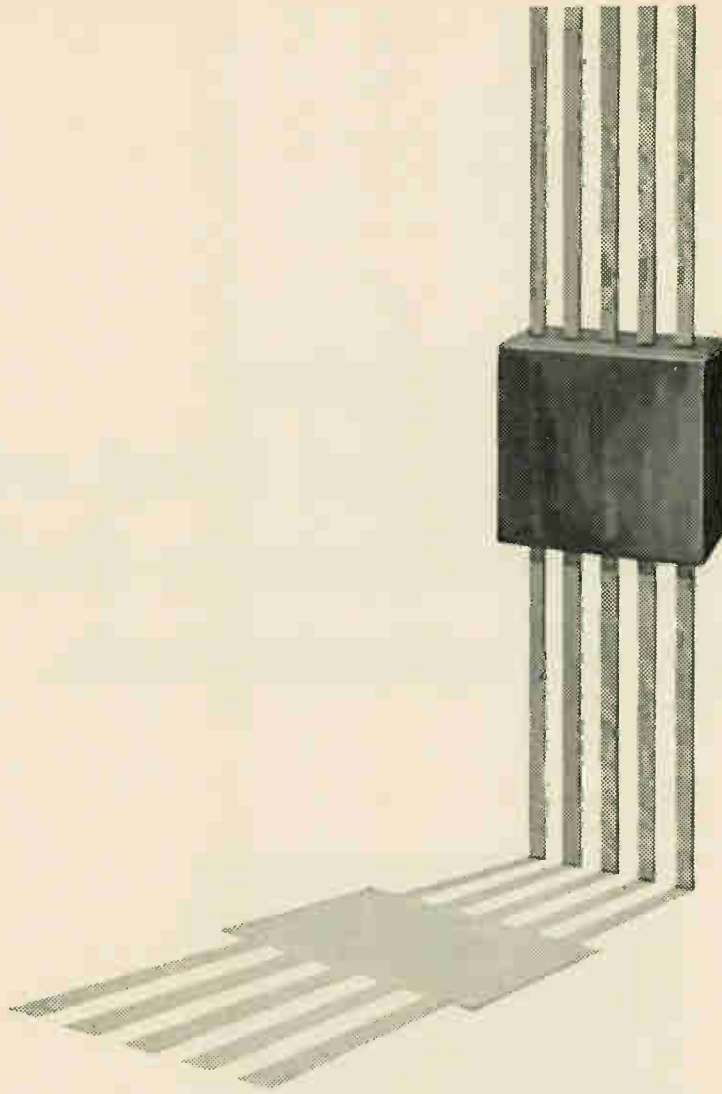

Paying \$2.00 for a 2¢ package ?

High quality protection—for just cents instead of dollars—is now possible in packaging integrated circuits with Dow Corning® silicone molding compound. So why pay the high costs of metal-to-glass seals so vital in metal cans and glass packages?

Device performance—in the past—could only be assured by these costly packaging approaches. Plastic packages available then affected device performance... failed to provide sustained protection.

Now, long term reliability—with Dow Corning silicone molding compound—is assured... device performance is equal to that obtained with metal and glass packaging. That's be-

cause silicone molding compound will not contaminate junctions, deform during soldering, burn, leach with heat or age and passes military moisture resistance tests. These properties, combined with its ability to be formed by molding, mean packaging economies without loss of device performance.

Improve your competitive position: Specify integrated circuits packaged in Dow Corning molding compound and take advantage of low cost packaging that affords high performance protection. For a list of manufacturers who offer various devices protected by this silicone material, write Dept. 3901, Electronic Products Division, Dow Corning Corporation, Midland, Michigan 48641.

DOW CORNING

NOW! Measure Noise and Field Intensity INSTANTLY with ONE Integrated Unit 1-10 gc

EXPANDABLE WITH ONE MODULE 10-22 gc



NEW!

Empire* NF-112-F Noise and Field Intensity Meter

- Automatic Variable Speed Scanning (Full and Sector)
- Impulse Noise Generator Calibration
- X-Y Plotting Provision
- Average, peak and metered slideback detection
- Dual Bandwidths—Narrow and Broadband

NOW you can measure noise and field intensity INSTANTLY over the entire 1-10 gc frequency range with ONE integrated unit, and CONVENIENTLY over the entire 10-22 gc range with ONE tuning module.

The new EMPIRE NF-112-F Noise and Field Intensity Meter combines advanced versions of the 1-10 gc tuning modules of the field-accepted NF-112 into one convenient package — your assurance of dependability and full compliance with the most stringent of military and commercial test requirements.

PLANNED UN-Obsolescence—is the unique METRICS concept of designing state-of-the-art instruments capable of fulfilling your expanding needs. Typical is

the Empire NF-112-F, which provides modular range expansion from 10 to 22 gc, and anticipates dramatic operational improvements. You save today and tomorrow through *Planned Un-obsolescence*.

INSTANT INTEGRAL operation is possible through Automatic Scanning and complete functional one-unit design. The NF-112-F is the world's only NFI Meter to provide Automatic Variable Speed Scanning, Impulse Noise Generator Calibration, and range-extendability *all in one light, integral package*. It is ideal for rack or field vehicle installation.

With the NF-315 (20 cps - 15 kc), NF-105 (14 kc - 1gc) and NF-112 series, the entire frequency range of 20 cps to 22 gc is covered with just three instruments.

MATCHED SYSTEMS CAPABILITY

Another exclusive! Typical is the *Empire PA-210 Spectrum Signature Analyzer*, which provides rapid display of RFI signals, and is matched to the NF-112-F and other *Empire NFI Meters*.

Empire devices are designed to match existing and planned instrumentation—minimizing complications in systems design—such as impedance matching and extra calibration.



Contact your Metrics Representative for descriptive literature and demonstration.

THE SINGER COMPANY
METRICS DIVISION

915 PEMBROKE ST., BRIDGEPORT, CONNECTICUT
PHONE (203) 306-3201 • TWX 710-453-3483

Design and production of PANORAMIC • SENSITIVE RESEARCH • EMPIRE • GERTSCH instruments for measurement



**You've just
decided to use
a lighted
pushbutton,**



**instead
of a
toggle
switch.**



Are you going to have to switch SWITCH suppliers?

Well, if you have been considering one of the 3,150 toggle switches we have at Control Switch, you can quietly stay right where you are and start considering one of our 1,800 lighted pushbutton switches.

Same salesman. Same distributor. Same supplier. Same superior engineering for applications where you can't afford to have a switch goof, even after a hundred thousand actuations.

You can stay with us just as easily, too, for leaf and lever, interlock and limit, hermetically-sealed and environment-free switches. To find out how convenient switch shopping can be, send for all the catalogs listed at the right. They'll put a mighty comprehensive switch reference file at your fingertips. Check with your nearest Control Switch distributor, too.

Here's the line-up! Check numbers on the Reader Service Card corresponding to those on the left below for any or all catalogs you want.

- 231 *Condensed Switch Catalog 100*
- 232 *Basic Snap-Action Switch Catalog 110*
- 233 *Toggle Catalog 180*
- 234 *Indicator Light Catalog 120*
- 235 *Hermetic Switch Catalog 130*
- 236 *Switchlite Catalog 220*
- 237 *Pushbutton Catalog 190*



CONTROL SWITCH DIVISION
1420 Delmar Drive, Folcroft, Pennsylvania 19032,

Cascode With FETs?

A parody on tubethinking, circa 1943

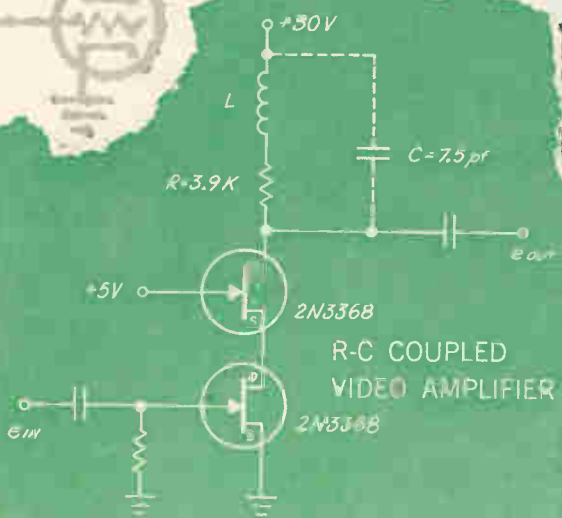

R-C COUPLED VIDEO AMPLIFIER

$C =$ Output capacitance + input C of next stage + shunt and stray circuit C

$L = mR^2C$
Depending on allowable overshoot in pulse response
"m" may vary from 0.25 to 0.6

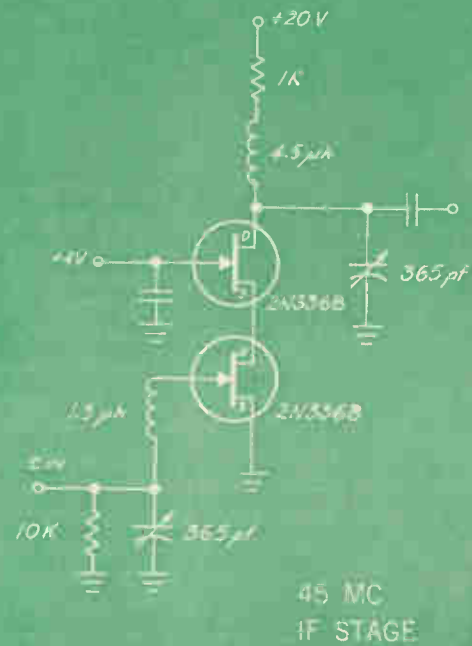

45 MC IF STAGE

Siliconix assumes no responsibility for circuits shown, nor does it represent or warrant that they do not infringe any patents.

A single triode tube was usually avoided in wide-band circuits or pulse applications because Miller effect capacitance seriously loaded the input. Then came the cascode scheme, lower noise, practically no more input capacitance than the tube's C_{gk} . Using FETs in cascode, you have a striking reduction in input C . With shunt peaking, the circuit shown offers a voltage gain of 10 with a 3 db bandwidth over 6 mc.

Cascodeing again with the 2N3368, we have an IF amplifier operating at 45 mc without neutralization. It has 20 db power gain and a bandwidth greater than 6 mc; for more gain cascade several stages. For more information on cascode-connected FETs, plus the ever-popular FET bibliography (72,000 now in circulation) drop us a line or circle the bingo number. Yes, the arrow is pointing the right way; *the 2N3368 is one of 24 new N-Channel FETs from Siliconix!*

Now available: MONITOR II PRODUCTION FET TESTER
First test set to check FETs, N- or P-channel, junction or MOS.
Go, No-Go, or analog readout; drives printer or digital voltmeter without modification. Write for further information.

 **Siliconix incorporated**
1140 W. Evelyn Avenue • Sunnyvale, California 94086
Phone 245-1000 • Area Code 408 • TWX 408-737-9948

FRANCHISED DISTRIBUTORS

ALA., HUNTSVILLE, Tec-Sel, Inc., 837-4541 • ARIZ., SCOTTSDALE, Barnhill Associates, 947-5493 • CALIF., HOLLYWOOD, Hollywood Radio and Electronics, 464-8321 • LOS ANGELES, Kierulff Electronics Inc., 685-5511 • MENLO PARK, Hollywood Radio and Electronics, 322-3431 • SAN DIEGO, Kierulff Electronics Inc., 278-2112 • SAN JOSE, Weatherbie Industrial Electronics, Inc., 297-9550 • COLO., DENVER, Barnhill Associates, 934-5505 • CONN., HAMDEN, Cramer Electronics Inc., 288-7771 • FLA., WEST PALM BEACH, Perrott Associates, Inc., 585-8647 • WINTER PARK, Perrott Associates, Inc., 647-3038 • ILL., CHICAGO, Semiconductor Specialists, Inc., 622-8860 • MD., BALTIMORE, Wholesale Radio Parts Co., Inc., 685-2134 • MASS., NEWTON, Cramer Electronics, Inc., 969-7700 • MICH., DEARBORN, Semiconductor Specialists, Inc., 584-5901 • MINN., MINNEAPOLIS, Semiconductor Specialists, Inc., 866-3435 • MO., ST. LOUIS, Semiconductor Specialists, Inc., 521-8866 • N. J., BERGENFIELD, Technical Electronics Distributors, Inc., 384-3643 • N. Y., BUFFALO, Summit Distributors, Inc., 884-3450 • NEW YORK CITY, Milgray, 989-1600 • SYRACUSE, Eastern Semiconductor Sales, Inc., 455-6641 • OHIO, DAYTON, Alpine Industries, Inc., 278-5861 • Semiconductor Specialists, Inc., 277-9784 • OKLA., TULSA, Oil Capital Electronics Corp., 836-2541 • PA., PHILADELPHIA, Simco Electronics, Inc., 299-1880 • PITTSBURGH, Semiconductor Specialists, Inc., 731-2050 • YORK, Wholesale Radio Parts Co., Inc., 755-2891 • TEX., DALLAS, Sterling Electronics, Inc., 351-9921 • HOUSTON, Lenert Company, 224-2663 • WASH., SEATTLE, Garretson Radio Supply, Inc., 682-8981 • WASH., D. C., HYATTSVILLE, MD., Milgray, 864-6330.
CANADA: MONTREAL; Preico Electronics, Ltd., 389-8051 • OTTAWA; Wackid Radio, Ltd., 232-3563 • TORONTO; Electro Sonic Supply Co., Ltd., 924-9251

DURANT

instrument counter accuracy with a
 $\pm .00000$ tolerance!



ENCLOSED

Both units shown actual size

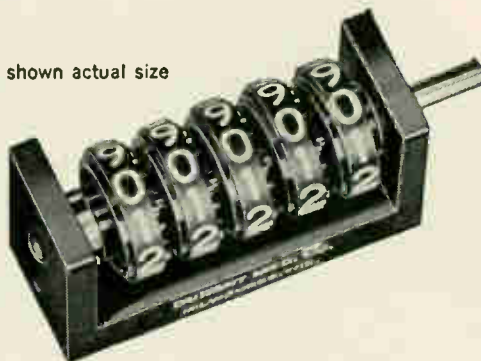

OPEN

Durant "Y" series counters are 100% accurate. No skipped numbers or lost counts. Speeds up to 1500 RPM continuous, 2000 RPM intermittent. Precision manufacture is one of the reasons. Here are others: built-in lifetime lubrication, one-piece die cast frame, stainless steel shafting and Nylatron pinions to mention just a few.

But that's only half of the Durant story. "Y" series instrument counters offer greater visibility than competitive models because of larger figures and open window design. They are also easier to "design in." 263 "standard" models offer the designer every conceivable variation of rotation, mounting, shafting arrangement and counting wheels. Ver-

satility without the expense and time delay inherent with "special" counters. "Y-7" models are resettable.

Durant "Y" series has been proven dependable when used in recorders, metering devices, tool position indicators, servo systems, digital voltmeters, navigation and other scientific instruments. They are as service free as a counter can possibly be.

"Y" series instrument counters are available in either open or the new enclosed models. Right or left hand drive. Clockwise or anti-clockwise rotation. Ability to add and subtract. Variety of special unit wheel graduations and drive ratios. Quiet operation. Low torque requirements.

Other "Standard" DURANT Instrument Counters

VERSATILE "D" SERIES

3, 4, 5 or 6-figure instrument counter without case . . . 1800 RPM intermittent duty, high speed models 2500 RPM intermittent duty . . . lubricated for life . . . fungus proof . . . 44 models . . . 1/4" figures . . . special unit wheels available.

SUB-MINIATURE "S" SERIES

3, 4 or 5-figure sub-miniature instrument counter without case for use where space and weight requirements are limited . . . 2500 RPM intermittent duty . . . lubricated for life . . . 12 models . . . 1/8" figures.

Write for Catalog 400; Durant Manufacturing Company, 612 North Cass Street, Milwaukee, Wisconsin 53201

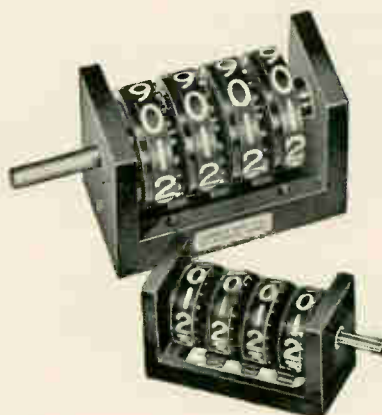

DURANT[®]
MANUFACTURING COMPANY
MILWAUKEE, WISCONSIN

The World's Best Receiver Systems use LEL Receiver Components Like These...

right out of LEL's Catalog!

RF PRESECTOR

1st CONVERTER

2nd CONVERTER

LINEAR/LOG IF

LIM. DISCRIMINATOR



Strip Transmission Line RF Preselector FSB 2250-100-5-T-NF

Freq. range 2200-2300MC
Response Tchebychev
Insertion loss 1db max.
Stop band loss 40db
Skirt shape 5 poles
Fixed tuned

Solid-State Mixer Preamplifier Model Series - 9

RF range 125MC-40GC (more than 60 coax or waveguide mixers are available within this range)
N.F. (overall) 9db (typ.)
IF cf 160MC
Bandwidth @ 3db 50MC
Gain (RF/IF) 30db
Lin. output +10dbm

Solid-State High Level Converter Internal Xtal L.O. Model RTC-1

RF cf 160MC
RF bandwidth 35MC
IF cf 60MC
IF bandwidth 20MC
Gain 10db
Noise Figure 12.5db
Lin. input -10dbm

Solid-State Log Amplifier Model ITL-2

IF cf 60MC
Bandwidth @ 3db 20MC
Dyn. Range 80db
Sensitivity 20MV/db

Solid-State Linear Amplifier Model ITA-5

IF cf 60MC
Bandwidth @ 3db 20MC
Gain 70db
AGC 60db
Noise Figure 7db max.

Solid-State Limiter Discriminator Model ITF-1

IF cf 60MC
Bandwidth @ 3db 10MC
Sensitivity 1v/MC
Input 50 ohm
Output Vid. Det.

LEL's catalog is a good place for you to choose from thousands of standard units engineered and manufactured with special receiver applications like yours in mind. Chances are you'll find just what you need. If not, we'll modify any catalogued item in short order... or build to your specifications. *Why not call LEL now?*



AKRON STREET COPIAGUE, L. I., NEW YORK 11726

(516) Amityville 4-2200 / (516) PYramid 9-8200 / TWX Code 516-691-5085

COMPONENT, DESIGN AND RELIABILITY ENGINEERS

The Components and Materials Laboratory of Hughes Aircraft Company in Southern California has immediate needs for engineers to fill important positions in the following fields:

COMPONENT ENGINEERS APPLICATION

Provide technical consultation and liaison to design activities, assist in selection and application of component parts, participate in design reviews.

MICROELECTRONIC ENGINEERS

Evaluate integrated and thin film microelectronic devices, analyze failure modes, investigate effects of environments and materials on device characteristics, determine application criteria.

COMPONENT STANDARDS ENGINEERS

Coordinate component-equipment requirements, provide technical consultation, select vendors, determine evaluation programs, initiate procurement documentation.

RELIABILITY ENGINEERS

Coordinate reliability programs, con-

duct component failure analyses, define and direct experiments, establish mathematical models, investigate component performance.

COMPONENT DEVELOPMENT ENGINEERS

Develop components using advanced techniques, investigate new design concepts, study component phenomena, direct experiments and design evaluations.

MAGNETIC DESIGNERS

Design static magnetic components, develop new magnetic devices, investigate and apply new design concepts, initiate evaluation tests.

SUPERVISORS

In addition to requirements for both junior and senior engineers for these positions, several supervisory openings are available.

Requirements: B.S. degree in Physics

or Electrical or Mechanical Engineering and a minimum of three years experience in one or more of the following or associated technical fields:

Display Tubes	Semiconductors
Servo	Potentiometers
Switches	Capacitors
Relays	Resistors
Microelectronics	Magnetics
Instruments	Mechanical

U. S. CITIZENSHIP IS REQUIRED

For immediate consideration, please airmail resume to:

MR. ROBERT A. MARTIN
Head of Employment
Hughes Aerospace Divisions

HUGHES

HUGHES AIRCRAFT COMPANY

11940 W. Jefferson Blvd.
Culver City 54, California

An equal opportunity employer

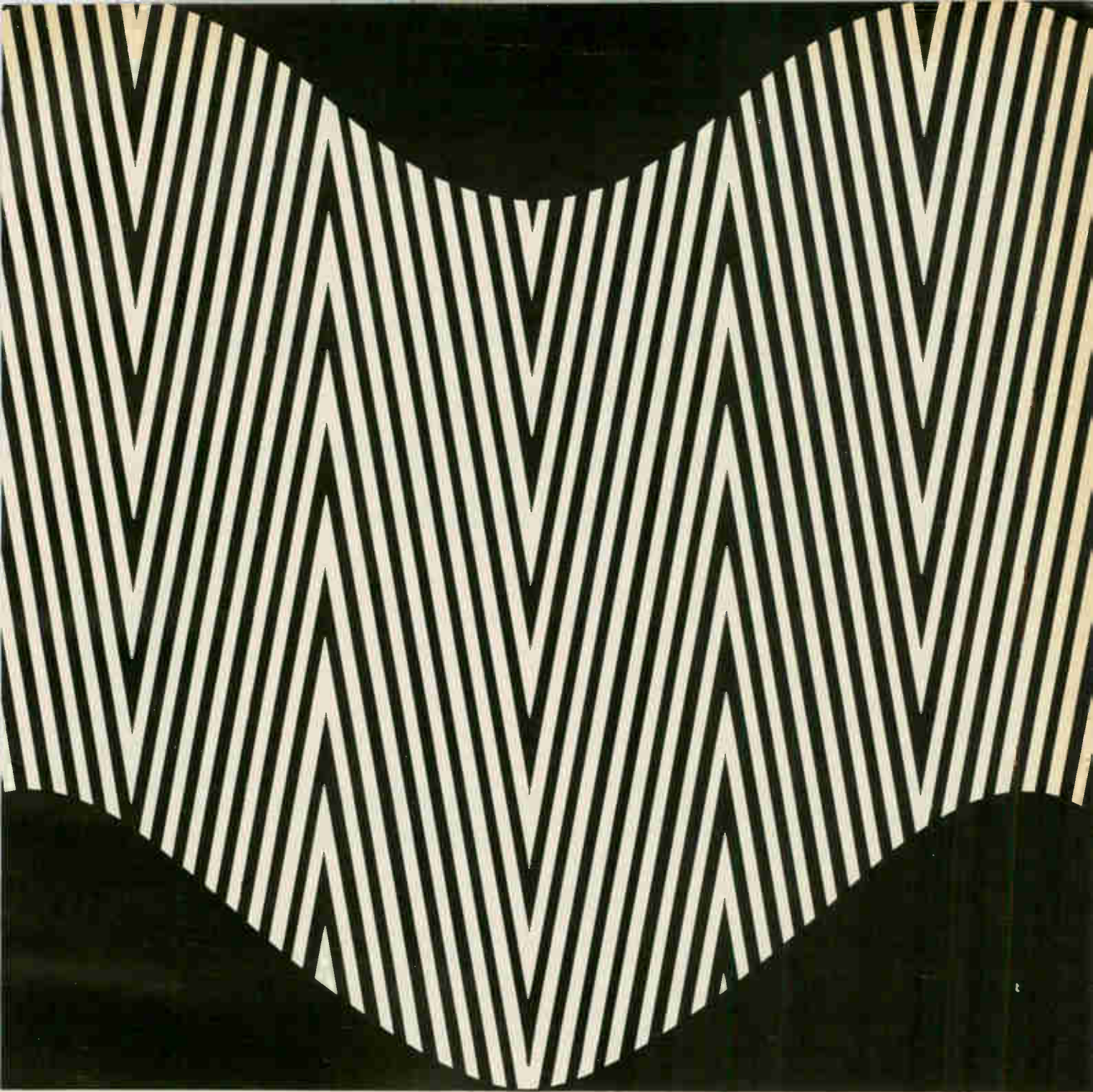

Optimizing the art... in microwave instrumentation

Typically, far-out instruments, such as ultrastable phase-locked oscillator systems, including readout, with setting accuracy to one part in 10^7 are ordinary off-the-shelf items at LFE; we'll ship several to you tomorrow. What we really like to sink our teeth into are ticklish problems like achieving ultrastability from 10 mc to 40 gc — residuals of better than 5 parts in 10^9 — phase-locking klystrons, BWO, and

VTM to oven controlled CRYSTALS — unique problems in noise measurement, frequency and pulse stability testing. Of course, our job is made much easier because of our advanced components capabilities — Optimized temperature controllers, transformers, amplifiers, and associated circuitry (we've got nifty delay lines, too). To OPTimize your measurements, OPT LFE.



LFE ELECTRONICS

A Division of Laboratory For Electronics, Inc.
WALTHAM, MASSACHUSETTS 02154

Delay Lines • Filters • Transformers • Amplifiers, and Associated Electronics
Microwave Measurement & Signal Generation Equipment

Circle 113 on reader service card

Facts about soft magnetic alloys which nobody else will tell you.

Any one of them could help you improve the design or production of relays, solenoids and magnetic switches.

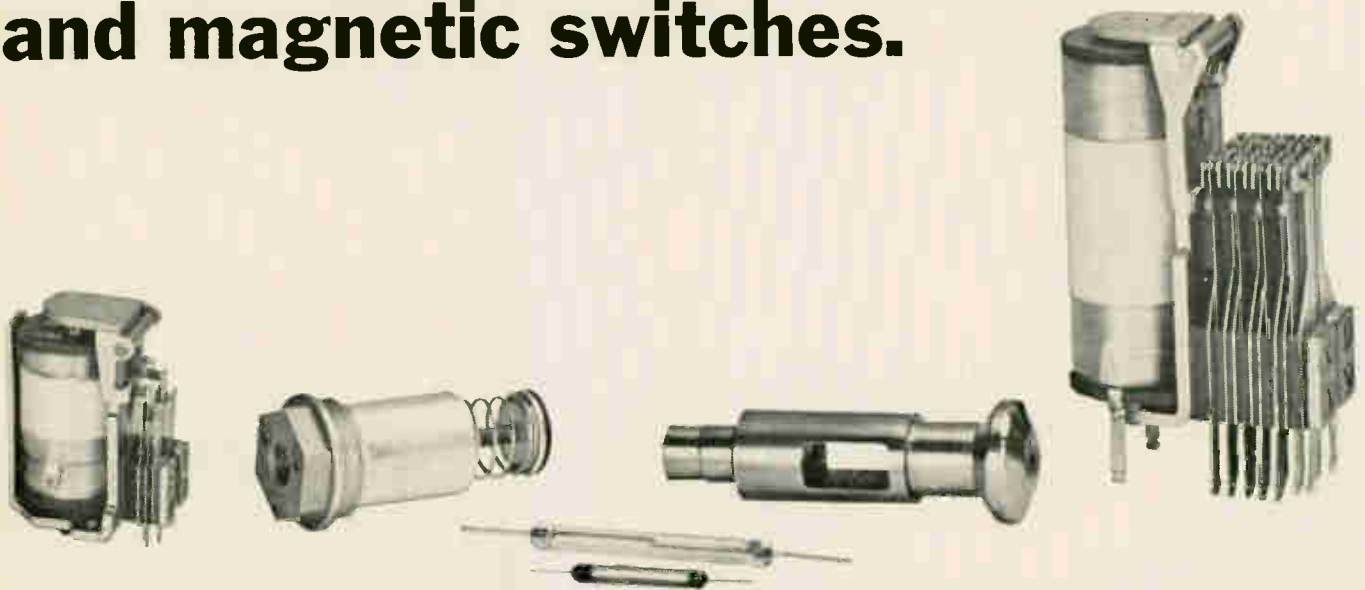

FACT NO. 1: You can get Silicon core irons with improved machinability without sacrificing magnetic or physical properties. For example: Carpenter's recently introduced Silicon Core Irons "A-FM" and "B-FM" for more economical volume screw machine operations.

FACT NO. 2: You can get corrosion resistance and still have low residual magnetism at high magnetizing force. How? By using Carpenter Type 430F Solenoid Grade.

FACT NO. 3: You can usually eliminate sticking relays by switching to a Carpenter soft magnetic alloy with less residual magnetism. For example: Carpenter High Permeability "49".

FACT NO. 4: You can get Carpenter Consumet Core Iron and Vacumet Core Iron with low gas content and minimum residual elements through vacuum melting. And Carpenter is the recognized leader in vacuum melting.

FACT NO. 5: You can get DC maximum permeabilities in excess of 200,000 for solid and laminated cores using standard design techniques. For example: Carpenter's HyMu "80".

FACT NO. 6: You can increase the operating efficiency of your solenoids by as much as 50% with proper heat treatment. We'll be glad to show you how to heat treat

these alloys so as to obtain optimum magnetic characteristics.

FACT NO. 7: You can have a wider choice of soft magnetic alloys. Carpenter offers you the most complete line available. And there are specialists to help you . . . experts who offer you the benefits of Carpenter's extensive experience and know-how in the development and production of soft magnetic alloys. We're waiting to serve you. Contact your Carpenter representative for qualified assistance. Or, if you prefer, write for our 68-page booklet, "Alloys for Electronic, Magnetic and Electrical Applications". The Carpenter Steel Company, 170 W. Bern St., Reading, Pa. 19603

Carpenter steel
IN A WORD, CONFIDENCE

ELECTRONIC, MAGNETIC AND ELECTRICAL ALLOYS • STAINLESS STEELS • HIGH TEMPERATURE ALLOYS
• TOOL AND DIE STEELS • SPECIAL-PURPOSE STEELS • TUBING AND PIPE • FINE WIRE SPECIALTIES

No matter what the test, Du Pont has a photorecording product to document the results:

(And if you don't see what you need . . .
contact your nearest
Du Pont Technical Representative.)

Lino-Writ Chemicals

Rapid processing kit (powder)—
processing of conventional papers in
stabilization processing equipment.

Liquid processing kit—
processing of conventional papers in
stabilization processing equipment.

Lino-Writ Developer—
conventional processing developer.

Rapid-access developer—
development by applicator-type processor.

Direct Writing Liquid Kit Type 1—
for processing unphotolyzed records on
direct writing photorecording papers.

Direct Writing Liquid Kit Type 2—
for permanizing photolyzed records on
direct writing photorecording papers.

High-speed stabilization chemicals (powder)—
for processing Lino-Writ 200 series papers.

Lino-Writ Photorecording Papers

Lino-Writ 1—3,000 i.p.s.†

Lino-Writ 2—6,000 i.p.s.

Lino-Writ 3—30,000 i.p.s.

Lino-Writ 4—50,000 i.p.s.

Lino-Writ 201 (Rapid Processing)—3,000 i.p.s.

Lino-Writ 202 (Rapid Processing)—6,000 i.p.s.

Lino-Writ 203 (Rapid Processing)—30,000 i.p.s.

Lino-Writ 5 (Direct Writing, Blue Sensitive)—
50,000 and 75,000 i.p.s.

Lino-Writ 7 (Direct Writing, Orthochromatic)—
85,000 i.p.s.

CRONAR* Photorecording Films

Lino-Flex Recording Film—Medium Speed, Light Matte

CRONAR Recording Film—High Speed, Clear Base

†inches per second

*Du Pont's registered
trademark for its
polyester photographic film



Photo
Products
Department



Better Things for Better Living . . . through Chemistry

THIS UNIT TESTS OVER 200



different types of digital cards and modules

Reduced to dollars and cents talk this means greater cost effectiveness for you. □ The Sperry Digital Card/Module Tester is actually a lightweight, compact computer. It's capable of instantaneously and automatically performing 80 tests involving measurements of delay times and true-false logic levels over a wide voltage range. □ It's ideally suitable for Factory, Flight line, Field shop and depot — wherever integrated circuits are used in military systems and sub-systems. □ The Sperry Digital Card/Module Tester weighs less than 50 pounds, is completely portable, meets requirements for MIL-T-21200 Class II equipment, is highly reliable, easily maintained.

Call **SPERRY MICROWAVE ELECTRONICS COMPANY, CLEARWATER, FLORIDA** immediately for a demonstration.



St. Joe is now supplying ZnO for -

MAGNETIC FERRITES • ZnO SINGLE CRYSTALS • PHOSPHORS • PHOTOCONDUCTIVE COATINGS

WHAT ELSE CAN ZnO DO IN ELECTRONICS ?

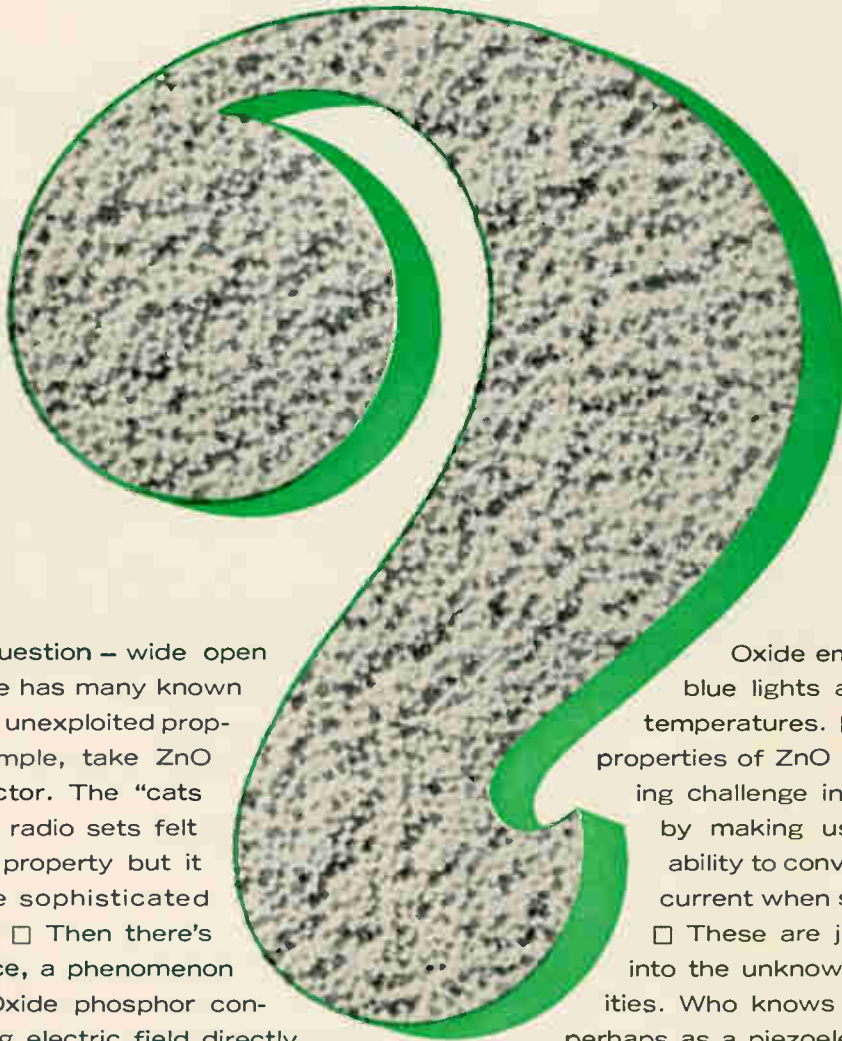

That's an open question – wide open because Zinc Oxide has many known but unexplored and unexploited properties. □ For example, take ZnO as a Semi Conductor. The “cats whisker” in crystal radio sets felt the effect of this property but it offers much more sophisticated possibilities today. □ Then there's Electroluminescence, a phenomenon in which a Zinc Oxide phosphor converts an alternating electric field directly into cold light. In using this property in light amplification, digital computers, television and other electronic devices, science is just crossing the threshold to a vast area of potentials. □ Other unexploited properties of ZnO involving light are Thermoluminescence – the ability to convert infra red rays into visible light, and Candoluminescence – wherein Zinc

Oxide emits brilliant red and blue lights at specific elevated temperatures. □ The Photovoltaic properties of ZnO present an interesting challenge in energy conversion by making use of Zinc Oxide's ability to convert light into electric current when suspended in water. □ These are just a few glimpses into the unknown realm of possibilities. Who knows what ZnO can do, perhaps as a piezoelectric, as a thermocouple, as a resistance element, etc. □ But whatever the future possibilities, St. Joe Zinc Oxide will share in them so long as stringent scientific control of product purity and uniformity are prerequisites.



ST. JOSEPH LEAD COMPANY
250 Park Ave., New York, N.Y. 10017
A LEADING SUPPLIER TO AMERICAN
INDUSTRY FOR OVER A CENTURY ZNO-200

ZERO DEFECTS



Albert Canning (left) presents Martin's Quality Supplier Award to Horace Potter, president of Reeves-Hoffman.

Reeves-Hoffman is the first crystal manufacturer to earn Martin's coveted "Zero-Defects" award!

With delivery of over 1,000 defect-free crystal-controlled filters for the highly reliable Bullpup missile, Reeves-Hoffman becomes the first and only crystal manufacturer to earn Martin-Orlando's Zero Defects Award.

The product that won the award was a complex miniature network package, which consists of crystals, glass-to-metal seals, temperature controlling and other circuitry.

In making the presentation, Mr. Albert J. Canning, technical requirements chief, quality, of Martin-Orlando, said in part: "This award from the Martin Company for Zero Defects is intended to reflect the thousands of systems components that Reeves-Hoffman has previously delivered. . . . It represents excellence in performance."

We think it is important to note that the award is also based on management cooperation and the meeting of scheduled delivery dates. Shipping defect-free products merely qualifies a supplier for the award, but does not guarantee it.

Whether our products are for outer space, undersea or "down-to-earth" applications, we do our utmost to deliver "zero defects" shipments on time. We invite your inquiries.



REEVES-HOFFMAN
DIVISION OF **DCA**



400 WEST NORTH STREET, CARLISLE, PENNSYLVANIA 17013

Start Designing Now with Integrated Circuits — the Easiest, Fastest, Most Economical Way



Get a TI Designer's Kit from R. V. WEATHERFORD

Here's everything you need to get a headstart in modern logic design — newest Series 73 modified DTL integrated circuits, test sockets, applications circuits, complete device data — all for much less than the price of the items if purchased separately.

In your Texas Instruments Series 73 Designer's Kit you'll receive:

- Eight digital integrated circuits in hermetically sealed flat packs — representing 24 separate circuit functions (flip-flops, gates, dual EXCLUSIVE-OR, and "one shot").
- Six breadboarding sockets. Each integrated circuit is mounted in its own *Mech-Pak*™ carrier for quick, easy transfer from socket to socket to accomplish various circuit functions.
- A mechanical sample of TI's new 16-pin plug-in flat pack. This is an optional package for Series 73 circuits, specially designed for fast insertion and flow-soldering.
- Applications Guide including sample assemblies that can be built with kit components.
- 28-page data brochure describing electrical and mechanical details of Series 73 integrated circuits.
- Catalog of TI's full line of more than 125 digital and linear integrated circuits.

Demonstrate for yourself the many economies and the high performance inherent in integrated-circuit design. Start now to design and breadboard integrated-circuit assemblies such as counters, shift registers, adders, and . . . well the rest is up to you. Order your kit today.



R. V. WEATHERFORD CO.

DISTRIBUTORS OF ELECTRONIC COMPONENTS AND EQUIPMENT

GLENDALE 1, CALIFORNIA: 6921 San Fernando Road, VI 9-3451
ANAHEIM, CALIFORNIA: 1651 State College Blvd., KI 7-7521
PALO ALTO, CALIFORNIA: 3240 Hillview Drive, Stanford Industrial Park, DA 1-5373





These slim PC Correed* terminals have “I-Beam Strength”

They make AE's new
printed circuit
dry reed switches
easier to insert...and
keep electrical contacts positive.

For extra strength and rigidity, the terminals are “ribbed” like an I-Beam.

Why? Because new PC Correeds are specifically designed for direct insertion into standardized grids. Terminals are spaced in multiples of 0.200 inches—for compact wiring pads and high packaging density. Magnetic shields surround the coils, preventing interaction. Diodes can be soldered directly to the upper side of terminals.

*U.S. patent applied for.

And for an extra measure of moisture resistance, AE uses glass-filled plastic bobbins. It's a practical way to prevent electrical failures.

What's more, the terminals in PC Correeds are separate from the leads. They're welded to the leads—not soldered. This takes the strain off the glass capsules.

Want some helpful information? Get fully detailed data on new AE Printed Cir-

cuit Correeds. See how they meet the needs of modern electronic circuitry. Simply write to the Director, Electronic Control Equipment Sales, Automatic Electric Company, Northlake, Illinois 60164.

2-capsule
(Forms 2A, 1B, or
1A Mag. Latch)

3-capsule
(Forms 3A,
2B, or 1A-1B)

5-capsule
(Forms 5A
or 2A-2B)



AUTOMATIC ELECTRIC
SUBSIDIARY OF
GENERAL TELEPHONE & ELECTRONICS **GTE**

YOU'LL NEVER DO IT!

WE ALREADY HAVE!

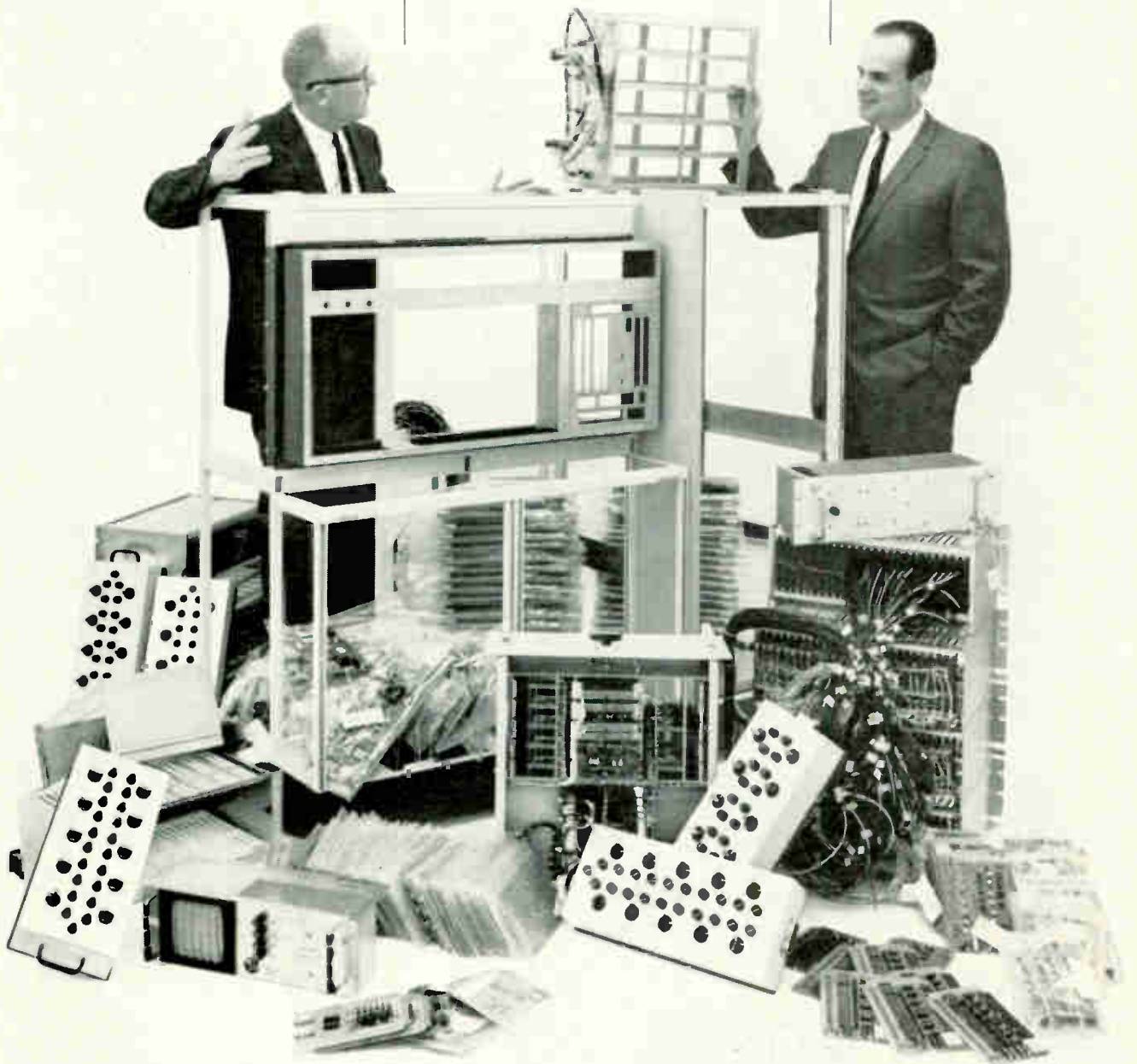

Superior packaging techniques enabled COMCOR to place *all* these components in our new 100-volt analog/hybrid computer. Recently introduced at the Fall Joint Computer Conference, the Ci-175 is designed for industrial firms that require a small economical computer for research, development, production and processing. Solid state throughout the Ci-175 will accommodate up to seventy-five 100-volt, 50 ma operational

amplifiers. Each system has built-in digital logic capabilities with separate logic patchboards, and full iterative timing and control. Ideal for "building-block" expansion, units can be joined for multiple systems requirements. For a look at the assembled unit, plus technical information and applications assistance—see *your COMCOR representative or contact COMCOR direct. Telephone (714) 772-4510 • TWX 714-776-2060.*



COMCOR

A SUBSIDIARY OF ASTRODATA, INC.

1335 SOUTH CLAUDINA STREET / ANAHEIM, CALIFORNIA 92803

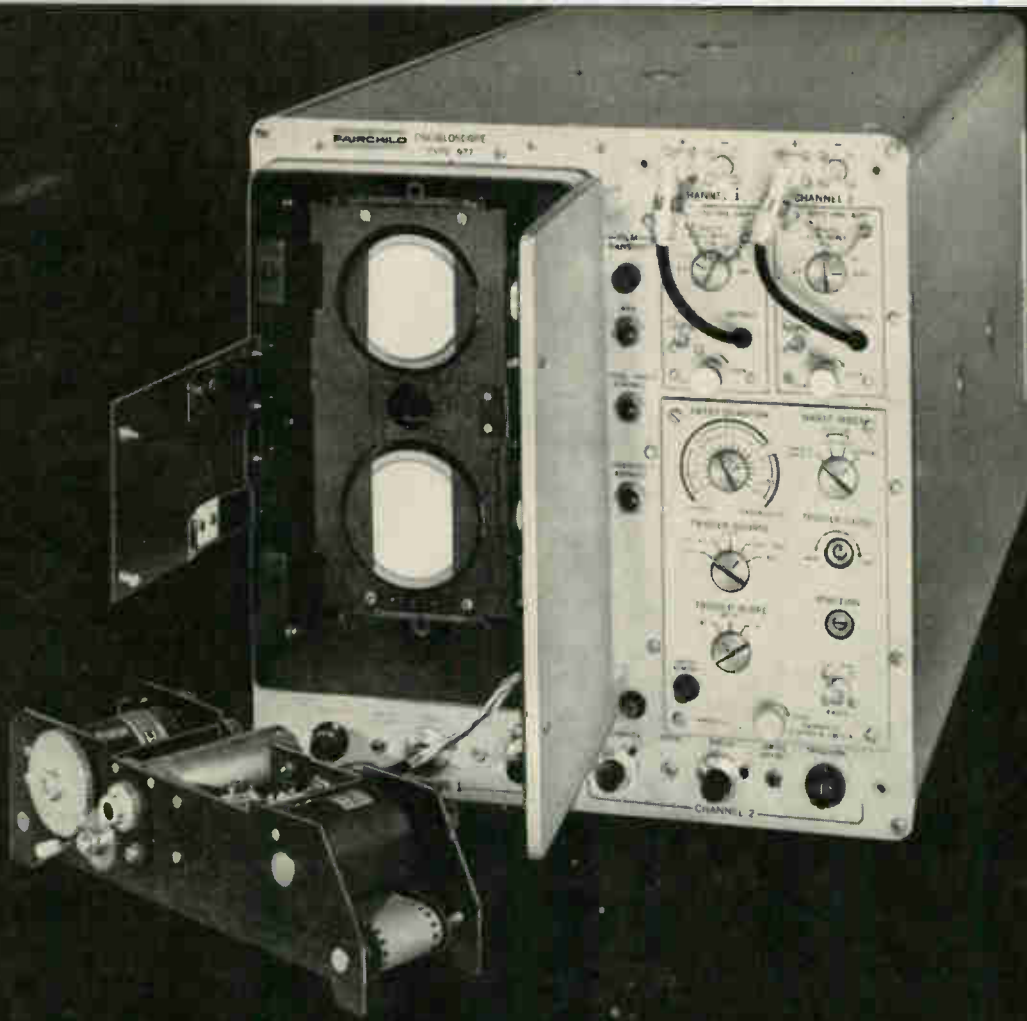

Typical single-shot photo of fast risetime pulses recorded on 977 Fiber Optic Oscilloscope using Type 2475 film.

You're looking at the first fiber optic oscilloscope

Here is another state-of-the-art development from Fairchild—the Type 977 fiber optic oscilloscope. It's the only commercially available fiber optic oscilloscope. The use of fiber optics, with their superior light-gathering power, enables the 977 to photo-record extremely fast wide-band transients. Two fiber optic CRTs provide a minimum resolution of 350 trace widths in the signal axis, 450 in the time axis. Single shot photographic writing rate is more than 5×10^{10} trace widths per second on Type 2475 film (ASA 1600 speed). That's less than an order of magnitude away from the speed of light.

Each unique faceplate contains more than 23 million glass fibers; each is 7 microns in diameter. The film transport holds each frame of 35mm film in contact with the faceplate. The 977 features two separate but identical signal channels of 100 MHz bandwidth. Risettime is 3.5 ns. Input is single ended or differential. Differential sensitivity is 1.25 v full scale, or 3.6 mv per spot diameter. Plug-in preamplifiers may be used for investigating smaller signals at a reduced bandwidth.

Ruggedized for use in the field as well as in the lab, the 977 employs

solid state circuitry throughout. The CRTs are potted as integral parts of the tube-shield assemblies.

The 977 fiber optic scope is another Fairchild "first." There will be many more. Look to Fairchild for innovations in the art of measurement. For Application Note 103 on Fiber Optics Photo Recording, write Fairchild Instrumentation, 750 Bloomfield Avenue, Clifton, New Jersey.

FAIRCHILD
INSTRUMENTATION

Probing the News

Space electronics

Rendezvous—the first step on the long journey home

NASA is deciding which system—radar or optics—will best guide the moon explorers in LEM to rendezvous with the orbiting command module for the return trip to earth

By Thomas Maguire

Boston Regional Editor

As the \$30-billion Apollo program for a round trip to the moon pushes well past the halfway mark this month, one crucial question is still being debated: what is the best system for the men who land on the moon's surface to rendezvous with the orbiting command module for the trip to earth? Should they depend on a radar or on an optical system to guide them to the rendezvous? While space officials de-

cide, both systems are being developed.

The final choice will be installed in the lunar excursion module (LEM) so the two moon explorers can home in on the command and service module (CSM) after they blast off from the moon. While the astronauts explore the moon, the CSM will wait by orbiting 80 miles above them.

Indecision. Until a year ago, the

plan was to use radar for the rendezvous trajectory, guiding the LEM close enough to the CSM for a manually controlled docking maneuver in the final stage. But the National Aeronautics and Space Administration decided to develop the LEM Optical Rendezvous System, known as LORS, to compete with the radar method.

Some NASA sources say the choice between radar and optics

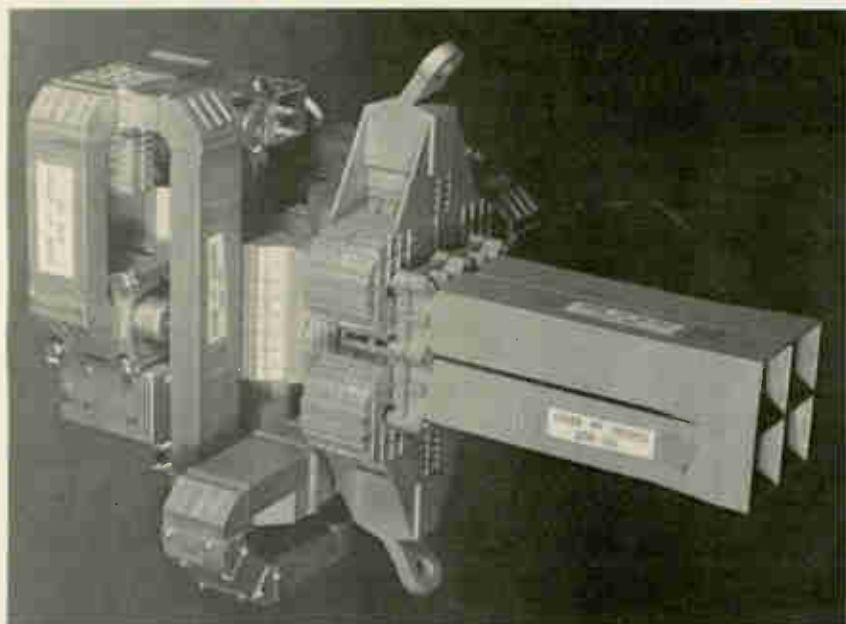

Before the lunar excursion module blasts off the moon's surface to rendezvous with the orbiting command service module for the return to earth, LEM's rendezvous radar must track the command module for several orbits, scanning a sector 140° by 225°. After blast-off, the 37.5-pound radar assembly locks onto the module and homes in to effect a rendezvous. The electronics package of the X-band system at the left includes the polarization duplexer, tone modulator, monopulse comparator, preamplifiers and gyros.

will be made within the next couple of months. Others claim the decision won't be made for a year.

The radar development is far ahead of the optical system. The Radio Corp. of America's Aerospace Systems division, Burlington, Mass., won the award for it in 1963 as part of a \$23.5-million radar subsystem contract. One preproduction model has already been delivered and a second model is scheduled to be turned over to the Grumman Aircraft Engineering Corp., the prime contractor for LEM, next month.

There is no optical system yet. Hughes Aircraft Co. got the 18-month contract only last summer, and thus far has produced just enough hardware to test the gimbaled telescope that would zero in on a flashing beacon to show the LEM astronauts the road back.

I. On the scales

The two systems will be compared by size, weight, power drain, simplicity and, of course, operational capability. Hughes claims the optical technique will offer advantages in all these areas.

Those for radar. Proponents of radar point to a safety feature that the optical system doesn't have: the radar can show range and range rate even if the guidance computer should fail. With optics, this information would have to be processed through a computer.

Also, optics is plagued with more than the ordinary line-of-sight requirement. Sunlight might blind an optical system, but a radar would work as usual.

Another plus for radar is the opportunity to test it prior to rendezvous as a ground-based device. Before leaving the moon, the two LEM astronauts would track the command module for several orbits to update the LEM computer information; it provides data for calculating a rendezvous trajectory requiring the least fuel.

Another point in radar's favor is its highly successful performance in the rendezvous of Gemini 6 and 7 [Electronics, Dec. 27, 1965, p. 31].

Advantages of optics. Advocates of the optical system argue that it, too, can track the command module from the moon's surface. Radar men say, however, that the module would need a very strong light,

which would require additional power and would add weight.

But the optics people claim less weight. Although the radar has been trimmed from 125 pounds to 70 pounds, Hughes hopes the optical system will weigh in at 50 pounds.

Either system—optical or radar—will work with the Apollo and LEM guidance and navigation systems being designed by the Instrumentation Laboratory of the Massachusetts Institute of Technology. A spokesman for the lab said the electrical interfaces for both systems would be identical, and only minor changes in the LEM computer programing are required.

II. Single-purpose radar

Since RCA began work on the rendezvous radar, the requirements have been reduced. For example, NASA last month decided to eliminate the system's secondary function which was to serve as a radar altimeter to back up the LEM landing radar system.

First of a kind. Like the Gemini rendezvous radar [Electronics, April 5, 1965, p. 110], the LEM radar is transponder-aided and would provide automatic guidance at long range. It could supply data up to within 50 feet of the target vehicle, but the present plan is for the astronauts to steer their vehicle manually to the CSM when they get close enough to see it.

The radar is designed to supply range, range-rate, and tracking angle data to the LEM guidance computer, and the same data plus angle rate information to the astronauts' display panels.

The primary output is to the LEM guidance computer, which calculates the flight plan for the rendezvous. The displays are for backup information should manual operation become necessary.

The rendezvous radar/transponder system (RR/T) is a phase-modulated, continuous-wave radar, the first ever in an aerospace operation. It has a longer range, and wider angular coverage than the Gemini radar, and it tracks by means of a gimbaled, inertially stabilized antenna.

Operating in X band, the RR/T is a solid state, coherent tracking radar, which means that LEM's transmitter and receiver and the



**AUTHORIZED
ERIE
DISTRIBUTOR**

For Erie Components In-Stock Call . . .

ARIZONA
Phoenix
Kierrulff Electronics Corp.—273-7331

CALIFORNIA
Glendale
R. V. Weatherford Co.—849-3451
Inglewood
Newark Electronics Corp.—OR4-8441
Oakland
Elmar Electronics, Inc.—TE4-3311
Palo Alto
R. V. Weatherford Co.—DA1-5373
San Diego
R. V. Weatherford Co.—BR8-7400
South Pasadena—Capacitors, Inc.—MU2-3541

COLORADO
Denver
Newark-Denver Elect. Supply—757-3351

DISTRICT OF COLUMBIA
Hyattsville, Maryland
Milgray/Washington, Inc.—UN4-6330

FLORIDA
Orlando
Crescent Elect. Sales Co.—423-8586

ILLINOIS
Chicago
Newark Electronics Corp.—ST2-2944

INDIANA
Indianapolis
Graham Elect. Supply, Inc.—ME4-8486

MARYLAND
Baltimore
Whlse. Radio Pts. Co., Inc.—MU5-2134

MASSACHUSETTS
Boston
DeMambo Electronics—783-1200
Cramer Electronics, Inc.—WO9-7700

MICHIGAN
Detroit
Newark-Ferguson Elect., Inc.—548-0250

MINNESOTA
Minneapolis 1,
Stark Electronics Supply Co.—FE2-1325

MISSOURI
St. Louis
Electronic Components for Industry
Kansas City Co.—647-5505
ECI Semiconductor, Inc.—931-0829

NEW MEXICO
Alamogordo
Kierrulff Electronics Corp.—437-0370
Albuquerque
Kierrulff Electronics Corp.—268-3901

NEW YORK
New York
Arrow Electronics—MY4-6800
Newark Electronics Center—255-4600
Milgray Electronics, Inc.—YU9-1600
Rochester
Rochester Radio Supply Co.—454-7800

NORTH CAROLINA
Winston-Salem
Electronic Wholesalers, Inc.—PA5-8711

OHIO
Cincinnati
Newark-Herrlinger Elect. Corp.—
Columbus 421-5282
Electronics Marketing Corp.—299-4161

OKLAHOMA
Tulsa
Texas Instruments Supply Co.—
LUL3-8121

PENNSYLVANIA
Philadelphia
Radio Elect. Serv. Co. of Pa., Inc.—
Pittsburgh WA5-5840
Cameradio Company—391-4000

TENNESSEE
Nashville
Electra Distributing Co.—AL5-8444

TEXAS
Dallas
Texas Instruments Supply—FL7-6121
Houston
Texas Instruments Supply—MO6-2175

WASHINGTON
Seattle
Universal Electronics Co.—MA3-2783

CANADA
Montreal 12, Quebec
Preico Electronics Ltd.
389-8051
Toronto, Ontario
Alpha Aracon Radio
Elect. Ltd.—635-6181
Vancouver 2, B.C.
Western Agencies Ltd.
685-7221





CALL YOUR AUTHORIZED
ERIE DISTRIBUTOR FOR...

“ACTIVE”

SUBMINIATURE Electronic Components

BY ERIE

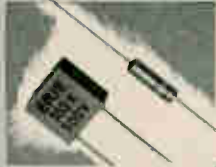

**SUBMINIATURE
MONOBLOC
CERAMIC CAPACITORS**
High capacitance to volume ratio.
Hermetically sealed in glass, precision
molded, and phenolic dipped types.



**MINIATURE
HERMETICALLY SEALED
BUTTON MICA CAPACITORS**
For -55 C to +200 C applications.



**SUBMINIATURE
BROAD BAND
R. F. I. FILTERS**
Eliminate RF noise in
10 KC to 10 KMC frequency range.



**HIGH RELIABILITY
TUBULAR and DISC
CERAMIC CAPACITORS**
General Purpose Temperature
Compensating, and High Stability types.



**MINIATURE
CERAMIC and GLASS
TRIMMER CAPACITORS**
Precision Trimmers with capacitance
and terminal arrangements to suit need.



**MINIATURE
FEED THRU and STAND-OFF
CERAMIC CAPACITORS**
Threaded bushing, eyelet, solder
type, high voltage types.



**MINIATURE
FILM CAPACITORS**
Designed for filter, bypass,
coupling and blocking applications.



**SUBMINIATURE
DIFFUSED SILICON RECTIFIERS**
High forward conductance, low-leakage
currents and reliable performance.
**FULL WAVE BRIDGES and
FULL WAVE DOUBLERS**
Rectifier assemblies in modular size for
printed circuit applications.



**SUBMINIATURE
SILICON GLASS DIODES and
GERMANIUM DIODES**
General purpose, fast-switching,
hermetically sealed types.

ERIE'S Project "ACTIVE" (Advanced Components Through Increased Volumetric Efficiency) now brings to electronics a series of high performance, subminiature components designed for applications where every cubic inch of space and every ounce of weight is critical to successful equipment performance.

These "ACTIVE" Erie components have been and are being designed into the circuitry of such demanding systems as Gemini, Apollo, Minuteman, Nike X, Telestar, Polaris, Honest John... advanced computers, oscilloscopes... and many other applications where size, weight and maximum reliability are vital.

We maintain complete inventories, in a wide range of values, of the Erie subminiature electronic components illustrated at left... and more. Remember, your authorized Erie distributor is *your one-stop source for quality components.*

- Write for your free copy of Erie's 28-page 1966 catalog
- Your nearby Authorized Erie Distributor is listed on the opposite page

ERIE
TECHNOLOGICAL
PRODUCTS, INC.

Formerly
Erie Resistor
Corporation



Advanced Components Through Increased Volumetric Efficiency

644 West 12th Street
Erie, Pennsylvania

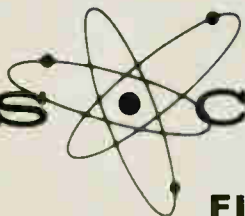
ANOTHER

NEMS-CLARKE
FIRST



A new equipment is available to the
telemetry systems designer.

- It is a
PREDETECTION DIVERSITY COMBINER
- It is a
POST DETECTION DIVERSITY COMBINER
- It is a
DUAL PREDETECTION CONVERTER
- It is a
PREDETECTION UP-CONVERTER
- It is a
COMPLETE DEMODULATOR
- It is

THE DCA-5100A
PREDETECTION/POST DETECTION
DIVERSITY COMBINER

All solid-state • Dual-channel • Optimum
ratio • AGC controlled • Five switch select-
able recording frequencies • 1000 cps
tracking loop bandwidth • Auto reset cir-
cuitry to reacquire phase lock • ± 500 cps
capture range

VITRO ELECTRONICS

PRODUCERS OF **NEMS-CLARKE** EQUIPMENT
 A DIVISION OF VITRO CORPORATION OF AMERICA

919 JESUP-BLAIR DRIVE • SILVER SPRING, MARYLAND • 2301 PONTIUS AVENUE • LOS ANGELES 64, CALIFORNIA

command module's transponder are all locked in phase. Solid state was used to insure low weight and high reliability.

The RR/T uses a varactor multiplier chain which steps up its input frequency of 102 megacycles to X band. For ranging, this X-band signal is then phase modulated with three tone frequencies: for coarse, medium, and fine accuracies.

The transponder on the command module sweeps in frequency and when it sees a signal from the LEM antenna, stops sweeping and locks into this signal. The transponder reradiates the received frequency plus a sidestep—a slight frequency shift. The signal sent back to LEM is 240/241 of the transmitted frequency plus one-half the doppler shift.

The LEM receiver, meanwhile, sweeps over a wider frequency range because of the round-trip doppler shift. When it senses the transponder radiation, the tone modulation is switched on automatically for range tracking.

Range rate is determined by measuring the two-way doppler frequency shift. The frequency tracker follows the coherent narrow-line spectrum received from the transponder. The tracker voltage-controlled-oscillator is phase-locked with the incoming signal.

IV. Light in the window

If the optical system under development by Hughes is substituted, the CSM will carry a flashing beacon of high intensity, pulsed 32 times per second and with a pulse width of 10 microseconds, says Hughes.

The beacon will peak at 350 watts, the peak power available on the CSM. The LEM will carry an optical tracker—a telescope mounted on gimbals—with a total field of view of 8 milliradians.

At the start of the ascent toward rendezvous, the tracker will scan the area in horizontal, or vertical, stepped sweeps until it picks up the beacon, isolating it from the star background. Then, using photomultipliers and control circuits, the tracker will go automatic and zero in on the beacon.

If, after nulling, the tracker still has to keep adjusting its gimbals, the tracker will feed signals to the LEM steering and thrust controls.

ADD

*new capabilities
to your*

SM-2000

SWEEP GENERATOR



These two new plug-in oscillators permit fast or slow scanning rates with built-in frequency indication and they're both solid-state.



VR-2M Plug-in Oscillator

200 Hz to 12 MHz

- Variable Sweeping Rate
- Ultra-stable Oscillator
- Built-in Variable Marker
- 1 V RMS Output

Here's the quickest route to direct determination of frequency response from audio through AM, FM, IF and video frequencies all in a single oscillator. The VR-2M gives the SM-2000 control unit a whole new degree of versatility in checking amplifiers, tuners, oscillators and other wide and narrow band devices. Sweeping rate of the unit may be varied from 0.01 to 100 Hz, and its integral marker system provides precise frequency location over the entire range. Output may be scope displayed or X-Y recording in slow mode, providing db vs. frequency, precisely and directly.



CRYSTAL FILTERS?

A primary application of the VR-2M is check-out of crystal filters. Exceptional stability and slow-sweep rates permit precise recordings of frequency response, as shown in the chart reproduction at left.

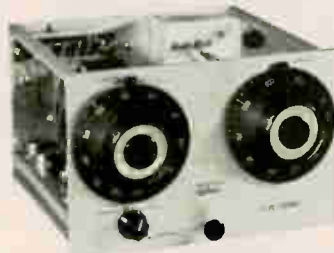

VR-50M Plug-in Oscillator

500 to 1000 MHz

- Sweeps 5 MHz to Full Octave
- Variable Sweeping Rate
- Solid State Dependability

The combination of an SM-2000 Controller with the new VR-50M oscillator can deliver a display of frequency vs db over its entire range of 500 to 1000 MHz in a single trace. It can also sweep any portion of that range from 5% up, and at a rate variable from .01 to 100 Hz. It provides fast answers for check-out, alignment and testing of frequency response in IF, RF, and broad-band video devices.

Combine all that performance with the VR-50's solid-state reliability, a .3v RMS level output, an integral, continuously variable frequency marker, and you have another reason why the SM-2000 is the most useful, inexpensive investment in swept instrumentation today.

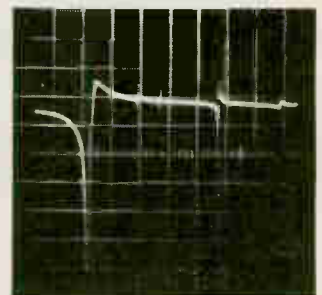

Detailed specification on these two new oscillators, the SM-2000 control unit and 18 other plug-in heads will be sent on request, or contact your nearest Telonic representative.

SWEPT FREQUENCY APPLICATIONS

An invaluable collection of data sheets covering swept frequency applications is also available—send for your set now.



INDUSTRIES, INC.

60 North First Avenue, Beech Grove, Indiana
Tel: (317) 787-3231 TWX: 810-341-3202

See Telonic at Salon des Composants in Paris, Booth 732.

Sealab II went swimmingly

Although the Navy's experiment in living at the bottom of the sea was a success, big problems still remain. The electronics industry has been asked to solve many of them

By Seth Payne

Washington News Bureau

Seven hundred signed up in advance and 1,400 arrived. Though each report was given twice, many industry representatives seeking to attend the symposium Jan. 11 and 12 in Washington on Sealab II were turned away. They wanted to hear the first details of the 45-day experiment in living at the bottom of the sea that began last August 28 off the coast of La Jolla, Calif.

Sealab is the man-in-the-sea portion of the Navy's Deep Submergence Systems Program [Electronics, Aug. 23, 1965, p. 111]. Twenty-eight men working in three teams stayed down for 14-day periods. One, astronaut Commander Scott Carpenter, stayed down for 45 consecutive days.

According to Navy officials, and

the engineers and aquanauts who lived in the underwater structure, the experiment was a great success. Man can successfully live and work on the ocean floor without harmful physical effect. However, better equipment is badly needed. The problems encountered in and around the 58-foot by 12-foot habitat are the performance requirements for a whole generation of new electronic equipment.

I. Communications

One of the weakest areas in the experiment was in underwater communications. Electronics engineer Berry L. Cannon of the Navy Mine Defense Laboratory, among the first to spend two weeks in Sealab II, says: "While swimming we

didn't really have any underwater communications—diver-to-diver or diver-to-Sealab." The problem, Cannon said, was speech distortion caused by helium.

Sealab contained a helium speech unscrambler for talking with the supply ship above, but, Cannon said, "while swimming, we had no such equipment while to overcome this problem." Even in Sealab there was an electrowriter—basically a pen and paper machine slaved to an identical machine in the supply ship—to back up the speech unscrambler.

Because of the helium effects, the Aquasonics communicator, which was tested twice in diver-to-diver use, was found unacceptable, as was the buddy-line system that uses bone phones.

Other problems. Helium was not the only problem in communications. To overcome the difficulty in articulation caused by the scuba mouthpiece, a mouthmask—similar to an oxygen mask—was designed. But this, Cannon said, interfered with breathing. A unit attached by wires affords poor voice intelligibility, Cannon said, and the diver may become entangled in it.

A good communicator is one using a modulated carrier with the entire package mounted on the diver's hood, Cannon said.

"A voice-operated microphone mounted in a gas-tight mouthmask would leave the diver's hands free. A bone-conduction unit could function as the earphone. And, some means of eliminating the helium speech distortion should be an integral part of the circuitry."

Cannon found that the AN/BQC 8.0875 kilocycle frequency single-



"We couldn't talk to each other. . . ." says Berry L. Cannon who spent 14 days in and out of Sealab II during its recent bottom-of-the-sea tests

GLASS-K

New CORNING® Glass-K Capacitor:
100,000 pf in this case size



Glass-K has rewritten the definition for size and stability with life* of CK-type capacitors.

CAPACITANCE—PF	STYLE CYK	SIZE		LIFE ΔC
		L Max.	D Max.	% (Max.)
1000 - 10,000	01	.250	.100	2%
12,000 - 20,000	01	.250	.100	2%
	02	.250	.140	
22,000 - 39,000	01	.250	.100	10%
	02	.250	.140	2%
47,000 - 51,000	01	.250	.100	10%
56,000 - 100,000	02	.250	.140	10%

The GLASS-K is a miniature stable capacitor that exhibits a high capacitance-to-volume ratio. It offers the size advantages of ceramic capacitors and the consistent performance associated with glass dielectrics made possible by development of a new dielectric material.

ADVANTAGES

- Smaller Size • Three Stability Characteristics • Repeatability (part to part) • Small ΔC with Life • Minimal Voltage Coefficient (AC & DC) • Good Frequency Characteristics • Automatically Insertable

*Method 108 mil std 202C. 200% rated voltage at 125°C for 1,000 hours.

Send for complete data to Corning Glass Works, 3901 Electronics Dr., Raleigh, N. C.

CORNING
ELECTRONICS

LIKE SILVER DOLLARS— WORTH MORE THAN FACE VALUE...



New Duncan Model 3233 —
a Commercial, $\frac{7}{8}$ " 10-Turn Precision
Wirewound Potentiometer. (Actual Size)

...AND THEY'RE NOT SCARCE— BUT AVAILABLE OFF THE FACTORY SHELF!

CHECK THESE VALUES...
2,000,000 Shaft Revolutions
 ± 0.25 Linearity
10 Ω to 200K Ω ($\pm 3\%$) Resistance Range
2.5 Watts at 40°C
-55°C to +105°C Temperature Range
100 oz.-in. Stop Strength
Uniform Torque

AND THESE BONUSES...
High-Impact Plastic Housing
Rugged Metal Lid and Clamp Bands
 $\frac{1}{4}$ " Stainless Steel Shaft
 $\frac{3}{8}$ -32 Coated Brass Bushing
Welded Terminations
Gold Plated Terminals

COST?... ONLY 7 CARTWHEELS and CHANGE—

\$7.13, that is, when you buy 250 at a crack
... and that's less than you'd pay
anywhere for a comparable pot.



Now for the first time, a rugged high-performance 10-turn precision potentiometer — backed by Duncan's engineering and production capability as one of the nation's leading manufacturers of high-reliability potentiometers for aerospace systems—available for your commercial/industrial applications. Don't flip a coin to select your pot source. Contact Duncan for complete technical data or prompt off-the-shelf delivery.

Look to Duncan for your "spec pots" too: linear, non-linear, single-turn multi-turn and multi-section.



DUNCAN electronics, inc.

2865 Fairview Rd., Costa Mesa, California • Tel.: (714) 545-8261 • TWX: 910-595-1128

sideband used to communicate between Sealab and the surface unit worked better than the Aquasonics communicator. Cannon says it sounded "just as clear as a telephone call." He said the Aquasonics equipment "had a lot of background noise" when used for the same task.

II. Other electronic gear

The pressurized helium atmosphere worked for and against the electronic equipment. Helium's heat transfer characteristic—which is about six times faster than air—improved efficiency by allowing the electronics to operate at much cooler temperatures than on land.

Helium leakage into pressure-sealed equipment, however, did cause problems. After several days in Sealab, some closed-circuit television cameras enclosed in pressure-proof housings lost contrast and focus capabilities.

Engineers ashore diagnosed the problem as leakage of helium past seals or diffusion through glass lens covers. As a result, internal pressure apparently built up enough to cause change in the electronic components, degrading the picture quality.

To correct this, new cameras were installed outside the Sealab II with the lens held flush against viewing portholes to monitor the aquanauts.

Some tv sets in Sealab II did not have leakage problems. The entertainment set was an 11-inch transistorized model sealed inside a pressure-proof container. The picture was visible through a 2-inch thick plexiglass window with O-ring seals.

Sonar. Similarly, Cannon reported, the hand-held AN/PQS-1B transistorized sonar worked well. It has a pressure-proof housing and could have been operated with the electronics package sealed at sea level pressure, Cannon thinks. To permit access to the batteries while the sonar was at Sealab depth, the housing was vented as Sealab was pressured to its 115 pounds per square inch. The sonar performed normally, Cannon said, with the components exposed. It is now back at the Navy's Mine Defense Laboratory and working well.

Minor problems occurred in Sealab II in plug connections with



15  15

Monolithic Diode Matrix

Now available in any configuration from 5x5 to 15x15. Another microelectronics breakthrough from Radiation Incorporated. New matrix, pictured actual size, is equivalent to 225 general-purpose planar diodes.



**RADIATION
INCORPORATED**

For data sheets, price and delivery information, write: Radiation Incorporated, Physical Electronics Division, Dept. EL-01, Melbourne, Florida 32902. Phone: (305) 723-1511.
Sales offices: 650 North Sepulveda Blvd., Suite 622, El Segundo, Cal., (213) 322-5432 • 600 Old Country Road, Suite 438, Garden City, N.Y., (516) 747-3730



new disciplines in DC

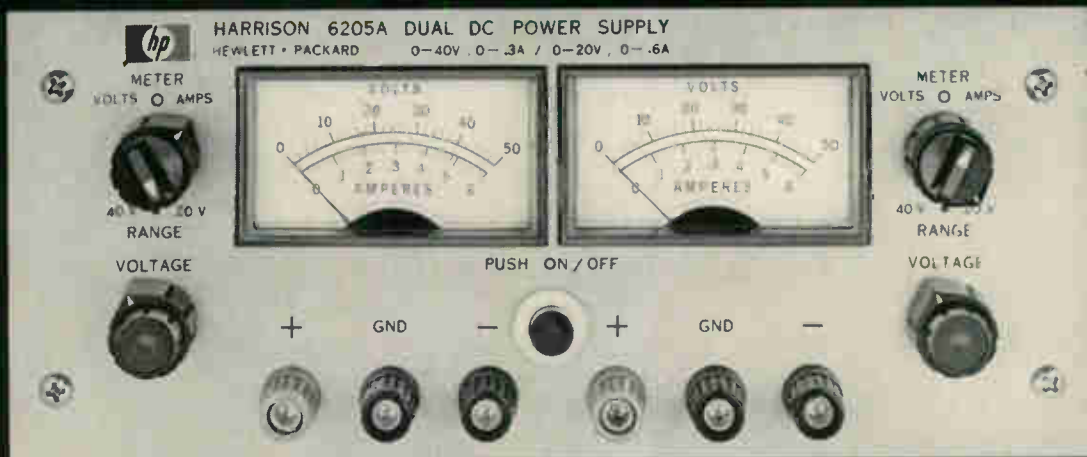

take the model with the unique equation ... **1+1=9**

Two dual range power supplies in one compact package provide nine different output combinations.

Many circuit applications require the simultaneous use of two DC power supplies — often a positive and a negative source. Harrison Division's versatile Model 6205A provides two independent outputs — each output can be set for either of two output ratings and can be operated as a plus or minus supply. Alternatively, the two sides can be seriesed to obtain up to 80 volts, or paralleled for up to 1.2 amps.

Multiple Scale Metering Optional • All-Silicon Design • Front & Rear Output Terminals • Remote Programming • Remote Error Sensing • 50 μ sec Recovery Time • Short-Circuit Proof • Current Limited Output • No Overshoot on Turn-On, Turn-Off, or Power Removal • Auto-Series, Auto-Parallel, Auto-Tracking Operation
 Rack Mounting Hardware Available.

OUTPUT A	OUTPUT B
0-20V @ 0-600 MA or 0-40V @ 0-300 MA	0-20V @ 0-600 MA or 0-40V @ 0-300 MA
Load Regulation:	0.01% + 4 MV
Line Regulation:	0.01% + 4 MV
Ripple & Noise:	200 μ V RMS
Size:	3½" H x 8½" W x 12¾" D
Weight:	10 Lb.
Price: Model 6205A	\$195.

HEWLETT
 PACKARD  HARRISON
 DIVISION

Contact your nearest Hewlett-Packard Sales Office for full specifications.

100 Locust Ave., Berkeley Heights, New Jersey 07922 AREA CODE 201 464-1234 TWX 201-464-2117

cabling running from the vehicle to the underwater weather station. Some current leakage occurred. Engineers believe seawater on the hands of the person that made the connections led to the leakage.

Another minor problem found in Sealab II was in changing outside lightbulbs. The divers must carry their own light source with them at these sunless depths. The Navy would like a versatile underwater light that is compact, inexpensive, portable, and with a bulb life of about 1,000 hours.

Habitat comfort. For the comfort of the aquanauts in future Sealabs, the most pressing need is for an atmosphere-control unit that operates automatically and with a high degree of reliability. Sealab II was outfitted with a closed-cycle life-support system that scrubbed out carbon monoxide through two lithium canisters. Odors were removed by passing the atmosphere through charcoal filters. Temperature was maintained at about 88°F with conduction, radiation and floor heating elements.

III. Full speed ahead

As a result of Sealab II, the Navy has new plans.

- Effective Feb. 1, the Deep Submergence Systems Program will be elevated to separate-office status under the Chief of Naval Material.

- Assistant Secretary of the Navy for Research and Development Robert W. Morse has been given policy supervision of ocean engineering and closely related matters.

- Morse is also chairman of a new Navy Oceanographic Policy and Programs Board.

- Sealab III has been moved up six months. It's now due on the ocean floor in January, 1967 instead of mid-1967. It will go deeper than Sealab II—more than 400 feet rather than 205 feet; it will cost between \$3 million and \$4 million, compared with the \$1 million to \$2 million of Sealab II; work will be done by industry rather than by the Navy; it will incorporate much that was learned from Sealab II.

In spite of the problems found with the Sealab experiment, the Navy is confident that its goals of being able to perform search, rescue and limited salvage operations at 600-foot depths within the next four years can be achieved.

*Will you be upset
if we now give you
an improved model
of our good old Type A time-delay relay*

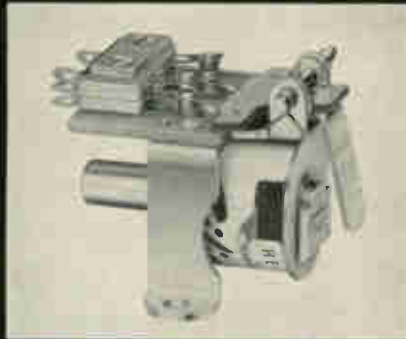

for the same good old price?

For years the Heinemann Type A time-delay relay has been a great buy for the money.

The second-generation model is an even better buy. It has a more efficient magnetic circuit. Heavier contact blades. Fine-silver contacts with gold-diffused contacting surfaces. Plus a few other refinements you can't hardly see unless you look very closely.

We haven't changed the hydraulic-magnetic actuating element one whit. (What kind of a nut would monkey around with a device that's been proved-out to the point of tedium?) And we haven't changed the package, either. The relay is still remarkably compact and light in weight.

The Type A and our other time-delay relay models are available in sixteen standard timings, from 1/4 to 120 seconds, with SPDT or DPDT switching and generous contact capacities (up to 5 amps at 125 or 250 VAC, in one model). All can be supplied with any of 20 AC or DC coil voltage ratings. And all have significantly lower power consumption and better temperature stability than thermal-type time-delay relays. Our Bulletin 5005 will give you full technical data. A copy is yours for the asking.

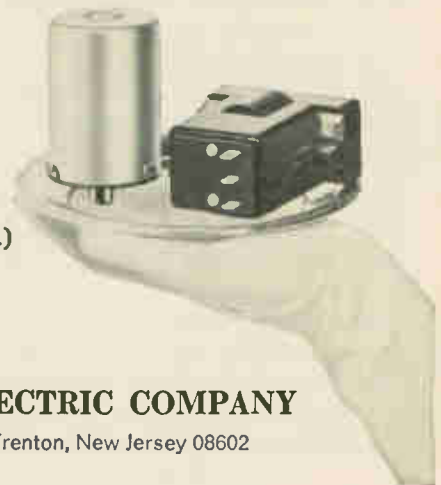

(We've improved these models, too.)



HEINEMANN ELECTRIC COMPANY

2600 Brunswick Pike, Trenton, New Jersey 08602

SA3327

Clash of symbols

Two opposing camps—the IEEE and the IEC—want to standardize symbols for insulated-gate field effect transistors but the American proposals face roadblocks on the way to a meeting in Tel Aviv

An electronics technician spent 30 frantic minutes last week trying to find out why a satellite his company was almost ready to deliver to Cape Kennedy was registering “dead” on the go-no-go indicator when that same morning the project engineer had pronounced it 100% “go.”

When the engineer came to his aid, he watched for a moment and spotted the trouble at once. The technician was testing for a depletion-type field effect transistor when the one in the satellite was an enhancement type. The reason for the mix-up was the overly generous supply of symbols that represent the same insulated-gate field effect transistor.

These devices, which were introduced on the market in 1964 by 13 companies, are being labeled with at least five conflicting sets of symbols [Electronics, Dec. 14, 1964, p. 76]. An engineer working constantly with the new transistors doesn't have much trouble keeping them straight, but engineers, technicians and servicemen in the field who work on a variety of equipment may get confused.

I. Help is coming

Standardization is on the way, but it will not arrive without worldwide harangues, debates and relatively benign intrigue.

In October, the International Electrotechnical Commission (IEC) will meet in Tel Aviv, choose a set of symbols from at least two sets that will be submitted, send it to the commission's national committees in 40 countries and ask each to vote. If at least four-fifths, or 32 of the countries, approve, the symbols will be issued as an IEC recommendation. While adoption of IEC recommendations is purely voluntary on the part of the mem-

ber nations, some countries immediately give them the force of law.

Backstage. The decision IEC will make in October will not be made without some travail. It's certain that at least two sets of symbols will be proposed (see page 136). One will come from a joint working group composed of representatives of the IEC, the International Consultative Committee on Radio (CCIR), and the International Telegraph and Telephone Consultative Committee (CCITT). This committee will coordinate the views of the three international groups. The other set of symbols will be offered by the IEC's U. S. National Committee.

An informed source says that the joint IEC/CCIR/CCITT symbols were evolved after a “sneak preview” of the U. S. proposal. It's rumored that the two approaches could be reconciled if the U. S. were to send adequate representation to Tel Aviv to defend its position.

The U. S. symbols, which were prepared by the IEEE Symbols Coordinating Committee, will be submitted to the IEC through formal channels. First, they will go to the American Standards Association's Y32 task group on IEC affairs, chaired by H. R. Terhune. Next, they go to the technical adviser on symbols to the U. S. National Committee of the IEC, A. F. Pomeroy. Finally, they will be sent to the IEC headquarters in Geneva.

While the route to Tel Aviv is more direct for the IEC/CCIR/CCITT joint working group, that isn't an advantage. All national committees will receive the IEC proposals in advance of the Tel Aviv meeting and will have enough time to comment on them and per-

haps submit alternate proposals. At Tel Aviv, the major advantage will go to the side putting up the best technical arguments in favor of its proposal.

Since the ASA requires the concurrence of so many member organizations, approval may take a long time. If it should, the symbols might be sent on to IEC without the ASA's blessing.

II. Possible roadblocks

Nevertheless, ASA's role is important. It has weight in the United States and abroad. It may approve the IEEE symbols when it receives them in March or April but, for three reasons, it might not:

- The ASA might be reluctant to standardize symbols in the United



Harold R. Terhune of the International Telephone and Telegraph Corp. is chairman of the ASA's advisory group on IEC affairs.

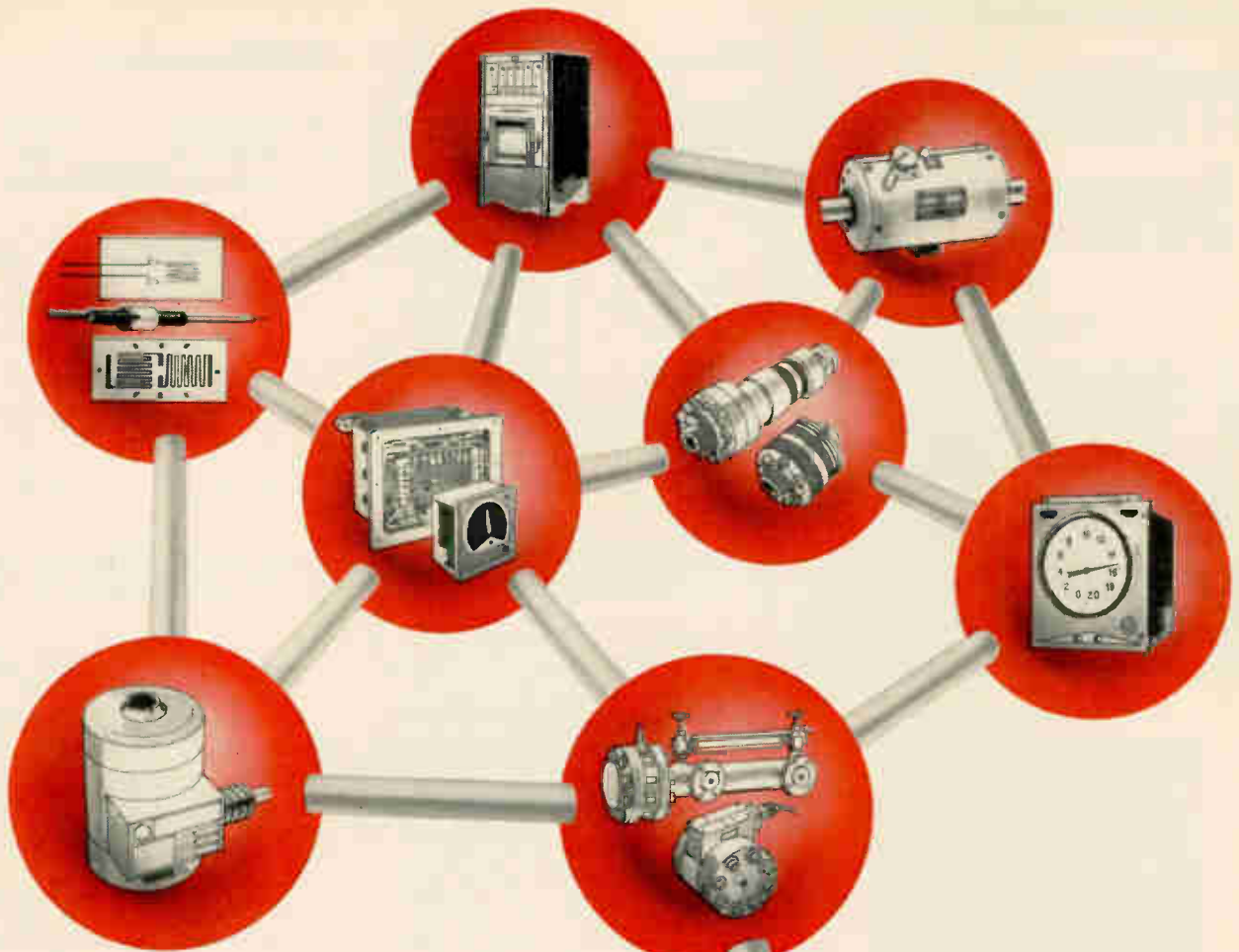

Precision measurement— a mature capability at BLH

Where do you turn for solutions to problems of precision electronic measurement? BLH's long experience and complete product line pay off with practical answers.

Take strain or temperature sensors. BLH offers over 200 different models. Or take transducers that incorporate these sensors to measure weight load, pressure, torque, flow and liquid level. BLH has been building them longer than anyone else in the industry.

BLH is also a specialist in conditioning signals from sensors to make them more accurate or easier to interpret, and to convert variables to standard control current or voltage signals. In the area of readout equipment, BLH is known for the reliability of its complete line of panel-mounted, field-mounted, portable and console instruments.

Direct your next measurement problem to the only company with such an experience-proved record of design, production and systems capabilities—BLH ELECTRONICS. Or, see your nearest BLH Sales Engineering Representative. BLH ELECTRONICS, a division of Baldwin-Lima-Hamilton, Waltham, Mass. Plants in Waltham, Mass., Pasadena, Calif., and Darmstadt, West Germany.

Strain Gages • Temperature Sensors • Load Cells • Pressure Cells • Torque Pickups • Recorders • Instrumentation • Integrated Systems

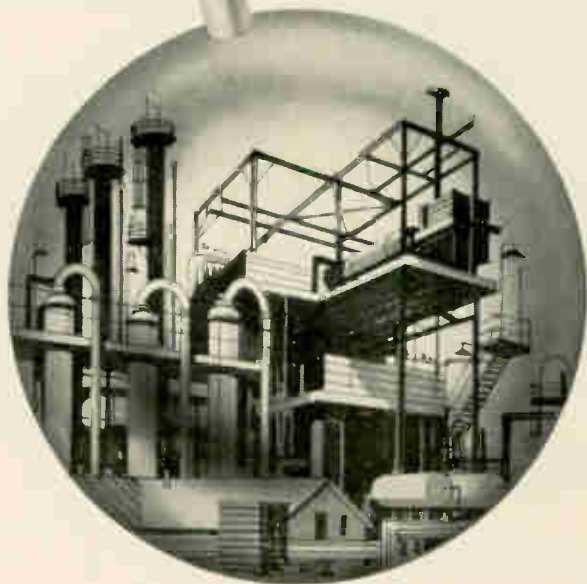

BALDWIN · LIMA · HAMILTON
A subsidiary of Armour and Company

BLH
ELECTRONICS

Problem Solvers

For precision clean manufacturing and research

White-Bench



Mobile Down-Flow Module



Convertible Laminar Flow Work Station



All our PROBLEM SOLVERS provide FED STD No. 209 Class 100 Absolute Filtered Air

For further information on these and other products contact:

MATTHEWS RESEARCH, INC. **mri**

4306 Wheeler Avenue
Alexandria, Virginia (703) 548-1600

In Canada: Brent Laboratories • International: Schuco

IEEE wants these

N-CHANNEL TRANSISTOR	P-CHANNEL TRANSISTOR
JUNCTION TRANSISTOR SYMBOLS	
OR	OR
INSULATED-GATE TRANSISTOR SYMBOLS	
3-TERMINAL DEPLETION TYPES	
3-TERMINAL DEPLETION TYPES SUBSTRATE TIED TO SOURCE	
4-TERMINAL DEPLETION TYPES	
4-TERMINAL ENHANCEMENT TYPES	
2-GATE 5-TERMINAL DEPLETION TYPES	
2-GATE 5-TERMINAL ENHANCEMENT TYPES	

D= DRAIN S= SOURCE
G=GATE B= BULK SUBSTRATE

But IEC proposes

N-CHANNEL TRANSISTOR	P-CHANNEL TRANSISTOR
JUNCTION TRANSISTOR SYMBOLS	
OR	OR
INSULATED-GATE TRANSISTOR SYMBOLS	
3-TERMINAL ENHANCEMENT TYPES	
3-TERMINAL DEPLETION TYPES	
3-TERMINAL ENHANCEMENT TYPES SUBSTRATE TIED TO SOURCE	
4-TERMINAL DEPLETION TYPES	
4-TERMINAL ENHANCEMENT TYPES	
4-TERMINAL ENHANCEMENT TYPES (ALTERNATE SYMBOLS)	

D= DRAIN S= SOURCE
G=GATE B= BULK SUBSTRATE

States that might not be chosen as the international set.

▪ Second, the ASA might object to the composition of a subgroup appointed by an IEEE committee on symbols. None of the 16 members of the IEEE's Symbols Coordinating Committee (SCC) is engaged in manufacturing transistors or even in closely related work. To correct this deficiency, the committee appointed three experts in FET work. But this move, may not satisfy the critics. The three experts are all from the same company—the Radio Corp. of America: S. R. Hofstein, Daniel Drusdow, and David M. Griswold. Some fear the symbols will reflect RCA rather than industry thinking.

Conrad R. Muller, chairman of SCC defends the choice of experts: "Having all three committee men from the same company made it easier for them to work on this project. Besides, Hofstein is a designer, Griswold is a manufacturer, and Drusdow is a user." Muller is assistant manager of standards for ITT Federal Laboratories, a division of the International Telephone and Telegraph Corp.

▪ Third, and more involved, the ASA wants to uphold its long-standing reputation for giving careful consideration to everyone who might become involved with the symbols concerned. The ASA must be convinced that the standard's sponsor has obtained a favorable consensus from all who might be affected. The ASA encourages a sponsoring group to distribute copies of a proposed standard to all interested organizations even though they may not be ASA members—2,200 companies and 138 technical societies and trade associations belong to the ASA. It also suggests publication of proposed standards in trade journals to obtain criticism and comments.

Conformity. Few working engineers in United States companies have ever seen the IEEE proposals and probably none have seen the European set (at left). Representatives from U. S. industry who have worked with the IEEE symbols have been, for the most part, standards administrators rather than engineers involved in the design or the application of the devices. Nevertheless, out of a desire to conform, many United States com-

LANTHANUM
CERIUM
PRASEODYMIUM
NEODYMIUM
SAMARIUM
GADOLINIUM
TERBIUM
DYSPROSIUM
HOLMIUM
ERBIUM
THULIUM
LUTETIUM
EUROPIUM
YTTRIUM
THORIUM

MEETING THE NEED WITH RARE EARTHS

put the **RED**
in color
television



ANOTHER EXAMPLE OF PRODUCT IMPROVEMENT USING RARE EARTH TECHNOLOGY AND THE UNIQUE CAPABILITIES OF OUR SPECIAL PRODUCTS DEPARTMENT

Product development starts with a customer need. Television makers needed a new red phosphor and researchers found the answer in two of our rare earths—with an europium-activated yttrium vanadate. We're proud of our role as supplier of these ultra-high purity raw materials. But that's the story of our life—exploring new ways... helping customers find the "way out" answers with rare earths, thorium and yttrium products. Got a problem? Our Special Products Department has the experience and practical application knowledge you need to fully utilize rare earths and rare earth technology. You can rely on our research assistance, backed-up by our fast, dependable delivery. ■ Write, call, or wire for detailed literature on our complete product line. RARE EARTH DIVISION, West Chicago, Illinois 60185. Phone 231-0760 (Area code 312).



American Potash & Chemical Corporation

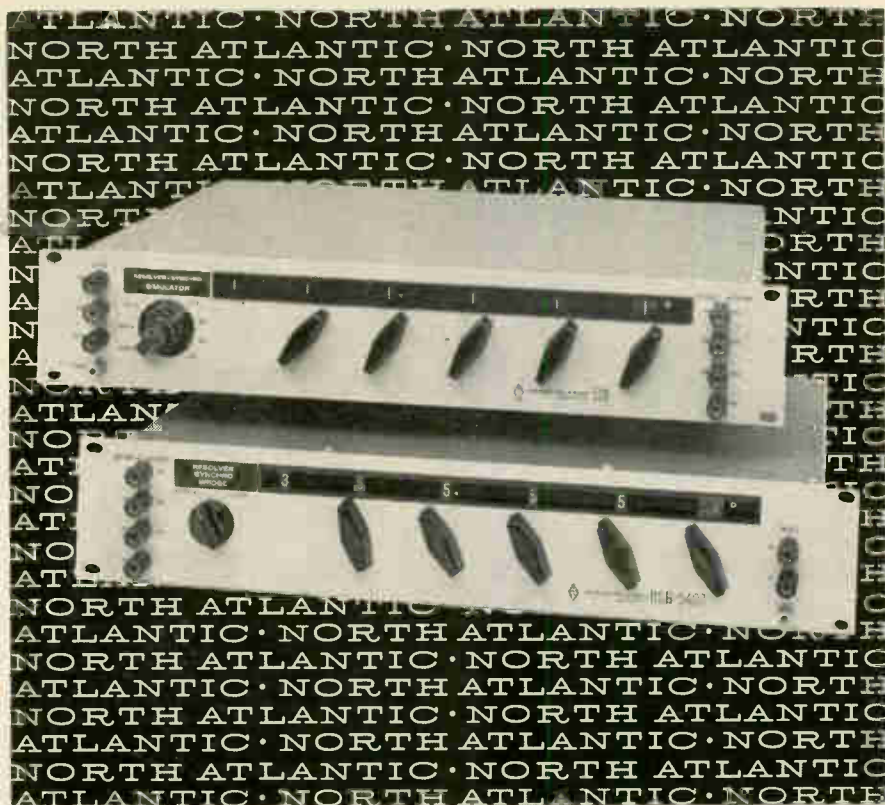

you are looking at the state-of-the-art in resolver/synchro testing

These two instruments provide the widest measurement capability available today for resolver/synchro testing. Each is a dual-mode unit, measuring both resolvers and synchros. Series 530 Simulators are ideal transmitters, and Series 540 Bridges are ideal receivers.

In addition to their dual-mode capability in 3½" of panel space, both series provide in-line decimal readout continuously switched through 360°, 2 second accuracy at any angle, and input/output isolation.

SERIES 530 SIMULATORS FEATURE

- Resolution 0.001°, 1°, or 5°
- Dual 26/115 volt excitation
- Switch selected line-line voltages 11.8, 26, 90, and 115 volts
- Low matched output impedance

SERIES 540 BRIDGES FEATURE

- Resolution 0.0001°, 1°, or 5°
- 500K input impedance
- Constant null-voltage gradient at all line-line voltages
- Unaffected by null detector loading

Prices range from \$1480.00 to \$2680.00

The flexibility of these instruments meets every need for rapid and accurate testing in the engineering laboratory, in production, and in ground support equipment. Used with a Phase Angle Voltmeter, they provide a complete facility for component or system test.

Programmable models with decade or binary input are also available. Your North Atlantic representative will be glad to arrange a demonstration. Call or write him today.



NORTH ATLANTIC industries, inc.
TERMINAL DRIVE, PLAINVIEW, L. I., NEW YORK • Overbrook 1-8600

panies are backing the IEEE symbols. Motorola, Inc., for example, has already decided to switch to IEEE's set on the assumption it will eventually be approved. Texas Instruments Incorporated, on the same basis, has gone even further; its literature, now being prepared, uses the proposed IEEE symbols.

There are dissenters. However, the Semiconductor division of the Fairchild Camera and Instrument Corp. likes the symbols it presently uses—which, incidentally, are more similar to the European set than to the American—and is not anxious to change. It will change, it says, if and when the proposed IEEE symbols are accepted.

Two points of view. The U. S. group, according to Drusdow, wants the simplest of symbols. For example, it proposes a single arrowhead on a bulk connection whereas the Europeans suggest two arrowheads—one on the source and the other on the drain connection. This is one of two major differences that could prevent international standardization.

III. Optimism at IEEE

The IEEE is optimistic. Charles A. Fricke, vice-chairman of the IEEE's committee—as well as secretary of the ASA's Graphic Symbols Task Force and an engineer at the Philco Corp.—believes the IEEE's proposals will be accepted without protest. Fricke anticipates support from five members of the IEEE's coordinating committee who are also members of ASA's committee on graphic symbols and designations.

ASA committee chairman A. F. Pomeroy believes ASA will approve the IEEE symbols, but not without a struggle. "I expect a lot of arguments when this one comes up," Pomeroy says. "I know that the two proposals differ. This will cause discussion." Pomeroy is an engineer with the Western Electric Co.

Getting the IEEE symbols to Tel Aviv may be assured—as Terhune says it is—with or without ASA approval. But whether they come back or not is something else.

Terhune says the IEEE's chances would be improved if the electronics industry and technical societies provided financial backing to send a delegation of experts to the IEC meeting.

Report from

**BELL
LABORATORIES**

Integrated circuits at microwave frequencies

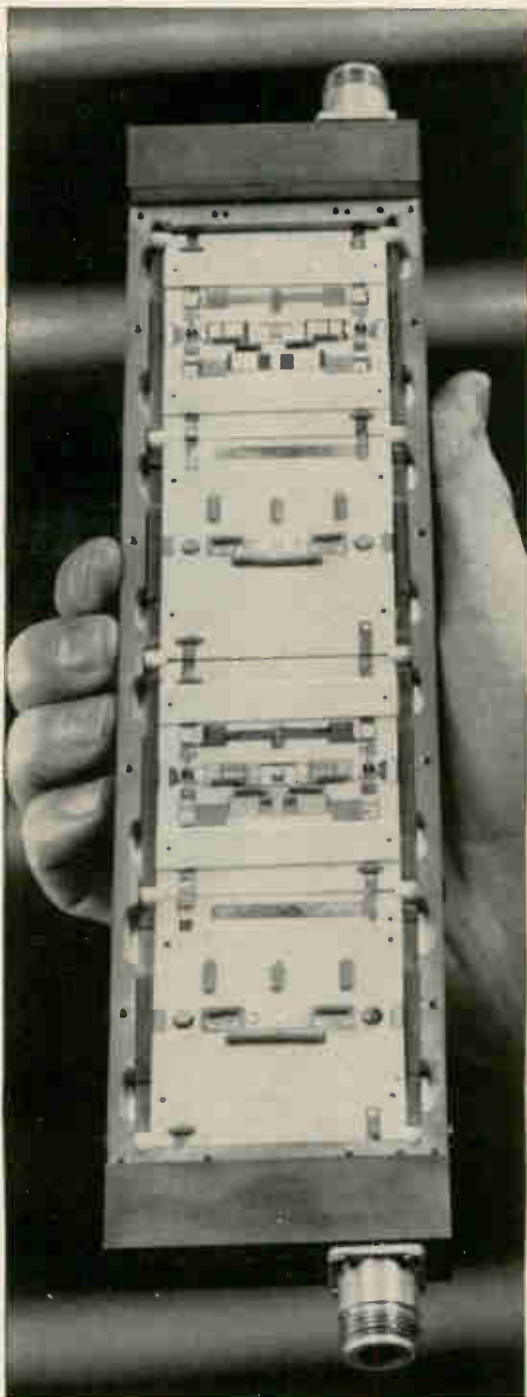

Laboratory model of a four-stage microwave amplifier which can provide up to 40-db gain and noise figures as low as 3 db in the 1- to 2-gigacycle frequency range. Similar amplifiers have been developed to operate at frequencies from 0.5 to 4 gigacycles with bandwidths of 1000 mc.

Engineers at Bell Telephone Laboratories have developed integrated circuits for use as amplifiers in the microwave range. Thin-film tantalum techniques are used to provide the precise, stable resistors, capacitors and transmission-line components required at microwave frequencies. Improved transistors provide up to 10 db of gain per stage and noise figures as low as 3 db.

A "balanced" design, using a power-splitting directional coupler, makes possible wideband, stable gain characteristics without the need for tuning adjustments. Up to the highest frequency for which these amplifiers are now usable—4 gigacycles—the electrical performance characteristics are equal or superior to those of low-noise traveling-wave tubes. In addition, they have the other advantages of solid-state circuitry, such as long life and reliability.

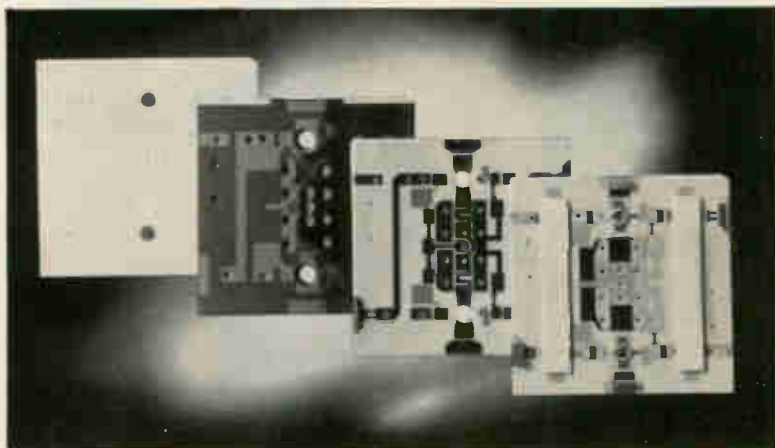

Thin-film techniques are used in the integrated microwave amplifier. Starting from bare ceramic substrates of about 2 x 2 inches (left), partially finished circuits are shown during the multi-step fabrication process. Circuit at right, complete with transistors, comprises one stage of amplifier. "Balanced" design with electrically similar transistors gives precise wideband amplification in the low-microwave-frequency range.



Bell Telephone Laboratories

Research and Development Unit of the Bell System

THESE CIRCUIT PROTECTORS ARE ENTIRELY MAGNETIC TRIP

Hermetically sealed AP Protectors meet or exceed MIL-C-39019. They repeatedly rupture 300A 250V AC, 500A 125V AC, 500A 50V DC, have magnetic time delay, but open a 1000% overload in 4 milliseconds. There is no trip at 100G shock or 20G vibration, carrying rated current. Available 10 MA to 20A, with a wide variety of circuit combinations, delay curves and auxiliary signal circuits. Ask for bulletin 16E-4.

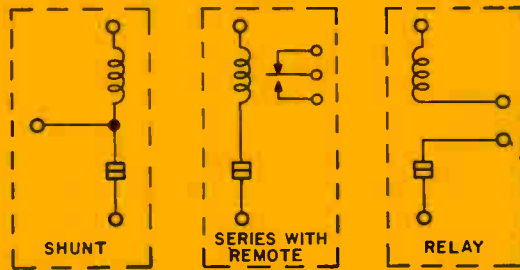

AP113



AP4



AP12



AP114



Everyman's laser for classroom and industry

Built-in mirrors and conventional a-c power supply result in a rugged, low-cost laser

With the growing interest in lasers, educators are looking for a cheap, rugged and reliable laser for laboratory instruction and experiments. Many small industrial concerns also would welcome a low-cost laser for such uses as alignment of optical systems and mechanical components.

At a selling price of \$295, a simple and reliable, low-power laser is being offered by Optics Technology, Inc., of Palo Alto, Calif. The laser, which weighs only about 30 pounds, is already attracting interest from such prospective users, according to the manufacturer. It can be powered from a wall socket, permitting unusual portability; also, built-in mirrors assure that users do not have to make adjustments to delicate and costly external end mirrors. This configuration also protects the mirrors from degrading effects that result from exposure to the atmosphere.

To produce a rugged, reliable laser at the price, Optics Technology developed an efficient mirror and built the reflective and output mirrors of the laser into the end portions of the plasma tube. The company says that because the mirrors are parts of the tube itself, they will never go out of adjustment because of vibration or jarring, will never collect environmental dust or be affected by ambient temperature variations—all common ailments of most commercial lasers. Optics Technology has its own facilities for glass blowing, mirror making, and grinding and polishing. Furthermore, a special plasma tube design keeps the corrosive plasma from coming too near the highly polished end mirrors. This is prevented by containing the plasma in two external chambers,

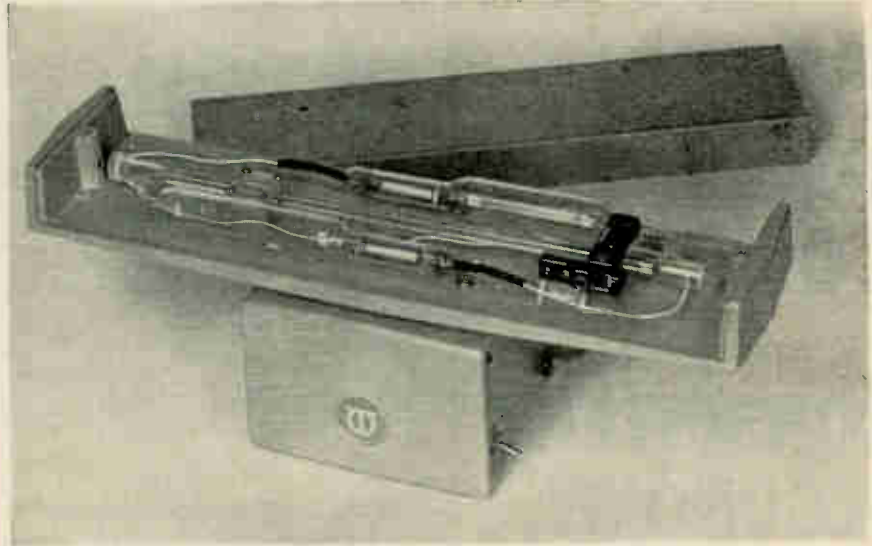

Plasma tube, shown with the laser's cover removed, has reflective and output mirrors built into its ends. One-inch extension at each end prevents plasma from reaching and corroding the mirrors.

each attached to the main tube by an orifice about an inch from the end mirrors. The end sections containing the mirrors are "extensions" of the main tube, and are thus protected from the plasma.

The tube is aligned by inexpensive, commercially available "gunsight" blocks, which apply force to the tube in small azimuth and elevational increments. If additional alignment is required, because of rough handling, the user can realign the tube easily. Each alignment position in the gunsight attachment locks in position; the tube can be realigned merely by "clicking off" the alignment positions. One benefit of the relatively short plasma tube (about 12 inches) in the OTI device is the ease of alignment compared with the longer plasma tube.

Operating in the visible red, with a wavelength of 6328 angstroms, OTI's laser is guaranteed to pro-

duce an output of 0.3 milliwatt after 100 hours. The tube is a cold-cathode, helium-neon design.

Since demand from schools—junior high school through university level—has been great, OTI has published a booklet of laser experiments, copies of which are available with each laser. The experiments include studies of coherence, diffraction, lenses, polarization, optical radar and quantum optics.

Specifications

Wavelength	6,328 Å
Laser power	More than 0.3 mw to TEM ₀₀ (uniphase) mode
Beam diameter	1 mm at exit aperture
Beam divergence	Less than 0.4 milliradian half-angle
Ripple	A-c excitation produces 120-cycle modulation of output beam
Power requirements	115 V a-c, 60 cps
Dimensions	16 in long, 5 in. high, 5 in. wide
Delivery	After Feb. 1

Optics Technology, Inc., 901 California Ave., Palo Alto, Calif.

Circle 350 on reader service card

What's in it for you when
you order **SILICON
SLICES** and **EPITAXIAL
SLICES** from the nation's
Number 1 specialist?

**CONSISTENT
QUALITY,
CONSISTENT
ECONOMY,
FASTEST
DELIVERY**

And the most complete line in Crystals and Slices...as sliced, lapped, etched, polished, diced and epitaxial in N/N+, P/P+, multilayer, oxidized. Top source for Germanium, too.

You can safely (and profitably) lower your own inventory when you order from Semimetals.

Try us and see for yourself.

S **SEMIMETALS, INC.**
172 Spruce Street
Westbury, L.I., N.Y. 516-333-8400

New Components and Hardware

Thermocouples with fast reponse time

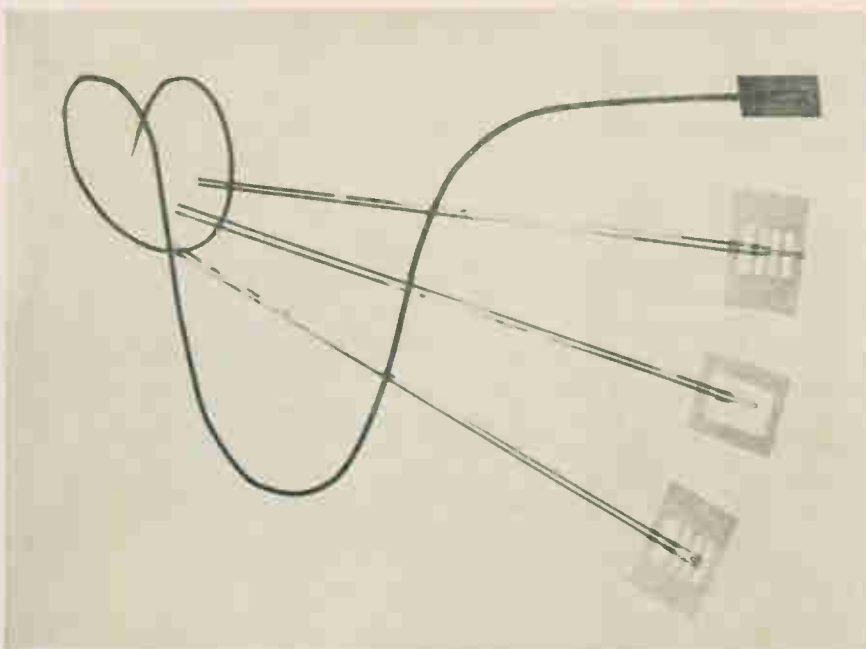

Thermal inertia in the junction of a conventional thermocouple limits the speed at which it responds to changes in temperature. Typical response time of a small-bead thermocouple is about 1 second. By using thin foils for the different metals of the thermocouple and thereby reducing the physical mass of the junction, the RdF Corp. of Hudson, N. H., has reduced the response time to the order of 1 to 10 milliseconds. Foils with thicknesses of 0.0002 to 0.0005 inch are butt-bonded by a special process so that there is no increase in thickness or mass at the junction of the foil filaments. Depending on the choice of the foil materials, the device may be used at temperatures as low as -320°F and as high as $1,500^{\circ}\text{F}$. In this respect it has advantages over thermistor elements, which have equivalent response time but are limited to temperatures between -100°F and 700°F . Its use is possible in cryogenics and high-temperature environments as well as in accurate measurement of temperatures of transistor and micromodule devices.

Free-filament and matrix versions of the thermocouple are

available. In the matrix version, the thermocouple element is laminated between two 0.003-inch-thick polyimide films. This version is intended to be bonded by adhesive to the surface of the device to be measured. The polyimide film limits the use of the matrix version to a maximum temperature of 500°F for extended periods of time, and 700°F for limited periods of time. Matrix versions have thermal responses on the order of 10 milliseconds.

The free-filament type of foil is fastened by thermoplastic adhesive to a few points on a single sheet of polyimide film. After installation, the polyimide may be peeled away by applying a little heat. Because the foil is exposed, the thermocouple may be mounted in intimate contact with the surface to be measured. As a result, response times of 1 to 5 milliseconds may be achieved. Free-filament versions may be used over the extended temperature range. Three of the four thermocouples shown in the photograph above are free-filament versions and show clearly the configurations of the filaments in the vicinity of the junction.

Connecting leads are either un-insulated foil ribbons, 0.001- to 0.002-inch thick, for high-temperature operation, or fiber glass insulated wire for lower-temperature operation.

Specifications

Thermocouple material	Chromel- Alumel	Chromel- Constantan	Copper- Constantan
Maximum operating temperature			
Free-filament type	1,500°F	1,200°F	700°F
Matrix type	500°F	600°F for 700°F 600 hrs 10 hrs	
Minimum operating temperature	-320°F		
Response time			
Free-filament type	1 to 5 ms	1 to 5 ms	1 to 5 ms
Matrix type	10 ms	10 ms	10 ms

RdF Corp., Hudson, N.H. [351]

Angled configuration improves heat sinks

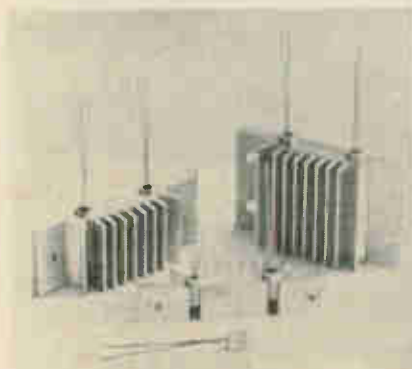

Extruded aluminum heat sinks for TO-1 case transistors feature a patented angled configuration that will provide a number of important benefits for manufacturers: lower cost, simpler and faster assembly, more effective clamping action.

The new heat sinks are said to cost from 50% to 75% less than comparable types. The one-piece construction eliminates clamping nuts and bolts, and saves time that must be spent aligning two-piece types. The curved configuration straightens out when mounted and provides effective clamping action and low thermal resistance. Thermal resistance from case to ambient is reduced by a factor of almost 2:1, permitting the user almost to double the power output of present devices.

Three types are available. Type HS-3 is a half inch long and is used in amplifiers up to 10 watts. The HS-2 is 1 inch long and is used as an independent heat-dis-

There are about 140 companies marketing potentiometers in the U.S.A. Of these, only 72 claim to make precision pots. Of these, only 6 make conductive plastic and wirewound precision pots. Of these, only 1 has six or more years experience in both conductive plastic and wirewound; has equal capability in both, and can objectively recommend either. That one is



new england instrument company

Kendall Lane, Natick, Massachusetts Tel. 617-655-1411, TWX: 617-875-4261
MEMBER OF PRECISION POTENTIOMETER MANUFACTURERS ASSOCIATION

<p>World's leading line of Precision Single-Turn Pots</p>	<p>Thousands of Custom Designs</p>
<p>Standard Conductive Plastic</p>	<p>Standard Wirewound</p>
<p>WAFERPOTS™ (industry's slimmest)</p>	<p>Resistive Elements</p>
<p>Also, NEI's ECONOPOTS™ are the world's only stock line of long life, infinite resolution, precision pots priced from \$11.55!</p> <p>Disassembled ECONOPOT, showing 3 basic assemblies ▶</p>	<p>ENVIRONMENTAL ECONOPOT TEST</p> <ul style="list-style-type: none"> MECHANICAL STRENGTH SHOCK VIBRATION HUMIDITY SOLDER HEATING HIGH SPEED LIFE TEMPERATURE SHOCK <p>FREE ON REQUEST</p>

Penta Power Tubes for Broadcast Applications

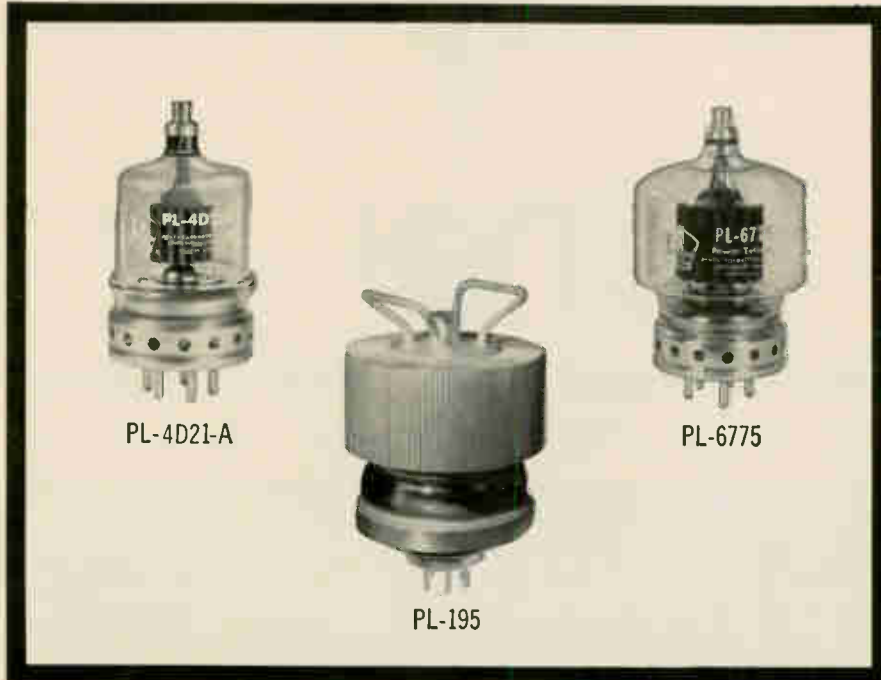

PL-4D21-A

PL-6775

PL-195

These power tetrodes for broadcast transmitters, available only from Penta, have already run up a service record for ruggedness and reliability.

The **PL-4D21A** is directly interchangeable with the 4D21 (4-125A), but has a plate dissipation of 175 watts. It runs cooler than the 4D21 (4-125A) and generally has longer life.

In the **PL-6775**, you have a more rugged version of the 8438/4-400A. It features the exclusive Penta filament-supporting insulator which minimizes interelectrode shorts.

Both these tubes have a unique, one-piece plate cap and seal which will not come loose or break off easily.

Penta beam pentodes are also of interest to designers of broadcast equipment. Highly suited to today's trend toward the use of AM linear amplifiers is the **PL-195**, with a plate dissipation rating of 4000 watts.

To find out about the complete Penta line of tubes for AM, FM and TV applications, send for a free copy of "Penta Broadcast Tubes." Write The Penta Laboratories, Inc., 312 North Nopal Street, Santa Barbara, California 93102. A Subsidiary of Raytheon Company.



New Components

sipating system. It is adequate for a 5-watt amplifier in free air. Type **HS-1** is 1½ in. long and will provide adequate heat sinking for two output pairs (4 transistors for stereo) for up to 10 watts per channel, when mounted on a chassis. Amperex Electronic Corp., Semiconductor and Receiving Tube division, Slatersville, R.I., 02876 [352]

Ceramic coil forms in 4 diameters



Ceramic coil forms are now stocked in 0.205-in., 0.260-in., 0.375-in. and 0.500-in. diameters. The ceramic material conforms to MIL-I-10 Grade 523 specifications.

Cores of brass and six grades of powdered iron permit use in frequency ranges between 50 kc and 300 Mc. Bushing-mounted forms with fiberglass collars for high-Q/low-loss applications are available in 2-terminal and 4-terminal configurations.

J.W. Miller Co., 5917 S. Main St., Los Angeles, Calif. [353]

Ten-turn potentiometer for industrial uses



A 10-turn, ½-in.-diameter precision potentiometer for industrial uses, Model 3707 is a rugged performer encased in a compact plastic case

TERMINATING INSERTS

for General Purpose, Low Reflection and Miniaturized Applications
BY
**RADAR
DESIGN
CORP.**

The RDC terminating insert series provides for both standard and half-height waveguide sizes as currently in use.

Complete range covers the following applications: general purpose models with a 1.04 max. VSWR for high quality loads; low reflection (1.02 VSWR) for precision loads; and very short, miniaturized models with VSWR 1.15 for use in broadband systems requiring mechanical ruggedness in small space. Over 1000 special inserts have been engineered to meet specific requirements.

Radars Design maintains a perpetual inventory of inserts and other standard components to assure ready off-the-shelf delivery. Modifications and custom designs promptly quoted.

For Technical Data Sheets write direct or contact nearest representative . . .



**RADAR
DESIGN
CORP.**

507 PICKARD DR., SYRACUSE, N. Y.

Circle 210 on reader service card

NEW High Voltage Reed Relay

Switches 5000 V

low cost
Reed relay
Reliability

Rated 50VA at 5000v
max. or 3 amps. max.

Life Expectancy—
20 million cycles at
rated load.

7/8" h (above mounting base)
1 1/16" w, 4 1/2" long.

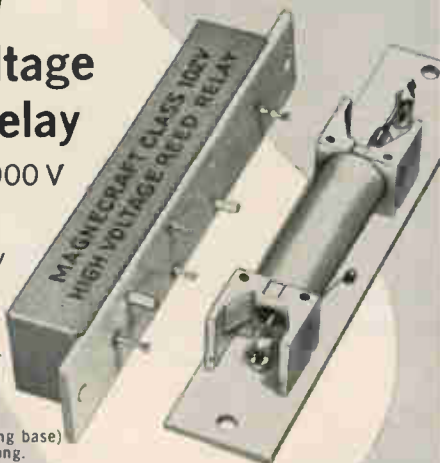

MAGNECRAFT 102V High Voltage Reed

Newest addition
to the largest
selection of
Mercury-Wetted
Contact and
Dry Reed Relays

Send for
Catalog.

- Contacts of special material, high vacuum sealed.
- Contact leads soldered to rigid terminal posts—prevents stresses that affect relay adjustment.
- Nylon bobbin and epoxy resin terminal board provide great dielectric strength and resistance to moisture absorption.
- Internally insulated metal cover provides electrostatic shielding; also protects relay from stray magnetic fields and mechanical injury.
- Stocked for immediate delivery with coils for standard operating voltages.

MAGNECRAFT Electric Co.

5565 N. Lynch, Chicago, Ill. 60630

(312) 282-5500

Circle 211 on reader service card

MODULAR A-D CONVERTERS



GREAT IDEA!

Why modular? Because now you can buy only the options you require . . . and all in one package.

By grouping the circuit elements into modular blocks, Navcor Series 2200 A-D Converters are constructed entirely from a family of compatible circuit modules. The basic units are available in ten-bit binary plus sign or three-digit BCD, with absolute value outputs or complement outputs for negative numbers, and operate at rates up to 8,000 complete conversions per second.

The variety and versatility of the plug-in modules assure compatibility with peripheral equipment, and system expansion is quick and easy. Sample and hold circuits, multiplexing, operational amplifiers, remote-output buffers, and other options may be added at any time.

Does the modular approach really pay off? You bet—with lower initial cost, flexibility and adaptability, and minimum system design time. Want more data? Just send in the coupon.

NAVIGATION COMPUTER CORPORATION

Valley Forge Industrial Park • Norristown, Pennsylvania
Dept. EL-021 • TWX 215-666-0779 • Phone 215-666-6531

NAVCOR®

Valley Forge Industrial Park
Norristown, Pennsylvania



OKAY! Please send me all the details on your Series 2200 A-D Converters.

Name _____
Title _____
Company _____
Address _____
City _____
State _____ Zip _____

Dept. EL-021

Circle 145 on reader service card

145

Depend on white-glove Tayloring!



Five compelling reasons for changing to Taylor copper-clad now

- Superior solderability
- Excellent printability
- Consistent uniformity
- Surface that accepts all acid resists
- Ready availability

The first three reasons are the results of white-glove handling, atmosphere-controlled white rooms, careful processing, and an extremely tight quality control system (governed by MIL-Q-9858—toughest spec in general use). The fourth is assured by a specially developed surface finish. The fifth is guaranteed by two fully equipped copper-clad facilities—one at Valley Forge, Pa., the other at La Verne, Calif.

We'll be happy to supply samples of Taylor copper-clad for test in your plant. Write today, describing your process and the type of copper-clad you use. And be sure to ask, too, for a copy of Bulletin 8-1B.

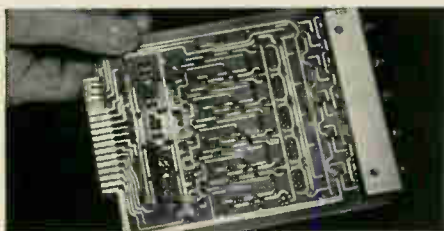

Typical high-fidelity, high-reliability printed circuit etched on Taylor copper-clad material. Courtesy of Navigation Computer Corporation, Valley Forge Industrial Park, Norristown, Pa.

Taylor copper-clad

TAYLOR CORPORATION • Valley Forge, Pa. 19481

Phone: 215-666-0300

West Coast Plant: La Verne, Calif.

Also manufacturer of Taylor laminated plastics, Taylorite® vulcanized fibre

New Components

measuring only 1 inch long. The company's Silverweld termination eliminates the industry's chief cause of precision pot failure. A special rotor design assures excellent wiper stability under 50-g shock and 10-g vibration.

Standard resistance range is 100 to 100,000 ohms; resistance tolerance, $\pm 5\%$ maximum; linearity, $\pm 1.0\%$; resolution, 0.09 to 0.02%; power rating, 1.0 w at 40° C; operating temperature range, -55 to +105° C; price, \$10 in 100-piece quantities.

Bourns, Inc., 1200 Columbia Ave., Riverside, Calif. [354]

Tiny, fast-acting magnetic reed switch

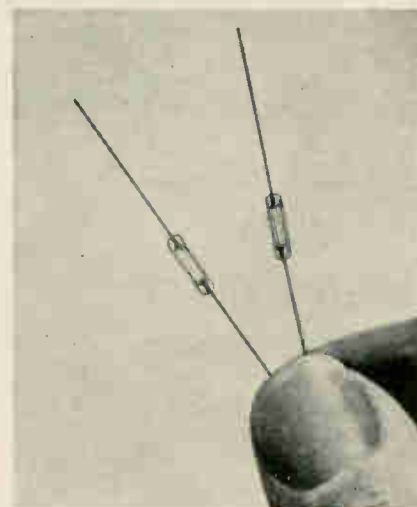

A microminiature magnetic reed switch is now commercially available. The MMRR-2 single-pole, Form A reed switch was specifically designed for ultrahigh-speed, low-level switching systems, such as switching into solid state circuitry. The extremely small size makes possible high-density circuit packaging. The switch has a glass length of 0.375 in. max., glass diameter of 0.090 in. max., and over-all lead length of 2 in., which can be trimmed to over-all length of 0.5 in.

Actuating time, with normal overdrive, is 0.5 msec average, including bounce (nearly twice as fast as ordinary reed switches), so it can follow up to 300 cps. Resonant frequency of reeds is approxi-

Check these specs for something new

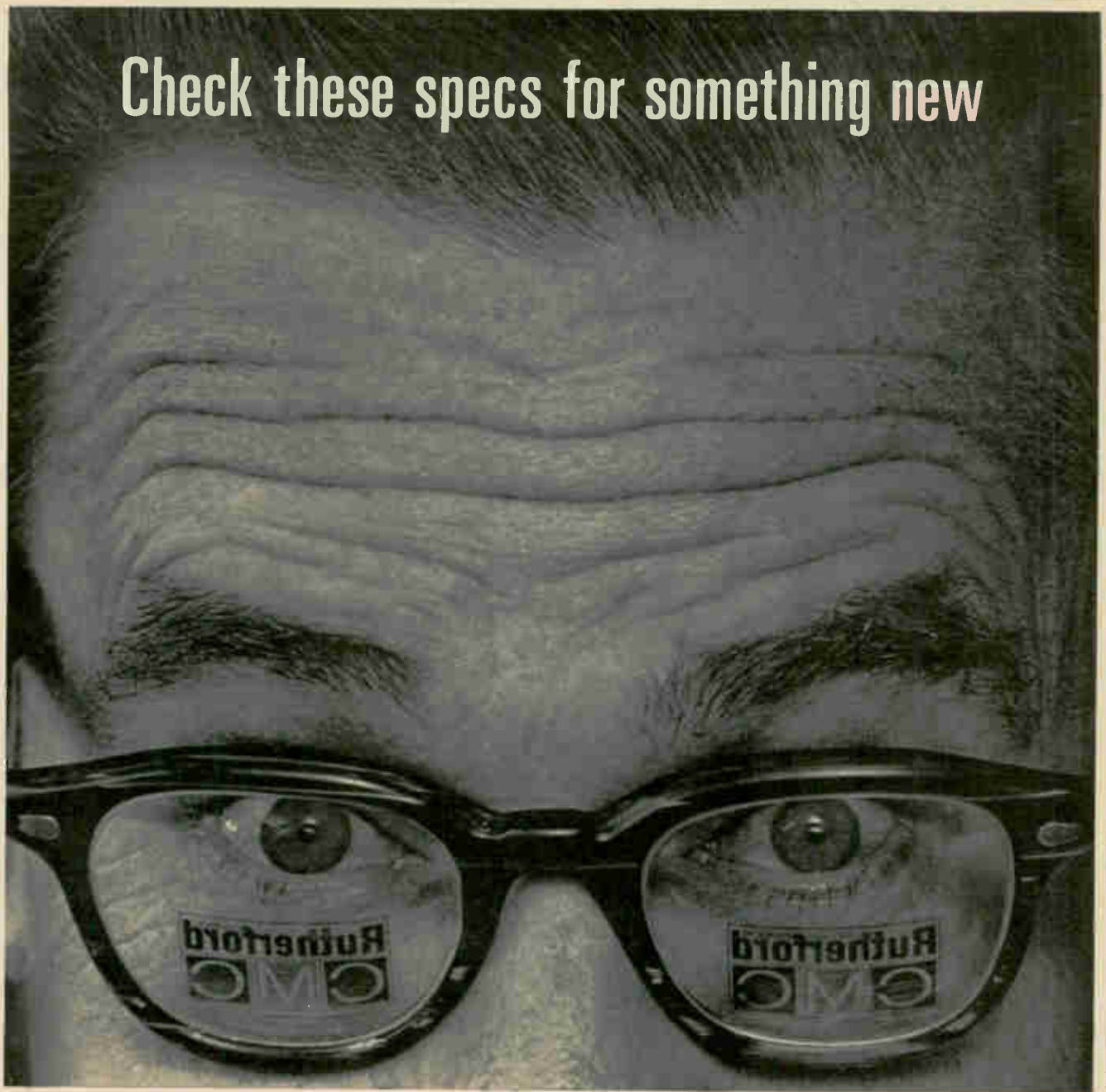

See it? We've got a new battlefield ally. Rutherford Electronics... the nation's number one name in pulse and time delay instrumentation... has joined our crusade as a division of CMC. What a way to finesse big, bad Beckman. (Poor guys, they don't even make a line of pulse generators or time delay generators.) And how about that for keeping our promise to compete with high-powered H-P right up and down their full line!

OK, so this is sort of a sneaky way to outdo those guys. But we warned

everybody that we were "hot", and on a crusade to shake up our competition in the instrument business. Now, with Rutherford at our side, we'll be creating some great new instrument improvements for you. Just wait and see what happens when we apply our combined digital and pulse circuitry know-how.



12981, Bradley • San Fernando, California • Phone (213) 772-6321 • TWX 213-647-5170

So, Crusading Engineers, look sharp! Look twice! Now we double-dare you to "check the specs". Check the specs of CMC counters and digital printers... AND, check the specs of our Rutherford division's great line of pulse generators, time delay generators, and the new dynamic range simulator. We honestly believe that spec-for-spec, you won't be able to beat CMC/Rutherford instruments for the money anywhere. Write us! You'll double your pleasure, and earn a glorious Crusading Engineer medal, too.

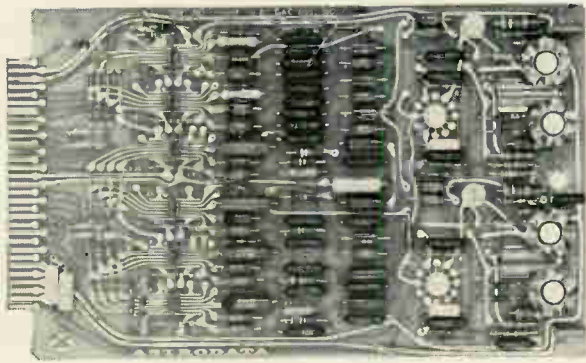

NEW DIGITAL TO ANALOG CONVERTERS WITH FLAT-PACK INTEGRATED CIRCUITRY

Now you can obtain highly reliable 8-bit and 12-bit D-to-A conversion in multi-channel applications with vastly reduced space and interfacing. As many as 60 8-bit DAC channels (including all internal reference regulators) accommodated in a single 19-inch rack frame, taking just a few inches in height. Built-in buffer storage which can be updated without affecting previous value in output amplifier utilizes data lines and load line common to all channels, separate enable line for each channel. Compatibility with loading/recording devices, expansion capability and performance options all designed into the flat-pack circuitry of the series 3500.

SPECIFICATIONS

	Model 3508	Model 3512
Number of channels	2 to 60	1 to 36
Input	7 bits and sign	11 bits and sign, or 3 BCD digits
Updating rate	0 to 100 KC	0 to 100 KC
Output	±10 volts at 100 ma	±10 volts at 100 ma
Accuracy	±0.2% F.S.	±0.04% F.S.
Linearity	±½ LSD	±1 LSD
30-day stability . . .	±0.2% F.S.	±0.04% F.S.
Size	7" high by 16" deep by 19" wide for rack mounting	
Power Supplies . . .	Self-contained, operates from 115VAC	



ASTRODATA

P. O. Box 3003 ■ 240 E. Palais Road, Anaheim, California ■ 92803

New Components

mately 4.5 kc. The leads are electroplated gold with a contact surface of rhodium over gold. Open-contact capacitance is approximately 0.25 pf and initial contact resistance is 300 milliohms max. at 150% overdrive. Minimum breakdown voltage is 250 v d-c. The MMRR-2 has a maximum contact rating of 10 v d-c, 0.010 amp.

Life expectancy is over 10×10^6 operations at full rating and almost infinite at dry circuit loads. Switches are available with a pull-in range of from 20 to 70 amp turns with $\pm 7\frac{1}{2}$ AT tolerance. Hamlin, Inc., Lake & Grove Sts., Lake Mills, Wis., 53551. [355]

Miniature-disk type ceramic capacitors

A line of ceramic disk capacitors features a unit with a maximum diameter of 0.230 in. in each style.

The series consists of styles 501, 506 and 511; all three types are available with long or stub leads for printed circuits. All units meet EIA specifications and have a 500-v rating. Capacitance range for the NPO and N750 styles of the 501 series is up to 33 pf and 68 pf, respectively; while the 506 styles, X5F, have a capacitance of up to 1,500 pf, and the 511 series, Z5U, up to 4,700 pf.

M.I.A.L., U.S.A., Inc., 165 Franklin Ave., Nutley, N. J. [356]

Dry reed relays provide fast response

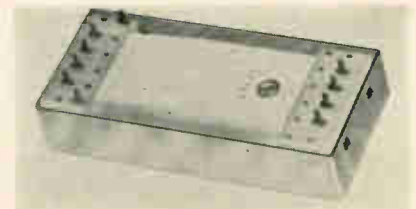

Operating time of the JR series relays is less than 3 milliseconds (including bounce), at nominal coil voltage at 25° C. Release time is 0.5 msec at 25° C. Temperature range is -50° to +85° C. Contact life is in the order of 20 million

operations at rated load with greater life expectancy at reduced loads. The relays are available in a wide selection of operational configurations. Two types of glass dry reed switches are utilized singly or in groups; either reed switch may be magnetically biased.

All JR relay assemblies, offered in five package sizes of from one to five capsules in a nylon bobbin inside an operating coil, are furnished in protective metal covers. Terminal pins are welded to the reed terminations and extend as printed terminals of 0.200 in. by 0.200 in. grid spacings.

Contact arrangements are Form A (spst normally open); Form B (spst normally closed); Form C (spdt) combining Forms A and B, and true Form C (spdt) in one capsule rated 20 watts. The ratings of Forms A, B and combination C are rated 15 or 50 watts.

The high sensitivity and compact size of the relays make them suitable for data processing, computers, logic circuitry, for voltage or current sensing and other types of sophisticated control circuits.

Potter & Brumfield, division of American Machine & Foundry Co., Princeton, Ind. [357]

Four-gang, multiturn precision potentiometer

Model 7810 features four electrically independent potentiometers in one compact case— $\frac{7}{8}$ in. o-d by 6 in. long. Cups 1, 2 and 3 provide an output voltage ratio linear with shaft rotation of 20 turns, while the output voltage ratio of cup 4 is the function sine -40 to $+20$ degrees.

Ganged multiturn potentiometers, as typified by model 7810, are used to provide linear or non-linear inputs to computers or other servo control loops in addition to the feedback control signal for the servo system associated with the potentiometer.

Specifications include: number of turns, 3 to 108; linearity, 0.05% to 0.5%; resolution, infinite; resistance, 1,000 to 125,000 ohms per 10 turns; number of taps, 1 per 10 turns; life, 10 million traverses of wipers over any line on the potentiometer element.

Computer Instruments Corp., 92 Madison Ave., Hempstead, L.I., N.Y. [358]

NOW...MEPCO IS MASS-PRODUCING FILM HYBRID MICROCIRCUITS

New unique production techniques, developed by Mepeco, have resulted in a major break-through in mass-producing Thick and Thin Film Hybrid Microcircuits. Consider these exceptional product features . . .

- *Reduce your existing logic to micro-packaging.*
- *Applicable to linear or digital circuits.*
- *Switching time of 10 nanoseconds.*
- *Clock rates of 10 megacycles are available.*
- *Tracking temperature coefficient characteristics of 10 PPM for a typical resistance ratio of 3 to 1.*
- *Shorter preparatory time for prototypes and initial production.*
- *Surprisingly low costs . . .*



MANUFACTURERS OF PRECISION ELECTRONIC DEVICES

For full details write or call today for TFMC Data Sheet.

MEPCO, INC.

COLUMBIA ROAD, MORRISTOWN, NEW JERSEY 07960 (201) 539-2000

NEW

For LEM-MOL-APOLLO-SATURN

BIT ERROR RATE MONITOR

- Compares serial data bits, DC to 2 MC
- Accumulates, stores, and displays bit errors
- Direct 3 or 4 digit display of bit error rate
- Internal data delay compensation: 0 to 5 bits
- Printer output: 1-2-4-8 BCD
- Bit matches selectable in place of bit errors
- Wide application as general purpose comparator



The DEI Bit Error Rate Monitor provides a means of comparing two serial NRZ data bit streams on a bit by bit basis. It accumulates the number of negative or positive comparisons over a bit interval selectable 10^3 to 10^7 bits or on a continuous basis. Provision is made for processing code forms other than NRZ. The number of bit errors (or bit matches) are presented on a visual digital display while simultaneously presented in BCD form as a printer output.

The BA-102 Series can be used in conjunction with PCM serial simulators to measure bit error rate of PCM processing systems. Operation is provided at bit rates from DC to 2 megacycles with data I/O threshold adjustable from +7 to -7 volts.

The power supply is self-contained and input/output connections are provided on both the front and the rear of the unit. A built-in delay to compensate for delay of the processing system under measurement is also provided.

For additional information write for Bulletin BA-102.



DEI
RESEARCH
DEVELOPMENT
MANUFACTURING

Defense Electronics, Inc.

Rockville, Maryland

(301)762-5700

TWX: 710-828-9783

New Semiconductors

IC multivibrator has direct-coupled input

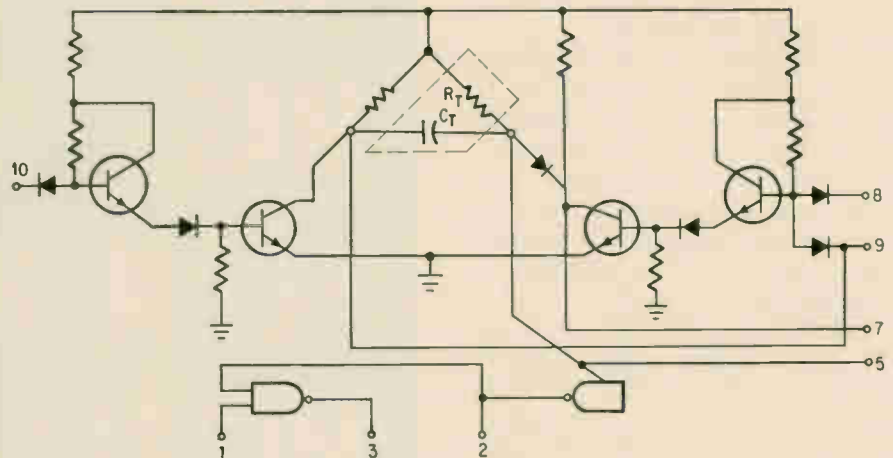

One-shot multivibrator circuit used in new Stewart-Warner monolithic integrated circuit. Tachometers are a main application for the IC.

For effective triggering, many one-shot multivibrator circuits require a certain minimum rise time by the leading edge of the trigger on a capacitor-coupled input. Now a direct-coupled input is available on an integrated-circuit, high-drive monostable multivibrator. Triggering of the multivibrator is independent of the input pulse width or rise time, according to the producer, Stewart-Warner Microcircuits, Inc., a division of the Stewart-Warner Corp.

Although designed for an automobile tachometer, the one-shot multivibrator also may find applications in digital instrumentation and control-system input-output devices. Direct coupling makes it compatible with all diode-transistor-logic (DTL) circuits.

After the multivibrator is trig-

gered, it produces a single output signal of precise width, which is determined by the value of an external capacitor. The capacitor can be adjusted to vary the signal width from a few microseconds to as much as several milliseconds. When the triggering pulse is reduced below the actuation threshold, the circuit returns to its original stable state.

The circuit may be useful as a buffer between two pieces of equipment with different operating rates.

In the tachometer application, the multivibrator receives its input pulse from the automobile's distributor. The multivibrator output sends a current pulse through the tachometer. The more often it is pulsed, the higher will be the average current flow through the tachometer, which is calibrated in revolutions per minute. Stewart-Warner also hopes to use the devices for timing circuits in digital process-control equipment, and as

Specifications

Accuracy	2% over 126° to -10° F
Supply voltage	+5 v
Output load capacity	40 ma
Input current	1.5 ma (max)
Triggering pulse	2 v
Frequency range	About 100 cps to 5 Mc
Size	T0-5 cans, or 0.250 by 0.175-in. flatpacks
Price (100 to 999 quantity)	Military type—\$16.85 each Commercial type—\$7.85 each

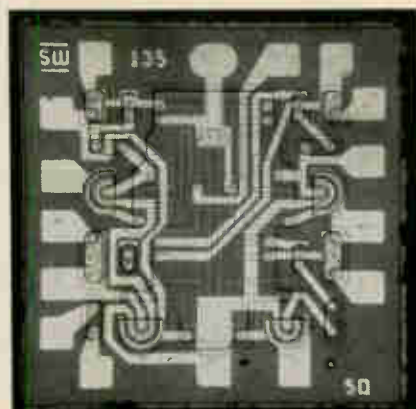



**If you are thinking of something new
and important in data-recording by photography,
you ought to have lunch in this place**

This is a dining room in the largest plant on earth devoted to photography. A majority of the Kodak men you see here are engineers whose entire professional careers are devoted to making photographic systems work supremely well.

Let us assume you are an engineer whose specialty does not happen to be photography and photographic systems, and let us assume you have a photographic problem or a photographic scheme (whichever you choose to consider it). It is quite possible that in this picture is the very guy who is best prepared in all the world to advise you to forget it and think of something else.

On the other hand, since he gets paid to make

photography successful, he has much stronger motivation to figure out with you what next step to take and what you have to decide.

But Kodak is a huge organization. How do you find him? How do you get in touch with him?

Actually there is nothing to *that* problem. We have a department whose major assignment has always been to learn enough about your case to get you together with the right party. You address that department as **Special Applications, Eastman Kodak Company, Rochester, N. Y. 14650.** Most contacts start by phone: (716)-325-2000, Ext. 5129.

Kodak

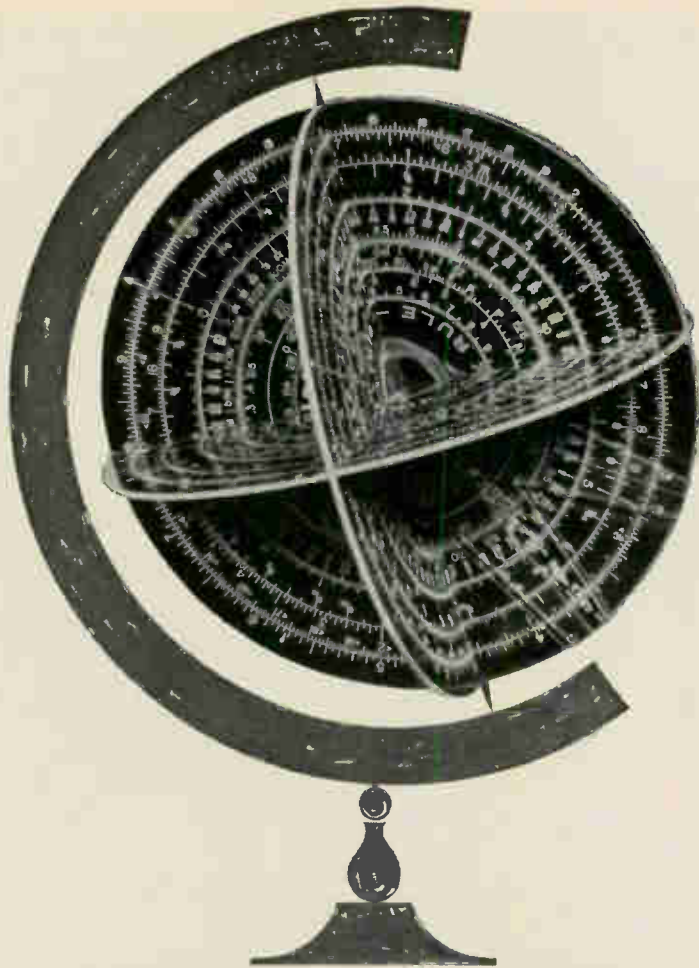

**INTERSTATE ELECTRONICS ...
where longitudinal experience and
latitudinal capability form a world
all by themselves.**

That's right, Interstate Electronics is long on experience and wide in capability. It took both to develop the sophisticated and highly successful test instrumentation equipment for the FBM weapon system of the Polaris submarine program. As prime contractor for this important equipment, Systems Development Division of IEC relies heavily on its staff of top experts, and excellent facilities. The same applies to the Data Products Division which specializes in the development of real-time permanent paper or film video recorders, phase lock devices, timing systems, data handling systems and analog-to-digital conversion equipment. Lots of savvy. Lots of ability.

And although the seas have been here since time began, Man is only now beginning to read, understand, and use the waters of the world. OceanicS Division, formerly National Marine Consultants Division, for over a decade has used scientific principles to develop unique products and methods for studying everything from piers to pollution, from sand to salinity. It's all done with people... the best in the business.

You see, it's really elementary. People with ability are what make the world go round at IEC.

INTERSTATE ELECTRONICS CORPORATION

707 E. VERMONT AVE., ANAHEIM, CALIFORNIA 92803

Regional Offices: Atlanta, Georgia • Washington, D.C.

Subsidiary of

INTERSTATE ENGINEERING CORPORATION



New Semiconductors

interface devices for input-output equipment.

Stewart-Warner Microcircuits, Inc., 730 E. Evelyn Ave., Sunnyvale, Calif. [361]

Glass package diodes feature low leakage

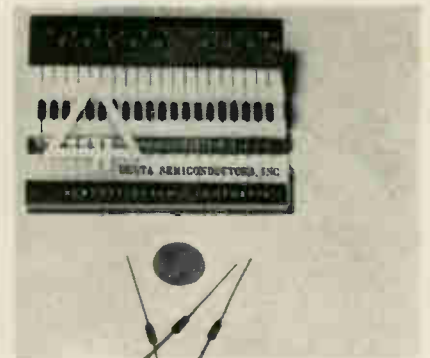

A series of glass package diodes now in production combines extremely low leakage with high conductance. Called the Sub-Nano-Amp series, these diodes exhibit less than 0.75 na leakage at rated piv's coupled with over 400 ma at 1 volt forward conductance.

The devices, numbered DR1 to DR5, sell from \$2 to \$2.50 in 100 to 999 quantities and are available for immediate delivery.

Delta Semiconductors, Inc., 879 W. 16th St., Newport Beach, Calif. [362]

High-voltage silicon rectifier

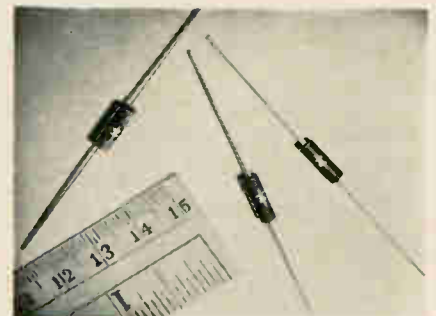

A miniature, multipurpose silicon power rectifier series, called Sem-pac, offers peak inverse voltages ranging from 100 to 10,000 v. Sem-pac is cylindrical in design, with insulated case and axial leads, similar to a computer diode. Better

**CINCH "QUADRICON"
CONNECTORS PROVIDE:**

- RELIABILITY** of a one-piece insulator
- CONVENIENCE** of crimp-on-snap-in contacts
- ECONOMY** of a one-piece insulator which requires no shells, brackets or other mounting hardware.
- PERFORMANCE** including low insertion force, low contact resistance, high current and voltage ratings and high insulation resistance.

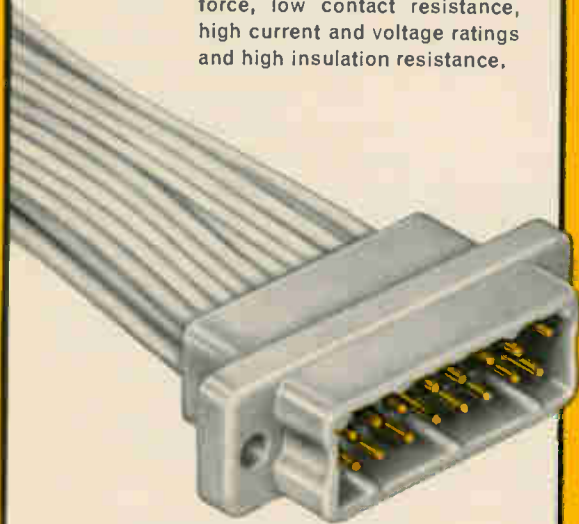

Cinch skills give you MIL connector performance at commercial prices



AVAILABLE WITH RECTANGULAR OR TRAPEZOIDAL MATING ARRANGEMENTS (Rectangular Version Shown)

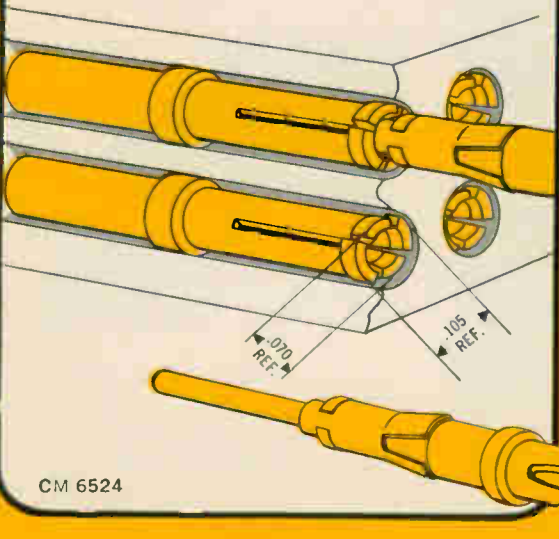

Reliability of the Cinch "Quadricon"* connectors starts with the one-piece, high shock resistant polycarbonate insulator. Add a one-piece female contact and a simple retention clip on the male contact and you have the minimum number of parts possible for a high performance connector with less than .002 ohms contact resistance (even when measured after salt spray corrosion tests). Also, there's a unique "dual diameter" feature on the female contact which provides two spring sections for gripping the inserted male contact and two additional spring sections to firmly grip the ID of the insulator bore.

The drawings show how the "dual diameter" female contact maintains closed entry. The contact cavity ID limits tine spread, effectively protecting against over-size probe insertion and providing superior contact retention. The two tines that engage the male pin provide a safer spherical engaging surface, and low, uniform mating force.

Write Cinch Manufacturing Company at 1026 South Homan Avenue, Chicago, Illinois 60624.

*U.S. Patent No. 3,212,052

CM 6524



Circle 153 on reader service card

To build or buy a power supply ...let Sola quote you both ways

Make the decision a realistic one. Let SOLA quote you on a custom built CV transformer and CVDC power supply. You will then have the costs and specifics to make the right decision.

Building your own d-c supply?

Start with the SOLA CV, custom built to match your power supply's outputs, exactly. Save extra component costs in your design. Get short circuit protection, regulation within $\pm 1\%$ for line variations to $\pm 15\%$. Send output power and circuit requirements, we'll return price of CV and values of circuit components.

Buying a complete d-c supply?

Choose the SOLA CVDC, custom built to your specified output requirements. Get a high watts-per-pound package combining the CV's tight regulation, low forward voltage drop of the rectifier and low output impedance of the capacity filter.

Let SOLA quote both ways. Send us your specs for custom-built CV's and CVDC's, or call your distributor and ask about his line of standard CV's and CVDC's.

Sola Electric Division, Sola Basic Industries, 1717 Busse Road, Elk Grove Village, Illinois 60007 (312) 439-2800.



Sola CV transformer matched to your output requirements



Sola CVDC built to your output requirements

INDUSTRY'S VOLTAGE REGULATION HEADQUARTERS

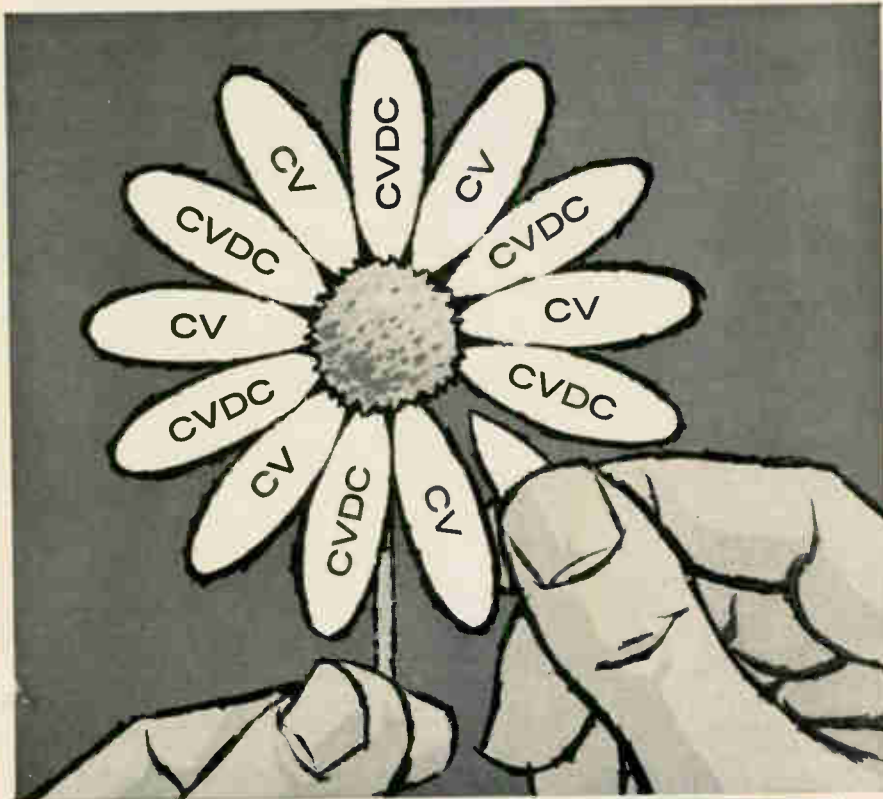

SOLA ELECTRIC

DIVISION OF SOLA BASIC INDUSTRIES

New Semiconductors

electrical characteristics are obtained by excellent thermal conductivity provided by Sempac's solid internal construction and pure silver leads. Hermetically sealed, Sempac is designed to meet stringent temperature-cycling and humidity requirements.

Units 0.235 ± 0.005 in. in length and 0.125 ± 0.003 in. in diameter will withstand 100 to 1,000v, 1 amp at 55°C (no heat sink), or 3 amps per MIL-STD-750; 1500 to 3,000 v, 0.25 amp at 55°C (no heat sink).

Units measuring 0.410 ± 0.005 in. long and 0.140 ± 0.005 in. in diameter will withstand 2,500 to 5,000 v, 0.150 amp at 55°C (no heat sink); 4,000 to 10,000 v, 0.10 amp at 55°C (no heat sink).

Storage and operating temperatures range from -55°C to $+175^\circ\text{C}$. Sempac is designed to meet the most critical military, industrial and consumer applications.

Semtech Corp., 652 Mitchell Road, Newbury Park, Calif. [363]

Power transistors in TO-3, TO-41 cases



A family of germanium pnp power transistors now available is packaged in the TO-3 and TO-41 cases. Over 175 registered types are presented and include the 2N1529-2N1556, 2N2137-2N2146 and 2N-3611-2N3618 series.

The new transistors have excellent gain and saturation voltage characteristics over the current range of $\frac{1}{2}$ to 10 amperes. Typical performance at 7 amperes is: h_{FE} , 45; $V_{CE(SAT)}$, 0.25 v; $V_{BE(SAT)}$, 1.0 v. Prices range from 60 cents up in quantities of 100.

Solitron Devices, Inc., 1177 Blue Heron Blvd., Riviera Beach, Fla. [364]

Vintage 1952

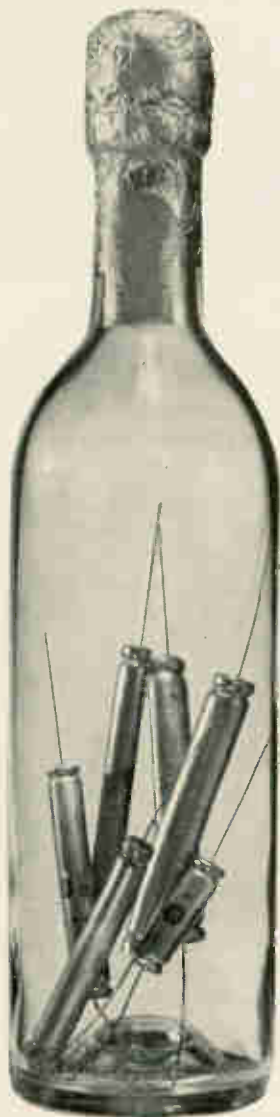

That's 14 years at 25C . . . with capacitance change less than 5%. The bouquet's still there! And long shelf life is only one reason for using G-E tantalum foil capacitors. Here are 3 others:

PROVED OPERATING LIFE: Our 85C tantalum foil has been on continuous test for over 50,000 hours, our 125C for more than 40,000 hours . . . with no capacitance change significant enough to affect performance. And with General Electric's Minuteman-proved true hermetic seal (now offered on most foil units for a small additional charge), life can be extended indefinitely.

REVERSE VOLTAGE STRENGTH: G-E tantalum foil capacitors are designed

to withstand unsuspected reversals.

SELF HEALING: Forget about low impedance circuit problems and catastrophic failures. G-E tantalum foil capacitors are self-healing.

G-E tantalum foil capacitors are available in ratings up to 450VDC, 0.15 to 3500uf, —55 to 85 or 125C.

We've been proving—and improving—them for 17 years. They're virtually risk-proof. And may cost a bit more. But don't the best grapes make the best vintage?

For all the facts on G-E tantalum foil reliability, write for Reliability Report, Section 430-27, General Electric Co., Schenectady, N. Y. 12305

14 years proved shelf life is just one more reason for G-E tantalum foil

ELECTRONIC COMPONENTS DIVISION

GENERAL  ELECTRIC



with this catalog
you can
choose
from
62,000
different
power supplies...



all available
for shipment
in
3 DAYS!

Write for
your copy today to
Acopian Corp.
Easton, Pennsylvania
or telephone
(215) 258-6149.



New Instruments

Graphic recorder for high frequencies

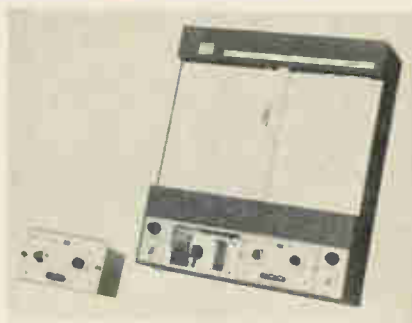

The sensitivity of graphic recorders at high-frequencies is limited by the inertia of the instruments' mechanical components. For applications where only the signal amplitude is of interest, Electronic Associates, Inc., has developed a plug-in module for its EAI Variplotter X-Y recorder that allows the instrument to record signals with frequencies from 20 cps to 100 kc.

In the model 12.1134 a-c module, an amplifier-diode half-wave rectifier circuit converts the rms value of sinusoidal a-c signals to proportional d-c voltages which drive the movable arm and pen of the plotter. Permanent, high-resolution records can thus be made of pure sine waves emanating from such sources as a-c amplifiers, transducers, audio-measuring instruments and analog computers.

The solid state module may be used in either axis of the plotter. It features nine calibrated voltage ranges from 0.05 to 20 volts rms per inch. In addition, a scale factor potentiometer provides zero to 100% attenuation over each range.

A chopper-stabilized operational amplifier provides the high gain necessary to make the circuit independent of variations in compo-

nent parameters. Furthermore, temperature coefficients of all resistors in the feedback and input circuits are compensated.

After rectification, the signal is fed through a second-order passive filter to reduce the ripple content of the d-c output over the entire operating range. Power for the 12.1134 module is supplied from the Variplotter.

Specifications

Frequency range	20 cps to 100 kc
Conversion ratio	0.1 volt d-c/1 volt rms
Price	\$425.00
Availability	45 days

Electronic Associates, Inc., West Long Branch, N.J. [371]

P-c card tester is fully automatic

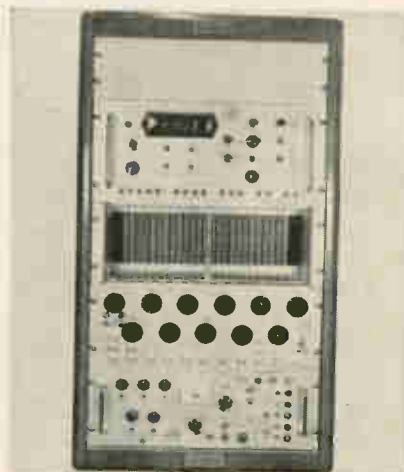

A series of static tests on conventional digital logic cards of various types can be performed automatically with a model CCE-PCT-101 card tester.

A complete series of input test levels is applied to the card sequentially, individually and in combination. A "go" signal must be obtained at each step from the card tester's output monitoring section before continuing with the next step.

This unit is completely self-contained with four internal variable d-c power supplies ranging from 0



to ± 30 v at up to 1 amp; one similar supply has a 5-amp capacity. All are fully regulated for line and load variations. Also included are a wide range oscillator with selectable sine wave, square wave and variable duration and sign pulse outputs over a frequency range from 10 kc to 1 Mc and an amplitude range from 0 to 20 v. Power supply monitoring, power control and sequence control panels are provided.

The tester is designed so manual dynamic tests can be made on critical circuits, with external monitoring equipment. A load-switching panel is included so the full range of expected loading can be applied to any output when the card is under test.

The tester is adaptable to most general-purpose logic cards and can be tailored to almost any series of related cards with a minimum of redesign.

Century Control Engineering division of Century-Detroit Corp., 6101 Concord, Detroit, Mich., 48211 [372]

Solid-state voltmeter is self-calibrating



A precision d-c voltmeter now available features infinite input resistance from 0 to 1,100 v d-c. The solid-state model 240A incorporates a photo resistor chopper in the fully guarded null detector, an ultra stable Zener reference, in-line display with automatic lighted decimal and a recorder output. The new instrument is self-calibrating and features accuracy of $\pm(0.03\% + 10 \mu\text{v})$ of reading and six-digit resolution. The optional battery pack eliminates errors from ground loops and common mode rejection.

Model 240A is designed for operation over an ambient temperature range of 55°F to 95°F, and is available in both cabinet- and rack-

Ballantine Sensitive R-A-P VTVM

(true-Rms) (Av.) (Peak)

Model 321

Price: \$560

Measures True-RMS, Average, or Peak Voltage

Same Accuracy and Resolution over entire Five-Inch Log Scales

Accuracy of 2% of Indication is far better over the lower half of the scale than for a linear scale instrument rated at 1% F.S.D.



THREE INSTRUMENTS IN ONE

Measures Wide Range of Voltages, Frequencies, and Waveforms

Ballantine's Model 321 is an electronic voltmeter designed for accurate measurements of the true-rms, average, or peak values of a wide range of voltages and waveforms. It is *not* limited to measurement of pure sine waves to obtain the specified accuracy, but will measure sine, distorted sine, complex, pulse, or random signals whose frequency components lie within the designated frequency range.

The instrument's five-inch voltage scales make it possible for you to specify uniform resolution and accuracy in % of indication over the entire scale length. This feature is not possible with a linear scale meter.

PARTIAL SPECIFICATIONS

VOLTAGE RANGE

RMS 100 μV — 330 V
Average & Peak 300 μV — 330 V
As null detector to 10 μV

WAVEFORMS

Sine, distorted sine, complex, pulse, random

Power Requirements: 115/230 V, 50 — 420 Hz, 90 W

FREQUENCY RANGE

RMS5 Hz — 4 MHz
3 db bandwidth2 Hz — 7 MHz

ACCURACY, ABOVE 300 μV , MID-BAND

RMS & Average2% of Indication
Peak 3% f.s.

Amplifier: 90 db
Mean Square Output (dc): 1 V

Available in portable or rack versions

Write for brochure giving many more details

Member Scientific Apparatus Makers Association

— Since 1932 —



BALLANTINE LABORATORIES INC.

Boonton, New Jersey

CHECK WITH BALLANTINE FIRST FOR DC AND AC ELECTRONIC VOLTMETERS/AMMETERS/OHMETERS, REGARDLESS OF YOUR REQUIREMENTS. WE HAVE A LARGE LINE, WITH ADDITIONS EACH YEAR. ALSO AC/DC LINEAR CONVERTERS, AC/DC CALIBRATORS, WIDE BAND AMPLIFIERS, DIRECT-READING CAPACITANCE METERS, AND A LINE OF LABORATORY VOLTAGE STANDARDS FOR 0 TO 1,000 MHz

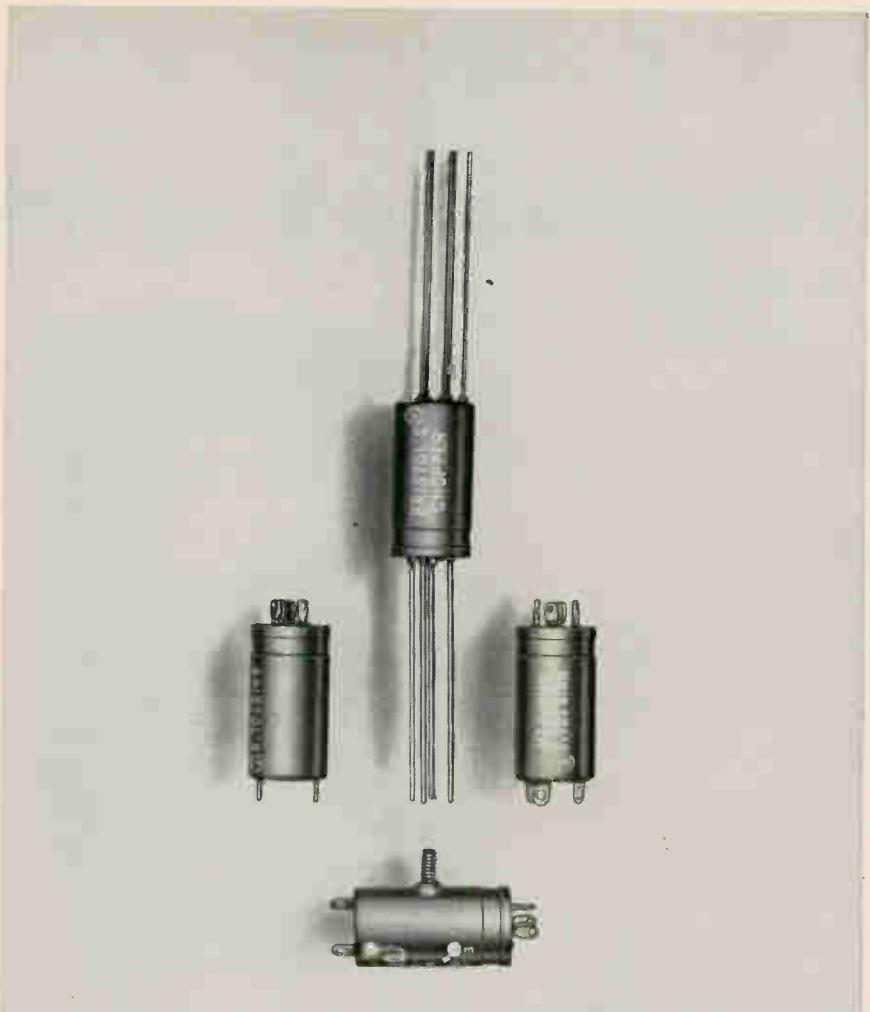

subminiature chopper
(actual size)

BIG SPACE FACTOR!

You'll always find room for this chopper—no matter how crowded you are for component space. And no matter what mounting you have, there's a style to fit it. All you need—for maximum precision and reliability—is 0.1 cubic inch. Bristol F Series Subminiature Chopper also gives you: complete shielding—welded construction—airborne environmental ratings—lowest noise level.

Write **The Bristol Company**, Aircraft Components Division, 152 Bristol Road, Waterbury, Conn. 06720. A subsidiary of American Chain & Cable Company, Inc.



S.12

AUTOMATIC CONTROLLING, RECORDING,
LOGGING AND TELEMETERING INSTRUMENTS
SUPERVISORY CONTROL SYSTEMS



World-Wide Service with manufacturing plants in Canada, Mexico, England, France, Italy, South Africa, Australia and the United States

New Instruments

mount configurations. It has very high off-null input resistance and a 1-mv full-scale null detector with greater than 1 megohm input resistance at 1 mv. Stability is 50 ppm/hr, 100 ppm/200 hr. Precision Standards Corp., 10930 Grand Ave., Temple City, Calif. [373]

Thermal writing portable recorder



The DG5511 two-channel thermal writing recorder has a three-in-one signal-conditioning capability that at present can be duplicated only through the use of multiple instruments. It can be used with attenuator plug-ins for high-level signals, with preamplifier plug-ins for low-level signals, or without plug-ins for high-level signals.

The unit is designed for a wide range of industries—from foods and pharmaceuticals to chemicals, construction, public utilities, and heavy equipment. It is usable in laboratory applications for research and development, in production areas for monitoring and inspection testing, and in the field for service and maintenance.

Truly portable (36 lb), the solid-state instrument records two channels of analog information on 50-mm-wide channels at frequencies from d-c to 125 cps. It utilizes a heated stylus.

Frequency range of the DG5511 is d-c to 70 cps at ± 1.5 db at full amplitude (50 mm), and d-c to 125 cps ± 2.0 db at 10-mm amplitude. Other features include quick, one-motion front chart loading and push-button selectable chart speeds with an automatic trace-density adjustment.

Price of the instrument with two plug-in attenuator-amplifier units is \$1,165; delivery is within 60 days.

Consolidated Electroynamics Corp.,
360 Sierra Madre Villa, Pasadena,
Calif. [374]

Solid-state generator sweeps audio band



Model 610B sweep generator is low in cost yet provides several unprecedented features for automatic frequency plotting, according to the manufacturer. Basic specifications are: sweep width, 20 cps to 20 kc; sweep speed, variable from 6 to 60 seconds; output, 2.5 v into 600 ohms with 80 db attenuation range; and a logarithmic sweep characteristic.

The four sweep modes are switch-selected. Internal circuitry generates a d-c control ramp voltage to program the oscillator in the two automatic sweep modes—continuous and one-shot. In the third mode, the 610B functions as a single-range, manually-tuned, 20-cps-to-20-kc generator. The fourth, or external, mode permits the generator frequency to be programed from external voltage or external resistance sources, such as recorder retransmit pots and function generators.

In the three internal sweep modes, the d-c control ramp voltage is delivered to front-panel binding posts. The ramp voltage may be used for the X drive of X-Y plotters to draw frequency response curves automatically. Oscillator frequency is read on a front-panel meter. Generator output is

The inside story of an extraordinary capacitor

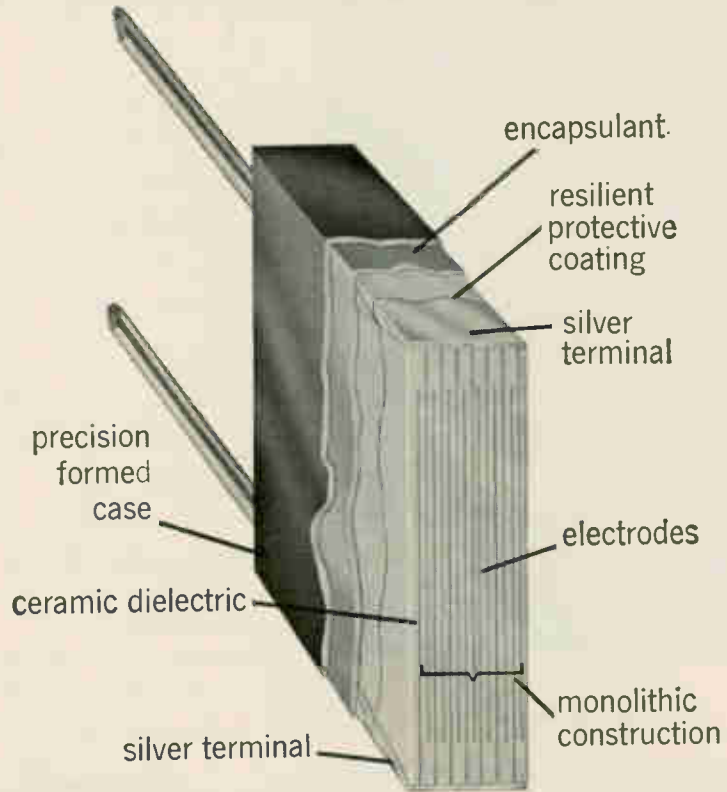

100,000 pf in a CK 06 Case Size!

The unique construction of the **VK 30 Monolithic Ceramic Capacitor** provides an exceptionally high reliability over the entire capacitance range. Volumetric efficiency is greater than 11 mfd per cu. inch . . . Insulation Resistance is 1,000 megohm mfds minimum . . . and Dissipation Factor is less than 2.5% at 2 ± 0.25 V RMS (at 1KC). Data Sheet C10 will give you the complete story on this extraordinary component. Various "monolithic" capacitors are compared in a feature article in the latest issue of **VITRAMON NEWS**. Reply now to receive your copy.

- Capacitance Range: 12,000 to 100,000 pf
- Tolerance: 10% or 20%
- Voltage Rating: 100 VDC (50% derating above 85°C)
- Temperature Range: -55°C to 125°C
- Capable of meeting the environmental tests in MIL-C-11015

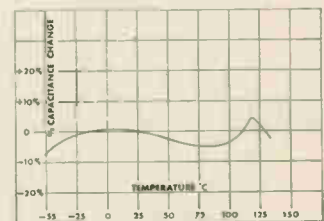

© Vitramon, Inc. 1965

Vitramon

VITRAMON, INCORPORATED
Box 544
Bridgeport, Connecticut 06601

In Greater Europe Contact:
Vitramon Laboratories Limited
Bourne End, Bucks
England

LAPP HEAVY-DUTY STAND-OFF INSULATORS

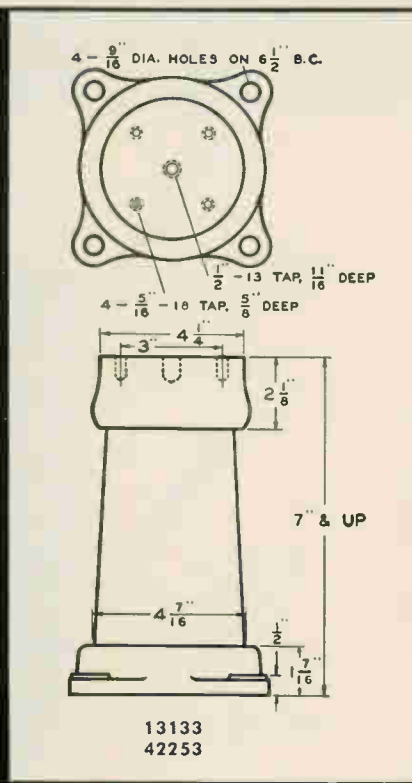
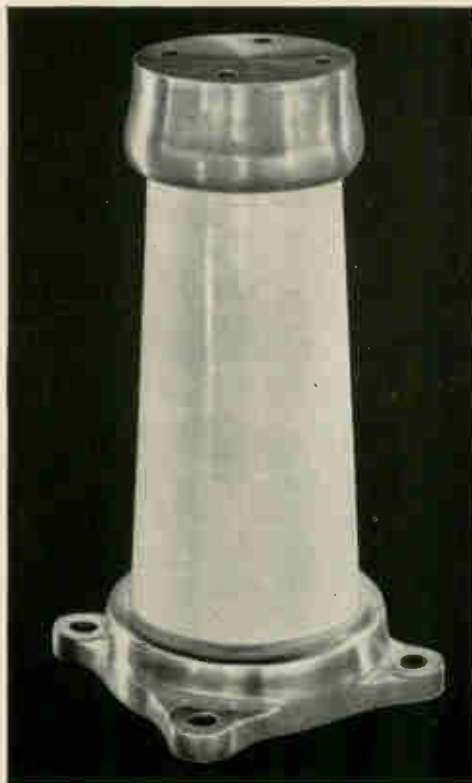

...in all these
**standard sizes to save
you time and money**

FLASHOVER AND RADIO RATINGS							
DRY FLASHOVER 60 kv eff.			RADIO RATING kv eff.				
Height in Inches	13133 42253	9063 26006	13133	42253	9063	26006	
6	37	*48			12 1/2	23	
8	57	*62	13 1/2	25	15 3/4	29	
10	*71	*72	16	30	18	33 1/2	
12	*82	*80	18	33 1/2	20	37	
14	*92		20	37			
16	*101		21 1/2	40			
18	107		22 1/2	41			

NOTE: *indicates in stock.

Other sizes available on special order, for fast delivery,
and at a price you know is fair. Write for Bulletin 301-R.

Lapp

Lapp Insulator Co., Inc.,
240 Sumner Street,
LeRoy, N. Y.

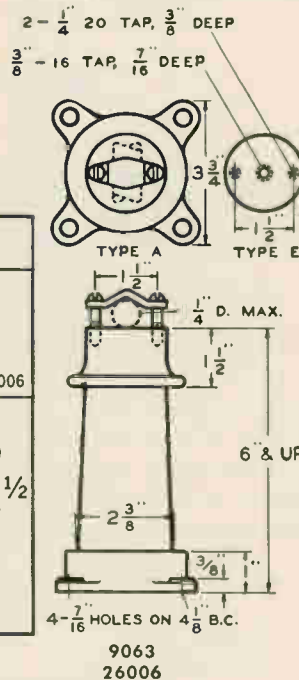

New Instruments

blanked out during recycling when operating in the continuous mode.

Construction is modular. The small case size of the 610B—6x4 1/4 x6 in.—is a space saver in systems and test stands. Price is \$1,000. Waveforms, Inc., 333 Sixth Ave., New York, N.Y., 10014. [375]

Acoustic calibrator for field and lab use

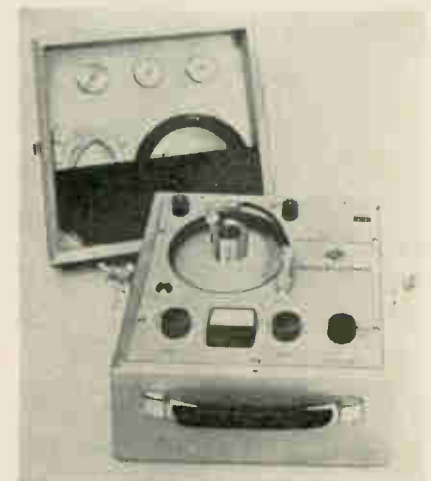

Model PC-125 acoustic calibrator is a self-contained oscillator, power-amplifier, PC-120 driver, and battery supply in a portable wooden case for calibrating the sensitivity and linearity of microphone systems in the field and laboratory. This calibrator is recommended for the pressure calibration of small microphones with flush diaphragms or protective grids. It operates on a fixed frequency of 1,000 cps. The sound pressure level is monitored on an indicating meter and can be varied in 10-db steps from 100 to 160 db. A continuously adjustable control can be used to vary the sound pressure level from +2 to -8 db at each fixed 10-db step.

The PC-125 may be used with an external oscillator for calibration of microphone systems over the standard range from 400 to 4,000 cps, or an extended range from 250 to 8,000 cps. An accurate calibration at 1/3 octave points will be furnished at additional cost. Photocon Research Products, 421 N. Altadena Drive, Pasadena, Calif., 91107. [376]

Engineers interested in developmental aviation have 3 ways to go at Lockheed-California.

Subsonic.



Lockheed's company speedometer spans speed regimes from 0 mph through Mach 12. And the opportunities for engineers interested in programs encompassing these regimes were never more diverse.

In subsonic airborne systems, Lockheed is taking a fresh look at basic problems. For example, it is deeply involved in STOL and V/STOL short-haul transports for mass travel between major cities. In addition, a Lockheed five passenger rigid rotor helicopter prototype is now flying. In the future: heavy-lift helicopters capable of transporting 24,000 or 40,000

Supersonic.



pounds for 100 or 200 miles. And under parallel development—advanced rotary-wing craft able to stop, fold, or start blades in forward flight.

Lockheed's supersonic efforts are also expanding. Its SST program alone is a major and growing endeavor. It reflects the unprecedented experience Lockheed engineers have gained in Mach 3, high altitude, titanium aircraft.

Manned hypersonic test and cruise vehicles, using the SCRAMJET approach, are under development at Lockheed. They point to the day when high priority passengers and cargo

Hypersonic.

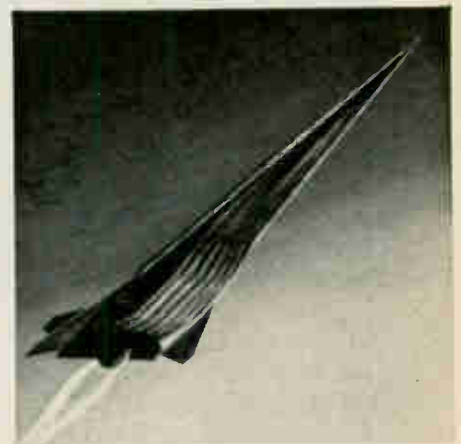

can travel at Mach 12 speeds to any place on earth.

A large number of engineering positions are now open in sub-, super-, and hypersonic speed efforts. For information concerning specific opportunities write: Mr. E. W. Des Lauriers, Professional Placement Manager, Dept. 1501, 2404 N. Hollywood Way, Burbank, California. An equal opportunity employer.

LOCKHEED-CALIFORNIA CO.
A DIVISION OF LOCKHEED AIRCRAFT CORPORATION

Now twice as many



COUCH 0.1 oz. rotary relays

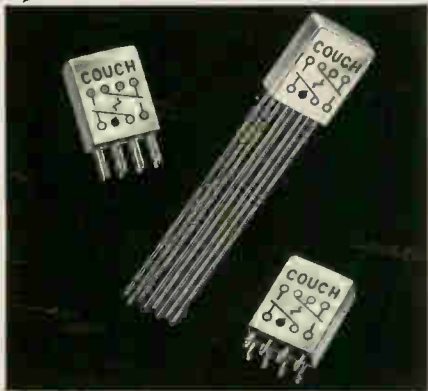

each available in
3 terminal styles . . .

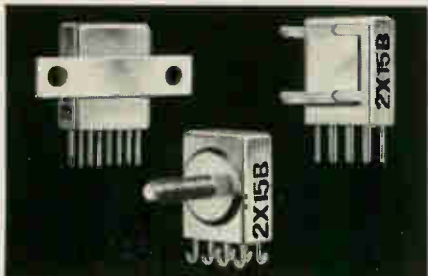

and in many mounting styles

We now offer a full line of SPDT relays, type 1X, to match our DPDT, type 2X, relay line. Except for coil data, specifications are identical for both types:

	2X	1X
Size	0.2" x .4" x .5"	same
Terminal Spacing	1/10" grid	same
Rating	0.5 amp @ 30 VDC	same
Coil Operating Power	150 mw	70 mw
Coil Resistance	60 to 4000 ohms	125 to 4000 ohms
Temperature	-65°C to +125°C	same
Vibration	20 G	same
Shock	75 G	same

Write for Data Sheets No. 9 and 10

RUGGED ROTARY RELAYS  Dynamically and Statically Balanced

COUCH ORDNANCE INC.

3 Arlington Street, North Quincy 71, Mass., Area Code 617,
Cypress 8-4147 A subsidiary of S. H. COUCH COMPANY, INC

New Subassemblies and Systems

Power supplies for system applications

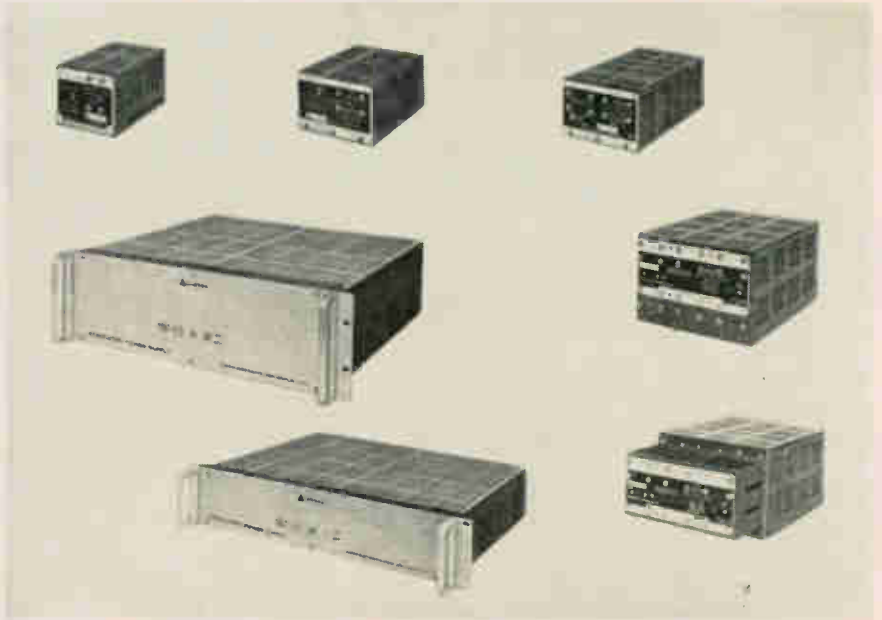

A new line of fixed-voltage power supplies introduced by Lambda Electronics Corp. provides system designers with a comprehensive selection of basic power sources which combine small size with high reliability.

Lambda's LM series comes in seven package sizes and covers fixed voltages to 250 volts d-c. The units range in volume and price from 25 cubic inches and \$79 to 1,600 cubic inches and more than \$500. Maximum output power available is 1,000 watts. In addition, each supply's current and voltage ratings are specified at four different temperatures—from 40° C to 71° C. This approach, according to a Lambda spokesman, was taken so the system designer could have a choice of modules to provide an optimum power package. These supplies, Lambda emphasizes, offer a basic power package stripped of extras for high reliability, providing the maximum possible current at a fixed voltage in the smallest size.

For the new supplies, Lambda designed a line of transformers, each intended for a specific output voltage. This differs from the usual procedure of using the same trans-

former for a wide range of voltages and selecting the desired voltage with a tap on the secondary. Since the maximum-current is independent of the secondary tap position, a more efficient design can be achieved in a transformer tailored to a specific voltage requirement.

The solid-state supplies are constructed on a modular basis. The circuit boards within each of the seven types are identical and a modular inventory is maintained to insure quick delivery. The units are convection cooled; the current ratings can be increased with forced-air cooling. The units can be mounted in a number of positions.

Available accessories increase the versatility of Lambda's LM series. These items can be added to the basic package at the time of ordering. The units have been designed for rack mounting. Rack adapters are available, predrilled to accommodate the most widely used chassis slides. An overvoltage protection accessory—an adjustable crowbar type protective circuit—can also be added. The units are available with panel-mounted voltmeters and ammeters. A plug-in regulator accessory can increase the line regulation by an order of

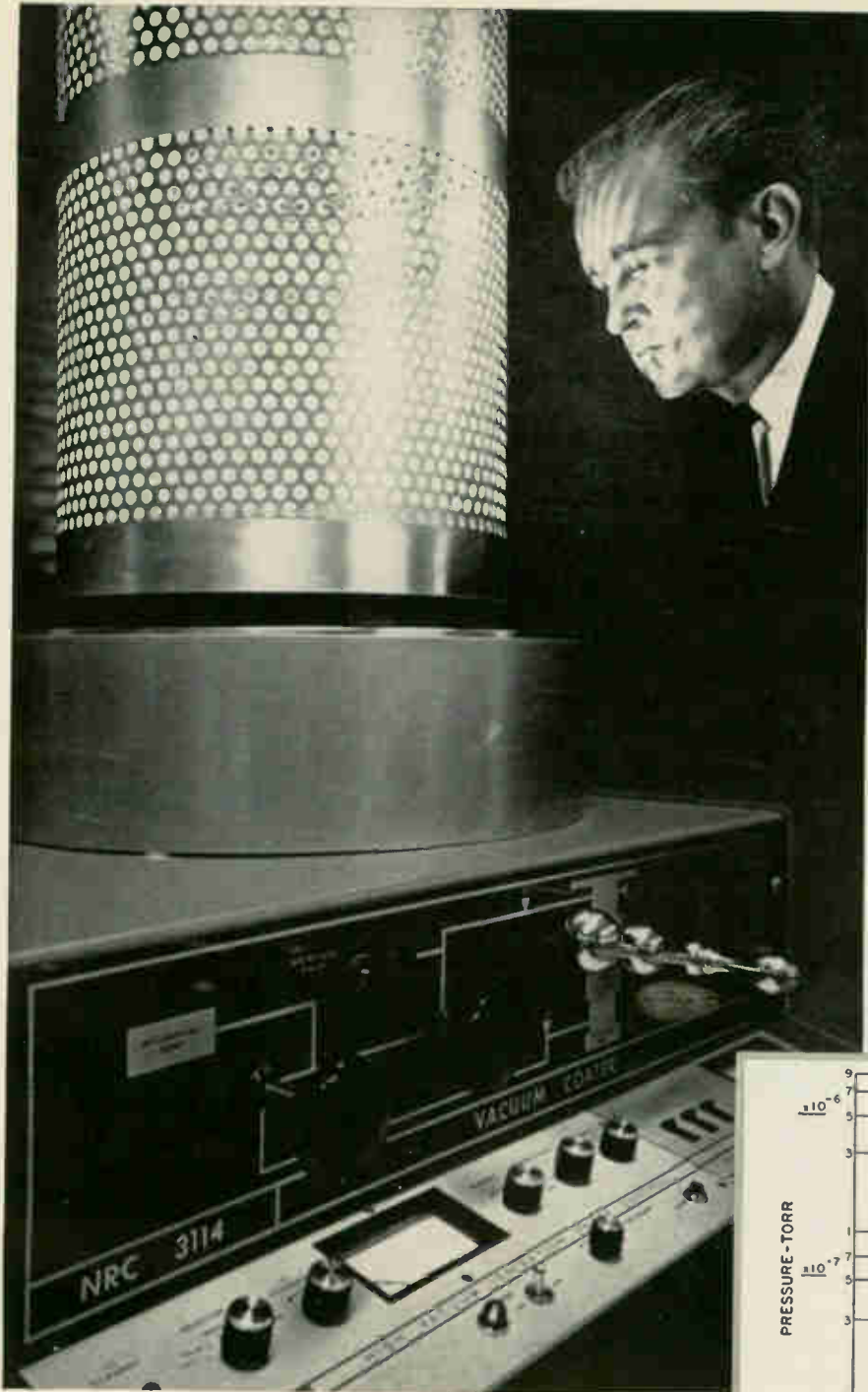

Take a close look at coater claims before you buy. Most companies advertise their vacuum evaporators on the basis of empty chamber pump-down curves. Selling out of an empty chamber strikes us as a curious approach when it's the system performance with work in the bell jar that the user is interested in. Our pump-down curves are deliberately conservative because we don't believe in getting people all excited and then disappointing them. Net pumping speed at the base plate on this NRC 3114 coater is 20 percent higher than with any other four-inch pumping system on the market. The price is \$2,995. Other features in this compact (31" by 33½") system include . . . log and linear scaled NRC 720 gauge control with an ionization gauge tube, two thermocouple gauge tubes . . . raised base plate with bell jar, nonmagnetic, guard and gasket . . . circular chevron multi-coolant baffle/cold trap combination. The electrical control center and gauge control are mounted on a hinged panel which may be lowered to provide complete system accessibility from the front of the unit. Many NRC standard components, including a feedthrough ring, are adaptable for greater flexibility.

The NRC 3114 general purpose coater for microcircuit production and research was introduced just six months ago. It is in use today across the U.S. and Canada in surface physics and solid state research and electronics development and production operations. Write for details or call for a sales engineer today.

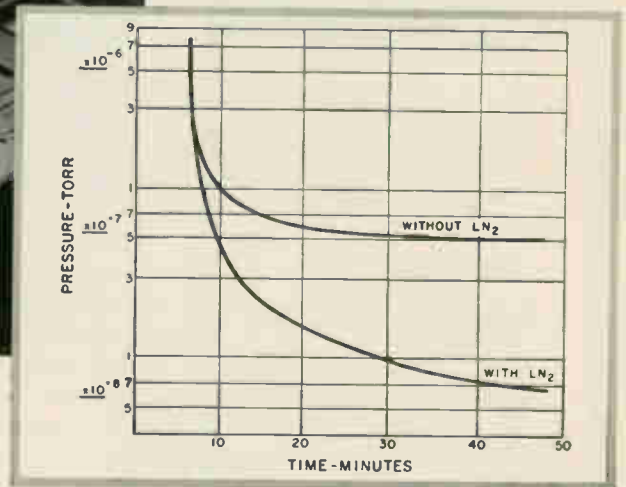

Take a close look at coater claims

EVAPORATORS • PUMPING STATIONS • POWER SUPPLIES
 FEEDTHROUGHS • CRYSTAL PULLERS • LEAK DETECTORS
 ELECTRON BEAM HEAT SOURCES • TUBULAR FURNACES

NRC EQUIPMENT DIVISION
 NATIONAL RESEARCH CORPORATION
 A SUBSIDIARY OF NORTON COMPANY

160 Charlemont Street, Newton, Massachusetts 02161 **NORTON**



New

5 1/2"

SHADED-POLE

Model 6500

PAMOTOR

Axial Fans

- Free air delivery in excess of 300 cfm at 3000 rpm
- Over 20,000 operational hours without maintenance
- Outstanding performance at moderate cost (under \$30.00 for single units)
- Only 2" deep
- 110 v or 220 v operation
- Stocked for immediate delivery

Write for technical data on the Model 6500 and other PAMOTOR axial fans to:

PAMOTOR, INC.
312 SEVENTH STREET • SAN FRANCISCO, CALIF.

New Subassemblies

magnitude to 0.005%. At the same time, it reduces the ripple to 1 millivolt peak to peak and provides temperature regulation of 0.01%° C.

The units are also externally programmable.

Specifications

D-c voltage	17 standard voltages from 2.48 vdc, 7 standard voltages from 48-250 vdc, non-standard on special order
Regulation	0.05% line 0.03% load
Temperature coefficient	0.03% /°C
Ripple	3 mv peak-to-peak
Overload protection	Thermostatic for thermal overload
Operating Temperature	-20° C to 71° C
A-c input	105-132 volts, 45-440 cps
Prices	Start at \$79.00

Lambda Electronics Corp., 515 Broad Hollow Road, Melville, L.I. [381]

Microcircuit logic modules

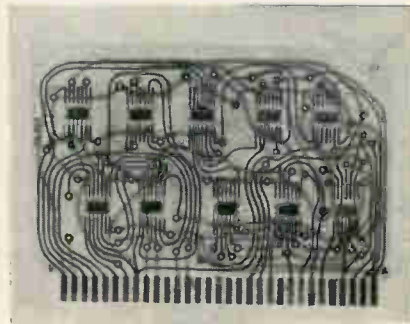

A new line of microcircuit logic modules features a broad selection of logic. Included are DTL, NAND, pedestal-gated flip-flops, decoders, adders, drivers, multivibrators and several combined logics and special circuits.

Module size is 4.375 x 2.750 in. (plus 0.312 in. for the connector). The boards are made of 1/16-in. glass epoxy and the connectors are nickel rhodium. Circuits are solder plate on 2-oz. copper laminate. The microcircuits are generally 14-lead flatpacks using silicon-planar-epitaxial and MOS integrated circuits. The microcircuits are soldered to the carrier board. The operating speed is 5 Mc with 32-nsec maximum switching time, 23 nsec



One of these connectors will outlast the equipment it was built for . . .

THE OTHER WON'T!

Some connectors are built so that they barely scrape by minimum acceptance specs . . . others are designed with long, satisfactory life, as well as specifications, in mind. And often there's little or no price differential between them.

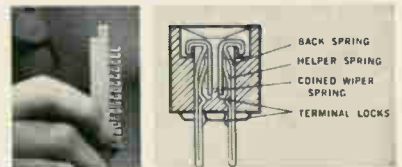

TRANSITRON PCD* printed circuit connectors, for example. Pick one up and you know it's built to last. You can see and feel precision in the molded body, in the spacing and setting of the contacts, in the finish of the metal.

And there's hidden quality . . . where it counts. In the patented Tri-Spring contacts, triple, independent leaf-spring action grips the board firmly over the entire contact area, significantly reducing wear, peel-back, and scoring. Inductive effect is entirely eliminated by shorting paths between board contact and wired tab.

And, interestingly enough, Transitron PCD Printed Circuit Connectors are no more expensive, in quantity, than many units which barely meet specifications.



Send today for this new condensed catalog which provides complete data on these and other fine PCD connectors.



Precision Connector Division

Transitron

electronic corporation
Wakefield, Massachusetts

typical. The temperature range is 0° to 75°C (-55° to +155°C on MilSpec version). Noise rejection is greater than 1 volt. Simplified gating rules allow design in multiples of standard positive loads for all interconnections.

The modules also feature 62-pin connectors (pin spacing, 0.125 in.) which allows a greater number of functions per board, reducing the cost per logic and simplifying application, according to the manufacturer. All units operate on 6 v so that a single power supply may be used.

A full complement of auxiliary equipment, such as mounting hardware and power supplies, is available, as well as complete supporting services of logic design, layout and manufacturing assistance.

Applied Development Corp., 1131 Monterey Pass Road, Monterey Park, Calif. [382]

Delay line device in solid-state module

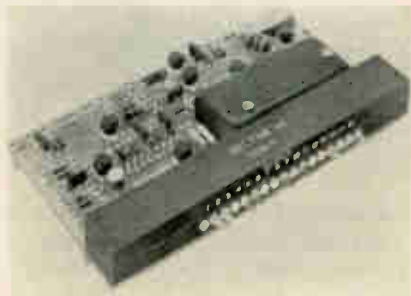

Model CGM-16 solid-state module utilizes magnetostrictive delay line techniques for pulse repetition rate multiplication. High-power pulse generators can be triggered by a single input at repetition rates up to 1 Mc by appropriate selection of pulses in the unit's output pattern. Supplied with the module are miniature jumpers, which are inserted into Teflon insulated jacks. An input trigger and d-c power are the only inputs required.

As an example, pulse repetition rates of 100 kc, 200 kc, and 500 kc can be converted into multiples to 1 Mc. Up to 16 output pulses are available that have a current of -6.6 v in amplitude, 0.5 μ sec in width, and a rise and fall time of less than 0.1 μ sec.

Weight of the CGM-16 is 8 oz, and over-all dimensions are 3 $\frac{3}{8}$ x



The Only Difference is Quality & Price

AND WHAT A DIFFERENCE! FAIRCON square and rectangular trimmers are engineered and manufactured to provide quality and reliability exceeding MIL-R-27208. What's more, they're designed to meet most portions of MIL-R-39015 - the new high reliability specification. That's QUALITY. You'll be pleasantly surprised at our PRICES too. Write today for complete specifications. And for immediate delivery from stock... see ARCO.

FAIRCHILD

CONTROLS

A DIVISION OF FAIRCHILD CAMERA AND INSTRUMENT CORPORATION

225 PARK AVENUE, HICKSVILLE, L. I., NEW YORK

TELEPHONE: (516) 938-5600 • TWX: (516) 433-9146

CABLE: FAIRCON-HICKSVILLE, NEW YORK, U. S. A.



VACTEC PHOTOCELLS

*Vital Components in the Electronic Scoreboard that Electrifies Sports Fans in Houston's Fabled*Astrodome*

Do they go to the Astrodome to see the game, or to enjoy the scoreboard? This \$2,000,000 electronic marvel puts on a show that really turns a crowd on. And Vactec is proud to be selected as supplier of approximately 11,000 matched cadmium sulfide photoelectric cells that are an integral part of the picture transmission system.

Specifically, the varying sensitivities of the Vactec cells control the brightness of the individual lamps

that transmit images on the scoreboard's huge center TV screen. Another example of Vactec's versatility and skill in the design and production of precise photosensitive devices.

Vactec provides a complete line of Se photovoltaic cells as well as CdS and CdSe photoconductive cells. Or Vactec will custom-design a unit for your application.

* Used by permission of Houston Sports Assn., Inc.

VACTEC  **INC.**

2423 Northline Industrial Blvd. Maryland Heights, Mo. 63045
Area Code 314, HE 2-4200

Circle 213 on reader service card

IF YOU BUY, USE OR
SPECIFY PRECISION RESISTORS,
JULIE RESEARCH HAS A FREE
ENGINEERING MANUAL FOR YOU.



NEW!

WHAT'S IN THE MANUAL: ■ How to specify precision resistors. ■ Ten critical checkpoints in resistor specs. ■ Specify by application for best price-performance mix. ■ A chart for selecting precision resistors. ■ Can you use a standard resistor? ■ Four new types of precision resistors. ■ Complete engineering guide to Julie resistors.



JULIE RESEARCH LABORATORIES, INC.

211 WEST 61st STREET, NEW YORK, NEW YORK / (212) CI 5-2727

New Subassemblies

6 $\frac{3}{4}$ x 1 $\frac{1}{16}$ in. Power requirements are ± 12 v d-c.

Selectro Corp., 225 Hoyt St., Mamaroneck, N.Y. 10544. [383]

Universal, low-cost analog building block

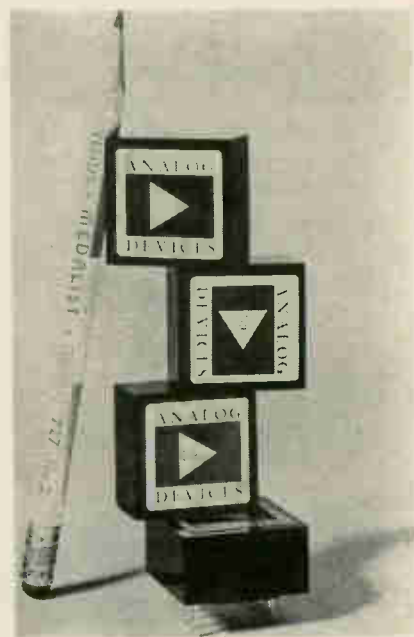

Series 106 d-c differential operational amplifier, priced at \$29, provides a price performance breakthrough that will have three significant effects, according to the manufacturer:

1) Design engineers can now buy precision circuits at lower cost than they can design them from scratch (\$29 is figured as roughly equivalent to two hours of design time). Development delays will be slashed because engineers can forget about circuit details, and concentrate on the "big picture."

2) Mechanical and other engineers who know little about circuit design or semiconductor theory can still build sophisticated electronic circuits. Simple use of Ohm's law puts the operational amplifier to work; external feedback networks determine over-all performance.

3) Original equipment manufacturers who switch from making their own custom-tailored circuits to buying these off-the-shelf build-

ing blocks will be able to transfer engineers to end-product design, and to free capital, space and other resources for more urgent use.

Specifications include: open-loop d-c gain, 80,000; bandwidth, 1.5 Mc; voltage drift, $20 \mu\text{v}/^\circ\text{C}$; output, $\pm 10 \text{ v}$ at 5 ma; input impedance (differential), 100,000 ohms; offset current, 20 na (model 107), and 200 na (model 106).

Applications include inverting, noninverting and difference amplification; null detection; integration; differentiation; relay operation; active filter circuits; selective amplifiers; precision rectifiers; meter drivers; comparator circuits; and many more.

Analog Devices, Inc., 221 Fifth St., Cambridge, Mass. [384]

Voltage-sensitive relay driver

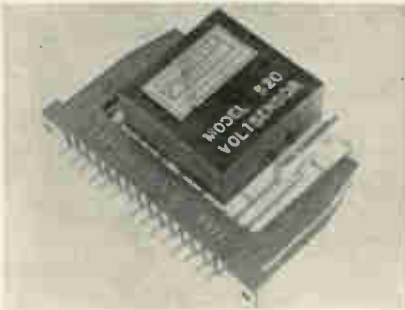

A low-cost, voltage-sensitive relay driver has an adjustable trip point. Model 520 Volt sensor uses silicon planar transistors and is designed for single or multiple use in industrial controls, alarm systems, production quality control, chemical equipment and general-purpose laboratory use.

Features include: input impedance, 100 kilohms; trip range, $\pm 20 \text{ v}$; operating time, less than $25 \mu\text{sec}$; hysteresis, less than 50 mv; output, $+20 \text{ v}$ d-c at 50 ma; trip point stability, better than $0.025\%/^\circ\text{C}$; operating temperature range, -40° to $+75^\circ\text{C}$.

Model 520 is priced at \$38 each with delivery from stock. Model 252 mounting kit, as illustrated, includes the p-c board, potentiometer and connector with built-in guides ready for mounting and use. It is available at \$10.

California Electronic Mfg. Co., P.O. Box 355, Alamo, Calif., 94507. [385]



FOR SUPERFINE
CUTTING OF
HARD, BRITTLE
MATERIALS...

THE S. S. WHITE AIRBRASIVE® UNIT

Airbrasive technicians get carried away with their demonstrations sometimes... there's nothing safe from a tool that cuts just about anything hard and brittle.

What does it prove? The Airbrasive is a unique tool of a thousand uses in shop or laboratory. A precise stream of gas-propelled particles (cuts as fine as 0.005") made it possible for us to cut this TV tube like a radish. The Airbrasive has a cool completely shockless cutting action, which can be applied to such hard-to-work materials as germanium, tungsten, glass, ferrites, and ceramics. It will clean, cut, abrade, remove surface coatings, adjust micro-miniature circuits, strip potentiometers, debur tiny parts, and perform many more delicate tasks.

In many cases you will find that the Airbrasive pays for itself on the first application by eliminating rejects, reducing handwork, or simply performing a job that you had previously thought impossible. For under \$1000 you can set up your own Airbrasive cutting unit.

You don't believe in magic wands?... just try us. Send samples of your impossible jobs... and we'll test them free of charge.

S. S. WHITE INDUSTRIAL DIVISION
Dept. EU, 201 East 42nd Street, N. Y., N. Y. 10017
Telephone 212-661-3320

SEND FOR
BULLETIN 6407A
Complete
information



S.S. WHITE COMPANY
Industrial Division



The shape of tomorrow, today

For more than 20 years, Ultra Carbon consistently has provided industry with advanced graphite technology. "F" purity graphite for the AEC ... semiconductor crystal crucibles, boats, headers and fixtures made from *Ultra purity* graphite—these are typical of our past contributions to the electronic industries.

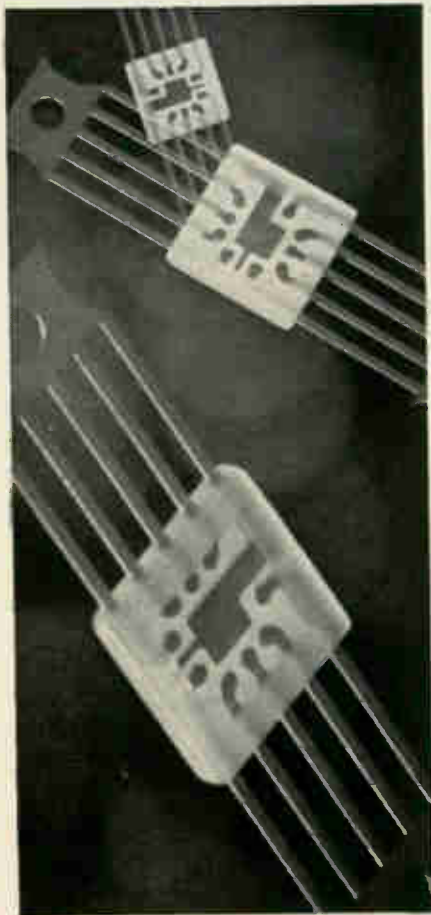

ULTRA/FGP® flat glass packs for integrated circuits in 10 lead configuration are available from stock. For our catalog, write Ultra Carbon Corporation, Box 747, Bay City, Michigan 48709.

New Microwave

Circulator handles 125 kw average

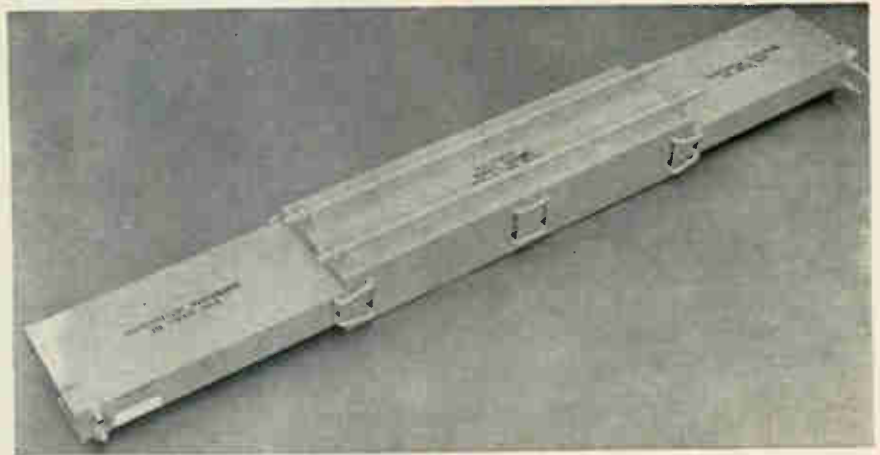

A new ferrite is credited with increasing the power handling ability of an S-band circulator by five times over others now available. Developed by the Raytheon Co., the circulator can handle 125 kilowatts of average power based on a 2-to-1 load mismatch. Peak power is rated at 30 megawatts. Raytheon won't reveal the nature of the ferrite material used.

Designed model CSH31 by the company, the circulator is a four-port device consisting of a differential phase shift section connected between two 3-decibel hybrid waveguide junction sections. It can be used as an isolator or a duplexer.

Usually, with circulators of this configuration, heating of the ferrite material in the phase shift section limits the amount of power that can be applied. As a result, du-

plexers or isolators were designed to handle high peak power but average power was limited.

Frequency range of the CSH31 is 3 to 3.6 gigacycles. It is water-cooled at five gallons per minute. To prevent arcing at the specified power levels, the circulator must be pressurized at 30 psig with a dielectric gas such as sulfur-hexafluoride.

Cost and delivery are available upon request.

Specifications

Isolation	20 decibels minimum
Insertion loss	0.4 decibel maximum
V _{swr}	1.20 maximum
Flanges	CPR type
Waveguide	WR-284
Weight	190 pounds
Length	78 inches

Raytheon Co., 130 Second Ave., Waltham, Mass. 02154 [391]

20-watt c-w power with twt amplifiers

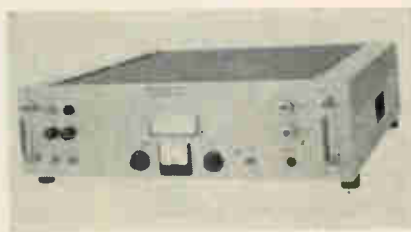

Twenty watts of c-w power is offered in five bands (1 to 2 Gc, 2 to 4 Gc, 4 to 8 Gc, 6 to 11 Gc, and 8 to 12.4 Gc) with these microwave amplifiers. A 35- or 50-db small signal gain is available in any band. Each amplifier will accept twt's of other bands after only minor adjustments are made. Noise figure is 35 db max. Power input is 105 to 125 or 210 to 230 v a-c, 50/60 cps. All twt's are warranted for 1,000

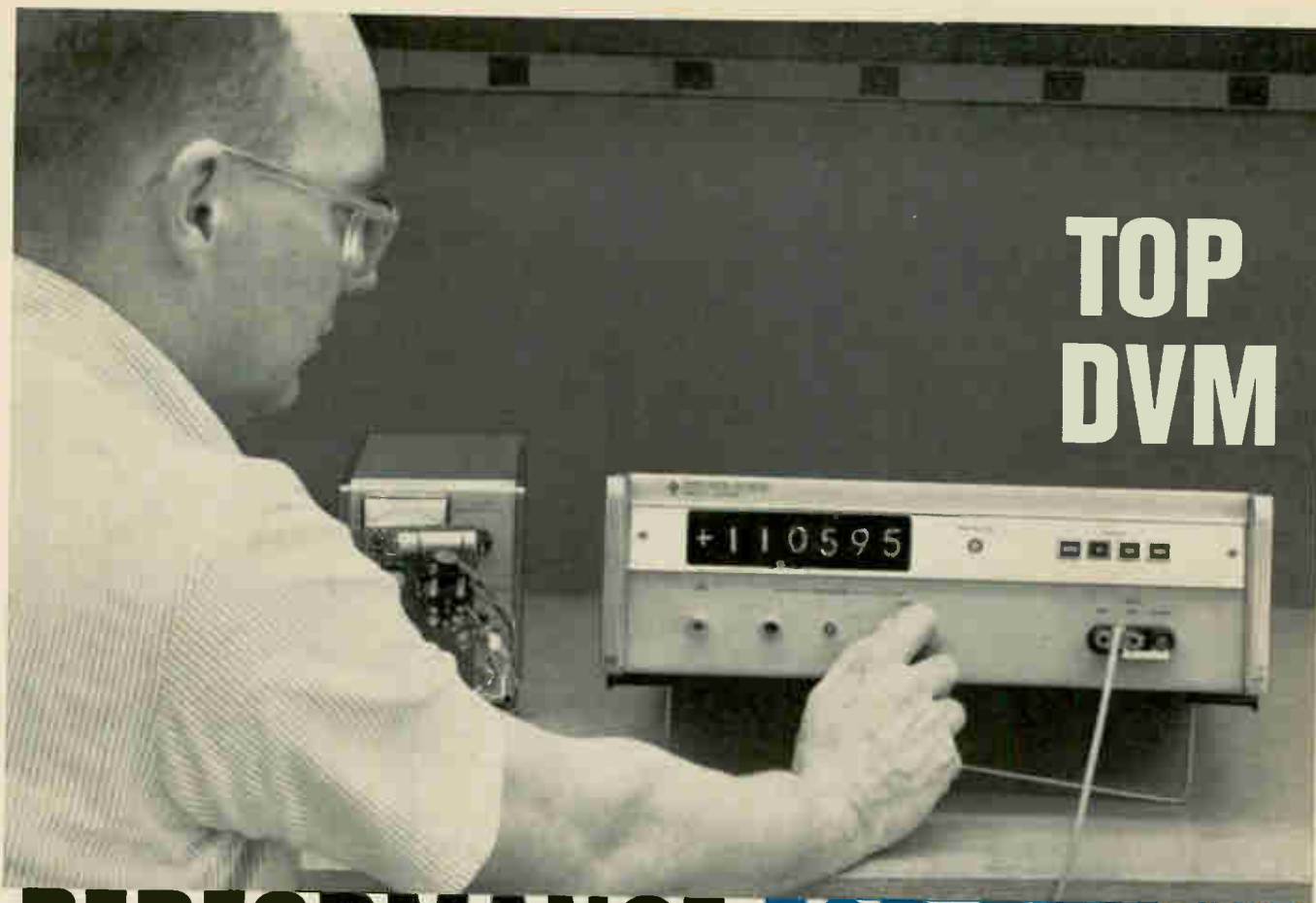

TOP DVM

PERFORMANCE FOR BENCH USE

the 3459A from Hewlett-Packard

*high accuracy
high common mode rejection
constant high input impedance
high resolution
pushbutton convenience*

All these performance characteristics make the hp 3459A the ideal digital voltmeter for your bench use.

It gives you 5-digit (100 μ v resolution) readout, for measurements 10 V to 1000 V full scale, 3 ranges, with standards lab accuracy (0.008%), 20% over-ranging with a sixth digit, readings from 2/second to 1/5 seconds.

A unique combination of integrating and potentiometric techniques gives you effective common mode rejection better than 150 db at all frequencies, 120% of full-scale superimposed noise can be tolerated.

Ranging is automatic or manual by pushbutton selection, depending on your bench task. Solid-state design insures reliability. Display storage gives you

a non-blinking readout. BCD output is optional.

Here's a bench DVM, easy to use, dependable, with best available performance... at a price that makes sense for your application: \$2850.

Ask your Hewlett-Packard field engineer for a demonstration. Or write for complete specifications: Hewlett-Packard, Palo Alto, Calif. 94304, Tel. (415) 326-7000; Europe: 54 Route des Acacias, Geneva.

Data subject to change without notice. Price f.o.b. factory.

HEWLETT  **PACKARD**
An extra measure of quality

FAMOUS ENCAPSULATING TECHNIQUES

with hull



... and by **HULL**



for **BIG** coils, too!

Not all electrical or electronic components for encapsulation by transfer molding are peanut-size! Take coils, for example, as used in transformers, solenoids, and motors. Hull has the field-proven process for your component . . . whether it's a tiny diode, or a coil 5" in diameter!

Whatever your encapsulating problem, Hull engineers can help you choose the most profitable solution. Hull techniques include direct encapsulation by transfer molding, by vacuum potting, and by continuous dispensing with the Blendmaster.

Get the "Hull Package"

From Hull, you get a complete service package: engineering, compound selection, design of mold and fixtures, presses, the work set-up, and assistance in start-up. Why not call or write us today to find out how Hull can help keep your quantity/quality ratios in line?

HULL CORPORATION, 6031 Davisville Road, Hatboro, Pa. 19040. Phone (215) 675-5000. H-21R



New Microwave

hours, prorated on use.

Size is 5¼-in. high by 19-in. wide by 21-in. deep for standard rack mounting. Bench mount adaptors, 400 cps operation, and modulation inputs can be provided.

Price of standard 35-db gain units is \$4,435; for standard 50-db gain units, \$4,710. Delivery is 45 to 60 days.

Alto Scientific Co., Inc., 4083 Transport St., Palo Alto, Calif., 94303. [392]

Dual-channel rotary joint

A high-speed, long-life, extremely-low-noise dual-channel rotary joint, Model 16-2255, covers the d-c to 2.3-Gc and d-c to 12-Gc bands. Typical low vswr characteristics are: d-c to 12-Gc channel, less than 1.65:1; d-c to 2.3-Gc channel, less than 2.0:1.

Model 16-2255 has a 2½-in. working diameter, is less than 5¾ in. long, and weighs approximately 1½ lb.

Diamond Antenna & Microwave Corp., Winchester, Mass., 01890. [393]

Millimeter-band frequency meters

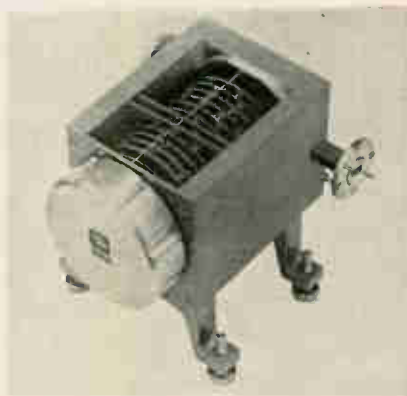

Series 551 direct-reading, millimeter-band frequency meters are available in seven models in the standard waveguide sizes, covering the range from 12.4 to 110 Gc.

This compact unit with integral stand and adjustable legs consists of a precision, highly polished tel-

GET MORE COOLING PER DOLLAR

New, patented Zero all-angle blower

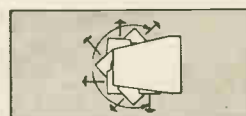

Air flow directed at any angle through 230°

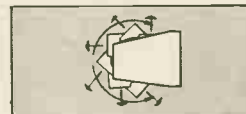

Motor-rotor assembly turned for this air flow pattern

Because cooling air flow can be directed at any angle through 230°, this new blower replaces thirteen older types, accurately directs air to exactly where it is needed, without efficiency-robbing sharp-angle ducting. Rotate each of the twin scrolls independently to the angle you need, or, reverse the motor-rotor assembly and create an entirely new flow pattern. You can even use one scroll for cooling and one for exhaust.

CHECK THESE FEATURES: Assured 400 CFM output • Mounts to standard EIA rack panel • MIL quality, heavy duty construction • Easy maintenance • Interference-free operation • Sealed ball bearings for long life • Cleanable filter — disposable filters available.

Other blowers available to suit your every requirement

Rack mounting. Many standard models with single or twin blowers. Refrigerated (6,000 BTU) units recirculate air and maintain pre-set temperature in cabinet. Quiet, interference-free.

For complete data and information, write for CATALOG R

Zero Manufacturing Co.

1121 Chestnut Street
Burbank, California 91503
Telephone Victoria 9-5521
area code 213
TWX 213-846-8094



Factories in Burbank, Calif. and Monson, Mass.

lurium copper cavity which operates in the TE_{1n} mode. A small hole in the narrow wall of the waveguide couples energy to the cavity and results in a resonance dip in transmitted power of 0.5 to 1.0 db over the waveguide band.

Cavity tuning is accomplished by means of a precision drive screw and noncontacting short circuit. Direct readout of frequency is provided by means of a 74-in.-long helical scale with 10-Mc marking increments.

TRG, a subsidiary of Control Data Corp., 400 Border St., East Boston, Mass., 02128. [394]

Ku-band amplifier suited for satellites

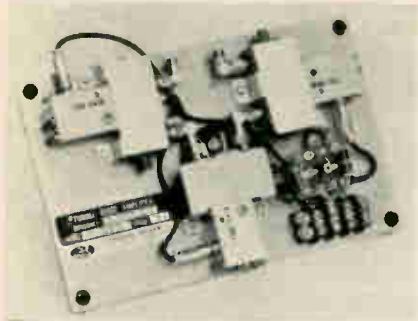

A Ku-band tunnel-diode amplifier now available offers wide bandwidth and high gain. Model NC-13001 operates over a frequency range of 12.9 to 13.9 Gc. Minimum gain is 45 db over the 1-Gc bandwidth. Noise at 13.9 Gc is only 6 db.

Compact in size, the device is ideally suited for satellite applications. It is powered from a 24-v d-c source and has OSM type connectors. Delivery is 45 to 60 days.

Micro State Electronics Corp., 152 Floral Ave., Murray Hill, N.J. [395]

Triode oscillator tunes from 2 to 4 Gc



A triode oscillator provides a high-

COMPARE PHYSICAL SIZE CAPACITANCE AND COST

YOU'LL SPECIFY

RMC MAGNACAPS

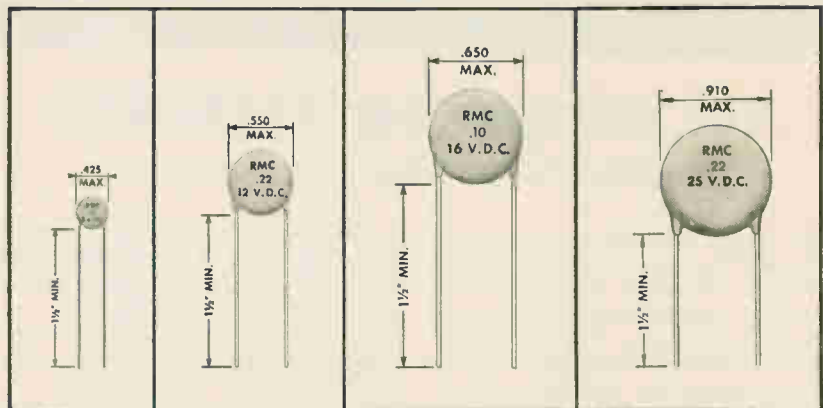

GENERAL SPECIFICATIONS

CAPACITANCE: Within tolerance @ 1KC, 0.05 vrms max. and 25°C.

TEMPERATURE COEFFICIENT: M-3—Z5R, Y5S, X5S, M-12, 16 and 25—Z5T, Y5T, X5U.

LIFE TEST: 250 hours @ rated voltage and maximum temperature.

BODY INSULATION: Durez phenolic—vacuum wax impregnated.

LEAD STYLES AVAILABLE: Long leads—#22 AWG tinned copper and kinked lead plug-ins for printed wire circuits.

■ For their size RMC Magnacaps offer the ultimate in the development of capacitance with acceptable temperature stability. Considering their small size and their proven reliability you'll find that Magnacaps are very economical.

Type M3 and M12 "MAGNACAPS" offer an extremely high efficiency ratio and are recommended for applications with lower operating voltages. The M3 type is available with a capacitance range of .05 mf to 2.2 mf. M12 Magnacaps cover the range from .05 mf to 1.0 mf. Their use as emitter bypass components is particularly suggested, as they retain their proper impedance characteristics well into the radio frequency range.

M16 and M25 "MAGNACAPS" offer an economical general purpose component for wide application with a capacitance range of .01 mf to .22 mf. Their conservative design rating, and high value of insulation resistance (10 megohms at rated voltage) has made these units particularly popular in mobile or portable battery operated equipment.

For additional information, write on your letterhead.

DISCAP
CERAMIC
CAPACITORS



RADIO MATERIALS COMPANY

A DIVISION OF P. R. MALLORY & CO., INC.

GENERAL OFFICE: 4242 W. Bryn Mawr Ave., Chicago 46, Ill.
Two RMC Plants Devoted Exclusively to Ceramic Capacitors

FACTORIES AT CHICAGO, ILL. AND ATTICA, IND.

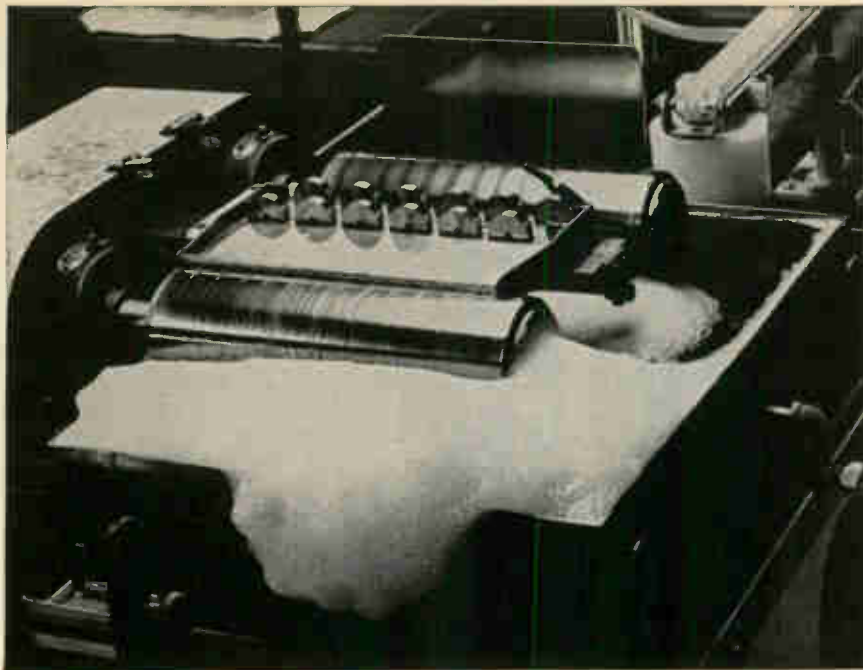

12 steps to .00025

(quality always takes a little longer)

We might possibly produce this particular fine precision wire in only six steps — However, the quality our customers require could not be maintained on that basis. At Secon, quality production of highly engineered, contamination-free, precision wire is a way of life.

As the leading supplier of this product to the Electronics Industry, we carry on a program of continuing metallurgical research and development. We are staffed to work solely on precision wire and ribbon products. And we are customer attuned — maintaining complete and accurate records of the physical and electrical properties of all materials shipped.

These records permit us to maintain a high level of production reproducibility — facilitating instant reaction to all customer requests.

Our years of experience in spool design (we pioneered the great majority of today's "Standards") — allows you to specify, or Secon to recommend, exceptionally precise spooling.

If your requirements are for very high quality, fine electronic wire or ribbon, you should have a copy of our comprehensive 48 page brochure. It lists the physical and electrical properties of available materials. Please write on your letterhead; no obligation, of course.



7 INTERVALE STREET, WHITE PLAINS, N. Y. ■ (914) WH 9-4757

Circle 172 on reader service card

To order reprints: Fill in, cut out coupon below, insert in envelope and mail to: Electronics Reprint Dept., 330 W. 42nd Street, New York, N.Y. 10036

Reprint order form

For listing of reprints available see the Reader Service Card.

U.S. Electronics Market 1966

Send me reprints of Key no. R-85 at 50¢ each.

For reprints of previous special reports fill in below:

Send me reprints of Key No.(s) @ ¢ each.

(For prices, see Reader Service Card)

Name

Number of street

City, State, Zip code

New Microwave

power signal source that is continuously tunable over the 2-Gc to 4-Gc frequency range. Model 2423 employs a triode mounted in a multiaxial cavity. Average power output is 1.5 watts; minimum is 1.0 watt. Tuning resolution is 40 kc or better with over-all residual f-m less than 10 kc.

Varactor element incremental frequency control is provided over the entire octave band with a tuning range of ± 0.4 Mc at 2.0 Gc to ± 0.8 Mc at 4.0 Gc, so the oscillator may be employed in phase-locking applications. The unit is housed in a heavy-walled, gold-plated case 2 in. in diameter by $11\frac{7}{8}$ in. long.

Price of the model 2423 is \$1,750; delivery four weeks.

Scientific-Atlanta, Inc., Box 13654, Atlanta, Ga., 30324. [396]

Klystron oscillators deliver 1 to 10 watts



Designed primarily for pumping parametric amplifiers, the VA-533 series of two-cavity klystron oscillators provides 1 to 10 watts at any fixed frequency between 12.4 and 18 Gc. Tubes of this series are also quite suitable for doppler navigation systems and as high-power sources for test sets and equipment that measures antenna patterns.

Typical electron beam requirements for a tube with a 2-w, c-w output are 1,000 v and 40 ma. For a c-w output of 10 w, a beam power of about 1,250 v and 80 ma is required. Cooling is through conduction.

Priced under \$2,000 each in small

quantities, VA-533 tubes are available approximately 60 days after receipt of order.

Varian Associates, 611 Hansen Way, Palo Alto, Calif., 94303. [397]

Crystal-controlled local oscillator



A crystal-controlled c-w oscillator now available operates at any frequency within a range of 1.05 to 1.35 Gc. It consists of a crystal-controlled oscillator and a step recovery diode multiplier.

The unit provides a stable output of 3 mw minimum with long-term frequency stability of 5 parts in 10^6 over a 24-hour period. Frequency stability vs temperature is 0.3 ppm/ $^{\circ}$ C and temperature range is -20° to $+70^{\circ}$ C. Altitude is unlimited. The Resonatron 9511-1040 weighs 5 oz, and is 2 in. long, $1\frac{3}{4}$ in. high and $1\frac{1}{8}$ in. wide, less projections.

Trak Microwave Corp., 4726 Kennedy Road, Tampa, Fla., 33614. [398]

Five-port circulators feature small size

Miniaturized 5-port circulators feature a removable connector so that long-line effects and connector vswr may be eliminated by direct integration with a tunnel diode amplifier. Devices can be produced with wide bandwidths within the range of 200 Mc to 16 Gc.

Specifications of a typical unit (CMC-909) are frequency, 6 to 8 Gc; isolation, 40 db minimum; insertion loss, 0.4 db maximum; size, 3 by $1\frac{3}{4}$ by $\frac{3}{4}$ in. Price is \$490; delivery, 30 to 45 days after receipt of order.

Western Microwave Labs, Inc., 1045 DeGiulio Ave., Santa Clara, Calif. [399]

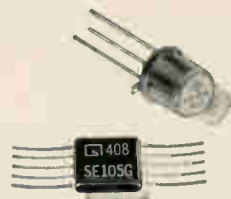

Need to say a lot in a little space?

(or make markings more durable...or more economical...or at higher rates?)



We can show you how

We can show you how to identify products so they will resist extreme amounts of handling, abrasion, many solvents and other atmospheric conditions . . . or how to sequentially number and identify components with savings of more than \$50 per 1000 . . . or how to print trademark, type number, value and date code on 90 units a minute . . . or how to produce an imprint that remains readable after 1000 hours at 200° C . . . or get 10 digits and 2 letters in a micro-circuit area of 0.090" — or 21 characters on a TO-5 case with interchangeable type number and date code . . . or save 75 cents of every dollar you now spend on buying, applying, inventorying and discarding obsolete preprinted labels.

The answers are in proven Markem machines, type and specialty inks, which daily produce better product or package identification by reducing costs, smoothing production control and increasing customer acceptance. And while Markem machines, type and inks are helping to produce better products through more complete and lasting identification, they frequently pay for themselves in the savings they make possible. Tell us what you make, what it must say, and for how long: we'll give you a specific recommendation and cost estimate right away. Write Electrical Division, Markem Machine Co., 305 Congress St., Keene, New Hampshire 03431.

MARKEM

0.005% absolute linearity now in a.c. pots!

VERNISTAT® MODEL 3C

This compact, size 18 package has the following characteristics:

Absolute linearity	0.005%
Nominal input impedance	40,000 ohms
Maximum output impedance	20 ohms
Nominal impedance ratio	2000
Maximum input voltage, 400 cps	35 volts
Output quadrature	0.05 mV/V
Theoretical resolution (100/N)	0.002%
Maximum output current	25 ma
Electrical rotation	30 turns, 10,800°

High absolute linearity is inherent in all Vernistat a.c. pots and over the entire shaft rotation range. The absence of end-trimming enhances system reliability, and you have live zero and live 100% too. The unique, high mutual coupling provides at least 10^3 ratio between input and output impedances assuring relative immunity to loading errors.

Couldn't these specifications improve and simplify a high-performance servo system or a fire control computer design? Try the Vernistat a.c. pots next time. A broad line of models and sizes is at your fingertips. Just write to Perkin-Elmer Corporation, Electronic Products Division, 751 Main Avenue, Norwalk, Connecticut.



PERKIN-ELMER

New Production Equipment

Electron-beam welder is fully automatic

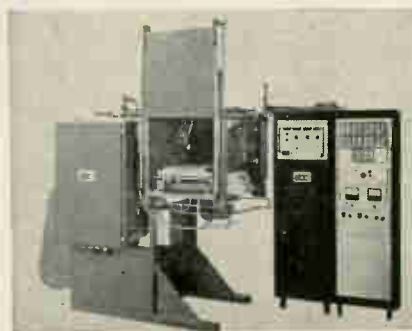

Model EBW-3B is specifically designed for high production welding of transformer core laminations. It can automatically weld 300 3 x 4-in. cores per hour.

The entire welding cycle can be sequenced by a control system operated by just four push buttons. The cycle consists of automatic pump down and weld program initiation, followed by air release and door opening and closing.

The weld cycle is programmed for 1 to 11 welding passes, and the distance between cycles may be set independently. Distance between passes is adjustable from 0.1 to 6 in. Welding speed is from 2 to 200 in. per minute.

Electron Beam Corp., 161 Pleasant St., Lynn, Mass., 01901. [401]

Soldering/stripping control console



Catalog No. 105111 control console combines in one 18x8x11-in. package three panels—one for thermal wire stripping, one for resistance soldering, and one for conduction

soldering. It fills the need for versatility in school, lab, or design shop work. On high-production set-ups, the console provides the exact control of heat and time needed for 100% repeatability.

The wire-stripping panel includes infinitely-variable voltage control, direct-reading voltmeter, pilot light, and on-off switch. The operator can dial high temperatures for stripping Teflon insulation, or low heat for stripping vinyl without sintering. The wire-stripping handpiece can be used with or without a foot switch.

The center panel is the resistance soldering facility. In addition to voltage control like that on the first panel, an electromechanical timer is included to govern the length of the heat pulse. The timer is an automatic nonrepeat type, calibrated from 0 to 15 sec at quarter-second intervals. It can be locked out, leaving pulse control with the foot switch. The voltage and time limits can be established by making sample connections; 100% repeatability is guaranteed for succeeding connections.

The third panel is the conduction soldering facility, which accommodates any soldering iron up to 150 watts. It controls working temperatures to fit any task. For example, it is suited for working on p-c board conformal coatings because it can provide the exact low heat needed. It also assures correct idling-temperature control.

All three panels are separately fused and controlled by on-off switches. One hundred watts is the maximum for each of the two resistance functions; 150 w for the conduction function.

American Electrical Heater Co., 6110 Cass Ave., Detroit, Mich., 48202. [402]

Hand-fed coil winder for laboratory use

A low-cost, hand-fed portable machine of a basically new design is announced for electronics laboratory and prototype wire winding on small bobbins and tubular forms. The model 3, developed to meet



NEW FROM CRAMER...

CRAMER LIFT-LOK Stools

adjust to every worker like fine tools!

Because Cramer Lift-Lok is infinitely adjustable! Just lift the seat and stop at the most comfortable height. It takes less time than to read this sentence. Since fatigue is a critical factor in efficiency of seated workers, it makes good sense to provide tools that minimize fatigue. With Lift-Lok every worker can seek exactly his own efficient level. Available in four base types, steel, wood or plastic seats, contoured or flat, adjustable or flexible backs. To find out about the stools that qualify as production tools, write:
V.P. Sales, Cramer, 625 Adams, Kansas City, Kan. 66105.

CRAMER

CRAMER INDUSTRIES INC. - KANSAS CITY, KANSAS

Industrial supplier
inquiries invited.

Fine seating—safety ladders—stands and related products for office, industry and institutions.

Circle 216 on reader service card

SPUTTERING or VAPOR DEPOSITIONS?

Which method is better? Thin film technologists are not always in agreement on this question. However, they do agree that

ULTRA-HIGH PURITY METALS

produce the best films.

For sputtering electrodes or vapor deposition materials prepared from zone refined vacuum melted metals, contact our



Advanced Materials Division
MATERIALS RESEARCH CORPORATION
Orangeburg, New York 10962
(914) ELmwood 9-4200

Circle 217 on reader service card

SERIES

GM MICROMINIATURE RF COAXIAL CONNECTORS

To meet the demands for reliable operating performance in a microminiature connector, GRFF perfected its own GM Series! Completely compatible with recently available tiny, lightweight cables, the GM Series are the only microminiature connectors featuring a *protective finger design* which couples the ground path to the mating connector! The GM Series are available in a wide range of plugs, jacks, etc. Most important, the GM Series are also available in new CRIMP configurations (only 3 basic parts) for fast and easy assembly!

GM Connectors are immediately available from stock!

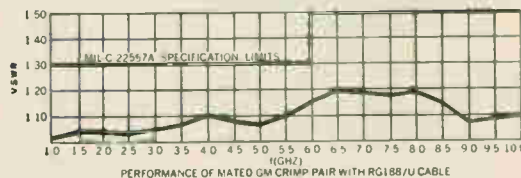

In addition to the GM, TM, TNC Series, GRFF also produces the miniature TPS Series; the new miniature 2900 Series which mate with OSM (and others); and custom microwave components to individual customer requirements.

Connectors shown above are actual size. Non-standard applications solved quickly and efficiently!

General RF Fittings, Inc.

702 BEACON ST. / BOSTON, MASS. 02215
Telephone: 617 267-5120

Circle 175 on reader service card

175

Look
to the
Leader

PERMACOR®

For Every
Electronic
Powdered
**IRON
CORE
Need!...**

As the world's largest producer of iron cores, Permacor has the capability and facilities to supply any requirement or meet any specification you may have.

Write for Complete Information

PERMACOR®

A Division of Radio Cores, Inc.

9540 Tully Ave., Oak Lawn, Ill.
Phone: 312-GARDen 2-3353

Circle 218 on reader service card

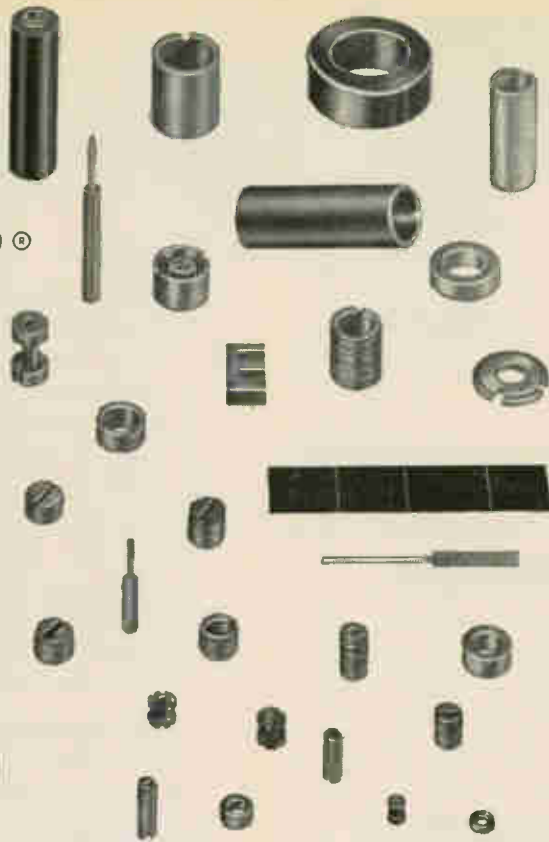

Production Equipment

the winding requirements of recent developments in ferrite pot cores and other nontoroidal cores, features electronically-controlled, variable-speed motor drive and a digital turns counter.

Standard adjustable dual-cone mandrel accommodates the standard sizes of ferrite pot core bobbins, and all other round and square forms from $\frac{1}{16}$ in. to $1\frac{1}{8}$ in. i-d, and up to 3 in. long. The mandrel is detachable by loosening a single set screw; special mandrels are available for extra-small and rectangular forms. Winding speed range is 100 to 1,500 rpm. The machine handles wire sizes from No. 20 to No. 48 Awg. Model 3 is said to offer unequalled time saving and accuracy for the lab worker who winds audio, video, or pulse transformers, filter inductors, or solenoids.

Base dimensions are 10 x 12 in.; weight, 8 lb. Price is \$89.50. Innes Instruments, 881 W. 18th St., Costa Mesa, Calif. [403]

Digital D. C. Voltmeters

0.1%
full
scale
accuracy

9 Standard Single
and Multi-Range
Models with
F.S. Ranges From
10 MV to 1000 VDC

from \$315

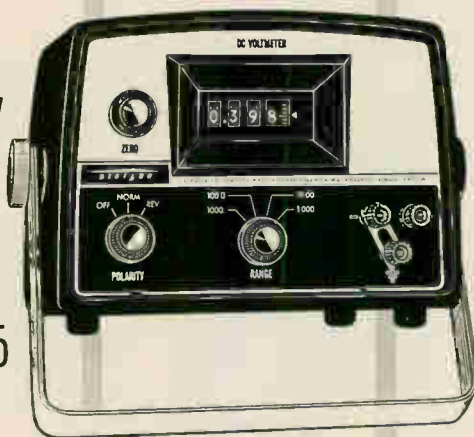

Model 201 (Shown)
1-10-100 and 1000 VDC Ranges
0.1% F.S. Accuracy
0.05% F.S. Linearity
2% Calibrated Over Range
2.2 Megohm Input Impedance
Portable, 5 1/2" x 8" x 7",
Wt. 8 lbs.

Available Options Include

- BCD Output
- Retransmitting Pot
- Auto-Polarity
- Min. or Max. Reading Retention
- Rack Panel Adaptor Kits
- Modular Units for OEM

All Instruments

- Certified Accurate
- Floating or Grounded Input
- Reading Retention
- Wide Viewing Angle
- Bright Glowing Readout
- Solid State Amplifier

Send for complete Catalog D-65

DIGITEC by **UNITED SYSTEMS CORPORATION**

918 Woodley Road, Dayton 3, Ohio (513) 254-3567

Stocking representatives
throughout the world

Lead processor for small components

Designed to handle components as small as 0.125 in. long and 0.050 in. in diameter, the Leadmaster model H-104 can cut and form axial leads of resistors, capacitors, diodes, etc. at rates up to 14,000 components per hour.

Continuously variable adjustments enable the machine to process components up to maximum size of 1.8 in. in length and 0.5 in. in diameter, with a maximum lead-wire diameter of 0.032 in.

The Leadmaster operates on 115 v, 50-60 cycles a-c, with a 220-v model also available. Virtually all types of component packaging can be handled by the Leadmaster, which subjects components to insignificant impact-shock.

Model H-104 can be equipped with accessory forming dies, hopper feed, de-reeler, bowl feeder, automatic counter, etc. In-plant demonstrations can be arranged on request.

Heller Industries, Inc., 30 N. 15th St., East Orange, N.J., 07017. [404]

Laminated plastic tubing

at its very best



all shapes and sizes



instant stock



fabricated

We're so well equipped that you can get practically any diameter, shape or wall thickness you want—in every commercial grade of Synthane laminated plastic tubing.

And we stock so many finished tubes we can often fill your order from our inventory. This saves you time if you do your own machining, gives us a flying start if we fabricate for you.

Ask for Synthane tubing by name. Write for information.

YOU FURNISH THE PRINT . . . WE'LL FURNISH THE PART

SYNTHANE CORPORATION
36 RIVER ROAD, OAKS, PENNA.

Synthane-Pacific, 518 Garfield Ave., Glendale, Calif. 91204



Circle 219 on reader service card

ALUMINUM INSTRUMENT KNOBS



UPGRADE YOUR EQUIPMENT WITH • NEW • MODERNIZED • DECORATIVE KNOBS OF FABRICATED ALUMINUM.

- ☆ 1-PIECE CONSTRUCTION
- ☆ SUPERIOR APPEARANCE
- ☆ MODERATELY PRICED
- ☆ EXPENSIVE STYLING



WRITE FOR SPECIAL LOW O.E.M. PRICES

ALCOKNOB

By ALCO ELECTRONIC PRODUCTS, INC., LAWRENCE, MASS.

WORLD'S ONLY

MINIATURE

ADJUSTABLE-STOP
ROTARY SWITCH
WITH 1/8" SHAFT



SHAFT: 1/8" DIAMETER — 11/16" LENGTH

First ultra-miniature, multiple-stop switch available. Usable 2 to 10 positions. 500 MA. @ 125 VAC. Long life cycle. Only 1/2" diameter, 36° spacing. Fully enclosed. \$3.85
Ideal for aircraft, computers, electronic equipment.

For use with standard miniature knobs

ALCOSWITCH

SEND FOR FREE CATALOG

LAWRENCE, MASS.

Circle 220 on reader service card



APPLY THESE RELAYS DIRECT

Who needs panels and connectors? Adlake molded (epoxy) head relays fasten directly to the point of application. You save on materials. Because they install faster, production costs are lower. Other advantages include: excellent insulating ability, dimensional stability, proof against flame—and additional Adlake reliability. Available as time delay and quick-acting load relays. **Send for a free catalog.**



Type MW-1600
Mercury
Wetted



Type MWSB-16000
Mercury
Wetted



Type MWS-16000
Mercury
Wetted



Type MWB-1600
Mercury
Wetted

Adlake makes more kinds of mercury relays than anybody.



The Adams & Westlake Company, Dept 4616, Elkhart, Indiana
Phone Area 219 COngress 4-1141

Circle 177 on reader service card

177

"ROOM AT THE TOP"

Here are growth opportunities in Communications with TRW Systems in Los Angeles and Houston

There is "room at the top" for your special talents on America's major missile and space programs with TRW Systems' Communication Laboratory in either Los Angeles or Houston. From the beginning of communications via space, this group has played a pre-eminent role in developing communications systems for the nation's major missile and space programs. Major achievements include the first unified carrier tracking, telemetry and command system and the first PCM telemetry system for space. Now is the time for you to investigate these opportunities with this outstanding professional organization.

MAJOR PROGRAMS . . .

- Apollo spacecraft systems
- Advanced Minuteman systems
- Mars mission and spacecraft studies
- Nuclear Detection (Vela) Satellites
- Pioneer interplanetary spacecraft
- Weather satellite systems
- Standardized tracking, telemetry and command system (SGLS)
- Advanced space probes
- Lunar telemetry systems
- Communication satellite systems

Senior Communication Engineers

For design, analysis and management of communication systems and evaluation of scientific and military applications of communication techniques for aircraft, spacecraft and underwater craft use. BSEE, MSEE or PhD.

Communication Equipment Design Engineers

Several years' experience in design and analysis in the following fields: RF filters, diplexers, antennas, phased arrays, feeds, solid-state transmitters, receivers, phase-lock loop techniques, cavity techniques, strip line, very wide and very narrow band circuits, circuit engineering, and modulation techniques. BSEE or MSEE.

Communication System Analysis Engineers

Conceptual design, analysis and synthesis of wide variety of digital and analog communication systems, employing coding, modulation, and statistical communication theory. Systems include integrated coherent-carrier systems, phase lock demodulation (restrictive/non-restrictive), communication satellites and deep space probes. MSEE or PhD.

Signal Processing Engineers

Design and development of sophisticated communication systems and components. Signal conditioners, analog and digital encoding and decoding, modulation tracking and carrier tracking phase lock loops, and multiphase modulation are involved in tracking, telemetry and command equipment which includes but is not limited to space applications. BSEE or MSEE.

Telemetry Circuit Design Engineers

To design a wide variety of analog and digital signal processing circuits for spacecraft digital telemetry equipment. Experience should relate to the design of analog-to-digital converters, analog and digital multiplexers, logic and data storage. Familiarity with micro-electronics desirable. BSEE or MSEE.

Telemetry System Engineers

Experienced in the functional and logical design of analog and digital telemetry systems. Familiarity with design, development, application and evaluation of spacecraft instrumentation systems. Experienced in the design of data systems to interface with a wide variety of data sources including scientific experiments, and engineering measurements.

Please submit resume and salary history in confidence to R. J. Brown, TRW Professional Placement, Dept. L-12, One Space Park, Redondo Beach, California 90278. TRW is an equal opportunity employer, male and female.

TRW SYSTEMS

New Books

Tubes

Principles of Electronic Tubes,
James W. Gewartowski and
Hugh A. Watson,
D. Van Nostrand Co.
655 pp., \$15

The latest in the Bell Telephone Laboratories series, has been developed from the course material presented in the company's Communication Development Training Program. It covers the principles and practical aspects of electronic tubes conscientiously and uses thorough mathematical derivations and proofs that can be followed readily. It is a useful technical reference for graduate engineers employed in the development and design of tubes as well as those designing and using tube circuits.

The organization is logical, with each chapter introduced by a clear explanation of the material to be discussed. Notation is consistent throughout the book, and the symbols used are adequately defined immediately after the table of contents. These features significantly aid comprehension. The authors devote several chapters to comprehensive coverage of electron emission, electron guns and beams, gas discharge phenomena, and noise. Other chapters are devoted to grid-controlled tubes; microwave tubes, including klystrons, traveling wave tubes, backward wave oscillators, and crossed-field devices; and gas discharge devices, including lasers. Each chapter stands by itself and thumbing back and forth is rarely necessary when using the book.

The authors emphasize microwave tubes and microwave phenomena, thus keeping in step with the latest trends in military and industrial applications. However, grid-controlled tubes also receive adequate treatment.

Commendations are due the writers for their clear and thorough discussions of tube circuitry which are superior to the treatments given in many other books. Carefully selected references are given at the end of each chapter.

There is an excellent presentation of noise. In addition to the familiar discussion of noise figure and thermal noise, the relationships

of shot noise, velocity fluctuations, and space-charge smoothing are also treated, as are other aspects of noise including induced grid noise, partition noise, flicker noise, and microwave tube noise.

The chapter on beams and lenses provides comprehensive coverage of electron stream focusing effects in beam tubes and includes the development of the basic relationships for electric lenses and magnetic lenses. The authors also discuss distortion effects due to aberration, electron beam dispersion, and deflection effects.

The authors have made good use of appendixes (16 in all) to give detailed formula development. The appendixes also show the most widely used vector relationships and their expansion into rectangular coordinates.

The problems of cathode emission life are mentioned only briefly. A more thorough discussion of the principles of coated-cathode emission as related to cathode life would have been desirable.

The book does ignore some special tube type problems, particularly in the high-power area. Theoretically, most of the low-power analyses apply as well to high-power tubes. However, high-power devices introduce special problems such as multipactoring, x-radiation effects, and ion interaction with electromagnetic energy. These problems are not covered.

A chapter on gaseous conductors is included but the discussion of gaseous tube types such as triggered gaps, hydrogen thyratrons, and ignitrons is superficial. Further, the existence of variable tuned magnetrons is overlooked as evidenced by the statement "Practical schemes for electronic tuning of magnetrons have not been developed at the time of writing." In a book that has a generally thorough discussion of all tube type principles, the complete omission of any mention of variable-tuned magnetrons is a mystery.

This modern technical book on electron tubes deserves a place on the reference shelf of electronics engineers, engaged in the development and design of tubes and in the design of tube circuitry.

Ernest R. Jervis
Robert I. Reed

Arinc Research Corp.



VHF Model M-150-4B

NEW... SMALLEST 50 WATT MOBILE DUPLExER! IN EITHER UHF OR VHF... FOR LESS THAN \$75.00*

Sinclair's Mobile Duplexers are only slightly larger than a package of cigarettes, but give big unit performance in the duplex operation of mobile transmitters and receivers in either the 150 or 450 Mc bands. Only 5 Mc separation between Tx and Rx frequencies, too! It's ruggedly engineered to take the bumps and jolts of tough mobile service and go on performing dependably for years.

The units are completely enclosed in self-mounting housings for external installation to the transmitter-receiver cabinet. Special packaging information available on request.

*VHF Model M-150-4B

Investigate today! Write for a complete FREE Sinclair Communications Catalog.

SINCLAIR RADIO LABORATORIES, INC. 523 FILLMORE AVENUE, DEPT. 101 TONAWANDA, NEW YORK

Vector Solid State Laboratories

Now available in
production quantities...

2N3866



- NPN silicon transistor designed for high-level broad-band VHF-UHF amplification
- f_T to 1000 mc measured at 15 V, 50mA
- Economical
- Can be supplied in a variety of cases

POWER OUTPUT VS. FREQUENCY

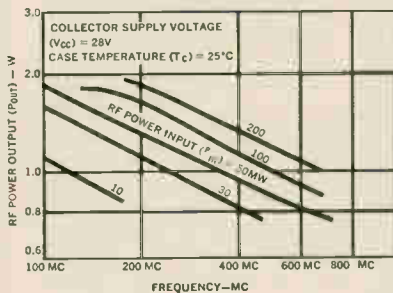

Contact your local representative for
data sheets, price and delivery
or phone Vector Solid State Laboratories
(215) EL 7-7600

Vector

U
DIVISION OF UNITED AIRCRAFT CORPORATION
A
SOUTHAMPTON, PENNSYLVANIA

Technical Abstracts

Measuring angles in space

Fluid rotor nutation sensor for satellite vehicles
Herbert B. Diamond, Sperry Gyroscope Co., Great Neck, N.Y.

A satellite traveling through space is affected by an oscillation known as nutation—oscillation in which a vehicle's spin axis traces a cone in space, causing unwanted yaw and pitch angles.

Space vehicles are provided with dampers to suppress these undesirable movements; the effectiveness of the damping is measured by low-threshold nutation sensors aboard the spacecraft.

The basic element of the nutation sensor (fluid gyro) is a spherical cavity solidly filled with a dielectric fluid. Fluid gyros are used because they can sense extremely low angles, in the order of a fraction of a second of arc. The element is body mounted, but need not be spun by its own drive motor relative to the spinning satellite vehicle.

To use the gyroscopic properties of this "free rotor," two ports are cut through the cavity wall about 45° from the spin axis of the cavity. If an angle δ exists between the spin axis, the ports are at unequal radii to the spin axis of the liquid body. Thus, the centrifugally induced pressures at the two ports are unequal. At one-half revolution of the cavity after the start position, the two ports will have switched positions, and the differential pressures will have reversed direction. A differential variable-capacitance transducer in the connecting passage between the ports will sense a pressure that varies at spin frequency. The output of the transducer will go to zero when the angle δ goes to zero. A pair of phase-sensitive demodulators, which use as references the outputs of a two-phase alternator coupled to the spin axis, will produce voltages proportional to rotations about two orthogonal axes lying in the plane normal to the cavity spin axis.

Power is required only for the excitation oscillator and pick-off amplifier-demodulator. The sensor will provide a d-c voltage output

NEW

Low Cost

tunable COILS

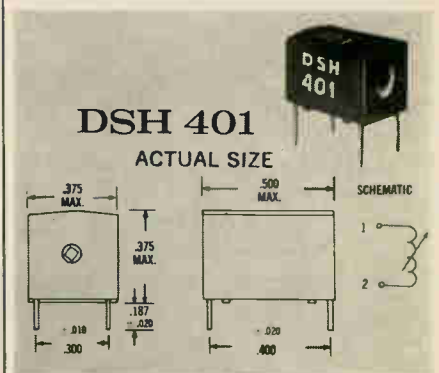
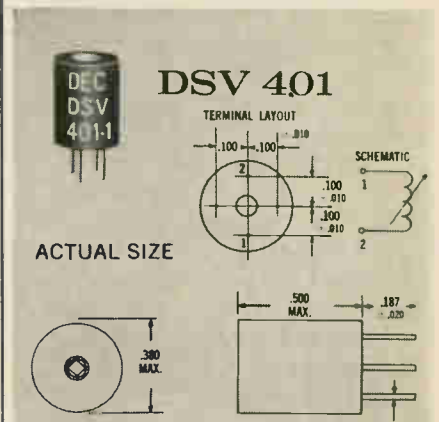

- Electro-static shield available for DSV 401.
- Electromagnetically shielded.
- Tunable from either end.
- Winding sealed in molded epoxy.
- Stable Q — Max 20% drop from nominal thru entire tuning range.
- Inductance range .10 to 10,000 μ h.

Meets MIL-C-15305 — Grade and Class 6. Manufactured under Delevan's Quality Proven Processes.

Delevan Electronics Corp.
Subsidiary of American Precision Industries Inc.
270 Quaker Road, East Aurora, N. Y. 14052

Take Any One

of these three books for only \$1.00

with your first selection and charter membership in the Electronics and Control Engineers' Book Club



**ELECTRONIC DESIGNERS'
HANDBOOK**
Publisher's Price: \$18.50

**HANDBOOK OF
SEMICONDUCTOR ELECTRONICS**
Publisher's Price: \$19.50

CONTROL ENGINEERS' HANDBOOK
Publisher's Price: \$23.50

Please accept any one of the three books pictured above, for just \$1.00—with your first selection chosen from the books listed in the coupon.

We invite you to look over these twelve books in the coupon. They are important technical books indispensable to a field so dynamic that even the well-informed can hardly keep up. And they suggest the quality of the volumes that will be made available to you as a Club member.

Membership in the Electronics and Control Engineers' Book Club is *easy and economical*. The Club will bring to your attention outstanding books in your field that you might otherwise miss. Possibly just one idea from one of these books could mean more to you in actual dollars and cents than many times the cost of the book. And you may obtain any or all selections at substantial savings.

How the Club operates. The Club will describe all forthcoming selections to you. Periodically, as issued, you will receive free of charge *The Electronics and Control Engineers' Book Club Bulletin*. This gives complete advance notice of the next main selection as well as a number of alternate selections. All books are selected by qualified editors and con-

sultants whose thoroughgoing understanding of the standards and values of technical literature will be your guarantee of the authoritativeness of the selections.

From this point on, the choice is yours. If you want the main selection you do nothing; the book will be mailed to you. If you want an alternate selection or if you want no book at all for that period, you notify the Club by returning the convenient card enclosed with your *Bulletin*.

We ask you to agree only to the purchase of four books over a two-year period. Certainly out of the large number of books in your field offered you during this time there will be at least four *you would buy in any case*. By joining the Club you will save, in cost, about 15 per cent from the publishers' prices.

You need send no money now. By taking advantage of this special introductory offer you will receive for just \$1.00 a copy of *Handbook of Semiconductor Electronics*, or *Electronic Designers' Handbook*, or *Control Engineers' Handbook*, together with your first selection—at the special club price. Take advantage of this offer *now*, and get two books for less than the regular price of one!

THIS COUPON WORTH UP TO \$22.50

Mail to: The Electronics and Control Engineers' Book Club
330 West 42nd Street, New York, N.Y. 10036 Dept. L124X

Please enroll me as a member of the Electronics and Control Engineers' Book Club. I am to receive the two books I have indicated below. You will bill me for my first selection at the special club price and \$1 for my new membership book, plus local tax where applicable, and a few additional cents for delivery costs. (The Club assumes delivery costs on prepaid orders.)

Forthcoming selections will be described to me in advance and I may decline any book. I need take only 4 selections or alternates in two years of membership. (This offer good in U. S. only.)

- | | |
|--|--|
| <input type="checkbox"/> Handbook of Semiconductor Electronics. Edit. by L. P. Hunter, 2nd Ed. Publisher's Price, \$19.50 Club Price, \$16.55. | <input type="checkbox"/> Electronic Amplifier Circuits. by J. M. Pettit and M. M. McWhorter. Publisher's Price, \$10.50. Club Price, \$8.95. |
| <input type="checkbox"/> Electronic Designers' Handbook. Edit. by R. W. Landee, D. C. Davis, and A. P. Albrecht. Publisher's Price, \$18.50. Club Price, \$15.75. | <input type="checkbox"/> Electronic Measuring Instruments. by H. Sisson. Publisher's Price, \$7.50. Club Price, \$6.40. |
| <input type="checkbox"/> Control Engineers' Handbook. by J. C. Truxal. Publisher's Price, \$23.50. Club Price, \$19.95. | <input type="checkbox"/> Modern Digital Circuits. by S. Weber. Publisher's Price, \$9.50. Club Price, \$8.10. |
| <input type="checkbox"/> Introduction to Radar Systems. by M. Skolnik. Publisher's Price, \$14.50. Club Price, \$12.35. | <input type="checkbox"/> Nonlinear-Magnetic Control Devices. by W. A. Geyger. Publisher's Price, \$12.50. Club Price, \$10.65. |
| <input type="checkbox"/> Mathematics for Electronics with Applications. by H. M. Nodelman and F. W. Smith, Jr. Publisher's Price, \$7.00. Club Price, \$5.95. | <input type="checkbox"/> Electrical Engineering for Professional Engineers' Examinations. by J. D. Constance. Publisher's Price, \$10.00. Club Price, \$8.50. |
| <input type="checkbox"/> Transistor Circuit Design. prepared by Engng. Staff of Texas Instruments Inc. Publisher's Price, \$15.00. Club Price, \$12.75. | <input type="checkbox"/> Electronic and Radio Engineering. by P. E. Tomman, 4th Ed. Publisher's Price, \$16.00. Club Price, \$13.60. |

Name (Please Print)
Address
City State Zip
L124X

No-risk guarantee. If not completely satisfied, I may return my first shipment within 10 days and my membership will be cancelled.

60±.03 cycle

POWER FOR FREQUENCY-SENSITIVE EQUIPMENT



DC to AC INVERTERS Battery Power to Quality AC



AC to AC FREQUENCY CHANGERS Inferior AC to Quality AC

For mobile and emergency operation of video tape recorders and other frequency or voltage sensitive equipment. Available from stock and field-proven.

- 1000, 500, 250 and 125 VA models
- All transistorized for high reliability, low acoustic noise, instant turn-on.
- Input: Inverters — 11-15 or 22-30 VDC Changers — 95-125 VAC, 50-500 cycles.
- Output: 115 V ± 5%; 60 ± .03 cycle sine wave, maximum 6% harmonic distortion.
- Used by Military, Government and Industry

SEND FOR COMPLETE CATALOG



TOPAZ, INCORPORATED
3800 HOUSTON STREET
SAN DIEGO, CALIF. 92110

Technical Abstracts

proportional to the instantaneous vehicle nutational angle; but no output will be produced because of gyro-vehicle misalignment or misalignment between the vehicle spin and the principal axis. Tests have shown that fluid gyros of this type can measure angles as small as 0.005°.

Twelfth Annual Aerospace Conference on Aerospace and Navigational Electronics, Baltimore, Md., Oct. 27-29.

Protective testing

Selective chromate conversion of integrated circuit interconnecting aluminization
D.A. Abdo
Boeing Co., Aerospace division,
Seattle, Wash.

A favorite cliché of reliability experts is that reliability cannot be tested into a faulty component. An exception may be a nondestructive, chemical test for monolithic integrated circuits that seems to leave the IC in better shape than before it was tested. The test consists of covering the circuit's aluminum thin-film conductors with a chromate conversion coating that reveals flaws in the circuit devices, oxide coating and conductors.

The coating might also protect the films from abrasion during circuit fabrication. The coating process thins the film a bit, but the coating itself is a good conductor.

As a method of pinpointing circuit flaws, chromate conversion is an improved version of a technique first described at the 1964 Physics of Failure symposium [Electronics, Oct. 19, 1964, p. 17]. The earlier method colored only p regions and associated conductors; the new method gives contrasting colors on p and n regions. Also, the new report, unlike the older, gives formulas for test solutions. Commercially available chromate conversion solutions are so strong that they can completely strip the aluminum conductors off the circuit; therefore the technique is useless without directions for modifying and diluting the solutions; the report gives these directions.

Presented at the Fourth Annual Symposium on the Physics of Failure in Electronics, Rome Air Development Center and IIT Research Institute, Chicago, Nov. 16 to 18.



Ultra-sensitive relays

HELPFUL DATA FOR YOUR CIRCUITRY IDEA FILE

The circuit drawing below indicates just one of the hundreds of ways many manufacturers utilize Micropositioner® polarized relays to solve complex control problems.

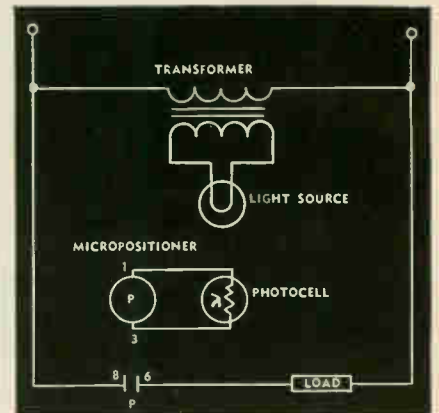

PHOTOELECTRICITY APPLICATION

Many stages of electronic amplification in photoelectric controls can be completely eliminated with a Barber-Colman Micropositioner, since a current generating photocell alone provides sufficient power to operate this relay directly.

A Micropositioner operating on 50 microwatt input (with fine silver contacts rated at 1 ampere, 110 volt 60 cycle, resistive load) is essentially a tubeless amplifier capable of two million times amplification.

Among the many applications for this simplified, nonelectronic photocell control are punch press safety controls . . . emergency lighting controls . . . door openers . . . burglar alarms . . . level controls . . . packaging, sorting, filling, and materials handling controls . . . plus many other automation functions.

If you are developing an application calling for photocell control, why not make a test with a Micropositioner designed for circuits similar to that shown above? Write for technical bulletins.

BARBER-COLMAN MICROPOSITIONER®

POLARIZED D-C RELAYS

Operate on input power as low as 40 microwatts. Available in null-seeking and magnetic-latching "memory" types of adjustment. Also transistorized types with built-in preamplifier. Write for our latest catalog with full information on polarized relays.

BARBER-COLMAN COMPANY
Electro-Mechanical Products Division
Dept. A, 1259 Rock Street, Rockford, Illinois

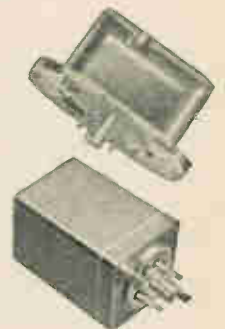

ELECTRONICS

Qualification Form
for Positions Available

ATTENTION: ENGINEERS, SCIENTISTS, PHYSICISTS

This Qualification Form is designed to help you advance in the electronics industry. It is unique and compact. Designed with the assistance of professional personnel management, it isolates specific experience in electronics and deals only in essential background information. The advertisers listed here are seeking professional experience. Fill in the Qualification Form below. **STRICTLY CONFIDENTIAL:** Your Qualification form will be handled as "Strictly Confidential" by Electronics. Our processing system is such that your form will be forwarded within 24 hours to the proper executives in the companies you select. You will be contacted at your home by the interested companies.

WHAT TO DO. (1.) Review the positions in the advertisements. (2.) Select those for which you qualify. (3.) Notice the key numbers. (4.) Circle the corresponding key number below the Qualification Form. (5.) Fill out the form completely. Please print clearly. (6.) Mail to: Classified Advertising Div., Electronics, Box 12, N. Y. 10036.

COMPANY	PAGE	KEY #
ATOMIC PERSONNEL INC.	235*	1
BAUSCH & LOMB	230*	2
BOOZ ALLEN APPLIED RESEARCH	184	3
COLLINS RADIO CO.	218-219	4
DOUGLAS AIRCRAFT CO.	237*	5
ELDORADO ELECTRONICS	230*	6
GENERAL DYNAMICS CORP.	232*	7
GENERAL TELEPHONE & ELECTRONICS	183	8
JET PROPULSION LABORATORY	200*	9
LAWRENCE RADIATION	234*	10
LOCKHEED CALIFORNIA CO.	161	11
LOCKHEED MISSILES & SPACE CO.	221*	12
NATIONAL CASH REGISTER CO.	206-207*	13
PAN AMERICAN AIRWAYS	234*	14
PHILADELPHIA NAVAL SHIPYARDS	232*	15
SANDERS ASSOCIATES INC.	231*	16
TRW SYSTEMS	178	17
XEROX CORP.	227*	18

* These advertisements appeared in the Jan. 10 Issue.

PERSONAL BACKGROUND

Name
Home Address
City Zone State
Home Telephone

EDUCATION

Professional Degree(s)
Major(s)
University
Date(s)

FIELDS OF EXPERIENCE (Please Check)		1/24/66
<input type="checkbox"/> Aerospace	<input type="checkbox"/> Medicine	
<input type="checkbox"/> Antennas	<input type="checkbox"/> Microwave	
<input type="checkbox"/> ASW	<input type="checkbox"/> Navigation	
<input type="checkbox"/> Circuits	<input type="checkbox"/> Operations Research	
<input type="checkbox"/> Communications	<input type="checkbox"/> Optics	
<input type="checkbox"/> Components	<input type="checkbox"/> Packaging	
<input type="checkbox"/> Computers	<input type="checkbox"/> Radar	
<input type="checkbox"/> ECM	<input type="checkbox"/> Radio-TV	
<input type="checkbox"/> Electron Tubes	<input type="checkbox"/> Simulators	
<input type="checkbox"/> Engineering Writing	<input type="checkbox"/> Solid State	
<input type="checkbox"/> Fire Control	<input type="checkbox"/> Telemetry	
<input type="checkbox"/> Human Factors	<input type="checkbox"/> Transformers	
<input type="checkbox"/> Infrared	<input type="checkbox"/> Other	
<input type="checkbox"/> Instrumentation		

CATEGORY OF SPECIALIZATION

Please indicate number of months experience on proper lines.

	Technical Experience (Months)	Supervisory Experience (Months)
RESEARCH (pure, fundamental, basic)
RESEARCH (Applied)
SYSTEMS (New Concepts)
DEVELOPMENT (Model)
DESIGN (Product)
MANUFACTURING (Product)
FIELD (Service)
SALES (Proposals & Products)

CIRCLE KEY NUMBERS OF ABOVE COMPANIES' POSITIONS THAT INTEREST YOU

4	5	6	7	8	9	10	11	2	3
13	14	15	16	17	18				

RESEARCH

at the

General Telephone & Electronics Laboratories Inc.

is Challenging, Diversified and Rewarding

GT&E Labs is the research subsidiary of the General Telephone & Electronics Corporation, the ninth largest industrial corporation in terms of total assets.

The General Telephone & Electronics Corporation:

through its Sylvania subsidiary is a quality leader in color television and other home electronic products; a major supplier of solid state components and electronic tubes; a leader in innovation in lighting products; and a major supplier of government electronic equipment.

through its Automatic Electric subsidiary is the largest independent producer of telephones and telephone equipment.

through its more than 30 telephone operating subsidiaries is the leading independent telephone system.

GT&E Laboratories OFFER research positions to match the breadth of the entire corporate complex.

MATERIALS

Preparation of new materials and the investigation of phenomena in the areas of semiconductors, luminescence, magnetism, dielectrics, ceramics, and metal physics.

MATERIALS ANALYSIS

Research and development on physical and chemical techniques for characterization of materials by bulk composition, purity, crystal structure imperfections and surface geometry.

DEVICES

Study of solid state and optical phenomena; conception and development of new devices ranging from discrete semiconductor, optical, and vacuum tube devices through to memory subsystems and sophisticated microelectronic circuits; application of these devices at the subsystem level for such purposes as communication at microwave, mm-wave, and optical frequencies, laser applications and optical displays.

ENERGY STORAGE AND CONVERSION

Exploration of new power generating devices and of the materials and phenomena underlying them.

THEORETICAL STUDIES

Prediction and understanding of new solid state phenomena, and the properties and applications of new electronic materials.

WE INVITE YOUR INQUIRIES

General Telephone & Electronics Laboratories

SUBSIDIARY OF
GENERAL TELEPHONE & ELECTRONICS **GT&E**

208-20 Willets Point Boulevard Bayside, New York 11360

An Equal Opportunity Employer (M&F)

DEVELOPMENT ENGINEERS SYSTEMS ENGINEERS

Mechanical Engineers • Physicists • Electronics Engineers

CLEVELAND, OHIO

Once again we find we must expand the personnel requirements of the mechanical and electronic commercial/industrial hardware, systems, and process development programs being performed within our Development and Design Division facilities in Cleveland, Ohio.

As a division of an extremely fine and reputable nation-wide applications research analysis and development firm our Development and Design Division, with multiple and confining programs, offers an outstanding opportunity to enhance professional growth; career opportunities exist.

We are seeking creative individuals who believe themselves to be well trained, experienced, operationally strong, and by virtue of their education, ability, interest and temperament, to be top-flight generalists.

We are not an easy firm for which to work. We are not, for that matter, an easy firm to get into, though many have been good enough. Excellence will demand excellence. Salary, is definitely open, benefits are competitive and we tend to recognize accomplishments and results more than stability, acceptability or seniority.

If the above information seems to reflect an engineering and organizational environment that appeals to you, and if the Cleveland area is attractive to you, contact: Robert Flint, Director of Staff Selection

BOOZ-ALLEN APPLIED RESEARCH, Inc.

Development and Design Division

**135 South La Salle Street, Chicago, Illinois 60603
312 — FR 2-1728**

An Equal Opportunity Employer

DIRECT LINE

to classified advertising results. Call the McGraw-Hill office nearest you.

404-875-0523
1375 Peachtree St., N.E.
Atlanta 30309

617-262-1160
607 Boylston St.
Boston 02116

312-664-5800
645 N. Michigan Ave.
Chicago 60611

216-781-7000
55 Public Square
Cleveland 44113

214-747-9721
1800 Republic
Nat'l Bank Tower
Dallas 75201

303-255-2981
1700 Broadway
Denver 80202

313-962-1793
856 Penobscot Bldg.
Detroit 48226

713-224-8381
2270 Humble Bldg.
Houston 77002

213-482-5450
1125 W. 6th St.
Los Angeles 90017

212-971-3594
500 Fifth Ave.
New York 10036

215-568-6161
Six Penn Center Plaza
Philadelphia 19103

412-391-1314
4 Gateway Center
Pittsburgh 15222

314-725-7285
Clayton Tower
7751 Carondelet Ave.
St. Louis 63105

415-362-4600
255 California St.
San Francisco 94111



YOU'RE H!RED

Do you need electronics engineers or technical management men? Electronics magazine is the way to recruit them. Electronics is designed specifically for the working engineer. 68,000 subscribers and an additional 133,000 pass-along readers turn to it to keep up with their industry. You can find the man that meets your qualifications with an advertisement in the Employment Opportunities Section.

For rates & information write: Electronics, a McGraw-Hill Publication, Classified Advertising Division, Post Office Box 12, New York 10036.

CLASSIFIED ADVERTISING
SEARCHLIGHT SECTION
BUSINESS OPPORTUNITIES
USED OR SURPLUS EQUIPMENT

**SEMICONDUCTORS
MAJOR BRANDS**
INTEGRATED CIRCUITS • DIF. AMPS DARLINGTONS • POWER DIODES & TRANSISTORS • SPECIAL DEVICES
Write for Catalog S-1
SEMICONDUCTOR SALES OF CALIF.
1063 Perry Annex (213) 696-7544 *Whittier, Calif.*

CIRCLE 951 ON READER SERVICE CARD
RADAR AUTO-TRACK & TELEMETRY ANTENNA PEDESTALS 3 & 10 CM. SCR 584 AUTOTRACK RADARS, M-33 RADAR TPS-1D SEARCH, APS-45 TPS-10D HT. FINDERS, WX RADARS, FPN-32GCA, APS-10 APS-15B APS-27 (AMTI) SEARCH, APN-102 DOPPLER, DOZENS MORE, CARCINOTRONS, PFN'S, .25-5-1-2-3-6 MEGAWATT PULSE MODULATORS, CAVITIES, PULSE TRANSFORMERS, IF STRIPS, WAVEGUIDE, BENDS 200 MC, 1 KMC, 3 KMC, 6 KMC, 9 KMC, 24 KMC, RF PKGS.
RADIO RESEARCH INSTRUMENT CO.
550 5TH AVE., NEW YORK 36, N. Y. JU 6-4691

CIRCLE 952 ON READER SERVICE CARD
SURPLUS
Field Telephone Set Two-Way Telephone communication or signaling to multiple stations. Range, 2 miles. Utilizes standard connecting telephone line—Features: Local or remote control. Battery powered.
MONMOUTH ELECTRIC CO., INC.
1805 Corliss Ave. Neptune, N. J.
Phone—201-776-5300

CIRCLE 953 ON READER SERVICE CARD
DEQUITE
BUYERS TURN TO THE SEARCHLIGHT SECTION IN ELECTRONICS
NEJULIO

New Literature

Test equipment. North Atlantic Industries, Inc., 200 Terminal Drive, Plainview, N.Y., 11803. An illustrated, four-page brochure provides quick reference to the basic instruments in the company's line of electronic test equipment. Circle 420 on reader service card.

Operational amplifiers. Nexus Research Laboratory, Inc., 480 Neponset St., Canton, Mass., 02021, announces a six-page catalog covering its line of operational amplifiers and related analog modules. [421]

IC time code generator. Electronic Engineering Co. of California, Box 58, Santa Ana, Calif., 92702. Model 911 integrated-circuit, 11-format time code generator is illustrated and described in an eight-page technical catalog. [422]

Differential voltmeter. InstruLab, Inc., 1205 Lamar St., Dayton, Ohio, 45404. A two-page data sheet describes the Evenvolt 300 series potentiometric differential voltmeter. [423]

Castable ceramic. Aremco Products, Inc., P.O. Box 145, Briarcliff Manor, N.Y., 10510. Product bulletin 505 deals with Ceramacast 505, a high-temperature castable ceramic that is used as an encapsulant, coating or cement. [424]

Solid-state power supplies. Electronic Research Associates, Inc., 67 Sand Park Road, Cedar Grove, N.J., 07009, has published a catalog sheet covering its low cost, highly regulated, solid-state power supplies. [425]

Medical instruments. Sanborn Division, Hewlett Packard Co., 175 Wyman St., Waltham, Mass., 02154, offers an 18-page condensed catalog giving illustrations, brief descriptions and prices for over 78 of its electronic medical instruments. [426]

True rms calibration checker. Greibach Instruments Corp., 315 North Ave., New Rochelle, N.Y., has released a data sheet on a true rms calibration checker, a completely passive instrument which combines the bifilar suspension meter movement with the Transquare solid state transducer. [427]

A-c potentiometers. Perkin-Elmer Corp., Main Ave., Norwalk, Conn. A-c potentiometer uses and advantages are detailed in a four-page booklet on Verni-stat potentiometers. [428]

Voltage-controlled crystal oscillators. Damon Engineering, Inc., 240 Highland Ave., Needham Heights 94, Mass. An eight-page brochure now available on the use of VCXO's (voltage-controlled crystal oscillators) is slanted toward many applications. [429]

Tin oxide resistors. Corning Glass Works, Electronic Products division, Raleigh, N.C. NA-style tin oxide resistors with a ± 100 ppm temperature coefficient and a 125° C rating are described in data sheet CE-2.21. [430]

EXTENDING THE CEI LINE



OF SUPERIOR FREQUENCY EXTENDERS

Meet the FE-1-4.5, newest and most versatile in our line of YIG-tuned frequency extenders. Covering the entire 1-4.5 gc range in 2 bands, it converts signals to a 160 mc IF output (optionally 60, 30 or 21.4 mc when used with CEI IFC-21 frequency converter). Each band has its own YIG preselector which is tracked electronically throughout its range, avoiding complex mechanical drives. A 27 inch spring steel tape dial assures greater resolution, ultra-precise tuning and permits resetability to $\pm 0.5\%$.

Completely solid state except for the ceramic triode in the highly stable local oscillator, the compact FE-1-4.5 offers high reliability and ease of operation with superior performance characteristics in a package just 3 1/2" high. Image rejection is 70 db and noise figures are typically 16 db with 18 db maximum.

For further information on the FE-1-4.5 or other CEI frequency extenders, please write:

COMMUNICATION ELECTRONICS INCORPORATED

6006 Executive Blvd., Rockville, Md. 20852 Phone: (301) 933-2800 TWX: 710-824-9603

Circle 224 on reader service card

WITH THIS HEAT SINK...

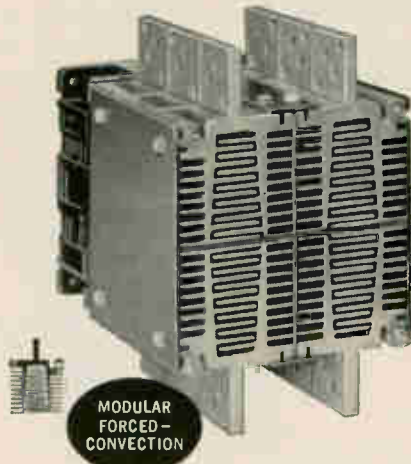

2 to 3 times previously achievable ratings

for power transistors
and power diodes

FLEXIBILITY permits easy design of custom packages using side panels as terminal boards or for component mounting.

ACCESSIBILITY of mounted components for installation, maintenance, or replacement on easy-to-get-at transistor shelves. (Specify any mounting pattern)

CIRCUIT EFFICIENCY with reduction of number of transistors needed and decrease of compensating capacitors and resistors.

LIGHT WEIGHT and high strength/weight ratio of aluminum permits use of combined unit as an integral part of component design.

COMPACT BLOWER is standard, commercial unit providing forced convection for banks of 4, 8, 12, 16 or more individual heat sinks.

One of over 80 Astrodyne standards, this "building block" design provides more heat transfer surface in less space than most other devices.

Astrodyne (successor to Astro Dynamics Heat Sink Div.) Representatives and Distributors throughout the USA and Europe are prepared to assist with immediate price and delivery information. Call, wire or write for detailed information.



astrodyne, inc.

SUBSIDIARY OF ROANWELL CORP. 207 CAMBRIDGE ST.
BURLINGTON, MASS. (617) 272-3850



ULANO EUROPEAN TECHNICAL CENTER FOR GRAPHIC ARTS

Ulano's technical center in Switzerland is headed by the very capable Mr. Henri Kunz. He is qualified by his many years of experience in the Screen Process and Graphic Arts fields. Demonstrations and technical seminars are held in many languages throughout the year. Complete laboratory facilities have been installed to provide demonstrations of the complete Ulano line. Large stocks of all famous Ulano films are available for immediate delivery to all parts of the world.

You are invited to contact Mr. Henri Kunz at ULANO A.G., Untere, Heslibachstrasse No. 22, Kusunacht 8700, Switzerland, Telephone 905959. It is our pleasure to serve you.



**DO YOU USE
SCREEN PROCESSING
IN THE PRODUCTION OF
COMPLEX
PRINTED
CIRCUITRY?**

**TWO NEW PRESENSITIZED FILMS TO
SPEED PRODUCTION - LOWER COSTS**

Ulano



Write today on
your letterhead
for free Special
Sample Kit 5248

HI-FI RED

HEAVY-DUTY INDUSTRY PROVED

Presensitized photo film used by many leading electronic firms for clean, sharp, tough, durable, almost indestructible screens of unmatched quality. Adheres tightly to wire, silk, nylon and dacron.

PREP®

PRESENSITIZED FOTO FILM

.002 Polyester support guarantees good register. Does not require a dark room. Very good resolution—suitable for halftones. Excellent adhesion to silk, nylon, dacron and metal mesh. Tough, strong emulsion—good for machine printing and long runs.

J. ULANO & COMPANY, INC.

610 Dean Street, Brooklyn, N. Y. 11238, U.S.A.

Cable address: "UlanoFilm"

In Europe: ULANO A.G., Untere, Heslibachstrasse No. 22
Kusunacht, Zurich, Switzerland

HERE'S HOW...



**LITHOGRAPHERS, ENGRAVERS, ARTISTS, SCREEN PROCESSORS ALL USE
THESE FAMOUS MASKING FILMS TO SEPARATE COLOR, ELIMINATE
OPAQUING, PREPARE DROPOUTS, SAVE TIME, REDUCE JOB COSTS**



Cut a piece of the desired film large enough to cover area to be masked. Tape it down firmly at the top with dull-side up.



With sharp blade, outline the areas to be masked. Do not cut through the backing sheet. The Ulano Swivel Knife does the job quickly, easily.

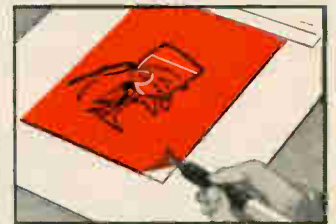

Using the tip of the blade, lift up a corner of the film thus separating it from the backing sheet.

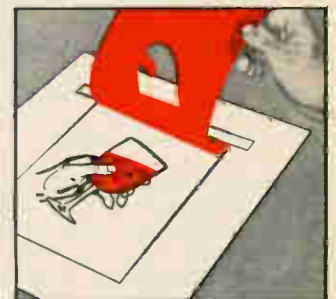

Now carefully peel off the film. Your art work is now separated with the "second color" on a clear Mylar overlay ready for camera and in perfect register.

Ulano T.M.

RUBYLITH T.M. • AMBERLITH T.M.

HAND CUT MASKING FILMS FOR THE GRAPHIC ARTS

ULANO RUBYLITH . . . a revolutionary knife cut red film is laminated to a stable transparent plastic backing sheet. The red film is "light safe" so that when contacted to a sensitized emulsion and exposed to a suitable light source, light passes through the cut-out portions only . . . not through the red film. ■ The mylar® backing is absolutely stable . . . insures perfect register. ■ Special effects such

as crayon tones, paste ups, benday sheets, and opaquing are easily combined with versatile ULANO RUBYLITH. T.M. Dupont Polyester Film

ULANO AMBERLITH . . . a companion to Rubyliith serves as a color separation medium used as the master on camera copy board to secure negatives or positives.

Available in Rolls and Sheets

ulano

NEW YORK • CHICAGO • ZURICH

610 DEAN ST., BROOKLYN, N. Y. 11238



Write today on your letterhead for free Special Sample Kit 5348

Soviet Union

The computer gap

The country that led the race into space seems to be lagging badly in the earthbound—but equally vital—realm of productivity. Soviet successes in space are evidence of the existence of powerful computers and of scientists who know how to use them. But the Russians are just beginning to react to increasing criticism of the slow pace at which industrial managers are making use of computers to organize and automate the economy.

The Russian press has been outspokenly critical in four broad areas:

- Poor quality of computers available for economic planning.
- Lack of computers and peripheral equipment.
- Failure to develop a universal computer language such as Cobol, which stands for Common Business-Oriented Language.
- Misuse of existing equipment.

Need for automation. An economy, particularly a controlled economy, requires electronic computers to keep track of materials and products and to plan for future needs. If the current five-year plan is to be realized by 1970, industrial production in the Soviet Union will have to double by the end of this decade and increase sixfold by 1980. To meet this schedule, each worker's productivity will have to be quadrupled—a goal that can be reached only through automation and electronic data-processing.

In the seven years ending in 1962, the number of people working on planning and industrial control increased 50%. Unless the present system is changed, planning for the national economy in 1980 will require 36 times as much work as for the 1965 economy.

Little and late. The supply of computers for industry is far behind demand, and available ma-

chines are too small and too slow.

One Russian study charges that the Soviet Union has only 20% of the computers it needs. The Ukraine, which produces more than one-fifth of the country's industrial output, has only about 150 computers of all types.

The Soviet magazine *Questions of Economics* charged last March that no available Soviet computer is "suitable for processing economic data." As an example of what can be done the authors, V. Bezrukov and G. Venikov, cited the System 360 series of the International Business Machines Corp. They noted that the 360 has uniform programing and uses compatible information, and they compared its nanosecond speed with the slower Russian machines'; for example, those in the Ukraine average under 15,000 operations a second.

Half-hour day. A recent survey in the Ukraine indicated that the average computer is in use between 2.6 and 8 hours a day, despite planners' instructions that they be kept busy 20 hours a day. At Chernovitsky University, one computer was found to be in operation only 36 minutes a day.

After much criticism, administrators of these computer centers hurried to correct the situation. They loaded the machines with every imaginable kind of task, merely to keep them busy. In the rush, many computer operations were duplicated and many of the results were never disseminated.

In the industrial Donets Basin, a section of the Ukraine, the regional economic council ordered a Ural 4 computer in 1962. It took more than a year for the machine to arrive, but three years after it was ordered the computer still was not working; it seems there had been a problem finding a suitable place to put it.

First steps. The present five-year plan provides for the first big steps toward solving another problem:



Minsk 22 is Russia's newest civilian computer. Its twin memory system has been called inefficient by Leningrad engineers, who modified it with a single memory block twice the size of either original memory. But production models still use twin memories.

failure to reorganize industrial work along lines suitable for data-processing by computers. One Soviet specialist estimates that less than 10% of the problems being solved by Russian computers are in economics and administration.

The current plan calls for completely automatic control of production and administration at three machinery plants in the Donets.

One of the first changes to integrated process control is being made at the Lvov Television Plant in the western Ukraine. The system will collect production data by means of teletypewriters and sensors, including photosensors; it will process the data automatically at a computer center and feed the results into central control equipment, which will use the information to alter controls on the production process.

In 1967 the entire economy of Estonia, the smallest Soviet re-

public, is scheduled to be translated into computer data, as a trial. The government has not disclosed what kinds of equipment will be used.

Remedies. Bezrukov and Venikov offered some specific suggestions for applying computer technology to the Soviet Union's massive economic problems:

- Data-processing machines and auxiliary equipment should be designed specifically to handle economic information.

- New computers should operate with multiprogramming.

- Microfilming methods and equipment should be developed, to permit the processing of documents by computers; also necessary is a method for automatically transferring data on to punched tape when a bill or document is being typed.

Australia

Betting on computers

Just when the action is heaviest, shortly before the horses go to the post, Australia's legal offtrack bookies have to close their windows to bettors so they can calculate the amount wagered on each horse and phone the information in to a central office. During these intervals of up to 40 minutes, the State of Victoria's racetrack agency figures its losses total \$1.25 million a week.

The agency is betting \$7.75 million it can cut this loss. At its control center in Melbourne it is installing two Data 3100 computers made by the Australian subsidiary of the Control Data Corp. for \$1.75 million; it is spending an additional \$6 million to tie in its 400 offices.

The computer. The data-processing system will permit the bookie to accept up to 1,100 bets an hour; as each ticket is sold, the information will be fed automatically to the computer's two magnetic memory drums, which can accept 3,000 messages a minute, each in a 29-character format. Besides storing data about each race, the computer will check the status of each bettor's account and reject his wager

if he is found to be overdrawn.

After the race, the computer will calculate the distribution of the winnings; regular accounts will be credited with any winnings the holders may have earned.

West Germany

Boxcars check in

Freight cars en route to Bremerhaven are sending ahead information to help yard workers speed the assembly of trains and reduce delays that can cause damage to perishable goods. The detection system, which reads 10-digit numbers transmitted by freight cars moving as fast as 60 miles an hour, sends the information to a monitoring

station where dispatchers switch the cars to appropriate trains.

Developed by Siemens & Halske AG, the detection system is being tested by the German Federal Railway and by Sweden's railroads. Another version being tested in Germany uses 3-digit numbers.

Q & A. The system consists basically of a transponder mounted near the bottom of each freight car, and a reader installed adjacent to the railroad track. The reader sequentially interrogates each of 10 circuits in the transponder, one for each digit in the car's number. Each interrogation requires five milliseconds; therefore the 10 digits stored in a transponder can be determined in 50 milliseconds.

The transponder and reader are inductively coupled. The interrogation signals are developed across

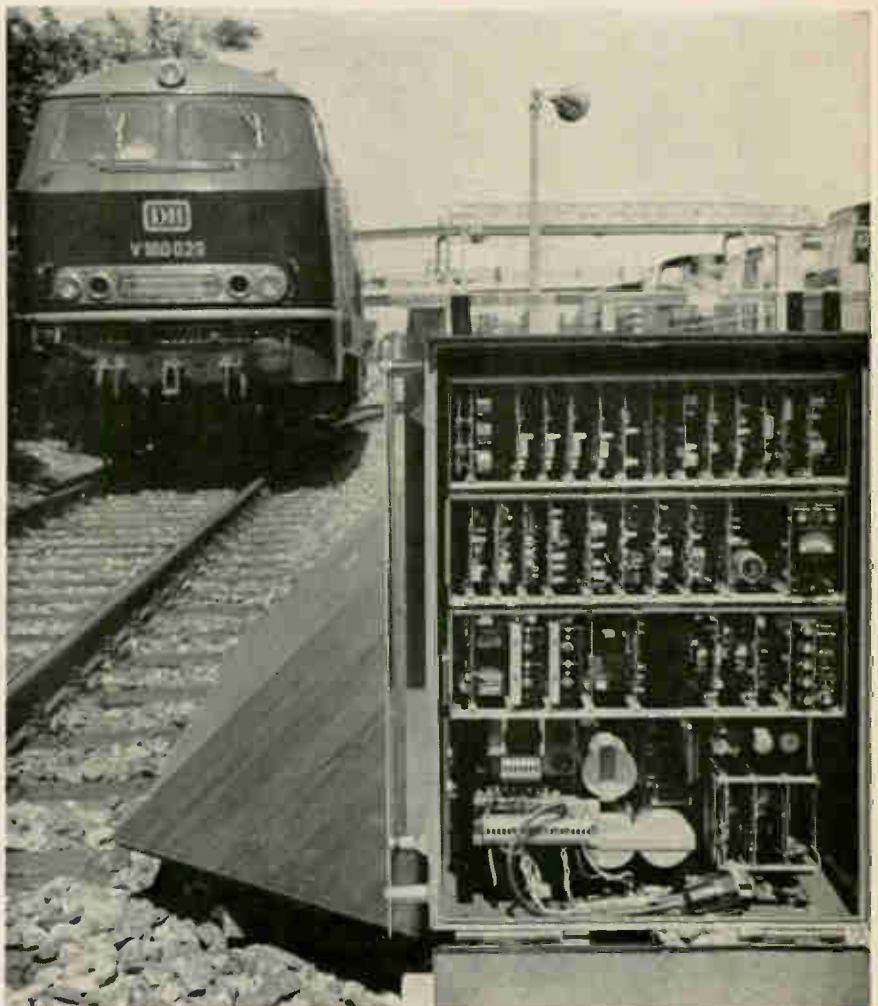

Railroad reader. When car passes automatic reader at right, numbers stored in transponder on car are inductively coupled to reader. Car numbers can be punched onto tape or written out on a typewriter at monitoring station.

an air-core coil, six feet in diameter, in the reader. The responder on each freight car contains an iron-core receiving coil.

Because all signals are transmitted at about the same frequency—110 kilocycles per second—the coils in the transponder can be small.

Ten frequencies. The reader's interrogating signal consists of the upper sideband and carrier of a 110-ke carrier, modulated by one of 10 audio frequencies. Each audio frequency, and therefore each sideband frequency, corresponds to one of the circuits to be interrogated in the transponder. The single-sideband signal is coupled to the transponder, where the carrier and sideband are separated. The sideband energizes a circuit that corresponds to one decade (units, tens, hundreds, etc.) in the stored number. This circuit, in turn, energizes two oscillators whose frequencies represent the digit stored in that decade. The two frequencies amplitude-modulate the 110-ke carrier after the carrier that was previously separated.

The upper sideband of this new signal is removed, and the carrier and lower sideband are coupled back to the reader. The reader demodulates the signal, amplifies it, and prints out the digit represented by the two frequencies. This process is repeated 10 times to obtain the car number.

Transistorization. The transponder mounted on the train requires no power supply; it is powered by a rectified portion of the signal received from the reader. The transistorized circuits operate on a minimum of power and require no warmup time. The replies to the reader have a signal-to-noise ratio greater than 10—more than adequate for clarity.

In contrast to number-detection systems based on television or optical techniques, the Siemens method is unaffected by snow, rain, ice, fog or dirt. However, it is expensive; a trackside reader is believed to cost about \$5,000, and a responder for a 10-decade car-number system costs about \$75 with present limited production.

Japan

Road to STARdom

Today's communications satellites act as extended cables between only two points on earth, but tomorrow's will offer multiple access—giving each earth station a choice of places it can call and permitting several calls to proceed at the same time. The most advanced system so far, chronologically if not technically, is one whose switching system was designed by the Nippon Electric Co. (NEC). The other hardware—antenna, transmitter, receiver, etc.—was provided by the Hughes Aircraft Co.

The system, with a stationary satellite simulated, was demonstrated last November near Tokyo. In May it will undergo another test, at a routing center Hughes is building in Fancy Hills, Ark.; Hughes hopes to use Early Bird for these tests if the satellite has any channels available. The Tokyo demonstration was witnessed by J. V. Charyk, president of the Communications Satellite Corp. and by other Comsat officials. Comsat also has invited Hughes and NEC to demonstrate the system in Hawaii or the state of Washington when stations are completed there.

The Hughes-NEC system is called STAR, an acronym for satellite telecommunications with automatic routing.

Open channels. STAR does not assign the satellite's channels to any specific ground station: any station can use any free channel. Channel assignments are made by a computerized routing center, to which all ground stations would be connected by one data channel via the satellites. Time-division multiplexing allows one data channel to serve all the ground stations; with time division, signals are multiplexed by being transmitted in predesignated intervals.

Channel spacing on STAR is large to permit wide-deviation frequency modulation, because the satellite's repeater bandwidth is broad but the power output is low.

Making a call. When a sub-

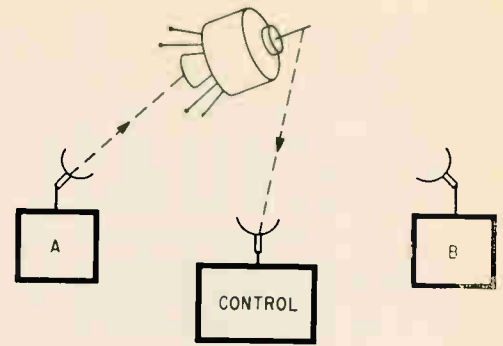

Station A informs control center, via satellite, that it wants to be connected with Station B.

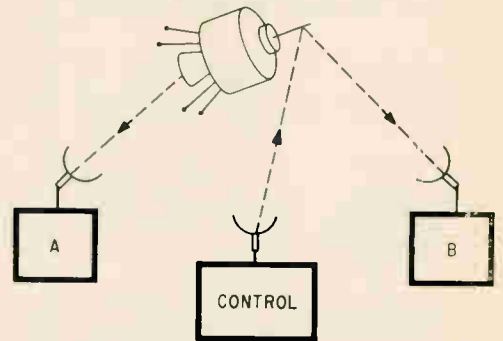

Control center finds two unused channels and assigns one to A and another to B.

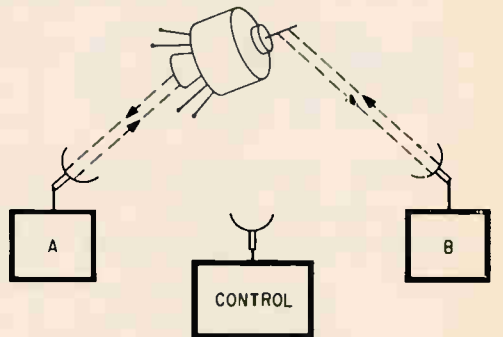

The ground stations communicate on assigned channels, via satellite. When call is completed, A informs control center so that channels can be reassigned.

scriber connected to station A wants to converse with station B, station A's routing equipment detects the request and sends the required information to the routing center through the time-division-multiplexed data channel. The routing center, whose memory contains call conditions in the entire system, finds two empty channels, one for each direction, and sends channel-assignment information to stations A and B. Transmitting and receiving frequencies are automat-

As a prime source...

WE HAVE

INDIUM

WE ARE THE PIONEERS IN PROCESSING

INDIUM

WE ARE THE ORIGINAL FABRICATORS OF

INDIUM

WE KNOW HOW TO USE

INDIUM

- Indium metal and alloys—standard and high purity grades
- Indium pellets
- Indium wire
- Indium foil
- Indium oxide all purities
- Indium plating solutions
- Indium salts
- Indium powders
- Indium ribbon
- Indium spheres
- Gallium



SOLDER KIT 13 Indalloy solders and 5 fluxes plus full instructions and an Indium test chart. \$16.50. Write Dept. E1.

We welcome your inquiries

INDIUM Corporation of America
1676 Lincoln Avenue
Dept. E1 • Utica, New York

Since 1934 . . . pioneers in the Development and Applications of Indium for Industry

Circle 225 on reader service card

MICO

**NEW MODEL 885
SEVEN RATIO
WIDE-RANGE ENGRAVER**

NO. 885

FOR LONG AND
MULTI-LINE WORK

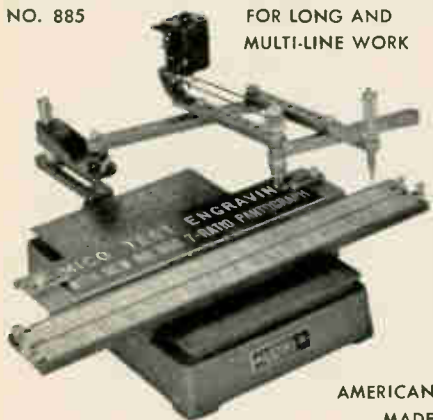

AMERICAN
MADE

- A time-saver for large plate work.
- Engraves 3" x 19" area in one set-up.
- Seven pantograph ratios—from 1.5:1 to 6:1.
- Choice of 3-ball-bearing spindle assemblies for 1/8", 3/16" or taper-shank cutters.
- HSS, COBALT and Solid Carbide Cutters.
- Single and multi-line copy carriers for holding blanks 3/4" to 3 1/2" high.
- Accommodates Mico standard accessories.

Send for bulletins and prices

MICO INSTRUMENT CO.

77 Trowbridge St. Cambridge, Mass. 02138

190 Circle 190 on reader service card

Electronics Abroad

ically set in accordance with the command from the routing center. When the call is completed, the routing center frees the channels.

Unused channels do not radiate a signal; furthermore, even channels in use have the carrier turned off when there is no voice signal.

This start-stop system, as NEC calls it, increases the number of available channels in two ways: it makes efficient use of the satellite's relatively low power, and it prevents intermodulation distortion between unmodulated carriers and those carrying messages. Transmission from A to B is off when the speaker at B is talking and A is listening; this results in a 2-to-1 improvement in utilization of satellite power. Even when B is talking, pauses constitute roughly one-half the conversation time, giving another power-utilization gain of roughly 2 to 1.

Disadvantages. STAR has two principal disadvantages:

- Initial cost. Switching, particularly for small earth stations, is more expensive than in systems where each station has a fixed circuit for each channel; but operation would cost less.

- Political considerations. STAR is based on a single routing center, whose location might be controversial. Furthermore, some countries may be reluctant to commit their efforts and funds to a system that depends entirely on a facility in another nation. NEC is believed to be studying ways to eliminate the routing center.

Computers for Sofia

Perhaps taking advantage of its freedom from ties with United States companies, Fujitsu, Ltd., has agreed to sell computer systems to Bulgaria for \$8.5 million. Approval from the Japanese government is expected.

Fujitsu is the only computer company in Japan that cannot run afoul of American restrictions on sales to Communist countries, because it is the only Japanese concern that relies entirely on its own technology for computers. The other six have agreements with American companies; one, IBM

Japan, is a subsidiary of the International Business Machines Corp.

General purpose. Fujitsu's medium-size series 230, model 30, is only the second general-purpose computer exported from Japan. The other is Fujitsu's FACOM 231 a somewhat smaller general-purpose computer sold recently to the Philippine Sugar Institute. IBM also has exported several special-purpose model 1440's.

Last year Fujitsu delivered \$17 million worth of computers. This year the company predicts that deliveries will total \$28 million. In April it will open another computer plant, which will turn out about 40 small computers a month.

Canada

Halting tv production

While many companies seek ways to capitalize on the boom in consumer electronics, the Canadian Marconi Co. is pulling out of the field at the end of this month. A spokesman says the company will concentrate on more complex equipment such as airborne navigation systems and portable communications for the military and police.

One reason for the shift is the threat of competition from abroad in the lucrative television and color-tv field. On June 14 a key patent, on the Parker system for superimposing a sound signal on video transmission and then separating them, will expire in Canada. The Canadian Patent Act bars foreign-made sets that use the Parker system. However, after June 14, companies from the United States, Japan and the Netherlands are expected to make heavy assaults on the Canadian tv market with both color and black and white sets.

Canadian Marconi, which is controlled by the English Electric Co., says it will dispose of its inventory of consumer-electronics products in about six months—about when the Parker patent expires. However, the company is guaranteeing service and the

availability of spare parts after that date.

Around the world

France. While New Yorkers were walking to work, Parisian transportation officials were planning to expand a radio-surveillance system that keeps close track of 30 buses on a four-mile line. When too many buses are tied up at one end of the line, a dispatcher can send more vehicles to the other end. Each bus has a low-power transmitter whose 24-kilocycle signals are picked up by radio receivers mounted on poles along the route. The binary-coded signals—representing each bus's code number and time of transmission—then go along telephone cables to a central office, where the signals are decoded and the information displayed for the dispatcher. The 1.5 watts that operate the transmitter come from the bus's electrical system.

Vietnam. Television came to Saigon last week. Two very-high-frequency channels were scheduled to begin operation from a Navy plane 12,000 to 15,000 feet above the South Vietnamese capital.

Italy. An Italian company, Industrie A. Zanussi, has signed an agreement whereby the Mitsubishi Electric Corp. of Japan will supply technical assistance for the production of six-inch transistorized television sets. Zanussi has been importing tv sets from Japan and selling them for \$320; production in Italy will start about July 1 and the sets will sell for about \$208, Zanussi says.

Japan. The International Business Machines Corp. is expanding its Tokyo plant for the production of computer models 20 and 40 in the System 360 series. Its subsidiary, IBM Japan, Ltd., recently raised \$16.6 million through the sale of additional stock. Deliveries of model-40 computers are expected to begin in the second half of 1966, and of model-20 units early in 1967. IBM Japan says it plans to discontinue production of its model 1440 gradually.

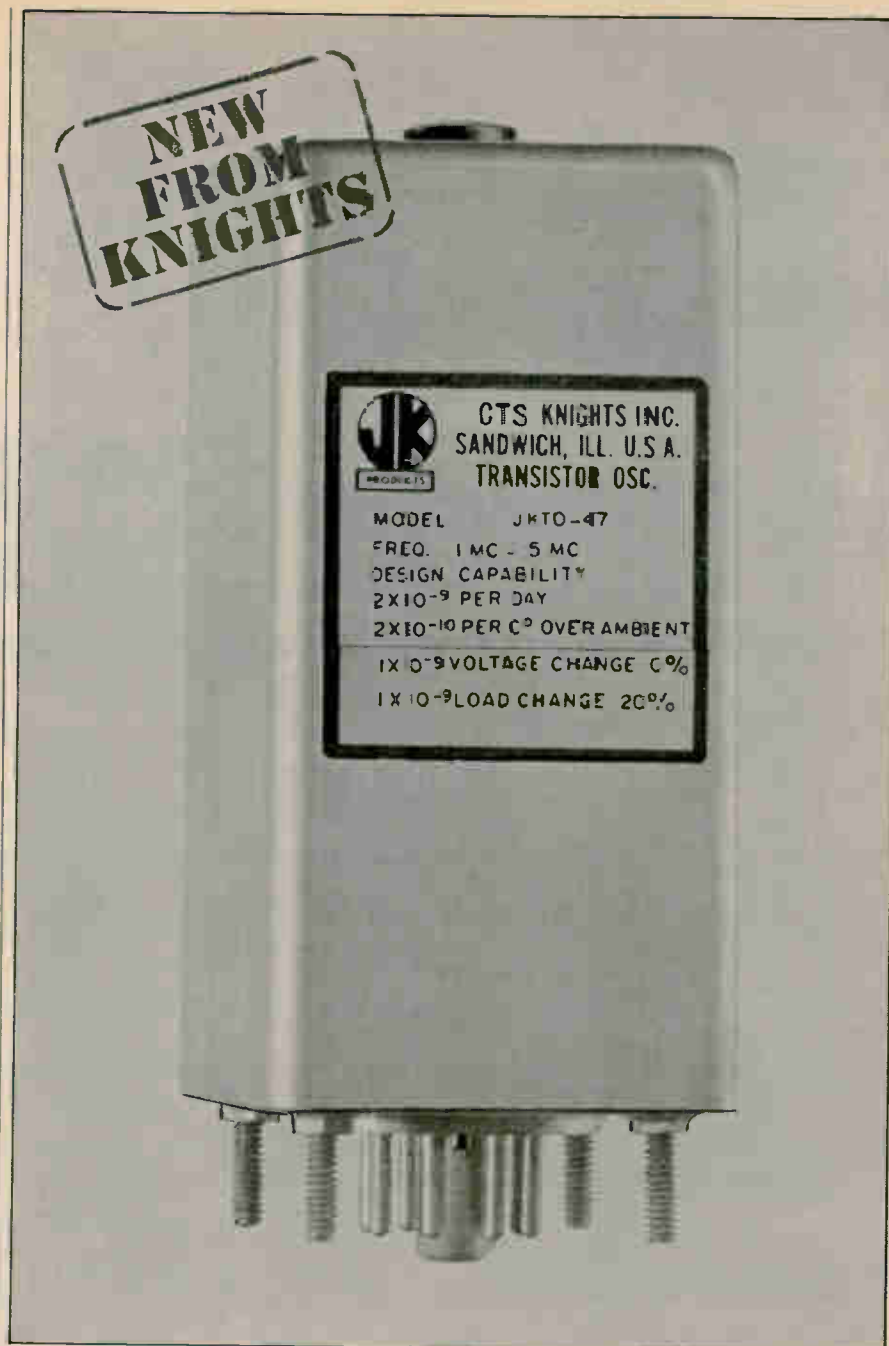

NEW CTS KNIGHTS OSCILLATOR PROVIDES FREQUENCY STABILITY BETTER THAN 2×10^{-9} PER DAY 1mc TO 5mc RANGE.

Model JKTO-47 uses a proportionally controlled oven with maximum thermal efficiency resulting in low input power demand.

Ideally suited for Airborne, mobile or fixed ground applications where ultra precision and low cost are important factors.

WRITE FOR DATA SHEET JKTO-47.



CTS Knights, Inc.

of Sandwich, Illinois
(formerly The James Knights Co.)
a subsidiary of CTS Corporation, Elkhart, Indiana

Prices reduced on all
Radiation digital equipment



NOW 12-BIT 50KC

A/D converter: \$3,025!

12 CHANNEL 8-BIT D/A CONVERTER: \$3,050

Increased reliability and accuracy offered by digital data acquisition and processing is now practical for all your requirements. Prices on industry's finest line of digital equipment have been substantially reduced. That's because of increased production, and lower cost of Radiation plug-in logic modules used in the design of these units.

For example, Radiation's Model 5516 A/D Converter is priced at only \$3,025, and Model 5610 D/A Converter at only \$3,050. In addition: Model 5710 Multiplexer Programmer is now \$1,225, Model 5416 16-Channel Unity Gain Multiplexer is \$1,350. Model 5817 Read/Write Electronics (for 7-track requirements) has been reduced to \$3,350, and Model 5819 (for 9-track) to \$3,790.

Write for data sheets on Radiation digital equipment, or phone for detailed information.



**RADIATION
INCORPORATED**

CONTROL AND COMMUNICATION DIVISION • DEPT. EL-01 • P.O. BOX 430 • MELBOURNE, FLORIDA 32902. PHONE: (305) 727-3711

Circle 192 on reader service card

Use the Below Coupon To Order Editorial Reprints From Electronics!

Fill in, cut out the coupon, insert in envelope
and mail to:

Electronics Reprint Department
330 West 42nd Street, New York, N.Y. 10036

Reprints Available:

(Price: 50¢ each unless otherwise noted.)

- Key no. **R-85** U. S. Electronics Markets 1966 24 page forecast report with 6 page fold-out chart.
- Key no. **R-84** European Electronics Markets 1966, 16 pages with 4 page foldout chart.
- Key no. **R-83** A Look at Japanese Electronics Technology, 36 pages.
- Key no. **R-82** Computer Time Sharing, 20 pages
- Key no. **R-80** The Packaging Revolution In Microelectronics (2 part series, 32 pages.) \$1.00.
- Key no. **R-79** MOS Integrated Circuits Save Space and Money, 16 pages.
- Key no. **R-78** The Overlay Transistor, 4 color special feature, 15 pages.
- Key no. **R-77** Cold Cathode Tubes (3 part series, 28 pages).

Reprint order form

(See the above list, please order by key number.)

To help expedite mailing of your reprints, please send cash, check, or money order when you order.

Send me reprint(s) of key no(s) at ¢ each.

Name

Number & Street

City, State, Zip Code

AD-YU ELECTRONICS INC.

249 TERHUNE AVE., PASSAIC N. J. PHONE 472-5622

PLOT ENVELOPE DELAY CURVE of IF amplifiers, TV equipment, filters, etc.

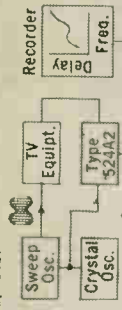

MEASURE PHASE WITH 1000% DISTORTED SIGNALS from transducers, accelerometers and other pickups.

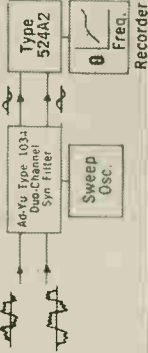

FEATURES:
No frequency adjustment, no amplitude adjustment.
Analog or digital output for external recorder or programmable system.
Relative accuracy = 0.03% with 5-digit voltmeter.

USES:
Plot phase vs. frequency curve from 20 cps to 500 kc.
Plot analog curve with RF sweep oscillator.
Use as standard phase meter with 5-digit d.c. voltmeter as readout.
Use as phase computer for system control.

THE ULTIMATE PHASE METER ±0.03 ACCURACY 20 CPS TO 500 KC



Type 524A2 Digital Phase Meter
(Phase Computer — \$965)

Siliconix Incorporated Phil MacTaggart Advertising	109
Sinclair Radio Laboratories Inc. John E. Hayes Company Inc.	179
■ Singer Company, Metrics Division Hepler & Gibney Inc.	107
Sola Electric Company Klau-Van Pietersom Dunlap Inc.	154
■ Sorensen Inc. Fuller & Smith & Ross Inc.	11
Space Craft Inc. Neals & Hickok Inc.	57
Spectral Dynamics Corp. of San Diego Teawell Inc. Advertising	61
Speer Carbon Company Hazard Advertising Company	37
Sperry Microwave Electronics Co. Liller Neal Battle & Lindsey Inc.	116
Sprague Electric Company The Harry P. Bridge Company	5, 10, 16
St. Joseph Lead Company Emil Mark & Company Inc.	117
Stackpole Carbon Company Meek and Thomas Inc.	92
Synthane Corporation Arndt, Preston, Chapin, Lamb & Keen Inc.	177
TRW Systems Fuller & Smith & Ross Inc.	178
Taylor Corporation Gray & Rogers Inc.	146
■ Tektronix Inc. Hugh Dwight Advertising Inc.	58
■ Telonic Industries Jansen Associates	127
Texas Instrument Incorporated Don L. Baxter Inc.	119
Topaz Incorporated Teawell Inc.	182
Transitron Larcom Randall Advertising Inc.	164
Ulano & Company, J. Byrde, Richard & Pound Inc.	186
Ultra Carbon Corporation Church & Guisewite Adv. Inc.	168
Union Carbide Corporation, Linde Division J.M. Mathes Inc.	105
United Systems Corporation Advertising and Merchandising	176
Unitrode Corporation Electronic Marketing Assistance	35
■ Vactec Inc. Ron Coleman Agency	166
Vector Div. of United Aircraft Corporation Cunningham & Walsh Inc.	180
Vitramon Inc. Ted Sommers Inc.	159
■ Vitro Corporation of America Buchen Advertising Inc.	126
White Company, S.S. W.L. Towne Company Inc.	167
Zero Manufacturing Company Guerin, Johnstone & Gage Inc.	170

Classified advertising

F.J. Eberle, Business Mgr.	
EMPLOYMENT OPPORTUNITIES	183-184
EQUIPMENT (Used or Surplus New) For Sale	184
ADVERTISERS INDEX	
Boaz-Allen Applied Research Inc.	184
General Telephone & Electronics Labs	183
Monmouth Electric Co., Inc.	184
Radio Research Instrument Co.	184
Semiconductor Sales of Calif.	184

■ For more information on complete product line see advertisement in the latest Electronics Buyer's Guide



Advertising sales staff

Gordon Jones [212] 971-2210 Advertising sales manager
Atlanta, Ga. 30309: Gus H. Krimsier, Michael H. Miller, 1375 Peachtree St. N.E., [404] TR 5-0523
Boston, Mass. 02116: William S. Hodgkinson McGraw-Hill Building, Copley Square, [617] CO 2-1160
Chicago, Ill. 60611: Robert M. Denmead, J. Bradley MacKimm 645 North Michigan Avenue, [312] MO 4-5800
Cleveland, Ohio 44113: Paul T. Fegley, 55 Public Square, [216] SU 1-7000
Dallas, Texas 75201: Richard P. Poole, The Vaughn Building, 1712 Commerce Street, [214] RI 7-9721
Denver, Colo. 80202: Joseph C. Page, David M. Watson, Tower Bldg., 1700 Broadway, [303] AL 5-2981
Detroit, Michigan 48226: Paul T. Fegley 856 Penobscot Building [313] 962-1793
Houston, Texas 77002: Kenneth George, 2270 Humble Bldg., [713] CA 4-8381
Los Angeles, Calif. 90017: John G. Zisch, 1125 W. 6th St., [213] HU 2-5450
Minneapolis, Minn. 55402: J. Bradley MacKimm 1104 Northstar Center (612) 332-7425
New York, N. Y. 10036: Donald R. Furth [212] 971-3615 Frank LeBeau [212] 971-3615 George F. Werner [212] 971-3615 500 Fifth Avenue
Philadelphia, Pa. 19103: William J. Boyle, Warren H. Gardner, 6 Penn Center Plaza, [215] LO 8-6161
Pittsburgh, Pa. 15222: Paul T. Fegley, 4 Gateway Center, (412) 391-1314
Portland, Ore. 97204: James T. Hauptli, Pacific Building, Yamhill Street, (503) CA3-5118
St. Louis, Mo. 63105: Robert M. Denmead The Clayton Tower, 7751 Carondelet Ave. [314] PA5-7285
San Francisco, Calif. 94111: James T. Hauptli, 255 California Street, [415] DO 2-4600
London W1: John W. Patten, Edwin S. Murphy Jr., 34 Dover Street, Hyde Park 1451
Milan: 1, via Baracchini Phone: 86-90-617 86-90-656
Frankfurt/Main: Gerd Hinske, 85 Westendstrasse Phone: 77 26 65 and 77 30 59
Geneva: Michael R. Zeynel, Joseph Wuensch, 1, rue du Temple Phone: 31 95 60
Paris VIII: Denis Jacob, 17 Avenue Matignon ALMA-0452
Tokyo: Nobuyuki Sato, 1, Kotohiracho Shiba, Minato-Ku (502) 0656
Osaka: Ryosi Kobayashi, 163, Umegee-cho, Kita-ku [362] 8771
Hugh J. Quinn: [212] 971-2335 Manager Electronics Buyers' Guide
David M. Tempest: [212] 971-3139 Promotion manager
Milton Drake: [212] 971-3485 Market research manager
Wallace C. Carmichael [212] 971-3191 Business manager
Theodore R. Geipel: [212] 971-2044 Production manager

Another Brush Innovation in Recording

The **Very** versatile
Brush
Mark 842.

For people who never know
what they'll be
recording next!

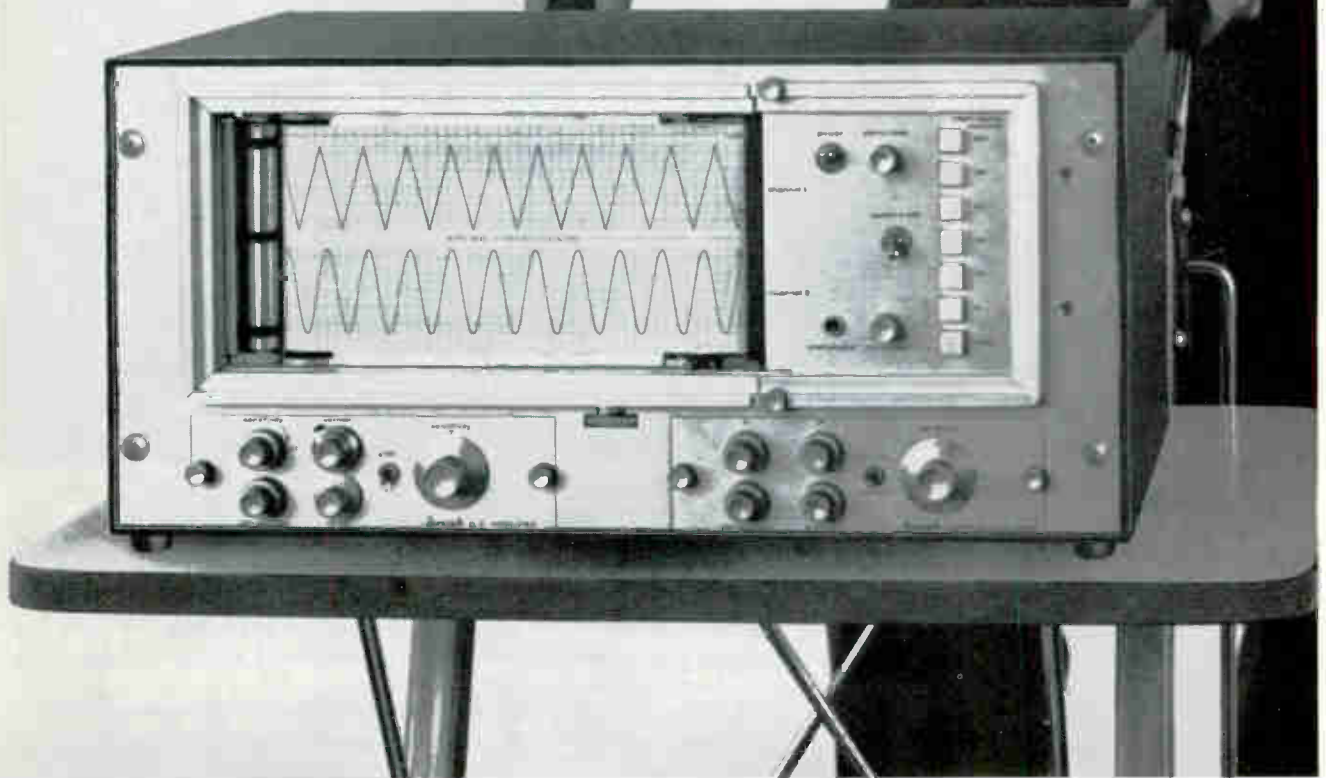

You know what we mean.

Recording requirements change. So it makes sense to buy a recorder you can change with them. Like the Brush Mark 842. See the two pre-amplifiers right below the display and controls? They're the interchangeable plug-in type. Brush gives you a choice of nine. Plus a pick of seven conversion couplers. And any mounting arrangement

you can think of. Lets you match the new Mark 842 to whatever recording job comes along. Great performance, too. Highest usable frequency response of any direct writing recorder . . . 75 cps full scale; flat to 150 cps at reduced amplitude. 1/2% Linearity. All solid state electronics. High torque penmotors. Rugged, crisp-writing styli to assure razor-sharp traces

of unmatched reproducibility. Pushbutton choice of 12 writing speeds. All yours in the clean, neat, easy-to-operate Mark 842. Built by Brush to meet your recording needs for years to come. Ask your local Brush Sales Engineer for a demonstration. A new brochure is yours for the asking. Brush Instruments Division, Clevite Corporation, 37th & Perkins, Cleveland, Ohio 44114.

brush **CLEVITE**
INSTRUMENTS DIVISION

Circle 901 on reader service card

The RCA Bialkali
Photocathode offers...
Up to 100 to 1
DARK-CURRENT
REDUCTION

Typical QE
at 3850 Å = 24%



THE RCA LINE OF BIALKALI CATHODE PHOTOMULTIPLIERS*			
Nominal Size	No. of Stages	Proto-type	Bialkali Variant
¾"	10	4460 7767	C70042G
1½"	10	4461	C70114F
1½"	10	6199 4438	C7151S
2"	10	6342A	C7164N
2"	10	8053	C70109F
2"	10	---	C70150
2"	10	---	C70144
2"	12	7850	C70101B
2"	12	---	C70101C
3"	10	8054	C70030E
3"	10	---	C70145
3"	10	---	C31009
3"	10	---	C31012
3"	14	---	C70045Dt
5"	10	8055	C70043G
5"	14	---	C70133

*All types shown are constructed with CuBe dynodes.
†Side-on type.

SPECTRAL RESPONSE CHARACTERISTICS

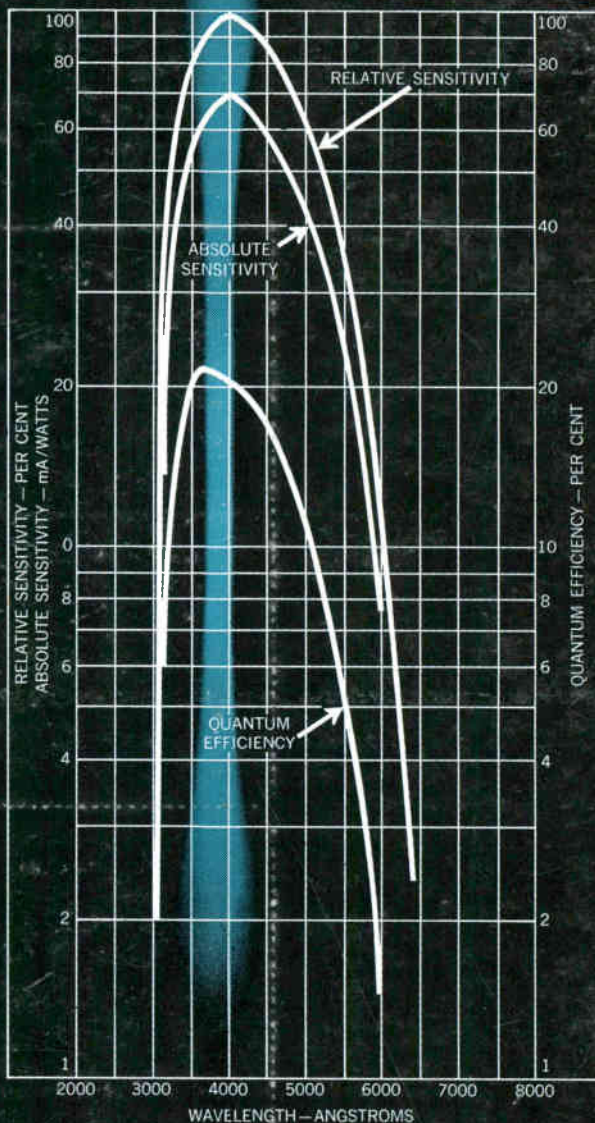

The Bialkali Photocathode is now available in many new RCA tube designs as well as in variants of most of RCA's commercially known photomultipliers. This new photocathode provides advantages in higher quantum efficiency and lower dark current. Designed for scintillation counting and other low-light-level detection and measurement systems, units with the RCA Bialkali cathode offer:

- A typical quantum efficiency of 24% at 3850 Å—a significant increase in performance (more than 50%) when compared with types having S-11 response (cesium-antimony photocathode).
- A dark-current reduction of as much as 100 to 1.

Proved in the unparalleled success of the RCA-8575, the RCA Bialkali Photocathode is now available in tube types with standard base, semi-flexible leads, or potted voltage dividers. Ask your RCA Representative about the advantages of the RCA Bialkali Photocathode in upgrading your existing system performance. For technical data on specific types, write: RCA Commercial Engineering, Section B-19Q-4, Harrison, N. J.

RCA Electronic Components and Devices



The Most Trusted Name in Electronics