

Electronics®

Processing radar signals optically: page 58
Error-control coding in communications: page 70
Special report — Electronics in Europe: page 81

December 27, 1965

75 cents

A McGraw-Hill Publication

Below: Focus on electronics
in European markets: page 85



ROLAND KISSLER
BOX 956
MOSES LAKE WASH
C 10

A Wave Analyzer That Gives You A Choice

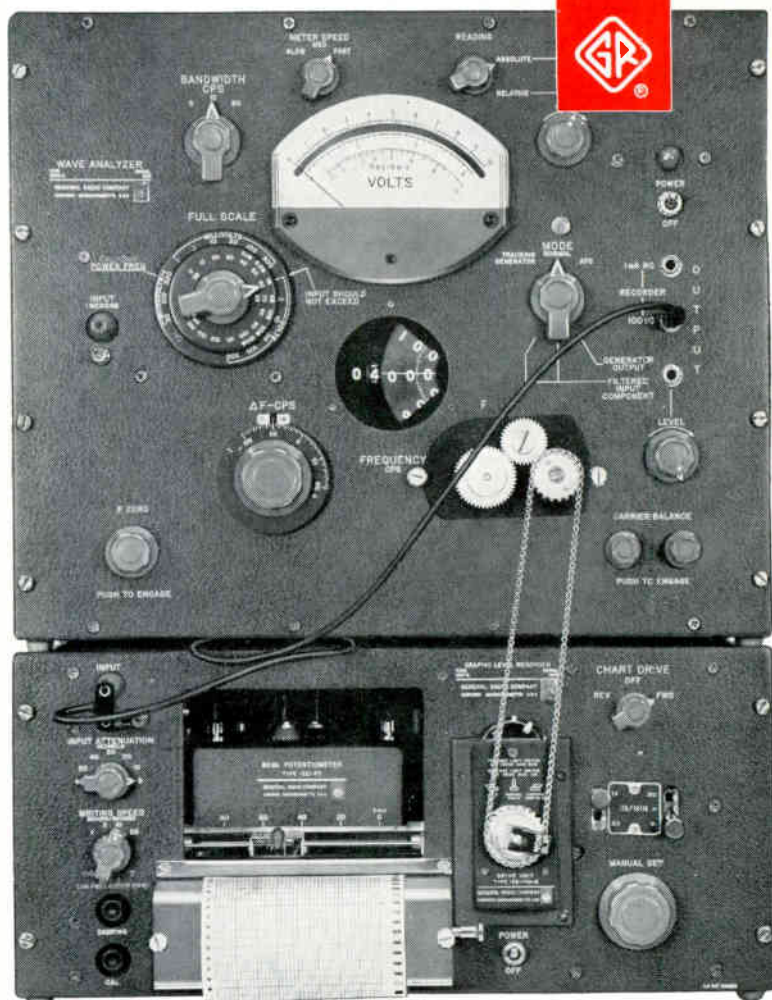

A Choice of **BANDWIDTHS: 3, 10, and 50 c/s**

Bandwidth skirts are better than 80-dB down at ± 25 c/s, ± 80 c/s, and ± 500 c/s for 3-, 10-, and 50-cycle bandwidths, respectively.

A Choice of **READOUTS**

Permanent chart record of analyzed spectrum plotted over an 80-dB dynamic range.

Meter readout for manual measurement of individual components present in a signal. Range is $30\mu\text{V}$ to 300 V, full scale, in 15 ranges. Accuracy is $\pm (3\%$ of reading + 2% of full scale).

A Choice of **3 METER SPEEDS**

Provides the correct response for measurements of either periodic signals or noise.

A Choice of **TWO RECORDER OUTPUTS**

A 100-kc filtered-and-amplified output for driving a GR Type 1521-A Recorder (80-dB dynamic range for inputs over 0.1 V), and a dc output for driving 1-mA recorders.

A Choice of **3 OPERATING MODES**

NORMAL for spectrum analysis

AFC to hold analyzer in tune despite input signal drift

TRACKING GENERATOR provides an output signal which is always in tune with the analyzer for use as an input signal to devices under test.

... and, in Addition ...

A Linear 20-c to 54-kc Range

Easy-to-read in-line readout is graduated in 10-cycle increments. $\pm 0.5\%$ calibration accuracy. Output is provided for measurement of frequency components with a counter, where extreme accuracy is desired.

Precise Frequency Setting

Incremental-frequency dial has twice the resolution of main dial—lets you fine-tune any component. Covers ± 100 -cycle range, independent of analyzer center frequency.

High Input Impedance

1-M Ω on all ranges, coupled with low-noise i-f circuits, makes for excellent sensitivity.

An Excellent Tunable Filter

For example, this instrument can be used to produce 3-, 10-, and 50-cycle bands of noise over a tunable range from 20 c/s to 54 kc/s when a random-noise generator is connected to the analyzer input.

Type 1900-A Wave Analyzer

\$2350 (in U.S.A.)

Type 1910-A Recording Wave Analyzer

\$3700 (in U.S.A.)

GENERAL RADIO COMPANY

WEST CONCORD, MASSACHUSETTS

IN CANADA: Toronto 247-2171. Montreal (Mt. Royal) 737-3673
IN EUROPE: Zurich, Switzerland — London, England

BOSTON NEW YORK, N. Y., 964-2722 CHICAGO PHILADELPHIA WASHINGTON, D. C. SYRACUSE DALLAS SAN FRANCISCO LOS ANGELES ORLANDO, FLA. CLEVELAND
(W. Concord) 646-0550 (Ridgefield, N. J.) 943-3140 (Oak Park) 848-9400 (Ft. Washington) 646-8030 (Rockville, Md.) 946-1600 454-9323 ME 7-2240 (Los Altos) 948-8233 469-6201 425-4671 886-0150

Circle 900 on reader service card

ECONOMY!

**Versatile,
Value-priced
x-y recorder
...just \$795!**

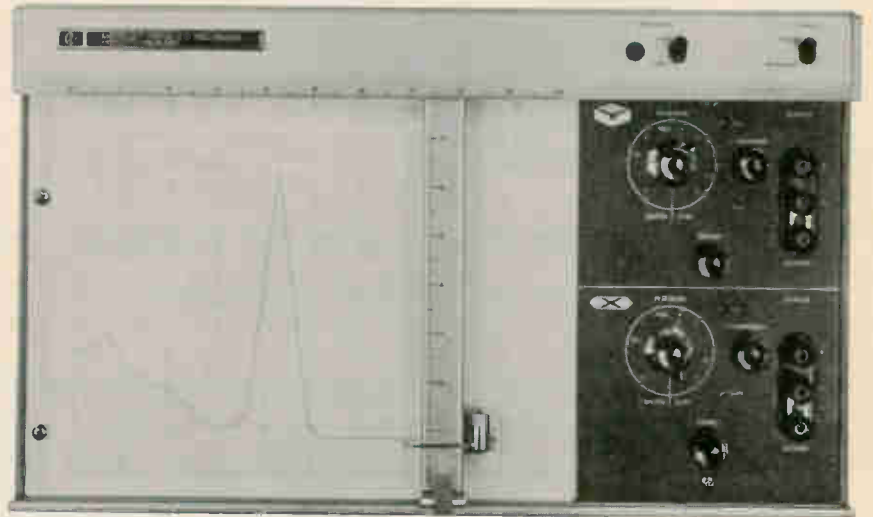

THE MOSELEY 7035A

This is a high-performance, low-cost solid-state recorder for every-day applications not requiring high dynamic performance. Five fixed calibrated ranges 1 mv/inch to 10 v/inch. High input impedance, floating guarded input, 0.2% accuracy at full scale. Adjustable zero set.

Each axis has an independent servo system with no interaction between channels. Maintenance-free AUTOGRIP* electric paper holddown, new writing system with inexpensive disposable unit. Options available include electric pen lift, locks for zero and variable range controls, rear input, re-transmitting potentiometers.

For general-purpose applications, you can't beat the Moseley Division 7035A. Ask your Hewlett-Packard field engineer for a demonstration. Or write for complete specifications to Hewlett-Packard, Palo Alto, California 94304, Tel. (415) 326-7000; Europe: 54 Route des Acacias, Geneva.

*Data subject to change without notice.
Price f.o.b. factory.*

**HEWLETT
PACKARD**  **MOSELEY
DIVISION**
An extra measure of quality

*Trade Mark Pat. pend.

6 WAYS TO GET IMPROVED MEASUREMENTS AT LOWER COST:

The new hp 419A DC Nullmeter and wide-range voltmeter!

1. Internal nulling supply for measuring high-impedance source voltages
2. 0.1 μv resolution with $< 0.5 \mu\text{v}$ drift per day
3. Noise immunity $> 80 \text{ db}$ superimposed ac rejection
4. Four times longer battery operation—30 hours between recharges
5. Overload—up to 1200 volts
6. Copper terminals eliminate thermal voltages

Price: only \$450

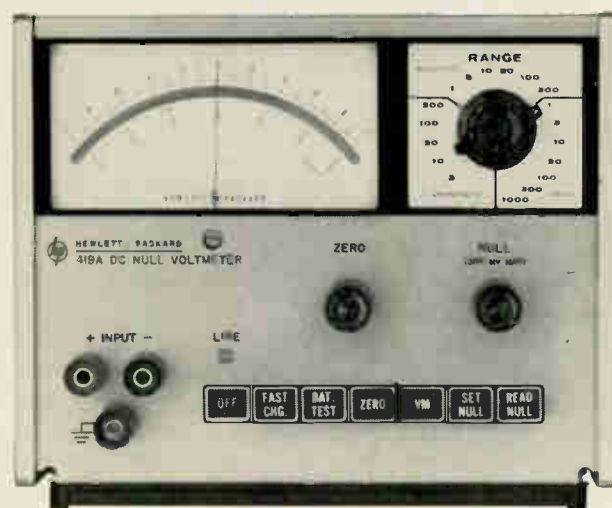

The Hewlett-Packard 419A represents a new approach to dc voltage measurement, offering an instrument that is more accurate, more stable, less noisy and more sensitive at a price that makes it today's best dc null-meter value. In addition, you may use it as a $3 \mu\text{v}$ to 1 kv zero center scale dc voltmeter. Accuracy is $\pm 2\%$ of end scale, $\pm 0.1 \mu\text{v}$. Response time is 3 sec on $3 \mu\text{v}$ range, 1 sec on 10 μv to 1000 v ranges (to 95% of final reading), with 2 sec recovery for 10^{+4} overload.

The 419A's internal nulling feature is unique. With it you may derive an essentially infinite input impedance on the $3 \mu\text{v}$ to 300 mv ranges, merely by bucking out the input voltage, pushing a button and measuring the internal supply itself. Ideal for applications involving high source impedances. Input impedance above the 300 mv range is 100 megohms.

Operate it from the ac line, during which batteries trickle charge, or isolate it from the power line and operate on furnished batteries that give four times longer operation between charges than comparable instruments available today. A fast charge feature (adjustable) lets you recharge batteries in 16 hours. The 419A may be operated up to 500 v dc or 350 v ac (rms) above ground. In addition, the 419A serves as an exceptionally stable dc amplifier, and recorder output of 1 v, with currents up to 1 ma, is provided.

Pushbutton convenience is provided by the human-engineered front-panel, including the Battery Test for reading battery strength on the meter and the Set Null and Read Null buttons and knob for using the internal bucking voltage. The zero control also can be used to compensate thermals at the lower ranges. A new chopper design in the solid-state 419A (patent pending) uses long-wear hp photocells with reduced on-time and battery drain.

Ask your hp field engineer for a convincing demonstration. Or write for complete data to Hewlett-Packard, Palo Alto, California 94304, Tel. (415) 326-7000; Europe: 54 Route des Acacias, Geneva; Canada: 8270 Mayrand Street, Montreal.

Data subject to change without notice. Price f.o.b. factory.

HEWLETT  PACKARD
An extra measure of quality

Electronics

December 27, 1965
Volume 38, Number 26

Page 4	Readers Comment
8	People
14	Meetings
16	Meeting Preview
23	Editorial
25	Electronics Newsletter
47	Washington Newsletter
119	New Products
134	New Books
136	Technical Abstracts
138	New Literature
150	Reprints

Electronics Review

Page 31	The date was kept	36	The speed limit
31	Not a whisper	38	Sound and safe
32	The F-111 market	38	Waterproof radio
33	Aiming with tv	39	A record problem
33	Light talk	40	Electronics notes
34	A seller's market		

Probing the News

103	Anxiety and affluence: why color-tv makers worry
106	Discriminating Press
112	Missile's sea cruise to be business trip

Electronics Abroad

145	Surgery calling the computer	147	Semiconductor battleground
146	Space mail	147	Bottleneck alert
146	Studies in space	148	Eye on the sky
146	Radar on the rails	148	Around the world
147	Video recorder		

Technical Articles

Advanced technology	58	New target for radar: sharper vision with optics Optical signal processing can handle more data than can electrical techniques as radar improves A.J. Talamini, Jr. and E.C. Farnett, RCA
Circuit design	67	Designer's casebook <ul style="list-style-type: none">• Modified flip-flop quadruples fan-out• Novel sweep circuit eliminates ramp pedestal• Gated multivibrator output provides constant pulse width
Communications	70	Coding for error control: an examination of techniques In the growing battle to reduce errors in digital communications, a variety of code structures and coding techniques have been developed A.G. Franco and M.E. Wall, Communications Systems Inc.
Marketing	81	European electronics markets 1966 The first comprehensive statistical analysis of electronics markets in key countries of Western Europe
	85	The boom continues A country-by-country analysis of electronics technology and markets in Western Europe and the Soviet Union
Annual index	139	Technical articles 1965 An index of technical articles and authors published in Electronics in 1965

Title R registered
U.S. Patent Office;
© copyright 1965
by McGraw-Hill, Inc.
All rights reserved,
including the right to
reproduce the contents
of this publication,
in whole or in part.

Electronics

Editor: Lewis H. Young

Senior editors

Technical: Samuel Weber

News: Kemp Anderson Jr.

Senior associate editors: John F. Mason, George Sideris

Department editors

Advanced technology: Joan Blum

Avionics: W.J. Evanzia

Circuit design: Michael Elia

Computers: Wallace B. Riley

Consumer electronics: Richard Lipkin

Electronics review: Stanley Zarowin

Instrumentation: Carl Moskowitz

Manufacturing: George Sideris

Military electronics: John F. Mason

New products: William P. O'Brien

Solid state: Jerome Eimbinder

Space electronics: Peter R. Sigmund

Special projects: Richard M. Machol

Regional editors

Boston: Thomas Maguire, editor; Robin Carlson

Los Angeles: William B. Wallace, Walter Barney, editors; June Ranill

San Francisco: Laurence D. Shergalis, Edmond G. Addeo, editors; Mary Jo Jadin

Copy editors

Howard Rausch, Sally Powell

Graphic design

Art director: Saul Sussman

Assistant art director: Donna M. Griffiths

Editorial production: Ann Mella

Production editor: Arthur C. Miller

Editorial secretaries: Claire Benell, Mary D'Angelo, Lynn Emery, Lorraine Fabry, Kay Fontana, Lorraine Longo, Carolyn Michnowicz

McGraw-Hill News Service

Director: John Wilhelm; **Atlanta:** Fran Ridgway; **Chicago:** Bruce Cross, Louis S. Gomolak;

Cleveland: Arthur Zimmerman; **Dallas:** Marvin Reid;

Detroit: N. Hunter; **Los Angeles:** Michael Murphy, Ron Lovell;

San Francisco: Margaret Ralston;

Seattle: Ray Bloomberg; **Washington:** Arthur L. Moore, Charles Gardner,

Herbert W. Cheshire, Seth Payne, Warren Burkett, Warren Kornberg

McGraw-Hill World News Service

Bonn: John Johnsrud, John Gosch; **Brussels:** Arthur Erikson; **London:** John Shinn;

Mexico City: Wesley Perry; **Milan:** Bruce Bendow;

Moscow: Donald Winston; **Paris:** Dan Smith;

Rio de Janeiro: Leslie Warren; **Tokyo:** Marvin Petal, Charles Cohen

Circulation manager: Hugh J. Quinn

Reprints: T.M. Egan

Publisher: C.C. Randolph

Electronics: December 27, 1965, Vol. 38, No. 26

Printed at 99 North Broadway, Albany, N.Y., 12207
Second class postage paid at Albany, N.Y.

Subscriptions are solicited only from those actively engaged in the field of the publication. Position and company connection must be indicated on orders. Subscription prices: United States and Possessions and Canada, \$6.00 one year, \$9.00 two years, \$12.00 three years. All other countries \$20.00 one year. Single copies, United States and Possessions and Canada 75¢. Single copies all other countries \$1.50.

Published every other Monday by McGraw-Hill Inc., 330 West 42nd Street, New York, N.Y. 10036. Founder: James H. McGraw, 1860-1948.

Subscribers: The Publisher, upon written request to our New York office from any subscriber, agrees to refund that part of the subscription price applying to copies not yet mailed. Please send change of address notices, subscription orders or complaints to Fulfillment Manager, Electronics, at the address below. Change of address notices should provide old as well as new address, including postal zone number if any. If possible, attach address label from recent issue. Allow one month for change to become effective.

Postmaster: Please send Form 3579 to Fulfillment Manager, Electronics, P.O. Box 430, Hightstown New Jersey 08520

Readers Comment

Another laser pioneer?

To the Editor:

The article "What's a laser patent worth?" [Sept. 20, p. 137] says that the confusion surrounding the development of the injection laser or the semiconductor laser is even greater. I would like to clarify the situation.

Jun-ichi Nishizawa, a professor at Tohoku University and manager of the Semiconductor Research Institute, Sendai, Japan, together with Yasushi Watanabe, president of Shizuoka University, applied for a patent for "semiconductor masers" on April 22, 1957. The patent was granted in Japan on Sept. 20, 1960, two years before the announcement of the observation of laser action in gallium arsenide in the United States.

Ichiemon Sasaki
Semiconductor Research
Institute
Sendai, Japan

No camera needed

To the editor:

The Nov. 29 article concerning the Perkin-Elmer laser tv camera was quite interesting. Unfortunately, I do not understand why it was necessary to use a photomultiplier instead of a vidicon or orthicon. Was it because these devices are not sensitive enough to receive the laser light or was it to simplify the circuit?

There might possibly be an advantage to using an image intensifier backed up by a vidicon. It would simplify the scanning requirements of the laser beam.

Bernard Fudim
Calvert Electronics
New York, N. Y.

▪ The multiplier phototube was used for simplicity and economy. One advantage of the laser tv system is that it does away with orthicons and vidicons.

Then there were . . . four

To the Editor:

In your article regarding the power failure, "When the lights came on again" [Nov. 29, p. 101]

All from Sprague!

ENERGY-STORAGE CAPACITORS for every type of discharge application

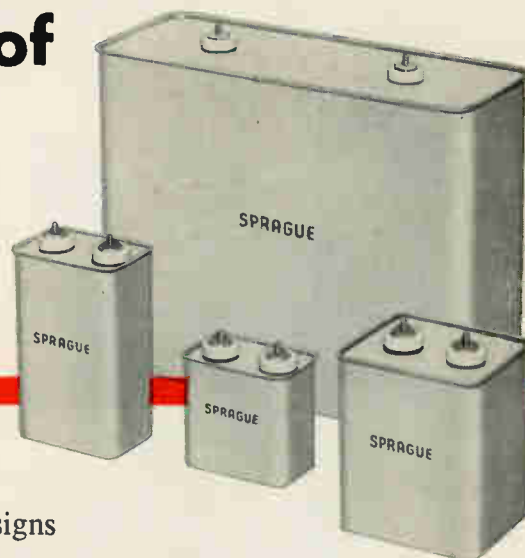

A pioneer in high voltage capacitors, Sprague has a broader line of designs for energy-storage applications than any other capacitor manufacturer. If your project involves lasers, masers, electronic photoflash, time-control circuits, exploding wire, thermonuclear fusion research, magnetization of permanent magnets, medical equipment, or similar discharge applications, Sprague can provide a capacitor to meet your specific needs.

Light, Moderate, or Heavy Duty Capacitors

Available types range from small, light-weight units for aerospace applications such as satellites, missiles, etc., to heavy-duty capacitors for high-current/high-frequency oscillatory discharges.

Broad Range of Electrical Ratings

Voltages from 2 kilovolts to 24 kilovolts. Energy ratings up to 6700 joules. Self-inductance as low as .0025 microhenry.

Paper, Metallized Paper, and Paper/Film Designs

Metallized capacitors intended for light-weight, space-saving applications . . . one-half the size, one-third the weight of conventional capacitors. Other available designs include castor oil impregnation for extremely long life (assuring a high number of discharges), and non-flammable synthetic askarel impregnation for applications where non-combustibility is a prerequisite.



Energy-Storage Electrolytic Capacitors

A selected line of cylindrical 'lytics for industrial applications requiring maximum capacitance in minimum space.

For complete information or application engineering assistance on Sprague Energy-Storage Capacitors, write to Field Engineering Department, Sprague Electric Company, 35 Marshall St., North Adams, Mass. 01248.

SPRAGUE COMPONENTS

CAPACITORS
TRANSISTORS
RESISTORS
INTEGRATED CIRCUITS
THIN-FILM MICROCIRCUITS
45C-1154

PULSE TRANSFORMERS
INTERFERENCE FILTERS
PULSE-FORMING NETWORKS
TOROIDAL INDUCTORS
ELECTRIC WAVE FILTERS

CERAMIC-BASE PRINTED NETWORKS
PACKAGED COMPONENT ASSEMBLIES
BOBBIN and TAPE WOUND MAGNETIC CORES
SILICON RECTIFIER GATE CONTROLS
FUNCTIONAL DIGITAL CIRCUITS



'Sprague' and '®' are registered trademarks of the Sprague Electric Co.

i/c's and modules tested...



DYNAMICALLY!

Now you can perform important *dynamic* tests in addition to ordinary static (dc) tests with TI's Model 553 *Dynamic Test System*. Measure propagation delay and noise feed-through; *dynamically* determine "fan-in"/"fan-out" ratios, and noise immunity; assess the effects of transients. Now, measure switching times in terms of percentage or absolute values. You save money by performing more tests at high speed with handling reduced by single-socket testing.

The 553 *Dynamic Test System* is designed for integrated circuits, transistors, diodes, thin films, logic cards, other circuit elements with 10, 20, 50, or more active leads. Testing can be done from dc to 50 mc, thereby simu-

lating actual operating speeds. Time or voltage is measured anywhere *on* or *between* pulses (widths from 10 ns to 1 ms) with a resolution of .000001%. Jitter is less than 50 ps; accuracies better than 2%.

Modular design and variable word-length program logic provide for infinite system expansion. Simplified programming language allows operators to learn to program in 45 minutes. Data as well as double-ended hi-lo limits can be produced at test rates faster than go/no-go systems with a wide variety of output recording techniques available.

For detailed information about the 553, contact your TI Field Office or the Test Equipment department, Houston.

INDUSTRIAL
PRODUCTS
GROUP



TEXAS INSTRUMENTS
INCORPORATED
P. O. BOX 66027 HOUSTON, TEXAS 77006
118 RUE du RHONE GENEVA, SWITZERLAND

you state that "While broadcasting stations with emergency generators in the blacked-out Northeast transmitted to transistor radios in streets, restaurants, office buildings and at home, the television transmitters were dead. But few receivers had operating power anyway."

We would like to advise you that one television transmitter did not go dead. WKTV in Utica, N. Y., went on its emergency generators at both the studio and transmitter immediately and continued to operate throughout the blackout, and we can guarantee that we had a minimum of four viewers, people who we personally know had battery-operated transistor television receivers.

D. T. Layton

Chief Engineer
WKTV
Utica, N.Y.

A patented approach

To the Editor:

The deep-sea Geiger counter [Nov. 15, p. 43] for continuous measurement of oxygen in water at depths down to 6,000 feet might be improved by use of a method described in my U. S. patent 2,711,482 (June 21, 1955).

Instead of piping the water and thallium (Tl-204) ions through a small, stainless steel pipe inside the Geiger counter, the solution could flow over or through a scintillation detector (for example, a plastic) which is mounted outside the pressurized housing of the photomultiplier and ancillary electronic components. When beta-rays strike the detector, the light released is transmitted to the photocathode through a glass or quartz window

mounted in the wall of the housing.

The equipment described in my patent was designed for use in radioactivity well-logging. However, it should be applicable with little modification to radio-release analysis of oxygen in the ocean and for water pollution problems.

Clark Goodman
Vice President-Technical Director
Houston Research Institute, Inc.
Houston, Tex.

The inventor replies:

The theory is good, but the practice is not possible.

Our first thought was to use a thick plastic scintillator as both the transducer and pressure window. However, we were unable even with the thickest plastic to prevent crazing of the material under pressures of more than 500 psi.

Then we adopted the technique which Goodman suggested: namely, using a thin piece of plastic scintillator optically coupled to a thick glass pressure window which was in turn optically coupled to the photomultiplier at atmospheric pressure. Again, this was not successful.

Plastic scintillators craze under even less than 500 psi and become almost useless as scintillators for our purpose. It was for this reason that we developed the Geiger counter with the internal small stainless steel tubing which carries the beta active solution. Incidentally, we achieve electronic simplicity by using Geiger-counter electronics rather than scintillation electronics.

Harold G. Richter

Radiochemist
Research Triangle Institute
Durham, N.C.

*the next best thing
to a primary standard*



NEW AC/DC DIFFERENTIAL VOLTMETER 0.01% DC—0.05% AC

Compare the high long-term range of accuracies offered by the Keithley 661! Weigh its full year guarantee on limits of error! Examine the outstanding features that make this combination ac/dc instrument the low cost answer to your secondary standard needs. See how its front panel polarity switch, large meter and in-line readout make it functionally easy-to-use. The 661 is ideal for virtually all calibration, stability and regulation checks. For proof, scan these advantages:

AC

0.05% limit of error
4x voltage ranges,
0.5 to 500v
6x null ranges,
1 mv fs to 100v
10 cps to 80 kc
bandwidth
1 meg, 45 pf input
impedance
10 μ v resolution
5 dial readout

DC

0.01% limit of error
4x voltage ranges,
0.5 to 500v
7x null ranges,
100 μ v fs to 100v
Input resistance,
infinite at null, 0-500v
guarded null detector
2 μ v resolution
5 dial readout

ONLY \$1275

FREE

engineering-
application
note giving
all details



OTHER KEITHLEY DIFFERENTIAL VOLTMETERS

Model 660A—0.02% dc accuracy \$650
Model 662—0.01% dc accuracy \$995



**KEITHLEY
INSTRUMENTS**

12415 Euclid Ave. • Cleveland, Ohio 44106

SUBSCRIPTION SERVICE

Please include an Electronics Magazine address label to insure prompt service whenever you write us about your subscription.

Mail to: Fulfillment Manager
Electronics
P.O. Box 430
Hightstown, N.J. 08520

To subscribe mail this form with your payment and check new subscription renew my present subscription

Subscription rates: in the U.S.: 1 year, \$6; two years, \$9; three years, \$12. Subscription rates for foreign countries available on request

CHANGE OF ADDRESS

ATTACH
LABEL
HERE

If you are moving, please let us know five weeks before changing your address. Place magazine address label here, print your new address below.

name _____

address _____

city _____

state _____

zip code _____

Pentode Pattern for Performance

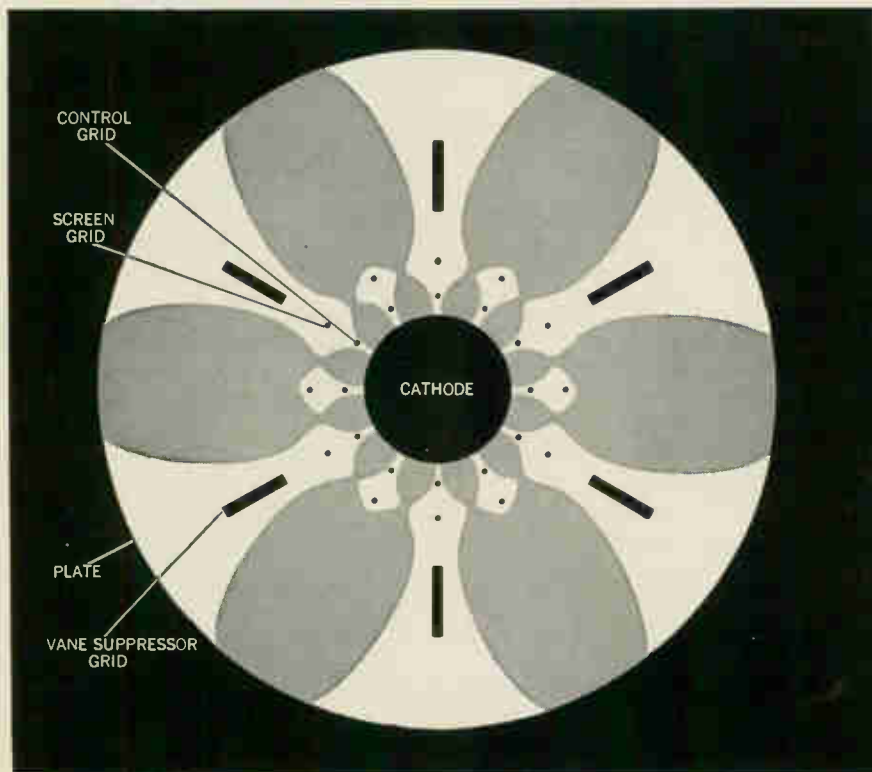

To prevent electrons from returning to the screen region of a transmitting tube, Penta's exclusive, patented vane-type suppressor grid does the trick. Plate current is practically independent of plate voltage. Kinks and wiggles are absent. Plate voltage can swing well below screen voltage without appreciable loss of current. The result is outstanding linearity, efficiency, stability. For example, Penta's PL-8295A—the ceramic version of the famous PL-8295/172—delivers 1000 watts of Class AB₁ useful output at only 2000 plate volts . . . more than 1500 watts at maximum Class AB₁ ratings. Penta tubes with vane-type suppressor grids were introduced in 1955 and their use in high-quality linear amplifiers is growing daily. Enjoy the advantages of this years-ahead design by specifying the PL-177A, PL-175A, PL-8295/172, or PL-8295A, for 100-watt to 1.5-kilowatt power output applications. Write for data sheets and Penta's latest Summary Catalog, which describes all Penta products, with prices. The Penta Laboratories, Inc., a Subsidiary of Raytheon Company, 312 North Nopal Street, Santa Barbara, California 93012



People

Underscoring the Fairchild Camera & Instrument Corp.'s move to broaden its share of the instrumentation market is the recent appointment of **Victor H. Grinich**, 41 years old, as technical director of the company's instrumentation division. The



division, which was created seven months ago, had been a department within Fairchild's huge Semiconductor division in Mountain View, Calif. Instrumentation is now located in Clifton, N. J. Despite the move, technical developments in the Semiconductor division are closely coordinated with the needs of the Instrumentation division.

That Fairchild is building bridges between the two units was apparent last week with the shift of Grinich, who had been Semiconductor's manager of applications engineering.

His appointment is probably the last in a round of shifts of Fairchild officials from the Semiconductor unit to top Instrumentation posts. Former marketing manager at Semiconductor, Thomas H. Bay, is now general manager of the Instrumentation division; Robert N. Noyce, Semiconductor's former general manager, is group vice president of both the Semiconductor and Instrumentation divisions; and Charles Askanas, formerly operations manager for Instrumentation's West Coast activities, is now operations manager for the entire division.

The changes offer a good way for Instrumentation to derive more benefit from the company's semiconductor technology, says Grinich, one of the founders of Fairchild Semiconductor.

"We're certain that as our new components get fairly complex, we will have a competitive advantage in the instrumentation business," Grinich asserts. "Most instrument manufacturers are conservative. They didn't accept transistors at first, and now they're very slow to accept integrated circuits. Fair-

200 kW power output with .7 kW drive from magnetically beamed Machlett triode

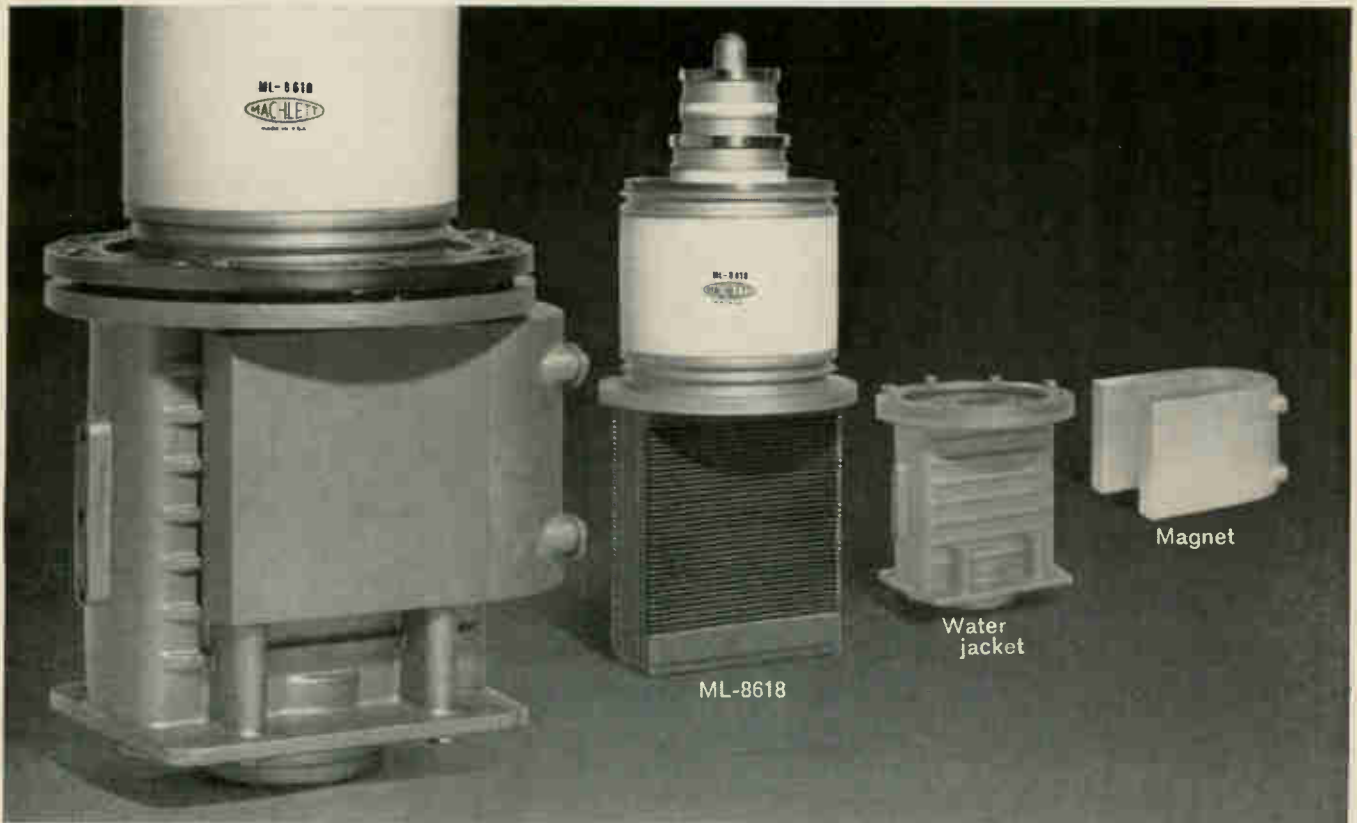

ML-8618, Machlett's new magnetically beamed water-cooled triode, provides high power gain, high plate efficiency and maximum cathode utilization. Electron trajectory from cathode to plate is magnetically controlled to greatly reduce electron interception by the grid . . . and therefore decrease grid current and heating and allow significantly higher performance levels.

Result: the ML-8618 delivers a typical 200 kW power output with .7 kW drive as a Class C rf amplifier or oscillator. As a switch tube in pulse modulators, it is capable of a maximum 8 Mw high duty pulse.

For full operating details, write to The Machlett Laboratories, Inc., Springdale, Conn. 06879. An affiliate of Raytheon Company.



ELECTRON TUBE SPECIALIST

New from Sprague!



LOW COST DUET[★] 3N123 DUAL-EMITTER CHOPPER TRANSISTORS

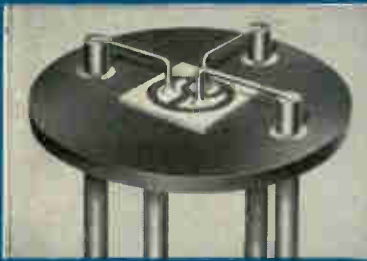

CHECK THESE FEATURES!

$$BV_{EEO} > 25 \text{ VOLTS}$$

$$/V_o / < 250 \mu\text{V}$$

$$/\Delta V_o / T_A < 2.3 \mu\text{V per } ^\circ\text{C}$$

$$f_T > 6 \text{ mc}$$

**HIGH VOLTAGE! RELIABLE
PLANAR CONSTRUCTION!**

Sprague offers more dual-emitter transistor types than any other source!

TYPE No	BV _{EEO} (volts)	V _o (μV)	TYPE No	BV _{EEO} (volts)	V _o (μV)	TYPE No	BV _{EEO} (volts)	V _o (μV)	TYPE No	BV _{EEO} (volts)	V _o (μV)	TYPE No	BV _{EEO} (volts)	V _o (μV)
3N90	30	50	3N95	50	200	3N104	20	50	3N109	50	150	3N116	12	200
3N91	30	100	3N100	10	50	3N105	15	250	3N110	30	30	3N117	20	50
3N92	30	200	3N101	30	50	3N106	30	250	3N111	30	150	3N118	20	100
3N93	50	50	3N102	40	50	3N107	50	250	3N114	12	50	3N119	20	200
3N94	50	100	3N103	50	50	3N108	50	30	3N115	12	100	3N123	25	250

★Trademark

For complete information, write to Technical Literature Service,
Sprague Electric Co., 35 Marshall St., North Adams, Mass. 01248

SPRAGUE COMPONENTS

TRANSISTORS
CAPACITORS
RESISTORS
THIN-FILM MICROCIRCUITS
INTEGRATED CIRCUITS
INTERFERENCE FILTERS

PACKAGED COMPONENT ASSEMBLIES
FUNCTIONAL DIGITAL CIRCUITS
MAGNETIC COMPONENTS
PULSE TRANSFORMERS
CERAMIC-BASE PRINTED NETWORKS
PULSE-FORMING NETWORKS



Sprague and *2* are registered trademarks of the Sprague Electric Co.

People

child has a head start in this technology and it will help us gain a more prominent position in the instrumentation field," he adds.

Outlining the Fairchild philosophy in the new organizational setup, Grinich says: "As the semiconductor component technology keeps growing, testing equipment becomes more critical. But on the other hand, the growing instrumentation field needs more sophisticated components. The two are complementary, so why not use the two in-house capabilities to enhance each other?" Fairchild is the only major instrumentation manufacturer that produces its own semiconductors.

Grinich received his bachelor's and master's degrees in electrical engineering from the University of Washington, and his doctorate from Stanford University. He worked at Stanford Research Institute before joining Fairchild.

The Bendix Corp. has formed an optronics division, with **Kenneth R. Stephanz** as general manager. The unit's only product will be Channeltrons, newly developed multiply-ing radiation detectors.



In selecting Stephanz, who is 38 years old, Bendix turned to a man with experience in both business and engineering. The new manager holds a bachelor's degree in electrical engineering and worked several years with the International Telephone and Telegraph Corp. as general manager of electronic tube operations. He has also served as an executive of several small electronics companies.

Although many of Channeltron's applications are classified, because of the military's interest in the component, this much is known: it will be used in low light level television applications and for detecting x-rays and ultraviolet light in space.

**1/2 to 1/3 the size and
less than 1/2 the weight
of conventional units . . .**



Sorensen ACR Voltage Regulators give up to 95% efficiency, too!

In these new Sorensen silicon controlled rectifier AC regulators, you get the best combination of power, performance, and packaging you've ever seen. The unit is reduced to the size of the transformer and control circuitry. Ideal for motor starting, lamp loads, tube filaments, X-ray applications, etc., ACR Series regulators are designed to control the RMS voltage to a variety of loads requiring precise regulation, fast response time, and low distortion.

- | | | |
|----------------------------------------------------------------------------|-------------------------------------------------------------|------------------------------------------------------------|
| 1. 8 MODELS AVAILABLE (500, 1000, 2000, 3000, 5000, 7500, 10000, 15000 VA) | 4. UP TO 95% efficiency | 7. LOW DISTORTION (3% max.) |
| 2. LOW PRICES (starting at \$290) | 5. INPUT VOLTAGE RANGE 95-130 VAC; OUTPUT RANGE 110-120 VAC | 8. STABILITY (.05% / 8 hours, after a 30-minute warm-up) |
| 3. SMALL SIZE AND WEIGHT | 6. FAST RESPONSE to line or load changes (30 ms) | 9. REGULATION $\pm 0.1\%$ RMS |
| | | 10. PROGRAMMABLE |
| | | 11. REMOTE SENSING |
| | | 12. CONVECTION COOLED |
| | | 13. EASY MAINTENANCE (removable "plug-in" printed circuit) |

For complete data on the ACR Series and other Sorensen products, send for the "Controlled Power Catalog and Handbook." Write: Sorensen, A Unit of Raytheon Co., Richards Ave., South Norwalk, Conn. 06856. Or use reader service card number 200.

ACR ELECTRICAL AND MECHANICAL SPECIFICATIONS

MODEL NUMBER	OUTPUT VA RANGE	REGULATION ACCURACY		EFFICIENCY (FULL VA)	TYPICAL POWER FACTOR	TEMPERATURE AMBIENT COEFFICIENT		DIMENSIONS (INCHES)				PRICE**
		LINE	LOAD			(°C)	(°C)	WIDTH	HEIGHT	DEPTH	RACK HEIGHT	
ACR 500	0-500	$\pm 0.1\%$	$\pm 0.1\%$	88%	75%	0-50	.03%	15*	5	9	5 1/4	\$ 290
ACR 1000	0-1000	$\pm 0.1\%$	$\pm 0.1\%$	90%	75%	0-50	.03%	19	5 1/4	11	5 1/4	340
ACR 2000	0-2000	$\pm 0.1\%$	$\pm 0.1\%$	92%	75%	0-50	.03%	19	5 1/4	15	5 1/4	435
ACR 3000	0-3000	$\pm 0.1\%$	$\pm 0.1\%$	95%	75%	0-50	.03%	19	7	15	7	555
ACR 5000	0-5000	$\pm 0.15\%$	$\pm 0.15\%$	95%	75%	0-50	.03%	19	7	20	7	715
ACR 7500	0-7500	$\pm 0.15\%$	$\pm 0.15\%$	95%	75%	0-50	.03%	19	12 1/2	20	12 1/2	850
ACR 10000	0-10000	$\pm 0.15\%$	$\pm 0.15\%$	95%	75%	0-50	.03%	19	12 1/2	20	12 1/2	1,200
ACR 15000	0-15000	$\pm 0.15\%$	$\pm 0.15\%$	95%	75%	0-50	.03%	19	17 1/2	20	17 1/2	1,500

* A 19 inch adapter (rack) panel is available.
** Optional Meter \$22.



Circle 11 on reader service card

**Planar II
is the purest
semiconductor
manufacturing
process ever
put into mass
production.**

Planar is a patented Fairchild process.

most versatile rf sweep generator



JERROLD 900B

- Sweep widths from 10kc to 400mc
- Frequency range 500kc to 1,200mc

Here is the ultimate instrument for all your IF, VHF, and UHF sweep requirements. Famous for its stability and built-in convenience: Crystal-controlled harmonic markers; variable-gain dc or ac-coupled scope preamplifier; precision turret attenuator from zero to 50db in 10db steps. Write for complete technical data.

\$1,980.00 f.o.b. Phila.



Government & Industrial Division
Philadelphia, Pa. 19132
Export: Rocke International, New York, N.Y. 10016

**SWEEP GENERATORS • AMPLIFIERS
PRECISION ATTENUATORS • COMPARATORS**

Meetings

Solid State Physics Conference, Institute of Physics and The Physical Society; Renold Building, Manchester, England, Jan. 4-7.

Sealab II Symposium, U.S. Navy; Statler Hilton Hotel, Washington, D. C., Jan. 11-12.

Conference on Electronics in Publishing, American University; International Inn, Washington, D.C., Jan. 17-20.

Instrumentation for Process Industries Conference, Texas A&M University; College Station, Tex., Jan. 19-21.

Conference on Symmetry Principles at High Energy, AFOSR, AEC, NASA; University of Miami, Coral Gables, Fla., Jan. 20-22.

Phonon Interaction in Solids Conference, Princeton University; Princeton, N. J., Jan. 20-21.

Helicopter Conference, Helicopter Association of America; Inn of Six Flags, Arlington, Tex., Jan. 23-26.

Aerospace Sciences Conference, Statler-Hilton Hotel, New York, N. Y., Jan. 24-26.

AE-4 Electromagnetic Compatibility Conference, SAE; General Dynamics/Convair, San Diego, Calif., Jan. 25-26.

National Electronic Representatives Association Marketing Conference, ERA; Riviera Hotel, Palm Springs, Calif., Jan. 26-30.

American Society of Testing and Materials Spring Meeting, ASTM; Shoreham and Sheraton Park Hotels, Washington, D.C., Jan. 30-Feb. 4.

International Symposium on Information Theory, AFOSR, IEEE; University of California, Los Angeles, Jan. 31-Feb. 2.

Integrated Circuits Seminar, IEEE, Basic Sciences Committee; Stevens Institute of Technology, Hoboken, N.J., Feb. 2.

Winter Convention on Aerospace & Electronics Systems, IEEE; International Hotel, Los Angeles, Feb. 2-4.

International Salon of Electronics Components, Federation National des Industries Electroniques; Parc des Expositions, Paris, Feb. 3-8.

Solid State Circuits Conference, IEEE, University of Pennsylvania; Sheraton Hotel, Philadelphia, Feb. 9-11.*

Radioisotope Applications in Aerospace, AFSC and Atomic Energy Commission; Sheraton-Dayton Hotel, Dayton, Ohio, Feb. 22-24.

Offshore Exploration Conference, OECON; Lafayette Hotel, Long Beach, Calif., Feb. 22-24.

Symposium on Manufacturing In-Process Control and Measuring Techniques, Air Force Materials Laboratory and Motorola Semiconductor Products Division; Hiway House, Phoenix, Ariz., Mar. 9-11.

International ISA Aerospace Instrumentation Symposium, ISA, College of Aeronautics; College of Aeronautics, Cranfield, England, Mar. 21-24.

International Convention and Exhibition of the IEEE; New York Hilton Hotel and the Coliseum, New York City, Mar. 21-25.

Call for papers

Conference on Mass Spectrometry and Allied Topics, Committee E-14 on Mass Spectrometry of the American Society for Testing and Materials; Sheraton-Dallas Hotel, Dallas, May 22-27. **Feb. 15** is deadline for submission of abstracts on subjects related to mass spectrography to Dr. H. M. Rosenstock, National Bureau of Standards, Washington, D. C., 20234.

SPIE Technical Symposium, Society of Photographic Instrumentation Engineers; St. Louis, Mo., Aug. 22-26. **Feb. 15** is deadline for submission of 300-word abstract on aerospace instrumentation, laser applications, optics, range instrumentation, data reduction, and image enhancement processing, to R. T. Hedden, 16 Harneywood Drive, St. Louis, Mo., 63136

* Meeting preview on page 16

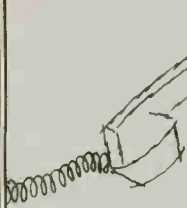

CALL **m**
MILGRAY



ERIE SUBMINIATURE BROAD BAND RFI FILTERS



Actual Size

Exclusive Features!

**HIGH ATTENUATION • HERMETICALLY SEALED
SUBMINIATURE • RELIABLE • IN-STOCK**

Erie's Subminiature Broad Band RFI Filters are only *one-fourth* the size of conventional filters . . . yet they provide better attenuation performance in the 10KC to 10KMC frequency range. That's why they are selected for major Aerospace Systems . . . size and efficiency.

These hermetically sealed Filters are designed to eliminate the problem of Electro-Magnetic Interference caused by switches, relays, motor commutators, SCR and transistor switching. No longer is it necessary to use bulky paper capacitor-coil combinations . . . or large conventional filters. Erie Broad Band Filters provide better attenuation *in only a fraction of the space*. AND THEY ARE AVAILABLE FROM STOCK . . . NOW.

The attractive price of these reliable filters makes them ideal for Commercial and Industrial applications as well as for Aerospace circuitry. Mounting arrangements to suit application.

In addition to Broad Band RFI Filters, Erie produces a complete range of subminiature filters suitable for YOUR SPECIFIC application. These too are available from stock.

Call or write now for quality ERIE RFI FILTERS. Remember, your ERIE distributor is your one-stop filter source.

Typical Attenuation Curve

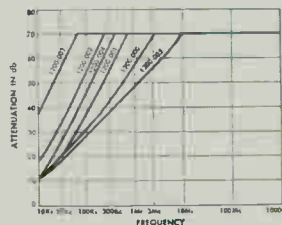

OTHER ERIE RFI FILTERS IN-STOCK

- Subminiature High Frequency, Low Pass 
- Miniature High Capacitance and High Voltage Types 
- Miniature Threaded Bushing and Eyelet Mount Types 
- Miniature 6 and 12 Section Filters 

ERIE

TECHNOLOGICAL

PRODUCTS, INC.



m
MILGRAY

MILGRAY / NEW YORK
160 VARICK ST. N. Y. N. Y. 10013 212 YU 9 1600
NEW JERSEY 201 HE 2 4300 TWX 212 640 5638 TELEFAX FQF

MILGRAY / WASHINGTON
5133 LAWRENCE PLACE HYATTSVILLE, MARYLAND 20781
202 864 6330 BALT 301 727 1870 TWX 301 422 1211
ENTERPRISE AND ZENITH NUMBERS IN LEADING INDUSTRIAL AREAS

Advanced Components Through Increased Volumetric Efficiency

Formerly
Erie Resistor
Corporation

644 West 12th Street
Erie, Pennsylvania

**Did you
know
Sprague
makes...?**

**SILICONTROL®
SCR GATE DRIVES**



For balanced SCR firing in 3-phase a-c or d-c power control. Pulse rise time of 1 to 3 microseconds to meet requirements of high-current-rated SCRs.

ASK FOR BULLETIN 85,520A

Circle 327 on reader service card

**DYNACOR®
BOBBIN
CORES**



Logical flux values in popular physical sizes are stocked in production quantities for fast delivery. Value engineered for quality with economy.

ASK FOR BULLETIN SERIES 50,000

Circle 329 on reader service card

**MOLDED-CASE
SHIELDED
R-F INDUCTORS**

Fully shielded, ultra-tiny, yet performance is comparable to that of larger units. Inductance values from 0.1 to 12,000 μ H. Molded for positive protection against humidity and handling. Meet requirements of MIL-C-15305.

ASK FOR BULLETIN SERIES 41,800

Circle 331 on reader service card

**TRIGGER
TRANSFORMERS
FOR SCR
CIRCUITS**



A better, less-expensive way to trigger SCRs. Will accommodate large SCR gate impedance differences. 3-winding or 2-winding designs for full-wave or half-wave applications.

ASK FOR BULLETIN 40,225.2

Circle 326 on reader service card

**VOLTAGE-SENSITIVE
SWITCHES**



Unique semiconductor device which remains in the "open" state until a specified actuating voltage is reached. When "breakdown" voltage is applied, switch closes almost instantaneously, providing a low-impedance conductive path between terminals. Breakdown voltages from 7 to 200 V.

ASK FOR BULLETIN 93,000

Circle 328 on reader service card

**INDISTOR®
R-L DELAY
NETWORKS**



Save space by replacing separate inductors and resistors. Guaranteed L/R ratio. Available in fully molded or epoxy-dipped cases.

ASK FOR BULLETIN SERIES 45,000

Circle 330 on reader service card

For complete technical data on any of these products, write for applicable Engineering Bulletin(s) to Technical Literature Service, Sprague Electric Company, 35 Marshall Street, North Adams, Massachusetts 01248.

45SC-416

SPRAGUE®
THE MARK OF RELIABILITY

Sprague and ® are registered trademarks of the Sprague Electric Co.

Meeting preview

Solid state in Philadelphia

Integrated circuit manufacturers and users will discuss large and complex IC arrays at the keynote panel of the 13th annual International Solid State Circuits Conference in Philadelphia, Feb. 9 to 11. Thirteen panel discussions and 57 papers are scheduled at the meetings, sponsored by the circuit theory group of the Institute of Electrical and Electronics Engineers, the IEEE Philadelphia sections and the University of Pennsylvania.

At the only daytime panel session, keynote panelists will present approaches to large-array integration, including comparisons of conventional and metal-oxide-semiconductor integrated circuits. The economics and problems of interconnection, yield, testing, reliability, packaging, repair and functional capability of integrated circuits will be discussed. Some of these problems will be examined by J. S. Kilby of Texas Instruments Incorporated and J. C. Logue of the International Business Machines Corp.

A second panel discussion, also on large-scale integration but with different panelists, will be held the first evening. M. J. Callahan of Motorola, Inc.'s Semiconductor Products division, will moderate.

Three of the invited papers will deal with bulk semiconductor devices and their applications. They were written by A. G. Chynoweth of the Bell Telephone Laboratories, M. E. Hines of Microwave Associates, Inc. and A. G. Fout of the Massachusetts Institute of Technology's Lincoln Laboratory. A panel discussion will follow.

The 12 evening panel sessions will include discussions of microwave circuits, optoelectronics, high-power radio-frequency circuit techniques, linear integrated circuits and solid state devices in medicine and biology.

At one session, trends in solid state microwave circuitry and components will be assessed. There also will be discussions of monolithic versus hybrid circuits and the impact of integrated circuits on the microwave field.

35 pounds of economic excellence

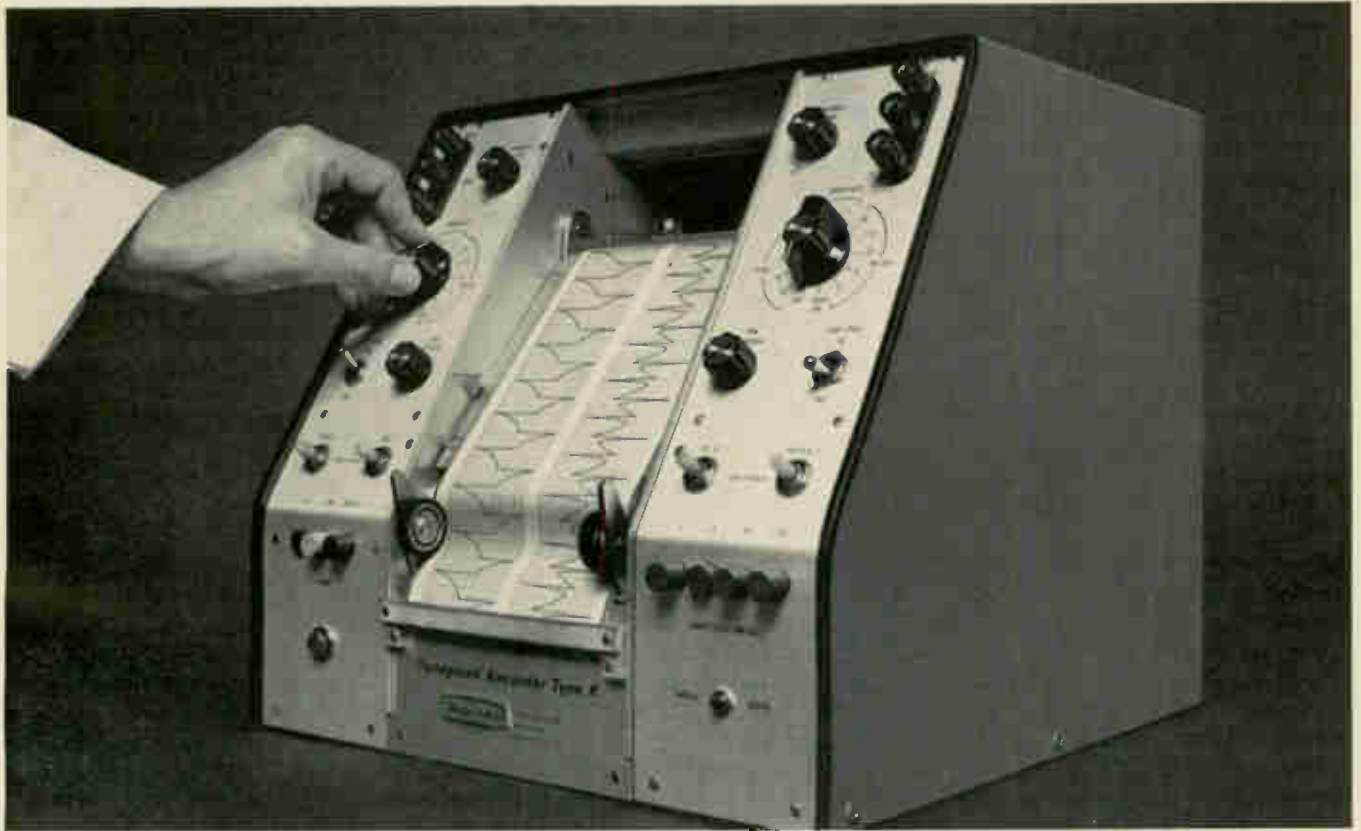

The Beckman Type K Dynograph® Recorder is a completely portable, two-channel, direct-writing oscillograph that incorporates every major feature of its larger counterparts without sacrificing accuracy, quality, or dependability...and the standard ink curvilinear version costs only \$1,295. It is simple to operate and maintain, and is ideally suited for applications in research and development laboratories, production and field tests, or servicing and maintenance.

All silicon solid-state, the extremely sensitive Type K provides ink or heat rectilinear, or ink curvilinear recording media: two analog plus two event channels: large capacity common ink reservoir, with push-button pen primers: simple paper loading: and chart speeds up to 100mm per second.

As for specifications, check these. Sensitivity range: 2mv/div to 10v/div; measurement range: 0.002 to 400v;

linearity: 0.5%; common mode rejection: 1000 to 1 or better.

Your local Offner Division Sales Engineering Representative has the full story on this lightweight, rugged, highly sensitive Type K Dynograph Two-Channel Portable Recorder. Contact him for details, or write direct.

Beckman® INSTRUMENTS, INC.
OFFNER DIVISION
SCHILLER PARK, ILLINOIS 60176

INTERNATIONAL SUBSIDIARIES: GENEVA; MUNICH; GLENVIEW, ILL.; SCOTLAND; TOKYO;
PARIS; CAPE TOWN; LONDON

GLASS

Now .1 mfd in this case size

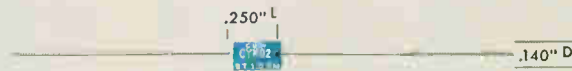

New CORNING® GLASS-K Capacitor with
CORNING® glass capacitor dependability

SS-K

CYK02—100,000 pf in just .250" L x .140" D.

CYK01— 51,000 pf in just .250" L x .100" D.

SMALLER SIZE BY FAR THAN CONVENTIONAL CK CERAMIC TYPES.

Ideal for cordwood packaging and machine insertion applications.

Stability: Remarkable! And predictable. 3 families for optimum stability, capacitance and size.

Voltage Rating: 50 VDC.

Tolerances: 10% and 20%.

Temperature Range: -55°C to +125°C.

Insulation Resistance: 10,000 megohms min.

Power Factor: 2.5% maximum.

Price: Competitive.

Let us tell you more.

Corning Glass Works, Electronics Drive, Raleigh, North Carolina

Please send complete data on the CORNING® GLASS-K Capacitor

Name _____ Title _____

Company _____

Address _____

City _____ State _____ ZIP _____

CORNING
ELECTRONICS

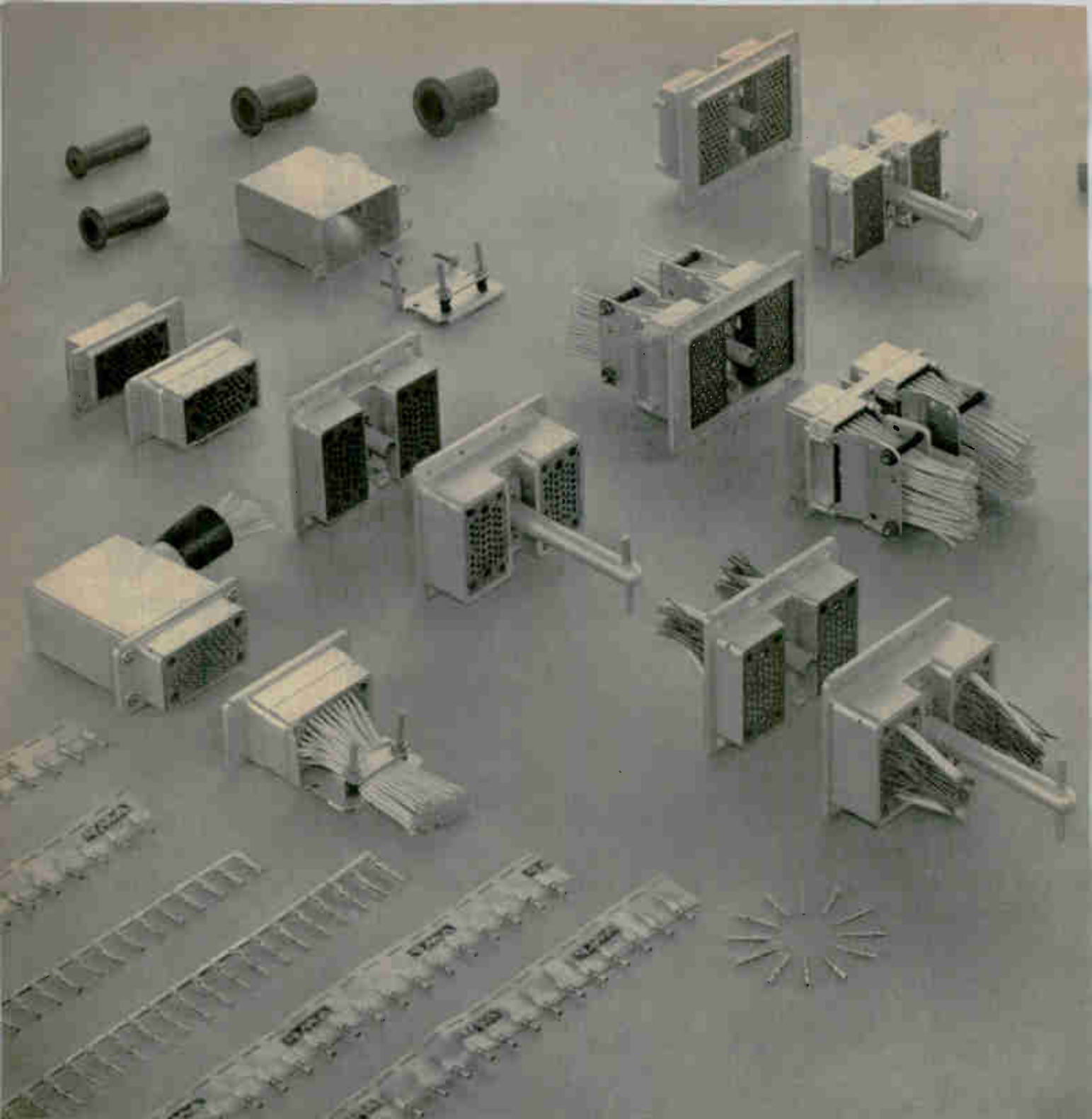

Off the shelf connectors with custom-built performance

Dry circuits, g forces, microcircuits, and gigacycles are some of the problems designers face when considering pin and socket connectors. AMP took into account these problems when designing each type of pin-and-socket connector: We developed a special gold over nickel plating for critical low level circuits; durable materials and rugged construction for rack and panel mounting; new contact designs for miniaturization; and the controlled pressure crimp for electrical reliability. You see here the results of this thorough approach to these and other connector problems.

The complete range of these pin and socket connectors cannot be illustrated, since there is an infinite combination of contact styles and sizes, housings, accessories, materials, and hardware. We do show representative samples of rectangular, circular, active pin, subminiature, military, and environmental connectors. All meet or exceed the reliability requirements for which they were designed.

Because of this built-in connector capability, AMP can offer you custom quality connectors off the shelf. And, AMP supplies valuable engineering assistance as well. Write for specific information on pin and socket connectors today—we'll be glad to hear from you.

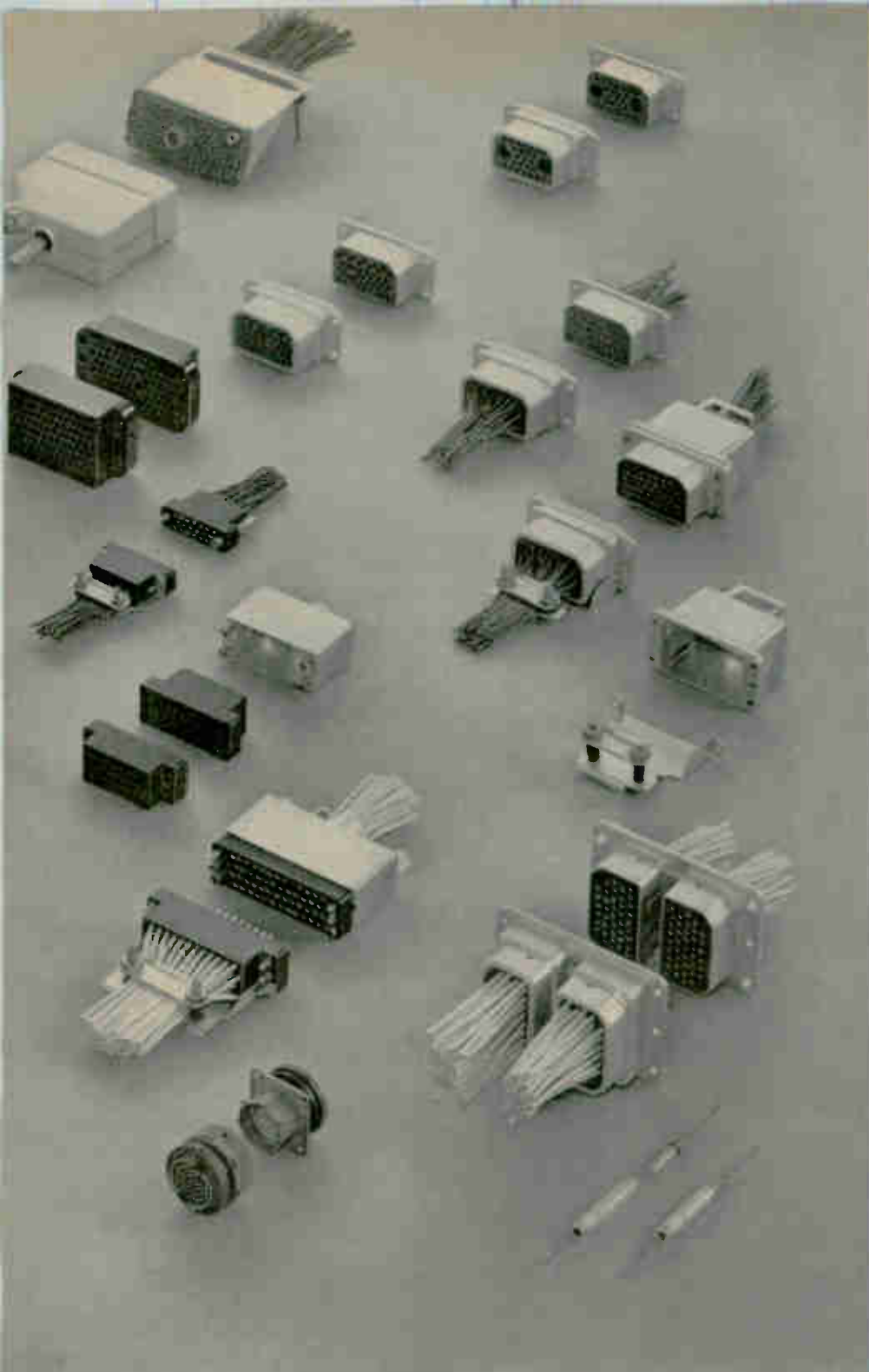

AMP's Series "DDE" pin and socket connectors are on twenty-four hour duty in the Nation's air defense surveillance systems.

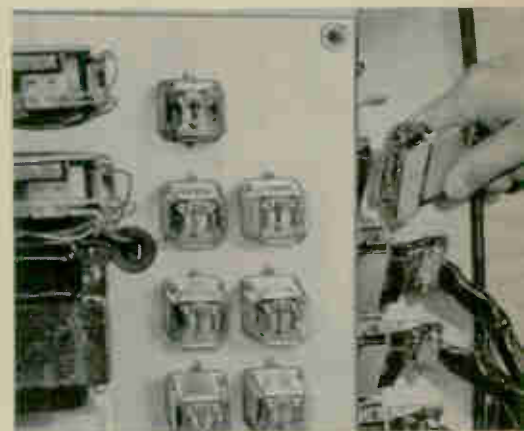

The computer portion of this bowling machine is linked to its power source by AMP Series "M" connectors.



AMP connectors are important in stock market data systems; allow desk units to obtain instantly quotations on 4,000 securities.

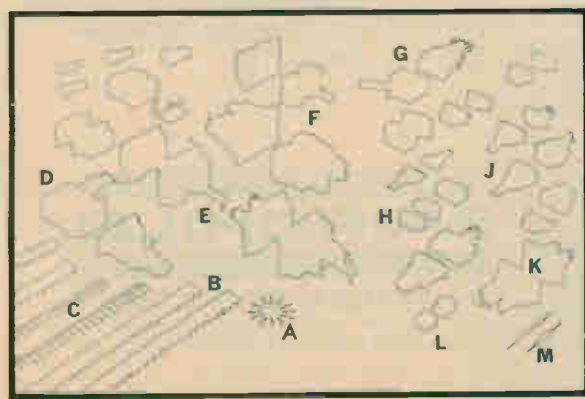

- A Single piece pin and socket contacts
- B Tape-mounted pin and socket contacts
- C Strip-mounted pin and socket contacts
- D A-MP* Series "D" Connectors with accessories
- E A-MP Series "DD" Connectors with accessories
- F A-MP Series "DDE" Connectors with accessories
- G A-MP 104 Position Center Fastener Connector
- H A-MP Series "M" Connectors with accessories
- J A-MP Series "W" Connectors with accessories
- K A-MP Series "WW" Connectors with accessories
- L CH-AMP* Subminiature Circular Connector
- M AMP Pin and Socket Breakaway Connector

AMP
INCORPORATED
 Harrisburg, Pennsylvania

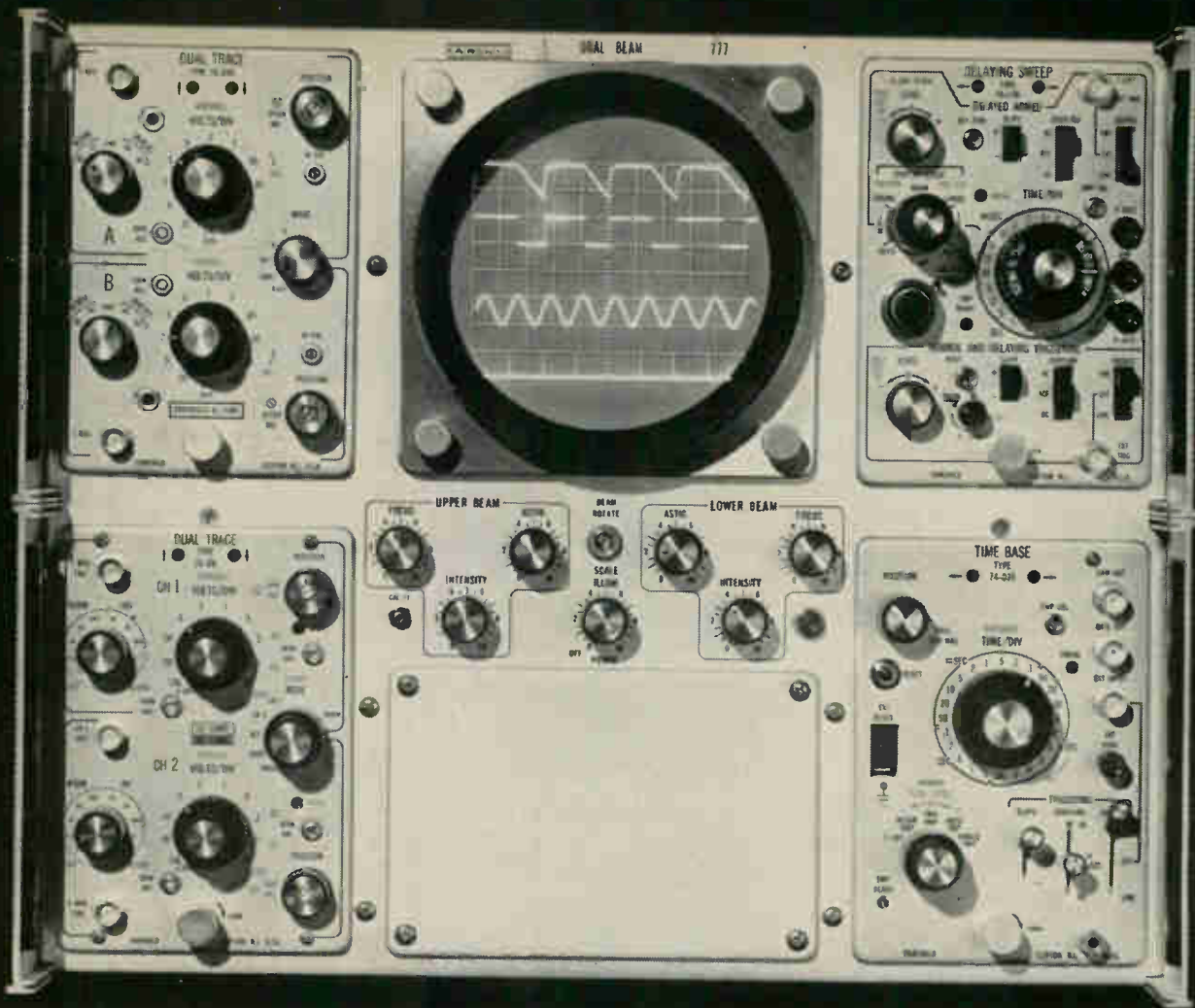

HOW MANY SCOPES CAN THIS ONE REPLACE?

A sizable number, depending upon the range of applications. For this is the Fairchild 777—the most versatile of all industrial scopes. The 777 is a dual beam, dual trace scope in which any four of 22 plug-ins are completely interchangeable in both X and Y cavities. These same plug-ins fit all Fairchild 765H Series scopes. They include DC-100 mc bandwidth, spectrum analyzer and raster display capabilities, sensitivity to 500 $\mu\text{v}/\text{cm}$, risetime to 3.5 ns.

Other features of the 777 include 6 x 10 cm display area for each beam with 5 cm overlap between beams for optimum resolution... unique 13 kv CRT with four independent deflection structures... solid state circuitry (with all deflection circuitry in the plug-ins)... light weight (44 lbs.)... environmentalized for rugged applications. Price (main frame): \$1,600 f.o.b. Clifton, N.J.



The 777 illustrates the Fairchild concept of value through versatility. One scope doing many tasks is only part of it. Future state-of-the-art capability is equally important because it helps you curb the high cost of Technological

Obsolescence. And finally, service. Fairchild has more service centers than any other scope manufacturer.

Ask your Fairchild Field Engineer for details on this and other new generation Fairchild scopes. Or write to Fairchild Instrumentation, 750 Bloomfield Ave., Clifton, N.J.

FAIRCHILD

INSTRUMENTATION
A DIVISION OF FAIRCHILD CAMERA
AND INSTRUMENT CORPORATION

*Technological Obsolescence

Circle 22 on reader service card

Editorial

No fallout for air traffic control despite Gemini's stunning success

When Gemini 6 and Gemini 7 met in space on December 15, engineers who had worked on the rendezvous radar and computer heaved gigantic sighs of relief, then broke into loud cheers. Everything electronic had worked to perfection.

Technical people involved in space study ran out of adjectives to describe the stunning success. The whole world applauded the achievement. More than any of the many successes the spacemen have had, the rendezvous proved that scientists and engineers have the technology of guidance and control well in hand and are continuing rapidly to advance its frontier.

After considering the magnitude of this accomplishment, a technical man has to wonder again why the same skills aren't being used to prevent midair collisions of aircraft and to control air traffic more efficiently and more safely. Clearly the Federal Aviation Agency has not been able to use technology with the same success as the National Aeronautics and Space Agency.

It's true that the FAA has never had anything like the giant sums of money that were given to NASA. But money is only part of the FAA's shortcomings—and maybe the smallest part. Too often, the agency has tried to freeze technology that was already on the verge of being obsolete. In the past three or four years, it has traded in its militancy on air safety for a Casper Milquetoast attitude. FAA men often seem more concerned about rocking the boat than about solving problems affecting travelers on commercial airlines.

In the past six months fatal air accidents have been frequent and frightening. At this time, it is hard to say which is more terrifying—the collision of an Eastern Airlines plane and a Trans World Airlines jet earlier this month or the FAA's "that's the way the ball bounces" attitude.

After the last major air collision of 1960, the FAA tried to improve its control system. It failed, but at least the agency was recognizing its responsibility. After this month's collision, the FAA figuratively shrugged its shoulders and said it had a system, to be installed by 1970, that might prevent such accidents. Then it went on to less controversial matters.

The FAA's technological history is a record of disaster. In 1958, right after the agency was officially founded through the merger of the Civil Aviation Agency and the Air Modernization Board, it launched a program to automate the air traffic control system with computers.

A contract was awarded and that same day experts outside the agency said the program would never work. The agency stuck by its guns until it proved the experts were right. One reason why the automation program failed was that the FAA insisted on mechanizing a control procedure invented in the mid-thirties to handle aircraft that landed and took off in farmers' fields. It felt it couldn't consider a new system that would use the full capabilities of computers. Another reason was the FAA decision to freeze technology in its system design as of 1958, even though computer technology was and still is among the fastest changing branches of engineering. By 1961, not only was the FAA's automatic system unworkable; its special computers were also obsolete.

It was after the 1960 collision of the United Airlines and Trans World Airlines planes over Staten Island, New York, that the FAA rushed the development of three-dimensional radar. Amid great publicity, a gigantic 14-story antenna, one-third of a proposed system, was erected in Atlantic City. The system never had the discrimination power—to measure altitude within 100 feet—that the FAA

needed so the project was buried.

The FAA is now convinced that data processing and three-D radar can never be applied to an air traffic control system. It ignores the unmistakable fact that the technology in both fields has made tremendous strides.

FAA's foot-dragging on safety measures shows up in other ways. Earlier this autumn, a United Airlines plane crashed at the Salt Lake City airport while landing and 42 people trapped in the crash died. One wonders how many might have lived had the FAA refused to allow the kind of seating that's permitted on tourist flights. A passenger who is not in an aisle seat is trapped inextricably if the passenger in front of him leans back. Questioned about the safety of such seating earlier this year, George Keck, president of United Airlines replied, "In a test we've found it takes very little time for a passenger to push the seat ahead of him up so he can squeeze out." But that test wasn't performed by passengers unfamiliar with the airplane, stunned, in shock or suffering broken arms as a result of a crash.

When the airlines blatantly violate an FAA safety regulation, and there's no crash to explain away, the agency is likely to forget the whole thing. For example, more airlines, particularly overseas airlines like Pan American World Airways, are putting freight in passenger cabins, replacing seats with freight loaders when passenger loads are small. Strict regulations about how such freight is to be carried are violated by the airlines. Freight is carried in old jagged containers with sharp corners, without being tied down. Often it's behind the passengers in the cabin, though the FAA insists that freight be placed ahead of passengers. When such violations are reported to the FAA, agency spokesmen shake their heads and ignore them.

A technological society in which two space capsules keep a rendezvous somewhere in the immeasurable universe should have no problem getting safe, efficient, comfortable air transportation. But first a major change in attitude and direction is required. The FAA has to do a lot more than count the bodies after an accident.

The Remarkable New Line of Clifton MOTORS and TACHOMETERS is important to YOU!

SERVO MOTORS



TEMPERATURE COMPENSATED MOTOR TACH

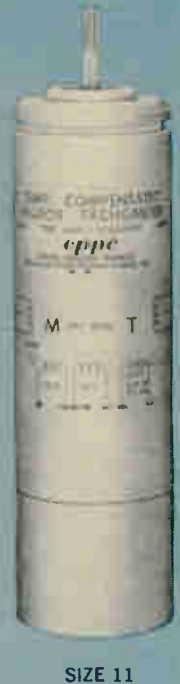

MOTOR TACHOMETERS

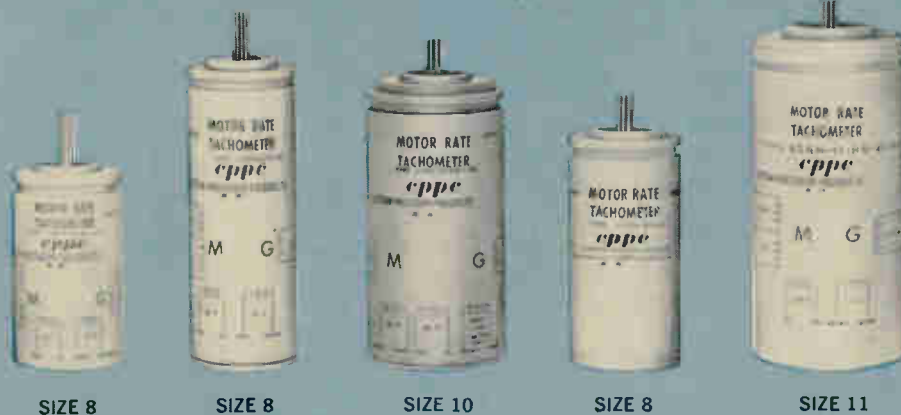

In this new line of motors and tachometers, Clifton has overcome to a significant degree, many limitations inherent in current servo motor designs.

For instance, the incompatibility of efficiency and a linear speed torque curve plagues servo motor users. We have designed a motor which will minimize this conflict. Efficiency has been improved by factors as large as 40% at no expense to speed torque linearity. Thus Clifton motors can give you: more torque for the same power input or same torque with less power consumption; better theoretical acceleration; a cooler more reliable motor with high capacity for being "over-driven" if necessary. These improvements have been achieved without degeneration of air gap or single phasing considerations.

Response time is another important area of improvement in our motors. Certain of our units are specially designed to reduce inertia and increase torque, thereby offering: decreased dead zone, increased slew rate, reduced velocity error.

A further refinement in our servo motors is: lower and more uniform starting voltages with levels as low as 1% of control phase voltage. This, of course, increases the dynamic range of a servo system.

In addition, our servo motors and tachometers are using less heat vulnerable materials such as: improved high temperature resistant magnetic wire; improved lubricant;

improved slot insulation; welded leads; flanged and shielded bearings; glass to metal seals, and high temperature resistant impregnation. As a result our motors can withstand temperatures considerably above the standard 125°C.

Motor Rate Tachometers

Because of the improved torque to inertia designs mentioned previously, no generator is necessary in situations where inherent self damping is sufficient. Smaller generators with less output, less length and less power consumption can now be used when needed. Synchro length *full drag cup* motor tachometers are now possible—a great saving in size and weight over the present long, heavy units.

In addition to a wide variety of off-the-shelf units, we custom design servo motors and tachometers with special requirements of torque, inertia, and temperature resistance. We are eager to serve your standard or custom needs. Clifton Precision Products, Division of Litton Industries, Clifton Heights, Pa., and Colorado Springs, Colo.



CLIFTON
PRECISION PRODUCTS
DIVISION OF LITTON INDUSTRIES



Electronics Newsletter

December 27, 1965

Hybrid emitter handles higher current densities

The Bell Telephone Laboratories has developed a hybrid cathode that combines the current density-handling capability of a matrix cathode with the electron-emitting advantages of an oxide cathode. Its life expectancy, estimated at 20,000 to 30,000 hours at 810°C and a current density of one ampere per square centimeter, is far longer than in cathodes now used in klystrons and traveling-wave tubes.

Several major producers of tubes are studying the development. The Bell device, called a coated powder cathode and designed by researchers Dean Maurer and Charles Pleass, is comparable in cost to oxide cathodes and less expensive than matrix cathodes.

To produce the emitter, a thin film of nickel, about 2.5% of the cathode coating, is vapor-plated onto carbonate particles, which are then sprayed onto a cathode base. The nickel increases the conductivity of the cathode coating and improves the ability to handle high current densities. When the cathode is heated, the carbonate is changed to an electron-emitting oxide. Conventional oxide cathodes, used in low-power electron tubes, are formed in much the same way, except that no metal is added to the mixture of barium and strontium carbonates. The coating on a matrix cathode used in high-power electron tubes is usually about 80% metal; this composition results in a relatively ineffective emitting area. It is the oxide, not the metal, which permits emission of electrons from the cathode.

3-D radar order due in January

A production award on lightweight three-dimensional radar for the Air Force is expected by mid-January. The Air Force's Electronic Systems division at Bedford, Mass., is evaluating technical proposals submitted this month. Under study contracts totaling \$500,000, the Westinghouse Electric Corp. and the Hughes Aircraft Co. proposed technical approaches for a 3-D radar that will weigh no more than 7,000 pounds and can be carried by a helicopter to a forward air-control post. The Tactical Air Command had asked for a 6,000-pound maximum unit [Electronics, Oct. 5, 1964, p. 118] but 7,000 pounds is now considered more realistic.

The new radar will replace the AN/TPS-35 now in the field. This is a two-dimensional L-band surveillance radar.

Inch-long flatpack holds 34 IC chips

Teledyne, Inc., is producing integrated-circuit arrays of up to 34 IC chips, each with a maximum of 50 components. The array fits into a package only 1-inch long, 0.75-inch wide and 0.06-inch high. The packaging density is some 36,000 parts per cubic inch. Other companies have built larger arrays experimentally but Teledyne says its methods are proven and give a "very high yield" in production.

The IC arrays are produced by Teledyne's Amelco Semiconductor division for the Systems and Controls division of the parent company. The arrays go into the computer of the military's Integrated Helicopter Avionics System (IHAS). The chips are mounted on a 17-mil-thick alumina ceramic substrate and interconnected by bonding gold lead wires to plated-gold wiring on the substrate.

A key problem was obtaining the required resolution of the plated interconnections—lines 8 mils wide and 8 mils apart. Jerry McNeal, project engineer, solved the problem by adapting the moly-manganese metallizing method, used in microwave-tube production, to coat the

Electronics Newsletter

substrate. Then the gold pattern was electroplated through openings in photoresist. Finally, the excess moly-manganese was etched.

Amelco hopes next to bond the chips face down, directly to a wiring pattern with a 2-mil resolution. This would double packaging density.

The package is sealed by welding a cap to a metal flange brazed to the substrate. The package can dissipate 1 watt of heat. To keep dissipation below this limit a low-power logic design was developed for digital arrays. The technique is also used for analog arrays and Teledyne expects it to be used in equipment other than IHAS.

Johnson named MIT president

Howard W. Johnson, 43, will become president of the Massachusetts Institute of Technology on July 1. Johnson, dean of the MIT School of Management for six years, will succeed Julius A. Stratton, who is retiring. Under Johnson, the School of Management has extended its scope to include major research programs in information and control systems.

RCA, Philco expand color-tv facilities

To meet the steadily increasing demand for color television sets, two expansion moves—one in the United States, the other in Canada—were reported this month.

The Philco Corp. says it will spend \$20 million to build and equip a color-tv tube plant in Lansdale, Pa., and the RCA Victor Co., the Canadian subsidiary of the Radio Corp. of America, says it will invest \$25 million to establish a color tube facility in Midland, Ontario.

Although Canada doesn't broadcast in color, some half-million viewers are within range of U. S. border stations. RCA claims the Canadian plant will be the largest color picture tube facility outside the U. S.

Lincoln Lab tests military satellites for communications

Two satellites that went into a quasi-synchronous equatorial orbit last week on the third flight test of the Titan 3-C are designed to test new devices and techniques for military communications in space. They were developed and built for the Air Force by the Lincoln Laboratory of the Massachusetts Institute of Technology and are the third and fourth Lincoln experimental satellites, LES-3 and LES-4. LES-1 and LES-2 were launched earlier this year.

LES-3 is an ultrahigh-frequency signal generator, designed to measure properties of the communication path between the satellite and various receiving terminals.

LES-4 is a solid state communications satellite operating in the X-band. Instead of using a wide beam, LES-4 uses a directional beam transmitted by an eight-horn electronically switched antenna on top of the satellite. Optical sensors and associated electronics control the switching of the transmitter output from one horn to the next, activating only the one horn whose beam is aimed in the direction of the earth.

Addenda

The Sperry Rand Corp. has received a \$39-million order from United Air Lines for a computer system to handle the airline's reservations and management needs. The system will be built around three Series 1108 computers. . . . The International Telephone and Telegraph Corp. has built the first portable transceiver for use on a space mission. The a-m radio—built to withstand heat, cold, vacuum and radiation—measures 1 by 1.8 by 8.6 inches. It's scheduled to be used in May during the Gemini 9 mission and will be worn in a backpack by an astronaut during a space walk. . . . Pay-television will begin operating in London on Jan. 7 under a two-year test authorized by the British government.

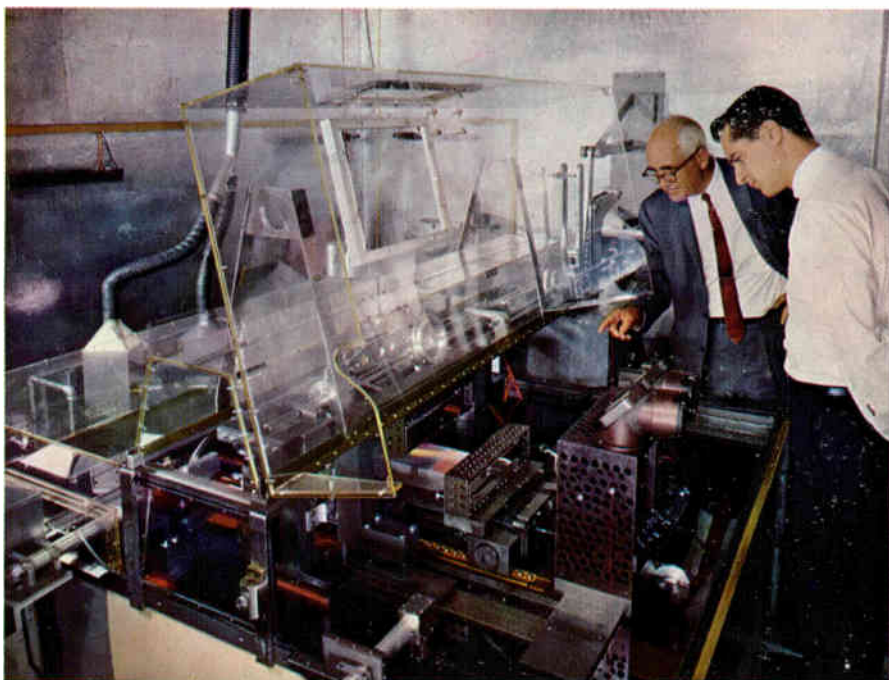

In the Spectroscopy Laboratory at MIT, Dean George R. Harrison and Stephen W. Thompson inspect interferometrically controlled ruling engine.

Laser keeps ruling engine on the track

It sounds easy, but ruling parallel tracks on a mirror surface—thousands per inch, every one parallel with every other one—can be frustratingly difficult. Lifetimes have been devoted to improving the diffraction grating, and for good reason: from this simple device, which breaks light down into its component wavelengths, has come more than nine-tenths of all that we know about the stars.

As astronomers probe deeper into space, they need ever larger gratings to improve the resolving power of their spectrographs. Some of the largest (10") and best gratings today come, surprisingly, from a 65-year-old ruling engine with warpage problems capable of causing errors 100 times the tolerable limit. The engine's secret: servo-interferometric control methods¹, recently enhanced by the use of uniphase coherent light from a Spectra-Physics Model 119 single frequency CW gas laser.

A new laser-controlled engine, designed by Dean Harrison and now taking shape at MIT, is expected to be able to rule gratings of twice the width and five times the area of today's largest. You may never need one, but if you're involved in any technology where precise measurement is important, you may someday be using a gas laser. If you'd like to know more about gas lasers, and why the

Beam from Model 119 laser, mounted in control room adjacent to engine, enters optical system via periscopes in foreground of upper photo.



great majority of applications use Spectra-Physics CW gas lasers, write us today at 1255 Terra Bella, Mountain View, California 94041. In Europe, Spectra-Physics, S.A., Chemin de Somais 14, Pully, Switzerland.

¹ G. R. Harrison, Proc. Am. Phil. Soc. 102, 483 (1958).



Spectra-Physics

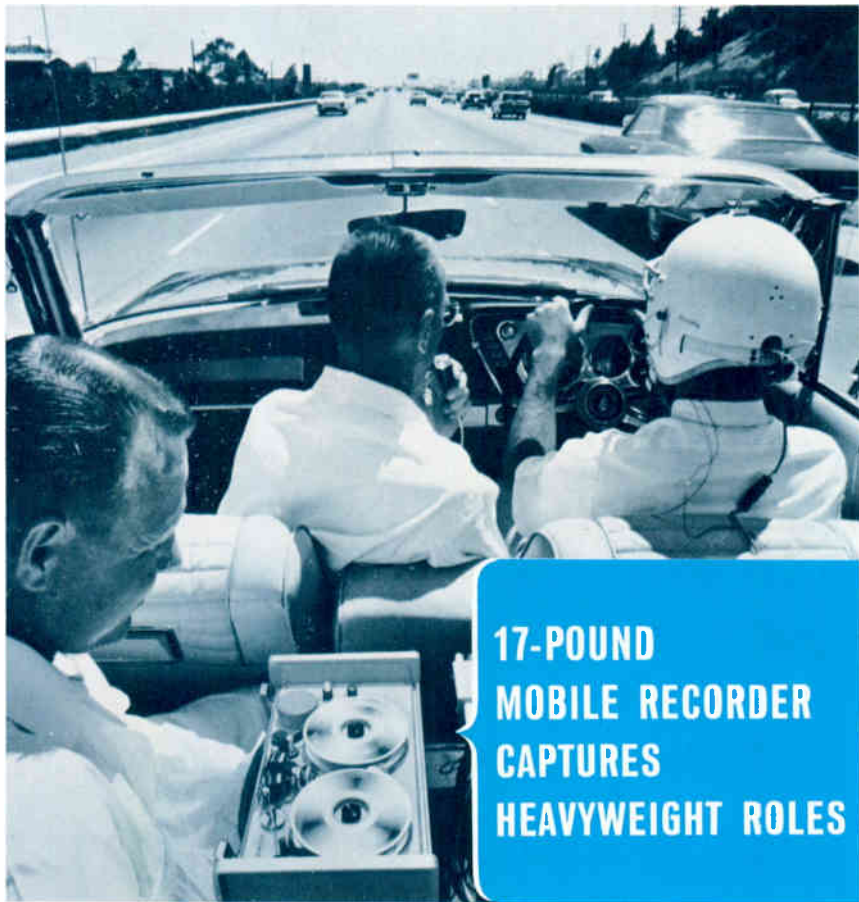

17-POUND MOBILE RECORDER CAPTURES HEAVYWEIGHT ROLES

At times when you need laboratory data that you just can't get in the laboratory — such as driver reactions and brain-waves in response to actual traffic situations — a Pemco portable magnetic tape recorder brings the laboratory to the scene of the action. Operator encephalograms, recorded not only in surface vehicles, but also in airborne and space vehicles, are typical of hundreds of scientific variables today being recorded on tape by the Pemco Model 110.

Unlike other recorders of similar weight, the Pemco is an all-around scientific data recorder, which packages in a fraction of one cubic foot such features as:

- Up to 14 channels record/reproduce, DC to 100 KC
- IRIG or extended-bandwidth FM and Direct, plug-in all-solid-state electronics
- Speeds $1\frac{5}{16}$ through 60 ips, $\frac{1}{4}$ to 1" tape
- Ability to operate anywhere, in any position, even at altitudes over 10 miles high

A copy of our 12-page illustrated technical brochure is yours without obligation. Write today to:



PEMCO

942 COMMERCIAL STREET, PALO ALTO, CALIF. 94303/(415) 321-1177/CABLE: PEMCO
EUROPEAN HEADQUARTERS: 301 KEMPHOTT LANE, BASINGSTOKE, HANTS., U.K., TEL. 21315

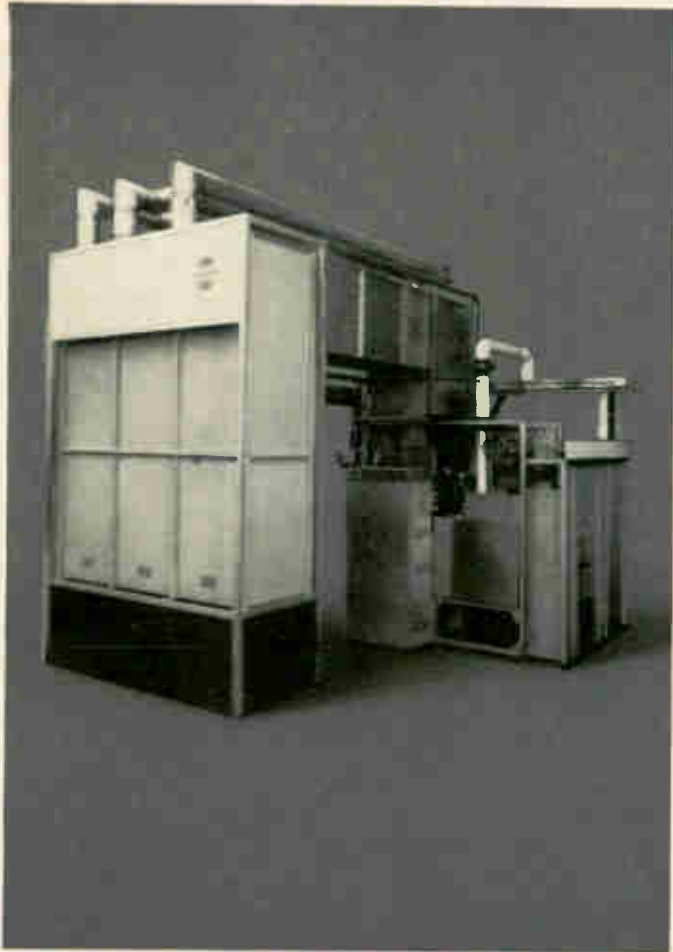

250 KW Transmitter Achieves Extremely High Tank Circuit Efficiency With Jennings Vacuum Capacitors

Two of the most significant features of Collins Radio Company's 821A 250 KW transmitter are the unusually high efficiency of the tank circuits in the final amplifier and the completely automatic tuning techniques. The output network employs large coaxial line sections which are automatically resonated by new internally forced-air cooled Jennings vacuum variable capacitors. It also utilizes the wide capacity range, high frequency response, and high voltage rating of Jennings capacitors to aid in automatic tuning anywhere in the frequency range of 3.95 to 26.5 megacycles.

This permits completely automatic tuning in a maximum of 20 secs and avoids the loss of valuable air time, usually 5 to 15 minutes, consumed by conventional transmitters.

In addition to the low loss dielectric and lowest inductance of any other capacitor Jennings new vacuum capacitors offer (1) highest maximum to minimum capacity change ratios (2) long life (3) high current capability (4) light weight (5) built-in corona rings on many models (6) shock resistant glazed ceramic envelope (7) wide variety to solve most desired combinations of capacitance, voltage, and current.

Whether it's 250 KW or 5 KW, Jennings vacuum capacitors will contribute more to superior transmitter performance than any other capacitor known. A brief examination of our new line of ceramic vacuum capacitors will suggest many new ways in which circuit design can be improved. We will be pleased to send complete details at your request.



JENNINGS TYPE
CVHP 650

Capacitance Range: 30-650 pf
Voltage Rating: 45 kv peak
Current Rating: 250 amps rms



JENNINGS TYPE
CFHP 1000

Capacity: 1000 pf
Voltage Rating: 45 kv peak
Current Rating: 215 amps rms

RELIABILITY MEANS VACUUM-
VACUUM MEANS

ITT Jennings

JENNINGS RADIO MFG. CORPORATION • Subsidiary
of International Telephone and Telegraph Corporation
970 McLAUGHLIN AVE., SAN JOSE, CALIF. 95108 • PHONE 292-4025

9 nsec ~~X~~ 3 1/2 mw

**Philco announces
the new Super/RTL family.
Speed-power product:
31 per gate.
Full military grade.**

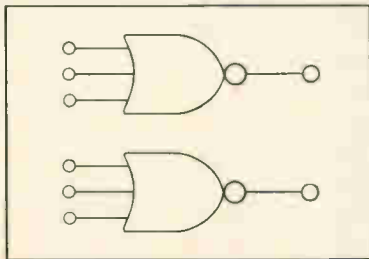

Dual Three Input Gate (PL 9603)

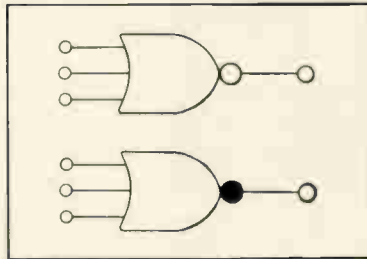

Dual Two Expander (PL 9604)

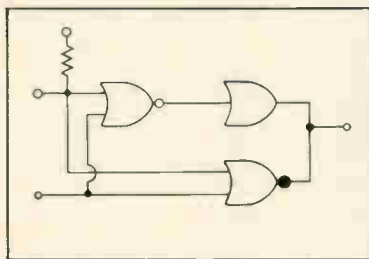

Buffer (PL 9602)

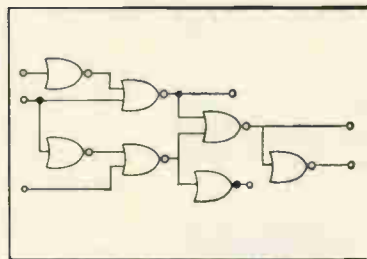

Half Adder (PL 9605)

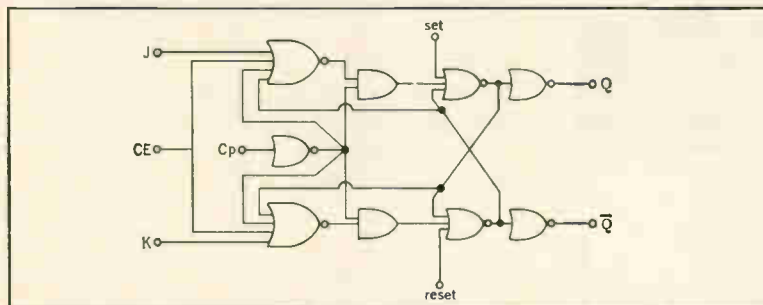

JK Flip-Flop (PL 9601)—also available is a JK Flip-Flop (PL 9600), identical except for inversion of K input.

This is the industry's newest line of high-speed, low-power logic circuits. The unprecedentedly low speed-power product of this "3rd generation" RTL family is made possible by Philco-developed small-geometry processing techniques which minimize parasitic capacitance and permit low propagation-delay times.

The S/RTL family of planar epitaxial integrated circuits was developed by Philco for critical high-speed data-processing functions where full military specifications are required. (Operating range: -55°C to 125°C .)

The six functions presently available are illustrated at left. We think you will find them remarkably convenient to work with. Your further investigation of individual functions will uncover some possibly unexpected advantages. (For example—the flip-flop will toggle at 30 mc at 30 mw dissipation!)

S/RTL circuits are available in $1/4 \times 1/4$ 14-lead flatpacks.

Speaking of availability: Design-sample quantities are immediately obtainable from Philco. For further information write, wire or phone Philco Headquarter Sales, Lansdale, Pa. (215-855-4681).

MICROELECTRONICS OPERATION
PHILCO
A SUBSIDIARY OF *Ford Motor Company*
LANSDALE DIVISION • LANSDALE, PA.
In Canada, Don Mills Road, Don Mills, Ontario, Canada

Electronics Review

Space electronics

The date was kept

"We have company tonight." On the 11th day of a fortnight in space that laconic message from Gemini 7, soaring about 180 miles over Guam, raised cheers from a waiting world. It was the signal that a rendezvous had been kept: that two spacecraft, traveling at 17,500 miles an hour would be able to come together for the docking that is a vital prerequisite to landing a man on the moon. The entire mission, of stunning complexity and unprecedented length, went off with barely a hitch.

The loudest kudos went to the Westinghouse Electric Corp.'s radar system [Electronics, April 5, pp. 110-112D] and the International Business Machines Corp.'s onboard computers [Electronics, May 3, p. 71]. The two systems helped the astronauts steer their crafts to the rendezvous.

Formal wear. The complex steps that led to the rendezvous began the morning of Dec. 15, with the successful launching of Gemini 6. For the occasion of their meeting with Gemini 6, Frank Borman and James A. Lovell, who had been riding in their long underwear, put on their spacesuits. Gemini 6 went into orbit at 8:43 a.m. (EST). Gemini 7 was in a higher and wider orbit at this time, so Gemini 6 had to adjust its orbit with tiny rocket bursts to bring it in line with Gemini 7.

Slowly, during a series of seven steps, the gap narrowed to about three feet.

Much of the catch-up operation was guided from the ground. It was only in the last 235 miles that the astronauts were left to their own devices—radar and computer—to find their way in space.

Direct talk. During the early part of the rendezvous exercise, com-



Soaring in space: Gemini 7 as seen from Gemini 6.

munication between the two craft was accomplished indirectly: messages from one capsule were first transmitted to the ground and then relayed to the other capsule. When they were within 230 miles of each other, the astronauts turned on small ultrahigh-frequency transceivers inside the craft so they could talk directly to each other. The radio was produced by the Collins Radio Co.

Meanwhile, on the ground, electronics scored another success. Live television pictures of the spacecraft recovery were relayed via Early Bird, from the mid-Atlantic to the shore. Tv pictures of the recovery, taken from the deck of the U.S.S. Wasp, were transmitted with portable equipment developed by the International Telephone and Telegraph Corp. The pictures received by home transmitters were of unusually good quality.

Not a whisper

The one electronic experiment that proved a dismal failure during the Gemini 6 and 7 flights was the laser communication test [Electronics, Dec. 13, p. 34]. But the

problem, actually a series of problems, was not with the Gemini 7 laser transmitter, which was produced by the Radio Corp. of America, nor with the ground station gear produced by Electro-Optical Systems, Inc., a subsidiary of the Xerox Corp.

The faults were on the ground and most were human errors. Bad weather also contributed to the trouble: heavy cloud cover often blocked transmission of the laser beam. Trouble began early in the mission. A fire at the first scheduled receiving station, at Ascension Island, destroyed a shed housing some of the ground-base equipment. At the next scheduled station, in Hawaii, trouble in adjusting the laser caused further postponement. By the time Gemini 7 reached the third station, in White Sands, N.M., the craft's angle of inclination was too low for voice communication.

Butterfingers. On succeeding days more problems cropped up. At Ascension, for example, a technician dropped a laser tube. Meanwhile, the astronauts reported they were having trouble spotting the laser beacon. In an attempted solution, the beam's width was widened, but this didn't help.

There was speculation about removing the green filter on the ground stations' transmitters to make the beam more visible but officials decided the task was too delicate to be rushed.

Some success was finally reported over Hawaii, a week after the mission began. Astronaut Lovell spotted the ground station's beacon, locked onto it for two minutes, but didn't get a chance to test the voice communication.

Military electronics

The F-111 market

A broader role for the General Dynamics Corp.'s F-111 (née TFX) could lead to one of the biggest single aircraft electronics markets yet. But this prospect is still full of "ifs."

The F-111 is being developed as a fighter-bomber for the Air Force and as a fighter for the Navy. Up to 1,500 will be bought. Electronics accounts for over 15% of plane's cost.

Now, Defense Secretary Robert S. McNamara has decided to ask Congress for \$1.8 billion to develop and produce some 210 long-range strategic and tactical bomber versions of the plane, to be called the FB-111.

This proposal follows another recent McNamara decision to de-

velop a reconnaissance version, the RF-111. No commitment for production of this model has yet been made, but an order for about 100 is expected.

Sales abroad. In addition, the Defense Department is trying to sell the F-111 overseas. Australia has ordered 24. Britain has an option to buy 10 planes initially to replace its now-canceled T5N-2.

But despite this seemingly bright outlook, so much controversy surrounds the F-111 that the market for the plane may never attain its indicated proportions.

The Navy has had difficulty keeping down the weight of its version for operation aboard aircraft carriers. Unless this problem is solved, the order may be cut.

Britain's declining aircraft industry and some members of Parliament have raised a storm about buying the F-111. They are pushing instead for joint development with the French of a similar plane, the Mirage 4. As Britain's F-111 option neared expiration this month, the government still had not made up its mind, so the option was extended.

To sweeten the deal, the United States is making this offer: if Britain agrees to buy the planes, the U.S. will agree to use mostly British-made electronics on them.

Old B-52's. But the biggest threat to McNamara's plans for the F-111 comes from his long-range bomber proposal. McNamara wants to convert the F-111 into a replacement

for 350 older-model B-52's, which would be phased out in the next five years.

Although the Air Force has raised no formal objection to his proposal, its acceptance is certainly reluctant. The Air Force would prefer to develop a brand-new intercontinental bomber. In the past, Congress has consistently sided with the Air Force on this issue and may well refuse to go along with McNamara in funding the F-111 as a substitute.

In any case, a major debate can be expected. The debate will turn on the question of whether the FB-111 can match the B-52's performance. McNamara contends it will equal the older B-52 in range, have twice the speed and possess greater capability to penetrate enemy defenses because of its ability to fly at lower altitudes.

His claims are subject to challenge, depending on the type and length of mission involved, as well as other variables. If the FB-111 does get off the ground, it will initially carry the same general kind of avionics the F-111 carries. McNamara proposes a quick modification program that would make the FB-111 operational as early as 1968. This short period would not provide enough time for the development of avionics especially designed for the bomber version.

Improved avionics. The Air Force, however, is working on two long-range development programs that could lead to improved avion-



Sales of the F-111 family of supersonic aircraft may set record.

ics for an FB-111. One program involves the Mark 2 integrated avionics system that will be in the basic F-111 fighter-bomber during the latter part of its production run. The other program is to develop long lead-time components for advanced electronics that would have been incorporated in the proposed Advanced Manned Strategic Aircraft (AMSA) that would have replaced the B-52. But McNamara has blocked development of the AMSA.

Whatever the fate of the FB-111 controversy, the related Short-Range Attack Missile (SRAM) program will continue. The SRAM could be used on either the remaining late-model B-52's, the RF-111 or AMSA. The Martin Marietta Corp. and the Boeing Co. are competing in a project-definition phase for the development contract.

Aiming with tv

United States fighter pilots firing Bullpup missiles against ground targets must first be within visual range of the target. Even then, they can't hit and run; they've got to remain nearby, guiding the missile by remote control as it zeroes in on the target. So the pilot can remain at a safe distance from ground fire—but still guide the missile and make sure it hits the target—military researchers are rapidly stepping up the development of television-guided missiles and bombs.

All the tv-guided weapons under development operate in the same basic way: tv cameras and transmitters are in the nose of the weapon. Inside the plane, the pilot watches a tv monitor that shows the view in front of the weapon. The weapons also contain equipment that can lock onto a target, keeping the missile on course during the last few moments before it hits.

Tv in the nose. The weapon that's closest to development is the Wall-eye, a free-fall bomb with a tv camera in its nose. As the bomb falls, the bombardier is able to see the scene below it. By remote control, the bombardier is able to

correct the angle of descent by adjusting fins on the bomb's tail. Three companies have been vying for the contract for the past year: North American Aviation, Inc., the Hughes Aircraft Co. and the Martin division of the Martin Marietta Corp. Indications are that the Pentagon will award the multimillion-dollar contract to Martin soon.

Condor progressing. Well along in the definition stage is another Navy weapon—the tv-guided Condor surface-to-air missile. North American and the Nortronics division of the Northrop Corp. have been competing for the development contract since April. The Condor is planned for the carrier-based A-6A attack plane.

The Air Force is also pushing to get into the field with a proposed tv-guided, air-to-ground missile, to be known as Maverick. The missile, designated AGM-65A, would be launched from the F-4C, F-5 and F-105 fighters. The Maverick has the backing of the Air Force's Aeronautical System division but it has not been finally approved by Air Force headquarters and submitted to the Defense Department's Research and Engineering Office for a go-ahead on starting project-definition competition.

Using North American's guidance hardware developed in the Walleye program, the Air Force modified another missile—the Hornet—for flight tests of the tv-guided system.

Communications

Light talk

The Navy's been doing it for years: using a bright searchlight to send semaphore messages ship to ship. But semaphore is cumbersome because of the slow pace of Morse code. With the development of the laser four years ago, researchers have turned their attention to techniques for modulating a coherent beam with voice signals. Despite many advantages of laser communications, technical problems re-



Optical communications system developed by David E. Wright, an engineer at Edgerton, Germeshausen & Grier, Inc. provides a low-cost voice link up to eight miles.

main. Moreover, the cost of building and operating a laser prices it out of the market for most communications needs. Now, Edgerton, Germeshausen & Grier, Inc., of Boston has applied the techniques of semaphore, plus the techniques of modulating coherent light with voice signals, and developed a portable optical communications system that uses noncoherent light. The result is a low-cost system that transmits voice messages over distances up to eight miles.

No noise. The system has several advantages: with point-to-point communications, the message is secure from eavesdropping; the electronics are relatively simple; the beam isn't affected by electrical noise in the vicinity, nor does it affect radio transmission or other electronic equipment.

Two instruments have been developed. One, using high-power gallium-arsenide (GaAs) optical diode, sits on a tripod, and produces infrared light. The other, using a xenon-hydrogen discharge tube, produces visible light and is hand-

held. Both models convert voice messages into light pulses, using pulse position modulation.

EG&G estimates that a customer could buy the more expensive, two-way GaAs system for about \$2,000; in full production, however, the price would drop to about \$600. The hand unit would cost considerably less.

The market for such units practically covers the spectrum of short-range communication needs. Power-line repairmen, for example, could use the device to communicate with a repair crew several miles down the line. The use of a walkie-talkie in this instance isn't practical because power lines "leak" so much electromagnetic interference that the high ambient noise obliterates communication; optical sources, however, are immune.

In another application, at a missile-launch facility, for example, the communication unit would be impervious to high ambient noise and wouldn't add noise itself.

Each of the communication systems was designed around the unique properties of its particular optical source.

Beacon, too. The GaAs optical diode, for example, with its extremely small active surface, was readily adaptable to a narrow-beam system for secure communications between fixed points.

The xenon system, on the other hand, with a wide range of peak intensities in the visible spectrum, could be used either as a beacon or as a transmitter. In the beacon mode, the tube's repetition rate is slowed, resulting in a very high intensity beam; in the transmitting mode, the repetition rate is speeded, producing a rapid sequence of lower-intensity peaks. The tube used by EG&G can produce a 10-joule flash once every second or 1-millijoule flashes at a 7-kilocycle repetition rate.

Both systems contain sending and receiving equipment; parabolic mirrors are used to focus a transmitted beam and to receive and focus a beam transmitted from afar.

Range of the systems, of course, is hampered by foul weather. Heavy rain, fog or snow could cut

communications completely; but in light rain, snow or haze, some communication is possible over short distances. In clear weather during the day, the GaAs unit has a range of about four miles and the xenon unit, about one mile. During the night, range is about quadrupled.



Hand-held optical communications unit converts voice signals into light pulses. Receiver reconverts the light into voice signals.

The developer of the systems, David E. Wright, an engineer at EG&G, says range can be nearly doubled if more sophisticated receiving circuitry is used to filter out ambient light.

Employment

A sellers' market

The Lockheed Aircraft Corp. sponsored a television program in New York recently that extolled the merits of Georgia as a place to live and work. Lockheed wasn't pushing tourism for the Peach State—it was trying to lure engineers to work in Marietta, Ga., on its C-5A transport plane, the subject of a multibillion-dollar contract. As a back-up to the soft-sell approach on tv, Lockheed has been running full-page want ads in newspapers and magazines across the country.

Lockheed obviously feels the expense is necessary. The problem, as most aerospace and electronics companies are discovering to their chagrin, is that there simply aren't enough good engineers around to

fill the ever-growing job lists.

Hard to find. "The situation is terrible; engineers are tremendously hard to find," says a personnel director at Motorola, Inc.'s Chicago headquarters.

The government confirms industry reports of the "tight" labor situation. A recent Labor Department statistical survey on unemployment in engineering had to be called off because there simply weren't enough unemployed engineers to provide meaningful figures. The best estimate that the agency can come up with is that only 1.3% of the engineer population is out of work. But the bureau can't identify the members of the group accurately. Says one agency official: "Many members of this unemployed group are probably moving between jobs." The agency classifies the engineering job situation as "among the tightest of all labor groups."

Accentuating the pinch being felt by electronics companies is the shift in employment trends. A personnel director for a California manufacturer says: "Ten years ago, we would have been happy with any competent engineer. But now, the man has to have a specialty. He has to be a laser expert, or a top-notch microwave man before he's useful to us. The commercial competition is too keen for us to spend time training him."

More engineers. The Aerospace Industries Association says the number of scientists and engineers on member firms' payrolls has climbed 7.3% from July, despite a general decline in the number of other workers.

Another indication of the spurt in the demand for engineers, says Burt Peterson of a Los Angeles recruiting agency that specializes in professional people, is newspaper advertising. "Help-wanted lineage for engineers is up more than 50% from last year," he notes. The boost started showing up in March, he adds, and it may not yet have reached its crest.

Not all of this advertising is directly tied to employment needs, concedes one New York employment agency official. "There's no doubt," he notes "that some com-

HERE'S WHAT THIS 5 WATT ZENER DID FOR ONE COMPANY!



- Reduced weight 93%
- Reduced size 90%
- Reduced cost 73%

IMPRESSIVE? Read on so you can achieve similar savings.

CASE HISTORY

This company has a design engineer--let's call him Bill--who had a problem. Line spikes were causing high base to emitter voltages that were destroying a transistor in the emitter-follower of Bill's solid state amplifier. Transistors with high base to collector voltages were both expensive and difficult to get.

The 24 volts of power for Bill's amplifier came from a high current, low voltage supply that also fed several other sub-assemblies. Bill found that when he inserted sufficient limiting impedance to protect the transistor, the circuit wouldn't operate satisfactorily.

What Bill needed was a line voltage transient clipper that would conduct high current during transient surges while having no steady state power consumption--a 36-volt zener!! Now he had a choice--a bulky 50 watt stud (1N3326), or an equally bulky 50 watt T03 (1N2885).

or

a Unitrode UZ5836, miniature axial leaved zener with a comparable surge rating. He chose the latter and saved in weight, size, and cost.

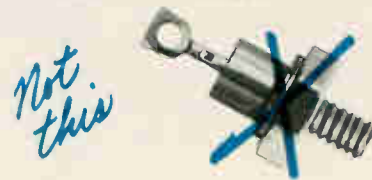
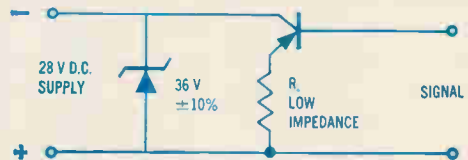

YOU CAN DO THE SAME. Contact the factory, call your local COMPAR office, or circle the reader service number on the magazine's reply card. All will insure your receiving data sheets and samples of Unitrode Zeners as well as information on other semiconductor devices immediately.



UNITRODE
"better always by design"

580 Pleasant Street, Watertown, Mass. 02172 Telephone (617) 926-0404 TWX (710) 327-1296

panies insert frantic want ads in the papers every Sunday in an effort to improve their public image. A potential investor looks at the want ads, thinks that the company's orders are up, and goes out and buys the stock. Presto! The price of the stock climbs."

But he adds, "Today's labor market is so difficult that very few companies are bluffing."

Electronics companies are using some unusual recruiting methods to fill their engineering ranks. Says John Harris, a job agency director in San Francisco: "There's been such an upsurge since last June that the big eastern companies have started coming out here looking for men."

Recruiting efforts merged. Not all companies go that far in recruiting top engineers. In California's San Fernando Valley area, for example, six electronics companies recently merged their recruiting talents and arranged an employment-opportunities weekend at a resort in nearby Orange County. Accentuating the labor shortage is the growing mobility of engineers; they know they can find a new, and possibly better, job without too much trouble.

What causes mobility among engineers? "It's not just salary," says Gordon Moore, who directs a Palo Alto, Calif., agency. "Often a guy is just looking for a more exciting area or a more secure firm."

Agency directors and companies' personnel chiefs ascribe the boost to three factors: the generally booming economy, the war in Vietnam—which is boosting demand for weapons systems—and the widespread drive by companies that lean heavily on military and government contracts to diversify into the commercial market.

Computers

The speed limit

A computer memory that is twice as fast as any commercially available memory has been developed

—without any radical changes in technology—by packing more bits to the inch. Built and tested only as an engineering model by the International Business Machines Corp., the new memory has a cycle time of 375 nanoseconds. IBM's lead may be short-lived; the de-

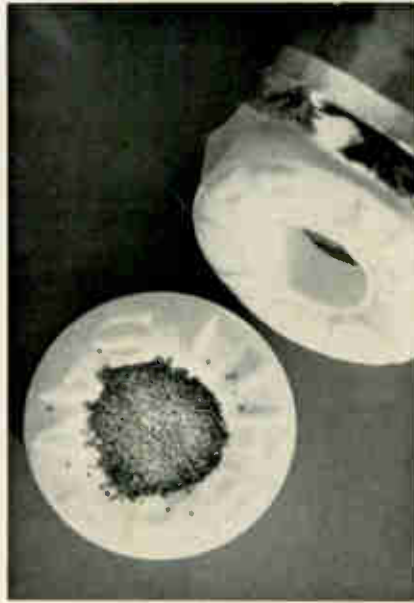

Over 17,000 ferrite memory cores can be poured into the hole in a single Life Saver. The cores, 7.5 mils in diameter, are like those used in an experimental memory recently built by IBM.

livery date of Control Data Corp.'s first model 6800, with a cycle time of 250 nsec, is mid-1967. Control Data has not disclosed details of the model nor has IBM announced its plans for commercial application of its new memory.

IBM's experimental memory's capacity is 8,192 words of 72 bits each, compared with hundreds of thousands of words in some commercially available computers.

G. E. Werner and R. M. Whalen, engineers at IBM's Poughkeepsie, N. Y., labs, attained the 375-nsec speed by incorporating three basic design concepts: tiny cores, close packing to keep the wires short and a memory organization that is intrinsically fast. There is a disadvantage—the short-wire memory organization increases addressing complexity and the cost.

Werner and Whalen are working to cut the cycle time to 110 nsec by using solid-logic driver circuits,

different physical arrangements and other design refinements. If they succeed, IBM would halve Control Data's time.

Time to switch. Most memories available now are made from ferrite cores strung on wires. The ferrite core is magnetized either clockwise or counterclockwise, depending on the direction of the wire current. Switching the magnetized state of the ferrite from one direction to the other takes time; the less ferrite there is to switch, the less time it takes. So, the smaller the core, the quicker it will switch, and the faster the memory can operate.

Small cores can be strung closely together so the memory can be strung with shorter wires; the shorter the wire, the lower the impedance. This, too, can increase the speed of the memory.

The cores used in this memory have a 7.5-mil inside diameter—three hairs will barely fit through one of them—and a 12-mil outside diameter. The cores are spaced 15 mils apart, center to center, and are packed 4,000 per square inch. In conventional memories, cores have a 20-mil inside diameter and are packed up to 1,000 cores per square inch. The cores in the new memory are strung on wires close to a ground plane that provides a return path for the current. The closeness of the wires to the ground also helps reduce the impedance even further.

2-D memory. The memory organization is two-dimensional: the cores are strung on two sets of wires. One set, in the x direction, corresponds to the words of data stored in the memory. The other set, in the y direction, corresponds to the bit positions in each word. Each word must have its own driver circuit. The two-dimensional organization is simple and fast, but it requires a complex address decoder for access to each individual word. This makes it expensive for large memories.

Another unusual feature of the new memory is its temperature control. Ferrite-core memories must be maintained at even temperatures for reliable operation. In IBM's memory, cooling liquid is pumped

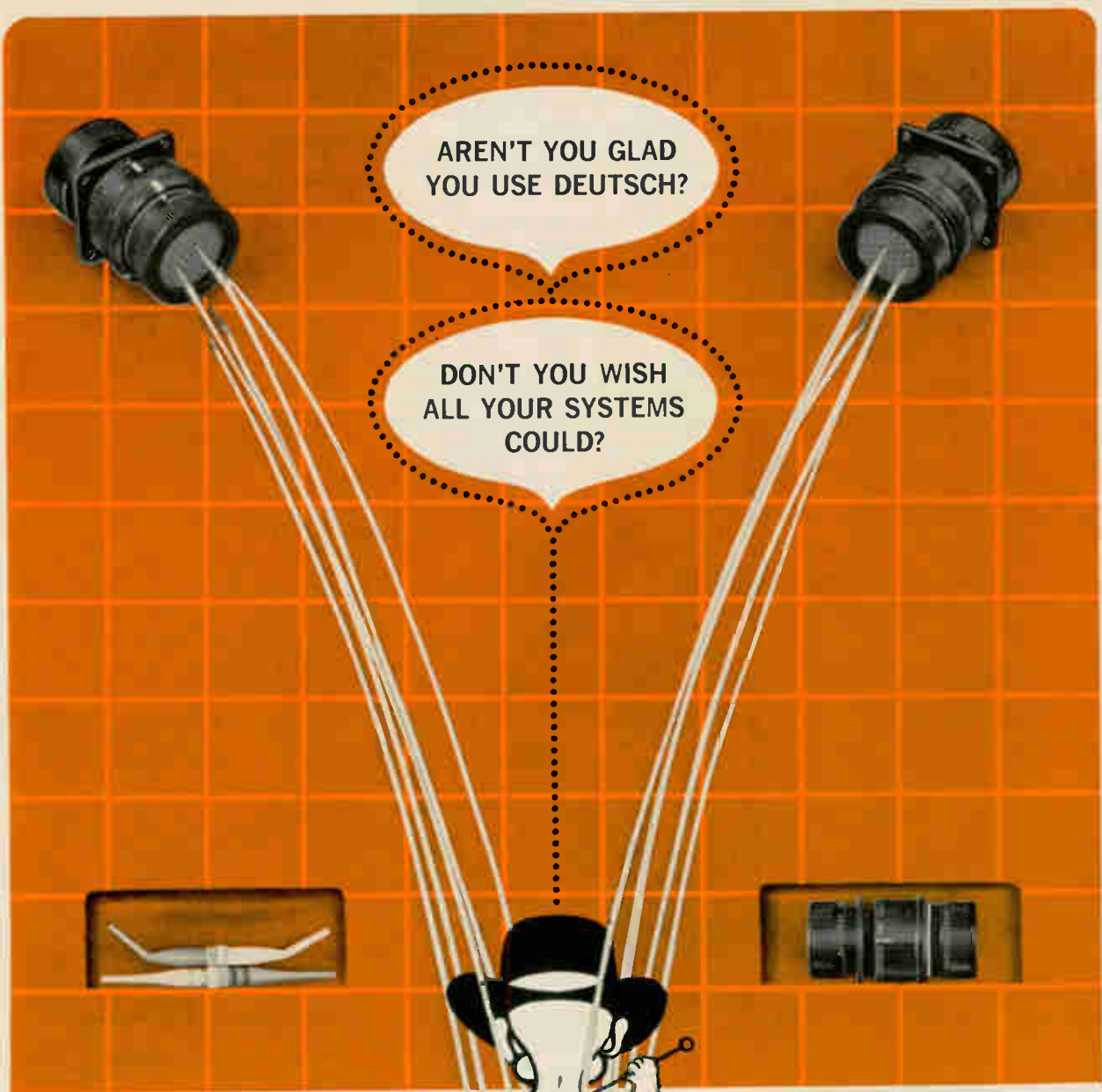

AREN'T YOU GLAD
YOU USE DEUTSCH?

DON'T YOU WISH
ALL YOUR SYSTEMS
COULD?

Around the Clock Protection! There are no soft-soap claims about the DBA Series. The National Aerospace Standards Committee had them put through a set of tests that only the strong could bear. They were cooked . . . frozen . . . whacked . . . shaken . . . saturated with everything from salt spray to lubricating oil . . . taken apart and put together again for thousands of hours — then came 408 hours of grueling, environmental cycling.

Squeaky clean! This new connector series passed all the tests . . . the first connector and contact series to qualify under NAS 1599 and 1600! The DBA 30 threaded coupling and the DBA 50 bayonet design are interchangeable and intermateable with 26500 and 26482 connectors. For an extra splash, we've also designed push-pull DBA 70's to NASC requirements. All DBA's have the rear-release contact system, Silicone inserts, fully interchangeable accessory hardware, and a "fail-safe" insertion/removal tool.



The Best Combination of Ingredients! With Deutsch manufacturing and reliability processes there's never a chance of being half-safe. A hard dielectric insert socket front with a lead-in chamfer that leads the pin into the socket contact, triple-chamber rear seals, and a "cork-in-the-bottle" interfacial sealing system — the hard-working ingredi-

ents that enable the DBA Series to clean-up on the most demanding requirements.

Helps heal irritated circuits! When harsh environments cause connector trouble to break out, apply Deutsch and get instant relief. Problem spots vanish in a hurry with regular use.

For a system you'd love to touch, your local Deutschman is your best bet — bar none. (For complete information, write for Data File E-5.)

DEUTSCH

ELECTRONIC COMPONENTS DIVISION • Municipal Airport • Banning, California

ADVANCED SPECIFICATION MINIATURE ELECTRICAL CONNECTORS

READ, PLOT, OR SCALE CURVES WITHOUT CALCULATION

The Gerber Variable Scale is based on a precision extensible spring, calibrated in hundredths. It allows you to read curve amplitudes directly, read frequencies directly, multiply by scale factors, plot with correction factors or other constants included, interpolate, normalize, etc. It eliminates routine calculations. Accurate to 0.05% in full scale of ten inches. ■ Partially shown below (actual size) plotting curve from original. ■ Send for literature: THE GERBER SCIENTIFIC INSTRUMENT CO., P.O. Box 305, Hartford 1, Connecticut.

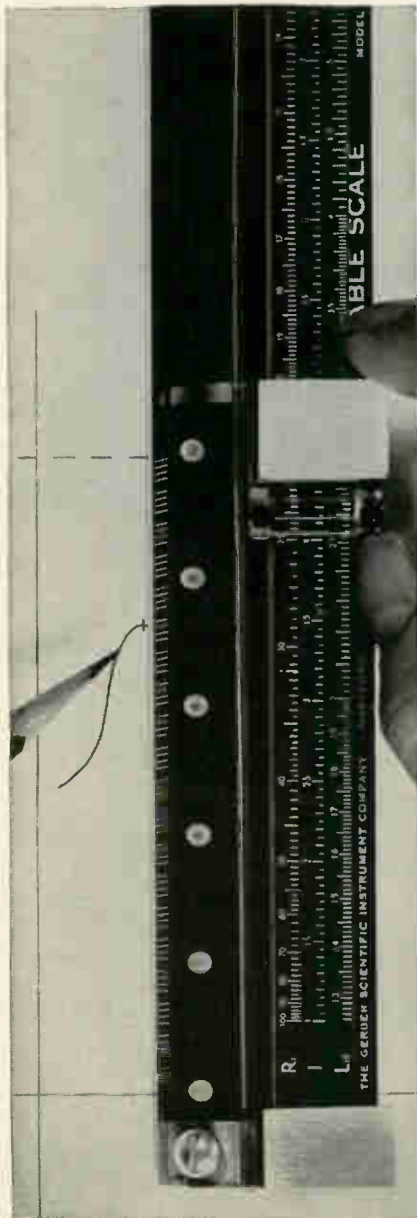

in from a temperature-controlled reservoir and circulated through the hollow ground plane.

Medical electronics

Sound and safe

Some time next year a team of doctors in New York will use an ultrasonic echo-ranging instrument to test for abnormalities in the eyes of 1,000 schoolchildren. The test will determine, among other things, the thickness of the eyeball—a measurement that can't be made directly with optical instruments.

The test points up doctors' increasing interest in echo-ranging as a diagnostic technique. At a Boston symposium on ultrasonics this month, sponsored by the Institute of Electrical and Electronic Engineers, physicians and engineers agreed that ultrasonics is permitting measurements that could not have been made earlier. The use of x-rays, radioisotopic scanning and catheterization all contain an element of hazard when applied to a sick person. Echo-ranging, on the other hand, is hazard-free and can be performed without the patient knowing that a measurement is being taken.

Check the beat. Portable echo-ranging equipment is already checking fetal hearts without disturbing the mother-to-be [Electronics, April 19, p. 35]. In addition, echo-ranging is being used at many hospitals for diagnosis before operations to help a heart surgeon determine which parts of the heart require attention. At the Carnegie Institute of Technology, ultrasonic doppler techniques are being developed to monitor the fetal heartbeat to detect defects prior to delivery of the baby. Joe S. Hitt, a Carnegie researcher, told the Boston meeting that the doppler returns are fed into a computer that is programed to detect heart abnormalities.

The application of ultrasonics to medicine is still in an early stage.

Much of the Boston symposium was devoted to discussions among doctors and engineers, with the medical men outlining their needs and the engineers outlining the capabilities, potentials and limitations of the technique.

Among the problems that still need to be solved before ultrasonics can have widespread application in medicine, says Dr. Joseph Holmes of the University of Colorado Medical School, are standards for time-base relationships and for sensitivity, resolution and alignment.

The most perplexing problem, Holmes adds, is the need for tissue standards to permit more reliable discrimination between normal and abnormal tissue as seen in the ultrasonic display. Currently, the edge of the liver, bladder wall or thigh is used as a standard. But this standard is woefully inadequate, says Holmes, for individuals of different physical contour or for cases when a pathological condition is interposed between the transducer and the tissue being used as a standard.

Consumer electronics

Waterproof radio

Until now, if a radio were to drop into water the only sound it might make would come from the splash. Now the MECO Corp. of Santa Barbara, Calif., is marketing a portable radio, called the Mk-II, that will continue to play even if it's submerged. Its designer, Joseph J. Montanaro, says the waterproof radio produces high-fidelity sound.

Montanaro seems to have found a way to encase the radio's loudspeaker in a watertight material without muffling the sound. He used neoprene, a strong material even when sliced into thin sheets, through which sound can pass easily. He determined that a sheet of neoprene less than 1.5 mils thick would rupture when dropped in water. He also learned that if the thickness was greater than 2.5

mils, the sound coming through it would have an echo quality. His choice for the thickness, therefore, was between 1.5 and 2.5 mils.

No seeping. To waterproof the rest of the radio, Montanaro designed the shell of high-impact plastic. O-rings were fitted around the shafts of all the exterior controls to keep water from seeping in behind the knobs.

In addition to resisting water, salt spray, sand and smog, the radio was also designed to withstand shocks. The radio will be built in Hong Kong by International Service Corp.

The company thinks boat owners will be the big market. But, because the radio works under water—at shallow depths, at least—a scuba diver might use it while he's swimming beneath the surface.

Japanese designers have toyed with the idea of a waterproof radio in the past. They attempted to waterproof the speaker by impregnation with a watertight material. The result was a tweeter with poor fidelity and the designs never got anywhere.

Avionics

A record problem

The most valuable clue in determining why an airliner crashed is the data contained in the flight recorder—a \$5,000 electronic instrument designed to record a plane's five key movements and survive a crash. But aeronautical investigators claim the instrument doesn't always record enough information, and worse than that, sometimes it doesn't even fully survive the crash. So the Federal Aviation Agency is looking for a new generation flight recorder that will register as many as 24 parameters and will be able to survive an impact five times as great as called for in design of present instruments. Industry officials say that a flight recorder that could accomplish this would cost between



**Who says this
is the finest trimmer
available for the money?**

Only the users!

If we were to claim that the Model 84 is better and less expensive than any comparable trimmer available today, you would doubt us. If we said that we are offering in this half-inch, single-turn, wire-wound trimming potentiometer quality features unavailable anywhere else, you would suspect we were breast beating. You might even doubt us when we stated that this trimmer really meets MIL-SPECS without faking—that is, with comfortable margins to spare.

And when we told you that the Model 84 price was half that of many larger square and rectangular models that perform to the same

environmental specs, you would be sure we were exaggerating.

So we won't tell you any of these things. Instead, we will just say that the Model 84 has been widely accepted as a standard in many important military applications and that our civilian users are enthusiastic in their praise. Beyond that, we won't try to sell you.

If you'd like a data sheet, contact us or your local Spectrol representative or distributor. Note that the Model 84 is rated at 1½ W. at 70°C, has a standard resistance tolerance of ±4%, and is completely immersible.

Spectrol Electronics Corporation
17070 E. Gale Ave., City of Industry,
California 91745

spectrol

GET YOUR



**MOTOROLA
RECTIFIER
HANDYLab Kit TODAY!**

Your franchised Motorola semiconductor distributor has the new Rectifier "HANDYLab" Kits in stock now. He can make immediate, off-the-shelf shipment to you . . . and, from his extensive inventory of all Motorola rectifiers and molded bridges, keep your "HANDYLab" stocked for all lab and prototyping needs!



CALL YOUR NEAREST MOTOROLA DISTRIBUTOR NOW!

EASTERN

ALABAMA, Huntsville • 2310 Bob Wallace Ave., S.W.	Electronic Wholesalers • 534-2461
ALABAMA, Huntsville • 8100 Memorial Parkway, S.W.	Gulf Semiconductors • 881-7737
CONNECTICUT, Hamden • 60 Cornolly Parkway	Cramer Electronics • 288-7771
D.C., Washington • 2345 Sherman Ave., N.W.	Electronic Wholesalers • HU 3-5200
FLORIDA, Miami • 7495 N.W. 48th St.	Gulf Semiconductors • 887-6541
FLORIDA, Orlando • 2049 W. Central Blvd.	Crescent Electronic Sales • 423-8586
GEORGIA, Atlanta • 1135 Chattahoochee Ave., N.W.	Jackson Electronic • 355-2223
MARYLAND, Baltimore • 3004 Wilkens Ave.	Electronic Wholesalers • WI 5-3400
MASSACHUSETTS, Cambridge • 71 Pearl St.	R&D Electronics Supply • 864-0400
MASSACHUSETTS, Newton • 320 Needham St.	Cramer Electronics • WO 9-7700
NEW JERSEY, Moorestown • Pleasant Valley Ave.	Angus, Inc. • 235-1900
NEW YORK, Buffalo • 916 Main St.	Summit Distributors • TT 4-3450
NEW YORK, Elmhurst, Queens • 80-02 51st Ave.	Cramer/Esco • GR 8-4000
NEW YORK, New York • 160 Varick St.	Milgray Electronics • YU 9-1600
NEW YORK, Syracuse • The Pickard Bldg., E. Molloy Rd.	Eastern Semiconductor Sales • 454-9247
NEW YORK, Westbury, L.I.	Schweber Electronics • ED 4-7474
NORTH CAROLINA, Winston-Salem • 938 Burke St.	Electronic Wholesalers • PA 5-8711
PENNSYLVANIA, Philadelphia • 701 Arch St.	Radio Electric Service Co. • WA 5-6900

CENTRAL

ILLINOIS, Chicago • 100 N. Western Ave.	Allied Electronics • HA 1-6800
ILLINOIS, Chicago • 223 W. Mad son St.	Newark Electronics • ST 2-2944
ILLINOIS, Chicago • 5700 W. North Ave.	Semiconductor Specialists • NA 2-8860
IOWA, Cedar Rapids • 618 First St., N.W.	Deeco • 365-7551
KANSAS, Kansas City • 2707 West 43rd St.	Precision Electronic Devices Co. • AD 6-4343
MICHIGAN, Dearborn Heights • 23203 Ann Arbor Trail	Semiconductor Specialists • LU 4-5901
MICHIGAN, Detroit • 12775 Lynden Ave.	Radio Specialties Co. • BR 2-4212
MINNESOTA, Minneapolis • 730 East 38th St.	Allied Electronics • TA 7-5401
MINNESOTA, Minneapolis • 601 West 66th St.	Semiconductor Specialists • UN 6-3435
OHIO, Cincinnati • 10 Knollcrest Dr.	Sheridan Sales • 761-5432
OHIO, Cleveland • 5403 Prospect Ave.	Pioneer-Standard Electronics • 432-0010
OHIO, Dayton • 2975 Far Hills Ave.	Allied Electronics • 298-9831
TEXAS, Dallas • 2642 Andjon Dr.	Sterling Electronics • FL 1-9921
TEXAS, Garland • 326 Kirby St.	Hall-Mark Electronics • BR 6-8531
TEXAS, Houston • 8000 Westglen	Hall-Mark Electronics • SU 1-0011
TEXAS, Houston • 1420 Hutchins	Lenert Co. • CA 4-2663

WESTERN

ARIZONA, Phoenix • 1741 No. 28th Ave.	Hamilton Electro of Ariz. • 272-2601
CALIFORNIA, Inglewood • 339 S. Isis Ave.	Liberty Electronics • OR 8-8111
CALIFORNIA, Los Angeles • 10912 W. Washington Blvd.	Hamilton Electro Sales • UP 0-3200
CALIFORNIA, Los Angeles • 5645 E. Washington Blvd.	K-Tronics • OV 5-5888
CALIFORNIA, Mountain View • 320 Middlefield Rd.	Hamilton Electro Sales-North • TE 4-3311
CALIFORNIA, Oakland • 140 11th St.	Elmar Electronics • DA 6-3366
CALIFORNIA, Palo Alto • 410 Sherman St.	Pencor Electronics • BR 8-2112
CALIFORNIA, San Diego • 8137 Engineer Rd.	Kierulff Electronics • San Delcor • 274-3131
CALIFORNIA, San Diego • 4618 Santa Fe	Kierulff Electronics • TA 5-7033
COLORADO, Denver • 1200 Stout St.	Kierulff Electronics • 437-0370
NEW MEXICO, Alamogordo • 811 First St.	Kierulff Electronics • 268-3901
NEW MEXICO, Albuquerque • 64C5 Acoma Rd., S.E.	W. H. Bintz Co. • 363-5821
UTAH, Salt Lake City • 433 W. Third So.	Hamilton Electro • AT 2-3836
WASHINGTON, Seattle • 516 First Ave., No.	



MOTOROLA Semiconductor Products Inc.
BOX 955 • PHOENIX, ARIZONA 85001

Electronics Review

\$10,000 and \$20,000.

The FAA is about to begin testing two models: one produced by the Whittaker Corp. and another by United Data Control, Inc., a division of the Control Data Corp. However, it will take more than a year for the FAA to evaluate the recorders.

Key measurements. Currently used flight recorders for commercial craft—now required in jets, turboprops and propeller planes pressurized for flights above 25,000 feet—measure five parameters: time, airspeed, altitude, heading and vertical acceleration, or G forces. The only strength requirement is that they be able to withstand an impact of 100 G's—"a pretty mild test" in the opinion of some FAA officials.

In addition to the present five measurements, the new recorder will monitor 19 others, including the angle of attack, pitch rate, yaw rate, roll rate, angle of bank, engine torque on each engine, exhaust temperature on each engine, control column position, rudder pedal position, control wheel position, wing flap position, outside air temperature and horizontal stabilizer reaction.

Tough standards. Survivability standards also are tougher. At the FAA's Atlantic City, N. J., laboratory, the devices will be subjected to an impact of 1,000 G's for five milliseconds, pressure of 4,000 pounds at its three axes for five-minute periods and a series of penetration tests.

Electronics notes

- **'Superman' suit.** An electronically controlled suit, designed to turn even the mildest chap into a Superman, is under development for the Navy by the General Electric Co. The suit, an "exoskeleton" made up of frames and braces that are strapped to the body, enables a man to lift as much as 1,500 pounds, with only 40 pounds of human effort. The existing model receives its power from an external source, but engineers hope to make the suit self-powered.

REDUCE YOUR ENGINEERING "DOWNTIME"!

with Motorola's New Rectifier HANDYLab Kit



Don't get caught in the "no-parts-handy-in-the-lab" squeeze!

With Motorola's Rectifier HANDYLab Kit you can now have a broad assortment of "just right" rectifiers for virtually all lab and benchwork requirements . . . at your fingertips . . . at less than half the cost of procuring the same devices in low quantity lots!

Just by reaching for it, you can select any one of 84 popular, first-quality Motorola rectifiers and molded rectifier bridges, in ratings from 1 to 35 Amperes, 200 to 3,000 volts!

ELIMINATES: delays in delivery of prototype quantities • hunting for misplaced devices • costly "small-order" requisitions • "odd-lot" inventory problems.



Call your franchised Motorola Distributor for details . . . on how you can get these practical, convenient rectifier prototype assortments immediately!

POWER UP WITH . . .

MOTOROLA
Semiconductor Products Inc.
Box 955, Phoenix, Arizona 85001

Here's what you get in the Motorola Rectifier HANDYLab Kit . . . **\$94.50**

Type No.	Ratings		Quantity in Kit	Actual Value (\$1.99 Quantities)
	Amperes	Volts		
RECTIFIERS				
MR994	0.25	3000	4	31.80
1N4003	1.0	200	8	4.80
1N4004	1.0	400	12	8.05
1N4007	1.0	1000	4	7.20
1N4721	3.0	200	4	2.68
1N4722	3.0	400	8	7.75
1N4725	3.0	1000	4	25.40
MR1122	12.0	200	4	4.72
MR1124	12.0	400	8	12.00
MR1128	12.0	800	4	22.40
1N1186	35.0	200	4	13.80
1N1188	35.0	400	4	23.40
1N1190	35.0	600	4	27.60

BRIDGES				
MDA920-4	1.0	200	2	4.50
MDA920-6	1.0	400	2	4.80
MDA942-3	1.5	200	2	5.30
MDA942-5	1.5	400	2	6.20
MDA952-3	6.0	200	1	4.45
MDA952-5	6.0	400	1	6.00
MDA962-3	10.0	200	1	4.85
MDA962-5	10.0	400	1	6.40

Totals	84			\$234.10
Value of Styrene Cabinet				3.00
TOTAL VALUE				\$237.10
Your Cost				\$ 94.50
You Save				\$142.60

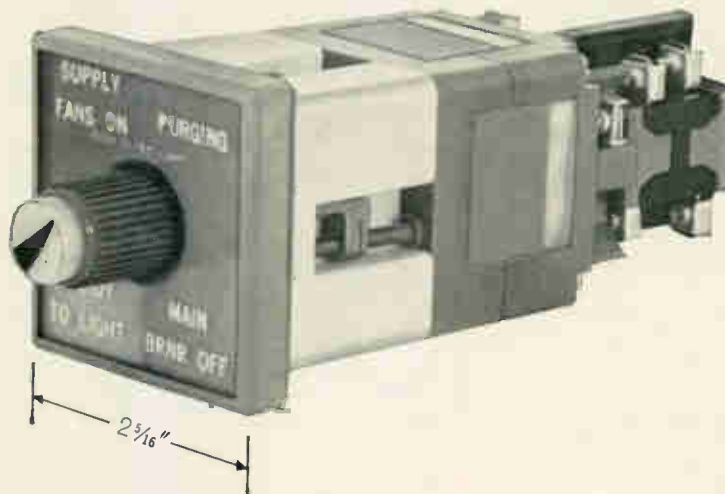

Coordinated Manual Control (CMC) combines so many functions in so little space...

...you may be surprised how much space it can save on your panels. The following facts will give you some idea:

CMC combines multi-function selector-push control and up to four lighted legends in one compact oil-tight unit.

CMC provides up to four isolated groups of circuits—electrically and mechanically isolated.

CMC allows you to open and close these circuits in an infinite variety of sequences.

Flexible cam design and optional contact blocks permit this variation in sequence. For example: 18 turn cams and 23 push cams are available—allowing an infinite number of circuit-control arrangements. Any

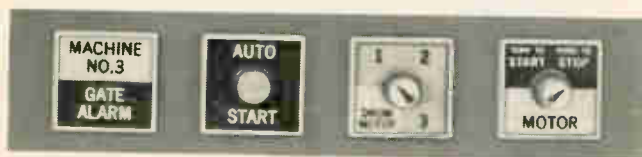

Four Basic CMC Units Available

INDICATOR UNIT for indication only.

PUSHBUTTON UNIT combines 4 lighted legends with pushbutton control.

SELECTOR UNIT combines 4 lighted legends with selector knob.

SELECTOR-PUSH UNIT combines 4 lighted legends with turn and or push knob.

one arrangement using a pair of cams and up to four contact blocks can provide a wide variety of control sequences.



Up to four contact blocks may be used to meet any circuit control requirement:

AVAILABLE CIRCUITRY

TYPE OF CONTACT BLOCK	WITH ONE PLUNGER	WITH TWO PLUNGERS
Each heavy-duty block	One N.O. and one N.C. circuit	Two N.O. and two N.C. circuits
Each electronic-duty block	Two N.O. and two N.C. circuits	Four N.O. and four N.C. circuits

Small wonder CMC is saving up to 3/5 of the panel space in many installations. Ask our CMC Application Engineering Department to show you how you can get more control in less space on your panels. Call a MICRO SWITCH Branch Office or Distributor (see Yellow Pages, under "Switches, Electric"), or write for literature.

MICRO SWITCH

FREEPORT, ILLINOIS 61033

A DIVISION OF HONEYWELL

IN CANADA: HONEYWELL CONTROLS LIMITED, TORONTO 17, ONTARIO

HONEYWELL IS WORLDWIDE • Sales and service offices in all principal cities of the world. Manufacturing in Brazil, Canada, France, Germany, Japan, Mexico, Netherlands, United Kingdom, United States.



ULANO EUROPEAN TECHNICAL CENTER FOR GRAPHIC ARTS

Ulano's technical center in Switzerland is headed by the very capable Mr. Henri Kunz. He is qualified by his many years of experience in the Screen Process and Graphic Arts fields. Demonstrations and technical seminars are held in many languages throughout the year. Complete laboratory facilities have been installed to provide demonstrations of the complete Ulano line. Large stocks of all famous Ulano films are available for immediate delivery to all parts of the world.

You are invited to contact Mr. Henri Kunz at ULANO A.G., Untere, Heslibachstrasse No. 22, Kusnacht 8700, Switzerland, Telephone 905959. It is our pleasure to serve you.



**DO YOU USE
SCREEN PROCESSING
IN THE PRODUCTION OF
COMPLEX
PRINTED
CIRCUITRY?**

TWO NEW PRESENSITIZED FILMS TO SPEED PRODUCTION - LOWER COSTS

Ulano



Write today on your letterhead for free Special Sample Kit 5248

HI-FI RED

HEAVY-DUTY INDUSTRY PROVED

Presensitized photo film used by many leading electronic firms for clean, sharp, tough, durable, almost indestructible screens of unmatched quality. Adheres tightly to wire, silk, nylon and dacron.

PREP®

PRESENSITIZED FOTO FILM

.002 Polyester support guarantees good register. Does not require a dark room. Very good resolution—suitable for halftones. Excellent adhesion to silk, nylon, dacron and metal mesh. Tough, strong emulsion—good for machine printing and long runs.

J. ULANO & COMPANY, INC.

610 Dean Street, Brooklyn, N. Y. 11238, U.S.A.

Cable address: "UlanoFilm"

In Europe: ULANO A.G., Untere, Heslibachstrasse No. 22 Kusnacht, Zurich, Switzerland

HERE'S HOW...



LITHOGRAPHERS, ENGRAVERS, ARTISTS, SCREEN PROCESSORS ALL USE THESE FAMOUS MASKING FILMS TO SEPARATE COLOR, ELIMINATE OPAQUING, PREPARE DROPOUTS, SAVE TIME, REDUCE JOB COSTS



Cut a piece of the desired film large enough to cover area to be masked. Tape it down firmly at the top with dull-side up.



With sharp blade, outline the areas to be masked. *Do not cut through the backing sheet.* The Ulano Swivel Knife does the job quickly, easily.



Using the tip of the blade, lift up a corner of the film thus separating it from the backing sheet.

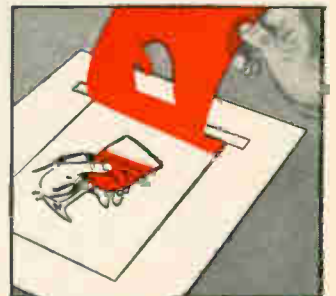

Now carefully peel off the film. Your art work is now separated with the "second color" on a clear Mylar overlay ready for camera and in perfect register.

Ulano T.M.

RUBYLITH T.M. • AMBERLITH T.M.

HAND CUT MASKING FILMS FOR THE GRAPHIC ARTS

ULANO RUBYLITH . . . a revolutionary knife cut red film is laminated to a stable transparent plastic backing sheet. The red film is "light safe" so that when contacted to a sensitized emulsion and exposed to a suitable light source, light passes through the cut-out portions only . . . not through the red film. ■ The mylar® backing is absolutely stable . . . insures perfect register. ■ Special effects such

as crayon tones, paste ups, benday sheets, and opaquing are easily combined with versatile ULANO RUBYLITH. *T.M. Dupont Polyester Film

ULANO AMBERLITH . . . a companion to Rubylith serves as a color separation medium used as the master on camera copy board to secure negatives or positives.

Available in Rolls and Sheets

ulano

610 DEAN ST., BROOKLYN, N. Y. 11238

NEW YORK • CHICAGO • ZURICH



Write today on your letterhead for free Special Sample Kit 5348



If your
Airfreight
shipments play
second fiddle
to passengers...

BETTER CALL A MAN ABOUT A TIGER!

Let's face it. You're paying for *airfreight* service. Why should your cargo take a back seat to passengers? At Tigers, airfreight is our business—our *only* business. So, we give your airfreight the same top priority passenger lines give to people. But, that's not all! Every Tigerservice is geared to save you time, money, effort and worry. That's why it makes sense to ship airfreight with The Airfreight Specialist. Call us for proof: You can't afford *not* to ship Tigers!

Get these Tiger Extras!

Wholesale "Blocked Space" Rates—save up to 15% coast-to-coast and to Chicago ■ Exclusive Advance Manifest Data System—lets you know where your shipment is at any time and when it will be delivered ■ Only Coast-to-Coast All-Cargo Flights with Nonstop Service Both Ways ■ Swingtall CL-44s—only airfreighter that can carry shipments up to 84 feet long!

FLYING TIGER LINE

THE AIRFREIGHT SPECIALIST



Get Fast Delivery on These TI Semiconductors From Weatherford

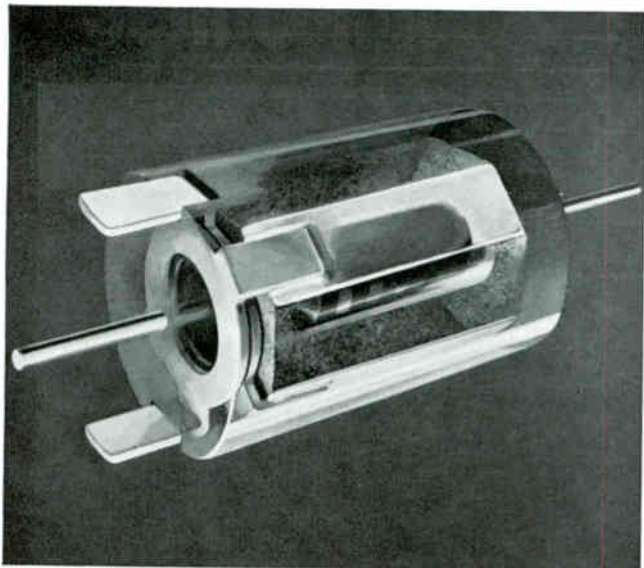

◀ New TI temperature-compensated diodes offer improved temperature coefficients, greater voltage range

New Texas Instruments temperature-compensated diodes offer you greatly increased design flexibility for high-frequency crystals, differential amplifiers, digital voltmeters, and voltage-reference instrumentation. Units are available in 14 standard ratings from 3.3 volts to 12 volts. Maximum TC ratings are 0.005%/°C from -55° to +100°C. Temperature coefficients as low as 0.001%/°C are available depending upon voltage range. The new TI diodes provide temperature stabilization over a wide current range and are relatively immune to voltage fluctuations. Temperature is maintained within 1°C over a 10% voltage change. Call us for immediate delivery of TI's new TC diodes — TIXD746-759.

Sensistor® silicon resistors provide economical, reliable temperature compensation or measurement

Sensistor silicon resistors offer unique, high, *positive* temperature coefficients of + 0.7%/°C (nominal). Available to meet any packaging requirement, they are useful as temperature sensing or measuring elements and provide excellent compensation for the temperature characteristics of silicon transistors. Wide selection available in power ratings from 10 mw to 1/4 watt. Resistance values from 10 to 10,000 ohms.

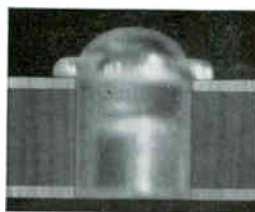

LS-600 in 1/16" PC board

Two TI light sensors give you high sensitivity, fast response

TI's LS-400 and LS-600 light sensors feature stability and uniformity of electro-optical characteristics. Typical light-to-dark current ratio is 100,000 to 1 — speed is fully adequate for all card and tape readers. Unique package design of the LS-600 allows assembly into printed circuit boards. Order now from our complete stock.

GET FULL INFORMATION ON THESE TI SEMICONDUCTORS!

Please send the TI brochures covering diodes, resistors and light sensors to:

(Please Print)

Name _____

Position _____

Company _____

Address _____

City _____ State _____ Zip Code _____

TC diodes Light sensors Sensistor resistors

New bulletins are available on TI temperature-compensated diodes, Sensistor silicon resistors and light sensors. For your copies, complete the coupon, check the information you desire, and send it to us at the address listed below.



R. V. WEATHERFORD CO.

DISTRIBUTORS OF ELECTRONIC COMPONENTS AND EQUIPMENT

GLENDALE 1, CALIFORNIA: 6921 San Fernando Road, VI 9-3451
 ANAHEIM, CALIFORNIA: 1651 State College Blvd., KI 7-7521
 PALO ALTO, CALIFORNIA: 3240 Hillview Drive, Stanford Industrial Park, DA 1-5373

AUTHORIZED
DISTRIBUTOR 

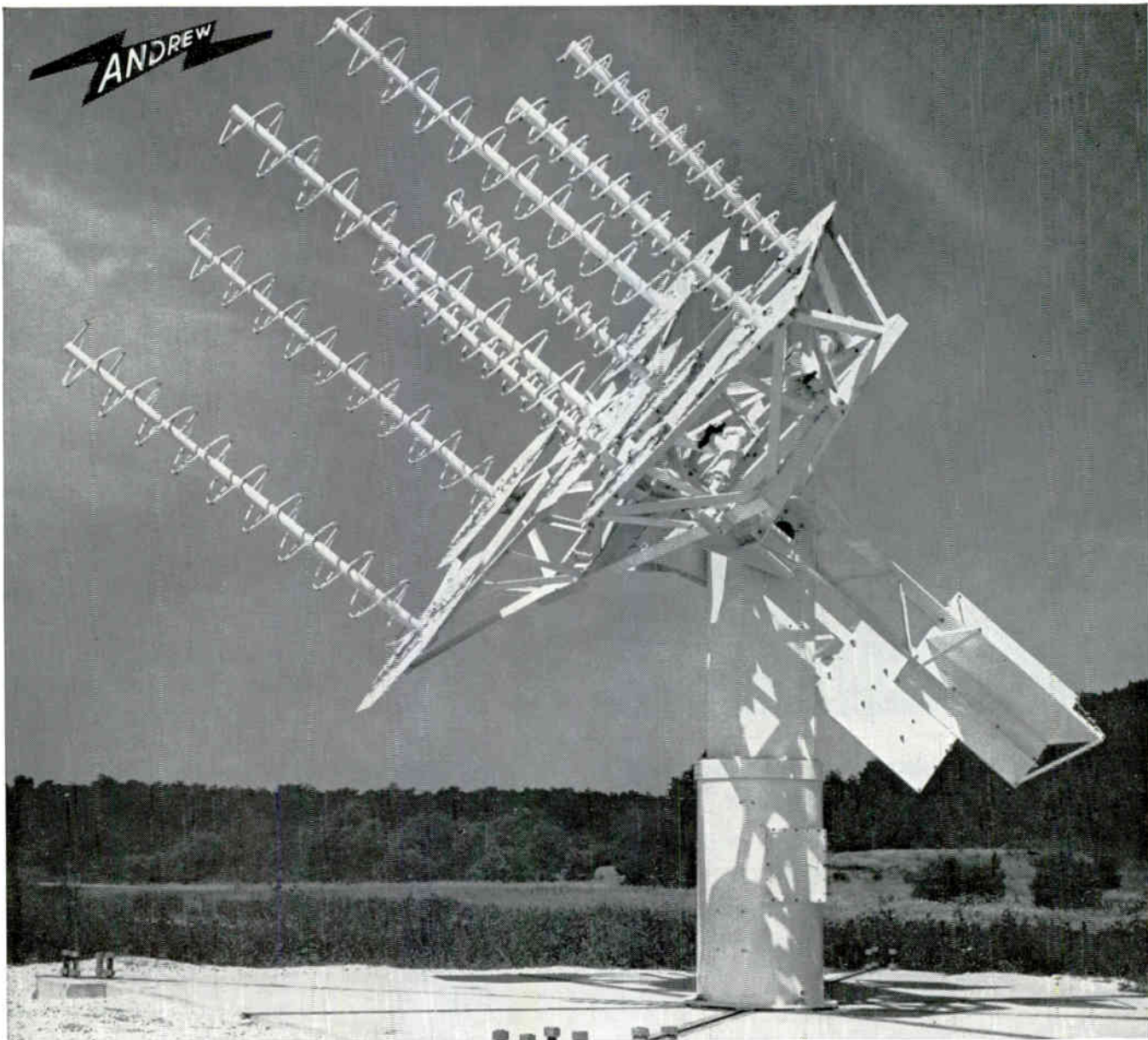

Standard single or dual axis positioners offer electro-manual control, solid state power supply, 125 mph design, and permanently sealed and lubricated motors. Optional features include optical equipment for aligning elevation and azimuth axis, servo controls, mechanical stops and adaptors, special mounts and counterweights.

EUROPEAN OPERATIONS: ANDREW CORPORATION, HØJSGAARDS-ALLE 82, HELLERUP, DENMARK

command control and telemetry antenna systems

**DESIGNED...ENGINEERED...
AND MANUFACTURED AS A COMPLETE PACKAGE**

Andrew antenna systems are designed as complete packages. Antenna and positioner engineering are integrated to guarantee system performance.

Andrew positioners are available with a wide choice of low, medium and high gain telemetry antennas to meet your requirements. HELIAX® coaxial cable provides the most reliable connection between transmitter or receiver and the antenna.

ONE SOURCE—ONE RESPONSIBILITY...Contact your Andrew sales engineer or write for complete system information and delivery.

5-65A

28 YEARS OF ENGINEERING INTEGRITY

Andrew
CORPORATION
P. O. BOX 807 • CHICAGO, ILLINOIS U.S.A. • 60642

Washington Newsletter

December 27, 1965

Military may face supply shortages

The Vietnam war is placing increasingly greater pressure on the military's supply facilities. Orders for off-the-shelf items the Defense Supply Agency buys for the military are running about 40% ahead of six months ago.

The rapid pace of shipments to Vietnam may lead to shortages of some military items. So far, however, no shortages of electronic items have been reported.

The DSA is already tackling the problem of potential shortages: it's warning industry—the textile industry now, with warnings to other industries likely later—that it may invoke production and delivery priorities under the Defense Production Act of 1950 to insure prompt delivery of war materiel.

For the next six months, the supply agency plans to boost spending for electronics equipment 20%, to \$81.3 million from the original estimate of \$67.4 million.

Vietnam spending delays Nike X . . .

The rise in military spending for the Vietnam war is resulting in some federal budget casualties. For example, Defense Secretary Robert S. McNamara is expected to recommend that the White House delay, for at least a year, its approval of production of the Nike X antimissile missile. McNamara's concern about a Red Chinese missile threat has not lessened—this was evident in his recent warnings to the North Atlantic Treaty Organization—but he feels there is still time to meet this potential missile threat even if production of the Nike X is put off for another year.

The Nike X program is expected to cost between \$6 billion and \$20 billion, depending on the sophistication of the electronics equipment designed for the system.

. . . development of the MOL . . .

Another casualty of the budget squeeze is the proposed manned orbiting laboratory (MOL). The Air Force requested \$300 million in fiscal 1967 for the MOL, but will receive only half of that or less. The cut would delay the first launch for one year to 1968 or 1969. This could mean serious trouble for the military project, because by then the National Aeronautics and Space Administration's three-man Apollo spacecraft will have been checked out for a landing on the moon, making the Apollo vehicle an attractive substitute for MOL.

Apollo is being developed by North American Aviation, Inc., and MOL by the Douglas Aircraft Co. and the General Electric Co.

. . . and NASA's probe of the sun

Suspension of work on the Advanced Orbiting Solar Observatory (AOSO)—another victim of White House budget-cutting—leaves several R&D projects in electronics uncompleted [Electronics, Nov. 29, p. 32]. The prime contractor for AOSO was the Republic Aviation Corp., which had a \$58-million order for two satellites. The major subcontractors were Honeywell, Inc., with a \$14.2-million contract to build the stabilization system, and Texas Instruments Incorporated, with a \$12.3-million order

Washington Newsletter

for a data-handling system for the satellite.

The announcement of the suspension caught the contractors by surprise: the Bendix Corp. disclosed a nearly \$1-million order to make a star tracker for AOSO just days before the stop-order was made public by NASA.

Despite the suspension, NASA says the project—which was to be begun in 1969—may still be reinstated.

Second source for satellites

By selecting TRW, Inc., to negotiate for the development of six 1,200-channel global communications satellites, the Communications Satellite Corp. is ending the virtual monopoly of the Hughes Aircraft Corp. in that field. The move gives Comsat a second source for synchronous communications satellites.

TRW won the contract even though its bid was reportedly about 20% higher than Hughes's. Another factor influencing Comsat's decision is said to have been TRW's assurance that it will use a dozen or more foreign components in its satellites. Comsat's overseas partners want a bigger share of the communications company's procurement dollar.

One action that will broaden Europe's participation in Comsat was Spain's decision to build its own ground station and begin service with 24 channels by 1967. Negotiations for the construction of the station, which would use an 85-foot dish, are being conducted with the International Telephone and Telegraph Corp. Other countries considering ground stations are Nigeria, Colombia, Peru, Ethiopia and Kuwait. And Algeria may build a station that would serve a bloc of Arab nations.

Within weeks, Comsat will issue a call for a multipurpose synchronous satellite capable of handling ship and aircraft communications as well as television distribution; the satellite may also be required to carry weather data. It's believed that Comsat will want the new satellite in service by late 1967.

Log-rolling delays work on accelerator

It will be at least a year before construction starts on that 200-billion-volt accelerator, proposed several years ago by the Atomic Energy Commission. Because of budget problems and politicians' squabbles over the site of the \$300-million facility, government officials are deleting from fiscal 1967's budget most of the \$7 million in engineering and design money needed to get work under way.

Italy's F-104 deal means \$170 million for U. S. suppliers

Agreement between the United States and Italy for Italy to build 162 F-104's, under license with the Lockheed Aircraft Corp., will mean about \$170 million in business for U. S. electronics companies. The U. S. government is arranging for \$85 million in credit for the deal, with Italy to finance the balance of the \$400-million purchase on its own.

Italy's Fiat S.p.A. will build the Mach-2.4 airplane, which will undergo some changes. The Raytheon Co. will partially redesign the Sparrow missile so it can mate with the F-104; the Autonetics division of North American Aviation, Inc., will modify the aircraft radar, and Lockheed will make some structural changes in the airplane.

U. S. suppliers will probably carry the program through the R&D and flight-test stages; Italian production should start within a year.

If you can't believe a low-cost molded electrolytic can be this good...
 Test the MTA yourself.

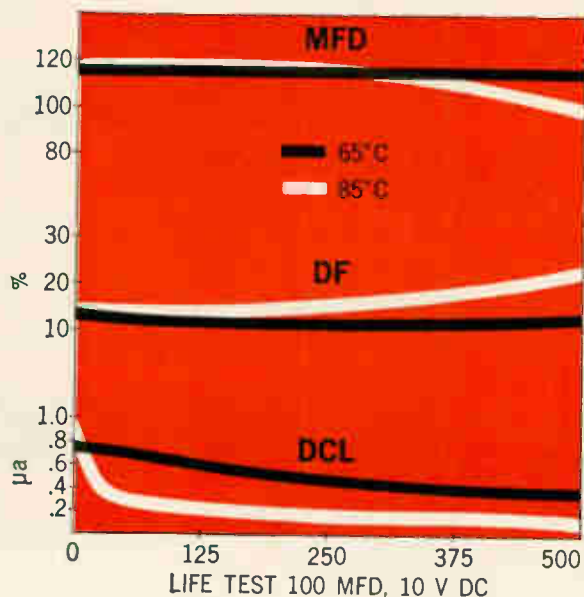
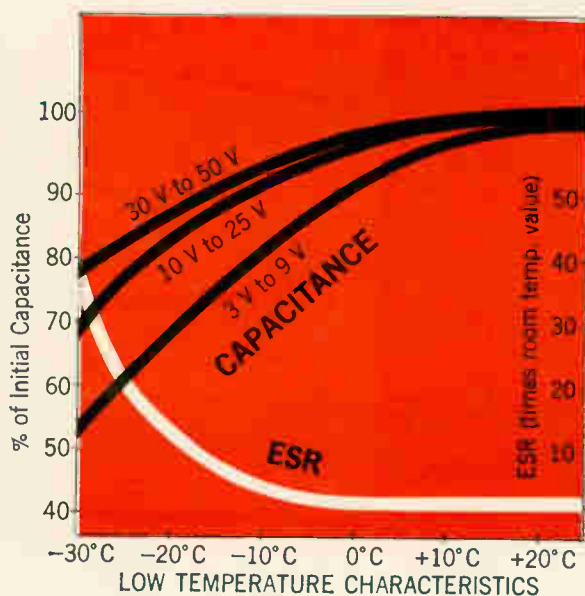

Here's what we've found out about the MTA:

Low Temperature Stability — equal to or better than many metal-case miniatures down to -30°C .

High Temperature Life — zero failures in one million piece-hours at 85°C . Only one failure in $2\frac{1}{2}$ million piece-hours at 65°C .

Maximum Values—800 mfd, 3 VDC to 85 mfd, 50 VDC.

*For a sample order for evaluation,
 call Jim Shaffer, collect, at
 317-636-5353, Extension 403*

*Or write Mallory Capacitor Company,
 a division of P. R. Mallory & Co. Inc., Indianapolis, Indiana 46206*



Available from stock at factory prices
 from franchised Mallory Distributors

now you see it...

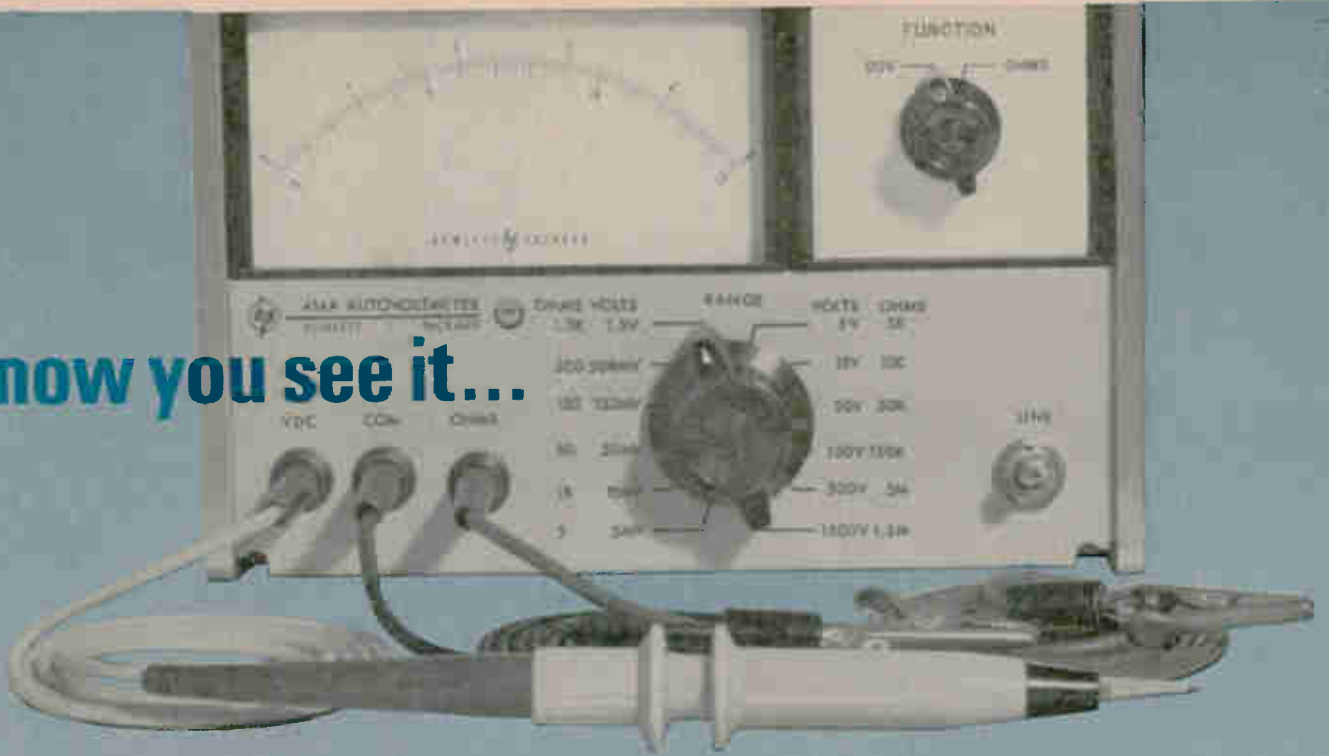

now you don't!



the case of a missing range switch SOLVED!

*A \$650 analog dc volt-ohmmeter with fast automatic ranging
plus an accuracy of $\pm 0.5\%$ of full scale $\pm 0.5\%$ of reading!*

No more manual range switching with the Hewlett-Packard 414A Autovoltmeter. Range and polarity change automatically . . . provide digital range, polarity readout in less than 300 milliseconds . . . and still give you the convenience and economy of unusually accurate analog measurements! What's more, the 414A lets you make *resistance* measurements, again with automatic ranging, on a *linear* analog meter scale!

Here's the world's first "touch-and-read" analog volt-ohmmeter with accuracy anywhere approaching what you require for trouble shooting, tweaking, peaking and nulling, probing a circuit without a schematic. Use it for maintenance testing, on the production line, in the lab.

In the dc voltage function you simply touch the point to be measured and in less than 300 msec read the range and polarity of the measurement on the digital display at the top of the 414A . . . the precise dc measurement on the individually calibrated, mirror-backed taut-band meter. Range 5 mv full scale to 1500 v full scale in 12 automatically selected and displayed ranges.

Or measure resistance 5 ohms to 1.5 megohms . . . on a linear scale that gives unprecedented accuracy, especially on the lower ranges. The 12 resistance ranges are automatically selected and displayed, as well.

Ranges also can be selected and held manually. Another feature is a Down Range control which lets you drop to the next lower range merely by pushing a front-panel button. High input resistance. All solid-state. Compact, only 10¼ lbs.

The details are in the specifications. But to get the true significance of this automatic instrument, you need to see it perform on your bench. Call your Hewlett-Packard field engineer for that convincing demonstration. Or write for complete information to Hewlett-Packard, Palo Alto, California 94304, Tel. (415) 326-7000; Europe: 54 Route des Acacias, Geneva; Canada: 8270 Mayrand Street, Montreal.

SPECIFICATIONS

DC VOLTMETER

Voltage range: ± 5 mv to ± 1500 v full scale, 12 ranges, manual or automatic ranging

Accuracy: $\pm 0.5\%$ of reading $\pm 0.5\%$ of full scale

Input resistance: 10 megohms on 5 and 15 mv ranges, 100 megohms on 50 mv range and above

Superimposed ac rejection: insensitive to 60 cps signal with peak value less than 7 times the full-scale dc level of the range in use in "Hold" position (rejection is 20% of reading in Autoranging)

OHMMETER

Resistance range: 5 ohms to 1.5 megohms in 12 ranges (manual or autoranging with linear scale)

Accuracy: $\pm 1\%$ of reading $\pm 0.5\%$ of full scale on any range

Source current: 1 ma through unknown up to 5 K ohms, 1 μ a above 5 K ohms

GENERAL

Range selection: voltage and resistance, automatically selects correct range in less than 300 msec; a particular range may be selected manually

Polarity selection: automatic
Meter: individually calibrated taut-band meter with mirror scale; linear scale, 0 to 5 and 0 to 15

Isolation resistance: at least 100 megohms shunted by 0.1 mf between common terminal and case
Floating input: may be operated up to 500 v dc above ground

Dimensions: 6 18/32" high, 7 25/32" wide, 11" deep (87 x 130 x 279 mm); 10¼ lbs (6,4 kg)

Price: \$650

Data subject to change without notice. Price f.o.b. factory.

HEWLETT  **PACKARD**
An extra measure of quality

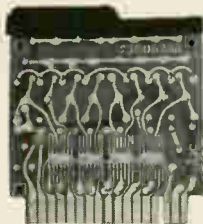

OD-335 OCTAL/DECIMAL DECODER PAC contains a prewired binary-to-octal decoder and two additional independent NAND gates to expand the matrix for BCD-to-decimal decoding.

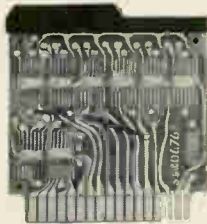

BC-337 FAST CARRY COUNTER PAC contains an eight-stage prewired counter which can be easily converted to a binary counter or BCD counter by using jumper connections.

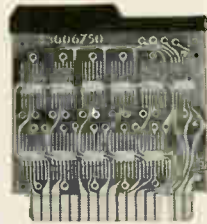

BC-336 BINARY COUNTER PAC contains between 8 and 20 prewired binary counter stages; number of stages is determined by user. Can be used for counting and frequency division.

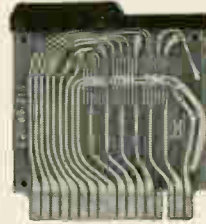

BC-335 COUNTER PAC contains six independent flip-flops with appropriate inputs for operation as binary counters; may also be employed individually as complementing flip-flops.

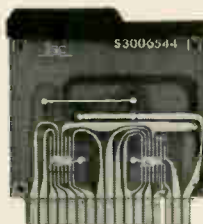

EO-335 EXCLUSIVE OR PAC contains five independent functional gate structures and one independent NAND gate; each contains 3 two-input NAND gates and performs AND-OR and AND-OR-INVERT functions.

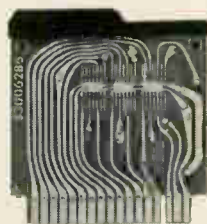

BR-335 BUFFER REGISTER PAC contains six flip-flops with independent set-reset capability for parallel loading of information. Common clock reset inputs make possible simultaneous operations on all stages.

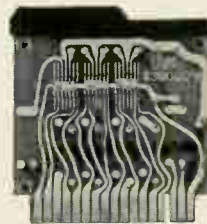

XD-335 TRANSMISSION LINE DRIVER PAC contains 6 two-input driver circuits. Each circuit is capable of driving standard 50 ohm, 75 ohm and 93 ohm coaxial cables at repetition rates up to 5 megacycles.



LD-330 LAMP DRIVER PAC contains twelve identical independent lamp driver circuits. Each circuit is capable of switching 70 milliamps of current at any positive voltage up to 20 volts, at a maximum frequency of 1 mc.

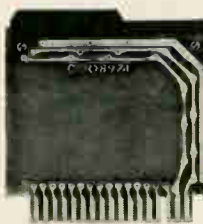

BP-330 BLANK PAC — standard card with etched buses for +6V, -6V and ground — facilitates mounting special circuits using standard component lugs and point-to-point wiring. Also available: standard copper clad PAC kit for custom etching.

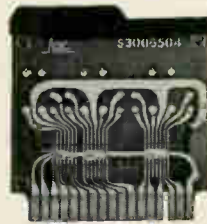

DL-335 NAND TYPE 2 PAC contains 6 four-input NAND gates; two have disconnected collector load resistors brought out on separate terminals. By tying the gate outputs to a single load circuit a number of gates can be connected in parallel without reducing output drive capability.

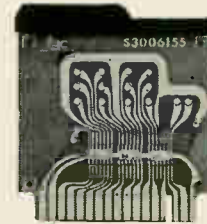

DN-335 EXPANDABLE NAND PAC contains 6 three-input NAND gates with nodes; two have disconnected load resistors which are brought out on separate terminals. Gate node input allows for expansion of the number of gate inputs by attachment of diode clusters.

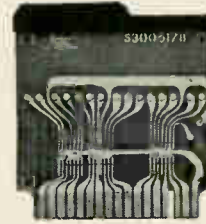

DI-335 NAND PAC contains 10 two-input NAND gates; two have collector loads separate from the collector outputs. By tying the gate outputs to a single load circuit, a number of gates can be connected in parallel without reducing output drive capability.

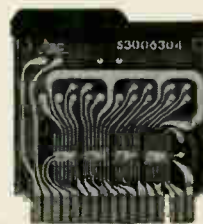

DG-336 SELECTION GATE TYPE 2 PAC contains two independent functional gate structures; each has 4 three-input NAND gates and performs the AND-OR-INVERT function.

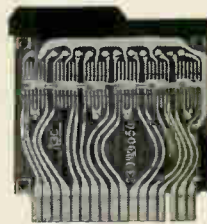

DG-335 SELECTION GATE TYPE 1 PAC contains four independent functional gate structures. Each has 3 two-input NAND gates and performs the AND-OR-INVERT function.

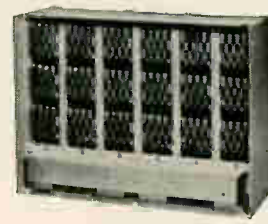

MOUNTING HARDWARE is available with PAC capacities between 24 and 144 modules, and a choice of wire-wrap or taper pin connectors. Power supplies are offered in plug-in or rack-mount models. Accessories include auxiliary wire wrap kits, wire wrapping tools, taper pin insertion tools, extender PACS, jumper lead sets, instruction manuals and logic symbol sticker kits.

Modules

5 mc operation • high packaging density • low cost per logic function • inherent reliability • noise protection in excess of one volt • low power consumption • NAND logic • DC coupled circuitry



FA-335 GATED FLIP-FLOP PAC contains four independent flip-flops, each with AC and DC inputs and a common reset; allows for control of the flip-flop from a variety of level and pulse inputs.

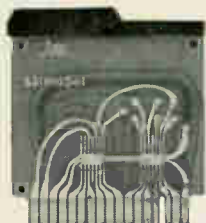

UF-335 UNIVERSAL FLIP-FLOP PAC contains three independent flip-flops each with AC and DC input gating and a common reset; can perform all functions of other μ -PAC flip-flops plus many additional logic operations.

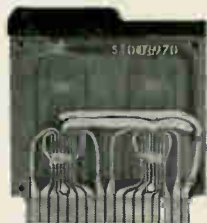

FF-335 BASIC FLIP-FLOP PAC contains eight independent flip-flops. Each stage has a DC set and reset input and a set and reset output. Circuit consists of two NAND gates internally wired back-to-back.

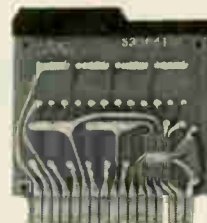

DC-335 MULTI-INPUT NAND PAC contains 2 six-input NAND gates with nodes and 4 three-diode clusters. Gate node input allows for diode cluster expansion of the number of gate inputs.

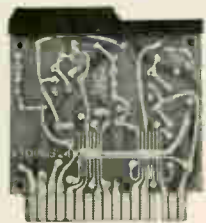

DM-335 DELAY MULTIVIBRATOR PAC contains two independent monostable multivibrators capable of generating assertion and negation pulses in a variety of widths. Each circuit has two NAND inputs, an Enable and three discrete variable delay taps.

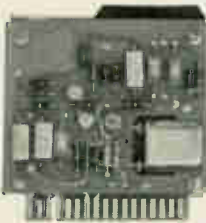

MC-335 MASTER CLOCK PAC contains a crystal controlled oscillator, a pulse shaper and a pulse amplifier. The oscillator operates between 200 kc and 5 mc. The pulse shaper section can vary pulse width between 50 and 150 nanoseconds.

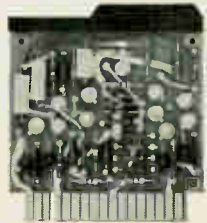

ST-335 SCHMITT TRIGGER PAC contains two independent trigger circuits capable of converting various shaped inputs to a μ -PAC output. Switching levels can be varied from +2.5 volts to -2.5 volts by making appropriate pin connections.

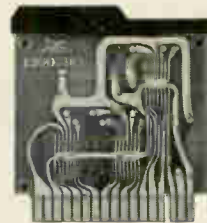

PA-335 POWER AMPLIFIER PAC contains 6 three-input high-drive NAND gates, each capable of driving 25 unit loads and 250 picofarads stray capacitance. Each gate has two electrically common outputs to reduce load distribution current.

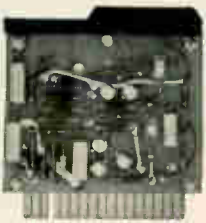

MV-335 MULTIVIBRATOR CLOCK PAC contains a free-running variable frequency multivibrator, a pulse shaper and a pulse amplifier. The multivibrator operates between 200 kc and 5 mc; frequency and pulse widths can be varied by means of potentiometer-capacitor networks.

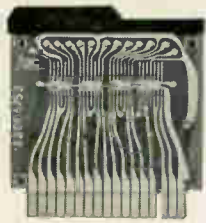

TG-335 TRANSFER GATE PAC contains four independent functional gate structures. Two of the structures have 4 two-input NAND gates, one input on each gate being common to the four gates. The remaining two structures have 3 two-input NAND gates, one input being common to the three gates.

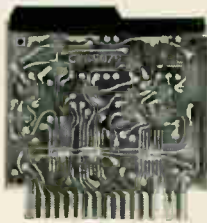

LC-335 NEGATIVE LOGIC LEVEL CONVERTER PAC contains 10 independent two-input circuits. Each circuit accepts signals at ground and -4 to -15 volts and provides a μ -PAC output. Also available is the S-PAC LC-35 Positive Logic Level Converter PAC which mates μ -PAC signals with 3C's S-PAC.

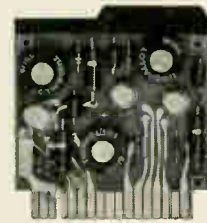

SD-330 SOLENOID DRIVER PAC contains three independent circuits for driving heavy resistive, capacitive or inductive loads. Each circuit has two NAND inputs and is capable of switching up to one ampere of current at 500 cycles per second from a positive supply of up to 28 volts. One independent two-input NAND gate is also included.



3C SALES OFFICES: NEEDHAM, MASS.; FOREST HILLS, N.Y.; LEVITTOWN, PA.; SYRACUSE, N.Y.; SILVER SPRING, MD.; HOUSTON, TEXAS; HUNTSVILLE, ALA.; ORLANDO, FLA.; DES PLAINES, ILL.; DETROIT, MICH.; CENTERVILLE, OHIO; LOS ANGELES, CALIF.; PALO ALTO, CALIF.; KENT, WASH.; ALBUQUERQUE, N.M.

COMPUTER CONTROL COMPANY, INC.
OLD CONNECTICUT PATH, FRAMINGHAM, MASSACHUSETTS 01702



TERMINALS FIT
0.062-INCH
GRID HOLES

0.200-INCH
CENTERS

Made for each other...

AE's new
dry-reed switches
and standard
printed-circuit boards

That's because PC CORREEDS* are specifically designed for direct insertion into standardized grids. Terminals are located on multiples of 0.200-inch centers. And all terminals are designed to fit standard 0.062-inch holes; permit the use of small wiring pads. Standardized terminal size and spacing also allow for greater packaging density.

In addition to this feature, PC Correeds have separate terminals to eliminate strain on the glass capsule.

These terminals are "ribbed" for added strength and rigidity, and are welded . . . not soldered . . . to the capsule leads. Individual capsules can be removed without having to remove the entire package. The bobins are made of glass-filled plastic for greater strength and to eliminate breakdown due to moisture absorption.

For the full facts on how these new AE Printed-

Circuit Correeds meet the requirements of modern electronic circuitry, write to the Director, Electronic Control Equipment Sales, Automatic Electric, Northlake, Illinois 60164.

2-capsule
(Forms 2A,
1B, or 1A
Mag. Latch)

3-capsule
(Forms 3A,
2B, or
1A-1B)

5-capsule
(Forms 5A
or 2A-2B)



*Patent applied for.

AUTOMATIC ELECTRIC
SUBSIDIARY OF
GENERAL TELEPHONE & ELECTRONICS **GTE**



DESIGNERS AND MANUFACTURERS OF PRECISION MICROWAVE EQUIPMENT
WEINSCHTEL ENGINEERING

GAITHERSBURG, MARYLAND • TEL. AREA CODE 301, 948-3434 • TWX 301 926-3730
SANTA MONICA, CALIFORNIA • 1318 SECONDO STREET • TEL. 213-879-0490 • PHAX 213-394-1154

the very best for you
this year
and always

THE PURSUIT OF PRECISION—The products on this page, new from Weinschel Engineering in 1965, continue the advancement of the "state of the art" in microwave measurements pursued by us for more than fifteen years. Weinschel Engineering's research into and development of attenuator design principles, microwave resistive films, connector improvements, and measurement techniques has resulted in a sustained flow of new precision components and instruments for the precise determination of power ratios, power, and impedance. For further information on these and other Weinschel Engineering products such as attenuators, RF sources, and power bridges, as well as impedance, insertion loss, and phase measuring systems, we proudly recommend your consulting our new Weinschel Engineering Condensed Catalog for 1966 (circle Reader Service #193). Your inquiries are solicited and welcomed.

LA RECHERCHE DE LA PRECISION — Les produits qui figurent sur cette page, fruit de la technique de Weinschel Engineering pour 1965, continuent à faire progresser la technique de la mesure des micro-ondes, objectif que nous poursuivons depuis plus de quinze ans. Les travaux que Weinschel Engineering a effectués dans le domaine de la recherche et de la mise au point concernant les principes constitutifs des atténuateurs, les films de résistance aux micro-ondes, les perfectionnements apportés aux bandes de connexions, et les techniques de mesure, se sont traduits par une succession importante de nouveaux composants et instruments de précision destinés à la détermination exacte des rapports de puissance, du courant et de l'impédance. Pour de plus amples renseignements sur ces produits ainsi que sur le reste de la production de Weinschel Engineering, tels que: atténuateurs, sources de haute fréquence et ponts, de même que les systèmes d'impédance, d'affaiblissement d'insertion et de mesure de phases, nous vous recommandons hautement de consulter le nouveau catalogue abrégé de notre maison pour 1966 (veuillez entourer d'un cercle le No. 193 du Service aux lecteurs). Il sera répondu avec empressement à toutes vos demandes de renseignements

DIE JAGD NACH PRAZISION — Die Produkte auf dieser Seite, vor kurzem erst von Weinschel Engineering entwickelt, zeigen die dauernde Verbesserung der höchstmöglichen Genauigkeit in Mikrowellen Messungen die von uns schon seit 15 Jahren verfolgt wird. Weinschel Engineering's Forschung und Entwicklung von neuartigen Dämpfungsgliedern, Widerstandsfilmen für Mikrowellen, Verbesserungen von Steckern und Messmethoden fanden ihren Niederschlag in einer Welle von neuen Teilen und Instrumenten für die genaue und präzise Bestimmung von Leistungsverhältnissen, absoluter Leistung und Impedanz. Wünschen sie Informationen über Weinschel Produkte, z.B. Dämpfungsglieder, R.F. Generatoren, Leistungsmessbrücken, Impedanz-, Dämpfungs- und Phasen-Mess Systeme, benutzen sie bitte unseren neuen Weinschel Engineering Katalog für 1966 (Für Zusendung bitte "Reader Service" Nummer 193 ankreuzen.) Ihre Anfragen werden prompt beantwortet.



Models 1 and 2, Precision Fixed Coaxial Attenuators: These DC to 12.4 Gc and DC to 18.0 Gc attenuators are made using the new special low temperature coefficient (0.0001 db/db/°C) resistive film and semi-precision stainless steel type N connector. Models are available in 3, 6, 10 and 20 db values. Absolute value is typically with $\pm 5\%$ in db of nominal. Calibrations at six frequencies are stamped on the attached name plate. (RS #194)

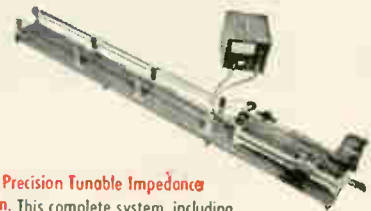

Model 1050, Precision Tunable Impedance Measuring System. This complete system, including Model 1000R Precision Slotted Line and Model 1800 Stabilized SWR Indicator, permits measurement of VSWR to 1.002 over a frequency range of 1.0 to 6.0 Gc. Exceptionally low slope and irregularity plus AGC for equivalent RF source stabilization make feasible the use of an expanded 1.06 SWR indicator scale. (RS #198)



Model 1800, Stabilized SWR Indicator. Automatic gain control compensates for RF source variations in this transistorized SWR indicator and makes possible the full use of a 1.06 VSWR expanded scale. With the addition of a precision 50 db audio substitution attenuator at the input, the instrument is also available as the Model 1801 Stabilized Attenuation Calibrator. (RS #195)



Model 1802, Displacement and Vibration Meter. This new high resolution device measures random or periodic displacements of any surface that reflects a microwave signal. Dynamic resolution of 1 microinch is possible with non-contact sensing out to 1 foot. The unique combination of high resolution and remote sensing permits many new and interesting applications. (RS #196)



Model HO-1 Heterodyne Mixer-Oscillator. This complete local oscillator-mixer package provides for the heterodyne conversion to 30 Mc of signals in the frequency range from 10 Mc to 12.4 Gc. The Model HO-1 was designed for use with the Model VM-3 Attenuator and Signal Calibrator, the Model VM-1 Standard Attenuator Comparator, and similar 30 Mc heterodyne receivers. (RS #199)

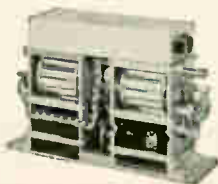

Model 90 and 91, Sliding Switch Step Attenuators: These models feature virtually frictionless sliding switch contacts and stable broadband high performance attenuation inserts. Available in both manual and motor driven programmable versions, all models operate over DC to 12 Gc with a wide selection of ranges as high as 100 db. (RS #197)

newest Esterline Angus design breakthrough

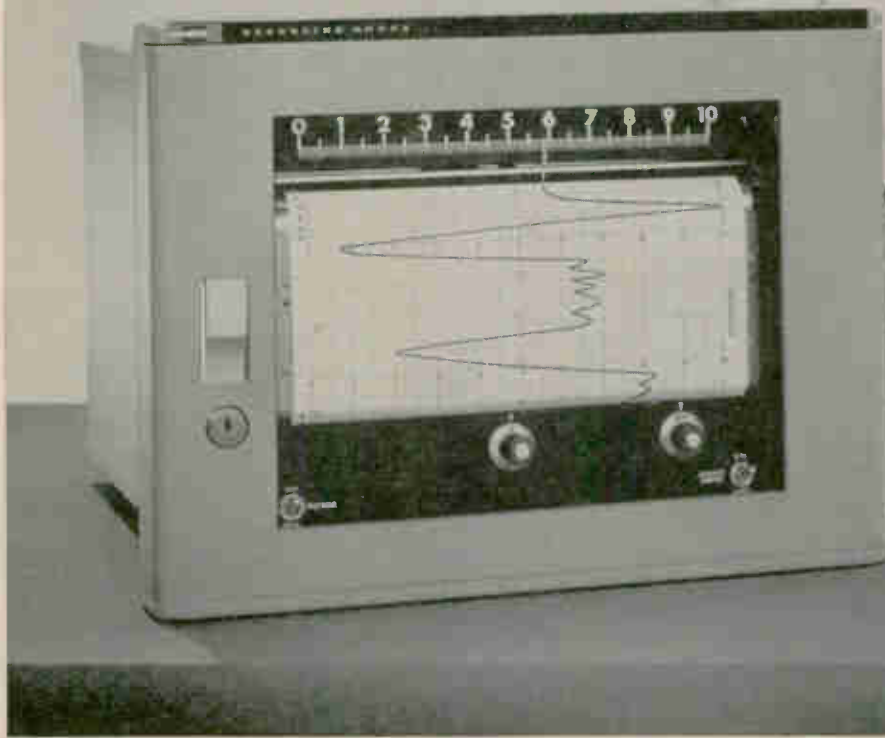

Illustrated is E1101S Speed Servo,® one of five new Series "E" recorders

**1/5 second response over 10" span }
+ inertial ink pump } = the only wide chart
Speed Servo®**

Never before has a servo recorder offered the versatility, dependability and reliability of the Wide Chart Esterline Angus Speed Servo.® It delivers:

- 1/5 second response over the full 10" span.
- spans as low as 1 MV.
- a servo mechanism with only one moving part . . . no drive cords to break or gears to wear.
- new inertial ink pump (patent applied for) provides skip-free writing at any pen speed.
- optional adjustable zero—adjustable span . . . zero displacement to ± 100 MV . . . spans from 1 to 100 MV.
- solid state amplifier.
- source impedance of 50,000 ohms.
- conductive plastic feedback potentiometer lasts thousands of hours longer than any wire wound potentiometer.

Our new Series "E" Catalog has the complete story. Write for it.

ESTERLINE ANGUS INSTRUMENT COMPANY, INC.
Box 24000-E • Indianapolis, Indiana 46224

Open door shows automatic chart drive controls . . . dial any one of 15 speeds instantly . . . from 1/2" per hour to 8" per second without gear change, motor change or screw driver adjustments . . . sloped writing surface and chart tear off bar are featured.



ESTERLINE ANGUS

Excellence in instrumentation for over 60 years



Technical Articles

**New target for radar—
sharper vision with
optics:
page 58**

As radar peers farther, sights more sharply and penetrates jamming better than ever, the information-processing capacity becomes a critical limitation. To cope with an explosion of data, engineers are developing optical signal processing techniques to replace conventional electrical ones. Because the new systems are two-dimensional, they can process two parameters simultaneously.

**Coding for error control;
an examination of
techniques:
page 70**

In the struggle to make digital communications error-proof, engineers are developing a lot of new codes and new approaches to coding. The brute-force method of repeating transmission is being replaced by block codes; nonblock codes have been proposed, but they are still in their infancy.

**European electronics
markets 1966:
page 81**

Electronics

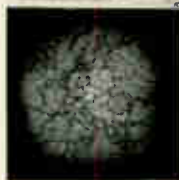

In Europe, the application of electronics grows rapidly, creating broad new markets for European, Japanese and U. S. products. Until now, there have been no detailed statistics available. To fill this gap, the editors of Electronics have surveyed the key countries of Europe—West Germany, Great Britain, France, Italy, The Netherlands, Belgium, Sweden, Switzerland and the

Soviet Union—to produce the first detailed information. Additionally, they examined the trends in technology and markets. In general, the biggest growth areas are in computers, communications and industrial electronics. Sales of consumer products seem to be in a plateau, faced with saturation, while production of military electronics declines because of the uncertainties in the future role of the North Atlantic Treaty Organization. For the cover, art director Saul Sussman created a unique world globe to focus on Europe.

**Coming
January 10, 1966**

- **Electronic's annual U.S. market report**
- **New semiconductor lasers**
- **Wideband oscillator uses tunnel diodes**
- **Electronic resolvers for analog computers**

New target for radar: sharper vision with optics

Information-processing capacity of systems faces challenge of supersonic speed; with optical techniques, more data is handled faster with less equipment

By A.J. Talamini, Jr., and E.C. Farnett

Radio Corporation of America, Moorestown, N.J.

Radar peers farther, sights more sharply, and penetrates jamming better than ever before. Big systems must sort out vast amounts of information on targets that are sometimes moving at supersonic speeds. To cope with this explosion of information, engineers are developing signal-processing methods based on optical rather than electrical systems.

A basic advantage of optical systems is their two-dimensional capability. Electrical systems are one-dimensional. This two-dimensional capability may be used, for example, to process two parameters simultaneously—such as range and velocity, or velocity and acceleration—through a single information channel. A significant advantage of this capability is that the system provides means of processing tremendous quantities of data in real time. Also, optical processing permits a considerable reduction in the size and complexity of the

equipment over that required by typical electrical approaches.

Several types of optical radar signal processors have been used over the past few years. Some of these have used cathode ray tubes, various types of film processing systems, and transparent optical quartz delay lines with both quasi-coherent and noncoherent optics for processing radar returns. Much of the work that will be described here has been derived from the concept of using a rotating optical disk as the basic component in the optical processing system.

Rotary optical correlator

The concept of using a rotating optical disk was first applied to a noise-correlation radar system. Noise-correlation radar systems often transmit continuous wideband noise-like signals. Targets are detected by correlating the received signals with a delayed replica of the transmitted signal. The delay that must be introduced to achieve a correlation peak is proportional to the target range.

The classical approach to a noise-correlation radar system is seen at the top of page 59. A pseudo-random or noise-like signal is generated and transmitted. A replica of this transmitted signal is delayed and then electronically multiplied with the received signal. The maximum integrated product occurs when the delay is equal to the round-trip time to and from the target. Thus, the presence of a target can be detected.

In practice, this system is limited since targets at only one range can be detected at any given time. By allowing the delay time to vary slowly, the system can be extended to detect targets at more than one range. The rate of change of delay, however, must be sufficiently slow to permit adequate integration time for any given target. An

The authors



Arthur J. Talamini, Jr., is an engineering leader in the advanced electronics technology section of the RCA missile and surface radar division. His experience has been with electronics development and technical direction, including television, radar, oscillography, instrumentation and missile automatic checkout.



Edward C. Farnett is an engineering leader in the advanced electronics technology section of the RCA missile and surface radar division. He is engaged in the development of advanced analog, digital, and optical processing techniques for advanced radar systems.

alternate way to increase range coverage is to add additional delays of varying lengths with multiple parallel multipliers and integrators.

A rotary optical correlator provides these additional delays without the need for actual physical delay lines, simultaneously performs the parallel correlation processes and, in addition, provides the capability of extracting doppler, or velocity, information as well as range information.

The capability of this rotary optical correlator is equivalent to a pulse compression ratio of 50,000 to 1, with a flexible exchange of time and bandwidth within this value. The ratio is that of the radiated signal pulse length to the equivalent range-resolution element. The rotary optical correlator can provide up to 50,000 range elements and 240 doppler elements for a total of 12-million range-doppler elements. A range or doppler element is the minimum resolvable distance or radial velocity, respectively, between targets. Readout requirements were set at 1,200 range elements and 240 doppler elements for a total of 280,000 range-doppler elements to be available at any one time, and techniques have been developed to allow search through the entire range dimension.

Loop of film

To introduce the concept of the rotary-optical correlator, the general method of operation will first be presented as though the reference signal, or transmitted signal, is obtained from a moving loop of film. Extension of this idea to a rotating optical disk will be obvious.

The optical correlation radar system is illustrated in the diagram below. The system has a constant-intensity light source L_1 and pick-up tube, a

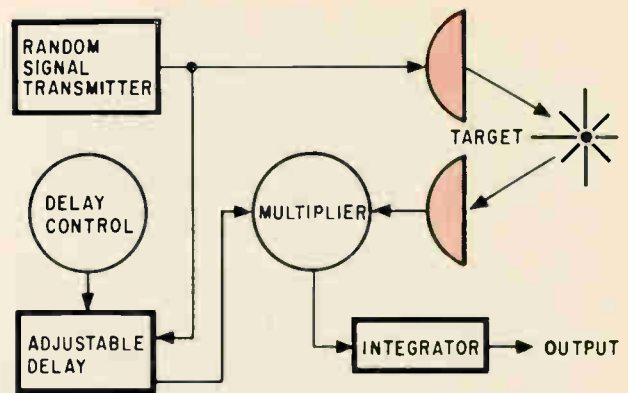

In a noise-correlation radar system, the target is detected by generating and transmitting a pseudo-random signal. A delayed replica of the signal is electronically multiplied with the received signal. The maximum integrated product occurs when the delay is equal to the round-trip time to and from the target.

modulated light source L_2 , a high-speed moving reference function, and an optical integrator and readout system. The reference signal is in the form of alternate transparent and opaque areas of varying lengths on the loop of film. The spacing or widths of the transparent and opaque areas correspond to the type of coding that is being used. This may be in the form of a frequency-modulated code, a pseudo-random noise code, or whatever form of complex coding is required. A light beam from a constant-intensity light source L_1 passes through the center track of the loop of film shown by the line through the center of the film. As the film loop moves past the light source, the beam of light is interrupted at a rate determined by the coding of this reference track. The light signal at

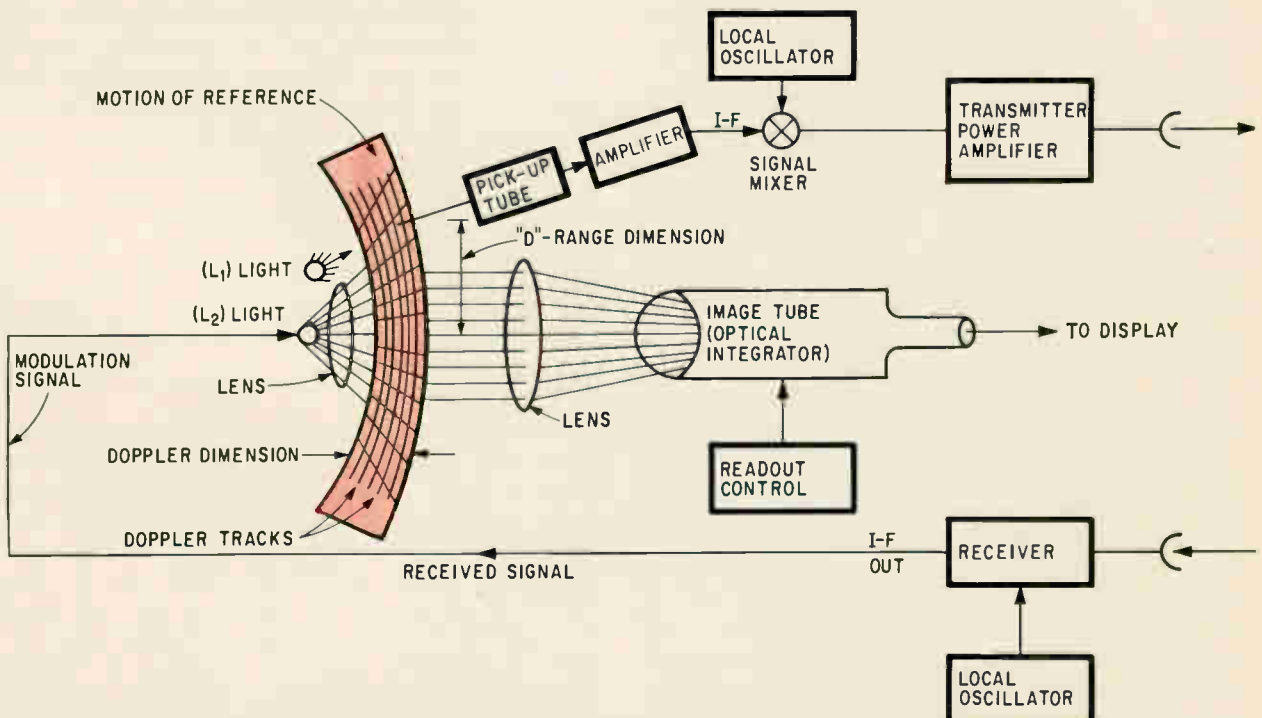

Optical correlation radar consists of a constant intensity light source L_1 and pick-up tube, a modulated light source L_2 , a high speed moving reference function, and an optical integrator and readout system.

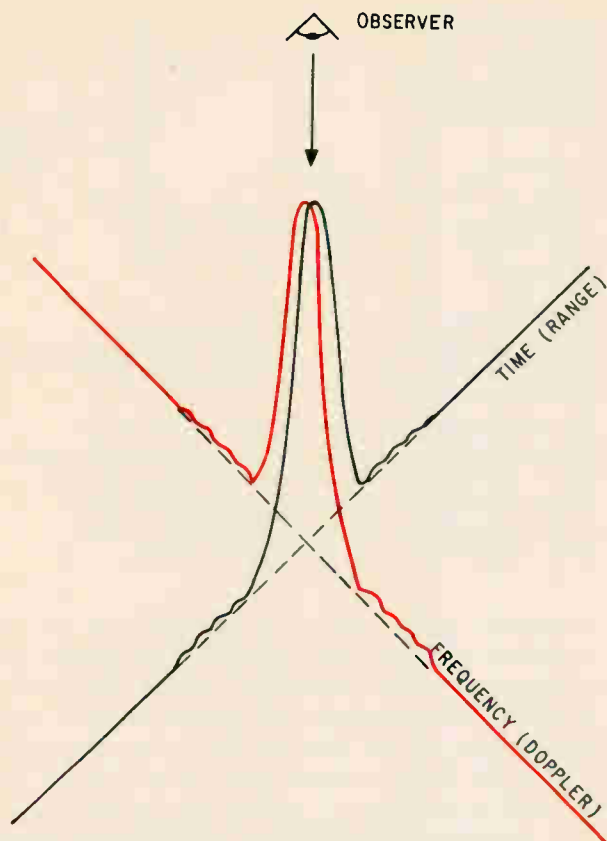

Typical two-dimensional ambiguity plot of a radar signal. Display brightness represents amplitude and display displacement represents time and frequency (range and doppler).

the phototube pickup is thus modulated in accordance with the coding in the reference track and, upon translation to the radar-carrier frequency, becomes the transmitted signal. The received signal intensity-modulates another light source, L_2 , which illuminates a portion of the film corresponding to the range interval to be monitored. During the time required for the transmitted signal to reach the target and return to the receiver, the film has moved through a distance, D , at which point the received signal modulating the light source L_2 will be coincident with the coding on the reference track. That is, transparent areas on the film will be coincident with high light levels from the modulated light source and opaque areas will be coincident with low light levels. At other points along the length of the film some opaque areas will be associated with high light levels, and vice versa, with the result that only at a position D inches from the phototube pick-off will there be a maximum accumulated light intensity collected on the integrating tube. The light intensity on the face of the image tube is proportional to the product of the signal modulating the light source L_2 and the signal on the film; the image tube performs a time integration of this product which yields a correlation function. The position of the correlation function along the vertical dimension of the image tube is thus a measurement of time or radar range. If multiple targets are present, a number of positions,

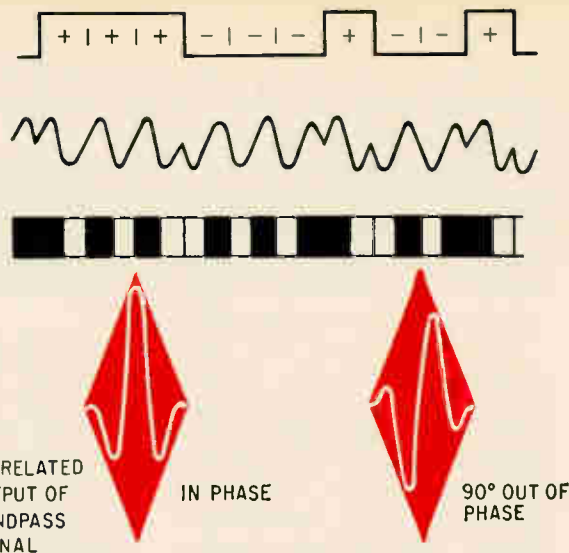

The sequence shown at the top is the pseudo-random binary phase code. It represents a code length of 50,000 elements, corresponding to a range of about 800 miles. A c-w sinusoid, which has been modulated by the code, is shown in the second line of the figure. This signal is translated to a radio frequency and used as the transmitted signal. Received signals are translated down to the same intermediate frequency and applied to the light modulator. The type of pattern on the disk is shown in the third line of the figure. On the disk are 241 doppler tracks, each with a slightly different scale factor corresponding to a particular doppler element. The resulting correlation function at the bottom of the figure shows the envelope of the function and the fine structure underneath the envelope for two particular phases of the received signals.

D_1 , D_2 , and so on, will result.

In addition to the single track along the center of the film, many other tracks may be placed on either side of the center track with the same coded waveform but with expanded and compressed scale factors. These tracks are for matching doppler-shifted signals, and will cause the correlation function to appear horizontally displaced from the center of the film by a distance proportional to the radial velocity of the target. The resulting correlation function thus appears at some point D along the vertical dimension corresponding to range, and horizontally displaced from the center line by an amount corresponding to doppler. The image tube can then be electronically scanned after each desired integration interval.

Three dimensions

The process is thus a two-dimensional filter, where one dimension of the optical plane is the time, or range dimension, and the other dimension is the frequency, or doppler dimension. The third dimension (normal to the plane of the other two) represents signal amplitude. This can be illustrated as shown in the figure at top left which is a typical two-dimensional ambiguity plot of a radar signal. The observer, in effect, is "looking down" on the function—with brightness representing amplitude and displacement representing time and frequency (range and doppler).

The rotary optical correlation approach utilizes

a rotating glass disk upon which is photographically placed the complex coded waveform from which the transmitted signal is derived, and doppler-shifted versions of the waveform against which received signals are correlated. The concept of the rotary optical correlator is shown in the figure below. The left portion of this diagram describes the generation of the coded waveform, which is used as the transmitted signal; the right portion of the diagram shows the two-dimensional optical correlator.

Transmitter excitation is obtained from the coded transmission waveform generator. A beam of light from a constant intensity light source passes through a track on the disk containing the coded waveform. The phototube pick-up is excited by the light beam as the disk revolves and thus generates the coded waveform which is used as the transmitted signal. Received signals are applied to a light modulator which intensity-modulates a light source corresponding to the received target information. The light modulator illuminates an area on the disk corresponding to the desired range-doppler window to be monitored. An integration plane collects the resulting modulated light, which is proportional to the product of the received signals and the patterns on the disk, and yields the resulting correlation functions. An image orthicon camera chain and monitor may be used for the integration plane and for the display. Time-of-arrival of the received signal, since proportional to the disk position referenced to the transmitter pick-off, provides the range information. Doppler is obtained from the doppler track yielding the correlation function. Hence, doppler is a function of the radial distance from the center of the disk, and range is proportional to distance measured along the circumference of the disk. Thus, a continuous analog range dimension is obtained. This contrasts with discrete range steps common in

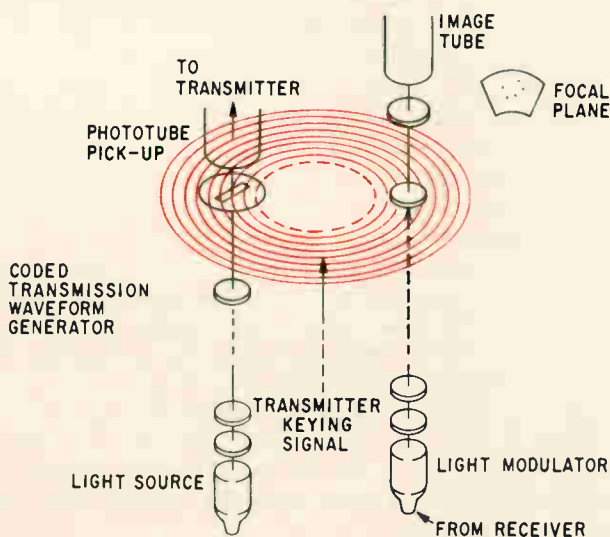

Rotary optical correlator. The left portion of the diagram shows the generation of the coded waveform used as the transmitted signal; the right portion shows the two-dimensional optical correlator.

electrical implementation by delay lines. In essence, an almost infinite number of delay lines is present in the form of the disk's angular position at any instant of time. For application in a system which does not employ separate antennas for transmission and reception, a transmitter keying signal may be provided by a timing code on the disk alternately to turn the transmitter on and off and to allow reception when the transmitter is keyed off.

Clock pulse used

The type of code used is a pseudo-random binary phase code, shown on the preceding page. The code is generated by a feedback shift register technique, consisting of a binary shift register with selected stages added to determine the new input to the register. The output of the register is shifted out of the last stage and the new input shifted into the first stage by a periodic clock pulse; it is the plus-minus sequence shown at the top of the figure. The code is 50,000 elements long. These 50,000 range elements correspond to an unambiguous range of 800 miles, or the limit of the code setup. By phase reversal, the code modulates a continuous-wave sinusoid to yield a modulated c-w signal as shown in the second line of the figure. This signal, after translation to a radio frequency, is used as the transmitted signal. Received signals are translated down to the same intermediate frequency and are applied to the light modulator. The type of pattern on the disk is shown in the third line of this figure. A typical track consists of alternate transparent and opaque areas corresponding to the code. Each of the 50,000 code elements is composed of two bits, corresponding to the positive and negative portions of a sine wave, for a total of 100,000 bits in each doppler track. A total of 240 doppler tracks, plus a zero doppler track, is placed on the disk, each with a slightly different scale factor corresponding to a particular doppler element. The resulting correlation function at the bottom of the figure shows the envelope of the function and the fine structure underneath the envelope for two particular phases of the received signals. The width of the envelope at the half-power points is equal to the width of one element of the code, and represents a compressed pulse with a compression ratio of 50,000 to 1.

A photograph of a portion of the disk is shown in the figure on page 62. The disk itself is approximately 16 inches in diameter and is designed for a speed of 6,000 revolutions per minute. The continuous-wave oscillator track is shown as the upper track of this photograph. As the disk rotates, it yields a c-w sine wave. The pseudo-random binary phase code itself is shown as the next track and consists of alternate transparent and opaque areas corresponding to the plus-minus sequence of the code. In external circuitry, the code modulates the c-w signal to produce the coded transmitted signal. The third track, used for test purposes, is a repeat of the code in the second

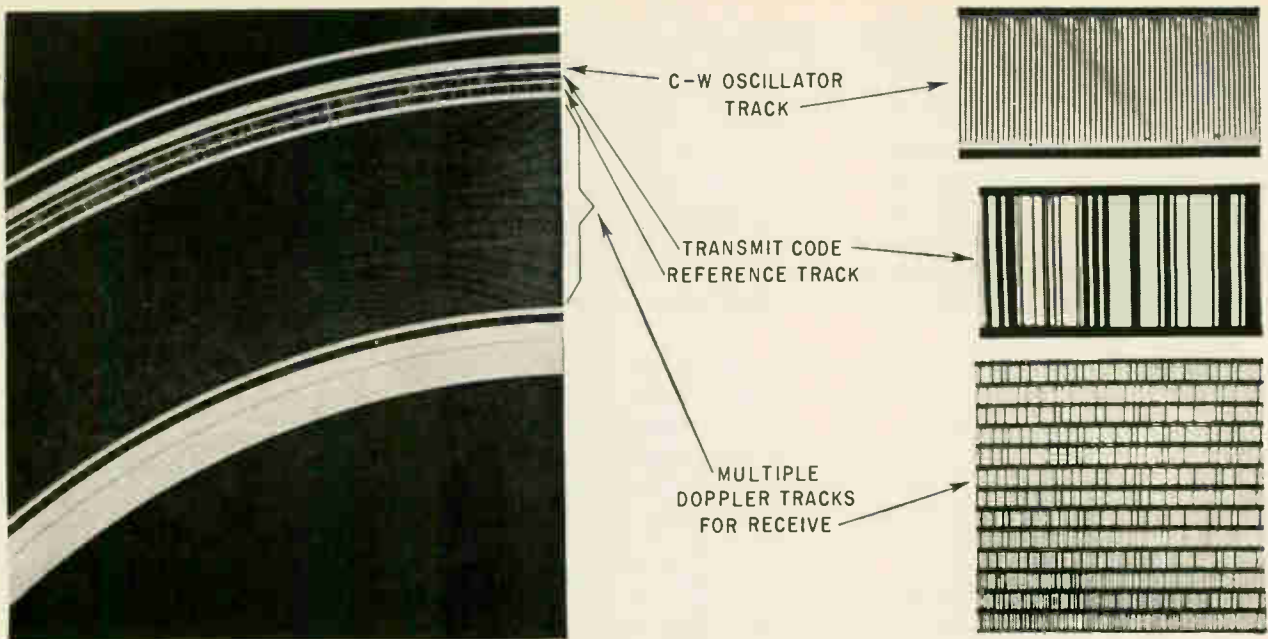

Optical disk represents a bank of 241 doppler filters for each of 50,000 range elements, or a total of about 12 million doppler filters. The 16-inch diameter disk is a hundred thousandth the size of conventional doppler-filter implementation. Photomicrographs of disk patterns are at the right.

track but angularly displaced from it. The remaining tracks are the 241 doppler tracks, which are spaced over a segment of the disk only $1\frac{1}{2}$ inches wide along the diameter. The average width of a line or space in each of the doppler tracks is approximately 400 micro-inches, representing a density of approximately 2,500 lines per inch. The disk is essentially a bank of 241 doppler filters for each of 50,000 range elements, or a total of approximately 12 million doppler filters. Comparing the volume of the disk alone with that which would be required by conventional doppler filter implementation yields a hardware size reduction of well over 100,000 to 1.

Components

Some of the components in the system are unique. One is the high-speed rotating glass disk, which bears the pseudo-random signals and generates and correlates the coded signals. After generation by a digital shift register, the code is recorded on paper tape, which is then used to control the exposure as each elemental area of the photosensitized disk is exposed to light. Step control of the exposure is accomplished with precision machine equipment.

If the speed of the disk varied, the jitter would destroy the time resolution of the resultant correlation function. A closed-loop servo system holds the speed to one part in 10 million. The mechanical Q or inertia of the rotating disk does the rest.

Light modulator requirements are met by using a short-persistence phosphor (P-16) on a cathode ray tube. As bandwidth requirements increase, the use of other light modulator materials such as potassium dihydrogen phosphate or cuprous chloride look attractive for applications where frequency responses above 20 megacycles will be required.

Other possibilities are modulated semicoherent or coherent light-emitting diodes for higher-frequency applications.

An image orthicon camera is used as an integration plane and as a read-out device displaying the correlation functions on a television screen display.

To permit photographing the correlation function on a television monitor, the field of view of a television camera is narrowed and a magnification of approximately 115 times is obtained. The field of view then embraces approximately 15 doppler channels and 150 range elements for a total of approximately 2,000 range-doppler elements. Range is measured along the horizontal axis, and doppler along the vertical axis. An A-scope display showing a horizontal scan through the target is shown at the top of page 63. The illustrated compressed pulse has a compression ratio of 50,000 to 1. For readout, the quantitative values of doppler and range are obtained from two counters—a doppler counter which reads out the location of the target in the doppler dimension, and a range counter which reads out the location of the target in the range dimension.

A block diagram of the experimental subsystem used for evaluation of these techniques is shown on page 63. The radar path block was simulated in various ways, including the utilization of an X-band transmitter-receiver system operated under a variety of jamming conditions. The results showed that the correlation gain and the large time-bandwidth of the system effectively improved signal-to-jamming noise ratio for several types of jamming signals.

Magnetic-optical processor

With a moving target, the correlation function will change position in range and doppler dimensions

as the target moves. However, resolving the doppler dimension may be difficult with an accelerating or decelerating target. If the target's acceleration is appreciable during the integration time of the system, smearing will occur in the doppler dimension. This will show up on a monitor screen as a spreading of the light spot over many doppler tracks, with a decrease in light intensity. For targets with large acceleration, it may be impossible to determine the target's velocity or even its presence. Hence, it is desirable to incorporate a filtering process to determine and compensate for this acceleration.

This problem led to investigations of rotary optical correlation for processing the two dimensions of velocity and acceleration, instead of velocity and range, as in the previous example. This system was intended for a coherent-pulse radar system, where coherent storage of the radar returns over the integration time of the system is required. The investigation centered on magnetic techniques for providing this storage capability as well as collating target returns by range elements, and processing of the range-gated stored returns by optical techniques for extracting velocity and acceleration information.

A concept diagram of the magnetic-optical processor is shown on page 64. A magnetic disk and an optical disk are mounted on the same shaft assembly and driven by a single disk drive and control. The upper part of the diagram is the magnetic storage portion of the system, and the lower part is the optical velocity-acceleration processor.

The magnetic part of the system operates as a

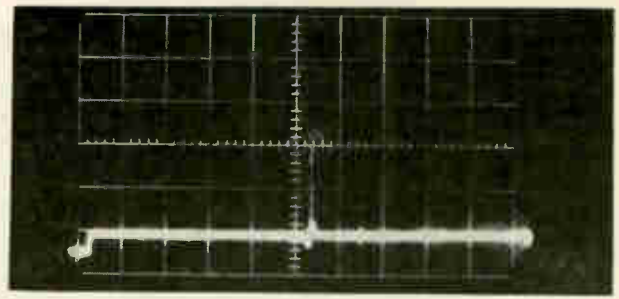

Oscillogram of correlation functions has a pulse compression ratio of 50,000 to 1.

conventional time-compression system. That is, the speed of rotation of the disk differs from the pulse-repetition frequency of the system by one pulse width. In this manner, successive radar returns are stored side by side on the disk for each range element.

The incoming data to be analyzed consist of radar target returns continuously recorded on the magnetic disk. The total storage time of the disk corresponds to the integration time of the system. As each subsequent signal is recorded on the disk the oldest signal is erased. The output of the magnetic disk is a signal representing the past history of the target returns in a particular range element, over the integration time of the system. This output is then fed to the optical velocity-acceleration processor.

The optical processor operates in a manner analogous to the optical correlator previously described, except that the two dimensions required are velocity and acceleration. The angular position

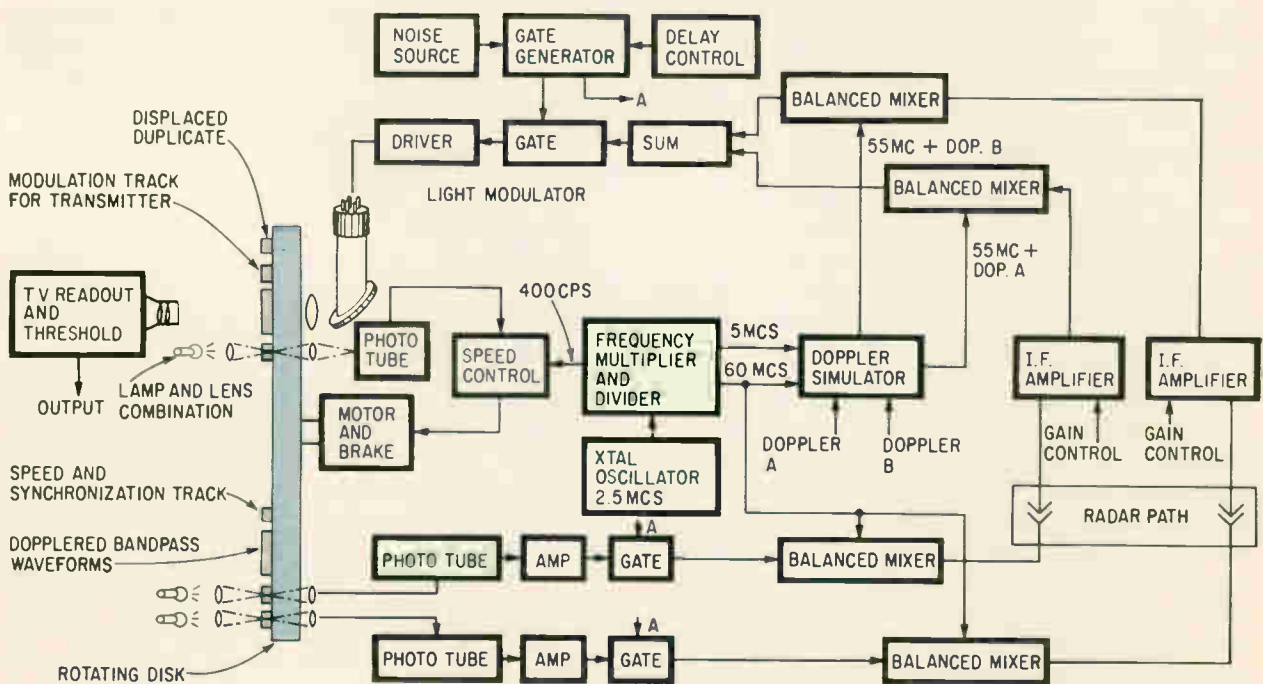

This experimental subsystem was used to show that the correlation gain and the large time bandwidth of the system improve the signal-to-jamming noise ratio.

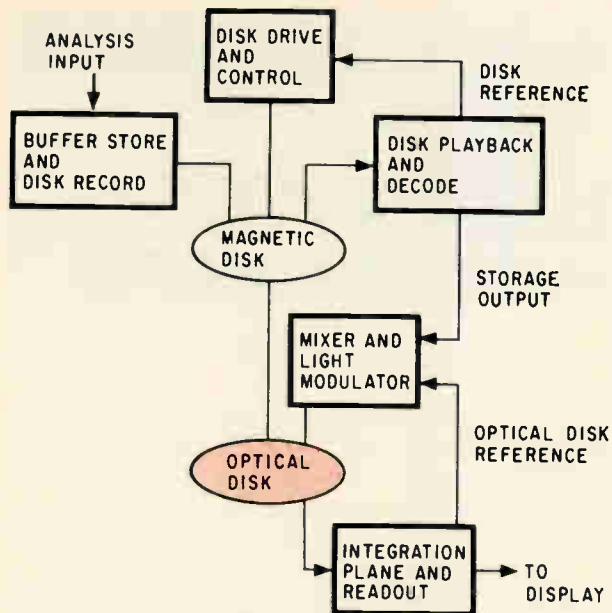

Magnetic-optical processor has a magnetic disk and an optical disk mounted on the same shaft assembly. The upper part of the diagram is the magnetic storage portion of the system and the lower part is the optical velocity-acceleration processor.

of the disk is used for the acceleration dimension. This may be accomplished by combining the incoming signal from the magnetic system with an appropriate reference signal obtained from the optical disk. The frequency of the reference signal varies as the disk rotates. The combined signal is then applied to a light modulator which illuminates an area on the optical disk corresponding to the velocity-acceleration window to be monitored. The integrated product of the light-modulated signal and the patterns on the disk provide the resulting correlation function, whereby the radial position of the disk yields the velocity parameter and the circumferential position of the disk provides the acceleration parameter.

Corresponds to velocity

The manner in which this is accomplished is shown in more detail in the diagram at the top of page 65. The magnetically preprocessed input information is a c-w signal whose duration is proportional to observation time, or integration time, of the system, whose instantaneous frequency at any instant of time corresponds to velocity and whose rate-of-change of frequency is proportional to acceleration. A typical case is shown in the time-frequency plot of curve A. In this example, the doppler or target velocity is increasing at a fixed rate and represents a constant acceleration value. Therefore, the incoming signal is linearly increasing in frequency over the integration time and the rate-of-change of frequency, or slope of this curve, is proportional to acceleration. The reference signal with which this incoming signal is combined is chosen to be a quadratic time-versus-frequency curve—curve B. The combination of these two curves is curve C, a quadratic curve similar to

curve B but shifted along the time and frequency axes. By proper choice of parameters it is possible to make this shift along the time axis proportional to acceleration, and the shift along the frequency axis proportional to velocity. The optical patterns which are placed upon the disk are multiple-radial tracks, each consisting of a quadratic time-versus-frequency curve. These are arranged on the disk so that when it is illuminated by a light-modulated signal corresponding to curve C, the correlation function is angularly displaced along the circumference of the disk by an amount corresponding to acceleration, and radially displaced from the center of the disk by an amount corresponding to velocity. By incorporating additional types of reference signals, it is possible to handle other than constantly accelerating targets.

Optical readout

One of the main advantages of optical processing is its inherently large information-handling capability. However, unless this great flow of information can be digested, a system bottleneck will soon develop.

A television display, however, does not adequately solve the readout problem. In the first optical correlator described, over 200,000 resolution elements were simultaneously available for readout. At the present state-of-the-art this number can easily be doubled or tripled. If it were necessary to update this information many times a second, information bandwidths on the order of many hundreds of megacycles per second would be required.

To solve this problem, techniques are being developed for an optical readout system, shown on page 65. This diagram may be broken down into three main sections: the optical system, which consists of the scanning device, fiber optic light guides and phototubes; the electronic processing system, which consists of the amplifiers and thresholding units; and a high-speed coordinate buffer memory unit. In the diagram, the two-dimensional correlator field is the output integration plane of an optical correlator. For this application, the two dimensions are range in the horizontal direction of the correlator field and doppler in the vertical direction.

Feeds to phototube

The optical scanning device effectively causes an image of the correlator field to scan in the horizontal, or range, direction past a fixed slit. At the slit a separate fiber optic light guide feeds the optical signal for each doppler channel to a separate phototube. The resulting electrical signal is amplified and thresholded. That is, only the upper portion of the signal is allowed to come through, eliminating any noise present at its base. In this manner all doppler channels are scanned simultaneously.

At the time of threshold crossing, the line on which the threshold crossing occurs corresponds

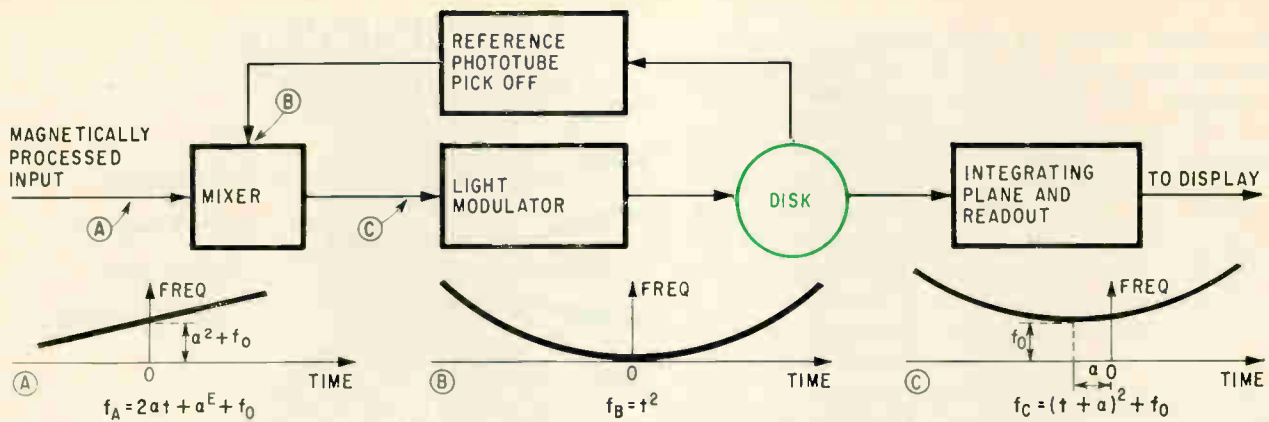

At the top is an optical velocity-acceleration filter. In curve A, target velocity is increasing at a fixed rate, representing constant acceleration. The slope of the curve is proportional to acceleration. The reference signal which is combined with the input signal is the quadratic time-vs-frequency curve B. Curve C, a combination of A and B, is similar to B, but shifted along the time and frequency axes. The optical patterns placed on the disk are multiple radial tracks each consisting of a time-vs-frequency curve. When the disk is illuminated by a signal corresponding to C, the correlation function is angularly displaced along the circumference of the disk by an amount corresponding to acceleration, and radially displaced from the center of the disk by an amount corresponding to velocity.

to the doppler of the target. At that particular instant the range is read from the range-reference counter. These two target coordinates are digitally stored in a buffer memory so that they can be read out in digital form at a smoothed rate. The effective readout rate, or output information rate, is then directly proportional to the number of targets present.

At the same time, the optical scanner also scans a range reference track. This is a precisely calibrated optical grating uniformly illuminated by a constant-intensity light source. This information is fed through a separate channel to a range reference counter, which is a fast propagation range counter specifically developed for data which vary rapidly. The output of the range reference counter at any instant of time is proportional to the position of the vertical line in the correlator field being scanned at that particular time. Also, at the beginning of each scan a calibrated brightness reference is provided for an automatic sensitivity

control loop around each multiplier phototube. This feature compensates for effects of fatigue in the phototube, and stabilizes the gain of all the doppler channels.

The feasibility of this approach has been demonstrated by a combination of optical, electrical, and mechanical techniques. Future work must be on more efficient and compact devices and should emphasize greater adaptability and internal decision-making within the readout system.

Investigations have already been started to solve these problems with microelectronic and thin-film techniques. Although initial application is being made to the readout problem, these investigations are showing potential in other areas of optical processing such as replacing the rotating optical disk described earlier with optoelectronic components having no moving parts.

An example of this approach is the use of arrays of microelectronic photosensitive elements addressed by thin-film scanners.¹ The schematic in

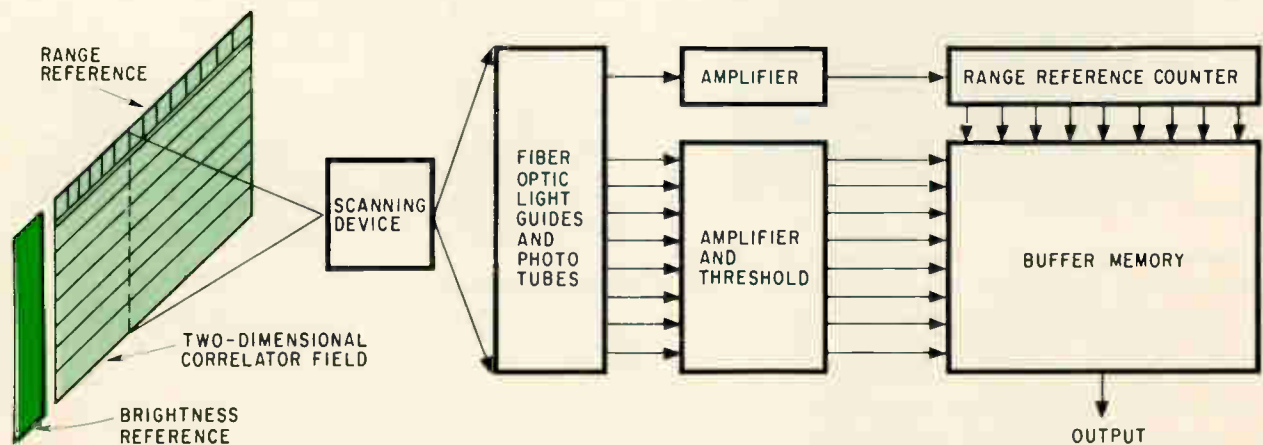

Optical readout system in three sections: the optical system, the electronic processing section, and a high-speed coordinate buffer memory unit. The two-dimensional correlator field is the output integration plane of an optical correlator. The dimensions are range in the horizontal direction of the correlator field and doppler in the vertical direction.

this column shows an experimental crossed-array, image-sensor panel driven by two thin-film scan generators. The photosensitive area is a crossed array of x-y coordinate strips deposited on a glass substrate. In the read-out application, this would be the time-integration plane of an optical correlator. At each intersection of the strips is a photosensitive element whose electrical output is proportional to the intensity of the light incident on it. Each element corresponds to a resolution cell on the integration plane. Also deposited along the periphery of the panel are two thin-film scan generators. These are essentially shift registers which permit selective scanning of certain areas within the array or programmed scanning of the entire array. This can result in a considerable adaptive scanning capability by programming the scanning sequence in accordance with the target density on the array.

A diagram of a single line array and a thin-film scanner is shown at the right. A row of photo-elements is shown in the lower part of this diagram. This corresponds to one horizontal line of photo-sensitive elements shown in the previous diagram. The upper part of the diagram is a 30-stage deposited scan generator.

The row of photo elements consists of 30 photosensitive thin-film transistors. The center-to-center spacing between these elements is $12\frac{1}{2}$ mils, and

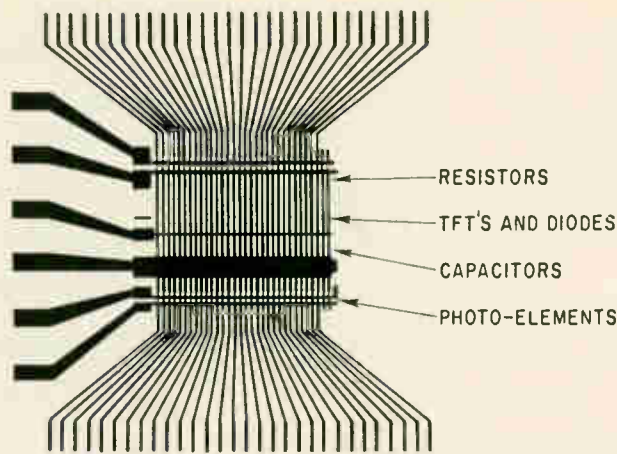

Diagram of a single line array and a thin-film scanner. In the lower part of the diagram is a row of photosensitive elements consisting of 30 thin-film transistors. It corresponds to one horizontal line of elements in the previous figure. The upper part of the diagram is a 30-stage deposited scan generator which contains 210 elements plus connections and crossovers. Extensions of this idea will provide two-dimensional arrays of thousands of photo-elements with digital logic control to address the individual elements.

present technology can greatly decrease this spacing. Above this row of photo elements is the 30-stage scan generator which consists of a row of 30 capacitors, 60 cadmium sulfide thin-film transistors, 30 field effect diodes, and 60 resistors. The length of each side of the scan generator, exclusive of the fan-out, measures approximately three-eighths of an inch or a total area of less than 0.2 square inch. Within this area there are a total of 210 elements plus numerous connections and crossovers. Adaptations will provide two-dimensional arrays consisting of thousands of photosensitive elements with address to individual elements provided by digital logic control.

Future of optical techniques

The techniques described do not require any critical light sources but use noncoherent light. With the availability of lasers having coherence in frequency and space, other techniques are possible. With either coherent or noncoherent light, depending on the methods used, optical systems can be utilized for functions normally electronic, such as radar pulse coding and decoding, two-dimensional filtering, steerable antenna array beam-forming and steering, analog computing and various similar forms of signal processing and data handling.

Acknowledgment

This work has been sponsored, in part, by the Bureau of Naval Weapons,² by the Rome Air Development Center,³ and by internal RCA advanced development programs.

References

1. P.K. Weimer, H. Borkan, G. Sadasiv, L. Meray-Horvath, and F.W. Shallcross, "Integrated circuits incorporating thin-film active and passive elements," Proceedings of the IEEE, December 1964.
2. "Radar signal correlation techniques," Contract No. NOW 61-0936d.
3. "Optical readout techniques," Contract No. AF 30(602)-3101.

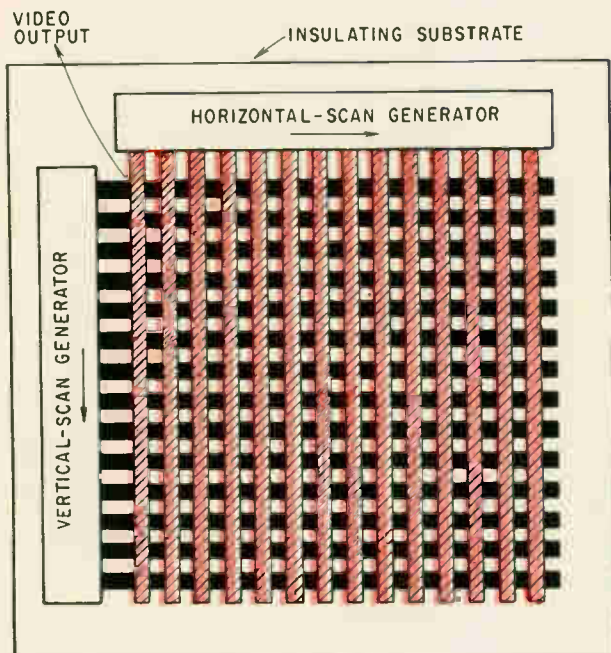

A crossed-array, image-sensor panel driven by two thin-film scan generators. The photosensitive area is an overlay of x-y coordinate strips deposited on a glass substrate. The electrical output of the photosensitive element at each intersection is proportional to the incident light. Each element corresponds to a resolution cell on the integration plane of an optical correlator. On the edge of the panel are two thin-film scan generators which act as shift registers. They permit selective scanning of certain areas within the array or programmed scanning of the whole array.

Designer's casebook

Designer's casebook is a regular feature in Electronics. Readers are invited to submit novel circuit ideas, packaging schemes, or other unusual solutions to design problems. Descriptions should be short. We'll pay \$50 for each item published.

Modified flip-flop quadruples fan-out

By D.J. Grover*

Marconi Instrument Ltd., St. Albans, England

Fan-out to as many as 60 other logic circuits is achieved with the flip-flop shown below by driving the bases of amplifier stages Q_1 and Q_2 directly from the emitters of Q_3 and Q_4 . The circuit is a worst-case design allowing for a transistor current gain (β) as low as 15 and permitting at least 10% tolerance on component values and power supply levels. The circuit improves the fan-out capabilities of a conventional circuit designed on the basis of a worst case analysis by a factor of 4 to 1.

In a conventional circuit, the amplifiers would

* Formerly with Standard Telephones and Cables, Ltd.

be connected to the collectors of the flip-flop through a coupling resistor and would be biased through a resistor divider connected between the supply voltages. The amplifier would turn off when the flip-flop to which it is connected is turned on. The problem is that the current available for back-biasing the amplifier is partially shunted by the divider network. When 10% tolerances on resistor values and supply voltages are considered, the loss in driving current can exceed 40% per stage. By connecting the amplifiers as shown in the schematic, Q_1 and Q_3 or Q_2 and Q_4 turn on and off together, and the only loss in driving current is the small amount shunted off by the bleeder resistors, R_1 and R_2 . As a result, the fan-out may be increased by a large factor.

Change-of-state occurs when a positive pulse is applied at the trigger input. The output has a one-microsecond rise time, and will drive 60 gates—each with an input impedance of 24,000 ohms to -20 volts. If Q_1 and Q_2 are replaced by transistors with betas greater than 50, the fan-out

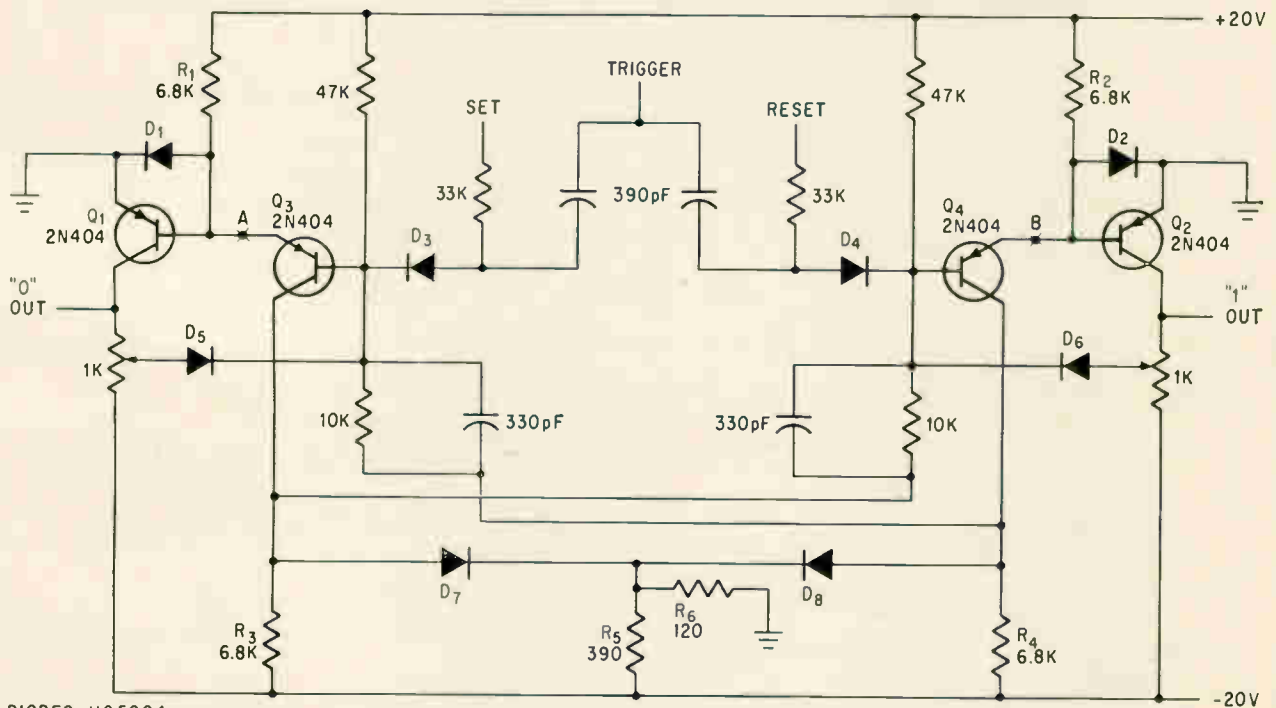

Directly coupled amplifiers, Q_1 and Q_2 improve current transfer efficiency when the tolerances on components and power supply voltages are large. As a result, the flip-flop can pulse 60 other circuits.

of the circuit can be increased to about 200.

If the emitter leads of Q_3 and Q_4 are opened at points A and B and are then connected to ground, the inner circuit becomes a conventional flip-flop. The grounded emitter is simulated in the complete circuit by holding the emitter of Q_3 about 0.3 volt above ground, either by the diode D_1 (if Q_1 and Q_3 are not conducting) or by the base-to-emitter voltage drop of Q_1 (if Q_1 and Q_3 are conducting). The slight variation in voltage at the emitters of Q_3 and Q_4 reduces the efficiency of the flip-flop. This is compensated, however, by

the improvement in current transfer to the bases of Q_1 and Q_2 which guarantees that the output stages will be saturated under worst case conditions.

The comparatively low values of R_1 and R_2 are necessary for reducing the turn-off time of Q_1 and Q_2 . Components D_5 , D_6 , D_7 , D_8 , R_5 and R_6 prevent saturation of Q_3 and Q_4 . If timing and triggering sensitivity are not critical, these seven components may be removed if the values of R_3 and R_4 are reduced to supply sufficient base current to Q_1 and Q_2 .

Novel sweep circuit eliminates ramp pedestal

By Gilbert Marosi

General Precision, Inc., Sunnyvale, Calif.

Phantastrans, transistorized versions of phantastron sweep-circuits, are used extensively to obtain linear ramps and gating signals for timing circuitry. A standard phantastron has two disadvantages. The ramp begins on a voltage pedestal instead of at ground because the timing capacitor is connected to ground through the base-emitter junction of a transistor. The second disadvantage is that the slope of the ramp is limited to a range of 20 to 1

by the gain of a transistor in the circuit.

The modified circuit shown below eliminates the voltage pedestal by connecting the timing capacitor C_2 directly to ground. The slope is independent of the gain of Q_1 , and may be varied through a range of 100 to 1 by adjusting potentiometer R_4 . In addition, the width of the gating signal pulse may be varied from 1 to 500 microseconds. Furthermore, since the recovery time of the circuit is very short, the duty cycle can be as high as 98%.

In the stable state, Q_4 and Q_5 are off and all other transistors are conducting. Because Q_1 is saturated, the voltage across C_2 is about 0.7 volt negative with respect to ground. The emitter of Q_2 is almost at ground potential. A positive trigger at the base of Q_1 forces Q_1 to turn off and turns on Q_4 and Q_5 . All other transistors continue to conduct.

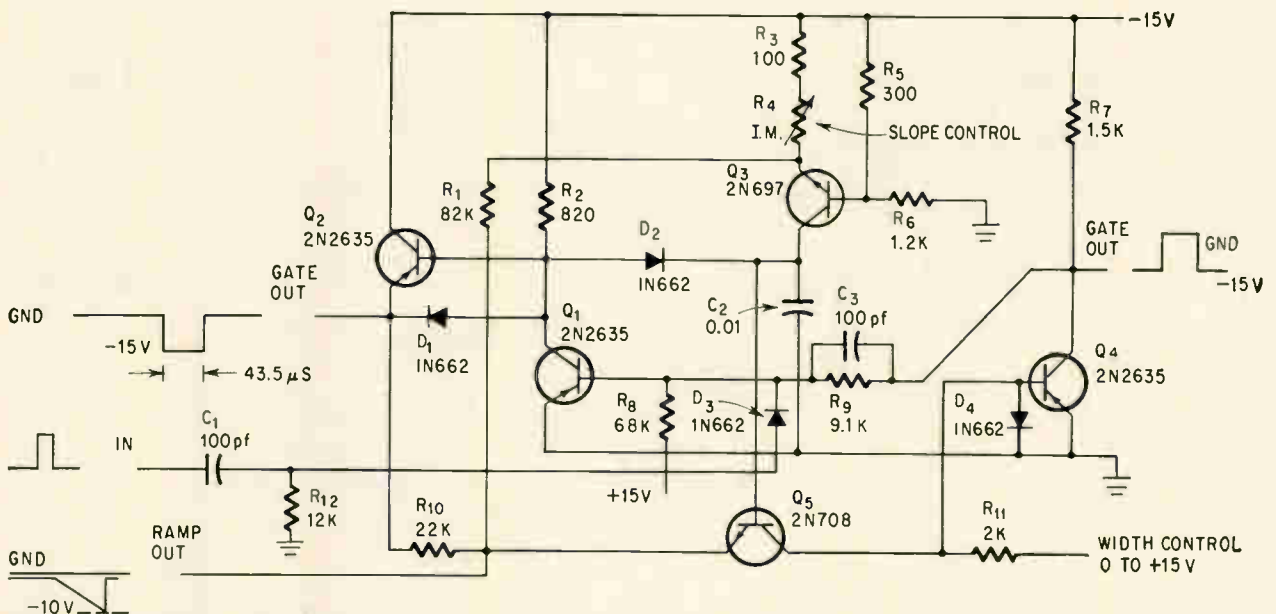

Phantastron circuit provides a linear ramp and gating pulses. When repetitively triggered, the gating pulses at the two output terminals are complementary.

Because Q_3 is a high-gain transistor, its input impedance will be at least 10,000 ohms even if potentiometer R_4 is short-circuited. As a result, the resistance divider consisting of R_5 and R_6 is not loaded down by Q_3 , and the voltage at the base and emitter of Q_3 remains constant at about -12 volts. Therefore the emitter current is constant, causing C_2 to charge linearly, resulting in a ramp at the emitter of Q_5 . Its slope is inversely proportional to $(R_3 + R_4)C_2$. R_1 at the emitter of Q_3 is a bootstrap resistor needed to maintain linearity at slow-sweep rates.

The manner in which the circuit returns to the stable state is dependent on the currents I_{e5} in the emitter of Q_5 , I_{b4} in the base of Q_4 , and I_{11} flowing through R_{11} . Neglecting the voltage drop across the base-to-emitter junction of Q_1 and assuming the emitter of Q_2 is clamped at -15 volts, then

$$I_{e5} \approx \frac{15 - V_{e2}}{R_{10}} \approx I_{b4} + I_{11}$$

where V_{e2} is the voltage across capacitor C_2 . Since the base of Q_4 may be considered to be at ground potential, I_{11} is a constant whose value is determined by R_{11} and the voltage on the width-control terminal. Therefore, from the equation, as V_{e2} increases, I_{b4} decreases. When $I_{b4} = 0$, Q_4 stops conducting and turns on Q_1 . C_2 discharges very rapidly through Q_1 and D_2 and the circuit returns to its stable state.

Since the width-control voltage determines the magnitude of I_{11} it also determines the amplitude of the ramp because of the relationship between I_{11} and V_{e2} expressed in the equation. With the width-control voltage fixed, varying R_4 varies both the slope of the ramp and the width of the gate. With R_4 fixed, the slope is constant and varying the width control changes both the width of the gate and the amplitude of the ramp.

For the gate and ramp shown in the schematic, the value of R_4 is 1,000 ohms and the width-control voltage is 0.4 volts.

Gated multivibrator output provides constant pulse width

By Reed Newmeyer

Sperry Utah Co., Salt Lake City, Utah

A train of pulses—all of constant width and free of transient spikes—are produced whenever a 6-volt gate is supplied to the base of Q_1 in the multivibrator shown below. The pulses may be used to drive stepping switches, to test circuit response and to operate counting circuits.

When the gate is applied, Q_2 and Q_3 are turned on and off as in a standard multivibrator. Since Q_1 and Q_2 are connected in series, they are either

fully on or fully off at the same time. In a conventional circuit, the first few pulses will vary in width because the charge on the capacitor during standby is greater than the maximum charge that occurs during operation. In this circuit, zener diodes D_5 and D_6 maintain a constant pulse width by forcing the capacitor-charging cycle to start at 5 volts.

Standoff diodes D_2 and D_3 are back biased when Q_2 and Q_3 , respectively, are not conducting. As a result, the outputs are clamped to either the 6-volt supply or to a few tenths of a volt above ground, depending whether the transistors are on or off.

Clamping diodes, D_1 and D_2 , insure immunity to noise spikes. Because of the clamping diodes, the output pulses are about 6 volts. Larger pulses may be obtained by raising the clamp voltage or by removing D_1 and D_2 from the circuit.

If the gate is removed, the circuit will stop supplying pulses when Q_1 and Q_2 are turned off.

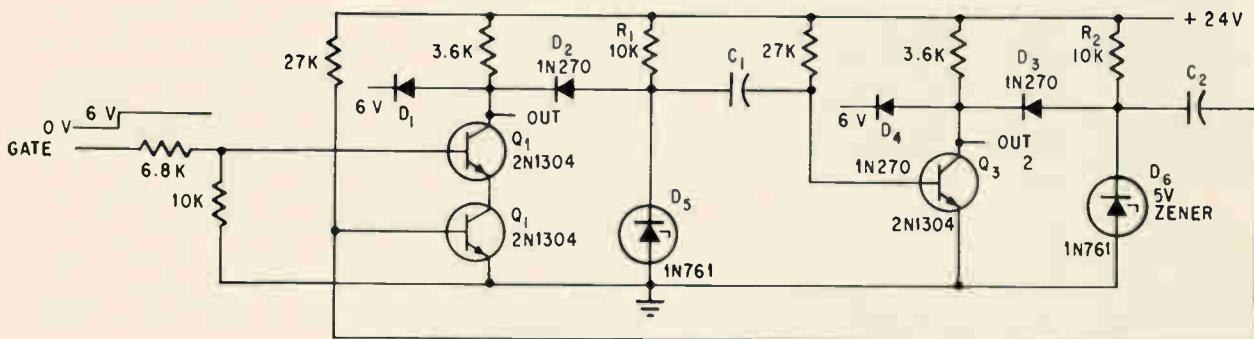

Complementary pulse trains appear at outputs one and two whenever a 6-volt gate is applied to the base of Q_1 .

Coding for error control: an examination of techniques

Through redundancy, a variety of code structures can detect and correct errors in digital communications. This second article in a series, describes the latest techniques and evaluates them for efficiency, complexity and cost

By Albert G. Franco and Mark E. Wall

Communications Systems Inc., Paramus, N.J.

Error-control coding is a technique that attempts to guarantee that a digital communication, despite any errors introduced by the transmission channel, will be received exactly as it was sent. Errors are detected and corrected through controlled redundancy inserted in messages.

The redundancy must spread the effect of channel disturbances over a number of interrelated bits. Using these interrelationships, a decoder checks the received message, finds errors, and corrects them to produce a message that exactly matches the original communication. The simplest example of encoding is replicate, or repeat, transmission, in which each bit of information is sent a minimum of three times to permit a majority decision. Any one bit in error can be corrected because of the

simple relationship between successive bits. But, for the amount of error protection it offers, replicate transmission wastes channel capacity. Better coding structures provide more complex interrelationships, thus giving greater capability for the correction or detection of errors, and make more efficient use of channel capacity.

Basic code construction

For the binary symmetric channel (one in which errors introduced by the channel are statistically independent with equal probability that either binary symbol will be transformed) the decoder uses an optimum decision scheme to select the transmitted sequence, x_j , most likely to result in the receipt of the sequence, y . Such a decoder is often referred to as the "ideal-observer" or "maximum-likelihood" decoder.

Maximum-likelihood decoding depends on the distance between code words. This distance is called the Hamming distance, after R. W. Hamming who proposed the concept. The distance between two n -bit binary sequences is defined as the number of bits that differ in the two sequences. For example, if $x_1 = 1001011$ and $x_2 = 1100010$, the sequences differ in the second, fourth and last digits, and the distance between x_1 and x_2 is 3. In maximum-likelihood decoding the decoder examines a received sequence y , and selects from a stored set of possible code words, that code word x which has the minimum distance from y . The maximum-likelihood decoder is therefore a "minimum distance" decoder.

An example might be the following bit sequences considered as a set of possible code words: $x_1 = 00000$, $x_2 = 10101$, $x_3 = 01011$ and $x_4 = 11110$.

The authors



Before he joined Communications Systems, Inc., Albert G. Franco was a staff member of the International Business Machine Corp.'s research division. There he worked on applying microwave techniques for high-speed computing. A graduate of Columbia University, he is a member of Eta Kappa Nu and Tau Beta Pi.



Mark E. Wall carries out studies in digital communications and error control for CSI. He was formerly with the Astro-Electronics division of the Radio Corp. of America. Wall is currently pursuing doctoral studies at New York University.

Assume the received sequence is $y = 10001$. The minimum-distance decoder will decode y as x_2 since the distance between y and x_2 is one, while the distance between y and any of the other transmitted sequences is greater than one.

Maximum error-correction capability of a code is obtained by making the minimum distance between code words as large as possible for a given code length and redundancy. Error correction capability and minimum distance between code words are very simply related: that is, one, two, and up to e -errors in transmission can be corrected if the minimum distance between binary code words of length n is $\geq 2e + 1$. This is a theoretical relationship, which is not usually achieved in practice.

Code structures differ widely in their error-correction capability, redundancy, and their encoding procedures. The best error-control code has an encoding process that is simple in concept, easily implemented, and inexpensive.

In minimum-distance decoding, the decoder stores a "table" or "code book" containing all the allowable binary sequences of the specified code word. Each of the received sequences is assigned to the stored code word that most closely matches it. It follows that for the longer, more powerful codes decoders increase in complexity as they increase their storage capability.

The problem of complex decoders for the longer codes has prompted development of the convolutional nonblock code, described later, which makes possible the construction of powerful code structures than can be decoded by simple decoders.

Thus far, the assumption has been that a code is used in the forward error-correcting (fec) mode. However, a code can also be applied in the error-detection mode, where error correction is obtained by requesting repetition of the code words detected in error (arq). The result is a considerably lower received-error rate. This is best understood from a geometric interpretation of the concepts of distance and minimum-distance decoding.

Consider the representation of a hypothetical code space, shown in the diagram above. The white circles represent six acceptable code words which will be received as a result of error-free transmission. The X's represent words received with errors. The code space is divided into subsets, just as it would be partitioned by a minimum distance decoder. All erroneously received sequences—the X's in a partitioned subset—are interpreted as the correct code word at the center of the subset.

The X's in the light red area represent sequences received with one error; in the paler area, two errors. For the partitioning shown, double error correction is possible because two errors result in a word still within the partition associated with the correct code word at the center. But sequences received with triple errors would be incorrectly decoded.

In error detection with repeat request, the only bit sequences that the decoder accepts are those

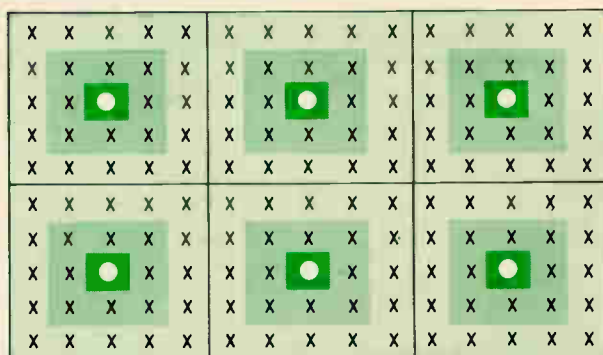

Hypothetical code space indicates distance between digital words. White circles represent correct code words. The X's in light red area represent same code word with one error, and X's in pale red area represent that word with two errors. For this code spacing, a minimum-distance decoder could not correctly decode a bit sequence with more than two errors.

depicted by the circles. The decoder rejects all other received sequences and initiates a request to repeat the transmitted code word. This decoding process can fail only if one acceptable code word is erroneously transformed into another acceptable code word. From the code space diagram it can be seen that there would have to be errors in at least five positions in a received sequence for such a transformation to occur. Such an event obviously occurs with less frequency than triple errors, thereby substantiating the claim of lower error probability when a given code structure is used for error detection rather than correction.

The selection of a mode depends on the user requirements, the nature of the digital traffic handled, and such factors as on-line data in which the data source generates a continuous bit stream with no provision for storage. The availability of a return channel will determine whether the arq mode of operation is possible.

1. Operational control techniques

Error-control systems fit into two basic classes: systems that detect and indicate to the recipient that a given character, word, or message contains errors; and systems that correct these errors. Further, the correction type systems operate by either of two methods: by detecting the error and requesting a repetition of the message from the transmitting end of the system; or by using a code structure that permits the correct characters to be determined from the received signals despite the errors.

Forward error correction

In forward error correction, redundancy is inserted into the transmitted bit stream and used at the receiver to correct errors that have occurred in transmission. The redundancy required for error correction is considerably higher than that for error detection, for the same degree of protection against

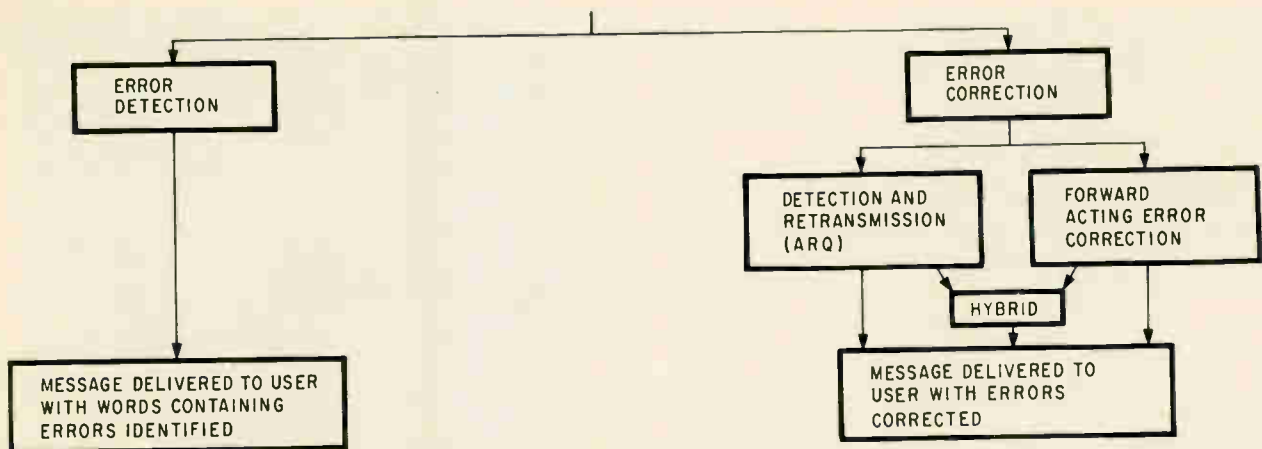

Classes of error-control systems. In error detection systems, the code words in error are identified, not corrected. Error-correction systems use various techniques to deliver error-free messages.

errors. Block or nonblock code structures may be employed in an fec system. Nonblock structures sometimes reduce the complexity of the decoder.

A continuous stream of data can be accommodated on a forward error-correction system. Since it isn't necessary to interrupt the data stream, a minimum of buffering, or temporary storage, is required. Synchronism between encoder input and decoder output is easily maintained. With non-block code structures, bit-by-bit encoding can be utilized so that the form of the message needn't be confined to any specific structure. The delay introduced between input and output is a function of the path delay and the interval in bits required for the coding.

Error detection and arq

In this mode of operation, information is most conveniently encoded into blocks containing redundant bits. Upon detection of an error at the receive terminal, a request for repeat (arq) is sent to the transmit terminal via a return channel.

Often, arq system are designed so that successive information blocks are sent only after the transmit terminal gets an acknowledgment from

the receive terminal. In such cases, only one block of information is repeated when necessary. A more efficient arq mode is one where continuous data is sent from the transmit terminal. Upon receipt of a repeat request in this instance, at least two data blocks are repeated. This happens because at least one block will be in the channel when the transmitter gets a request to repeat transmission.

With either arq mode, the data system is interrupted when repeat requests occur. As a result, synchronism cannot be maintained between the data source and sink without additional buffering. If buffers are used to provide an even flow of data, the data transmission rate must exceed the incoming data rate at the receiver so that the decoder buffer can continuously empty its contents. Otherwise, there is a certainty of buffer overflow during long messages, which results in lost data. Rate conversion equipment provides an even data flow for arq systems.

Interrupted data flow isn't a problem when transmitting between stores and sinks in which the data flow is controlled. Practical examples are the arq system in transatlantic Teletype service.



Forward-error-correction systems insert redundancy into the transmitted bit stream to correct errors. Greater code redundancy is required for error correction than for error detection.

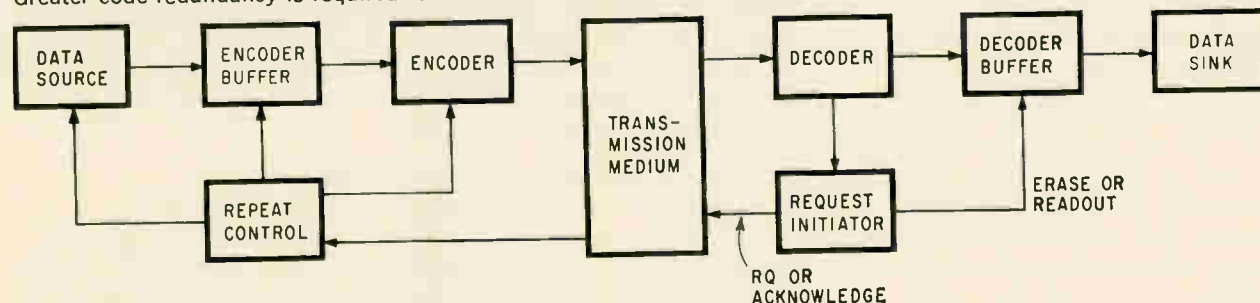

Error detection with automatic repeat request (arq) inserts redundancy in the transmitted bit stream to detect errors. Correction is obtained by requesting a retransmission of any bit sequence in which errors are detected.

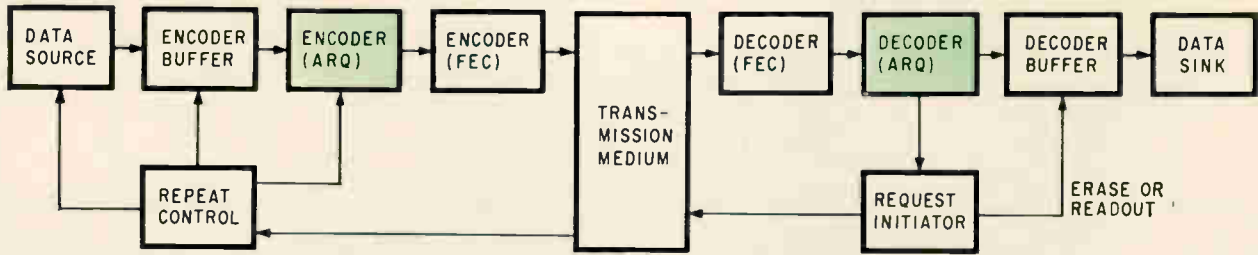

Hybrid error-control system has automatic repeat request, color, and forward error control in tandem. The combination lessens the probability of a repeat request and increases channel efficiency.

Both forward error correction and arq can be combined in a single code structure. The hybrid mode of operation may take either of two forms. One form has forward correction as the basic error-correcting technique, but can initiate repeat requests when the decoder fails. The other form includes a small amount of error correction in a block structure used in an arq system.

A hybrid technique that uses forward error correction in tandem with arq is shown in the block diagram above. Separate encoders and decoders are used for the fec and arq sections.

Hybrid systems generally exhibit characteristics similar to those of a simple arq system. Since fec lessens the probability of a repeat request, channel efficiency may be higher.

II. Coding structure classification

The choice of a coding structure depends on the user's error-control techniques, channel noise characteristics and resulting error probabilities, and the complexity and cost of the error-control equipment.

Code structures are categorized in the chart on next page. Block codes are formed by encoding information and check bits into blocks of n bits. For nonblock codes, each transmitted parity bit is continuously determined, to some extent, by all of the bits which have already been transmitted.

Constant-ratio codes

Constant-ratio codes consist of a block structure in which the number of zeroes and ones is constant. One such code is the three-out-of-seven arq code, which is used extensively in radio telegraphy. Its simplicity and effectiveness account for its use,² although there are others which outperform it.

In a 3/7-code each character has a block length of $n = 7$ bits (3 bits are ones). The number of characters that can be obtained from this code is

$$\frac{7!}{3! 4!} = 35$$

The maximum efficiency of this code word is the ratio of the information content in a 35-letter alphabet to that in a 7-bit word.

$$\text{Efficiency} = \frac{\log_2(35)}{\log_2(2^7)} = 0.733$$

Errors are detected by counting the number of ones, or marks, in each received word. It is a valid code word if it contains three marks. Because a single error will change the number of ones to either two or four, the code detects all single errors. All combinations of three, five, or seven errors can be detected.

But, not all of the even-numbered error patterns will be detected with constant ratio codes. For example, if there are two errors, one error changing a mark to a space and the other error changing a space to a mark, the number of marks will remain three. That pair of errors will pass undetected as will four- and six-error patterns.

Another constant-ratio code is the IBM 4-out-of-8 code (IBM data transceiver code). It is an 8-bit code with 256 different bit patterns but only those with a fixed number of four ones and four zeroes are used to represent characters. The redundancy is the same as that of the 3/7 arq code and the same limitations prevail, although the number of characters is increased to

$$\frac{8!}{4! 4!} = 70$$

Despite their simplicity, constant-ratio codes have limited advantages. They can be used only for error detection and need higher redundancy than parity-check codes for equal detecting capability. Implementing the codes is difficult when the data source generates a random binary bit stream. The chief application of these codes has been in transmission of alphanumeric data, which, in any case, requires an arbitrary translation to digital symbols.

III. Parity-check codes

Parity-check codes are formed by algebraically relating a sequence of k information bits to a series of parity checks. Code words, or vectors, of k information bits and $(n - k)$ check bits are formed. They have the properties of mathematical groups and are therefore sometimes called group codes.

Essentially, all important block codes for error detection and correction are parity-check codes. Among them are the cyclic codes, which are principally random-error correction codes,^{3, 4} and those codes specifically designed to correct error bursts.^{5, 6}

Classes of code structures

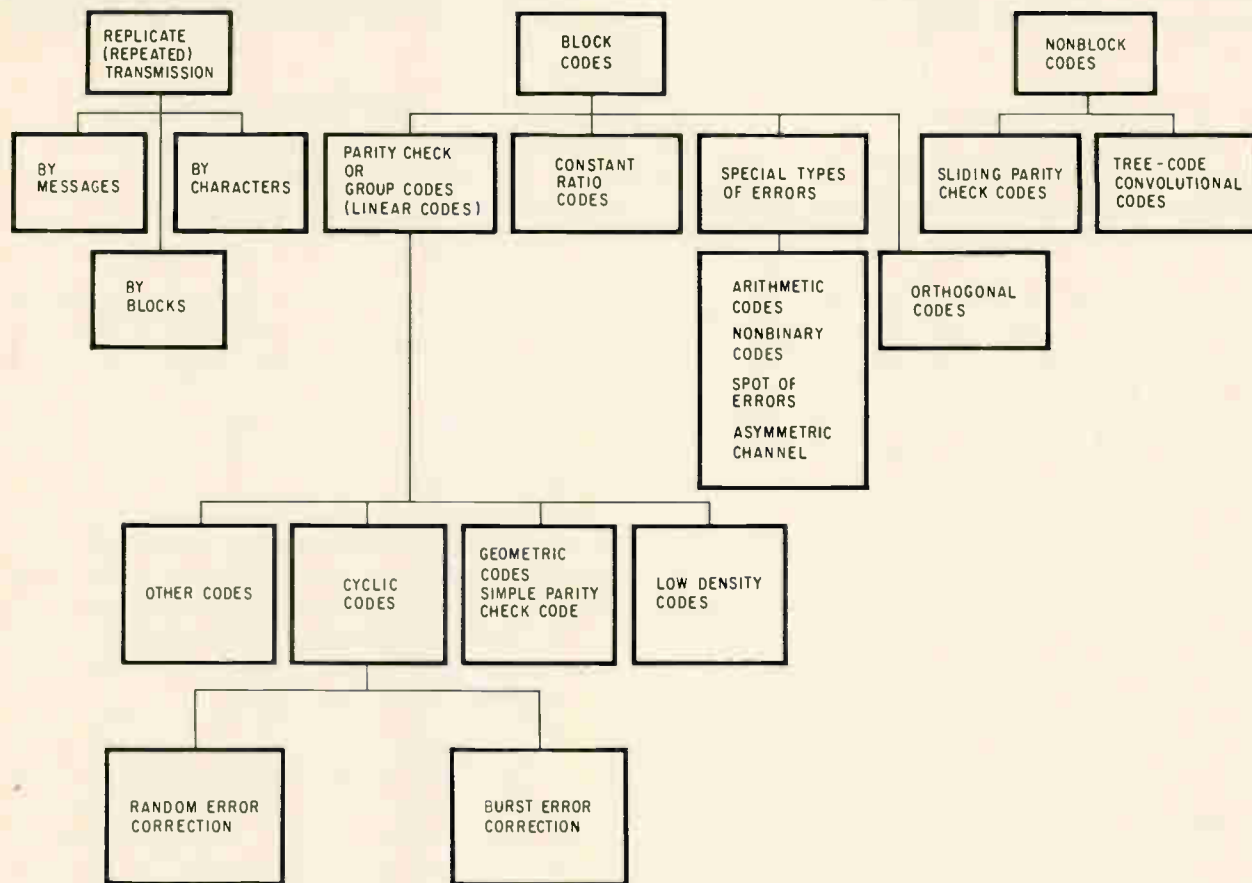

The three basic code structures for error control are replicate block and nonblock code structures.

Replicate, or repeat, transmission is the simplest. It is a brute-force method in which each message is transmitted several times over the same channel or simultaneously over several separate channels, permitting a majority decision at the receiver; but channel capacity is not efficiently used.

The more efficient block codes are used in many error-control systems. Each message unit has a fixed block length—The important block codes—called parity-check codes—permit forward error correction by establishing a mathematical relationship between in-

formation bits and parity-check bits within a block, or code word. Cyclic codes, a class of parity-check codes, are derived from the fact that any cyclic permutation of a code word results in another code word. These codes can be implemented with simple shift registers and can be formulated to correct either random or burst errors. Geometric codes are parity codes used to detect errors on computer punched cards or tape, where the data is arranged in rows and columns. The parity checks are formed for a two-dimensional block of data. Constant-ratio codes are block structures in which the ratio ones to zeros in the block is constant. These codes can only detect

errors, therefore a return channel is necessary for error correction. Other block codes have been developed for dealing with special kinds of errors, such as multiple bursts, a cluster of errors in a two-dimensional array, correcting for a bit loss or gain, and errors occurring in the asymmetric channel.

The recently developed nonblock, or convolutional codes show great promise in reducing the complexity of decoders. These codes do not have a fixed block structure. The information bits are encoded one at a time, instead of in groups as in the block codes. With simple shift registers and logic circuits, a receiver can examine each bit to determine if it is in error.

Simple parity-check codes

The most elementary binary error detection code is the simple parity-check code. The parity-check digit is the sum modulo-2 (binary addition without carry) of all the bits in the block. Although the n -bit block, including the parity-check bit, can be received in 2^n different ways one, and only one, corresponds to the transmitted block. If an odd number of errors have been introduced, the parity check will indicate an error. Thus, half of all possible error patterns can be detected with just one

check bit.

Adding more parity bits increases the redundancy and complexity of the code but the protection afforded is increased considerably. Many schemes have been devised for deriving the parity-check digits from the information digits, and each scheme results in a code whose error protection characteristics are unique.

Hamming codes

The codes named after R. W. Hamming¹ correct single errors and detect double errors. They are

based on the fact that a single bit error within a block of n binary bits, consisting of k information bits and $m = n - k$ check bits, can be corrected if the following relationship holds:

$$2^m \geq n + 1 = m + k + 1$$

This relationship is derived from the fact that the minimum number of bits necessary to locate a position in one of n places is $\log_2(n)$. Adding a further restriction, (that is, the case where no errors occur), the number of bits required to correct a single error in n places is $\log_2(n + 1) \leq m$ or, $2^m \geq n + 1$.

Information messages consisting of four bits each, $k = 4$, provide a good example. The minimum value of m which satisfies the Hamming relationship for single error correction is $m = 3$. Therefore, a (7,4) code, in which the block length is 7 bits, must be used to correct single errors. With this code, there are $2^k = 2^4 = 16$ possible messages, each with four information bits.

Cyclic codes

The concept of cyclic, or polynomial, codes is considered one of the major breakthroughs in coding theory. Their importance stems from the fact that they can be implemented easily.

Any cyclic permutation of a code word results in another code word. That is, if the sequence of bits $a_1a_2a_3 \dots a_{n-1}a_n$ is a code word, then the sequence $a_2a_3 \dots a_n a_1$ is also a code word and so is $a_n a_1 \dots a_{n-1} a_2 \dots a_{n-1}$. Such sequences can be generated rather simply by a system of shift registers and adders.

Cyclic codes can be generated by a shift register of length k , the number of information bits, or length $n - k$, the number of redundant bits. The latter type, which results in a shorter and cheaper shift register, is illustrated for an error detection mode in the diagram below.

To detect errors, the received block is checked for parity-check violations by a simple shift-register circuit similar to the one in the encoding equipment. If the received block is unacceptable, retransmission is requested. The probability of un-

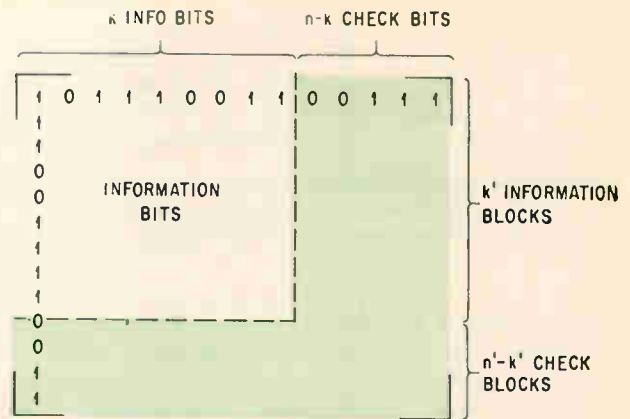

Geometric code structures provide parity checks in two dimensions. The horizontal rows of information bits have parity-check bits, as in simple parity checking. But with geometric coding, the vertical columns are also appended with a parity-check sequence.

detected errors can be made as small as desired at a relatively low cost in redundancy with longer block cyclic codes.

Some classes of cyclic codes, for example, the Bose-Chaudhuri code, are extremely powerful in correcting random errors. Certain other cyclic codes are effective in correcting error patterns confined to a single burst within a block. A shift register of length $(n - k)$ and simple logic circuits can correct an error burst whose length is one-third the number of redundant bits $(n - k)$ in a block. As with any block code, cyclic codes require a message buffer to store each received word until the error pattern and location are determined. Generally, burst decoders will fail to detect isolated errors beyond the confines of the burst limits.

Complex equipment is needed to correct random-error patterns by cyclic codes. The decoding complexity grows as a power of n for a fixed code redundancy.

On the other hand, for error detection and retransmission systems, these codes require a decoder that is as simple as the encoder. A feedback

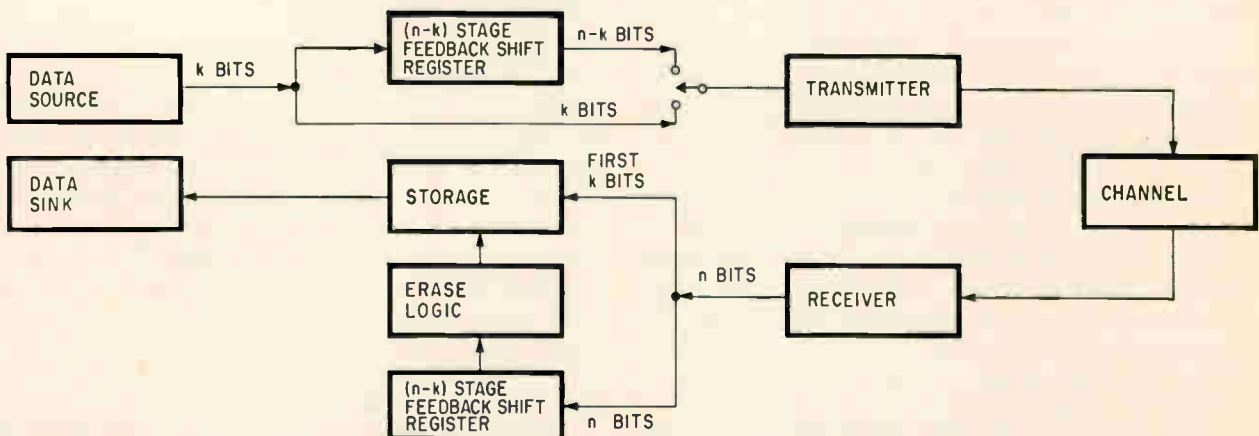

Cyclic codes can be implemented easily. Each code word is a cyclic permutation of another code word. Typical cyclic encoding and decoding scheme shows a shift register that generates the parity-check bits. An identical register at the receiver recomputes the parity checks to determine if the code word should be accepted.

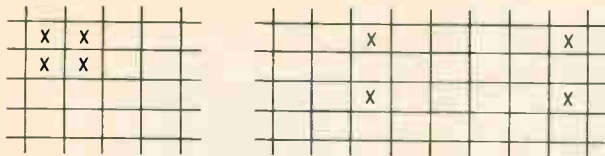

Rectangular error patterns, a possibility in geometric structures, could cause parity checks to look like correct bit sequences and errors would escape detection.

shift register of length $(n-k)$ bits is required to encode and decode data for arq systems. At the receiver, k bits must be stored so that the complete n -bit code word can be received and checked for errors before it is released to the data sink.

The Bose-Chaudhuri code is a cyclic code designed to correct random errors. The number of errors it can correct depends on the distance between code words, which, in turn, is directly proportional to the redundancy. Therefore, the greater the redundancy, the larger the number of correctable error patterns. The longer B-C block structures have excellent capability for detecting burst errors as well. For example, a 255, 223 B-C code—255-bit block length having 223 information bits—has an efficiency of 87% under ideal channel conditions. This code, when confronted with a burst of pure noise input, (all bits are random ones or zeroes with probably of $\frac{1}{2}$ for either) will fail to detect an error with a probability of less than 1×10^{-9} .

The Fire code⁶ describes cyclic codes designed specifically for the detection or correction of burst errors. Basically, its encoding and decoding technique is similar to that of the B-C codes. Although the Fire code is capable of correcting single error bursts of much greater length than can a B-C code, it is vulnerable to only a few scattered errors within a block. For example, a Fire code that can reliably correct up to five bits in error in a single burst, might fail to correct two bit errors occurring more than five bits apart.

Fire codes and other burst correction codes can be extremely efficient when the duration and frequency of bursts are precisely defined.

Geometric codes

Geometric codes⁷ are parity-check codes extended to more than one dimension. Considering the bit structure of previously described codes as forming a straight line, one can envision geometric codes as forming rectangles or even cubes.

These codes provide horizontal and vertical parity checks on a code word arranged in a plane, as well as the higher dimensional code structures, such as stacks of planes. A two-dimensional code structure with a single parity check for each dimension is simple to implement. Such codes have been extensively applied to data on computer cards or tape for error detection.

Although geometric codes are fairly efficient and easy to implement for the arq mode, cyclic codes are more practical for forward error correction. Geometric codes for error correction have been

studied, but no good practical implementation has yet evolved. Higher dimensional codes for partial error correction and error detection have been analyzed and found to provide relatively efficient use of channel capacity but at the expense of considerable terminal storage requirements.

One of the most attractive features of geometric codes is the logical way in which standard information code formats may be grouped to form a block. By using a fixed number of code words for a row while varying the column depth, a rectangular block structure can be formed that adapts to changes in channel conditions without imposing format restrictions on incoming data.

An application of one such coding technique uses simple horizontal and vertical odd parity-checks on a punched card containing 80 characters, each with an information content of 8 bits. A repeat request of the entire card is initiated if any one of the parity checks is not satisfied. There is a possibility of undetected errors when the error patterns on the card are rectangular as shown in the diagram above. However, the probability of such an error pattern is very low.

Zierler codes

Zierler codes,⁸ based upon the principle of encoding characters rather than bits, have been proposed but not yet implemented. One such structure, 2,040 bits long, and consisting of 255 symbols with 8 bits per symbol, seems fairly simple to implement. The basic construction of the code is similar to that of the B-C code but with 255 8-bit symbols in the block, instead of 255 bits per block. For a Zierler code, a variable number of check symbols, C , may be used. The result is that e or fewer symbol errors can be corrected, where $e = C/2$. The advantage of grouping bits into symbols is that longer block lengths are obtained with only a modest increase in decoder complexity. The efficiency of this technique lies in its ability to handle clusters of errors occurring within a code word; the number of random errors that can be corrected is limited.

Low-density block codes

A low-density parity-check block code⁹ is one with a low ratio of ones to zeroes in the parity-check matrix. Low-density codes are often capable of correcting a high percentage of all the possible patterns of errors with moderately complex decoders. For the same block length, the greater the redundancy, the greater the number of possible error patterns that can be corrected. For instance, a typical (500, 250) code will correct almost all patterns of 30 errors and a (500,125) code, almost all patterns of 65 errors. It is important to note, however, that this coding technique is primarily applicable to relatively large block code structures.

Other block codes can deal with special kinds of errors. They include codes for error location, for correcting multiple bursts, for correcting a cluster of errors in a two-dimensional array, for correcting

for bit loss or gain, and codes which can be adapted to an asymmetric channel.

IV. Convolutional codes

Convolutional codes are widely used nonblock codes in forward error-correction systems because these nonblock structures can be decoded simply. They differ from the codes already described in that they have no fixed block structure. Information bits are encoded sequentially, with each information bit entering into the formulation of check digits for a period extending over k message bits or n transmitted bits. The length of this bit sequence is called the constraint length of the code.

The convolutional encoding process is best described with the help of the diagram below. The sequence M_1, M_2, \dots , of information bits passes through a shift register k digits long. Each position in the register is associated with a bit in the parity check network. The transmitted check digits are computed by multiplying an information bit with its associated parity bit and forming the sum modulo 2 of the products.

In the case illustrated, the absence or presence of connections between the k -stage shift register and the parity network represents the multiplication between a code-structure bit sequence and the data. The entire process may be thought of as a convolution of the information bit stream with the code. Information bits and check bits are read out alternately according to a fixed procedure. The resulting sequence of modulo 2 sums interleaved with message bits is the transmitted message. The choice of connections into the modulo-2 adder is determined by a particular code.

Convolutional codes are still being formulated through heuristic procedures. At present, the two decoding methods are sequential decoding¹⁰ and threshold decoding.¹¹ Sequential decoding is more powerful but information bits must be highly interrelated. Threshold decoding uses a rather loose structure to permit insertion of isolated parity checks in the bit stream.

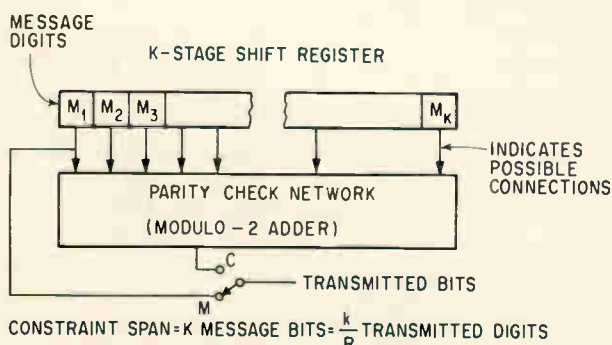

Convolutional codes have no fixed block structure. A convolutional encoder consists of a shift register and a modulo-2 adder to form the parity checks. In this way, individual information bits enter into the computation of many check bits. Each parity check is interleaved between each information bit.

Sequential decoding

Sequential decoding was developed for convolutional codes of long constraint lengths.¹⁰⁻¹³ Digits are decoded in sequence and each is tested to determine whether it's zero or one. Whenever a decision as to its value can be made with sufficient confidence a digit is read out of the decoder. The decision depends on the entire received sequence containing the symbol. Hypothetical sequences are searched out systematically and tested for distance from the received sequence. When a sequence within present limits of acceptable distance is found, the first symbol of the sequence is read out of the decoder and a new last symbol read in. If at first no acceptable sequences are found, or if two similar sequences corresponding to different alternatives are found, then the lengths of the sequences under investigation are altered until one alternative or the other becomes significantly more probable. At this point, an irrevocable decision is made and the next digit is examined.

Sometimes, due to excessive noise, the desired level of confidence cannot be reached. When this is anticipated, a procedure may include acknowledgment of a decoding failure and retransmission will be requested. As a result, the probability of reading a wrong symbol out of the decoder is very low.

One problem with the sequential method is the variable computation time needed to decode different symbols. Incoming data must be stored in a buffer during long computational periods. Whenever the buffer capacity is exceeded, a decoding failure is declared and retransmission is necessary.

Sequential decoding uses redundancy efficiently, and it adapts easily to changing channel conditions. Once an encoder and decoder are constructed for a given constraint length, the encoding structure may be varied within that constraint length by changing the logic procedures. The main disadvantages of sequential decoding are the large amount of equipment required because of the complex decision procedures, long constraint lengths, and the long decoding time which must be allowed.

Threshold decoding

Convolutional codes can be decoded by a majority count of the parity-check bits associated with an information bit. This is called threshold decoding.

To understand this decoding technique, consider a specific convolutional encoder with threshold decoding. The code for this example is a $\frac{1}{2}$ rate code, that is $k = n/2$. In this example $n = 12$ (p. 78, top).

A continuous stream of information bits is simultaneously fed into the shift register, the communication channel and the parity-check generator. The parity-check generator is a modulo-2 adder that sums the most recently introduced information bit with the previous third, fourth, and fifth information bits, and produces a parity-check bit.

This parity-check bit is transmitted immediately after its associated information bit (the most re-

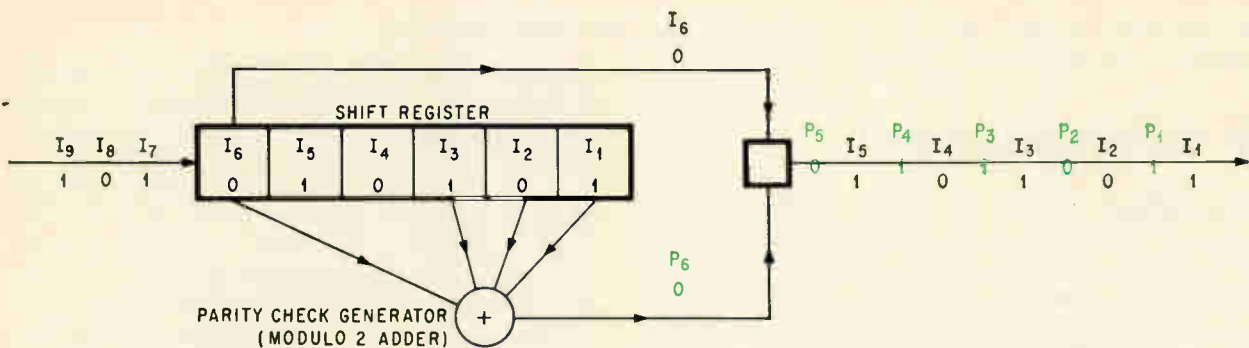

Convolutional encoder for threshold decoding. Information bits are simultaneously fed into the communication channel, shift register and parity-check generator. The parity-check generator is a sum modulo-2 adder. It adds the most recently introduced information bit with the previous third, fourth and fifth information bits, to provide a parity-check bit (color) immediately after its associated information bit.

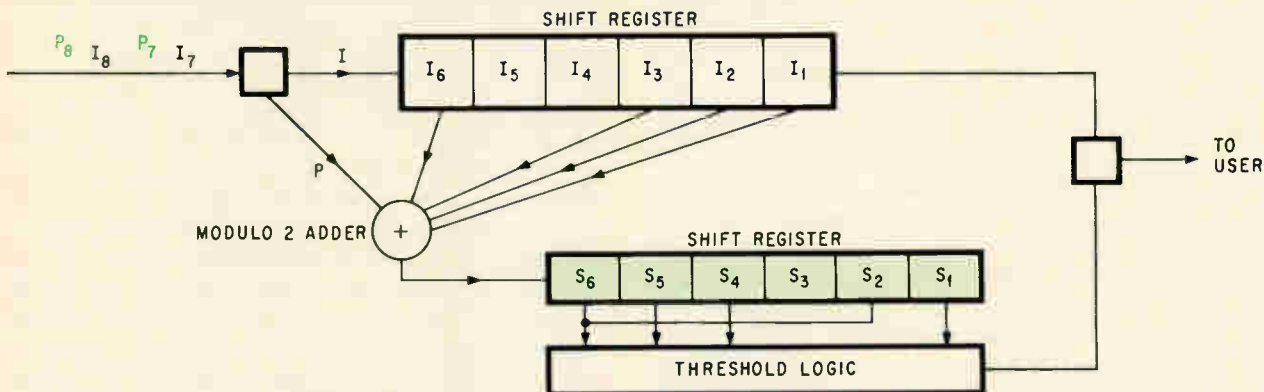

Convolutional threshold decoder. The data stream is separated into two streams—information and parity bits. These are fed to a shift register identical to the one at the encoder. The adder gets an additional input, the received parity-check bit. If there are no errors, the adder output is a parity-check bit added to itself, or zero. If there are errors, they will be produced as one's; they go from the adder to the lower shift register (color) to be corrected ultimately by the threshold logic circuits.

cently introduced bit). At the instant illustrated in the diagram, information bit I_6 is just entering the channel and its parity check P_6 is being determined. In the next bit interval, I_1 will be shifted out of the register and discarded. As an example of this technique, consider the 9-bit message 101010101 entered into the encoder from right to left. Assuming that the shift register initially contained all zeroes, the encoded form of this message reading from right to left would be:

$P_9 I_9 P_8 I_8 P_7 I_7 P_6 I_6 P_5 I_5 P_4 I_4 P_3 I_3 P_2 I_2 P_1 I_1$
 0 1 0 0 0 1 0 0 0 1 1 0 1 1 0 0 1 1

At the receiver, the data stream is separated into two streams, one containing the original information bits and another the parity bits. The information bits are fed into a shift register identical to the one used for encoding. However, the modulo-2 adder at the receiver has an additional input, the received parity-check bits. If there have been no errors in transmission, the adder's output will be a parity-check bit added to itself, which is zero. A one in the output of the adder represents an error in transmission. The output of the adder is fed to a second shift register as shown in the diagram above.

The presence of one's in the second shift register can only result from errors. For example, consider the moment illustrated in the decoder diagram. The first six of the interleaved informa-

tion and parity bits have already entered the decoder. The contents of the six stages of the shift register are given by

$$S_1 = E(I_1) + E(P_1)$$

$$S_4 = E(I_1) + E(I_4) + E(P_4)$$

$$S_5 = E(I_1) + E(I_2) + E(I_5) + E(P_5)$$

$$S_2 + S_6 = E(I_1) + E(I_3) + E(I_6) + E(P_2) + E(P_6)$$

where $E(I_j)$ or $E(P_j)$ is a one only if I_j or P_j is in error, and is zero otherwise.

The stages of the shift register, which are examined by the threshold logic circuit, are designed so that each logic equation formed will contain $E(I_j)$ once, while all the other $E(I_j)$ and $E(P_j)$ terms appear no more than once in the entire set of equations. In the example under consideration, the decoder is attempting to determine the correct value of information bit I_1 . Assuming two or less errors in the eleven bits (6 information bits, the $E(I_j)$ terms, and 5 parity bits, the $E(P_j)$ terms) contained in these equations, a decision on the value of $E(I_1)$ can be made on the basis of the following rule: If three or four of the sums shown equal one, then $E(I_1)$ will be considered a one and bit I_1 will be considered in error.

The logic circuit is implemented to correct I_1 as it leaves the register and simultaneously correct all the S stages which contain $E(I_1)$. This threshold decoding scheme always gives a correct decision as long as no more than two errors are present in

Constraint length vs corrected errors

Efficiency (Rate)	Constraint length	Errors corrected
0.5	12	2
0.5	24	3
0.5	44	4
0.5	68	5
0.5	104	6

any 12 consecutive bits—6 information and 6 parity bits. However, it can correct some of the error patterns containing more than two errors.

Since the decoder is always examining 6 information bits and 6 parity check bits, this code is said to have a constraint length of 12. However, the principles illustrated in the previous example apply to codes with various constraint lengths and various rates. Some typical constraint lengths and the number of errors within that length that are guaranteed to be corrected are listed above.

These codes can be used in long-burst error correction by a method called diffuse convolutional coding.¹⁴ It consists of taking a code like that just described and extending the constraint length over a long sequence of bits, only a few of which are used in computing the value of the parity-check bit.

The code can be extended to accommodate not only various burst sizes, but can handle various coding rates as well. The only limiting factor in the size of the burst that these codes can correct is the register capacity.

Probabilistic decoding

Unlike the coding methods previously described, probabilistic decoding is not a specific technique but a means of improving decoding techniques by bringing more information to bear on the decision process. The idea is to preserve some of the information usually lost in the demodulator when it assigns either of the values zero or one to a received waveform, and the probability for either value is nearly equal. Recapturing the lost information can be accomplished, for example, by recording the probability that each received digit was a one. This information is used in the decoder to determine the most likely code word. The process could also be considered one in which the demodulator makes use of the structure of the code to improve the reliability of its decisions. Actually, the result is to combine or interrelate the functions of the demodulator and the decoder.

An interesting example would be a threshold decoding scheme where the parity-check bits for a received sequence have the following probabilities of being one: 0.1, 0.2, 0.6, 0, 0.5, 0.8, and 0.9. This would ordinarily be demodulated as 0010111, assuming a decision rule that arbitrarily assigns the value one in cases of equal probability (0.5). With no further information, the decoder would merely detect the presence of an error for that parity check. But, with the probabilities available, it is

possible for a decoder in conjunction with a logic circuit to change the least confident decision, namely, that regarding the value of the fifth digit where an arbitrary choice was made. This change could cause the majority logic estimators to decide that the correct value for the bit being decoded is one. Without the additional probabilistic decision process, an incorrect decision would have resulted.

This procedure uses the information in the received waveform more efficiently but its implementation requires complex equipment, including a device for storing probabilities.

Which code for what mode

For error detection the choice is limited to block codes. Among these, the Bose-Chaudhuri codes are preferred because of their relative ease of implementation, efficiency, and error-control capability. Geometric block codes perform almost as well in this mode and have desirable properties for formatting, that is, the arrangement of the information bits within a block of binary bits.

When considering codes for forward error correction, nonblock structures become extremely attractive. Convolutional codes with sequential decoding are extremely effective for fec although the necessary equipment is complex and expensive. Although simpler equipment is required for threshold decoding, the error-correction capability for a particular code redundancy is reduced. Block coding structures are not usually used in the fec mode because the decoders required are prohibitively expensive. Zierler codes are the exception; they show promise of providing versatile error correction capabilities with decoders no more complex than sequential decoders.

References

1. R.W. Hamming, "Error Detecting and Error Correcting Codes," Bell System Technical Journal, vol. 29, April, 1950, pp. 147-160.
2. M. Nesenbergs, "Comparison of the 3/7 ARQ with Bose-Chaudhuri-Hocquegen Coding Systems," IEEE Transactions on Communications Systems, vol. CS-11, June, 1963.
3. R.C. Bose and D.K. Ray Chaudhuri, "A Class of Error Correcting Binary Group Codes," Information and Control, vol. 3, March, 1960, pp. 68-79.
4. E. Prange, "Cyclic Error Correcting Codes in Two Symbols," Technical Note AFRL-TN-57-103, AF Cambridge Research Labs. Bedford, Mass., September, 1957.
5. N.M. Abramson, "A Class of Systematic Codes for Non-Independent Errors," Technical Report 51, Electronics Research Lab, Stanford University, Palo Alto, Calif., December, 1958.
6. P. Fire, "A Class of Multiple-Error-Correcting Binary Codes for Non-Independent Errors," Report RSL-E-2, Sylvania Electronic Products, Mt. View, Calif., March, 1959.
7. T.G. Kuhn, "Retransmission Error Control," IEEE Transactions on Communications Systems, June, 1963, pp. 186-201.
8. N. Zierler, "Error Correcting Code-Decoder. Summary of Results of Phase I," TM-04104, Mitre Corp., Bedford, Mass.
9. R.G. Gallagher, "Low Density Parity Check Codes," IRE Transactions on Information Theory, vol. IT-8, January, 1962, pp. 21-28.
10. J.M. Wozencraft and B. Reiffen, "Sequential Decoding," Technology Press of MIT, Cambridge, Mass., and Wiley, N.Y., N.Y., 1961.
11. J.L. Massey, "Threshold Decoding," The MIT Press, Cambridge, Mass.
12. R.M. Fano, "A Heuristic Discussion of Probabilistic Decoding," IEEE Transactions on Information Theory, vol. IT-9, April, 1963, pp. 64-74.
13. K.M. Perry and J.M. Wozencraft, "SECO, a Self Regulating Error Correcting Code-Decoder," IRE Transactions on Information Theory, vol. IT-8, September, 1962, pp. 128-135.
14. "Diffuse Coding for Data Transmission," Technical Bulletin 4, Codex Corp., Cambridge, Mass.



Pulse System Packages and Pulse Networks

More power to you, from AMP

When it comes to power, your specifications reign supreme. That's why AMP specializes in the custom engineering of pulse system packages and pulse networks to the customer's requirements. We make packaged pulse modulators for high-power radar systems with weight and cube reductions of 50% or more compared to standard systems.

We've developed over 2,500 different types of pulse forming networks, covering all combinations of pulse widths, impedances, and charging voltages. These units are designed with exact compliance to pulse shape, rise time, and ripple tolerances.

All A-MP* power packages are characterized by light weight, rugged construction and extreme reliability. Here, for example, are specifications for a typical high power pulse modulator shown above:

Magnetron Filament Voltages: 13.75 volts—standby
7.8 volts—operate

Peak Pulse Amplitude: 22.0 kilovolts \pm 4%

Rate of Rise: 140 \pm 20 KV/ μ sec.

Pulse Width (current): 0.7 \pm 0.05 μ sec.

Positive Backswing: 20% max.

Fall Time (current): max. 30% of pulse width

Ripple Detected RF: 14% max. on 711 magnetron

Overload Protection: 200% of protective diode current

Trigger Amplitude: 110 volts \pm 10%

Trigger Pulse Width: 1 \pm 5% μ sec.

Trigger Rise Time: 0.2 \pm 10% μ sec.

Programming: 2 sec. delay

Inputs: DC voltage, system triggers, and AC filament voltages

Additional features—overload protection current, average magnetron current output, thyatron filament and mounting, line filters and RF bypass.

Our facilities and engineering staff have the capability to provide many other items for land, sea, and aerospace applications. Why not get in touch with us today.

Custom pre-engineered high voltage power supplies • low voltage power supplies • high voltage lead assemblies & connectors • high voltage capacitors

AMP | **CAPITRON**
INCORPORATED | **DIVISION**
155 PARK STREET, ELIZABETHTOWN, PA.

CAPITRON products and engineering assistance are available in Canada through Aircraft-Marine Products Ltd., Toronto, Ontario, Canada ★Trademark of AMP Incorporated



European electronics markets—1966

By the editors of Electronics

In the first detailed statistical compilation of electronics consumption in Europe, the editors of Electronics predict the industry will grow 10 percent next year, to \$7.8 billion. Consumer and industrial segments of the industry will grow the fastest; many countries expect a sharp decline in military electronics, which are already small in most countries, reflecting the completion of defense projects and the obstructionism of France in NATO.

Contents:

West Germany p. 86
United Kingdom p. 89
France p. 92

Italy p. 94
Others p. 96
Soviet Union p. 100

TOTAL ELECTRONICS CONSUMPTION

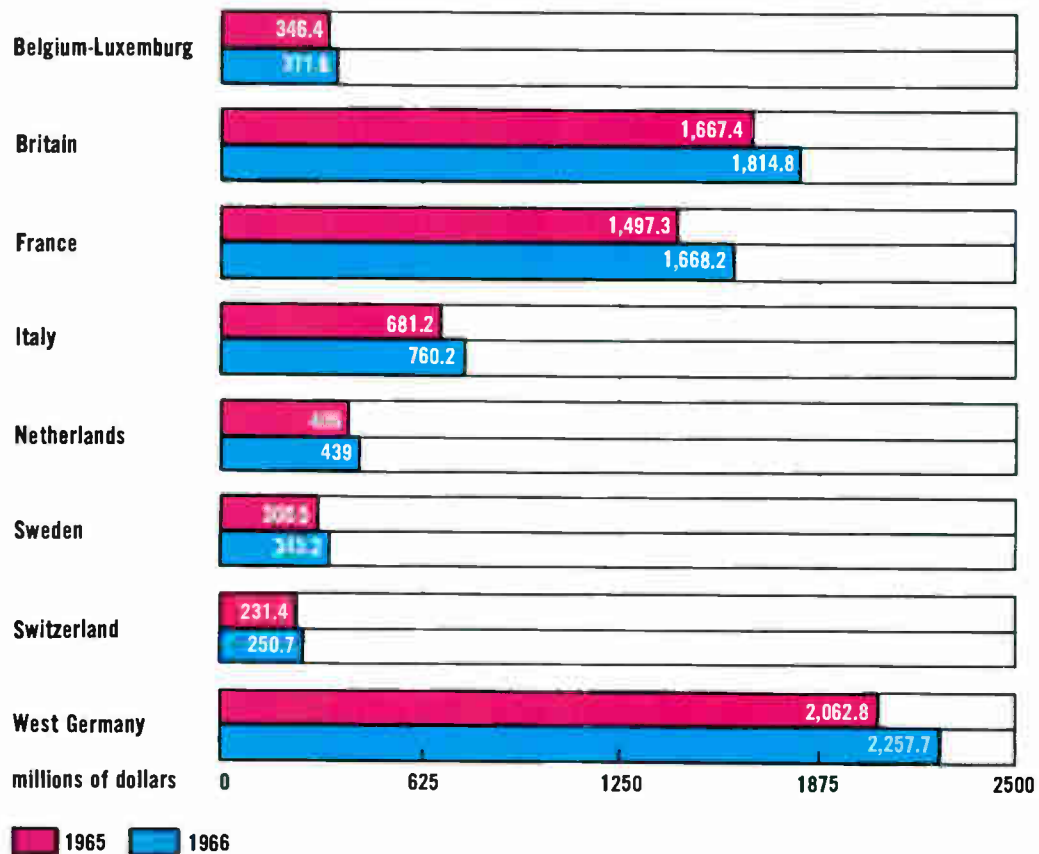

EUROPEAN ELECTRONICS MARKETS

	1965	1966
Components	2,035.6	2,196.7
Consumer products	1,582.3	1,673.4
Medical equipment	127.6	137.3
Communications	1,309.3	1,430.8
Computers & related equipment	923.8	1,057.1
Nuclear instruments & equipment	79.9	91.8
Production, control & other equipment	647.0	769.4
Test & measuring instruments	487.5	548.9
Electronics Industry, total	7,193.0	7,905.4

Statistics were obtained by Milton Drake, director of market research, with additional reporting by McGraw-Hill correspondents in London, Paris, Bonn, Stockholm, Brussels, Zurich, Milan, Vienna and Copenhagen. This team interviewed representatives of more than one hundred industry associations, governmental agencies, banks, diplomatic sources and companies to obtain estimates of electronics consumption in each country. Statistical techniques were then applied to produce a consensus of these estimates.

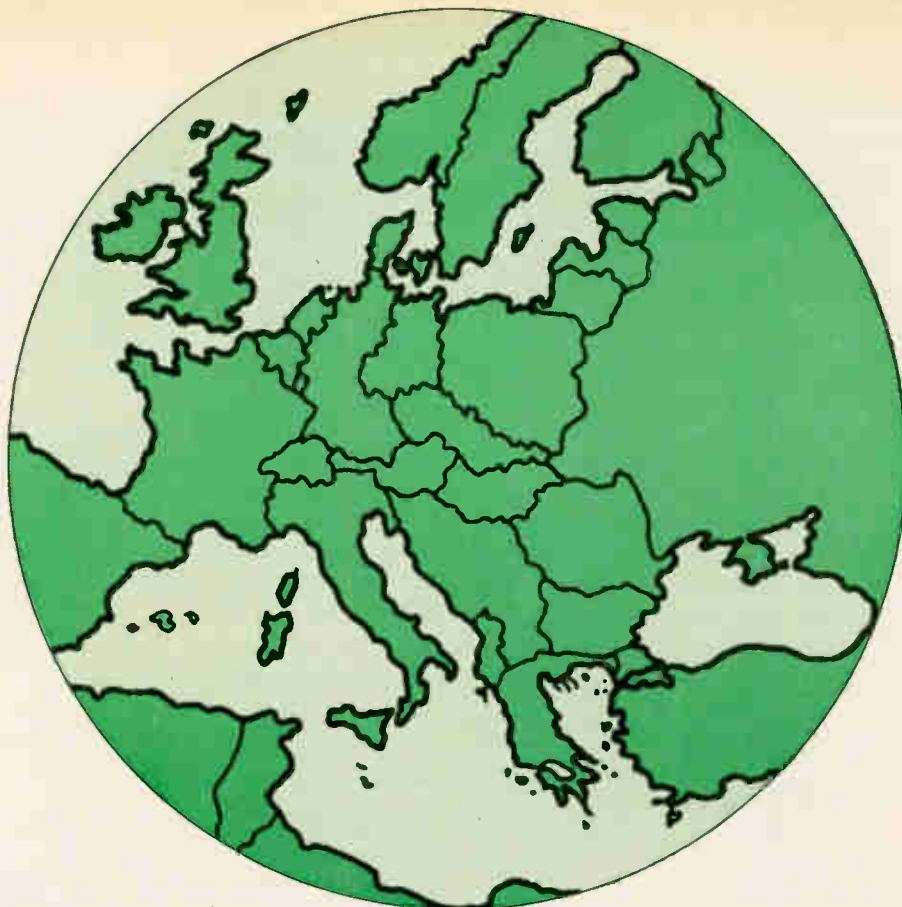

European electronics market

The boom continues

Electronics' first European forecast indicates uninterrupted growth in all nine countries studied and in every major sector of the electronics field. Expenditures should total \$7.9 billion in 1966

Western Europe's electronics markets will continue to expand next year with West Germany, Great Britain and France continuing as the biggest consumers, in that order.

Electronics' first European market survey indicates that sales will climb to \$7.90 billion from \$7.19 billion in 1965. Germany's booming economy will use \$2.25 billion of electronics equipment, up from \$2.06 billion this year. Sales in Britain will total \$1.81 billion, compared with \$1.66 billion this year; France will spend \$1.66 billion on electronics, up from \$1.49 billion this year.

Increases will cover all sectors of the electronics field: consumer, communications, computers, instrumentation and industrial equipment.

The consumer sector, although the second-largest and still growing, has cooled off slightly. Consumer products are expected to account for \$1.67 billion in sales next year, up from \$1.58 billion in 1965; but with the television market approaching saturation and color tv still at least three years off, sales of tv sets are not increasing as rapidly as in the past. The replacement market is not taking up all of the slack; however, sales of phonographs,

radios and tape recorders figure to continue the fast growth experienced this year.

Industrial electronics, spurred by labor shortages and a demand for automation, continues to gain rapidly. In Germany, for example, only 5% of the factories have automation approaching that of American companies; this is expected to double in the next decade.

Also growing is the demand for computers. Sales are expected to exceed \$1-billion for the first time next year; in 1965, sales of computers and related equipment totaled \$923.8 million.

In communications, where European technology is pretty much keeping pace with that of the United States, expanding government budgets assure continued growth. Britain, for instance, spends \$750 million a year on telecommunications. Electronic switching for telephone systems is being tested in

Britain, West Germany, France, Sweden and elsewhere. Systems based on pulse-code modulation are due for delivery this year.

As in the United States the military market is uncertain. There are a few big contracts in the works, however—the French Mirage 4 bomber and Sweden's Viggen multipurpose warplane, to name two. Britain has been switching to American-made planes to reduce her defense costs, but the British expect to continue to supply much of the electronic gear.

The North Atlantic Treaty Organization also continues to buy electronic equipment, although its promise has not been fully realized.

West Germany is developing into a market for space electronics. Early this year the Ministry for Scientific Research estimated that it would spend \$500 million by 1970.

West Germany



Industry rides on economic crest

The West German economy heads into 1966 at its strongest level since before World War II. And riding the crest of this economic wave will be the thriving electronics industry, the biggest in Europe; domestic consumption reached \$2 billion in 1965 and is expected to total \$2.2 billion next year.

Last year, West Germany satisfied its own domestic demand for electronic gear and ranked second only to the United States as an exporter of industrial electronic products. West German electronic equipment has found a worldwide market, from electronic telephone-switching equipment in Rome to automatically controlled tankers on the high seas.

Because of restrictions imposed on West Germany by the Allied occupation forces following World War II, the country's modern electronics industry is really only 10 years old. So West Germany has a long way to go to catch up with the United States in many advanced applications and advanced research and development. Many West German research workers eye the massive infusion of U.S. government funds into research and development with envy.

At the sprawling central laboratories in Munich of the giant Siemens & Halske AG, the largest electronics company in Germany, a research official says: "We cannot afford the wide-ranging projects that are possible in the U.S. In fact, less than 1% of our research and development budget comes from the government." But the West German electronics industry is hopeful that some year

soon it will rank as a leading innovator in the field.

Government and defense

On its own and in cooperation with other European countries, West Germany is hard at work on such diverse projects as satellite-launching rockets, research and communications satellites, satellite ground-control stations, vertical/short-range take-off and landing (V/STOL) tactical fighters and transports, and helicopters. In 1966 and the coming years, these will represent a growing market, but a market in which the German electronics companies are going to fight harder than in the past.

Earlier this year, the West German Ministry for Scientific Research estimated the country's need for space projects funds at nearly \$500 million for the next five years. And in the past year or so, a number of German companies have moved to strengthen their position in advanced applications by seeking ties with other companies, both domestic and foreign.

For example, Telefunken AG joined a consortium led by the Hughes Aircraft Co. to snag a North Atlantic Treaty Organization air-defense ground-environment (Nadge) contract. Siemens joined an opposing consortium led by the Westinghouse Electric Corp. AEG, Telefunken's parent, is working closely with the General Electric Co. in atomic power. Siemens produces some of the Radio Corp. of America's line of computers and sells them in West Germany.

Still, the U.S. is the major source for much of the electronic gear vital to West Germany's defense and is likely to remain so as long as the West German Army is considered only a part of NATO.

Last year, 30% of the radio equipment orders in West Germany were filled by the U. S. To change this, German companies are setting up more lucrative links with U.S. firms, tapping American know-how through licenses, exchanges or out-

right acquisitions. An example of the latter is Telefunken's take-over of the majority interest in GE's subsidiary, Elektronische und Luftfahrtgerate, GmbH, which services airborne electronic equipment.

Bucking this trend, though, are the subsidiaries of the U.S. companies actually manufacturing in Germany. For instance, 80% of the computers manufactured in Germany are made in American-owned plants, as are about 20% of all military and industrial electronics equipment and about 15% of consumer electronics.

Consumer electronics

The West German electronics industry is expected to show strength across-the-board except in some areas of consumer electronics. Sales of radio receivers will be stimulated when the West German broadcasting companies and the post office—which as in other European countries is responsible for radio and television transmission—begin stereo broadcasting around the end of 1966.

Although it will not be ready before 1967 at the earliest, color television is already far along in manufacturers' planning. The coming year will be a time for readying production lines to avoid the pinch the U.S. industry is now feeling because demand is far outstripping production.

But the West German electronics industry is in no real hurry to push color television into the marketplace. Sales of black-and-white sets are

strong and more than 50% of the West German households now have at least one television set. By the end of 1966, this should reach nearer 70% and only then will the manufacturers feel the threat of saturation and the need for a new product. The domestic makers know they must be ready with color-television sets because a hefty 30% of the West German tv-set market now is filled by imports from other European nations. Without a competitive color set, this percentage might rise.

Sales are expected to rise in tape recorders and record-playing equipment and there are also great hopes for automobile tape recorders using easily changeable cartridges, a product introduced only this year.

Industrial electronics

Electronics in the factory is gaining fast in West Germany as the demand from the country's prosperity outraces production capacity. A factor, too, is the chronic labor shortage that is being met—not always successfully—by the Gastarbeiter, as the foreign worker is called. Over 1.2 million strong, this labor force—recruited from Greece, Yugoslavia, Italy and England—is an important factor of many electronic plants.

So far, only about 5% of West Germany's factories including heavy industry have anything approaching the automation of American industry. The percentage is expected to double in the next

West German electronics markets

(millions of dollars)

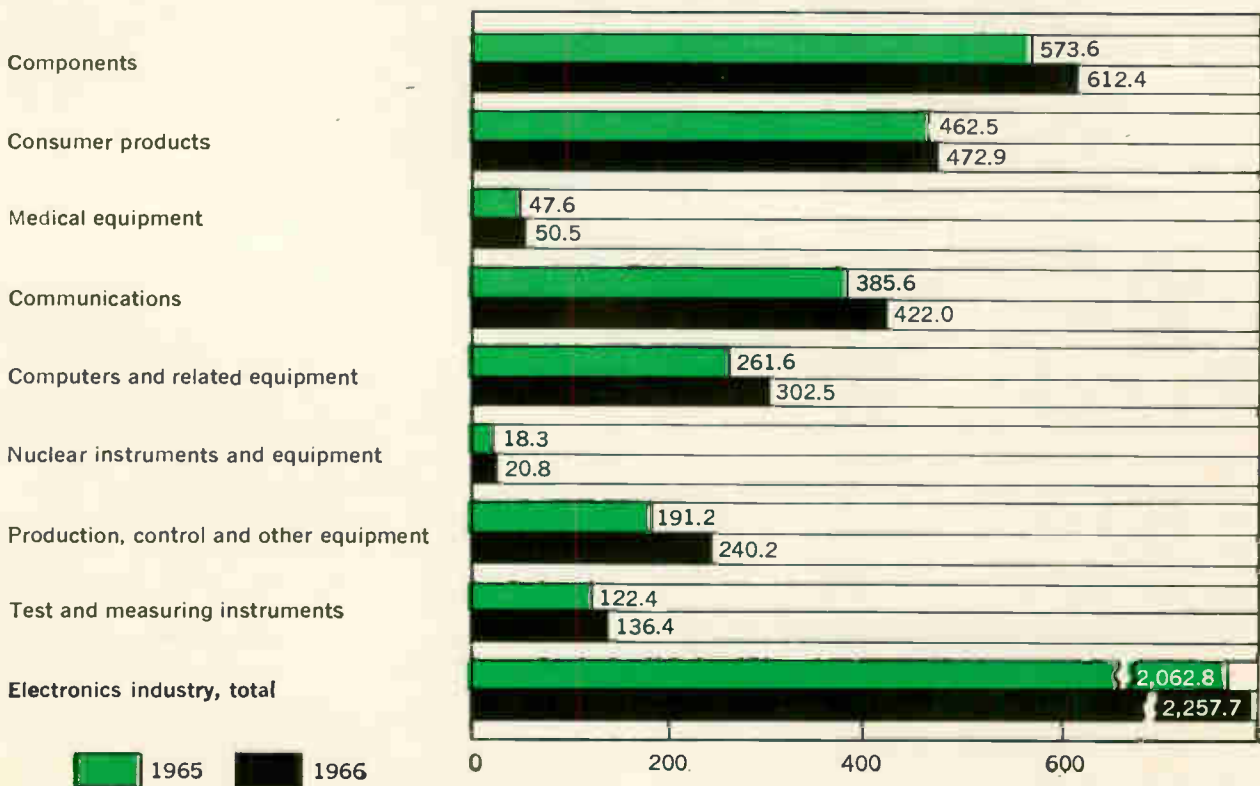

five years, opening a large market for electronic-control, measuring and testing equipment.

Last year, nearly half of the control, measuring and testing instrument imports came from the U.S. Although the competition from the rest of Europe, especially in process-control computers is growing, the American position is expected to stay at a high level in 1966.

In just about every segment of West German commercial and industrial activity, sophisticated controls systems are being planned and electronic devices form their backbones. Numerical control is hurting the traditionally stolid West German machine tool industry. Not only has numerical control fathered a new generation of machine tools, but it is also pushing electronics into new areas—one of particular note in West Germany is the increasing automation of automobile design.

Next year will see several computer-controlled steel-rolling mills operating. One will be at the Fried. Krupp-owned Bochumer Verein in the Ruhr that was designed from the ground up for computer control. These mills have already triggered competition for new control systems both in the steel industry and elsewhere and 1966 should see an expansion of interest—and of orders—for electronic process control.

The fast-growing, and ultimately the most lucrative industrial market, is for process-control equipment, with the digital computer far and away the most attractive product. International Business Machines Corp. now supplies some 70% of the West German computer market, but Siemens—with a 6% share of the market—hopes to cut down IBM's near-monopoly in 1966. The West German company recently announced it planned expenditures of \$125 million "within the next few years" to build up its electronic-data processing business.

Siemens intends to spend \$10 million of that amount almost immediately by building a new computer development center in Munich. Another \$5 million will be spent to expand already existing computer-production plants in that city. Siemens signed an agreement about a year ago with RCA to share licenses and sales facilities for RCA's Spectra 70 computer, which Siemens will distribute in Germany as the 4004 system. About 70% of the 4004's components are U.S.-made, but Siemens hopes to reduce this to about 30%.

Transportation is feeling the impact of electronics, too. Next year, this market will grow as both the railroads and the various government road agencies step up their programs for traffic-flow control. The Deutsche Bundesbahn, which runs the railroad network, has installed electronic controls in major train terminal switchyards and on some sections of the mainline right-of-way. The company is also looking at block control systems. Under the direction of a computer, these systems feed information back into the cab of a locomotive rather than just to the signals at trackside. Similar systems are being tested for subways in several

West German cities.

And the West Germans, long-standing innovators in highway development, have installed computer-directed traffic control systems in the heart of West Berlin and Munich. West Berlin regulates traffic on the major road leading out of the city to the Hanover Autobahn. The control system, made by Siemens, employs a signal processor for routine work and a Siemens-Halske 303 process computer for tasks that require complex decisions. The machines cost a total of \$250,000.

Siemens also has installed a control system, which uses radar detectors, in Neu-Ulm, in southern Germany. In a previous setup in Hamburg, the company used pneumatically operated strips to measure traffic flow and select a control program electronically. Munich installed a specialized computer made by a British firm, Elliott-Automation, Ltd. Costing \$350,000, the machine will select programs from a repertoire of 40 that control the timing of traffic lights.

The telephone network in West Germany, as in the United States, is going through an evolutionary upheaval with direct distance dialing to many neighboring countries an accomplished fact and electronic switching systems appearing—both for central offices, such as one installed in Munich, and for private branch exchanges.

Some 30 to 40% of the market for West German telephone equipment is abroad, according to Siemens. So American companies can expect continuing competition in foreign markets from West German equipment, which is as advanced as American wares in many areas and in some—such as desk-top call director units—even more advanced. For example, one Siemens desk-top director has both a memory for each of its labeled buttons—addressed by punching the punch-button dial on the set—and also a temporary memory to store the last number called in case it is busy and there is a need to call again.

Components

In components, West Germany still lags behind the United States applying advanced products. As with many other electronic products, West Germany may be just a bit too late with its integrated circuits. Says a Siemens executive charged with semiconductor production: "So far, there is no real demand here for integrated circuit production. And what interest there is can be more easily—and more cheaply—met through licensing." Siemens is making integrated circuits for in-house use in the computers it makes under the agreement with RCA.

Besides being a market nearly ripe for integrated circuits from the U.S., West Germany can absorb healthy amounts of other components, such as advanced types of transistors, even specialty tubes. West Germany now purchases nearly 30% of her component imports from the U. S. and is expected to continue as a strong market for U. S. components next year.



Gains expected in computer, military, communication sales

Increased spending for military electronics, telecommunications and computers should lift the British electronics market 9% to \$1.81 billion in 1966 from \$1.67 billion in 1965.

The military electronics industry had been hurt by the cancellation of the sophisticated TSR-2, a British fighter plane, in early 1965, but contracts are beginning to come through now for British-built equipment on planes bought from the United States. Contracts were awarded for the Hercules C-130, a turbo-prop heavy transport made by the Lockheed Aircraft Corp., and negotiations are going on now for supplying the electronics on the Phantom 2, a twin-engine attack bomber built by McDonnell Aircraft Corp.

In telecommunications, the British Post Office has announced an increase in the budget, from \$500 million a year to \$750 million annually over the next decade. Computer purchases are expected

to climb to \$234 million next year from \$221.2 million in 1965. The component market is expected to grow to \$558.7 million next year from \$516.3 million in 1965.

The biggest puzzle for the electronics industry is the state of the British economy. The pound has been healthy since standby credits were arranged with foreign central banks in September. With luck, the government will achieve a balance of payments by the end of 1966 without the need of further deflationary measures and without a recession.

However, the deflationary measures taken in successive stages since November 1964 have had little effect. There is a labor shortage, and despite the government's price and income policy, wages are rising steeply—7% to 8% a year.

If wages continue to rise, foreign investors may get edgy again, the pound may weaken, and the government may be forced to further deflationary action. This could cause a recession. Deflationary measures adopted by the government in 1964 included a boost in the banks' basic interest rate to 7%, the highest level in modern times. The rate was lowered to 6% in June of this year. Sterling outflow was stemmed with an import levy of 15% which was dropped to 10%. Further government regulations may be necessary if exports lose their buoyance—they've risen about 5½% this year—and imports rise again.

There are some who say a recession will come

British electronics markets

(millions of dollars)

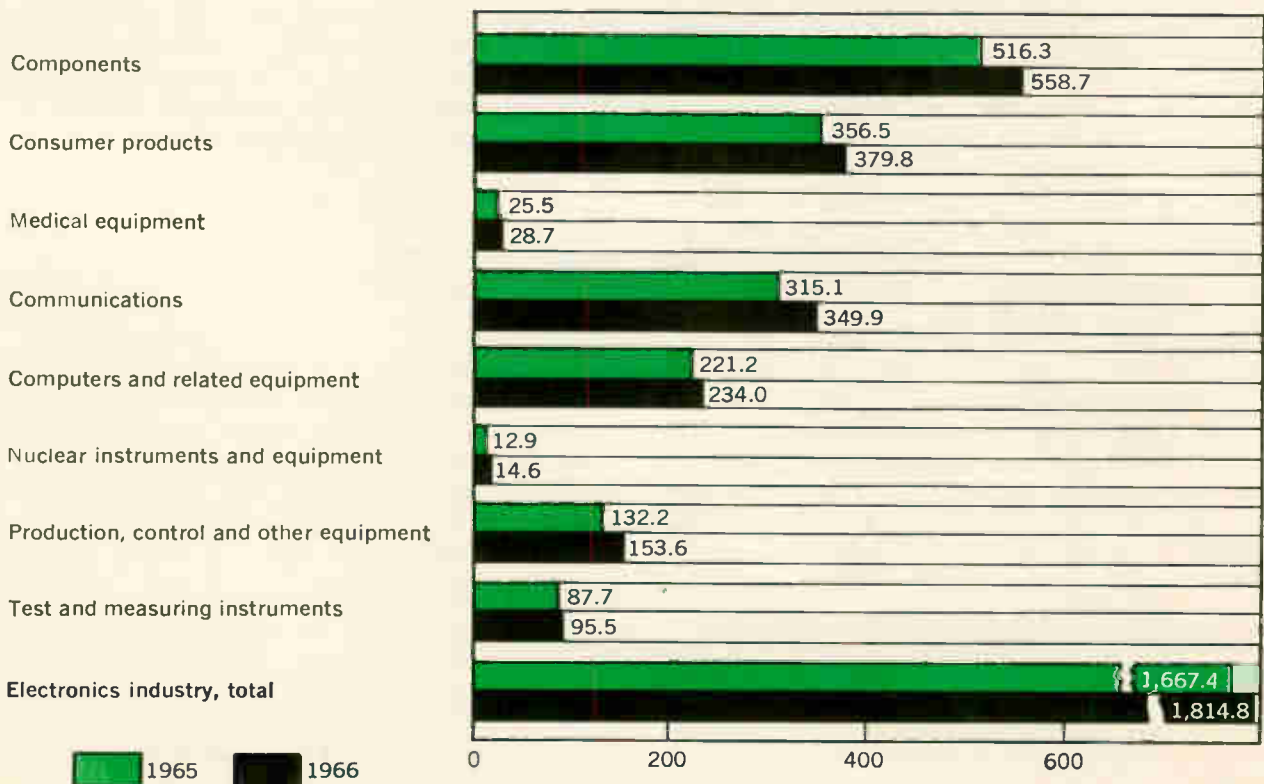

anyway as the government's measures—particularly the cutback in public capital spending—bite more deeply.

Two prestigious British economics groups have just predicted that the growth next year will be slow, with a rise of only 2% in production. They also say a recession will be avoided and by the end of 1966, trade should be about balanced.

A blow to the military market was the abandonment of the TSR-2 in 1965. When the plane contract was cancelled, about \$33 million had been spent or committed by the British government for electronics. The total cost of the electronic systems would have been \$90 million. Involved in the contract were firms such as Elliott-Automation, Ltd., Ferranti Ltd., and EMI Electronics, Ltd.

However, the industry expects contracts for American-built planes. The British Electronics Engineering Association, for example, worked out a deal with the Ministry of Aviation, to provide electronic equipment for the 75 to 80 Lockheed C-130 aircraft Britain is purchasing.

Negotiations are still under way for outfitting McDonnell's Phantom 2 with about \$54 million worth of avionics and weapons system controls over the next few years.

Supplying the equipment for the C-130 will be Ekco Electronics, Ltd., weather radar; the Plessey Co., uhf/vhf communications; Marconi, Ltd., vhf communications, instrument landing and automatic direction finding; Ultra Electronics, Ltd., inter-communications equipment; Standard Telephones & Cables, Ltd., a subsidiary of the International Telephone and Telegraph Corp., radio altimeter; Decca Navigator, Ltd., Doppler equipment, navigational computers and display system; S. Smith & Sons, Ltd., autopilot; and A.C. Cossor, Ltd., identification equipment.

The Royal Air Force also has budgeted \$132 million for radio, radar and navigational equipment for 1965-66. (The British defense budget's fiscal year begins in April.) About \$44 million of this \$132 million is being sent for the national computerized air-traffic control system. One computerized system is being installed at Britain's main air-traffic control center at West Drayton near London Airport. The \$300-million system will be operational by 1969. Plessey has the contract for the computer complex, and Marconi is supplying the radar and traffic-control displays.

The British Army will be spending about \$16 million for radars and supporting equipment for the Thunderbird-2 anti-aircraft missile system and for manpack radios. The Navy has budgeted \$69.2 million for electronic and electrical stores for the Polaris program. The Army is still bogged down in its studies of a tactical radio communications system, called the Hobart plan, which has been plagued by soaring costs—from an estimate about a year ago of \$270 million for the forward line to \$450 million this year. The Hobart plan covers the gamut of Army signals from complex headquarters exchanges to manpack sets in the forward units. A

complete reappraisal is now being made, to reduce the cost by \$180 million.

A decision on the British purchase of the General Dynamics F-111A, and another project, the Anglo-French Jaguar strike-fighter/trainer consortium, may come next spring, following a government defense review.

Expanding telecommunications

Between one-quarter and one-third of the Post Office's annual \$750 million investment is earmarked for telephone exchange equipment and associated apparatus. Although barely a beginning has been made, a market is slowly developing for electronic telephone exchanges. D.A. Andrews, chief telecommunications superintendent of the Post Office, says: "We are progressing slowly from research to production."

Already operating are two experimental 200-line electronic switching units. One 800-line exchange will be installed next year, and contracts have been awarded for three more 800-line exchanges and a 1000-line exchange. A 3,000-line exchange is now being installed and will be ready for field trials in 1966. In these exchanges, which are space division multiplex systems, the reed relay is used for speech-path switching and certain control functions. The systems were developed by the joint electronics research committee, which consists of five telecommunication equipment suppliers. They are Associated Electrical Industries, Ltd., Automatic Telephones & Electric, Ltd., the L.M. Ericsson Telephone Co., the British General Electric Co. and Standard Telephone & Cables.

The country's expanding telephone system will also benefit makers of microwave equipment. Some 20 microwave stations will be built in the next three years. A 600-foot tower in London, the focal point of the national microwave system, was constructed this year. When in service, the tower will link the country's principal cities with those on the continent and in the U.S. via satellites.

Preparations for satellite communications are being made now. A second 85-foot antenna, which will allow the station to track two satellites simultaneously or provide a continuous communications service—by having each antenna track alternate satellites as they appear over the horizon—is being built at Goonhilly Downs.

In other aspects of the electronics industry, the mobile radio equipment market is also expanding. During the last four years, the number of mobile stations has nearly doubled from about 24,000 in 1961 to more than 44,000 in 1965. The Post Office expects the trend to continue into the 1970's.

Consumer question mark

What will happen to the television business is not so clear. Some industry officials are pinning their hopes on further expansion by the state-owned British Broadcasting Corp.'s second television channel—BBC 2. The channel, transmitting on 625-line uhf, is seen by about one-quarter of

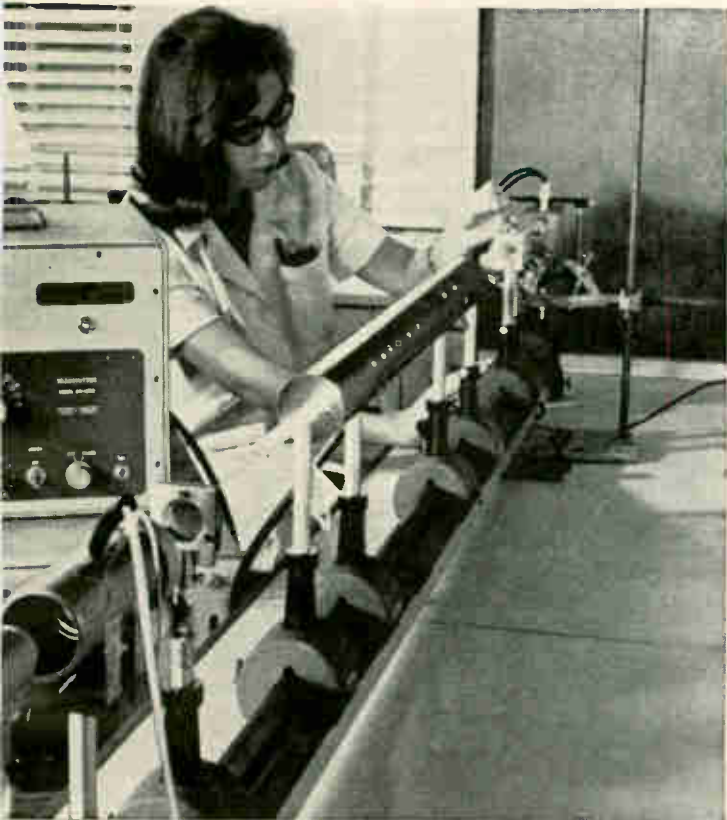

British companies, such as Marconi Company, are working on research projects from lasers to microcircuitry.

Britain's population and is expected to reach 70% of them by the end of 1966. But sales failed to increase as expected when the service started early in 1965, and manufacturers found themselves with a surplus of sets. There's also the chance there may be a second commercial channel—625-line uhf. But the Post Office, which regulates television, hasn't made its position known.

Keith Miller, group marketing manager of Thorne Electrical Industries, Ltd., which produces more tv sets than its two largest competitors together, sees only moderate growth over the next few years.

He says industry output next year will be about the same as this year—about 1.85 million sets. Saturation is high—about 90% of the British homes have tv sets, either owned or rented. Miller says more tv sets can be sold by encouraging people to own two sets instead of just one.

Color television is seen as the bright hope to spur sales, but not this year. The government still has to decide on a system and when it will be introduced. However, the Television Advisory Committee has recommended to the Post Office that Britain adopt the West German PAL system. Because of the delay in deciding on a system, color tv cannot come to Britain before late 1967 or early 1968. "Even then," one official says, "there won't be any sudden rush of buyers because of the initial high price of color receivers," probably between \$500 and \$700.

Radio is having its problems, too, with the

market for the less-expensive transistorized portable sets leveling off. Sales of very high frequency sets (a-m and f-m) will remain stable at two million. Most of the market for small, transistorized portable radios has been captured by imports from Japan, Hong Kong and Taiwan. About 1.5 million radios were imported in 1965, and 1.7 million in 1964.

Brisk computer business

The British computer market is a rarity: it's one of the few European countries not completely dominated by the International Business Machines Corp. in sales, although IBM does share the lead. Estimates vary, but most experts believe IBM commands 35 to 40% of the market as does International Computers & Tabulators, Ltd. The market is estimated at \$234 million in 1966, up from \$221.2 million in 1965.

Efforts to counter the foreign influence are being made. ICT introduced the 1901 computer series, this year, and English Electric, Ltd., has announced the System 4 series, which uses integrated circuits in its processors. The System 4 will be rolling off the production lines early in 1967.

The computer industry has been an early recipient of the Labor Party's effort to help industry by initiating research in computer techniques. Computer firms have found it encouraging. One official commented: "It is the first time we have ever had interested civil servants talking the language of manufacturers."

Another effort to improve the competitive situation is being made in a joint effort by British and French electronics companies. They are seeking money from their respective governments for an Anglo-French computer consortium that would design a large computer by the 1970's that would reportedly dwarf the biggest present U. S. machine—Control Data Corp.'s 6600.

Growing IC market

British companies are also struggling for a foothold in the infant market of integrated circuits. This year, sales totaled about \$3 million, a figure that will increase to about \$8 million in 1966. The integrated circuits have been used mainly for military equipment and computers.

Although British companies are behind the U. S. in technology, they are developing a capability for IC production.

One of the most active companies is a microelectronics affiliate of Elliott-Automation, Ltd., with about 200 people now working and plans under way for a \$2.8 million plant. The company's efforts include thin-film, monolithic and metal-oxide semiconductor technology.

Marconi is producing a microelectronic computer called the Myriad, a real-time data processing computer.

Over-all, the British component market reached \$516.3 million this year, and is expected to total \$558.7 million in 1966.

France



Big increase in military spending to aid electronics

President Charles de Gaulle wants more money spent on the military—more than is spent by any other Western European country. He'll have his way—and as a result will boost France's electronics market 11.4% to \$1.6 billion in 1966.

De Gaulle's "force de frappe" provides a growing market. The military will pour \$290 million into electronics, up 20% in a year.

Other segments of the electronics business also look for increases. Computer purchases are booming, and will reach \$250 million, a 23% increase from 1965. The component industry will climb to \$458.9 million. Sales totaled \$426.0 million in 1965.

On the other hand the television market appears to be little more than marking time with sales of \$285 million expected in 1966, a 5.5% increase which depresses the industry's total percentage of growth.

Complete capability

De Gaulle's efforts to build a complete defense capability in France has spurred French firms to develop new capabilities, and has protected them somewhat from foreign competition. However, because France is short of cash, the French military is still forced to buy many items on the world market on a low-bid basis.

Big military-oriented companies such as Compagnie Générale de Télégraphie Sans Fil (CSF), the largest electronics concern in France, have benefited from increases in electronics budgets. CSF, which does about two-thirds of its business in military electronics, builds both airborne and surface radar, and is working on phased-array radars. CSF produces air-defense radars operating on a wavelength of 10 centimeters, and long-range surveillance radars operating at 23 centimeters, with peak powers of two megawatts. CSF has the bombing-navigation radar for the Mirage 4, and supplies electronics for France's fledgling space program.

Electronique Marcel Dassault (EMD) supplies an analog type of computer for the Mirage 4 bombing-navigation system. EMD, which does most of its business with the military, also builds ground-checkout equipment for Mirage 4.

Compagnie IBM France, an affiliate of the International Business Machine Corp., is one of the exceptions to the "buy French" policy. The firm has a number of contracts including the computers and data processors for the new French air-defense

system, Strida 2.

French firms are also putting their technology to work in civilian avionics. CSF, in work sponsored by the French government, is developing solid state airborne navigation and landing equipment, both for airlines and military use. CFS also is the prime contractor on a traffic-control simulator scheduled in 1966. Société Française d'Équipements pour la Navigation Aérienne makes aircraft gyro instruments and automatic pilots.

The French firms also manage to snare a share of the military business in other European countries. The Austrian air-defense system was reportedly built by CSF; Compagnie Française Thomson Houston (CFTH) served as technical adviser for the Western European Hawk missile program, and Laboratoire Central de Télécommunications (LCT) will build the European Space Research Organization's ESRO 1 polar ionosphere satellite. LCT is a subsidiary of the International Telephone and Telegraph Corp.

Thomson Houston, which has about 10% of its business in the military—mostly in ground and shipboard radar—is building high-power air-defense radar systems for Sweden.

Big in R&D

Although French firms complain about the lack of government dollars for research and development—and also say they are lucky to get \$1 in R&D contracts for every \$5 they invest on R&D—they are active in research, from communications to radar to lasers.

CSF has the most irons in the fire. It points to some \$2 million to \$4 million annually in research contracts from the United States Department of Defense.

CSF is working on a troposcatter system that it says will give the same or slightly better results as present quadruple-diversity systems but will cost about 30% less. Another effort is with a system to bounce communications signals off the ionosphere. Basically, the technique, which has been tested in a simulated ionosphere, would consist of mixing two transmitter beams in the ionosphere to produce a harmonic which would be stronger than either input beam. Tests in the ionosphere are scheduled for 1966.

CSF is also deeply involved in the development of lasers, solid state devices, the detection of clear-air turbulence by an infrared radiometer, and the use of holograms for data processing and automatic-reading machines.

Other companies working with lasers include Société Anonyme de Télécommunications, Compagnie Générale d'Electricité, and LCT.

LCT is also working on an experimental airborne computer using microcircuits, and will deliver to the French military in 1966 a scaled-down version of a pulse-code modulation system built with integrated circuits.

Another firm, Société d'applications Générales d'Electricité et de Mécaniques, which developed

inertial guidance systems for the French ballistic missiles, reportedly is applying semiconductor microcircuits to its digital computer and inertial platform developments.

IBM France reportedly has studies under way for development of an airborne digital computer for use in the Concorde, the Anglo-French supersonic transport.

The emphasis on research has caused a boom in the market for laboratory instruments. Sales increased from \$60 million to about \$77 million in 1965 and are expected to rise another 26% to about \$97 million in 1966. American companies have been getting about half of this business. Until recently there was a simple explanation for this: French companies, with their limited market, just couldn't afford to make the broad range of instruments offered by the American firms. However, as the market has grown so have the lines of French manufacturers until today they make just about all the equipment that their U. S. competitors do.

Some U. S. firms assemble instruments in Europe. For instance, the Hewlett-Packard Co., assembles many of the instruments it markets in France at its British and German factories but most of the components it uses come from the United States.

Gains in television

Television has been growing slowly, with an increase in sales of 5.5%, up to \$285 million in 1966 from \$270 million expected this year. About

40% of French homes now have tv sets. One reason for this relatively low percentage may be the strict governmental control of programming which has limited the entertainment value of television. The second set is almost nonexistent in French homes.

Radio sales are expected to drop from \$52.6 million this year to \$51.5 million in 1966.

Like many other countries, France expects color television to boost tv sales, but not in 1966. France has an additional interest in color. The French color system, Secam, is being vigorously promoted throughout Europe. Compagnie Française de Télévision, a 50-50 affiliate of CSF and Saint-Gobain, the large French glass and chemicals firm, controls the process. The French government has strongly backed efforts in behalf of Secam.

Although on the surface not much has happened since last spring, when the Soviet Union announced its support of the French system, CFT has been busy behind the scenes lining up votes for Secam. It apparently has a long way to go before convincing the whole of Europe to adopt Secam, but CSF officials confidently declare that they have eliminated the American National Television Standards Committee (NTSC) system from the race. This leaves the West German PAL process, or some variation of PAL, in their view, as the main competition.

Alain Peyrefitte, the government's minister of information, says that regular color telecasts will start in September, 1967, a year earlier than planned. However, it will be several years after

French electronics markets

(millions of dollars)

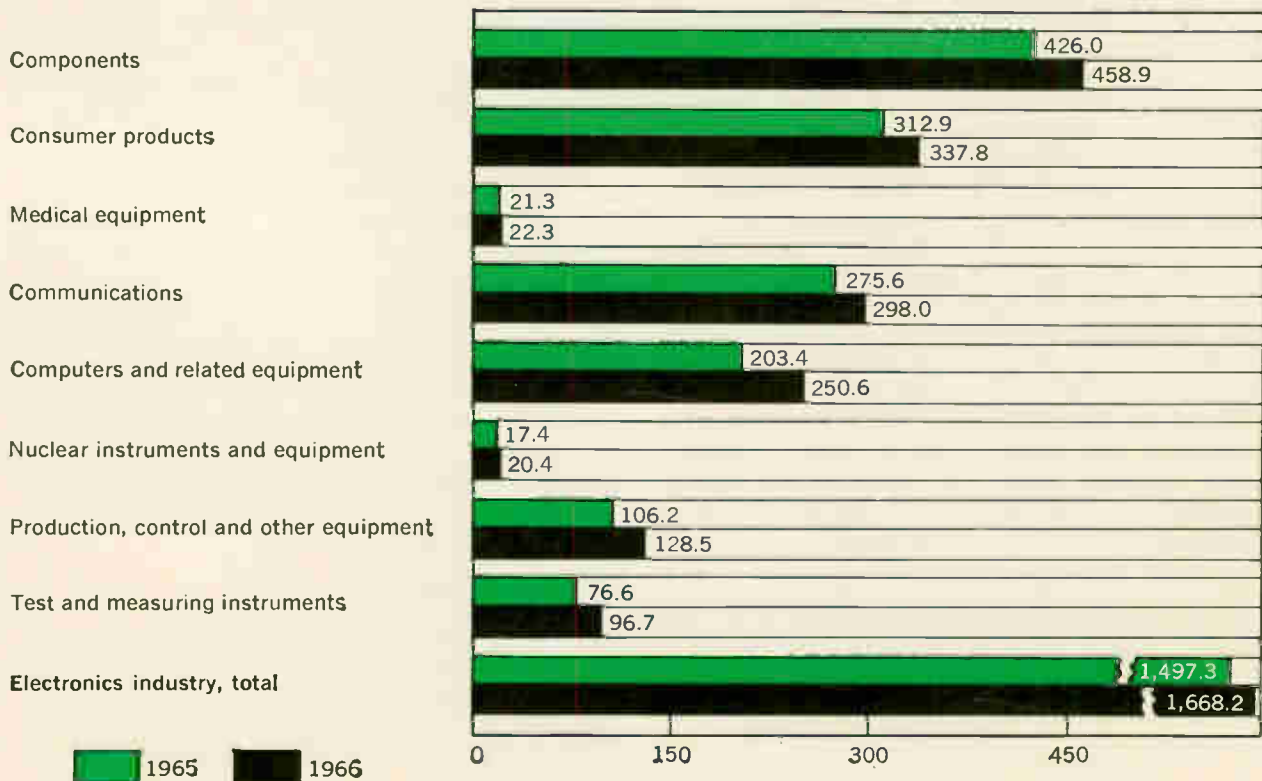

that before color sales will become a factor.

CFT is now tooling up to produce a tube that might have a strong impact on the European, and eventually the world, color-tv market. It's a bright, easy-to-build color television tube that is expected to cost one-third less than present shadow mask tubes.

Rapid growth in computers

The growth rate of the French computer market is making the International Business Machines Corp. happy: IBM is generally understood to have installed three of every four machines in use in France. In 1966, sales are expected to shoot up about 23% to \$250 million. This year sales were \$230 million.

GE-Bull, an affiliate of the General Electric Co., is going after some 15% to 20% of the French market. Two French firms, CSF and Compagnie Général d'Electricité, have a joint entry in the computer field. The firm, Citec, is developing process-control computers and recently formed a consortium with two British firms which has applied to the French and British governments for financial backing to build a scientific computer.

Roger Aubert, CSF general manager for technical matters, predicts a growth of 300 to 500% a year in the process-control field during the next few years as French industry automates.

IBM and GE-Bull executives agree that process control has a big future in France, but plan to sell their general-purpose equipment to the market.

Although big growth is predicted, one problem is pointed out by Donald W. Pendery, IBM director of data processing for Europe. "The lack of trained people could become the really limiting factor in the growth of the computer market. Management is almost always behind the introduction of computers, but if they can't get people to run them this will be a pretty theoretical interest.

Pendery doesn't see anything else to prevent the European market from growing as did the U.S. market. "The growth rate, however, is probably that of the U.S. several years ago," he says.

IC production

France, like other European countries, has been slow in producing integrated circuits. Foreign firms with mass production were able to beat prices set by French companies despite the 15% duty the French apply on most semiconductor imports.

However, France's three largest semiconductor companies will start to mass-produce integrated logic circuits in 1966. They are CSF, La Radiotechnique, a subsidiary of Philips Gloeilampenfabrieken, N.V., of the Netherlands, and Societé Européenne des Semiconducteurs (Sesco), a joint venture of Compagnie Française Thomson-Houston and the General Electric Co.

Texas Instruments Incorporated is the fourth largest semiconductor producer in France, and the Societé General Semiconduttori (SGS) of Italy has just opened a new plant.

Italy



Industry emerging from recession

Italy's electronics industry should emerge in 1966 from an economic recession that has dogged the entire country through 1965. Total domestic sales for the industry in 1966 are forecast at \$760.2 million, about \$80 million ahead of 1965.

Helping the electronics manufacturers shake off the recession will be a big boost in military sales: Italy has just signed a \$170 million contract with the United States to buy 162 F-104's; the plane will be built in Italy.

The television market, though, is still in a slump. The gross national product is expected to climb about 4.5% in 1966 but manufacturers of tv sets point out that sales of consumer goods generally lag several months behind the over-all economic indicators.

One bright spot is the outlook for exports. Italian companies have recorded larger increases in export sales than in domestic sales.

Another hopeful sign is the increased research and development. Although Italy is far behind U.S. and Western European levels of research activity, a number of companies—often affiliates of U.S. companies—are building up their R&D efforts. An Italian company that might be a big winner in the R&D sweepstakes is Raytheon-Elsi, S.p.A., a subsidiary of the Raytheon Co. Elsi has signed a contract with Compagnie Française de Télévision to develop the production processes to build a picture tube for the Secam color tv system. If Elsi succeeds it could mean a bonanza because the company would be the world's only producer of the tube.

Because of Italy's technological backwardness, the industrial electronics market—stagnant over the past two years—won't make any spectacular improvement in 1966. Sales of advanced controls and instrumentation are expected to gain little headway. Numerical control (NC) for machine tools is a good example of what's happening. Although both Ing. C. Olivetti & Co., S.p.A., and Costruzioni Eletttroniche Automatismi-Parego make NC equipment, only a handful have been installed in Italy. Guido Luccherini, Parego's commercial director, says his company sold only nine pieces of NC equipment over the past two years, and expects to sell no more than 10 in Italy next year.

Television shakeout

"Italy's television industry is seeing a shakeout," says Mario Malerba, director of Fabbrica Italiana Apparecchi Radio (FIAR)—GE's Italian television and radio-producing subsidiary. He points out that although there are now about 58 producers turning

Italian electronics markets

(millions of dollars)

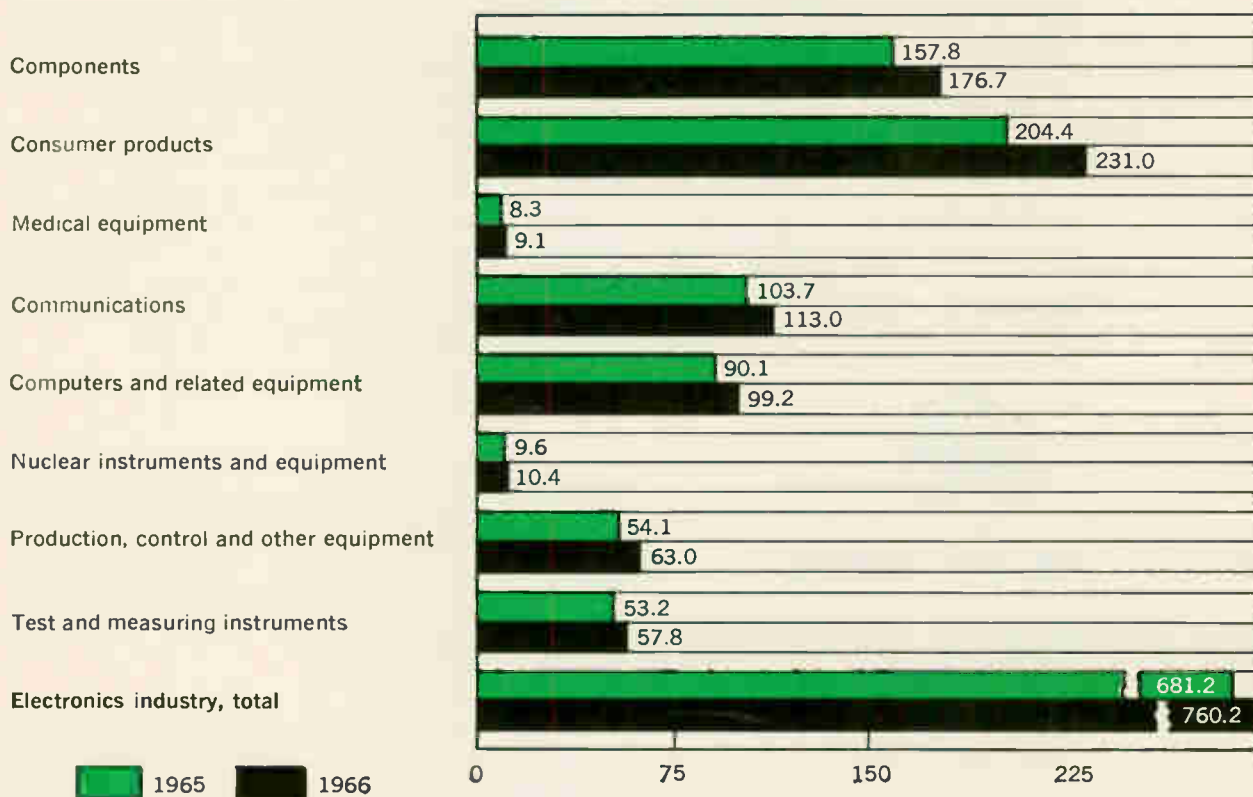

out 72 brands, eight hold 61% of the market.

During the first nine months of this year, 869,220 new television sets were registered with RAI, the government broadcasting monopoly; 774,500 were registered in the first nine months of 1964. Malerba believes the Italian industry is about where the U.S. industry was when its 1955-1958 shakeout came along. RAI is expected to start broadcasting in color in 1967. Sales of receivers, however, aren't expected to react for several years after that because tv set prices are expected to be high initially.

Telecommunications up

The telecommunications market totals about \$32 million a year for electronics suppliers and is increasing at the rate of 7% to 10% a year. According to Virgilio Floriani, president of Telettra, the biggest purchaser of telecommunications equipment in Italy is the government's Società Finanziaria Telefonica Per Azioni (STET) telephone group. But the Ministry of Post and Telegraph is another big customer. The military makes other, but smaller purchases. Next year should be a good one because the ministry is pushing a major expansion of its network.

Military business good

The industry is eagerly awaiting the signing of the F-104 Starfighter which is expected to pick up the slack left by the completion of the Hawk missile and the F-104 Starfighter programs this year. The new plane will be modified to handle the Sparrow

air-to-air missile; this will involve adding a very precise fire-control system to the plane.

Work on a \$20-million air-defense system for Italy will start in 1966. Italy is also expected to get a \$15-million slice of the North Atlantic Treaty Organization's air-defense ground-environment system (Nadge).

Components growing

The component market will expand from \$157.8 to \$176.7 million in 1966. A good market for semiconductor is seen developing in television. Laurence Curry, manager of marketing services for Società Generale Semiconduttori, a Fairchild Camera & Instrument Corp. affiliate, predicts that about 10% of the 1966 television sets will be transistorized.

Philips Gloeilampenfabrieken, N. V., the Dutch electronics giant, sees the most important increase in semiconductor sales in Italy coming from power semiconductors, for such equipment as motor controls, d-c converters and welding machines. A few companies have started building prototype models of power converters using transistor power diodes instead of tubes.

Integrated circuits are slowly coming into use. For example, Telettra, using integrated circuits in its pulse-code-modulation multiplex telephone equipment, is now conducting field tests and expects to have the equipment in commercial use next year. Olivetti is said to have constructed a small computer in its laboratory, using integrated

circuits, to measure transistor characteristics.

Exports becoming important

Hurt by the drop in the Italian market, a number of electronics firms have been trying to improve sales through exports. FIAR, which has been exporting tv sets for two years under other labels, now exports about 20% of its tv production. Magnadyne, another television firm, also exports about 20% of its output, with Germany, Austria and France the principal customers.

FIAR, which also enjoyed large exports because it built equipment for the Hawk and Starfighter military programs, is now pushing hard to sell tv repeaters outside Italy. It has already been working

with government networks in Rhodesia and South Africa, and is now talking with buyers in Australia, Spain, Portugal and South America.

Italy has become the main export base for several companies. Calosi of Raytheon says that 50% of the sales of Selenia, another Raytheon affiliate and a major military supplier, are outside Italy.

Computers are becoming a significant export item and International Business Machines Corp. has decided to build a plant to produce its 360 Model 20 computer. Also in 1966 Olivetti-General Electric, S.p.A.—a company owned 75% by GE and 25% by Olivetti—plans to build about 300 data processing systems around the 4115 computer, two-thirds of which will be sold outside Italy.

Netherlands



Business booming for Philips

As Philips Gloeilampenfabrieken, N. V., of Eindhoven goes, so goes the Netherlands electronics industry. And for 1966, Philips sees a rise in sales of about 12% over the estimated \$2.1 billion worth of business the company did worldwide this year.

Even if Philips' forecasts for the coming year—an increase of \$252 million—turn out to be somewhat optimistic (hardly likely because of Philips' down-to-earth Dutch way of doing business), 1966 should nevertheless see an upturn in the company's sales curve. After three sparkling years of 12% increases, the sales gain slowed in 1965.

The slower gain came as no surprise to Philips' top brass; they had seen it coming. For one thing, 1964 sales of television sets got a strong fillip from the Olympic Games, relayed from Tokyo to Europe by satellites. Also during 1964, Philips delivered some whopping orders for military gear and telecommunications equipment that boosted sales figures. After a year like that, slowdown in sales growth is practically inevitable, even for a high-flying outfit like Philips.

But prospects now point to a strong upswing for the coming year. Philips' major market is Western Europe, where the company rings up slightly more than three-fourths of its sales. And for Western Europe, 1966 should be a good year. The Commission of the European Economic Community (EEC), for example, predicts the gross national product for the six Common Market countries will climb nearly 5%, a faster pace of growth than EEC turned in this year. The seven European Free Trade Area (EFTA) countries, led by Great Britain, should do equally well.

With that rosy general economic outlook as the background, Dirk D. Otto, manager of Philips'

commercial planning department, predicts sales of electronics and electrical consumer goods in Western Europe will increase between 6% and 9%. In his opinion, industrial and military electronics equipment will do even better—15% or 16% above 1965 sales. A large part of this gain, he expects, will come from computers.

Scramble in tv

Like all European set makers, Philips will be scrambling for tv sales in a market that is becoming tougher to crack. Long gone are the days of the late 1950's and early '60's when consumers snapped up just about everything set makers could turn out. With 55 million sets in use at the end of 1965, the Western European market is between 50% and 55% saturated; the degree varies from 20% saturation in Spain to 80 to 90% in Britain.

Even so, Philips marketing men see a 5% yearly growth through 1970, which will boost the number of sets in use to 70 million and the over-all saturation to 73%. At the same time, the ratio of initial sales to replacement sales will just about flip-flop completely. Now, the ratio is 70% initial sales, 30% replacement sales; over the next five years it will swing to 66% replacement and 34% initial sales. That means a market much more sensitive to consumer whim.

The whim, of course, could well be changed to serious buying when color tv comes to Europe. But that advent seems at least three years off because of the hassle over which color-tv system the government-run networks of Europe should adopt as their standard. There was a standoff at this year's CCIR meeting at Vienna. CCIR is the International Radio Consultants Committee of the International Telecommunications Union, which represents countries on both sides of the Iron Curtain. The general feeling in the electronics industry is that Europe will wind up with two incompatible color systems—Secam in France and the Eastern European countries, and the West German PAL—an offshoot of the American NTSC system—elsewhere. Great Britain's recent swing to PAL has just about killed the chance for NTSC. Even so, Philips

is continuing the experimental broadcasts in NTSC color it started last year.

Watching color

Philips' reading on the introduction of color tv in Europe now looks like this: 1967 or 1968 for Great Britain, West Germany and Italy; 1968 or 1969 for France, the Netherlands, Spain, Sweden and Switzerland; 1969-1970 for Austria, Belgium, Denmark and Finland. Until then, Philips—like other European set makers—can count only on a slowly growing black-and-white market while wistfully watching the color boom in the United States. There's some small comfort, though, in a second-set market starting to shape up now. To tap that market, Philips introduced late this year a fully transistorized set with a 14-inch screen and a vacuum-tube set with an 11-inch screen.

For the other major segment of the consumer electronics market—radios—sales for 1966 are expected to rise by 5% over this year's figure of 17.5 million sets, 13 million of them portables. To stem the Japanese invasion of the market, Philips will go to market with sets produced on automated lines, priced in the \$17 to \$26 range. With these, Philips says it can "fully compete with Japanese competition."

For the consumer goods that account for two-thirds of its total sales, Philips sees the wholesale introduction of microcircuits as "several years off." Still, 1966 will see the company's first move into the consumer market with microcircuits. The product: a hearing aid with a linear circuit.

Expanding in computers

Although Philips expects that computers will be a prime factor in the gain of 15% or 16% in sight for industrial and military equipment in 1966, its computer division won't be in the market in the usual sense of the term. True, the division now has under way design of a whole family of process-control computers based on integrated circuits, and Philips is well along in an effort to "computerize" a radio-set producing plant. But for the moment, the company sees itself as its own best customer for its recently formed computer division, which along with the basic computer hardware, turns out tape punch and memory units.

In the business computer field, Philips is getting its feet wet through a 40% holding in Electrologica, a small company based in The Hague. Despite its size, Electrologica has cornered a small part of the market in the face of competition from giants like the International Business Machines Corp. and Bull-General Electric, which is jointly owned by the Compagnie des Machines Bull of France and the General Electric Co. of the United States.

Military sales

The vagaries of the military market don't have too much impact on Philips since military sales add up to only about 5% of total sales. N.V. Hollandse Signaalapparaten, the subsidiary that ranks

as the sole important Dutch producer of fire-control equipment, won't see its sales boom in 1966 but there's no slump in sight: the company has a substantial backlog of orders from NATO countries, South American countries, Sweden and Switzerland. Signaalapparaten will also deliver next year the phase 2 equipment for the air-traffic control system at the Amsterdam Airport plus a "free route" control system that will oversee traffic for the West German Air Force in the northern part of the country.

Belgium



Industry expecting drop next year

Champagne corks will not be popping when Belgian electronics companies greet the new year—business is expected to drop for them next year although the domestic market, in which imports are a big factor, will be up about 7% to \$371.6 million from \$346.4 million for Belgium and Luxembourg.

The main reason for the decline: military contracts—some \$80 million worth for the North Atlantic Treaty Organization's Starfighter and Hawk missile programs which had buoyed the industry over the past four years—have dwindled to practically nothing. But there is one major military contract that could help the industry, which is dominated by a trio of companies—Manufacture Belge de Lampes et de Matériel Electroniques (MBLE), Ateliers de Construction Electriques de Charleroi (ACEC) and Bell Telephone Manufacturing Co. (BTM).

Sales of television sets—expected to reach nearly \$24.6 million this year—should stay about the same at \$24.7 million in 1966, according to Jaques LaGrange, head of MBLE, the country's leading components manufacturer.

Military electronics

The contract Belgian electronics producers count on most is their \$11.8-million share of the \$280 million Nadge (NATO's air-defense ground-environment) project, scheduled for award this March. Nadge is NATO's plan for an integrated air-defense network stretching from Norway to Turkey.

The industry also expects a communications gear contract when Belgium buys 300 tanks from either France or West Germany probably early next year. Belgium will stipulate that its own firms get tank-equipment contracts amounting to just about the cost of the tanks.

MBLE also will have prototypes of a transceiver for paratroopers ready next year and hopes to produce them by 1967. BTM is now field testing pulse-

code-modulation equipment for the Belgian Army. The circuit boards have both microcircuits and discrete components, but the circuitry was designed for an eventual switchover to microcircuits.

Space technology

All three companies are just starting in space projects through the European Launcher Development Organization (ELDO) and the European Space Research Organization (ESRO). Belgian engineers will install the ELDO downrange guidance system in northern Australia next year. The system is currently being tested at Grimbergen Airfield near Brussels. MBLE was prime contractor for the system, but both ACEC and BTM supplied much of the equipment.

Industrial outlook

The lone bright spot in the outlook for next year is in industrial equipment, likely to pick up by about 15%. One possible shot in the arm for next year or 1967 is the instrumentation for three nuclear power stations Belgian public utilities have tentative plans to build.

Sweden



Market booming for automatic equipment

The Swedish electronics industry expects a 14% boost in domestic business next year to \$343 million, primarily because of a demand for automatic-control equipment by manufacturing companies—a demand prompted by a labor shortage and salaries that are the highest in Europe. The computer market is expected to expand to \$40.6 million in 1966 from \$35.4 million this year. The \$40.6 million includes \$4.8 million worth of process control systems.

"Everyone is using electronics—in power, instrumentation and process control," says Stephen Finta, managing director of Nordiska Elektronik AB, which represents a number of American electronics components manufacturers in Scandinavia.

The industrial business boost is expected to be large enough to offset a sharp decline in military electronics, deepened by a two-year delay in production of the Swedish Air Force's type-37 Viggen (Swedish for thunderbolt) aircraft. The new all-purpose defensive aircraft is now scheduled for service in 1971.

Some other healthy business signs:

- The consumer market, with television sales predicted at \$30 million, is up \$1.4 million over 1965. Most sales will be for replacement sets and will be made by three firms—Svenska AB Philips,

Luxor Industri AB and AGA AB. Next year, the government is expected to announce the start of a second Swedish tv channel in 1968 and color telecasting in 1969.

- In communications, the major achievement will be the installation of an electronic telephone switching system by the L.M. Ericsson Telephone Co. The system, using space division, will serve 5,000 subscribers. Space division employs a separate wire path for each conversation. In time division, logic gates sample several conversations in rapid sequence, then switches connect pairs of telephones in sequence.

- The opening in Sweden, a country that imports most of its components, of a semiconductor manufacturing plant by Società Generale Semiconduttori, of Italy in 1966.

Industrial growth

Saab Electronics, the civilian electronics sales division of the Swedish aircraft, automobile and electronics manufacturer, is typical of a number of Swedish companies moving fast to take advantage of industrial electronics growth. Jan Bakstrom, sales manager of Saab Electronics, says his firm's "main line is to develop and market products for automation for both Swedish and foreign industry."

In the process-control field, Saab has developed a system for automatic control of dyeing machines in the textile industry. Saab is also selling a new line of equipment, which can be controlled remotely by computers. Arenco Electronics AB, sees 1966 as the year of the big breakthrough for numerical control (NC) with between 50 and 100 systems being sold.

The industrial market is also being eyed by other firms, such as L.M. Ericsson. Although concentrating on communications, the company is watching the industrial control field, says Christian Jacobaeus, chief technical officer.

Military need slowing down

In addition to the delay in producing the type-37 Viggen aircraft, there's been a general slowdown in the military market, according to Frank Hammar. Hammar is the managing director of Standard Radio & Telefon AB, which is the Swedish subsidiary of International Telephone and Telegraph Corp. "The order books are filled because of previously heavy orders, but new military orders are down about one-third from what they have been," he says. "We look at the future with some concern." He expects Standard Radio's business to be up in 1966 though, partly because of its export sales in air-traffic control equipment. The company recently delivered a traffic control system to Arlanda International Airport outside Stockholm.

Spokesmen see no strong improvement next year in the price war in components, which has affected the Swedish agents and the American, British, French and German manufacturing companies which supply the market.

Switzerland



Market growing

Although the Swiss are renowned for their precision work in watchmaking, machine tools and instruments, their country is regarded as "a bit backward" in electronics. A leading electronics researcher says Switzerland is interested in applications rather than new directions.

Electronics sales totaled \$231.4 million this year and are expected to climb to \$250.7 million in 1966.

Military electronics is concentrated narrowly. Contraves AG, in Zurich, develops special equipment for the Swiss Army and sells military systems to other countries. One product, a mobile radar fire-control system called the super-fledermaus, is sold to members of the North Atlantic Treaty Organization. Contraves is also participating in a satellite prospect of the European Space Research Organization satellite.

Communications is a growing area. Albiswerk AG of Zurich is installing a semielectronic telephone switching system. It's a time-multiplex system with an electronic logic unit. This year, the government's telephone and telegraph agency has spent about \$100 million for telecommunications equipment; next year's expenditure is expected to reach \$120 million.

Philips AG produces about 60% of the television sets sold in Switzerland. About 59,000 sets were sold this year, and the same number is expected to be sold in 1966. The population of Switzerland is 5.8 million.

Generally, consumer electronics is not attractive to Swiss industry because of high tariffs in exporting to Common Market countries. However, Switzerland is a prime market for such imports as instruments and computers, thanks to a labor shortage. Until recently the economy depended largely on foreign labor; one out of every three wage and salary earners was a foreigner. However, the Swiss government has ordered a reduction in immigration of 5% this year and a similar percentage in 1966. For Swiss manufacturing and service industries, this has resulted in automation. Scientific and industrial instruments and equipment are reported to be expanding at a rate of 10% to 20% a year.

Switzerland is building one nuclear electrical plant with a capacity of 250 to 300 megawatts of energy, with another plant being planned. Also being considered are electronic steering of reactors and a wide range of electronic equipment.

Although Switzerland is light on electronics research, two American companies operate research centers in Switzerland: the International Business Machines Corp. at Ruschlikon and Radio Corp. of America in Zurich. RCA has an ambitious materials program that includes fundamental work in ferro-electrics and dielectrics.

Austria



Fast rise in imports

Imports are becoming increasingly important in Austria's electronics industry. The country of seven million people is growing in prosperity and becoming a more inviting market as protectionist measures fade as a result of Austria's participation in the European Free Trade Association together with Denmark, Norway, Portugal, Sweden, Switzerland and Great Britain.

The consumer market is growing slowly. Sales of radio sets next year are expected to remain at the 1965 level, but the cost per set is expected to increase, increasing the dollar total to \$15.3 million from \$14 million in 1965.

The television market is expected to grow slightly in 1966 from the \$12.6-million level of this year. Imports have been making big gains, to about \$7.2 million this year 1965 from \$1.7 million in 1964. Most imports come from West Germany, Sweden and Denmark.

The Postal and Telegraph Administration has expansion plans, but has been hampered by a shortage of funds. It recently bought \$2 million worth of coaxial application equipment from Standard Telephones & Cables, Ltd., a British affiliate of the International Telephone and Telegraph Corp.

Another trend in Austria is importing of computers to be leased to Communist countries in Eastern Europe. One Viennese dealer has computers on lease in several Soviet-bloc countries.

Denmark



Seeking buyers abroad

Danish electronic companies, most of which have fewer than 500 employees, are facing a severe labor shortage, tight credit and high taxation.

Last spring, to control inflation the government restricted credit and, as a result, reduced consumer spending. Many producers of television, radio and hi-fi equipment are burdened with heavy inventories. Some are turning to exports; some say as much as 95% of their output is sold outside the country. Credit restrictions are expected to continue 18 months more.

Almost all companies report an increase in business with the Communist countries of Eastern Europe, including the Soviet Union. Some companies say their Soviet-bloc sales have climbed 20% to 25%. Czechoslovakia is the biggest market, followed by Hungary and Rumania.



No threat seen to West in sale of electronics

The Soviet consumer electronics industry is far from primitive; however, for the foreseeable future the Soviets will offer no competition to Western producers. In fact, Russians will remain hungry, even starved, for Western imports.

This is the image emerging through the static of military secrecy and statistical reports in which electronics is not treated as an industry at all.

Recently, a Soviet official, asked if there was any computer larger or faster than the Minsk-22, then on display at an international showing, replied: "Yes, but they're beyond the Urals." That's Russian slang for "military secret."

And in the USSR's annual book of vital statistics, running to more than 700 pages, nowhere is there to be found a figure relating to electronics in any useful way. Electronics production figures are wrapped up heavily in the military budget, which in turn is hidden behind headings such as "machine building" or "gross chemical output." (In fact, the old Ministry of Medium Machine Building was a code cover for the Soviet nuclear weapons production authority.)

Space program opened the door

It was the Soviet space program that released some facts on the country's electronics industry. Manned sputniks, moon shots, and deep-space probes told much that was new.

It's been demonstrated that the Soviets no longer are counting on the cushion that large booster rockets gave them in the early days of space exploration. The move is clearly toward denser electronic packages, though not necessarily toward American-style microminiaturization. The Soviets, apparently, will always favor the big power pack.

This year the Russians brought back 1,100-line pictures of the far side of the moon from a distance of several hundred thousand miles. Earlier they orbited a communications satellite with 40 watts of power, or ten times that of Early Bird. They claim they'll be able, shortly, to broadcast directly from an orbiting satellite into community television antennas.

And they've announced their soft-landing Luna package which contains radar plus a computer complex to measure distance to target, compute optimum time for retro-fire, and give the firing order.

Increasing complexity of the Soviet space effort indicates substantial solid state computing power on the ground, though it is apparent that none of

this hardware has become available to the civilian industry.

The Russians continue to claim superiority in computers, but they make no secret of their desire to buy Western models. Recently a group of visiting American businessmen were asked to evaluate the possibility of holding an American computer and industrial electronics exhibition in Moscow. British companies, led by Elliott-Automation, have been selling industrial-process computers and instrumentation to the Soviets for several years, and the general belief is that relaxation of controls by the West would lead to a flood of such sales.

Meanwhile, the Russians are showing signs of putting heftier budget sums into civilian electronics research. Last summer Moscow sponsored a month-long exhibit of Soviet and East European information equipment at which it was learned that progress has been substantial. The Soviets are now working hard to develop a common computer language and common components standards for Eastern Europe, and within a few years they may achieve success.

In their civilian applications the Russians have now reached the point of full transistorization with modular sections, but they have yet to apply molecular or integrated circuitry. They appear to be about one generation short of Western achievements. They've developed random-access retrieval systems along the lines of American devices of 1959 and 1960.

Consumer electronics

On the purely consumer electronics front, progress has been much swifter, relatively. Within the past 12 months the Soviets have put transistor radios, modern-styled television sets, and portable phonographs on the market. Now they've agreed to use the French Secam color-television system, with "commercial" broadcasts scheduled in 1967.

Radio and phonograph production actually declined between 1963 and 1964, from 4,800,000 to 4,750,000. Television-set production inched up from 2,470,000 to 2,920,000.

The production for 1965 increased slightly. For the first three quarters, tv set production was up 22% and radio and phonograph production up 7% according to official statistics.

The Russians don't import any consumer electronics, and have no plans to do so.

Exports decline

Electronics export figures show that the Russians are caught up in worldwide price trends. Exports of 72,400 radios in 1963 were valued at just over \$3 million, or \$40 each. But last year 111,300 radios exported cost an average of only \$20 each, for a net decline in foreign exchange of about \$800,000—on nearly 60% volume increase.

Reprints of this report are available. Use the reader service card at the back of this issue.

© copyright 1965, Electronics © A McGraw-Hill Publication



Tally perforators make more chad per dollar, save it for New Year's Eve!

Whether you welcome an astronaut, celebrate New Year's or just plain punch tape day-in-day-out, your Tally perforator will supply you with perfect chad—and more of it. (Our chad drops from perfectly round holes in perfectly spaced tape.)

Take the minor mountain of chad we generated here. This is the first part of the life test on our new P-120 Perforator. 600 million perfect holes or 120 million characters were made to prove reliability. This is no one-time deal either. Every new Tally product gets the same going over when it's new and periodically as long as we offer it for sale.

Recently, our engineers' have given us a good number of new products including perforators, readers, data communications equipment, and logic systems. Let us send you the details. Address Mr. Ken Crawford, Tally Corporation, 1310 Mercer Street, Seattle, Washington 98109, Phone: (206) MA 4-0760. TWX: (910) 444-2039. In the U. K. and Europe, address our man in London, H. Ulljohn, Tally Europe Ltd., Radnor House, 1272 London Road, London, S.W. 16, England, Phone: POLlards 9199.

 **TALLY®**

Circle 101 on reader service card



new disciplines in DC



take the model with the unique equation ... 1+1=9

Two dual range power supplies in one compact package provide nine different output combinations.

Many circuit applications require the simultaneous use of two DC power supplies — often a positive and a negative source. Harrison Division's versatile Model 6205A provides two independent outputs — each output can be set for either of two output ratings and can be operated as a plus or minus supply. Alternatively, the two sides can be seriesed to obtain up to 80 volts, or paralleled for up to 1.2 amps.

Multiple Scale Metering Optional • All-Silicon Design • Front & Rear Output Terminals • Remote Programming • Remote Error Sensing • 50 μ sec Recovery Time • Short-Circuit Proof • Current Limited Output • No Overshoot on Turn-On, Turn-Off, or Power Removal • Auto-Series, Auto-Parallel, Auto-Tracking Operation
Rack Mounting Hardware Available.

OUTPUT A	OUTPUT B
0-20V @ 0-600 MA or 0-40V @ 0-300 MA	0-20V @ 0-600 MA or 0-40V @ 0-300 MA
Load Regulation:	0.01% + 4 MV
Line Regulation:	0.01% + 4 MV
Ripple & Noise:	200 μ V RMS
Size:	3½" H x 8½" W x 12¾" D
Weight:	10 Lb.
Price: Model 6205A	\$195.

Contact your nearest Hewlett-Packard Sales Office for full specifications.

HEWLETT
PACKARD  HARRISON
DIVISION

100 Locust Ave., Berkeley Heights, New Jersey 07922 AREA CODE 201 464-1234 TWX 201-464-2117

Circle 102 on reader service card

Probing the News

Consumer electronics

Anxiety amid affluence: why color-tv makers worry

With demand for their product outstripping plant capacity by 30%, 13 major companies are rushing into transistorization. Some are doing it reluctantly, under the pressure of competition

By Louis S. Gomolak

Chicago News Bureau

Makers of color-television sets are worried. Although demand is 30% ahead of their ability to produce receivers, they fear technological obsolescence.

With transistors working their way into color tv, and integrated circuits beginning to appear in design rooms, can the producer afford to stand pat with his present designs?

Last June, when the Philco Corp. announced plans to build hybrid 19-inch sets late this year—with 32 semiconductors and 16 vacuum tubes—its competitors' initial reaction was: "Who needs another technical advance? Changing to a rectangular picture tube from a round one is enough for one season." But every major producer put its engineers to work designing solid state circuits for color tv.

And last month, when it was disclosed that the Admiral Corp.—which ranks third in color-tv sales—plans to use an integrated circuit to demodulate the color signal in a 15-inch portable, the activity intensified in design rooms and in executive suites. Even companies that oppose the shift now, on technical grounds, are among the 13 big concerns that plan to introduce semiconductors in early models. Many agree with Admiral, which considers transistorization necessary, beyond technical reasons, to maintain what one official describes

as "the company's image as a progressive force in the consumer market."

I. Reluctant innovator

At the Zenith Radio Corp., J. E. Brown, vice president for engineering and research, warns: "Degraded performance, starting with the tuner, is all you'll get" in changing to transistors. "There isn't a radio-frequency transistor on the market as free of cross-modulation phenomena as the vacuum tube you want to get rid of," he declares. Brown concedes that one solution may be the field effect transistor, a high-impedance de-

vice whose characteristics resemble those of a vacuum tube. But these are not being produced in great enough volume, he adds.

Yet Zenith is planning to offer hybrid receivers next year. So is Setchell-Carlson, Inc., despite the fact that its chief engineer, Fred G. Melius, agrees with Brown's technical objections.

One of the transistor's strongest advocates is Raymond L. Osborn, director of tuner engineering at the Oak Electro-netics Corp., the biggest supplier of tv tuners. "We've produced over 100,000 transistorized color-tv tuners since the second quarter of this year," he



Admiral Corp.'s Leonard Dietch, believes transistors should be used wherever they are economically possible. Admiral plans to transistorize everything but the high-voltage deflection circuits. It will also use an integrated circuit.



how to measure resolver or synchro position with 30 second repeatability

In both production test and ground checkout systems, North Atlantic's high performance Angle Position Indicators provide exceptional operator ease and precision in the measurement of synchro and resolver position. Features include digital readout in degrees and minutes, 30 second resolution, continuous rotation, plug-in solid-state amplifier and power supply modules. Due to the design flexibility of these units, they can be readily provided with a variety of features for specific requirements. Typical units in this line incorporate combinations of the following features:

- Single Synchro or Resolver Input
- Dual Synchro or Resolver Inputs
- Retransmit Synchro, Resolver, Potentiometer, or Encoder
- 2-Speed Synchro Input
- Multi-frequency Inputs
- DC Input
- 0-999 Counter

BASIC SPECIFICATIONS

Range	0°-360° continuous rotation
Accuracy	6 minutes (standard)
Repeatability	30 seconds
Slew Speed	25°/second
Power	115 volts, 400 cps
Size	API-8025 1¾" h x 9½" w x 9" d
	API-8027 3½" h x 4¼" w x 9¾" d



Your local North Atlantic representative has complete data on the API line. Call him today or write direct for technical literature.

NORTH ATLANTIC industries, inc.
TERMINAL DRIVE, PLAINVIEW, L. I., NEW YORK • OVERbrook 1-8600

says, adding, "the noise and gain figures are competitive with tube tuners."

Oak's vice president for marketing, Paul W. Wheaton, adds that the transistorized tuners are also competitive in price with tube tuners.

Little by little. Some companies plan to ease into hybrid design by transistorizing the least demanding spots first—the low-level processing and control circuits. Theodore S. Zelazo, assistant chief engineer at Muntz Tv, Inc., thinks the best place to start transistorization is in the sound and synchronization circuits. C. J. Dumas, a research manager at the Hoffman Products Corp., thinks reliability would be doubled if all low-level circuits were transistorized. Both companies are designing 19-inch hybrids.

But Admiral's manager of color tv engineering, Leonard Dietch, believes transistors should be used now wherever they are economically possible. Admiral plans to transistorize everything but the high-voltage deflection circuits. The use of transistors to this extent, Dietch says, "doubles set reliability, shrinks package size and cuts power consumption." The company's 19-inch hybrid will consume 160 watts, he says, compared with 265 watts for Admiral's comparable all-tube set.

All the way. Sylvania Electric Products, Inc. opposes hybridization; the subsidiary of the General Telephone and Electronics Corp. expects to have a fully transistorized receiver ready by 1967. W. D. Shuster, engineering manager in the entertainment products division, says, "It makes more economic and performance sense than just going half way."

The Wells-Gardner Electronics Corp. and Warwick Electronics Corp. have both confirmed plans to build hybrid sets, but will not disclose the extent to which they will use transistors. Warwick sells its receivers under the Sears Roebuck Corp.'s Silvertone label and Wells-Gardner supplies tv's for the W. T. Grant Co., the J. C. Penney Co. and the Western Auto Supply Co.

Four manufacturers, all reported to be designing hybrid sets, will not talk about it. The General Elec-

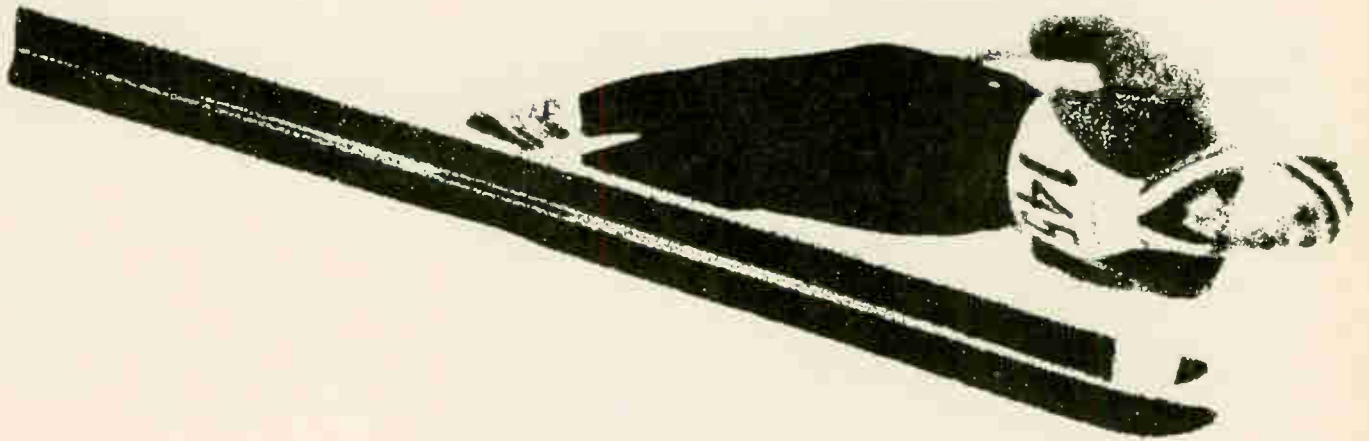

QUALITY PERFORMANCE

Ski jumping and electronics? Poles apart you might say. Not really.

Ski jumping is a sport in which Norwegians excel. And like these sporty types among our fellow countrymen we have the desire to be perfectionists.

Just like them, our technicians are eager to reach the

level of outstanding quality, style and performance. One big difference: in our case no need to go to winter sports to see for yourself.

Just drop us a line for full details.

About a winner – in electronics.

Ⓜ RADIO LINK Ⓜ CARRIER FREQUENCY EQUIPMENT Ⓜ COMMUNICATIONS TRANSMITTERS

Radiolinks carrying 12–300 telephone channels, or a 625-line television video signal. Frequency ranges 225–470 and 1900–2300 MHz. Stationary or mobile 1–24 channel carrier frequency equipment for radio links or cables. Channel bandwidth 0.3–3.4 kHz, outband signaling. HF communications transmitters in the HF-range 1.5–25 MHz with automatic tuning and remote control. Output 5 kW. Complete radio stations for the mobile maritim service with SSB and Telex. Broadcast programme channeling equipment for radio links or coaxial cables. All equipment is tested in arctic and tropical climate. Radiolinks and carrier frequency equipment is fully transistorized.

 **ELEKTRISK BUREAU** Founded in 1882 – 1500 employees – Annual turnover 160.000.000 Norw. Cr.
Oslo – NORWAY

tric Co. is said to be working on both hybrid and completely solid state versions of its 11-inch Porta Color set. The Radio Corp. of America, the leading producer of color-tv sets, is reported to be designing 15- and 19-inch hybrids; Motorola, Inc., a 19- and possibly a 21-inch set; and the Magnavox Co., a 21-inch set.

II. Deflection circuits?

All the companies interviewed, except GE, agree that transistorization of the high-voltage deflection circuits is impractical now for technical and economic reasons.

"There is no single economical device that can handle 25,000 volts," says Warren C. Letsinger, customer assistance manager at the General Motors Corp.'s Delco Radio division. "One transistor, the experimental 2N2580 could, but one of them costs \$100." Two Delco DTS 423's in series, which cost about \$8 each at the distributor, could also do the job. But these transistors would be operating so close to their maximum ratings that their switching times would have to be perfectly matched.

Delco, along with Texas Instruments Incorporated and Motorola, is working on a single device to solve the deflection problem. Delco's unit, similar to its DTS 423, but with a higher rating, is believed to be the farthest advanced.

Despite its reluctance to discuss its plans, GE seems to have solved the deflection-circuit problem. Peter Humeniuk, engineering manager at the company's tv-receiver department, says, "Devices are available to transistorize the entire set, from tuner to deflection stages. The somewhat higher cost is to be expected."

Economics. How much will the consumer be willing to pay for the more expensive solid state components?

Zelazo, at Muntz, says, "The magic pulling power of the word transistor is worth a price differential of \$30 or more in the market." John H. Schumacher, head of Warwick's design engineering, says, "Between \$15 and \$25 retail." Dietch, of Admiral, Humeniuk of GE, Pierce of Wells-Gardner and Melius of Setchell-Carlson, generally agree that hybrid sets should only cost 5% to 10% more

than present tube sets do.

Dietch adds that increased component cost for hybrid sets could be somewhat offset by the labor-saving techniques by which the sets could be fabricated.

Brown, of Zenith, believes that improved styling, resulting from smaller components, will support higher prices. Brown believes hybrids will cost \$50 or \$60 extra, but he says the public will pay it. Second generation sets, he adds, will cost less because of lessons learned while producing the first generation.

Philco is recommending a retail price of approximately \$450 for its 19-inch hybrid tv. The Philco 21-inch all-tube set now sells for about \$370.

III. IC's in 3 to 5 years

Although Admiral is already introducing an integrated circuit into its sets, most producers don't expect widespread use of IC's for three to five years. Dumas, of Hoffman, sees "very good possibilities for an IC set by 1968." Brown, of Zenith, says, "A minimum of three years, but more likely five." Philco sees 1972 as the big year for IC's in color tv. "We estimate six to eight (integrated) circuits will be

used per set," a spokesman says. "By 1972, from 20 million to 25 million circuits will be needed to meet production needs." He declines to predict the dollar volume of the requirement because "the same wild pricing that affected transistors has already engulfed integrated circuits."

Admiral is keeping IC's out of the video strip at present, Dietch says, "because transistors do the job there and cost less." The company is using an IC in the color demodulator in its 15-inch hybrid "because the frequency-range requirements are low, and one IC replaces many tubes or transistors in one shot," he explains. The IC replaces all the components previously used in the color demodulator, also two other transistors and their associated circuitry.

Hoffman Electronics may be the next to use IC's. The company believes, according to Dumas, that "any low-level circuit handling from 20 to 50 volts can be replaced by IC's now." Dumas says this includes the video i-f amplifiers, color demodulator, sound circuits, f-m amplifier, synchronization processing and amplifying stages, vertical integrator and automatic-gain-control (agc) stages.

Military electronics

Discriminating Press

Study seeks to analyze the fiery signature of warhead during reentry

By Thomas H. Maguire

Boston Regional Editor

On the Kwajalein atoll in the Marshall Islands, 2,000 miles from Hawaii, sites were being prepared this week for new radar and optical systems to increase the capabilities of Project Press (Pacific range electromagnetic signature studies)—the six-year old program to find out how defense radars and other sensors can pick out a genuine warhead in a blizzard of decoys and penetration aids.

Since 1959, the Advanced Research Projects Agency of the Department of Defense has spent \$160 million on Project Press. Press is part of Project Defender, ARPA's over-all program to explore defense against missiles and satellites and for development of penetration aids for United States missiles.

Improvements costing more than \$20 million include a radar that tracks and measures the configura-

For air/surface/sub-surface environments

Ferranti ADA System:

compatible with any naval fighting force in the world

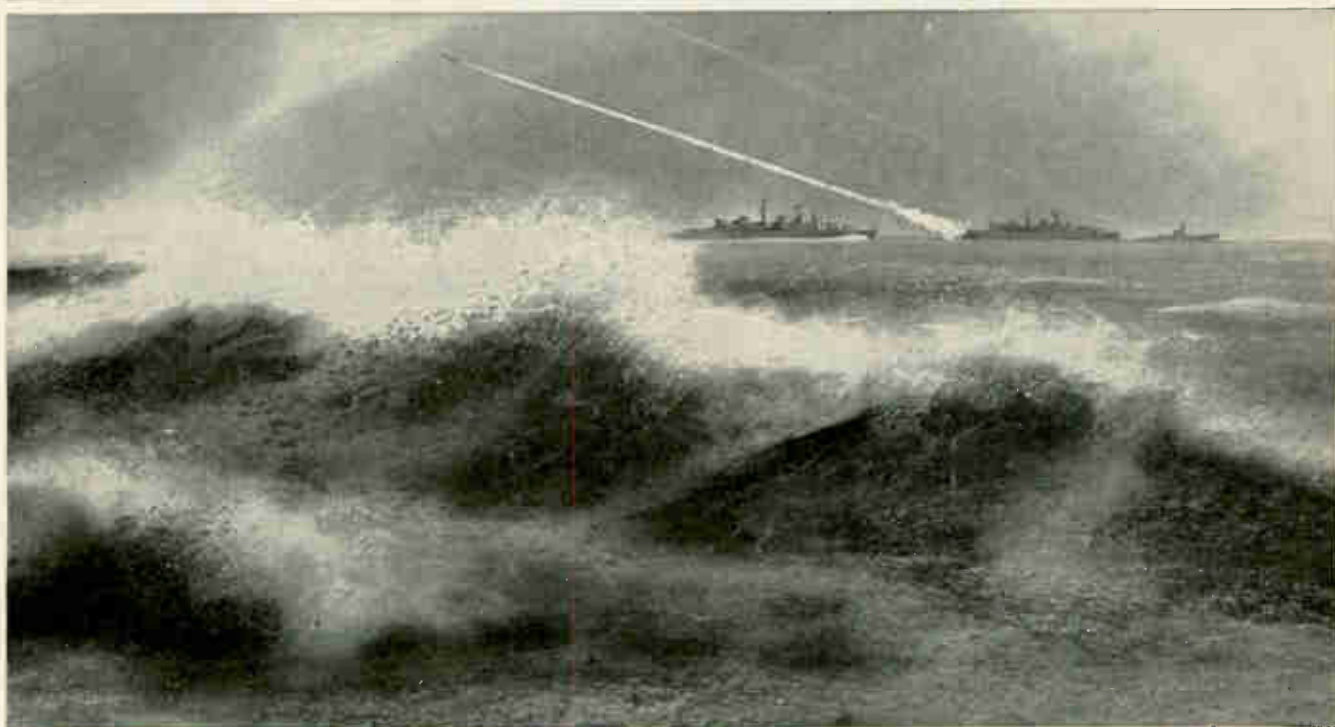

Action Data Automation is based on a series of ship-borne computer systems for command and control of sensor and weapon equipments. The installing of an ADA System greatly enhances the overall effectiveness of weapons already fitted, and—by virtue of its inherent flexibility—enables optimum use to be made of new weapons in any foreseeable situation in the future.

ADA provides Central Command with a comprehensive tactical picture of air, surface and sub-surface situations from all available sources. It recommends the action to be taken against an enemy and supplies immediate solutions to urgent tactical problems. To achieve successful combat it predicts and transmits vital 'kill point' and control data to fighter aircraft, missile complexes and helicopter-borne weapons systems.

ADA computer systems perform all these functions in micro-seconds. Subject to human decision, real-time action can proceed instantly.

The computer systems initially developed by Ferranti DSD in collaboration with the British Admiralty Surface Weapons Establishment for air

defence duties aboard HMS *Eagle*, can be used to maximise the effectiveness of guided missile destroyers, anti-submarine frigates, anti-aircraft frigates and submarines. Utilizing advanced micro-miniaturization techniques the ADA System can be installed in helicopters and fast patrol boats. Ferranti possess the experience to understand and evaluate the most complex defence needs, and—equally important—the large-scale resources to produce computer-based systems to meet specific Service requirements. Having worked closely and successfully with members of NATO, Ferranti are uniquely qualified to undertake national defence projects of vital importance.

FERRANTI

**DIGITAL SYSTEMS FOR
MILITARY APPLICATIONS**

Ferranti Limited, Digital Systems Department, Moston, Manchester 10, England.
DSD Research and Development Laboratories, Bracknell, Berkshire, England.

DS7

Lambda adds 42 new models... 2 VDC and up silicon modular power ...low-cost overvoltage protection

New

42 power supplies designed for integrated circuit and other fixed voltage applications—maximum amps per cu. in. . . . maximum amps per dollar

New

Adjustable crowbar type overvoltage protection accessory—\$25

- Designed for continuous operation—no external fuse required
- Temperature coefficient—.05%/°C
- Mounting provisions provided—2-terminal connection

Model	Adj. Volt. Range	Size: H x W x D	Price
LMOV-1	3- 8 v	1¼" x 3¾" x ⅝"	\$25.
LMOV-2	6-20 v	1¼" x 3¾" x ⅝"	\$25.
LMOV-3	18-70 v	1¼" x 3¾" x ⅝"	\$25.

For use with all LM Series power supplies



4 DC OUTPUTS IN 3½" LRA-4 RACK ADAPTER

PATENT PENDING

Mounting provisions for use with chassis slides

LM Series . . . Data and Features

- A-C Input—105-132 VAC
45-440 CPS
- Reg. Line—.05% + 4 MV
Load—.03% + 3 MV
- Ripple—1 MV rms—3 MV peak-to-peak
- Temp. Coef.—.03%/°C

- Meet Mil. Environment Specs.
RFI—MIL-I-16910
Vibration: MIL-T-4807A
Shock: MIL-E-4907A • Proc 1 & 2
Humidity: MIL-STD-810 • Meth. 507
Temp. Shock: MIL-E-5272C • (ASG) Proc. 1
Altitude: MIL-E-4970A • (ASG) Proc. 1
Marking: MIL-STD-130
Quality: MIL-Q-9858

Multi-Position-Rated™ and Multi-Current-Rated™ for 40°, 50°, 60° and 71°C

		I MAX. AMPS ¹					Price
Model	VDC	40°C	50°C	60°C	71°C		
LM 201	0- 7	0.85	0.75	0.70	0.55	\$ 79	
LM 202	0- 7	1.7	1.5	1.4	1.1	99	
LM 203	0-14	0.45	0.40	0.38	0.28	79	
LM 204	0-14	0.90	0.80	0.75	0.55	99	
LM 205	0-32	0.25	0.23	0.20	0.15	79	
LM 206	0-32	0.50	0.45	0.40	0.30	99	
LM 207	0-60	0.13	0.12	0.11	0.08	89	
LM 208	0-60	0.25	0.23	0.21	0.16	109	

RACK ADAPTERS

LRA 6—5¼" Hgt. by 14⅛" Depth
[for use with chassis slides]
Price—\$60.00

LRA 3—5¼" Hgt. by 3" Depth
Price—\$35.00

LRA 4—3½" Hgt. by 14⅛" Depth
[for use with chassis slides]
Price—\$55.00

LRA 5—3½" Hgt. by 3" Depth
Price—\$35.00

		I MAX. AMPS ¹					Price
Model	VDC	40°C	50°C	60°C	71°C		
LM 217	8.5-14	2.1	1.9	1.7	1.3	\$119	
LM 218	13-23	1.5	1.3	1.2	1.0	119	
LM 219	22-32	1.2	1.1	1.0	0.80	119	
LM 220	30-60	0.70	0.65	0.60	0.45	129	
LM B2	2 ±5%	3.4	3.0	2.3	1.4	119	
LM B3	3 ±5%	3.4	3.0	2.3	1.4	119	
LM B4	4 ±5%	3.4	3.0	2.3	1.4	119	
LM B4P5	4.5±5%	3.3	2.9	2.2	1.4	119	
LM B5	5.0±5%	3.3	2.9	2.2	1.4	119	
LM B6	6.0±5%	3.2	2.8	2.2	1.3	119	
LM B8	8.0±5%	3.0	2.7	2.2	1.3	119	
LM B9	9.0±5%	2.7	2.5	2.1	1.3	119	
LM B10	10.0±5%	2.6	2.4	2.1	1.3	119	
LM B12	12.0±5%	2.4	2.3	2.1	1.3	119	
LM B15	15.0±5%	2.1	1.9	1.7	1.2	119	
LM B18	18.0±5%	1.8	1.6	1.5	1.2	119	

All models in grey are new.

- Current rating is from zero to I max.
Current rating applies over entire output voltage range.
Current rating applies for input voltage 105-132 VAC
55-65 cps. For operation at 45-55 cps and 360-440 cps
derate current rating 10%.

		I MAX. AMPS ¹					Price
Model	VDC	40°C	50°C	60°C	71°C		
LM 225	0- 7	4.0	3.6	3.0	2.4	\$139	
LM 226	8.5-14	3.3	3.0	2.5	2.0	139	
LM 227	13-23	2.3	2.1	1.7	1.4	139	
LM 228	22-32	2.0	1.8	1.5	1.2	139	
LM 229	30-60	1.1	1.0	0.80	0.60	149	
LM C2	2 ±5%	4.9	4.2	3.5	2.4	139	
LM C3	3 ±5%	4.9	4.2	3.5	2.4	139	
LM C4	4 ±5%	4.9	4.2	3.5	2.4	139	
LM C4P5	4.5±5%	4.9	4.2	3.4	2.4	139	
LM C5	5 ±5%	4.8	4.1	3.3	2.4	139	
LM C6	6 ±5%	4.6	4.0	3.1	2.4	139	
LM C8	8 ±5%	4.4	3.8	3.0	2.0	139	
LM C9	9 ±5%	4.2	3.6	3.0	2.0	139	
LM C10	10 ±5%	4.0	3.5	2.9	2.0	139	
LM C12	12 ±5%	3.8	3.3	2.8	2.0	139	
LM C15	15 ±5%	3.4	3.2	2.7	1.8	139	
LM C18	18 ±5%	3.0	2.8	2.5	1.7	139	
LM C20	20 ±5%	2.9	2.7	2.4	1.7	139	
LM C24	24 ±5%	2.5	2.4	2.2	1.5	139	
LM C28	28 ±5%	2.3	2.1	2.0	1.4	139	



LAMBDA ELECTRONICS CORP.
615 BROAD HOLLOW ROAD, MELVILLE, L. I., NEW YORK • 11749

supplies

New

Higher ratings with forced air cooling

Ventilated construction affords substantial increases in rating with small amounts of air flowing over surfaces of power supply.

Example: LM 217 is rated at 2.1 amps at 71°C ambient with 200 linear ft./min.; at 60°C ambient with 100 linear ft./min.

- Convection cooled—no heat sinking or forced air required
- Thermally Protected and Short Circuit Proof—Current Limiting
- Remote Programming
- Mount 3 ways on chassis or in rack
- All Silicon Semiconductors Hermetically Sealed

Ambients



Package D

4 15/16" x 7 3/4" x 9 3/8"

Model	VDC	I MAX. AMPS ¹				Price
		40° C	50° C	60° C	71° C	
LM 234	0-7	8.3	7.3	6.5	5.5	\$199
LM 235	8.5-14	7.7	6.8	6.0	4.8	199
LM 236	13-23	5.8	5.1	4.5	3.6	209
LM 237	22-32	5.0	4.4	3.9	3.1	219
LM 238	30-60	2.6	2.3	2.0	1.6	239
LM D2	2 ±5%	13.1	11.3	9.2	6.2	199
LM D3	3 ±5%	13.1	11.3	9.2	6.2	199
LM D4	4 ±5%	13.1	11.3	9.2	6.2	199
LM D4P5	4.5 ±5%	13.1	11.3	9.2	6.2	199
LM D5	5 ±5%	12.6	10.8	9.2	6.1	199
LM D6	6 ±5%	12.4	10.6	8.9	6.0	199
LM D8	8 ±5%	12.2	10.3	8.8	5.9	199
LM D9	9 ±5%	11.3	10.0	8.6	5.7	199
LM D10	10 ±5%	10.8	9.7	8.5	5.7	199
LM D12	12 ±5%	10.0	9.2	8.3	5.7	199
LM D15	15 ±5%	9.0	8.4	7.9	5.3	209
LM D18	18 ±5%	7.9	7.4	6.9	5.0	209
LM D20	20 ±5%	7.4	6.9	6.5	4.9	209
LM D24	24 ±5%	6.7	6.3	5.8	4.8	219
LM D28	28 ±5%	6.0	5.6	5.2	4.7	219

tion and velocity of its target and conversion of the world's largest-aperture spectrometric telescope. The new optical instrument is designed to track a missile and measure its radiation during reentry.

I. Design is aided

Performance details of Press are classified, but DOD officials say the program has greatly increased our knowledge of reentry phenomena and has aided missile-systems design, for both attack and defense. Unarmed missiles are being used.

Lincoln Laboratory of the Massachusetts Institute of Technology is scientific director of Press. C. Robert Wieser, assistant director of the Laboratory, heads a 120-man Lincoln force working at Kwajalein and at the Lexington, Mass. laboratory, where all of the data is flown after each mission for analysis and interpretation.

The scientists working on the program describe Press as a study of physical effects—recorded at optical, infrared and radio frequencies—which occur during the flight of a ballistic missile, especially during reentry. Press is the full-scale field measurements part of the program, building on results of laboratory and model measurements of reentry.

Says a member of the Press team: "We would like to be able to base the identification of an incoming missile on immutable physical laws—not on things which an enemy can change like size, shape or speed of the object. We are looking for something in the physics of the atmosphere that tells us something specific about an object hurtling through it."

Press explores the potentials of atmospheric filtering as a means of identifying a warhead. What kind of special signature does a ballistic missile write during reentry? What does a warhead do to the atmosphere, and vice versa, that will enable defense radars to sort it out from dummies, and decoys?

"These are controlled measurement experiments, not war games," says Wieser. "Of course," he adds, "you cannot tell sheep from goats unless you have both there." So the firings down the Pacific range include both missiles and decoys.

Nike-X link. Although Press is a reentry measurements program and not directly involved in development, a close relationship is maintained with the Kwajalein test site of the Nike-X antiballistic missile program. Pointing data from the Press computer is fed to the Nike-X site, where tests are under way for an operational ABM system. Information is interchanged with Western Electric Co., developer of Nike-X.

Whenever a ballistic missile is fired from Vandenburg Air Force Base down the 4,500-mile Western Test Range to the Kwajalein impact area, Press's computer-directed network of ground-based and airborne optical sensors is trained on the warhead as it reenters the atmosphere.

II. Second generation radar

The new radar, called Altair for ARPA long-range tracking and instrumentation radar, will be installed on Roi-Namur Island at the northern tip of the atoll. It will be used by some 50 American scientists, who commute daily by air from their living quarters on Kwajalein Island.

Altair will provide improved resolution and sensitivity, also a greater versatility of frequencies and waveforms than the Tradex radar now being used. Tradex, for target resolution and discrimination experiments, is a modified version of the AN/FPS-49 designed for the ballistic missile early warning system. It was the first trifrequency radar.

Like Tradex, Altair will locate the reentry vehicle for the other sensors. It will then provide data on the object for subsequent analysis. Many characteristics of an object in space—size, shape, orientation, materials of construction—can be determined through radar signal returns measured in terms of amplitude, polarization, phase relationship, and doppler shifts. The measurements are modified by the atmosphere, by ionization layers, the earth's magnetic fields and other factors. For the purposes of Press, the radar gathers as much raw data as possible about the object and its immediate environment.

When the Altair installation is completed, it will take over the

LAPP GAS FILLED CAPACITORS ARE DESIGNED FOR

HIGH
VOLTAGE

HIGH
CURRENT

HIGH
CAPACITANCE

APPLICATIONS



These uniquely designed Lapp Gas-Filled Capacitors are completely unaffected by atmospheric or dust conditions. They are precision built and of extra strong construction to assure years of accurate, trouble-free operation. ■ Lapp Gas-Filled Capacitors are available in either fixed or variable models. All are equipped with an external safety gap to protect against internal flashover on excess voltage peaks. Capacitance available up to 30,000 mmf, safety gap settings up to 85 kv peak and current ratings up to 400 amps at 1 mc. ■ Write for Bulletin 302... get our complete Gas-Filled Capacitor story. Lapp Insulator Co., Inc., Radio Specialties Division, 239 Sumner St., LeRoy, N.Y. 14482.

Lapp

uhf and vhf capabilities now performed by Tradex. If Tradex is kept at all, it will perform only as an L-band radar.

Until Altair is ready, Tradex's uhf capability (425 megacycles) will be used for target detection, acquisition and tracking. This transmitter has a peak power of four megawatts, with 300 kilowatts of average power coming from the triode amplifier. The L-band radar provides signals for detection, display and target analysis at 1,320 Mc, with a klystron providing five megawatts peak power. The vhf radar operates at 60 Mc.

Under a \$16.2-million contract from ARPA, Sylvania Electric Products, Inc., a subsidiary of General Telephone and Electronics Corp., is designing Altair. Radiation, Inc. will build the steerable parabolic reflector. Continental Electronics Manufacturing Co., a subsidiary of Ling-Temco-Vought, Inc., will supply a vhf transmitter; and Energy Systems, Inc., the uhf. Hazeltine Corp. has the subcontract for pulse compression equipment; and the Computer Control Co. will furnish a digital computer for real-time control of the system.

III. The telescope

A site is also being prepared at Roi-Namur for the new spectro-metric tracking telescope with a 48-inch aperture that will be shipped to the Pacific early next year from Lincoln Laboratory. The telescope was built for field studies of small reentry vehicles fired from Wallops Island, Va., [Electronics, May 10, 1963, p. 16]. It is being converted at Lincoln for tracking and measurement of radiation from full-scale

Another ARPA-sponsored program aimed at upgrading Press capabilities is a satellite that aids in testing the sensitivity of radars, particularly their ability to analyze reentry signatures. Developed by Lincoln Laboratory, the satellite is a carefully machined aluminum ball whose radar backscattering cross section is precisely known. Since its position is also known at all times, the correct radar return is easily determined [Electronics, May 17, p. 18]. Lincoln Laboratory plans to launch additional spheres at orbit altitudes especially suited for Press radar as soon as payload space is available.

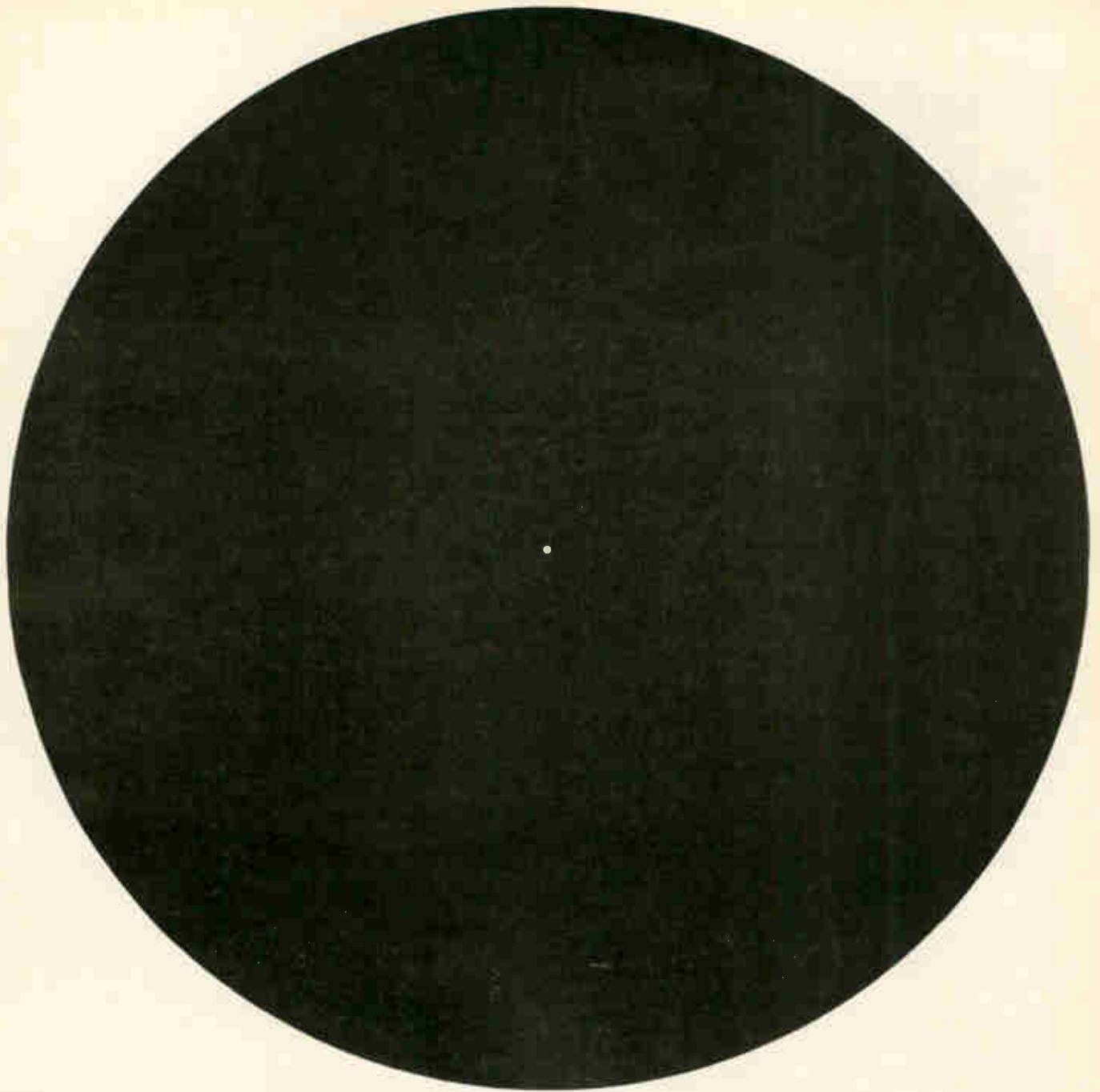

The small pin hole in the center of this circle is more than enough light for MTI Image Orthicon Television Cameras.

MTI is the world's largest manufacturer of low light level TV systems. This simply means that low light levels are our specialty. Specifically, at 1×10^{-5} foot candles of ambient light (approaching total darkness) MTI image Orthicon TV cameras will produce high resolution pictures. So the amount of light illustrated by the pin hole is more than enough.

There are hundreds of applications for MTI low light level equipment. Here are just a few: viewing nocturnal animals performing tasks, observing stars, examining small components such as transistors, diodes, capacitors and relays for minute flaws, and so on. In any application where low light levels are of prime importance, MTI can solve your problems.

Seven different line scan frequencies are available "off the shelf". Specific details available on request. If you have an application problem, call us. We can help.

mti MARYLAND TELECOMMUNICATIONS, INC.
York & Video Roads, Cockeysville, Maryland / Area code 301, 666-2727
WORLD'S LARGEST MANUFACTURER of low light level image Orthicon cameras)



Missile's sea cruise to be business trip

Shipboard trials will test range, reliability, accuracy, and reaction time of the Standard missile that will replace extended-range Terrier and medium-range Tartar

By Gerald Parkinson

Los Angeles News Bureau

Before March, the Navy's new Standard missile will blast off the deck of a destroyer in hot pursuit of an F-9F jet drone streaking along at 500 knots. If all goes well, the missile will overtake the drone within a few seconds, passing close enough for the Standard's killer warhead to destroy the plane—if the missile were armed.

Preparations for the shipboard tests have been under way for several months at the Naval Ordnance Test Station in China Lake, Calif. Ground and flight tests have been 70% successful—a high percentage, the Navy says, for a developmental system only one year old.

The Navy's Bureau of Weapons is so satisfied that it doesn't plan any design changes. And the General Dynamics Corp.'s Pomona division, the prime contractor, is making only minor package improvements from lessons learned during the tests. The Standard missile will replace two surface-to-air missiles, Tartar and Terrier—known as the two T's. The two T's have had so many problems they are often called the "terrible T's."

I. No shipboard maintenance

Primarily an anti-aircraft defensive weapon, the Standard represents a new generation in defense as well as in electronics technology. It is a better weapon because of its increased range, accuracy, reliability, ease of maintenance and reaction time. Reliability failures have been cut in half and maintenance aboard ship has been eliminated. Standard-carrying vessels will not even carry test equipment; the missiles will be tested only every three to five years. Warm-up

time on the launcher before firing is only one second, another improvement over the two T's, which required 20 seconds. The same

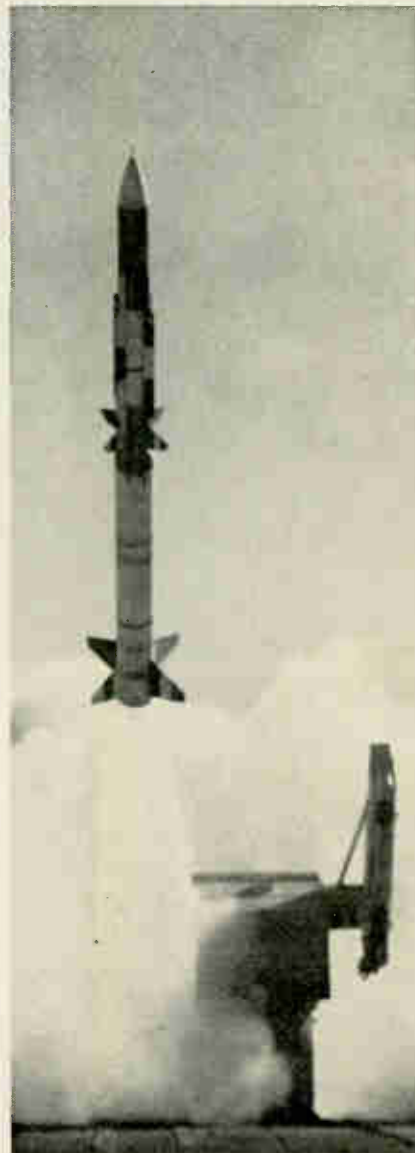

Extended-range Standard blasts off the launch pad at White Sands, N.M. The missile will soon go to sea for testing.

launch and control systems for the two T's, with minor modifications, will be used for Standard. The system automatically selects missiles from the ship's magazine, loads them on the launcher, trains them on the target and fires them.

The missile. The Standard is being developed in two versions, one to replace Tartar and the other for Terrier, both also built by General Dynamics.

The medium-range replacement for Tartar uses one solid-fuel rocket and will have a range "a good deal more than Tartar's 10 nautical miles," according to Capt. Lewis J. Stecher Jr., project manager. The extended-range missile replacement for Terrier will use one solid-fuel rocket and a sustainer rocket with a range "a lot more than 30 miles," Stecher says.

The medium-range missile is 14 feet long and weighs 1,200 pounds—about a foot shorter and 100 pounds lighter than Terrier. The diameter of both Standards is just over one foot.

The Standard can also operate as a surface-to-surface weapon against enemy ships; the two T's could not.

Guidance. Standard, like its predecessors, is guided by a semi-active homing system. A large shipboard radar blankets the target with radio signals, and the missile picks up the reflected signals and homes in on the target. Although the principle is the same as that for the two T's, the Standard's system is designed so the missile can penetrate an enemy's electronic countermeasures more efficiently.

The Standard system's signal-to-noise ratio is also better than the

Cinch achievements in selective plating reduce your connector costs

REDUCES GOLD
REQUIREMENTS
OVER 60%

This revolutionary selective plating technique can reduce gold requirements over 60%, with no adverse effects on contact reliability, durability or electrical performance. Cinch puts the gold plating only where you need it—at the area of contact. (A gold "flash" may be applied to the rest of the connector if desired.)

The new Cinch .045" square tail connector (patent pending) utilizing this selective plating, combines the contact reliability of a flexing bifurcated contact with the stability of a rigid .045" square tail. This is achieved by inserting a wire core into the tail section and forming the flexible contact material into a .045" square tail with the sharp corners so necessary for reliable wire wrap attachments.

For additional information of this connector, with selectively plated contacts, write to Cinch Manufacturing Company, 1026 S. Homan Avenue, Chicago, Illinois 60624.

CM-6509



CINCH

DIVISION OF UNITED-CARR

At Signetics we stick our neck out to get above the fog level.



announcing a new kind of integrated circuit data sheet.

No foggy "typical characteristics" talk. Signetics new data sheets provide the systems designer with the clarity of *GUARANTEED WORST CASE DESIGN LIMITS*. Now you can design without calculating or worrying about any additional safety factors or guard bands. And for component and reliability engineers, each data sheet is a model procurement document, complete down to details of acceptance, quality assurance, and environmental test methods and limits in accordance with all applicable M.L. specifications. Get above the fog level. Know exactly what you are buying. Mail the coupon today.

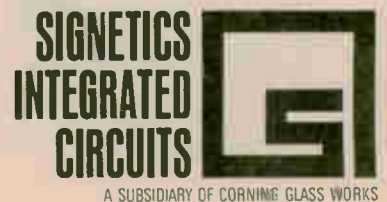

SIGNETICS CORPORATION, 811 E. ARQUES AVE., SUNNYVALE, CALIF.

All right, Signetics, prove it. I want your new Data Sheets on your complete line of DTL elements.

NAME _____

COMPANY _____

ADDRESS _____

CITY _____

STATE _____

ZIP _____

114 Circle 114 on reader service card

Electronics | December 27, 1965

Terrier and Tartar systems—so much better that the signal can distinguish a ship from the sea and operate as a surface-to-surface missile; the two T's could not.

Another innovation that makes Standard more effective against surface vessels is a contact fuse. The two T's, which had been using a proximity fuse only, are now being equipped with the contact fuse developed for Standard as well.

II. Solid state circuits

Standard has a number of component improvements over Tartar and Terrier. Standard uses solid state circuits, rather than a mixture of tubes and transistors. Some of the components are made with integrated circuits, but the use of IC's is limited to areas where their advantage has been proved. One example is in the timers, where IC's save space and money and the application is simple enough to assure reliability.

"We don't have enough solid information on IC shelf life, decay rates, and reliability under service conditions," says Stecher, explaining the Navy's limited use of IC's.

But, future versions of the Standard missile will probably make wider use of IC's. According to Joe Benish, Standard project manager, IC's are "definitely applicable" for greater use in the missile. Pomona has preliminary designs of missiles like Standard "using up to 90% IC's," Benish points out.

Packaging. Standard's electronic system will be about 50% smaller than that in the two T's, thanks to a more compact type of assembly. Welded-wire modules will be used instead of the five wheel-shaped, soldered assemblies, whose rims form the skin of the system in the two T's.

Although Standard is shorter and lighter than the two T's, the 50% reduction in space required for electronic gear has left more room for a larger rocket motor, a different warhead and for even more electronic equipment if the Navy should decide to improve on the Standard.

Another benefit of the switch from soldered to welded construction, says the Navy, is the higher reliability of the welded joints. The Navy learned this from its experience with welded-wire modules in

the Polaris missile's guidance and control systems.

III. Adaptive control

The autopilot on Standard "is the first truly adaptive autopilot for an anti-aircraft missile," Benish declares. The autopilot, developed by General Dynamics, is designed to adjust to a wide range of dynamic pressures.

Actuator. In its adaptive control, the autopilot makes use of an electric actuator developed by GD to drive the tail of the missile. This tail, like the ailerons and rudder of an aircraft, controls the missile's movement. The actuator also enables the Standard to use an all-electric control system: all the power comes from a silver-zinc primary battery. This eliminates any need for hydraulic systems—used to steer Terrier and Tartar—which are less reliable and less efficient because they leak and require more energy.

The actuator is a bistable, non-linear device with a d-c motor to drive the missile tail. The d-c drive is operating constantly at full speed. Special clutches are continually engaged and disengaged to drive the tail rapidly in either direction. The tail vibrates rapidly during flight and takes an average position, depending on the required maneuver. Benish says he thinks this is the first time a clutch system has been used for missile guidance. Steering is accomplished by four independently actuated control surfaces on the aft section.

The autopilot continuously monitors the vibration or, "dithering," of the tail, which reacts differently according to speed and altitude. Thus, when a change in course is signaled, the autopilot knows how much to move the tail to make the change.

The system requires no more circuitry than that for the autopilot in Terrier and Tartar, Benish says. The Terrier-Tartar autopilot obtains air-density readings from a static pressure probe in the nose of the missile, and has a complicated system of sensors to pick up information about dynamic pressures. This is expensive and not as reliable as the adaptive autopilot.

The autopilot contains a roll-free gyro and a roll-rate gyro to stabilize the roll loop, and rate gyros

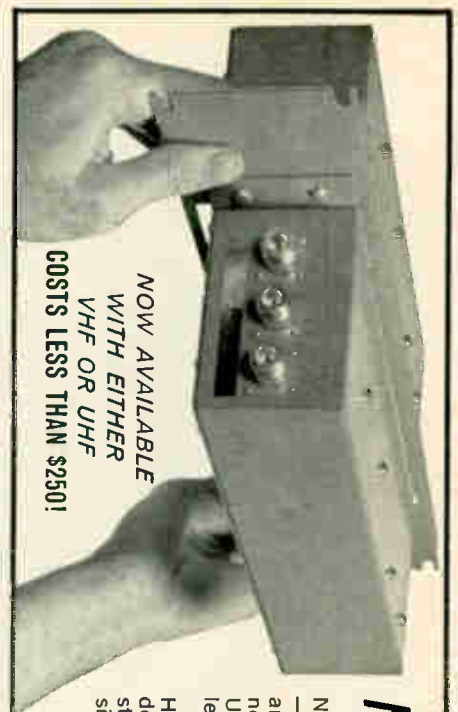

NOW AVAILABLE
WITH EITHER
VHF OR UHF
COSTS LESS THAN \$250!

NEW... SMALLEST BASE STATION DUPLER (ONLY 2" HIGH)

Now—in a fourth or less of the space formerly required—you can stack a duplexer right with your transmitter and receiver... all at eye level. Only 3" of rack space needed for Sinclair's new VHF Duplexer... 3" for the UHF model. And these surprisingly compact units cost less than \$250!

Don't let the low price throw you! These new Model H-150 and H-450 duplexers are packed with all the dependable quality features of larger Sinclair base station duplexers. They allow simultaneous transmission and reception from a common antenna with separation between frequencies as low as 3 Mc at 150 Mc and 5 Mc at 450 Mc. Retuning to a new frequency—if desired—is easily done by retuning the cavities. Neither cable nor harness need be changed.

Though small in size, these new duplexers have standard power rates of 100 watts (optional ratings up to 200 watts are available). The temperature range of from -20°F to 150°F makes them exceptionally versatile in either base station or repeater station applications. Investigate today! Write for complete FREE information on all Sinclair duplexers, antennas and multiconplers.

SINCLAIR RADIO LABORATORIES, INC.

523 FILLMORE AVENUE, DEPT. 101, TONAWANDA, NEW YORK

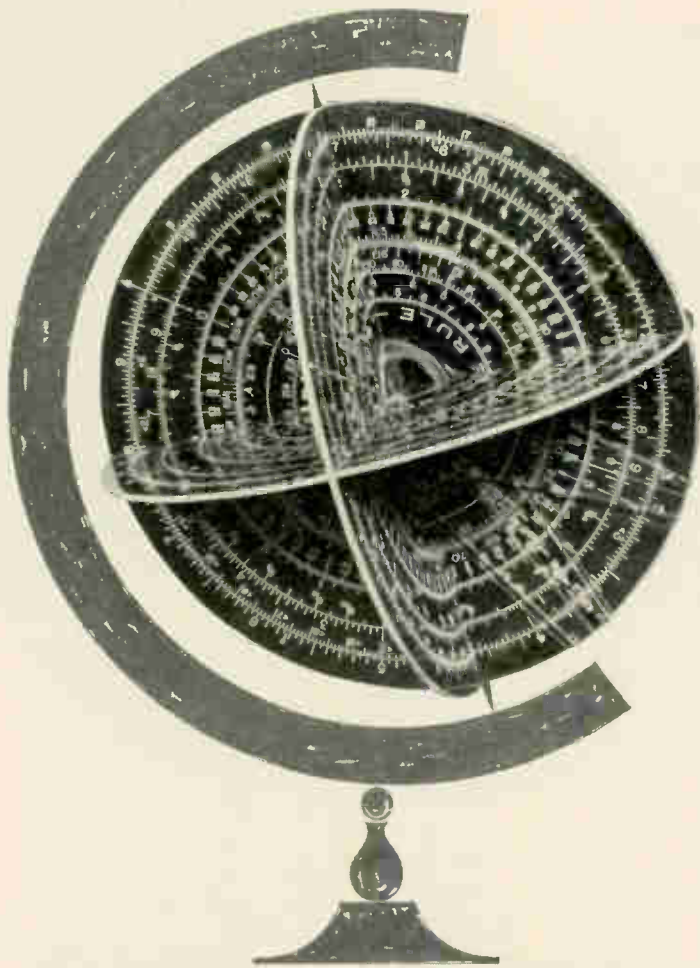

INTERSTATE ELECTRONICS ... where longitudinal experience and latitudinal capability form a world all by themselves.

That's right, Interstate Electronics is long on experience and wide in capability. It took both to develop the sophisticated and highly successful test instrumentation equipment for the FBM weapon system of the Polaris submarine program. As prime contractor for this important equipment, Systems Development Division of IEC relies heavily on its staff of top experts, and excellent facilities. The same applies to the Data Products Division which specializes in the development of real-time permanent paper or film video recorders, phase lock devices, timing systems, data handling systems and analog-to-digital conversion equipment. Lots of savvy. Lots of ability.

And although the seas have been here since time began, Man is only now beginning to read, understand, and use the waters of the world. OceanicS Division, formerly National Marine Consultants Division, for over a decade has used scientific principles to develop unique products and methods for studying everything from piers to pollution, from sand to salinity. It's all done with people... the best in the business.

You see, it's really elementary. People with ability are what make the world go round at IEC.

INTERSTATE ELECTRONICS CORPORATION

707 E. VERMONT AVE., ANAHEIM, CALIFORNIA 92803

Regional Offices: Atlanta, Georgia · Washington, D. C.

Subsidiary of

INTERSTATE ENGINEERING CORPORATION



IEC

to control pitch and yaw, with accelerometers for stabilization.

In the Standard, the autopilot is immediately in front of the rocket motor and behind the battery. In Terrier and Tartar, it is behind the guidance system at the front of the missile. Benish notes that it is more desirable to have the autopilot farther back so the warhead can be as far forward as possible. However, in Terrier and Tartar, the autopilot is mounted forward to minimize wiring between the autopilot and associated instrumentation.

IV. Contracts

General Dynamics is now one year into the three-year development program, and is just getting into pilot-line production. The work is being carried out under a fixed-price-incentive contract, an arrangement that works out well, Stecher says, if the contract has been drawn up carefully. The fixed-price-incentive, Stecher says, is undoubtedly a trend and will become more prevalent. Also, making one contractor responsible for the entire program has made for a smoother operation.

Benish says it is too early to make a judgment on the contract from General Dynamics' viewpoint, because incentives for deliveries and missile performance will not become important until about the middle of 1966, during pilot-line production.

The company is doing all development and production work on Standard, buying only components. The warhead and rocket motors—the same as those used for Terrier and Tartar—are government furnished.

Competitive bids. Full production is scheduled for fiscal 1967, when the Navy plans to put the contract up for competitive bidding. When manufacture starts, the two T's will begin to be phased out of production.

The two T's are on more than 60 U. S. ships, plus some French, Italian, Australian, Japanese and Dutch vessels.

General Dynamics has commitments through 1968 for installing missiles on 26 more ships. Tartar usually goes on destroyers and Terrier on frigates, cruisers and aircraft carriers.



Silicone greases solve unique problems of moisture, corrosion, temperature and contamination

Silicone greases have many unique properties that make them perform when other types of greases fail. Silicones are chemically inert and therefore compatible with most materials. They are also usable from -100°F to 450°F , and maintain the same viscosity without solidifying or melting. They are hydrolytically stable and water repellent. Silicones also resist oxidation and gumming. And they exhibit low evaporation and bleed loss. Here are some examples of how industry takes advantage of these unique silicone properties:

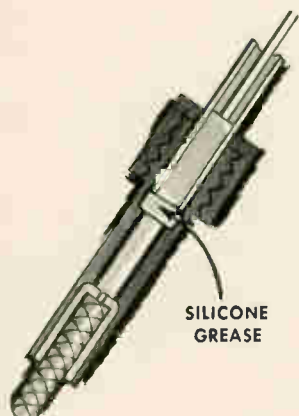

SILICONE GREASE

Inert silicone grease fills joints of explosive separation system for space vehicles. Prevents entrance of liquid air if seals or bonds leak. Grease is easily applied.

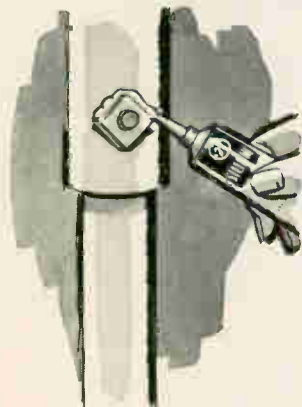

Outdoor lighting fixtures used galvanized bolts that corroded badly in a year. Thin coat of silicone grease resulted in zero corrosion, permitting bolts to be removed.

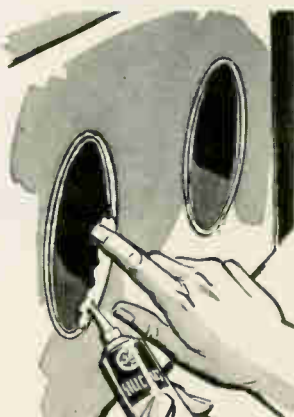

Grease film is applied to organic rubber O-rings on gloved box. Box must be leak-tight to prevent spread of radioactivity. O-ring life doubled, saving replacement work.



Rotor for a watt-hour meter is permanently lubricated with silicone grease. Six years and one million meters later, not one case of failure due to grease breakdown has occurred.



A small amount of silicone grease is used to fill connector plugs for down hole oil well equipment. Petroleum greases failed at 400°F and washed out. Silicones protect against salt water.



Silicone grease is applied to the cutouts in the thrust bearings of a turbo drill. The grease prevents adhesion to a rubber surface and also provides corrosion protection in service.

Silicone Products Department, Waterford, New York

GENERAL  ELECTRIC

Silicone Greases are available from these distributors:











- ALABAMA**
ARGO and COMPANY
7 — 18th St., SW, Birmingham
- ARIZONA**
ELECTRICAL SPECIALTY COMPANY
120 S. 29th St., Phoenix
R. V. WEATHERFORD COMPANY
9310 N. Central Ave., Phoenix
- CALIFORNIA**
ELECTRICAL SPECIALTY COMPANY
2820 E. 12th St., Los Angeles
ELECTRICAL SPECIALTY COMPANY
213 E. Harris Ave., S. San Francisco
R. V. WEATHERFORD COMPANY
6921 San Fernando Rd.
Glendale 1
R. V. WEATHERFORD COMPANY
3240 Hillview Ave., Palo Alto
- COLORADO**
ELECTRICAL SPECIALTY COMPANY
2026 Arapahoe St., Denver 5
- CONNECTICUT**
R. H. CARLSON COMPANY, INC.
7 Bruce Park Ave., Greenwich
- DISTRICT OF COLUMBIA**
READ PLASTICS, INC.
317 Cedar St., NW, Washington 12
- FLORIDA**
GULF SEMICONDUCTORS, INC.
129 Almeria Ave., Coral Gables 34
2733 Scarlet Rd., Winter Park
- ILLINOIS**
FEDERAL INSULATION
549 W. Randolph St., Chicago 7
J. J. GLENN & COMPANY, INC.
605 W. Washington Blvd.
Chicago 7
- INDIANA**
HYALINE PLASTICS CORPORATION
1019 N. Capitol St., Indianapolis
- IOWA**
PLASTIC SUPPLY INC.
512 S.W. 9th St., Des Moines
P.O. Box 1482
- KENTUCKY**
GENERAL RUBBER & SUPPLY CO.
3118 Preston Hwy.
Louisville 40213
- MASSACHUSETTS**
NORTHEAST CHEMICAL COMPANY
581 Boylston St., Boston 16
- MICHIGAN**
F. B. WRIGHT COMPANY, INC.
9999 Mercier St., Dearborn
- MINNESOTA**
D. A. SCHULTZ COMPANY
801 S. E. 8th St., Minneapolis
- MISSOURI**
D. A. JAMES COMPANY
911 St. Charles St., St. Louis 1
REGAL PLASTIC SUPPLY COMPANY
1735 Main St., Kansas City
- NEBRASKA**
REGAL PLASTIC SUPPLY COMPANY
2324 Vinton St., Omaha
- NEW YORK**
CHAMBERLIN RUBBER COMPANY
455 E. Main St., Rochester 14604
CHAMBERLIN RUBBER COMPANY
210 Marcellus St., Syracuse 4
PUNT, INC.
160 Woodbine Ct., Box 99
Floral Park
- OHIO**
THE PHILPOTT RUBBER COMPANY
2077 East 30th St., Cleveland 15
PARKWAY PRODUCTS, INC.
1230 W. 7th St., Cincinnati 45203
- OREGON**
ELECTRICAL SPECIALTY COMPANY
2360 N.W. Quimby St., Portland 10
- PENNSYLVANIA**
SMITH OF PHILADELPHIA
Second & Somerset St.
Philadelphia 33
SPECK-MARSHALL COMPANY
P.O. Box 110, Nichol Ave.
McKees Rocks 15136
- TEXAS**
HOUSTON INDUSTRIAL SUPPLY CO.
P.O. Box 52507, 1902 Bell Ave.
Houston 52
LAWRENCE ELECTRONIC COMPANY
P.O. Box 20676, 3422 Cridelle,
Dallas 20
- WASHINGTON**
ELECTRICAL SPECIALTY COMPANY
2442 First Ave., S., Seattle
- WISCONSIN**
R. J. WITTENBURG COMPANY
1338 W. Atkinson Ave.
Milwaukee 53206

If you can find one **POTENTIOMETER**
that's best for all applications

... choose it

We don't think you will.

Only IRC makes all these different types ... can recommend without bias.

 <p>RECTANGULAR TRIMMER Thick-film Metal Glaze. MIL-R-22097 performance. 1/2-watt, 100 ohms to 1 meg. without gaps.</p>	 <p>1/2" SQUARE TRIMMER Shock resistant. Metal Glaze or wirewound element. 3/4 and 1 watt, 10 ohms to 1 meg. Military and commercial.</p>	 <p>1/2" ROUND TRIMMER Low cost, speedy adjustment. Metal Glaze or wirewound element. 3/4 and 1 watt, 10 ohms to 1 meg.</p>	 <p>3/16" CUBE TRIMMER Ideal for miniaturization. Metal Glaze or wirewound element. 0.3 and 0.6 watt, 50 ohms to 500K.</p>	 <p>METAL CLAD TRIMMER 1/2" dia., 10 times more resolution, 0.1% stability. Shock—moisture resistant. 1.5 watts, 25 ohms to 150K.</p>
 <p>PLASTIC CASE MULTI-TURNS Most popular. Ruggedly built. 3/8" and 1 1/2" dia. 3, 5 and 10 turns. In 3, 4 and 5 watt ratings. 25 ohms to 600K.</p>	 <p>COMMERCIAL MULTI-TURNS Most economical. 3/4" dia., 10 turns. 2 watt rating. 100 ohms to 100K.</p>	 <p>STANDARD PRECISION MULTI-TURNS 1/2", 3/4" and 1" dia. metal case. 5 to 20 turns. 1 to 5 watts, 50 ohms to 600K.</p>	 <p>MOISTURE SEALED MULTI-TURNS 3/4" and 1" dia., 5 and 10 turns. 2, 3, 4 watts, 25 ohms to 500K. O-ring panel seal available.</p>	 <p>HERMETICALLY SEALED MULTI-TURNS 3/4" dia. metal case, dry nitrogen filled. 5 and 10 turns. 2 and 3 watts, 100 ohms to 250K.</p>

Write for complete trimming and precision multi-turn potentiometer catalog.



INTERNATIONAL RESISTANCE COMPANY

PHILADELPHIA, PA. 19108

Circle 118 on reader service card

Power control and conversion technique

Voltage regulator using a new type of variable inductor offers advantages over ferroresonant transformer

Voltage regulators featuring a new type of variable inductor have been put on the market by the Wanlass Electric Co., of Santa Ana, Calif. These are the first instruments produced by the infant company.

The regulator's advantages over the common ferroresonant transformer, Wanlass says, are that it is insensitive to frequency changes between 40 and 70 cycles, produces an adjustable output, and can regulate the voltage at the load. The ferroresonant transformers, the company admits, are a lot cheaper. To meet price competition, Wanlass has also introduced an economy line which is less sensitive.

The heart of the regulator is a new type of variable inductor, which Wanlass will not discuss, except to say that it uses no mechanical or solid state elements. Application for a patent are now in process. It is the voltage drop across the variable inductor which controls the output voltage.

Input voltage is stepped down by an autotransformer and then fed to the variable inductor. A transistorized circuit senses the output voltage and feeds it back to the inductor through a servo unit containing a zener reference.

The regulators will handle both line and load changes over a range of 95-130 volts. If the load is constant, a change in input voltage would cause a corresponding change in output voltage. But any change in output is detected by the sensor and fed back to the servo. The zener actuates the control winding of the inductor and modifies the inductance so that the voltage change across it exactly matches the change that would otherwise occur in the output voltage. A similar correction is applied if changes in the load cause the voltage to change.

If the load is connected, at a re-



mote location, voltage drops in the line may be a problem. In this case the load can be included in the feedback loop, to insure regulation at the remote terminals.

Voltage regulation generally includes some form of waveform distortion. Constant voltage transformers, Wanlass says, tend to produce a square-wave output, which is characterized by a flat output near the peak of the waveform. In contrast, the Wanlass transformer has a small dwell time around zero voltage, but is more sinusoidal over the remainder of the cycle. As a result the Wanlass transformer may be used to drive motor loads which are generally subject to overheating when fed by a square wave.

The regulators come in three lines:

- R-1000, a precision 0.1% line and load regulator with output filtering which reduces waveform distortion to 3%.

- R-2000, a 0.5% regulator which operates under varying line, load, and frequency conditions.

- R-3000, a 1% regulator which controls line fluctuations under rela-

tively fixed load conditions.

The difference in the three types is mainly in the sensors. Wanlass offers three kinds: root mean square, for most a-c applications, average, for a combination of a-c loads and d-c power supplies; and peak, for d-c power supplies with capacitive output filters.

Wanlass expects to use its variable inductor principle to make d-c power supplies, d-c to d-c converters and d-c to a-c inverters.

Specifications

Series	R-1000	R-2000	R-3000
Capacity (kva)	1-10	1.2-10	0.5-10
Frequency (cps)	50-60	50-60	50-60
Nominal input voltage	115	115	115
Line regulation in volts for ± 15 -volt input variation	± 0.1	± 0.5	± 1
Load regulation in volts from zero to full load	± 0.1	± 0.5	Fixed load operation
Response time (milliseconds)		30-100	
Remote sensing	Yes	Optional	No
Standard sensor	RMS	RMS	Peak
Price	\$375	\$100	\$49

Waveform filters, average sensors, line isolation and other options are available.

Wanlass Electric Company, 2189 South Grand Ave., Santa Ana, Calif.
Circle 350 on reader service card.

IMPROVED TONE!

in S&G "Building Block"
MODULTONE

for Remote Control or Monitoring
over Telephone Line, RF Carrier,
or any Two Wire System

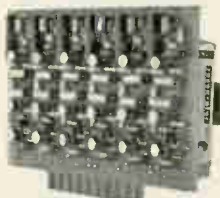

ENCODER

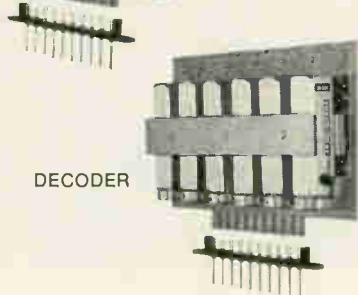

DECODER

Thanks to S&G Resonator[®] resonant reeds, these encoders and decoders have superior frequency stability . . . can control or monitor hundreds of functions—over ten simultaneously!

Printed circuit boards permit ease of maintenance and easy expansion . . . as simple as building with blocks. Because of the unique encoder design there need be no current drain in either unit in an un-activated condition. S&G's encoders will stabilize in less than 200 milliseconds after the application of power. Nominal decoder response is 100 milliseconds, so overall circuit response is only 300 milliseconds.

For low-cost, high quality, stable multi-tone modules insist on S&G Modultone.

WHY NOT WRITE US NOW
FOR DETAILS.

A RESONANT
REED PRODUCT
from the leader
in the resonant
reed field



ELECTRONICS
SARGENT & GREENLEAF, Inc.
ROCHESTER, NEW YORK 14621

New Components and Hardware

Tiny relay works fast and long



A solid state relay, said to be the smallest of its type available, provides high speed and reliable operation, according to Controlotron Corp., of Hicksville, N. Y. The relay, known as a series 500 is hermetically sealed in a standard MIL-R-5757D case, the size of a crystal can. The smallest unit is a bit over an inch high.

The relay has an operating speed of 1 microsecond and possesses the reliability inherent in silicon transistorized devices. Although not primarily intended for interchange with electromechanical relays, the series 500 offers in relay applications the advantages of long life and ability to meet military

environmental specifications.

Like its electromechanical counterpart, the solid state relay provides isolation between actuating and switching circuits. Models are available with actuating voltages from 1 to 70 d-c or 6.3 to 115 a-c. Since the relay does not exhibit a hysteresis effect, its pull-in and drop-out ratings are the same. Switching current ratings range from 1 to 15 amperes and the devices are available in spst, spdt and dpdt configurations.

Available as an option is protection against overvoltages, transients, and short circuits. The short-circuit protection feature requires no series element in the load circuit.

Specifications

Size	MIL-R-5757D crystal can
Operating speed	1 microsecond
Sensitivity	1 ma at 4 volts a-c minimum 10 millivolts d-c
Control ("coil") ratings	1, 6, 12, 26.5 and 70 volts d-c or 6.3, 28 and 115 volts a-c
Transistor switch ("contact") ratings	1, 3 and 15 amperes
Transistor switch configurations	Spst (normally open or normally closed), spdt or dpdt

Controlotron Corporation, P. O. Box 535, Hicksville, L.I., N.Y. [351]

Variable resistor fits in limited space

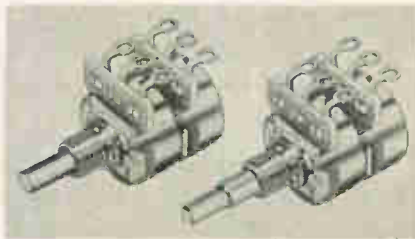

A 1/4-watt, 5/8-in.-diameter, series 200 variable resistor is now available in tandem construction with straight (type 2-200) or concentric

(type C2-200) shafts. In addition, newly designed solder lugs are now available on all 200 series controls.

The 200 can be furnished with rear-extended or conventional shafts in 0.125 in. or 0.156 in. diameter, with ear or bushing mounting, and with various associated switches when desired, and can be mounted with shaft perpendicular or parallel to the panel. Printed-circuit terminals and single construction are also available. The composition element has been proven in over one billion field applications. Resistance range is 200 ohms through 5.0 megohms.

Price in quantities of 3,000 to

CEC's VR-3600 establishes new record for head life

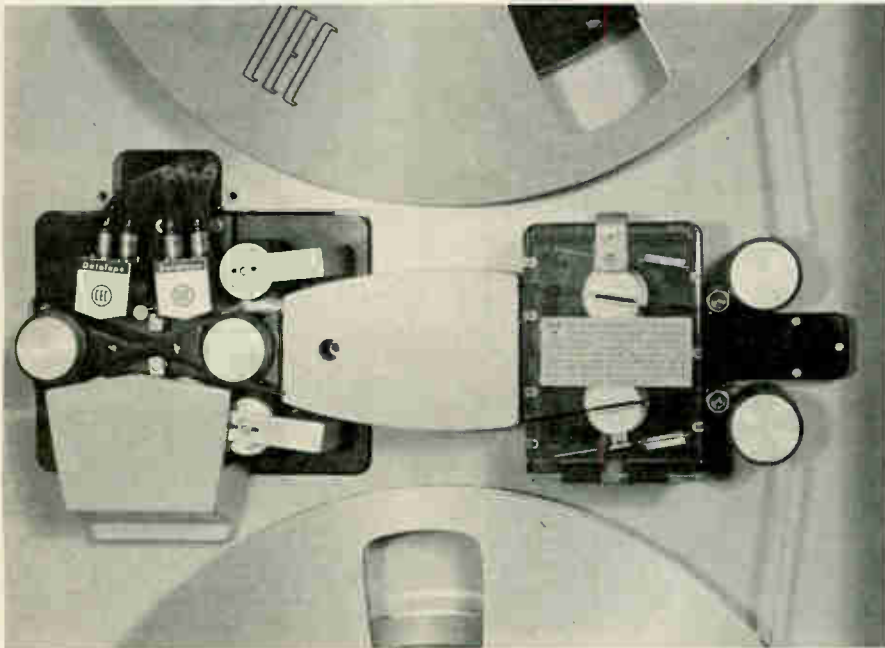

It is not news that the VR-3600 is the most advanced of all magnetic tape recorder/reproducers. This has been proved in countless telemetry and laboratory applications. But what *is* news, is the remarkable durability of the instrument's recording heads.

All reports have shown that CEC's head life guarantee of 1000 hours is not only realistic but very conservative, since in virtually every case the new recording heads have surpassed this figure with little sign of wear. Compare the 1000 hour achievement with the performance of the VR-3600's closest competitor, and the savings to the user become significant indeed.

Reason behind the performance: these CEC recording heads are of a unique material and solid metal pole-tip design which completely eliminates the weaknesses of conventional head lamination or other solid-tip designs.

Result: a head that both provides superior performance at frequencies to 1.5 mc and reduces head wear and cleaning to a minimum.

Other advantages of the VR-3600 include...

- 1** Bandwidth switchability. With a mere flick of a switch, the operator may instantly change from wideband to narrow band, and back again — thus doubling the unit's capability with *no change* of components required. (On special order.)
- 2** Constant flux recording for assured machine-to-machine compatibility at all frequencies and tape speeds (with IRIG standards).
- 3** Six speed switchable video FM — d-c to 500 kc.
- 4** Single source responsibility. All components are designed and manufactured by CEC... including the video FM!

Important features:

- ▣ Pushbutton selection of six transport speeds along with associated electronics.
- ▣ Each of the VR-3600's 7 or 14 record/reproduce channels can be used for data storage in the 400 cps to 1.5 mc or d-c to 500 kc frequency range.

- ▣ Automatic end-of-reel sensing stops tape without leaders; transfer switch provides start command for nearby recorder and 30 second overlap of recorded data between machines—at no extra cost.

- ▣ IRIG or 18.24 kc AM servo system or time expansion/contraction servo system using common assemblies mean low cost for any version or combination of servo systems.

- ▣ Tape is constantly cleaned by optional vacuum/ionization; tension controlled, in all modes, by closed-loop servo control.

- ▣ Individual plug-in equalizers (6 per amplifier) meet all specifications simultaneously. Buy only those required, then set and forget.

- ▣ Record and reproduce amplifiers are solid state; the direct system fully amplitude- and phase-equalized.

- ▣ Tape transport skew is less than 0.5 μ sec; complete cumulative flutter less than 0.30% p-p at 120 ips.

- ▣ The system may be supplied in single or dual rack configurations, with or without a dolly.

For all the facts about the VR-3600, call CEC or write for Bulletin 3600-X23.



CEC

Data Recorders Division

CONSOLIDATED ELECTRODYNAMICS

A SUBSIDIARY OF BELL & HOWELL/PASADENA, CALIF. 91109
INTERNATIONAL SUBSIDIARIES: WOKING, SURREY, ENGLAND
AND FRIEDBERG (HESSSEN), W. GERMANY

FREE

DRESSEN-BARNES
ALL SILICON
ULTRAMODULE
DC POWER SUPPLIES
(SEE OTHER SIDE FOR OTHER ULTRAMODULES)

DRESSEN-BARNES
100 N. VINEDO AVE. PASADENA, CALIFORNIA 91101

D/B **ELECTRONICS CORP.**
710 N. VINEDO AVE. PASADENA, CALIFORNIA 91101

NOTES

V I SPECIFICATIONS

Model	Output Voltage (V)	Output Current (mA)	Regulation (%)	Efficiency (%)	Temperature Range (°C)
15S	1.5	1000	±0.5	75	-55 to 125
20S	2.0	1000	±0.5	75	-55 to 125
30S	3.0	1000	±0.5	75	-55 to 125
41S	4.1	1000	±0.5	75	-55 to 125
51S	5.1	1000	±0.5	75	-55 to 125

1/3 ACTUAL SIZE

get this
ULTRAMODULE
DC power supply
circular slide rule
from

DRESSEN-BARNES ELECTRONICS CORP.

250 N. VINEDO AVE. / PASADENA, CALIF. / SEND CIRCULAR SLIDE RULE TO:

NAME	TITLE		
COMPANY	TELEPHONE		
STREET	CITY	STATE	
VOLTAGE RATINGS THAT INTEREST ME	V	V	V
CURRENT RATINGS THAT INTEREST ME	A	A	A
IMMEDIATE APPLICATIONS	V	A	A

Circle 203 on reader service card

NEW THERMOCOUPLE REFERENCES WITH 25 CHANNELS ONLY \$259.00!

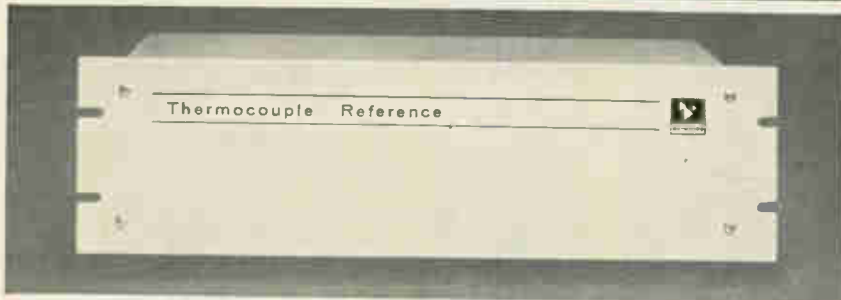

Now — ACROMAG Series 330 Thermocouple References with 25 channels of 0°C ice-point compensation for only \$259.00, including ALL 25 thermocouples! Uniformity 0.05°C, one-second warmup, easy to use. Ideal for scanned TC systems, DDC, and laboratory use. Series 340 References (150°F oven-type) with 25 channels for \$289.00! Both Series stocked in ISA Types, J, K, T, R & S. Others to order.

Request Technical Data 32

ACROMAG
INCORPORATED

15360 Telegraph Road • Detroit, Michigan 48239
Phone (313) 538-4242 • Teletype (313) 583-4536

Makers of Precision Instrumentation and Controls



New Components

9,999 is under 20¢ each for bush-mounted controls, and approximately 16¢ each for ear-mounted controls. Delivery is 3 to 6 weeks. CTS Corp., Elkhart, Ind. [352]

Thin, rectangular trimming pot



Model 58 is a thin, rectangular trimming potentiometer offered with either printed circuit pins or solder lugs. It is said to be the industry's only trimmer with a slim RJ12 style plastic housing and terminals staggered in RJ11 configuration. The unit is less than 0.200 in. thick and requires only two-thirds the board space of an RJ11 trimmer.

The new trimmer features a cermet resistance element with essentially infinite resolution and standard resistances from 10 ohms to 2 megohms. Power rating is 1 watt at 85°C, and the total operating temperature range is -65° to 175°C.

Helipot Division of Beckman Instruments, Inc., 2500 Harbor Blvd., Fullerton, Calif., 92634. [353]

Miniature switch is easy to disassemble

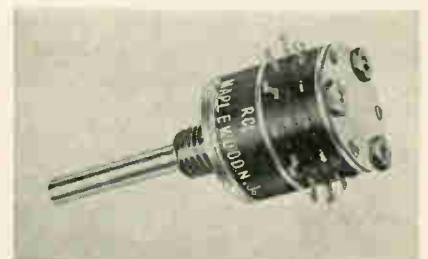

A half-inch rotary switch is being produced with a new "wire easy" construction. This construction al-

lows the operator to disassemble the switch at the work bench, facilitating wiring by allowing switch connections to be made on a flat surface, instead of in a hard-to-reach assembly, closely surrounded by other components. Disassembly is accomplished by removing only three units.

With up to 12 positions per deck, and as many as 6 poles per deck, shorting and nonshorting poles may be grouped on one deck, in any combination. Since all individual deck parts are self-contained, and are permanently molded into place, assembly is said to be fool-proof because decks cannot be assembled incorrectly. There are no loose parts to be misplaced or lost during reassembly.

Life expectancy of the switch is 200,000 operations. Contact resistance is an average of 0.0025 ohm, with a current-carrying capacity of 0.75 amp at 28 v d-c. A positive stainless-steel, roller-type detent snaps from position to position.

RCL Electronics, Inc., 2 Hixson Pl., Maplewood, N.J. [354]

Heat dissipator for semiconductors

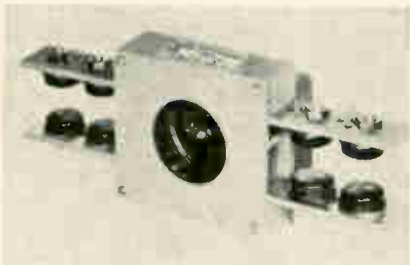

A forced-air heat dissipator is available for semiconductor cooling. The basic unit is 6½ in. long x 4¾ in. high x 4 in. wide and dissipates approximately 800 watts. The thermal resistance is approximately 0.25°C/watt. The unit mounts 12 semiconductors, more when stacked. It has a built-in heavy-duty blower and built-in air flow switches, and is thermostat-controlled.

Units may be modified to suit customers' specific needs. Delivery is 2 to 4 weeks. Price is approximately \$75, depending on customer specifications.

Vemaline Products Co., Franklin Lakes, N.J. [355]



NRC'S *new microcircuit Trump Card will suit your needs!*

If you can't afford to gamble on microcircuit performance and feel that you've been priced out of the **quality** high vacuum coater market, the NRC 3114 economy coater should be welcome news. Designed for general-purpose R & D thin film operations, the NRC 3114 incorporates many of the features of more sophisticated systems, such as the NRC 3176, with the rock-bottom price of a bargain-basement evaporator. The price is about \$3,000. Luxury features include **10⁻⁸ torr range blank-off**, a liquid nitrogen baffle, top-rated NRC 4-inch diffusion pump and the very latest in high vacuum gauge instrumentation — the log and linear-scaled NRC 720 ionization gauge control. Controls are conveniently grouped in an easy-to-read, one-position panel. The compact (31 by 33½") system also features a 5 cfm mechanical pump, an NRC 507 ionization gauge tube, two NRC-521 thermocouple gauge tubes, a raised baseplate with bell jar, guard and gasket. Complete accessibility for routine maintenance is provided through the removable panels on all four sides. For detailed information on our complete line of evaporators and associated equipment for microelectronics, write or call today.

EVAPORATORS • PUMPING STATIONS • POWER SUPPLIES
FEEDTHROUGHS • CRYSTAL PULLERS • TUBULAR FURNACES
ELECTRON BEAM HEAT SOURCES • LEAK DETECTORS



EQUIPMENT DIVISION
NATIONAL RESEARCH CORPORATION

A SUBSIDIARY OF NORTON COMPANY

160 Charlemont Street, Newton, Massachusetts 02161



Now twice as many



Couch 0.1 oz. rotary relays

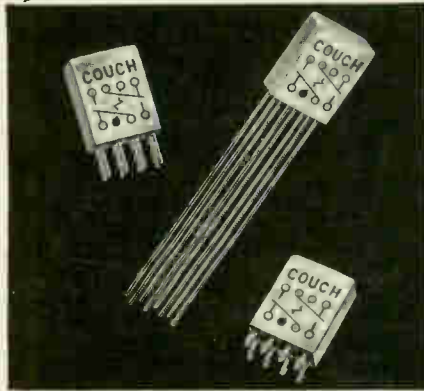

each available in
3 terminal styles . . .

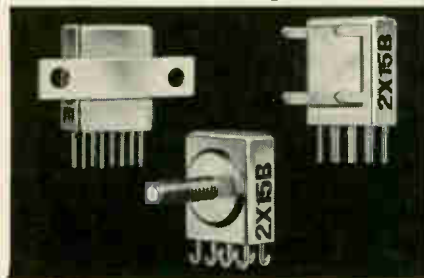

and in many mounting styles

We now offer a full line of SPDT relays, type 1X, to match our DPDT, type 2X, relay line. Except for coil data, specifications are identical for both types:

	2X	1X
Size	0.2" x .4" x .5"	same
Terminal Spacing	1/10" grid	same
Rating	0.5 amp @ 30 VDC	same
Coil Operating Power	150 mw	70 mw
Coil Resistance	60 to 4000 ohms	125 to 4000 ohms
Temperature	-65°C to +125°C	same
Vibration	20 G	same
Shock	75 G	same

Write for Data Sheets No. 9 and 10

RUGGED ROTARY RELAYS  Dynamically and Statically Balanced

COUCH ORDNANCE INC.

3 Arlington Street, North Quincy 71, Mass., Area Code 617, CYPRESS 8-4147 A subsidiary of S. H. COUCH COMPANY, INC

New Semiconductors

Scr handles 1,800 volts

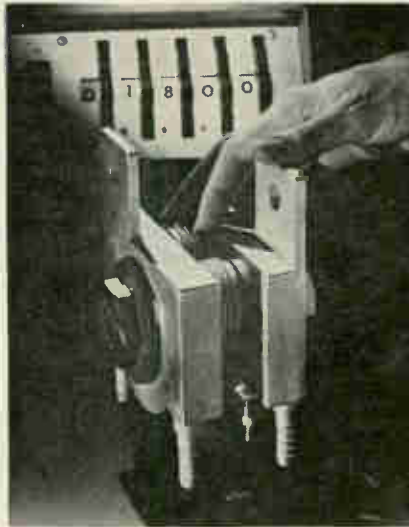

A silicon controlled rectifier, capable of switching up to 1,800 volts and high currents, is available from the General Electric Co. Until now, such switching required using several units strung in series. GE's new unit, containing a pair of water-cooled scr's mounted between two heat sinks, dramatically increases the power-handling capacity of solid-state switches by incorporating extra-large silicon pellets in a configuration that permits cooling on both sides of the pellet, thus preventing thermal fatigue.

The unit, which does not yet have a GE type number, can handle up to 1,800 volts, 1,200 amperes root mean square of continuous current and permits switching of 1.5-megawatt loads.

One advantage of the new unit: it can be operated directly from a-c distribution lines, such as the 480-volt and 550-volt lines now becoming more popular for powering heavy industrial equipment. It can also be used in 600-volt, d-c motor controls, battery-charging equipment, welding controls, high-power plating power supplies, and industrial lighting controls.

To achieve the high-voltage capabilities of the new device, GE increased the pellet size of its 1,200-volt, 470-ampere scr by 55%, and altered the pellet geometry.

GE plans to bring out an air-cooled version of the 1,800-volt

unit during 1966. The present water-cooled assembly measures six inches square and five inches deep.

The units are being produced at GE's Philadelphia facility. The company will begin delivering samples during the first quarter of 1966. Prices have not been set yet but a company spokesman said the initial price will probably be around \$500.

Specifications

Blocking voltage	1,800 volts
Surge current	7,000 amperes
Rms continuous current	1,200 amperes
Thermal resistance, junction to water	0.11° C/watt
Water flow	2 gallons per minute
Availability	90 days
General Electric Co., Auburn, N. Y. [371]	

Operational amplifier offers high gain

The μ A709 monolithic operational amplifier is designed for use as a general purpose amplifier in d-c servo systems, high-impedance analog computers, and low-level instrumentation applications, and for the generation of special linear and nonlinear functions.

The new circuit, which uses non-Darlington input to achieve low offset and to minimize thermal drift, offers performance comparable to the best discrete component designs; it is exceptionally stable over the full military temperature range. It is constructed using the standard patented Planar epitaxial process.

The μ A709 features a voltage gain of 45,000, an output swing of ± 14 v, and an input voltage common mode range of ± 10 v. Other features include an offset voltage of 1 mv, power consumption of 80 mw, and thermal drift of $3 \mu\text{v}/^\circ\text{C}$. The unit is guaranteed over the full military temperature range of -55° to $+125^\circ\text{C}$.

Prices are \$50 for 100 to 999; \$60 for 25 to 99; \$75 for 1 to 24.

Fairchild Semiconductor, a division of Fairchild Camera and Instrument Corp., 313 Fairchild Dr., Mountain View, Calif. [372]

Versatility



ANYTHING YOU CAN PUT ON FILM
YOU CAN DISPLAY ON IEE READOUTS
(EVEN COLORS!)

NUMBERS, LETTERS, WORDS, SYMBOLS, COLORS!
There is literally no limit to the display versatility of IEE readouts. As rear-projectors, they operate by back-lighting display symbols arranged on film and projecting the selected message on a non-glare viewing screen.
VERSATILITY OF SIZES, TOO! Five sizes with maximum character heights of $\frac{3}{8}$ ", $\frac{1}{2}$ ", 1", 2", 3 $\frac{1}{2}$ ".

SEND TODAY FOR COMPLETE INFORMATION!

INDUSTRIAL ELECTRONIC ENGINEERS, INC.

7720 Lemona Avenue • Van Nuys, California
Phone: (213) 787-0311 • TWX (213) 781-8115



Representatives in Principal Cities

Circle 204 on reader service card

USE
ZIP CODE
NUMBERS
IN ALL ADDRESSES

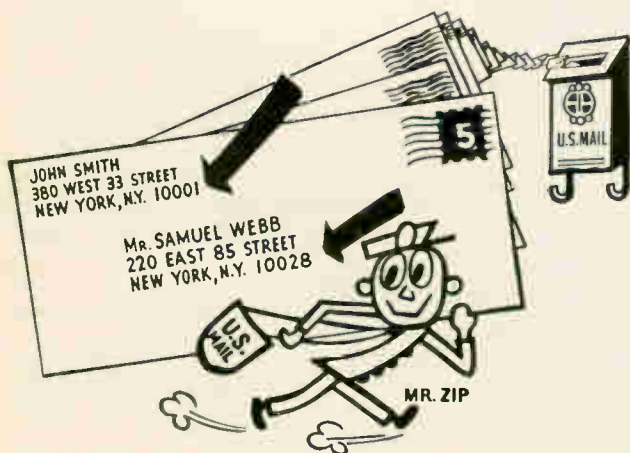

MANUAL Switching Simplified

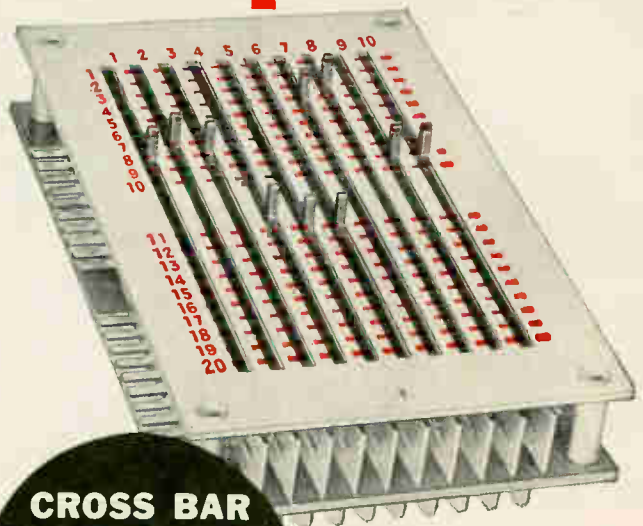

**CROSS BAR
TYPE
SELECTOR
SWITCH**

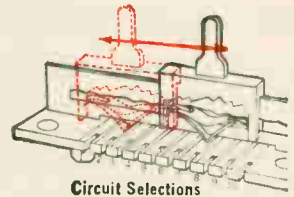

Circuit Selections

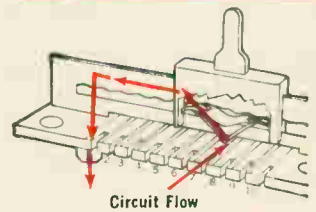

Circuit Flow

Ideal for:

- PROGRAMMING
- SELECTING
- CONNECTING

Programming repetitive data in computers.

Selecting different power supplies or resistance values in test equipment.

Connecting large groups of inputs into relatively few outputs in programming.

Electrical capacity:

1. Current carrying only (no make or break) 3 amp 125 V AC or DC
2. Make or break 1 amp 15 V DC, 150 m.a. 125 V AC



The complete snap-action switch line!



Cherry Electrical Products Corporation

P. O. Box 437-12 — Highland Park, Ill.

IN CANADA: BARRY ELECTRIC, LTD., REXDALE, ONT.

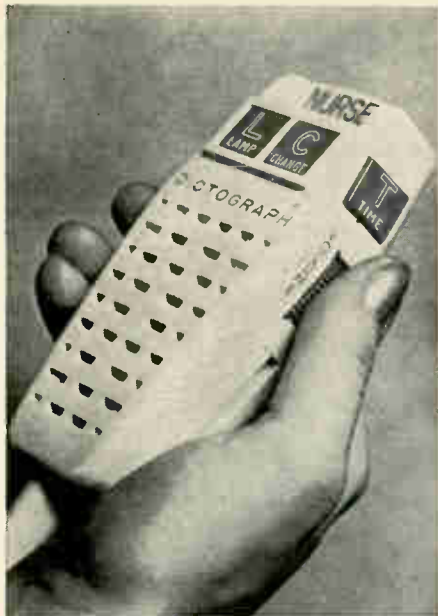

Polycarbafil housing for Dictograph speaker is injection molded by Waterbury Co., Randolph, Vt. Nylafil switch housing, push-buttons and volume control wheel are molded by Hinchman Mfg. Co., Inc., Roselle, N. J.

Polycarbafil® has toughness needed for new hospital speaker

Impact strength important in speaker for hospital patients

The pillow speaker for individual hospital patients made by Dictograph Products, Danbury, Conn., must be able to withstand accidental dropping on the floor. Dictograph looked for a material that would have the impact resistance and toughness for this, plus rigidity, dimensional stability and low coefficient of thermal expansion. They chose Polycarbafil, fiberglass reinforced polycarbonate. Fiberglass reinforcement increases all of these properties.

In addition, Nylafil, fiberglass reinforced nylon, was chosen for push-buttons, volume control wheel and switch housing for its strength and wear resistance.

Compare Physical Properties

Property	Unit	Unreinforced Polycarbonate	Polycarbafil G-50/20
Tensile Strength @ 73°F	PSI	8,000	18,500
Flexural Strength @ 73°F	PSI	13,500	25,000
Coef. Linear Thermal Expansion / °F.	In./In.	1.0x10 ⁻⁵	1.02x10 ⁻⁵
Heat Distortion Temp. @ 66 PSI	°F	285	308
Water Absorption 24 hrs.	%	0.15	0.11

Polycarbafil and Nylafil are only two of the full line of fiberglass reinforced thermoplastics pioneered and patented by Fiberfil. Only Fiberfil can give you complete technical data, practical experience and a full line of reinforced materials. Send for your free copy of the FRTP engineering manual. Fiberfil, Inc., Evansville, Indiana 47717.

FIBERFIL

Fiberglass Reinforced Thermoplastics®

New Instruments

Phasemeter 98% accurate costs \$998

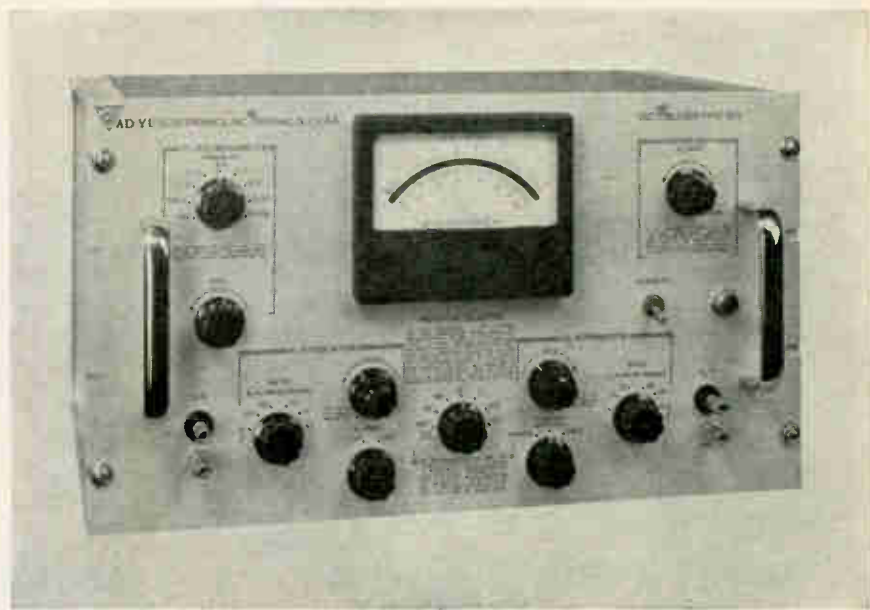

A phasemeter that is said to be the most accurate and sensitive in the moderate price range has been introduced by Ad-Yu Electronics, Inc. The instrument measures the phase relationship of two voltages.

The Model 203 Vectorlyzer has an accuracy of $\pm 0.004^\circ$, or $\pm 2\%$ of full scale, at any range from 50 cps to 20 kc, and its lowest full scale range is 0.1° , which gives the best resolution in any phasemeter.

Its price—\$998—is about one-half that of other instruments of comparable performance, according to Paul Yu, president of Ad-Yu.

Input to the Vectorlyzer may be two voltages whose phase relationships are unknown, or one input may be a precisely established phase reference. The circuit is designed so that when the magnitudes of the two input voltages are made equal, the output of the circuit is directly proportional to the sine of the angle between the two inputs. This technique reduces the complexity of the circuitry required, and results in lower cost.

The inputs to the Vectorlyzer are applied one at a time. A rough adjustment of each is first made with a step attenuator, and the final adjustment with a continuously variable attenuator. The magnitude

of the first signal is varied until the output meter reads full scale. The second signal is then applied and its magnitude adjusted until the meter reading is nulled. The meter is then switched to lower ranges until the operator achieves the desired resolution, and the phase-angle difference read directly from the output meter. A rectifier bridge circuit is the phase difference detector. Cathode followers in each signal channel provide impedance matching between the signal sources and the attenuator circuits.

Since the instrument was designed to measure small phase-angle differences, differential amplifiers are used to provide high gain. Further signal clarity is achieved by including an adjustable bandpass filter to isolate harmonics and noise.

The range scale may be extended from 180° to 360° by an additional control on the front

Specifications

Frequency range	50 cps to 20 kc
Full scale deflection	Seven ranges: 0.1° , 0.2° , 1° , 2° , 10° , 20° and 180° (180° switch adds 180° to above scales for angles to 360°)
Accuracy	$\pm 0.004^\circ$ or $\pm 2\%$ of full scale on any range
Input impedance	20 pf in parallel with 1 megohm

panel. Another feature allows the operator to determine whether the phase relationship between the two signals is leading or lagging. Ad-Yu Electronics, Inc., 249-259 Terhune Ave., Passaic, N.J. [381]

Frequency meter gives readings to 225 Mc

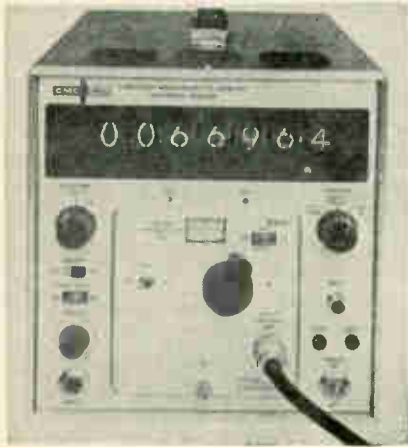

A frequency meter using silicon semiconductors provides direct readings to 225 Mc. The half-rack model 616A is designed for rugged field use and is operative at temperature ranges of -20° to $\pm 65^{\circ}$ C. It is especially valuable for communication-system trouble shooting and calibration.

The instrument measures frequency directly from 10 cps to 10 Mc. A direct reading up to 225 Mc can be achieved by prescaling the input signal. An optional frequency converter plug-in, model 634D, provides increased frequency measurement range through 322 Gc by use of heterodyne techniques. Additional plug-in units are being planned to increase frequency measurements to 12 Gc.

Measurements are displayed on a 7-decade in-line readout, with an eighth decade optionally available. Automatic decimal point and memory are standard.

Model 616A is designed to be compatible with the company's model 410A printer through the installation of an optional data output connector. The 616A and 634D are available at a price without optional equipment of \$2,185 and \$825 respectively.

Computer Measurements Co., 12970 Bradley Ave., San Fernando, Calif., 91342. [382]

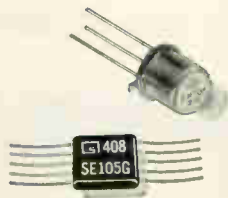

Need to say a lot
in a **little space?**

(or make markings
more **durable**...or
more **economical**...
or at **higher rates**?)

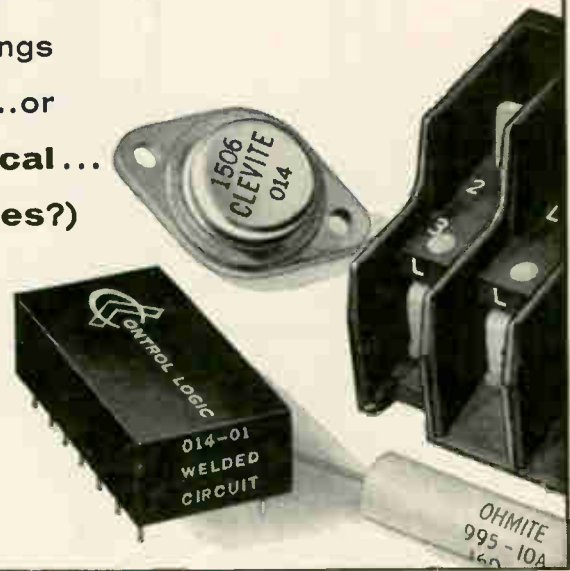

We can show you how

We can show you how to identify products so they will resist extreme amounts of handling, abrasion, many solvents and other atmospheric conditions . . . or how to sequentially number and identify components with savings of more than \$50 per 1000 . . . or how to print trademark, type number, value and date code on 90 units a minute . . . or how to produce an imprint that remains readable after 1000 hours at 200° C. . . or get 10 digits and 2 letters in a micro-circuit area of 0.090" — or 21 characters on a TO-5 case with interchangeable type number and date code . . . or save 75 cents of every dollar you now spend on buying, applying, inventorying and discarding obsolete preprinted labels.

The answers are in proven Markem machines, type and specialty inks, which daily produce better product or package identification by reducing costs, smoothing production control and increasing customer acceptance. And while Markem machines, type and inks are helping to produce better products through more complete and lasting identification, they frequently pay for themselves in the savings they make possible. Tell us what *you* make, what it must say, and for how long: we'll give you a specific recommendation and cost estimate right away. Write Electrical Division, Markem Machine Co., 305 Congress St., Keene, New Hampshire 03431.

MARKEM

Vector Solid State Laboratories

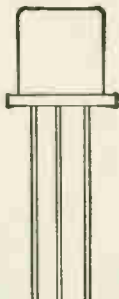

2N3866

- NPN silicon transistor designed for high-level broad-band VHF-UHF amplification
- f_T to 1000 mc measured at 15 V, 50mA
- Economical
- Can be supplied in a variety of cases
- Available in production quantities

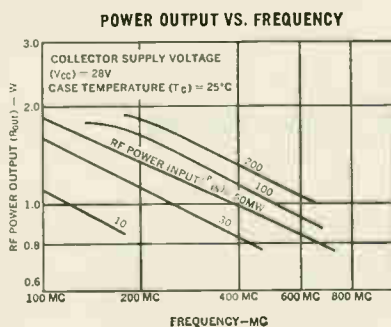

Contact your local representative for data sheets, price and delivery or phone Vector Solid State Laboratories (215) EL 7-7600

Vector

U
A
DIVISION OF UNITED AIRCRAFT CORPORATION

SOUTHAMPTON, PENNSYLVANIA

New Subassemblies and Systems

Printer is simpler, costs less



Mechanical printers are usually very complex, and consequently very expensive. The Potter Instrument Co. says its Model 3502 is fast, reliable, and low in cost because of simple design. It sells for one-quarter to one-sixth the price of other printers running at similar speeds.

Among the fastest impact printers on the market (excluding electrostatic and photographic units) are several models in which the type slugs are mounted on an endless chain running past the surface of the paper. These printers have a hammer for each position to be printed across the paper—usually between 100 and 150 positions. Each hammer strikes the rear of the paper just as the slug bearing the character to be printed passes on the other side. The need for each hammer to strike quickly and at exactly the right moment, so the moving slug will not blur or smudge, requires complex mechanical and electronic design.

Engineers at Potter say they have solved this problem using only 90 mechanical parts and 110 electronic parts. There are only half as many hammers as positions in the printed line; each hammer spans two print positions. The type slugs on the chain are arranged so that there is never more than one slug opposite a hammer.

The "chain" is a neoprene-nylon

belt of the type used as timing belts in some new automobile engines; these belts are so tough that the pulleys wear out first. The metal type slugs are attached to the belt.

The normal alphabet, or font, holds four sets of 48 characters each, arranged around the length of the chain. Chains are also available at lower speeds, two 96-character fonts or one 192-character font.

The printer can be equipped with a line buffer. Without the buffer, the computer must retain the data to be printed, and cannot continue with its program until the line has been printed. With the line buffer, the computer can store a whole line at electronic speeds, and continue the program while the printer works.

The line buffer, and the timing logic that continually compares the characters on the chain to the characters that are to be printed, are built wholly of integrated circuits—another reduction in cost and complexity.

The Model 3502 is Potter's first attempt to market a purely commercial printer; their printers have been used by the military, notably in Polaris submarines.

Specifications

Printing speed	600 lines per minute (48-character font) 190 lines per minute (192-character font)
Printing format	6 lines per inch vertical 10 characters per inch horizontal
Line length	128 characters maximum
Transfer rate to buffer	250,000 characters per second
Characters on chain	4 fonts of 48 characters 2 fonts of 96 characters 1 font of 192 characters
Paper speed	17½ inches per second
Price	\$5,800 basic \$12,140 with line buffer

Potter Instrument Co., 151 Sunnyside Blvd., Plainview, N. Y. [401]

Epoxy-encapsulated FET amplifiers

Two new all-silicon, epoxy-encapsulated operational amplifiers exhibit ultrahigh input impedance.

Models 1553 and 1953, which use field-effect input transistors, feature 10^{12} ohms input impedance and 100-kc bandwidth at the rated output of ± 10 v at 20 ma.

Other specifications include a gain of 106 db and a small signal bandwidth of 1.5 Mc. The 1953 measures only 1.2 x 1.8 x 0.6 in. Unit prices are: 1553, \$165; 1953, \$185.

Burr-Brown Research Corp., Box 11400, Tucson, Ariz. [402]

Shift register module is a 4-bit unit

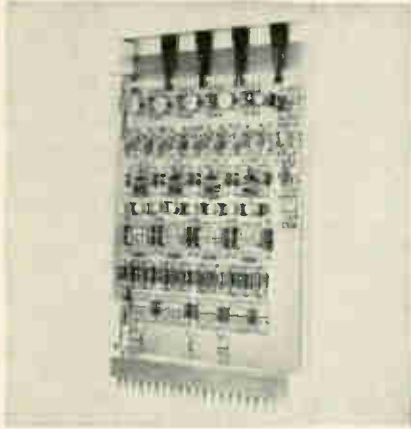

Model 08 shift register module is one of a complete new line of 1-Mc system logic functions, available in both germanium and silicon versions. It is a complete 4-bit shift register, designed for parallel-to-serial and serial-to-parallel conversions. Pedestal gates are provided for transferring data into the register, and each flip-flop has its own neon indicator for readout of the data, for checkout purposes.

The modules can be cascaded to form shift registers of any length. The shift input has its own pedestal gated amplifier to simplify control of the shift operation and to provide minimum loading on the shift command. Inputs to a master reset bus are provided in both d-c and pedestal gated forms.

A clamp voltage supply is incorporated on the module to supply the necessary clamp voltage on the flip-flops. The presence of this supply on the card itself eliminates the problem of susceptibility of a flip-flop to noise on a clamp supply bus.

Price is \$103; delivery from stock. Navigation Computer Corp., Valley Forge Industrial Park, Norristown, Pa. [403]

For precise temperature testing from -300°F to $+525^{\circ}\text{F}$

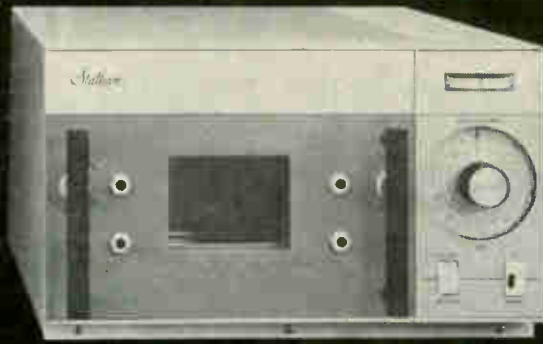

STATHAM MODELS SD6 AND SD3 ARE 700 CU. IN. CAPACITY CHAMBERS FEATURING $\pm \frac{1}{4}^{\circ}\text{F}$ CONTROL ACCURACY

Designed for precise temperature testing of electronic components, Statham Models SD6 and SD3 chambers feature true proportional control of heater power by all solid-state circuitry.

This new generation of test chambers eliminates the conventional heater power relay, prevents cycling about the control point, and substantially *reduces* RFI noise.

The controller maintains a set-point temperature within $.01^{\circ}\text{F}$ per $^{\circ}\text{F}$ ambient. An improved controller design provides excellent temperature uniformity with gradients of $\pm 1.3^{\circ}\text{F}$ at 300°F .

SUPERIOR TEMPERATURE CONTROL



24 Inch Dial Control

Models SD6 and SD3 feature 24 lineal inches of calibrated set-point scale. Temperature readout is obtained by a deviation meter calibrated in one-degree increments. This expanded scale approach provides a level of accuracy and readability not attainable in conventional chambers.

Optional Push-Button Control

Frequently repeated temperature settings can be made faster and more accurately with Statham's *push-button* temperature selection control. The buttons, which may be set at any desired temperature, provide precise repeatability.



Cycle Time Controller

Statham cycle time controllers permit programming the chambers in any required sequence of hot-ambient-cold-ambient, etc.



Statham Instruments, Inc.
Environmental Products Division
2221 Statham Blvd., Oxnard, Calif.
HUnter 6-8386 (Area Code 805)

Write for Statham's new
12-page Temperature Test
Chamber Brochure.

ARE YOU YOUR OWN COMPUTER?



Rules of three, percentages, multiplications, divisions, currency conversions... with its circular slide-rule, the Chronomat calculates them all!

This amazing chronograph is very much more than simply a high-precision timepiece. It is a working tool indispensable to your profession, to your technical studies, to your hobbies. It is made by Breitling of Geneva.

For my information, please send me, free:

- the amazing world of chronographs
- the special catalogue of Breitling models (Mark a cross where applicable)

Name: _____ First name: _____

Profession: _____

City: _____ State: _____

E1

Breitling-Wakmann
15 West 47th street, New York 36 N.Y.

New Microwave

2-Gc extender is YIG-tuned



A frequency extender that allows receivers to operate in the 1-to-2 gigacycle range for radio-frequency surveillance, telemetry, or radio-frequency interference measurements has been developed by Communication Electronics, Inc. Designated FE-1-2A, it converts the input r-f to a 160-megacycle intermediate frequency. The extender was developed for military applications and is now the only one commercially available at frequencies above 1 gigacycle, according to the company.

The FE-1-2A has a four-section YIG (yttrium iron garnet) preselector that makes it electronically tunable over the frequency range; it is not mechanically tuned. The preselector design also reduces unwanted radiation from the local oscillator back to the antenna to less than 75 microvolts.

The tuning frequency is critically dependent on the regulation of the power supply. So, the power supply was designed to have a total noise and ripple voltage less than 1 microvolt.

The noise figure throughout most of the r-f range is 16 decibels; in the upper 11% of the r-f range, it rises to 18 decibels.

Except for the ceramic triode in the stable local oscillator, all other active devices are solid state. As a result, the FE-1-2A is compact—requiring only 3.5 inches of rack space—and consumes only 25 watts.

On special order, the FE-1-2A can be built to convert to a 24.1 megacycle i-f, instead of 160 Mc. Price is \$4,000; delivery within

45 days after receipt of order.

Specifications

Image rejection	70 decibels minimum
I-f stability	50 parts per million per °C
Operating voltage and frequency	115 volts, 50 to 400 cps
Weight	20 pounds
Front-end bandwidth	8 megacycles

Communication Electronics, Inc., 6006 Executive Blvd., Rockville, Md. [421]

Coaxial magnetrons operate at Ku-band



A line of light-weight, coaxial magnetrons is announced for operation at Ku-band. The units—the QKH-1302, 1325, and 1368—are designed for airborne radar applications requiring high efficiency, frequency stability, and small size. They will meet the most rigorous airborne environment conditions.

The QKH 1302 is tuned mechanically over the 16.6- to 17.1-Gc frequency range. The QKH1325 operates at a fixed frequency of 16.5 Gc, and the QKH1368 at a fixed frequency of 17.2 Gc. Peak output power for the QKH1325 is 65 kw; for the other two units, 35 kw.

These coaxial magnetrons have

integral stabilizing cavities incorporated in the resonant structure of the tubes. This design is responsible for lower push-pull figures, longer tube life, and higher reliability than in conventional magnetrons.

Raytheon Co., Microwave & Power Tube division, Foundry Ave., Waltham, Mass. [422]

X-band oscillator uses silicon diode

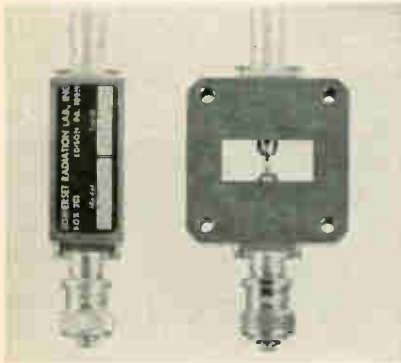

A planar epitaxial silicon diode produces strong oscillations at X-band in the model X910 oscillator. Output in X-band is obtained with a back bias voltage of 80 v and a reverse current of 4 to 7 ma. The bias supply is pulsed to produce a steady shf output that permits making ordinary laboratory frequency and power measurements.

Model X910 oscillator consists of a silicon diode mounted in a short section of X-band waveguide. BNC receptacles at both ends of the diode and waveguide matching assembly allow an external bias load resistor to be conveniently connected. Either polarity of the diode can be selected, depending on the polarity of the available power supply. Operational data and test setup instructions are included with each unit.

Power output is typically -25 dbm at 9.0 Gc; bias voltage, 80 v maximum pulsed at 1,000 pulses per sec; reverse bias current, 8 ma maximum; maximum diode power consumption, 500 mw; waveguide, 0.900 x 0.400 i-d (8.2-12.4 Gc); waveguide length, 0.75 in.; weight, 4 oz.

Price of the model X910 is \$80; delivery, from stock. Somerset Radiation Laboratory, Inc., P.O. Box 201, Edison, Pa. [423]

LATEST

BENDIX-PACIFIC

Telemetry Discriminator

MODEL
TDA-410



All solid state... Optimum performance... High reliability

With a straightforward phase lock loop circuit design, Model TDA-410 offers excellent performance, reliability and maintainability, at low cost. The basic circuitry, used extensively in the successful TDA-300 series, has been further refined to take advantage of silicon semiconductors for greatest reliability.

175 ma. of output current at ± 1 to ± 10 volts with short circuit protection and output current limiting are but a few of the discriminator's many advanced features.

The minimum size of Model TDA-410 permits mounting 6 discriminators, together with power supply and meter unit, in a rack only 5¼" high x 19" wide x 20½" deep as illustrated.

Bendix-Pacific engineers are available for application assistance on Model TDA-410 and other telemetry. Please write Bendix-Pacific, North Hollywood, California.

Pacific Division



TRANSFORMER ELECTRONICS COMPANY

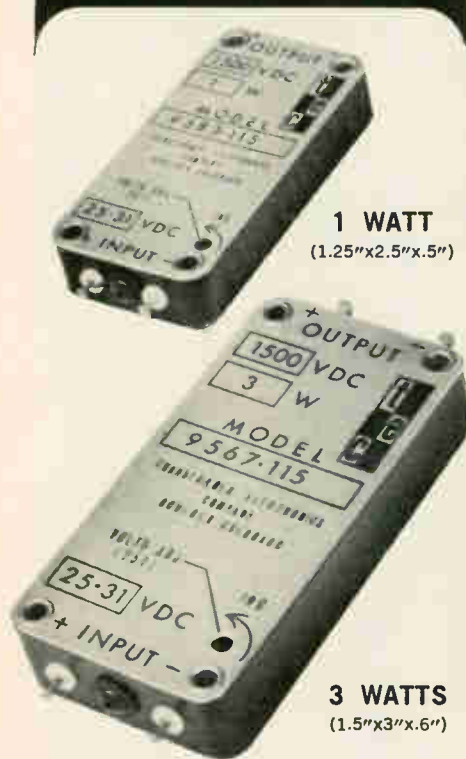

MINIATURE REGULATED POWER SUPPLIES

Cost-Performance Optimized
Reduces System Design Effort
Meets Extreme Environments

9583 SERIES

1 Watt output power capability
18 models—3 vdc to 3000 vdc
25-31 vdc input

9567 SERIES

3 watt output power capability
24 models—3 vdc to 5000 vdc
25-31 vdc input



**TRANSFORMER
ELECTRONICS
COMPANY**

BOULDER INDUSTRIAL PARK
BOULDER, COLORADO

TWX 303 443-2561 PHONE (303) 442-3837

POWER SUPPLIES • INVERTERS
CONVERTERS • TRANSFORMERS

New Production Equipment

High-temperature vacuum furnace



A high-temperature vacuum furnace called HotVac has been introduced for small-scale production and development processing at temperatures up to 4,000°F. Applications include sintering tantalum capacitors, carbides, nitrides and borides; heat treating of refractory and reactive metals; homogenizing refractory alloys; diffusion bonding; emissivity studies; thermocouple calibration; and high-temperature environmental testing.

Features included in the series 3400 model 612 HotVac are said to be those most often specified by users. A heating element measuring 6 in. i.d. by 12 in. high is of expanded tantalum mesh, providing 340 cu in. of loading volume. A balanced, 3-phase input power supply provides 30 kva output, stepless, controlled by a saturable core reactor. The 100% stainless steel, full-opening, double-wall chamber is electropolished for operation at hard vacuum levels. The pumping system, which uses full-bore manifolding to match the 7-in.-i.d., 1500-liter/sec diffusion pump, employs a gate valve with chevron multi-coolant baffle and bellows-sealed roughing and fore-line valves. When specified with

Viton seals, available at no extra cost, the furnace will perform in the 10^{-8} torr range.

The furnace is priced below \$12,000 complete, including demonstration and certified performance test data.

Vacuum Industries, Inc., 34 Linden St., Somerville, Mass., 02143. [451]

Thermal wire stripper produces clean cut

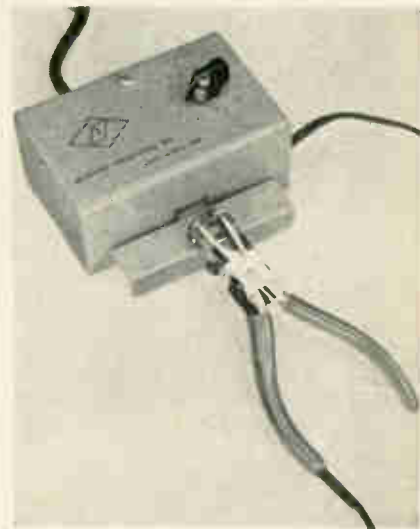

Model PM1056D thermal wire stripper features the "no nicking" patented action that allows the operator to sever, strip and remove the insulation slug from the wire in one combined operation. Recent improvements in the special alloy heater wires reduces build-up of carbon deposits and produces an exceptionally clean cut. All thermoplastic insulations, including Teflon, DuPont H Film and Raychem No. 44, are handled with the same tool.

The PM1056D is particularly useful for coaxial cable. The fine heater wire eliminates high-potential test rejections between the conductor and shielding of the co-ax since it is virtually impossible to overheat the shield in normal operation.

New cushion-grip, non-slip plastic handles have been added for additional operator comfort and convenience. The Teflon-covered guide guard provides maximum protection against scratching of the

stripped bare wire as it is withdrawn from the stripper. The guide also prevents accidental burns to insulation of adjacent wires, and offers additional safety to the operator.

Pioneer Magnetics, Inc., 1745 Berkeley St., Santa Monica, Calif., 90404. [452]

Lab instrument slices and dices crystals

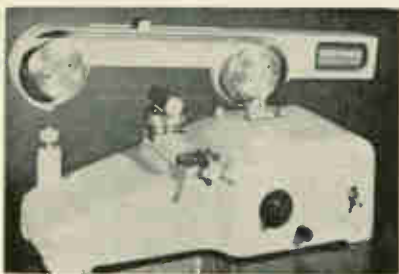

A crystal slicing and dicing instrument is announced for pilot-plant work and laboratories. Model 5D-12 will slice and dice a variety of crystals including silicon, quartz, indium antimonide, gallium arsenide, barium titanate and germanium. It slices from 0.006 in. thick with no more loss than a 0.006-in. kerf per cut.

The instrument employs an endless wire blade within an abrasive slurry, which laps its way through the crystals. The cutting arm maintains a perfect balance and is equipped with adjustment of cutting pressure. Due to the use of the abrasive slurry, the finished wafers are exceptionally smooth and uniform.

Dicing is easily accomplished on the mounting table, which rotates a full 360°. A wafer is mounted and cut in one direction and then rotated 90° to complete the dicing operation.

Motor, speed control and splash guard are integral parts of this compact instrument. It is supplied with calibrated indexing on the work station, variable blade speed, interchangeable mounting plates and calibrated cutting pressure. The unit is finished in enameled aluminum and measures 10 in. high x 22 in. long x 9½ in. deep. It weighs 25 lb and the power supply is 110 v a-c.

Evans Equipment Co., Pleasant Rise, Brookfield, Conn., 06804. [453]

if

you're an Electronic Engineer specializing in micro-electronic circuits, then you will gain by coming to Douglas.

We're looking for Electronic Engineers with specialized background in circuit design. We're especially eager

to find men with automatic-pilot control hardware experience. We also have openings for men with microwave experience.

If these advanced programs interest you, and if you hold a BSEE or Master's degree with two to five years experience, then send your resume in confidence to B. P. MacDonald, Douglas Missile and Space Systems Division, 2700 Ocean Park Boulevard, Santa Monica, California.

An equal opportunity employer

DOUGLAS

MISSILE AND SPACE SYSTEMS DIVISION

IN
ELECTRONICS

BIG THINGS ARE HAPPENING

At

LOCKHEED-GEORGIA

*Openings at all technical levels in
these areas of*

ELECTRONIC SYSTEMS ENGINEERING

Systems Analysis, Design, and
Integration . . .
Command and Control . . .
Radar Theory . . .
Surveillance Systems . . .
Data Processing . . .
Displays . . .
Simulation . . .
Communications . . .
Navigation Electromagnetic
Compatibility . . .
Antennas . . .
Circuit Design . . .
Aircraft Instruments . . .
Electrical Power Systems . . .

You and your family will like living and working in the growing metropolitan Atlanta area with its pleasant climate and many cultural and recreational advantages.

Send resume to: CHARLES E. STORM, Professional Employment Manager, Lockheed-Georgia Company, 834 West Peachtree Street, Atlanta, Georgia 30308, ZZZ-88

LOCKHEED-GEORGIA COMPANY

A Division of Lockheed
Aircraft Corporation

An equal opportunity employer

New Books

Heat dissipation

Cooling Electronic Equipment
Allan D. Kraus
Prentice-Hall, Inc., 390 pp., \$16

Cooling electronic equipment successfully requires understanding of basic principals of conduction, convection, and radiation. Kraus deals nicely with these fundamentals and goes on to describe their application in the design of extended surfaces and heat exchangers.

The book adequately covers most aspects of thermal design. However, some chapters lack thorough handling and concise presentation. The work-sheet approach, though effective in describing the particular solutions presented, fails to provide the designer with guidelines applicable to a variety of systems. There is also one striking deficiency: physical data and heat-transfer parameters are not presented.

However, the over-all treatment of cooling methods is good. Equipment designers will appreciate the chapter on network analogy: analogies between the concepts of heat transfer and the principles of circuit analysis familiar to the electrical engineer are emphasized. This chapter also should help clarify, for those with an electrical background, the mechanisms of effective heat transfer.

Kraus starts with an explanation of the basic modes of heat transfer; he puts sufficient emphasis on fundamentals so that a reader with only a modest understanding of the subject will be informed. The ensuing development is sufficiently detailed and logical so that the practicing engineer should have no trouble following it.

The chapters on extended surfaces and component cooling are important to those directly involved in cooling electronic equipment. The illustrations point up applications of the basic principles of the preceding sections. The author describes most of the classic solutions for extended surfaces of various cross sections and offers a mathematical formulation of the optimum physical dimensions of the more common profiles.

He considers the primary mechanisms involved in cooling transistors, vacuum tubes, and microwave components. Although the chapter on change-of-phase cooling does not go into great detail, the information is more than sufficient to stimulate the thermal designer to consider the use of this often-disregarded mechanism.

Other well-presented topics include discussions of thermoelectric coolers, cold plates, and thermal considerations in design of space vehicles. The importance of the various techniques are summarized and some of the advantages and disadvantages are considered in the chapter on system optimization and trade-offs. This is worthwhile for those involved in optimizing payloads in terms of weight, efficiency, or some other particularly critical parameter.

The book also contains an excellent bibliography of the heat-transfer literature.

As a whole, the book is a well-organized guide and source of reference material for design of cooling systems and should be a valuable addition to the library of any one involved in this field.

John H. Sununu

Chief Engineer
Astro Dynamics, Inc.
Burlington, Mass.

Recently published

Structural Synthesis of High-Accuracy Automatic Control Systems, M.V. Meerov, Pergamon Press, Inc., 340 pp., \$15

Principles of Technical Writing, Robert Hays, Addison-Wesley Publishing Co., 324 pp., \$6.50

The Doppler Effect, T.P. Gill, Academic Press, Inc. 149 pp., \$6.50

Communication Processes, NATO Conference Series, Vol. 4, Edited by Frank A. Geldard, Pergamon Press, Inc., 299 pp., \$14

Ten-Decimal Tables of the Logarithms of Complex Numbers, Mathematical Tables Series, Vol. 33, Pergamon Press, Inc., 110 pp., \$7.50

Optical and Electro-Optical Information Processing, Edited by James T. Tippett, et. al., The Massachusetts Institute of Technology Press, 780 pp., \$30

Analogues for the Solution of Boundary-Value Problems, International Tracts in Computer Science and Technology, and Their Application, Vol. 13, Translated from Russian, Volynski, V.E. Bulchman, Pergamon Press, 460 pp., \$15

Principles of Communication Engineering, J.M. Wozencraft, I.M. Jacobs, John Wiley & Sons, Inc., 720 pp., \$11

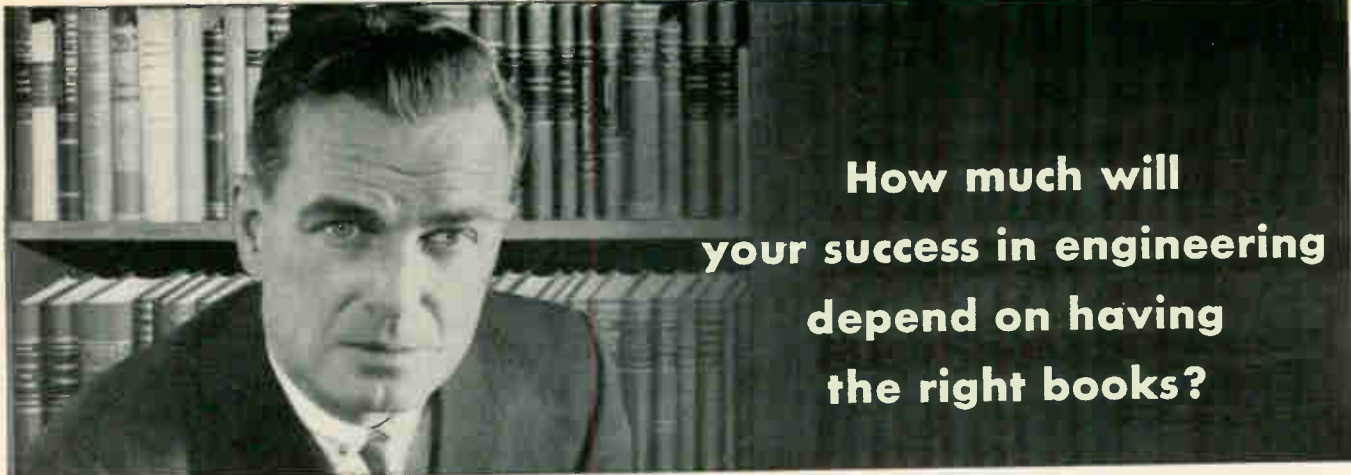

How much will
your success in engineering
depend on having
the right books?

The Electronics and Control Engineers' Book Club helps you keep ahead in your field . . . at a savings

Start your membership with any of these selections:



Introduction to Radar Systems by M. Skolnik. Covers everything from the prediction of radar range performance to applications.

Publisher's Price, \$14.50
Club Price, \$12.35



Mathematics for Electronics with Applications by H. M. Nodelman and F. W. Smith, Jr. Methods for solving practical problems.

Publisher's Price, \$7.00
Club Price, \$5.95



Transistor Circuit Design, prepared by the Engineering Staff of Texas Instruments Inc. Reduces theory to actual practice.

Publisher's Price, \$15.00
Club Price, \$12.75



Electronic Amplifier Circuits by J. M. Pettit and M. M. McWhorter. Gives reliable guidance on electronic amplifier circuit design.

Publisher's Price, \$10.50
Club Price, \$8.95



Modern Digital Circuits by Samuel Weber. A practical reference on design aspects of digital-type circuits.

Publisher's Price, \$9.50
Club Price, \$8.10



Electronic and Radio Engineering by F. E. Terman, 4th Ed. Helps solve modern problems in the electronic and radio engineering fields.

Publisher's Price, \$16.00
Club Price, \$13.60



Electronic Measuring Instruments and Control by H. Soisson. Covers electronic equipment used for precise measurements and control.

Publisher's Price, \$7.50
Club Price, \$6.40

Your engineering career owes a great deal to books. Why not take advantage of this convenient, economical way to have the best professional books available when you need them? THE ELECTRONICS AND CONTROL ENGINEERS' BOOK CLUB brings you the essential technical literature in your field. It also helps you overcome today's high cost of building a professional library by saving you an average of 15% from publisher's prices.

How the Club Operates. You regularly receive free of charge *The Electronics and Control Engineers' Book Bulletin*, as issued. This gives complete advance notice of the next selection-of-the-month, as well as many alternate selections. If you want the main selection you do nothing: the book will be mailed to you. If you want an alternate selection—or no book at all—you can notify the Club by returning the convenient card enclosed with each *Bulletin*.

Saves You Time and Money. You agree only to the purchase of four books over a two-year period. Certainly out of the large number of books offered in your field there are at least four you would buy anyway. By joining the Club you save both money and the trouble of searching.

Send No Money Now. Just check the book you want as your first selection on the coupon below. With it you will be sent *Handbook of Semiconductor Electronics* for only one dollar. Take advantage of this offer and receive two books for less than the regular price of one. (If coupon is detached, write to The Electronics and Control Engineers' Book Club, Dept. L-1227 330 W. 42nd St., New York 36, N. Y.)



ACCEPT THIS
\$19.50 BOOK

FOR ONLY **\$1.00**

with membership in
The Electronics and
Control Engineers'
Book Club

HANDBOOK OF SEMICONDUCTOR
ELECTRONICS

Prepared by a Staff of 18 Specialists
Edited by LLOYD P. HUNTER

Here is a wealth of reliable information to assist you in understanding the basic physical action of transistors, diodes, and photocells — for assembling necessary equipment, and fabricating typical semiconductor—and, above all, for designing a large variety of transistor circuits for use in various frequency ranges.

Handbook of Semiconductor Electronics is typical of the selections of THE ELECTRONICS AND CONTROL ENGINEERS' BOOK CLUB. All books are chosen by qualified editors and consultants. Their thoroughgoing understanding of the standards and values of the literature in your field guarantees the authoritativeness of the selections.

(NOTE: If you already own this volume, you may substitute any other book on this page as your DOLLAR book. Check two books below and you will receive the higher priced selection for only \$1.00.)

CLIP AND MAIL THIS COUPON TODAY

The Electronics and Control Engineers' Book Club, Dept. L-12-27
330 West 42nd Street, New York, N.Y. 10036

Please enroll me as a member of the Electronics and Control Engineers' Book Club. You will bill me for my first selection indicated at right at the special club price and \$1 for *Handbook of Semiconductor Electronics* (or alternate choice), plus local tax where applicable, and a few cents delivery costs. (The Club assumes delivery costs on prepaid orders.) Forthcoming selections will be described in advance and I may decline any book. I need take only 4 selections or alternates in 2 years of membership. (This offer good in U. S. only.)

PLEASE PRINT
Name
Address
City State Zip
Company

NO RISK GUARANTEE: If not completely satisfied, you may return your first shipment within 10 days and your membership will be canceled.

Send as my first selection: (If more than one book is checked we will send the higher priced selection as your \$1.00 book.)

- Introduction to Radar Systems, \$12.35
- Mathematics for Electronics with Applications, \$5.95
- Transistor Circuit Design, \$12.75
- Electronic Amplifier Circuits, \$8.95
- Modern Digital Circuits, \$8.10
- Electronic and Radio Engineering, \$13.60
- Electronic Measuring Instruments, \$6.40

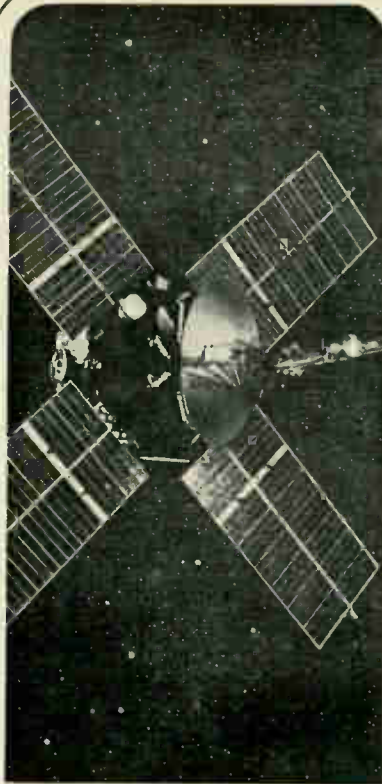

**Mariner IV
looked at Mars thru
a GEC vidicon . . .**

New projects and programs have created more opportunities and challenges at GEC. With excellent lab and support facilities, we are expanding our scope and depth in our four divisions. We seek a professional for the following assignment in our Electronics Division.

**ELECTRONIC
ENGINEER**

Experienced in video circuits, with background in video and deflection amplifiers. Degree or equivalent experience. Salary open. Write: Fred Cason, Mgr Prof Emplmt, Box 798, Garland, Texas 75041



**GENERAL ELECTRODYNAMICS
CORPORATION**
AN EQUAL OPPORTUNITY EMPLOYER

Technical Abstracts

Low-cost, tunable amplifier

A low-noise transverse wave electrostatically focused backward-wave amplifier for ultra-high frequency.

Peter Everett

Zenith Radio Corp., Chicago, Ill.

Recent interest in inexpensive, voltage-tunable amplifiers for radar has prompted a reexamination of the transverse-field interaction that was first proposed when the conventional, longitudinal-field, traveling-wave tube (twt) was developed in the 1940's. The basic focusing structure of a transverse-field tube consists of two rows of parallel plates as shown in the sketch. All the plates marked A are connected to a positive potential, V_1 , and the plates marked B are connected to another positive potential, V_2 . As a result, the plates form a series of two-dimensional electron lenses in which the potential alternates at each successive lens. When an electron travels rapidly through the slot between the two rows of plates, the transverse impulse from the lens field is averaged into a single force. This force acts in the direction of the axis and may be used to cancel the self-repulsion of a beam of electrons.

A single electron traveling near the axis will undergo a simple harmonic motion at frequency f_p , defined as the focusing frequency. When a beam of electrons passes through the structure, the electrons have an average drift velocity along the axis and a transverse oscillation at the focusing frequency. At any frequency there is a fast and slow wave, each of different wavelengths and phase velocities, and of positive and negative kinetic energies.

As in any beam tube, noise is associated with the waves because of the random positions and velocities of the electrons. If a converging electron lens is placed near the cathode, electrons with the same velocity will cross the axis at the same point. If a narrow slit is placed at the crossover point to intercept electrons that have the wrong velocity, the velocity fluctuations—and consequently the noise temperature—of the beam will be reduced. For a dispenser cathode at

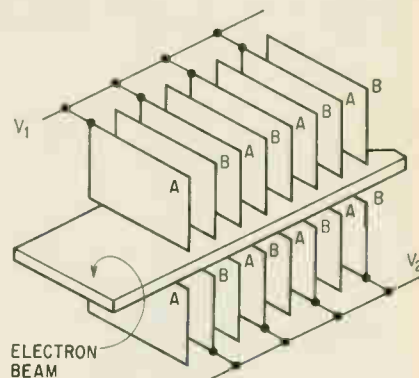

Basic focusing structure of a transverse field twt is a series of electron lenses.

2,000°K with a beam thickness of 5 mils at the cathode and a slot that intercepts 90% of the beam, the noise temperature is less than 300°K over a frequency range from 450 to 900 megacycles.

To make this tube act as a backward-wave amplifier, inductances are connected across the plates. The equivalent circuit of this structure is an iterated bandpass filter comprising series capacitors and shunt resonators. In this circuit, the instantaneous phase increases in the direction of the load. This means that the direction of phase velocity is from the load to the generator. Because the power flows from the generator to the load, the phase velocity and group velocity are in opposite directions. As a result, a backward wave is sustained at the tube.

The first experimental tube designed to test this theory used an old, low-noise gun developed at the Zenith Radio Corp. in the early 1950's. Because the gun operated with low-current densities, a number of compromises had to be made in the design: spacing between focusing disks was large; noise figures were around 5 db; and the beam voltage had to be varied from 100 to 1,000 volts to linearly control frequency from 350 to 700 Mc.

Another tube was designed to optimize operation over the 450- to 900-Mc band and to reduce the required tuning voltage. Both of these factors were obtained by reducing the space between the parallel focusing plates; however, this also required reducing the slot between

the two sets of parallel plates. This posed a problem of mechanical tolerances and set a practical limit for reducing the size of the tube. In this tube, the tuning voltage was only 50 to 500 volts.

Presented at the IEEE International Electron Devices Meeting, Washington, Oct. 20-22.

Guiding star

Sensor problems in space and interplanetary navigation, Hans D. Heyck, Aircraft Armaments Inc., Cockeysville, Md.

Space missions near earth are controlled by networks of ground radar and radio command stations. But deep-space probes do their own navigating, and like the ancient mariners, must look to the stars to guide them.

Successful space travel requires extremely precise information on a vehicle's trajectory. Six degrees of freedom must be known and controlled:

- Angular acceleration, velocity and position (or altitude) must be found in three axes: pitch, roll and yaw.

- Linear acceleration, velocity, and position also must be known in three axes: fore and aft, up and down, and left and right.

The Mariner spacecrafts, in the Venus and Mars fly-by missions, used the sun and one of the brightest stars, Canopus, as direction references. The difficulties Mariner 4 had in finding Canopus, and staying locked on, indicated need for improved sensors.

Typical accuracies of sensors today are: direction 0.001° to 0.01° ; attitude 0.1° to 0.5° ; acceleration $0.001 G$ to $0.01 G$; velocity 10 feet per second to 100 feet per second; position 1.0 to 10 miles.

The shortcoming of today's sensors are described by Heyck. He then tells of proposed equipment which may help. One instrument is a space velocity meter based on angular star aberrations. The device would use single telescopes with fused-silica prisms in front of the receiving optics. Heyck also discusses design of optical rendezvous systems, which, because of their light weight and low power consumption could replace bulkier microwave radar.

Twelfth Annual East Coast Conference on Aerospace and Navigation Electronics
Baltimore, Md., Oct. 27-29.



Beckman solves space age problems in DeKalb-Atlanta

Where can a company get a good deal on warehouse space—close to the booming space age projects of the Southeast? Beckman Instruments, a leader in the field of producing instruments for industry, science and biochemical research, found the industrial site and technical talent it needed in DeKalb-Atlanta's Peachtree Industrial Blvd. District. From DeKalb, Beckman markets direct—developing an increasingly productive relationship with Southeast customers. If you have a space—or space age—problem, DeKalb-Atlanta may be your launching site, too. Write today for more details.

Reid Williamson, Jr., Manager, Industrial Committee
of 100, or B. H. Manning, Jr., Chairman,
DeKalb County Commission, P.O. Drawer 15059,
Atlanta, Georgia 30333

NAME _____
TITLE _____
COMPANY _____
ADDRESS _____
CITY & STATE _____



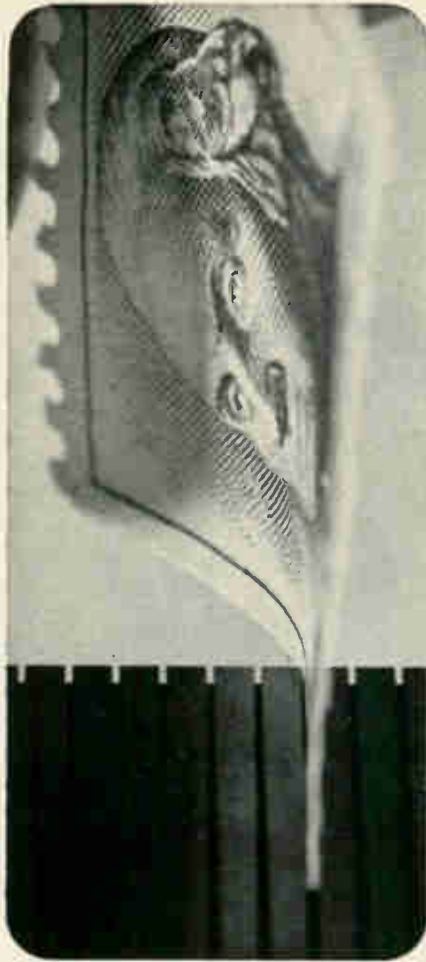

Need graphite with 0.003" slots?

Call on Ultra Carbon. Typical capability: graphite machined with 0.003" slots. Shown, six times actual size, 0.006" slots.

Your most exacting specifications in graphite parts can be met by the microprecision machining capabilities of Ultra. Complex and precise broaching, milling, slotting and drilling of graphite is achieved with the newest and best in machine tools. The Ultra emphasis is on service to meet your tomorrow's demands. An engineering staff of specialists in graphite is always ready to help you. Why not submit your drawings or sketches and an outline of your application to us? Write P. O. Box 747, Bay City, Mich. 48709.



New Literature

Telecommunications organization. The Ericsson Corp., 100 Park Ave., New York 10017. A new edition of the comprehensive data file on the worldwide Ericsson Group of telecommunications companies contains basic information on the group and its operations, arranged and indexed for quick reference. Circle 461 on reader service card.

Diamond tools for substrate processing. Aremco Products, Inc., P.O. Box 145, Briarcliff Manor, N.Y., 10510. Product bulletin 107 describes a line of diamond tools for drilling glazed alumina ceramic substrates for thin film circuits, and for scribing fragile single crystals of silicon and germanium for semiconductor devices. [462]

Low-pass filters. Gulton Industries, Inc., 212 Durham Ave., Metuchen, N.J., has issued bulletin H-16b on a series of miniature, high-frequency, low-pass filters which effectively reduce or eliminate radio-frequency interference and feedback in low power circuits. [463]

Electron beam gun technology. Microperov, Inc., 1384 Pompton Ave., Cedar Grove, N.J. A six-page, illustrated brochure summarizes the theory of electron beam gun technology and its application to commercial research and production tools. [464]

Silicon varistors. Victory Engineering Corp., P.O. Box 187, Springfield, N.J., 07081. Technical bulletin MSV111 describes diffused-junction silicon varistors which consist of a pair of parallel-connected, matched, oppositely poled silicon diodes. [465]

Coaxial switches. Electronic Specialty Co., 4561 Colorado Blvd., Los Angeles, Calif., 90039, has published a 12-page catalog describing 23 types of hermetically sealed coaxial switches. [466]

Lead forming tool. Davey Products Co., Box 567, Fairfield, Conn., offers a two-page bulletin on a low-cost, caliper-like component lead forming tool. [467]

Kelvin double ratio set. Leeds & Northrup Co., 4907 Stenton Ave., Philadelphia, Pa., 19144. Data sheet A11.1222 describes a six-dial Kelvin double ratio set that compares shunts, standards and other resistances of 10 ohms and less to one or a few parts per million. [468]

Vibration isolator. Robinson Vibrashock division, Robinson Technical Products, Inc., Teterboro Air Terminal, Teterboro, N.J., 07606. Bulletin CS 65-2 describes an all-metal, vibration- and shock-control mount for airborne, vehicular and industrial applications. [469]

Precision pots. Bourns, Inc., Trimpot Division, 1200 Columbia Ave., Riverside, Calif. Short-form catalog No. 3 is a six-page brochure giving specifications and prices on 25 types of precision potentiometers. [470]

Data acquisition system. Dana Laboratories, Inc., Irvine, Calif., 92664. Data sheet DL-488 contains a complete description and specification information on the model 8001 data acquisition system that measures d-c volts, a-c volts, millivolts, and ratios. [471]

Electromagnetic equipment. Westinghouse Electric Corp., Hendy Ave., Sunnysvale, Calif., 94088. A six-page illustrated publication covers the types of custom-built magnetic equipment the company can supply to meet the needs of science and industry. [472]

Printed-circuit design. Lockheed Electronics Co., 6201 E. Randolph St., Los Angeles, Calif., 90022, has published a brochure to aid engineers in the design of producible, reliable and economical printed circuit boards. [473]

Trimming potentiometers. Helipot Division of Beckman Instruments, Inc., 2500 Harbor Blvd., Fullerton, Calif., 92634, has available a short-form catalog describing 20 different models of Helitrim Mil spec and commercial trimmers. [474]

Subminiature sensors. Pickering & Co., Sunnyside Blvd., Plainview, N.Y., 11803, has available a two-page product data sheet detailing a subminiature linear variable differential transformer series capable of ultrasensitive measurements. [475]

Furnace control instrumentation. General Electric Co., 40 Federal St., West Lynn, Mass., 01915. GEA-8192 is a 12-page booklet describing a line of instrumentation for diffusion, vacuum, and heat-treating furnaces. [476]

Full-wave chopper. Solid State Electronics Corp., 15321 Rayen St., Sepulveda, Calif., 91343, offers a two-page bulletin on the model 171 transformer-coupled full-wave chopper. [477]

Analog-to-digital converter. Stellarmetrics, Inc., 210 E. Ortega St., Santa Barbara, Calif. Model ADC-1 data sheet gives specifications for an analog-to-digital converter designed to meet the unique requirements of telemetering signals. [478]

IC logic modules. Scientific Data Systems, 1649 Seventeenth St., Santa Monica, Calif., 90404. A line of high-speed, integrated-circuit logic modules (series SDS T) is described in a six-page brochure, 64-51-02A. [479]

Electronic-grade chemicals. Nitine, Inc., 45 S. Jefferson Rd., Whippany, N.J., has available a catalog listing over 200 chemicals commonly used in semiconductor processing for etching, doping and cleaning, with individual analyses and prices for commercial and laboratory quantities. [480]

Spur gearmotors. Globe Industries, Inc., 2275 Stanley Ave., Dayton, Ohio, 45404. Two-page bulletin B-1742 supplies data on 28 standard concentric spur gear ratios from 2.56:1 to 16,833:1, rated to 50 oz-in. output. [481]

Electronics index

Technical articles

Volume 38, 1965

Technical articles

A

ADVANCED TECHNOLOGY

Bright hopes for display systems: flat panels and light deflectors p. 56 Nov. 29
Computing at the speed of light p. 72 Sept. 6
Controlling laser oscillation p. 101 Sept. 20
Light on the laser's future p. 119 Apr. 19
Monkeys and microelectronics p. 90 Feb. 22
More power to the laser—with Q switching p. 91 Oct. 18
New target for radar: sharper vision with optics p. 58 Dec. 27
Switching with light p. 58 Nov. 1

AMPLIFIERS

Amplifier gain is constant despite changes in load p. 75 June 28
Cascode amplifier stabilized by reducing internal feedback p. 70 May 17
IC's improve differential amplifiers—and vice versa p. 75 Aug. 9
Simple circuit tunes audio amplifier p. 84 Mar. 22
Stable differential amplifier designed without choppers p. 73 Jan. 25

ANTENNAS

Antenna's reflecting surfaces increase beacon bandwidth p. 77 Jan. 11
Making the antenna an active partner p. 93 Aug. 9
Transmitters towed through air test antenna's radiation pattern p. 96 Oct. 18
Very low frequency antennas are going back to work p. 80 Jan. 11

AVIONICS

Data dots identify aerial photos p. 106 Sept. 20
Low light tv sees in the dark better than the human eye p. 78 June 28

C

CIRCUIT DESIGN

Adding a component reduces recovery time p. 78 Jan. 25
Cold-cathode tubes as triggers p. 76 Apr. 5
Designing transmission lines into multilayer circuit boards p. 90 Nov. 1
Feedback: perils and potentials in designing integrated circuits p. 67 May 31
FET performs well in balancing act p. 88 Sept. 20
Filter design easy as pi p. 93 Sept. 20
Impedance matching with nonlinear loads p. 82 Feb. 22
Magnetoresistors isolate load from control circuit p. 60 Feb. 8
Modified decade counter eliminates components p. 74 Dec. 13
Modified flip-flop quadruples fan-out p. 67 Dec. 27
Modulated pulse width converted to analog voltage p. 99 Oct. 4
Multi's output duration controlled by input p. 88 Feb. 22
Multivibrator provides bidirectional output pulses p. 87 Aug. 23
Negative resistance in FET's: an aid or an ailment p. 57 July 26
New look at coaxial cavities for varactor multipliers, A p. 56 May 17
New ways to improve transistor bias stability p. 87 Feb. 22
Nomograph and chart pinpoint source of ripple voltage limitation p. 64 Sept. 6
Nonreactive filter converts triangular waves to sines p. 96 Mar. 8
Novel sweep circuit eliminates ramp pedestal p. 68 Dec. 27
One discriminator senses pulse width and height p. 90 Apr. 19
One-transistor multi delays digital pulses p. 85 Aug. 23
Phase demodulator needs no tuning p. 99 Oct. 4
Photocell triggers counting circuit p. 74 June 28
Precise 6-volt input triggers circuit p. 80 July 12
Pulse generator circuit doubles as modulator p. 91 Apr. 19

Pulse generator controls rise, fall time independently p. 98 Sept. 20
Pulse width converted to pulse sequence p. 86 Feb. 22
Pulses with variable mark-to-space-ratio p. 78 July 12
Quick-on-the-trigger design p. 105 June 14
Reduced loading improves accuracy of cascaded pots p. 110 Nov. 15
Reliable repertoire of display circuits p. 60 Jan. 25
Remotely tuned crystal filter eliminates tuned transformer p. 113 Nov. 15
Retrieving data from Gemini p. 83 May 3
R-f switching matrix cuts out crosstalk p. 67 Nov. 1
Rise time adjustment independent of fall time p. 76 Jan. 25
Sawtooth generator uses FET as constant current source p. 87 Sept. 6
Scr monitors power failure p. 63 July 26
Scr multivibrator switches reliably p. 95 Mar. 8
Scr's regulate a-c line voltage p. 61 Feb. 8
Scr ring counter switches up or down p. 84 Sept. 6
Scr switch turns off with reverse bias p. 88 Apr. 5
Short-circuit protection consumes little power p. 68 Nov. 1
Silicon controlled switch can generate pulses p. 79 Jan. 25
Sharp discrimination of voltage differences p. 97 Sept. 20
Simple circuit increases measurement accuracy p. 69 Nov. 1
Simple diodes keep voltages constant p. 68 Sept. 6
Simple multivibrator operates at 5 Mc p. 86 Aug. 23
Six possible routes to noninductive tuned circuitry p. 114 Nov. 15
Slow sweep generator controls camera shutter p. 82 Aug. 9
Simple circuit tunes audio amplifier p. 84 Mar. 22
Stable differential amplifier designed without choppers p. 73 Jan. 25
Timing circuits control relays p. 85 Mar. 22
Transistor circuit pulses 1,000 volts p. 86 Sept. 6
Transistor switch passes current both ways p. 79 Jan. 11
Triangle generator adjusts output slopes and peaks p. 85 June 14
Triangular waveforms have 1% linearity p. 86 Apr. 5
Tunnel diode sensor protects regulator from short circuit p. 75 Dec. 13
Two transistors simulate high-current tunnel diode p. 63 Feb. 8
Unijunction transistor latches relay with short pulses p. 62 May 3
Unijunction transistor turns off latching relay p. 109 Nov. 15
Using cold-cathode tubes to count and store p. 80 Apr. 19
Variable damper impedance improves tv scan linearity p. 90 Oct. 18
Zener diode protects backward wave oscillator p. 65 Nov. 29
Zero-crossing detector provides fast sync pulses p. 91 Apr. 19

COMMUNICATIONS

Antenna's reflecting surfaces increase beacon bandwidth p. 77 Jan. 11
Army lays the groundwork for satellite communications p. 86 May 31
Capsule is no isolation booth, The p. 88 May 3
Coding for error control: an examination of techniques p. 70 Dec. 27
Detector circuit measures phase and amplitude p. 84 June 14
Electronic variable attenuator for use with uhf receivers, An p. 97 June 28
Error-control systems get the message across p. 125 Nov. 15
Finally, the armed forces get solid state communications p. 63 May 3
Foil and styrofoam polarize radar beam p. 75 May 31
Laser-television system developed with off-the-shelf equipment p. 75 Feb. 8
Making the antenna an active partner p. 93 Aug. 9
Messages by meteor p. 102 Oct. 18
More and faster communications p. 122 Apr. 19
Navigational satellites: beacons for ships and planes p. 79 Feb. 8
Protecting digital transmission with optical matched filters p. 76 May 17
Retrieving data from Gemini p. 83 May 3

R-f switching matrix cuts out crosstalk p. 67 Nov. 1
Shortcut to calculating the Q p. 85 July 12
Suppressing noise at the connector p. 65 May 17
Telemetry that's compact and reliable p. 77 May 3
Very low frequency antennas are going back to work p. 80 Jan. 11

COMPONENTS

Broader choice of components for silicon integrated circuits, A p. 48 May 3
Cold-cathode tubes as triggers p. 76 Apr. 5
Continuously variable delay line for frequencies below 100 Mc p. 73 May 31
Detonators that tune out stray r-f p. 76 May 31
Flat disks reduce the cost of making cathode-ray tubes p. 113 Apr. 5
Inductors that fit integrated circuits p. 62 May 31
Light-coupled semiconductor switch for low-level multiplexing p. 54 Feb. 8
Magnetoresistors isolate load from control circuit p. 60 Feb. 8
New look at coaxial cavities for varactor multipliers, A p. 56 May 17
Picking the right potentiometer p. 78 June 14
Scr's regulate a-c line voltage p. 61 Feb. 8
Solid state multipliers for servosystems p. 120 Nov. 15
Suppressing noise at the connector p. 65 May 17
10,000 volt d-c latching relay achieved with reed switch p. 64 Nov. 29
Thin-film capacitance elements: which is best for your purpose? p. 67 Jan. 25
Using cold-cathode tubes to count and store p. 80 Apr. 19
Using the cold-cathode tube: Part 1 p. 78 Mar. 22
What's new in semiconductor emitters and sensors p. 98 Nov. 15
Wideband tape-recorder users claim obsolete standards impede technology p. 90 Jan. 25

COMPUTERS

After a lull, numerical control is in demand p. 106 Dec. 13
Automatic test equipment: a million-dollar 'screwdriver' p. 88 Aug. 23
Campus computer helps students do their homework at Dartmouth p. 85 Nov. 29
Computer approach for people who know nothing about computers, A p. 83 Nov. 29
Computer trio runs the works at big British steel mill p. 80 Jan. 25
Computers design the layout: Part III p. 88 Nov. 1
Computers for the electric utility industry p. 124 Apr. 19
Computing at the speed of light p. 72 Sept. 6
From war gear to coal mines p. 93 Mar. 22
IBM's flexible addition to System 360 p. 79 Nov. 29
Manual process control makes way for computers p. 110 Dec. 13
Packaging revolution, The, Part IV: Bigger, better multilayer boards p. 90 Nov. 29
Solid state multipliers for servosystems p. 120 Nov. 15
Time-sharing: one machine serving many masters p. 72 Nov. 29
Who's on the right track? p. 71 July 26

CONSUMER ELECTRONICS

Colorful, faithful, easy to operate: goals for an all-European tv system p. 97 Mar. 22
From Japan, a startling new color tv set p. 81 May 31
Satellite computers as interpreters p. 87 Nov. 29
Solid state stereo set built in modules, A p. 88 Aug. 9
Wonderland for the consumer, A p. 109 Apr. 19

D

DESIGNER'S CASEBOOK

Amplifier gain is constant despite changes in load p. 75 June 28
Antenna's reflecting surfaces increase beacon p. 77 Jan. 11
Bipolar limiter reduces d-c loss p. 65 Nov. 29
Bipolar pulse detector features meter display p. 63 Nov. 29
Cascode amplifier stabilized by reducing internal feedback p. 70 May 17
Chopper adapts voltmeter to d-c p. 66 Nov. 1
Circuit inverts d-c voltage p. 100 Sept. 20

Circuit keeps voltage constant for welder battery p. 88 Oct. 18
 Clamp and spark gap protect twt modulator p. 64 July 26
 Continuously variable delay line for frequencies below 100 Mc p. 73 May 31
 Controlling scr firing angle regulates d-c load voltage p. 80 Aug. 9
 Crystal accurately controls avalanche pulse generator p. 112 Nov. 15
 Darlington maintains constant unity gain p. 69 Nov. 1
 Detector circuit measures phase and amplitude p. 84 June 14
 Diode eliminates multivibrator bias p. 62 Feb. 8
 Diode quiets input to monostable multi p. 99 Sept. 20
 Diodes protect meter from overloads p. 85 Sept. 6
 Duty cycle is constant at any trigger frequency p. 62 July 26
 Electronic capacitor is continuously variable p. 89 Oct. 18
 Electronically tuned hybrid notch filter p. 92 Mar. 8
 Feedback system detects 1% amplitude difference p. 68 May 17
 FET circuit stores light measurement p. 66 Nov. 1
 FET circuit stretches 1-msec pulse to 30 hours p. 87 Apr. 5
 FET in bridge circuit gates a 300-kc signal p. 60 May 3
 FET increases Schmitt trigger input impedance p. 65 July 26
 Foil and styrofoam polarize radar beam p. 75 May 31
 Forming accurate dividers with nonprecise resistors p. 100 Oct. 4
 Gate circuits eliminated in scr static switch p. 80 July 12
 Gated multivibrator output provides constant pulse width p. 69 Dec. 27
 Grounded-grid circuit sweeps better than Miller or bootstrap p. 83 Mar. 22
 Improving Darlington speed p. 83 Aug. 9
 Isolating transistor improves one-shot p. 76 Dec. 13
 Local feedback improves transistor characteristics p. 108 Nov. 15
 Low-cost adjustable regulator consumes little power p. 109 Nov. 15
 Low-cost Schmitt trigger reduces hysteresis p. 63 Nov. 29
 Magnetoresistors isolate load from control circuit p. 60 Feb. 8
 Matching gate potential to FET pinchoff voltage p. 81 Aug. 9
 Modified decade counter eliminates components p. 74 Dec. 13
 Modified flip-flop quadruples fan-out p. 67 Dec. 27
 Modulated pulse width converted to analog voltage p. 99 Oct. 4
 Multi's output duration controlled by input p. 88 Feb. 22
 Multivibrator provides bidirectional output pulses p. 87 Aug. 23
 New ways to improve transistor bias stability p. 87 Feb. 22
 Novel sweep circuit eliminates ramp pedestal p. 68 Dec. 27
 Off-the-shelf ic's in timer p. 70 Dec. 13
 One discriminator senses pulse width and height p. 90 Apr. 19
 One-transistor multi delays digital pulses p. 85 Aug. 23
 Phase demodulator needs no tuning p. 99 Oct. 4
 Photocell triggers counting circuit p. 74 June 28
 Photoconductors chop d-c signal levels p. 61 May 3
 Photodetector gain control aids signal discrimination p. 111 Nov. 15
 Photodiodes control pulse intervals p. 72 May 31
 Phototransistor regulates illumination intensity p. 101 Oct. 4
 Pnp plus npn equals unijunction transistor p. 94 Mar. 8
 Precise 6-volt input triggers circuit p. 80 July 12
 Pulse frequency measured by photoconductor and scopes p. 77 June 28
 Pulse generator circuit doubles as modulator p. 91 Apr. 19
 Pulse width converted to pulse sequence p. 86 Feb. 22
 Pulse generator controls rise, fall time independently p. 98 Sept. 20
 Pulses with variable mark-to-space-ratio p. 78 July 12
 Reduced loading improves accuracy of cascaded pots p. 110 Nov. 15
 Remotely tuned crystal filter eliminates tuned transformer p. 113 Nov. 15
 R-f switching matrix cuts out crosstalk p. 67 Nov. 1
 Rise time adjustment independent of fall time p. 76 Jan. 25
 Sawtooth generator uses FET as constant current source p. 87 Sept. 6
 Scr monitors power failure p. 63 July 26
 Scr multivibrator switches reliability p. 95 Mar. 8
 Scr's regulate a-c line voltage p. 61 Feb. 8
 Scr ring counter switches up or down p. 84 Sept. 6
 Scr switch turns off with reverse bias p. 88 Apr. 5
 Sharp discrimination of voltage differences p. 97 Sept. 20
 Short-circuit protection consumes little power p. 68 Nov. 1
 Simple circuit increases measurement accuracy p. 69 Nov. 1
 Simple circuit tunes audio amplifier p. 84 Mar. 22
 Simple multivibrator operates at 5 Mc p. 86 Aug. 23
 Slow sweep generator controls camera shutter p. 82 Aug. 9
 10,000 volt d-c latching relay achieved with reed switch p. 64 Nov. 29

Timing circuits control relays p. 85 Mar. 22
 Transistor circuit pulses 1,000 volts p. 86 Sept. 6
 Transistor increases multiplier phototube sensitivity p. 83 July 9
 Transistor switch passes current both ways p. 79 Jan. 11
 Triangle generator adjusts output slopes and peaks p. 85 June 14
 Triangular waveforms have 1% linearity p. 86 Apr. 5
 Tunnel diode sensor protects regulator from short circuit p. 75 Dec. 13
 Two transistors simulate high-current tunnel diode p. 63 Feb. 8
 Unijunction transistor latches relay with short pulses p. 62 May 3
 Unijunction transistor turns off latching relay p. 109 Nov. 15
 Variable damper impedance improves tv scan linearity p. 90 Oct. 18
 Zener diode protects backward wave oscillator p. 65 Nov. 29
 Zero-crossing detector provides fast sync pulses p. 91 Apr. 19

INDUSTRIAL ELECTRONICS

After a lull, numerical control is in demand p. 106 Dec. 11
 Computer trio runs the works at big British steel mill p. 80 Jan. 25
 Computers for the electric utility industry p. 124 Apr. 19
 From war gear to coal mines p. 93 Mar. 22
 Light pulse system shrinks high-voltage protection device p. 71 May 17
 Manual process control makes way for computers p. 110 Dec. 13
 Picture looks better for closed-circuit television, The p. 70 Nov. 1
 Powerful scr's, connected in parallel control industry's biggest machinery p. 110 Oct. 4
 Regulating bias on a ship's hull p. 84 Aug. 9
 Scr's break the frequency barrier p. 88 Sept. 6
 Who's on the right track? p. 71 July 26

INSTRUMENTS

Dark side of the laser, The p. 93 Apr. 19
 Digital system continuously converts transducer into meaningful units p. 102 Mar. 8
 FET performs well in balancing act p. 88 Sept. 20
 Infrared fault-finder pinpoints defects in multilayer boards p. 96 Nov. 29
 Measure it, but don't touch p. 65 Aug. 23
 Measurement of stored charge in diode clearly defines switching speed p. 84 June 28
 Step by step to a linear frequency sweep p. 66 July 26
 Stress-sensitive integrated circuits p. 81 July 12
 Television's toughest challenge p. 80 May 17
 Transmitters towed through air test antenna's radiation pattern p. 96 Oct. 18
 Two ways to measure distortion p. 80 Oct. 4
 Variable persistence increases oscilloscope's versatility p. 66 Nov. 29
 Wideband tape-recorder users claim obsolete standards impede technology p. 90 Jan. 25

M

MAGNETICS

Solid state multipliers for servosystems p. 120 Nov. 15

MANUFACTURING

Aluminum bonding is key to 40-watt microcircuits p. 98 Aug. 23
 Better bonding methods improve hybrid circuits p. 86 Mar. 22
 Chips are down in new way to build large micro-systems p. 102 Oct. 4
 Crossbred technology automates production of hybrid microcircuits p. 66 June 28
 Designing transmission lines into multilayer circuit boards p. 90 Nov. 1
 Dip soldering in miniature—a new way to assemble modules p. 94 May 31
 Endless belt process makes assembly flexible p. 95 July 12
 Ferris wheel programs insertion of components p. 108 Feb. 22
 Flat disks reduce the cost of making cathode-ray tubes p. 113 Apr. 5
 For low-cost flatpacks: remove the wires, put circuits in glass p. 99 July 12
 Infrared fault-finder pinpoints defects in multilayer boards p. 96 Nov. 29
 Japanese technology, the new push for technical leadership p. 77 Dec. 13
 Laminates and cribbage boards connect integrated circuits p. 67 Feb. 8
 New leads and potting mate flatpacks and cord-wound parts p. 96 July 12
 New masking techniques for micropower transistors p. 76 Feb. 22
 Oxide-poisoning problem solved by hole in grid cup p. 107 Feb. 22
 Packaging revolution, The, Part I: Form and function interact p. 72 Oct. 18
 Packaging revolution, The, Part II: Design and manufacturing overlap p. 75 Nov. 1
 Packaging revolution, The, Part III: Computers design the layout p. 88 Nov. 1

Packaging revolution, The, Part IV: Bigger, better multi-layer boards p. 90 Nov. 29
 Paper path shortcut to mass trimming job p. 98 Sept. 6
 Pieces of plastic keep components clear of board p. 97 Aug. 9
 Small parts are aligned and assembled by vibration p. 106 Feb. 22
 'Sniffer' removes solder from board p. 114 Apr. 5
 Special electrode shapes solve welding problems p. 98 Aug. 9
 Through the looking glass to bond semiconductor chips p. 100 Sept. 6
 Two-step method simplifies hybrid-circuit assembly p. 99 Sept. 6

MARKETS

Changing face of the West, The p. 60 Aug. 9
 Computers for the electric utility industry p. 124 Apr. 19
 Cramming more components onto integrated circuits p. 114 Apr. 19
 Electronic market in 1965 p. 87 Jan. 11
 European electronic markets 1966 p. 81 Dec. 27
 Expanding market, The p. 96 Oct. 4
 First 35 years of Electronics, The p. 100 Apr. 19
 Forward look at electronics, A p. 106 Apr. 19
 Japanese technology, the new push for technical leadership p. 77 Dec. 13
 Light on the laser's future p. 119 Apr. 19
 More and faster communications p. 122 Apr. 19
 Research for space enters the electronics age p. 117 Apr. 19
 When you're second, you try harder p. 81 Dec. 13
 Wonderland for the consumer, A p. 109 Apr. 19

MEASUREMENTS

Adding force to integrated circuits p. 72 July 12
 Automatic test equipment: a million-dollar 'screwdriver' p. 88 Aug. 23
 Detector circuit measures phase and amplitude p. 84 June 14
 Dark side of the laser, The p. 93 Apr. 19
 Digital system continuously converts transducer into meaningful units p. 102 Mar. 8
 FET circuit stores light measurement p. 66 Nov. 1
 FET performs well in balancing act p. 88 Sept. 20
 Measure it, but don't touch p. 65 Aug. 23
 Measurement of stored charge in diode clearly defines switching speed p. 84 June 28
 Pulse frequency measured by photoconductor and scopes p. 77 June 28
 Shortcut to calculating the Q p. 85 July 12
 Simple circuit increases measurement accuracy p. 69 Nov. 1
 Step by step to a linear frequency sweep p. 66 July 26
 Transmitters towed through air test antenna's radiation pattern p. 96 Oct. 18
 Two ways to measure distortion p. 80 Oct. 4
 Variable persistence increases oscilloscope's versatility p. 66 Nov. 29

MEDICAL ELECTRONICS

Bioengineering: a new discipline p. 111 June 14
 Dark side of the laser, The p. 93 Apr. 19
 Electronic detours of broken nerve paths p. 110 Sept. 20
 Physical exam in orbit p. 99 Apr. 5
 Special world of biotelemetry design, The p. 89 June 28

MICROELECTRONICS

Adding force to integrated circuits p. 72 July 12
 Aluminum bonding is key to 40-watt microcircuits p. 98 Aug. 23
 Better bonding methods improve hybrid circuits p. 86 Mar. 22
 Broader choice of components for silicon integrated circuits, A p. 48 May 3
 Chips are down in new way to build large micro-systems p. 102 Oct. 4
 Cramming more components onto integrated circuits p. 114 Apr. 19
 Crossbred technology automates production of hybrid microcircuits p. 66 June 28
 Expanding market, The p. 96 Oct. 4
 Feedback: perils and potentials in designing integrated circuits p. 67 May 31
 IC's improve differential amplifiers—and vice versa p. 75 Aug. 9
 Japan seeks its own route to improved IC techniques p. 90 Dec. 13
 Making light of the noise problem p. 52 July 26
 Monkeys and microelectronics p. 90 Feb. 22
 MOS integrated circuits save space and money p. 84 Oct. 4
 Off-the-shelf ic's in timer p. 70 Dec. 13
 Packaging revolution, The, Part I: form and function interact p. 72 Oct. 18
 Six possible routes to noninductive tuned circuitry p. 114 Nov. 15
 Stress-sensitive integrated circuits p. 81 July 12
 Thin-film capacitance elements: which is best for your purpose p. 67 Jan. 25
 Through the looking glass to bond semiconductor chips p. 100 Sept. 6
 'Tuning forks' sound a hopeful note p. 84 Sept. 20

MICROWAVES

Bidding for world leadership in solid state microwave gear p. 99 Dec. 13
 Continuously variable delay line for frequencies below 100 Mc. p. 73 May 31
 Electronically tuned hybrid notch filter p. 92 Mar. 8

Foil and styrofoam polarize radar beam p. 75 May 31
 Measure it, but don't touch p. 65 Aug. 23
 New look at coaxial cavities for varactor multipliers, A p. 56 May 17
 Phasing unwanted images out of microwave receivers p. 89 July 12
 Selecting the right diode for r-f switching circuits p. 70 Mar. 22

MILITARY ELECTRONICS

Army lays the groundwork for satellite communications p. 86 May 31
 Automatic test equipment: a million-dollar 'screwdriver' p. 88 Aug. 23
 Data dots identify aerial photos p. 106 Sept. 20
 Designing against radiation p. 70 Jan. 11
 Detonators that tune out stray r-f p. 76 May 31
 Finally, the armed forces get solid state communications p. 63 May 3
 Just in case . . . p. 94 Apr. 5
 Low light tv sees in the dark better than the human eye p. 78 June 28
 Modernizing the missile range: Part I p. 94 Feb. 22
 Modernizing the missile range: Part II p. 108 Mar. 8
 Navigational satellites: beacons for ships and planes p. 79 Feb. 8

R

RADAR

New target for radar: sharper vision with optics p. 58 Dec. 27
 Step by step to a linear frequency sweep p. 66 July 26

S

SOLID-STATE ELECTRONICS

Adding force to integrated circuits p. 72 July 12
 Bidding for world leadership in solid state microwave gear p. 99 Dec. 13
 Broader choice of components for silicon integrated circuits, A p. 48 May 3
 Combing the field for ways to match overlays' performance Part III p. 82 Aug. 23
 Controlling scr firing angle regulates d-c load voltage p. 80 Aug. 9
 Cramming more components onto integrated circuits p. 114 Apr. 19
 Diodes protect meter from overloads p. 85 Sept. 6
 Expanding market, The p. 96 Oct. 4
 Feedback: perils and potentials in designing integrated circuits p. 67 May 31
 FET detects alpha particles better and more precisely p. 64 Feb. 8
 FET in bridge circuit gates a 300-kc signal p. 60 May 3
 FET performs well in balancing act p. 88 Sept. 20
 Good teamwork from scr's p. 60 Aug. 23
 IC's improve differential amplifiers—and vice versa p. 75 Aug. 9
 Matching gate potential to FET pinchoff voltage p. 81 Aug. 9
 Measurement of stored charge in diode clearly defines switching speed p. 84 June 28
 MOS integrated circuits save space and money p. 84 Oct. 4
 New masking techniques for micropower transistors p. 76 Feb. 22
 Nonreactive filter converts triangular waves to sines p. 96 Mar. 8
 Now, new unijunction geometries p. 93 June 14
 Overlay transistor, new geometry boosts power, The, Part I p. 71 Aug. 23
 Photodiodes control pulse intervals p. 72 May 31
 Powerful scr's, connected in parallel control industry's biggest machinery p. 110 Oct. 4
 Putting the overlay to work at high frequencies Part II p. 78 Aug. 23
 Quick-on-the-trigger design p. 105 June 14
 Scr's break the frequency barrier p. 88 Sept. 6
 Scr multivibrator switches reliably p. 95 Mar. 8
 Scr ring counter switches up or down p. 84 Sept. 6
 Scr switch turns off with reverse bias p. 88 Apr. 5
 Selecting the right diode for r-f switching circuits p. 70 Mar. 22
 Simple diodes keep voltages constant p. 68 Sept. 6
 Solid state stereo set built in modules, A p. 88 Aug. 9
 Stable differential amplifier designed without choppers p. 73 Jan. 25
 Transistor increases multiplier phototube sensitivity p. 83 Aug. 9
 Transistor switch passes current both ways p. 79 Jan. 11
 'Tuning forks' sound a hopeful note p. 84 Sept. 20
 Unijunction device gets high marks in stringent tests of reliability p. 98 June 14
 Unijunction transistor, The p. 87 June 14
 What's new in semiconductor emitters and sensors p. 98 Nov. 15
 When you're second, you try harder p. 81 Dec. 13
 Zener diode protects backward wave oscillator p. 65 Nov. 29

SPACE ELECTRONICS

Capsule is no isolation booth, The p. 88 May 3
 Designing against radiation p. 70 Jan. 11
 Gemini's electronic 'firsts' p. 71 May 3
 Just in case . . . p. 94 Apr. 5
 Physical exam in orbit p. 99 Apr. 5
 Project Gemini: giant step on a stairway to the moon p. 89 Apr. 5
 Navigational satellites: beacons for ships and planes p. 79 Feb. 8
 Rendezvous: climax of Project Gemini p. 110 Apr. 5

Research for space enters the electronics age p. 117 Apr. 19
 Retrieving data from Gemini p. 83 May 3
 Telemetry that's compact and reliable p. 77 May 3
 Tv looks at the dark side p. 106 Apr. 5
 Television's toughest challenge p. 80 May 17

T

TRANSISTORS

Combing the field for ways to match overlays' performance Part III p. 82 Aug. 23
 FET circuit stretches 1-msec pulse to 30 hours p. 87 Apr. 5
 FET detects alpha particles better and more precisely p. 64 Feb. 8
 FET increases Schmitt trigger input impedance p. 65 July 26
 FET performs well in balancing act p. 88 Sept. 20
 Matching gate potential to FET pinchoff voltage p. 81 Aug. 9
 Negative resistance in FET's an aid or an ailment p. 57 July 26
 New masking techniques for micropower transistors p. 76 Feb. 22
 New ways to improve transistor bias stability p. 87 Feb. 22
 Now, new unijunction geometries p. 93 June 14
 Overlay transistor, The new geometry boosts power, Part I p. 71 Aug. 23
 Pnp plus npn equals unijunction transistor p. 94 Mar. 8
 Putting the overlay to work at high frequencies Part II p. 78 Aug. 23
 Quick-on-the-trigger design p. 105 June 14
 Sawtooth generator uses FET as constant current source p. 87 Sept. 6
 Transistor circuit pulses 1,000 volts p. 86 Sept. 6
 Transistor increases multiplier phototube sensitivity p. 83 Aug. 9
 Transistor switch passes current both ways p. 79 Jan. 11
 'Tuning forks' sound a hopeful note p. 84 Sept. 20
 Two transistors simulate high-current tunnel diode p. 63 Feb. 8
 Unijunction device gets high marks in stringent tests of reliability p. 98 June 14
 Unijunction transistor latches relay with short pulses p. 62 May 3
 Unijunction transistor, The p. 87 June 14

Author Index

A

Adelman, S. M. Sr., Detonators that tune out stray r-f p. 76 May 31
 Augustine, C. F. et al, Measure it, but don't touch p. 65 Aug. 23

B

Baird, I., Pulse frequency measured by photo-conductor and scopes p. 77 June 28
 Barnes, C., Jr., Transmitters towed through air test antenna's radiation pattern p. 96 Oct. 18
 Beck, C., et al, Tv looks at the dark side p. 106 Apr. 5
 Belanger, D. S., Simple circuit increases measurement accuracy p. 69 Nov. 1
 Bergman, D. L., Electronic capacitor is continuously variable p. 89 Oct. 18
 Bialer, M. et al, Chips are down in new way to build large microsystems p. 102 Oct. 4
 Blais, P. D., Diodes protect meter from overloads p. 85 Sept. 6
 Bohm, B. N., Telemetry that's compact and reliable p. 77 May 3
 Bond, M. E., Cold-cathode tubes as triggers p. 76 Apr. 5
 Bonin, E. L., Light-coupled semiconductor switch for low-level multiplexing p. 54 Feb. 8
 Bonin, E. L. et al, What's new in semiconductor emitters and sensors p. 98 Nov. 15
 Brach, E. J., Photo-cell triggers counting circuit p. 74 June 28
 Bray, T. E., Switching with light p. 58 Nov. 1
 Brocato, L. J., Zener diode protects backward wave oscillator p. 65 Nov. 29
 Bridgeman, J. N., Crystal accurately controls avalanche pulse generator p. 112 Nov. 15
 Brokaw, A. P., Reduced loading improves accuracy of cascaded pots p. 110 Nov. 15
 Brooks, D. D. et al, Sawtooth generator uses FET as constant current source p. 87 Sept. 6
 Brown, M. F. et al, An electronic variable attenuator for use with uhf receivers p. 97 June 28
 Brueckmann, H. et al, Continuously variable delay line for frequencies below 100 Mc p. 73 May 31
 Budde, C. A., Pulse width converted to pulse sequence p. 86 Feb. 22
 Burger, R. M. et al, A broader choice of components for silicon integrated circuits p. 48 May 3
 Busignies, H., More and faster communications p. 122 Apr. 19

C

Carley, D. R. et al, Overlay transistor, Part I: The new geometry boosts power p. 71 Aug. 23
 Carr, J. W., III, et al, Satellite computers as interpreters p. 87 Nov. 29
 Carvajal, R. L., Phototransistors regulates illumination

intensity p. 101 Oct. 4
 Chunn, G. A. et al, Short-circuit protection consumes little power p. 68 Nov. 1
 Cianciola, M., Improving Darlington speed p. 83 Aug. 9
 Clark, L., Now, new unijunction geometries p. 93 June 14
 Cohen, M. et al, Electronically tuned hybrid notch filter p. 92 Mar. 8
 Cohler, E. U., Computers design the layout Part III p. 88 Nov. 1
 Cohn, N., Computers for the electric utility industry p. 124 Apr. 19
 Cook, C. R., Jr. et al, For low-cost flatpacks: remove the wires, put circuits in glass p. 99 July 12
 Covington, M. B., Jr., et al, Impedance matching with nonlinear loads p. 82 Feb. 22
 Cumming, W. A., Antenna's reflecting surfaces increase beacon bandwidth p. 77 Jan. 11
 Curtis, J. G., Crossbred technology automates production of hybrid microcircuits p. 66 June 28
 Cushman, R., Powerful scr's connected in parallel, control industry's biggest machinery p. 110 Oct. 4

D

Delpech, J. F., Simple circuit tunes audio amplifier p. 84 Mar. 22
 Triangular waveforms have 1% linearity p. 86 Apr. 5
 Dick, J. E., From war gear to coal mines p. 93 Mar. 22
 Donahue, D. J. et al, Putting the overlay to work at high frequencies Part II p. 78 Aug. 23
 Dosch, E. L., Scr switch turns off with reverse bias p. 88 Apr. 5
 Dulberger, L. H. et al, Electronics markets in 1965 p. 87 Jan. 11
 Duncan, J. D., Shortcut to calculating the Q p. 85 July 12

E

Eimbinder, J., The unijunction transistor p. 87 June 14
 Combing the field for ways to match overlays' performance Part III p. 82 Aug. 23
 The expanding market p. 96 Oct. 4
 Erdmann, R. G., Retrieving data from Gemini p. 83 May 3
 Evans, E. J., Adding force to integrated circuits p. 72 July 12
 Evezia, W. J., Finally, the armed forces get solid state communications p. 63 May 3
 Low light tv sees in the dark better than the human eye p. 78 June 28
 Automatic test equipment: A million-dollar 'screw-driver' p. 88 Aug. 23

F

Farina, D. E. et al, MOS integrated circuits save space and money p. 84 Oct. 4
 Fekete, R., Selecting the right diode for r-f switching circuits p. 70 Mar. 22
 Felker, D. E. et al, Small parts are aligned and assembled by vibration p. 106 Feb. 22
 Fenwick, R. B. et al, Step by step to a linear frequency sweep p. 66 July 26
 Ferrie, R. G., One discriminator senses pulse width and height p. 90 Apr. 19
 Finnell, R. et al, Oxide-poisoning problem solved by hole in grid cup p. 107 Feb. 22
 Franco, A. G. et al, Coding for error control: an examination of techniques p. 70 Dec. 27
 Franco, A. G. et al, Error-control systems get the message across p. 125 Nov. 15
 Fritz, W. H., Nomograph and chart pinpoint source of ripple voltage limitation p. 64 Sept. 6

G

Giroux, J. R., Multi's output duration controlled by input p. 88 Feb. 22
 Gitlin, R. M., Magnoresistors isolate load from control circuit p. 60 Feb. 8
 Gray, S. B., Local feedback improves transistor characteristics p. 108 Nov. 15
 Bipolar limiter reduces d-c loss p. 65 Nov. 29
 Grayling, B., Flat disks reduce the cost of making cathode-ray tubes p. 113 Apr. 5
 Grover, D. J., Modified flip-flop quadruples fan-out p. 67 Dec. 27

H

Haas, P., Timing circuit control relays p. 85 Mar. 22
 Hansen, D. O., Transistor circuit pulses 1,000 volts p. 86 Sept. 6
 Hari, Y., Gate circuits eliminated in scr static switch p. 80 July 12
 Harris, S. E. et al, Controlling laser oscillation p. 101 Sept. 20
 Hays, S. A., The packaging revolution, Part IV: Bigger, better multilayer boards p. 90 Nov. 29
 Hilbiber, D. F., Stable differential amplifier designed without choppers p. 73 Jan. 25
 Hirschfeld, R., IC's improve differential amplifiers—and vice versa p. 75 Aug. 9
 Honeycutt, R. K., Scr monitors power failure p. 63 July 26
 Horvath, A. Kis, Photodiodes control pulse intervals p. 72 May 31
 Howard, P. H., Feedback system detects 1% amplitude difference p. 68 May 17
 Hussian, M. I., Circuit inverts d-c voltage p. 100 Sept. 20

I
Ichikawa, A., Manual process control makes way for computers p. 110 Dec. 13
Ingemarsson, I., Darlington maintains constant unity gain p. 69 Nov. 1
Isaacson, H. M., Dip soldering in miniature—a new way to assemble modules p. 94 May 31
Iverson, J. et al., IBM's flexible addition to System 360 p. 79 Nov. 29

J
Jeynes, G., Using cold-cathode tubes to count and store p. 80 Apr. 19
Johnson, C. F. et al., Bipolar pulse detector features meter display p. 63 Nov. 29
Johnson, P., Digital system continuously converts transmitter data into meaningful units p. 102 Mar. 8
Jones, D. V., Quick-on-the-trigger design p. 105 June 14
Jones, J. T., Computer trio runs the works at big British steel mill p. 80 Jan. 25

K
Kalisz, J., Isolating transistor improves one-shot p. 76 Dec. 13
Karlin, R. A., One-transistor multi delays digital pulses p. 85 Aug. 23
Kawcyn, R. A., Transistor increases multiplier phototube sensitivity p. 83 Aug. 9
Keats, E. S., Navigational satellites: beacons for ships and planes p. 79 Feb. 8
Kelley, A. J., Research for space enters the electronics age p. 117 Apr. 19
Kerns, C. R., FET circuit stores light measurement p. 66 Nov. 1
Klein, C. P., Duty cycle is constant at any trigger frequency p. 62 July 26
Kleinberg, L. L., et al., New ways to improve transistor bias stability p. 87 Feb. 22
Kojima, T. et al., When you're second, you try harder p. 81 Dec. 13
Knowlton, D., Modulated pulse width converted to analog p. 99 Oct. 4
Ko, W. H., et al., Bioengineering: a new discipline p. 111 June 14
The special world of biotelemetry design p. 89 June 28
Kolar, R. H., Variable persistence increases oscilloscope's versatility p. 66 Nov. 29
Krochmal, R. S., et al., Controlling scr firing angle regulates d-c load voltage p. 80 Aug. 9

L
Lampell, A. A., Off-the-shelf IC's in timer p. 70 Dec. 13
Larsen, D. G., Pulse generator controls rise, fall time independently p. 98 Sept. 20
Latorre, V. R., Messages by meteor p. 102, Oct. 18
Protecting digital transmissions with optical matched filters p. 76 May 17
Lattauer, E. L., et al., Regulating bias on a ship's hull p. 84 Aug. 9
Lavigne, R. C., et al., Amplifier gain is constant despite changes in load p. 75 June 28
Lee, D. N., Rise time adjustment independent of fall time p. 76 Jan. 25
Levine, S., Just in case . . . p. 94 Apr. 5
Liben, W., Monkeys and microelectronics p. 90 Feb. 22
Loss, M., Phasing unwanted images out of microwave receivers p. 89 July 12
Lott, L. R., FET increases Schmitt trigger input impedance p. 65 July 26
Lynch, D. P., Unijunction transistor turns off latching relay p. 109 Nov. 15

Mc
McGee, M. E., FET circuit stretches 1-msec pulse to 30 hours p. 87 Apr. 5
McGinnis, R. W. et al., New masking techniques for micropower transistors p. 76 Feb. 22

M
MacDougall, M. A., Using the cold-cathode tube: Part 1 p. 78 Mar. 22
Maiman, T. H., Light on the laser's future p. 119 Apr. 19
Maloy, R. W., Transistor switch passes current both ways p. 79 Jan. 11
Mapham, N., Scr's break the frequency barrier p. 88 Sept. 6
Marcellino, F. T. et al., Circuit keeps voltage constant for welder battery p. 88 Oct. 18
Marley, J., Laminates and cribbage boards connect integrated circuits p. 67 Feb. 8
Marosi, G., Novel sweep circuit eliminates ramp pedestal p. 68 Dec. 27
Mason, J. F., Modernizing the missile range: Part I p. 94 Feb. 22
Modernizing the missile range: Part II p. 108 Mar. 8
Army lays the groundwork for satellite communications p. 86 May 31
Masters, J. I., More power to the laser—with Q switching p. 91 Oct. 18
Meadows, F. D., The picture looks better for closed circuit television p. 70 Nov. 1
Mergner, W., R-f switching matrix cuts out crosstalk p. 67 Nov. 1
Merryman, J. D., Making light of the noise problem p. 52 July 26
Mesner, M. H., Television's toughest challenge p. 80 May 17

Messin, S. et al, A solid state stereo set built in modules p. 88 Aug. 9
Middlebrook, R. D. et al, Nonreactive filter converts triangular waves to sines p. 96 Mar. 8
Milberger, W. et al, Clamp and spark gap protect twt modulator p. 64 July 26
Miller, W. A., Data dots identify aerial photos p. 106 Sept. 20
Moore, C. R., Two ways to measure distortion p. 80 Oct. 4
Moore, G. E., Cramming more components onto integrated circuits p. 114 Apr. 19
Moore, W., Photoconductors chop d-c signals levels p. 61 May 3
Moulton, C. H., Light pulse system shrinks high-voltage protection device p. 71 May 17
Murphree, F. J. et al, FET in bridge circuit gates a 300-kc signal p. 60 May 3

N
Nathanson, H. C. et al, 'Tuning forks' sound a hopeful note p. 84 Sept. 20
Newmeyer, R., Gated multivibrator output provides constant pulse width p. 69 Dec. 27
Noble, D. E., A wonderland for the consumer p. 109 Apr. 19
Nuckolls, R. L., III, Slow sweep generator controls camera shutter p. 82 Aug. 9

O
Ober, H. E. et al, Foil and styrofoam polarize radar beam p. 75 May 31
Olesen, H. H. L., Designing against radiation p. 70 Jan. 11
Olson, H., Remotely tuned crystal filter eliminates tuned transformer p. 113 Nov. 15
Osborne, C. S., Diode eliminates multivibrator bias p. 62 Feb. 8
Owen, R. P., Forming accurate dividers with nonprecise resistors p. 100 Oct. 4

P
Pacela, A., Low-cost Schmitt trigger reduces hysteresis p. 63 Nov. 29
Parks, G. S. Jr., Detector circuit measures phase and amplitude p. 84 June 14
Patillo, D. L., Pulse generator circuit doubles as modulator p. 91 Apr. 19
Peart, L. T., Picking the right potentiometer p. 78 June 14
Peddie, J. G., Scr ring counter switches up or down p. 84 Sept. 6
Perkins, R. E. et al, The capsule is no isolation booth p. 88 May 3
Peter, C. J. et al, Laser-television system developed with off-the-shelf equipment p. 75 Feb. 8
Petkunas, F., New leads and potting mate flatpacks and cordwood parts p. 96 July 12
Popodi, A. E., Reliable repertoire of display circuits p. 70 Jan. 25
Preston, K. Jr., Computing at the speed of light p. 72 Sept. 6
Prigozy, S., Zero-crossing detector provides fast sync pulses p. 91 Apr. 19

Q
Queen, I., Chopper adapts voltmeter to d-c p. 66 Nov. 1

R
Radzik, L. C. et al, Adding a component reduces recovery time p. 78 Jan. 25
Ratner, V. A., Wideband tape-recorder users claim obsolete standards impede technology p. 90 Jan. 25
Rhinehart, W. A. et al, FET performs well in balancing act p. 88 Sept. 20
Riley, W. B., Time-sharing: one machine serving many masters p. 72 Nov. 29
Riley, W. B. et al, Who's on the right track? p. 71 July 26
Rippin, J. F. Jr., Making the antenna an active partner p. 93 Aug. 9
Ristic, V. M., Simple multivibrator operates at 5 Mc p. 86 Aug. 23
Roizen, J. et al, Colorful, faithful, easy to operate: goals for an all-European tv system p. 97 Mar. 22
Rowlands, E. et al, Suppressing noise at the connector p. 56 May 17
Ruegg, F. C., Multivibrator provides bidirectional output pulses p. 87 Aug. 23
Ruggiero, E. M., Aluminum bonding is key to 40-watt microcircuits p. 98 Aug. 23

S
Scidmore, A. K., Simple diodes keep voltages constant p. 68 Sept. 6
Schaffner, G., A new look at coaxial cavities for varactor multipliers p. 56 May 17
Schenkel, F. W., Thin-film capacitance elements: which is best for your purpose? p. 67 Jan. 25
Schlickman, J. J. et al, The dark side of the laser p. 93 Apr. 19
Seal, H. R. et al, Physical exam in orbit p. 99 Apr. 5
Seashore, C. R. et al, FET detects alpha particles better and more precisely p. 64 Feb. 8
Shifman, J. C., Filter design easy as pi p. 93 Sept. 20
Sideris, G., Ferris wheel programs insertion of components p. 108 Feb. 22

Simmonds, B. D., Diode quiets input to monostable multi p. 99 Sept. 20
Sing, C., Grounded-grid circuit sweeps better than Miller or bootstrap p. 83 Mar. 22
Stemmons, J. W. et al, Better bonding methods improve hybrid circuits p. 86 Mar. 22
Slenker, S., Inductors that fit integrated circuits p. 62 May 31
Smith, B. R. et al, Matching gate potential to FET pinchoff voltage p. 81 Aug. 9
Soanes, S. V., Two transistors simulate high-current tunnel diode p. 63 Feb. 8
Someya, I., Bidding for world leadership in solid state microwave gear p. 99 Dec. 13
Soref, R. A. et al, Bright hopes for display systems: flat panels and light deflectors p. 56 Nov. 29
Sosoka, J. R., Special electrode shapes solve welding problems p. 98 Aug. 9
Springfield, W. K., Designing transmission lines into multilayer circuit boards p. 90 Nov. 1
Staller, J. J., The packaging revolution, Part I: form and function interact p. 72 Oct. 18
Staller, J. J. et al, The packaging revolution, Part II: design and manufacturing overlap p. 75 Nov. 1
Strasser, J. A. et al, Project Gemini: giant step on a stairway to the moon p. 89 Apr. 5
Strenglein, H. F., Phase demodulator needs no tuning p. 99 Oct. 4
Sugihara, Y. et al, From Japan, a startling new color tv set p. 81 May 31
Summer, S. E., Unijunction transistor latches relay with short pulses p. 62 May 3
Sydenham, P. H., Photodetector gain control aids signal discrimination p. 111 Nov. 15
Sylvan, T. P., Unijunction device gets high marks in stringent tests of reliability p. 98 June 14
Measurement of stored charge in diode clearly defines switching speed p. 84 June 28

T
Takesuye, J., Tunnel-diode sensor protects regulator from short circuit p. 75 Dec. 13
Talamini, A. J., Jr. et al, New target for radar: sharper vision with optics p. 58 Dec. 27
Tarui, Y., Japan seeks its own route to improved IC techniques p. 90 Dec. 13
Tescic, S., Pulses with variable mark-to-space-ratio p. 78 July 12
Todd, C. D., Negative resistance in FET's: an aid or an ailment p. 57 July 26
Sharp discrimination of voltage differences p. 97 Sept. 20
Togino, K., After a lull, numerical control is in demand p. 106 Dec. 13
Townes, C. H. et al, A forward look at electronics p. 106 Apr. 19

U
Uzunoglu, V., Feedback: perils and potentials in designing integrated circuits p. 67 May 31
Six possible routes to noninductive tuned circuitry p. 114 Nov. 15

V
Valliant, H. D., Scr multivibrator switches reliably p. 95 Mar. 8
Vester, B. H. et al, Rendezvous: climax of Project Gemini p. 110 Apr. 5
Vodovnik, L. et al, Electronic detours of broken nerve paths p. 110 Sept. 20
Volgelsang, P., Variable damper impedance improves tv scan linearity p. 90 Oct. 18

W
Walter, J. C., Very low frequency antennas are going back to work p. 80 Jan. 11
Ward, P., Modified decade counter eliminates components p. 74 Dec. 13
Wechsler, R., Scr's regulate a-c line voltage p. 61 Feb. 8
Good teamwork from scr's p. 60 Aug. 23
Wells, J. D., Low-cost adjustable regulator consumes little power p. 109 Nov. 15
White, L. M. et al, Infrared fault-finder pinpoints defects in multilayer boards p. 96 Nov. 29
Wieder, H. H., Silicon controlled switch can generate pulses p. 79 Jan. 25
Solid state multipliers for servosystems p. 120 Nov. 15
Wilson, R. A., Pnp plus npn equals unijunction transistor p. 94 Mar. 8
Wisnia, J. A., 10,000 volt d-c latching relay achieved with reed switch p. 64 Nov. 29
Womson, R. C., Stress-sensitive integrated circuits p. 81 July 12
Wood, M. D., Cascode amplifier stabilized by reducing internal feedback p. 70 May 17
Woody, R. F. Jr., Precise 6-volt input triggers circuit p. 80 July 12

Y
Young, L. H., Japanese technology, The new push for technical leadership p. 77 Dec. 13
The first 35 years of Electronics p. 100 Apr. 19

Z
Zane, R., Triangle generator adjusts output slopes and peaks p. 85 June 14
Zani, W. M., Campus computer helps students do their homework at Dartmouth p. 85 Nov. 29

CLASSIFIED ADVERTISING

SEARCHLIGHT SECTION

BUSINESS OPPORTUNITIES
USED OR SURPLUS EQUIPMENT



GET INSTANT MONEY!!

We want your surplus, obsolete, or excess inventory equipment, components & parts! Need ground & air communication equip., teletype, all GRC, PRC, AHC, ARN—all test equip. What have you? WE PAY TOP DOLLARS! We make deals—now! And we pay freight. Tell us what you have—not tomorrow—today!

COLUMBIA ELECTRONICS—Dept E
4365 W. Pico Blvd.,
Los Angeles, Cal. 90019

CIRCLE 952 ON READER SERVICE CARD

RADAR AUTO-TRACK & TELEMETRY ANTENNA PEDESTALS
3 & 10 CM. SCR 584 AUTOTRACK RADARS. M-33 RADAR
TPS-10 SEARCH. APS-45 TPS-10D HT. FINDERS. WX RADARS.
FPN-32GCA. APS-10 APS-15B APS-27 (AMT) SEARCH. ■ ■
APN-102 DOPPLER. DOZENS MORE. CARCINOTRONS. PFN'S.
25-5-12-3-6 MEGAWATT PULSE MODULATORS. CAVITIES.
PULSE TRANSFORMERS. IF STRIPS. WAVEGUIDE. BENDS
200 MC. 1 KMC. 3 KMC. 6 KMC. 9 KMC. 24 KMC. RF PKGS.

RADIO RESEARCH INSTRUMENT CO.
550 5TH AVE., NEW YORK 36, N. Y. JU 6-4691

CIRCLE 953 ON READER SERVICE CARD

SEMICONDUCTORS MAJOR BRANDS

INTEGRATED CIRCUITS • DIodes AMPs DAR-
LINGTONS • POWER DIODES & TRANSISTORS
• SPECIAL DEVICES

Write for Catalog S-1

SEMICONDUCTOR SALES OF CALIF.
1063 Perry Annex Whittier, Calif.
(213) 696-7544

CIRCLE 954 ON READER SERVICE CARD

New VACUUM PENCIL

for picking up miniature parts

\$7.50 ea.

Some 800 D instruments available.

PHILIP FISHMAN COMPANY
7 CAMERON ST., WELLESLEY, MASSACHUSETTS

CIRCLE 955 ON READER SERVICE CARD

Color DIAL TELEPHONES \$10.95

Factory rebuilt Western Electric in white, beige, ivory, pink, green, or blue. If 4 prong plug is required add \$2.00. Fully guaranteed. Write for free list. All shipments FOB.



SURPLUS SAVING CENTER
Dept. E-12275
Waymart, Pa.

CIRCLE 956 ON READER SERVICE CARD

"SEARCHLIGHT"

IS

Opportunity Advertising

—to help you get what you want—to help you sell what you no longer need.

Take Advantage Of It

For Every Business Want

"THINK SEARCHLIGHT FIRST"

ADDRESS BOX NO. REPLIES TO: Box No. Classified Adv. Div. of this publication. Send to office nearest you.
NEW YORK, N. Y. 10036: P. O. Box 12
CHICAGO, Ill. 60611: 645 N. Michigan Ave.
SAN FRANCISCO, Cal. 94111: 255 California St.

POSITION VACANT

Specifications Writer—Electronics \$10,090
—\$12,110 requires 4 yrs. exp. in electronic equipment field incl. preparation of purchase specs plus degree in eng. or 4 additional yrs. of exp. Write: NYS Dept. of Civil Service, R-174F, State Campus, Albany, NY 12226.

POLYMER CHEMIST or CHE.

Graduate training desirable, but not essential. For small group active in application of polymer technology in the formation of molded electronic components and in encapsulation of components by various methods.

Applicants should have five or more years experience, preferably in this type work or related technology. An asset if familiar with wide variety of polymer materials—and techniques for preparation of molding compounds, coatings and methods of forming.

New well-equipped laboratories convenient to educational and recreational facilities of metropolitan Western New York.

Submit resume and salary requirements to Director, Personnel Relations, Speer Carbon Company, Division of Air Reduction Company, Inc., St. Marys, Pa.

An Equal Opportunity Employer

SENIOR ELECTRONIC ENGINEERS

Design and project responsibility for high performance digital commercial instruments. Strong background in design/analysis solid state circuits, switching theory, analog circuits desired. BSEE or Physics. Salary open. Contact D. Condon.

ELDORADO ELECTRONICS

601 Chalamar Road
Concord, Calif. 94520
(415) 686-4200

An Equal Opportunity Employer

EMPLOYMENT OPPORTUNITIES

The advertisements in this section include all employment opportunities—executive, management, technical, selling, office, skilled, manual, etc.

Look in the forward section of the magazine for additional Employment Opportunities advertising.

— RATES —

DISPLAYED: The advertising rate is \$60.00 per inch for all advertising appearing on other than a contract basis. Contract rates quoted on request. Effective Jan. 1966, rate is \$60.00 per inch.

An advertising inch is measured 1/8" vertically on a column—3 columns—30 inches to a page.

Subject to Agency Commission.

UNDISPLAYED: \$2.70 per line, minimum 3 lines. To figure advance payment count 5 average words as a line. Box numbers—count as 1 line.

Discount of 10% if full payment is made in advance for 4 consecutive insertions.

Not subject to Agency Commission.

Send new ads to:

ELECTRONICS

Class. Adv. Div., P.O. Box 12, N.Y., N.Y. 10036

SEATTLE

UNITED CONTROL CORPORATION

An expanding work load on new contracts and an increasing business backlog, have created the following new requirements:

ELECTRONIC ENGINEERS

(Several Levels)

Capable of preliminary design and equipment development involving advanced systems concepts and hardware techniques for control equipment used in aircraft and missiles. Analysis of closed loop control systems and computer simulations. Must have demonstrated ability in design—both analytic and hardware—development, and preparation for release to manufacturing of hardware consisting of such special basic building blocks as: Integrating amplifiers, logic circuitry, voltage comparators, inverters, flip-flops, choppers, and other special purpose circuitry.

United Control Corporation, together with its 570 employees, enjoys the reputation of being one of the Pacific Northwest's most modern, well equipped, financially sound, professionally managed firms in the electronic industry.

A graduate engineer in the top 20% of his group would do well to investigate this opportunity to provide his family with excellent living conditions and have his work in an area where he can enjoy all kinds of outdoor life just a few minutes from the office.

Send your resume in confidence to:

UNITED CONTROL CORPORATION

OVERLAKE INDUSTRIAL PARK
REDMOND, WASHINGTON 98052

An equal opportunity employer

10 gram guard



Reverse-voltage defense is just one more reason for G-E tantalum foil

Forget about a surprise reverse with G-E tantalum foil capacitors. They're designed to take it. And reverse-voltage defense is just one reason for using G-E tantalum foil. Here are three others:

PROVED IN-CIRCUIT RELIABILITY: They've been proved—and improved—for over 17 years. More than 20 million have been successfully applied. G-E tantalum foil earned a 0.00023 reliability record (per 1000 hours) on Minuteman reliability tests,

based on the Minuteman acceleration factor.

NO CATASTROPHIC FAILURES: Low impedance circuits and catastrophic failures are no problem with G-E tantalum foils. They're self healing. **LONG SHELF LIFE:** We're up to the 14 year mark . . . with less than a 5% capacitance change at 25C. That's shelf life!

G-E tantalum foil capacitors are available in ratings up to 450VDC, 0.15 to 3500uf, -55 to 85 or 125C. They're

virtually risk-proof. And may cost more. But isn't a proved line your best defense?

For all the facts on G-E tantalum foil reliability, write for Reliability Report, Section 430-25, General Electric Co., Schenectady, N. Y. 12305.

ELECTRONIC COMPONENTS DIVISION

GENERAL  ELECTRIC

Electronics New subscription application

Please start my one year subscription and bill me for \$6.

I prefer 3 years for \$12. Payment enclosed. Bill company.

SUBSCRIPTION INCLUDES 1,200-PAGE ANNUAL BUYERS' GUIDE ISSUE

Name _____ Title _____

Company _____

Company address _____

City _____ State _____ Zip code 

Product manufactured _____ or Service performed _____

Please check your department or function:

Research, design, development. Production, operation, maintenance

Other (please describe): _____

L-
M-

14-L 2 5

Electronics New subscription application

Please start my one year subscription and bill me for \$6.

I prefer 3 years for \$12. Payment enclosed. Bill company.

SUBSCRIPTION INCLUDES 1,200-PAGE ANNUAL BUYERS' GUIDE ISSUE

Name _____ Title _____

Company _____

Company address _____

City _____ State _____ Zip code 

Product manufactured _____ or Service performed _____

Please check your department or function:

Research, design, development. Production, operation, maintenance

Other (please describe): _____

L-
M-

14-L 2 5

First Class
Permit No. 42
Hightstown, N. J.

Business reply mail

No postage stamp necessary if mailed in the United States

Postage will be paid by McGraw-Hill, Inc.

Electronics

**P. O. Box 514
Hightstown, N. J. 08520**

Subscription department



First Class
Permit No. 42
Hightstown, N. J.

Business reply mail

No postage stamp necessary if mailed in the United States

Postage will be paid by McGraw-Hill, Inc.

Electronics

**P. O. Box 514
Hightstown, N. J. 08520**

Subscription department



Soviet Union

Surgery calling the computer

A Moscow hospital has given a crucial task to a small, slow digital computer: it must make a diagnosis on every patient who is to undergo surgery. Officials at the Vishnevsky Institute of Surgery say their system gives a correct diagnosis 91% of the time and is never wrong; the worst it can do, they say, is reply "no diagnosis."

The institute specializes in the treatment of rheumatic virus diseases and of diseases of the heart and liver. Its diagnostic system is limited to these diseases.

Physicians explain that automatic diagnosis often relieves them of time-consuming research into a case; this is important in a country like the Soviet Union, which has a severe shortage of doctors. It also spares some patients painful tests, such as those requiring drawing of large amounts of blood or spinal fluid.

Simple hardware. In contrast with the West, where real-time computers are used widely in medical research and in data-handling at some hospitals, the Russian institute employs an almost-primitive computer to perform a simple task. The heart of the Soviet system is a Ural 2, a vacuum-tube machine with a memory of only 2,040 bits and a speed of only 8,000 operations a second.

With this computer and its peripheral equipment, together with machines that punch and sort cards, the institute has constructed a system with adaptive features, incorporating probability thresholds for identifying diseases and equipped with a medical "library" of 1,500 cases so far. About 200 cases are added to the archives annually.

The interview. When a patient checks into Vishnevsky, a doctor asks him hundreds of questions

and enters the yes-or-no replies onto a four-page questionnaire. Digital answers must be either 1 or 0; in the category "femaleness," for example, the doctor writes 1 for yes or 0 for no.

Health officials in the United States estimate that one diagnosis requires an average of 600 yes-or-no answers.

After the interview, the patient's condition and symptoms are reduced to a stack of punched cards and fed into the computer. The Ural 2 makes a probability compar-



M. L. Bykhovsky in his lab

ison between each symptom and a given disease, eliminating "impossible" diseases. For instance, if a patient's systolic and diastolic blood pressure are within certain limits, diseases of certain parts of the heart can safely be eliminated.

The computer's memory is programmed with a series of thresholds, so that equivocal results can be evaluated. If a positive diagnosis is impossible, the doctor is given a list of possible diseases for further investigation.

Probability. A supplementary system, to determine the probability of a diagnosis, is called phase-interval analysis. Soviet physicians have developed lists of symptoms common to more than one disease, and mathematical measures of any symptom's "distance" from the "center," or positive identification, of the disease. The distance is not an absolute measure, but a com-

parison with distances of that symptom from other disease centers.

This analysis gives the probability of a specific disease being present in any group of symptoms.

Phase-interval analysis requires the handling of about 10,000 bits of information and the computation of many integrals. Because of the Ural 2's limited capacity, this requires several runs in the computer.

Digital to analog. Dr. Mikhail L. Bykhovsky, director of the institute's computing center, expects to switch to analog computers. Experiments with a pair of analog machines, each containing 30 amplifiers, have convinced him and other doctors that the digital approach is too elaborate.

He notes that accuracy to 2% is sufficient for the electronics in a diagnostic system—because the doctor's role is still crucial—and that a good analog machine can give this accuracy. "After all," Bykhovsky continues, "diagnosis is, in the final analysis, an art. What the doctor needs is help in evaluating a large number of symptoms simultaneously, and in locating previous cases of the disease."

An analog computer can do just as good a job, he says, and do it less expensively than a digital machine.

The next step, according to Bykhovsky, may be a master computer system with a series of satellite analog computers. The system would be based on manufactured "memory blocks" that would be distributed to local clinics and updated at a central institute.

Other approaches. Elsewhere in the Soviet Union, computers are performing other medical tasks. The Leningrad Polytechnical Institute claims to have developed an analyzer algorithm that permits computer diagnosis in 10 to 15 minutes, based on deviations in norms for pulse, heartbeat, encephalograms and other measurements.

At Yerevan, in Armenia, research-

ers have developed a program that is said to permit a computer to analyze electrocardiograms for as many as a dozen parameters.

France

Space mail

To Arthur C. Clarke, radio engineer and science writer, communications satellites are the fulfillment of a prediction made two decades ago. Clarke, who is generally credited with being the first to write about communications satellites in precise technical terms, is still looking into the future—and seeing wonders wrought by the switchboards in the sky.

At a week-long meeting of Unesco—the United Nations Educational, Social and Cultural Organization—in Paris this month, Clarke predicted direct satellite-to-home radio and tv broadcasts in five years. He also saw:

- Mail transmitted by satellite across the Atlantic as quickly as it travels between cities in the same country.

- A nationwide newspaper for the United States, whose international editions would be printed around the world from type set on orders relayed by satellite.

- Worldwide educational television.

Phone rates. Other participants predicted that satellites would effect reductions in long-distance telephone rates, but nobody would say how much. They pointed out that present rate structures are based on distance, but that a satellite doesn't care whether a call is going 500 miles or 5,000. Some suggested a flat rate some day for calls anywhere on earth.

Other speakers stressed the problems that will accompany the benefits—problems such as frequency allocations, equipment compatibility, priority of satellite use, control of receiver facilities, government versus private ownership, and competition among different satellite systems.

Studies in space

Ten days after the French A-1 joined American and Soviet satellites in space, France's first scientific satellite sailed into orbit on the nose of a Scout booster Dec. 6 and began to analyze the wave field produced by radio transmitters operating on the ground at very low frequencies—16 to 25 kilocycles per second. The FR-1 satellite was launched in California by the United States National Aeronautics and Space Administration.

The 132-pound satellite is collecting information about five components of the very-low-frequency electromagnetic field. Loop aerials are gathering data in the ionosphere about three magnetic components, and dipole aerials are collecting data about two electric ones.

Ground transmitters. FR-1 most resembles two Lofti satellites, launched by the United States in 1961 and 1963. These also studied wave fields produced by signals from the ground. The French transmitters are at Sainte-Assise near Paris and at Balboa, Panama Canal Zone.

The French satellite amplifies the signals on board, and transmits the amplitudes back to earth by telemetry link, on command from ground stations in the United States' Stadan network and the French five-station Iris network. The data will help to learn the basic characteristics of the field—its intensity, polarization and direction of polarization—and of the medium through which the field operates—its refractive index and electron density.

Satellites in the American Explorer and the Anglo-American Ariel series studied ionospheric characteristics with transmission originating on the spacecraft. The Canadian satellite Alouette 1 is transmitting sound waves from the top of the ionosphere to the bottom; these waves never reached the ground, but made it possible to study the ionosphere's upper layers, which are difficult to probe in any other way. The Soviet Union also has conducted atmospheric studies with satellites, but details are skimpy.

Japan

Radar on the rails

Radar is preventing collisions in the air and at sea; now the Japan National Railway, operator of the 125-mile-an-hour Tokaido Express and other lines, is studying a microwave system designed to detect obstacles in the path of its swift locomotives.

The system, developed jointly with Hitachi, Ltd., transmits pulses along leaky waveguides and monitors the return signals. Short (17-nanosecond) pulses are sent through a low-loss circular waveguide adjacent to one rail. As the energy leaks out through a longitudinal slit along the waveguide, a parabolic reflector directs it across the track to another waveguide. The energy then travels back toward the transmitter, but along the opposite rail, and is detected by a receiver.

Spotter. When an obstacle is on the track between the transmitted signal and the receiving waveguide, it reflects some of the signal's energy, thereby reducing the signal's amplitude at the receiver. This decrease shows up as a deep notch on the oscilloscope display.

In the waveform shown below, the notch was caused by a man standing on the track. The system will also detect a log, a large piece of machinery or any other kind of obstacle that may have fallen onto the track.

A circular waveguide with a helical coil along its inner surface was chosen because it supports the TE₀₁ mode, which has the lowest loss of any waveguide; at 50 gigacycles per second its loss is only

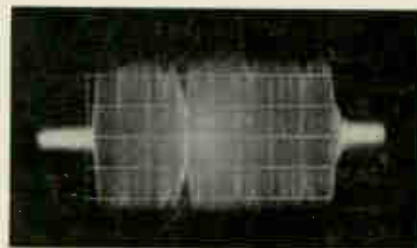

Notch in output waveform is caused by a man on the track.

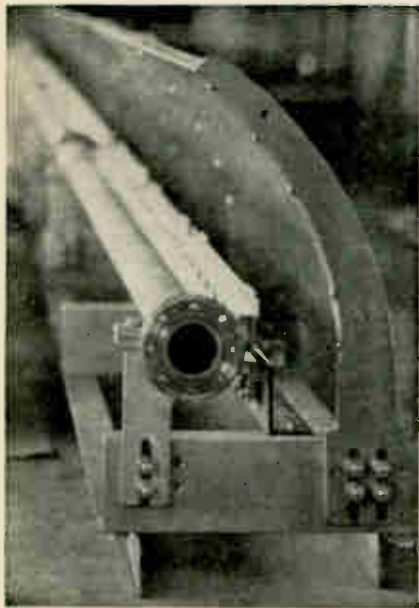

Leaky waveguide has loose-pitch helix on inner surface. Energy leaking out of longitudinal slit in waveguide is directed across track by a parabolic reflector.

4.8 decibels per kilometer. The principal source of loss is the coupling between the transmitter and receiver lines—90 db per meter of separation.

Cost obstacle. The Japanese probably will install it only on high-speed lines and possibly at busy terminals and yards. Because the system also provides position information, it would be a useful adjunct for existing monitoring equipment.

In the United States, no comparable system is known to be under study. Cost is the big drawback, according to Irwin Goldstein of the T. J. Kauffeld engineering firm of New York, a specialist in engineering for railroads. "The costs resulting from damage to railroad equipment due to obstacles on the track is very small," he declares.

Another video recorder

A second Japanese company is preparing to compete for the United States market in video tape recorders for the home. The Shiba Electric Co. says it will offer two types next spring: a helical-scan recorder for about \$500 and a linear-scan for about \$300.

The only recorders sold in America for private use are helical-scan units. The Ampex Corp. offers one for \$1,095 and the Sony Corp.—Japanese concern—has a recorder-monitor combination for \$995.

Helical vs. linear. A helical-scan recorder achieves high head-to-tape speed by moving the recording head past the tape rapidly; linear-scan machines move the tape past the head. The heads on a helical-scan recorder are mounted on a fast-revolving drum over which the tape moves slowly—7.5 inches per second in Shiba's unit.

A linear-scan recorder is similar to a standard audio recorder except that the reel-to-reel tape speed is very fast—60 inches per second for Shiba's—to allow recording at video frequencies. Linear machines have limited bandwidth and resolution, use vast amounts of tape, and often produce noisy, jittery pictures.

In Japan, another company—the Matsushita Electronics Corp.—says it will sell a helical-scan tape recorder there next spring for about \$500.

West Germany

Semiconductor battleground

Bavaria is about to become a battleground for United States semiconductor companies. Factories are planned by West German affiliates of Texas Instruments Incorporated and of the Fairchild Camera & Instrument Corp.

In February, TI expects to begin production of silicon transistors and diodes at a 10,000-square-foot building in Freising, 22 miles north-east of Munich. The company has an option to buy 25 more acres adjacent to its present 3-acre plot. Initial manufacturing will be done by 35 to 40 employees, but TI says the work force should expand to 200 by the end of the year.

Fairchild's affiliate, SGS-Fairchild GmbH, plans to make silicon planar semiconductor elements in epoxy packages, later adding a line

of integrated circuits, a spokesman says. The plant will be in Wasserburg, 30 miles east of Munich.

Why Bavaria? Freising and Wasserburg are in an area that has good transportation and training facilities, and a supply of skilled manpower in a country that suffers from an acute labor shortage. More important, perhaps, is the large concentration of electronics companies in Bavaria, putting the two new plants close to a big chunk of their market.

I. Milton LeBaron, general manager of TI's affiliate—Texas Instruments Deutschland GmbH—predicts that the German company will become the country's biggest manufacturer of semiconductor products. The parent company's sales are expected to exceed \$400 million this year.

Bottleneck alert

The 2,000-mile autobahn system in West Germany, long the international standard for highway excellence, is succumbing to the international problem of traffic proliferation. But before expanding its highway-modernization program to build new stretches of autobahn, the government is taking a hard look at an electronic system designed to warn motorists of bottlenecks ahead.

Developed by Telefunken AG in cooperation with the government's traffic ministry, the early-warning system provides for information to be transmitted to vehicles either via an attachment to the car radio or by means of a self-contained receiver in the car. Two miles from each exit, a driver would receive one of 24 prerecorded messages. Depending on what he hears, he may decide to turn off onto an alternate route.

No interference. A broadcast is triggered when a vehicle passes over a wire embedded one inch below the road's surface, in the expansion joint between concrete slabs. The wire is the start of an inductive loop enclosing an area two miles long and two lanes wide.

By limiting broadcasts to the area inside a loop, Telefunken permits

several messages to be sent without interference on the same frequency—70 kilocycles per second—on adjacent stretches of road. In this way, vehicles passing in opposite directions can receive different messages.

The loop is fed by a 40-watt transmitter coupled with a 24-track continuous tape recorder.

The cost. The warning system would be expensive—\$20 million to \$25 million for installation, according to a Telefunken official, plus about \$15 for each attachment to a car radio. But that's still a lot cheaper than building new roads.

Traffic information for broadcast would come from police cars, helicopters and perhaps traffic-sensing devices consisting of similar induction loops in the roadway but smaller than the two-mile ones for radio messages.

The Telefunken system is strictly for the open road so far. In its present form it cannot cope with city traffic because of the length of the loops—long enough for the motorist to receive the full message three times while traveling 60 miles an hour. Even at a 20-mile-an-hour speed in the city, a comparable loop would have to cover 15 streets in an area where traffic conditions might change from street to street.

The Netherlands

Electronic eye on the sky

Legend has it that a wooden-shoed moppet once saved Holland from a flood by plugging a leaky dike with his finger. With this tradition of digital control, it's not surprising that this country is a leader in applying digital computers to the control of air traffic.

A bigger reason, probably, is that the tiny Netherlands is the home of one of the world's biggest electronics companies, Philips Gloeilampenfabrieken, N.V. The Dutch system of air-traffic control, which is getting increased attention in other countries, is called Signaal after a Philips subsidiary, N.V. Hol-

landse Signaalapparaten, in Hengelo.

Three steps. Signaal's phase-one equipment has been operating since 1961 at Schiphol, Amsterdam's airport. Since then, Signaal has received orders for phase-two gear for Schiphol and for a more advanced system for the West German Air Force. Signaal calls its basic system Satco, an acronym for Signaal automatic air-traffic control.

Satco's phase one performs automatic processing of flight-data strips. Phase two, scheduled to go into operation in February, will process the flight-control boards automatically, giving the controller information for setting his control patterns. The third phase will add a plan-position indicator. The system for Germany will compare radar inputs with flight-plan information to conduct, automatically, a continuous search for collision courses.

Progress strips. Satco's phase one processes flight plans, converting them into 900 flight-progress strips a day to help air-traffic controllers keep track of planes flying into or out of the Amsterdam airport. But by February the printed strips will be on their way out as the phase-two equipment starts to take over.

The big difference in appearance is the method of display. The phase-two equipment provides an automatic alphanumeric indication on progress boards. These are made up of electromechanical indicators developed by Signaal. Rather than cathode-ray tubes, the designers wanted devices that would retain the last available flight information for the controllers in case of a power failure.

The phase-two gear will also move closer to automation of flight control. The computer automatically will check for a conflict every time a new flight plan is fed into the system. If the check shows that two planes are scheduled to reach the same place at the same time, a warning light will flash.

Free-route system. Even more sophisticated will be the Satco system to be installed next year in Bremen. It will control five military airports in West Germany, serving aircraft whose routes are not fixed

as with commercial aircraft.

For this "free route" system, inputs from a radar system will be used together with flight-plan data to aid in the continuous search for collision courses. To correct position data, the controller can compare a plane's actual position on a plan-position indicator (PPI) scope with a display of its calculated position. A "rolling ball control" on the controller's console brings computed and actual positions together, constantly changing the data stored for the aircraft in question. The system going to West Germany will have capacity in its flight-data memory to store the flight plans of 200 planes at a time.

Around the world

Great Britain. A closed-circuit television network to serve 1,000 schools is being considered by the Inner London Education Authority. It would begin operation in 1970.

Israel. In 1968, France and Israel will be linked by an 1,800-mile submarine cable through the Mediterranean Sea. The 96-channel cable will carry telephone and telegraph messages as well as some data. It will cost \$17 million, and be built by a new Franco-Israeli company owned 60% by the Israeli Ministry of Posts and Telecommunications and 40% by France Cables et Radio.

Saudi Arabia. Britain has outbid United States companies for a \$300-million agreement to supply arms to Saudi Arabia. Most of the money will go for supersonic Lightning fighter-bombers; a big share also will go for American-made anti-aircraft missiles. The Lightnings will be armed with Hawk missiles, and the sale will include radar gear.

India. A plant to manufacture electronic equipment for atomic-energy programs may be built soon by India's Atomic Energy Establishment, according to H. J. Bhabha, chairman of the agency. The plant would be near Thumba Beach, site of India's rocket-launching center for atmospheric studies.

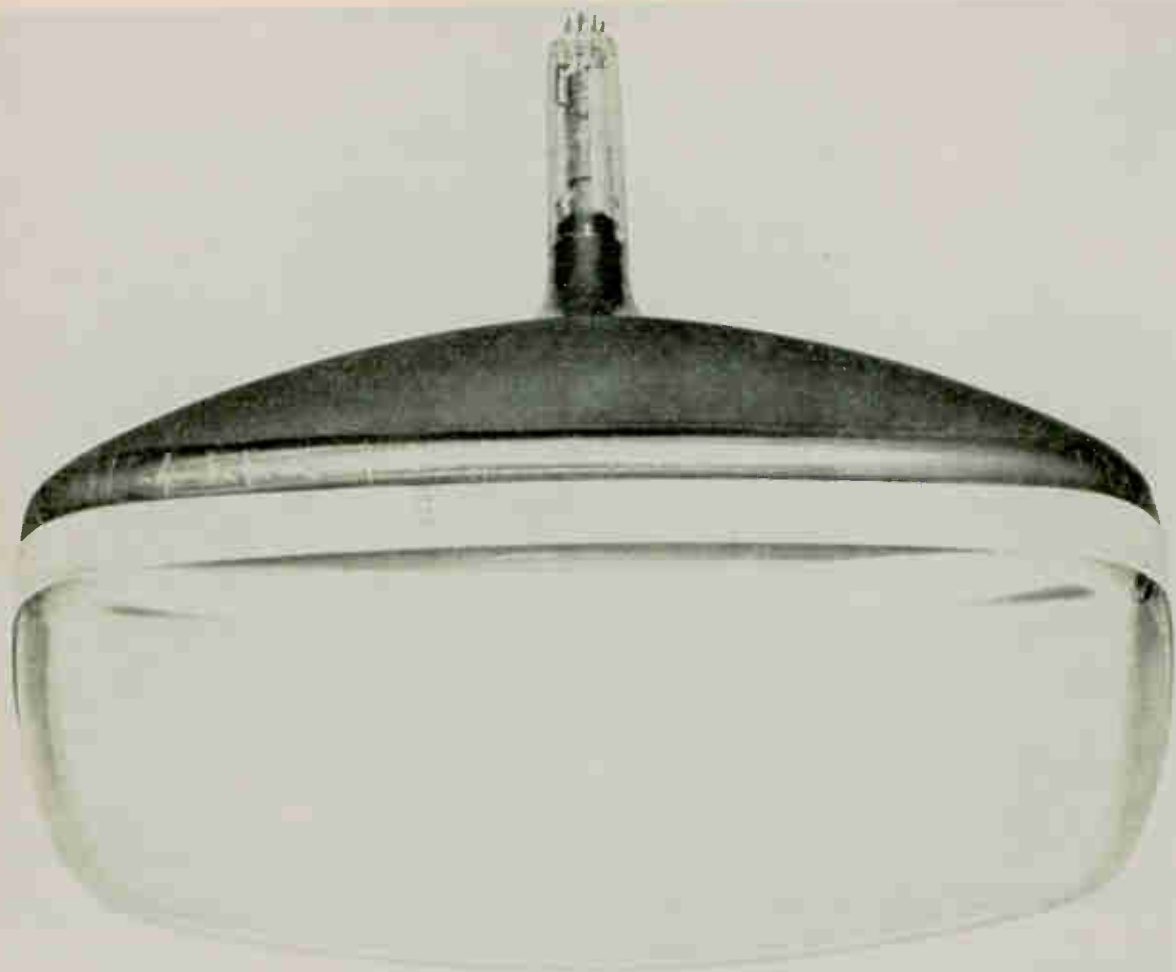

Will you be our next 12" customer?*

A simple comparison with other picture tubes (including price, naturally) ought to produce an affirmative answer.

**310AUB4 (12" b/w picture tube) $E_f=12.6$ volts
 $I_f=50$ mA Deflection: 110° T-Band Protection**

***Or a 16", 19", 23" customer?**



HITACHI SALES CORPORATION: 333, N. Michigan Avenue, Chicago 1, Ill., U.S.A. Tel: 726-4572, 4 / 666, 5th Avenue, New York, N.Y. 10019, U.S.A. Tel: 581-8844 / 12715, S. Daphne Avenue, Hawthorne, Calif., U.S.A. Tel: 757-8143
HITACHI, LTD., DUESSELDORF OFFICE: Graf Adolf Strasse 37, Duesseldorf, West Germany Tel: 10846

GLOBE

RUSH!



**WHEN YOU NEED A PROTOTYPE
MOTOR OR BLOWER RIGHT NOW
CALL GLOBE 513-222-3741
WE WILL SHIP YOUR ORDER
WITHIN 24 HOURS**

Typical sample of our extensive 24-hour stock (subject to change)

A.C. MOTORS		HYSTERESIS		SYNCHRONOUS				
type	P/N	dia.	length	torque	rpm	volts	cycles	phase
SC	53A106-2	1 1/8"	1 3/8"	.12 oz. in.	12,000	115	400	1
MC	18A107	1 1/4"	2 1/4"	.7 oz. in.	1,800	115	60	1
MC	18A108	1 1/4"	2 3/4"	.7 oz. in.	3,600	115	60	1
FC	75A119-2	1 1/8"	2 1/4"	1.0 oz. in.	1,200	115	60	1
FC	75A120-2	1 1/8"	2 1/4"	1.0 oz. in.	1,800	115	60	1
FC	75A121-2	1 1/8"	2 1/4"	1.0 oz. in.	3,600	115	60	1

D.C. MOTORS									
type	P/N	dia.	length	torque	rpm	volts	amps		
SS	41A100-13	3/8"	1 3/8"	.20 oz. in.	17,000-20,000	27	.18 to .25		
MM	3A1002-10	1 1/4"	2 1/2"	.5 oz. in.	9,000	24	.30		
LL	3A1003-1	1 1/4"	2 3/4"	1.0 oz. in.	11,000	24	.30		
GRP	166A100-7	2 1/4"	3 3/4"	.75 lb. in.	8,000	27	4.0		

GEARMOTORS				PLANETARY				
type	P/N	dia.	length	torque	rpm	volts	cycles	phase amps
MM	5A555-1	1 1/4"	3 1/4"	250 oz. in.	11.5	24 v.d.c.	—	— .6
MC	33A515-2273	1 1/4"	3.650"	525 oz. in.	5.28	115 v.a.c.	400	1 —
FC	83A114-3382	1 1/8"	3.964"	750 oz. in.	.354	115 v.a.c.	60	1 —

BLOWERS									
type	P/N	dia.	cfm @	"H ₂ O	volts	cycles	phase		
VAX-1-AC	19A1173	1 1/8"	10	.6"	26 v.a.c.	400	1		
VAX-1-DC	19A1040	1 1/8"	8.5	.5"	26 v.d.c.	—	—		
VAX-3-GN	19A908	3"	68	1.5"	115 (a.c. or d.c.)	60	—		
AC-AXIAL	19A533	2 5/8" sq.	20	0"	115 v.a.c.	60	1		
DC-AXIAL	19A522	2 5/8" sq.	58	0"	27 v.d.c.	—	—		

Globe Industries, Inc.

2275 Stanley Ave., Dayton, Ohio 45404, U.S.A., Area 513 222-3741

Circle 150 on reader service card

**"Use the Below Coupon To
Order Editorial Reprints
From Electronics!"**

Fill in, cut out the coupon, insert in envelope and mail to:

Electronics Reprint Department
330 West 42nd Street, New York, N.Y. 10036

Reprints Available:

(Price: 50¢ each unless otherwise noted.)

- Key no. R-83 A Look at Japanese Electronics Technology, 36 pages.
- Key no. R-82 Computer Time Sharing, 20 pages
- Key no. R-80 The Packaging Revolution In Microelectronics (2 part series, 32 pages.) \$1.00.
- Key no. R-79 MOS Integrated Circuits Save Space and Money, 16 pages.
- Key no. R-78 The Overlay Transistor, 4 color special feature, 15 pages.
- Key no. R-77 Cold Cathode Tubes (3 part series, 28 pages).
- Key no. R-76 Automated Trains: Who's On The Right Track? 16 pages.
- Key no. R-74 Unijunction Transistors, 24 pages.

Reprint order form

(See the above list, please order by key number.)

To help expedite mailing of your reprints, please send cash, check, or money order when you order.

Send me reprint(s) of key no(s) at ¢ each.

Name

Number & Street

City, State, Zip Code

Electronics advertisers

December 27, 1965



<ul style="list-style-type: none"> ■ AMP Incorporated 20, 21, 80 Garceau, Hargrave & McCullough Inc. Acromag Inc. 122 Watkins, Rogers Incorporated ■ Andrew Corporation 46 The Fensholt Advertising Agency ■ Automatic Electric Company 54 Tatham-Laird & Kudner Inc. 	<ul style="list-style-type: none"> Gerber Scientific Instrument Company 38 Franklin P. Folts, Inc. Globe Industries Inc. 150 Odiorne Industrial Adv. Inc. 	<ul style="list-style-type: none"> Radio Corporation of America 4th Cover Al Paul Lefton Company
<ul style="list-style-type: none"> Beckman Instruments Inc., Offner Division 17 Hixson & Jorgensen Inc. Bendix Corporation, Bendix-Pacific Division 131 Anderson-McConnell Adv. Breitling-Wakmann 130 Georges Caspari, Intl. Adv. Agency ■ Brush Instruments, Div. of Clevite Corporation 3rd Cover Carr Liggett Adv. Inc. 	<ul style="list-style-type: none"> ■ Hewlett-Packard Company 2, 50, 51 Lennen & Newell Inc. ■ Hewlett-Packard Co. Harrison Labs. Division 102 Healy Advertising Agency ■ Hewlett-Packard Co. Moseley Division Lennen & Newell Incorporated 1 Hitachi Ltd. 149 Dentsu Advertising Ltd. 	<ul style="list-style-type: none"> ■ Sargent & Greenleaf Inc. 120 Wolff Associates Inc. Signetics Corporation 114 Cunningham & Walsh Inc. Sinclair Radio Laboratories Inc. 115 John E. Hayes Company Inc. ■ Sorensen Inc. 11 Fuller & Smith & Ross Inc. Spectra Physics 27 Hal Lawrence Adv. Inc. Spectrol Electronics Corporation 39 Jones, Maher, Roberts Adv. Sprague Electric Company 5, 10, 16 The Harry P. Bridge Company Statham Instruments Inc. 129 Anderson-McConnell Adv. Agency Inc.
<ul style="list-style-type: none"> Cherry Electrical Products Corp. 125 Jd Culea Advertising Inc. Chrono-Log Corporation 152 The Hill Associates Inc. ■ Cinch Manufacturing Company 113 Stral Advertising Company Inc. ■ Clifton Precision Products Co. Div. of Litton Industries 24 Ivey Advertising Inc. Computer Control Company 52, 53 Franklin P. Folts, Incorporated Consolidated Electrodynamics Corporation 121 Hixson & Jorgensen Inc. Corning Glass Works 18, 19 The Rumrill Company Inc. Couch Ordnance Inc. 124 Culver Advertising Inc. 	<ul style="list-style-type: none"> Indium Corporation of America Inc. 152 Darvoe, Breck & MacFarland Inc. Industrial Electronic Engineers Inc. 125 Gumpertz, Bentley & Dolan Adv. International Resistance Company 118 Gray & Rogers Inc. Interstate Electronics Corporation 116 Hixson & Jorgensen Inc. 	<ul style="list-style-type: none"> Tally Corporation 101 Bonfield Associates Inc. Texas Instruments Incorporated Industrial Products Group 6 Robinson Gerrard Inc. Texas Instruments Incorporated Semiconductor Components Division 45 Don L. Baxter Inc. Transformer/Electronics 132 Dacey, Wolff & Associates
<ul style="list-style-type: none"> DeKalb County Chamber of Commerce 137 Burke Dowling Adams Inc. Deutsch Electronic Components Div. 37 Michael York/Adv. Consultant Douglas Aircraft Co. Inc. 133 J. Walter Thompson Company ■ Dressen-Barnes Corporation 122 Writing and Advertising Inc. 	<ul style="list-style-type: none"> ■ Jennings Div. of ITT 29 L.H. Waldron Advertising Jerrold Electronics Corp. 14 Irving Gould Advertising Inc. 	<ul style="list-style-type: none"> Ulano & Company, J. 43 Byrde, Richard & Pound Inc. Ultra Carbon Company 138 Church & Guisewite Adv. Inc. Unitrode Corporation 35 Electronic Marketing Assistance
<ul style="list-style-type: none"> Elektrisk Bureau 105 B.J. Kverneland Adv. Agency Erie Technological Products Co. Inc. 15 Altman-Hall Associates Esterline Angus Instrument Company, Inc. 56 Caldwell, Larkin & Sidener-Van Riper Inc. 	<ul style="list-style-type: none"> ■ Keithley Instruments Inc. 7 The Bayless Kerr Company 	<ul style="list-style-type: none"> Vector Div. of United Aircraft Corporation 128 Cunningham & Walsh Inc.
<ul style="list-style-type: none"> ■ Fairchild Instrumentation 22 The Wexton Company Inc. ■ Fairchild Semiconductor 12, 13 Faust/Day Inc. Advertising Ferranti Electric, Inc. 107 Rowlinson-Broughton Ltd. Fiberfil Inc. 126 Tri-State Advertising Co. Inc. Flying Tiger Line 44 Cole Fischer Rogow Inc. 	<ul style="list-style-type: none"> ■ Lambda Electronics Corporation 108, 109 Michel Cather Inc. ■ Lapp Insulator Company Inc. 110 Wolff Associates Inc. Lehman Brothers 152 Albert Frank, Guenther Law Lockheed-Georgia Company 134 McCann-Erickson Inc. 	<ul style="list-style-type: none"> Weinschel Engineering Company 55 S. Gunnar Myrbeck & Company
<ul style="list-style-type: none"> ■ General Electric Company, Electronic Components Sales Div. 144 George R. Nelson Inc. ■ General Electric Company, Silicone Products Dept. 117 Ross Roy Inc. General Electrodynamics Corporation 136 Evans Young Wyatt Adv. General Radio Company 2nd Cover K.E. Morang Company 	<ul style="list-style-type: none"> Machlett Laboratories Inc., The 9 Fuller & Smith & Ross Inc. ■ Mallory & Company, P.R. 49 The Aitkin-Kynett Company Markem Machine Company 127 Culver Advertising Inc. Maryland Telecommunications Inc. 111 Raymond E. Finn Advertising McGraw-Hill Book Co. Inc. 135 ■ Micro Switch Div. of Honeywell 42 Batten, Barton, Durstine & Osborn Inc. Motorola Semiconductor Products Inc. 40, 41 Lane and Bird Advertising Inc. 	<hr/> <p>Classified advertising</p> <p>F.J. Eberle, Business Mgr.</p> <p>EMPLOYMENT OPPORTUNITIES 143</p> <p>EQUIPMENT (Used or Surplus New) For Sale 143</p> <hr/> <p>Advertisers Index</p> <p>Columbia Electronics 143</p> <p>Eldorado Electronics 143</p> <p>Fishman, Philip 143</p> <p>Radio Research Instrument Co. 143</p> <p>Semiconductor Sales of Calif 143</p> <p>Speer Carbon Co. 143</p> <p>Surplus Saving Center 143</p> <p>United Control Corp. 143</p> <hr/> <p>■ For more information on complete product line see advertisement in the latest Electronics Buyers' Guide</p>

Executive, editorial, circulation and advertising offices: McGraw-Hill Building, 330 West 42nd Street, New York, N.Y., 10036. Telephone (212) 971-3333. Teletype TWX N.Y. 212 640-4646. Cable: McGraw-Hill, N.Y. Officers of the Publications Division: Shelton Fisher, President; Vice Presidents: Joseph H. Allen, Operations; Robert F. Boger, Administration; John R. Callahan, Editorial; Erwin E. DeGraff, Circulation; Donald C. McGraw, Jr., Advertising Sales; Angelo R. Venezian, Marketing. Officers of the Corporation: Donald C. McGraw, President; L. Keith Goodrich, Hugh J. Kelly and Robert E. Slaughter, Executive Vice Presidents; John J. Cooke, Vice President and Secretary; John L. McGraw, Treasurer. Title R registered U.S. Patent Office; © copyright 1965 by McGraw-Hill, Inc. All rights reserved, including the right to reproduce the contents of this publication, in whole or in part.

This announcement is neither an offer to sell nor a solicitation of an offer to buy these securities. The offer is made only by the Prospectus.

Not a New Issue

635,000 Shares



Tektronix, Inc.

Common Shares
(without par value)

Price \$33.25 per Share

Copies of the Prospectus may be obtained in any State only from such of the several Underwriters, including the undersigned, as may lawfully offer these securities in such State.

Lehman Brothers

Blyth & Co., Inc.

Eastman Dillon, Union Securities & Co.

Hornblower & Weeks-Hemphill, Noyes

Lazard Frères & Co.

Wertheim & Co.

Bache & Co.
Incorporated

Carl M. Loeb, Rhoades & Co.

White, Weld & Co.
Incorporated

The First Boston Corporation

Goldman, Sachs & Co.

Kidder, Peabody & Co.
Incorporated

Smith, Barney & Co.
Incorporated

Dean Witter & Co.

Paribas Corporation

December 3, 1965.

Circle 208 on reader service card



Advertising sales staff

Gordon Jones [212] 971-2210
Advertising sales manager

Atlanta, Ga. 30309: Gus H. Krimsier,
Michael H. Miller, 1375 Peachtree St. N.E.,
[404] TR 5-0523

Boston, Mass. 02116: William S. Hodgkinson
McGraw-Hill Building, Copley Square
[617] CO 2-1160

Chicago, Ill. 60611: Robert M. Denmead,
J. Bradley MacKimm
645 North Michigan Avenue,
[312] MO 4-5800

Cleveland, Ohio 44113: Paul T. Fegley, 55
Public Square, [216] SU 1-7000

Dallas, Texas 75201: Richard P. Poole, The
Vaughn Building, 1712 Commerce Street,
[214] RI 7-9721

Denver, Colo. 80202: Joseph C. Page, David
M. Watson, Tower Bldg., 1700 Broadway,
[303] AL 5-2981

Detroit, Michigan 48226: Paul T. Fegley
856 Penobscot Building
[313] 962-1793

Houston, Texas 77002: Kenneth George,
2270 Humble Bldg.,
[713] CA 4-8381

Los Angeles, Calif. 90017: Ashley P.
Hartman, John G. Zisch, 1125 W. 6th St.,
[213] HU 2-5450

Minneapolis, Minn. 55402: J. Bradley
MacKimm 1104 Northstar Center
[612] 332-7425

New York, N. Y. 10036:
Donald R. Furth [212] 971-3615
Frank LeBeau [212] 971-3615
George F. Werner [212] 971-3615
500 Fifth Avenue

Philadelphia, Pa. 19103: William J. Boyle,
Warren H. Gardner, 6 Penn Center Plaza,
[215] LO 8-6161

Pittsburgh, Pa. 15222: Paul T. Fegley,
4 Gateway Center, (412) 391-1314

Portland, Ore. 97204: James T. Hauptli,
Pacific Building, Yamhill Street,
(503) CA3-5118

St. Louis, Mo. 63105: Robert M. Denmead
The Clayton Tower, 7751 Carondelet Ave.
[314] PA5-7285

San Francisco, Calif. 94111:
James T. Hauptli, 255 California Street,
[415] DO 2-4600

London W1: John W. Patten, Edwin S.
Murphy Jr., 34 Dover Street,
Hyde Park 1451

Milan: 1, via
Baracchini Phone: 86-90-617
86-90-656

Frankfurt/Main: Gerd Hinske, 85
Westendstrasse Phone: 77 26 65 and
77 30 59

Geneva: Michael R. Zeynel, Joseph Wuensch,
1, rue du Temple
Phone: 31 95 60

Paris VIII: Denis Jacob, 17 Avenue
Matignon ALMA-0452

Tokyo: Nobuyuki Sato, 1, Kotohiracho
Shiba, Minato-Ku (502) 0656

Osaka: Ryosi Kobayashi, 163, Umegee-cho,
Kita-ku [362] 8771

Hugh J. Quinn: [212] 971-2335
Manager Electronics Buyers' Guide

David M. Tempest: [212] 971-3139
Promotion manager

Milton Drake: [212] 971-3485
Market research manager

Wallace C. Carmichael [212] 971-3191
Business manager

Theodore R. Gelpel: [212] 971-2044
Production manager

DIGITAL CLOCKS

for

- ✓ REAL TIME
- ✓ ELAPSED TIME
- ✓ COUNTDOWN APPLICATIONS

with accuracy and reliability established during eight years of actual field operation. You can use these precision instruments with utmost confidence to provide date and time for:

- Data-handling systems
- Data loggers
- Data transmission systems
- Time displays
- Telemetering systems
- Computer systems

Both solid state and electro-mechanical models are available. And our prices are far lower than you might think.

To get the full story on the entire line, write for complete technical literature, or phone (215) EL-6-6771.



CHRONO-LOG CORP.
2583 W. CHESTER PIKE, BROOMALL, PA.

As a prime source . . .

WE HAVE

INDIUM

WE ARE THE PIONEERS IN PROCESSING

INDIUM

WE ARE THE ORIGINAL FABRICATORS OF

INDIUM

WE KNOW HOW TO USE

INDIUM

- Indium metal and alloys—standard and high purity grades • Indium pellets • Indium wire
- Indium foil • Indium oxide all purities • Indium plating solutions • Indium salts • Indium powders
- Indium ribbon • Indium spheres • Gallium



SOLDER KIT 13 Indalloy solders and 5 fluxes plus full instructions and an Indium test chart. \$16.50. Write Dept. E1.

We welcome your inquiries

INDIUM Corporation of America
1676 Lincoln Avenue
Dept. E1 • Utica, New York

Since 1934 . . . pioneers in the Development and Applications of Indium for Industry

Circle 209 on reader service card

Another Brush Innovation in Recording:

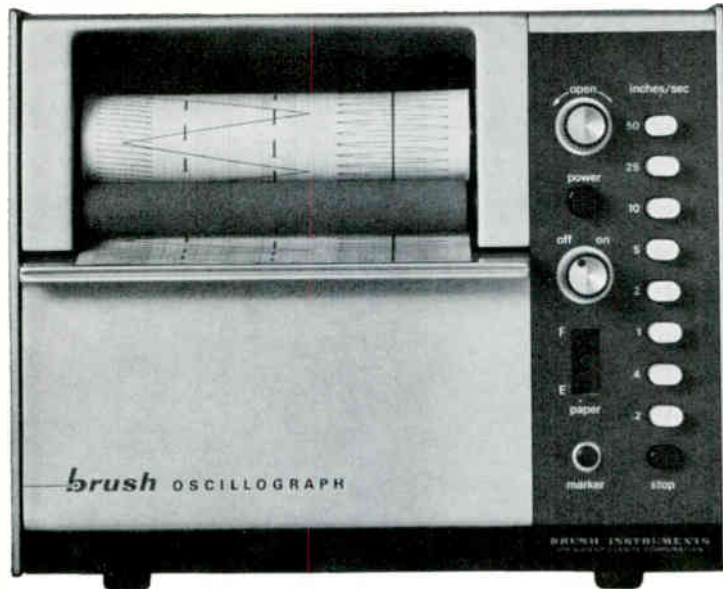

The Brush 2300.

Best recorder around
for getting lots of data down
on one piece of paper.

No wonder the Brush 2300 light beam recorder can handle just about any industrial recording job you can name.

It's available with 1 to 16 analog channels. Writing speeds from 0 to 30,000 inches per second. Push-button choice of eight different chart speeds—or sixteen if you like. And all the frequency response you'll ever need.

Power requirements? Next to nothing . . . even operates off a car battery. One model operates off flashlight batteries!

And here's the topper. *Anyone, anywhere* can operate a 2300. The controls are logically grouped, chart paper loads from the front and the

galvos can be switched and adjusted in seconds. Simple. Rugged. Lightweight. Low cost per channel. That's the 2300. The common-sense selection for almost every industrial recording requirement.

A demonstration will prove it.

Get in touch with your local Brush Sales Engineer. Or, call us collect . . . 216—EN 1-3315. An illustrated brochure is yours for the asking. Brush Instruments Division, Clevite Corporation, 37th & Perkins, Cleveland, Ohio 44114.

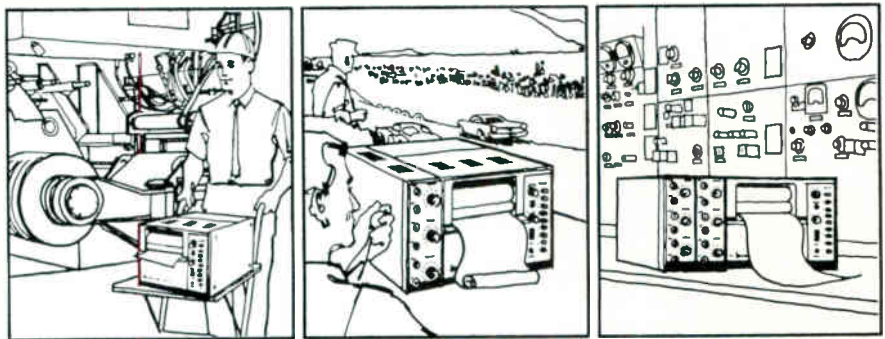

brush INSTRUMENTS DIVISION

CLEVITE

Circle 901 on reader service card

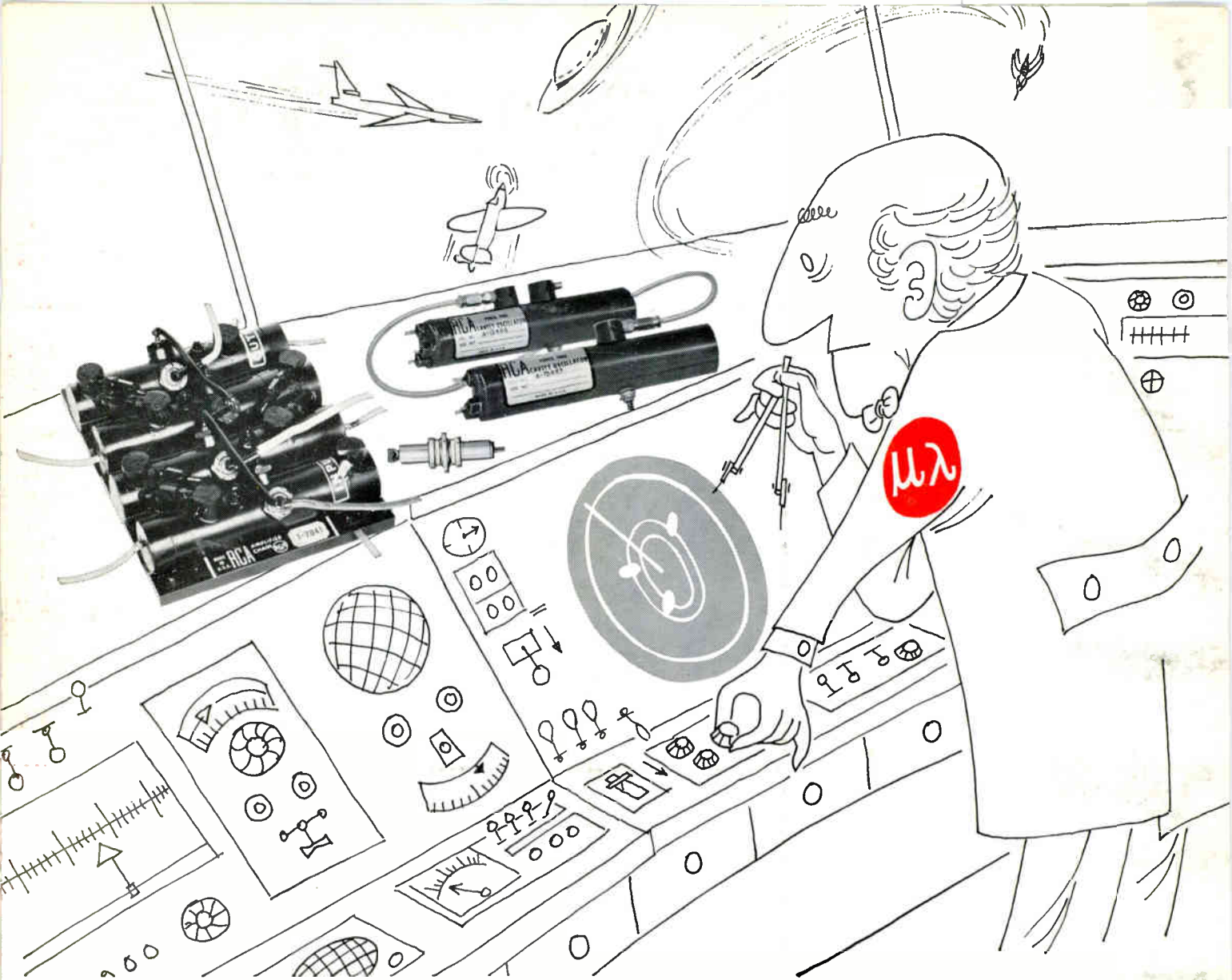

Bothered by unidentified flying objects?

THINK RCA FOR AIMS/FAA INTERROGATORS AND TRANSPONDERS

Think RCA to solve your identification systems design! RCA offers a new, total microwave capability—from pencil triodes to complete, complex packages—designed to meet the stringent grid-pulse specifications of AIMS/FAA interrogators and transponders.

With these RCA units, you can design sophisticated lightweight systems for transmitting traffic control and altitude information in aircraft, target drones, satellites, and ICBM experiments. Modified versions of these devices are also applicable in ground-to-ground intrusion alarm interrogation systems.

Reflecting precision control of both tube and cavity, the RCA types employing integral design have improved efficiency in pulse applications for better life, and also have improved stability, less weight, and small size. Integral design also greatly simplifies maintenance and logistic requirements.

Check the chart for some of the RCA devices which lend themselves to AIMS/FAA requirements (even under worst conditions). For technical data on specific types, write: Commercial Engineering, Section L19Q-4, RCA Electronic Components and Devices, Harrison, N.J.

INTEGRAL CAVITY TYPES	PEAK POWER OUTPUT (WATTS)	FREQUENCY Mc/s	PEAK PLATE POWER INPUT (at .001)	TYPICAL SIZE	WEIGHT
4060-4061 (A15487-A15488) Osc./Amp.	500	1090	2.0 Kw	4 $\frac{3}{8}$ " x 7 $\frac{1}{8}$ " 4 $\frac{3}{8}$ " x 7 $\frac{1}{8}$ "	7 oz. Total
J2041 4-Stage Amp.	200 45 dB Gain	1030	1.1 Kw	4.5" x 5.5" x 1.25"	12 oz. Total
A15551-A15552 Osc./Amp.	1000	1090	4.0 Kw	4 $\frac{3}{8}$ " x 7 $\frac{1}{8}$ " 4 $\frac{3}{8}$ " x 7 $\frac{1}{8}$ "	7 oz. Total
A15550	50	1030	0.2 Kw	10" x 7 $\frac{1}{8}$ "	3.5 oz. Total
PENCIL TRIODES					
4028A Ceramic-Metal	1000	Up to 3300	4.8 Kw	1.5" x 0.5"	0.3 oz.
4055 Ceramic-Metal	1300	Up to 3300	5.2 Kw	1.7" x 0.5"	0.4 oz.
4058 Glass-Metal	800	Up to 3300	5.2 Kw	2.2" x 0.5"	0.4 oz.



The Most Trusted Name in Electronics