

Electronics®

Boosting laser power by Q-switching: page 91

Airborne equipment tests antennas: page 96

Communicating via meteor trails: page 102

October 18, 1965

75 cents

A McGraw-Hill Publication

Below: Integrated circuits bring new packaging concepts: page 72

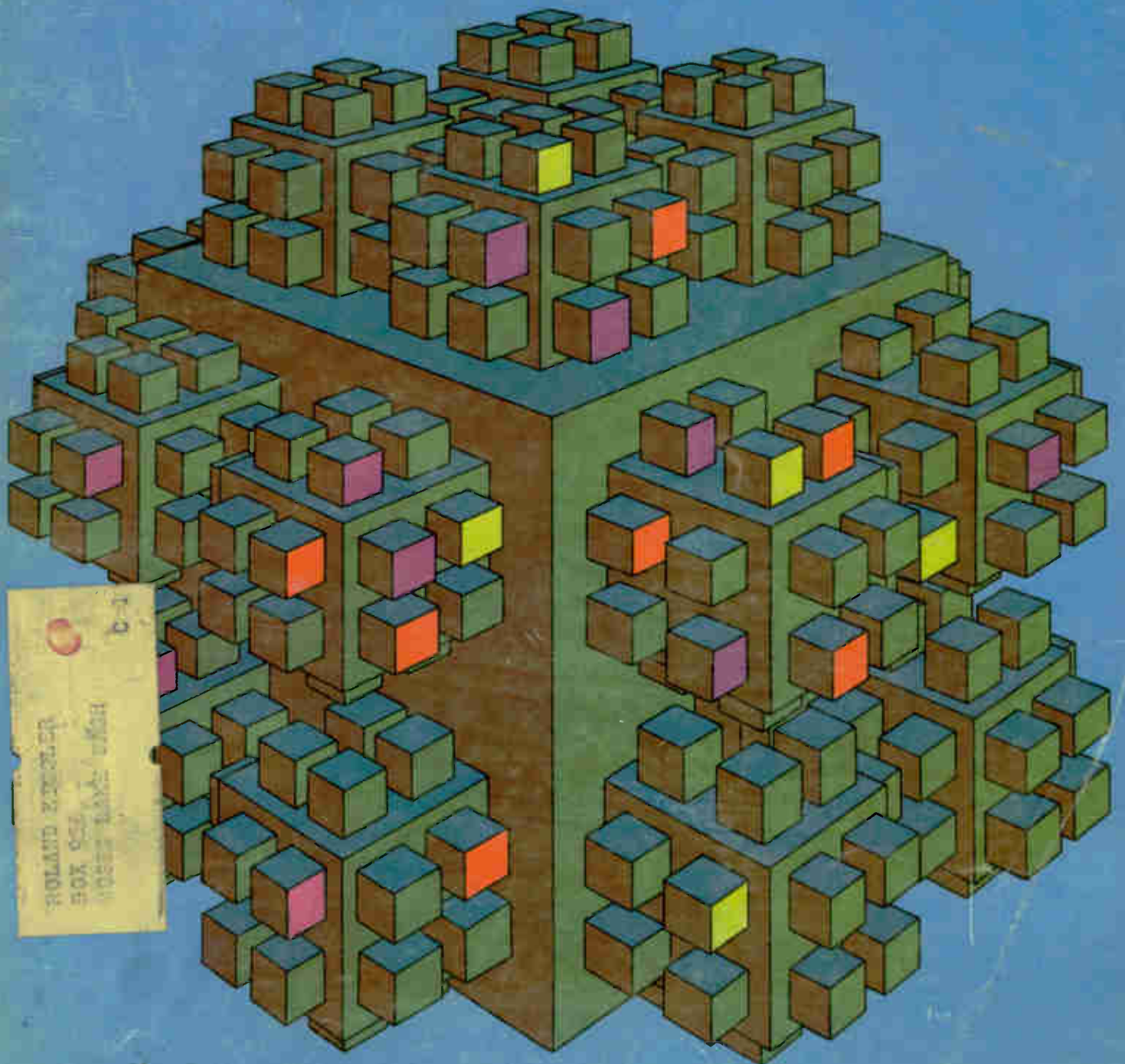



DI-T200™ SERIES

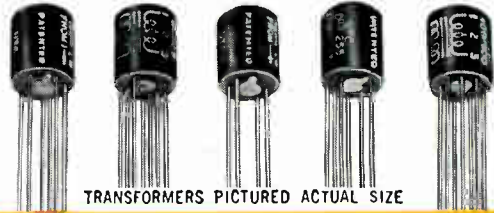

ULTRAMINIATURE TRANSISTOR TRANSFORMERS & INDUCTORS

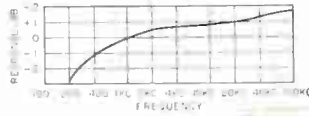
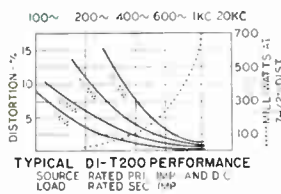

- DUMET LEADS
(gold plated, weldable and solderable)
- STRAIGHT PIN TERMINALS
(printed circuit application)
- HIGHEST PERFORMANCE
for size in the industry
- METAL ENCASED
(Grade 4, Ruggedized)

**ALL STOCK UNITS MIL TYPE TF4RX
Class "S" Available on Special Order**

High Power Rating up to 100 times greater.
Excellent Response twice as good at low end.
Low Distortion reduced 80%.
High Efficiency up to 30% better . . . compare DCR.
Moisture Proof hermetically sealed to MIL-T-27B.
Ultraminiature Size 5/16 Dia. x 3/8" H, 1/15 Oz.

Type No.	Pri. Imp.	DC ma \pm in Pri.	Sec. Imp.	Pri. Res.	Mw Level	Application
DI-T225	80 CT 100 CT	12 10	32 split 40 split	10	500	Interstage
DI-T230	300 CT	7	600 CT	20	500	Output or line to line
DI-T235	400 CT 500 CT	8 6	40 split 50 Split	50	500	Interstage
DI-T240	400 CT 500 CT	8 6	400 split 500 split	50	500	Interstage or output (Ratio 2:1:1)
DI-T245	500 CT 600 CT	3 3	50 CT 60 CT	65	500	Output or matching
DI-T250	500 CT	5.5	600 CT	35	500	Output or line to line or mixing
DI-T255	1,000 CT 1,200 CT	3 3	50 CT 60 CT	110	500	Output or matching
DI-T260	1,500 CT	3	600 CT	90	500	Output to line
DI-T265	2,000 CT 2,500 CT	3 3	8,000 split 10,000 split	180	100	Isol. or interstage (Ratio 1:1:1)
DI-T270	10,000 CT 12,000 CT	1 1	500 CT 600 CT	870	100	Output or driver
DI-T273	10,000 CT 12,500 CT	1 1	1,200 CT 1,500 CT	870	100	Output or driver
DI-T276	10,000 CT 12,000 CT	1 1	2,000 CT 2,400 CT	870	100	Interstage or driver
DI-T278	10,000 CT 12,500 CT	1 1	2,000 split 2,500 split	620	100	Interstage or driver
DI-T283	10,000 CT 12,000 CT	1 1	10,000 CT 12,000 CT	970	100	Isol. or interstage (Ratio 1:1)
DI-T288	20,000 CT 30,000 CT	.5 .5	800 CT 1,200 CT	870	50	Interstage or driver
DI-T204	Split Inductor (2 wds)	§ .1 Hys @ 4 maDC, .08 Hys @ 10 maDC, DCR 25 Ω §§ .025 Hys @ 8 maDC, .02 Hys @ 20 maDC, DCR 6 Ω				
DI-T208	Split Inductor (2 wds)	§ .9 Hys @ 2 maDC, .5 Hys @ 6 maDC, DCR 105 Ω §§ .2 Hys @ 4 maDC, .1 Hys @ 12 maDC, DCR 26 Ω				
DI-T212	Split Inductor (2 wds)	§ 2.5 Hys @ 2 maDC, .9 Hys @ 4 maDC, DCR 630 Ω §§ .6 Hys @ 4 maDC, .2 Hys @ 8 maDC, DCR 157 Ω				
DI-T216	Split Inductor (2 wds)	§ 4.5 Hys @ 2 maDC, 1.2 Hys @ 4 maDC, DCR 2300 Ω §§ 1.1 Hys @ 4 maDC, .3 Hys @ 8 maDC, DCR 575 Ω				

DCma shown is for single ended usage (under 5% distortion—100mw—1KC) . . . for push pull. DCma can be any balanced value taken by 5W transistors (under 5% distortion—500mw—1KC) DI-T200 units have been designed for transistor application only . . . not for vacuum tube service. U.S. Pat. No. 2,949,591 other pending. Where windings are listed as split, 1/4 of the listed impedance is available by paralleling the winding. §Series connected; §§Parallel connected.

The unique structural design of the DI-T200 series transformers and inductors provides the excellent electrical characteristics, high reliability and wide application possibilities inherent in the UTC DO-T family of miniaturized units. The DI-T200 series units employ the same high quality design found in UTC's DO-T, DI-T, and PIP lines. This unique transformer constructural concept affords unprecedented power handling capabilities coupled with extremely small size. Further, the high degree of reliability has been dynamically proven in the field. These characteristics are basic in the structure, which is ruggedized, hermetically sealed, employing a completely rigid bobbin, eliminating stress and wire movement. The turns are circular in shape rather than square, eliminating turn corner stress, and effecting uniform wire lay. The coil wire and external lead are rigidly anchored terminal board fashion, employing no tapes and brought out through strain relief. The curves illustrated indicate the superior performance of these units compared to similar size units now on the market.

The leads are uninsulated 1" long, .016 D Dumet wire, spaced on a .1" radius circle to conform to terminal spacing techniques of the "T0-5" case semiconductors and micrologic elements.

**IMMEDIATE DELIVERY
FROM STOCK**

Write for catalog of over
1,300 UTC HIGH RELIABILITY
STOCK ITEMS
IMMEDIATELY AVAILABLE
from your local distributor.



UNITED TRANSFORMER CORP.

150 VARICK STREET, NEW YORK 13, N. Y.

PACIFIC MFG. DIVISION: 3630 EASTHAM DRIVE, CULVER CITY, CALIF.
EXPORT DIVISION: 13 EAST 40th STREET, NEW YORK 16, N. Y. CABLE: "ARLAB"

Circle 900 on reader service card

DISTORTION ANALYZERS GO SOLID-STATE



to offer you harmonic distortion measurements 5 cps to 600 kc with 0.1% full-scale distortion sensitivity...plus these features:

"AUTOMATIC NULLING" for simple, fast measurements

0.3 v rms input sensitivity for 100% Set Level reference

300 μ v rms voltmeter full-scale sensitivity (residual noise < 25 μ v)

Solid-state design in four Hewlett-Packard distortion analyzers offers you extended frequency range, greater Set Level sensitivity, improved selectivity, greater overall accuracy, unprecedented ease of use. All four measure total distortion down to 0.1% full scale, 5 cps to 600 kc, with harmonics indicated to 3 mc. They measure voltage 300 μ v to 300 v full scale, have flat frequency response 5 cps to 3 mc. Distortion analyzer and voltmeter input terminals are the same. One-megohm input impedance. Floating input and floating, low-distortion output for scope or true rms voltmeter monitoring.

Two models feature automatic fundamental nulling (>80 db rejection): Manually null to less than 10% of the Set Level reference, flip a switch, and nulling is completed automatically. No more tedious tuning on the more sensitive ranges! Two other models employ high reduction gear drive to aid manual tuning.

Two of the analyzers provide a switchable high-pass filter which attenuates frequencies below 400 cps on signals greater than 1 kc . . . removes hum and gives you pure distortion measurements.

Two models incorporate an amplitude modulation detector that covers 500 kc to greater than 65 mc, measures distortion at carrier levels as low as 1 v. Options include an indicating meter with VU ballistic characteristics (O1) and rear terminals in parallel with front input terminals (O2).

Ask your Hewlett-Packard field engineer for a demonstration of the model incorporating features most useful to your application. Or write for technical data on all four models to Hewlett-Packard, Palo Alto, Calif. 94304, Tel. (415) 326-7000; Europe: 54 Route des Acacias, Geneva; Canada: 8270 Mayrand St., Montreal.

Model	Automatic Fundamental Nulling	High-Pass Filter	AM Detector	Gear Reduction Tuning	Price
331A				✓	\$590
332A			✓	✓	\$620
333A	✓	✓			\$760
334A	✓	✓	✓		\$790

Data subject to change without notice. Prices f. o. b. factory.

HEWLETT  PACKARD
An extra measure of quality

Multiply the advantages of
100mm
wide chart recording

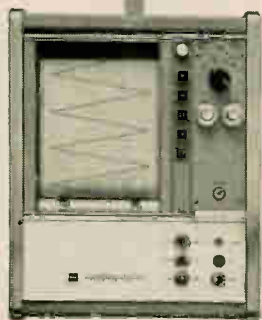

by two... four... six
(or any number the test calls for)

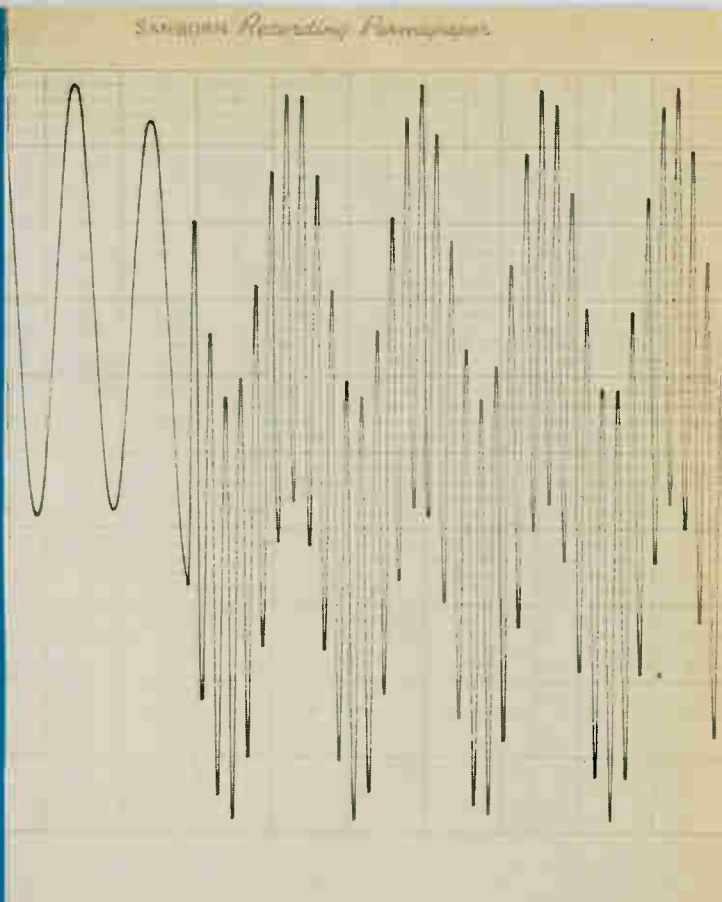
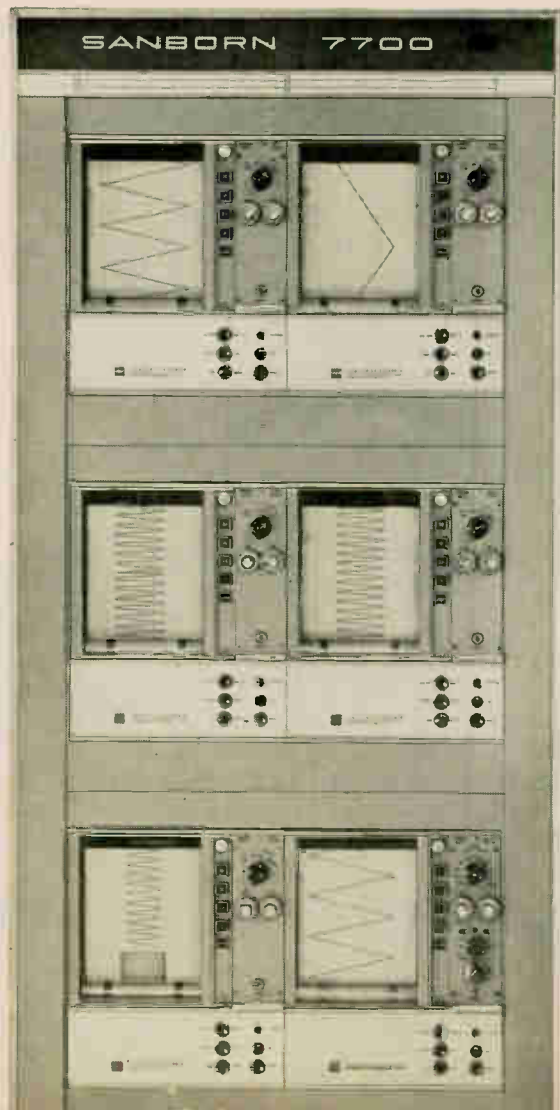

All the advantages of the Sanborn single-channel 100 mm wide-chart recorder are now immediately applicable to tests requiring measurement of 2, 3, 4, 6 or more parameters.

You see the signal far more clearly on 100 mm wide charts. Amplitude variations representing changes as small as 1 uv can be easily resolved.

You have precise control and wide signal conditioning capabilities with interchangeable plug-in preamplifiers — just plug in the one you need. Four different DC preamplifiers are available with sensitivities of 1 uv/div (to 250 V full scale), 1 mv/div, 5 mv/div and 20 mv/div; all except the last have zero suppression to expand the portion of signal of greatest interest. High-gain type has floating and guarded input. Carrier preamplifier for AC transducer outputs has 10 uv/div sensitivity. Phase-sensitive demodulator preamplifiers measure in-phase or 180° out-of-phase components with respect to a 60 cps to 20 kc reference.

You can record at four chart speeds from 0.5 mm to 50 mm/sec. — or at eight speeds from 0.5 mm/min. to 50 mm/sec. with optional version.

You pay for only as many channels as you need — unused channels are not operating needlessly. Measure similar or unrelated parameters individually or simultaneously. And you still have portability: take one complete channel into the field by removing lightweight, compact recorder from the cabinet and using it in its own carrying case.

System may be ordered with as few as two or as many as eight recorders — from \$2925 to \$10,050. Call your local H-P Field Engineering Office for complete specifications and application help . . . to put the right instrumentation to work on your measurement/signal conditioning/recording requirements. Or write Sanborn Division of Hewlett-Packard, Waltham, Mass. 02154. In Europe, Hewlett-Packard S.A., Route des Acacias 54, Geneva, Switzerland.

**HEWLETT
PACKARD**  **SANBORN
DIVISION**

Electronics

October 18, 1965
Volume 38, Number 21

Page 4	Readers Comment
8	People
14	Meetings
16	Meeting Preview
23	Editorial
25	Electronics Newsletter
55	Washington Newsletter
143	New Products
182	New Books
184	Technical Abstracts
191	New Literature

Electronics Review

Page 41	Solid state klystron	46	Gambling against transistors
42	Sensing danger		
42	Earthquake DEW line	47	Triple-deckers
43	In deep water	48	Moving holograms
44	Sound effects	49	Electronics notes
46	Color by cholesterol		

Probing the News

123	Come on in! The water's fine
126	Lockheed's C-5A contract
130	Talking Apollo out of earth-orbit

Electronics Abroad

193	Market for nuclear power	195	Yen counter
		195	Trade with the West
193	New computers	196	Down with interference
194	Sound diagnosis	196	Around the world

Technical Articles

I. Design

Integrated circuits	72	The packaging revolution: part I (cover) Building complex systems with IC's requires radically new design concepts J.J. Staller, Sylvania Electronic Systems
Circuit design	88	Designer's casebook <input type="checkbox"/> Circuit keeps voltage constant for welder battery <input type="checkbox"/> Electronic capacitor is continuously variable <input type="checkbox"/> Variable damper impedance improves tv scan linearity
Advanced technology	91	More power to the laser—with Q switching Both active and passive devices can boost pulsed laser output to gigawatts Joseph I. Masters, Technical Operations, Inc.

II. Application

Instrumentation	96	Transmitters, towed through air, test antenna's radiation pattern Measurement technique overcomes terrain problems in testing large antennas Cecil Barnes Jr., Stanford Research Institute
Communications	102	Messages by meteor Bouncing signals off meteor trails over the horizon provides stable, low-cost transmission Victor R. Latorre, University of California

Title R registered
U.S. Patent Office;
© copyright 1965
by McGraw-Hill, Inc.
All rights reserved,
including the right to
reproduce the contents
of this publication,
in whole or in part.

Electronics

Editor: Lewis H. Young

Senior editors

Technical: Samuel Weber
News: Kemp Anderson Jr.

Senior associate editors: John F. Mason, George Sideris

Department editors

Advanced technology: Joan Blum
Avionics: W.J. Evanzia
Circuit design: Michael Elia
Components: Michael F. Tomaino
Computers: Wallace B. Riley
Consumer electronics: Richard Lipkin
Electronics review: Stanley Zarowin
Industrial electronics: Robert Cushman
Instrumentation: Carl Moskowitz
Manufacturing: George Sideris
Military electronics: John F. Mason
New products: William P. O'Brien
Solid state: Jerome Eimbinder
Space electronics: Peter R. Sigmund
Special projects: Richard M. Machol

Regional editors

Boston: Thomas Maguire, editor; Robin Carlson
Los Angeles: William B. Wallace, editor; June Ranill
San Francisco: Laurence D. Shergalis, Edmond G. Addeo, editors; Mary Jo Jadin

Copy editors

Howard Rausch, Sally Powell, Walter Barney

Graphic design

Art director: Saul Sussman
Assistant art director: Donna M. Marchyn
Editorial production: Ann Mella
Production editor: Arthur C. Miller

Editorial secretaries: Claire Benell, Mary D'Angelo, Lynn Emery, Kay Fontana, Carolyn Michnowicz, Lorraine Longo, Lorraine Werner

McGraw-Hill News Service

Director: John Wilhelm; **Atlanta:** Fran Ridgway; **Chicago:** Bruce Cross, Louis S. Gomolak; **Cleveland:** Arthur Zimmerman; **Dallas:** Marvin Reid; **Detroit:** N. Hunter; **Los Angeles:** Michael Murphy, Ron Lovell; **San Francisco:** Margaret Ralston; **Seattle:** Ray Bloomburg; **Washington:** Arthur L. Moore, Charles Gardner, Herbert W. Cheshire, Seth Payne, Warren Burkett, Warren Kornberg

McGraw-Hill World News Service

Bonn: Robert Dorang; **Brussels:** Arthur Erikson; **London:** John Shinn; **Mexico City:** Wesley Perry; **Milan:** Bruce Bendow; **Moscow:** Donald Winston; **Paris:** Dan Smith; **Rio de Janeiro:** Leslie Warren; **Tokyo:** Marvin Petal, Charles Cohen

Circulation manager: Hugh J. Quinn

Reprints: T.M. Egan

Publisher: C.C. Randolph

Electronics: October 18, 1965, Vol. 38, No. 21

Printed at 99 North Broadway, Albany, N.Y.
Second class postage paid at Albany, N.Y.

Subscriptions are solicited only from those actively engaged in the field of the publication. Position and company connection must be indicated on orders. Subscription prices: United States and Possessions and Canada, \$6.00 one year, \$9.00 two years, \$12.00 three years. All other countries \$20.00 one year. Single copies, United States and Possessions and Canada 75¢. Single copies all other countries \$1.50.

Published every other Monday by McGraw-Hill Inc. 330 West 42nd Street, New York, N.Y. 10036. Founder: James H. McGraw, 1860-1948.

Subscribers: The Publisher, upon written request to our New York office from any subscriber, agrees to refund that part of the subscription price applying to copies not yet mailed. Please send change of address notices, subscription orders or complaints to Fulfillment Manager, Electronics, at the address below. Change of address notices should provide old as well as new address, including postal zone number if any. If possible, attach address label from recent issue. Allow one month for change to become effective.

Postmaster: Please send Form 3579 to Fulfillment Manager, Electronics, P.O. Box 430, Hightstown New Jersey 08520

Readers Comment

Germany concurs

To the Editor:

Your reader Lee E. Davies is quite correct; the conversion factor for putting English measurements into the metric system is 1 inch = 2.54 centimeters [Electronics, July 12, p. 4]. This is stated in the German DIN (for "Das ist Norm," or in English, "this is standard") listings, the official German standard.

Some years ago we developed this special conversion method, which was approved by the German government and published in an official governmental report under the designation "Telefunken-method." I am one of the inventors of this method and it was my task to train other engineering people and technical designers.

Hans J. Loeffelbein
Ulm, Germany

Value judgment

To the Editor:

Of the more than 50 electronic development engineers who have been under my supervision, at one time or another during the last 10 years, almost all have pursued graduate studies in engineering subjects. Almost every one of these engineers has expressed resentment of the requirement which most schools impose for matriculation with the "intention" of obtaining a master's degree.

Most of these men are quite competent to decide what courses will be of most value to them; however, they are forced to take some courses which they have no desire to take. (There is no objection to requiring legitimate prerequisites, although even this point is often abused.) Thus these men are penalized both financially and socially through the loss of their time, by the feudalistic actions of some academic administrators whose calm arrogance is hardly consistent with an ideal of public service.

In most cases I think that the average engineer is in a better position to decide what courses will be of value to him than is the average engineering dean. Also, I

Now from Sprague!

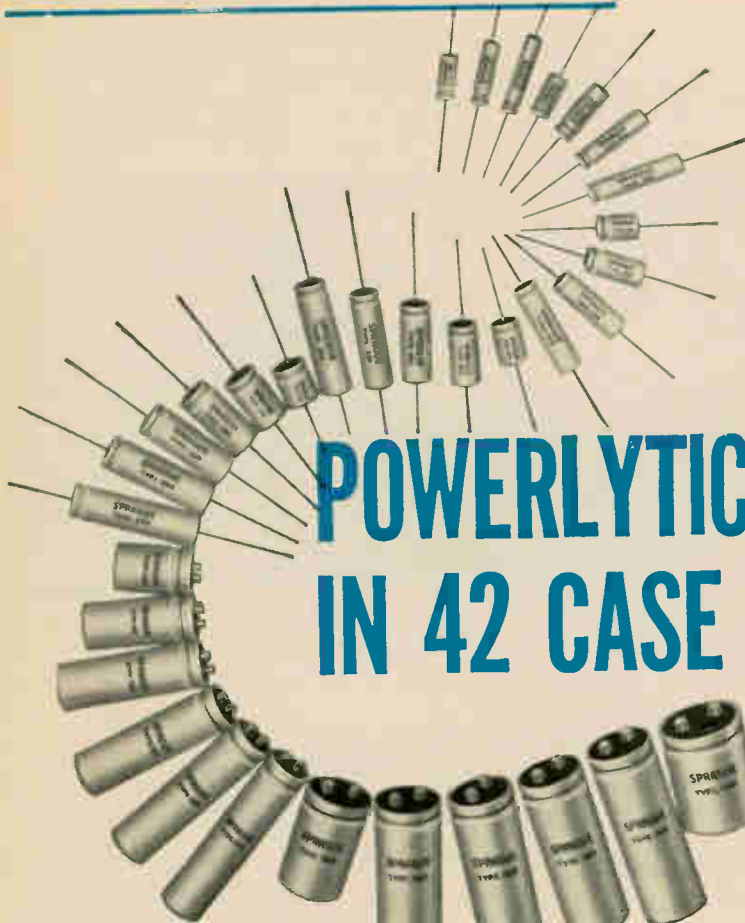

POWERLYTIC[®] CAPACITORS IN 42 CASE SIZES...

for maximum capacitance in minimum space!

Type 36D Cylindrical Case

Designed specifically for space economy, in applications such as computer power supplies, industrial controls, high gain amplifiers, etc. Case sizes from $1\frac{3}{8}$ " x $2\frac{1}{8}$ " to 3 " x $5\frac{3}{8}$ ". Improved temperature capabilities—may now be operated at 85 C. Low equivalent series resistance, low leakage current, excellent shelf life, high ripple current capability. Superior seal employs molded cover with recessed rubber gasket. Reliable safety vents. Solder lug or tapped terminals. Standard ratings from 3 to 450 VDC, capacitance values to 270,000 μ F.

Type 39D Tubular Case

Smaller companion to proven 36D capacitor, possessing same outstanding performance. Case sizes from $\frac{1}{2}$ " x $1\frac{1}{8}$ " to 1 " x $3\frac{3}{8}$ ". Designed for operation at temperatures up to 85 C. Unique construction—anode and cathode terminals are welded—no riveted or pressure connections—prevents open circuits, even in microvolt signal range. Improved molded phenolic end seals contribute to unusually long life (expectancy, 10 years or more). Low effective series resistance, low leakage current. Standard ratings include capacitance values to 18,000 μ F, voltages from 3 to 450 VDC.

For complete technical data on Type 36D or Type 39D Powerlytic Capacitors, write for Engineering Bulletins 3431B and 3415, respectively, to Technical Literature Service, Sprague Electric Co., 35 Marshall Street, North Adams, Mass. 01248.

Popular ratings are now available for fast delivery from your Sprague Industrial Distributor.

SPRAGUE COMPONENTS

CAPACITORS
TRANSISTORS
RESISTORS
INTEGRATED CIRCUITS
THIN-FILM MICROCIRCUITS
45C-3123

PULSE TRANSFORMERS
INTERFERENCE FILTERS
PULSE-FORMING NETWORKS
TOROIDAL INDUCTORS
ELECTRIC WAVE FILTERS

CERAMIC-BASE PRINTED NETWORKS
PACKAGED COMPONENT ASSEMBLIES
BOBBIN and TAPE WOUND MAGNETIC CORES
SILICON RECTIFIER GATE CONTROLS
FUNCTIONAL DIGITAL CIRCUITS



Sprague and *®* are registered trademarks of the Sprague Electric Co.

With this Analog Frequency Meter you can:



Measure directly
from 3 c/s to 1.5 Mc/s

Monitor changes in frequency
with easy-to-follow analog meter

Measure fm deviation
and incidental fm

Record directly
from the 1- to 5-mA output



Do you always need the accuracy and resolution of a digital counter to make your frequency measurements? Many measurements require only a small fraction of a counter's capability, and can be made as well, if not better, with an analog instrument. A GR Type 1142-A Frequency Meter and Discriminator for these measurements can save you hundreds of dollars in primary and accessory equipment costs.

The Type 1142-A is an analog instrument with $\pm 0.2\%$ accuracy. Its large, logarithmic meter and dc recorder output (1- to 5-mA) make it particularly useful for monitoring frequency changes and stability; drift measurements at 100 Mc/s can be made to a resolution of one part in 10^9 with heterodyne techniques, for example. Accurate measurements are possible with input signals of only 20 mV, thanks to this instrument's high sensitivity.

This instrument is also an extremely linear fm discriminator, with residual fm noise at least 100 dB below full output. It can be used with an ac voltmeter to measure fm deviation, or with a wave analyzer to determine individual components of incidental fm in oscillators and multipliers.

SPECIFICATIONS:

Frequency Range — 3 c/s to 1.5 Mc/s in five decade ranges.

Input Sensitivity — 20 mV from 20 c/s to 150 kc/s, rising to 200 mV at 3 c/s and 1.5 Mc/s. Impedance: 100 k Ω , dropping to a minimum of 5 k Ω above 500 kc/s.

As a Frequency Meter — Logarithmic meter maintains constant accuracy. Calibrated interpolator effectively expands meter scale by a factor of 10. Higher frequency measurements can be made by heterodyne techniques. Readings independent of waveform.

As a Discriminator — Output is 15V, full scale. Low noise; residual fm is down more than 100 dB below 1 Mc/s.

Accuracy — In the "direct" mode, 1% of reading. In the "interpolate" mode, 0.2% of full scale.

Recorder Outputs — Adjustable from 1 mA to 5 mA; current proportional to input frequency. Interpolator output for high-Z recorders; voltage is proportional to frequency deviation.

Price — \$565 in U.S.A.



Measure Directly to 15 Mc/s

GR's new Type 1156-A Decade Scaler is a completely self-contained 10:1 divider of any input frequency up to 100 Mc/s. A five-position input attenuator provides sensitivities of 0.1, 0.2, 0.5, and 1 volt, peak-to-peak (35 mV to 0.35 V, rms), at 50 ohms;

and 1 volt, peak-to-peak (0.35 V rms), at 500 ohms. Output is a 20-mA square wave that delivers 1 volt into a 50-ohm load, sufficient to operate most frequency meters without amplification. \$490 in U.S.A.

IN CANADA: Toronto 247-2171, Montreal (Mt. Royal) 737-3673
IN EUROPE: Zurich, Switzerland — London, England



GENERAL RADIO COMPANY

WEST CONCORD, MASSACHUSETTS

BOSTON NEW YORK, N. Y., 964-2722 CHICAGO PHILADELPHIA WASHINGTON, D. C. SYRACUSE DALLAS SAN FRANCISCO LOS ANGELES. ORLANDO, FLA. CLEVELAND
(W. Concord) 646-0550 (Ridgfield, N. J.) 943-3140 (Oak Park) 848-9400 (FL Washington) 646-8030 (Rockville, Md.) 946-1600 454-9323 FL 7-4031 (Los Altos) 948-8233 469-6201 425-4671 886-0150

Circle 6 on reader service card

think the fact that at least half of these men have no particular interest in obtaining a master's degree, even though they might eventually obtain the required number of point credits, is a sign of maturity on their part since the major value of an advanced degree is as a prestige symbol when changing jobs.

Frederick B. Sylvander
24 Carlton Terrace
Rutherford, N. J.

▪ Perhaps reader Sylvander should check directly with engineering schools. Most welcome qualified students in graduate courses on a nonmatriculated basis.

Average, or rms?

To the Editor:

In the Aug. 9 issue of Electronics (p. 88) there is an article titled solid state stereo "A solid state stereo set built in modules", and I have a question for the authors.

On page 88 and again on page 90, they refer to "rms power." I have seen this expression somewhere else recently, and now I am wondering if a new concept has crept into electrical engineering or whether my own education is lacking. According to my lights, if a sinusoidal voltage with rms value V (and peak value $V_{\text{pk}} = \sqrt{2}V$) is applied to a resistor, and a current with rms value I (and peak value $I_{\text{pk}} = \sqrt{2}I$) flows as a result, then the peak power is $2 IV$, the average power P is IV , and the rms power is what students sometimes mistakenly call the product of the rms current and the rms voltage; that is, the average power.

Is it possible that the authors

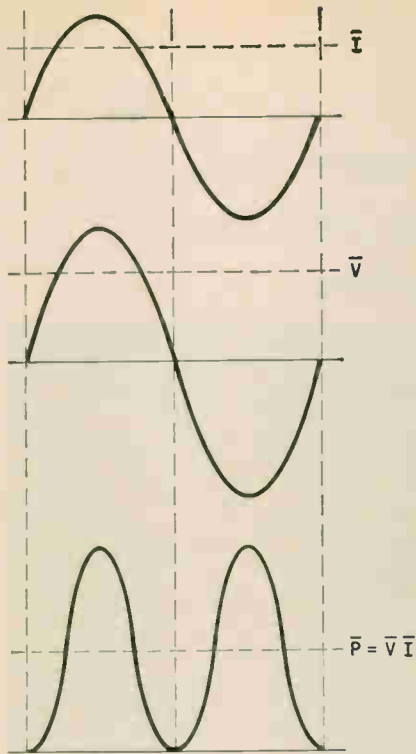

are calling \bar{P} the rms power? Or do they know something that I don't?

Norman A. Forbes

Louisville, Ky.

▪ Author Sam Messin replies: Reader Forbes is right. What is referred to as "rms power" in the article is really the continuous average power that can be supplied by a system with a constant-frequency input. However, the term "rms power" is commonly used by high-fidelity manufacturers to distinguish this type of rating from that established by the Institute of High Fidelity Manufacturers. The IHFM rating refers to the momentary power that an audio system is capable of delivering at any frequency, which is a function of the capacitance in the system.

In Volume Production!



a compatible line
of DTL Logic
CERACIRCUIT®
Thin-film Microcircuits

5 Mc DTL LOGIC CIRCUITS

The basic member of the Sprague series of DTL Logic Modules is the UC-1001B NAND/NOR Gate (see schematic), with typical propagation time delay of 10 nsec per stage over a temperature range of -55°C to $+125^{\circ}\text{C}$. Other DTL Logic Ceracircuits include SCT Flip-Flop, Buffer-Driver, Exclusive OR/Half-Adder, 8-Diode Gate, and 5-Diode Gate.

To facilitate contact packaging and assembly on printed wiring boards, all 5 Mc DTL Modules are encapsulated in one standard case, 1.0" wide x 0.4" high x 0.2" thick.

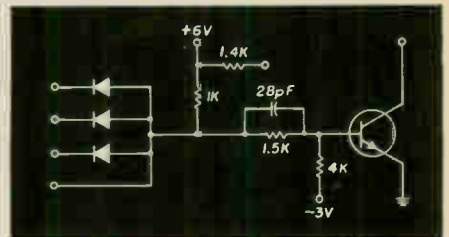

Circuit schematic, UC-1001B NAND/NOR Gate.

CUSTOM-TAILORED CERACIRCUITS

Ceracircuit Ceramic-base Microcircuits provide the circuit designer with desirable features — component familiarity, design versatility, increased reliability, circuit economy. Thin-film technology permits wide ranges of resistance and capacitance values, holding close tolerances without high-cost penalties. Each passive component keeps its identity, allowing conventional design procedures.

Write for Brochure ASP-363
to the Technical Literature Service,
Sprague Electric Co., 35 Marshall St.,
North Adams, Mass. 01248

45 MC-3104



Sprague and *®* are registered trademarks of the Sprague Electric Co.

SUBSCRIPTION SERVICE

Please include an Electronics Magazine address label to insure prompt service whenever you write us about your subscription.

Mail to: Fulfillment Manager
Electronics
P.O. Box 430
Hightstown, N.J. 08520

To subscribe mail this form with your payment and check new subscription renew my present subscription

Subscription rates: in the U.S.: 1 year, \$6; two years, \$9; three years, \$12. Subscription rates for foreign countries available on request

CHANGE OF ADDRESS

ATTACH
LABEL
HERE

If you are moving, please let us know five weeks before changing your address. Place magazine address label here, print your new address below.

name

address

city

state

zip code

Magnetically Beamed Triode 250 kW CW with 1 kW Drive 8 Mw High Duty Pulse



Machlett's new ML-8618 magnetically beamed water-cooled triode features high power gain, plate efficiency and maximum cathode utilization. As a Class C amplifier or oscillator, the ML-8618 is capable of a continuous output in excess of 250 kW with only 1000 W driving power. As a switch tube in pulse modulators, it can deliver more than 8Mw pulse power at long pulse widths and high duty. For details on this or the soon-to-be-available ML-8619 vapor-cooled or ML-8620 forced air-cooled versions, write: The Machlett Laboratories, Inc., Springdale, Conn. 06879. An affiliate of Raytheon Company.

MACHLETT
ELECTRON TUBE SPECIALIST

People

John Fogarty has been named a vice president and general manager of the De Havilland Aircraft of Canada, Ltd.'s division for special products and applied research. In his new post he will spearhead De Havilland's drive to balance its business between military and nonmilitary operations. Fogarty will direct the development of such product lines as control instrumentation, radiometers, spectrometers and laser devices for surveying.



The move to balance military and civilian business isn't only in one direction: from military to nonmilitary applications. In some instances the reverse is true. For example, the company is redesigning for the military its pop-up antenna that was developed for National Aeronautics and Space Administration satellites. Such a pop-up antenna, says Fogarty, stays safely buttoned up until it's needed.

Before joining De Havilland, Fogarty served as an executive of several North American divisions of Ferranti, Ltd., a British electronics company.

For most of his military career, **Col. Robert F. Long** has been a weatherman. This week he takes command of the Air Force Cambridge Research Laboratories, where he will direct basic and applied research on weather—in the widest possible meaning of that word.



The lab is the largest Air Force facility conducting research into the physical and environmental sciences. Although it remains a major center for military-oriented electronics research, its responsibility has broadened during this decade with new emphasis on the



Denny Fallon's doing great things with Bendix silicon power transistors.

Now it's your turn.

Thanks to the efforts of our engineers like Denny Fallon, the Bendix® line of silicon mesas now offers you a wider-than-ever range of improved 2N performers. 2N3055, 2N3232, 2N3235, 2N1483-90, 2N1015, A-D and 2N1016, A-D to name a few.

Look at some of the great things you can do with them. Put them to work in amplifiers, voltage and current regulators; choppers, inverters, relay and solenoid actuating circuits; and high power switching applications.

All have high voltage capabilities, diffused construction for fast switching, higher frequency capabilities and come in a wide range of package options. Included, too, are new commercial grades, lower cost types and newer-concept audio power types as well as popular types 2N1487-2N1490 meeting military specification

MIL-S-19500/208(EL). You'll find all have excellent beta stability over the entire operating temperature range of -65°C to $+200^{\circ}\text{C}$, with I_C to 15 A, V_{CB} to 200 V and P_C to 175 W. Like we say, Denny's been doing some great things.

And you can put them to work with no fear of secondary breakdown either, because Bendix offers you SOAR (Safe Operating Area) specified silicon mesas. Presently there are 12 SOAR specified types available, with more on the way. (See typical SOAR chart).

These then, are the highlights of what Denny's been doing to the Bendix line of silicon mesas. Want to make something out of all his great efforts? Just phone or write our nearest sales office. Tell us you've got great things in mind. We'll understand.

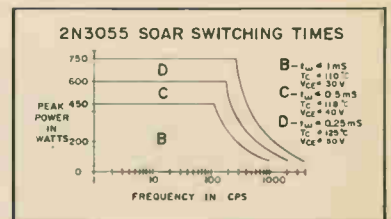
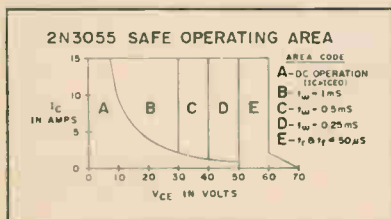

Bendix Semiconductor Division
 HOLMDEL, NEW JERSEY



Baltimore (Towson), Md.—(301) 828-6877; Chicago—(312) 637-6929; Dallas—(214) 357-1972; Detroit—(313) JO 6-1420; Holmdel, N. J.—(201) 747-5400; Los Angeles—(213) 776-4100; Miami Springs, Fla.—(305) 887-5521; Minneapolis—(612) 926-4633; Redwood City, Calif.—James S. Heaton Co., (415) 369-4671; Seattle—Ray Johnston Co., Inc., (206) LA 4-5170; Syracuse, N. Y.—(315) 474-7531; Waltham, Mass.—(617) 899-0770; Export—(212) 973-2121, Cable: "Bendixint," 605 Third Ave. N. Y.; Ottawa, Ont.—Computing Devices of Canada, P.O. Box 508—(613) TA 8-2711.

"NO LIGHT?" JUST RIGHT FOR MTI ORTH CAMERAS!

mti —
World's Largest Manufacturer
of Low Light Level TV Systems

This is the MTI ORTH III IMAGE ORTHICON CAMERA...

... unequaled in performance and adaptability. Simplified operation makes you an expert in a matter of minutes.

The advanced engineering, rugged construction, compact size and light weight of the MTI Orthicon TV Cameras permit adaptability in many situations where other image orthicon cameras are rendered useless.

Stability is assured by: Solid State regulated power supplies and the generous use of self-compensating feedback circuits in both sweep and video sections. Controls pre-set stay set.

Solid State, modular construction used throughout the camera and control unit. Reliability is "designed in."

With selected Image Orthicon tubes, (available at MTI) MTI Image Orthicon TV Cameras will produce high resolution pictures even at 1×10^{-5} foot candles of ambient darkness (approaching total darkness).



THE ORTH III IS ONE OF ELEVEN DIFFERENT MODELS AVAILABLE. LINE SCAN FREQUENCIES INCLUDE: 525; 675; 875; 945; 1023; 1029 OR 1201. CHOICE OF INTERNALLY GENERATED FULLY INTERLACED SYNC OR EIA SYNCHRONIZATION.

**CALL
AN MTI MAN
TODAY!**

mti —

MARYLAND TELECOMMUNICATIONS, INC.

VIDEO INSTRUMENTATION

York & Video Roads — Cockeysville, Maryland (301) 666-2727

environmental sciences, specifically solar and radio astronomy, space physics, the dynamics of the ionosphere and meteorology.

Col. Long comes to his new post from Andrews Air Force Base in Maryland, where he was commander of the 4th Weather Group, a unit of the Air Weather Service.

Despite its name, the lab is not in Cambridge. It's a part of the huge Air Force complex at Hanscom Field, Bedford, Mass., where its neighbors are the Air Force Electronics Systems division, Lincoln Laboratory of Massachusetts Institute of Technology, and branches of the Mitre Corp.

In fiscal 1965, the lab, under Col. Long, will award and monitor more than \$40 million in research contracts to industry and universities, in addition to in-house research. It is the world's largest user of research balloons and will launch more than 100 this year. Since its first rocket-borne research payload went aloft in 1946, the lab has launched more than 600 rockets to probe the "weather" in the atmosphere and beyond, and to test instrumentation. The Cambridge lab is the Air Force's principal research center for space weather, and since 1961 the center has forecast solar flares and proton showers for the National Aeronautics and Space Administration. Manned space flights are not launched until data from the lab's Sacramento Peak Observatory says it is safe.

For the past four years, Col. Long has been staff meteorologist for the Air Force Systems Command and the Office of Aerospace Research, in addition to commanding the weather group at Andrews Air Force Base.

"Environmental aspects are an essential concern in all weapons systems," he points out. "Though huge, these systems are in some respects fairly fragile. We have to know the environment which complex systems will contend with from launch on: wind shear, lightning, temperature changes, atmospheric density, then solar flares and proton showers in the space environment."

A native of Boston, 46-year-old Col. Long received a physics degree from Boston College, studied meteorology at MIT and electronics at Ohio State University.



Nose Go's or No Go's are our business The Sperry C201 Radar Simulator determines beacon transponder operational readiness. This completely portable, battery-operated instrument is designed for range or depot use. It is capable of interrogating conventional C- and S-band transponders up to several thousand yards by using an external, standard gain directional antenna. □ Individual tuning and readout of interrogate and receive frequency provide test capability to suit individual beacon requirements. Reply and interrogation code format can be viewed directly on a three-inch oscilloscope. □ The Radar Simulator is completely solid state except for the triode cavity power oscillator, the receiver local oscillator and cathode ray tube. It weighs only 27 pounds and the effective radiated power is a full 12 KW. Modular construction and hand-wired, plug-in circuit boards provide optimum maintainability and facilitate future innovations. □ For complete information, contact

SPERRY MICROWAVE ELECTRONICS COMPANY, CLEARWATER, FLORIDA
SPERRY EUROPE: 7, Avenue de l'Opera, Paris **Moehlstrasse 24, Munich 27, W. Germany**

SPERRY
 DIVISION OF
 SPERRY RAND
 CORPORATION

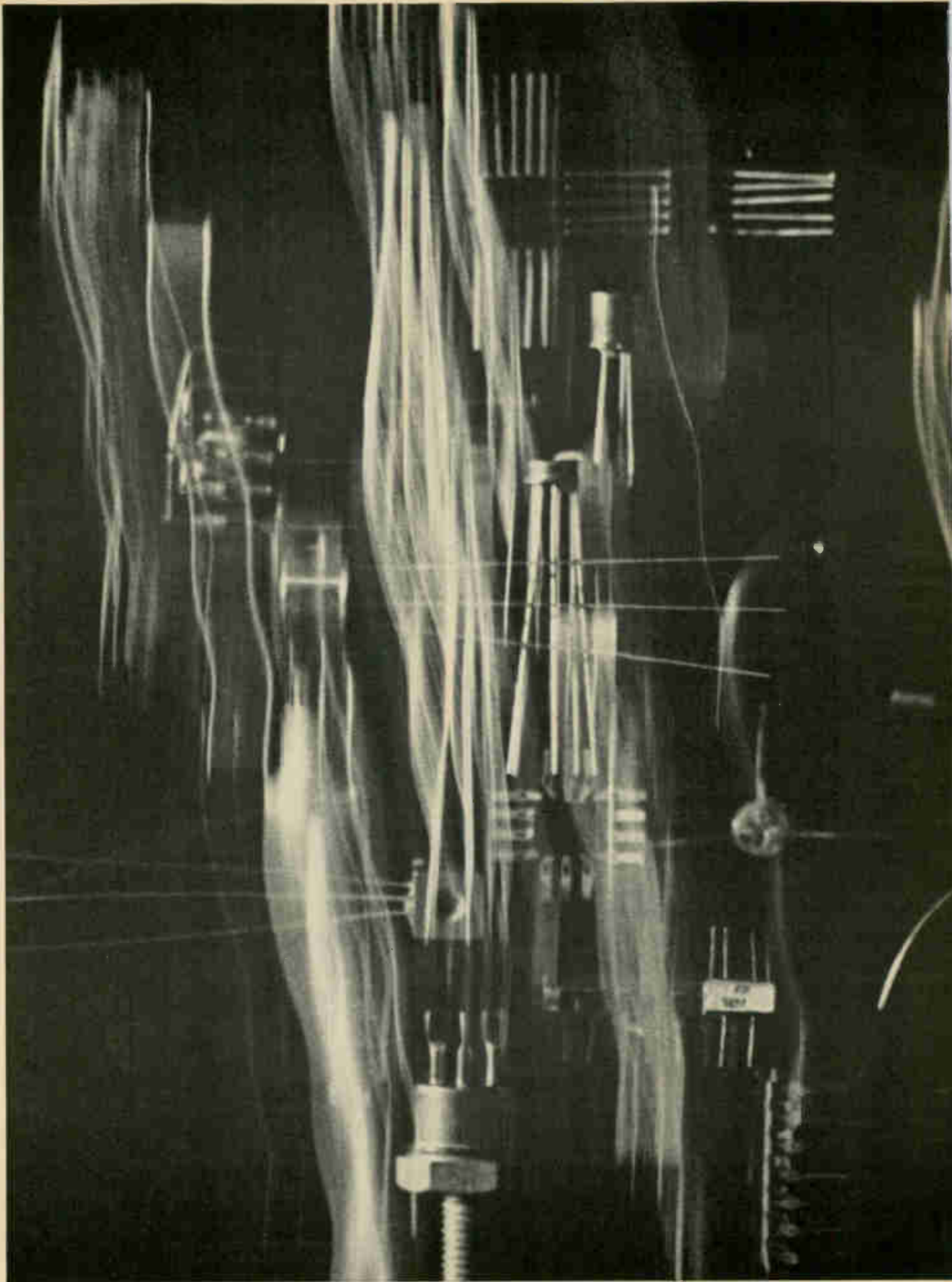

FAIRCHILD SEMICONDUCTOR / A DIVISION OF FAIRCHILD CAMERA AND INSTRUMENT CORPORATION ■ 313 FAIRCHILD DRIVE, MOUNTAIN VIEW, CALIFORNIA, (415) 962-5011 ■ TWX: 910-379-6435

Below: a Hermet next to a TO-5. Both are transistor packages; both are hermetically sealed; both are readily available. But, there is a difference:

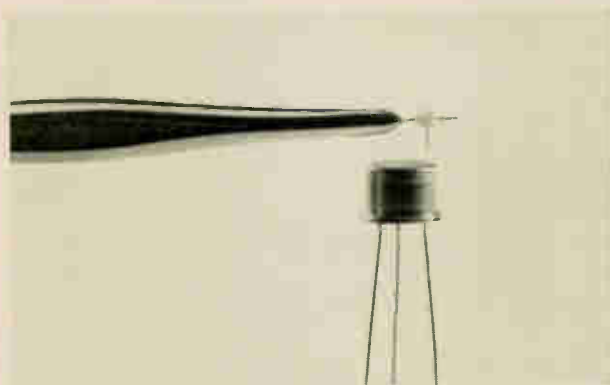

You can get TO-5 packaging anywhere. You can get the Hermet only from Fairchild. The standard Fairchild line includes some very special packages: Cerpak, Flatpak, Dual in-line, matched duals, TO-50, TO-51, and Hermet.

Hermet: 80x80x60 mils. Gold over kovar leads. Hermetically sealed. Accommodates all Fairchild transistors except power devices.



New from Sprague!

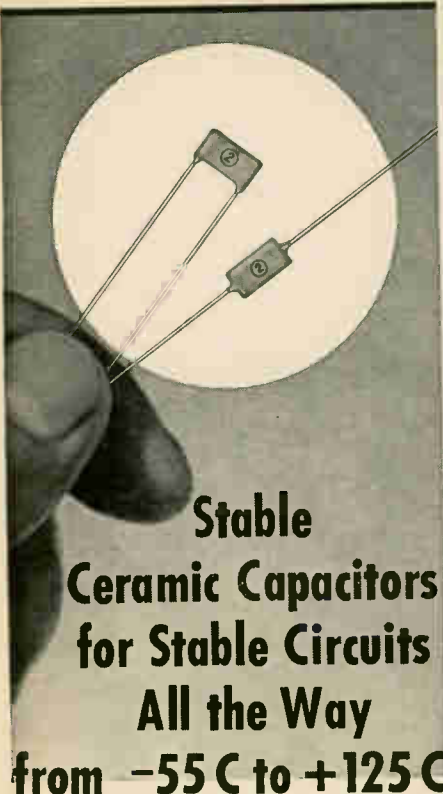

**Stable
Ceramic Capacitors
for Stable Circuits
All the Way
from -55 C to +125 C**

■ Sprague's new temperature stable Formulation 067 Monolythic® Capacitors are guaranteed not to deviate from room temperature capacitance by more than +10, -15% over the wide temperature range from -55 C to +125 C.

■ Layer-built construction produces reliable units with high capacitance values in small physical size. Alternately sprayed layers of ceramic dielectric and metallic electrodes are fired as a single piece into one homogeneous block. A 0.56 μ F capacitor is only .500" x .500" x .235" thin!

■ Absence of anti-resonant points up to 1000 mc makes Monolythic Capacitors uniquely suited for d-c to high-frequency applications.

■ Voltage rating, 100V @ 85 C or 50V @ 125 C. Available in axial-lead as well as radial-lead configurations.

For complete technical data, write for Engineering Bulletin 6205 to the Technical Literature Service, Sprague Electric Co., 35 Marshall St., North Adams, Mass. 01248.

45C 5138



*Sprague and ® are registered trademarks of the Sprague Electric Co.

Meetings

National Electronic Conference, IEEE; McCormick Place, Chicago, Oct. 25-27.

Aerospace and Navigation Electronics East Coast Conference (ECCANE), G-Ane, Baltimore Section of IEEE; Holiday Inn, Baltimore, Oct. 27-29.

Electronics Div. of the American Ceramic Society Convention, Southern Calif. Section, American Ceramic Society; International Hotel, Los Angeles, Oct. 27-29.

Energy Conversion and Storage Conference, Oklahoma State University, Stillwater, Oct. 28-29.

Microwave Acoustics Symposium, AFCRL; Holzman Seminar Room, L. G. Hanscom Field, Bedford, Mass., Oct. 28-29.

Space Electronics International Symposium, G-SET, IEEE; Fontainebleu Hotel, Miami Beach, Nov. 2-4.

Nondestructive Testing and Measuring Apparatus Meeting, Bureau of International Commerce (BIC); U. S. Trade Center in London, Nov. 2-12.

Northeast Electronics Research and Engineering Meeting (NEREM '65) NEREM; War Memorial Auditorium, Prudential Center, Boston, Nov. 3-5.*

Data Processing Conference and Business Exposition, Data Processing Management Association; Dallas, Texas, Nov. 3-5.

Conference on Men, Machines and Automation, Institution of Production Engineers; Eastbourne, England, Nov. 7-10.

Conference on Hall Effect Applications, Electron Devices Group of IEEE; Kresge Little Theatre, MIT, Cambridge, Nov. 8-9.

Materials for Electron Devices and Microelectronics Meeting, ASTM; ASTM Headquarters, Philadelphia, Nov. 9-10.

Industrial Electric Exposition, Electric League of Western Pennsylvania; Hilton Hotel, Pittsburgh, Nov. 9-11.

Research and Development Meeting, New Jersey Council for Research and

Development; Princeton Inn, Princeton, N. J., Nov. 10.

Engineering in Medicine and Biology Conference, ISA, IEEE; Sheraton Hotel, Philadelphia, Nov. 10-12.

Anti-Missile Research Meeting, Advanced Research Projects Agency; U. S. Naval Postgraduate School, Monterey, Calif., Nov. 15-17.

Magnetism and Magnetic Materials Conference, IEEE; San Francisco, Nov. 15-18.

Industrial Photographic & Television Exposition, Financial Times; Earls Court, London, Nov. 15-20.

Physics of Failure in Electronics, IIT Research Institute, Rome Air Development Center, N. Y., Nov. 16-18.

Research Conference, Stevens Institute of Technology; Hoboken, N.J., Nov. 17.

Call for papers

Communications Satellite Systems Conference, AIAA; Washington, D. C., May 2-4. Nov. 30 is deadline for submission, in duplicate, of a 500- to 1000-word proposal abstract, and a second 200-word abstract which describes the paper to the program assistant in the field of interest: Military Systems and Technology, Mr. Jay J. Cohen, Communications Satellite Project, Defense Communications Agency, 8th and S. Court House Road, Arlington, Va.; Technology, Mr. Ned Feldman, Electronics Dept., The RAND Corp., 1700 Main St., Santa Monica, Calif.

National Aerospace Electronics Conference (NAECON), IEEE, AIAA; Dayton Sheraton Hotel, Dayton, Ohio, May 16-18. Dec. 1 is deadline for submission of 300-word abstract of papers in aerospace and aeronautical electronics to John M. Mayer, NAECON papers Chairman, 4525 Fernbrook St., Kettering, Ohio 45440.

* Meeting preview on page 16



How do you unscramble signals from a moon-bug?

At top speed and accuracy, using the most advanced data reduction system ever designed. Months before the first Americans blast off toward the moon, an Astrodata system is already at work digesting and displaying messages from the bug-like Lunar Excursion Module. No other data reduction system in operation today has been able to handle data with as much speed and flexibility . . . *automatically!*

Astrodata systems superiority comes from mating proven components with functionally-oriented software. For example, all telemetry conversion units are directly under computer program control. Stored commands therefore automatically calibrate all sub-systems: selecting bandwidths, frequencies, rates,

formats and outputs; control speeds, tracks; provide tape search, and other data traffic functions conventionally requiring extraneous controls and adjustments.

In effect, this means significantly less error, greater speed, optimum performance and economy in your data reduction system.

Perhaps you're not headed for the moon, but you do have other problems in data acquisition and processing, telemetry, or range instrumentation. Then Astrodata's expert know-how should be of interest to you. Write for your free copy of our 20-page brochure "Astrodata's Systems Experience."



ASTRODATA

P.O. Box 3003 ■ 240 E. Palais Road, Anaheim, California ■ 92803

Circle 15 on reader service card

A date to jot down:
 Feb. 3-8 1966
 PARIS
 (at the Porte de Versailles)

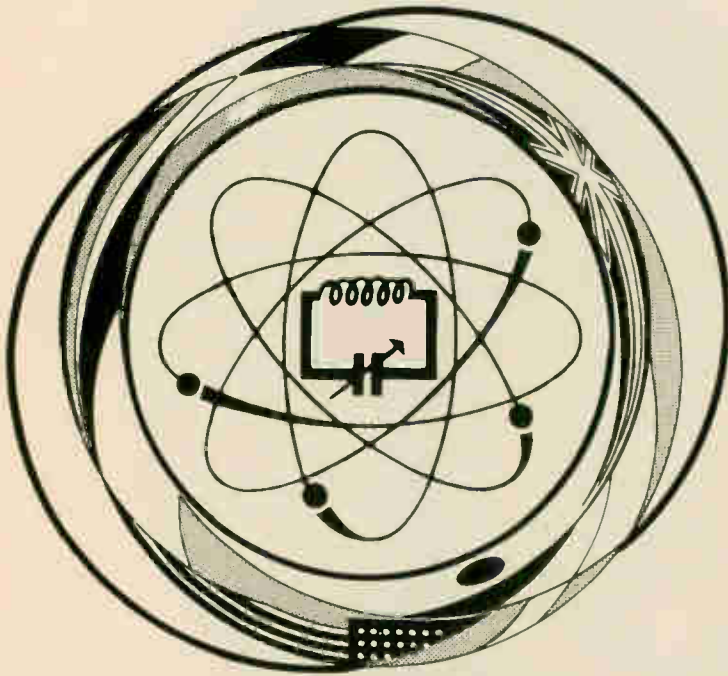

Electronic industry's first world-wide reunion of
 1966 at the international exhibition of

ELECTRONIC COMPONENTS

The latest advances in electronic technology: components, tubes and semi-conductors; measurement and control equipment, audio-equipment.

For information and literature, please write to:
 S.D.S.A. 16 rue de Presles—Paris 15° tel: 273
 24 70 Official carrier: Air France, Overseas Trade
 Show Department, 683 Fifth Ave.—New York,
 N. Y. 10022

PUBLIC SERVICE
 PARIS

For official invitation, fill out and return the attached
 form to: **S.D.S.A. Relations Exterieures**
16 rue de Presles—Paris 15° France

Name

Firm

Address

Meeting preview

Nerem in Boston

A record attendance of 20,000 is expected when the New England sections of the Institute of Electrical and Electronics Engineers opens its 19th meeting Nov. 3 in Boston. The previous high was 16,000 attendees last year.

Sharp increases also are expected in technical papers—to 126, more than double last year's total—and in exhibits—to 500, up 20%.

A big share of the interest at the three-day Northeast Electronics Research and Engineering Meeting (Nerem) will center on the Nov. 4 sessions on biological effects of lasers. The sessions will be continuations of those held at the Boston Laser Conference which for several years has featured studies of lasers' effects, or good or evil, on living organisms. The Nerem sessions are being organized by Dr. Samuel Fine of Northeastern University, and cosponsored by Nerem and by the United States Surgeon General's Office.

A seminar on microwave component needs for communications systems will be sponsored by the microwave group of the Electronic Industries Association. Five speakers will spell out the needs for microwave components.

At a session on satellite communications, J. J. Cohen, a technical adviser to the Defense Communications Agency, will outline plans for the first defense communications satellite, scheduled for launch early next year. Leonard Jaffe of the National Aeronautics and Space Administration will describe plans for a 1966-67 series of "application technology" satellites with capabilities for broadcasting voice and tv directly to home receivers.

A session for late-breaking technical news is scheduled Nov. 4. Later that day, "characteristics of the creative company" will be discussed by four company presidents: Donald B. Sinclair of the General Radio Co.; Howard O. McMahon of Arthur D. Little, Inc.; A. Y. Taylor of Jackson & Moreland, Inc., a division of United Engineers & Construction, Inc., and Edward L. Ginzton of Varian Associates.



STRATEGIST

THE TRIPLE-DIFFUSED PLANAR TRANSISTORS

That's Silicon Transistor Corporation. Always the right move. Now that the dust has settled, now that everyone has said, "we can supply the Honeywell triple-diffused planars," Silicon says simply, "we have always supplied them as part of the broadest line of silicon power transistors—with the additional plus of our unique, rugged clip and post construction for high reliability."

2N2657-58, 2N2632-34, 2N2877-80, MHT4451-56, MHT4483, MHT6308-16, MHT6001, MHT6011-16, MHT6031. All available in TO-5 and TO-62 and TO-59. NO EXCEPTIONS.

And Silicon Transistor Corporation takes one step further and offers the 2N1722 and 2N1724 in planar, too. These meet military requirements like the rest.

For complete specifications and information so you can work out a winning strategy, contact:

EAST GATE BLVD., GARDEN CITY, NEW YORK 11532, 516. Pioneer 2-4100. TWX 510-222-8258

REGIONAL OFFICES:

CHICAGO, ILL. 60625, 5555 NORTH LINCOLN AVE., 312-271-0366-7, TWX 910-221-1304

LOS ALTOS, CALIF. 94022, 1 FIRST ST., 415-941-2842. HUNTSVILLE, ALA. 35807, P.O. BOX 1467

 **SILICON
TRANSISTOR
CORPORATION**



New easy-to-apply RTV-757 silicone rubber foam protects newspaper from 5000°F flame



Spread on RTV-757

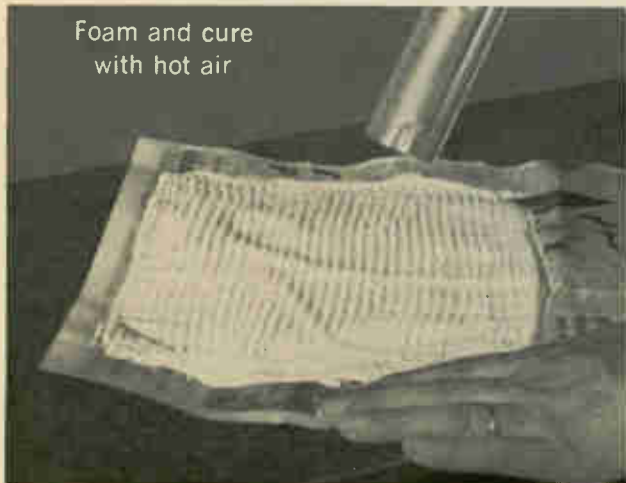

Foam and cure
with hot air



Forms flame-resistant
thermal insulation

General Electric's new RTV-757 foam can protect equipment and materials against heat and direct flame. It even protects an ordinary newspaper, as shown in the demonstration above.

RTV-757 is a thixotropic compound. Just spread it on. Then expose it to hot air. It cures instantly and forms a sponge-like, lightweight, yet tough, blanket with a density of 0.7-0.8.

Along with typical RTV resistance to aging, ozone and weathering, RTV-757 offers these features for firewall and thermal insulation applications.

- cast-in-place application
- one-step cure and foam system
- low density, floats in water
- excellent adhesion throughout temperature extremes
- controlled work life, doesn't foam until heated
- low-temperature flexibility, below -150°F
- high-strength foamed properties, eliminates honeycomb fabrication
- can be modified to pour or spray

Where to use RTV-757

The unsurpassed flame and heat resistance, plus outstanding thermal insulating properties, make RTV-757 uniquely qualified for use as an ablative shield, flame-resistant packaging material, fire-resistant sealant, flame-resistant shield for launch and support equipment, flame-resistant fabric coating, and as a protective barrier for aircraft, tanks, ships and stationary equipment.

7 common properties of all G-E RTV silicone rubbers

- Extreme temperature resistance
- Room temperature cures
- Chemical resistance
- Ozone, weather and age resistance

- Strong bonds
- Excellent dielectric
- Minimum shrinkage

Three more new RTV developments from General Electric

RTV adhesive/sealants now available in handy caulking cartridges



Tight, confined areas of electrical and electronic apparatus are a cinch to seal with General Electric's compact caulking cartridge. Also useful on production lines, they speed up sealing jobs. They provide a strong, flexible bond without priming.

Already mixed, RTV adhesive/sealants need no curing catalyst. Available in white (RTV-102) and translucent (RTV-108). Six and 12 ounce sizes fill standard hand or air-powered caulking guns.

Type I Low Viscosity	RTV-8111 RTV-8112 RTV-8113	Fast Cure Medium Cure Slow Cure
Type II Moderate Viscosity	RTV-8262 RTV-8263	Medium Cure Slow Cure
Type III Thixotropic	RTV-8372 RTV-8373 RTV-8382 RTV-8383	Medium Cure Slow Cure Medium Cure Slow Cure

Nine new RTV's to meet MIL-S-23586 (Wep)

Nine new RTV products have been specially formulated to meet this new military specification which covers the requirements for room temperature vulcanizing silicone rubber compounds most useful in aircraft, electrical and weapons applications. The specification describes the product and performance requirements for such electrical and mechanical applications as potting, encapsulation, sealing and bonding.

The new spec provides a convenient method for specifying RTV compounds for many military and non-military applications.

Tough, new RTV-630 for molding and plastic processing



High-strength RTV-630 can be used to fabricate flexible processing tools which assure long runs in thermoforming, matched die, plastics castings and other reinforced plastic molding operations.

It is also an economical flexible mold material for prototype reproduction, since less rubber is required to form a strong durable mold. RTV-630 molds are more flexible, parts are easier to remove and molds last longer. RTV-630 can be cured rapidly in thick sections.

It may also be used in potting, encapsulating, release coatings and other applications requiring maximum strength.

AUTHORIZED DISTRIBUTORS RTV INDUSTRIAL SEALANTS

ALABAMA
Argo & Company
Birmingham

ARIZONA
Electrical Specialty Co.
Phoenix

CALIFORNIA
Electrical Specialty Co.
Los Angeles
Electrical Specialty Co.
South San Francisco
R. V. Weatherford Co.
Glendale

COLORADO
Electrical Specialty Co.
Denver

CONNECTICUT
R. H. Carlson Co., Inc.
Greenwich

D. C.
Read Plastics, Inc.
Washington

FLORIDA
Gulf Semiconductors, Inc.
Coral Gables
Gulf Semiconductors, Inc.
Winter Park

ILLINOIS
Allied Radio Corp.
Chicago
Federal Insulation Corp.
Chicago
J. J. Glenn and Co., Inc.
Chicago

INDIANA
Hyaline Plastics Corp.
Indianapolis

IOWA
Plastic Supply, Inc.
Des Moines

KENTUCKY
General Rubber &
Supply Co.
Louisville

MASSACHUSETTS
Northern Chemical Co.
Boston

MICHIGAN
F. B. Wright Co., Inc.
Dearborn

MINNESOTA
D. A. Schultz Company
Minneapolis

MISSOURI
D. A. James Company
St. Louis
Regal Plastic Supply Co.
Kansas City

NEBRASKA
Regal Plastic Supply Co.
Omaha

NEW JERSEY
Smooth-on Mfg. Co.
Jersey City

NEW YORK
Punt, Inc.
Floral Park

Queen City Rubber Co.
Buffalo
Adhesive Products Corp.
New York
Chamberlin Rubber Co.
Rochester
Chamberlin Rubber Co.
Syracuse

OHIO
Philpott Rubber Co.
Cleveland
Parkway Products, Inc.
Cincinnati

OREGON
Electrical Specialty Co.
Portland

PENNSYLVANIA
Smith of Philadelphia, Inc.
Philadelphia
Speck-Marshall Co.
McKees Rocks

TEXAS
Lawrence Electronic Co.
Dallas
Houston Industrial
Supply Co., Inc.
Houston

WASHINGTON
Electrical Specialty Co.
Seattle

WISCONSIN
R. J. Wittenburg Co.
Milwaukee

For complete information on one or all of the latest G-E RTV compounds, write to Section N10168, Silicone Products Dept., General Electric, Waterford, New York.

GENERAL  **ELECTRIC**

now you see it...

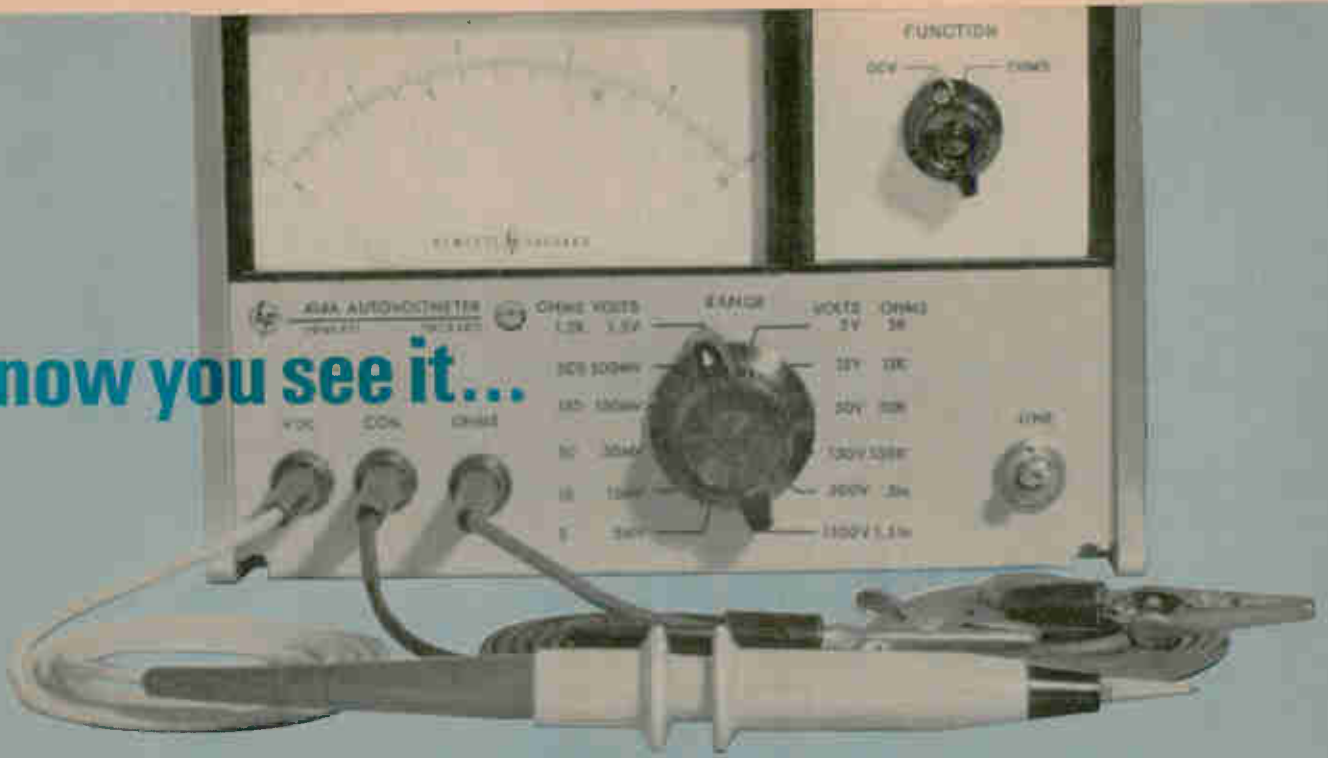

now you don't!



the case of a missing range switch SOLVED!

*A \$650 analog dc volt-ohmmeter with fast automatic ranging
plus an accuracy of $\pm 0.5\%$ of full scale $\pm 0.5\%$ of reading!*

No more manual range switching with the Hewlett-Packard 414A Autovoltmeter. Range and polarity change automatically . . . provide digital range, polarity readout in less than 300 milliseconds . . . and still give you the convenience and economy of unusually accurate analog measurements! What's more, the 414A lets you make *resistance* measurements, again with automatic ranging, on a *linear* analog meter scale!

Here's the world's first "touch-and-read" analog volt-ohmmeter with accuracy anywhere approaching what you require for trouble shooting, tweaking, peaking and nulling, probing a circuit without a schematic. Use it for maintenance testing, on the production line, in the lab.

In the dc voltage function you simply touch the point to be measured and in less than 300 msec read the range and polarity of the measurement on the digital display at the top of the 414A . . . the precise dc measurement on the individually calibrated, mirror-backed taut-band meter. Range 5 mv full scale to 1500 v full scale in 12 automatically selected and displayed ranges.

Or measure resistance 5 ohms to 1.5 megohms . . . on a linear scale that gives unprecedented accuracy, especially on the lower ranges. The 12 resistance ranges are automatically selected and displayed, as well.

Ranges also can be selected and held manually. Another feature is a Down Range control which lets you drop to the next lower range merely by pushing a front-panel button. High input resistance. All solid-state. Compact, only 10¼ lbs.

The details are in the specifications. But to get the true significance of this automatic instrument, you need to see it perform on your bench. Call your Hewlett-Packard field engineer for that convincing demonstration. Or write for complete information to Hewlett-Packard, Palo Alto, California 94304, Tel. (415) 326-7000; Europe: 54 Route des Acacias, Geneva; Canada: 8270 Mayrand Street, Montreal.

SPECIFICATIONS

DC VOLTMETER

Voltage range: ± 5 mv to ± 1500 v full scale, 12 ranges, manual or automatic ranging

Accuracy: $\pm 0.5\%$ of reading $\pm 0.5\%$ of full scale

Input resistance: 10 megohms on 5 and 15 mv ranges, 100 megohms on 50 mv range and above

Superimposed ac rejection: insensitive to 60 cps signal with peak value less than 7 times the full-scale dc level of the range in use in "Hold" position (rejection is 20% of reading in Autoranging)

OHMMETER

Resistance range: 5 ohms to 1.5 megohms in 12 ranges (manual or autoranging with linear scale)

Accuracy: $\pm 1\%$ of reading $\pm 0.5\%$ of full scale on any range

Source current: 1 ma through unknown up to 5 K ohms, 1 μ a above 5 K ohms

GENERAL

Range selection: voltage and resistance, automatically selects correct range in less than 300 msec; a particular range may be selected manually

Polarity selection: automatic

Meter: individually calibrated taut-band meter with mirror scale; linear scale, 0 to 5 and 0 to 15

Isolation resistance: at least 100 megohms shunted by 0.1 mf between common terminal and case

Floating input: may be operated up to 500 v dc above ground

Dimensions: 6 18/32" high, 7 25/32" wide, 11" deep (87 x 130 x 279 mm); 10¼ lbs (6,4 kg)

Price: \$650

Data subject to change without notice. Price f.o.b. factory.

HEWLETT  **PACKARD**
An extra measure of quality

IN LOW COST POWER SUPPLIES

KEPCO FLUX-O-TRAN[®]

MAKES THE DIFFERENCE!

NEW IMPROVED REGULATION

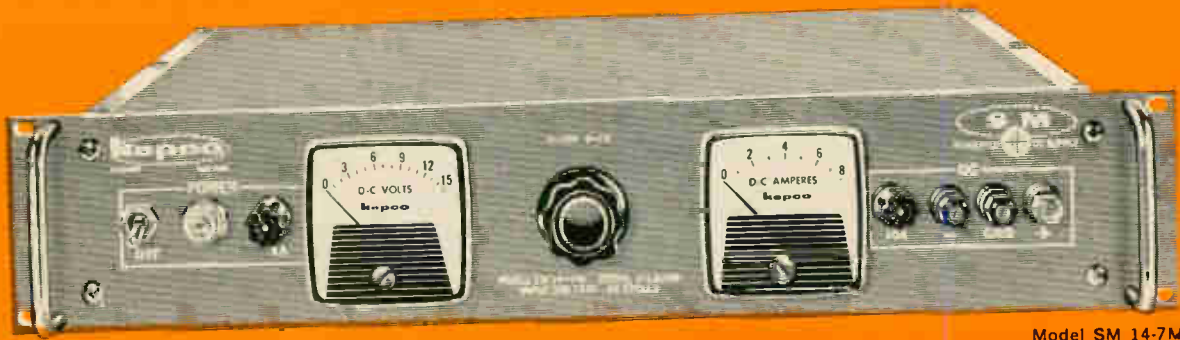

Model SM 14-7M

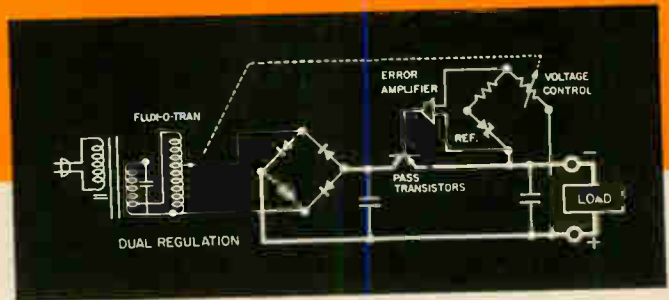

NOW AT EVEN LOWER PRICES!

New improved characteristics at new low prices make the Kepco SM Design Group of experience-proved Regulated Power Supplies more attractive than ever. All of the unique advantages provided by the patented Flux-O-Tran line-regulating transformer are utilized in this high reliability design concept.

SM Design Group features:

- 0.01% line and 0.05% load regulation
- Wide voltage range
- Continuous voltage control
- Minimum regulator dissipation
- Patented Kepco Bridge Circuit†
- 50 microsecond recovery time
- Less than 1 millivolt ripple rms
- Dual regulation

†Applicable Patent Nos. furnished on request



OUR NEW CATALOG CONTAINING COMPLETE SPECIFICATIONS AND APPLICATIONS NOTES IS NOW AVAILABLE. WRITE FOR YOUR FREE COPY!



MODEL	DC OUTPUT RANGE		DIMENSIONS			MAX INPUT AMPS at 125 V AC	PRICE
	VOLTS	AMPS	H"	W"	D"		
SM 14-7M	0-14	0-7	3½	19	13¾	3.5	\$405.00
SM 14-15M	0-14	0-15	5¼	19	13¾	5.5	525.00
SM 14-30M	0-14	0-30	8¾	19	13¾	10.5	725.00
SM 36-5M	0-36	0-5	3½	19	13¾	4.0	395.00
SM 36-10M	0-36	0-10	5¼	19	13¾	6.5	525.00
SM 36-15M	0-36	0-15	8¾	19	13¾	10.5	625.00
SM 75-2M	0-75	0-2	3½	19	13¾	4.0	425.00
SM 75-5M	0-75	0-5	5¼	19	13¾	6.5	525.00
SM 75-8M	0-75	0-8	8¾	19	13¾	10.0	625.00
SM 160-1M	0-160	0-1	3½	19	13¾	3.5	425.00
SM 160-2M	0-160	0-2	5¼	19	13¾	5.5	525.00
SM 160-4M	0-160	0-4	8¾	19	13¾	10.5	625.00
SM 325-0.5M	0-165-325	0-0.5	3½	19	13¾	3.5	440.00
SM 325-1M	0-325	0-1	5¼	19	13¾	5.0	555.00
SM 325-2M	0-325	0-2	8¾	19	13¾	11.0	675.00

See our complete Catalog in

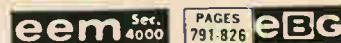

KEPCO, INC. • 131-38 SANFORD AVENUE • FLUSHING, N.Y. 11352 • Phone: (212) 461-7000 • TWX #212-539-6623 • Cable: KEPCOPOWER NEWYORK

Editorial

Japan stresses research

(This is the second of a series of editorials from the Far East by editor Lewis H. Young.)

The Japanese electronics industry has existed on ideas and technology borrowed from abroad. Low labor costs have enabled the industry to absorb licensing costs and still meet foreign competition; but their increasing dependence on foreign patents has impressed manufacturers with the need for originality.

The result has been a startling growth in research. Nine separate research facilities have been established at the Matsushita Electric Industrial Co., a producer of consumer goods, communications equipment, and semiconductors. Though eight of them are attached to operating divisions, the ninth is a central research laboratory with 500 employes who are investigating projects in physics, chemistry, and electronics. Matsushita expects to double the size of the central lab in a few years.

Matsushita is not alone. Hitachi Ltd.'s central research facility has grown from 600 to 1,400 employes in the last five years, and another hundred will be added. The research lab formed by Sanyo Electric Co., Ltd., in 1961 has grown to 230 employes and will hit 300 in a few months. The Electrical Communications Laboratory, the research arm of the Nippon Telegraph and Telephone Public Corp., added a big new building last year and plans another.

Such growth is reflected in the amount of money being spent on research and development. Nippon Electric Co., Ltd., spends 7% of its sales, which last year were \$231 million, on R&D; Hitachi, which makes everything from transistors to locomotives and last year had total sales of \$1.1 billion, spends 5% of electronics sales for electronics research. The rate is double Hitachi's average for research in all fields. Matsushita spends 3.8% of sales on R&D, though many of its products, like wiring devices and pumps for homes, require little R&D money.

Some of the projects now under way in research labs are advanced; examples are voice analysis at Nippon Electric, diffraction of crystals by slow electron beams at Tokyo Shibura

Electric Co. (Toshiba), investigation of new electroluminescent materials at Sanyo Electric, and of active thin film devices at the Mitsubishi Electric Corp., and the development of languages for hybrid (combined digital and analog) computers at Hitachi.

But originality has not been a hallmark of Japanese research. There are two basic reasons, one historical and one economic.

For nearly 300 years, until the middle of the 19th century, Japan cut itself off from the rest of the world, and consequently fell far behind in technology. The country scrambled to catch up, borrowing heavily from the West—then saw the major part of its industry wiped out in World War II. The catching-up process had to begin all over again, and the important goal was technology itself, not innovation. Japanese electronics engineers, says the senior managing director at Matsushita, Tetsujiro Nakao, "were educated with technology imported from the United States and Europe. They digested it and used it the best way they could."

A further barrier to basic research was erected by Japanese management, which, like management anywhere, tends to demand that research prove its worth quickly. Since development produces results much faster, the product of most Japanese research has been mixed R&D.

A recession which is current in Japan has not helped; to combat a drop in sales, companies are concentrating on new products, stressing development at the expense of research. For example, Matsushita's central lab has just come up with a design for a new consumer video tape recorder—a project most United States companies would have assigned to a development engineering department.

But management is beginning to see the light—and one reason is that U. S. companies, which hold patents on key techniques, have put a stranglehold on Japanese technology. Research offers the only path around the U. S. patents. Matsushita has developed a new ceramic piezoelectric material, lead titanate, for ultrasonic generators so that it will not need barium titanate, which is covered by U. S. patents.

In general, research is succeeding. When the Hokushin Electric Works, Ltd., signed with the Fischer & Porter Co. in 1958, it agreed to pay the U. S. company royalties of from 5% to 8%. In 1963, that agreement was replaced by a 25-year nonroyalty technical exchange and cross-licensing agreement. And next March, when Mitsubishi's 15-year-old one-way pact with the Westinghouse Corp. expires, it will be replaced by an exchange agreement that will allow for two-way flow of technical information.

**SAVE \$2⁰⁰*
PER RELAY
AND GET
EXTRA
CONVENIENCE
TOO!**



**WIRE
THIS**



This precision-built socket starts you off to a savings of nearly \$2.00* per installed LS telephone-type relay when you specify our relay-socket-cover combination instead of a similar relay with factory-wired, octal-type plug. Also (1) you have the convenience of a plug-in component, and (2) you can use a relay having more contacts than octal-type plugs will accommodate.

Two sizes of sockets are available. The 16-pin smaller one (1.39" x 1.71") accepts relays with contact arrangements from 1 Form C to 4 Form C. The larger 28-pin one (1.39" x 2.11") will take relays with contact arrangements up to 8 Form C. Each size socket has four coil terminals for single or dual coil relays.

**Approximate. Based on single lot price. Savings depend on contact arrangements.*

GENERAL

Description: Medium coil telephone type relay with bifurcated contacts.

Time Values:

AC: Operate: 3 to 15 milliseconds.
Release: 3 to 15 milliseconds.

DC: Operate: 5 to 50 milliseconds.
Release: 5 to 140 milliseconds.

Precise time values depend upon coil power and contact arrangement.

Operate and release time delay slugs and fixed or adjustable residuals are available for DC relays.



**PLUG
RELAY IN**

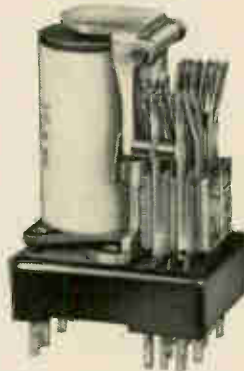

Plug the LS into the socket . . . just as you would a vacuum tube. The relay's tab terminals mate snugly with the socket, will hold the relay in place under normal conditions. When the relay is mounted horizontally, or when vibration is a problem, two banana plugs or two machine screws may be used.

A choice of cadmium or gold plated socket terminals is available . . . and the pierced solder terminals are designed also for AMP-78 taper tab connectors.



**SLIP ON
DUST COVER**



The transparent, high impact, high temperature resistant dust cover fits over the socket nearly flush with the chassis. Covers as well as sockets of either size may be purchased separately. With socket and cover, the LS relay is designated the LSP . . . a sparkling addition to this series of reliable telephone type relays.

Here is a neat, modern, cost-reducing approach to using the reliable, versatile LS relay. Better send for complete information today.

LS SERIES ENGINEERING DATA

Expected Life: 100,000,000 mechanical operations minimum.

Contacts: 100,000 operations minimum at rated load.

Temperature Range: -55°C to +85°C standard (+105°C available on special order).

Weight: Approximately 3/4 ozs. (open).

CONTACTS:

Arrangements: AC: Up to 12 springs (6 per stack-4 movables). DC: Up to 24 springs (12 per stack).

Material: 1/4" dia. twin palladium is standard for bifurcated contact arms.

Gold-alloy, other contact materials, and single contacts are available for specific applications.

Rating: AC: 4 amps @ 115 volts AC, 60 cycle resistive (open relay @ +25°C).
DC: 4 amps 28 volts DC resistive.

COILS:

Voltage: AC: To 230 volts 60 cps.
DC: To 220 volts.

Resistance: DC: 55,000 ohms maximum.

Power: AC: 4.37 voltamps.
DC: 65 milliwatts per movable arm minimum, 5 watts maximum @ +25°C.

Duty: Continuous.

STANDARD P&B RELAYS ARE AVAILABLE AT LEADING ELECTRONIC PARTS DISTRIBUTORS



POTTER & BRUMFIELD

Division of American Machine & Foundry Company, Princeton, Indiana
In Canada: Potter & Brumfield, Division of AMF Canada Ltd., Guelph, Ont.

Electronics Newsletter

October 18, 1965

RCA hints at move into civilian IC's

Formation of a new marketing organization within the Radio Corp. of America's integrated-circuit operation apparently presages a major move by the company into the commercial IC area. Ben A. Jacoby, formerly manager of market planning for industrial semiconductors, heads the new IC marketing group. Roy H. Pollack moves from manager of rectifier engineering to manager of linear-circuit marketing. Arthur M. Kiebshutz, who was Eastern district manager for TRW Electronics has been brought in to direct digital circuit marketing.

Are there IC's in IBM's future?

The International Business Machines Corp. has reportedly found a way to use its solid logic technology hybrid circuits at ultrahigh speeds, and by so doing is closing the door to use of monolithic integrated circuits for now. Called advanced solid logic technology, or ASLT, the circuits are to be used in the large computers, such as the System 360 model 95, which has yet to be formally announced. They will be made on the same production line with the same techniques used for SLT circuits in the smaller models of the 360. The production lines can be readily converted to monolithic IC's if IBM decides to end its long hold-out against them.

The circuits represent a solid-logic version of an old-time transistor circuit technique called current steering, or current switching, in which logic functions are implemented by switching current from one path to another rather than by turning the current on and off as in diode-transistor logic. No diodes are used in the ASLT. The new circuits have an average delay time of only 1.6 nanoseconds—over three times as fast as the fastest SLT circuits. IBM puts four circuits in a single module, mounting them on the four surfaces of two stacked substrates. This reduces interconnections between circuits, contributing to the speed.

A new factory in Burlington, Vt., is beginning mass production of the new circuits, which are also in production at IBM's Components division plant in East Fishkill, N. Y.

Satellites to link Apollo and Houston

The Communications Satellite Corp. (Comsat) will provide communications service during the earth orbits of the three-man Apollo spacecraft that will start in 1967. Final negotiations on the cost of the service are now under way.

The need stems from the National Aeronautics and Space Administration's desire to get 24-hour, real-time feedback of Apollo telemetry to the Manned Spacecraft Center in Houston as the spacecraft passes over remote areas of the world. To provide this, Comsat will place two synchronous satellites in orbit, one over the Atlantic and the other over the Pacific Ocean, keep two spares ready for backup launching, establish 42-foot diameter dish antennas in Britain's Ascension Island, Spain's Grand Canary Island and at Carnarvon, Australia. The Navy will furnish three 30-foot diameter portable stations on ships in the Indian Ocean, Atlantic and Pacific.

In addition, Comsat will provide three portable 42-foot diameter ground stations in Maine, Hawaii and Washington, to work exclusively with the Apollo satellite network.

The Hughes Aircraft Co. will build the satellites for the system, using

Electronics Newsletter

Early Bird equipment where possible. To provide six reliable channels for NASA, plus multiple access by at least two ground stations, including the smaller shipboard stations, the Apollo satellites will have three traveling-wave tubes in parallel, producing 18 watts of power, compared with a single six-watt tube for Early Bird.

Laser scan may do crt's job in tv set

Researchers at Beckman & Whitley, Inc., of San Carlos, Calif., have developed a laser-scanning technique that may open the way to the design of a laser-television system which does not need a cathode-ray tube. Beckman & Whitley is a subsidiary of Technical Operations, Inc.

In the system developed by researchers Willard Buck and Tom Holland a continuous-wave, helium-neon laser beam is reflected off the mirrors of an interferometer. A piezoelectric crystal is attached to one of the mirrors. When an electric field is applied to the crystal, the mirror vibrates with an amplitude of about the wavelength of light. The reflected laser beam appears in the field of a telescope as an interference pattern—or fringe—with a small, oscillating lateral displacement. When focused, the moving fringe becomes a spot that may be displayed on a screen. The spot can be deflected at rates up to 100 kilocycles per second. The sweep frequency of a standard television receiver is 15 kilocycles.

A specialist familiar with the design says that a full 60° deflection of the beam is caused by a change in the index of refraction of an undisclosed element in the interferometer. The technique is inherently low-loss, making it especially valuable for large display systems.

Soviet moon shot: nearly a success?

Luna 7 failed to make a soft landing on the moon this month, but the Soviet attempt may have come much closer to success than had been believed. Signals from the moon probe were received by Western tracking stations three seconds after the time Luna 7 was reported by the Russians to have crashed. This could mean the instrument package survived the crash briefly.

Addenda

The first commercial equipment to use metal-oxide-semiconductor (MOS) integrated circuits will be introduced at the Business Equipment Exposition in New York City next week when the Victor Comptometer Corp.'s Victor 3900 makes its debut. The desk-top calculator uses MOS IC's that contain 250 transistors each. The integrated circuits are made by General Micro-electronics, Inc. . . . United Air Lines is expected to be the first airline to receive Federal Aviation Agency approval of a Category II automatic landing system. Under Category II, a plane may be landed automatically with runway visibility of only 1,200 feet and a ceiling of only 100 feet. . . . Major modifications to the Lockheed Aircraft Corp.'s F-104 jet fighter planes, being built by Italy under license, are expected to be announced soon by the Italian government. The Italian Air Force has long wanted to beef up the plane by equipping it with the Sparrow air-to-air missile. This would be the first joining of a Sparrow missile and an F-104. The Sparrow is built by the Raytheon Co. . . . The Douglas Aircraft Co. will equip a fleet of eight C-135 aircraft to provide communications with the Apollo spacecraft during crucial phases of the mission (see page 130) Douglas teamed with the Bendix Corp. in the study phase. A fixed-price contract of \$27 million was made by the Air Force's Electronics Systems division at Hanscom Field, Mass.

MICROWAVE SEMICONDUCTORS

A versatile spider diode for multi-channel RF switching

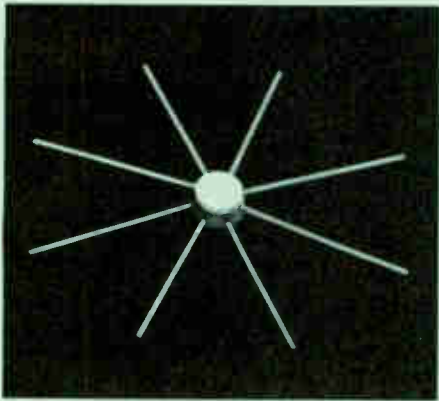

Until now the requirement for multiple channel switching called for a separate diode for each channel. For instance, an 8-channel switch required eight individually packaged diodes, each with its own separate leads and individual junctions. Sylvania and Advanced Development Laboratories of Nashua, N. H., recently combined efforts in coming up with a far more practical answer in a versatile all-new package.

The need for an 8-lead diode, originally designed as a single-pole multiple-throw microwave switch, has directly led to the development of a new concept in diode packaging.

Now any junction device such as the PIN diode, varactor and solid-

structure tunnel diode can be assembled in a new hard glass package having multiple radial flat kovar leads. Dubbed the "spider" diode, the new multiple-lead package also features a molybdenum center stud with glass-to-metal seal and nail-head bonded junctions. Interestingly, one spider diode package with eight leads occupies less space than one DO-7 package. All in all, it's a versatile device for use in printed circuit, coaxial or strip line applications.

This multiple-junction device is available in two basic designs: a single chip having multiple junctions, or multiple chips—each with a single junction. The latter type is especially useful where diodes with diverse characteristics are required.

In the style having the single chip with multiple junctions, the electrical characteristics of the individual devices are always closely matched. This particular package, incidentally, has been referred to as the first step toward integrated microwave circuitry. The unit is especially suited for coaxial input.

The spider diodes themselves have controlled junction uniformity as a result of Sylvania batch processing. The electrical similarity from diode to diode in a single package is within $\pm 5\%$. Also of interest to design engineers is that all junctions are in line with the radial leads, allowing circuit configurations to be fully symmetrical.

The switching PIN spider diode is designed especially for applications involving multiple channel switching. As an example: in low power applica-

tions an arm typically exhibits 25 db isolation with 1.1 db insertion loss at 3 GHz. The addition of a D-5720 (PIN diode in a pico min package), in series with any lead from the spider diode, increases the isolation from 25 db to over 50 db with only a slight increase in insertion loss.

Advance Development Laboratories uses the spider-package PIN switching diode in its four-pole single-throw microwave switch. This ADL device replaces a mechanical microwave switch weighing 40 pounds and measuring 12" x 18" x 4". The newer switch is 3/16" thick, has a diameter of 2" and weighs only 3 ounces.

CIRCLE NUMBER 300

This issue in capsule

CRT's—how special cathode ray tubes can further fiber optic advancements.

Receiving Tubes—why the 6146B by Sylvania is the preferred power amplifier.

Integrated Circuits—how SUHL circuits solved a manufacturer's computer function assembly problem.

Readouts—hermetically sealed solid-state information displays for space rides; also, customized drivers for simplified EL systems.

Diodes—diode bridges and ring modulators now available in molded epoxy packages.

Receiving Tubes—how a new high voltage rectifier solves arcing and radiation problems in color TV sets; also what's newest in vertical deflection amplifiers.

Add arc-free, long-term reliability; eliminate spurious radiation in TV design

Problem #1. Until recently, most high-voltage rectifiers for color TV circuitry were rated at peak inverse voltages of 30,000 volts. These tubes were operated at the top of their capability and a peak inverse rating of 35,000 volts was needed.

Problem #2. In addition, the same high-voltage rectifiers too often displayed assorted other shortcomings; among them: poor emission stability, abrupt emission slump on life, poor reaction to line voltage variation, major arcing problems and spurious radiation effects.

Now with Sylvania's new 3BF2 these problems are solved before they begin. A large measure of reliability has been added to the critical high-voltage rectifier socket function with a tube type whose superiority has been proven in dynamic life tests, high voltage testing and TV set evaluation.

The 3BF2 includes a heater cathode design that provides long-life emis-



sion stability which is consistent with color set requirements. Design features include a rhenium tungsten, dark overcoat heater with an increased heater power input. This provides a higher average and peak current capability. The added capac-

ity precludes undesirable emission slump during life, as well as slump due to line voltage variation.

The type 3BF2 has been shown to be consistently superior in resisting all forms of arcing in tests and actual usage. Arcing can cause transients which can result in damage to the picture tube.

With its larger diameter anode, the 3BF2 is less susceptible to anode-to-heater and heater-to-plate arcing than types with smaller anodes. Also, external arcing along glass to surrounding objects is greatly minimized due to increased spacing between anode and shield, a design feature which also reduces voltage gradient along the bulb.

The unique design features of this new high-voltage rectifier completely eliminate spurious radiation problems associated with other high-voltage rectifiers.

CIRCLE NUMBER 301

What's newest in vertical deflection amplifiers for TV

The important change of color television designs into low B+ operation has put sharply increased burdens on the sets' vertical deflection systems. Until recently, the only tube types available for this function were, at best, marginal for scan. Simply stated, higher peak current capabilities became the order of the day. As a part of its "Tubes for Color" program, Sylvania engineering has designed new types that are already answering that need.

A new family of vertical deflection amplifiers, the LR8 and LU8 series, represent a realistic reappraisal of tubes for this application. These have also proven ideal for low B+ wide angle deflection black-and-white sets.

The 6LR8, 21LR8, 6LU8 and 21LU8 are all triode-pentode vertical deflection amplifiers and oscillators in single T-12 glass envelopes. The essential difference is in base construc-

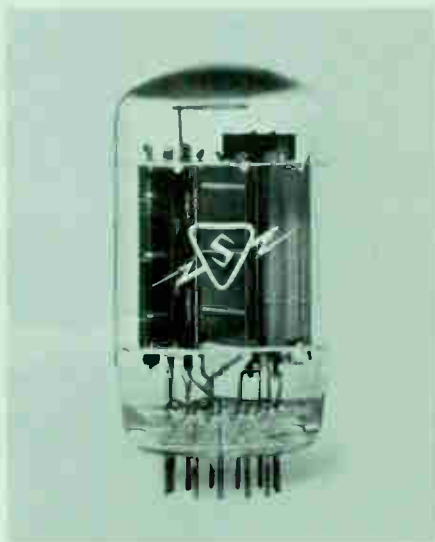

tion. The LR8's have 9-pin Novar bases; the LU8's are 12-pin Compactrons. Within this tube family, two types are for parallel heater and two for series heater operation.

These multi-function tubes feature a low knee of approximately 40 volts,

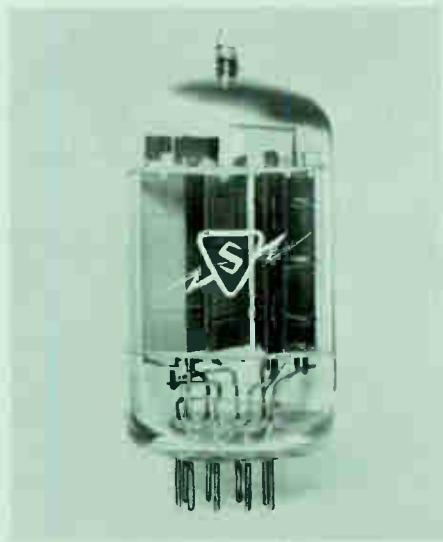

ideally suiting them for low B+ operation. This in turn allows a screen dropping resistor to be used where screen variations must be held to a minimum—an important consideration for black-and-white circuitry also.

CIRCLE NUMBER 302

Computer function assembly solved with SUHL* circuits

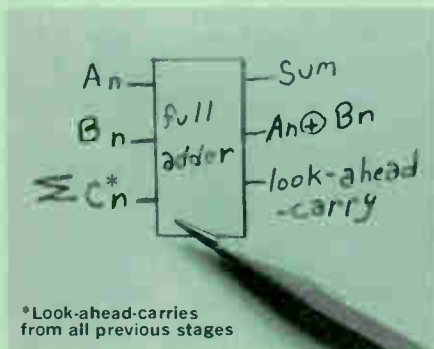

Here's a graphic example of how Sylvania SUHL circuits solved one manufacturing firm's computer function assembly problem.

The actual photographs speak

*Sylvania Universal High-level Logic

pretty much for themselves and for Sylvania's Performance Improvement Program. Both boards shown were assembled using wave soldering or dip soldering techniques. It's clearly evident that this manufacturer earned big savings in board layout costs as well as external soldering techniques.

Simplifying the layout complexity was only one portion of the benefits accrued. The Sylvania solution also added considerably faster speed due to the minimizing of wiring capacitance. More logic functions were added to the board. And, in the final analysis, a higher degree of reliability

was gained due to the substantial reduction of the number of solder joints.

This is only one of innumerable solutions that SUHL integrated circuits offer for solving computer function assembly problems. All SUHL circuits are also available in flat packages. And all of Sylvania's high-level TTL (SUHL I and II) are characterized by high noise margin, fast speed, high logic swing, high fan-out, low power and capacitance drive capability. SUHL is the fastest saturated logic family available today for applications down to 5 nanoseconds.

CIRCLE NUMBER 303

NEW



Four SUHL II circuits in plug-in packages (above) do the work previously done by a larger circuit board full of components (below). Approximately 90% of the board space is now available for more fast adder stages or additional logic functions.

OLD

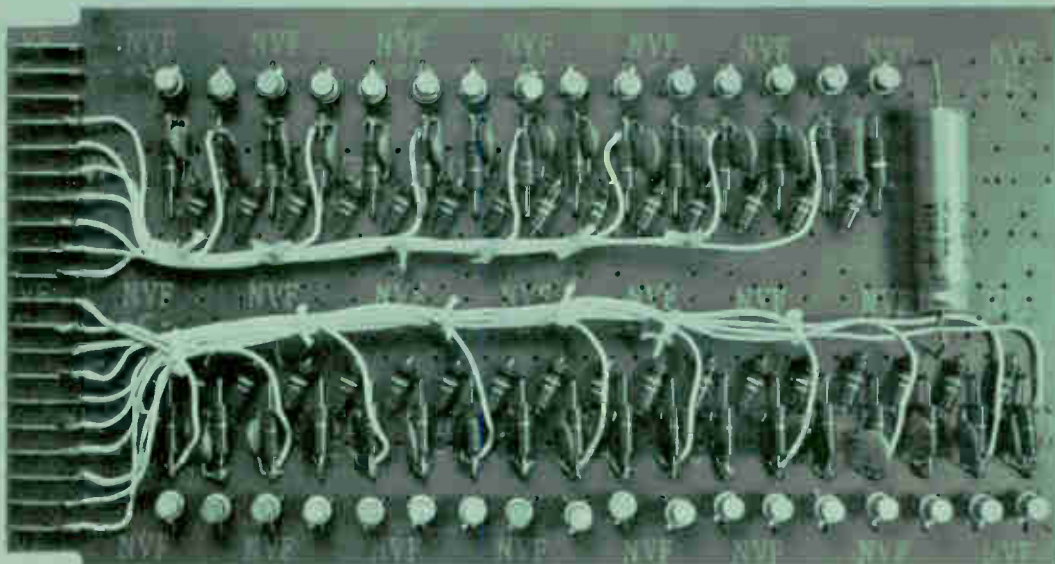

Solid-state EL information display systems for aerospace use

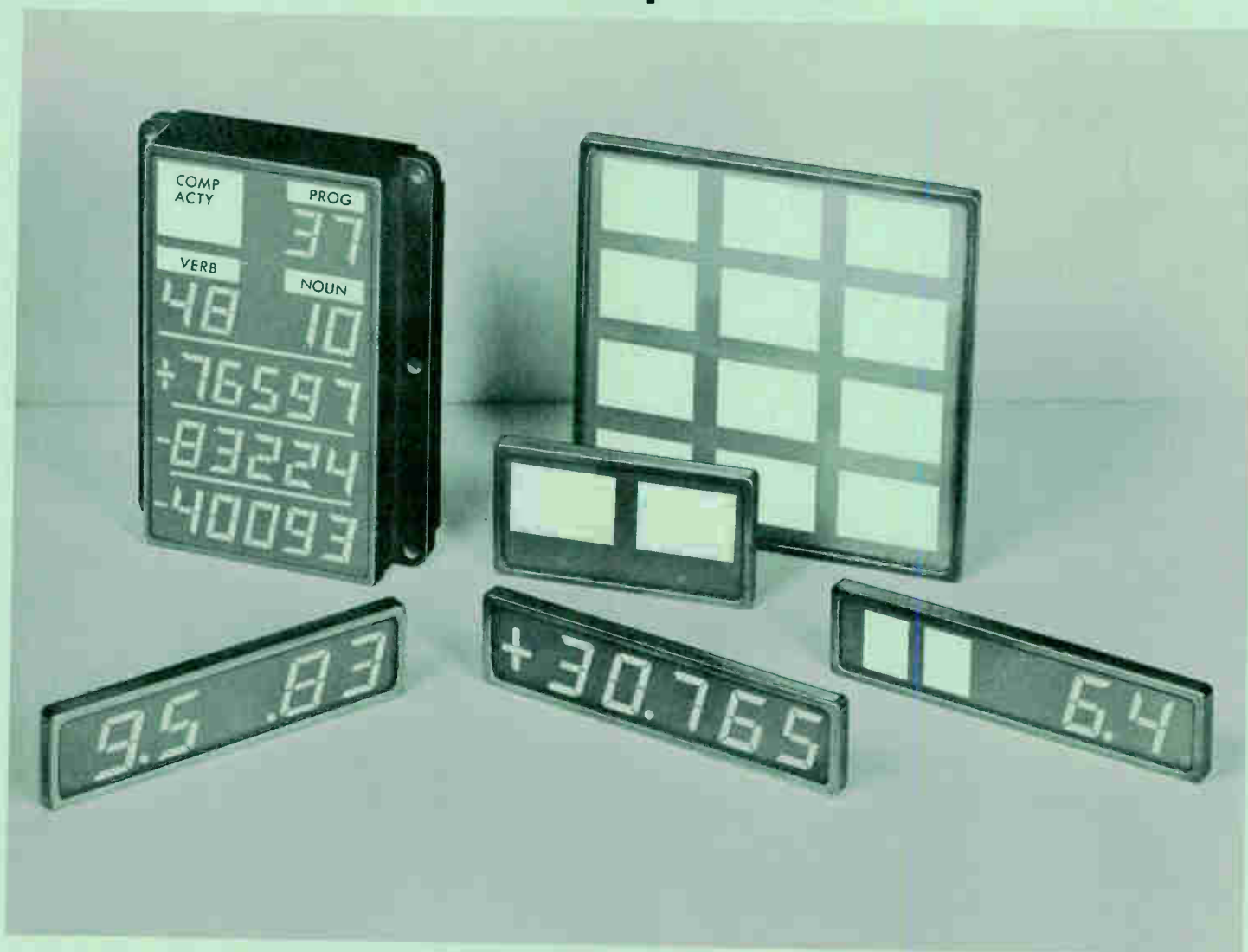

Before our astronauts began multi-orbiting around the earth, Electroluminescence (EL) had come into its own for earthbound information display. Its solid-state construction, small space requirements, reliability, durability, et al, were rapidly proven and commercially accepted. It was just a matter of little time before rugged EL was to be looked at in terms of relevance to manned satellites as well as planetary expedition vehicles.

By their inherent nature, EL readouts are especially suited to aerospace display use. True hermetic sealing is virtually the final touch to customizing these display panels for outerspace conditions. Now Sylvania's hermetic-sealed EL readouts are featured in the only fully solid-state display system selected for one of the nation's major space programs.

Assured protection to moisture-sensitive phosphors comes primarily from stringent sealing that is measured at $0.5 \cdot 10^{-8}$ cc/sec., maximum helium leak rate at 1 atmosphere pressure differential. Hermeticity plus EL's solid-state nature adds the feature of stable performance under conditions of temperature extremes, intense pressures, severe shock and vibration.

Still another aerospace consideration is met with the sandwich-tight compactness of the panels, a factor that goes a long way in minimizing space and weight factors. Also minimal is EL's power consumption.

Before shipment for aerospace application, hermetic-sealed EL panels must be subjected to demanding tests for varying environmental conditions. To test their performance under temperature extremes, all units must

function normally in a temperature cycle from -55°C to 94°C . All leads are tested with 4-pound axial pulls.

Hermetic seals are verified under separate tests for sealing and humidity. Then the panels are given a 50-G, 6-millisecond shock-mounted test.

As in Sylvania's line of commercial EL readout panels, these hermetic-sealed varieties will not fail abruptly, as other readouts can. Over a period of time, light output will decrease in relation to ambient illumination.

Other features of EL include the wide viewing angle of almost 180° , the easy-to-read soft blue-green color, and the variety in size (up to 6" high) of both numeric and alphanumeric characters. Also, information can be displayed fast; in fact, even faster than the human eye can respond.

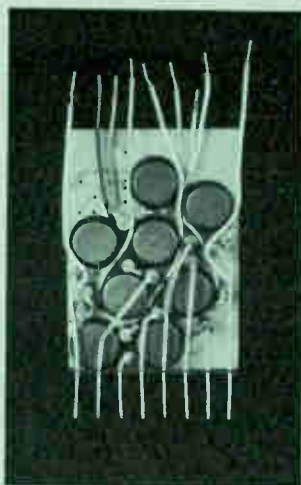

its reliability, readability, weight and size factors. In addition, the subcontractor requested a solid-state driver subassembly to actuate a 5-digit Electroluminescent readout with 7-segment characters to turn on a 250 volts RMS, 400 cps ac operation.

The result: in a minimum of time Sylvania designed, built and delivered in quantity an assembly combining solid-state components and printed circuitry into a small (1-5/8" x 1-3/16" x 3/8") package. The unit does its switching with silicon controlled rectifiers requiring only 6-volts dc trigger input to control the 250 volts for the EL panel.

Sylvania designed a separate driver for each digit. The five separate drivers were then potted in a single epoxy block with leads exposed at one end and EL sockets at the other. All in all, the features of small size, light weight, power economy and solid-state reliability were combined into the perfect solution to a design problem.

Simplified EL readout systems with custom-designed drivers

A new solid-state driver assembly proves the inherent flexibility in designing with Sylvania's EL (Electroluminescence) readout systems. As a prime producer of EL readouts,

Sylvania is frequently called upon to custom-design entire systems or even individual components with a system.

In a recent instance, a major subcontractor specified EL because of

RECEIVING TUBES

Why Sylvania's 6146B is the preferred power amplifier

The newest version of a long-time industry standard power amplifier represents a major stride in tube technology for the communications equipment industry. Sylvania's "B" version of the popular 6-volt 6146 beam powered pentode has the highest levels of efficiency and sensitivity ever offered in this tube.

Of special interest is that Sylvania has effectively incorporated its Hi-Con plate construction into the tube, eliminating the problems of hot spots and resultant gassing. The Hi-Con plate is basically a steel core which is first copper-plated and then nickel-plated. The result is far greater uniformity in heat conduction along with greater efficiency in heat radiation. These factors add up to a considerably higher safety factor.

The Sylvania 6146B has a dark-coated heater that virtually eliminates failure due to wire embrittlement. The heater, in turn, is electrically isolated from the cathode by a heavy oxide insulating coating. And increased heat transfer at a lower heater temperature is effected by the dark-



Unretouched photo of 6146B with conventional plate. Note pronounced hot spot.

colored outer coating. Together, these improvements aid in maintaining rated power output even at reduced heater voltage.

Peeling and flaking of the emissive coating has been eliminated by using a new type of cathode cold-rolled from a blend of powdered metals.



Unretouched photo of Sylvania 6146B with Hi-Con plate. Note absence of any color.

And power output is substantially enhanced by progressive reactivation of the emissive materials.

In addition, the possibility of secondary emission has been reduced by gold-plating the No. 1 and No. 2 grids with molecular bonded wire.

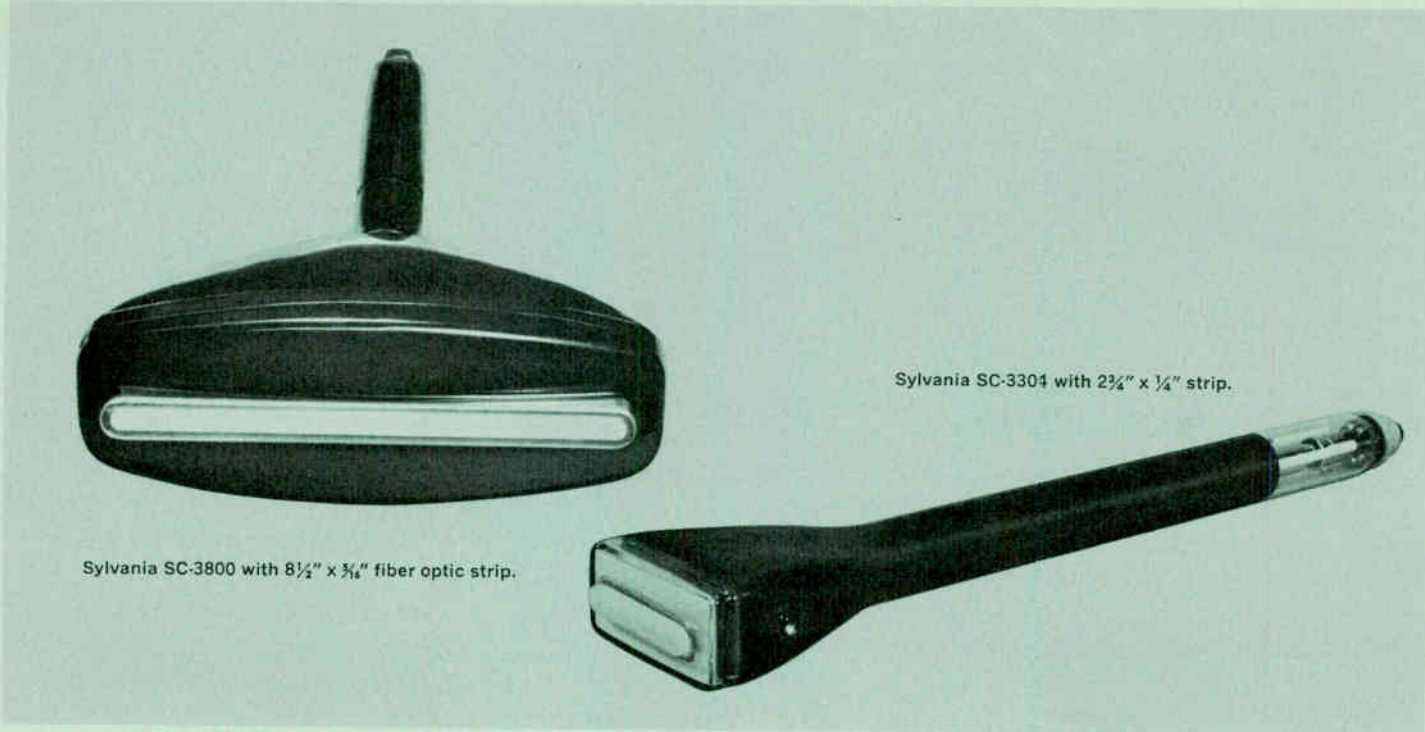

Custom-engineered tubes for advanced fiber optic systems

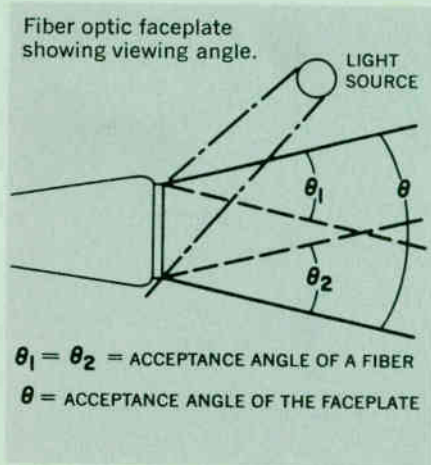

Fiber optics offers the electronic equipment designer relatively new, but proven, techniques for optical coupling from cathode ray tubes to photographic film. It is an effective means of increasing light output without increasing system complexity. Light is transmitted from the phosphor to the film with an effective gain in light intensity of up to 30 times, compared with refractive optics using efficient lens systems. This story tells how precision CRT's are furthering the advancement of fiber optics.

Many novel uses of fiber optics have been suggested for use in CRT's. Among these are time-base transla-

tion, increased resolution, image magnification and curved field flattening. Other applications are image scrambling for optical coding as well as decoding and contrast improvement under high ambient light. The more conventional purposes are direct photographic printing, flying spot scanning and other types of recording.

Sylvania has designed several types of high-resolution cathode ray tubes with fiber optic faceplates as well as full faceplate arrays for these and other purposes.

Some of these CRT's are shown in the table on this page. Other customized types can include faceplates of up to 4" x 6". Types are available with magnetic or electrostatic deflection and focus, P11 or P16 screens, aluminized or non-aluminized. Fiber sizes range from 75 microns down to 4 microns.

To maintain the effect of resolution obtained with the CRT used for pho-

tographic recordings, it is necessary that the fiber size be approximately 1/10 the diameter of the cathode ray tube spot size.

It is possible to fuse these bundles into the faceplate of the cathode ray tube so that direct recording of information presented on the CRT may be made on film which is in contact with one end of the light bundle. The phosphor screen is applied directly to the inside surface of the fiber bundles.

One of the Sylvania CRT's, the SC-3800, featuring a fiber optic strip inserted in the faceplate, is designed especially for high-resolution photographic recording. The fiber optic strip has an approximate active area 8-1/2 inches long by 5/16 inch wide. The tube has electrostatic focus and magnetic deflection.

Other types shown in the table all have magnetic focus as well as magnetic deflection.

CIRCLE NUMBER 306

BASIC CHARACTERISTICS OF FIBER OPTIC CRT'S				
Tube Type	Fiber Strip Size	Focus	Deflection	Line Width
SC-3800	8 1/2 x 3/16	electrostatic	magnetic	0.005"
SC-3304	2 3/4 x 1/4	magnetic	magnetic	0.001"
SC-3850	4 1/2 x 1/2	magnetic	magnetic	0.0008"
SC-3876	8 1/2 x 3/16	magnetic	magnetic	0.004"
SC-3507	8 1/4 x 1/2	magnetic	magnetic	0.002"

Diode bridges and ring modulators now in molded epoxy packages

Now available in miniaturized molded epoxy packages are diode bridges and ring modulators. Sylvania offers these diode devices in a choice of two package styles, the axial lead and plug-in types.

Both package types take up a minimum of space and allow quick adaptation in circuit layouts. The plug-in package is especially important for manual or automatic insertion, and it readily lends itself to flow-soldering installation on printed circuit boards. Typical specifications for the molded epoxy bridges and ring modulators are shown in the table.

As many as eight discrete diodes,

matched to individual specifications, are now available in a single epoxy plug-in package from Sylvania. Plug-in leads are evenly distributed on .100" centers.

Package size for an eight-diode plug-in unit measures .905" x .190" x .345" max., while the bridge/ring

modulator package with four diodes measures .636" x .360" x .115" max. The axial lead unit is .465" x .310" x .200".

Sylvania also supplies ring modulators and diode bridges in 4-lead TO-46 packages.

CIRCLE NUMBER 307

MOLDED EPOXY BRIDGE				
Type No.	No. of Diodes	Fwd. Current @ 1.0 volts (ma)	PRV (volts)	Matching Fwd. Current (@ 2ma mv)
SID4C-7	4	30	50	—
SID4C-8	4	50	75	20
MOLDED EPOXY RING MODULATOR				
Type No.	No. of Diodes	Fwd. Current @ 1.0 volts (ma)	Matching Fwd. Current (@ 2ma mv)	
SID4D-3	4	50	20	

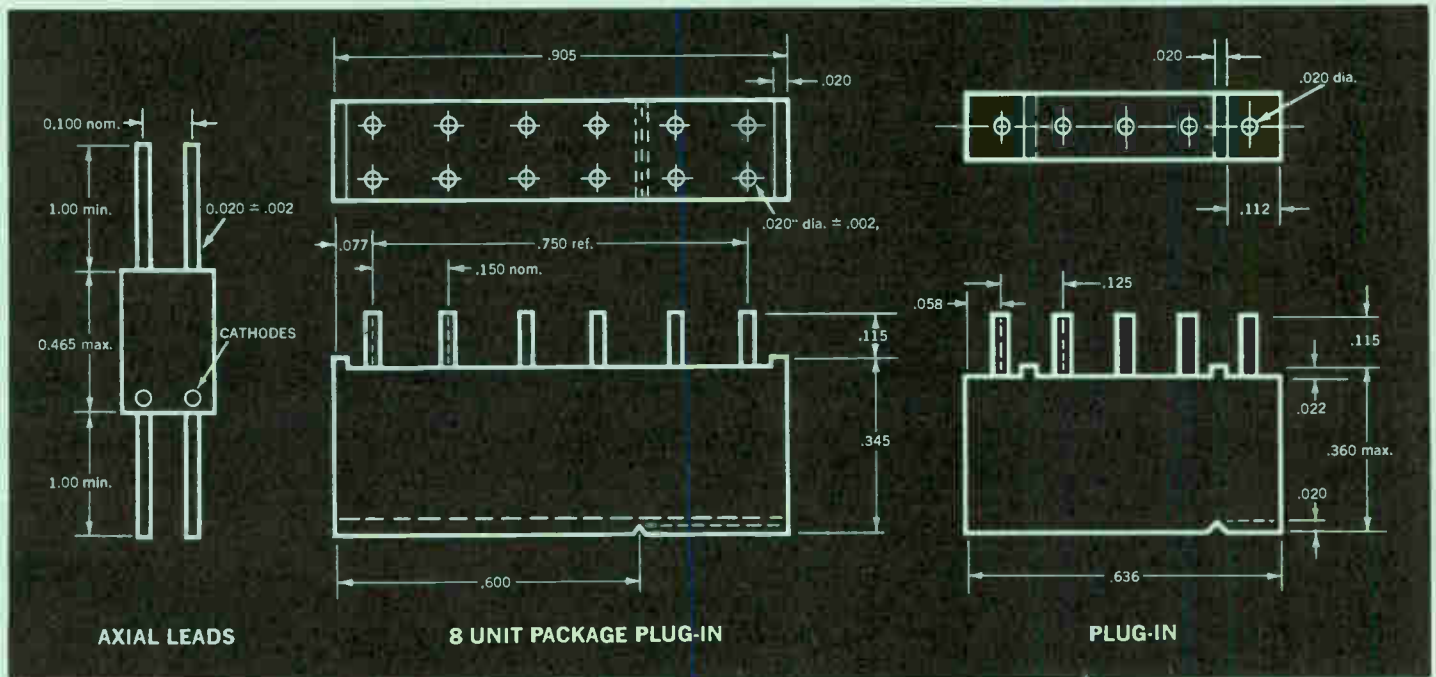

HOT LINE INQUIRY SERVICE

Use Sylvania's "Hot Line" inquiry service, especially if you require full particulars on any item in a hurry. It's easy and it's free. Circle the reader service number(s) you're most interested in; then fill in your name, title, company and address. We'll do the rest and see you get further information almost by return mail.

FIRST CLASS
Permit No. 2833
Buffalo, N. Y.

BUSINESS REPLY MAIL
No Postage Stamp Necessary if Mailed in the United States

POSTAGE WILL BE PAID BY
SYLVANIA ELECTRONIC COMPONENTS GROUP
Sylvania Electric Products Inc.
1100 Main Street
Buffalo, New York 14209

Dept. 999



More facts, fewer gimmicks, please

Look back for a second at our friend the equipment design engineer of not too many years ago. In retrospect he was versatile, very versatile. And what an engineer! He seemed to know the advantages and weaknesses of *all* components and, even more remarkably, from personal experience.

Whatever he didn't know, he had at his fingertips. Supplementing his ready knowledge were reams of case history data covering countless facets to which he could always turn. And, his principal references were a small collection of dog-eared catalogs and technical handbooks.

Then in rapid and overlapping succession came miniaturization, the Space Age, new environments, solid-state technology, et al. Suddenly our friend found himself snowed under with all sorts of technical publications in an era of specialization. Vast new generations of components emerged and even today they continue to branch and grow in staggering proportions. Those yellowed catalogs and handbooks are long gone. Today's catalog sheets abound in profusion, often obsolete before the ink is dry.

But now where's that same engineer we started out with? If he dares try to maintain his versatility, he may never dig out from under the moun-

tain of so-called information.

When he finds time to properly probe and evaluate, he's liable to find that simple variations are too often played up as major innovations. Insufficient information below the banner or headline can actually be a deterrent to accurate evaluation or ready application.

Too often the basic rules of effective technical communications fall by the wayside or are ignored totally. While the profusion of new products constitutes a problem in one sense, it also spells success for both the design engineer and that supplier who has not forgotten the communications needs of the engineer.

It is as important for Sylvania to exploit new product developments as it is for the next company. We are also sincerely enthusiastic about Sylvania's own contributions and their potential significance to broad scientific achievement. But we are equally aware of both the engineer's dilemma and the negative effects of the use of empty superlatives as substitutes for fact and completeness.

We also know that readers want to be communicated with because they're seeking information. Sylvania's technical writing specialists take pains to carefully tailor all output to

the user's requirements. Let's take, for example, characteristics curves and all other extensive mechanical details. These ingredients are essential to the equipment designer. Characteristics curves are purposely large for direct use, with scales that have to be directly divisible, an almost forgotten art, it seems.

In addition, Sylvania gives special attention to uniformity of presentation and terminology to facilitate product comparisons and groupings within product families. Naturally, we want our literature to have eye appeal and distinction, but these must be achieved without gimmickry or any irrational organization that may otherwise destroy continuity. As an example, we invite you to examine any Sylvania application handbook. You'll also see that it is as complete as we can make it. And if a particular answer isn't known, we won't disguise the fact in a play on words.

We at Sylvania think we can best sum it all up with our own philosophy on the subject. Effective communication with the customer is as important as the product itself.



R. A. Humphreys

R. A. HUMPHREYS

This information in Sylvania Ideas is furnished without assuming any obligations.

SYLVANIA

SUBSIDIARY OF
GENERAL TELEPHONE & ELECTRONICS **GTE**

NEW CAPABILITIES IN: ELECTRONIC TUBES • SEMICONDUCTORS • MICROWAVE DEVICES • SPECIAL COMPONENTS • DISPLAY DEVICES

NAME _____
 TITLE _____
 COMPANY _____
 ADDRESS _____
 CITY _____ STATE _____

Circle Numbers Corresponding to Product Item

300	301	302	303	304
305	306	307		

Please have a Sales Engineer call



HOT LINE INQUIRY SERVICE

Need information in a hurry? Clip the card and mail it. Be sure to fill in all information requested. We'll rush you full particulars on any item indicated.

You can also get information using the publication's card elsewhere in this issue. Use of the card shown here will simplify handling and save time.

Take Any One of these three books for only \$1.00

with your first selection and
charter membership in the
**Electronics and Control Engineers'
Book Club**

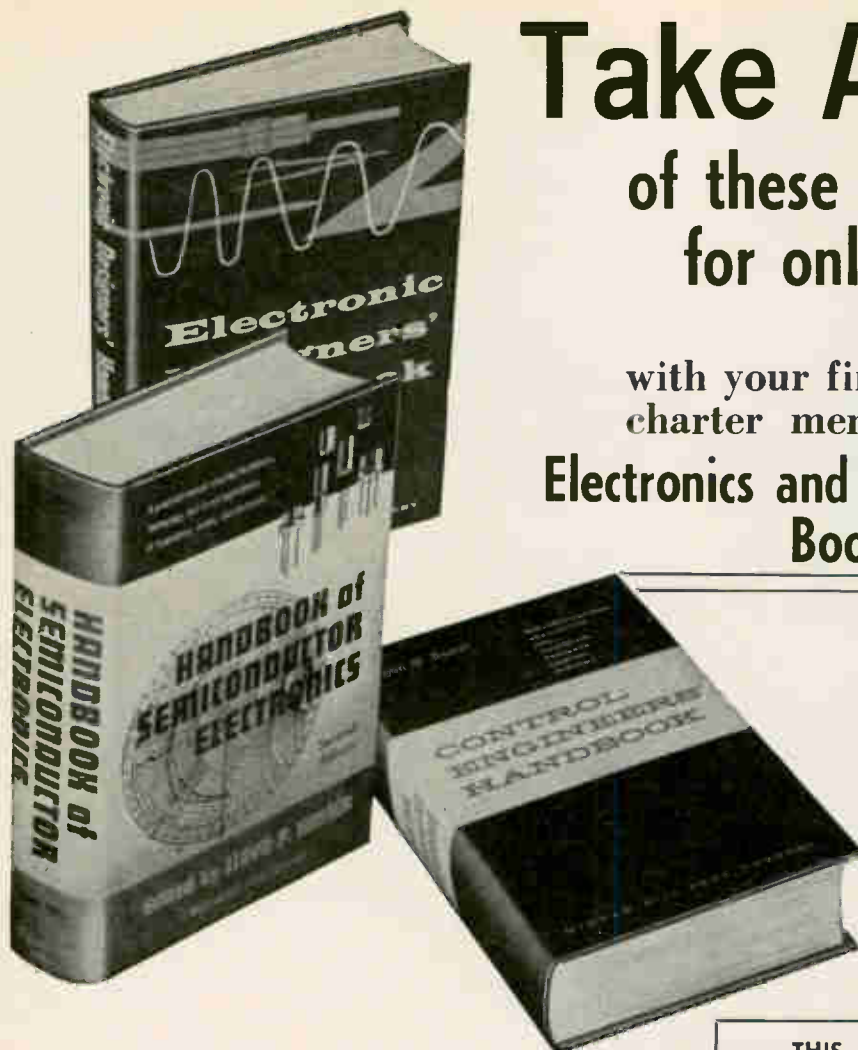

**ELECTRONIC DESIGNERS'
HANDBOOK**
Publisher's Price: \$18.50

**HANDBOOK OF
SEMICONDUCTOR ELECTRONICS**
Publisher's Price: \$19.50

CONTROL ENGINEERS' HANDBOOK
Publisher's Price: \$23.50

Please accept any one of the three books pictured above, for just \$1.00—with your first selection chosen from the books listed in the coupon.

We invite you to look over these twelve books in the coupon. They are important technical books indispensable to a field so dynamic that even the well-informed can hardly keep up. And they suggest the quality of the volumes that will be made available to you as a Club member.

Membership in the Electronics and Control Engineers' Book Club is *easy and economical*. The Club will bring to your attention outstanding books in your field that you might otherwise miss. Possibly just one idea from one of these books could mean more to you in actual dollars and cents than many times the cost of the book. And you may obtain any or all selections at substantial savings.

How the Club operates. The Club will describe all forthcoming selections to you. Periodically, as issued, you will receive free of charge *The Electronics and Control Engineers' Book Club Bulletin*. This gives complete advance notice of the next main selection as well as a number of alternate selections. All books are selected by qualified editors and con-

sultants whose thoroughgoing understanding of the standards and values of technical literature will be your guarantee of the authoritativeness of the selections.

From this point on, the choice is yours. If you want the main selection you do nothing; the book will be mailed to you. If you want an alternate selection or if you want no book at all for that period, you notify the Club by returning the convenient card enclosed with your *Bulletin*.

We ask you to agree only to the purchase of four books over a two-year period. Certainly out of the large number of books in your field offered you during this time there will be at least four you *would buy in any case*. By joining the Club you will save, in cost, about 15 per cent from the publishers' prices.

You need send no money now. By taking advantage of this special introductory offer you will receive for just \$1.00 a copy of *Handbook of Semiconductor Electronics*, or *Electronic Designers' Handbook*, or *Control Engineers' Handbook*, together with your first selection—at the special club price. Take advantage of this offer *now*, and get two books for less than the regular price of one!

THIS COUPON WORTH UP TO \$22.50

Mail to: The Electronics and Control Engineers' Book Club
330 West 42nd Street, New York, N.Y. 10036 Dept. L1040

Please enroll me as a member of the Electronics and Control Engineers' Book Club. I am to receive the two books I have indicated below. You will bill me for my first selection at the special club price and \$1 for my new membership book, plus local tax where applicable, and a few additional cents for delivery costs. (The Club assumes delivery costs on prepaid orders.)

Forthcoming selections will be described to me in advance and I may decline any book. I need take only 4 selections or alternates in two years of membership. (This offer good in U. S. only.)

- | | |
|---|---|
| <input type="checkbox"/> Handbook of Semiconductor Electronics , Edit. by L. P. Hunter, 2nd Ed. Publisher's Price, \$19.50. Club Price, \$16.55. | <input type="checkbox"/> Electronic Amplifier Circuits , by J. M. Pettit and M. M. McWhorter, Publisher's Price, \$10.50. Club Price, \$8.95. |
| <input type="checkbox"/> Electronic Designers' Handbook , Edit. by R. W. Landee, D. C. Davis, and A. P. Albrecht, Publisher's Price, \$18.50. Club Price, \$15.75. | <input type="checkbox"/> Electronic Measuring Instruments , by H. Seisson, Publisher's Price, \$7.50. Club Price, \$6.40. |
| <input type="checkbox"/> Control Engineers' Handbook , by J. C. Tuzal, Publisher's Price, \$22.50. Club Price, \$19.95. | <input type="checkbox"/> Modern Digital Circuits , by S. Weber, Publisher's Price, \$9.50. Club Price, \$8.10. |
| <input type="checkbox"/> Introduction to Radar Systems , by M. Skolnik, Publisher's Price, \$14.50. Club Price, \$12.35. | <input type="checkbox"/> Nonlinear-Magnetic Control Devices , by W. A. Geiger, Publisher's Price, \$12.50. Club Price, \$10.65. |
| <input type="checkbox"/> Mathematics for Electronics with Applications , by H. M. Nofelman and F. W. Smith, Jr., Publisher's Price, \$7.00. Club Price, \$5.95. | <input type="checkbox"/> Electrical Engineering for Professional Engineers' Examinations , by J. D. Constance, Publisher's Price, \$10.00. Club Price, \$8.50. |
| <input type="checkbox"/> Transistor Circuit Design , prepared by Chuck Staff of Texas Instruments Inc, Publisher's Price, \$15.00. Club Price, \$12.75. | <input type="checkbox"/> Electronic and Radio Engineering , by P. E. Ternan, 4th Ed. Publisher's Price, \$16.00. Club Price, \$13.60. |

Name (Please Print)

Address

City State Zip

L1040

No-risk guarantee. If not completely satisfied, I may return my first shipment within 10 days and my membership will be cancelled.

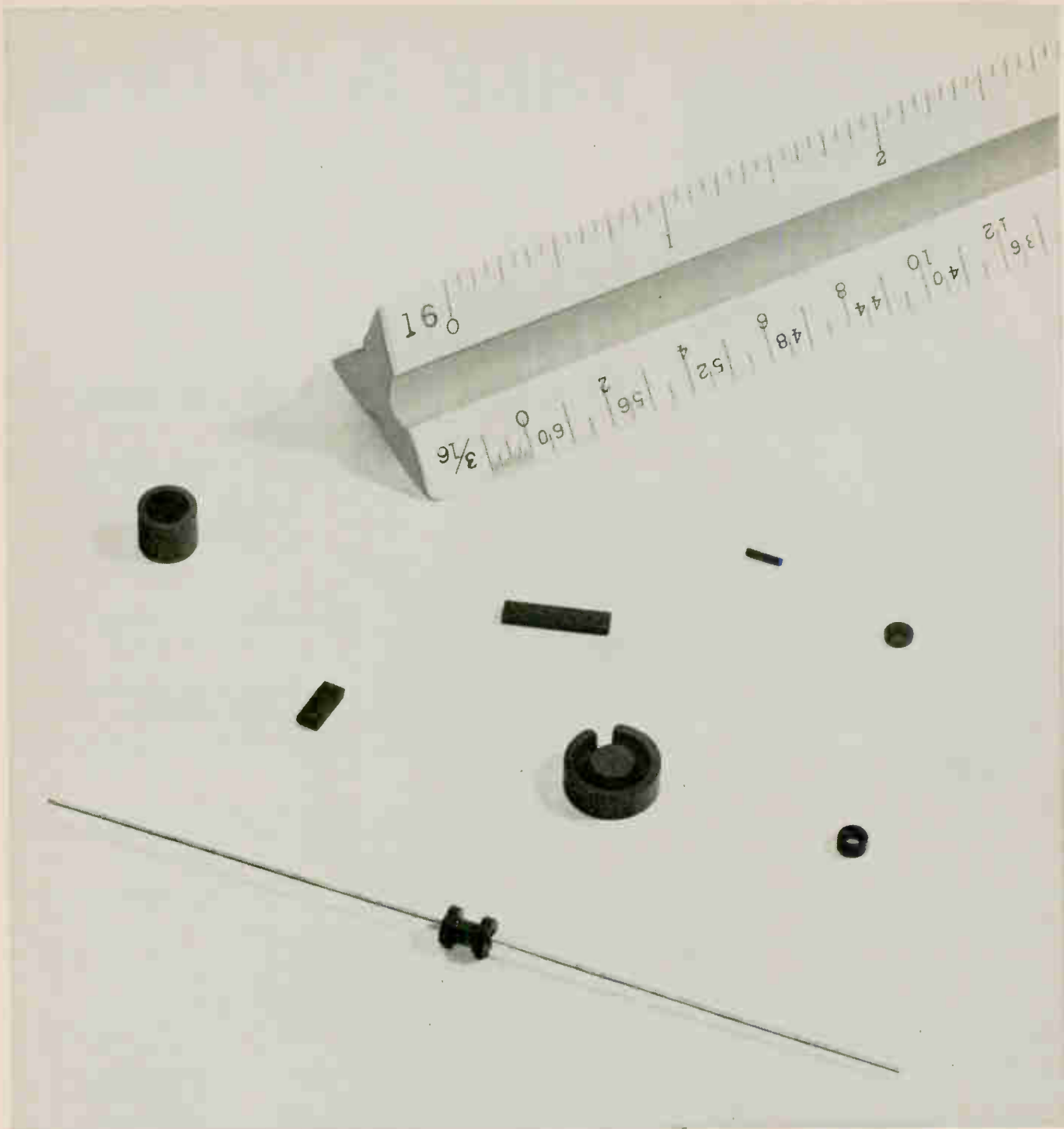

No matter how small the ferrite piece,
**WHEN MECHANICAL AND ELECTRICAL SPECS ARE TIGHT...
 SPECIFY STACKPOLE**

Stackpole makes them all:

- Toroids down to .120" OD
- Cups as small as .250" OD x .130 Hgt.
- Bobbins smaller than .080" OD
- Cores of .031" D x .170" Long
- Coil forms below .060" D x .187" Long
- Sleeves to .075" OD x .028" ID
- Rectangular Solids smaller than .120" x .120" x .218"

But subminiature size isn't Stackpole's only claim to fame in ferrites. One customer put it this way, "Your ferrite cores are more consistent from order to order than any of your competitors."
 Over 30 grades. Isn't that what you're looking for?



2500 2600

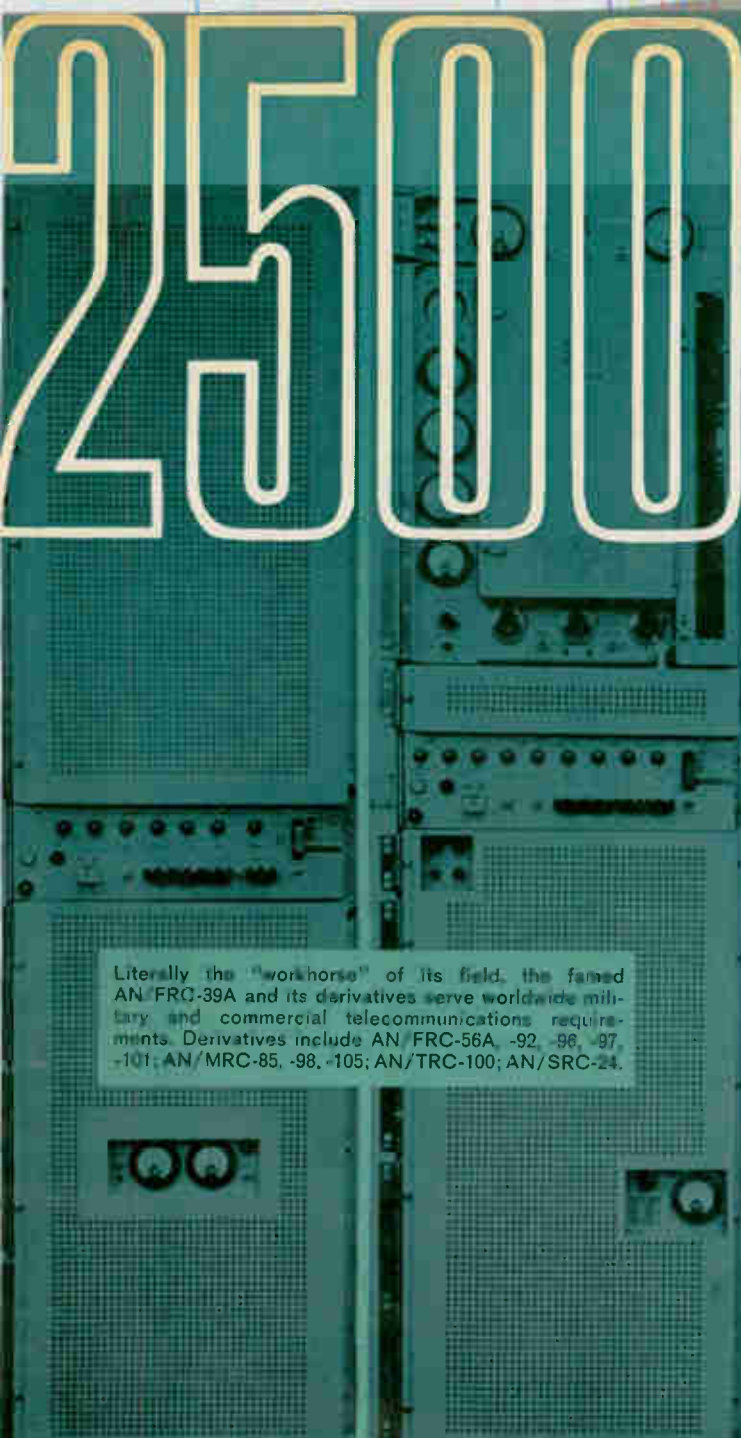

Literally the "workhorse" of its field, the famed AN/FRC-39A and its derivatives serve worldwide military and commercial telecommunications requirements. Derivatives include AN/FRC-56A, -92, -96, -97, -101; AN/MRC-85, -98, -105; AN/TRC-100; AN/SRC-24.



Solid-state version of the 2500 Series, the new REL 2600 Series offers one-fifth the size, weight, and power drain of its tube-state counterpart.

Advanced, all solid-state design makes the new 2600 Series from REL an ideal solution to your critical requirements in tropospheric scatter, line-of-sight microwave, and satellite ground station communications.

Designed to be compatible and interchangeable with the famed AN/FRC-39A(V), this "new generation" of equipment, the 2600 Series, meets or exceeds Defense Communications Agency requirements as well as CCIR and other international standards.

Modular construction gives the 2600 Series optimum size and weight flexibility for tactical, mobile, fixed, or shipborne installations where ruggedness and reliability are also prime requisites.

Now in production and operation, the 2600 Series represents another dimension of creative engineering by REL—the only company devoted principally to the design, development, and manufacture of tropo and microwave radio relay equipment.

Special REL Literature File available upon request.



RADIO ENGINEERING LABORATORIES
Division of Dynamics Corporation of America
Long Island City 1, New York



Circle 37 on reader service card

INTEGRAL ELECTRONICS COURSES

EAST COAST

NOVEMBER 29 - DECEMBER 3, 1965

SHOREHAM HOTEL
WASHINGTON, D. C.

WEST COAST

JANUARY 17 - 21, 1966

AIRPORT-MARINA HOTEL
LOS ANGELES, CALIF.

A Five-day Course Based on Motorola's Integrated Circuit Texts

*... and ARINC Research's three-year study for the
Air Force and NASA of more than eighty inte-
grated circuit manufacturers and users*

HIGHLIGHTS — Semiconductor physics ■ circuit processing, assembly, process control ■ thin films ■ circuit elements ■ transistor models ■ parasitic effects ■ digital and analog circuits ■ testing of circuits ■ reliability ■ specifications ■ system economic considerations ■ impact of integral electronics on systems ■ management decisions.

Write or call:

 **ARINC** RESEARCH CORPORATION

East Coast — W. H. von Alven, ARINC Research Corporation, Annapolis Science Center, Annapolis, Maryland • (202) 296-4626.

West Coast — J. B. Harmon, ARINC Research Corporation, 1222 East Normandy Place, P. O. Box 1375, Santa Ana, California • (714) 547-7594.

ONLY \$1395

Now...the world's most reliable and versatile DVM has a modern new package and new low price!

**CONDENSED SPECIFICATIONS
ALL THESE FEATURES FOR \$1395!**

Read-out speed:	2 readings/per second
Accuracy: DC	.01 %
Ratio	.05 %
Ranging:	Automatic or manual
Polarity:	Automatic
Accessories:	Optional



Prices and specifications subject to change.

If you consider price, features, and quality . . . the Cubic DV-271 is your best digital voltmeter buy! Based on the time-proved design of the famous Cubic V-71, this new transistorized 4-digit DVM offers a clean-cut front panel for easy read-out . . . **and sells for only \$1395!**

Versatile DV-271 is ideal for your most highly-specialized measurement needs. It is the only low-cost DVM available with both dependable reed-relay operation and built-in ratiometer!

For complete information on this and other digital equipment, write: Cubic Corporation, Industrial Division, Dept. D-224, San Diego, California 92123.



CUBIC
CORPORATION
SAN DIEGO, CALIFORNIA 92123
INDUSTRIAL DIV.

1 PPM

Potentiometric Measuring System

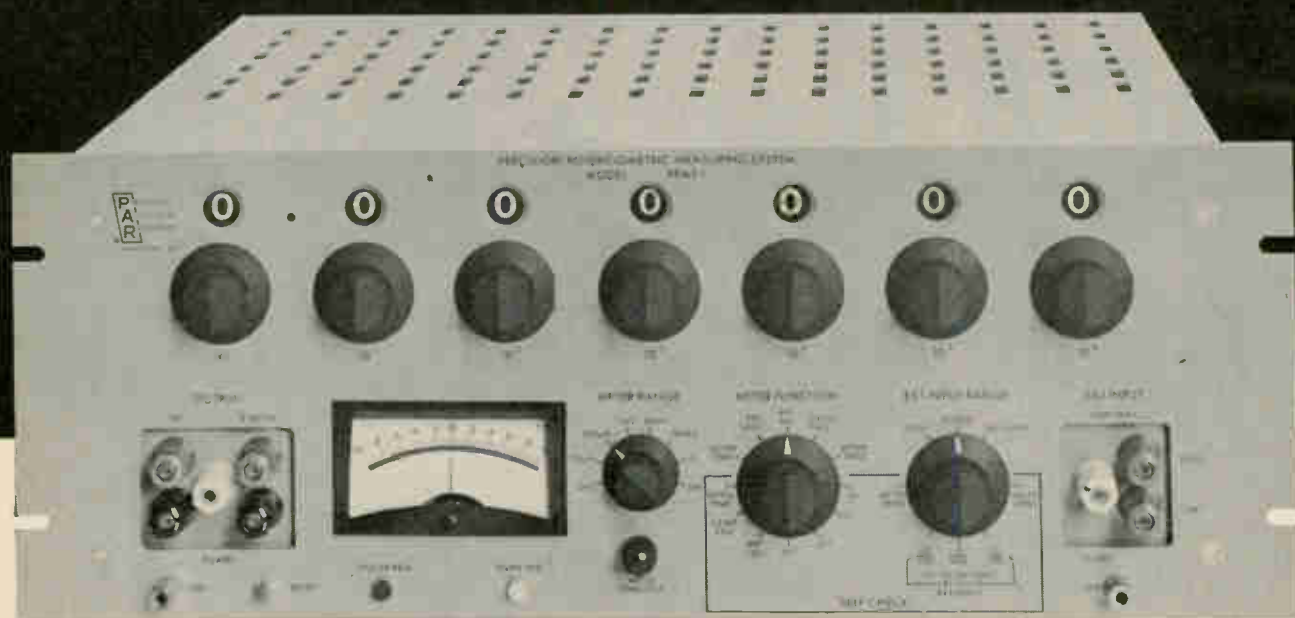

The PAR Model PPMS-1 is a self-contained system consisting of the basic components required for making one part per million measurements of external resistance ratios or external DC voltages extending to 1000 volts. The system, with accuracy traceable to N.B.S., consists basically of a 10 volt DC source whose saturated standard cell reference is housed in a proportional temperature controlled oven (maintained within 0.001°C), a self-calibrating 7 decade Kelvin-Varley divider and a null indicator having a basic full scale sensitivity of ± 1 microvolt.

An output signal fully isolated from, but proportional

to the deflection of the null meter is provided to drive strip-chart recorders and thereby function as a self-contained monitor of the stability of other voltage supplies. In addition, this unit can serve as the controlling element in ultra-stable variable voltage or current supplies with the addition of power amplifiers which are available as accessory items.

A unique method of self-calibrating the four most significant decades of the Kelvin-Varley divider without additional equipment as well as means of verifying oven temperature and standard cell voltage are provided. Price \$4950.

Write for bulletin No. 121 or ask for information about PAR's complete line of precision reference sources.

PAR
PRINCETON
APPLIED RESEARCH CORP.
Dept. D
Box 565, Princeton, N. J. Tel. (609) 799-1222

Advanced technology

Solid state klystron

The Sperry Rand Corp. became the first company to make public its work on diode oscillators with its announcement this month that a silicon diode had been made to oscillate continuously in the microwave region, from a direct-current source, at the company's Sudbury, Mass., research center.

Two Sperry physicists, Martin I. Grace and Henry T. Minden, will report on the achievement this week at the annual technical meeting of the IEEE's Electron Devices Group in Washington. Bell Telephone Laboratories, Inc., had indicated that it might announce a similar device before the meeting opened; in any case, Bell's B.C. LeLoach will deliver a paper on microwave oscillators at the session on new microwave semiconductor devices.

No r-f source. Sperry's oscillator, a reverse-biased diode, does not need a radio-frequency source, and in that sense it is one of a new class of devices which includes Gunn oscillators. But the diode microwave oscillator (DMO) is an avalanche junction mechanism, rather than a bulk-effect device like the Gunn oscillator.

The DMO might loosely be called a solid state klystron. It is basically a tiny silicon planar epitaxial diode, reverse-biased beyond breakdown and mounted inside a small tunable resonant cavity. It operates much like a klystron, the dominant mechanism of both microwave sources being the time delay of carriers passing across a drift space.

The key to the oscillation is the average time delay between the electric field across the device and the current across its terminals, according to Grace and Minden. Part of the delay is produced by the avalanche process, a cumulative

multiplication of carriers caused by impact ionization, and part is produced by requiring the junction to cross a drift region. When the diode, which has a predominantly capacitive impedance, is coupled to a cavity of induction impedance, a resonant circuit is formed which can go into oscillation through the diode's negative resistance element.

Low-power uses. Sperry research and marketing officials believe that the DMO will eventually replace klystrons and varactor multipliers in some low-power microwave applications. The DMO reportedly

technology is all that is required, but details of fabrication aren't being disclosed. The device reportedly lends itself to standard microwave packaging. For the experiments so far, a standard planar diffused epitaxial chip was mounted in a high-Q X-band microwave cartridge.

Milliwatt outputs. In early experiments, Grace observed c-w outputs of a few milliwatts and pulsed outputs of as high as 400 milliwatts. Efficiencies have ranged from 0.2% c-w to 5% pulsed.

Gross tuning of the output is

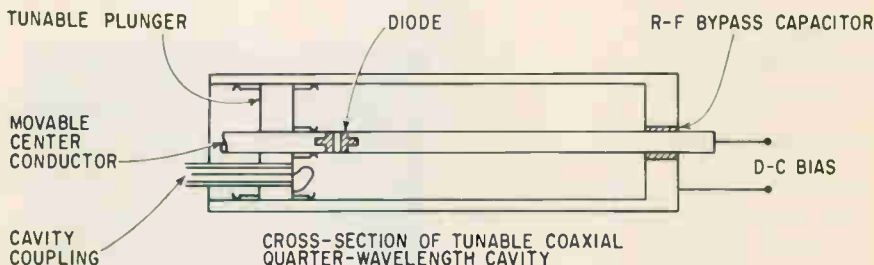

Experimental design for a diode device that can oscillate continuously in the microwave region. The diode, developed by the Sperry Rand Corp., could replace klystrons and varactor multipliers in a number of low-power microwave and future millimeter-wave applications.

promises simpler fabrication, lower cost, longer life and higher reliability than klystrons. Varactor multipliers, which do require an r-f input, have not exhibited the broadband tunability of the DMO.

The Sperry Microwave Electronics division in Clearwater, Fla., will investigate possible use of the DMO as a transmitter in radar altimeters, in portable radar units and in low-power beacons. It's small, light and cheap, says Minden, and will probably be used principally as a local oscillator in portable radar and radio.

According to Sperry, the experimental high-frequency source can be fabricated easily and at low cost. "We can make it for about the price of a standard microwave mixer diode," says Minden.

The developers report that present standard silicon production

achieved by changing the dimensions of the cavity; fine tuning can be done electronically, by varying the d-c input.

The DMO's spectral purity and frequency stability have been comparable to the characteristics of a stabilized reflex klystron, the researchers say, and the instantaneous linewidth has held steady at approximately 50 kilocycles.

In experiments, signals as low as 900 megacycles have been generated. Says Minden: "I think it should be possible to get the output down into the television range of frequencies. As a local oscillator in a tv set, it would have advantages in cost, size and reliability over tubes. We think we know how to lower the output frequency—by opening up the length of the drift region."

The other direction. Minden and

Grace also say that there is nothing to prevent operation of the DMO at the other extreme, millimeter wavelengths. "It could be used, for example," says Minden, "as the pump in a parametric amplifier."

The genealogy of the DMO can be traced to the Read diode, proposed in 1957 by W. T. Read of Bell Labs. But not until recent months were there indications that microwave signal generators of this type were close to production and marketing.

Work on such generators is known to be under way at Microwave Associates, Inc., in Burlington, Mass., and at other labs, as well as at Sperry Rand and Bell Laboratories.

Instrumentation

Sensing danger

Radiation is like vodka in one respect—you don't know you've had too much until it's too late. To protect researchers who work in "hot" areas from harmful doses of radiation, makers of nuclear instruments have developed a variety of radiation dosimeters. In general, those instruments fall into two categories: chemical sensors, which can read high-level doses but are costly (about \$300) and require up to two weeks of chemical analysis to determine how much radiation they have received; and relatively inexpensive semiconductor devices, which can read only low-level doses by emitting small electrical pulses when struck by a radioactive particle.

Quick reading. Now Siliconix, Inc., of Sunnyvale, Calif., has developed a semiconductor sensor, called a Radistor, which costs only \$15, can measure a broad range of doses—from 10^{13} to 10^{16} neutrons per square centimeter—and quickly indicate the total amount of radiation detected over any period of time.

Radistors contain p-type silicon semiconductor material; when high-speed neutrons or protons

strike the semiconductor material, their passage creates dislocations in the crystal structure.

These dislocations act as traps for the majority carriers in the semiconductor; this, in turn, reduces the number of free carriers in the material.

Reducing conductivity. Although the number of impurities placed in the material does not change, the effective concentration of majority carriers is reduced. Since the conductivity of a doped semiconductor is proportional to the majority-carrier concentration, the radiation has the effect of lowering the conductivity. Hence, an accurate measurement of this change in conductivity will provide a measure of the amount of irradiation.

Because the change in conduc-

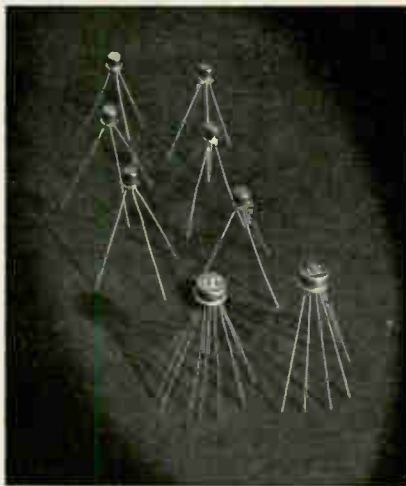

Radiation sensors can detect large doses and provide quick readings.

tivity is permanent, Radistors measure total exposure to radiation. They can operate for long periods and can be measured any time after irradiation. Readings can be taken between bursts of radiation, an advantage over other radiation-measuring devices.

Wide range. The carrier "removal" rate is independent of the impurity concentration; therefore various ranges of radiation can be measured by using devices with different concentrations of impurities. The device with the higher impurity concentration would be used to measure greater radiation

doses. Radistor devices can measure approximately one order of magnitude of radiation; the devices can be packaged individually to cover only one range, or together to cover three ranges— 10^{13} to 10^{14} , 10^{14} to 10^{15} , and 10^{15} to 10^{16} neutrons per square centimeter.

Earthquake DEW line

Even before the shock waves of the 1964 Alaska earthquake had subsided, a group of scientists met in Washington, summoned by Donald F. Horning, director of the President's Office of Science and Technology.

Their task, Horning said, was to organize a massive research program to uncover the causes of earthquakes and design ways to predict them. Post-earthquake studies have indicated that with proper warning—of a few days, for instance—80% of the disaster deaths could have been prevented.

Along the coast. Last week, the panel made its report public. It called for a kind of distant early warning line for earthquakes—a network of permanent and portable arrays of instruments to be installed along the 400 miles of the San Andreas fault, from San Diego to San Francisco, and in Alaska, from Juneau to Anchorage and Fairbanks, and out through the Aleutians. Following up the panel's report, Interior Secretary Udall established the National Center for Earthquake Research at Menlo Park, Calif.

Such DEW lines would require a new generation of electronic instruments, 10 to 100 times more sensitive than those now used in the Project Vela nuclear detection network, according to Frank Press, a Massachusetts Institute of Technology geophysicist who is chairman of the panel. The report proposed a 10-year, \$137-million program to build the forecasting system and to draw up an engineering code for the construction of earthquake-proof buildings.

Here are some of the electronic detectors that the panel says will have to be developed:

- Laser triangulation surveying

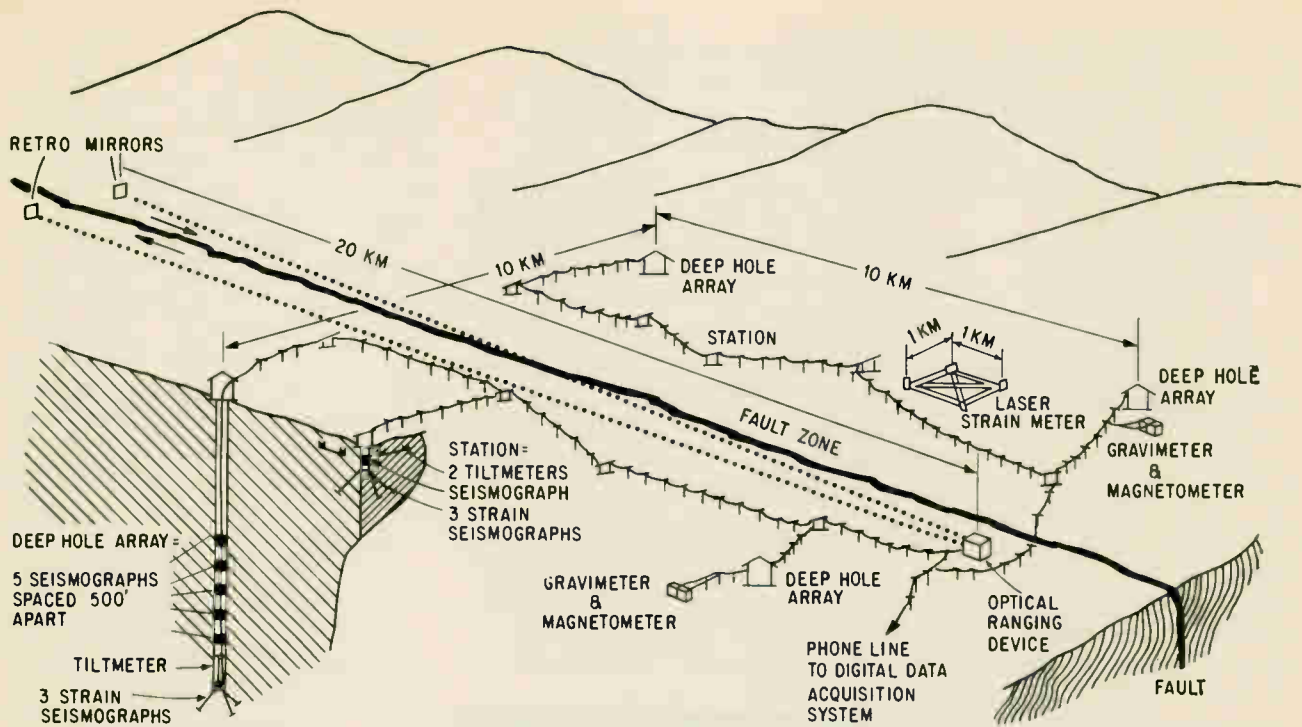

Earthquake early-warning system proposed for the Pacific Coast. Clusters of sensitive electronic sensors would be installed from earthquake-prone California to Alaska.

devices. Permanently mounted mirrors on either side of fault zones coupled with a laser 10 to 20 kilometers away to measure shifts between the sides of the fault of one or two centimeters, enough to measure the daily activity of the fault zone. Multifrequency lasers might be used, Press suggested, to overcome errors caused by changing temperatures, humidity and air pressure. Strain sensitivity of 10^{-7} or 10^{-6} after correction is needed, he said.

▪ Special laser strainmeters to measure strain changes of 10^{-9} over distances of about one kilometer. "These devices will probably require light paths in buried pipes, which are evacuated or filled with dry nitrogen," Press reported.

▪ Supersensitive microseismometers responding to displacements of 1 to 10 angstroms for periods between one second and 1/100 of a second, and limited only by background noise in the earth, to attempt to detect the suspected buildup of tiny earthquakes or microseisms ahead of a ground-shaking earth movement. The microseismometers would be buried in wells as deep as 100 to 10,000 feet.

▪ Tiny tiltmeters, sensitive in two axes, with a sensitivity to changes on the order of 10^{-9} radians or better, to detect the underground and surface tilting believed to precede earthquakes.

▪ Magnetometers of rubidium vapor, or an equivalent type, with a sensitivity to changes in field of 1/10 gamma to be installed in pairs, monitoring two horizontal components of the natural telluric field. Magnetic field strength and orientation changes are believed to accompany the buildup of stress in rocks preceding an earthquake, Press said.

▪ Recording gravity meters (gravimeters) capable of sensing changes in gravity (acceleration) of one microgal and able to return to zero position from a maximum gravity shift corresponding to a tenth of a G.

Military electronics

In deep water

"If we had to do it all over again, I don't think we would have bid

on the project," concedes an engineer at the Bunker-Ramo Corp. He was talking about the frustrations of installing the underwater electronic equipment for one of the Navy's undersea warfare projects, the Atlantic Underwater Test and Evaluation Center (Autec) off the coast of the Bahamas [Electronics, Feb. 22, p. 44]. Bunker-Ramo's part of the project is already a year behind schedule and the company is believed to have lost more than \$300,000, although its fixed-price portion of the project was for only \$460,000.

Deep trouble. Bunker Ramo had more trouble than it expected in getting delicate electronic sensors and cables to operate a mile below the water's surface. First, the company had to contend with leaks, then it was salt water corroding the metal parts, and finally, fish began nibbling on the equipment. In one case a swordfish speared a cable and broke it; the "sword" was still embedded in the cable when it was hauled out of the water. Shark teeth have also been found stuck in the cable.

In the year that the company has been trying to install the cable, five failures were recorded. Three

times, engineers repaired the gear at the site; twice, all the gear was shipped back to the United States for overhaul and further design work. This month, the company will make its sixth attempt to install the equipment.

Change in plans. The electronic gear consisted originally of 23 sensors to measure temperature and pressure and record sound at 14 points along a one-inch armored, nontwist coaxial cable. In the latest attempt, Bunker-Ramo decided to eliminate the sound velocimeters and redesign the instrument cages; it was found that the velocimeters simply would not stand up under pressure.

Research into these problems is under way. Sealab II, the Navy's project to see how well men can work under water, has just been completed and engineers now are studying the results. One of the aims of the Sealab project is to find ways to protect electronic gear that must function deep beneath the waves for extended periods. In addition, the Woods Hole Oceanographic Institute of Massachusetts is studying the problem of protecting electronic gear from hungry fish.

Contract problems. These problems are giving the Navy other headaches, too. Contractors, aware of the difficulty of designing underwater gear, are balking at fixed-price contracts. Litton Industries, Inc., and Sanders Associates were recently given cost-plus-incentive contracts for development of four instrumented buoys in the Navy's antisubmarine weapons environmental prediction program (Asweps). The Navy candidly admits that it probably would not have gotten any bidders if it had offered only fixed-price development and installation contracts.

Asweps may run into some of Autec's difficulties. The instrumented buoys, which will collect data on air temperature and wind direction and speed, will be anchored in 15,000 feet of water. Underwater sensors along the first thousand feet of mooring cable will record water temperature and pressure.

Consumer electronics

Sound effects

High fidelity is so high that only the most demanding audiophile can detect much difference among the more expensive systems. The challenge now for the system designer appears to be in making the equipment smaller, easier to operate and less expensive. Three examples of such improvements were introduced at the High Fidelity Music Show in New York last week.

▪ Kenwood Electronics, Inc., displayed a working model of an f-m tuner, called the XK-65, that contains a fully electronic dialing system with but one moving part, the



High fidelity tuner made by Electro-Voice is packed into small cabinet.

station indicator, which is a needle on a milliammeter. To dial a station, the user simply turns a spring-loaded switch that causes the tuner to search out the next station in the direction that the switch was turned, and stops. The system automatically locks onto the station and keeps it in tune. If only stereo is wanted a stereo button is pushed, and the tuner will skip over all monaural stations. To tune to the opposite band of the dial the user need only keep the switch turned on.

Automatic tuners aren't new, but all earlier models needed a motor to crank the tuning condenser. The XK-65 has no motor and no tuning condenser.

Just how the tuner works is still secret. Jiro Kasuga, chief engineer of the Trio Corp. of Tokyo, which

developed the tuner, explains that patents for the system are still being sought in the United States and Japan. Kenwood, a subsidiary of the Japanese company, hasn't yet scheduled manufacturing or marketing plans.

The technique of electronic tuning has been designed into some new military communications gear. Instead of condensers and inductors, hybrid thin-film techniques are used. The receiver's front end is broadbanded, with r-c filters, so that all frequencies in the passband are received. A frequency is selected by throwing a single switch that sets up a counter circuit in the feedback loop of a variable-frequency oscillator. The counter circuit sets up the frequency at which the incoming signal and reference oscillator signal mix. The mixed signal is then passed to standard audio detection stages.

Another method, simpler and cheaper, uses the voltage-variable capacitance characteristics of a varactor diode. By varying a d-c voltage applied to the diode in a resonant circuit, the receiver can be tuned anywhere in its frequency range [Electronics, April 6, 1964, p. 49].

▪ A piece of equipment that the audiophile can purchase immediately is a compact f-m/a-m tuner and matching 50-watt amplifier that is less than half the size of comparable sets. The tuner and amplifier, produced by Electro-Voice, Inc., each measure only 3 inches high, 8 inches wide and 10 inches deep.

Carl Goy, an engineer at Electro-Voice, says no integrated circuitry was used to shrink the size of the equipment. "It was all done with efficient packaging and printed circuits," he says. Heat-resistant silicon transistors were used, rather than the less stable germanium transistors, to prevent the overheating, caused by packing components closely together.

Despite the improvements, Goy says, the new model costs less than the company's earlier model. The tuner retails for \$195 and the amplifier for \$124.50. A combination

TRW will put hair on your zeners



OR COPPER

OR TINNED
COPPER

OR GOLD-PLATED
COPPER

OR TINNED DUMET

OR GOLD-NICKEL
DUMET (very fancy)

OR YOU NAME IT

We'll give you any lead material, diameter or length — or no lead at all, if that's the way you want it. We'll put the same leads on both ends — this should be a big help. We do all this on other diodes too — try us for rectifiers or Varicaps. In short, TRW diodes are made just for you.

If you have a hairy welding or soldering problem, write us at 14520 Aviation Blvd., Lawndale, Calif. or call 213-679-4561 (ext. 263). TRW zeners are products of TRW Semiconductors Inc., a leading manufacturer of specialized semiconductor devices.

TRW SEMICONDUCTORS

6-9

Seconds from now,
these cables will be

- R.F.I. SHIELDED
- PROTECTED FROM ABRASION
- GROUNDED
- —AND HAVE EXTREME FLEXIBILITY!



ALL THIS BECAUSE OF

SHN-3 Zippertubing®

You could do the same for your wiring or cables — in a single zip-quick operation — by specifying SHN-3 Zippertubing®. SHN-3 is a lamination of vinyl impregnated Nylon cloth and aluminum foil, with tinned copper braid attached to the inside of the overlap.

Like to know more about Zippertubing®? Write or call:



THE Zippertubing® CO.

Main Office and Plant:
13000 S. Broadway, Los Angeles 61, Cal. • FA 1-3901
Eastern Office and Warehouse:
480 U. S. Hwy. 46, S. Hackensack, N. J. • HU 7-6261

Electronics Review

model is also available.

▪ From the Sony Corp. comes a miniature tape recorder for only half the price of comparable competing models. The instrument, the Sonymatic 900, sells for \$67.50 and includes such features as a fast-forward control (so the user can quickly skip over recorded material to get a section far back in the tape), the option of using battery or plug-in power and an automatic volume-control device which maintains proper recording levels without a recording meter. The Sony model does not need special high-priced tape cartridges, because the tape is wound reel to reel.

Components

Color by cholesterol

The chemical substance, cholesterol, suspected by many doctors of causing heart trouble is doing anything but that to engineers testing components at the Boeing Co.'s Aerospace Center in Kent, Wash.

Using derivatives of cholesterol, Boeing researchers produced a liquid-crystal mixture that pinpoints trouble spots in such electronic components as a multilayer printed circuit board, a diode and a resistor matrix. The liquid changes color almost instantly with even slight changes in temperature.

When a trouble-free component is painted with the cholesterol mixture, all of it turns a uniform red, for example, as the component heats up. If one part of a component were defective, it would turn a different color because of its temperature differences. A badly defective component would look like an artist's palette, because each part of the component would heat up at a different speed and turn a different color.

In reverse. The Boeing engineers have prepared five different cholesterol mixtures, from one that operates over a spread of 2°F to one that operates over a spread of 10°F.

The technique is reversible. For example, if an engineer wants to see if a component cools off evenly, or if a heat sink is operating efficiently, the cholesterol mixture can be used to provide accurate readings of drops in temperature.

In developing the temperature-sensitive mixture, the scientists took advantage of the fact that as crystals heat up, they move further apart almost instantly, changing the way light is reflected off them; this change appears to the observer as a change of color.

Solid state

Gambling against transistors

At least three semiconductor manufacturers are scurrying to get a toe hold, however briefly, in a new market: solid state replacements for horizontal damper tubes in black-and-white and color television sets. The vying companies are the General Instrument Corp., Newark, N. J., Electronic Devices, Inc., Yonkers, N. Y., and Slater Electric, Inc. of Glen Cove, N. Y.

The immediate market for the solid state devices is clear. The troublesome damper tube must be replaced on an average of three times during the lifespan of a typical television set. Adding to the appeal of the usually more reliable solid state device is the fact that by eliminating the tube, heater power is cut by several watts and warm-up time is shortened by about five seconds.

But the long-term market is debatable. Since transistorized television sets don't need high-voltage damper tubes, the question is how quickly solid state devices will capture the tv market. The three companies investing in the damper tube replacement seem to be betting against a quick take-over.

Two views. Ted Herkes, a vice president of consumer products at Motorola, Inc., which has invested heavily in solid state design, says that in two years most black-and-white tv sets will be transistorized.

But John Rogers, general manager of Slater's diode operation, says a survey by his company indicates that by 1969 half of the black-and-white sets and nearly all color sets will still be made with tubes.

Herkes says it is impossible at this time to predict when solid state devices will dominate color television. But he points out, "If the solid-state industry continues to develop at its present rate, it will only take a few years."

General Instrument appears to have a slight edge in the race to the marketplace with the damper tube substitute. It says two television manufacturers have already designed its unit into their 1966 lines. Slater Electric is not far behind. It has been supplying samples for several months and will be tooled up for volume production before the end of the year. And Electronic Devices says it will be supplying samples by December.

No price lists. The solid state devices are silicon stacked rectifiers; they carry a voltage rating of 5,000 to 6,000 volts and a 250-milli-ampere average current rating at high temperatures. None of the three manufacturers has announced prices yet, but it's expected that the device will cost about 85 cents in high-volume orders. Damper tubes sell for between 60 cents and \$1 in large quantities.

The role of the damper tube in a tv set is to cut off shock-excited oscillations when the magnetic field in the horizontal deflection coils collapses.

Integrated circuits

Triple-deckers

One way to sharply increase component density in monolithic integrated circuits, several manufacturers are discovering, is to build the circuit sandwich-fashion, with layers of metal separated by layers of oxide. One company, Stewart-Warner Microcircuits, Inc., with a triple-decker (three oxide and three



SOLUTIONS—HOPKINS FILTERS! OBVIOUSLY IN ALL SIZES AND SHAPES!

Where components and equipment generate conducted or radiated RFI, control measures must be taken to produce a compatible environment. Hopkins has in excess of 2,000 solutions to problems in RF Interference and designed proper filters for maximum noise suppression. When you are plagued with an RFI problem, Hopkins will solve it—and provide the engineering, design, prototype, testing and production of custom filters to specification.

Our service includes complete RFI testing to a wide variety of military specifications in our certified shielded enclosures.

We are here to solve your RFI filter problems and welcome your contact.

Our literature is as close as your telephone or letter.



SINGLE & DUAL CIRCUIT FILTERS FOR POWER LINES
Data-Log SK-109D



FILTERS FOR COMMUNICATION CIRCUITS
Data-Log 258B



GENERAL PURPOSE RFI FILTERS
Data-Log RFI 2000

HOPKINS
Engineering Company

12900 Foothill Blvd., P.O. Box 191 • San Fernando, Calif. 91341
Telephone: (213) 361-8691 • TWX 213-764-5998 • Cable: HOP

A Subsidiary of Maxson Electronics Corporation

If you are in the Electronics Industry... you probably belong in MARYLAND

AVAILABILITY OF LABOR

The availability of personnel, particularly engineers and scientists, is recognized as a chief criterion governing the location of an electronics firm.

There are almost 30,000 scientists and over 25,000 engineers living and working in Maryland and the District of Columbia. And the number is increasing every day.

PROXIMITY TO FEDERAL AGENCIES

Proximity to major decision makers in the industry, such as federal agencies in Washington, D. C., afford the unique advantage of constant personal contact, which is considered an increasingly important locational criterion.

No other state is as convenient to as many Federal agencies as Maryland. For example, Maryland's major government scientific installations include NASA, AEC, NIH, the National Bureau of Standards, plus some 20 others.

**THESE PRIME
REQUIREMENTS,
(plus others)
CAN BE MET IN
MARYLAND!**

Get All The Facts
Write, Wire or Phone Collect

MARYLAND
DEPARTMENT OF
ECONOMIC DEVELOPMENT

Division E • State Office Bldg. • Annapolis, Md.

Electronics Review

metal layers) IC chip that measures approximately 100 by 100 mils, may have set the record for the number of components on a single chip: 2,150 [Electronics, Oct. 4, p. 25].

Another IC producer, Texas Instruments Incorporated, working on the triple-decker approach, recently placed 200 separate circuits—containing five to eight components each—on a single chip.

The advantages of the multilayer oxide approach are clear: with more levels for interconnections between circuits or components, a higher density of functions on the chip can be achieved.

Growing demand. In one of the earliest applications of the multilayer technique, the Westinghouse Electric Corp. about two years ago built a small quantity of multiplegate arrays for the Jet Propulsion Laboratory of the California Institute of Technology. The specially designed circuits were only double-deckers and continued development of such circuits wasn't pushed because of a general lack of demand at the time for expensive high-complexity IC's.

Recently, however, with more customers demanding higher and higher component density, an increasing number of manufacturers are pushing research into the multideck IC.

Fairchild Camera & Instrument Corp, for instance, although not ready to deliver a multilayer circuit, concedes that it's hard at work perfecting a two-layer IC.

In general, the multilayer IC won't compete with the complex metal-oxide-semiconductor (MOS) integrated circuit. Says Texas Instruments marketing engineer, William Martin: "Each circuit will have its place." The multilayer IC, he says, will be for high-speed digital requirements, while the MOS IC's will be for low-speed, low-power needs.

Tunneling technique. To further increase interconnections between components in the Texas Instruments microcircuit, the company incorporated tunneling (cross-under) techniques: low-resistance silicon conduction paths in the chip which link parts of the IC.

TI's circuit used patterns of

metal on the surface of the first oxide layer to link components into individual circuits. Additional metal on the middle oxide layer provided interconnection between the circuits. And the top oxide layer contained the metal that connected the circuit groups to the bonding pads.

By the thousands. In Stewart-Warner's chip, the first oxide layer connects rows of diode anodes to common end bars; the middle layer ties diode cathodes into groups, and the remaining layer connects the component groups to the bonding pads. The chip contains 2,000 diodes, 100 resistors, with a total resistance of 10 megohms, and 50 transistors.

"Thin-film resistors and capacitors can also be deposited on the oxide layers," says Fran Hogle, Stewart-Warner's director of research and development. This can be done where very high tolerances are needed and where conventional monolithic techniques can't provide the component values that can be obtained with thin-film techniques.

The company, a subsidiary of the Stewart-Warner Corp., won't disclose the name of the customer for the triple-layer circuit, but it says delivery will be made early next year.

Optoelectronics

Moving holograms

The Q-switched ruby laser equipment developed by Technical Operations, Inc., takes holograms so fast—in 20-nanosecond exposures, at two-second intervals—that they can be strung together like frames of movie film. Holograms are three-dimensional pictures formed in space, so what the Burlington, Mass., company has come up with is, essentially, a real 3-D movie.

The Technical Operation's equipment [Electronics, Oct. 4, p. 25] was developed in cooperation with the Air Force Cambridge Research Laboratory. The Air Force will use

it to take rapid-sequence holograms of fog as part of a weather research project.

The system uses a ruby laser, passively Q-switched with uranyl glass (see page 90 for more on Q switching) to illuminate the object and a mirror. The light reflected by the mirror is still in phase, but because the object has an irregular shape, its reflections are out of phase. When the two reflections meet at a piece of photographic film, an interference pattern is produced.

Building an image. This pattern bears no resemblance to the object; it looks like a blurred thumbprint. But when the film is developed and a beam of coherent light passes through it, the object is reconstructed in three dimensions at a focal point.

Technical Operations uses a continuous-wave helium-neon laser to reconstruct the image.

At present, the "moving hologram" comes in two sets of colors—red and black and blue-green and black. But it is theoretically possible to mix a few laser wavelengths and obtain the full spectrum.

The Q-switched laser's exposure time of 20 nanoseconds is about nine orders of magnitude faster than other available holograph equipment.

A simulation of these rapid-fire pictures has been achieved at the University of Michigan, where researchers have taken holograms at slow speeds, then projected the images rapidly.

Electronics notes

▪ **Kidney pacemaker.** Taking their cue from the developers of the heart pacemaker—which provides tiny pulses of current to the heart to keep it beating at a healthy pace—researchers at the St. Louis University College of Medicine have designed what is, in effect, a kidney pacemaker. The instrument, a portable device worn in a patient's

Ballantine DC/AC Precision Calibrator

Model 421

Price: \$600

0-111 V AC or DC

RMS or Peak-to-Peak
at 400 or 1000 Cps

0.15% Accuracy

Digital Readout



Portable!

Saves time, steps in calibrating Voltmeters, Recorders, Oscilloscopes (and other ac and dc voltage-sensing devices)

Also ideal for use as an accurate and stable voltage source for measurement of gain or loss — as a calibrated voltage source for transfer measurements — as a stable biasing source for bridges, and strain gauges

Ballantine's portable Model 421 DC/AC Precision Calibrator enables you to check or calibrate your instruments without removing them from service. And with an accuracy (0.15%) never before possible.

Note its many versatile features: Small, rugged, easy-to-operate ● Provides known dc outputs up to 111 V, positive or negative, and ac outputs of either 400 cps or 1 kc, indicated as rms or peak-to-peak ● Clear, left-to-right digital readout ● Unmatched calibration accuracy of 0.15% ● Good long-time and short-time stability (0.01%) ● Low waveform distortion (less than 0.1%) ● Minimum line voltage effect ($\pm 10\%$ line voltage change causes less than 0.05% change in output voltage).

Member Scientific Apparatus Makers Association



— Since 1932 —
BALLANTINE LABORATORIES INC.
Boonton, New Jersey

CHECK WITH BALLANTINE FIRST FOR LABORATORY VACUUM TUBE VOLTMETERS, REGARDLESS OF YOUR REQUIREMENTS FOR AMPLITUDE, FREQUENCY, OR WAVEFORM. WE HAVE A LARGE LINE, WITH ADDITIONS EACH YEAR ALSO AC/DC LINEAR CONVERTERS, CALIBRATORS, WIDE BAND AMPLIFIERS, DIRECT-READING CAPACITANCE METERS, AND A LINE OF LABORATORY VOLTAGE STANDARDS 0 TO 1,000 MC.



how to convert resolver and synchro angles to digits (and vice versa)

North Atlantic now brings you a new family of solid-state analog-to-digital and digital-to-analog converters for resolver and synchro data. They offer a major advance in conversion accuracy in modern navigation, simulation, data processing and measurement systems.

Typical of these new instruments is the Model API-5450 shown here. It provides both continuous and command conversion of both resolver and synchro angles, accommodates all line-to-line voltages from 11.8 to 90 volts at 400 cps. Output data is in decimal digits and is presented both as a Nixie-tube display and a five-digit printer output with supplementary print command. Accuracy is 0.01° and update time is less than 1 second.

All instruments in this family are designed to MIL-T-21200 and feature all solid-state circuitry and precision transformers—there are no motors, gears, or relays. Their flexible plug-in modular circuit design permits a wide range of variations to suit your specific requirements. For example:

- 18 bit or 10 second accuracy and resolution
- binary, BCD, or decimal inputs/outputs
- multiplexed channels
- multi-speed inputs/outputs
- high conversion speeds
- other signal frequencies

Your North Atlantic representative has complete application information. He'll be glad to help you solve interface problems in measurement and data conversion. Simply call or write.



NORTH ATLANTIC industries, inc.
TERMINAL DRIVE, PLAINVIEW, L. I., NEW YORK • OVERbrook 1-8600

Electronics notes

pocket, has silver-tipped catheters that are surgically installed near the top of a patient's ureters, muscular tubes that connect the kidney and the bladder. Usually, when a patient suffers a kidney ailment, these tubes lose their muscle tone and become so dilated that they cannot halt a strong backflow of urine from the bladder; if urine gets back into the bladder, it can injure a weakened kidney even more. The pacemaker, by providing a series of tiny pulses to the tubes, sets up peristaltic motion in them, keeping the urine flowing in only one direction.

The developers hope eventually to design a pacemaker that provides pulses via conduction, so that wires need not be inserted surgically in the patient.

• **Finer wires, faster.** Ultrasonic baths have long been used to clean parts between production steps. Bell Telephone Laboratories, Inc., has found that if wire is scrubbed ultrasonically while it is being drawn, its diameter can be reduced more rapidly, with fewer dies, and the wire will be smoother. The drawing is done in a lubricant, ultrasonically cavitated to clean particles continuously from the wire and the dies. The ultrasonic agitation keeps the particles suspended in the lubricant and prevents them from collecting in the entry areas of the dies. Hence, they do not score the wire as it is drawn through the dies. Pure copper wire, for example, can be reduced in diameter to 0.003 inch from 0.01 inch at 1,000 feet a minute with nine dies instead of the usual 14. Aluminum must be drawn slowly, but drawing problems are eased by the removal of abrasive surface oxide. Copper and nickel-chrome wires as fine as 0.0007 inch have been drawn with the laboratory equipment.

Fine-finished wire, for example, is desirable in those types of magnetic memories that store information on a thin film of metal plated onto a wire. The wire should be as smooth as possible so that the film can be deposited very evenly.

Specialty Gas

RESPONSE . . . by *Air Products*

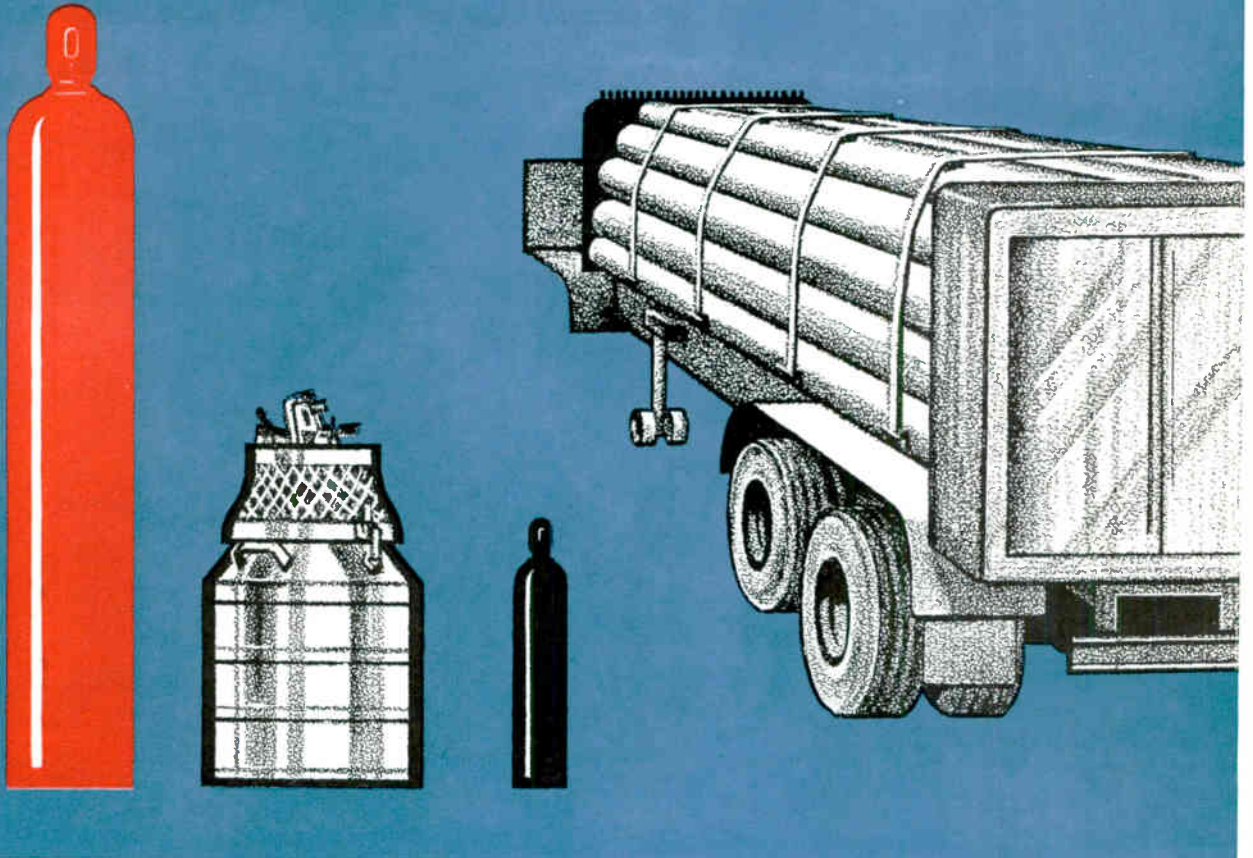

**to supply your
RARE, DOPING, CALIBRATION,
RESEARCH OR SPECIAL GAS requirements**

Complete Line

Over 100 standard gases. Precision-blended gas mixtures. All are available from Air Products — your single source for specialty gases in the purities and quantities required.

Precision-Purity

Take the industry's most advanced quality-control standards. Add Air Products unique gas-blending, packaging, and analytical techniques. Result: the exacting product purities demanded by your special applications — impurity levels as low as 1 ppm.

Cylinder to Bulk-Liquid Quantities

Air Products specialty gases are available in cylinder, tube-trailer, dewar, or bulk liquid quantities. Easy to order? Just call any of Air Products 68 sales offices to arrange for deliveries. Convenient stocking points can also be established to meet customers' special needs.

Technical Service

An Air Products technical representative can help you select and utilize specialty gases most effectively and

economically. Added dimensions of technical support derive from Air Products 25 years' experience in cryogenics, our own use of specialty gases, and our many R&D projects for industry and government. This total experience assures a realistic understanding of your laboratory, pilot-plant, or commercial demands.

A New Catalog for 1965

Available now — Air Products new 1965 Specialty Gas Catalog. For your copy, or additional information, please write:

 *Air Products and Chemicals*
Allentown, Pennsylvania **INC.**

Check
your
lacing
tape
requirements
here 

- HIGH TEMPERATURE**
General use Gudebrod Tapes are unaffected by temperatures to 250°F.; specially designed tapes are essentially stable in excess of 1500°F.
- LOW TEMPERATURES**
Most popular Gudebrod Tapes are stable down to -67°F., others are designed to take temperatures as low as -100°F.
- BURNPROOF**
Gudebrod has lacing tapes of completely fireproof materials, others will not support a flame.
- OUTER SPACE**
Gudebrod has a tape that won't outgas in outer space—especially suitable for space, or industrial applications in vacuum.
- FUNGISTATIC**
Whenever possible with the material of construction Gudebrod guarantees its tapes to be fungistatic or fungicidal.
- MIL-T-713A**
Gudebrod's Gudelace 18 meets all requirements of specification MIL-T-713A, type P, class two. Other Gudebrod Tapes meet or surpass these specs.
- TENSILE STRENGTH**
All Gudebrod Tapes are available in a number of widths and thicknesses to meet varying size requirements.
- CUT LENGTHS**
Gudebrod Tapes can be supplied in handy dispenser packs of cut lengths to suit your harnessing needs.
- COMPATIBLE MATERIALS**
From the wide range of basic materials and finishes used in Gudebrod Tapes the selection of a tape compatible to your insulation is easy.
- COLOR CODED TAPES**
For complicated circuitry, color coding with Gudebrod Lacing Tapes makes assembly and tracing easy.
- SPECIAL APPLICATIONS**
Gudebrod will work with your engineers to develop a special tape to meet sophisticated requirements.

THEN GET THE RIGHT TAPE FROM **GUDEBROD!**

Perhaps you are regularly using Gudebrod Gudelace 18, the standard, wax impregnated nylon tape that's known round-the-world for its non-slip knotting (meets MIL-T-713A specs, too). You are doing well then—with the finest tape and saving money on harnesses, too!

But when you are making gear for tropic or arctic use, if you are involved with outer space or

special industrial applications—come to Gudebrod. Here is your one best source for lacing tape information. Ask for a copy of our Product Data Book describing the more than 200 different tapes in our regular stock. In it you'll probably find the tape that fits your requirements—but if you don't, inquire about having one made to your particular specifications.



GUDEBROD BROS. SILK CO., INC.

FOUNDED IN 1870

Electronics Division

12 SOUTH 12th STREET, PHILADELPHIA, PENNSYLVANIA 19107

Area Code 215, WA 2-1122

So you're changing to integrated circuits?

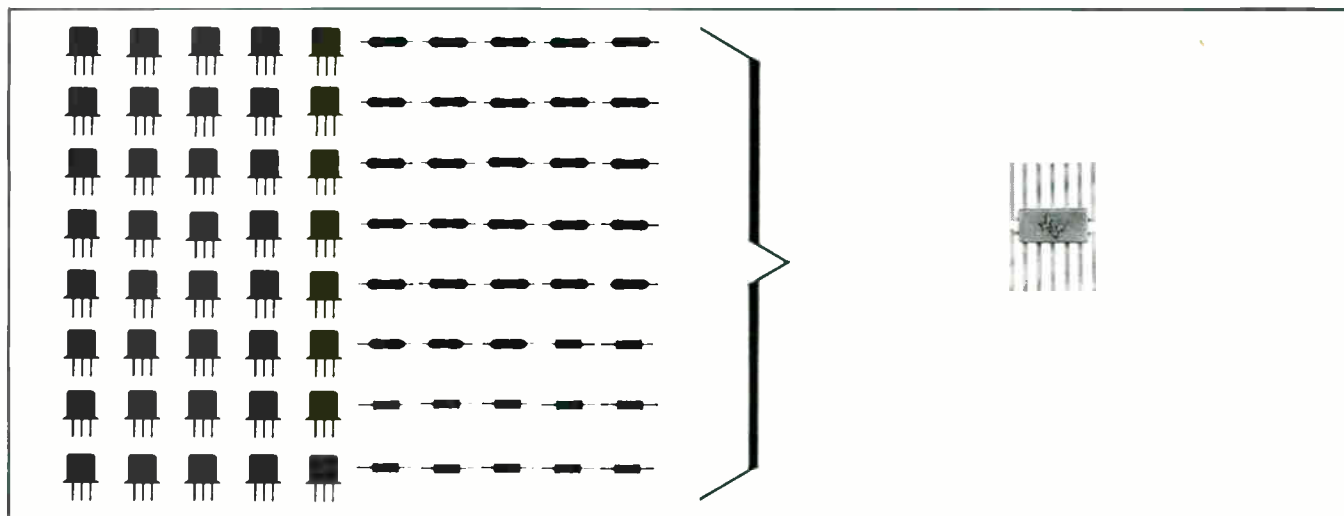

These 32 npn and 8 pnp transistors, 28 resistors and 12 capacitors ($\frac{3}{4}$ actual size) are replaced by the dual J-K flip-flop shown actual size above.

**Good, we've got 'em ... from Texas Instruments.
And you can get 'em fast ... from Weatherford.**

So you want speed with noise immunity? Texas Instruments Series 54 TTL logic family gives you 13-nsec propagation delay with a big one-volt noise margin...and power dissipation of only 10 mw/gate. These high-performance units are establishing a new industry standard in saturated logic. Operating temperature is -55° to $+125^{\circ}\text{C}$.

So you want low cost with reliability? Texas Instruments new Series 73 modified-DTL industrial integrated circuits give you all the economy advantages of TI's "multi-function" approach to circuit design. Since three or four

complete circuits can be built in a bar of silicon for little more cost than a single circuit, the cost-per-circuit-function goes down fast. Yet, you get this economy without any quality sacrifice — in the same welded, hermetically sealed flat pack as military units. Designed for operation in industrial environments of 0° to $+70^{\circ}\text{C}$.

So you want fast delivery? We carry full stocks of both Series 54 and Series 73 integrated circuits (and more than 50 other digital and linear types as well). You may be assured of fast, accurate service and shipment.

SO ASK — GET FULL INFORMATION ON SERIES 54 AND SERIES 73



Fill out this coupon and send it to us at the address listed below for TI's new Series 54 bulletin (20 pages) and new Series 73 bulletin (28 pages). You'll get complete performance specifications on the many types available in both series.

Please send the TI Series 54 and 73 bulletins to:

Name _____

Position _____

Mail Station or Bldg. Code _____

Company _____

Address _____

City and State _____



R. V. WEATHERFORD CO.

DISTRIBUTORS OF ELECTRONIC COMPONENTS AND EQUIPMENT

GLENDALE 1, CALIFORNIA: 6921 San Fernando Road, VI 9-3451
ANAHEIM, CALIFORNIA: 1651 State College Blvd., KI 7-7521
PALO ALTO, CALIFORNIA: 3240 Hillview Drive, Stanford Industrial Park, DA 1-5373



International Rectifier Exclusive!



The Ultimate Assurance of Zener Quality and Reliability

International Rectifier's nine years of Zener diode superiority is based on fact: 99.98803% demonstrated industrial reliability! This unmatched record makes IR's LIFETIME GUARANTEE possible. Only IR can offer it. The guarantee covers all IR Zeners: glass, top hat, flangeless and stud mounted from 250 mw to 50 watts, including JEDEC types, house numbered and temperature compensated

devices. Look for the seal of IR's LIFETIME GUARANTEE! It is proof that the manufacturer has made no compromise with quality—it assures the user the ultimate in Zener diode performance.

For full information about IR Zeners and the LIFETIME GUARANTEE contact your local International Rectifier sales office or write to 233 Kansas Street, El Segundo, California.



WORLD'S LARGEST RECTIFIER SPECIALISTS



INTERNATIONAL RECTIFIER

INTERNATIONAL RECTIFIER CORP., EL SEGUNDO, CALIF., PHONE OR 8-6281 • CABLE RECTUSA • REGIONAL OFFICES IN NEW YORK CITY, CH 4-0748 • FORT LEE, N.J., WI 7-3311 • SYRACUSE, N.Y., HE 7-8495 • CAMBRIDGE, MASS., UN 4-6520 • ARDMORE, PA., MI 9-3666, GR 3-3931 • SILVER SPRING, MD., JU 9-3305 • MIAMI, FLA., 445-5201 • CHICAGO, ILL., OR 6-4090 • CLEVELAND, OHIO, 734-4100 • DAYTON, OHIO, 223-7691 • HUNTINGTON WOODS, MICH., LI 8-1144 • ST. LOUIS, MO., TE 8-6333 • MINNEAPOLIS, MINN., 920-1200 • RICHARDSON, TEX., AD 1-2504 • SAN MATEO, CALIF., 349-2373 • LOS ANGELES, CALIF., 678-2181 • IN CANADA: TORONTO, ONT., 421-5970 • MONTREAL, QUEBEC, 861-0562
EUROPEAN GENERAL SALES OFFICE: 38 AVENUE DES ARTS, BRUSSELS 4, BELGIUM • TELEPHONE: 111774

Washington Newsletter

October 18, 1965

MOL subcontracts are up in the air

Subcontracting competition for the Manned Orbiting Laboratory is wide open. The Douglas Aircraft Co., prime contractor for the laboratory module has already asked 44 concerns to bid for 22 subcontracts involving six systems: communications; data management; navigation; attitude control; fuel-cell power supply, and environmental control and life support.

Douglas expects to select its subcontractors by early November. They may not be the subcontractors who made up the team that submitted the original proposals to the Air Force.

The same policy is expected from the General Electric Co., prime contractor for the experiments packages, although GE's requests for proposals from subcontractors may not go out for another two months—it may take that long for GE to conclude its negotiations with the Air Force to define and separate the equipment experiments from the basic spacecraft equipment.

Decision awaited on air defenses . . .

Defense Secretary Robert S. McNamara will decide within the next 2½ months whether to order the Nike X antimissile system into production. The rising cost of the war in Vietnam and evidence that the Russians are deploying new defensive missiles complicate the outlook. But odds still favor a limited go-ahead for Nike X.

McNamara seems to be interested in a "cut-rate" system capable of effective defense against primitive Chinese missiles. The alternative is a complex system offering only partial protection against a sophisticated Russian attack. The scaled-down version would cost \$6 billion to \$8 billion; the full system \$24 billion to \$30 billion.

The Nike X defense against the Chinese would be built around the Zeus missile, which attacks incoming missiles in space; its multifunction array radar would be simpler than the one now being developed for the full system. Most likely it would not include the high-acceleration, short-range Sprint missile. The Chinese are not expected to be able to penetrate the United States' missile defense for decades.

Award of a \$21-million contract to the Western Electric Co. to develop a Zeus with longer range and greater payload—thus providing broader area defense—heightens prospects for approval of an anti-Chinese Nike X system. Western Electric also received a \$221-million contract to continue over-all Nike X development for another year, including \$12.4 million for preproduction planning and engineering studies.

Army officials are concerned that the increasing cost of the Vietnam war might cause McNamara to delay Nike X production for another year. McNamara may decide on postponement, but he insists that, if he does, that would not be the reason. He says U. S. affluence is so great, the war can be financed without cutting or delaying programs.

. . . and on new attack aircraft

Decisions on other major weapon systems are also pending. Among them: whether to develop a new strategic bomber and an advanced armed helicopter for the Army, and what airplane to select as a new strike fighter, primarily for use in Vietnam.

McNamara still has reservations about replacing the B-52 with a stra-

Washington Newsletter

tegic bomber. If he decides that a strategic bomber should be kept in the Air Force's inventory after the B-52 is phased out in the 1970's, he may turn to the F-111. He appears to like the idea of modifying the F-111 to perform strategic missions; the plane is now under development as a tactical fighter-bomber. If the F-111 is modified for strategic operations the Air Force's hopes for a totally new plane would be dashed.

The Army is eager for McNamara's early approval of a proposal to develop a helicopter designed specifically as an aerial weapons platform; the new model would replace helicopters that were designed for other missions, and to which heavy guns were later added. The Army is evaluating proposals from the Lockheed Aircraft Corp. and the Sikorsky Aircraft division of the United Aircraft Corp. In addition, the Army is considering speeding development of a less-ambitious interim helicopter that uses off-the-shelf avionics rather than an integrated avionics system. If approved, such a craft could be developed quickly for use in Vietnam.

A decision is expected soon on whether to purchase a new strike-fighter to replace the aging propeller-driven Douglas A-1. The leading competitors would be the Northrop Corp.'s F-5, now sold only abroad and the A-7A, which is being developed by Ling-Temco-Vought, Inc.

Satellite may teach 3 R's around world

A huge, synchronous satellite, which would broadcast directly to television receivers throughout the world, is being considered quietly by high officials of the United States and other countries. It would be used primarily for education in areas with high illiteracy rates. The satellite would be owned by the Communications Satellite Corp., with the U. S. government providing assistance in ground-station equipment.

The project is technically feasible, but subject to criticism for disseminating what some countries might consider propaganda. At present there is no consideration of broadcasting to communist countries.

Computer controls for transit sought

About \$64 million of the \$90 million provided in the new Mass Transit Act is earmarked for research. The spending will begin soon, with much of the money going for studies of computer controls. At least four companies are working on automatic control systems: the Westinghouse Air Brake Co., General Electric Co., Westinghouse Electric Corp. and General Railway Signal Co. These systems are being designed for slower speeds, but presumably could be adapted for the speeds being discussed for 10 to 15 years hence—300 to 500 miles an hour.

The problem seems to be one of application rather than original research. "So much work has been done in aviation and space that no new gear is needed," one government engineer explains.

Research funds to hit the road

The Federal Bureau of Public Roads is providing research funds for the development of a nationwide network of emergency communications systems on interstate roads.

The agency, which can allocate up to 78% of the total cost of a development project is expected to approve requests made by Maryland, New York and Michigan. Both telephone and radio systems are being considered.



As final protection, a replaceable cover thermoformed of SURLYN® A (the new ionomer resin three times as puncture-resistant as polyethylene) is snapped on each drum of Precision Cleaning Agent.

For cleaning that's really critical, you need FREON® PCA... the solvent prepared and sealed under "white room" conditions

FREON Precision Cleaning Agent is guaranteed to contain no more than one part per million of combined soluble residue and particulate matter. Intensive testing and analysis assure that every lot meets this purity standard. Specially developed packaging techniques and materials maintain and protect it.

To maintain "just packaged" purity, each drum is lined with a special epoxy-modified phenolic plastic. After filling and registering, the drum openings are sealed with

a plastic cap and a highly transparent, puncture-resistant cover of new Du Pont SURLYN A is applied. This reusable cover keeps dirt and water away from the top of the drum and its openings. The cover's toughness allows drum stacking as well as outdoor storage.

For more information, write Du Pont Co., Room 2724E, Wilmington, Delaware 19898.



Better Things
For Better Living...
through Chemistry



FLUSHED



INSPECTED



FILLED

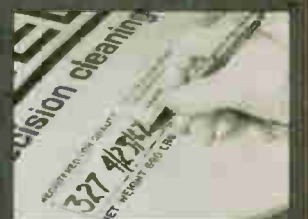

REGISTERED



SEALED

*FREON® and SURLYN® A are Du Pont's registered trademarks for its fluorocarbon solvents and ionomer resins respectively.

RCA HOMETAXIAL-BASE MEANS

HOMOGENEOUS-BASE DESIGN IN AXIAL DIRECTION REDUCES RISKS OF SECOND BREAKDOWN...

Used in RCA Silicon Power Transistor Line for applications up to 50 Kc/s

RCA HOMETAXIAL-BASE TECHNOLOGY

Electron injection point

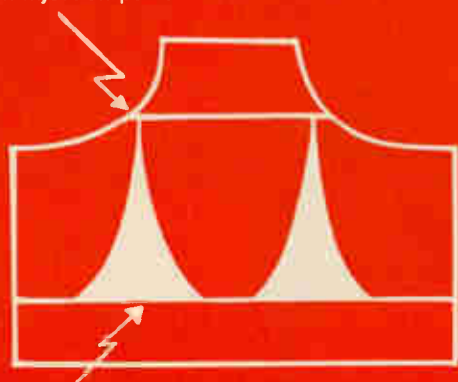

Electron collector area

Hometaxial-Base means uniform junctions and homogeneous base construction free of fields in an axial direction. It is in the region of these fields, that second breakdown and electrical collapse occur, caused by excessive concentration of minority carriers. Hometaxial-Base technology provides current "fan-out" to the collector and creates carrier dispersion in the base, thereby reducing risks of second breakdown. Thus, every transistor can be used within its maximum current-voltage-temperature boundaries without derating!

EVERY RCA HOMETAXIAL-BASE TRANSISTOR MEANS RUGGEDNESS!

- Power-Rating Tested (PRT) at maximum power level for 1 second.
- Low saturation voltage for greater switching efficiency.
- Sharp saturation voltage knee for greater circuit efficiency.
- Mechanically rugged—proved after long experience in Mil-approved and demanding aerospace applications.
- Demonstrated superior performance in environmental tests of vibration, shock, and acceleration.
- Improved beta characteristics for less distortion during operation.
- From a family of single diffused types manufactured by RCA since 1957 and backed by more than 50 million hours of operational life tests.





RCA HOMETAXIAL-BASE TRANSISTORS ARE NOW USED IN:

- | | | |
|--------------------------------------|--------------------------------|-------------------------------|
| ■ Series Regulators | ■ Magnetic Deflection Circuits | ■ Ignition Circuits |
| ■ High Fidelity Power Amplifiers | ■ Switching Regulators | ■ Servo Power Amplifiers |
| ■ Inverters/Converters | ■ Vehicular Voltage Regulators | ■ Public Address Amplifiers |
| ■ Solenoid or Relay-Control Circuits | | ■ Ultrasonic Power-Amplifiers |

NO ELECTRICAL COLLAPSE

RCA'S HOMETAXIAL-BASE ECONOMY SILICON TRANSISTORS

Offer the ultimate in design simplicity for applications from 1 mA to 30A

 TO-5 I _C (Max) TO 1A	 TO-66 I _C (Max) TO 4A	 TO-3 I _C (Max) TO 15A	 TO-3 I _C (Max) TO 30A
40347 $h_{FE} = 20-80$ @ I _C = 450 mA V _{CEV} (Max) = 60V	40250 $h_{FE} = 25-100$ @ I _C = 1.5A V _{CEV} (Max) = 50V	40251 $h_{FE} = 15-60$ @ I _C = 8A V _{CEV} (Max) = 50V	2N3771 $h_{FE} = 15-60$ @ I _C = 15A V _{CEO} (sus) (Min) = 40V
40348 $h_{FE} = 30-100$ @ I _C = 300 mA V _{CEV} (Max) = 90V	2N3054 $h_{FE} = 25-100$ @ I _C = 0.5A V _{CEV} (Max) = 90V	2N3055 $h_{FE} = 20-70$ @ I _C = 4A V _{CEV} (Max) = 100V	2N3772 $h_{FE} = 15-60$ @ I _C = 10A V _{CEO} (sus) (Min) = 60V
40349 $h_{FE} = 25-100$ @ I _C = 150 mA V _{CEV} (Max) = 140V	2N3441 $h_{FE} = 20-80$ @ I _C = 0.5A V _{CEV} (Max) = 160V	2N3442 $h_{FE} = 20-70$ @ I _C = 3A V _{CEV} (Max) = 160V	2N3773 $h_{FE} = 15-60$ @ I _C = 8A V _{CEO} (sus) (Min) = 140V

AVAILABLE FROM YOUR RCA SEMICONDUCTOR DISTRIBUTOR

RCA's Hometaxial-Base Silicon Transistor line is the workhorse of the industry at medium and low frequencies. Check into it. You'll find the industry's widest choice in current and voltage ratings—the right combination of characteristics that's right for your applications. This economy silicon line is backed by a comprehensive program of testing, so you can be sure every unit measures up to its reliability specifications.

For prices and delivery information see your RCA Representative. For technical data, and your copy of SMA-35, 12-volt Audio Amplifier and Converter Designs using RCA Silicon Power Transistors, and a copy of the new 4-page folder describing RCA's Hometaxial-Base transistor line, write: RCA Commercial Engineering, Section I-N-10-3, Harrison, N.J.

RCA ELECTRONIC COMPONENTS AND DEVICES, HARRISON, N. J.



The Most Trusted Name in Electronics

Circle 59 on reader service card

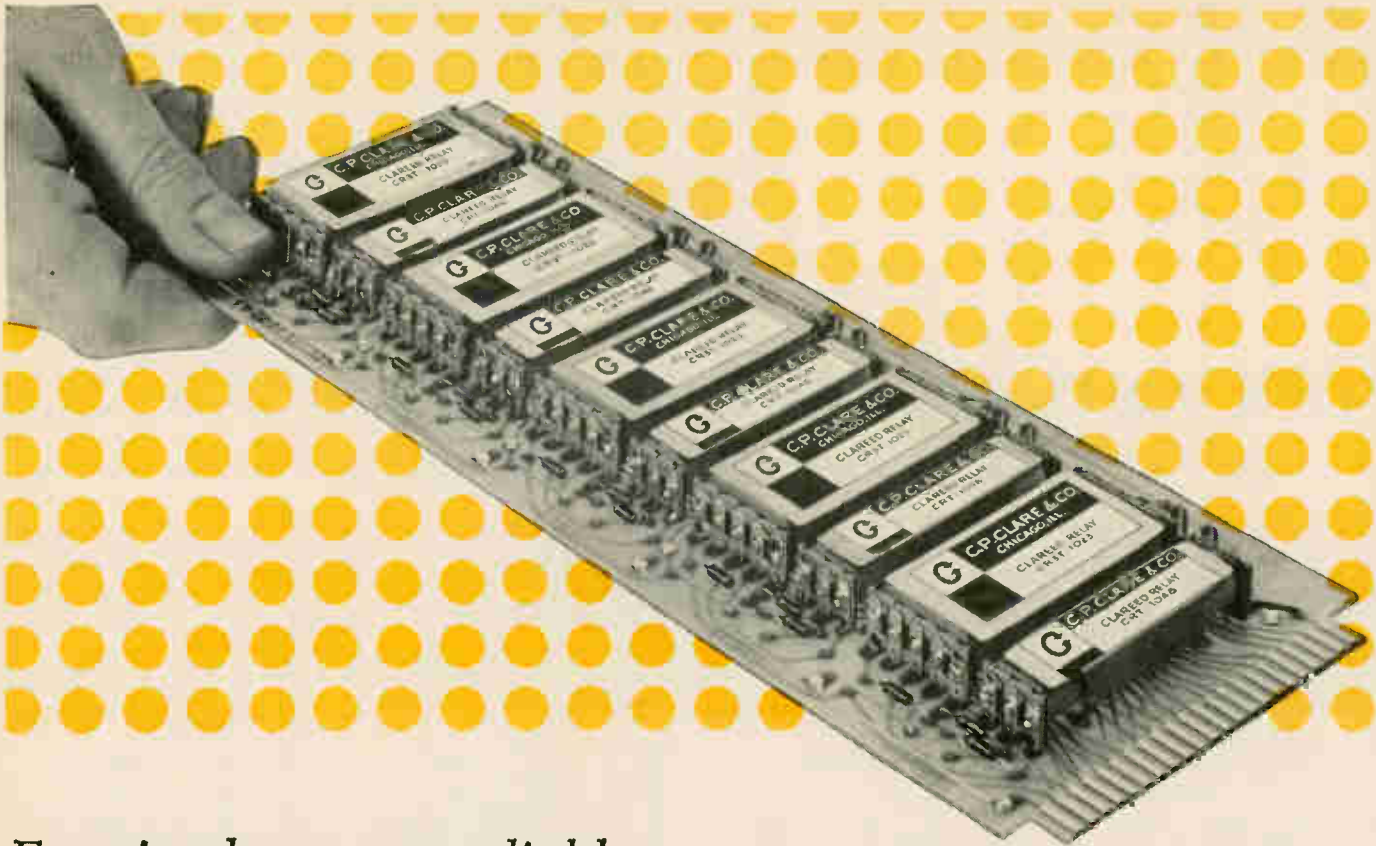

For simpler, more reliable

digital control circuits...

CLAREED®

CONTROL MODULES

pre-packaged counting, selection and logic devices

■ Counting, selection and logic switching problems are readily solved with Clareed Control Modules. Pre-packaged (or custom-designed if your problem is a new one), these modules combine speed, simplicity, and reliability ...at lower cost than comparable solid state circuitry, and without unnecessary design delay.

Counting. Pre-packaged printed circuit board modules in wide variety, for assembly to perform as decimal ring counters, radix (n) counters, bi-directional counters, shift registers, etc. Typical applications include scanning systems, digital clocks, data tracking and data transmission systems.

Selection. Pre-packaged printed circuit board modules in wide variety, for interconnection to perform as selection matrices. Typical applications include more versatile equivalents of traditional cross-bars, selection matrices capable of individual memory, and check-out matrices which can be operated with all contacts either normally open or normally closed. (Combining these Selection Modules with Clareed Counting Modules, the designer can readily provide a wide variety of scanners.)

Logic. Pre-packaged units for printed circuit board assembly in custom-designed logic modules, which efficiently perform such logic functions as AND, inclusive OR, exclusive OR, NAND, NOR, exclusive NOR, etc. These standard Clareed units, in Clare-customized systems, provide master control circuitry which greatly reduces complexity and cost of digital control systems.

Take a look at these Clareed advantages! You'll see how this versatile switching concept can fit into your plans for industrial or commercial systems.

- multiple input and output capabilities, making possible logic at both input and output
- switching capabilities from low level up to 15 va, ac or dc, automatically available at all points without additional output circuitry
- complete isolation between input and output. The output is the contact closure
- immunity to transient and external noise
- data handling speeds up to 120 bits per second, 250 bits as special
- modular printed circuit board construction compatible with modern electronic assembly techniques...meets the requirements of almost any application

TYPICAL CLAREED CONTROL SYSTEM APPLICATIONS

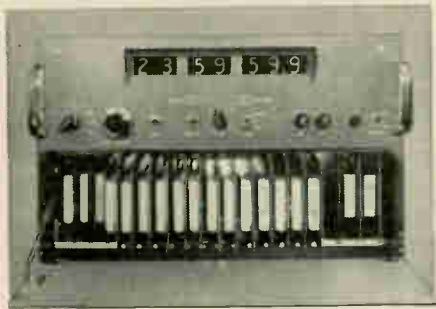

Digital Clocks using Clareed Control Modules as ring and binary counters, illustrate a variety of solutions for basic counting circuits in application for timed events, testing and systems control. Counting is performed by flux operated flip-flop elements; switching in the high-rate counter is done by Clare mercury-wetted contacts. This design provides:

- Greenwich time output
- elapsed time output
- local and/or remote visual readout
- local and/or remote control
- 7 digit capability

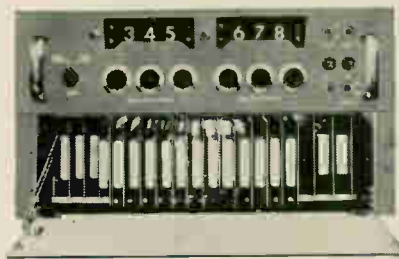

Industrial Preset Counters demonstrate production counting and control applications which provide a wide range of switching functions. Clareed flip-flop Modules are the basic switching elements used to provide this more versatile control. This design provides:

- low-cost anti-coincidence circuit for multi-channel operation
- preset 3 digit or 6 digit capability
- multi-channel input
- batch mode operation
- preset unit and batch operation
- special packages available to meet NEMA general purpose, explosion-proof, gas-tight, and water-tight enclosure requirements

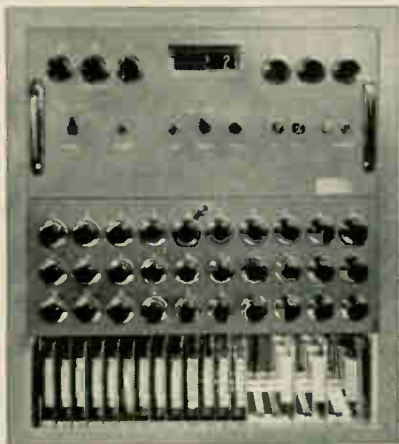

Scanners exemplify flexible sub-systems for instrumentation sampling, data logging and control systems requiring multiplexing. In the example shown, the driver is a three-decade counter composed of Clareed flip-flops; the control section uses flux and contact logic to control the driver and provide strobe drive to the matrix. A broad range of scanning options is possible:

- scan rate up to 100 crosspoints per second
- any number of crosspoints
- any number of poles per crosspoint
- special crosspoints for low level scanning
- contact forms A, B, C, or D at any crosspoints
- sequential scan with stop and recycle modes
- random scan of any 10 points in any sequence

Clareed Control Modules can be applied to the switching requirements of most systems. Proven Clareed solutions span many completely different application areas, including:

- machine tool numerical control
- telephone peripheral equipment
- engine test cell scanning systems
- psychological testing equipment
- process counting and recording
- missile checkout systems
- supervisory control and alarm annunciator systems

What's more important is how can Clareed Control help with your switching problems? Take another look at the Clareed advantages. Then, ask your Clare engineer how these plus features apply to your system. Write for Manual 400, Clareed Control Modules, or ask for specific data on Clare Industrial Preset Counters, Digital Clocks and Scanners. C. P. CLARE & CO., Group 10N4, 3101 Pratt Boulevard, Chicago, Illinois 60645.



relays and related control components

**GET
THE
FULL
PICTURE**

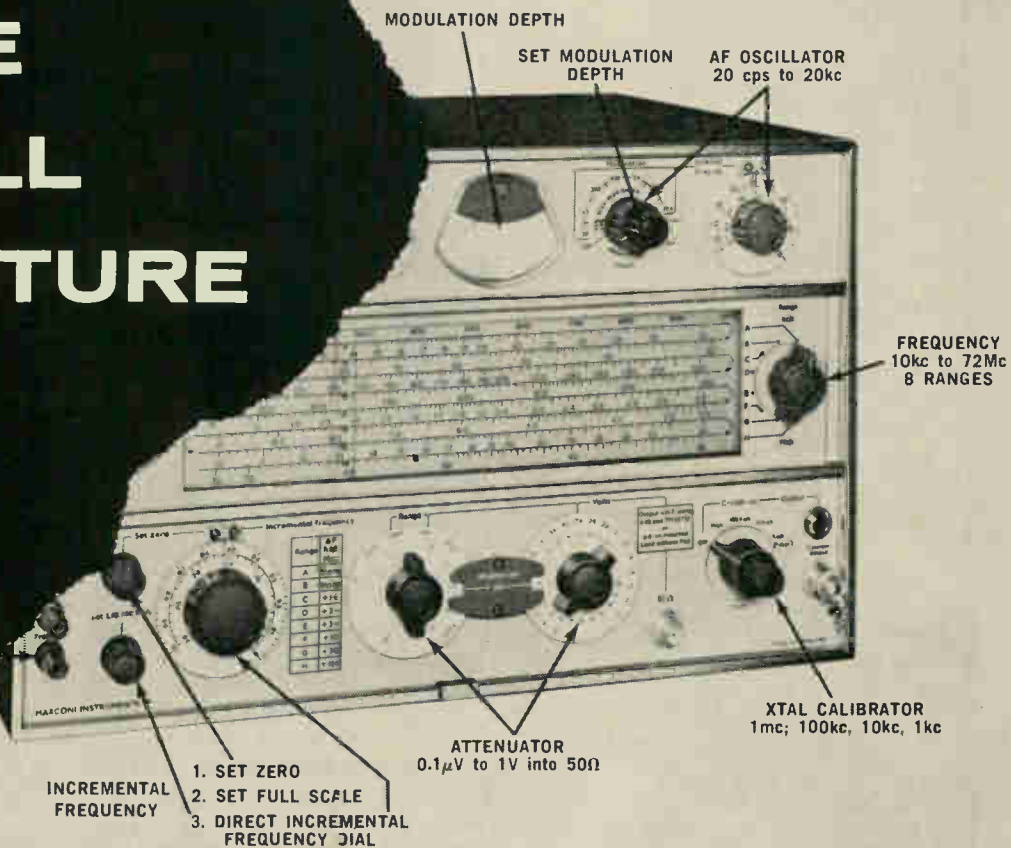

THE FIRST SOLID STATE SIGNAL GENERATOR

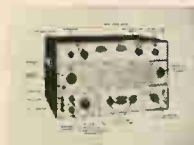

Get the full picture plus complete technical literature.

Circle Reader Service 262



Free! Marconi Instrumentation, a quarterly, technical information bulletin.

Circle Reader Service 263

FREQUENCY RANGE

- 10kc to 72 mc on fundamentals
- Fine tuning discrimination 300 p.p.m

MODULATION AM — 20 cps to 20kc, 0 to 100%.

Other — may be used for manual or automatic frequency control, f.m., phase mod. or sweeping above 100kc.

**MARCONI
INSTRUMENTS**

Division of English Electric Corp.

111 CEDAR LANE, ENGLEWOOD, NEW JERSEY

Circle 63 on reader service card →

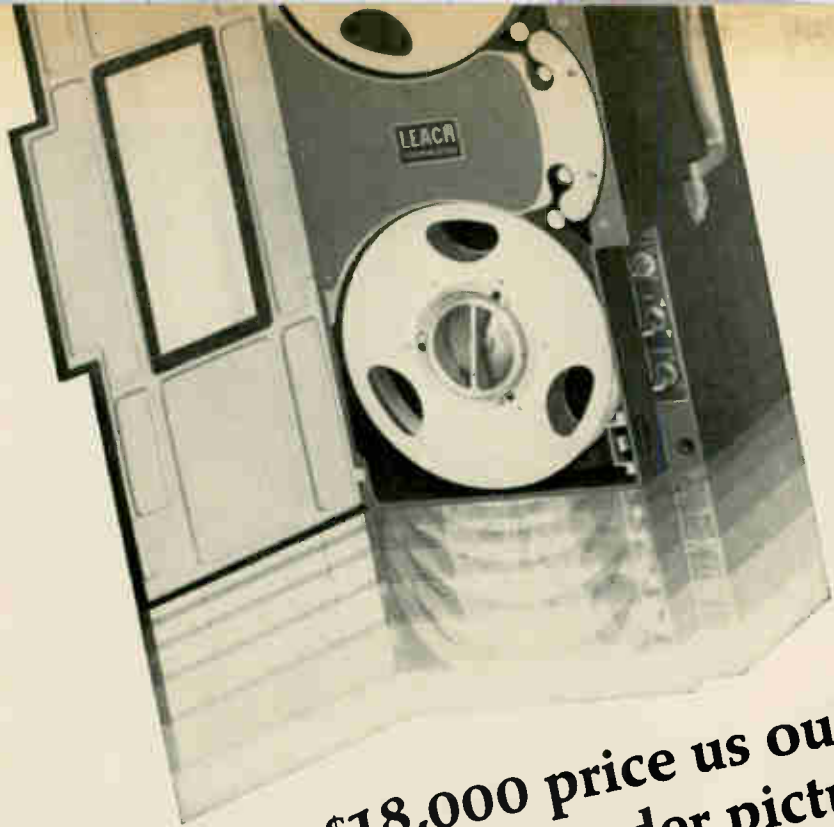

**does \$18,000 price us out
of your tape recorder picture?**

Perhaps. But where critical applications demand maximum performance, the MTR-3200 is really the only one *in* the picture. Check these environmental specs against any recorder/reproducer at any price. Shock: 10g, 11ms, 1/2 sine — 3% peak to peak flutter. Vibration: 10g rms random operating — 6% peak to peak flutter. Flutter: less than 0.5% peak to peak at 60 ips. Acceleration: 25g operating. Temperature: —40°C to +70°C operating. Humidity: 95% operating. Altitude: 150,000 ft. (unlimited for 20 hours).

The MTR-3200 is rugged. Versatile. Maddeningly precise. And all in a portable 44 lb. package. In exchange for a modest power requirement of only 55 watts at 28 VDC, it records, stores and reproduces data anywhere. Need as many as 7 tape speeds? Got 'em. Up to 14 channels analog and FM, or 16 digital channels. And you can utilize them in any combination.

Even data bandwidths are extended beyond IRIG standards. What's more, the entire unit is compatible with IRIG standard data reduction equipment.

For really big spenders, a wide range of little luxuries are available such as special analog to digital, serial to parallel and parallel to serial conversion equipment. Or extended broadband FM recording and reproduction with a frequency response of DC to 800 KC or analog from 500 cps to 2.4 mc. We'll supply just about anything in the way of electronic options, on special order. Just ask.

If you're not quite ready to write a P.O., then send for our brochure on the MTR-3200. It has all the details.

LEACH CORPORATION

CONTROLS DIVISION: 717 North Coney Avenue, Azusa, California. Phone: (213) 334-8211. Export: LEACH INTERNATIONAL S.A.



Best Value in a scope camera

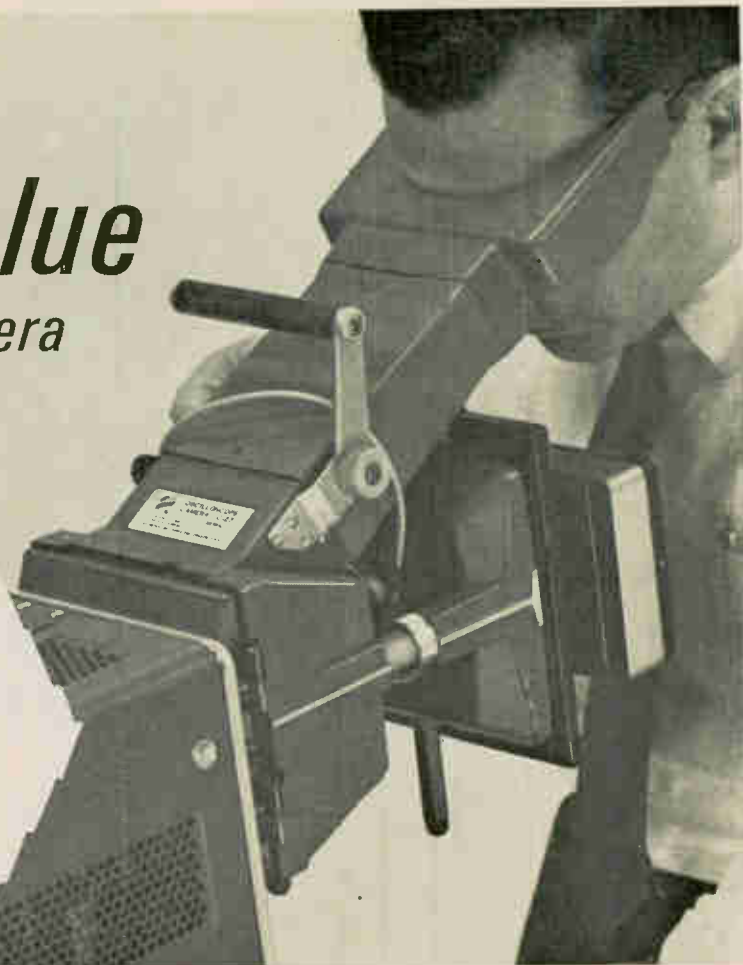
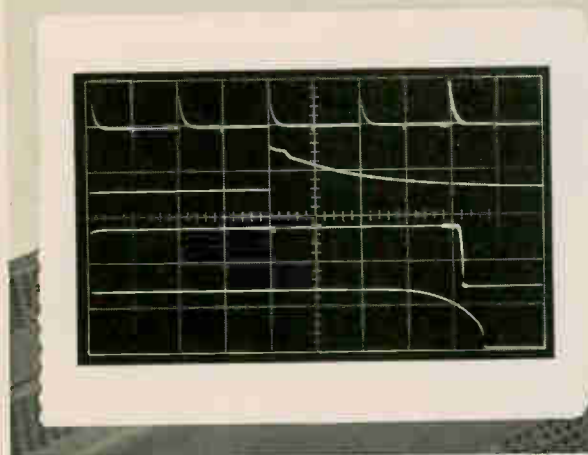

Combined features give the Tektronix camera highest all around performance

You can use Polaroid* film. Or, use other film, with a Graflok[†] back.

You can interchange any of 7 lenses—f/1.9 (1:0.9), f/1.9 (1:0.85), f/1.9 (1:0.7), f/1.9 (1:0.5), f/4.5 (1:0.7), f/1.4 (1:1), and f/1.3 (1:0.5). Since the lenses are housed in prefocused and calibrated mounts with keyed threads, you can set the shutter speed and diaphragm opening quickly and simply. No confusion—for these controls always appear at the same convenient position.

You can focus with a single knob and lock the setting.

You can position the sliding back either horizontally or vertically. You can interchange any of 4 film-holding backs, and lock the film back in any of 9 detent positions to simplify multi-exposure photography.

And you get assistance when you need it—for full field engineering services back up every camera. For the complete story on this "best value" oscilloscope camera, call your Tektronix Field Engineer.

Tektronix, Inc.

P.O. BOX 500 · BEAVERTON, OREGON 97005 · Phone: (Area Code 503) 644-0161 · Telex 036-691
TWX: 503-291-6805 · Cable: TEKTRONIX · OVERSEAS DISTRIBUTORS IN OVER 30 COUNTRIES
TEKTRONIX FIELD OFFICES in principal cities in United States. Consult Telephone Directory.

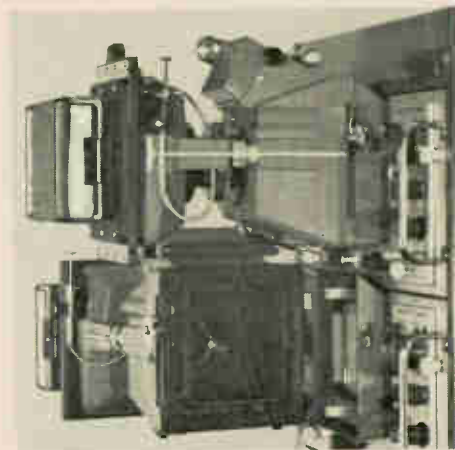

C-27 camera With viewing tunnels removed and carrying handles folded out of the way, the new C-27 Cameras can be stacked one atop the other—on such rack-mount oscilloscopes as the Tektronix multi-purpose Type RM561A (upper) and split-screen storage Type RM564 (lower).

Using shutter-actuator accessories with the C-27 Cameras permits simultaneous display recording.

Using optional Graflok backs and 4x5 film holders permits complete 10-cm by 10-cm display recording.

C-27 Camera, illustrated \$420
Includes: f/1.9 lens (with 1:0.85 object-to-image ratio) complete with cable release, Polaroid* back focus plate.

U.S. Sales Price, f.o.b. Beaverton, Oregon

*Registered by Polaroid Corporation.
†Trademarks of General Precision.

ROTRON

solves your cooling problems
a free service at our
 aerodynamic laboratories



- Staffed by trained Rotron engineers
- Most up-to-date facilities
- To select most efficient cooling and protection for your equipment
- Assurance

Rotron has now expanded its laboratory facilities to readily service customers anywhere in Europe, or the Western Hemisphere.

In the European and two U.S. laboratories, Rotron offers the opportunity for the electronics engineer to determine cooling requirements for sub-assemblies or entire electronic and computer systems. The electronic package is placed in the AMCA test chamber and its characteristic impedance to airflow is measured and accurately plotted. This allows the engineer to determine in the prototype stage the optimum cooling or pneumatic requirement (air flow, physical size, acceptable noise level, power requirement, cost) necessary to maximum reliability in your product.

The recognized leader in the highly specialized and vital field of cooling electronic equipment, Rotron has extended their capability a step further with the opening of the newest laboratory in The Netherlands complementing the already existing facilities at Glendale, California and in Woodstock, New York. You are cordially invited to utilize these facilities as your projects require. There is no charge.

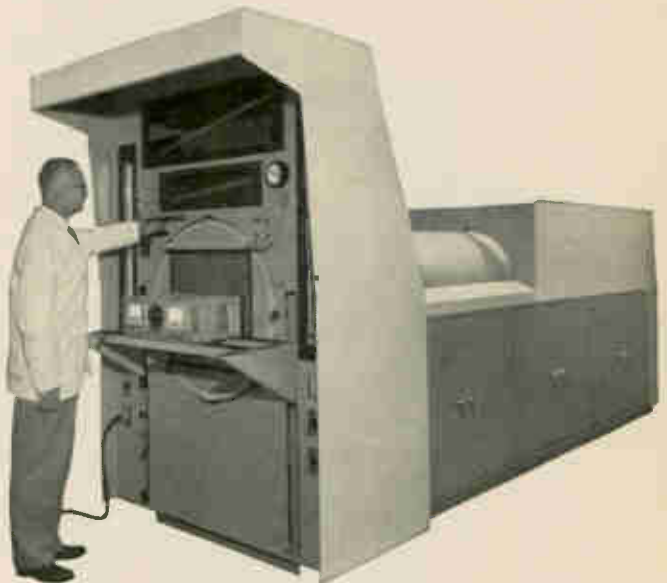

ROTRON MANUFACTURING COMPANY, INC.
 WOODSTOCK, NEW YORK
 West Coast: Rotron / Pacific, Glendale, Calif.
 Canada: The Hoover Co., Ltd., Hamilton, Ont.
 Rotron-Vactric Europa (N.V.) Breda, The Netherlands

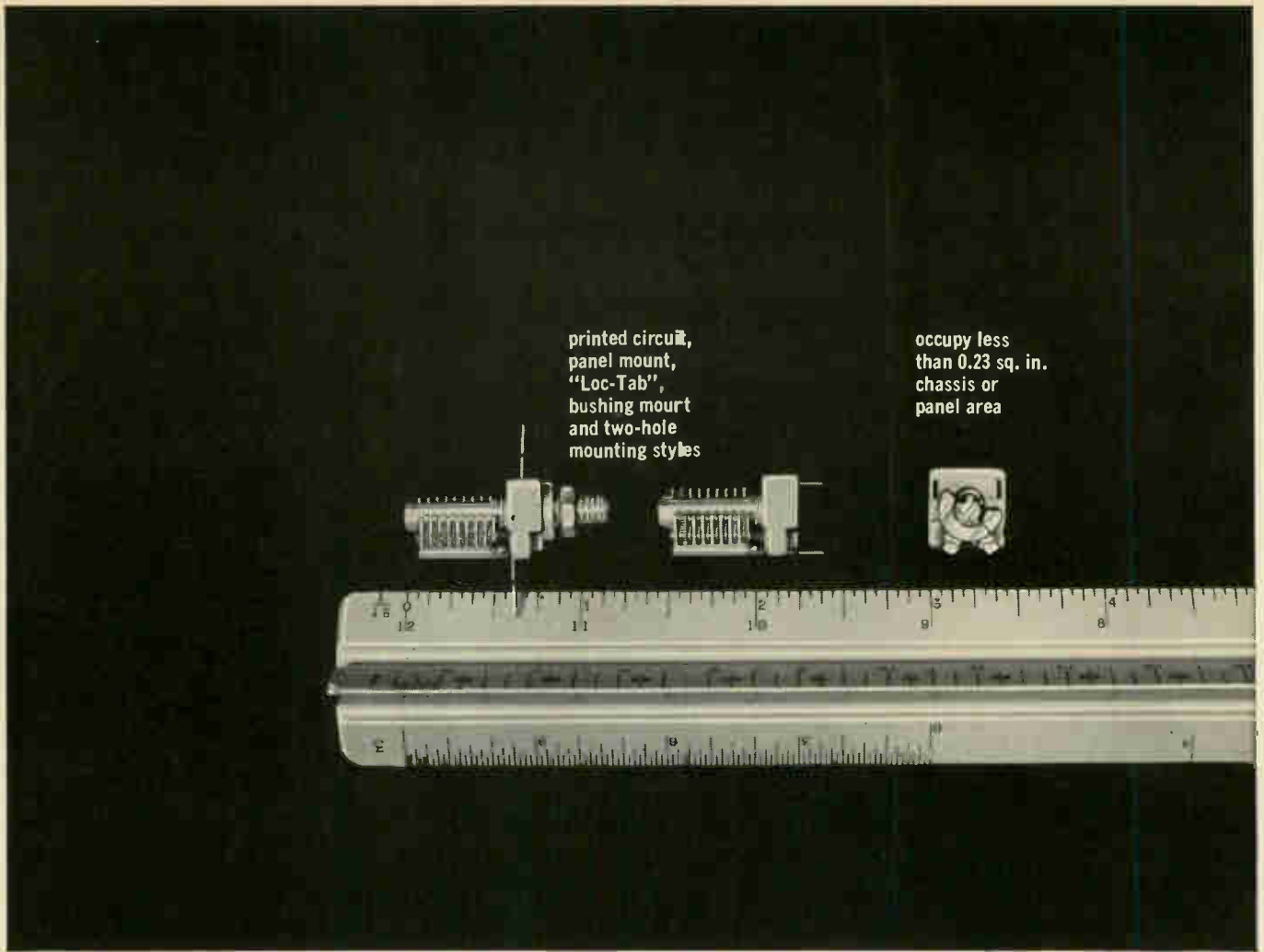

printed circuit,
panel mount,
"Loc-Tab",
bushing mount
and two-hole
mounting styles

occupy less
than 0.23 sq. in.
chassis or
panel area

THESE TINY AIR VARIABLES SOLVE BIG DESIGN PROBLEMS!

Cut costs—improve performance—and save valuable space with these tiny sub-miniature air variable capacitors! "U" requires less than 0.2 square inch for chassis or panel mounting . . . types "UA" and "UB" require less than 0.23 square inch! Unique precision design with stators and rotors machined from one piece of solid brass, provides outstanding mechanical stability and uniformity. High "Q"—greater than 1500 at 1 Mc. High torque-to-mass ratio— $2\frac{1}{2}$ to 10 inch-ounces. Exceptionally low temperature coefficient—plus 45 ± 15 PPM/°C. Provides absolute freedom from moisture entrapment found in trimmer capacitors of the enclosed or solid dielectric type. All metal parts silver-plated. Ceramic is Grade L-423 steatite, or better. Exceptionally uniform delta C and voltage characteristics. Choice of wide, double-pierced or printed circuit style terminals. Single-section models available in "Loc-Tab"; 2-Hole; Printed Circuit; and #10-32 Bushing Mount Types—Differential and Butterfly models available in Printed Circuit Types.

TYPE "V" MINIATURES—Slightly larger than the Type "U" series, the "V" miniatures offer all of the design, construction and performance features of the "U"s plus higher capacity with little increase in mounting area requirement. Available in Single Section types for printed circuit or panel mounting.



"U-LC" TUNERS—Combines precision machined Type "U" capacitor with air-wound, silver-plated inductor. Offers low cost, compact tuneable L-C circuit with excellent "Q" and temperature stability!



DETAILED CATALOG AVAILABLE—In addition to the variable capacitors described above, Johnson also manufactures other electronic components. For complete specifications and current prices, write for Components Catalog 984.



E. F. JOHNSON COMPANY

3332 TENTH AVE. S.W. • WASECA, MINNESOTA 56093

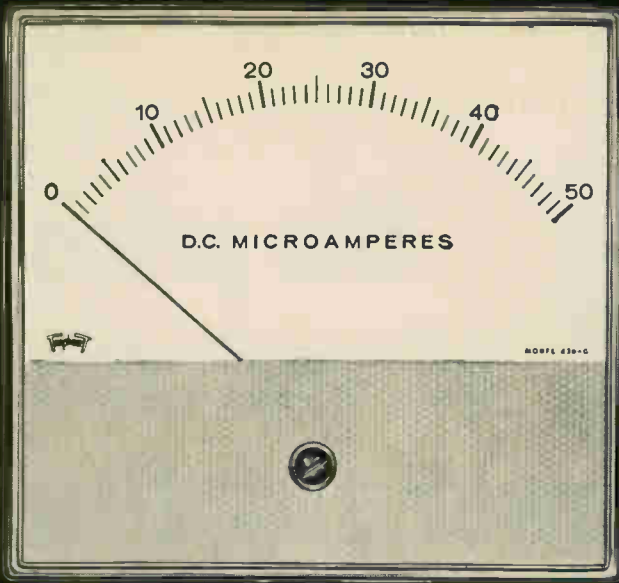

now you see it



now you don't



THE PANEL INSTRUMENT WITH BUILT-IN FLEXIBILITY

New Triplet G-Series Panel Instruments offer a modern design that features a greater degree of flexibility and interchangeability.

- 1** Two types of mounting are available—conventional flush type or behind-the-panel with a bezel for modern picture window appearance.
- 2** The insert shield on the front of the meter can be custom painted or printed to meet customer's requirements.
- 3** Triplet's famous self-shielded Bar-Ring magnet, with one-piece die-cast frame, all DC and DC suspension type instruments.

Available in three popular sizes: 2½", 3½" and 4½" models with black molded dustproof cases and clear molded plastic fronts.

TRIPLET

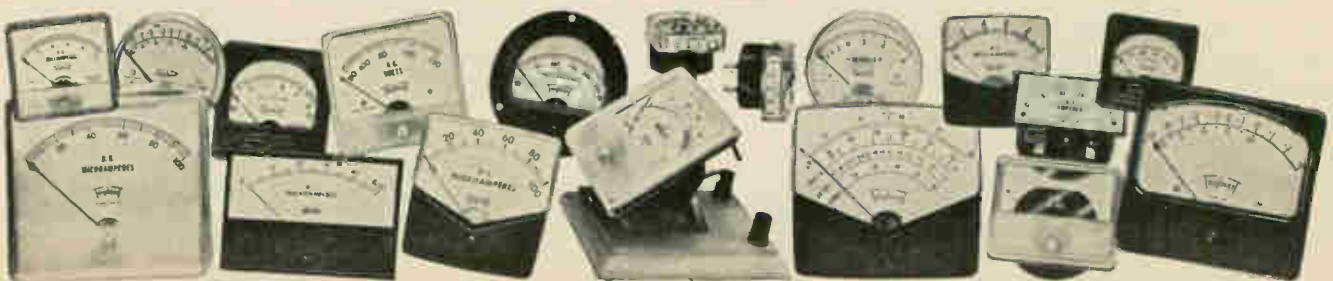

TRIPLET ELECTRICAL INSTRUMENT COMPANY, BLUFFTON, OHIO

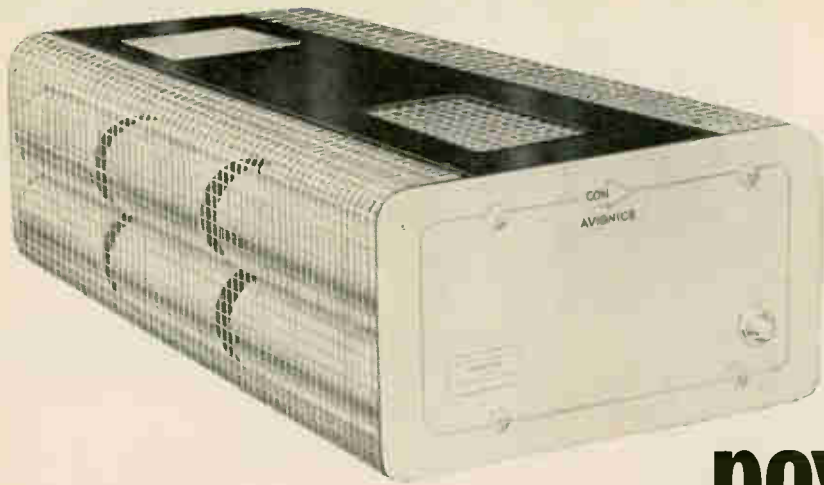

**the price
of systems
power supplies**

Just Dropped \$100

(Con Avionics Has Another New Line)

When we cut \$100 from the going market price for systems power supplies, we kept all the features you need most.

For example, Con Avionics' new line carries an unconditional five year guarantee. It has a Mean Time Between Failure of 35,000 hours, calculated according to Mil Handbook 217. We use silicon transistors exclusively, so the units operate to 75°C. They are designed and manufactured to meet specifications under the worst possible combination of operating conditions.

The secret to maintaining all this quality at a low price lies in designing a *systems* power supply right from the start. Most modules used in high power systems applications are just modified lab units.

But when you design a supply just for systems use you worry about things like panel space. So Con Avionics new HS supplies are available in rack and half-rack size. You can pack 12 volts at 20 amps into 5½" of panel height and 8" of width.

And in a system supply you design-in optimum air flow, for both vented and forced air cabinets. Our units are self-cooled, too.

Before you buy another power supply for a systems application, remember that the price is now \$100 lower than it used to be. Call, write, wire or TWX Mr. Gerry Albers at Con Avionics for all the details.

CONSOLIDATED AVIONICS

800 Shames Drive ■ Westbury, L. I., New York ■ 516-ED 4-8400

PARTIAL SPECIFICATIONS
 Input: 105-125 VAC, 47-63 cps
 Regulation: (Line and load combined) ±0.05%
 Ripple: 1 mv RMS max.
 Response time: 25 microseconds
 Temperature Coefficient: 0.015%/°C or 18 mv/°C, whichever is higher
 Temperature: 75°C max.
 The entire voltage range between 5.5 vdc and 51.0 vdc is covered in twenty-six models. Currents range from 8.0 amps to 46.0 amps. Wattages from 104.5 to 816.

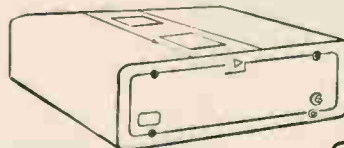

FULL RACK SIZE

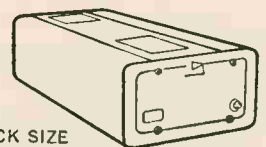

HALF RACK SIZE

A DIVISION OF  CORPORATION

How much reliability... how much capacitance... can you get in miniature size?

For your current high-reliability designs, evaluate the Mallory MTPH miniature wet slug tantalum capacitor. It's made in the same "white room" facilities that we use for making similar capacitors for Minuteman II, for Autonetics Division of North American Aviation.

Zero failures in 3.7 million unit-hours.

Reliability is documented by continuing 85°C tests at rated voltage. Results to date: zero short circuit or DC leakage degradation failures. Complete reliability testing and quality control programs to Minuteman specifications have been in operation on this product line for over 2 years in our plant.

High C-V ratings. Maximum ratings go up to 170,000 mfd.-volts per cubic inch... up to 5 times higher than solid tantalum types, up to 40% higher than other miniature wet slug models.

Small size. Three case sizes, 0.115" dia. by 0.400", 0.145" dia. by 0.590", 0.225" dia. by 0.775". Ideal for use with thin films and other microcircuits. Ratings from 450 mfd., 6 volts to 6.8 mfd., 50 volts.

For a review of our reliability data, write or call Mallory Capacitor Company, a division of P. R. Mallory & Co. Inc., Indianapolis, Indiana 46206.

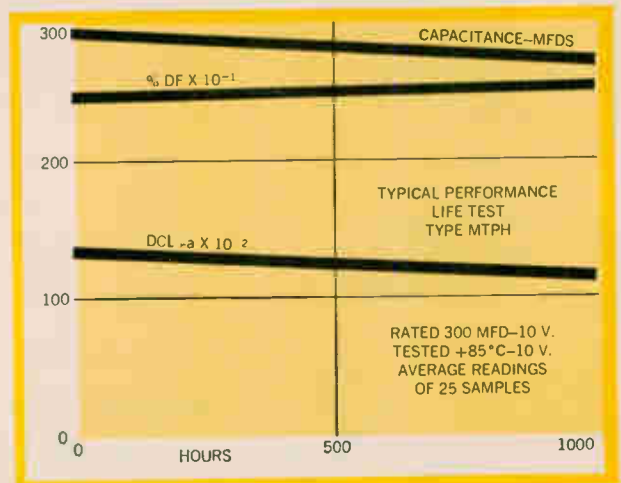
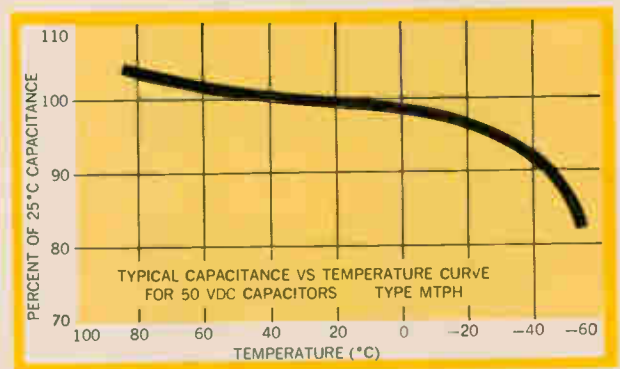

MALLORY

ANOTHER UNIQUE INSTRUMENT FROM ROHDE & SCHWARZ



275
TO
2750 mc

TYPE SLRD

SPECIFICATIONS

Frequency range
275 to 2750 mc in two overlapping ranges:
275 to 1000 mc and 850 to 2750 mc

Accuracy
±2%

Discrimination
One part in 10⁴

Frequency drift within 15 minutes after a 2-hour warm-up period
Less than 5 parts in 10⁵

Output
At least 1 w over the entire range
At least 20 w from 500 to 1700 mc

Characteristic impedance
50 ohms for model BN 41004/50
60 ohms for model BN 41004/60

Output power
275 to 500 mc above 10 w
500 to 1700 mc above 20 w
1700 to 2400 mc above 5 w
2400 to 2750 mc above 1 w

Output attenuator
Continuously adjustable from about 10⁻¹⁰ w at max. power, 80-db range logarithmic calibration

Attenuator accuracy
±5% ±0.5 db

Power indication
By panel voltmeter at output, calibrated in watts for matched load; ranges 0.05/0.5/5/50 w

Accuracy of power indication
±12% (without frequency response)

Frequency response of power indication
Less than ±15% in the range 275 to 2000 mc
Less than +30% in the range 2000 to 2750 mc

Output impedance
50 ohm cable and connector, external 50 ohm termination required

Internal modulation
Switch-selected

Type of modulation
Amplitude modulation

Waveform
Square wave

Frequency
1000 cps

Modulation depth
100%

Hum modulation
Less than 0.3%

Power supply
115/125/220/235 v +10%
47 to 63 cps (350 va) -15%

DELIVERY
FROM STOCK

20-WATT UHF POWER SIGNAL GENERATOR

APPLICATIONS

As a result of its high output power, among other applications the Type SLRD will determine the radiation characteristic of antennas, measurements being carried out on filters and four-terminal networks of high attenuation or on wattmeters and directional couplers of high coupling attenuation and directivity. It can also be used as a generator for impedance, VSWR and attenuation measurements and for calibration procedures for which a known power is necessary.

**12 OTHER POWER SIGNAL GENERATORS ARE AVAILABLE
FOR HIGHEST ACCURACY REQUIREMENTS
AT FREQUENCIES UP TO 11,400 MC**

Our extensive line of power signal generators is the result of a quarter of a century of research and development in the electronic measuring field. It covers the frequency spectrum from millicycles to kilomegacycles. All deliver large output in volts, offer very high frequency stability and accuracy, and have wide range attenuators. Excellent resolution is obtained by means of calibrated vernier. And incidental frequency modulation due to hum noise, etc., is of the order of 3 parts per million.



Write For Additional Information

ROHDE & SCHWARZ

111 Lexington Ave., Passaic, N. J. • PRescott 3-8010

ELECTRONIC MEASURING EQUIPMENT FOR THE UNCOMPROMISING

Technical Articles

**The packaging revolution:
page 72**



The impact of integrated circuits on equipment design is beginning to make itself felt in ways more profound than most engineers imagined possible. It is becoming increasingly difficult to separate the circuit, the system and the packages. In fact, in large systems the main limitation on speed, performance and cost is the packaging. In this first article of a series, we examine the problems and some of the ingenious solutions to this rapidly developing technology. Our cover is an artist's rendition of an advanced packaging concept.

**More laser power with Q switching:
page 91**

If the laser is ever to realize its potential, all the barriers to producing high power output must fall. In pulsed lasers a technique known as Q switching has been developed that can allow lasers to emit bursts of light in the gigawatt range. Two types of Q switching—active and passive—have different advantages and limitations, which must be understood to be applied properly.

**Transmitters, towed in the air, test antenna patterns:
page 96**

Determining radiation patterns of large antennas is often complicated by problems of terrain and environment. One way to get around these is to fly around the antenna, transmit a signal from an aircraft and record the reception at the antenna as a function of aircraft position. This airborne technique has been refined with the design of a towed transmitter called the Xeledop, capable of broadcasting at eight frequencies, and at any polarization.

**Messages by meteor:
page 102**

It sounds exotic, but propagation of radio signals by reflection from ionized meteor trails has some very practical advantages for inexpensive communications where slight delays can be tolerated. Meteor-burst propagation features excellent phase stability, so it can be used in a wide-ranging time-synchronization system or for data transmission where speed is not essential.

-
- Coming November 1**
- Optoelectronic computer logic
 - High-resolution television
 - Designing multilayer connections
 - Packaging: parts II and III



The packaging revolution, part I: form and function interact

Because wiring and hardware design has not kept up with advances in integrated circuit design, packaging is now the main limitation on the speed and performance of large systems built with IC's

By Jack J. Staller

Sylvania Electronic Systems division of Sylvania Electric Products, Inc.,
Needham Heights, Mass.

The major barrier to full realization of the advantages of integrated circuits (IC's) is packaging—the technology of protecting, connecting, cooling and housing the circuits.

Most of the anticipated gains in size and weight reduction, cost, reliability, speed and lower power consumption have been won at the circuit level, but only a fraction of these gains exist as yet in systems, particularly in computers and other large systems. One could easily be misled by the dramatic advances in, say, size reduction. Actually, the central processor of a computer which is built with monolithic IC's and is well-packaged by today's standards may be 50,000 times as large as the volume of the silicon monolithic chips which perform the logic functions.

Even so, the first large-scale use of semiconductor or monolithic integrated circuits (MIC's) has been in computers, which pose a full range of knotty, interrelated packaging problems. For example, even a small plug-in module can contain so many MIC's that all the modules may be different. This has played havoc with the concept of building digital systems with a few types of identi-

cal building blocks. Design, manufacturing and maintenance becomes immeasurably more complex. Completely new approaches to systems analysis and modular separation are required. The solutions—even the partial solutions—which have been worked out can readily be applied to many other types of systems.

I. The packaging puzzle

The packaging engineer's dilemma is basically this: how can he integrate the MIC into the system without sacrificing most of the benefits the individual circuit offers? Consider the factors:

Size. The "inefficiency chart" on page 75 shows how poorly present-day packaging capitalizes on the small size of the MIC's monolithic silicon dice, or chips.

Reliability. The tighter one tries to pack the circuits, the higher the power and connection density, which tends to lower reliability and increase costs. An MIC is inherently more reliable than a discrete-component circuit. However, careful thermal management is needed because studies indicate that circuit life drops 20% to 50% for each 10°C rise in temperature over 25°C. Microscopic joints and conductors are difficult to make perfectly, and new interconnection techniques are not fully proven.

Maintainability. Fault isolation techniques that will quickly isolate trouble to a specific block of circuits are required, since the block is often the smallest removable element.

If the MIC's are to be individually replaceable, isolation at that level must be accommodated in the packaging design. An MIC is almost always useless after one removal. In one system, 80% of

The author



Once a machine-gun designer, Jack J. Staller switched from mechanical engineering to electronics 19 years ago. He now manages Sylvania's Advanced Electro-Mechanical Systems department. He is past secretary of the EIA's Microminiature Circuit Applications Committee and past chairman of the Working Group on Microelectronic Packaging.

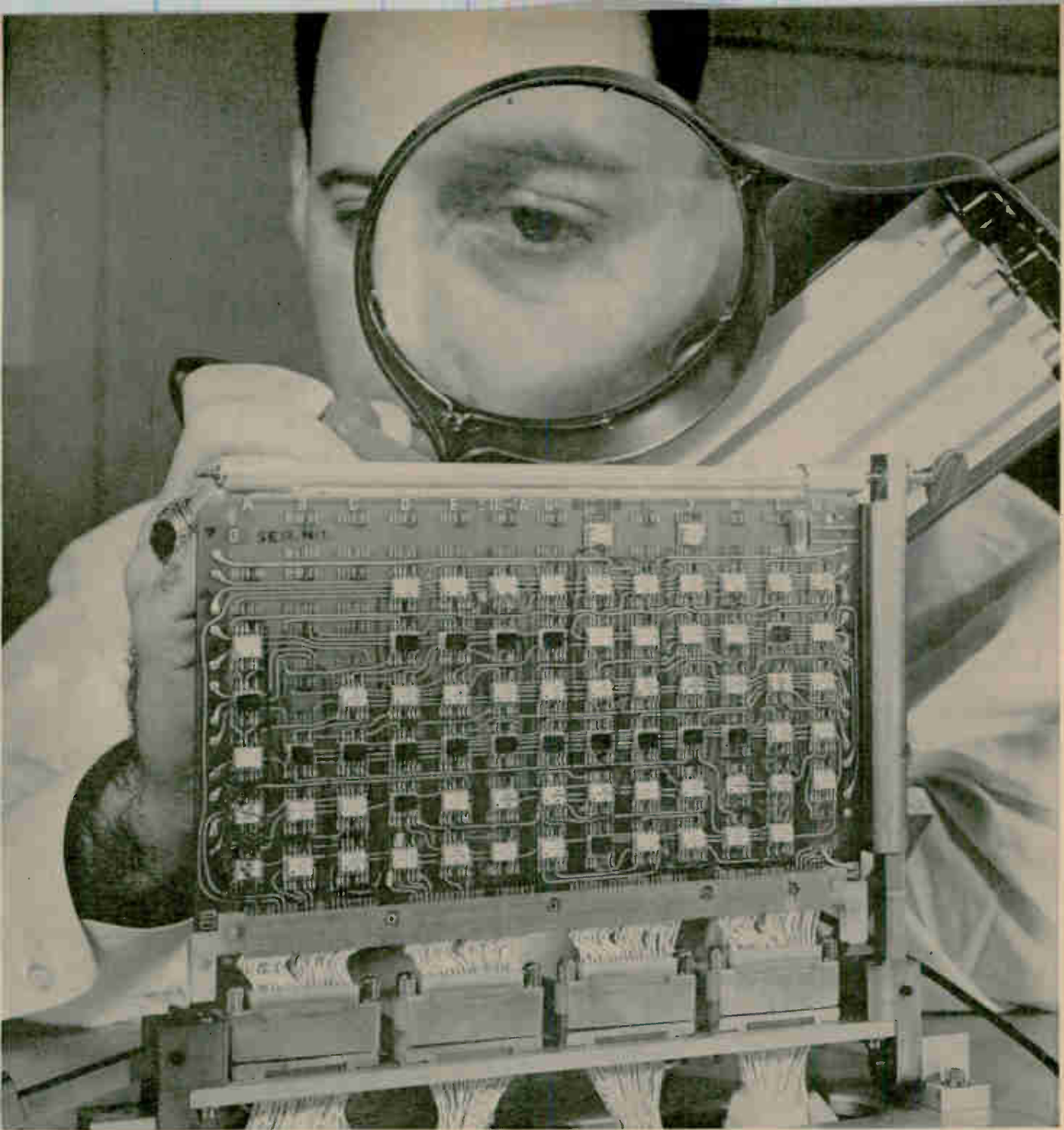

Today, the packaging of most large, integrated-circuit systems depends on multilayer circuit boards for circuit mounting and interconnection. This board is part of the logic and control subsystem of Sylvania's MSP-24 computer. The board has been pulled out of the subsystem, which is shown on page 82, for operational testing.

the circuits removed proved to be not faulty—and it is not sound economics to replace good circuits.

Often, the fault-isolation equipment is as complex as the operating equipment.

As reliability, or mean time between failures in the system, increases, a surprising problem arises: maintenance calls become so rare that it is impractical to train troubleshooters. It may be cheaper to build the system with large, expensive assemblies or modules, and throw them away when they fail.

Spares logistics. A large module improves reliability and maintainability; but the larger the

module, the more likely it is to be unique. If all modules are unique, 100% stocking of spares is necessary. And the designer cannot be sure that the same circuits, with known reliability and characteristics, will remain available in years to come. There is, therefore, a tradeoff between making modules large, for reliability, and keeping them small, for interchangeability.

Speed. Circuits are getting faster, due to new processing techniques. A 10-nanosecond circuit delay was once considered fast; now 5, 1 and even fractions of nanoseconds are being announced or discussed. The main reason is that chip size and

Packaging in Utopia

There are ideal design approaches to each packaging goal, but they frequently conflict. If compromises were not required, this is how a system might be designed for:

- Highest reliability: all circuit packages permanently or semipermanently interconnected, without friction contacts, in a so-called pluggable system.
- Least spares: every circuit package a plug-in, replaceable module (with 60,000 pins in a 5,000-MIC system).
- Best cooling: every circuit package mounted on a heat sink or the system's outside case.
- Smallest size and weight: if a thimble (p 75) isn't available, use lead-to-lead connections to assemble the circuit packages into a system that is cube-shaped.
- Easiest fault isolation and maintenance: each module a functional whole, readily tested by the system itself and easily replaced; module sizes can vary.
- Lowest production cost: modules are repeatable, mass joining instead of single-lead welding is used, and expensive multilayer boards and connectors are not needed.
- Simplest modification: all interconnections are point-to-point wiring that is readily changeable.
- Fastest system: all signal leads are short, or transmission lines; all ground and voltage lines are low resistance, low-inductance planes with power-supply decoupling capacitance that is adequate and built in.
- Moisture, contamination and interference-proof system: case is completely shielded and sealed, and all heat transfer is by conduction to the case exterior.

propagation path lengths are minute. Computers with clock rates of 25 to 100 megacycles—perhaps higher—become feasible.

Now the speed limitation becomes the length and characteristics of the wiring outside the chip. The interconnection's inductance and capacitance becomes part of the circuit. Simple wire must be replaced with transmission lines, aggravating the packaging problems and increasing interconnection volume.

With higher speed, it becomes necessary for the locations of circuits in the system, the delays in the wiring, and crosstalk to be considered in the system, interconnection and packaging designs.

Thermal management. Circuit density is rising faster than power is dropping, requiring increasing care in the dissipation of thermal power. Conductive cooling is essential in the vacuum atmosphere of space and is becoming increasingly desirable in all systems.

Cost. MIC costs per circuit function are dropping rapidly. Packaging cost is rising because the interconnection processes are more expensive. The packaging costs more than the circuits now in large microsystems, so the packaging engineer must be well-versed in the economics of design and process alternatives.

Manufacturability. The use of large cables, terminal boards and standard connectors diminishes drastically in the assembly of building blocks. The

assembly is often done under a microscope. The choice of the assembly technique must usually be made by the packaging engineer in cooperation with the manufacturing organization.

The subject of joining IC leads to intraconnections of a module is one of the most controversial—sometimes it is even emotional—in packaging. Soldering, welding, diffusion or thermocompression bonding, adhesives, crimping, clamping and many other methods can be used.

The connection-reliability goals are stringent—about 0.00001% per 1,000 hours for joints, compared to the 0.001% goal for monolithic IC's. To assure 0.00001% at a 90% confidence level, one would have to operate a million connections of each type for 10,000 hours—more than a year—under controlled conditions and find no more than five failures. The cost of such tests has made useful data on the reliability of joints scarce.

The naked chip? Not yet

A monolithic chip is often no larger than this square. Unconnected, unpackaged and inoperative, it is worth only pennies. About 9,400 chips, enough to make a computer, will fit in a thimble.

But, a thimble-size computer is still a pipe dream. Each chip needs about eight interconnections—a total of 37,600 leads and 75,200 joints. If each chip radiated 10 milliwatts, and there were no cooling system, the thimble would glow like a 100-watt bulb.

That's why the volumetric efficiency of today's computers is so poor, as shown in the "inefficiency chart." Flatpacks, the most efficient chip package now in use, multiply circuit volume 500 times. The volumetric or 3-D packaging used in spacecraft quadruples that figure, and printed-circuit planar assemblies make the modules 50,000 times as large as the working chips.

Happily, the vast increase in volume alleviates the packaging problems. Even so, engineers are not complacent about this because the inefficiency raises cost and limits performance. Computer architects are investigating new logical organizations that can use larger logical devices or batch-fabricated arrays of devices, and circuit designers and packagers are developing ways of making them.

Bigger circuits, fewer packages

Packaging design starts with the circuit, whether the circuit engineer chooses monolithic IC's or hybrid IC's made by attaching active devices to passive film circuits. Most designers choose monolithic IC's for computer logic today. For special applications, hybrids and all sorts of marriages between films and chips are advantageous. The photo on page 76 shows a few varieties.

The more mounting, connection, heat transfer and protection done by the individual package, the less that has to be done in the over-all system. Four ways of raising the functional content of the package are being pursued:

- More functional content in each IC. MIC's with

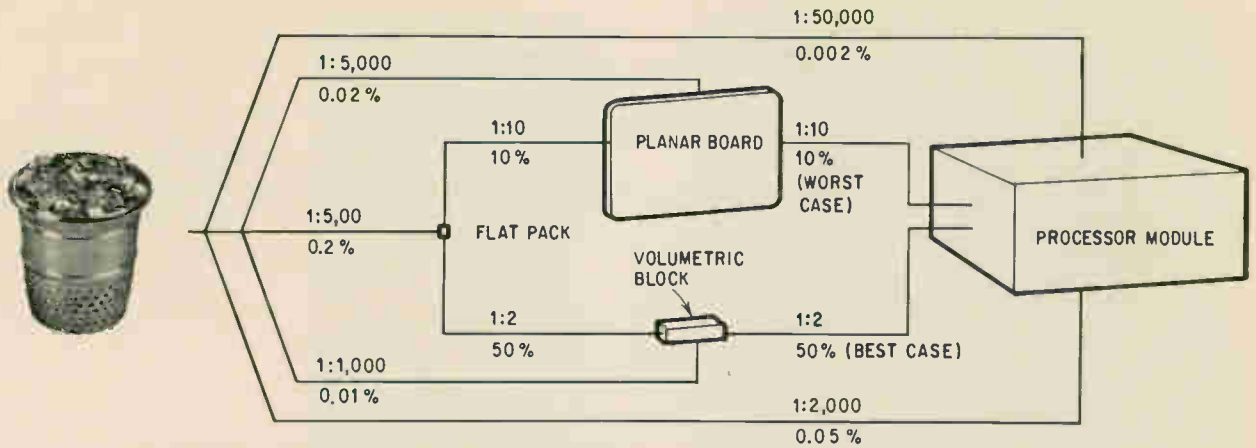

"Inefficiency chart" and a thimbleful of MIC chips illustrate the basic packaging problem. The 9,400 chips in the thimble aren't useful until they are packaged, repackaged and interconnected, resulting in a system that is 2,000 to 50,000 times the thimble's size.

about 100 components are now being made and the numbers are expected to multiply.

- **Multicircuit chips.** Silicon dice are being made now with 20 or more intraconnected circuits; and by next year the figure may be 100. The system packaging has fewer leads to contend with, but each circuit is more likely to be unique. Metal-oxide-semiconductor (MOS) techniques are also being used to make circuits that are essentially subsystems, such as the 100-bit shift register shown at the right, below.

- **Multichip circuits.** Different types of chip circuits are interconnected with thin films on a common substrate. For example, the Univac division of the Sperry Rand Corp. is bonding 180 chips to a small glass plate to make a memory system.¹ The future of this approach appears to depend on the success of mass-bonding or soldering methods and the reproducibility of thin-film equivalents of multilayered circuit boards. Such boards are made

with several layers of wiring in order to increase interconnection density.

- **Hybrid combinations.** A promising marriage of silicon-planar, MOS and film technology is the active thin-film circuit. Chip attachment is avoided by depositing semiconductor crystals as well as passive films.

Moreover, cryoelectric-device researchers now contend that these can be inexpensively made in batch-fabricated arrays.

Various definitions of different forms and functions of IC's have been published. In this article, the terminology generally agrees with the definitions adopted by a users' committee.²

Packaging dominates cost

Integrated circuits are the primary components of the central processors of virtually all new computers. Essentially, IC's replace assemblies of discrete components with single components. There-

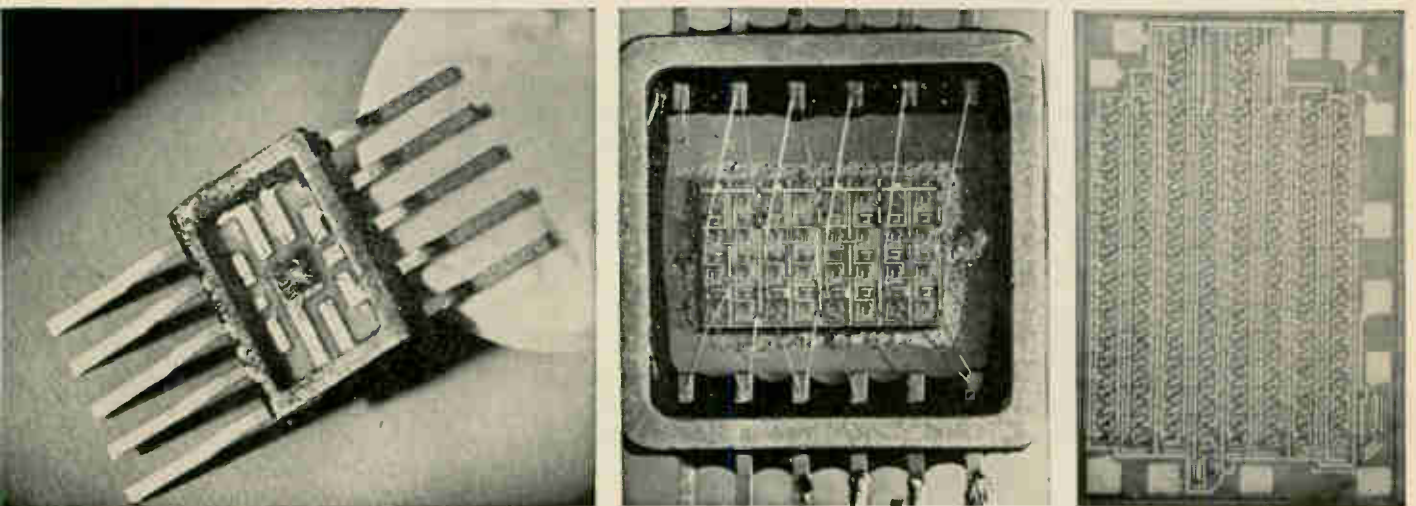

Monolithic circuits are growing in complexity. At left is a standard-sized MIC, shown leaning on an aspirin pill; in the center is 32-gate, 4-bit shift register made by the Westinghouse Electric Corp.; next is a 100-bit shift register made in MOS form by General Micro-electronics, Inc.

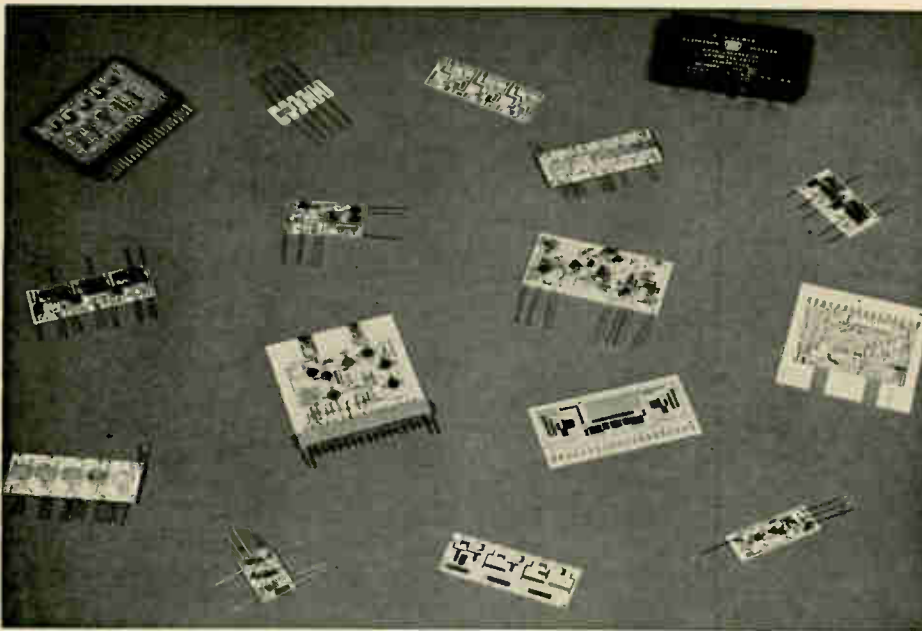

A collection of hybrid circuits made by Sylvania. Hybrids can be built in many ways, with various forms of film conductors and passive components, packaged or unpackaged active components, and pins or leads.

fore, component interconnection grows in importance, since it joins functions rather than small parts of functions. Often, it is the wiring and hardware design which determines whether a new computer is competitive in performance and cost.

Monolithic IC's are now cheaper than the discrete-component circuits they replace, but the packaging usually costs as much as if not more than the IC's themselves. If the individual circuit packages are considered part of the system hardware, which they rightly are, then packaging is the only significant cost. In the past, circuit costs predominated and designers aimed at reducing the number of discrete components. Today, the cost of individual components in an MIC is negligible.

In other respects, packaging offers the best chance to benefit from improved design: smaller size and weight, shorter signal paths, better reliability through improved cooling, and fewer mechanical contacts and welded or soldered joints.

Computer-system economics

The cost balance swung in favor of monolithic IC's in some military applications two or three years ago, even though the IC's then cost more than their conventional equivalents. Overriding considerations of size, weight and reliability, in systems like the Minuteman missile computer, made premium prices and high design costs acceptable.

Now the costs are parallel to conventional circuits in military systems; and often IC's cost less in military ground computers, whose size and weight are important but not primary considerations. For example, the MSP-24, built by Sylvania, a subsidiary of the General Telephone & Telegraph Corp., is about the size of a high-fidelity audio system. Yet the MSP-24 has the data-processing capability of the truck-sized Mobidic field computer or of a large commercial computer. It can be

built for a fraction of the earlier computers' costs, and is cheaper to maintain.

The first major civilian use of monolithic IC's will be in large computers. They will not be produced in quantity until next year or 1967, but such computers have been announced by the Radio Corp. of America, Honeywell, Inc., and the Burroughs Corp.

Some companies got off to a head start with low-cost forms of hybrid circuits in smaller computers. Most commercial firms elected to wait until they could stabilize designs, obtain adequate supplies of mass-produced custom or semicustom MIC's at prices competitive with those of conventional commercial-quality circuits, and devise economical packaging and assembly techniques. The crossover point at which MIC's have a cost advantage over conventional circuits is expected in early 1966. A rough estimate is \$1 per circuit function.

It can be very bad business for a military firm to delay production until a design solidifies; often such delay is impossible since the computer is part of a weapons system that is also being modified. But it is good business for a commercial firm to do so.

Commercial systems modification consists primarily of shuffling a mix of subassemblies and peripheral equipment to suit customer needs. The military system manufacturer is more likely to be concerned with the ease of rearranging circuits.

Lower MIC costs save less money in commercial computers than in military ones. The size, weight and reliability nut is easier to crack. The peripheral equipment isn't a ship or missile, but something the customer buys along with the computer. The commercial system's central processor, where most of the monolithic IC's are used, is only 20% to 25% of the system cost. The savings in a small computer would be slight.

Comparing integrated-circuit and conventional modules in photos such as this has become a cliché, but it's the best way to show the size reduction. The three boards and the module of 12 flatpackaged MIC's are both six-bit shift registers used in Burroughs computers.

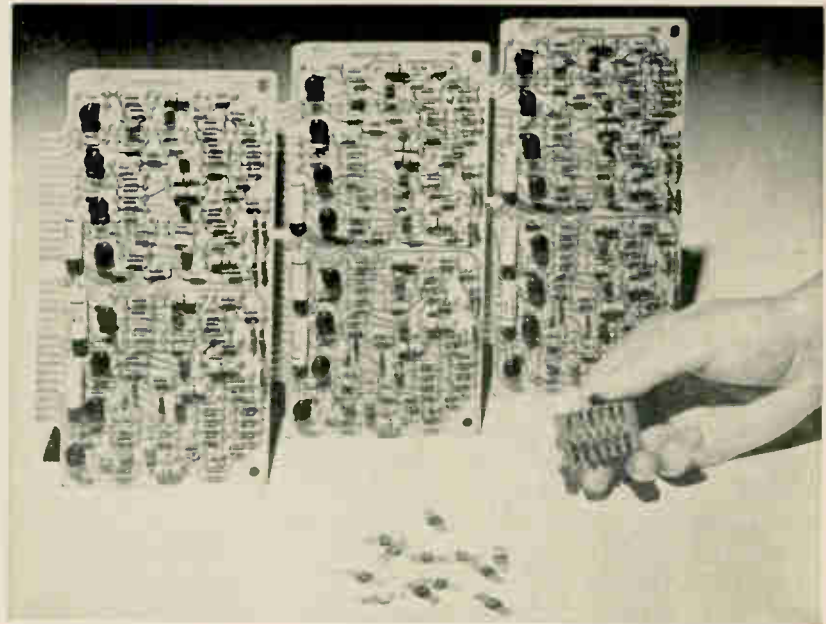

However, the savings—in hardware, power and cooling—become attractive in large computers. Also, a more important design need comes into play—the need to keep the computer's speed and capacity competitive. Honeywell could build its huge 8200 with discrete components, comments a Honeywell engineer, but overcoming signal-path delay would be "pretty painful." One final point is that the larger the computer, the more economical its maintenance becomes, as discussed on page 80.

The differences between military and civilian assembly methods are diminishing in interesting ways. For instance, commercial producers use flatpacks but prefer to join the circuit leads to circuit boards by dip soldering rather than surface welding or resistance soldering. Multilayer circuit boards are also used commercially, but they are simpler and partially prefabricated, and employ discrete as well as etched wiring.

Basic packaging decisions

With integrated circuits, the minimum assembly level shifts upward from the circuit component to the circuit function. But the use of IC's has not changed the basic packaging design approach, in which the system is broken down into smaller, manageable sections.

One definition of these sections which has proved useful in integrated circuit system packaging is:

- Level I. A logical function module of intraconnected circuits.
- Level II. A subsystem of interconnected Level I modules that usually are easily replaced.
- Level III. A system of Level II modules.

Figures of merit for the packaging efficiency on these levels can be obtained by calculating the number of packages per square inch of mounting area or per cubic inch or foot of volume. The old formula, components per cubic foot, is difficult to

use because the integrated equivalents of discrete components may not be clearly defined.

The three-level approach requires decisions on the type of circuit package and the method of joining the leads to the intraconnections at Level I, the optimum size of the modules and the number of their input-output connectors, thermal management, and module interconnection. These decisions are affected by the factors previously discussed and involve numerous trade-offs.

The ill-defined problems

Before he starts work, the packaging designer should also be aware of several subtler problems.

The discrete-component module of 10 to 40 parts was generally replaceable by soldering or plugging. The MIC is small, and the joining processes specialized. Large numbers of very small plug-in contacts would degrade the very reliability which makes MIC's attractive. And astronomical numbers of contacts would make it impractical to build the very complex systems which MIC costs and reliability make attractive.

Therefore, the designer must use large functional blocks of circuits, but at the same time keep the number of input-output pins to each block small. Often, this requires replanning the entire system organization.

Also, it is difficult to build an engineering model that permits frequent design changes but truly represents final system performance. Discrete-component breadboarding methods no longer apply. The prototype interconnections must be miniaturized to evaluate the speed accurately and to coordinate the timing of microsystem operations.

When multilayer boards are to be used, the most popular solution is to prefabricate the board layers unlikely to change, such as those which carry voltages or ground, clock and reset signals. Logical signal wiring is applied or added in a readily

removable manner; edge-soldered etched wiring, posts for point-to-point wiring, or pluggable signal patterns may be used to make model wiring duplicate the properties of production wiring. Care must be taken with signal-path-lengths, which significantly affect operating speed, and with the emphasis placed on ground-loop effects and transmission-line techniques.

The variable wiring is frequently called "soft" wiring and the prefabricated form "hard" wiring. Conversion from the soft wiring to a form suitable for production is called "hardening."

Designers of large, high-speed systems are attempting to achieve optimum geometric arrangements of circuits and modules to minimize path lengths and interconnection affects. Several approaches are illustrated opposite. In most of these examples, the Level I modules are 400 volumetric assemblies, Level II is a planar module and Level III is volumetric. The concept shown on the cover is volumetric at all three levels.

Finally, to accommodate fault isolation, each functional block may use a different number of circuits. The modules must be variable in size; or if that is not acceptable, a solution must be found to the inefficient use of the mounting capacity of standard-size modules.

II. Designing the system packaging

Until the day of the throwaway system comes, the sections of large systems must be mechanically and electrically joined. A system with all devices semi-permanently connected, with no friction connections such as pin connectors, would be the most reliable one. It would also be the least maintainable and most difficult to control and test during manufacture.

The most difficult packaging decision concerns where the system should be separated into Levels I, II and III.

Level I modules may have as few as six and as many as hundreds of circuits. Compare the Sylvania MSP-24 and the Mobidic computers. Each pluggable module in Mobidic was a flip-flop, or two gates; six modules were on a motherboard (see below). The MSP-24 has an average of 110 MIC's per board.



Mobidic computer's Level II assembly had six modules with one or two circuits per module. The small objects in front of the pencil are volumetric assemblies of equivalent function, used as Level I microelectronic modules.

Carving up the system

The circuits and the logical connections between them are defined in an over-all block diagram prepared during system design and mechanization of the logic. Then the system, mechanical, logic and circuit engineers cooperate in carving the diagram into the three modular levels, observing all constraints and design rules. These may be based on early decisions as to the most IC's in a Level I module, number of input-output pins, permitted heat concentration, and desired module repeatability.

The first step may simply be the drawing of a circle around related groups of circuits, counting the connections that are crossed and determining whether the numbers of circuits and pins can be accommodated by the Level I modules. Arithmetic logic requires few connections compared with control logic, so it may be desirable to reserve half of each module for each type to average out pin requirements.

Level II connections are then considered. At this stage of design, different engineers have been working on different machine functions, so signal-pin assignments may not coincide. The layouts are "massaged" so that the functions line up. If pin counts are excessive and connections cannot be shifted into the Level III wiring, the logic, circuit and packaging engineers must compromise. The circuit designer, for example, can redistribute the control logic or reduce the wiring requirement by the use of buses.

Compromises are usually required. Tradeoff analysis charts, which compare categories of system performance under different packaging approaches, are used. A typical trade-off chart for a high-speed system with critical speed constraint would probably include these categories:

Circuit and interconnection wiring delay; degree of noise or crosstalk; ease of interplane power-supply decoupling; waveform amplitude and phase distortion; average wiring length; circuit speed capability under operating loads; design and development cost; quantity production cost; flexibility or adaptability; maintainability time (mean time to repair); maintainability cost (replaceable part cost); volume, weight, thermal management; reliability.

In all, 15 factors must be analyzed and weighted for each feasible design. Computers are increasingly being used to help in making these decisions.

Best module size

Establishing Level I module size is the most critical decision the packaging engineer makes. He must balance conflicting requirements of reliability and maintainability. The number of MIC's in a replaceable module may range from one to 1,300. The table on page 86 and 87 indicates how widely module sizes may vary in microelectronic systems.

As the number of circuits rises, the number of input-output pins per circuit falls, helping reliabil-

Modular interconnection concepts

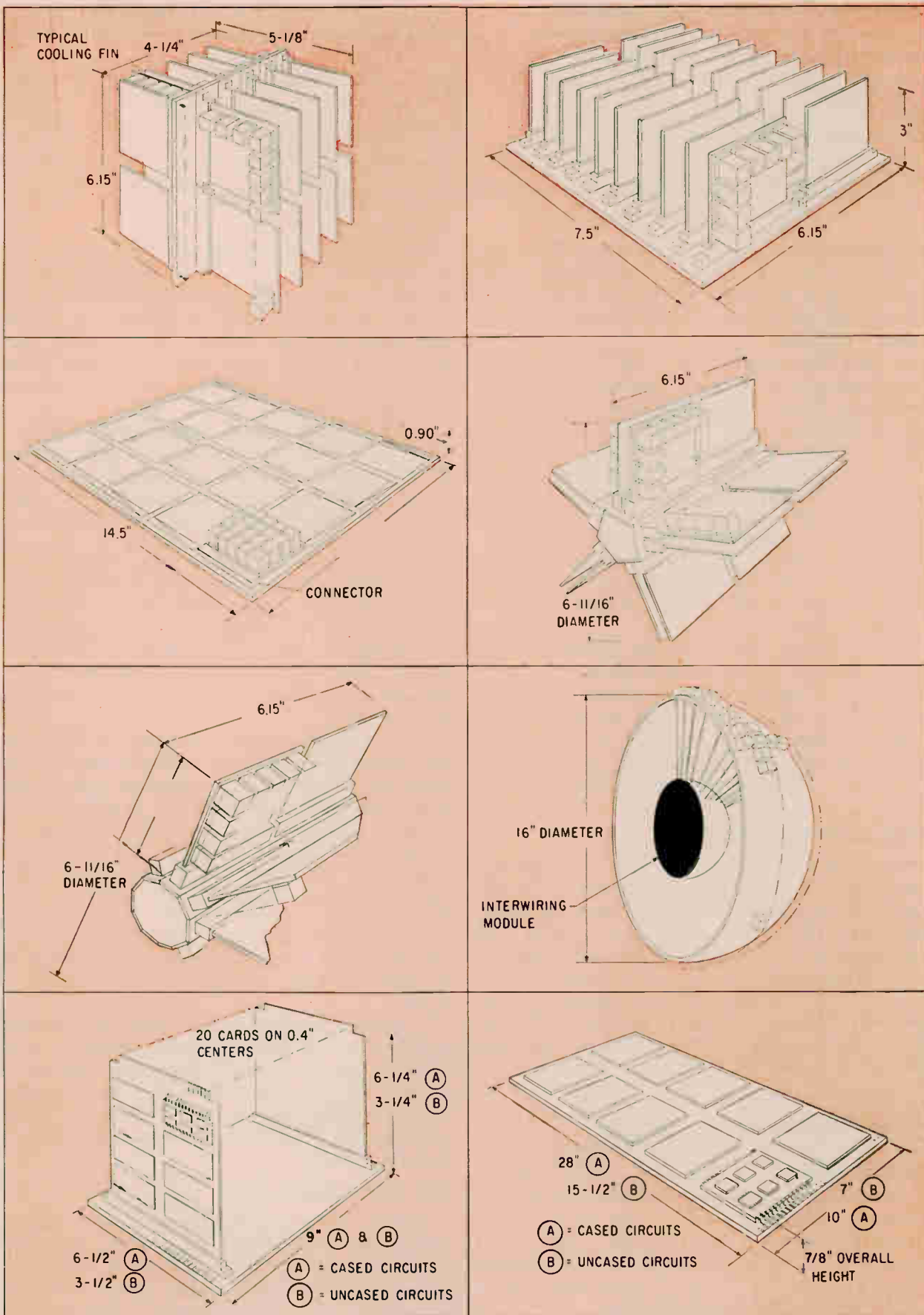

Level I module sizes, pin numbers and repeatability

Average number of MIC packages per module	1	5	10	20	40	50	100	250
Module input-output leads per IC package								
Register logic.....	10	5*	4*	3½*	3*	2*	1*	0.85*
Control logic.....	12	9*	9*	9*	7*	2*	1*	0.85*
Types of modules in 1,600-MIC system.....	—	10	15	18	25	31	16	8
Repeatability of Level I modules, percent#.....	—	96.8	90.6	77.5	37.5	3.1	0	0

* Does not include power and voltage leads

This percentage is the inverse of the percentage of the system represented by a set of the modules.

ity. However, the more circuits the module has, the more unique it becomes. A preliminary study indicates that at around 50 circuits per module virtually all modules in a data processor will be logically different.

A chart demonstrating the relationship between circuit and pin numbers and module repeatability is printed above. It is generalized from studies of a number of systems; it has been checked against other systems and generally conforms.

The use of connectors at some level in the system is inescapable. The "pin limitation" of the Level I module—the number of connector pins which can be provided—is a severe problem, related to the functional organization of the circuits in the module. The figures given in the chart represent a striving for efficient logical interconnection to reduce pin numbers.

The chart does not apply if the design objective is repeatability. This can be accomplished by using pins less efficiently. An extreme case is bringing all the signal leads of each circuit out to the Level I module plug, with only power and ground as common leads. Although pin usage increases tremendously, this approach is used in several systems.

Modules and maintainability

Circuit-type modules, in which circuit leads are brought out to edge connectors for Level II interconnection, are widely used in discrete-component computers. This is efficient because a plug-in card has only enough room for a few circuits, and use of such cards standardizes subassembly fabrication. It also allows for easier maintenance, since relatively few types of cards must be stocked as spares. Technicians can readily repair such circuits with hand tools.

Fault isolation and pin numbers

Assembly type*	A	B	C	D	E
Major subassemblies	1	1	5	5	5
Cards or modules...	0	44	0	46	556
Number of pins.....	580	8,940	1,450	10,050	18,356

* Types are defined in text on page 81.

Circuit-type modules are little used in the new IC computers. Large numbers of circuits can be placed on a 4-by-6 or 6-by-8-inch card, but even if each circuit lead could be brought out to the card edge, the edge couldn't carry enough connector pins. Cards would have to be tiny or the number of circuits on them low and Level II hardware multiplied.

Instead, the functional approach is preferred. Circuits are intrac connected in the module to form all or part of a subsystem. Fewer pins and less wiring and hardware in Level II are required. Also, it is easier to isolate a fault to a function than to an individual circuit.

The rub is that as the functional assemblies become larger and hence more efficient, the maintenance problems become more severe. The spare parts required for a small computer might be another computer, unassembled. Otherwise, field technicians would have to try to repair the modules on the spot, a prospect which makes reliability engineers shudder.

The spare parts problem becomes less severe as the computer becomes larger. Module repeatability improves, and can be helped along by dividing the larger functions among several modules. That, however, is still difficult to achieve in practice.

The functional approach suits the commercial practice of providing on-site maintenance and spares for large computers. The military manufacturer can better afford to put large functional assemblies in smaller computers, because identical computers are more likely to be concentrated in the field—for example, in a squadron of planes or missiles.

It is worth noting that the functional approach is also seen as a means of readily updating computer designs to use the larger circuits discussed on page 74. The design changes to accommodate the higher functional content of the new circuits would mainly be made in the interconnection and packaging design.

Throw-away module costs

Another factor significant to module size is whether the modules which fail in use are to be thrown away or repaired at a depot or factory. In the past, \$50 has been a widely accepted military throw-away cost. As the circuit's reliability and

their mean time between failures (mtbf) rise, the cost can be higher; \$100 is now being discussed. One approach gaining favor is to establish a figure of merit based on operating hours per dollar for an assembly. One figure quoted is \$1 per 10,000 hours. That figure has been used to prepare the table and chart at right.

Monolithic IC failure rates are about 0.008% per thousand hours at present; 0.003% is anticipated in the near future and 0.001% is reasonable for long-range planning. To this must be added joint and interconnection failure rates. This is 0.00001% per joint, or 0.0002% for the average IC interconnection of 20 joints. Thus, the designer can plan on a failure rate of 0.0032% for each assembled IC.

The permissible prices per module given in the table were computed by dividing the mtbf by 10,000. The allowable price per packaged circuit in the module is inversely proportional to the number of circuits. It is questionable whether circuits can be provided in a system as cheaply as the \$7.80 figure for a 20-circuit throwaway module. Obviously, the 50-circuit module must be repairable.

The relationship between module size and device reliability at all three MIC failure rates is plotted on the same basis in the chart.

Fault isolation

To simplify fault isolation, it is desirable to make each Level I module a complete logical function, so that a known input will give a clearly defined output. Otherwise, the logic must be carved into unnatural blocks, requiring extensive test equipment to analyze performance.

Fault isolation is most efficient when the module size and complexity is completely variable. Otherwise, a size large enough to cover the worst case is selected; the other modules are used less efficiently or two logic functions are combined in a module.

A different approach, used in several systems, is to have a basic Level I building block of only 8 to 12 IC's and to build larger functional modules of these. This is not significantly different than the mother-daughter board assemblies of earlier discrete-component systems except that the Level I assemblies are the equivalent of the former Level II assembly.

For example, in the Mobidic computer, a $7 \times 15 \times \frac{3}{4}$ -inch assembly carried 6 to 8 circuit functions. A $1\frac{1}{2} \times \frac{1}{2} \times \frac{1}{8}$ -inch assembly could be the MIC replacement; 15 of these, measuring $2 \times 3 \times 4$ inches, would replace an $8 \times 18 \times 18$ -inch drawer-type Mobidic assembly.

Isolation vs. pin count

The relationship between pin numbers and functional size in various module breakdowns of a 5,000-MIC central processor were studied, with the results shown in the lower table on page 80.

In case A, all the monolithic IC's are in one assembly, with no further logical separation possible. It is most efficient in pin and volume use and

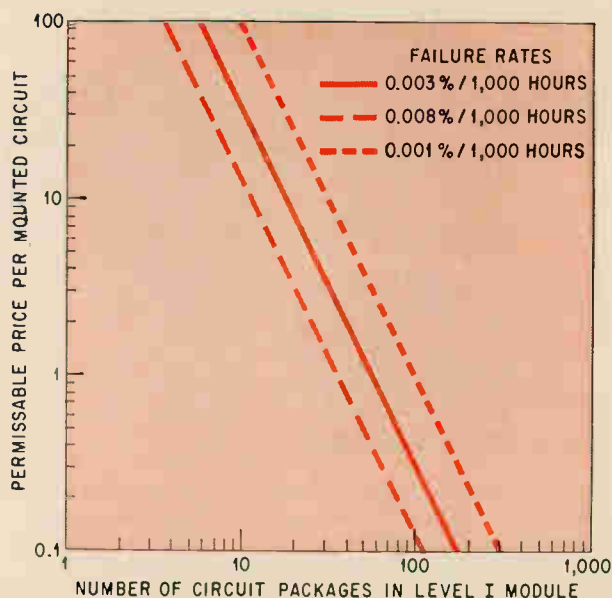

Selling prices for assembled MIC modules under the \$1/10,000 formula

N Number of MIC's per Level I module	$\frac{1,000}{N\lambda} = 10^5 = N\lambda$ MTBF per module	MTBF = 10 $\frac{10,000}{N\lambda}$ Permissible module price	$\frac{\$}{\text{module}} = \frac{10}{N} = \frac{10}{N\lambda}$ Average price per mounted MIC
1	31,200,000	\$3,120	\$3,120
10	3,120,000	312	31.20
20	1,560,000	156	7.80
50	625,000	62.50	1.25
100	312,500	31.25	0.31
250	125,000	12.50	0.05
500	62,500	6.25	0.0125

λ = Failure rate in % per 1,000 hours per connected integrated circuit = 0.0032%/1,000 hours

If a throw-away cost of \$1 for each 10,000 hours of operation becomes a maintenance-cost rule, MIC prices must plummet to justify large modules. The circuit prices include packaging and assembly costs.

in gross isolation of faults, but who could afford to produce or maintain it?

Case B is essentially the approach used in the MSP-24. There are 44 logical groups. Level I modules average 110 MIC's although the board mounting capacity is 178 IC's. The lower figure is due to logical requirements, wiring density limitations and pin limitations.

Case C is idealized for fault isolation, with only five pluggable assemblies. One assembly has 2,000 MIC's, another has 1,000, a third has 500, and there are two with 750 MIC's each.

Case D takes the five blocks of case C and further separates them into the 110-MIC cards of case B. Some sacrifice of pins and packaging efficiency is needed to retain the use of ideal isolation blocks.

Case E represents an often-used compromise, the mother-daughter arrangement mentioned above. There are 556 Level I assemblies averaging 9 IC's



Multilayer boards raise interconnection density by increasing the amount of wiring in a given volume. This board was made by Autonetics for use in aerospace computers. The flatpacks are mounted on conduction-cooling strips.

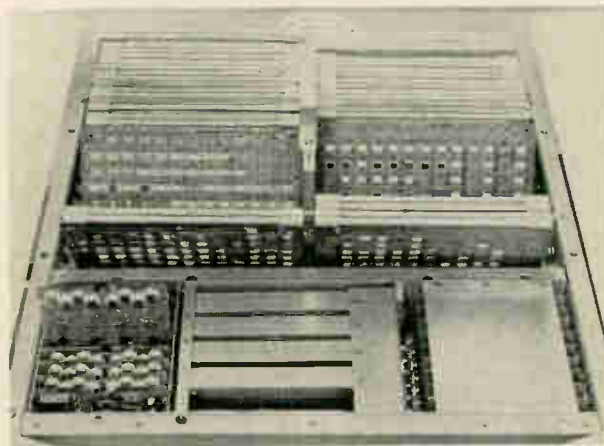

Logic and control subsystem of the Sylvania MSP-24 computer. The multilayer boards are assembled like pages in a book to facilitate testing and design modification. The wiring of this prototype assembly has not been hardened fully—some discrete wiring is also used.

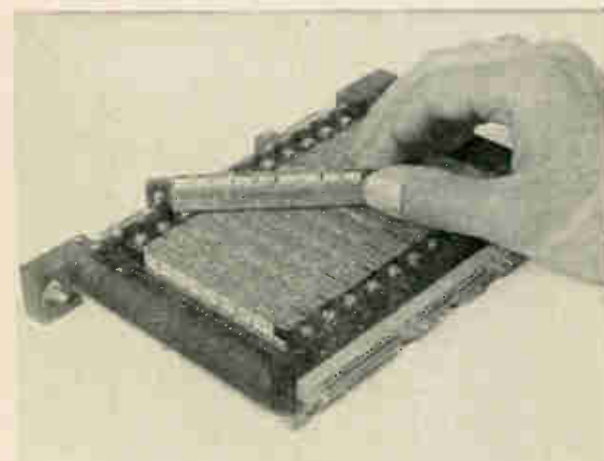

Cordwood modules used in the General Electric Co.'s A-212 computer have a core which does triple duty as connector, cooler and flatpack mount. At left, Level I and II assemblies are seen. At right is a portion of Level III.

each. The Level II modules are the five blocks of case C. The pin number can be reduced by employing semipermanent joints (solder, weld, split-pin Wire-Wrap or Termini-Point) between Levels I and II. There are 16,906 such joints, leaving 1,450 pins (besides the interwiring joints within each Level I and II module).

Package size and shape

The next major step is selecting the circuit package style. This, of course, is influenced by—and influences—all the design requirements and constraints: size, weight, power, speed, environment, maintenance philosophy, factory handling, cooling medium and reliability, to name a few.

The packaging designer now has three general form factors to choose from:

- Flat packages, or “flatpacks,” which are small cases with radial leads. Flatpacks are generally rectangular, but round ones are sometimes used when a large number of leads are needed [see *Electronics*, Oct. 4, 1965, cover]. Some perpendicular-lead configurations are being considered.

Radial-lead flatpacks are taking the lead in military applications and where minimum use of space is needed. Strong points are: the reduced height reduces system volume; the form factor is efficient for 3-D packaging; leads are not limited to the 12 on TO-5 package types; the heat-transfer surface is accessible for conductive cooling; and there is greater freedom in lead terminations.

- TO packages. These resemble transistor cans but have more leads. The TO-5 and TO-18 styles are commonly used. Their advantages are: lower cost than flatpacks, an advantage which may disappear as production volumes of flatpacks increase; better hermetic seal (the industry's long experience in making circular metal-to-metal seals customarily result in a seal that is roughly 10 times as good as in other package forms, but the actual difference in leakage rates may be extremely small); and a well-known form factor, so that users need

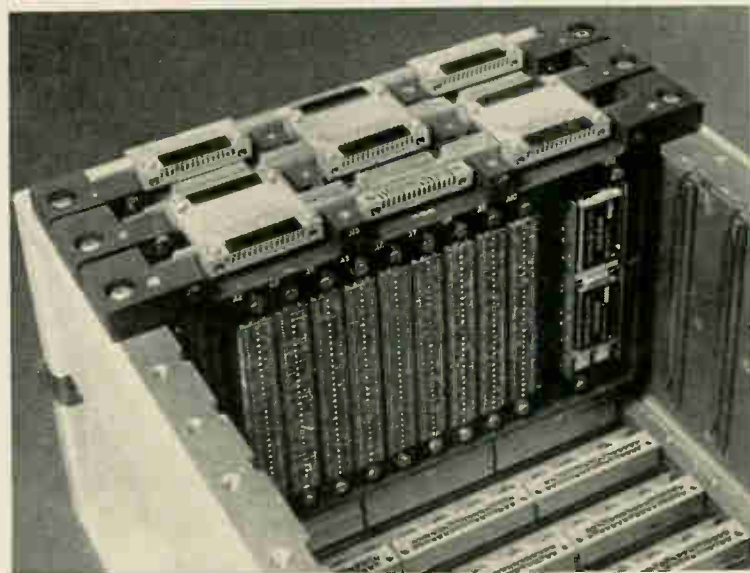

make only minor changes in test-handling and assembly and can employ present flow or dip-soldering equipment.

- In-line or plug-in flatpack. These were recently introduced to suit commercial MIC applications where minimum design and assembly costs are more important than minimum size, weight and ability to withstand severe environments.

The in-line packages have stiff, vertical leads spaced 0.1 inch apart, twice the spacing of flatpack leads. This relaxes the requirements for printed circuit precision and has a number of other cost-cutting advantages on the production line.

Interconnection designs

Today's integrated circuit modules are almost invariably made in the two general shapes which have been employed in discrete-component packaging—volumetric or 3-D styles similar in concept to the familiar cordwood module, and planar or surface-mounting styles. In large MIC systems, the latter style usually requires multilayer circuit boards.

The two styles can be combined in many ways. For example, 3-D Level I modules can be assembled as a planar Level II module. Conversely, planar Level I's can be stacked on a motherboard so that the Level II is essentially a large 3-D block.

The drawings on page 79 are conceptual designs for using the two basic forms. In most, there are 400 3-D Level I modules. The overall configurations are Level III modules in which path lengths are generally short, but surface areas large to accommodate thermal management.

Multilayer boards

Various microminiaturized forms of fabricated and discrete wiring are evolving. Presently preferred in large systems is the multilayer board (MLB), an advanced form of printed circuit. It is made of laminated layers which carry lead-bonding pads or posts, signal wiring, voltage and ground

planes, and often conductive cooling materials. One edge is usually reserved for connector pins. Typically under a square foot in area and a few cubic inches in volume, such boards can carry hundreds of monolithic integrated circuits in flatpacks.

Many fabrication and layer-to-layer connection techniques are used; the common problems are costly and time-consuming design, long fabrication cycle, high cost of manufacturing setup, and difficulty in modifying wiring design. Two general styles of multilayer printed circuit boards have emerged in computer applications:

- All or most of the layers are unique in design. The best-known examples are the MLB's used by the Autonetics division of North American Aviation, Inc., in the Minuteman missile guidance and other computers. They provide very high circuit density.

- Partially prefabricated boards are used in the Sylvania MSP-24 and several other new military and commercial computers. Density of interconnections is slightly lower, but the boards are more economical and can be made more quickly. The board previously described is of this type (see p. 73); internal layers are standardized and modifications to suit the need are made on the two exposed surfaces.

Multilayer designs

Many ways of making MLB's have been developed in the last 5 to 10 years; the objective is a higher interconnection density than the conventional printed circuit affords.

The major technical barrier to wider use of MLB's is the difficulty of fabricating electrical communications between layers. The three primary means are: plating through holes in the laminate, or filling the holes with solid pins or solder; sequentially forming the connections as the board layers are fabricated; and combinations of these methods.

These, and other methods of fabricating con-

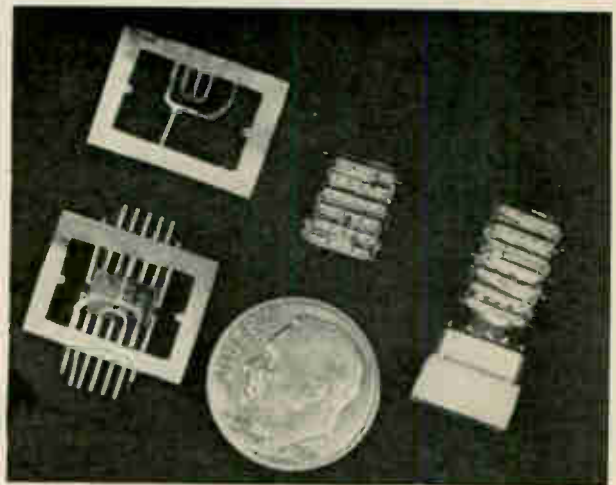
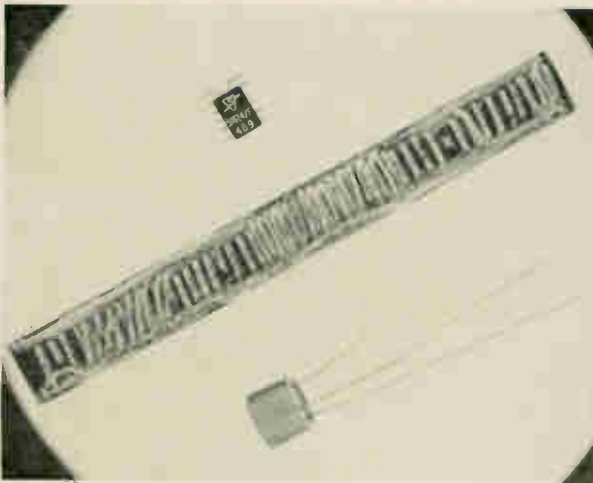

Stacked-flatpack assemblies for spacecraft. At left is a 40-circuit assembly made by Sylvania Electronic Systems, contrasted with single integrated-circuit packages (TO can, bottom, and flatpack). Normally, 12 flatpacks are stacked in a sealed can, as shown at right.

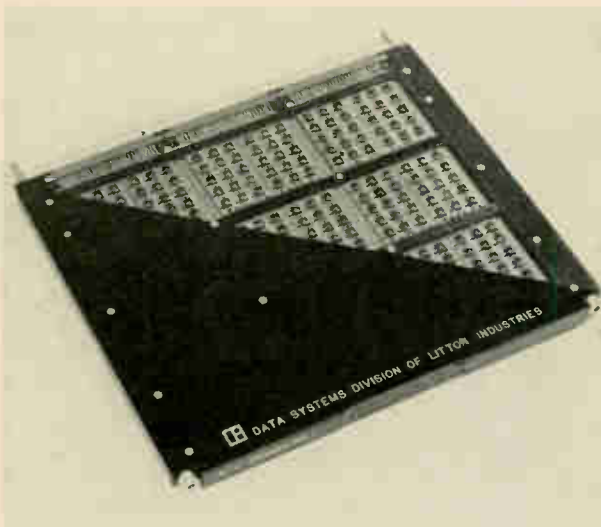

Cutaway view of drawer-type assembly in the new L-304 computer developed by Litton Industries, Inc. There are nine multilayer daughter boards on each side of a multilayer motherboard and conduction cooling assembly.

nections, will be further discussed in a portion of this report to be published shortly.

The special requirements that high speed places on Level I and II wiring have been noted, and also will be further discussed. Very fast switching circuits can induce voltages in the ground or voltage lines. Simultaneous switching of a number of circuits can create a cumulative effect that will overcome noise margins and undesirably switch other circuits.

To avoid this effect, it is desirable to use non-inductive planes for ground and voltage distribution and to provide distributed capacitance between them to filter undesired pulses. Similarly, at very high speeds it becomes mandatory that the signal paths be made as terminated transmission lines. This can be simulated in MLB's by having ground runs paralleling each side of the signal lines.

Because MLB's permit such design, while also supplying heat transfer paths and very high density of interconnections, they are used in one form or another in virtually every large microelectronic system.

Planar packaging

Flatpacks can be mounted on one or both sides of an interconnection plane. The efficiency is measured by the number of circuits per square inch. Planes are ideal for conductive cooling, since the flatpacks can be mounted on heat transfer plates bonded to the plane's surfaces. Also, the flatpack leads are exposed for testing and circuit replacement.

Large planar plates are subject to damage by high-frequency vibration, since such plates normally resonate at low frequencies.

Two-side mounting uses the area more efficiently. Normally, it doesn't raise the height of an MLB

assembly, because the edge connector is usually thicker than the MLB plus the flatpacks. Examples are the MLB assemblies of the Sylvania MSP-24 and the D26B and D37C computers made by the Autonetics division of North American Aviation, Inc. All have continuous ground and voltage planes to minimize the induced voltages which result from the reactive action of rapid-switching circuits. The D26B board is highly efficient; each flatpack takes 0.106 square inch of mounting area. The higher density is achieved by staggering the flatpacks and interlacing the leads on 0.025-inch (25-mil) centers.

One-sided mounting of circuits or of plug-in Level I assemblies has become popular in commercial computers. Assembly is easier and the second side can be used on MLB's for discrete wiring, thereby easing board design and production problems.

A number of connector manufacturers are offering IC mounting and interconnection structures. An unusual one-sided approach is the ITT Cannon-International Telephone & Telegraph Corp.'s 1 1/4-inch-square prefabricated connector boards. Up to 12 flatpacks are welded to nickel posts on one side and a flexible two-sided printed circuit is welded to the other ends of the posts to interconnect them.⁷

The Sippican Corp. has developed a way of interconnecting mounting posts that are molded into a plastic sheet. The post-to-post interconnection is made by heat-strippable magnet wire that is welded to the posts. The weld energy first strips the insulation, then makes the weld. With this method, the wire does not have to terminate at the post, but can connect any number of posts.

Volumetric packaging

High volumetric efficiencies, minimum weight and more rigidity is offered by 3-D packages. Up to 60% of the assembly volume can be occupied by the flatpacks and their leads. There are a great many ingenious techniques being used. Often, the packages are merely stacked vertically and some form of riser wires or ribbons are used to interconnect the lead ends, after which the assembly is potted. These are very compact, but difficult to make. Some of the more unusual approaches, each aimed at simplifying assembly as well as packaging efficiency, are:

- Accordion-folded circuits, used in the Burroughs Corp.'s D-84 computer. Up to 12 MIC's in flatpacks are welded to a flexible printed-circuit strip (see photo on p. 77). Then, copper-foil tabs are placed on the flatpacks for grounding and heat sinking. This assembly is folded, inserted into a comb-shaped header with 28 pins, and potted. It is plugged or soldered into a motherboard printed circuit.

- Cordwood type used in the General Electric Co.'s A-212 aerospace computer (see photos on p. 82). The core is an extruded aluminum channel that provides stiffness and heat transfer. A connector fits lengthwise inside the channel and is bonded to two printed-circuit strips. Nine MIC



Monolithic and hybrid circuits are generally employed in the memories of new, small aerospace computers. At left, the memory of Honeywell, Inc.'s H-387 computer is being assembled. At right, a portion of the logic system is being put together. Multilayer boards are used to interconnect the logic circuits.

The packaging designer: an integrated engineer

Integrated circuits are creating a revolution in the electronics industry. Their applications have already fanned out from military avionics and space systems into military ground equipment and they are rapidly being adopted by manufacturers of industrial and commercial electronics equipment.

The effects of this revolution will be greater than the changes brought about by the switch from vacuum tubes to transistors. Sweeping changes in the manner of designing, developing, manufacturing and using electronic equipment are starting to become apparent.

A new class of engineer is needed for the microelectronic era. More than ever, he must keep up with technological advances. Electrical engineers must know the characteristics of the new building-block circuits and how to interconnect them as a system. The mechanical—or packaging—engineer must know the physics and chemistry as well as the mechanics of mounting, interconnecting and cooling integrated circuits.

Circuit-design engineers, as we know them now, will virtually dis-

appear. Most circuit designers will be working for integrated-circuit manufacturers or on limited-quantity, special circuits for systems manufacturers. Systems design will be primarily the logical integration of available integrated circuits.

In many cases, the use and arrangement of the building blocks will be the easiest design job. Design of the interconnection and packaging and their manufacture will be more difficult.

The packaging engineer must adapt himself to radically new ways of developing, designing and building systems. Technical requirements are higher for integrated circuit packaging than for conventional assemblies. Microelectronic packaging requires creative use of mechanics, thermodynamics, chemistry, metallurgy, electrochemistry and physics. It also demands the ability to work with and understand the needs of other types of engineers. There must be cooperation, to an unprecedented degree, among the logicians who conceive the overall system operation, the electronic engineers who select and develop the circuitry and design the

subsystems, the packaging engineers, and the manufacturing and process engineers.

The packaging engineer should know how and when to use precision spotwelding, resistance soldering, vacuum deposition and other techniques which have become important to the construction of microelectronics systems. Similarly, the manufacturing personnel must adapt themselves to these techniques. The amount of standard assembly hardware—cabling, terminal boards and connectors—diminishes drastically and often most of the microelectronics system is assembled with the aid of a microscope.

Integrated circuits are also upsetting and traditional relationships between the parts supplier and the systems manufacturer. Relatively few of the components of a microelectronics system are discrete. Therefore, parts manufacturers are entering the circuit market and eyeing the systems market, since circuits are the major parts of systems—and the systems manufacturers are looking at the circuit manufacturing business.—J.J.S.

Integrated-circuit packaging systems

System or technique	Application	Level I capacity MIC packages	Level I size (inches)	Level I total connection leads	Level I assembly method	MIC-to-interconn. joining method	Level I intra-connection method	Level I to Level II connection method	Level I modules in Level II
Autonetics D37C * computer	Minuteman II missile (Air Force)	196	4.12 × 5.5	160	planar 2-sided mounting	lap solder	multilayer (8 layers) sequential or plated through	connector	23 (total system)
Sylvania MSP-24 computer	ground military (adaptable to air/missile)	178	7 $\frac{1}{2}$ × 5 $\frac{1}{2}$	200	planar 2-sided mounting	lap solder	dual assy of two	connector	40 (7,120 MIC's)
Burroughs D-84 computer	general military	12	1 × 5 (folded into $\frac{1}{2}$ cu. in.)	28	volumetric (accordian fold) or planar	solder or weld	2-sided flexible etched circuit	connector or solder	48 (466 MIC's)
General Electric A-200 computers	aerospace	18	approx. $\frac{1}{2}$ × $\frac{1}{2}$ × $3\frac{1}{2}$	31	volumetric cordwood	solder	two 2-sided etched circuits	connector	13 (234 MIC's)
ITT micro-component boards	broad military and commercial	12	1 $\frac{1}{4}$ × 1 $\frac{1}{4}$	20	planar 1-sided mounting	dual-gap weld	2-sided etched ckt. plus nickel pads and risers	connector	variable 10 shown
Hamilton-Standard microcircuit module **	Army-sponsored	10 wafers	0.390 square —0.4 to 0.8 high	20	volumetric vertical stack	wafer beam welded to riser wires	36 riser wires	connector	
Sperry Gyroscope Loran-C	airborne navigation	5		70	carrier for integrated circuits	friction-clamp contact	none	friction-clamp contact	20 (100 MIC's)
Navy's proposed functional blocks	all Navy	2 film circuits or up to 20 MIC's	2 $\frac{3}{8}$ × 2 $\frac{3}{8}$ × 0.3	40	2 ceramic & film wafers	solder	conductive films on ceramic	connector	variable
Honeywell H-200 Series computers†	commercial computer line	50	5 × 6	80		flow or dip solder	multi-layer (4 layer)		
Computer Control Co. modules	commercial plug-in modules and systems	22	2.9 × 2.7 × .24	34	1 or 2-sided mounting	resistance solder (reflow)	etched wiring, 2-sided or multilayer	connector (etched tabs on card)	24 to 144
IBM system 360 computers	commercial computer line	6 to 24 ceramic circuit packages	multiples of 1.5 × 1.625	24	planar 1-sided	machine soldered	2-sided etched wiring	plug connector	up to 66
Univac 1824 computer#	airborne & space	256	2.8 × 4.4 × 0.7	480	volumetric	solder	multilayer (9 layers) soldered into connector	flexible printed cable	4 plus memory & power supply (1,024 MIC's)
Litton L-300 & L-3000 computers	aerospace	30	1.9 × 2.5 × 0.1	72	planar 1-sided	noble metal alloy diffusion bonding	multilayer post type, (6 layers)	noble metal alloy diffusion bonding	18 (540 MIC's)
Honeywell H-387 computer	airborne digital computer	160 on each of 2 boards bonded back to back	6 × 12 × 0.2 (assumed)	420 (dual board)	planar 2-sided	parallel-gap welded	two multi-layer boards soldered-wire feed-throughs	flexible lead 38-conductor segments	6 for central processor, (2,160 MIC's)
RCA Spectra-70 computers	commercial computer line	16	4 × 5	variable 32 to 48	planar inserted leads	flow solder	2-sided etched circuits	connector etched tabs on boards	up to 130

* Autonetics' D26C general-purpose military computers are similar in Level I construction, but boards are generally larger, have 320 pins and can mount over 500 MIC's.

** Sponsored by U.S. Naval Avionics Facility at Indianapolis and Navy Bureau of Weapons

Univac's new 1830 airborne computers have a planar Level I with 24 soldered MIC's and 49 leads on a 3 $\frac{1}{2}$ -inch square double circuit board.

† Honeywell is believed to be developing Level I assemblies that are 4 × 5" two-sided, etched circuits with 48 leads, carrying 16 MIC's mounted by flow soldering.

Level II size or leads	Level II Intra-connection method	Heat transfer method	Reference
21×10×6 (366 leads)	multilayer	conductive	3
17×8×7	point-to-point wiring	forced air	4
160 leads	2-sided etched circuit on gnd. & heat transfer plate	conductive	5
approx. 5×7×1 160 leads	multilayer	conductive	6
	2-sided etched circuit		7
		conductive in Level I	8
	Plug-in printed-circuit cards	conductive direct to aluminum strip	various
	point-to-point wire, wrapped and welded joints	conductive at Level I to air stream	9
approx. 24×24×6	point-to-point wiring plus printed-circuit boards		Honeywell
variable 6×12¼×5¼ & 17×12½×5¼	point-to-point wiring, wrapped taper pins	forced air	μ-Pack manual
mounting card 8¾×12½	multilayer wiring (4 layers) plus point-to-point wiring	forced air	various
variable with memory 360 to 808 cu. in.	flat flexible printed cable	conductive	Univac brochures
7.2×8.1×0.5 524 leads	poke-home crimp type pin & socket connector point-to-point wire	conductive to external heat exchanger	Litton
5×7.6×19 45 leads	multilayer master interconnect	conductive to cold plate or forced air	Wescon Session 2, 1965
approx. 17×17×5	multilayer (6) plus point-to-point wiring		RCA

flatpacks are bonded to each side of the channel. Their leads are inserted into the boards and joined to the etched wire by solder. An unusual feature of this assembly is that the core serves as the assembly fixture and individual flatpacks can be replaced—a rarity in volumetric assemblies.

▪ Stack assembly, presently used in a satellite motor drive by Sylvania (see photos on p. 83). Two new interconnection developments make this very dense, all-welded assembly more practical than previous stacks.

First, each MIC flatpack's leads are intraconnected in advance by an etched nickel foil bonded to the top of the flatpack and welded to the leads. This greatly reduces the number of external interconnections needed.

Second, the leads don't have to be twisted 90°; this procedure, normal when straight riser wires are used, puts heavy stress on the flatpack seals. Instead, a continuous ladder of nickel ribbon encloses each lead where a connection is needed. The Kovar lead is sandwiched between two nickel ribbons and the sandwich is welded by an opposed-electrode welder. The stack is mounted on a header whose pins are welded to the nickel ribbon. The assembly can be hermetically sealed in a metal can in a controlled atmosphere, or the can can be filled with an encapsulant.

Bigger and smaller

The chart at left, based primarily on published data, sums up the packaging of many integrated circuit digital systems. It indicates two diverging packaging trends:

▪ Functional Level I modules are getting larger and larger. Once the point of nonrepeatability is reached in the functional module—around 50 MIC's—it is more efficient to make them really big.

▪ Small circuit-oriented modules are combined to form large functionally-oriented Level II modules. This compromise is aimed at winning the advantage of both approaches.

References

1. Max Bialer, A.A. Hastbacka and T.J. Matcovich, "Chips are down in new way to build large microsystems," *Electronics*, Oct. 4, 1965, p. 102.
2. Electronic Industries Association Microminiature Circuit Applications Committee, Terminology List, revised June 2, 1964.
3. "Digital Computer Aspects of Integrated Circuit Applications," Pub. T-168/33-3 Rev., Autonetics division, North American Aviation, Inc.
4. M.J. Berberian, "Packaging Design for a General Purpose Computer," Sixth International Electronic Circuit Packaging Symposium, San Francisco, 1965.
5. Brochure DSG-1-65-01, Burroughs Corp.
6. "Microminiature General Purpose Computers," General Electric Co. (brochure issued by Light Military Electronics Department).
7. John Marley, "Laminates and cribbage boards connect integrated circuits," *Electronics*, Feb. 8, 1965, p. 67.
8. D.J. Garibotti and L.R. Ullery, "Production-line packaging of solid-state circuits," *Electronics*, Sept. 7, 1964, p. 73.
9. "Standard Hardware Interface Program," U.S. Navy Data Handbook OD30353, Code Ident. 10001 April 7, 1965, U.S. Navy Avionics Facility at Indianapolis (and prior NAFI publications on production and use of modular building blocks). See also "Navy's all-purpose circuits," *Electronics*, April 5, 1965, p. 119.

This is the first part of a two-part article.

Designer's casebook

Designer's casebook is a regular feature in Electronics. Readers are invited to submit novel circuit ideas, packaging schemes, or other unusual solutions to design problems. Descriptions should be short. We'll pay \$50 for each item published.

Circuit keeps voltage constant for welder battery

By F.T. Marcellino and A.A. Dargis*

Applied Physics Laboratory, Johns Hopkins University, Silver Spring, Md.

A portable welder requires constant battery voltage to maintain output current pulses that are equal in amplitude. Usually, the batteries are charged overnight, and each morning they are discharged to the required voltage level. The circuit shown below charges the battery to maintain a constant terminal voltage at all times.

The circuit senses whether the battery voltage,

at a load current of one ampere, is above or below the required value. If the sensing voltage is too low, a one-shot timer is actuated, which causes charge to flow into the battery for a preset interval. At the end of the charging interval, the load is applied again and the battery voltage is measured. If the voltage is still low, the process is repeated. If the voltage is too high, the load remains on until the battery voltage drops to a value where the charger is actuated again. In this way, the battery voltage can be kept to within 0.1 volt.

Transformer T_1 and diodes D_1 through D_4 form a charger. Resistors R_1 and R_2 limit the amplitude of the charge current. The differential amplifier consisting of Q_6 , Q_7 and Q_8 senses the battery voltage level. R_3 is adjusted so that when the battery voltage falls below 25 volts, Q_7 collector current flows, actuating the one-shot circuit, which consists of Q_2 , Q_3 and Q_4 . When the one-shot is on, Q_4 is open and Q_5 and Q_{10} turn off Q_9 . Q_9 opens the path for the load current through R_{24} ,

*Now with the Engineering Physics Co., Rockville Md.

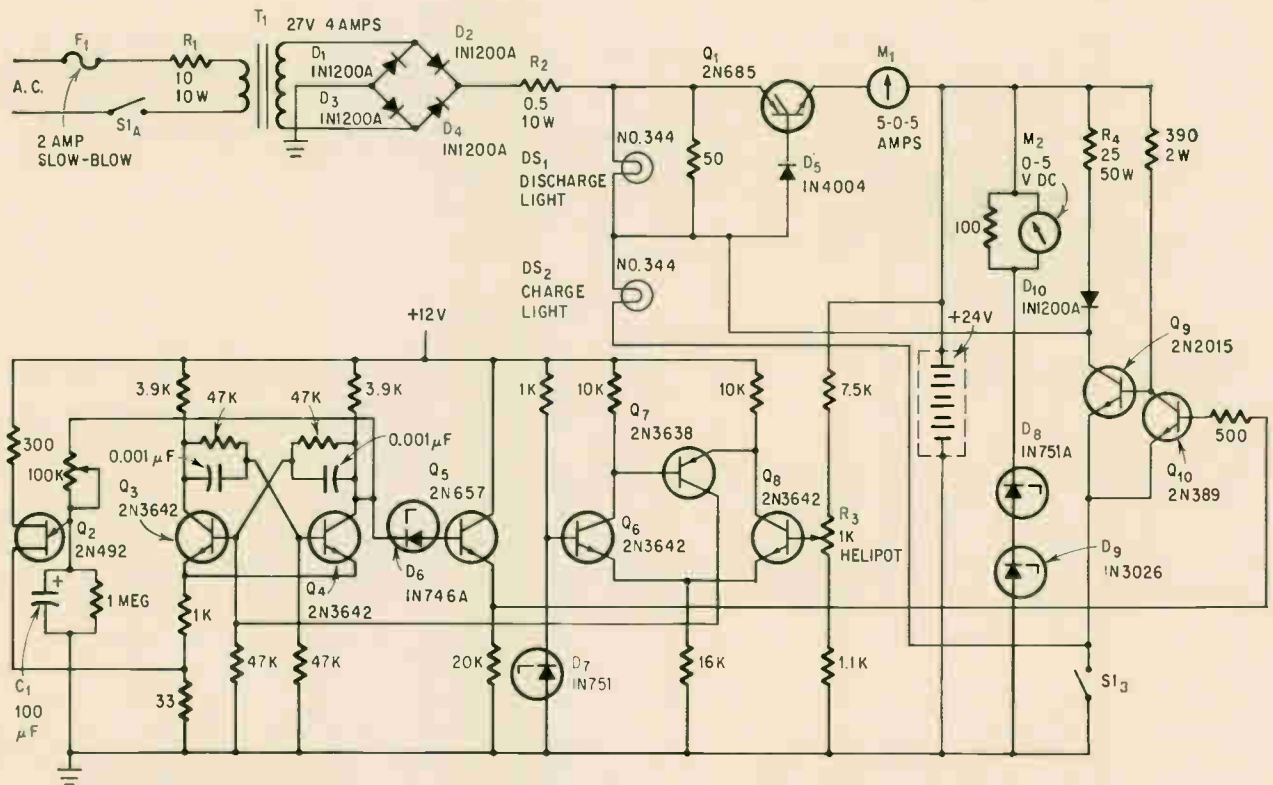

Regulator maintains constant battery voltage so that load current pulses for a welder have uniform amplitude.

and simultaneously turns on scr Q_1 , which permits charge current to flow into the battery. When the one-shot turns itself off, Q_9 conducts, permitting

load current to flow and reverse-bias the gate of the scr, thus ending the charge cycle. D_5 prevents cathode-to-gate breakdown of the scr.

Electronic capacitor is continuously variable

By David L. Bergman

Pacific Missile Range, Point Mugu, Calif.

It is possible to build a two-terminal electronic circuit with the characteristics of a capacitor whose capacitance may be adjusted to a desired value. This electronic capacitor, shown in the circuit diagram below, provides values from 0.1 to 100 microfarads, continuously variable in three ranges. Maximum voltage rating is +10 volts; it is essentially a polarized capacitor. Frequency range is from d-c to 45 cycles per second, but the upper limit can be extended to about 10 kilocycles under certain conditions. Leakage current of the electronic capacitor compares favorably with that of good tantalum capacitors. The d-c resistance between terminals is about 2.5 megohms.

When a capacitor C_1 is placed across an amplifier from output to input, the effective capacitance C_{eff} seen at the input terminals is increased if the amplifier's voltage gain A is negative. By varying A , C_{eff} may be varied according to the Miller effect equation: $C_{eff} = C_1(1 - A)$.

The capacitance of C_1 is effectively increased because the amplifier causes it to draw and supply a larger amount of current.

In the circuit diagram, the gain A can be adjusted at R_1 and also at R_2 , which is used to calibrate the amplifier. The amplifier has a high input impedance to minimize current leakage through the electronic capacitor. Output impedance is low so that the voltage gain will not fall off due to negative feedback through C_1 ; that is, the amplifier must be capable of supplying sufficient output current to capacitor C_1 , without the output voltage dropping because of the loading effect of C_1 .

The upper frequency is limited to 45 cps when the input signal is maximum (a sinusoid varying from 0 to +10 v) and the effective capacitance is maximum (obtained at maximum amplifier gain). Under these conditions the amplifier cannot deliver enough current to C_1 because its reactance is low. Therefore, waveform distortion results at high frequencies. For the electronic capacitor, this means that the higher the capacitance, the lower the operating frequency must be, and vice versa. But with reduced input signal amplitude and low effective capacitance, the upper frequency limit is about 10 kilocycles, being limited only by the amplifier rise and fall times of about 15 microseconds.

The negative bias at the emitter of Q_2 adapts the capacitor to input voltages of 0 to +10 volts. The circuit will also work for input signals from -5 to +5 volts if the negative bias voltage is increased to -6 volts d-c. For this case, the electronic capacitor would be analogous to a nonpolar capacitor with a 5-volt rating.

This electronic capacitor was designed for use in a waveform analyzer. It served in a low pass RC filter with an adjustable cutoff frequency.

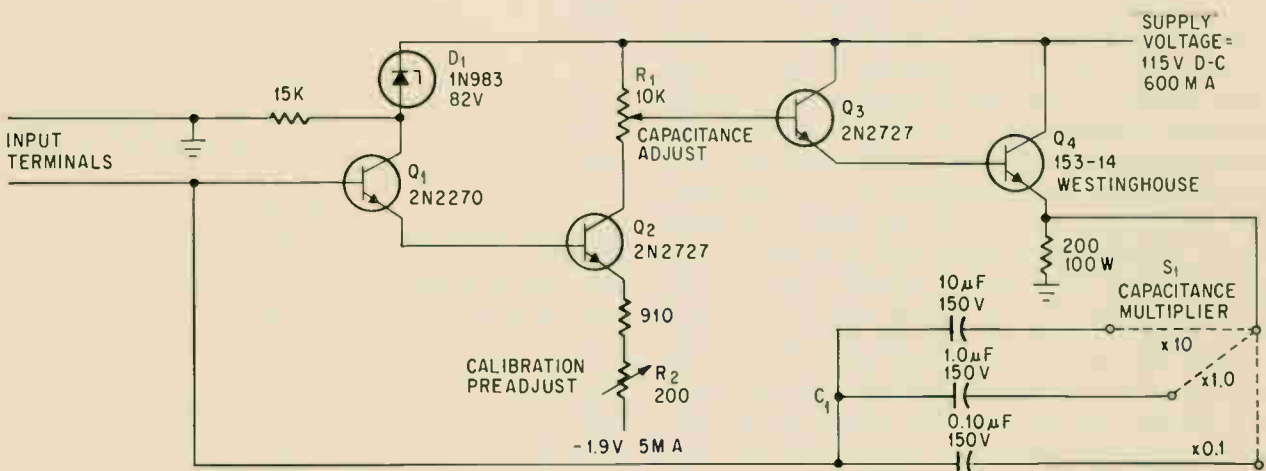

Electronic capacitor is continuously variable, within three ranges, from 0.1 to 100 microfarads.

Variable damper impedance improves tv scan linearity

By Peter Volgelgesang

Miratel Electronics, Inc. St. Paul, Minn.

The resonant horizontal deflection circuits in most television cameras and monitors produce substantial nonlinearity in the left side of the raster because the deflection-yoke current discharge into the damper diode is nonlinear. This results in a characteristic left-hand stretch of the tv image.

The discharge rate of the deflection yoke can be controlled by varying the impedance of the damper diode during the discharge interval. This is accomplished by varying the plate voltage of the damper diode with a waveform that is synchronous with yoke current. Ideal yoke-current linearity can be achieved by making the voltage waveform at the damper plate complementary to the usual yoke-current waveform.

Diode D_1 in the circuit diagram at the right, supplies a sustaining voltage to the plate of the damper tube so that its plate voltage cannot fall below the supply voltage. A winding on the horizontal coupling-transformer supplies a positive pulse to the anode of D_2 during horizontal flyback, placing a charge on capacitor C_1 , and increasing the damper plate voltage at the beginning of each horizontal scan. This increased voltage lowers the impedance of the damper and slows discharge of the yoke. The damper plate voltage decreases as C_1 discharges, thus allowing the yoke to discharge more rapidly as its current approaches zero. The discharge voltage of C_1 (and consequently the impedance of the damper tube) is very nearly complementary to a normal inductive discharge into a constant impedance, as shown by the waveshapes.

Ideal linearization of the yoke discharge current is achieved when the amplitude of the damper plate voltage is adjusted to produce the required left-hand compression, and when C_1 is adjusted to be completely discharged at the instant the yoke current reaches zero. Amplitude of the compensating waveform is adjusted by the number of turns on the coupling transformer and is approximately 150 volts peak for a typical television monitor deflection system. Such a voltage can be obtained from about 12 turns of wire on the transformer.

Diode D_2 must handle peak currents of about 6 amperes at a repetition rate of 15.75 kilocycles in a 525-line television system. A high-speed rectifier such as the 1N3883 is recommended at line rates above 525 but less expensive rectifiers, such as the 1N538, are suitable at the lower rate, if

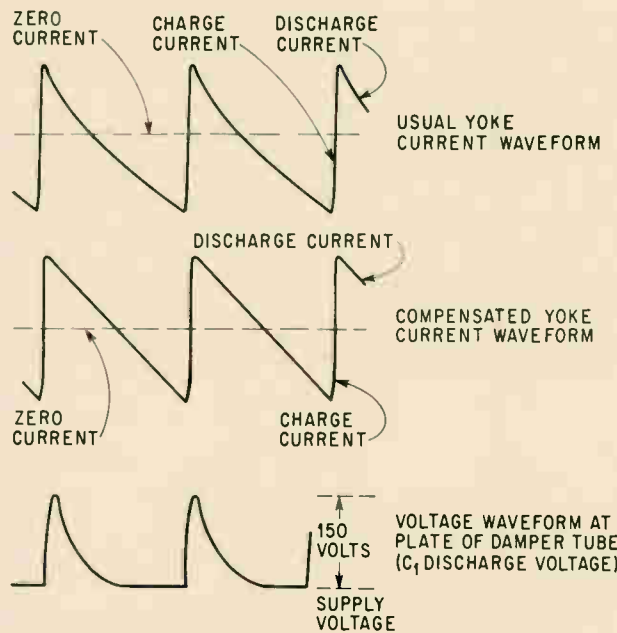
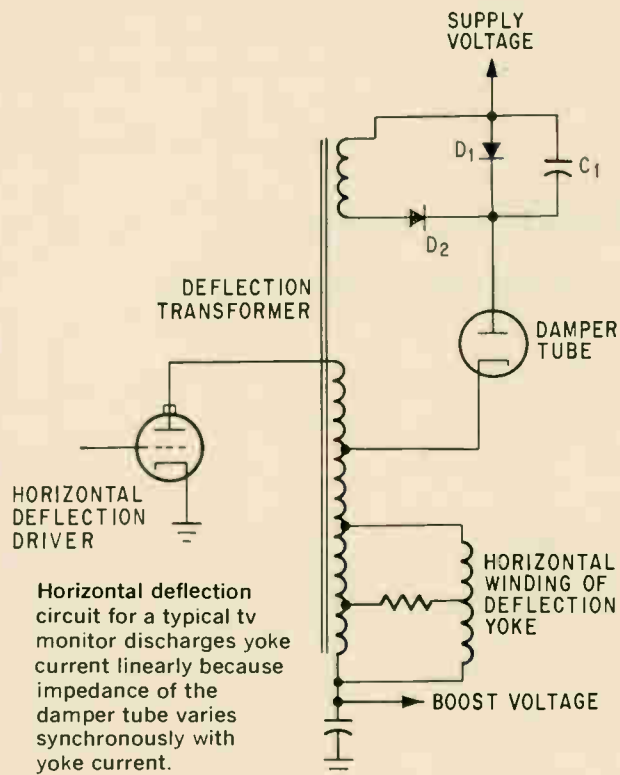

Discharge voltage of C_1 in plate circuit varies damper tube impedance. Result is linear yoke current during entire discharge interval and elimination of distortion at the left side of tv image.

they are mounted on a proper heat sink. The circuit shown was used in several different monitor deflection systems at line rates from 525 to 1,203 with equal success. The value of C_1 varied from 0.1 to 0.05 microfarad. Horizontal deflection linearity of 1% was obtained with a 90° kinescope.

More power to the laser— with Q switching

There are two ways to store laser power until it builds up to the gigawatt range. Here are the relative merits and the promise of each

By Joseph I. Masters

Technical Operations, Inc., Burlington, Mass.

Short, intense bursts of light are being produced by lasers with Q switching—a technique for inhibiting resonance until the laser has stored enough energy to deliver gigawatts of power.

The older, more conventional type of Q switching is active switching, using shutters that are made transparent at the proper instant by external means. In the past two years nonlinear, passive components have become available, which become transparent automatically, at the best moment, without any external control. The biggest advantage of passive switching is its simplicity.

The ability to produce high pulsed power, using both active and passive Q switching, opens up many applications for the laser. The military value of the laser's destructive capability is well known, but constructive uses of such power are more numerous and perhaps more interesting. These include:

- Research into nonlinear effects of coherent light in materials. One such effect is frequency scattering—the production of frequencies different from the laser frequency when a giant pulse passes through an active medium. Under proper conditions, harmonics of the laser frequency are produced. These could be used in laser parametric amplifiers. Or the laser wavelength might be shifted

from, say, red to blue, for use in oceanographic applications. Water is relatively transparent to blue laser light.

- Chemistry, metallurgy and materials studies. Changes in the structure and physical characteristics of compounds and alloys under high-intensity laser irradiation might produce new materials or electronic devices.

- Biological studies. The response of living tissue to laser pulses of high energy could lead to the prevention and cure of diseases.

- Plasma generation for spectroscopic analysis and plasma diagnostics.

- New electronic systems such as rangefinders and surveillance radar.

Principles of laser oscillation

It will be recalled that laser oscillations are amplified light waves that are partially reflected at the end mirrors of a resonator to produce standing waves. Optical gain occurs by stimulated emission. The absorption of energy from an external source or "pump" excites the atoms of the active laser material. When these excited atoms are stimulated by light photons at the laser's wavelength, they drop to a lower energy level, each atom emitting a new photon whose wavelength and direction are the same as the stimulating photon's.

Pumping enables ground-state laser atoms to make quantum transitions—energy-level jumps—to a more energetic, longer-lived (one- to five-millisecond) metastable state. The excitation level of the laser material, $\Delta N/N_0$, is the number of atoms in a given volume that are excited to this metastable state, minus the number remaining in the ground state, divided by the total number of available laser atoms. If this ratio is positive—that is, when the number of metastable atoms exceeds the num-

The author



Joseph I. Masters, senior staff physicist, joined Technical Operations, Inc., in 1951. He initiated its laser research program and pioneered in the development of passive Q switching, he has written articles on microwave-magnetic resonance and applied mathematics of heat transfer.

ber in the ground state—the active atom population is said to be inverted and the material exhibits gain; the ratio is also called the inversion level. The gain coefficient may be expressed as $a = a_0(\Delta N/N_0)$, where a_0 is the absorption coefficient of the unexcited material at the wavelength in question.

In general, laser oscillations will occur when the optical gain per light transit equals or exceeds the transmission loss per transit in the resonator. This defines the laser threshold condition:

$$r \exp [l a_0(\Delta N/N_0)] \geq 1 \quad (1a)$$

$$r = (1 - a_1)(1 - a_2) \dots (1 - a_i)$$

where l is the resonator length, r is an over-all reflectivity, $\Delta N/N_0$ is the threshold inversion level, and a_1, a_2, \dots, a_i are the fractional transmission losses per transit. Such losses are due to scattering and to reabsorption of the laser light in nonproductive transitions, and to energy loss by transmission of the output pulse through one or both of the end mirrors.

The quality factor, Q , which increases with r , is given in equation 1b, where λ is the wavelength of the laser resonance.

$$Q = 2\pi l \lambda (1 - r) \quad (1b)$$

In the absence of Q switching, the power of laser oscillations depends on how high the inversion level can be maintained above its threshold value for a given amount of transmission loss. This level, in turn, depends on two factors:

- The speed at which active atoms are excited by optical pumping to supply the needed gain for lasing.
- The ability to dissipate heat before it damages the laser rod and alters the laser's characteristics.

After the onset of lasing, the most that can be done without Q switching is to pump energy into the laser rod as fast as it can be converted into radiant energy; this increases output roughly linearly, resulting in only a modest power increase.

Therefore, to provide a continuous-wave output, it is necessary to have a continuous light source with a high power density, acting as a pump, coupled to the laser rod. The rod's temperature must be kept low so that the input energy is not dissipated as soon as it is supplied. Both criteria are met by increasing the surface to volume ratio of

the laser rod (using a small-diameter rod). By focusing the pump light to a thin beam, the laser rod absorbs a large value of pump energy per unit volume and also lends itself to cooling by heat conduction. For larger lasers, however, continuous pump sources of sufficient output are not available. Therefore, cycle-pulsed pumps, such as flashlamps, are used to give a pulsed laser output.

Q switching and energy storage

A Q switch prevents lasing momentarily by inhibiting a laser's resonance until the laser has stored up a large amount of power. Such an inhibitor can convert a 10^4 -watt pulsed crystal laser into a gigawatt-pulse generator. Power enhancement is limited only by the ability to excite the laser medium and by the destruction threshold of such components as the laser rod itself.

This rapid change in the Q , or quality factor, is achieved by inserting a suppressor into the resonant cavity in which the laser's energy is built up. Introduction of the Q switch causes optical losses, which decrease the laser medium's Q factor momentarily. When the switch cannot absorb any more light, it opens or becomes transparent, restoring the Q factor to its normal level and releasing the pent-up energy all at once. These giant pulses occur because the switching element permits the simultaneous existence of high Q and high inversion level. An ideal switch should, at the proper time in the pumping cycle, change instantaneously from low light transmission to perfect transparency.

Because of a relatively long excitation lifetime (about 10^{-3} seconds), the laser rod can be made to store energy far beyond the threshold level, provided that the de-excitation effect of lasing is suppressed or temporarily held off during the pumping phase. In an amplifier laser rod, oscillation delay and energy storage are achieved simply by removing end reflection. The Q is thereby reduced to its zero-feedback value, $2\pi l/\lambda$, as in the case of an open waveguide, and lasing is precluded in accordance with equations 1a and 1b. There remains, however, the de-excitation effect due to the laser's ability to amplify its own spontaneous emission. If the rod has an amplification path longer than about six inches, this effect can severely limit the inversion level attained by pumping.

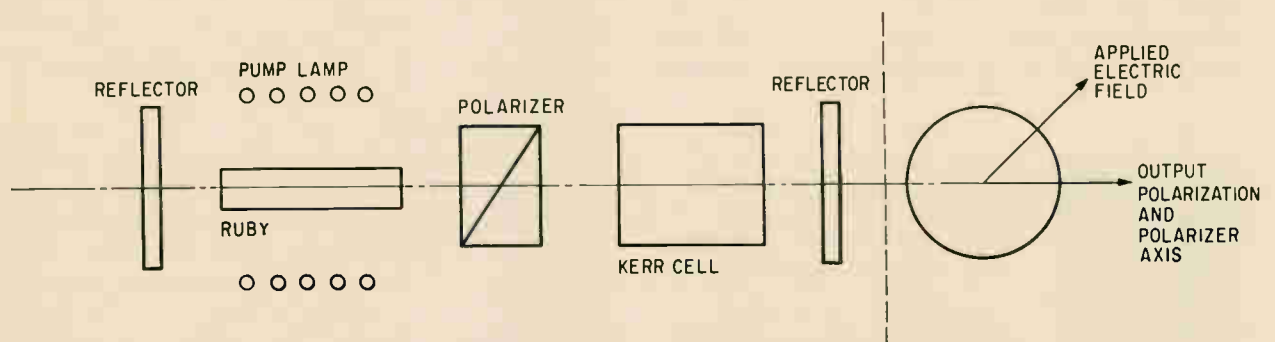

Kerr-cell Q switch goes from no transmission to almost complete transmission in less than 5 nsec. But losses in the polarizer are so high as to make this type of switch relatively inefficient.

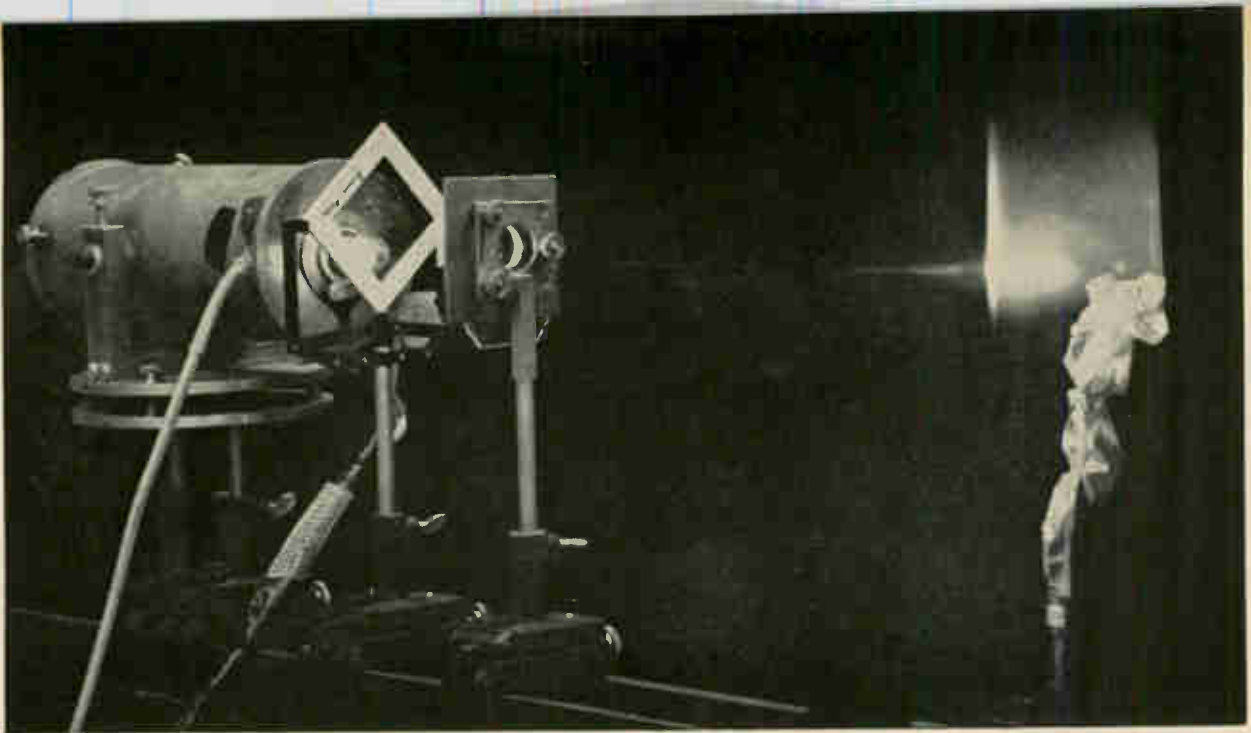

Multiple-exposure photograph shows multimewatt Q switched laser beam bursting a balloon. Thin film (passive Q switch) is clamped in diagonal position.

Active Q switches

Active Q switches are shutters that are made transparent by external means. The time for the onset of transparency must be preset or synchronized to coincide with peak excitation of the laser rod. Passive types, on the other hand, do not require external control and synchronization. Transparency of the passive element occurs when the laser has been pumped to an unusually high threshold excitation level, which depends on the presence of the lossy element in the resonator. Therefore a proper match of pump energy and Q-switch absorption will result in threshold occurring at the time of peak excitation. Thus, the passive system is inherently self-synchronizing.

The principal active Q-switch systems are the Kerr cell and the spinning prism.

For a Kerr cell, the shutter consists of two parallel capacitor plates in a fluid medium that exhibits the electro-optical polarization phenomenon known as the Kerr effect. When an electrical field is applied to such a medium, the plane of polarization of the light passing through it is rotated. Usually the medium is nitrobenzene.

When the electric field is zero, light travels through the medium at a constant speed that is independent of the radiation's vector properties. When an electric field is applied to the medium, however, a plane wave propagated normal to the field, and polarized so that its electric vector is parallel to the field, has a velocity different from that of a similar wave of the opposite plane polarization. Usually, the light entering the cell has been polarized so that its electric vector forms a 45° angle with the field.

Upon entering the Kerr-cell medium, the two components of the light's electric vector have the same time phase. Because of the Kerr effect, however, the phase of one of these components con-

tinuously lags behind the other's as the light travels through the cell. As a result, the light's polarization follows this sequence: elliptical, circular, elliptical, and finally—when the phase lag becomes π radians—plane polarized, or perpendicular to its entrance orientation. If the Kerr cell's optical path is terminated at this point, and is followed by a polarizer oriented perpendicular to the entrance polarization of the light, the shutter system—except for residual losses—will be transparent. The Kerr-cell shutter system will remain opaque, however, when the field is zero, because the polarized light will be unaltered by the Kerr cell, and the pulse cannot be transmitted under these conditions.

For lasers, a Kerr cell and a polarizer are generally required (see diagram on opposite page). Because of reflecting end mirrors, polarized light passes through the cell twice. Manufacturers adjust cell parameters for low transmission (45° rotation per pass) with the field on, and high transmission (no rotation) when the cell is discharged.

Switching of a Kerr cell in a laser is fast—less than five nanoseconds—but residual losses in the polarizer (usually a Wollaston prism) can be as high as 40% per transit of the beam. Furthermore, passage of the giant pulse through the nitrobenzene medium produces a stimulated emission effect—a loss, because an appreciable fraction of the laser radiation is converted into light at new frequencies, which cannot be amplified in the laser medium. Therefore, the Kerr cell-polarizer is a relatively inefficient Q switch.

Another active Q switch is the spinning prism, a simple arrangement in which one fixed-end reflector of the laser resonator is replaced by a roof prism that has total internal reflection. This prism's reflectivity varies when the prism rotates about an axis perpendicular to its roof. The resonator's Q is impaired by misalignment, and is restored when

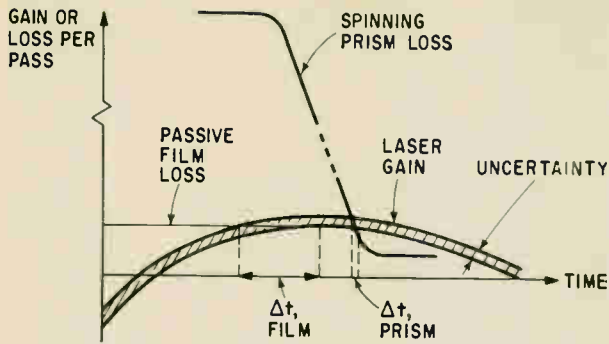

Gain or loss per pass of light energy through resonator. The uncertainty of the gain curve gives rise to greater uncertainty in the time for the onset of the pulse in the case of passive Q switching.

Laser's peak power vs. absorption of thin-film passive switch for 2-in. by 0.25-in. ruby rod. Laser's excitation level affects speed of a passive element, but not of an active one, making the passive type less efficient at low inversion levels.

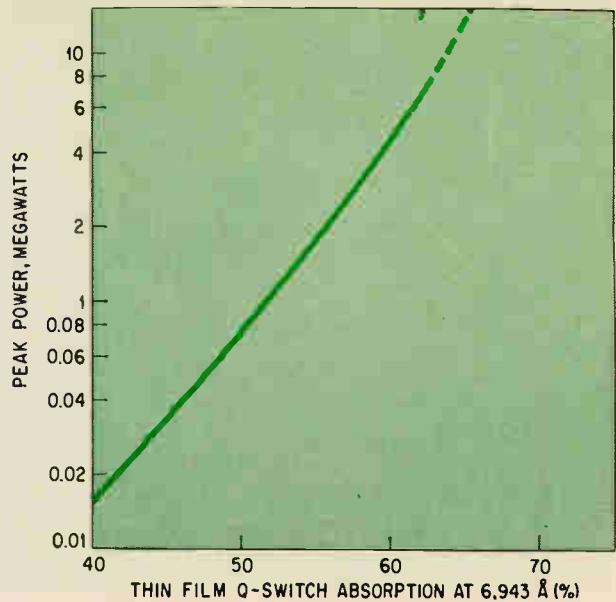

the prism roof is perpendicular to the laser's optical axis. When the pump pulse is initiated at the proper time, peak laser excitation and prism alignment occur simultaneously; this allows the stored energy to be discharged at its maximum value.

Passive Q switches

Nonlinear, passive components have three major potential roles in laser technology: in Q switching, pulse shaping, and isolating sections of a laser during pumping to decrease self-amplification of spontaneous emission. The following discussion is based primarily on ruby-laser passive Q-switching data.

Ideally, a passive Q switch is an optically flat, fractional absorber with parallel sides. It may be placed anywhere within the resonator [see photo on p. 93].

The resonator loss resulting from the known absorption of the passive element significantly raises the pump-energy threshold for lasing to a value equivalent to a high inversion level. When this threshold is exceeded, initial lasing saturates the passive element to transparency, producing the desired Q-switch conditions for generating a giant pulse. These conditions are a high inversion level and a large value of resonator Q. For passive Q-switch operation, therefore, a passive element should be chosen whose value of low-power light absorption raises the laser's pump threshold to a value slightly below the desired operating pump energy.

At present, only chromium-doped ruby and neodymium-doped glass lasers can attain the high levels of excitation necessary for production of Q-switched giant pulses. Although gas and liquid lasers contain roughly the same number of active laser molecules as a solid laser, competing processes—such as scattering and absorption losses, also pumping limitations—prevent the excitation of enough molecules to generate a giant pulse by Q

switching. It seems unlikely that such effects will be overcome soon.

There are many types of passive Q-switch materials; these can be categorized roughly according to their probable saturation mechanisms, even though in many cases these are not completely understood.

The materials include thin organic dye films, colored filter glasses (Jena glasses), organic solutions and doped glass. The organic solutions and doped glass, unlike dye films, undergo reversible switching.

Passive techniques for switching neodymium lasers are currently under study at Technical Operations, Inc., and elsewhere. Until recently, the neodymium-doped glass laser was switched entirely by active techniques. The search for a passive element is difficult because few materials emit in the near-infrared. Recently, pentacarbocyanine dyes have shown promise. Neodymium-glass laser rods also offer the possibility of being doped with a suitable passive Q-switching molecule.

The nonlinearity associated with passive Q switching is basically a saturable absorption process—one in which the absorption of laser energy of sufficient power level causes the absorption coefficient of the passive element to decrease and to approach a limiting value that may be nearly zero. This broad definition applies to a variety of partially transparent nonlinear media that are bleached by strong light: it does not require that the saturation process be reversible. The phrase "reversible process" refers to those interactions that are chemically and physically restored to their original state after saturation.

Passive vs. active switching

Each type of Q switching has advantages. Active and passive switching can be compared with respect to timing of the giant pulse, efficiency, and differences in operation.

Any uncertainty in the laser's gain curve has a

Peak power energy and width of giant pulse

Q-switch type	In 20-cm. resonator	In 45-cm. resonator
Diphenyl- α -naphthyl methane thin film (50% absorption)	17 Mw, 10 nsec*	8 Mw, 20 nsec
Cryptocyanine cell (50% absorption), 1-mm. thickness	10 Mw, 10 nsec 0.13 joules	2 Mw, 25 nsec 0.06 joules
Cryptocyanine cell (50% absorption), 5-mm. thickness	10 Mw, 10 nsec 0.12 joules	1 Mw, 30 nsec 0.05 joules

* Output mirror damage

greater effect on the time of passive Q switching than on active switching. Because passive Q switching is a threshold phenomenon, it is most efficient when the flat maximum of the laser's gain curve barely exceeds the passive element loss. This relationship is shown in the graph at the top left of the opposite page.

The switching characteristics of a passive element vary with the degree of laser excitation. However, the laser's excitation level does not affect the switching speed of active Q-switch systems.

Switching efficiency of passive systems depends on the number of available laser photons per passive molecule per second. In all Q switching, generation of giant pulses is slow for low inversion levels; therefore the photon rate for effective passive switching is reduced. As a result, passive Q switching is characteristically less efficient than active switching at low laser-inversion levels (see graph at top right of opposite page).

At higher inversion levels, however, the performance of passive switching is competitive with, if not superior to, that of active techniques. The exact transition point is difficult to fix because of the general lack of quantitative data and because of the potential for improvement in passive Q-switching technology. At present, on the basis of absorption properties of Q switches at low power levels, it is estimated that a passive Q switch with an absorption value greater than 45% will allow giant pulses of peak power comparable to, or exceeding, the pulses obtained with an active Q switch in the same laser system.

Although passive-element switching speed increases at higher inversion levels, complete transparency of the element during giant pulse generation is seldom attained, because of possible nonlinear effects. Two important effects have recently been observed at high power levels: the desirable effect of mode selection, in which spectral purity of the giant pulse is greater than that obtained in lasers that are not passively switched,

and the detrimental effects of frequency scattering.

Measurements of giant pulses have been made, using a fast photodiode-oscilloscope combination and a calorimeter. Scattering effects due to the passive element were purposely enhanced by increasing the length of the optical path in the laser resonator, as given in the table at the left. It is evident that an increase in resonator length produces a noticeable reduction in peak power for all the passive Q-switch elements listed. Because of scattering in the passive element, this reduction is large for a cell five millimeters thick, significantly smaller for a thinner cell of the same absorption, and smaller yet for thin-film samples.

The larger pulses obtained with films are probably due in part to a smaller loss from scattering than is encountered in the liquid cell; other causes are the fundamental differences in the saturation process, which affect system switching speed.

Passive Q switching is simpler in operation and offers a more convenient way to generate giant pulses in ruby lasers over a large operating range. Its basic shortcomings are slower switching at low levels of laser excitation because of reduced photon flux per passive molecule, and an uncertainty in the timing of the giant pulse.

The future of Q switching

Major advances are more likely to be made in passive than in active Q switching because the former is a relatively new technology.

Advances are probable in the development of new stable molecules for Q-switching ruby and other high-energy lasers wherein fewer passive molecules will be required for suppressing laser action. This is a task for the dye chemist, whose research should also improve the efficiency of passive Q switching for powers below the megawatt range. (Efficiencies of Q-switched lasers are, at present, only about 0.1% to 0.2%.)

Another goal is to increase efficiency by reducing the large power losses that prevent the switch from becoming completely transparent. A valuable way to investigate this phenomenon is high-speed, time-resolved spectroscopy, which allows observation of the absorption properties of a passive switch while it is in operation. But because the switching time is only about one nanosecond, we can expect the problem to be difficult.

Bibliography

- F.J. McClung and R.W. Hellwarth, "Characteristics of Giant Optical Pulsations from Ruby," *Proceedings of the IEEE*, vol. 51, no. 1, January 1963, pp. 46-53.
- J.I. Masters, "Ruby Laser De-Excitation Losses," *Nature*, vol. 202, no. 4937, June 1964, pp. 1090-1092.
- J.I. Masters and E.M.E. Murray, "Comparison of Passive Q-Switch Components and Observation of Scattering Effects," *Journal of Applied Physics*, vol. 35, no. 1, January 1965, p. 76.
- "Saturable Filter Investigation," Lear Siegler, Inc., Laser Systems Center Semiannual Technical Report to Office of Naval Research on Contract No. Nonr 4125(00) (19 February 1964).
- B.H. Soffer, "Giant Pulse Laser Operation by a Passive, Reversibly Bleachable Absorber," *Journal of Applied Physics*, vol. 35, no. 8, August 1964, p. 2551.
- G. Bret and F. Gires, "Giant-Pulse Laser and Light Amplifier Using Variable Transmission Coefficient Glasses as Light Switches," *Applied Physics Letters*, vol. 4, no. 10, May 1964, pp. 175-176.

Transmitters towed through air test antenna's radiation pattern

Signals transmitted by airborne equipment are measured at the antenna to obtain accurate measurements at high and very-high frequencies

By Cecil Barnes Jr.

Stanford Research Institute, Menlo Park, Calif.

In theory, the radiation pattern of extremely large antennas can be calculated. In practice however, it is not always possible because the pattern is affected by local topography, conductivity of the soil, and by reflections from other antennas, power lines, or metal structures in the area. Because of all these factors, methods of checking are needed to determine whether existing antennas meet directional requirements. One cannot complacently assume that the calculated values will give the correct radiation pattern of an antenna constructed in the field.

Modeling techniques are impractical because the conductivity of the antenna cannot be scaled and the ground constants are often unknown. The only sure way to determine the pattern of a large antenna is by direct measurement.

Towing the transmitter

One way of getting direct measurements is to fly around the antenna as a signal is transmitted from the aircraft and to record the reception of the signal by the antenna. A plot of the voltage measured at the antenna terminals as a function of aircraft position will give the radiation pattern. The airborne technique covers angles above the horizon, and is considerably faster and more accurate than either walking or riding around an

antenna while it is transmitting, and measuring the pattern with a field-strength meter.

Simple as the measurement from an airplane sounds, many complications arise. One, in particular, is that at high frequencies (3 to 30 Mc) some part of the airframe may be resonant and introduce an error in the results by reradiating additional signals. For this reason, when testing high-frequency antennas from the air, it is necessary to place the transmitter in an aerodynamically stable housing and tow it at a distance that makes reradiation negligible.

The latest transmitter designed for towing by aircraft is called the Xeledop, an acronym for transmitting elementary dipole with optional polarity. Eight transmitters in the Xeledop can broadcast at eight different frequencies. These frequencies are selected to cover the antenna's complete bandwidth. One Xeledop can be used to test several antennas simultaneously. To measure the polarization characteristics of the receiving antenna, the Xeledop can be easily oriented in either a horizontal or vertical position.

The Xeledop system is an improvement over the pioneering techniques previously used [*Electronics*, Nov., 1955, pp. 134-136]. The advent of transistors has eliminated tube filaments and consequent battery drain, allowing operation of several transmitters over many hours. When oriented vertically, the Xeledop remains vertical regardless of air speed. Today, the pilot has a constant-distance indicator to assist him in maintaining a constant radius around the antenna being tested. And data processing is speeded with the aid of computer techniques.

Xeledop design

Two different Xeledops are used for high and very-high frequencies. The h-f Xeledop is a glass

The author



Associated with Stanford Research Institute since 1950, Cecil Barnes has been most recently at work in their Communications Laboratory where he has been instrumental in the development of new techniques for measuring the radiation patterns of high-frequency antennas.

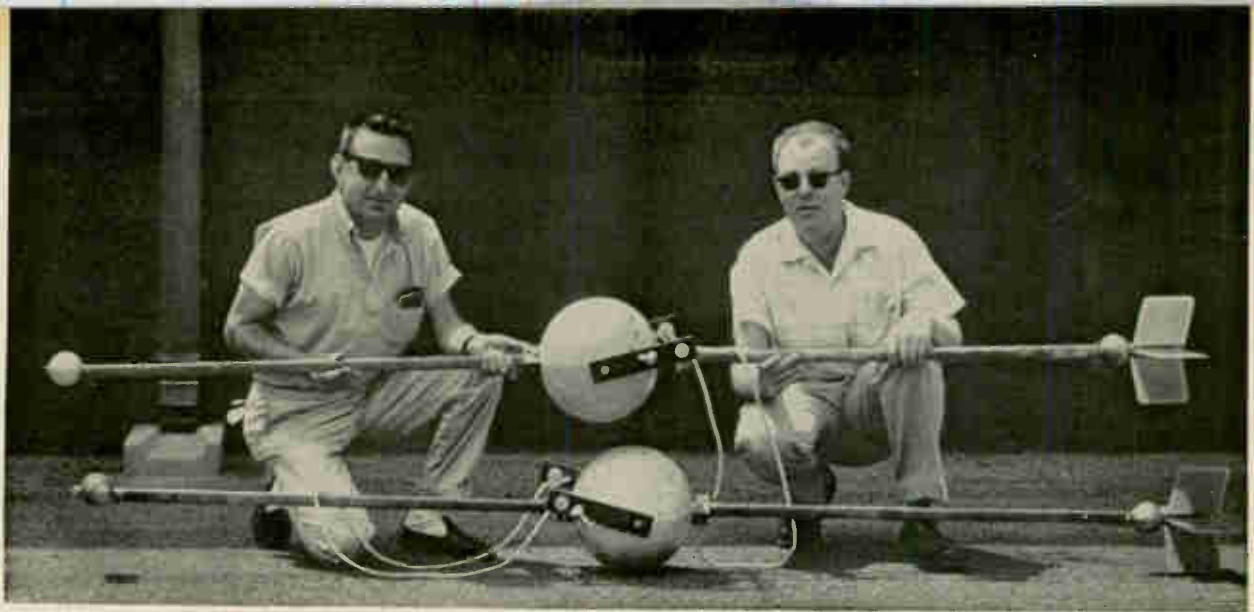

High-frequency Xeledop, equipped with fins for horizontal polarization, assembled and ready to be loaded on plane. Second Xeledop is kept in plane as spare. Only one unit can be flown at a time.

Glass fiber fins on one radiator and an iron counterweight on the other keep the Xeledop horizontal when towed, as shown in the top diagram. For vertical polarization, the fins and counterweight are removed and a lead weight is substituted for one of the hollow balls. The bottom diagram shows how the drag cone is deployed to aid in keeping the Xeledop vertical as it is towed.

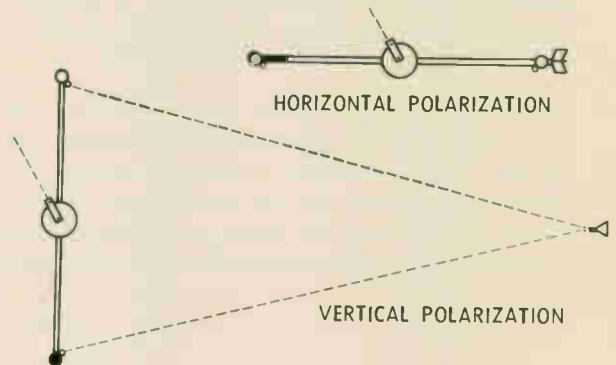

fiber sphere approximately 11 inches in diameter, from which extend two streamlined 44-inch radiators. Each radiator terminates in a 3-inch-diameter hollow metal ball. The h-f Xeledop is normally towed 300 feet behind a fixed-wing aircraft, traveling at speeds between 100 and 170 miles per hour, on a single $\frac{3}{8}$ -inch-diameter line of braided nylon with a breaking strength of 1,000 pounds. The line is attached to the Xeledop with a Dacron bridle and a nonconducting phenolic handle pivoting on an axle extending through the center of the sphere.

To make the Xeledop assume a fore-and-aft horizontal position and thus radiate horizontally polarized signals, glass fiber fins are attached to the end of one radiator and counterbalanced by a small weight inside the other.

To achieve vertical polarization, the fins and forward counterweight are removed and a 5½-pound lead ball is substituted for one of the hollow balls. A drag cone is added to prevent pitching. In this way, the center of pressure (from the slip stream) lies on the axle; the center of gravity lies below it.

The third direction of polarization is horizontal with the dipole axis at right angles to the line of flight. For this, a helicopter is used, flying at slow speed with two separate tow ropes attached from the ends of the Xeledop dipole to two support points on the helicopter; in this case the drag cone is used to prevent yawing.

The length-to-width ratio of the radiators, the diameter of the small top-loading balls, and the

shape of the main housing (spherical) are chosen so that the assembly will function electrically and at the same time be aerodynamically stable whether vertical or horizontal. The batteries and other components inside the sphere are placed so their center of gravity is at the center of the sphere. Flight tests with an airplane have shown that the Xeledop is stable in the first two configurations between 40 and 250 mph; it is not stable below 40 mph, and it has not been tested above 250 mph. The changes required to switch from one polarization to the other do not detune the antenna system or affect the radiated power because no conducting parts are affected.

The vhf Xeledop is similar to the h-f model except that the sphere is nine inches in diameter and the radiating elements are a half-wavelength long at the highest frequency. Glass fiber extension rods hold fins and weights, as needed, 16 inches away from radiating elements to avoid electrical interaction. When flying vertically, a lead weight is carried 16 inches below the bottom radiator and a balsa-wood ball of equal drag, is mounted 16 inches above the top radiator.

Dipole and bandwidth

The Xeledops must be designed to simulate elementary (or short) dipoles so that their radiation pattern will be known. This means that the total length of the radiators cannot exceed one-half wavelength. However, short elements have low

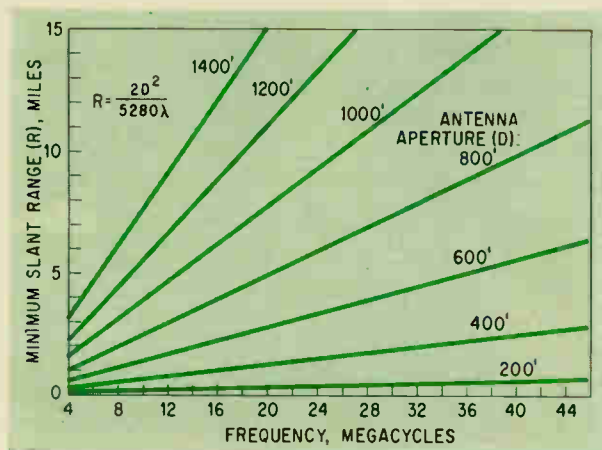

Minimum distance from the antenna to Xeledop, based on the highest Xeledop frequency to be used, is plotted for different antenna apertures, largest antenna dimension or distance between nearby reflecting objects.

radiation resistance; if the elements are too short, it becomes difficult to match the transmitter output to the dipoles without excessive losses in the matching network. On the other hand, if the elements are too long, the dipole cannot be considered "elementary," and it will not have the desired radi-

ation pattern. The dipole dimensions govern the bandwidth over which the Xeledop operates.

The configuration of the h-f Xeledop allows operation at frequencies as high as 50 Mc before the pattern is distorted. Operation at frequencies as low as 2 Mc is achieved by top loading each element with the 3-inch metal ball and by suitable choice of high-Q circuit components in the dipole matching networks. Each transmitter is matched to the dipole through a balanced ceramic-ferrite toroidal transformer using different materials for frequencies below and above 20 Mc.

The h-f Xeledop can transmit pulses sequentially on eight crystal-controlled frequencies in the 2-to-50-Mc band. The pulse width depends on the cycling rate. This is set to give the desired sampling rate for one frequency, and is governed by the detail of the pattern to be studied and the speed of the airplane, normally about half a degree of azimuth per second.

Stepping switch

An electronic stepping switch is used to key each transmitter sequentially and connect it to the dipole. The stepping switch, or keyer, consists of a free-running pulse generator which drives a 9-stage

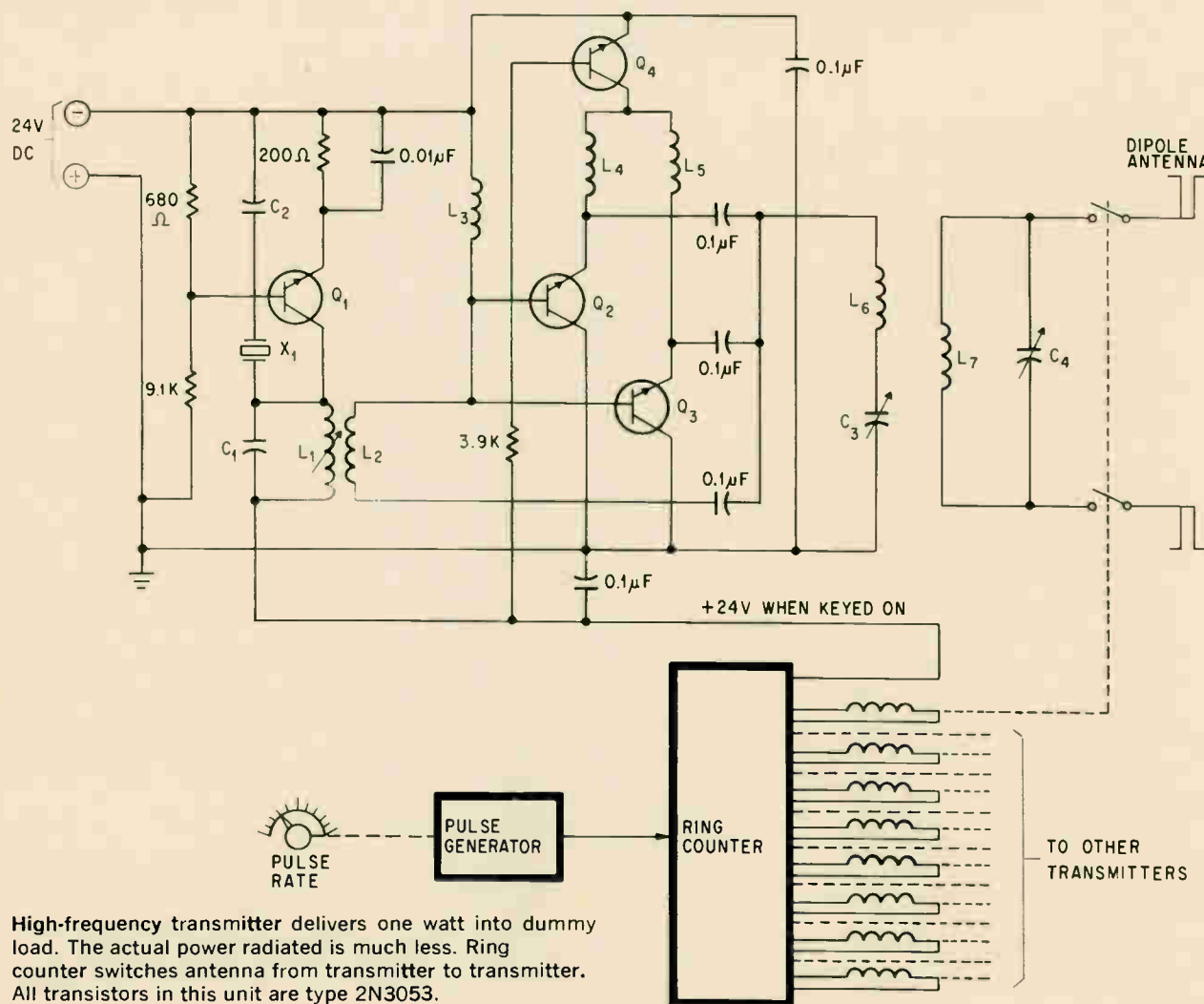

High-frequency transmitter delivers one watt into dummy load. The actual power radiated is much less. Ring counter switches antenna from transmitter to transmitter. All transistors in this unit are type 2N3053.

ring counter using silicon-controlled switches. The first ring counter stage generates a quiet pulse period for timing and other operations in an automatic recording system. Each subsequent stage drives an antenna switching relay and keying circuit for its associated transmitter unit. The frequency of the pulse generator is variable from 2.5 to 40 cycles per second; each pulse from the generator causes the ring counter to step ahead, keying a transmitter, releasing one relay, and closing the next so that one transmitter at a time is turned on and connected to the antenna. The ring counter may be adjusted to bypass one or more stages: thus the Xeledop can cycle at a steady pulse rate (5-millisecond interval between pulses) on any number of transmitters from two to eight, or it can transmit continuously on one frequency. Pulses transmitted are the same width and unmodulated.

The vhf Xeledop was designed to transmit on three frequencies. The keyer is similar to the h-f unit except a four-stage transistor ring counter is used, and the need for antenna switching relays is eliminated by a passive multicoupler.

Positioning the Xeledop

When he's ready to take the Xeledop aloft, the pilot takes along aerial photographs or topographic maps of the area with a flight-path circle drawn around the antenna. At low altitudes this circle is a guide enabling him to fly the airplane on an accurate track. At high altitudes or when flying over water or above clouds, the pilot is guided by a zero-center milliammeter mounted on the instrument panel. This meter, known as a deviation indicator, is driven by an interrogator, operating with a transponder at the antenna. The meter, similar to an instrument-landing system indicator, shows the pilot his deviation from the desired circular path and gives him right-left steering indications.

Lines on the face of the meter represent deviations of approximately one-tenth mile off the circular course. The deviation indicator is initially set with reference to the ground. When over a landmark on the flight circle at a specified altitude, the pilot sets the indicator to zero and locks the control. The pilot may deviate appreciably from the flight track without introducing serious error in the results. A 10% change in the distance between the airplane and the antennas causes less than 1 decibel change in the signal level. In any event, changes in range are allowed for in the data reduction.

Orbiting a hemisphere

To conduct the pattern measurements at elevation angles below 45°, the pilot flies over the surface of an imaginary hemisphere, keeping his radius constant during each orbit by means of the deviation indicator. He covers the surface of the hemisphere in steps, usually from 3° above the horizon to 45°, maintaining a constant altitude during each orbit plus a 30° overlap for a validity check. Seven to ten orbits are usually required to get satisfactory coverage for an antenna pattern;

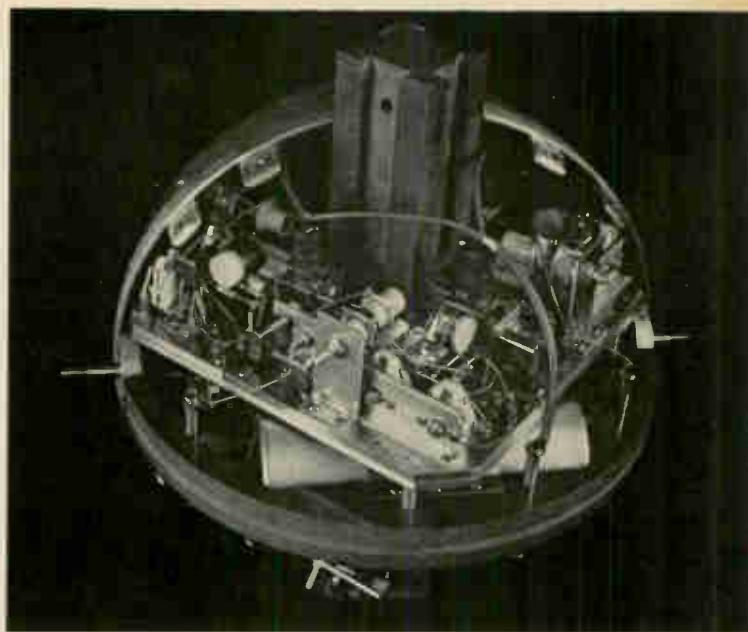

With the cover removed, three of the Xeledop's transmitters can be seen. One of the nickel-cadmium batteries is visible below the transmitters.

one orbit is chosen to take the Xeledop through the antenna's estimated main beam. Calibration of the ground equipment is repeated while the pilot is changing altitude.

The radius at which the airplane is flown depends on the frequency of the test signal and on the size of the antenna to be measured. In some cases, it is limited by the airplane's ceiling. According to a rule of thumb commonly applied to pattern measurements, the aircraft should be far enough from the antenna to satisfy the equation:

$$R = \frac{2D^2}{\lambda}$$

where R = slant range from antenna to aircraft, D = diameter of antenna aperture, λ = wavelength of highest Xeledop frequency.

The term D may represent simply the largest over-all dimension of the ground antenna including its ground plane, if any; or it may be the largest dimension of a complex installation of many antennas if reflections from other antennas and guy wires are to be considered. In most cases, a radius of 3 to 5 miles is satisfactory. The minimum slant range at which the airplane should fly for various frequencies and antenna apertures is indicated in the graph on page 98. Even so, bringing the airplane in to one-half this distance introduces an error of only a few percent in the measured antenna gain.

Circle or grid

Experience has shown that a pilot can fly a fixed-wing aircraft above a cloud layer on a constant radius of 4 to 10 miles with the deviation indicator as his only guide at angles up to 45° above the horizon. At higher angles, the indicator be-

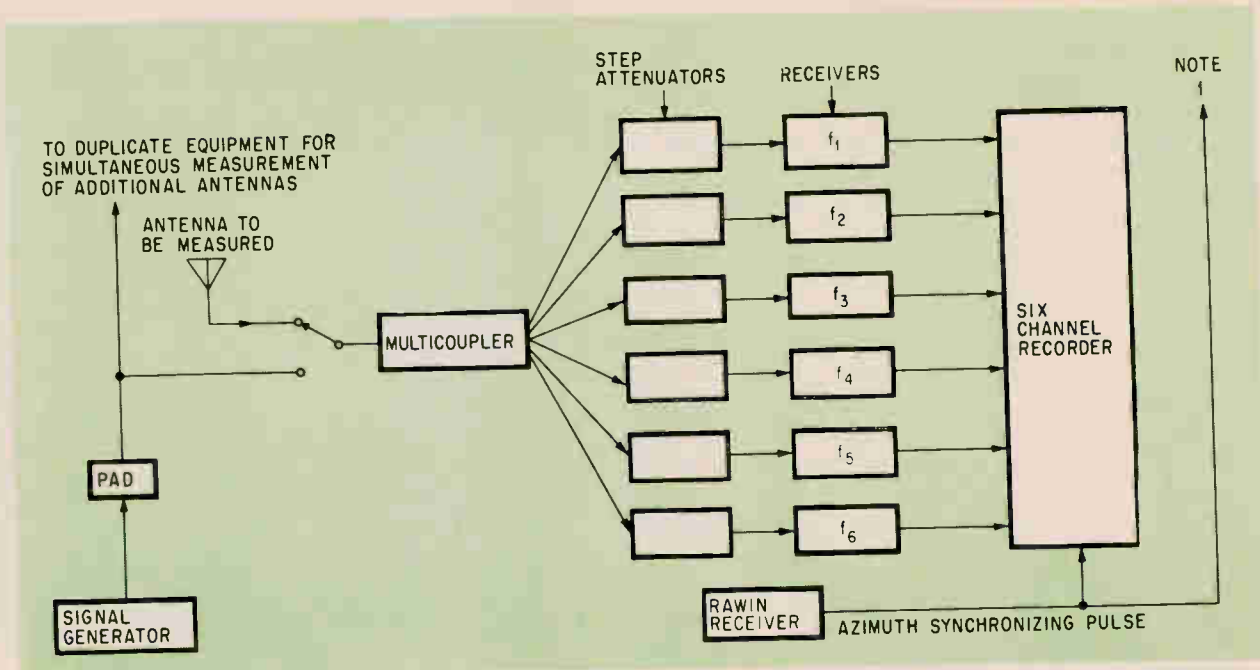

Ground equipment necessary to test one antenna at six frequencies. Adjacent antennas can be measured simultaneously. A Rawin receiver (radar used to measure wind velocity and direction) tracks the airplane, in azimuth and elevation, and supplies the pulse to the recorder for coordinating received signals with plane position.

comes difficult to follow and accuracy drops.

For elevation angles above 45° , therefore, the airplane flies a rectangular grid pattern at a constant altitude over the antenna site, with the ground equipment tracking it on each pass. To fly this pattern, the pilot must have a clear view of the ground unless some rather exotic navigational equipment is on board. If the Xeledop is horizontally polarized, the pilot reports his heading, and consequently the direction of the dipole axis, on each pass. Because of cross winds, these headings may not coincide with the grid tracks; this conflicting data is later corrected by a computer.

The azimuth and elevation of the aircraft is determined by automatic ground radio tracking equipment. The slant distance to the aircraft is calculated from the measured elevation angle above the horizon and the altitude reported by the pilot.

On circular flights, the airplane can complete about three orbits per hour depending upon radius, including climbing and descending, or three hours to complete data-taking below 45° at one polarization. A grid pattern takes six hours.

Getting the information

The recorder input signals are the automatic gain control supply voltages of the receivers. The gains are set so that 40 decibels occupy the width of one channel. Attenuators handle signal variations in excess of 40 db by adding or subtracting attenuation in 10-db steps. Analog-type recording has been used so far, with recorders designed so that the operator can continuously monitor the recorded information and immediately detect any malfunction. Since high-frequency response is not required, a multichannel paper-strip recorder is satisfactory, producing a clear, easily interpreted

record. The figure on page 101 shows a sample record of four frequencies recorded as the aircraft made an orbit around a pair of antennas. The pilot flew more than 360° in azimuth to create an overlap, thus providing one method of checking the results. Each spike on the record represents a pulse transmitted from the Xeledop. The space between pulses shows the noise level on each channel, indicating the signal-to-noise ratio; in this example, however, the noise on all the channels is below the threshold set for the test. The height of the pulses represents signal strength. The lobe structure of the antennas being tested is clearly visible. A rectangular waveform made by the marker pen along the top edge of the chart provides a synchronizing signal for comparison with the separately recorded plane position.

The first step in the data reduction process, a screening process, consists of a visual inspection of the strip charts and field notes. During this inspection, the data for further analysis is selected and the azimuth synchronizing-pulse correlation numbers are written on the charts. Next, the analog information from the strip charts is transferred to punch cards along with data relating to the antenna, frequencies used, aircraft altitude, Xeledop polarization, nominal slant range, date and test number. On each card is entered the appropriate synch-pulse number and an amplitude for each channel of interest. Readings are taken for every 5° of azimuth and at all points of maximum or minimum recordings.

The azimuth-elevation information from the ground tracking equipment is punched into a second set of cards from a record, which is printed at six-second intervals, showing azimuth angle, elevation angle, and a synch-pulse number. This com-

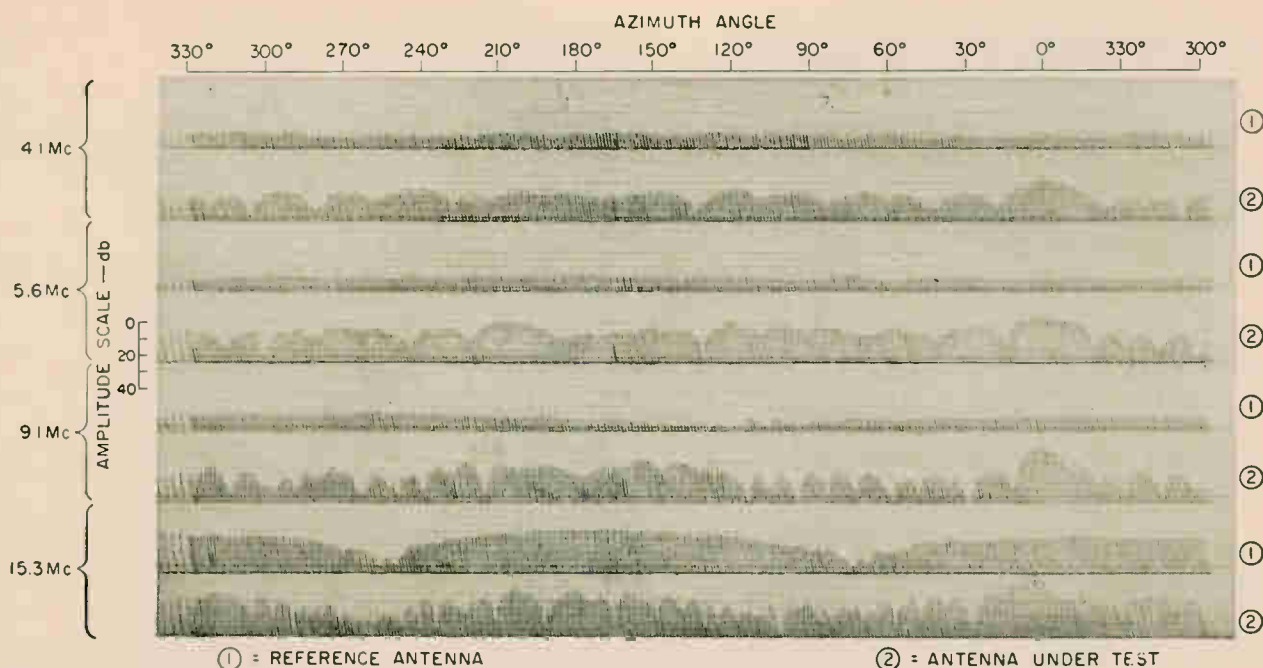

Typical chart recording of the signals received at the ground station clearly show the lobe structure at four different frequencies. Each spike on the recording represents one pulse from the Xeledop. It is clear from the plot, second from bottom, that the reference antenna had two nulls, 180° apart, at 15.3 megacycles.

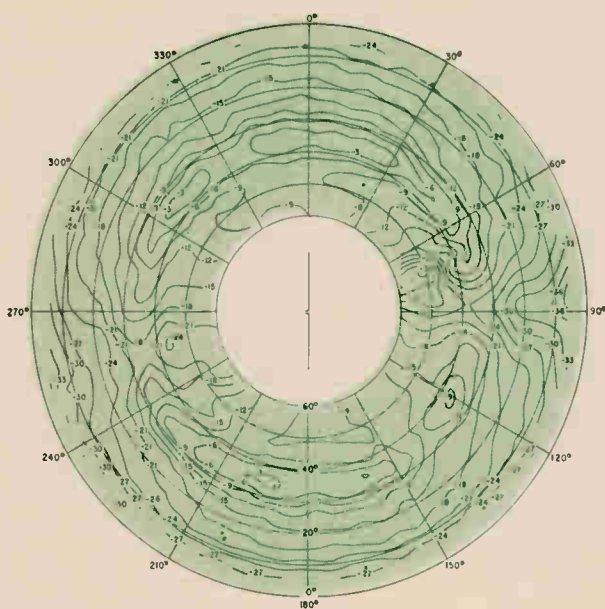

Contour lines, at 3-db intervals, are plotted by the computer from information it has received from punch cards. This pattern is of a horizontal dipole 2-feet-high and 78-feet-long. The signals were recorded at 10 Mc with the Xeledop vertically polarized.

pletes the manual processing of the data.

The two sets of punched cards are fed into a digital computer which combines the information on the input cards and incorporates corrections for the following: parallax due to the distance between the antenna and tracking equipment, change of slant range when flying a grid pattern or due to an eccentric or off-course orbit, Xeledop antenna pattern, distance of Xeledop below and behind

airplane, and a shift of azimuth zero reference from true north to the nominal direction of the main beam. In addition, the computer remembers the largest signals recorded; this information is used later to normalize all signals of one frequency to zero decibels. This information is also used to compare the gain of one antenna with another. The punched card output of this computer is fed into another computer along with a program for drawing and labeling contours

Drawing the pattern

The magnetic-tape from the second computer is fed into an automatic plotting machine which plots contour maps of the antenna patterns by drawing contour lines for 3-db intervals and writing the decibels below the maximum reading at suitable locations along the contour lines. The pen-recorder also makes several small registration marks near the edge of the paper; these are later used as guides for photographically superimposing a polar grid. In the process of computing the contour-line locations, the computer interpolates between measured values and thus is able to establish field-strength levels at locations between orbits where the airplane did not fly. It is because of this capability that the aircraft need not fly a perfect grid or a perfect orbit around every antenna.

A T-11 Beechcraft and a modified B-25 bomber have been used satisfactorily for pattern-measurement. The Xeledop is carried inside the airplane during takeoff and landing and lowered through a hatch in the floor for use. Helicopters have been used on special occasions where vertical descents or horizontal polarization at right angles to the line of flight were required.

Messages by meteor

Meteor burst communications systems transmit secure data over the horizon; excellent phase stability provides time synchronization with only 200-nanosecond error

By Victor R. Latorre

University of California, Davis

With a meteor trail and simple, inexpensive equipment, very high frequency signals can be transmitted over the horizon to a point as far distant as 1,200 miles. The technique, known as the meteor scatter mode, cannot be used to transmit real-time data because the meteor scatter mode is not a continuous medium. The meteor trails that reflect signals occur at discrete intervals of time, rather than continuously, and would not be suitable, for example, in a command data link where real-time data must be transmitted without delay.

However, for those situations where delays between data transmission can be tolerated, a meteor scatter system is far less expensive than tropospheric and ionospheric scatter systems.

One of the advantages of the meteor scatter mode is excellent phase stability, which can be applied in a time distribution system that could synchronize clocks at distant locations within about 200 nanoseconds. Such a system would be simple and yet have five times the accuracy of the best currently available time distribution system.

The meteor scatter mode depends upon signal reflection from meteor trails, a phenomenon that has been fairly well analyzed in the past few years. It is interesting that early investigators attributed the enhancement of vhf signals beyond the horizon to holes created in the ionosphere by meteor

particles, although it is now known that the trail created by the particles causes the reflections.

In this article the scattering mechanism itself is analyzed, and its important features are discussed for the system designer. The basic considerations are evaluated for a meteor burst system design and the results are presented from an experimental system that has been in operation for the past two years between Montana State University, in Bozeman, and the Boeing Co., in Seattle.

Shower and sporadic meteors

To analyze the properties of the meteor burst propagation medium, a logical starting point is the meteor particle itself, since it is responsible for the existence of the scattering surface or volume of the medium. Individual meteor particles vary in radius from about 40 microns to about 8 centimeters, and their mass varies from 10^{-7} gram to about a kilogram. The velocity of the particles varies between 11.3 and 72 kilometers per second.

Millions of meteor particles enter the earth's atmosphere each day. Normally, they are placed into two distinct categories—shower meteors, which are predictable and occasionally quite spectacular, and sporadic meteors.

Shower meteors are concentrated in streams of well-defined orbits about the sun; they travel in an ecliptic plane in much the same direction as the earth moves about the sun. But only a small percentage of the total number of meteors are shower meteors. Since the sporadic meteors occur much more frequently, they are far more important for radio communications. Both their location and frequency of occurrence seem to be random.

Meteor trails

The actual mechanism by which the trail of the meteor is formed is not well defined, but a reason-

The author



Victor R. Latorre is an assistant professor at the University of California, Davis. His current research project involves remotely measuring the temperature changes in a rat's brain.

able explanation of it can be offered. A fast-moving particle approaching the earth enters a region in which there is a relatively rapid change in atmospheric density. This region extends from about 80 to 120 kilometers above the earth's surface and is characterized by a diffusion constant that varies from about 1 to 140 square meters per second. (Diffusion constant, which is a function of the air density, describes the rate at which the electrons in the meteor trail tend to disperse.)

Above this region, a meteor trail can't form because the air is too thin; below this region, a meteor trail can't exist because the meteor is pretty much burned up due to the heavy air density. The collision between the high-velocity particle and the air molecules in this region produces ionization, heat, and light. Because the mass of the particle is quite large relative to the air molecule, the velocity of the particle remains fairly constant until it vaporizes. When the particle vaporizes it produces a thin meteor trail that can be as long as 50 kilometers and that varies in radius between 0.5 and 4.35 meters.

Some investigators say that the trail has an outer sheath, which is indicated by the presence of intense ultraviolet light. This sheath has a different electron density from that of the rest of the trail. At frequencies higher than about 50 megacycles, the sheath causes some reflection in addition to that caused by the trail itself; at lower frequencies, the sheath is essentially transparent to incident electromagnetic radiation.

Most investigators have categorized the meteor trails into four groups: underdense, underdense-distorted, overdense, and overdense-distorted trails. The first two categories are characteristic of low-density trails (less than 10^{14} electrons/meter), whose electrons act as individual in-phase scatterers, each one affecting the signal equally. The underdense and underdense-distorted trails are also distinguished from the others because signals reflected from them have a fast rise time. The difference between the underdense and underdense-distorted trails is the irregular shape of the latter, which is caused by wind shear. Because of its irregular shape, the underdense-distorted trail causes modulations during the decay interval of the reflected signals.

Overdense trails have a higher concentration of electrons (i.e., greater than 10^{14} electrons/meter). Signals reflected from these trails are characterized by a relatively slow rise time and a fairly constant amplitude. Because it's more dense, the overdense-distorted trail is broken into several distinct blobs, or segments, when wind shear is sufficient. Thus, the amplitude of a signal reflected from such a trail will fluctuate somewhat.

For the case where long signal wavelengths (low frequencies) are to be considered, the trail is assumed to be a long, thin cylinder, since the wavelength is longer than the radius of the trail, and the duration of the trail is much greater than its formation time. For short wavelengths, however, the

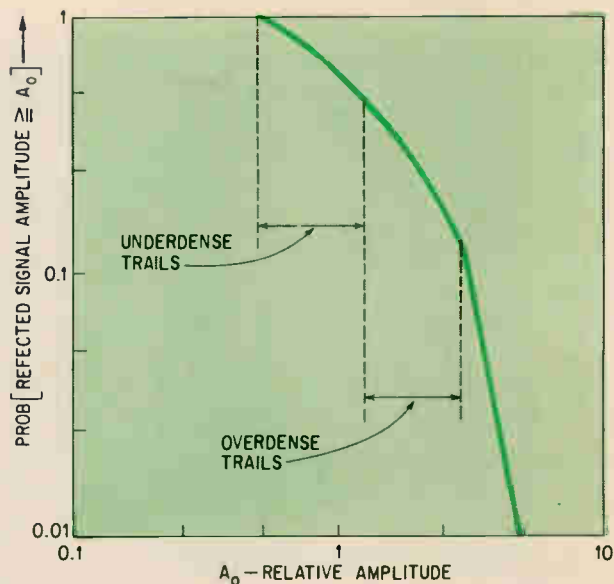

Statistical distribution of signal amplitudes reflected from meteor trails, as measured on the experimental meteor scatter link between Seattle and Bozeman, Mont. Chart is a plot of the measured probability of reflected signal amplitudes that will be greater than some arbitrary reference. Underdense bursts are characterized by that part of the distribution curve whose slope varies from 0 to -1 ; overdense bursts are characterized by slope from -1 to -4 . The curve becomes discontinuous falling off to a constant slope = -5.7 , which indicates additional ionospheric scattering, and multiple trails in the burst.

wavelength is equal to or smaller than the radius of the trail. Therefore, the trail is essentially always in a transient condition, and must be considered as having the shape of a paraboloid.

The pertinent mathematical expressions for the various burst modes will not be derived here. Instead, the physical phenomena will be explained qualitatively.

Physical considerations

Perhaps the most important point to realize is that the received power in a meteor burst system is a direct function of the wavelength raised to the n th power, where n varies between 3 and 6, depending on many factors, including frequency and the shape of the trail. Because of this, meteor scatter systems operate in the lower portions of the vhf frequency band, where the wavelengths are longer. Research is presently under way at the University of California to determine experimentally the practical upper frequency limit.

Another consideration is that reflections from the nondistorted underdense and overdense trails are specular. That is, the angle of incidence at which the signals arrive at the trail is equal to the angle of reflection. This implies that meteor scatter links are somewhat directional in nature, and therefore can provide some degree of privacy from unauthorized or unintended interception of messages.

Since the meteor burst channel is not continuous, it is necessary to describe it statistically. In general, the statistical fluctuations are divided into

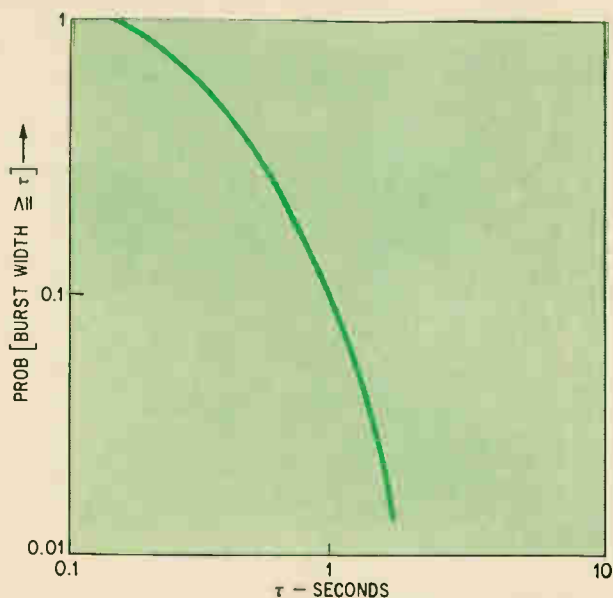

Statistical distribution of burst durations as measured on the Seattle-Bozeman link. Curve is a plot of the measured probability of meteor bursts occurring whose duration is greater than an arbitrary duration.

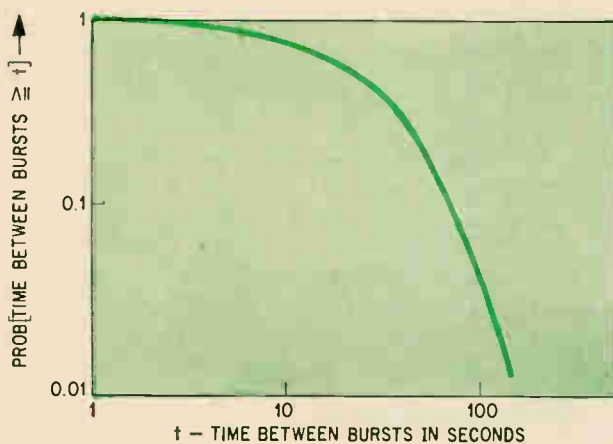

Measured statistical distribution of period between bursts.

two distinct parts—short-term and long-term variations. Representative distributions obtained last year on the meteor burst communications link between Seattle and Bozeman are shown in charts. The chart on the preceding page shows the measured statistical distribution of reflected signal amplitudes greater than any given arbitrary reflected amplitude. From this chart, it can be seen that all of the reflected signals will have an amplitude greater than approximately $0.6 A_0$, while only about 10% will be greater than about $3.0 A_0$, where A_0 is an arbitrary reference level.

The chart at the top of this page shows the measured statistical distribution of the duration of meteor bursts as a function of time. Of the burst durations measured, 100% lasted more than about 0.15 seconds, while only 2% lasted for as long as 1.5 seconds. Burst durations theoretically have a Poisson distribution, which characterizes purely random events. However, the measured curve is

slightly different from the expected distribution for short burst durations; this is due primarily to the presence of distorted overdense bursts.

The measured statistical distribution of time between bursts is shown in the other chart on this page. Here, it can be seen that the minimum time between bursts was one second, and that only about 5% of the intervals between bursts were greater than 100 seconds. Although meteor bursts occur randomly, the measured data again deviates from theory, due to distorted overdense bursts.

Signal variations

The majority of meteor burst channels operate in the vhf range of the spectrum (30 to 300 megacycles), where signals are subject to absorption in the D-layer in the same manner as signals that depend on normal ionospheric reflections. At night, this absorption is generally negligible for vhf frequencies. At about midday, however, signals in this frequency range may suffer up to 10 decibels of attenuation. And absorption increases during ionospheric disturbances, such as solar flares or auroral activity caused by magnetic storms, affecting meteor scatter signals up to 100 megacycles.

In addition to susceptibility to absorption in the ionosphere, other variations in signal can be caused by: geographical location of both the transmitter and receiver; the actual path length between the transmitter, the meteor trail and the receiver; and the antenna patterns employed. The optimum antenna pattern for the burst channel appears to be a split-beam pattern. Research is in progress, however, on self-adaptive antennas whose patterns can be varied in accordance with diurnal variations in the ionosphere.

Other types of diurnal and seasonal variations must also be considered. For example, there are diurnal variations in meteor arrival rate (the maximum occur at around sunrise and the minimum at sunset), meteor velocity, and effective radiants (position in the sky of the meteor trails); all of which affect system performance. The major seasonal variation seems to be in the meteor arrival rate. The maximum number of bursts occur in August; the minimum in February.

Typical meteor scatter system

In a meteor scatter communications network, one station is a master, or base, station and the others are slave, or remote, stations. The most obvious requirement of the typical meteor scatter system is some method to inform a slave station that a usable meteor trail is available. A slave station will remain silent until it receives an individual and distinct interrogation, or pilot tone, from the master station. When the pilot tone exceeds a preset threshold, the slave station transmits any information it may have at that time. When the pilot tone falls below the threshold, this signifies that the trail has decayed, and transmission ceases. In a system with two or more stations capable of transmitting information to each other, each station transmits a

pilot tone, which, when received by another, initiates information transmission.

There are several possible methods for alerting the system to the presence of meteors, but all have the same basic purpose—to inform other stations in the network that satisfactory communication is possible. This closed-loop feature is characteristic of all meteor scatter systems.

The preceding discussion implies the existence of another characteristic peculiar to meteor burst systems; namely, the ability to make decisions.

Meteor scatter systems are limited by the kind of information that can be transferred. In the case of data transmission, for example, only non-real-time data can be transmitted, since the channel is not continuously available. Thus, this propagation mode would be impractical for a command-control system because it sometimes takes as long as 30 minutes for a suitable meteor trail to form. Such a long delay obviously could be most disastrous for the quick-response requirements of modern military systems.

Experimental system

Although the meteor burst system between the Boeing Co. in Seattle and the Electronics Research Laboratory at Montana State University in Bozeman is experimental, a discussion of it nevertheless illustrates the techniques and the practical problems encountered with operational systems.

The Boeing-ERL meteor scatter link, which was established in the early part of 1960, spans a linear distance of some 550 miles. Most of the initial effort with this channel was devoted to determining the basic propagation path loss, the channel's duty cycle (ratio of available transmit time to dead time) as a function of time of day and as a function of receiver threshold, the cumulative burstwidth

distributions, and the channel's reciprocity conditions (offset between the master and slave stations' transmit frequencies). Subsequent tests were performed using frequency modulation and correlation detection techniques.

Phase stability and time synchronization

In 1962, a series of experiments produced statistical information concerning the phase stability of signals reflected from the meteor trails. The results of these phase stability tests were very encouraging and formed the basis for the design of an experimental instantaneous time-synchronization system between Bozeman and Seattle.

In such a system, a pulse is transmitted from one site to the other at an accurately known time according to the clock. The operator at the receiving station is informed via telephone as to the precise time the pulse will be transmitted, and he sets his clock accordingly. The error between the two clocks is only that caused by the delay time in the equipment, since the delay time due to the data-transmission path can be measured and taken into consideration when the clocks are synchronized. Even though it was rather crude, initially, the system was still capable of synchronizing clocks at the two locations within 15 microseconds.

A block diagram of the equipment used in the phase stability experiments is shown below.

At the Seattle terminal, a 46.548-megacycle signal was transmitted. When a suitable meteor trail occurred, the signal was received at Bozeman. By examining the waveform envelope of the received signal, it was possible to identify the specific propagation mechanism; that is, whether the propagation was indeed by meteor (and the specific type of meteor trail, or whether it was by sporadic-E, a phenomenon characterized by occasional lowering

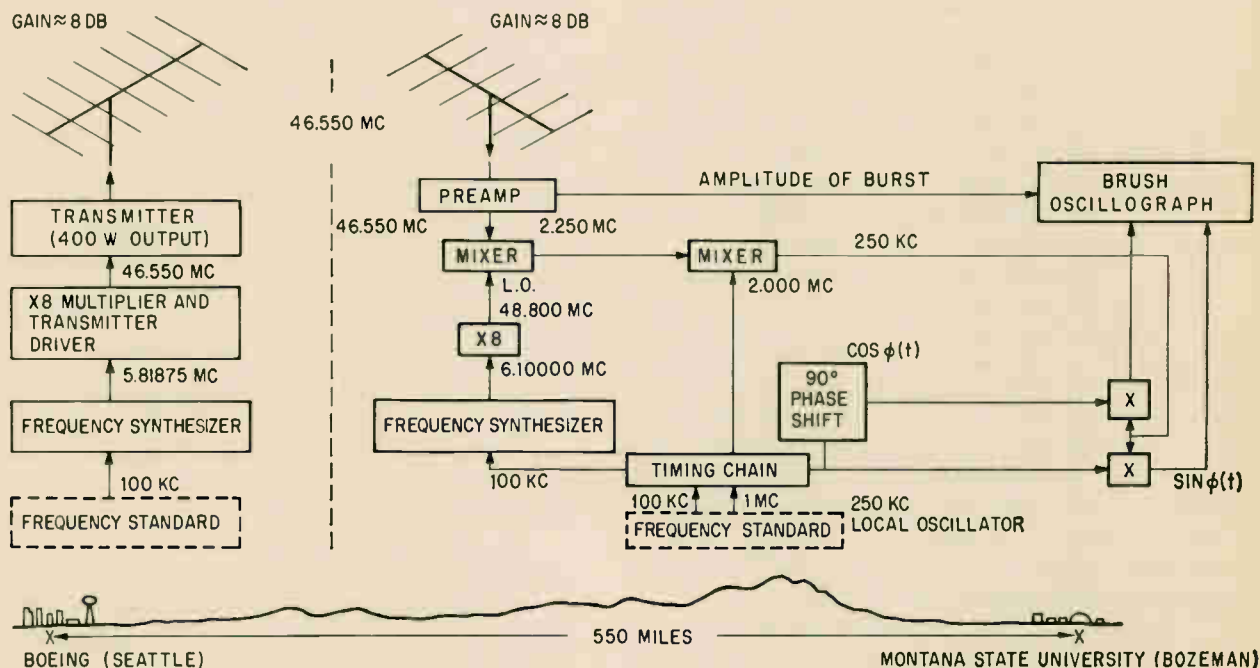

Block diagram of system used to measure phase stability of the meteor scatter channel.

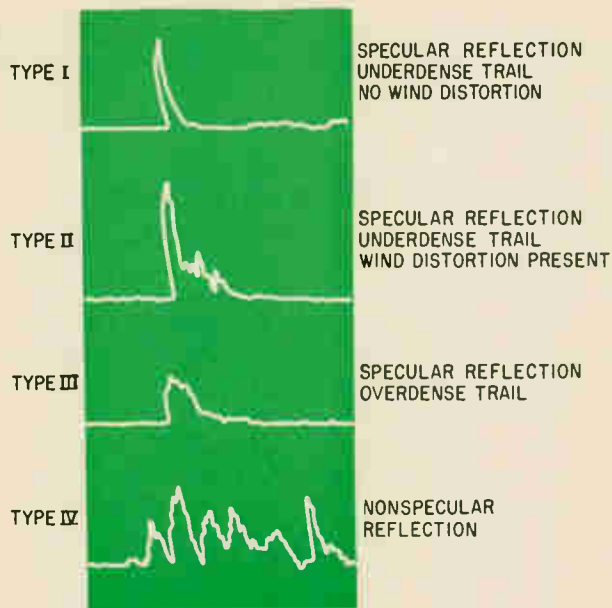

Waveform envelopes of signals received from the various types of meteor trails are shown in recordings presented at the Navy Research and Development Clinic, Bozeman, Mont., July, 1964.

of the E-layer of the ionosphere, or by other ionospheric effects. Only those signals reflected from meteor trails were used in the phase stability analysis. In addition to the envelope of the demodulated signal, the quadrature signals, $\sin \phi(t)$ and $\cos \phi(t)$, which describe the phase characteristics of the signal, were recorded on a multiple channel recorder.

The test data was analyzed on an IBM 1620 computer. From an analysis of the phase information for both the underdense and overdense trails, it was determined that phase shift in meteor burst propagation is very nearly a linear function of time, and is so small that a time distribution system using the meteor scatter mode would be capable of operating with timing errors as small as 20 nanoseconds. This becomes clear from the data for a typical trail of 300 milliseconds duration, during which the phase shift varied at a rate of 20 radians per second. This results in a total change in time delay of about 20 nanoseconds, which is the ultimate timing potential of the medium.

It is interesting to observe that the degree of expected accuracy using this mode is considerably greater than that obtained with conventional high-frequency systems, such as the National Bureau of Standards' WWV time and frequency distribution system, which transmits standard frequencies at 10 and 20 Mc, and pulses at accurately measured intervals according to the clock. But since the WWV system relies on ionospheric reflection of h-f signals, where it is difficult to precisely determine the path length, it is able to provide timing information within only a millisecond.

Meteor scatter time-synchronization systems are potentially equal to or greater than the best currently available system—the loran-C, which is

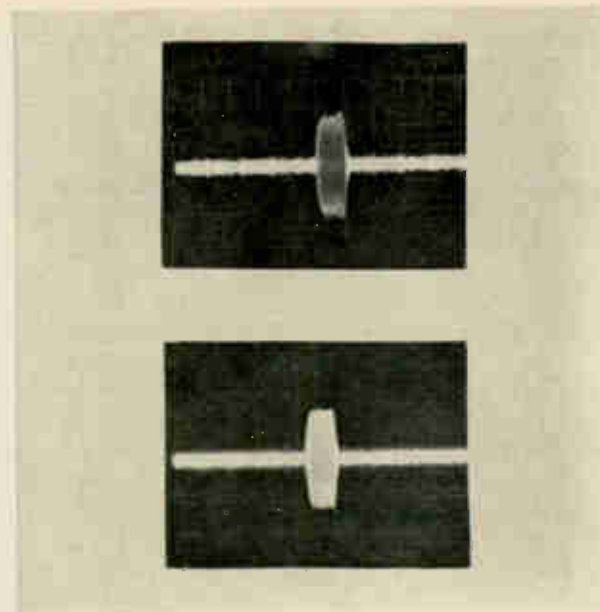

Pulses received via meteor scatter over the Bozeman-Seattle link. Top pulse was reflected by an underdense burst, and pulse at bottom by an overdense burst. Phase of received pulses indicates relatively stable path lengths.

capable of achieving time synchronization to within about a microsecond.

Correlation techniques

The application of correlation techniques to the detection of signals transmitted via the meteor scatter mode is another important tool for the communications system designer.

The results of an experiment establish that the usable duration of meteor bursts can be extended with correlation detection techniques and a delay line matched filter.

Besides effectively increasing the signal-to-noise ratio and increasing usable burst time, correlation techniques may be applied in systems that require protection from intentional jamming or from unwanted interception of messages.

Bibliography

- G.W. Pichard, "A Note on the Relation of Meteor Showers and Radio Reception," *Proc. IRE*, Vol. 19, No. 7, July, 1931.
- Von R. Eschleman, "The Mechanism of Radio Reflections for Meteoric Ionization," *Tech. Report No. 49, Electronics Research Laboratory, Stanford University, July 15, 1952.*
- D.M. Reynolds, "Antennas for Meteor-Burst Communication Systems," *Tech. Report No. 2, Electronics Research Laboratory, Montana State University, January, 1959.*
- J.D. Belenski, "Meteor Burst Communication Research Program," D2-20788, The Boeing Co., Seattle, Wash.
- J.D. Belenski, "The Application of Correlation Techniques to Meteor Burst Communications," 1962 IRE Wescon Proceedings.
- D.K. Weaver, P.C. Edwards, A.E. Bradley, and D.N. March, "Final Report, Meteor Burst Time Synchronization Experiments," ERL Tech. Report, Montana State University, August, 1963.
- George Sugar, "Radio Propagation by Reflection from Meteor Trails," *Proc. of IEEE*, Vol. 52, No. 2, pp. 116-136, February, 1964.
- V.R. Latorre and G.L. Johnson, "Time Synchronization Techniques," *IEEE International Convention Proceedings*, March, 1964.
- Hewlett-Packard Co. Application Note No. 52, "Frequency and Time Standards," Hewlett-Packard Co., Palo Alto, Calif., 1962.
- V.R. Latorre, "The Phase Stability of uhf Signals Reflected From Meteor Trails," *IEEE Transactions on Antennas and Propagation*, July, 1965.

An oscilloscope picture in 10 seconds: any longer is a waste of time.

Polaroid Land films don't make you wait to see if your trace zigged when it should have zagged.

They let you know in ten seconds.

They give you an oscilloscope picture you can study, attach to a report, send as a test record with a product shipment, or file for future reference.

You have a choice of 5 films for oscilloscope recording.

The standard film has an A.S.A.

equivalent rating of 3000. It comes in both roll film [Type 47] and pack film [Type 107]. They both give you 8 pictures $3\frac{1}{4} \times 4\frac{1}{4}$ inches. This emulsion is also available in 4 x 5 sheets [Type 57].

For extremely high-speed recording, there's Polaroid PolaScope Land film [a roll film, Type 410]. It has an A.S.A. equivalent rating of 10,000.

It can take pictures of traces too fleeting for the human eye: such as a scintillation pulse with a rise time of less than 3 nanoseconds.

One thing all these films have in common is a sharp, high-contrast image that's easy to read. Because the films are so sensitive, you can use small camera apertures and low-intensity settings.

To put these films to work on your scope, you need a camera that will take a Polaroid Land Camera Back.

Most oscilloscope camera manufacturers have one. For instance: Analab, Beattie-Coleman, BNK Associates, Fairchild, EG&G, General Atronics, Hewlett-Packard, and Tektronix.

You can get complete information by writing to Polaroid Corporation, Technical Sales Department, Cambridge, Massachusetts 02139, or by writing to one of the manufacturers mentioned above.

It will probably take a little longer than 10 seconds, but we promise the information won't be a waste of time.

"Polaroid" and "PolaScope"™

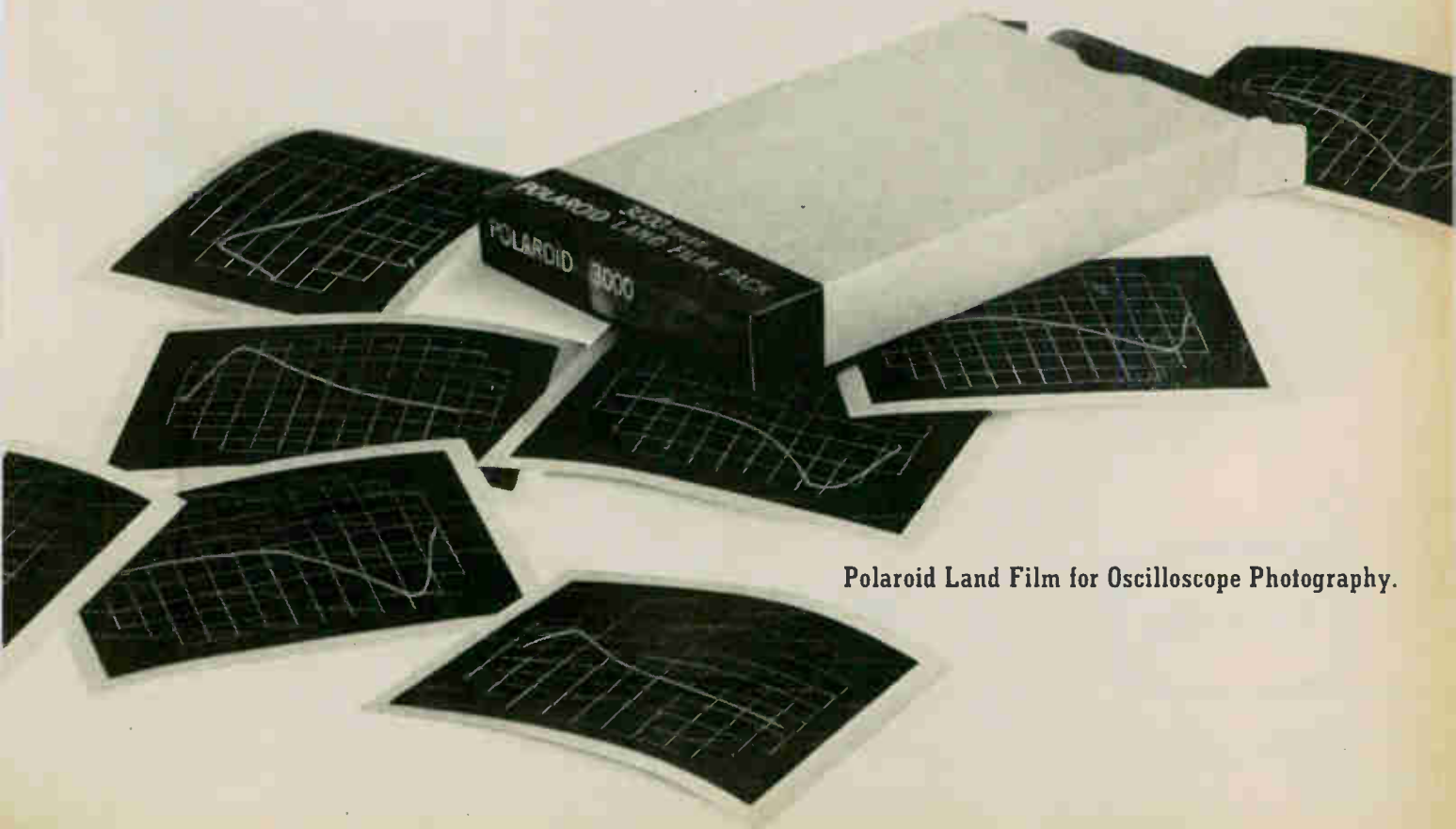

Polaroid Land Film for Oscilloscope Photography.

See your Sound and Vibration Problems Analyzed... in Seconds!

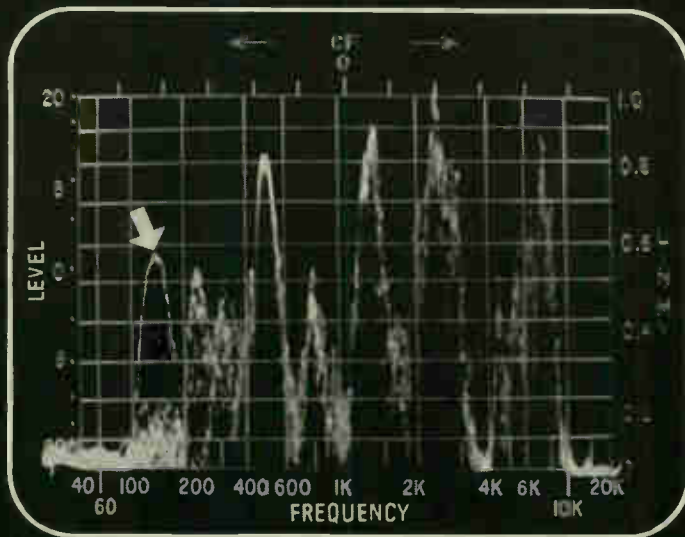

Gyro motor analysis on "quick-look" log-log scan. Note transient at 150 cps appearing during one scan of 15-scan exposure.



Harmonic contents of a complex waveform analyzed on the 12" x 4½" chart readout of the SY-1 Sonic Analysis System.

The unique Panoramic* SY-1 Sonic Spectrum Analysis System displays calibrated level vs frequency plots of vibration, sound, and other random or periodic waveforms in the 5 cps to 22.5 kc range. You obtain faster and more comprehensive analysis than by tedious point-by-point methods. The rapid SY-1 scans are preset with automatic optimum resolution for simple foolproof operation. Its highly-persistent displays on a 5" CRT provide quick-look scans showing the overall audio spectrum or any selected segment.

Excessive vibration levels, resonances and noise are pinpointed for go — no go tests or for highly selective narrow band tests using the SY-1 slower scan modes. Precise pre-calibrated 12" x 4½" readouts are traced on the built-in Model RC-3b strip chart recorder.

The SY-1 system is designed around the widely-used Panoramic LP-1az Sonic Spectrum Analyzer which provides the preset quick-lock capabilities with broadband log adjustable linear scans. The virtually drift-free local oscillator of the LP-1az makes it an ideal building block for the slower scans and 2 cps selectivity of the SY-1 system.

The C-2 Auxiliary Function Unit provides step skirted filters and smoothing for random signal analysis, manual scanning for fix-tuned measurements, sensitivity equalization and smoothing filters for random signal analysis, and other controls for added versatility. The SY-1 is not equalled by systems at three times the cost for rapid readout, distortion-free 60 db dynamic range, 2 cps resolution, and general all-round usefulness.

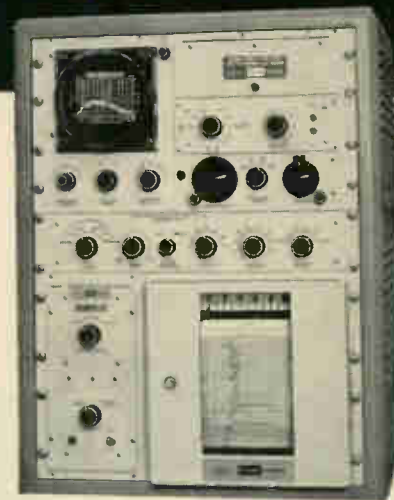

Put a quarter century of PANORAMIC SPECTRUM ANALYZER leadership experience to work for you. Write today for complete specifications and application data for the SY-1 and other SY Sonic Analyses Systems.

Applications specialists for PANORAMIC Instruments are available to assist you in solving measurement problems.



THE SINGER COMPANY METRICS DIVISION

915 PEMBROKE ST., BRIDGEPORT, CONNECTICUT
PHONE (203) 306-3201 • TWX 710-453-3483

Design and production of PANORAMIC • SENSITIVE RESEARCH • EMPIRE • GERTSCH Instruments for measurements

P-65-12

How do you measure slosh?

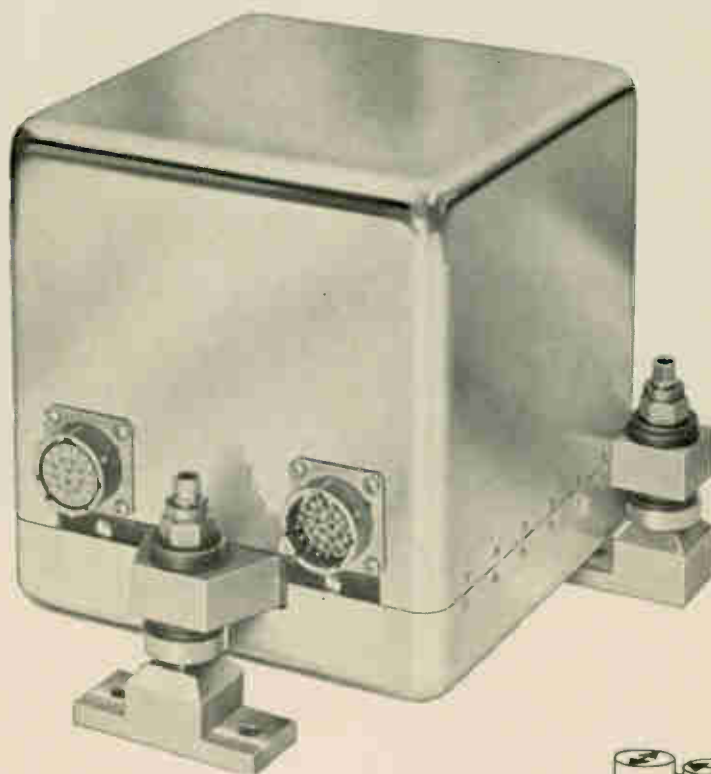

This compact 3-Axis acceleration sensing system is already doing it!! . . . measuring the tiny accelerations induced by ullage motors and fuel slosh oscillations in orbit. An accurate, versatile, proven design for missile, aircraft and space exploration applications, the unit may be mated with telemetry, computer, integrator, or auto pilot. It is temperature independent (has its own controlled temperature environment) and provides three separate channels of acceleration measurement.

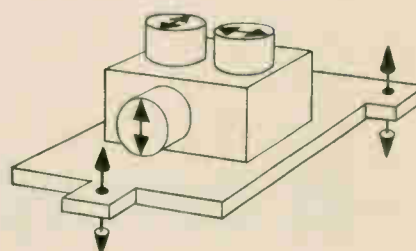

Accelerometers orthogonal within 5' of arc.
Mounting surface adjustable $\pm 2^\circ$ of arc.

SYSTEM COMPONENTS include 3-Model VII B Accelerometers, 3-Servo-Amplifiers, 1-Power Pack, 1-Mounting Block (Adjustable), 1-Heater, 1-Temperature Control and 1-Inclosure.

SPECIFICATIONS

RANGE

$\pm 5 \times 10^{-4}$ g's Full Scale to ± 150 g's Full Scale or any "g" level between these limits, individual channels may have different "g" ranges

MEETS MIL-SPECS.
**NULL STABILITY
SCALE FACTOR STABILITY
LINEARITY

Better than 5×10^{-5} g's
Better than .005%
Better than 0.01% of
input acceleration

OPERATING ENVIRONMENT
POWER REQUIRED
SIZE
WEIGHT

-80°F to +200°F
28 V.D.C.
7" x 7" x 8" (overall)
7.5#

**Regardless of History (Temperature, Shock Vibration and Storage).



POWER HOUSE

ES OFFERS COMPLETE ROTARY POWER CAPABILITY. YOU NAME IT. WE MAKE IT.

Take advantage of Electronic Specialty Co. Connecticut Division's wealth of experience in all aspects of specialty power equipment from instrument to motors to servo systems or complete precise power systems. In designing and manufacturing special purpose motors, for instance, ES/Connecticut has more than 50 years experience...since 1913.

ES can do the whole power job or any part of it; we even produce the accompanying equipment such as controls. We can design and manufacture an entire system or "tailor-make" all or part of the system to your specifications.

Call us and make us prove we can deliver. More power to you.



ELECTRONIC SPECIALTY CO./CONNECTICUT DIVISION 401 Watertown Road, Thomaston, Connecticut

Los Angeles, Calif. / Anniston, Ala. / Ft. Madison, Ia. / Harrisonburg, Va. / Hurst, Tex. / Pomona, Calif. / Portland, Ore. / Thomaston, Conn. / Toronto, Ont.



Great editorial is something he takes to a meeting

(What a climate for selling!)

Electronics magazine helps engineers make decisions. It keeps a vital audience of technical men informed on what is new, different and changing in their highly complex world.

These key men are influential in purchasing a wide range of products and services. For example: nearly 80% buy or specify electronic components; nearly 80% buy or specify electronic equipment.

More than 65,000 engineer-subscribers here and abroad depend on the great editorial of Electronics to help them do their jobs effectively. They read Electronics carefully, and pass along their copies to 119,000* additional readers.

You can sell these important customers and prospects when they are most responsive, by advertising in Electronics.

Electronics

A McGraw-Hill Market-Directed Publication
330 West 42nd Street, New York, N.Y. 10036



© 1964 McGraw-Hill, Inc. All rights reserved. Printed in the U.S.A.

Many properties

LOW
DISSIPATION
FACTOR

HIGH
DIELECTRIC
STRENGTH

LOW
DIELECTRIC
CONSTANT

ARC
RESISTANCE

HEAT
RESISTANCE

MOISTURE
RESISTANCE

many forms



Sheets

Rods and Tubes

Fabricated Parts

And 81 ways to electronic design freedom

When laminated plastics are indicated in your design Synthane gives you a real break. There are 81 grades of Synthane laminates to choose from. Each has its own balance of electrical, chemical and mechanical properties. Yet, each grade emphasizes certain specific properties. This wide choice, coupled with the variety

of Synthane shapes and sizes, frees you from material limitations, enables you to achieve optimum product performance at a satisfactory cost.

You stand to gain many additional advantages by letting us fabricate your parts as well as furnish the material. Write today for complete in-

formation about Synthane laminated plastics or fabrication, or both. Synthane Corporation 36 River Road, Oaks, Pa.

SYNTHANE
CORPORATION **S** OAKS, PENNA.

Synthane-Pacific, 518 Garfield Avenue, Glendale 4, California

Inside story of the new look in series regulators

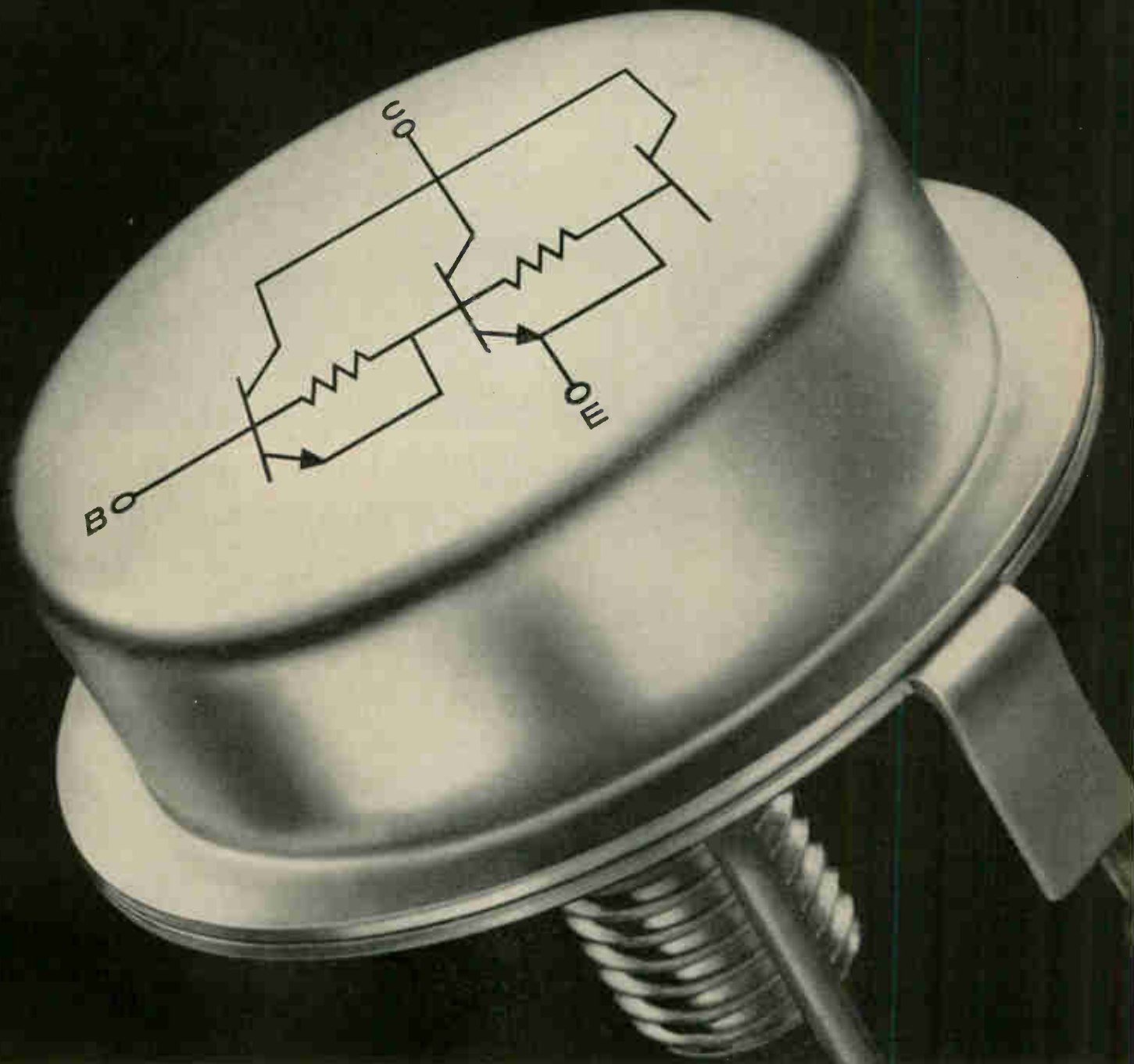

Westinghouse power integrated amplifiers eliminate a complete driver stage.

Save space, improve reliability, cut costs with Westinghouse power integrated amplifiers. Types 2N2233 and 2N3477 provide exceptionally high gain at high power levels— $h_{FE} = 400$ at 10 amps I_c , $V_{CE} = 200$ volts and $P_D = 150$ watts. Single and double ended packages provide complete design flexibility. Check these exclusive features:

- Hard soldered junctions eliminate thermal fatigue.
- Large emitter-base area puts an end to secondary breakdown.
- True monolithic construction stops runaway leakage.

SINGLE ENDED	DOUBLE ENDED	V_{CE}	h_{FE}
2N2226	2N3470	50	100 @ 10A
2N2227	2N3471	100	
2N2228	2N3472	150	
2N2229	2N3473	200	
2N2230	2N3474	50	400 @ 10A
2N2231	2N3475	100	
2N2232	2N3476	150	
2N2233	2N3477	200	

You can be sure if it's Westinghouse



And, of course, reliability is assured by the exclusive Westinghouse Lifetime Semiconductor Guarantee.* For full information call your Westinghouse salesman or distributor, or write to the Westinghouse Semiconductor Division, Youngwood, Pennsylvania.

*Westinghouse warrants to the original purchaser that it will correct any defect or defects in workmanship, by repair or replacement f.o.b. factory, for any JEDEC-type silicon power semiconductor during the life of the equipment in which it is originally installed, provided said device is used within manufacturer's published ratings and applied in accordance with good engineering practice. This warranty is applicable to devices of the stated types shipped after March 9, 1964, until further notice. This warranty shall constitute a fulfillment of all Westinghouse liabilities in respect to said products. This warranty is in lieu of all other warranties expressed or implied. Westinghouse shall not be liable for any consequential damages. SC-2050



Bulova needed a battery smaller than a button to power its Accutron^{*} timepiece for 15 months.

Mallory made it.

What can we do for you?

The Mallory people pride themselves on solving specialized problems. What they did for Bulova, they can do for you. Mallory's skilled engineers lead the way in miniaturized power sources for every power need. From hearing aids to Bulova electronic clocks for Gemini spacecraft, Mallory has solved the problem of packaging long-lasting power in button-size batteries. Quality manufacturers are willing to spend more to bring their customers the best batteries in the business. They come to Mallory.

BATTERY ENERGY PER OUNCE

MALLORY MERCURY
MALLORY ALKALINE MANGANESE
ORDINARY

High Energy. The secret of Mallory batteries long-lasting life is high energy. More energy per ounce squeezed into each battery reduces battery changing to a minimum. Mallory high-energy battery systems offer the longest life—more maximum hours of service than any other battery commercially available. Mallory Mercury batteries for electronic circuits have about 4 times more energy per unit volume than ordinary zinc carbon batteries.

Mallory heavy-duty Alkaline batteries have about 3 times more energy than conventional zinc carbon batteries. All this adds up to peak power at a lower cost per hour usage.

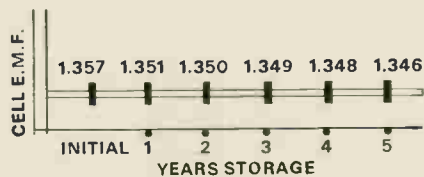

Higher Stability. Mallory high-energy Mercury batteries have the unique property of staying exactly at the same operating range throughout long life. Their output is so exact, they are used as laboratory voltage standards. This stability is most useful and often essential in powering products which remain idle for months but must operate perfectly when the occasion arises. This also means that Mallory battery systems have exceptional shelf stability. In fact, Mallory has had cells in storage for 12 years and more which still maintain useful capacity.

The reason for this higher stability is that the Mallory Mercury system is inherently inactive when not being discharged; and is, in effect, hermetically sealed, preventing evaporation of the electrolyte.

Of course, Mallory high-energy batteries cost more, but they're worth more because of the superior performance they give your product.

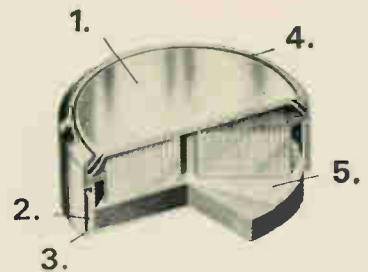

1. Double top seal. 2. Sealing grommet. 3. Self-venting structure. 4. Non-corroding metal structure. 5. Long-life barrier.

If you're thinking of an energy system for your new product, call in the Mallory people. They're constantly looking for new problems to solve. Find out what they can do for you. For a consultation on your specific requirements, write Mallory Battery Company, Division of P. R. Mallory & Co. Inc., S. Broadway, Tarrytown, New York 10591. Telephone: 914-591-7000.

*T/M Bulova Watch Company, Inc.

MALLORY It's good business to do business with Mallory



Wherever
there's
electronics
there's
Transitron

NEW 22-LEAD FLAT PACK FOR INTEGRATED CIRCUITS

HLTTL IC's Now Available in 14-Lead Plug-in Package

Transitron HLTTL circuits are now available in a 14-lead, plug-in package designed for automatic handling and printed circuit board insertion, and which is readily adaptable for flow or wave-soldering installation.

The new package is a highly reliable, hermetically-sealed unit utilizing ceramic-glass construction and a ceramic-glass lid seal. Nominal dimensions are .700 in. long and .250 in. wide. The in-line leads, positioned in two rows of 7 leads each, are on 100 mil centers with 300 mil spacing between rows.



HLTTL Circuits available in this 14-lead plug-in package

The new Transitron package provides significant advantages over other currently available packages of the same type.

- (1) more rigid leads, which maintain the advantages of automatic handling and printed circuit board insertion. Leads are 10 mils thick at the point of emergence from the body.
- (2) greater reliability — a result of hermetic ceramic glass construction and sealing techniques.
- (3) greater pin configuration flexibility — achieved by eliminating a fixed ground pin from the package.

Transitron is currently offering the following HLTTL standard functions in the in-line lead package, in both the -55 to +125°C and 0 to 75°C temperature ranges:

Single 8 input Nand/Nor Gate — Dual 4 input Nand/Nor Gates — Quad 2 input Nand/Nor Gates — Dual 4 input "OR" Gate, expandable — Triple 3 input "OR" Gate, expandable — Quad 2 input "OR" Gate, expandable — Dual 4 input "OR" expander Gates — Quad 2 input "OR" expander Gates — Dual 3 input Gated 2 phase flip-flop — Master Slave General purpose flip-flop with and without buffer — Charge Storage JK flip-flop.

INDUSTRY'S FIRST 22-LEAD PACKAGE OFFERS GREATER DESIGN FLEXIBILITY

Wakefield, Mass. — A new hermetically-sealed, 22-lead flat package for use with selected HLTTL integrated circuits has been announced by Transitron.

Providing greater expanded capability in the packaging of multi-element circuitry, the new Transitron unit extends the already unmatched selection of packaging options available for the firm's HLTTL line.

High-Reliability Hermetic Seal

Construction of the 22-lead package utilizes proven ceramic-glass technology which insures a highly reliable hermetic seal. Nominal dimensions of the package are .250 in. (width) x .450 in. (length). The eleven leads on each side are 4 mils thick and 14 mils wide, and are located on 50 mil centers. The package has a gold-plated kovar bottom plate, allowing for greater power dissipation capability.

The first circuits, currently available, to be offered by Transitron in the new package are: Quad 4 input Nand/Nor Gates (TNG 3481F through TNG 3484F); and Dual Master Slave JK flip-flops (TFF 3181F through TFF 3184F). See functional diagrams below.

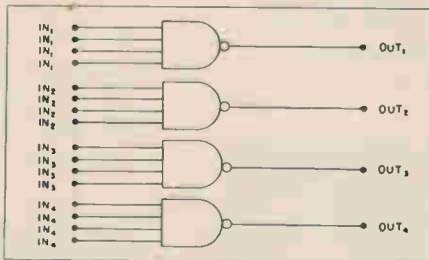

Block Diagram of HLTTL Quad 4 Input Nand Gates

Additional HLTTL functions which will be available in this package in the near future include 2-stage shift register circuits and 2- and 4-stage counter circuits.

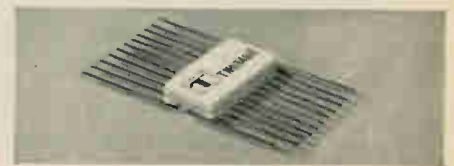

New 22-lead flat pack

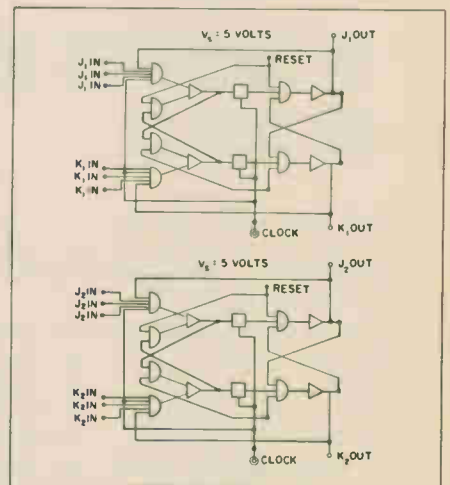

Block Diagram of Dual HLTTL master slave JK flip-flop

Another Transitron "First"

Introduction of the 22-lead package marks the latest in a series of recent Transitron innovations in the integrated circuit field, including: (1) the first HLTTL general purpose 20 megacycle flip-flop, (2) the first HLTTL Nand Gates to be offered with 10 nanosecond maximum propagation delay without sacrifice of other high performance characteristics, and (3) the first complete HLTTL commercial series of circuits.

NEW DATA AVAILABLE — Send for free data on these new integrated circuit packages by Transitron. Write to Transitron Electronic Corporation, 168 Albion St., Wakefield, Mass. 01881.

CALL YOUR NEAREST TRANSITRON SALES ENGINEER — Baltimore: (301) Chesapeake 3-3220 · Boston: (617) 245-5640 · Camden: (609) Ulysses 4-7082 · Chicago: (312) Village 8-5556 · Dallas: (214) Fleetwood 7-9448 · Dayton: (513) 224-9651 · Detroit: (313) 838-5884 · Kansas City: (913) ENdicott 2-6640 · Los Angeles: (213) MADison 9-2551 · Minneapolis: (612) 927-7923 · New York: (914) 834-8000 · Orlando: (305) CHerry 1-4526 · Phoenix: (602) 277-3366 · Rochester: (716) LU 6-0468 · San Francisco: (415) 961-1954 · Syracuse: (315) HOward 3-4502 · Canada: Toronto 18, (416) CLifford 9-5461

what if we told you
your graphic recorder
is now obsolete?

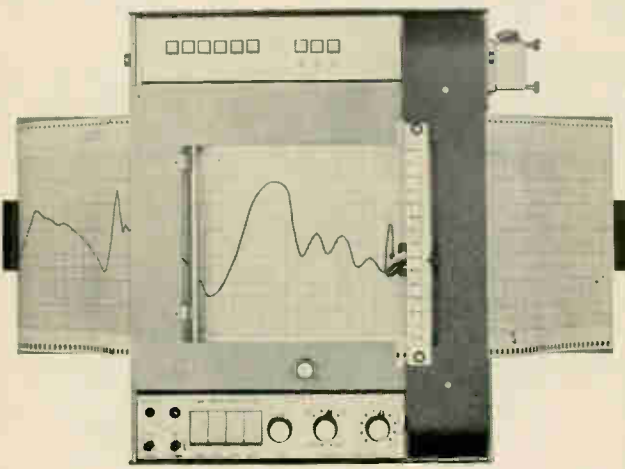

the OMNIGRAPHIC RECORDER
can prove it!

Your strip chart recorder...your X-Y recorder...your T-Y recorder is totally obsolete today because the new OMNIGRAPHIC™ RECORDER combines all their functions into one! In fact, it:

- | | |
|-------------------------------------|------------------------------|
| performs all these functions | with these features |
| ■ STRIP CHART | ■ Z-fold paper |
| ■ X-Y | ■ 144,000:1 range |
| ■ T-Y (Sequencing Chart) | ■ 1/3 sec. f.s. pen response |
| ■ PROGRAMMING CHART | ■ 20 voltage ranges |
| ■ PROGRAMMABLE CHART | ■ .15% accuracy |
| ■ PULSE CHART DRIVE | ■ potentiometric input |

Dollar for dollar, this new OMNIGRAPHIC™ RECORDER will deliver more functions, more features and more conveniences than any other recorder...or any other two recorders on the market today. It is a genuine new concept in graphic recording. The cost is far less than you may imagine.



Push button selection Z-fold paper Tears to std. chart size

houston OMNIGRAPHIC corporation
a subsidiary of houston instrument corporation
4950 Terminal Ave./ Bellaire, Texas 77401
(713) 667 7403 / cable HOINCO / TWX (713) 571 2063

IN EUROPE: Houston Instrument N.V. Keizersgracht 450, Amsterdam, Holland, Tel. (020) 238138

Order your copy now,
of the Complete 1964
Electronics Index to
Volume 37

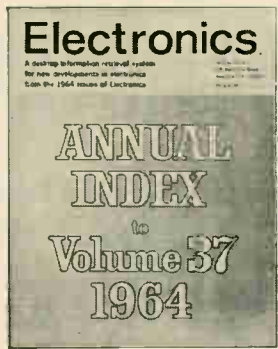

This new, easy to use Index is 40 pages long, and is available for \$1.00.

The Complete Electronics Index for 1964 contains 4 helpful, informative sections:

Subject index—catalogs all articles; technical features, news letter items, Electronics Review, Electronics Abroad and Probing the News stories, also key new product items. They're grouped in more than 250 categories and cross-indexed for easy reference.

Authors index—lists alphabetically all authors of articles which appeared in 1964, so articles may be found when authors are known.

Manufacturers index—This corporate reference gives the page and issue for each mention of an electronics company in the editorial pages of Electronics. It also references government and military organizations.

Advertisers Index: Every advertiser in the 1964 issues of Electronics is listed in this section alphabetically with the issue dates and page numbers of their ads.

This index is a valuable, year round reference tool for your home, office or company library. Use the coupon below to order your copy today. Price is \$1.00.

Send your order to:
Electronics Reprint Dept.
330 West 42nd Street
New York, N.Y. 10036

Enclosed is my check for \$1.00.
Please send me a copy of the Complete 1964 Index.

Name

Number & Street

City, State

Zip Code

The Hughes NASA Syncom stands still at 6875 mph to talk to a billion people.

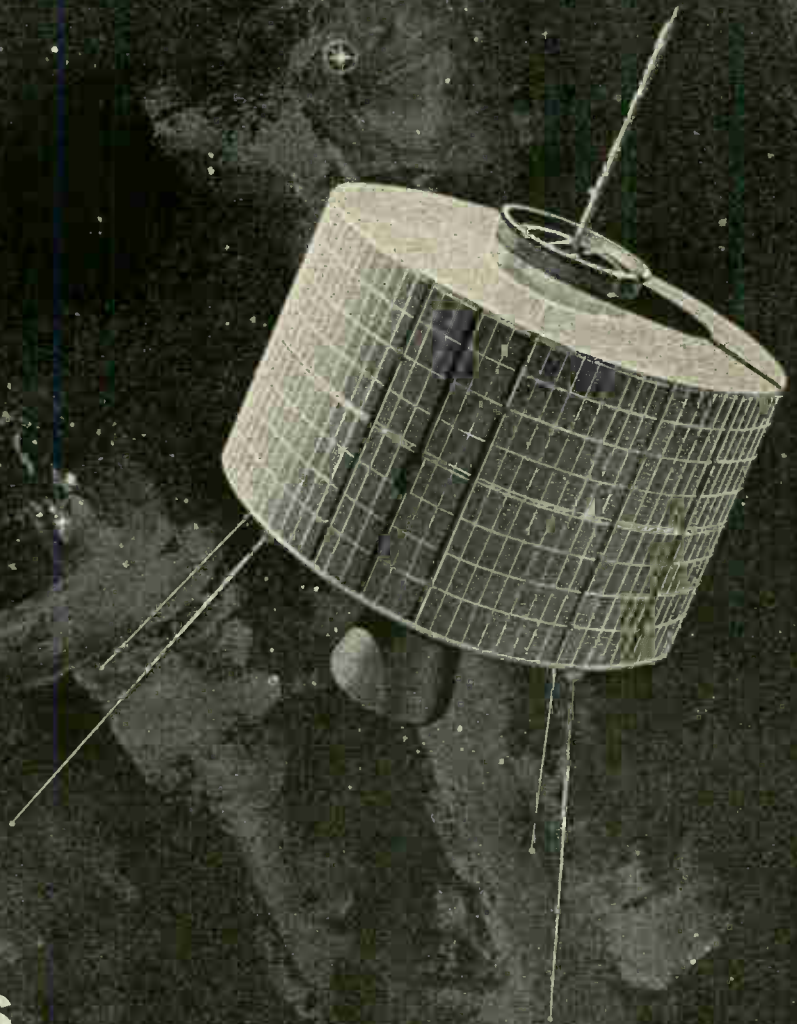

CIRCUIT DESIGNERS... is your appointment in space with Hughes?

Today, Hughes is one of the nation's most active aerospace/electronics firms: Projects include: F-111B PHOENIX Guided Missile System, TOW Anti-Tank Missile, SURVEYOR Lunar Spacecraft, SYNCOM, POLARIS, VATE, Hard Point Defense and others.

This vigor will assist the qualified engineers and scientists towards more and better opportunities for both professional and personal growth.

Many immediate openings exist. The engineers selected for these positions will be assigned to the following design tasks: the development of high power airborne radar transmitters, the design of which involves use

of the most advanced components; the design of low noise radar receivers using parametric amplifiers; solid state masers and other advanced microwave components; radar data processing circuit design, including range and speed trackers, crystal filter circuitry and a variety of display circuits; high efficiency power supplies for airborne and space electronic systems; telemetering and command circuits for space vehicles, timing, control and display circuits for the Hughes COLIDAR (Coherent Light Detection and Ranging).

If you are interested and believe that you can contribute, make your appointment today.

For immediate consideration, please airmail your resume to:

Mr. Robert A. Martin
Head of Employment
Hughes Aerospace Divisions
11940 W. Jefferson Blvd.
Culver City 27, California

Creating a new world with electronics

HUGHES

HUGHES AIRCRAFT COMPANY
AEROSPACE DIVISIONS

An equal opportunity employer.

U. S. CITIZENSHIP REQUIRED

Sperry Semiconductor Is Truly THE Second Source for the MICROLOGIC* Family of Integrated Circuits

*Sperry Rand Corporation, through a cross-licensing agreement with Fairchild Camera and Instrument Corporation, is licensed under processing techniques patented by Fairchild to produce MICROLOGIC INTEGRATED CIRCUITS which are completely interchangeable with Fairchild units. Fairchild trademarks μ L, μ Logic, and MICROLOGIC are licensed to Sperry.

RTL MICROLOGIC FROM SPERRY - NOW . . .
Sperry Micrologic 900, 914, 915, 925 and 926 are completely interchangeable with Fairchild units. Check these distributors for them. Keep in touch with **SPERRY SEMICONDUCTOR, Norwalk, Connecticut 06852.**

SPERRY

DIVISION OF
SPERRY RAND
CORPORATION

ALABAMA
Huntsville
Radio Electric Service Co.
205-539-5156

ARIZONA
Phoenix
Avnet Electronics Corporation
602-272-6821

CALIFORNIA
Culver City
Avnet Electronics Corporation
213 UP 0-6141

Los Angeles
Radio Product Sales, Inc.
213 RI 8-1271

Mt. View
Avnet Electronics Corporation
415-961-7700

Oakland
Elmar Electronics
415-834-3311

San Diego
Avnet Electronics Corporation
714-279-1550

COLORADO
Littleton
Industrial Electronic Sales
303-798-8575

FLORIDA
Winter Park
Perrott Associates, Inc.
305-423-7316

ILLINOIS
Franklin Park
Avnet Electronics Corporation
312-678-8160

IOWA
Cedar Rapids
Deeco, Inc.
319 EM 5-7551

MARYLAND
Baltimore
Radio Electric Service Co.
301 LE 9-3835

Hyattsville
Milgray Washington, Inc.
301-UN 4-6330

MASSACHUSETTS
Burlington
Avnet Electronics Corporation
617 BR 2-3060

Newton
Green Shaw Co.
617 WO 9-8900

MISSOURI
St. Louis
Target Sales Corp.
314 JA 1-3800

NEW YORK
Buffalo
Summit Distributors
716-TT 4-3450

New York, New York
Milgray Electronics, Inc.
212 YU 9-1600

Westbury, L. I., New York
Avnet Electronics Corporation
516 ED 3-5800

Yonkers
Delburn Electronics
212 BA 7-9280

OHIO
Cincinnati
Mytronics Co.
513-961-4600

PENNSYLVANIA
Philadelphia
Milgray Delaware Valley, Inc.
215 BA 8-2000

TEXAS
Arlington
Beta Electronics Co.
Dallas TA 1-1120
Fort Worth CR 7-2231

Houston
Busacker Electronic
Equipment Co.
713 JA 6-4661

UTAH
Salt Lake City
Avnet Electronics Corporation
of Utah
801-486-7566

WASHINGTON
Bellevue
Avnet Electronics Corporation
206-454-4911

Seattle
Hyak Supply, Inc.
206 PA 5-1550

WISCONSIN
Milwaukee
Electronic Expeditors, Inc.
414 UP 1-3000

CANADA
Toronto 19, Ontario
Avnet Electronics Corporation
of Canada
789-2621

Sperry Europe Continental, 7 Avenue de l'Opera, Paris 1, France

Is this trip worthwhile?



It is...if a photographic approach to your data-recording needs makes sense

First tell us by mail or phone the parameters of your specific data-capture requirements. If photography is *not* a practical answer, we'll tell you so. If it is, we'll arrange a blackboard session for you with fellow engineers well qualified to point you to a solution without getting you lost in bewildering photo-technology.

Behind this offer there is something more than engineering depth. There's also a new line of Kodak films designed for such fast, compact, and outwardly simple processing that you get all the advantages that are inherent in photo-recording without need for space-, time-, and labor-consuming manipulation.

To find out whether your high-volume data-recording job is one where we (or even some other company) could help by talking, write to *Eastman Kodak Company, Special Applications, Rochester, N. Y. 14650. Or call 716-325-2000, Ext. 5129.*

Kodak

COMPONENT COMMENTS *From Speer*

Has our traveling resistor show visited you yet?

We're referring to our new slide film presentation called "How a Speer Resistor Gets Its Stripes."

This lively 20-minute sound and color film follows a typical group of Speer composition resistors as they try to "shape up" to today's tougher MIL-R-39008 specs.

Starting with the first manufacturing steps, you'll see the

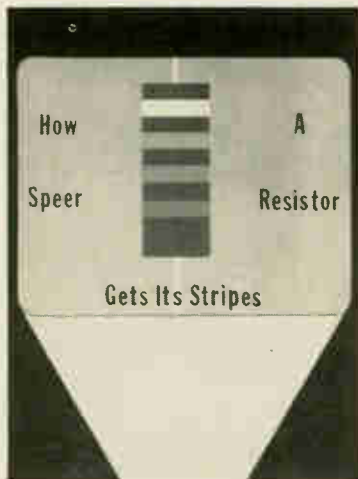

various tests that the raw materials have to pass. You'll see the exhaustive checks that accompany every step of resistor production. You'll see the latest electronic quality control and reliability equipment in action. And you'll see the proud moment when the resistors receive their insignia of uniformity and high quality — five colorful stripes.

If you're concerned with meeting military specifications, you'll want to arrange a free screening of this slide film. To do so, simply contact your nearest Speer representative. If you don't have his name, mail the coupon and we'll let you know where to reach him.

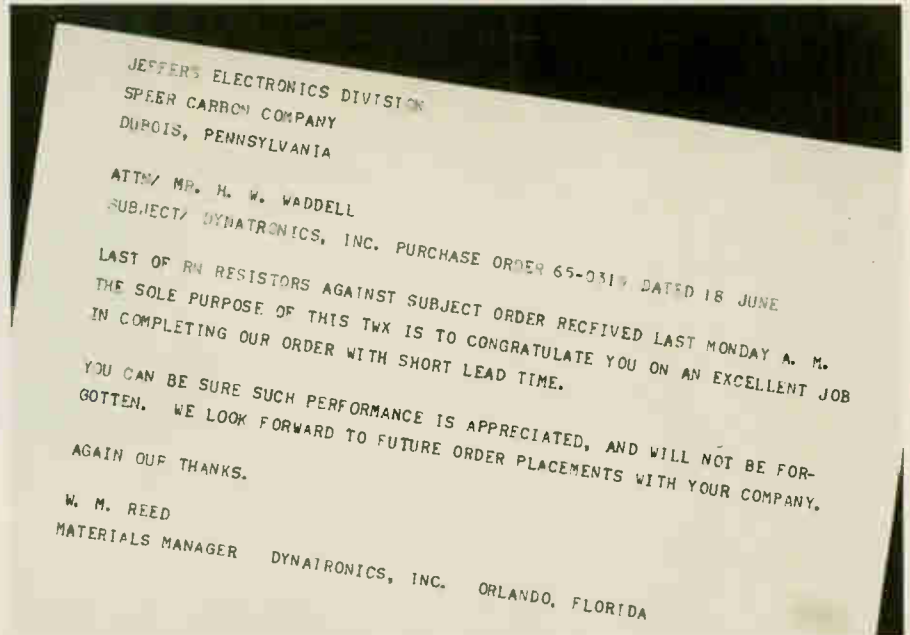

Fan letter. It seems that Dynatronics needed large quantities of .1% tolerance metal film resistors in a week. And only Jeffers Electronics would promise to meet their deadline. As you can see, we also kept that promise. Do we always deliver this fast? No. But even our normal delivery of standard JXP resistors is three times faster than the service you may be getting elsewhere.

If you're looking for the best temperature stability and least cost in a precision resistor, forget about its TC

We're as respectful of traditions as anyone. And we're well aware that the traditional determination of resistance-temperature stability is based upon resistance measured at two specified temperatures. (Otherwise known as "TC".)

We believe, however, that there is a more advantageous way to express resistor temperature stability — one that will prove less costly to you in situations where a high degree of stability is required.

We recommend instead a "design tolerance" or "total resistance deviation limit" expression of the stability of a precision resistor. For example, a resistor with an allowable total resistance deviation limit of 1,000 ppm over a given temperature range will satisfy the same circuit requirement as a resistor that is specified by a ± 5 ppm TC. Yet specifying a 1,000 ppm limit delivers a resistor that would cost only one third as much (and delivers it a lot faster, too).

We might mention our ultra-precise JXP metal film resistor at this point. It is available in tolerances that can meet

your toughest stability requirements.

A detailed discussion of our new stability determination method can be found in our article entitled "Specifying Resistance Temperature Stability." If you'd like a copy, simply mail the coupon.

JEFFERS ELECTRONICS DIVISION,
Speer Carbon Company
DuBois, Pennsylvania

Speer Carbon Co. is a Division of Air
Reduction Company, Inc.

- Rush "Specifying Resistance Temperature Stability."
 Rush the name of my nearest Speer representative.

Name _____

Title _____

Company _____

Street _____

City _____

State _____ Zip _____

Exhibiting at NEREM '65. Booth 2D66 Nov. 3-5



Don't be fooled!

"There is no other integrating 4-digit DVM as accurate or as stable at a lower price."

There are other integrating 4-digit DVM's. There may be other 4-digit DVM's as accurate; or there may be other 4-digit DVM's as stable. But there are no other 4-digit DVM's which combine all 3 capabilities selling as low as \$2395! The Hughes Model 4000 is an outstanding buy. Just check these specs.

Accuracy is ± 1 digit on all ranges. 100 microvolts sensitivity on lowest range. Complete bipolar noise rejection. Constant high 1000-plus megohms



of unattenuated input impedance. Fast readings—9.9 per second. Automatic ranging and polarity. All electronic, solid state components. The price—only \$2395!

To obtain additional information and complete specifications on the new

Hughes Model 4000 Digital Voltmeter, or to make arrangements for an in-plant demonstration, just **teletype**, **write** or **call**: HUGHES INSTRUMENTS, 2020 Oceanside Boulevard, Oceanside, California 92057 — or 1284 North Broad Street, Hillside, New Jersey. For export information, write: HUGHES INTERNATIONAL, Culver City, California



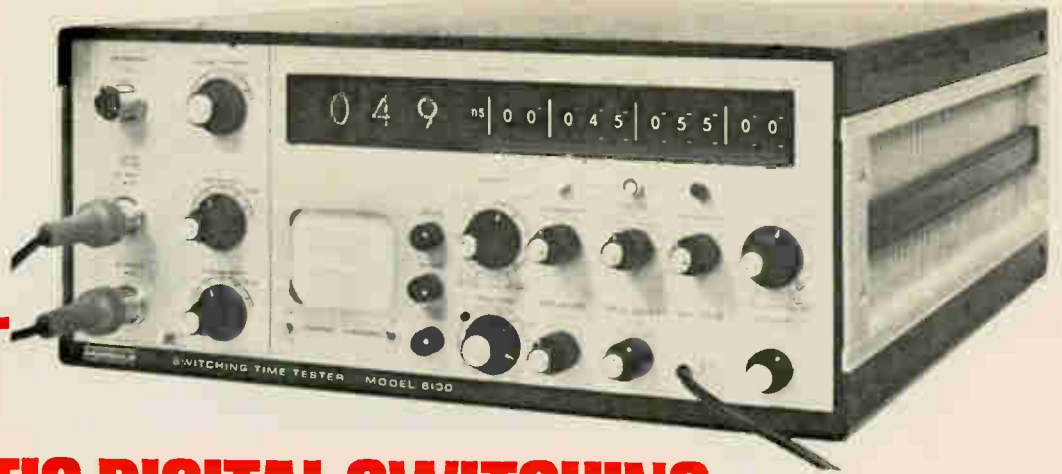

THE FIRST AUTOMATIC DIGITAL SWITCHING TIME TESTER WITH REMOTE PROGRAMMING

Fairchild's solid state Model 6100 offers the widest programming flexibility available without card changes — plus picosecond accuracy.

- **Adjustable display time; optional display averaging.**
- **Go/no-go display, BCD output for printer or punch.**
- **Time resolution range from 10 psec.**
- **Voltage measurement range from 2mv.**
- **Bench or rack mount flexibility.**

An unlimited number of tests per device may be programmed without hand-wired cards. Programming is completely controlled from the front panel or remotely from any storage or read-in device—tape reader, card reader, magnetic disc. The 6100 measures switching time, time interval, time delay or pulse rise time, fall time or width, plus saturation voltage and pulse height and sag under actual operating conditions. Clear-cut digital display eliminates the possibility of interpretive error.

The 6100's versatility and ease of operation give it wide application in both laboratories and production facilities. The need for accessory test equipment is minimized and test set-ups and procedures are greatly simplified.

Applications include: precision measurement of all displayed waveforms in lab set-ups; discrete tests with data logging or go/no go sorting; quality control production or receiving inspection.

The diagram below shows a typical set-up for an automatic measurement system with the Model 6100 plus Fairchild's switching time test fixture Model 70.

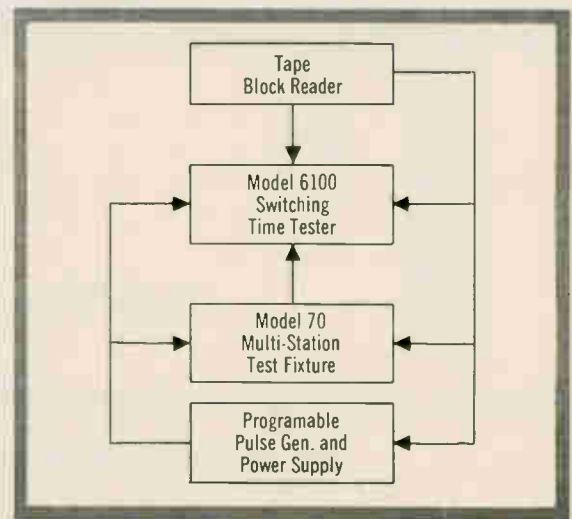

INTERNATIONAL SALES AND SERVICE ■ U.S.A.: Direct factory sales and service in principal cities. **Europe:** Fairchild Instrumentation, 80 Chaussee de Charleroi, Brussels, 6, Belgium. **Asia:** Tokyo Electron Labs, Inc., TBS Building, Tokyo, Japan.

FAIRCHILD
INSTRUMENTATION

Probing the News

Oceanology

Come on in! The water's fine

After a tentative dip into the rich market under the sea, the electronics industry seems ready to make a big splash

By John F. Mason

Senior Associate Editor

For a long time the electronics industry has been dipping its toe into the cruel sea. Now, some of its hardier representatives have taken a deep plunge; they say the water's fine and they plan to stay in it.

A typical example is Honeywell, Inc. Ten years ago the company got into the undersea business by buying out a small, highly-technical, but unprofitable laboratory in Seattle that made instrumentation for pure research in oceanography. The lab continued to operate at a loss for eight years, but is now showing a bright promise. Charles L. Davis, vice president of Honeywell's military products group, predicts that by 1970 the market for basic research instruments will hit \$50 million a year.

The lab's first marketable product, a sonar that scans the bottom of the sea, produced ten years ago, is still being used. Between 1960 and 1963, Honeywell turned out a temperature-recording sensor buoy and an ambient accoustical noise-recording buoy for basic research.

Davis' advice for an electronics company wanting to get into undersea work: "An eye on the future and a deep purse in the present."

I. In the swim

The Lockheed Aircraft Corp.

Contributions to this nationwide roundup were made by Thomas Maguire in Boston, Louis S. Gomolak in Chicago, Arthur Zimmerman in Cleveland, Marvin Reld in Dallas, Ronald P. Lovell in Los Angeles, Edmond G. Addeo in San Francisco and Seth Payne in Washington.

started on undersea work because of defense spending cutbacks, according to E. P. Wheaton, vice president of the corporation and general manager of the Lockheed Missiles and Space Co. (LMSC) division. "Ours was strictly a diversification move," Wheaton said. "We decided that oceanology was an ideal place to use a great deal

of our space effort capabilities."

Oceanology is the practical application of oceanography and LMSC is already spending millions of dollars in research and development on it; it expects this investment to pay off in about three years. The market Lockheed is shooting for is big systems and the electronics they require. Although, the com-

Ocean Systems, Inc. transports two divers to ocean bottom oil and construction sites by this submersible decompression chamber. The man in bottom section can emerge and work, while the one in the top half is prepared to help out if necessary.



pany does not want to say much at present, it is working on underwater sensors and imaging systems. One problem Lockheed is trying to solve is how to get underwater pictures with quality as good or better than television pictures, and at great distances.

LMSC has already developed a sonar optical correlator, a device that enhances sonar signals by means of an optical rotating drum with predetermined signal characteristics. LMSC feels this can be sold on the current market, primarily to the Navy.

Two years ago LMSC organized an Oceans Systems Group, a staff of about 100, headed by Capt. C. G. Welling, an ex-pilot and avid oceanology buff. "Everyone is taking equipment developed and designed for other requirements and adapting it to oceanology," Welling says. "What is actually needed now is the research work required to design new equipment. We're back where aviation was in the early 30's, when fabric and cloth-covered planes had reached their end and something had to be done about redesigning."

LMSC is building a multimillion dollar undersea research vessel called Deep Quest, a four-man, 40-foot submarine designed to carry modular work payloads to the ocean's floor for a variety of research missions.

Deep Quest will become operational in late '66. It may be the forerunner of a new fleet of undersea vessels carrying the colors of many firms.

LMSC is also bidding on the rescue submarine part of the Navy's Deep Submergence Systems Program.

To coordinate work in oceanology being done by all of Lockheed's divisions, the corporation bought and has recently occupied a 12,000 square-foot building in San Diego called the Lockheed Marine Laboratory.

Growth area. Westinghouse Electric Corp., which has been active in undersea work since it began to make torpedos 25 years ago, now has a full-fledged undersea division and estimates that by 1970 its undersea work will account for 10% of the corporation's business. Oceanology is one of the four major growth areas the company is watch-

ing closely. (The other three are desalinization, rapid transit, and refuse disposal.)

Westinghouse is building four submersibles, called Deep Star, with depth limits ranging from 2,000 to 20,000 feet.

Aside from its marine division in California, Westinghouse has facilities near Annapolis, Md. on Chesapeake Bay which it plans to expand. It will move into a two-floor, 120,000-square-foot building. Docking facilities will be available and 350 people will be hired.

II. West Coast activity

According to F. Ward Paine, president of Ocean Science Capital, Inc., a Palo Alto, Calif. investment company specializing in oceanography, companies in the San Francisco Bay Area are spending between \$25 million and \$50 million a year on oceanography, and he expects that will triple over the next five years.

CM², in Mountain View, Calif., is producing instrumentation to analyze the biological content of water, and conductivity meters and tensionmeters for cables. The company says the market for this gear is growing.

Berkeley Instruments, Inc. in Richmond, Calif., says the same about its specialty—underwater meteorological equipment.

The Data Technology Corp., also in Mountain View, supplies the Navy's Oceanographic Office with 80% of all of its data collecting

and conversion equipment. This market represents 40% of the company's total business.

The Lockheed California Co., a subsidiary of the Lockheed Aircraft Corp. is studying underwater waves, ocean wave forecasting, temperature, salinity and sedimentation. For the latter work, the company has designed a special sedimentation corer. It also built a bottom slope sled for contour mapping.

The Bissett-Berman Corp. in Santa Monica, Calif. bought its marine divisions, a small company in San Diego, about three years ago. The division, which now accounts for about 40% of the company's business, makes instrumentation to measure pressure, temperature, ambient light, and bottom proximity. It has also developed buoy-mounted data systems including sensors, data handling and telemetry equipment. It is currently developing a new type of barometer for use at sea surface.

Beckman Instruments Inc.'s entry in the field has been modest. According to Edward Wheeler, of Beckman's Advanced Technology Group, the company is selling instruments to the Navy for chemical analysis of seawater and an instrument to monitor synthetic atmospheres for the Man-in-the-Sea program.

The Beckman Systems division is supplying a digital data acquisition system installed in a 40-foot instrumentation buoy that the Con-

Instrumentation market for undersea mining is being helped along by the Bureau of Mines experiment in Tiburon, Calif.



vair division of General Dynamics Corp. is building for the Office of Naval Research.

Nuclear devices. The Tracerlab division of Laboratory for Electronics, Inc., in Richmond, Calif. is concentrating on nuclear devices for its share of the undersea market. Working under contract with the Bureau of Mines, Tracerlab has a four-man team working on nuclear instrumentation for analyzing sediment.

I. J. Wright, manager of the Earth Sciences department of Tracerlab says, "In a few years oceanography will develop into a much broader field and we want a share of the nuclear instrumentation market that will develop with it."

III. Submersibles

The two-man submersible called Star II, that General Dynamics Corp. designed and built for studies by the University of Pennsylvania Museum, has been in great demand during its first year of operation. Equipped with sonar, a television camera and a long-range telephone to talk with its support ship, the Museum has used it for oceanographic surveys in the Aegean Sea, the University of Rhode Island to survey plant life in Long Island Sound, and the Smithsonian Institute to study coralline algae in the North Atlantic. Although the University owns the sub, GD is its leasing agent and gets a percentage of its rental fee.

Subs for rent. Star II has been so successful that GD is building another one that it will own, operate and offer for rent. The second Star II will go down to 1,200 feet.

Apparently GD sees more profit in hanging on to their submersibles than in selling them outright. It sold its aluminum submarine, the Aluminaut to Reynolds International, Inc. for \$2 million. GD uses its shallow-diving (200 feet) Star I to test the company's oceanographic instrumentation products.

GD is conducting a feasibility study for the Bureau of Commercial Fisheries for a nuclear-powered submarine that carries a 24-man crew to study the breeding and migration habits of fish. The estimated cost is \$25 million. GD also got the first major contract in the Deep Submergence Systems Pro-

gram for studying ways to salvage sunken ships.

In July, GD opened a Marine Technology Center in San Diego where work is under way on anti-submarine warfare, undersea oil exploration and salvage.

'Send engineers.' Convair division's 40-foot discus-shaped buoy, put off the coast of Jacksonville, Fla. in May, has been successfully making oceanographic measurements, storing them on tape as well as transmitting them to shore ever since. An Office of Naval Research project, the buoy has 100 sensors, a 24-hour memory as well as a one-year memory.

Robert Devereux, manager of Convair's buoy program says the best way to sell to oceanographers is to send scientists and engineers to do the selling. Oceanographers, Devereux said, don't like to talk with marketing men.

North American Aviation, Inc., also planning to capitalize on its aerospace experience, has spent \$1 million for a deep submergence system office under Don H. Pickrell, Jr. to coordinate the corporation's underwater activities.

"We want to sell equipment," Pickrell says. "Possibilities include underwater vehicles, sonars, navigation, power sources, life-support systems for submarines, underwater tools, and propulsion units."

The Nortronics division of Northrop Corp. has finished a preliminary design for the rescue vehicle in the Navy's DSSP and Litton Industries, Inc., has built one submersible, Alvin I, and plans to build two more.

IV. Remote control

"In the next three years, one to two million acres of underwater oil land will be opened up for lease in the Santa Barbara Channel alone. This will result in a great need for underwater television gear, telemetry devices to position vessels as the drilling goes into deeper and deeper water." This was the prediction of Henry Wright, chairman of the off-shore committee of the Western Oil & Gas Association.

"What electronics companies should do." Wright pointed out, "is to get with the oil companies and find out what they want, and discuss their problems with them.

"We don't want the Rube Gold-

berg things they show us now. If they'd come around and ask, we'd be more than happy to give electronics marketing people a good look at the field. Then they might design things we could use."

The main drawback to undersea mining, according to Jeffrey C. Frautschy, assistant director of the Scripps Institution of Oceanography, is the cost. "There is much commercial interest in mining the sea floor," Frautschy said, "but it would take from \$60 million to \$100 million to start an underwater manganese mining operation."

Sea-bottom gear. Efforts to mine the ocean floor from platforms or barges on the ocean's surface are "ridiculous," says J. Leslie Goodier, chief of systems development at the Bureau of Mine's 70-acre site near Tiburon, Calif.

"Working the ocean's bottom through cables is not going to do the job," he says. "We think the demand is for equipment to rest on the sea floor and operate from there. But we need electronics to operate such equipment for periods of ten years without maintenance. We need sampling devices, monitoring equipment, data collection and communications gear including closed-circuit television, and devices to delineate the sea floor and set boundaries for geologically productive areas."

V. The market

Looking far ahead, some electronics companies see the day when they will be outfitting underwater cities where men will live and work. This view has just been confirmed by the success of the Man-in-the-Sea project [Electronics, Aug. 23, p. 111]. In that undersea venture, three shifts of ten men lived and worked for two-week periods in a 57-foot by 12-foot cylindrical shelter, called Sealab II, 210 feet below the coastal waters of California.

Early reports from the Sealab II aquanauts on future equipment needs reveal tremendous gaps that must be closed before extensive mining and diving operations can become a big market. But the sooner improved gear is developed, the sooner oil and mining companies—and of course the electronics industry—can get to the big money at the bottom of the sea.

ONLY TRYGON HR-B Series POWER SUPPLIES give you all these features

- All silicon —60°C operation
- Constant voltage/constant current
- .01% regulation; 0.5 mv ripple
- Up to 300 watts—voltages to 160V.
- Remote sensing—remote programming
- TRYLINK® precision current mode
- Automatic overvoltage protection option
- Half Rack Size—Bench or rack mount



Looking for a challenging engineering opportunity with growth potential? Contact D. Hauptman at Trygon. An equal opportunity employer.

TRYGON
ELECTRONICS, INC.
Roosevelt, N.Y. 11575

Please rush me your new 52-page Power Supply Handbook—FREE

Name _____
Title _____
Company _____
Address _____
City _____ State _____ Zip _____

Circle 126 on reader service card

Avionics

Electronics to get a big slice of Lockheed's C-5A melon

A third of the costly avionics on the giant transport will outperform any existing gear

By Fran Ridgway

Atlanta News Bureau

Although the Lockheed Aircraft Corp. has won the contract to build the huge C-5A transport for the Air Force, it is remaining silent on who will supply the plane's electronics. Nor has Lockheed made public its estimate of the cost of the electronics package, except to say that it will be the biggest and most expensive ever installed on a cargo plane. About a third of the equipment, Lockheed says, will be advanced.

The C-5A will actually be built at the Lockheed-Georgia Co. in Marietta, where the C-130 and the C-141 Starlifter were built. A large part of the equipment on those transports was government-furnished, however, and the C-5A program will be Lockheed-Georgia's first venture in broad-scale avionics procurement. The company will draw on the experience of the Lockheed-California Co.'s procurement organization, which worked on the F-104 fighter.

It's a safe bet that leading contenders for the subcontracts are already emerging as a result of the work of a 35-man procurement task force set up by Lockheed in July, 1964. The group has been receiving and evaluating subcontractor proposals since then, and continued its work even after Lockheed and its competitors, the Boeing Co. and the Douglas Aircraft Co., submitted their final proposals to Washington last spring.

The purpose of the pre-contract screening, according to the Air Force's director of materiel, John McCarthy, was "to evaluate industrial capacity over the country and to maintain a competitive subcontractor environment during the time the company was preparing its bid for prime contract."

I. New equipment

The malfunction detection system is one of the major innovations going into the C-5A. This system

Artist's conception of the 340-ton C-5A, which will carry highly improved station-keeping, navigation, radar and landing aids.

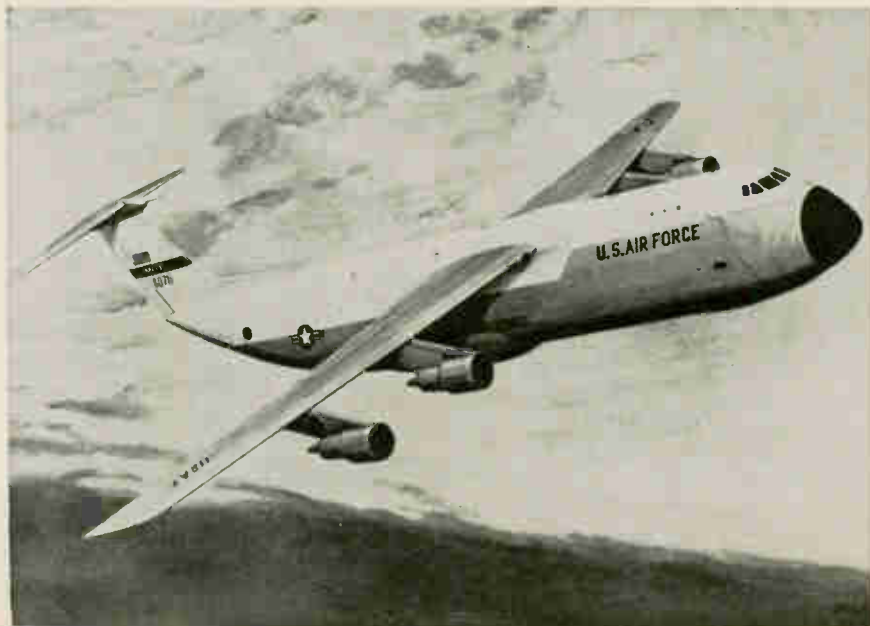

NEW CAPABILITY FOR ZENER DIODES

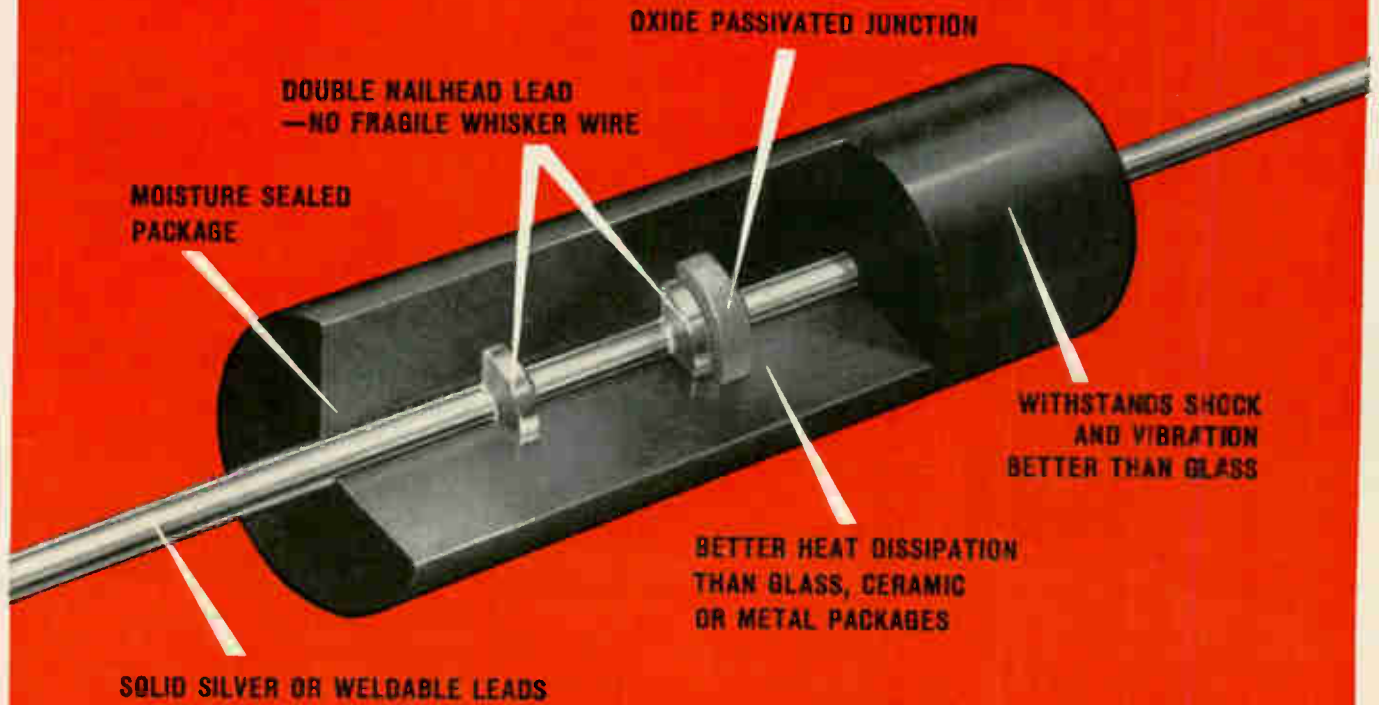

FIRST 1 WATT ZENER IN A DO-7 PACKAGE

Saves 30% circuit space • Dissipates 2½ times higher wattage

Now available in a DO-7 package, this new 1 watt Poly-Sil zener diode offers superior mechanical characteristics as well as significant space and cost savings.

Poly-Sil is a new molding and sealing material that completely surrounds all internal parts. This results in a rugged unit that is up to 30% smaller than most popular 1 watt packages. Wattage dissipation is 2½ times higher than glass packages of the same physical size.

Solid construction provides greater thermal and mechanical strength and more dependable performance. Double nail head leads eliminate fragile whisker wires and conduct heat away from the junction.

In addition to 100% scope testing, these units have been tested to 250°C without catastrophic failures. Write for samples, literature and prices.

CAPSULE SPECIFICATIONS

Actual size

MIL:	Designed to meet MIL-S-19500
WATTAGE:	To 1 watt @ 70°C
VOLTAGES:	6.8 to 200 volts
DIMENSIONS:	DO-7 (.255" long x .10" dia.)
TOLERANCES:	5%, 10%, 20%
LEADS:	Solid silver, Dumet available.
JEDEC TYPES:	IN4323 thru IN4358



NORTH AMERICAN ELECTRONICS, INC.

DIVISION OF INTERNATIONAL RESISTANCE COMPANY

71 LINDEN STREET • WEST LYNN, MASSACHUSETTS



Malfunction detection and recording system will warn the flight engineer when a component fails and tell him if a replacement is aboard.

adds a real-time dimension to Lockheed's much-publicized malfunction detection recorder, which the Air Force is using on the B-52 and B-47. The Air Force system, known as Madrec, tape-records malfunctions and potential malfunctions for after-flight, on-ground analysis. The malfunction detection system to be used in the C-5A will provide for in-flight trouble shooting as well.

Readings from some 1,000 test points throughout the plane will be relayed to the flight engineer's station and displayed on both a printer and an oscilloscope. The maintenance monitor will sense, locate and identify malfunctions—and in some instances, potential malfunctions—and supply the flight engineer with such information as the unit's name, location, and part number, as well as replacement time and any special tools that might be needed. It then goes one step further and lets him know whether or not the aircraft is carrying a spare aboard.

Roughly half the test points will feed back information on functions

with well-defined operating criteria, such as hydraulic line pressure limits or fuel flow and temperature. For functions on which monitored data is not easily recorded—radar and flight controls, for instance—the system provides a pictorial display.

Station keeping. The Air Force has not yet released details on the station-keeping equipment, which is said to be based on Lockheed's Lask, which used a radar transponder in each plane in a formation, with a master transponder in the lead. Each plane was able to maintain its correct position in relation to the lead plane.

Radar. The Air Force also refuses to discuss the advanced approach it will use in the "multi-mode radar system." It is known, however, that it will handle ground mapping, terrain avoidance, automatic terrain following, and high-accuracy navigation. Using the radar, without ground-based aids, the plane will be able to land with a 200-foot ceiling and half-mile visibility.

The inertial doppler navigation system, which will be used for en route and terminal navigation, is 50% more accurate than existing systems, a Lockheed official said. It will let the C-5A make air drops within a tolerance of 300 feet, with no ground-based electronic or visual aid.

II. Lockheed's homework

In its all-out effort to snare the C-5A contract, Lockheed-Georgia has had some 1,800 engineers and technicians working on the project since December, many of them a full seven days a week. It spent a reported \$15 million of its own on the project, along with more than \$6 million in Air Force funds—a gamble that will pay off well in a contract expected to run close to \$2.2 billion. The initial order will be for 58 planes.

Winning the contract means that the current employment figure of 20,000 at Marietta will remain relatively constant for at least the remainder of the decade. No substantial number of new workers will be added because the C-5A will gradually absorb many employees now assigned to the C-130 and C-141.

UNITRODE®

NORTH AMERICAN SALES OFFICES

MARYLAND — Lutherville
Daniel & Company
301-825-3330

PENNSYLVANIA (EASTERN) — Glenside
Daniel & Company
215-887-0550

CANADA — Montreal
Kaytronics Engineering
514-489-9335



...OR, THESE
COMPAR OFFICES

ALABAMA — Huntsville 205-539-8476

ARIZONA — Scottsdale 602-947-4336

CALIFORNIA—
Burlingame 415-697-6245
Glendale 213-245-1172

COLORADO — Englewood 303-781-0912

CONNECTICUT—Hamden 203-288-9276

DELAWARE — see: Maryland

FLORIDA — Orlando 305-855-3964

GEORGIA — see: Alabama

ILLINOIS—
Chicago 312-775-5300
(Southern) See: Missouri

INDIANA — (Northern) see: Illinois
(Southern) see: Ohio

IOWA — see: Illinois (Northern)

KANSAS — see: Missouri

KENTUCKY — see: Ohio

LOUISIANA — see: Texas

MAINE — see: Massachusetts

MASSACHUSETTS—
Newtonville 617-969-7140

MICHIGAN — Livonia 313-476-5758

MINNESOTA—
Minneapolis 612-922-7011

MISSOURI — St. Louis 314-428-5313

NEW HAMPSHIRE — see: Massachusetts

NEW JERSEY — Clifton 201-471-6090
(Southern) see: Pennsylvania

NEW MEXICO—
Albuquerque 505-265-1020

NEW YORK—
(NYC and LI) see: New Jersey (Clifton)
Albany 518-436-8536
Depew 716-684-5731
Endwell 607-723-8743

NORTH CAROLINA—
Winston-Salem 919-724-0750

OHIO — Fairborn 513-878-2631
Fairview Park 216-333-4120

OKLAHOMA — see: Texas

OREGON — see: Washington

PENNSYLVANIA — (Western)
See: Ohio (Fairview Park)

RHODE ISLAND — see: Massachusetts

SOUTH CAROLINA — see: North Carolina

TENNESSEE — see: North Carolina

TEXAS — Dallas 214-327-3944
Houston 713-645-2135

UTAH — see: Arizona

VERMONT — see: Massachusetts

VIRGINIA — see: Maryland

WASHINGTON — Seattle 206-622-0622

WISCONSIN — see: Illinois

...READ ALL ABOUT IT!



EXTRA — All New 16 Page High Voltage Assembly Catalog

EXTRA — New Stacks and Bridges — Standard and Fast Recovery

EXTRA — Complete Applications Information

To get your copy, call our local sales office listed at the left, or circle reader service No. 129.

UNITRODE CORPORATION

580 PLEASANT STREET • WATERTOWN, MASSACHUSETTS 02172 • TELEPHONE (617) 926-0404 • TWX (710) 327-1296

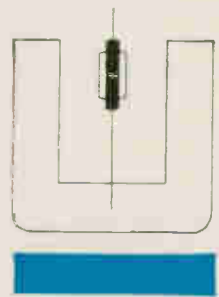

Export : Dage Corporation

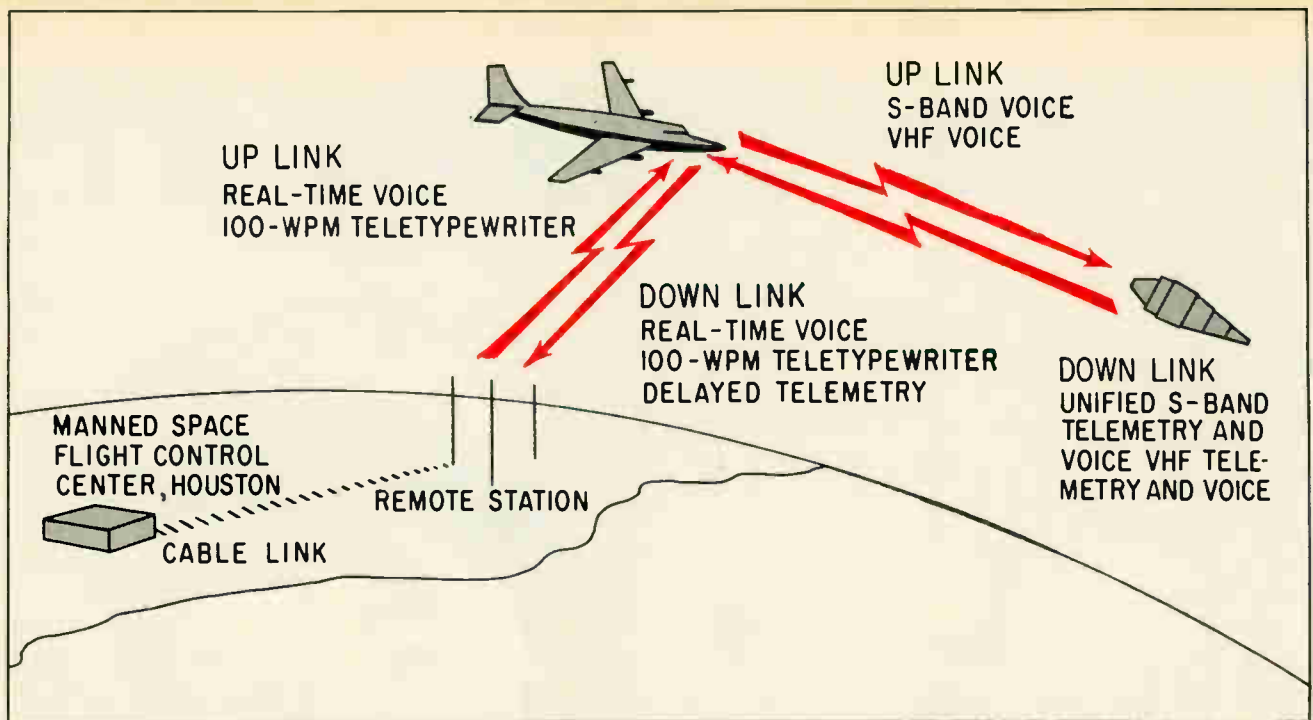

Fleet of eight jet planes will fill in gaps in line-of-sight communications network to keep Apollo and Houston in voice contact throughout the spacecraft's orbiting of the earth, during the critical period when it blasts off for the moon, and far enough along its lunar journey to make sure the historic flight is off to a good start.

Space electronics

Talking Apollo out of earth-orbit

After two years' research and development, NASA to order specialized relay planes that will permit voice contact with the astronauts just before, during and after their spacecraft takes off for the moon

By Thomas Maguire

Boston Regional Editor

At the critical moment, when the three Apollo astronauts are ordered to leave earth orbit and take off for the moon, the command will come by voice from the flight director at the National Aeronautics and Space Administration's Manned Spacecraft center in Houston. Nine chances out of ten, the words will be relayed by one of a fleet of eight aircraft specially equipped for the job. The C-135A jet transport planes are called ARIA, for Apollo range instrumented aircraft.

A contract to provide instruments for them will be awarded this month by the Air Force Systems Command's Electronic Systems di-

vision at Hanscom Field, Mass. The winner will be one of two teams that have completed definition-phase studies that lasted four months—the Douglas Aircraft Co. teamed with the Radio division of the Bendix Corp., and Collins Radio Co. allied with Lockheed Air Services, a division of the Lockheed Aircraft Corp.

The ARIA project at Hanscom Field consists of a 30-man group, headed by Lt. Col. Lawrence M. Politzer and aided by a team of instrumentation specialists from NASA's Goddard Space Flight Center in Maryland.

The aircraft, which are extensions of the eastern and western

missile-test ranges, will be operated by personnel of the Air Force National Range division. Although the planes are designed primarily to support project Apollo, they will also be used for defense projects such as the manned orbiting laboratory, Minuteman and Polaris missile launches, and tracking of advanced reentry vehicles.

I. ARIA's role

ARIA will ensure that the astronauts are able to communicate with their control center during the crucial phase of the mission.

Existing stations on land and aboard ships cannot cover, with line-of-sight communications sys-

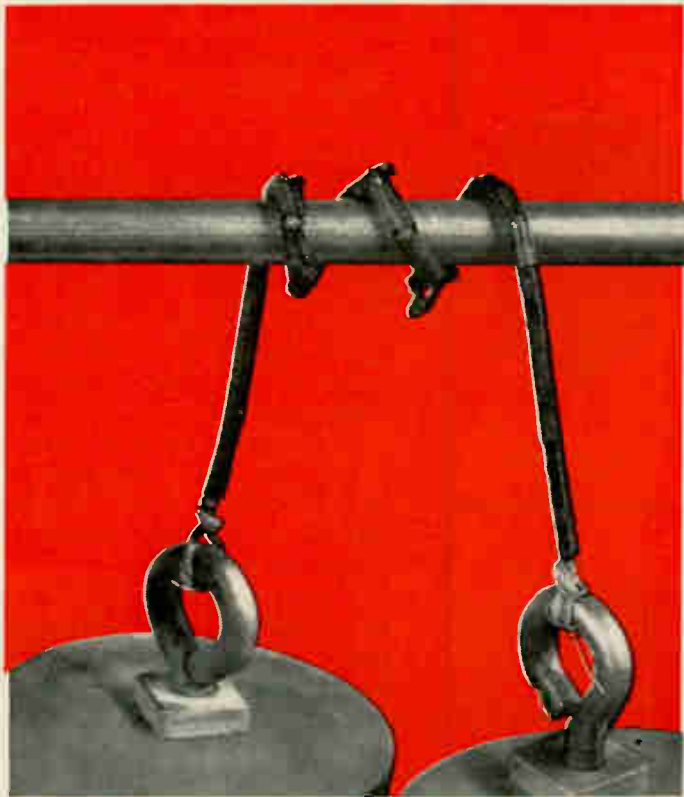

PVC/nylon after 9 hours at 200°C, sample weighted to compress insulation and tense conductor per MIL-W-81044.



Poly/Kynar after 120 hours at 200°C

Vinyl goes to pieces, Poly/Kynar* looks like new

Heat, abrasion have little effect on tough new MIL-W-81044 aircraft wire

High-temperature capability—Poly/Kynar wire is rated at 135°C for continuous operation. Each lot is acceptance-tested for six hours at 225°C, followed by stringent bending and dielectric tests. The self-extinguishing, nonflowing insulation and jacket are radiation cross-linked for maximal high-temperature form stability, which imparts Poly/Kynar's unique resistance to soldering iron damage.

Poly/Kynar is absolutely nonwicking, since it contains no glass or nylon braid. And the tough Kynar jacket is highly resistant to abrasion, cut-through, solvents and fuels—including Skydrol and jet fuels.

Its light weight and smaller diameter make it ideal for airborne and space applications.

Four types are available: Types 1 and 2 for 600-volt, heavy-duty aircraft and hookup work; Types 3 and 4 for lightweight hookup, instrumentation, black boxes. Want details or engineering samples? Write Dept. E, ITT Wire and Cable Division, International Telephone and Telegraph Corporation, Clinton, Massachusetts. In Canada, write or call ITT Royal Electric Company (Quebec) Limited, Pointe Claire.

*Kynar is a Pennsalt Chemical Corp. trade name.

wire and cable division **ITT**



Type A—Open Frame,
Open Contacts

Type F—Hermetically Sealed
Plug-In

Type H—Dust-tight
Plug-In

Type B—Open Frame,
Enclosed Contacts

Type C—Phenolic Case,
Quick-on Terminals

TIME-DELAY RELAYS in five economy-size packages

Any of these five Silic-O-Netic® time-delay relays can save you money. And space.

But not because the price is cheap (though it is competitive). Or because of any miracles of miniaturization (though the relays are small and compact).

The economy comes from our relays' continuous-duty construction.

The coil is specially built to enable it to remain energized indefinitely after relay actuation. This gives the relay a unique dual-function capability. It can serve as both a delay device and a load-carrying component.

If you can get by with up to 5 amps' contact capacity and SPST, SPDT or DPDT switching, you won't need a separate load relay or slave circuit.

Even if this dual-function capability holds no special allure for you, you may be interested in our Silic-O-Netic relays simply as well-made, reliable time-delay switching devices. They're available in a wide range of timings from ¼ to 120 seconds, and with a variety of AC and DC coil voltage ratings. Bulletin 5005 will give you detailed specifications. We'll be glad to send you a copy.

HEINEMANN ELECTRIC COMPANY

2600 Brunswick Pike, Trenton, New Jersey 08602

tems, the vast area in which the spacecraft might be at the moment of the decision to ignite the Saturn rocket's second stage and inject the Apollo vehicle into a lunar path. The spacecraft's location at that moment will depend on many variables: the vehicle's orbit, the condition of all systems on board, the relative positions of the earth and moon, and the condition of the astronauts. Also, important telemetry data must be transmitted a few minutes before, during and after this power-flight phase, for study later.

"The voice relay is the primary justification for spending the money," Politzer says. "Telemetry data is an additional benefit for diagnostic purposes."

The system was designed around the critical 10-minute interval during which injection burn occurs. ARIA planes will also be used to keep track of Apollo as the spacecraft reenters the earth's atmosphere, but this is a secondary part of ARIA's mission.

Multipath's challenge. One of ARIA's major engineering targets is to overcome multipath effects, the appearance at the receiver of both direct and reflected signals with a resulting loss of data. In a digital data system, the arrival of signals that have traveled along separate paths often smears zeros and ones and degrades the information content.

"ARIA represents one of the most thorough investigations of multipath effects in line-of-sight transmission ever attempted," Politzer says.

Ground stations combat multipath interference by using large-aperture antennas, which produce narrow beams and are therefore insensitive to signals arriving along a path outside the beam pattern. But multipath problems become more pronounced in the air. "Range isn't a problem; we are angle-limited," says David J. Graham, head of the ARIA instrumentation program at Goddard, where the problem has been studied intensively for the past two years. Signal strength at the horizon may be strong, but it fades fast with elevation, he explains. At S band, the signal fades as often as 200 times a second. Over water, the duration of a fade varies widely, depending

8A3189

absolutely NO spurious response!

New Hewlett-Packard 537A. Today's easiest-to-use, easiest-to-read, and most dependable coaxial frequency meter gives you 3.7 to 12.4 gc measurements, the broadest bandwidth available, for only \$500.

The error-proof 537A uses a one-quarter wavelength tuning mode and capacitive loading to guarantee no spurious responses (half-wave types, for example, can give responses at 4, 8 and 12 gc). And dip at resonance is at least 1 db. Here's an instrument that can't be mis-read!

And it gives you direct and accurate reading of frequencies: High resolution is provided by a spiral dial with an 80" scale, with all frequency calibrations visible. To tell you, at a glance, the specific portion of the band you're measuring. Excellent resolution and readability permit individual scale correction charts to be made and readings repeated with even higher accuracy. Calibration marks are 10 mc apart.

Even at the high-frequency end of the dial, minimum spacing between calibrations is about 1/32", so you may easily resolve small differences of frequency. The tuning plunger is spring-loaded, to eliminate backlash.

Similar performance, 960 mc to 4.2 gc, is yours with the Hewlett-Packard 536A Coaxial Frequency Meter, \$500. Calibration increments of the 536A are 2 mc apart.

The specs tell the story. The 537A is a value-priced, quality instrument you can't afford to be without if you need to measure frequencies in expanding applications for coax systems or devices. Ask your Hewlett-Packard field engineer to demonstrate, or write for complete technical data. Hewlett-Packard, Palo Alto, California 94304, Tel. (415) 326-7000; Europe: 54 Route des Acacias, Geneva; Canada: 8270 Mayrand Street, Montreal.

COAX FREQUENCY METER to 12.4 GC

SPECIFICATIONS, 537A

Frequency range:	3.7 to 12.4 gc
Dial accuracy:	±0.1% (includes backlash)
Overall accuracy*:	±0.17%
Dip at resonance:	at least 1 db
Reflection coefficient off resonance:	<0.33 (2.0 swr)
Calibration increments:	10 mc
Connectors:	Type N female
Size:	5 3/4" high, 3 1/2" diameter, 4 3/8" base width, including connectors (146 x 89 x 117 mm)
Weight:	3 1/2 lbs. (1,6 kg)
Price:	\$500

*Includes allowance of ±0.02% for 0-100% relative humidity, ±0.0016% per °C from 13-33°C



HEWLETT *hp* PACKARD
An extra measure of quality

Data subject to change without notice. Price f.o.b. factory.

Rosenthal
RIG

WATER COOLED

(MINIATURIZED)

&

AIR COOLED

CERAMIC

**TRANSMITTER
CAPACITORS**

14 kVp—150 A RF 1500 kVAr



15 kVp—24 A RF 50 kVAr

For:

**COMMUNICATIONS
INDUCTION HEATING**

Write for literature to:
**United Mineral
&
Chemical Corp.**

129 HUDSON ST.
NEW YORK, N. Y. 10013
(212) 966-4330

on how rough the sea's surface is.

Multiple remedies. The basic strategy for combating multipath effects in the air is to carry as large an antenna as possible aboard the aircraft. The ARIA dual-frequency antenna, a seven-foot steerable parabolic dish in the nose of the aircraft, is believed to be the largest dish ever placed on an aircraft. It will have a wide frequency range, permitting transmission and reception of very-high-frequency and S-band signals from the one aperture. The high-gain steerable antenna will scan to acquire the target, and then autotrack.

Polarization diversity will also join the fight on multipath interference. Vertical and horizontal signal elements will be received simultaneously and sent to separate receiver systems. This should further increase reliability.

Another technique will be to tilt the tracking antenna upward electronically. "We will be able to lift the horizontal portion of the vhf beam with phase shifters," Graham says; "in other words, we will shape the bottom of the beam in a way that will minimize the gain in the direction of the signal reflected off the water."

Frequency-diversity techniques also will be tried where available in the down-links from the spacecraft. The same video signal will modulate two carriers, and the receiver system will choose the best available signals.

More reliability. The ARIA system will use predetection recording—the technique of recording all telemetry data and demodulating it later. This is already in use on the Atlantic missile range [Electronics, Feb. 22, p. 98].

ARIA will also use a predetection combining system. The predetection combiner will sample each channel instantaneously and determine the degree of interference present. The receiver will then detect and combine the two signals proportionately, with the weighting function dependent on the degree of interference, rather than on the input signal level, as in a conventional receiver.

Rfi too. By careful filtering and design, engineers hope to avoid radio-frequency interference problems aboard the ARIA planes. The aircraft will have a delicate com-

ination of powerful transmitters and highly sensitive receivers. Low-noise broadband preamplifiers, probably tunnel diodes or parametric amplifiers, will be designed into the front ends.

The antenna in the nose of the plane will put out 100 watts at S band for voice and 100 more watts at vhf for voice. Simultaneously, it will be receiving voice and telemetry signals from the spacecraft. A trailing wire antenna and wing probes will be transmitting 1,000 watts for the air-to-ground voice relay.

II. Up and down links

The up-link from ARIA to Apollo will carry S-band voice channels at 2,100 to 2,300 megacycles per second, and vhf voice channels at 296.8 Mc. The down-link will carry S-band telemetry and voice, also vhf telemetry and voice.

Two-way voice channels between ARIA jets and the space vehicle will be relayed instantaneously to the Mission Control Center at Houston via high-frequency radio and the Defense Communications System network. Voice going up from Houston to the aircraft by high-frequency carrier will key an ARIA transmitter, which will then convert the signal instantaneously to vhf and transmit it to the spacecraft in a fraction of a second. The reverse procedure will take place with voice signals traveling from Apollo to Houston.

Other channels will provide for two-way teletypewriter transmission at 100 words per minute between Houston and the ARIA planes, and the down-link from Apollo will include provisions for delayed telemetry. This data will be recorded aboard the aircraft and either flown to the nearest ground station or dumped via vhf channels, when in reach of a ground station or ship. Telemetry equipment will operate in the 215- to 260-megacycle band.

Decision tracker. To save space, the ARIA planes will use a two-channel monopulse tracking system instead of the more common three-channel technique. Two receivers will constitute the tracking unit. By means of a diversity combiner, all outputs of the receivers will go into this tracking unit and the built-in logic will decide to which output

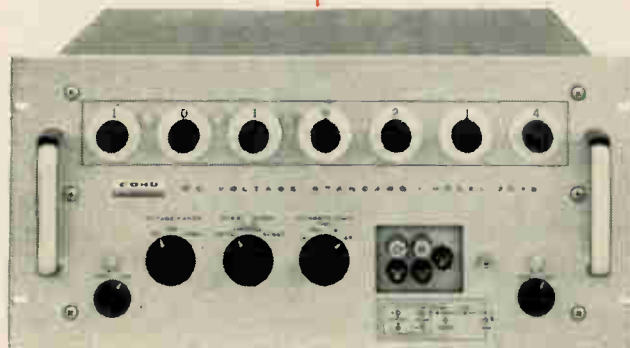

KIN TEL'S remarkable Model 303B DC Voltage Standard

NEW! DC STANDARD ACCURATE AND STABLE ENOUGH TO CALIBRATE ANY DIGITAL VOLTMETER!

Now there's a source of accurate, precisely adjustable DC from zero to over ± 1100 volts for just about any laboratory or industrial application—including calibrating and testing digital voltmeters! It's KIN TEL'S Model 303B DC Voltage Standard.

1 μ V-STEP ADJUSTMENTS. Look at its seven decade controls. These readout-type dials let you control output in microvolt steps from 0 to over ± 11 volts, in 10-microvolt steps to over ± 111 volts, and in 100-microvolt steps to over ± 1111 volts.

0.01% ACCURACY, 0.0025% STABILITY. The output is accurate to within 0.01% of the dial setting, and is stable to within 0.0025% for seven days and to within 0.005% for six months. Resolution is 0.1 part per million of full scale.

5, 10, 15, or 25 MA CURRENT. With the 303B, you can get up to

25 milliamperes of current on any voltage range, or you may limit the output by panel control to 5, 10, or 15 milliamperes. If the current you select is exceeded or if the output voltage deviates from the dial setting, an overload relay automatically disconnects the output terminals and causes an indicator lamp to glow.

FLOATING GUARDED CIRCUIT. Because the circuit is fully isolated from both ground and chassis, and is completely shielded and guarded, you may operate it either grounded or floating. Common-mode rejection is 120 db at 60 cps. Separable, sampling terminals provide effective source impedance at the load of 0.001 ohm.

Price: \$2695. F.O.B., San Diego. (Additional export charge; programable, AC/DC, and cabinet versions at factory request.) Write for literature or demonstration.

Representatives in all major cities • Box 623, San Diego, California 92112 • Phone (714) 277-6700



Acme Electric SHOULD BE YOUR BEST SOURCE

FOR REGULATED D. C. POWER SUPPLIES

If design experience and performance reliability are factors to be considered in your buying, then Acme Electric should be your first-choice source for D. C. Power Supplies. Converting alternating current to direct current is an old Acme Electric specialty. In over 35 years we have produced millions of low-voltage power supplies for battery charging and thousands of high voltage power supplies for electrostatic precipitons. We've had our hand in the "state-of-the-art" for a long time and know the limits of each component for each application.

The standard stock model "off-the-shelf" D. C. Power Supplies listed below were designed to provide reliable performance at an economical price.

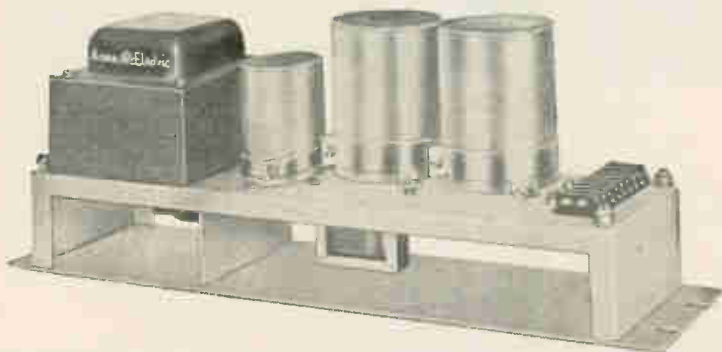

Check these features:

- ✓ All solid state components are rated for continuous duty.
- ✓ Convection cooled — no fan or other moving parts.
- ✓ May be paralleled for multiplying ampacity.
- ✓ Fast response to line and load changes.
- ✓ Line regulation, $\pm 1\%$.
- ✓ Load regulation $\pm 2\%$.
- ✓ Ripple, 1% RMS maximum.
- ✓ Operating temperature range, 0°C. to 50°C.

PARTIAL LISTING OF STOCK MODELS AVAILABLE SINGLE PHASE, 100-130 Volts; Input 50 or 60 Cycles

Catalog Number	D. C. OUTPUT			Catalog Number	D. C. OUTPUT		
	Volts	Amps	Watts		Volts	Amps	Watts
PS-47509	10	4	40	PS-1-47461	24	75	1800
PS-47623	12	3	36	PS-1-47200	24	100	2400
PS-47508	15	2	30	PS-47202	26	4	104
PS-57352	22	25	550	PS-47638	28	8	224
+PS-41422	24	2	48	PS-47712	28	25	700
+PS-41423	24	6	144	PS-57355	28	30	840
PS-57353	24	10	240	PS-57356	44	25	1100
+PS-47125	24	15	360	PS-41424	38	4	192
PS-57354	24	20	480	PS-57357	48	6	288
+PS-47173	24	25	600	PS-47519	48	10	480
PS-1-47127	24	50	1200	PS-57358	48	15	720

+ 24 volt output units of same current rating can be paralleled to multiply current capacity.

Write for catalog 175 and full list of "off-the-shelf" D. C. Power Supplies.

Acme  Electric

Engineers and Builders of...

3110 WATER STREET, CUBA, NEW YORK

Canadian Representative: Polygon Services, Ltd.

50 Northline Rd., Toronto 16, Ont.

SAA-3932-3220

REGULATED POWER SUPPLIES
STATIC POWER RECTIFIERS
VOLTAGE STABILIZERS
VOLTAGE REGULATORS

the antenna servo system should be responding; it will select the output that is not necessarily the strongest, but the one with the least signal interference.

The servo system will steer the antenna continuously. If the signal is lost momentarily, a memory device will permit continued tracking at the same rate and in the same direction.

Under consideration by the Air Force and NASA is a digital computer that will be used to monitor the entire system and to aid in tracking.

III. The future

If the proper kind of satellite were available, says Graham, ARIA could use it as a relay station. "It is now technically feasible," he declares, but the satellites would require higher-gain antennas and higher transmitter power than those on the currently available Early Bird satellite.

In late 1966 Goddard will put up the first of its advanced technological satellites.

ATS-1 will have a two-way voice relay capability and operate in vhf; its high-gain antennas and transmitter will add up to radiated power of 300 watts.

Vhf transponders aboard a satellite would require only simple omnidirectional antennas on the planes. Engineers working on ARIA say they expect such communications satellites to be available soon. Meanwhile, ATS-1 is still considered an experimental satellite.

In addition to Apollo and other space-program needs, vhf-equipped satellites would be valuable in two-way ground-to-aircraft communications for commercial airlines. Last August, after NASA disclosed plans to equip the ATS-1 with a vhf transponder, several airlines and the Federal Aviation Agency started plans for experiments to test the satellite's value in commercial aviation. Arinc, Inc. is coordinating the airlines' participation in the tests.

The satellites to be launched in 1967 by the Communications Satellite Corp. for ship-to-Apollo links (see p. 25) cannot be used by the ARIA fleet. For tracking, two satellites would require prohibitively large antennas aboard the aircraft.

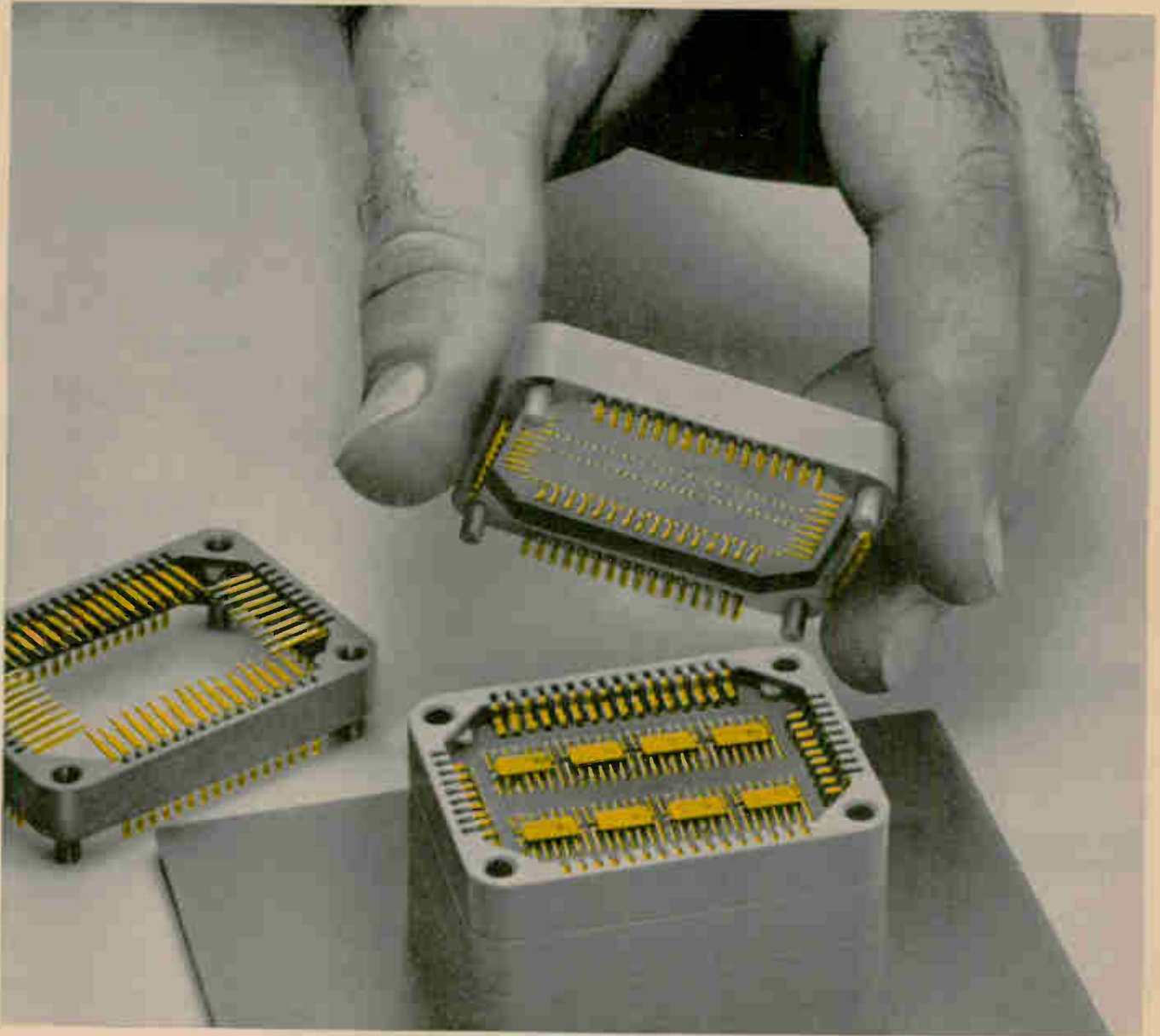

Heads up microcircuitry

Microcircuitry itself is presently available in many forms with units packaged principally in flat packs, transistor cans or cubical cases. Innumerable variations are available in each of these package types. And for each type of package AMP has a connector, including this new active pin stacking connector.

The A-MP★ Stacking Connector is capable of housing eight flat packs or other types of pre-wired microcircuitry, and is presently available in a 50-position contact size. The one-piece active pin contacts are plug-gable to plated holes in a board. They can be flow soldered, if desired, after the circuit test and burn-in phases have been completed. Additional connectors can be stacked on the first. Interconnections through the stack is accomplished by the active pin contacts. These interconnections are easily programmable. A typical application variation of this basic connector is a special receptacle with crimp-on, snap-in contacts used to interconnect the stack instead of a circuit board.

Each A-MP Active Pin Stacking Connector features:

- 50 active pin contacts on .075" centers
- AMP's exclusive gold over nickel contact plating
- Tough, heat-resistant LEXAN® housings
- Polarized housings

- Integral heat vents
- Housing occupies a maximum of three square inches
- Each connector accommodates eight flat packs or will accept other pre-wired microcircuits
- Maximum top-of-the-board, multi-level circuit flexibility at low installed cost.

Each system for packaging microcircuits is different. The A-MP Active Pin Stacking Connector is only one of many special connecting systems designed by AMP to satisfy a variety of requirements.

For the complete story on the head start AMP has on microcircuit packaging write for the informative booklet "Connectors for Microminiature Circuits".

©Trademark of General Electric Co., Inc

★Trademark of AMP INCORPORATED



A-MP★ products and engineering assistance are available through subsidiary companies in: Australia • Canada • England • France • Holland • Italy • Japan • Mexico • Spain • West Germany

**Last week,
you needed
a
switchlite.**



**Today,
you need a
pushbutton
switch.**



**Tomorrow, a
subminiature
toggle
switch.**



**Next Tuesday, a
hermetically-
sealed
switch.**



Good thing Control Switch is around to help.

We're unique among switch suppliers. No other manufacturer makes all the kinds of switches we make. And some don't make any of them.

When we're around to help, you can have your choice of:

3,150 toggle switches

4,200 pushbutton switches

1,240 hermetically-sealed switches

1,800 lighted pushbutton panel switches

460 basic precision switches

1,180 indicator lights.

... plus countless more standard variations.

These are quality switches and switchlites ... for computers, aircraft, missiles, controls, industrial and electrical equipment where performance standards demand the ultimate in reliability.

Keep your Control Switch distributor ... or us ... in mind. Today. Tomorrow. Next Tuesday.



CONTROL SWITCH DIVISION
1420 Delmar Drive, Folcroft, Pennsylvania 19032

NEW LOW NOISE FETS from DICKSON with FULL NOISE SPECS

and they cost no more than the 2N units from which they evolved

■ If you have a circuit on the bench that uses low noise FETs, then you'd better take a close look at the specs on these new units from Dickson. Here's real low noise performance . . . and you don't have to pay a premium for it either. Briefly, these new Dickson FETs are high input impedance voltage controlled N-channel silicon epitaxial passivated devices supplied in a TO-18 case. Temporary device numbers are:

DN3066A	DN3365A
DN3067A	DN3366A
DN3068A	DN3367A
DN3069A	DN3368A
DN3070A	DN3369A
DN3071A	DN3370A

■ Prices are identical to the popular 2N3066-71 and 2N3365-70 JEDEC series from which they were developed. The big difference in these new Dickson units is their exceptionally low noise figure (NF). In addition to the NF measurement, Dickson has gone a step further and expanded the noise specifications.

NOISE CHARACTERISTICS DICKSON DN3066A-71A and DN3367A-70A				
	Typical	Max	Unit	Test Condition
Noise Figure (NF)	0.1	0.25	db	$R_i = 1 \text{ megohm}$
Equivalent (E_N)	--	50	$nV/\sqrt{\text{Hz}}$	$f = 100 \text{ Hz}$
	--	25	$nV/\sqrt{\text{Hz}}$	$f = 1 \text{ kHz}$
	--	15	$nV/\sqrt{\text{Hz}}$	$f = 10 \text{ kHz}$
Equivalent Noise (R_{N_s}) Resistance	5,000	--	Ohms	$V_{DS} = 25V \quad V_{GS} = 0$

*nV = 10^{-9} volts

■ FET NOISE REPORT AVAILABLE

For additional information on FET noise characteristics write for Dickson FET Engineering Noise Report #1

FOR COMPLETE TECHNICAL INFORMATION use this publication's reader service card or write, wire, or phone Dickson



DICKSON
ELECTRONICS CORPORATION
P.O. BOX 1387, SCOTTSDALE, ARIZONA 85252
EUROPEAN SALES OFFICE
MUNICHEN 55, GERMANY, OSSINGERSTR, 21, TEL. 746565

Manufacturers of quality zener diodes, rectifiers, tantalum capacitors, solid state circuit breakers, field effect transistors.

The next time, buy Weston

Local service available coast to coast

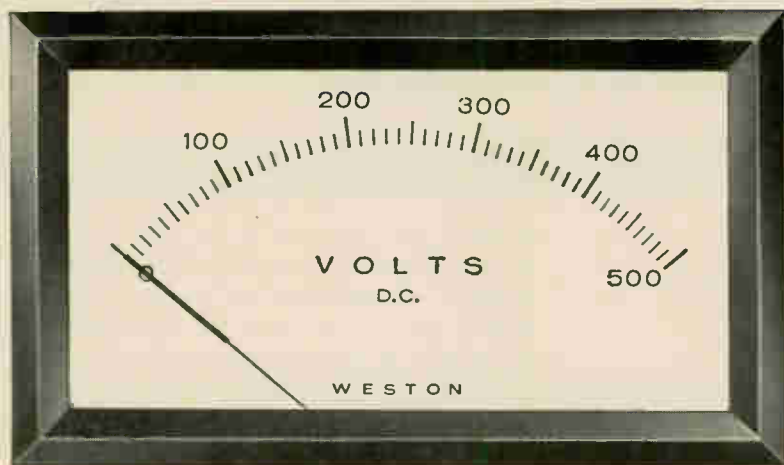

- Available off the shelf ■ Competitive prices
- Same-day delivery ■ Fastest delivery on custom designs

Ask for Weston...

Call your local Weston distributor or Sales-Servicenter today.
And don't forget to ask for your copy of the new Stock Panel Meter Selector.

QUALITY BY DESIGN
 **WESTON INSTRUMENTS, INC.**
614 Frelinghuysen Avenue, Newark, New Jersey 07114



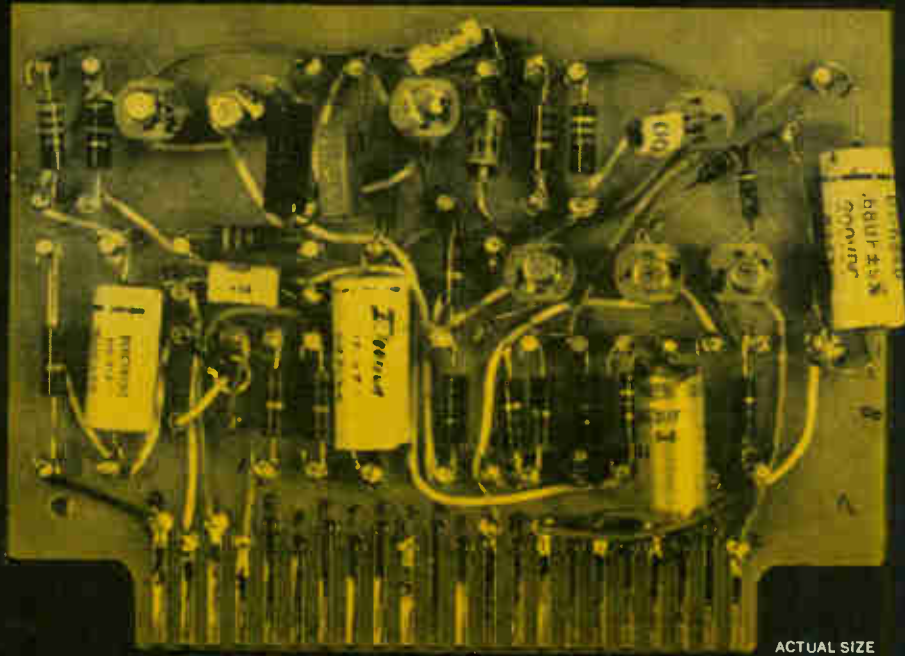

ACTUAL SIZE

What made this avionic DC amplifier circuit obsolete?



ACTUAL SIZE

Hamilton Standard's new Microcircuit Packaging Technology

The use of Hamilton Standard microcircuit modules has reduced the size and weight of temperature controls in the Navy's advanced Ling-Temco-Vought A7A light attack aircraft. They function as DC amplifiers in two identical controls for the cabin and pilot's vent suit.

Each module replaces a multi-component 3½ x 4½-inch circuit board,

resulting in a 16% weight reduction. Design, production and testing are greatly simplified. Reliability is improved by electron-beam welding of interconnections within the module, and complete hermetic sealing.

Hamilton Standard's design team is experienced in custom circuit packaging and will assist circuit designers in component selection and circuit layout.

This technology allows flexibility in interconnecting and packaging both uncased integrated circuits and semiconductors for both digital and linear applications.

For more information on this new microcircuit packaging technology, write to Sales Manager, Electronics Department, Hamilton Standard, Broad Brook, Connecticut 06016.

Hamilton Standard DIVISION OF UNITED AIRCRAFT CORPORATION

U
A

ELECTRONICS • ATTITUDE CONTROLS • STABILIZATION SYSTEMS • ENVIRONMENTAL CONTROLS • FUEL AND AIR INDUCTION CONTROLS
ELECTRON BEAM MACHINES • PROPELLERS • STARTERS • TURBOMACHINERY • GROUND SUPPORT EQUIPMENT • OVERHAUL AND REPAIR

A versatile operational amplifier

Single unit combines top performance for gain, bandwidth, slewing rate, input impedance, and d-c drift

An engineer who wants an operational amplifier with 10-megacycle bandwidth can buy one without much trouble; if he requires an instrument with a 126-decibel open-loop gain, he can get that, too. But an amplifier that meets both specifications is likely to be costly; and if he wants maximum voltage drift of 5 microvolts per degree centigrade, a slewing rate of 30 volts per microsecond, and 6 megohms differential input impedance, his only recourse is to build his own.

Or it was, until Analog Devices, Inc., of Cambridge, Mass., came up with an off-the-shelf differential amplifier that meets all five specs and is priced lower than other amplifiers that are far less versatile. The unit, which comes in three models in the Series 102, also delivers a short-circuit-proof ± 11 -volt output at 20 milliamps.

Most differential amplifiers with 10 Mc or more of bandwidth require that the plus input be grounded to obtain fast response. Analog's amplifier, however, provides high-frequency gain on both the plus and minus inputs (see schematic). This feature, explains

Ray Stata, Analog vice-president, enables the amplifier to maintain fast response in differential and noninverting operating modes.

The maximum drift figure is guaranteed. Many competitive amplifiers are specified in terms of "typical" drift. The Series 102 has three voltage-drift grades, models A, B, and C, with maximum drifts of 20, 10 and 5 microvolts per degree C. This choice, according to Stata, enables a user to pay only for what he needs, without overspecifying to allow for deviations from "typical" drift figures. Maximum current drift for all models is 0.2 nanoamp per $^{\circ}\text{C}$ from -25°C to $+75^{\circ}\text{C}$. Long-term drift is less than $10 \mu\text{V}$ per day.

Stata sees the Series 102 amplifier as ideal for the whole range of instrumentation, computing, and control applications. He cites the specifications as being eminently suitable for fast analog-digital converters, sample-and-hold circuits, sensitive go-no-go detectors, null detectors, and zero-crossing monitors. In the operational field, he foresees uses as scalars, differentiators, summers, subtractors, and

low drift integrators.

Owing to the amplifier's unusually high input impedance and low current drift coupled with fast response in the differential mode, Stata also sees applications as fast voltage-followers, unloading amplifiers, and pulse amplifiers.

Specifications

Bandwidth at unity gain	10 Mc
Gain at d-c	126 db (2×10^6)
Slewing rate	30 volts/ μsec , full output to 500 kc
Differential input impedance	6 megohms
Common-mode input impedance	500 megohms
D-c common-mode rejection ratio	20,000 to 1
Output	± 11 volts, 20 ma
Current drift	0.2 nanoamp / $^{\circ}\text{C}$ max.
Voltage drift	20 $\mu\text{V}/^{\circ}\text{C}$ max. (Model A)
	10 $\mu\text{V}/^{\circ}\text{C}$ max. (Model B)
	5 $\mu\text{V}/^{\circ}\text{C}$ max. (Model C)
Construction	P-c mounting, epoxy encapsulated package.
Size	1.2 in. x 2.1 in. x 0.62"
Unit Prices	1-4 5-9 10-24
Model A	\$90 \$87 \$81
Model B	\$100 \$97 \$90
Model C	\$120 \$116 \$108

Analog Devices, 221 Fifth St., Cambridge, Mass.

Circle 350 on reader service card

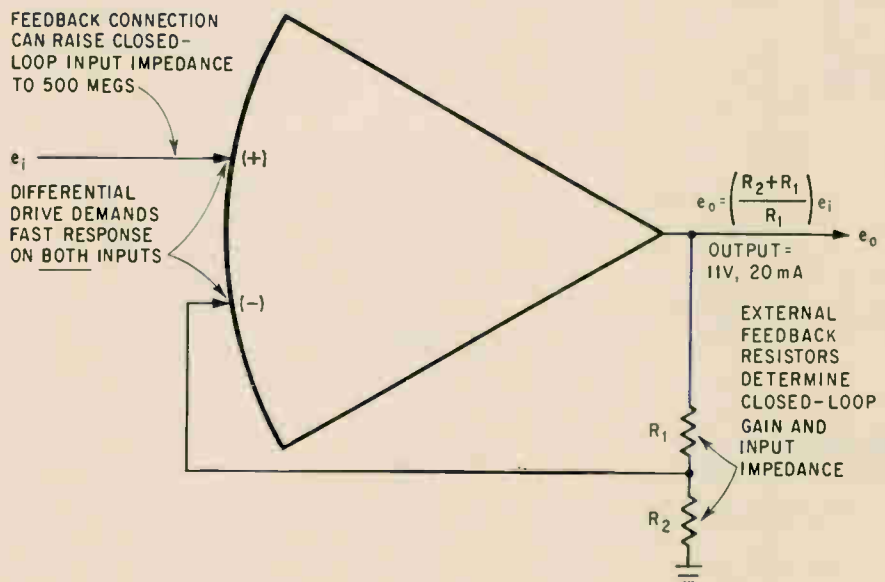

Bulova forks solve low frequency problems

Let the experience behind 300,000 forks per year help you!



American Time Products forks are now available up to 25 kc, thanks to years of experience plus new design techniques developed by Bulova. (Including the tiny forks for Accutron® electronic timepieces, Bulova made 300,000 last year alone!)

Result: ATP units provide lower cost, smaller size, lighter weight and greater long term stability in such applications as Computers, Navigation Systems, Doppler Radar, Motor Drives, Encoders and Timers. Accuracies of up to 0.001% are available.

Bulova fork oscillators offer the added advantage of simplicity of design and circuitry. Fewer components mean greater reliability. Finally, Bulova fork products are uniquely capable of withstanding severe shock and vibration environments. No wonder Bulova sold 300,000 last year!

FS-11 FORK FREQUENCY STANDARD

Standard Frequencies: Up to 10,000 cps

Accuracy: Up to $\pm 0.001\%$
Input: 28V DC (others on request)

Output: 5 volts p-to-p min. into 10K ohms
Temperature Range: As low as -55°C to as high as $+85^{\circ}\text{C}$
Size: $1\frac{1}{2}$ in. sq. x $\frac{3}{8}$ "



SUB-MINIATURE TF-500 TUNING FORK

Standard Frequencies: Up to 2400 cps

Accuracy: Up to $\pm 0.001\%$ at 25°C

Input: 28V DC (others on request)

Output: Up to 5V rms into 20K ohms

Temperature Range: As low as -55°C to as high as $+85^{\circ}\text{C}$

Size: $\frac{3}{8}$ " x $\frac{3}{4}$ " x $1\frac{1}{2}$ " max.

Write or call for specifications on Bulova's complete line of tuning fork products. Address: Dept. E-16.

BULOVA

AMERICAN TIME PRODUCTS

ELECTRONICS DIVISION OF BULOVA WATCH COMPANY, INC.

61-20 WOODSIDE AVENUE WOODSIDE, N.Y. 11377, (212) DE 5-6000

New Components and Hardware

Crimped connector joins wire reliably

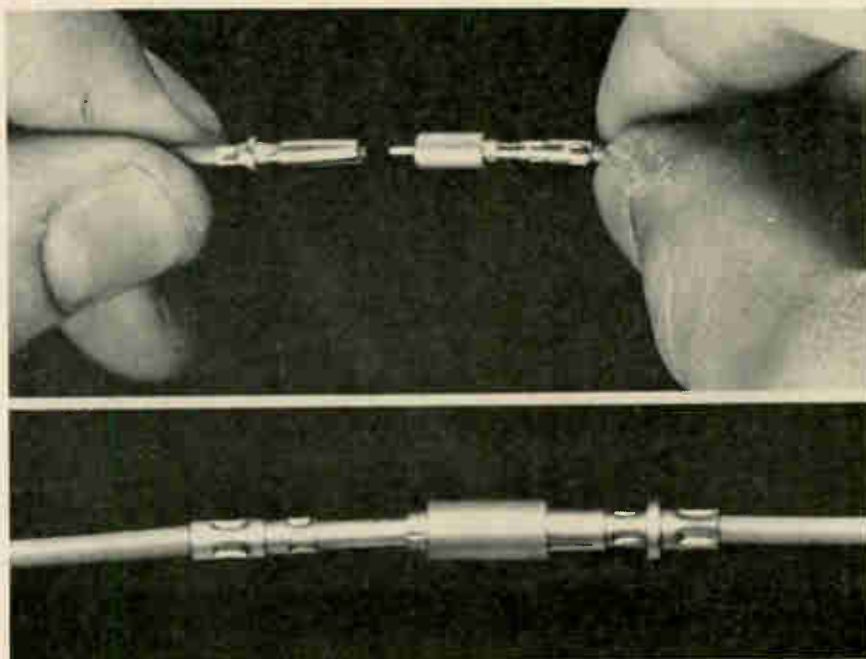

In electronic circuits, it is often necessary to provide a reliable interconnection between two small wires, either by soldering, welding, using retention clips, or connecting the ends of the wires to a standard pin-and-socket connector. Each of these methods has its own advantages and disadvantages as to reliability of the connection, cost of assembly, and ease of connecting and disconnecting the wires.

A new type of connector, developed by Solatron Enterprises, Culver City, Calif., is said to combine the advantages of present methods used to connect wires, without their disadvantages. Solatron's ConeX connectors permit wires to be joined at any point in a circuit, and work equally well with either solid or twisted wires.

The connectors consist of a sleeve end, which fits into a metal collar, or collet. Wires are inserted into both ends, and can be crimped with a special tool. However this tool is used to facilitate assembly and is not essential to a sound connection. The ends of the wires make direct contact with each other, and the terminals are held securely by the metal collar. The terminals can be permanently con-

nected to the wires, or quickly disconnected. The connections are claimed to be more reliable than a conventional pin-and-socket connector because of the direct connection between the two wires. In a standard pin-and-socket connector, the terminals may be dislodged. Also, pin and socket misalignment may introduce extraneous electrical noise.

At the present time, the connectors are sold as individual pieces. However, the company plans to provide them arranged as groups in strips or panels.

The connectors are suitable for use in test equipment, instrumentation, radio and tv circuits, and industrial circuits. A company spokesman says the connectors will cut the cost of present methods used to assemble circuits because no solder joints are required, and because assembly is easier than in conventional methods.

Specifications

Connection	Wire-to-wire
Wire sizes	20, 22, 24
Insulation	5/32-in.-diameter shrink sleeving. 250°C insulation available
Military specs	Gold plated per MIL-G-45024, type II, class I.
Cost	\$1.40 each
Solatron Enterprises, 5658 Bankfield Ave., Culver City, Calif., 90230 [351]	

Small metal film resistor meets military specs

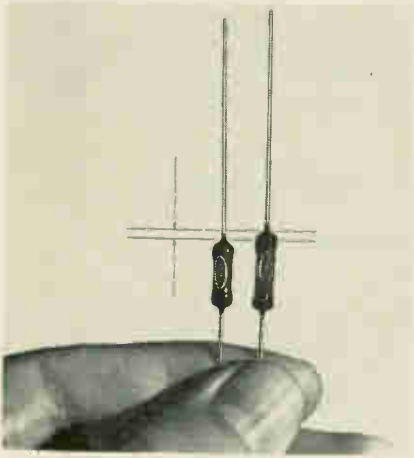

A half-watt metal film resistor is available that meets the electrical and environmental requirements of MIL-R-10509, Characteristics B, C, D and E, but is much smaller than existing types.

The resistor designated MFF- $\frac{1}{2}$ -8, has a packaging density of 55 units per cubic inch, compared with 43 per cubic inch for the standard MFF- $\frac{1}{2}$. It is epoxy coated and its body length, bare lead to bare lead, is only 0.615 in. compared with 0.718 in. for the company's standard MFF- $\frac{1}{2}$. Length of the new resistor, end cap to end cap, is 0.436 in. Maximum diameter is 0.203 in.

The MFF- $\frac{1}{2}$ -8 has a resistance range of 49.9 ohms to 1.25 megohms. Maximum working voltage is 500. Operating temperature at full power is from -65° to 125°C , de-rating to zero power at 175°C . Standard tolerances are 1%, 0.5%, 0.25%, 0.1% and 0.05%.

Dale Electronics, Inc., P.O. Box 488, Columbus, Nebr. [352]

H-v vacuum relay offers fast switching

This spst, high-voltage vacuum relay is capable of switching up to 5 kv in 600 μsec . Model H5/S5, rated at 5 kv and tested at 7.5 kv, has a continuous current-carrying capacity of 4 amps. Designed specifically for high-speed switching of an antenna coupler in a military re-entry vehicle, the unit will withstand shock and vibration in excess of the requirements of MIL-R-5757. Con-

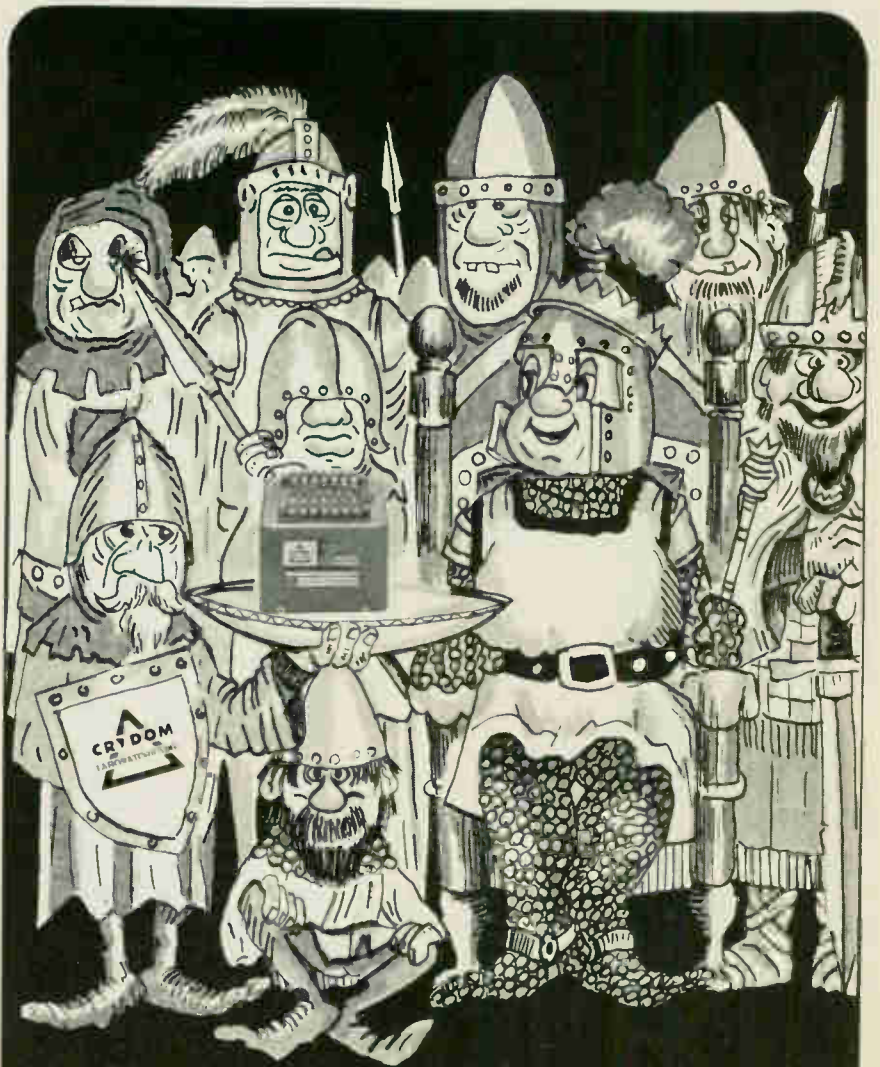

Good Enough to Serve Before a King

You don't have to be a king to get the best in SCR firing circuit modules. Not if you are familiar with Crydom's long line of power control functions. The SCR firing circuit module is designed to provide maximum flexibility and reliability in SCR Circuitry. These units combine the advantages of magnetic amplifier signal isolation with fast response. Isolated gate signal outputs allow application to both AC and DC circuits. Units operate over frequency input range of 50-60 CPS.

Prices start from under \$50. Normal delivery three to four weeks.



laboratories, inc.

3115 WEST WARNER AVENUE • SANTA ANA, CALIFORNIA
Area Code 714 • 540-1390

how to get your Pulse Generator "made to order" from TI

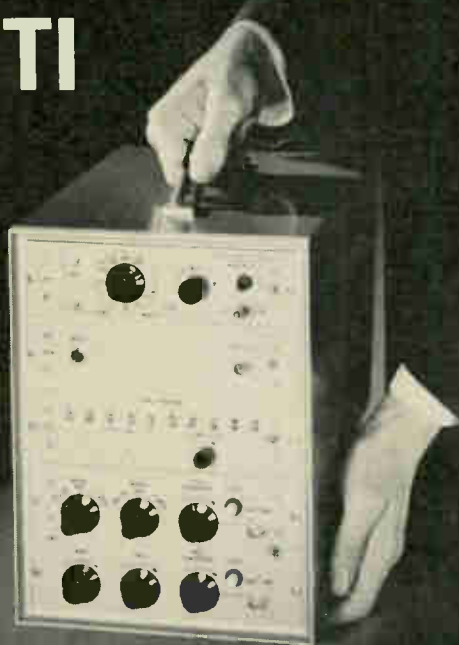

"Special" Pulse Generators are made to order at TI. Modular construction allows assembly of the right building blocks to meet your requirements. Now, "specials" cost you no more, frequently cost less than conventional pulse generators.

For example, the 6613 is an economical general-purpose unit with PRF from 15 cps to 15 mc, priced at only \$950. Another model, the 6325, is a ten-channel, word-bit programmable unit operating up to 25 mc. The single unit does the job of ten discrete generators, at half the cost, and fits in a cabinet 23 in. wide, 38 in. high, 18 in. deep.

TI Pulse Generators give you outstanding performance: PRF's to 100 mc, fast rise and fall times, variable pulse width and delay, variable rise and fall times, plus and minus outputs, pulse mixing, programmed and random word generation. You have your choice of portable or rack-mounting cases.

When you need special pulse generator performance, choose one of the thousands of standard pulse generator combinations from Texas Instruments. For more information, contact your nearest TI Authorized Representative or write to the Industrial Products Group in Houston.

INDUSTRIAL
PRODUCTS
GROUP



TEXAS INSTRUMENTS
INCORPORATED
P. O. BOX 66027 HOUSTON, TEXAS 77006
118 RUE du RHONE GENEVA, SWITZERLAND

New Components

tact resistance is 0.020 ohm, maximum, and coil voltage is 24 v d-c. High Vacuum Electronics Inc., 538 Mission St., South Pasadena, Calif. [353]

General-purpose plug-in relay



A general-purpose plug-in relay, series PAP, offers wide application in automation devices, industrial controls, communications and many other areas where contamination tends to impair normal operation. The rugged and completely reliable relay is molded of general-purpose phenolic and is enclosed in a polystyrene case.

The PAP series boasts excellent insulation properties and dimensional stability, and is furnished with standard 8-pin or 11-pin plug-in base. Relays are available in all standard a-c and d-c voltages from 1- to 3-pole, double-throw, with 5-amp gold-plated silver contacts and 10-amp gold-plated silver cadmium oxide contacts. Hillburn Relay Corp., 55 Milbar Blvd., Farmingdale, N.Y. [354]

Tube sockets feature wire-grip contacts



A line of low-cost tube sockets is available with wire-grip contacts. The contact device provides a safe,

PART 8 of a series on THE STATE OF THE CHOPPER ART

INPUT CIRCUIT IMPEDANCE ABOVE 1000 MEGOHMS

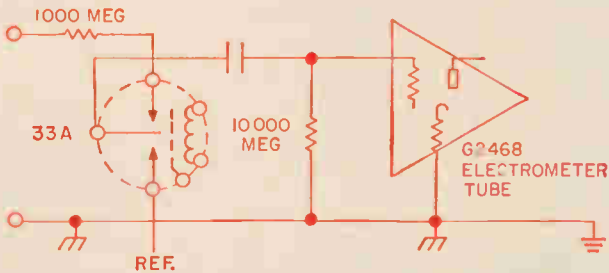

AT 1000 MEGOHMS USE A 33A

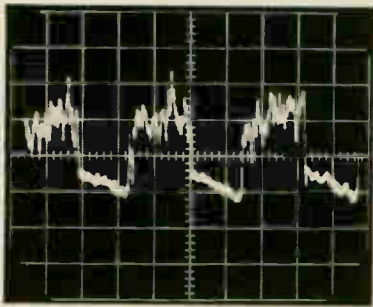

150 MICROVOLT SIGNAL, 10,000 MEGOHMS



33A

We do feel awfully apologetic about using a tube. Maybe if we just kept at it we could get a MOS FET with INSULATED GATE working, and we do know how much better SOLID STATE is. But our Chief Engineer has a mighty small appreciation for creative art. He said meet the budget. So we're sorry, but a G2468 electrometer tube works at 10,000 megohms but only costs a couple bucks. Same reason we used a 33A chopper. No romance. No fun developing new circuits. It just works. Noise and offset? Down around $\frac{1}{4}$ uv.

OFFSET VALUES BELOW 10 NANOVOLTS

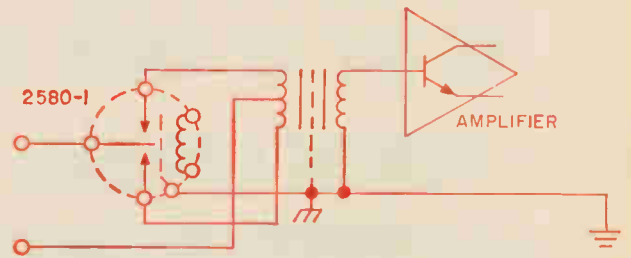

AT 10 NANOVOLTS USE A 2580-1

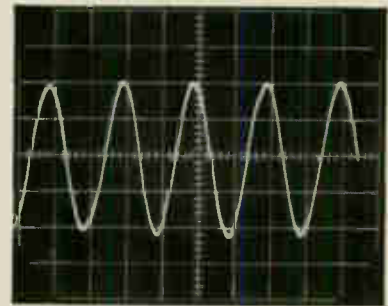

$\frac{1}{2}$ MICROVOLT SIGNAL, 10,000 OHMS



2580-1

We have been deluding our faithful readers. The Airpax choppers we have foisted off all these years were not completely free of noise. In fact some of them, like the 33A next door, were loaded. They run upwards of 200 or 300 nanovolts—0.2 of a microvolt. But perhaps we can make it up to you with the 2580-1. It doesn't seem to have any hum pickup or fixed offset or variable offset. A most rash and unscientific statement. Interpreted, means we don't know how to measure below 10 nanovolts.

Should you use the same chopper at 10,000 ohms or 10,000 megohms? You can. It might be more expensive. Mechanical choppers perform for three reasons. The open contact approaches infinite resistance. The closed contact approaches zero resistance. And the transit between zero and infinity approaches zero time. Reliability? We have photo choppers and transistor choppers to sell you, when you need not save money. Or when you need over 25,000 hours life.

AIRPAX ELECTRONICS incorporated Cambridge, Maryland (301) 228-4600

PULSE GENERATOR and WAVEFORM GENERATOR IN 3½" OF RACK SPACE? YOU'RE LOOKING AT IT!



This compact, all solid state Pulser easily generates pulse patterns like this:

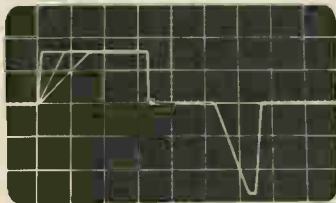

BIPOLAR OUTPUT All widths, amplitudes, slopes separately adjustable—width independent of slope.

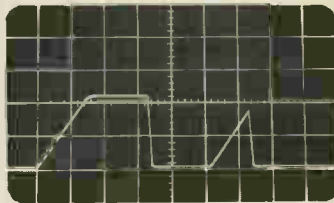

BIPOLAR OUTPUT Negative channel provides offset. Two pulses with adjustable delay.

And complex waveforms like this:



TRAPEZOIDAL PULSE ON PEDESTAL



PULSE ADDED TO RAMP

Fact is, Intercontinental's new PG-32 Bipolar I/E Pulser is designed to handle just about any job you're likely to have for a pulse/waveform generator. For example—repetition rate goes all the way from 0.1 c/s to 20 mc/s. Two dual pulse channels permit either single or delayed pulse operation, simultaneous positive and negative output, or bipolar output. Outputs can be voltages up to 35 volts and currents up to 400 ma. Slope conformity is linear within 5%. Rise time is variable from 8 ns, with 100:1 slope control on any scale.

At \$1385, the PG-32 is an unbeatable buy for performance, versatility and application flexibility. A call will arrange a demonstration or bring you complete specs.



INTERCONTINENTAL INSTRUMENTS INC.

125 Gazza Boulevard, Farmingdale, N.Y. 11735
(516) MY 4-6060

New Components

economical method of wiring assembly. There is no time lost due to replacement of wires before soldering, since the wires cannot work loose once they are inserted.

The tube sockets are supplied with laminated insulating plates of XP or XXP phenolic or X2B hard rubber. Contacts are available as cadmium-plated or electroless-tinned brass. Integral ground tabs can be provided. Both 7-pin miniature and 9-pin noval types are available.

Prices range from 4½ to 6 cents, depending on quantity, with 1000 as a minimum order.

Cinch Mfg. Co., 1026 South Homan Ave., Chicago, Ill., 60624. [355]

Boron nitride useful in mounting wafers

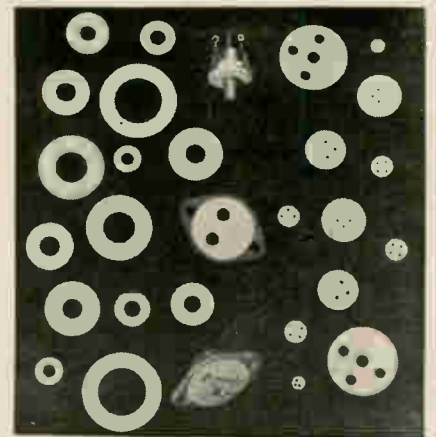

Semiconductor mounting wafers of boron nitride are now available in 17 different sizes and shapes. An unusual combination of properties in boron nitride allows the wafer to insulate the semiconductor from the chassis while conducting heat generated in the semiconductor into the chassis, which acts as a heat sink. Because dry boron nitride has a thermal resistance of less than 0.1°C per watt, conductive greases are often not required.

Available in 1/16- and 1/8-inch thicknesses, the wafers are tough and durable, yet soft enough to permit penetration of chassis burrs, simplifying assembly and improving thermal contact, the manufac-

turer says. Because they are 33% lighter than other premium materials, they reduce package weight considerably, according to the company.

Union Carbide Corp., Carbon Products Division, 270 Park Ave., New York, N.Y., 10017. [356]

Attenuator uses a rocker switch

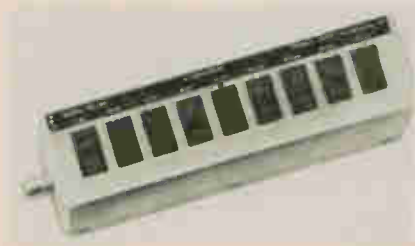

A wide-range rocker-switch attenuator, model SA-50, covers a range of 0 to 102 db in 1 db steps. The use of a rocker switch instead of the conventional bat-handle toggle switch enables the user to vary attenuation quickly and accurately with finger-tip control.

The SA-50 operates over a range from d-c to 1 Gc. Vswr is 1.2 to 500 Mc and 1.5 from 500 Mc to 1 Gc. Impedance is 50 ohms; power rating, 1 w. Accuracy is ± 0.3 db/pad up to 500 Mc and typically ± 0.5 db/pad from 500 Mc to 1 Gc. Connectors are BNC.

The attenuator measures $6\frac{1}{2} \times 1\frac{3}{4} \times 1\frac{3}{4}$ in. Price is \$85; delivery 30 days.

Texscan Corp., 51 Koweba Lane, Indianapolis, Ind. [357]

Miniature trimmer with high resistance

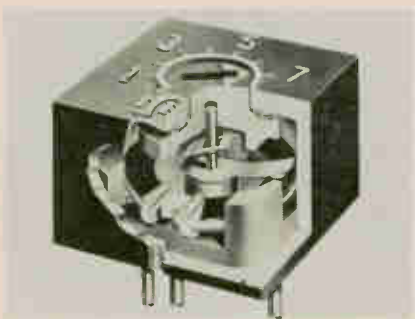

The resistance limit of these new $\frac{1}{8}$ -in.-cube trimmers has been effectively increased by using metal

So what's new in FETs besides sources?



We introduced the industry's first Field Effect Transistors in 1961. Now, there are nearly as many sources of FETs as there are customers for them. But, for really new ideas in FETs, Crystalonics is still the one to watch. For example, here are new FETs introduced by us during a recent 12-month period!

FOTOFET™ . . . a light-sensitive FET designed for Photo-Choppers, Photo-Couplers, Laser Detectors, Hi-Speed Photo-Switches, etc. . . . packaged in a TO-18 case with a glass lens top. Typical drain-current sensitivity is 30 microamps per foot-candle. Gate dark current is typically 0.05 nano-amps. Measured rise and fall times are 30 and 50 nanoseconds, respectively. Because FOTOFET is voltage-operated, you can adjust its sensitivity over a million-to-one range simply by varying the gate resistor. FOTOFETs are available from distributor stock for only \$22.50 each in 1-99 quantities. To request Application Note ANF8, Circle Reader Service = 284

POWRFETs™ . . . 4 new High Power Gain FETs designed for RF Amplifiers, Hi-Speed Switches, Laser Drivers, etc. Types CP600-603 feature typical on-resistance of 40 ohms, typical gate-to-drain capacitance of 10 picofarads, drain currents as high as 300 milliamperes, and transconductances as high as 60,000 micromhos. POWRFET prices start at \$42.75. Delivery is from stock. To request Application Note ANF9, Circle Reader Service = 285

Ultra-Low Noise FETs . . . designed for IR Detectors, Transducer Amplifiers, High Impedance Amplifiers, etc. . . . featuring a typical noise figure of 0.1 DB, and a maximum of 0.5 DB. With a 500 pfd capacitive source, our 2N3088A and 2N3089A FETs generate a typical broadband noise level of only 1 microvolt from 10 cps to 15 KC. They are ideal for video applications through 10 MC, as well as sonar, infrared, and other high detectivity requirements. They're available from distributor stock at \$45 each in 1-99 quantities. To request Application Note ANF7, Circle Reader Service = 286

Solid State Electrometer. Our Applications Engineering Department also has been innovating. Want to know how to use a low cost junction FET like our C680 as an electrometer with less than 10 pico-amps of input current over a broad temperature range? Throw out that noisy, unstable MOS and Circle Reader Service # 287

Circle Reader Service Numbers shown above.

i Crystalonics, Inc.

EASTERN - 147 SHERMAN STREET • CAMBRIDGE 40, MASS. • TEL: 617-491-1670
WESTERN - 6715 HOLLYWOOD BLVD. • HOLLYWOOD 28, CAL. • TEL: 213-463-6992



FOTOFET APPLICATIONS



POWRFET APPLICATIONS

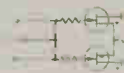

LOW NOISE FETs



A JUNCTION FET ELECTROMETER

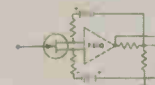

JAMES
ANNOUNCES  **State-of-the-Art**

BREAKTHROUGH

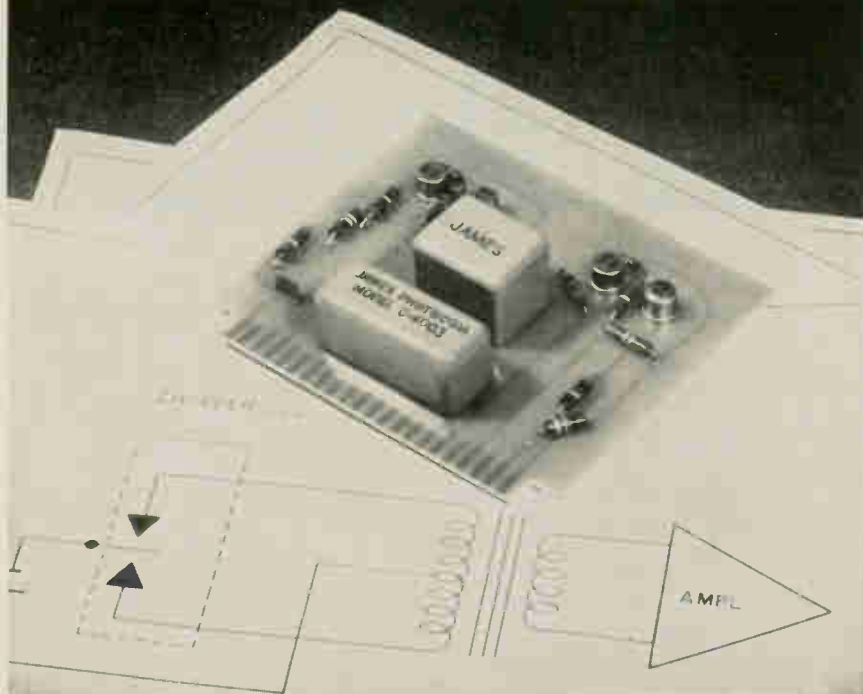

**CHOICE OF SPDT DPDT SWITCH CIRCUITS
AC & SELF-DRIVEN DC OPERATION**

"Photocom"

SOLID STATE CHOPPER

with less than: $1\mu\text{V}$ DRIFT (24 HOURS)
 $3\mu\text{V}$ NOISE (INTO 1 MEGOHM)

- JAMES ELECTRONICS has achieved a state-of-the-art breakthrough with a new solid state chopper incorporating high and medium speed photoresistive light actuated elements.
- The PHOTOCOM chopper is designed for printed circuit board and 7 pin plug-in mounting. It has wide application in null-seeking servo systems, low-level DC amplifiers, and other industrial and military ground control equipment.
- Ten models are available in SPDT and DPDT switch circuits for either AC (up to 2,000 cps) and self-oscillating (200 cps) DC operation.
- Write for the new JAMES PHOTOCOM catalog (F-5186) for complete technical details, specifications, and application data.

MECHANICAL-PHOTO CHOPPERS • MULTIPLEX RELAYS • INSTRUMENT TRANSFORMERS

JAMES[®]
ELECTRONICS INC.

4050 North Rockwell • Chicago, Illinois 60618 • 463-6500

New Components

glaze for the resistance element. The versatile units provide a virtually infinite resolution output in standard ranges from 50 to 500,000 ohms. Particularly suited to high-density packaging, they are rated at 0.3 w at 70°C and conform to all applicable environmental specifications of MIL-R-22097.

Positive stops and single-turn screwdriver adjustment from top (model 350) or side (model 360), coupled with adaptability to high-frequency circuits, offer appeal to both the design and packaging engineer. Units are priced at \$2.85 each in lots of 100; delivery 30 days.

International Resistance Co., 401 N. Broad St., Philadelphia, Pa. [358]

Compact, magnetic push-button switch

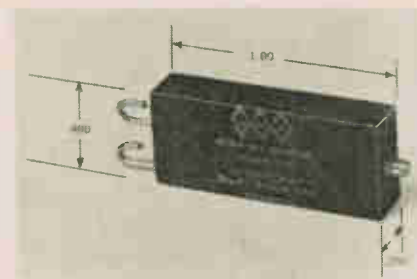

Series B is a low-priced, magnetic push-button switch that offers high reliability in compact size. Designed for dual-purpose use, it is basically a pin-actuated model for cam operation, but can easily be adapted for panel mounting. A press-fit button and mounting attachment are available from the factory for this purpose. The series is currently being produced in two forms—normally open and normally closed. Both are spst.

The device's dry reed contacts are hermetically sealed under glass with an inert gas, and are insulated with epoxy and enclosed in an epoxy case. Basic dimensions are 0.200 in. thick by 0.400 in. wide by 1 in. long. In operation, magnetic lines of force are used to open or close switch contacts. This design insures low bounce and closed contact resistance and permits actuation pressure to be ad-

justed from as low as 17 grams up to several pounds.

This positive open/close action eliminates false actuation due to operator fatigue and provides extremely long switch life. Because it is hermetically sealed, the series B is suited for use in explosive or corrosive atmospheres. It has dielectric strength of 500 v a-c and insulation resistance of 100 meg-ohms, and can be operated at a maximum of 0.125 v a-c.

Price is \$1.50 to 85 cents, depending on quantity; delivery from stock.

George Risk Industries, Inc., 672 15th Ave., Columbus, Neb. [359]

Completely sealed thumbwheel switch

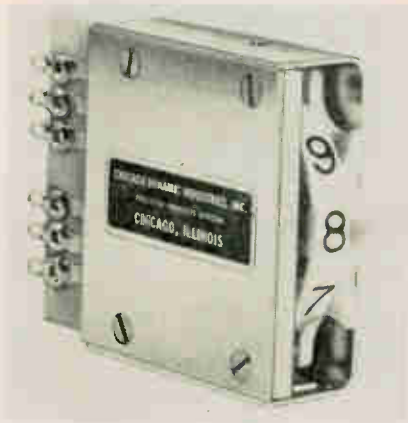

A completely sealed tab-type thumbwheel switch is offered with panel and switching elements separately sealed against all types of hostile environments. (It is believed that no other switch with complete elements and panel sealing is available.) Series PS (panel-sealed) is assembled in a clean-room atmosphere. The complete sealing not only protects the switch itself against dust, salt spray, corrosion and other contamination, but also prevents any contamination from getting through to relays and other components.

The switch is especially recommended for rfi applications. It retrofits series TTS and can be furnished in both decimal and coded versions. Switch life is in excess of 100,000 operations. Only $\frac{5}{8}$ in. panel space is required for each switch module. It is available with extended p-c boards for diode and resistor mounting. Numbers are

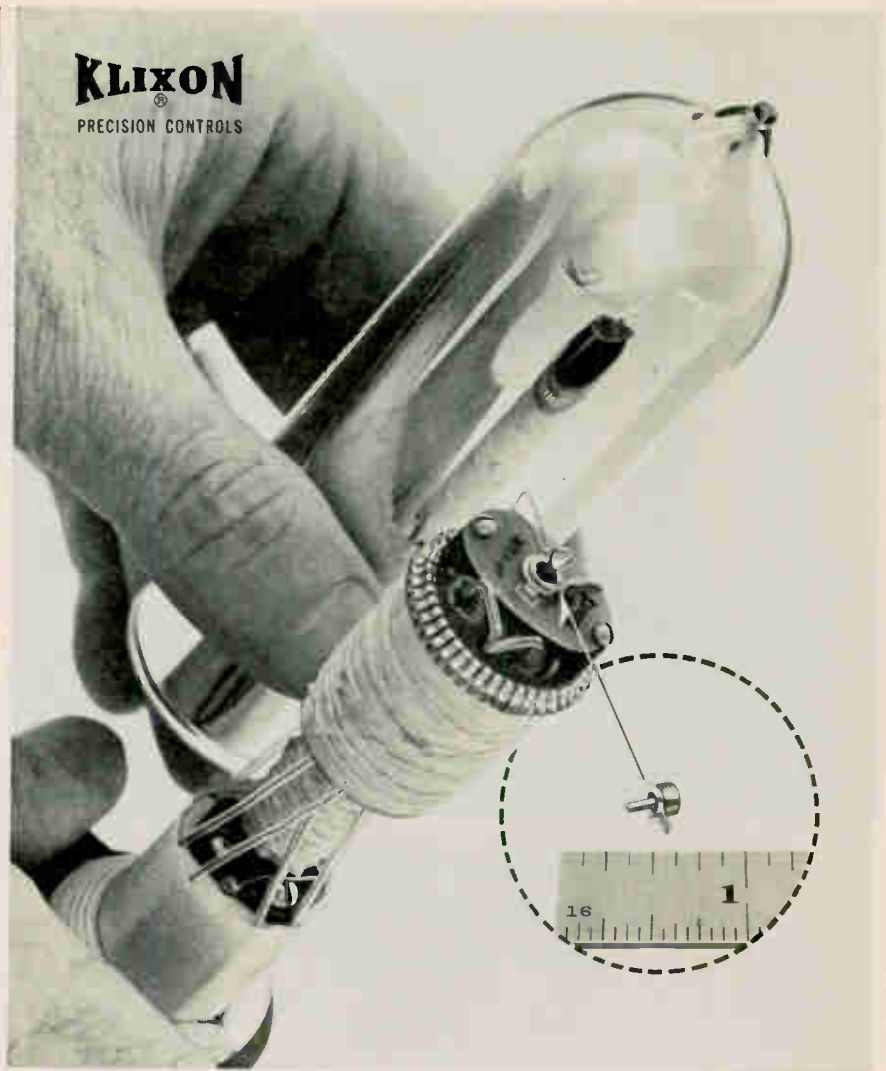

**When there's only space enough
for the smallest thermal switch . . .**

RELY ON TI FOR TEMPERATURE CONTROL

Western Electric Company does! This famous producer of advanced communications systems uses the KLIXON® 3BT Series "Tiny-Stat" thermal switch. Mounted inside a vacuum flask, it helps to control the temperature of electronic components which logarithmically compress twelve voice signals before transmission over a single telephone line.

Why specify 3BT? Because it's the smallest, fastest, snap-acting thermal switch on the market today. It responds to temperature change five times faster than its nearest equivalent and is rated up to 1 amp, 115 v-ac, 30 v-dc for 10,000 cycles. Temperature range is 0° to 350 F, open or close on temperature rise. Vibration resistance is 5 to 2000 cps at 30 G.

For complete information, about the 3BT "Tiny-Stat", write for Bulletin PRET-12. We'll also send you our "Tunnel of Horrors" booklet which describes our testing procedures.

KLIXON
CONTROL PLANTS IN
Attleboro, Mass. • Versailles, Ky.
Richmond Hill, Ontario
Holland • Italy • Australia
Argentina • Brazil • Mexico



METALS & CONTROLS INC.
5010 FOREST ST. ATTLEBORO, MASS.
A CORPORATE DIVISION OF
TEXAS INSTRUMENTS
INCORPORATED

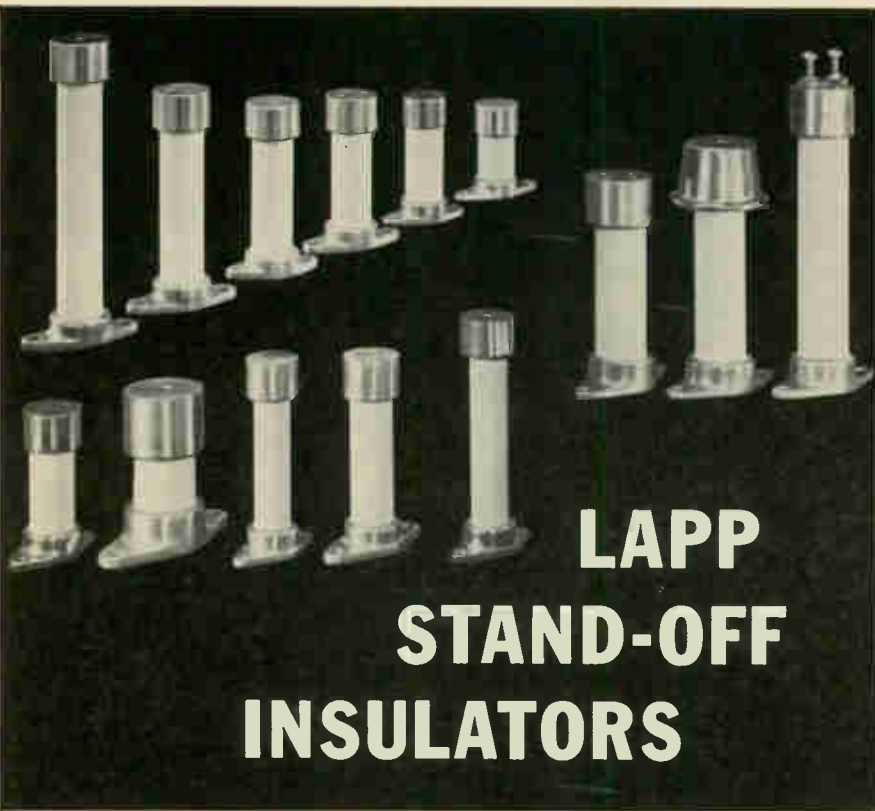

LAPP STAND-OFF INSULATORS

*...in all these standard sizes
to save you time
and money*

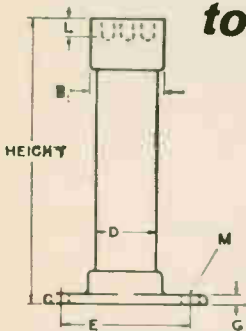

Other tapped hole sizes or arrangements available on special order.

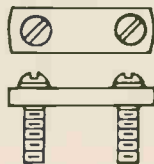

ORDER
KEEPER
SEPARATELY

STAND-OFF INSULATOR DIMENSIONS IN INCHES (STOCK HEIGHTS LISTED BELOW)

Cat-log No.	Material	Cantilever Strength inch-pound	Height in inches	B	D	E	G	L	M	N	P	Q
14761 24229	Porcelain Steatite	375 450	4-6-8	1 $\frac{3}{8}$	1	2 $\frac{1}{4}$	$\frac{3}{16}$	$\frac{3}{32}$	$\frac{3}{32}$	$\frac{1}{4}$ -20	$\frac{1}{4}$ -20	$\frac{3}{16}$
14760 24114	Porcelain Steatite	600 700	4-6-8-10	1 $\frac{3}{8}$	1 $\frac{1}{4}$	2 $\frac{3}{8}$	$\frac{7}{32}$	$\frac{3}{8}$	$\frac{3}{32}$	$\frac{1}{4}$ -20	$\frac{1}{4}$ -20	1 $\frac{3}{16}$
22408 41775	Porcelain Steatite	1200 1400	6-8-10-12	1 $\frac{7}{8}$	1 $\frac{1}{2}$	2 $\frac{7}{8}$	$\frac{1}{4}$	$\frac{7}{16}$	$\frac{3}{32}$	$\frac{1}{4}$ -20	$\frac{1}{4}$ -20	1 $\frac{3}{8}$
13981 24110	Porcelain Steatite	1800 2100	6-8-10-12	2 $\frac{1}{4}$	1 $\frac{3}{4}$	3 $\frac{3}{4}$	$\frac{1}{4}$	$\frac{9}{16}$	1 $\frac{1}{32}$	$\frac{5}{16}$ -18	$\frac{3}{16}$ -16	1 $\frac{1}{4}$
42588	Porcelain	4000	6-8-10-12	3 $\frac{3}{8}$	2 $\frac{1}{2}$	5	$\frac{3}{8}$	$\frac{1}{2}$	1 $\frac{1}{32}$	$\frac{5}{16}$ -18	$\frac{3}{16}$ -16	2



Insulators shown are standard. Similar insulators available with caps or bases on both ends.

WRITE for Bulletin 301-R.
Lapp Insulator Co., Inc.,
237 Sumner Street, LeRoy, N. Y.

New Components

large and clear. Only one number at a time can be seen through the bezel window. Approximate prices are \$6.50 (decimal), \$9.50 (binary). Delivery is 30 days.

Chicago Dynamic Industries, Inc., Precision Products Division, 1725 Diversey Blvd., Chicago, Ill., 60614. [360]

Miniature relays can sense voltages

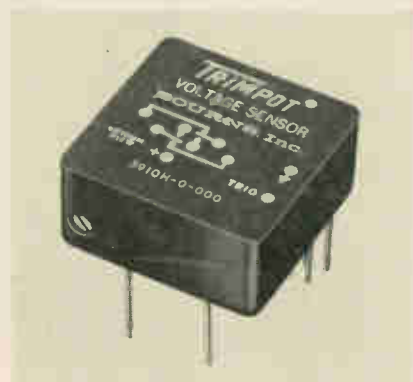

Two miniature voltage-sensors now available occupy only 0.5 cu. in. yet are extremely accurate. Model 3910 offers a 1-amp dpdt electro-mechanical relay output, while model 3917 features a spst normally-open solid-state output.

Said to be smaller by far than any other types available, each can sense voltages from 6 to 12 v d-c without need of external components. With the use of external fixed resistors, both units can sense up to 1,000 v. Sensing below 6 v d-c can be accomplished with proper biasing.

Both models offer internal adjustment of the trigger level provided by a Trimpot potentiometer over a range of ± 5 v when external components are used. This gives the design engineer flexibility in selecting an external resistor for use at any desired voltage.

The repeat accuracy of both models is high: Under static temperature conditions, the units will repeatably sense voltage levels within $\pm 1\%$ of the selected value. Under environmental extremes, the maximum deviation will not exceed $\pm 5\%$.

Stability—the ability to set the internal level adjustment to a given

trigger voltage—is $\pm 0.5\%$. Trigger input current required is 0.7 ma maximum. Trigger input impedance is 2,000 ohms/volt. Standard pick-up to dropout differential is 1% to 4%. Operating temperature range is -55 to $+105$ C. Units will withstand vibration of 20 g, 10 to 2,000 cps, and shock of 75 g, 11 ± 1 msec half sine wave.

Bourns, Inc., Trimpot division, 1200 Columbia Ave., Riverside, Calif. [361]

Ultraminiaturized audio transformers



The PIL-50 audio transformer measures $\frac{1}{16}$ in. in diameter by $\frac{1}{16}$ in. high, and weighs only 1/20 oz. It is metal-encased, hermetically sealed, and manufactured and guaranteed to MIL-T-27B by full environmental testing.

The DO-T type structure overcomes inherently poor electrical characteristics often found in miniature audio transformers. All ultraminiature PIL transformers are subjected to a 500-v dielectric strength test, instead of the usual 100 v, for higher safety margins and reliability.

These are ruggedized units with a complete rigid cylindrical bobbin eliminating wire movement and stress. The turns are circular, effecting uniform wire lay and eliminating corner stress. The leads are rigidly anchored to the coil wire in terminal-board fashion, eliminating the use of tape, and brought out through strain relief. The units are terminated in weldable and solderable, insulated, gold-plated Dumet leads.

United Transformer Corp., 150 Varick St., New York, 10013. [362]

Circle 153 on reader service card →

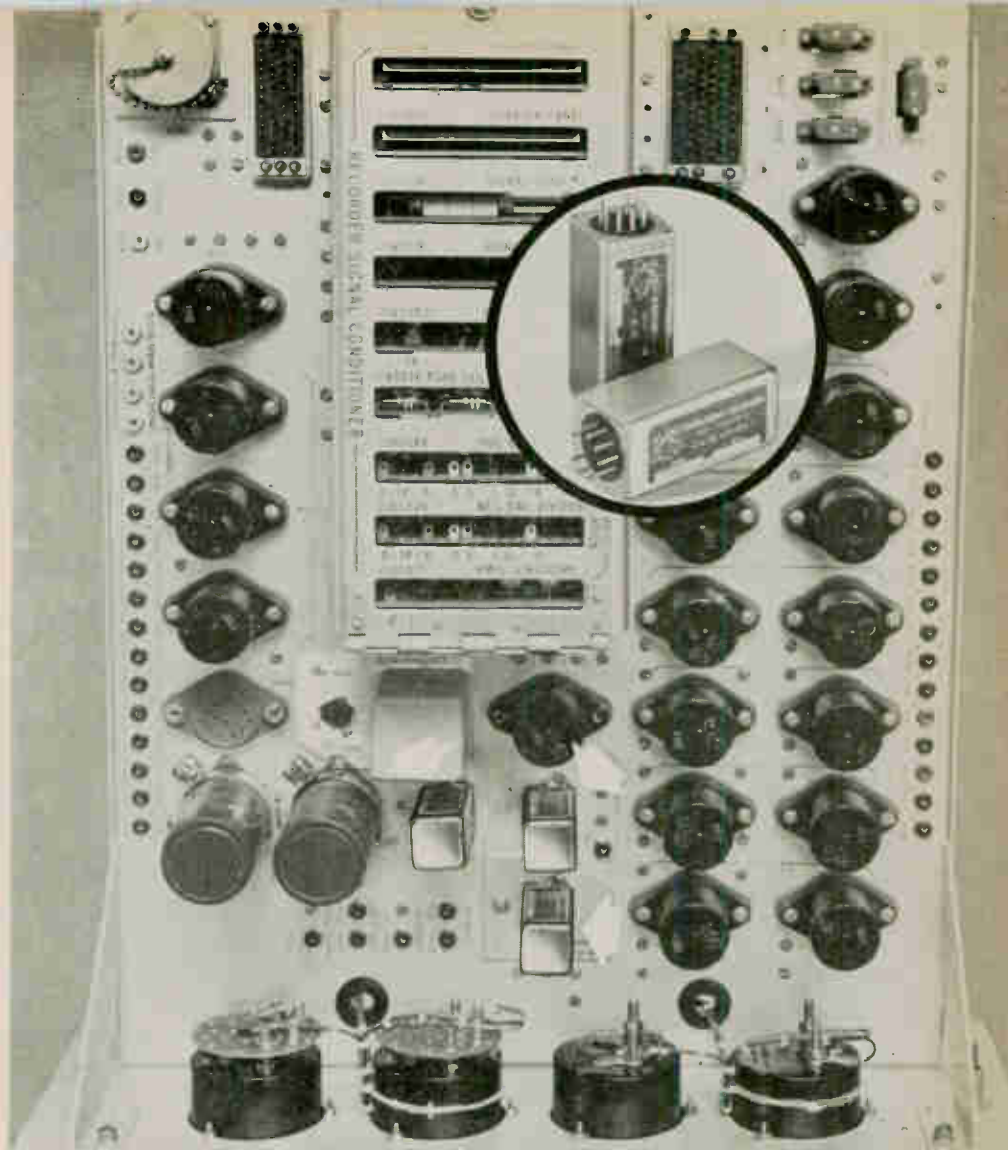

Teledyne amplifiers play 3 roles in Westinghouse signal conditioner

Slated for submarine service, each of three Taber TELEDYNE® Model 198-1 Solid State AC Voltage Amplifiers is employed for a different purpose in this Westinghouse signal conditioner for magnetic tape recording. One isolates signal sources from an AC meter. A second sums four signals for recording on one track of magnetic tape. The third amplifies audio signals to proper recording level.

Aerospace Division of Westinghouse Electric Corporation reports, "The Taber amplifiers, once adjusted, operate efficiently with almost no further adjustment over long periods of time. They were selected because of their small size, minimum weight and ability to withstand shock, vibration and severe temperature changes."

Often employed because of their reliability, Taber amplifiers are available to meet a wide range of AC and DC amplification requirements. They can be combined with Taber TELEDYNE® Strain Gage Transducers to provide high level pressure sensing packages or used for signal conditioning in conjunction with many other sensing devices.

For detailed information, write: Aerospace Electronics Division, Taber Instrument Corp., Section 158, 107 Goundry St., N. Tonawanda, N. Y.



Pressure Transducers • Signal Conditioning and Readout Devices



NEW TRANSISTORIZED PHASEMETER

COVERS

5 ^{CPS} TO 500 ^{KCPS}

50 ^{MV} TO 150 ^V

DYNAMIC RANGE



Phasemeter
Model 301

Measures phase angle between two sinusoidal signals for calibrating vibration and acoustical instruments; for testing amplifiers, potentiometers, servo components and systems, passive networks and transformers.

- simultaneously produces 0-360° panel meter readings and square wave output
- up to 3000:1 input amplitude ratio
- 1° accuracy
- available with low-impedance DC output, 0 to +3.600v
- 6" taut band meter with 4 ranges
- price: portable or rackmount, \$795.00 - with low impedance DC output, \$970.00

For further details, write to:

DRANETZ

ENGINEERING LABORATORIES, INC.

11 Washington Ave., Plainfield, N. J.
Telephone (201) 755-7080

New Semiconductors

N-channel enhancement-mode FET



In designing digital devices with metal-oxide-semiconductor field effect transistors, it's often desirable to use complementary circuitry—that is, to use both p-channel and n-channel enhancement-mode FET's in the same circuit. Such complementary circuitry provides very low power dissipation (because the fixed-value lead resistor used in conventional circuitry is replaced by an active element), and very high speed (because of the low channel resistance during both turn-on and turn-off).

Unfortunately, although p-channel MOS FETs have been readily available, the n-channel type have not, because of the difficulty in controlling the device parameters accurately during manufacture, and the resulting device instability during operation.

Now the Semiconductor Products division of Motorola, Inc., is ready to supply the missing link. It is offering two new MOS FETs, one n-type and one p-type, that are specifically designed for complementary operation. The n-channel device is the model MM2102 (picture); in its manufacture, Motorola has overcome the traditional problems by extremely close control of the processes affecting the interface between the gate oxide and the silicon surface. The companion p-channel transistor is known as the MM2103.

Both devices carry 25-volt drain-to-source breakdown voltage, and have 200°C operating channel temperature and 300-milliwatt dissipa-

tion ratings at 25°C. Both the MM2102 and the MM2103 are specifically designed for digital applications. Maximum rise and fall times for both is 50 nanoseconds at a drain current of 5 milliamperes and a drain-to-source voltage of 10 volts.

The MM2102 is priced at \$25.50 per unit in quantities under 100; for 100 to 999, the price is \$17.00. The MM2103 is priced at \$21.00 and \$14.00, respectively, for the same quantities. Delivery is from stock.

Specifications for the MM2102:

Drain-to-source maximum voltage	25 volts
Maximum threshold voltage	4 volts
Maximum drain-to-source resistance	200 ohms
Reverse transfer capacitance at 10 volts	1.5 pF
Case	TO-72

Motorola Semiconductor Products Division, Phoenix, Ariz. [371]

Axial lead rectifiers are small, light

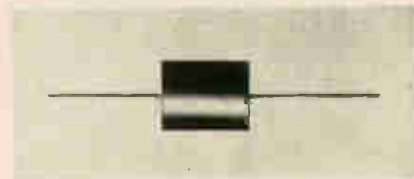

Twelve new 3-amp axial-lead rectifiers are offered with piv ratings from 15 to 1200. Eight of these are covered by JEDEC numbers 1N4139 to 1N4146. The rectifiers are packaged in hermetically sealed cases insulated from their solid silver leads. Average d-c current rating for the rectifiers without heat sink is 3 amps up to 50°C, derated linearly to 0 at 175°C. Nonrepetitive surge currents up to 300 amps can be handled for 0.008 sec, and currents to 4 amps can be accommodated for several minutes.

Their small size and light weight make the rectifiers particularly suitable for miniature airborne power supplies, battery chargers, handheld tools and appliances, and sim-

CONSIDER COLORADO

...where there's room to grow... Industrial elbow room. On the plains and in the mountains.

Consider 39 fully improved industrial development areas located in as many communities throughout the State. Ample reserves of electricity, natural gas and water. Construction costs equal to, or lower than many areas of the United States. A highly skilled, highly stable labor force—with educational levels that rank among the highest in the nation. Add Colorado's climate and outdoor advantages to attract and hold personnel and you have every reason to consider industrial Colorado for your business expansion or relocation.

For complete information on the capabilities of industrial Colorado, address your inquiry to Dwight E. Neill, Director, Division of Commerce and Development, 17 State Services Building, Denver, Colorado.

INDUSTRIAL COLORADO



NEW FROM KNIGHTS



new low price
proportional
control ovens
for precise
control of
temperature
environment
for crystals
and components.

Four new proportional control ovens — 952 thru 955 Series — eliminates usual noise problems associated with thermostat controlled ovens. Temperature remains constant without deviations due to thermostat on-off cycling found in other devices. Models 952 and 953 are designed primarily for crystals and small components. The larger Models 954 and 955 are for large components, oscillators, etc. and can be supplied with 4, 7, or 9 pin internal sockets. Standard operating temperatures are 65° , 75° and $85^{\circ}\text{C} \pm 5^{\circ}\text{C}$. Other temperatures and closer tolerances are available. At constant ambient temperature oven stability is $\pm .025^{\circ}\text{C}$ max.

Standard input voltage is 28VDC. Other voltages available on special order.

For detailed information request Bulletin 952-5 from your CTS Knights representative or from the main office.



CTS Knights, Inc.

of Sandwich, Illinois
(formerly The James Knights Co.)
a subsidiary of CTS Corporation, Elkhart, Indiana



New Semiconductors

ilar applications. Availability is from stock.

Soliton Devices, Inc., 256 Oak Tree Road, Tappan, N.Y., 10983. [372]

Planar epitaxial silicon transistors

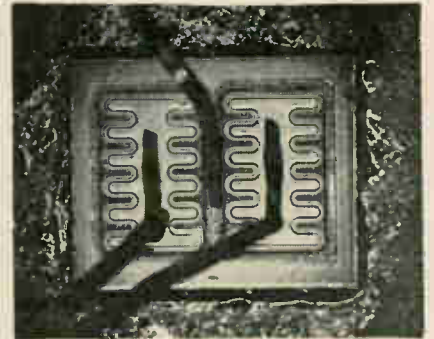

A silicon transistor series of the planar epitaxial npn type, now in production, delivers high power at high voltage at high temperature. It combines nichrome thin-film techniques with the company's planar epitaxial process of semiconductor manufacture to eliminate secondary switchback and hot spots, major areas of difficulty in npn power devices.

The FT7207 series—the FT7207H and FT7207M—eliminate hot spots and secondary breakdown, which develop when a localized area of the transistor begins to draw more current than it should. This is accomplished by a nichrome thin-film resistor in series with the emitter. The innovation enables the units to offer a maximum power dissipation of 30 w at 40 v and 100°C case temperature. This voltage at such a high power and temperature is said to be double that of earlier npn power devices.

The FT7207H has a breakdown voltage of 80 v minimum and the FT7207M a 60-v minimum. The series also offers low collector saturation voltage of 1.5 v maximum and a high gain-bandwidth product of 70 Mc.

Prices are: FT7207H, \$42 each in lots of 1 to 99 and \$28 each in lots of 100 to 999; and FT7207M, \$36 each for 1 to 99 and \$24 each for 100 to 999.

Fairchild Semiconductor, 313 Fairchild Dr., Mountain View, Calif. [373]

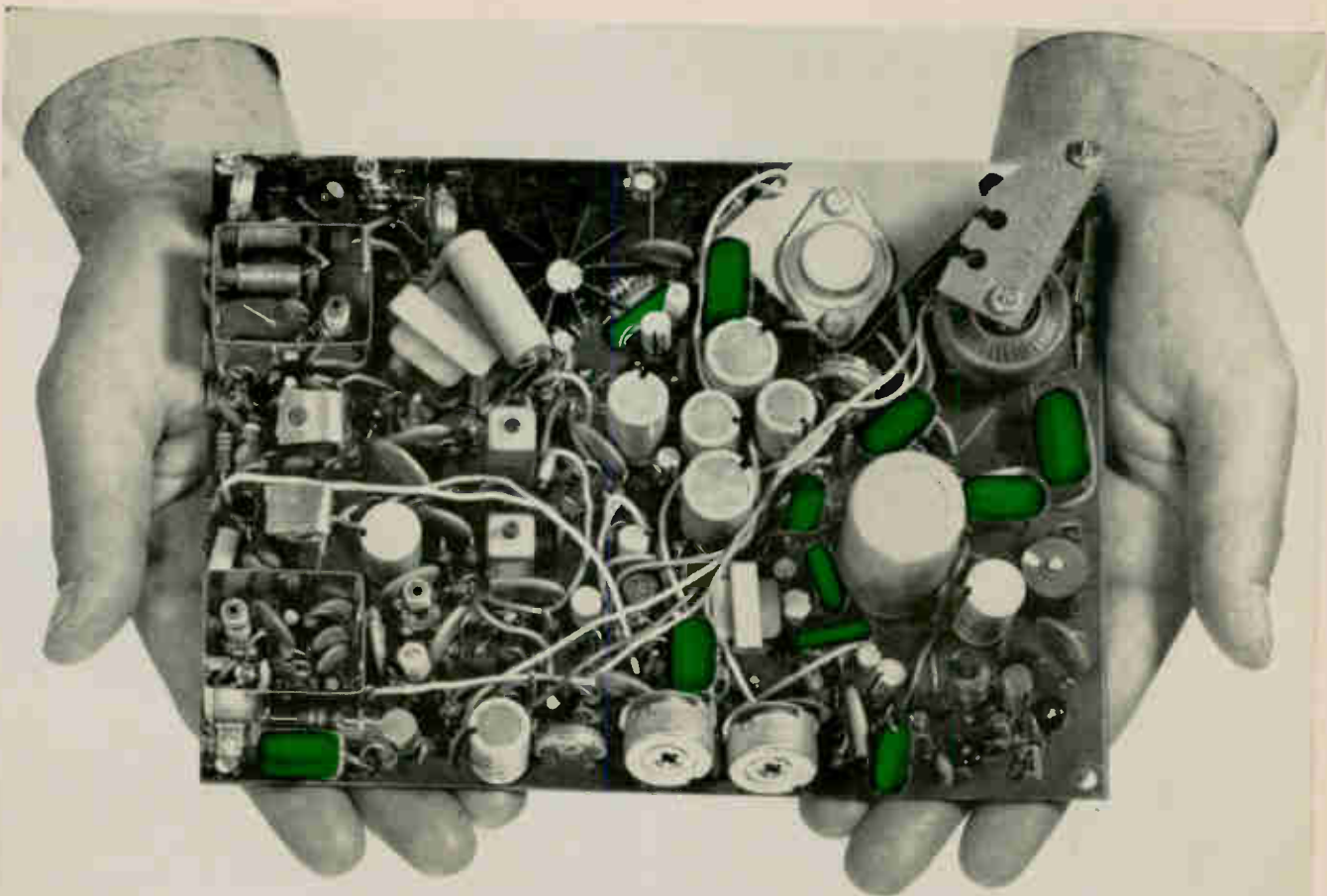

**General Electric
says size is important,
but reliability
is more important.**

**(Now you know two reasons why G.E.
uses capacitors of Mylar® in its 9" TV.)**

In its "play-anywhere" TV shown above, G.E. uses dipped, molded and wrap-and-fill capacitors of MYLAR*, and also capacitors that are self-cased units where extra wraps of MYLAR provide protection and anchorage for the leads. All are considerably smaller than paper capacitors of equivalent rating.

"But no matter how small they were," says Jim Nease, Component Engineer, "we wouldn't even consider using capacitors of MYLAR if they weren't reliable. Our tests have proven the outstanding reliability of these capacitors. That's the main reason we use them, not only in our 9" set, but throughout our line."

Reliability . . . reduced size. Two big reasons G.E. uses capacitors of MYLAR. But there's a third reason, too. Price. Capacitors of MYLAR cost no more, and often cost less than paper capacitors.

For more information to help you investigate the ways capacitors of MYLAR can help your designs for home entertainment and similar circuits, write Du Pont Co., Room 2797, Wilmington, Delaware 19898. In Canada: Du Pont of Canada, Ltd., P.O. Box 660, Montreal, Quebec.



only DU PONT makes

MYLAR®
POLYESTER FILM

Better Things for Better Living
Through Chemistry

MYLAR is a registered trademark of E. I. du Pont de Nemours and Company.

IF...
your computer,
calculator,
automated machines,
process instrumentation,
or communications equipment

failed in the
next five minutes...

do you have a man
who can fix it?

Almost every company in the United States is using sophisticated electronics equipment in its office, production and distribution operations. All of it demands expert maintenance and service . . . work that can only be handled by men who know basic electronic theory and principles.

Whose responsibility is it to train these men — the man's or the Company's?

Many companies believe this responsibility rests squarely on their shoulders . . . and know the right time to start this training is when plans are made to buy and install the equipment. They'll have trained men ready and able to prevent the failure of expensive, sophisticated equipment when it goes into operation. They know that providing this training is just as critical as planning and purchasing the equipment.

Since 1934, Cleveland Institute of Electronics has "tailored" electronics training programs to the specific needs of many companies. It's fast, effective and most economical. Send coupon below for complete information. Cleveland Institute of Electronics, Dept. E-12, 1776 East 17th St., Cleveland, Ohio 44114.

SEND COUPON TODAY

**Cleveland Institute
of Electronics**

Dept. E-12, 1776 E. 17th St., Cleveland, Ohio

Gentlemen: I am interested in learning more about your Electronics Home Study Programs. Please send complete information.

Name _____

Title _____

Company _____

Address _____

City _____ State _____ Zip _____

Accredited Member, National Home Study Council.

New Instruments

Wheatstone bridge is highly accurate



A Wheatstone bridge is on the market that features an operating range of 0 to 11,111 megohms. Stated accuracy of the model 6003EA (0.0025%) is an unqualified percent-of-actual-resistance measurement, and not a percent of full scale. A $\pm 0.001\%$ accuracy of actual reading can also be obtained by utilizing calibration charts that can be obtained on request from the company.

The bridge is said to contain unique damage-prevention design features. An accidental or deliberate short circuit across the Rx terminals will cause no damage to the bridge under any operating conditions. The resistors or resistive components being measured cannot be damaged by overvoltage, regardless of the setting. These error-proof features are accomplished through a bridge circuitry that automatically limits the voltages, current, and, therefore, the power being supplied.

The go/no-go meter reads error in percent or parts per million of the component under test. All resistors with values within the preset tolerance read in the white (go) area. Resistors to be rejected read in the grey (no-go) portion of the meter. The percentage deviation of the resistor from the nominal value can be determined directly from the scale reading.

Model 6003EA includes a self-contained power supply and null detector. The bridge's accuracy is guaranteed over the temperature range of $+20^{\circ}$ to $+30^{\circ}\text{C}$ and a line

voltage variation of 105 to 125 v at all automatic settings.

General Resistance, Inc., 430 Southern Blvd., New York, N.Y., 10455. [381]

A-c to d-c converter is highly accurate



A linear a-c to d-c converter is announced for use in making accurate a-c voltage measurements on any d-c digital voltmeter, and for applications to a d-c recorder, or to a type K potentiometric system.

Model 710A linearly converts an a-c voltage from 1 mv to 1,000 v in decade steps at frequencies from 30 cps to 250 kc. Its accuracy of conversion is better than $\frac{1}{4}\%$ from 1 mv to 250 v at midband frequencies of 50 cps to 10 kc.

Among other characteristics: d-c output for each decade of a-c input is 1.000 to 10.00 volts, thus making full use of a four digit d-c voltmeter; and a maximum sensitivity is 10 mv full scale a-c for 10 v d-c output.

Price is \$510 for the portable model; \$530 for the 19-in. relay rack version.

Ballantine Laboratories, Boonton, N.J. [382]

Compact, two-channel logarithmic converter

This solid-state instrument accurately delivers logarithmic counterparts of d-c or a-c signals to 100 kc. Two entirely separated channels of improved performance are provided in the space formerly occupied by one. Model 7560A facilitates semi-log or log-log plotting with Moseley X-Y recorders, acts as the logarithmic converter in deci-

Perhaps you didn't realize that CTS is a major supplier of trimmers

Look at the versatility of the CTS Trimmer Line

- Broadest line of CERMET™ trimmers in the world
- Wide range of most popular styles of wirewound and carbon trimmers
- Unexcelled resistance materials technology
- Broad choice of resistance elements best suited to your applications
- Unsurpassed tooling and high volume production capability
- Complete capability for military, industrial and entertainment applications
- From 10⁴ production quantity types to highly sophisticated types

**Immediate availability from distributor stocks*

Note the wide range of types and sizes. However, if you don't see what you need, we can design one to your exact specification.

CERMET Trimmers

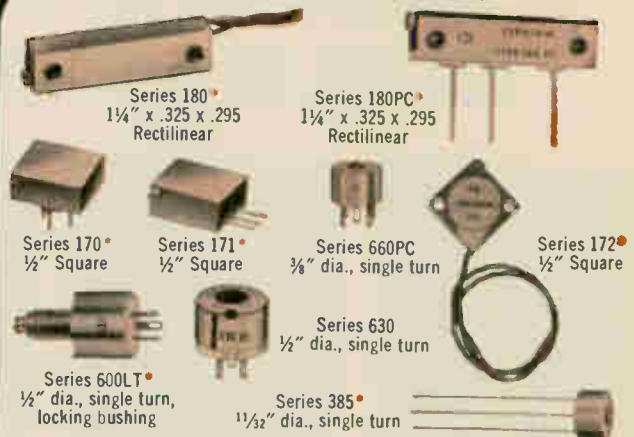

Wirewound Trimmers



Carbon Trimmers

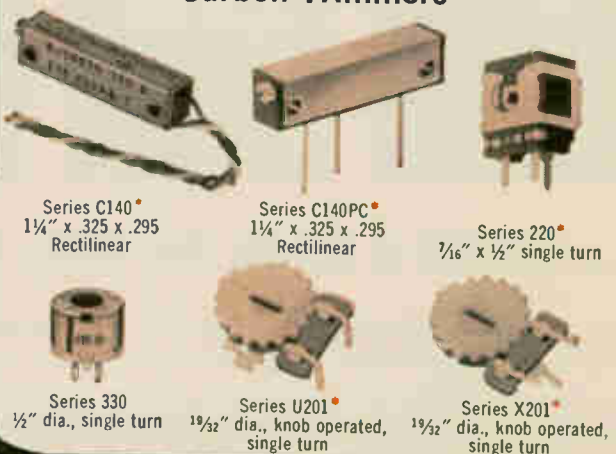

Founded 1896

CTS CORPORATION
Elkhart, Indiana

Sales Offices and Representatives conveniently located throughout the world.

Principal Products

Variable Resistors
Selector Switches
Loudspeakers
Trimming Potentiometers
Microminiature Components
• Circuit Packages
Crystals, Filters,
Oscillators & Drivers

Subsidiaries

CTS of Asheville, Inc., Skyland, N. C.
CTS of Berne, Inc., Berne, Indiana
CTS of Paducah, Inc., Paducah, Kentucky
Chicago Telephone of California, Inc.,
South Pasadena, Calif.
CTS of Canada Ltd., Streetsville, Ontario
CTS Microelectronics, Inc., Ridgeland, Conn.
CTS Research, Inc., Lafayette, Ind.
CTS Knights, Inc., Sandwich, Ill.

MINIATURE BRISTOL PRESSURE SWITCHES



GAGE

SUBMINIATURE
ADJUSTABLE



ABSOLUTE

LOW-RANGE



ALTITUDE

ALTITUDE

...there's a model for every application

Long life, repeatability and accuracy—and a proved ability to resist effects of temperature, vibration, shock, acceleration, and overpressure surges—are features that have made miniature Bristol pressure switches designers' favorites throughout the aircraft and missile industries.

Many models and modifications available (most conform to specifications of MIL-E-5272A). Let Bristol engineers review your specific requirements.

Write: **The Bristol Company, Aircraft Equipment Division, 152 Bristol Road, Waterbury 20, Conn.** A Subsidiary of American Chain & Cable Company, Inc.
In Canada: The Bristol Company of Canada Ltd.

3.7

BRISTOL ...engineers for precision, builds for reliability



New Instruments

bel systems, or serves as a computing element to multiply and divide. Each channel has 60-db dynamic range.

In a-c applications, the 7560A user may select either peak or average detection. Accuracy is 0.5 db to 50 kc, 1.0 db to 100 kc. Input attenuators provide full-scale input ranges from 1 mv to 100 v a-c, 3.16 mv to 316 v d-c.

Both channels of model 7560A are housed in a rack-convertible module only 3½ in. high. Power supply is self-contained. Price is \$975; delivery, about 12 weeks. Hewlett-Packard/Moseley Division, 433 North Fair Oaks Ave., Pasadena, Calif., 91102. [383]

Stable and sensitive solid-state vom's



Models TVM4 and TVM6 volt-ohm-milliammeters are reported to combine the most desirable features of conventional multimeters and vacuum-tube voltmeters. The instruments' solid-state design achieves high input impedance (2 megohms per volt on the most sensitive range), stability and sensitivity, with a battery life approaching the battery's normal shelf life.

The unit is virtually burnout-proof, employing semiconductor protection of the amplifier and meter movement. It has a full-scale meter sensitivity of 150 mv on d-c. Nine d-c voltage, seven a-c voltage, nine d-c current and six resistance ranges are employed in a 1.5, 5 sequence.

Model TVM 4 employs a 4-in. taut-band meter, measures 6⅞ in. long by 5¼ in. wide by 2¼ in. deep, weighs less than 3 pounds, and is priced at \$55. Model TVM 6 employs a 6-in. meter, measures

7 $\frac{1}{8}$ in. by 6 $\frac{1}{8}$ in. by 3 $\frac{1}{2}$ in., and is priced at \$65. Delivery for both units is 30 days.

Aul Instruments, Inc., 47-29 36th St., Long Island City, N.Y., 11101. [384]

Testing components in microcircuits

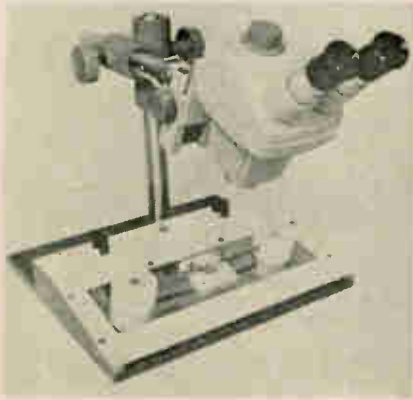

A portable tool now available quickly and economically measures component values in thin-film circuitry. The probes of this instrument remain where placed to free the operator's hands for performing other jobs such as scribing resistors, adding components, adjusting test equipment, etc. This unit easily probes pad sizes as small as 0.005 in. square on substrates as large as 1 $\frac{1}{2}$ in. square without moving the substrate.

Special units can be made for larger substrates or for probing substrates that are mounted on a mother board as large as 4 in. by 6 in. The standard test probe, model WH332, has two probes. Units with up to five probes are available by special request. Headway Research Inc., P.O. Box 848L, Richardson, Texas, 75081. [385]

Integrating dvm for 100 mv to 1,000 v



An integrating digital voltmeter, model 500, provides five full-scale

NEED INDUCTORS FOR PRINTED CIRCUIT BOARD MOUNTING?

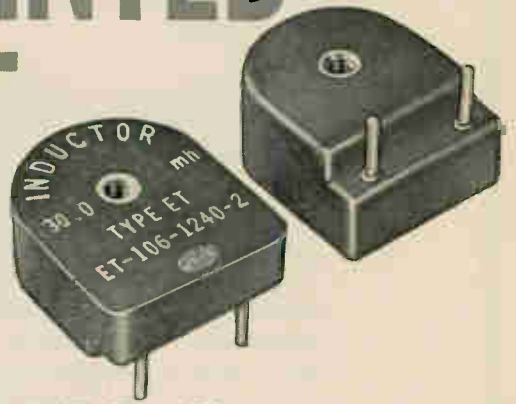

Sangamo offers 72 hour delivery on all prototype encapsulated inductors.

With Sangamo encapsulated inductors, your assembly time is shortened. There's no need to solder individual

wire leads to terminals. Mount the Sangamo inductor onto the card and dip solder—that's all.

SIZE: The type ET is a miniaturized toroidal inductor. Dimensions, shown on diagram, make it ideal for mounting on circuit boards where spacing is critical. Any custom inductance value from 1.00mh to 2.50h is available at no additional cost.

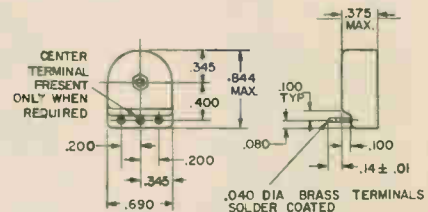

CONFIGURATION: The design of the ET-1 provides an excellent wash area for easy flux removal after soldering. Units are available with a third terminal to provide a tapped inductor.

FEATURES: Vacuum encapsulated units assure a void-free envelope. Inductors are impervious to moisture and have extremely stable electrical and temperature characteristics, plus exceptionally high Q values. Send for Engineering Bulletin 2721A.



EC 65-2

SANGAMO ELECTRIC COMPANY • P.O. BOX 359 • SPRINGFIELD, ILLINOIS 62705

**ELECTRICAL / ELECTRONIC
ENGINEERS**
DESIGN · ANALYSIS · TEST

BSEE, plus appropriate experience in any of the following areas:

- Communications
- Computer Software
- AGE Systems
- Field Engineering
- Circuits/Systems
- Electro-optics
- Microwaves
- Power Systems
- Propulsion
- Instrumentation
- Guidance & Controls
- Batteries

Write: Lockheed Missiles & Space Company,
Professional Placement Staff, Suite 456, 599
North Mathilda Avenue, Sunnyvale, California.

LOCKHEED
MISSILES & SPACE COMPANY
A GROUP DIVISION OF LOCKHEED AIRCRAFT CORPORATION

AN EQUAL OPPORTUNITY EMPLOYER



*In a bind for thin, flat, odd-
shaped precision parts?*

use the

*theory of
probability
to solve your problems*

This is where experience counts! Chances are, Photoforming by Hamilton will get you quickly from the drawing board stage to prototype production of thin, flat, odd-shaped precision parts. No dies . . . no burrs . . . no bent edges . . . no stresses . . . no delays when parts are produced by the Hamilton process called Photoforming. Another plus, Photoformed parts can be heat-treated, plated, or formed according to your specifications. Write for the facts—you'll get useful data on Hamilton's Photoforming and other facilities.

INDUSTRIAL AND MILITARY PRODUCTS DIVISION



HAMILTON

WATCH COMPANY

LANCASTER, PA.

New Instruments

ranges from ± 100 mv to $\pm 1,000$ v. Readings are displayed in three significant digits with an accuracy of $\pm 0.05\%$ of reading ± 1 digit. Over-ranging adds a fourth significant digit to all readings between one and three times full scale.

The voltage-to-frequency converter, plus an electronic counter, enables the model 500 to display the integral or average value of the voltage present during the measurement time interval. This technique greatly reduces errors caused by hum and noise superimposed on the data signal. Further hum reduction is achieved by using a 1/60th of a second measurement interval.

The frequency counter portion of the instrument is available separately to measure frequency in the range of 10 cps to 200 kc with a maximum sensitivity of 100 mv rms. The counter provides a four-digit display in selectable gate times of 0.1 and 1.0 sec.

Other features of the model 500 include an internal calibrator, measurement speeds of up to nine readings per second and a variety of easily installed plug-in options. Price is \$985.

Vidar Corp., 77 Ortega Ave., Mountain View, Calif., 94041. [386]

**Lab meters provide
inexpensive accuracy**



Model M-1 d-c voltmeter and matching model M-2 d-c milliammeter have $\pm 1/2\%$ of full-scale accuracy and the M-1 has nearly 20,000 ohms/volt sensitivity. The M-1 and M-2, both with 11 ranges, cover 0-0.2 to 0-500 v and 0-50 μ a to 0-100 ma, respectively. Current load-

New Horizons in Instant Graphic Recording



IONOSPHERE — Radar returns from ionosphere are continuously integrated on a real-time basis by Aldel helix recorder in 1500-mile backscatter study.

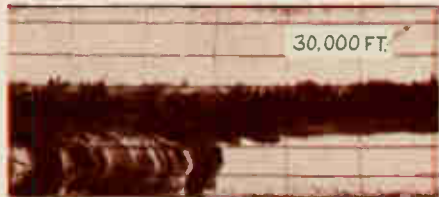

ATMOSPHERE — Ceilometer Recording illustrates high resolution possible with exclusive Aldel techniques. Radar returns from clouds, fog, rain, snow, ice crystals are easily distinguishable.



UNDERWATER — Continuous seismic profile of bottom and sub-bottom strata is provided by Aldel recorder. Alfax paper records sub-bottom penetration in greater detail at all frequencies.

Simple, reliable Aldel "flying spot" helix recording techniques — combined with ALFAX electrosensitive paper — produce visible, informative "pictures" of sonar, radar, infrared and other instrumentation outputs. Pulse length, relative strength and timing of electronic signals are continuously integrated on a single real-time recording. Data from sampling arrays, time-base signals, or scan or sweep sources are synchronized with the Aldel "flying spot" helix and presented as scale model "visual images" of observed phenomena, with new and essential meaning instantly revealed.

It's simple to get started.



Aldel "flying spot" Component Recorders, detachable drives, plug-in electronics, accessories are available to incorporate the Aldel instant graphic recording techniques into your instrumentation.

Complete Aldel instant graphic recording laboratories — with all plug-in units and accessories — are also available.

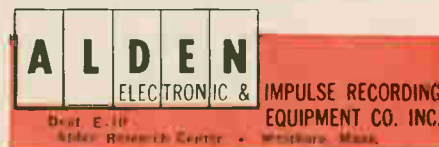

ing and voltage loss are specified to $\pm 0.1\%$ on all ranges.

A taut-band meter with five-inch scale and 0.1% multipliers and shunts yield considerable long-term reliability and accuracy. The M-2 can be used with standard external 50-mv shunts to extend the ranges with no loss of accuracy. Nearly any voltage or current within the range can be measured to within $\pm 1\%$ of actual reading using the highly overlapping ranges in 1-2-5 sequence. Accuracy of $\pm 1/4\%$ is also available. Burn-out protection is provided.

According to the manufacturer, this combination of specifications is unavailable on any other meter. Routine on-the-bench electronics measurements at modern levels of accuracy are now economically feasible. Price of the M-1 is \$110; the M-2, \$115.

Albionics, 10033 S.E. 95th Place, Renton, Wash., 98056. [387]

A self-contained stored charge meter



The model QS-3 meter measures the stored charge recovered from a semiconductor diode when the diode is switched from a known forward biased state to a reverse biased condition. It is designed as a substitute for sampling oscilloscope measurements of reverse recovery time and for stored-charge measurements or pulse capacitance measurements when minimum or maximum values are required for successful circuit operation. The instrument is self-contained, requiring no external cables, pulse generator or oscilloscope.

The solid state unit contains three current ranges: 0.1, 1 and

There's nothing so simple or satisfactory as recording with

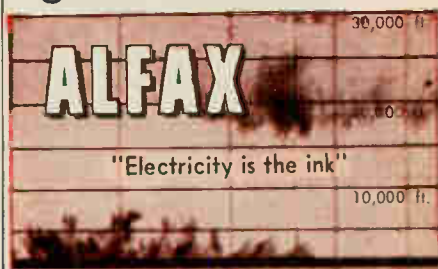

High-altitude weather data from radar ceilometer is recorded instantly and vividly on ALFAX electrosensitive paper. 20-minute chart segment shows returns to 30,000 feet.

Progressive innovators are obtaining vital information never before possible and often unsuspected in such fields as . . .

- **LONG RANGE RADAR DETECTION**
As opposed to scope cameras, operator sees returns instantly, evaluates more rapidly, gets permanent record with increased sensitivity.
- **RADAR SAMPLING**
Tone shades keyed to signal intensity provide vivid "picture" of radar return even when bulk of data is gated out.
- **SONAR ACTIVE AND PASSIVE**
Unparalleled identification and location of returns even in poor signal to noise ratio through integrating capability of Alfax paper.
- **OCEANOGRAPHY**
High resolution capability, dynamic tone shade response with Aldel recording techniques adding synchronizing ease provide "optimization" of underwater sound systems.
- **FREQUENCY ANALYSIS, SAMPLING AND REAL TIME**
Intensity modulation and frequency vs. real time provide continuous vital information with permanence and past history to achieve previously unattainable evaluation.
- **SEISMIC STUDIES**
Dynamic response at high writing speeds yields discrete geological data at resolution never before possible.
- **HIGH SPEED FACSIMILE**

Why? Because of ALFAX EXCLUSIVES

- broad, dynamic response of 22 distinct tone shades
- remarkable expansion at low level signal, where slight variation may provide critical information
- records in the sepia area of the color spectrum where the eye best interprets shade differentials in diminishing or poor light
- writing speed capabilities from inches per hour up to 1400 inches/second
- captures 1 microsecond pulse or less
- dynamic range as great as 30 db
- integration capability for signal capture in signal to noise ratio conditions worse than 1 to 4
- resolution capabilities of 1 millisecond = 1 inch of sweep
- accuracy capabilities of few thousandths of an inch
- sensitivity to match most advanced sensing devices

By merely passing a low current through Alfax everything from the faintest trace signal of microsecond duration to slow but saturated signal can be seen instantly, simultaneously.



write for
ALFAX HANDBOOK OF INSTANT GRAPHIC RECORDING PAPERS



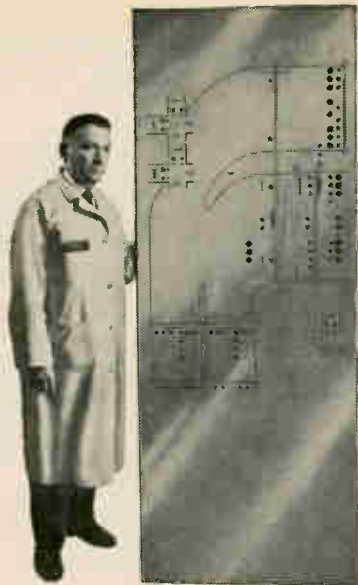

think
BIG

(also small)



Now engrave anything from 6 ft. panels to tiny nameplates

Engravograph tackles them all. Right in your own shop, effortlessly, speedily — ideal for unskilled workers. Adjustable ratio engraves 21 different sizes.

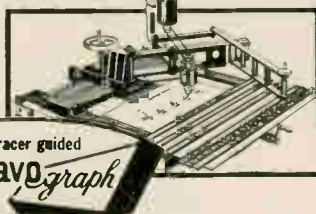

Write for illustrated catalog # 114

new hermes engraving machine corp.

154 WEST 14th STREET, NEW YORK 11, N. Y. Chicago, Atlanta, Dallas, Los Angeles, Montreal

AIRCRAFT STARTING

GROUND POWER BATTERY CHARGING

PROPS

JETS

COPTERS

CHRISTIE
D-C
POWER

AIRLINES

CORPORATE

PRIVATE



- Static Maintenance-Free Power Without Radio Interference

- Non-Aging Silicon Power Diodes with 7 Year Warranty

CHRISTIE ELECTRIC CORP. Since 1929

3400 West 67th Street, Los Angeles, California 90043

New Instruments

10 ma, automatic zero adjustment, automatic polarity indication, built-in calibration, and five stored charge ranges of 10, 30, 100, 300, and 1,000 pico-coulombs. Price is \$865.

B-Line Electronics Corp., 4 Music Hall Ave., Waltham, Mass. [388]

Phase-tracking vlf receiver

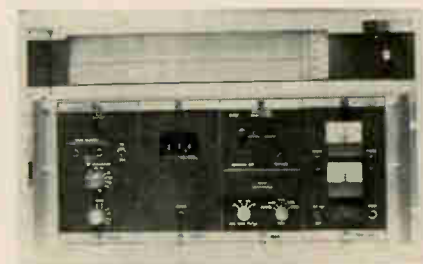

Model 1320 is a vlf phase-tracking receiver that tunes from 5 through 80 kc (751 channels). It is designed for calibrating frequency standards by comparison with stabilized Government vlf transmissions.

Special features, in addition to the wide frequency coverage, include image rejection better than 100 db, spurious-response rejection better than 60 db, sensitivity of 0.01 μ v, and improved packaging.

All controls and adjustments are accessible from the front—including electronic servo, digital thumb-wheel channel selection, both 10- and 100- μ sec full-scale readout, and 90 db calibrated input attenuator. Specifications are maintained over 0° to 50°C. The unit is shown with companion model 9103 strip chart recorder, which displays twelve full hours of recorded data. Price of the model 1320 is \$3,500. RMS Engineering, Inc., 486 Fourteenth St., N.W., Atlanta, Ga., 30318. [389]

Counter-timer uses silicon transistors

A portable counter-timer, now available, uses silicon transistors. Model CF-250 features a frequency-measuring capability of 2 Mc with sample time intervals of 10⁻⁵ to 10 sec. The internal time

base is a crystal-controlled 100-ke oscillator. Period averaging is provided from 1 to 10^6 input cycles.

The silicon transistors provide the unit with a maximum operating temperature of 70°C . The counter-timer features an input sensitivity of 10 mv, permitting use directly with low level signals. Time interval measurements are possible from 10^{-5} seconds to 11.6 days.

Model CF-250 is available with either five or six Nixie tubes for display. The portable cabinet is $9\frac{1}{2}$ in. wide, $7\frac{1}{8}$ in. high and $13\frac{3}{4}$ in. deep. Prices start at \$1,070.

Anadex Instruments Inc., 7833 Haskell Ave., Van Nuys, Calif. [390]

Communications-type delay equalizer

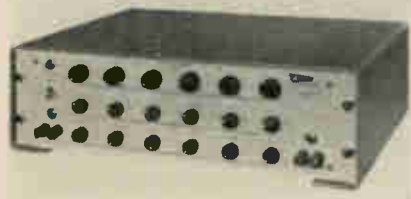

An all-solid-state delay equalizer, model 475A, is applicable for use on 600-ohm data or voice transmission lines to equalize the delay and amplitude loss across the selected frequency band. It is also recommended for laboratory use in adding compensation during the development phases of communications equipment.

Exceptional versatility is claimed for the instrument, which contains six delay modules, each of which is capable of providing continuously adjustable delays from 0.25 to 2.5 msec. Cascading of modules can provide up to 15 msec of delay at any of the operating frequencies between 1 and 2.8 kc.

Amplitude controls provide for ± 3 db of level control at the selected frequency. Nominal gain of the delay modules, however, is 0 db. Optional amplifiers can provide up to 40 db of flat gain and have four-step attenuators to compensate for losses.

The entire instrument measures $5\frac{1}{4} \times 19 \times 12$ in. and weighs 15 lb.

Acton Laboratories, Inc., subsidiary of Bowmar Instrument Corp., 531 Main St., Acton, Mass. [391]

WHAT'S THE LATEST IN DISC CATHODES? ASK SUPERIOR.



Full power for 6.3 volt-600 ma heater applications

Full power, narrow-neck for 600 ma heater applications

$\frac{3}{4}$ power for 450 ma heater applications



$\frac{1}{2}$ power for 300 ma heater applications

Shielded full power for better temperature uniformity in 600 ma heater applications

Shielded low power for 12.6 volt 85 ma heater applications

Widest choice of disc cathode designs

There are three basic types of Superior disc cathodes. Each has its own advantages. All feature close control of the E-dimension (distance between top of cap and top of ceramic), flare at the shank opening to facilitate assembly, shadow groove in the ceramic to inhibit electrical leakage and are available in wide choice of both cap and shank materials. Available in 0.121", 0.100" and 0.090" outside diameter shanks. Ceramic diameters can be either 0.490" or 0.365", with either round or triangular center hole.

New shielded disc cathodes—Full power and low power

In the full power design the emitter is separated from the ceramics by a shield which minimizes the conducting X-section from the shank to the ceramic. In the low power design, the slender shank, thermal shield and thin ceramic permit low heater power consumption and fast rise time. The shield also acts to eliminate leakage if sublimation takes place.

Widest choice of disc cathode materials

Superior's disc cathodes feature separate nickel cap and shank alloys. Hence you may choose the most suitable material for each. The Cathaloy® series, developed and controlled by Superior Tube Co., offers alloys with high strength, high activity, low sublimation, freedom from interface impedance, or any desired combination.

Cathaloy A-31. Approximately twice as strong as tungsten-free alloys at high temperatures.

Cathaloy A-33. Combines the high emission of active alloys with freedom from sublimation and interface impedance.

Cathaloy P-51. More than 100% stronger than X-3014 at high temperatures.

X-3014. Powder metallurgy pure nickel for resistance to sublimation. Suggested for shanks.

X-3015. Special shank alloy for strength with resistance to sublimation and for non-emitting characteristics.

Nickel 220, Nickel 225, Nickel 230 and Nickel 233. Suggested for caps requiring normal emission with rapid activation.

Driver Harris 599 and 799. Provide rapid activation plus high level d-c emission. For caps only.

For your copy of our Catalog 51, write Superior Tube Company, 2500 Germantown Ave., Norristown, Pa.

Superior Tube

The big name in small tubing

NORRISTOWN, PA. 19404

West Coast: Pacific Tube Company, Los Angeles, California

Johnson & Hoffman Mfg. Corp., Carle Place, N.Y.—an affiliated company making precision metal stampings and deep-drawn parts

Tunnel diode amplifiers— a note on gain, bandwidth, cubic inches and the state of the art

Putting one parameter next to the other — what's happened in the TDA field? Let's try it with our new P704 C-band amplifier: *Frequency Range:* 4.5 to 5.5 Gc... *Bandwidth:* 1 Gc (± 1 db gain variation)... *Gain:* 20 db... *Max Noise:* 5 db (or 4.0 db with GaSb diode)... *Volume:* 15 cu. in.... *Weight:* 11 oz.



In gain-bandwidth considerations this represents, we believe, the present capability of the state of the art.

Like all our tunnel diode amplifiers, the

P704 is offered with germanium diodes — for greatest resistance to burnout and maximum dynamic range — or with gallium-antimonide diodes for lowest noise figures.

What about other bands? Well, the P702 X-band amplifier, for example, offers excellent electrical performance for the size and weight involved: *Frequency Range:* 8.2 to 9.0 Gc... *Gain:* 16 ± 1 db... *Max Noise:* 5.5 db (or 4.5 db with GaSb diode)... *Volume:* 27 cu. in.... *Weight:* 16 oz.



Reliability? We start ahead of the game here, because we use our own ultra-reliable microwave tunnel diodes and are in a position to specify completely the diode characteristics. This also permits us to offer a *quick* reaction to your custom-design requirements. Try us.

For detailed information and technical help, call, write or wire Russ Wright, or at least circle the Reader Service Card. (Phone: 215-855-4681.)

SOLID-STATE PRODUCTS OPERATION

PHILCO

A SIBS DIVISION OF *Ford Motor Company*,
LANSDALE DIVISION • LANSDALE, PA.
In Canada, Don Mills Road, Don Mills, Ontario, Canada

ELECTRO

...EXACTLY THE POWER SUPPLY YOU NEED!

Conservatively-rated components... overload protection.
Top quality construction, long life... guaranteed one year.



1.



2.

1. Need good but not super regulation? ... you can save \$250 to \$650.

Electro "NFB" Power Supply . . . one of the industry's lowest cost-per watt-output, priced at only \$250. Regulation: 13% at maximum output; 0-32 vdc up to 15 amperes; . . . Low dc impedance: 0.3 ohms, no load to full load. (Rack model NFBR . . . \$275.)

2. Need low ripple, high voltage: ... Electro has both for only \$150.

Electro "EFB" . . . a low cost power supply delivering up to 128 watts, with top-load ripple less than 0.1% at only \$150. Low cost-per-watt-output. Two ranges, continuously variable 0-32 vdc up to 4 amperes; 0-16 vdc to 8 amperes. Regulation: 1.25 volts for each ampere of load current change between 0-4 amperes in 32 volt range; 1.0 volt for each ampere of load change between 0-8 amperes in 16 volt range. (Rack model EFBR . . . \$175.)

3. Need others?

. . . 18 standard models, 6 to 500 vdc from \$27.50 stocked at your electronic distributor; custom designs for O.E.M. and special applications.

Write for complete line catalog

5185



Since 1936—Pioneers in Low Voltage DC Power Supplies
• Proximity Switches • Magnetic Pickups • Tachometers
• Pres-Con Controls • Dynamic Micrometers

ELECTRO PRODUCTS LABORATORIES, INC.
6125-F HOWARD, CHICAGO, ILL. 60648 • 312/775-5220

Analog curves accurate to 0.05%

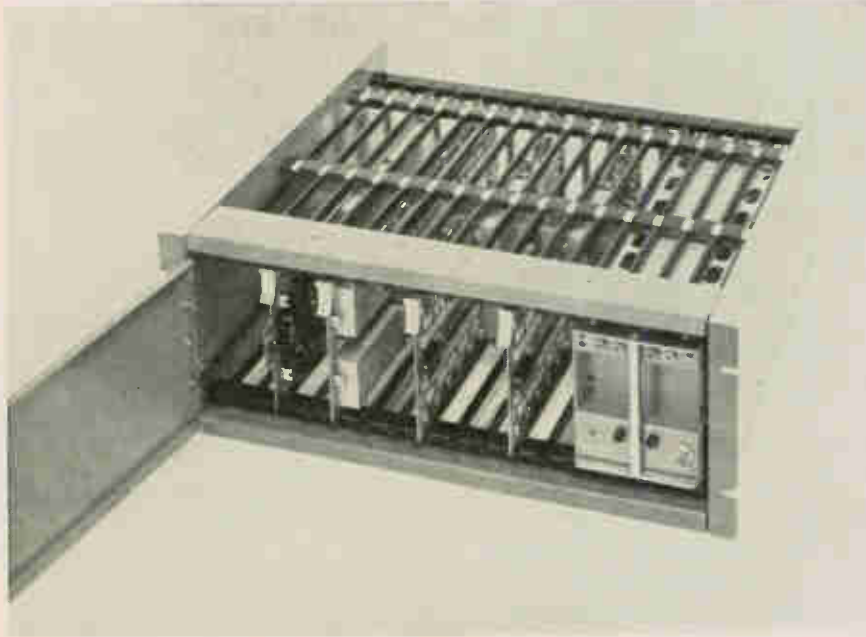

The accuracy of analog computers is limited by how closely complex mathematical functions can be approximated by electronic wave-shapes. While some mathematical operations, such as summing or subtracting, may be represented by simple straight lines, which are relatively easy to produce electronically with accuracy, more complex functions must be synthesized by stringing together a number of small straight-line segments that are tangent to the desired curve.

In analog computers, the segments are usually produced by resistor-diode networks. The number of resistors and diodes used depends on the accuracy desired. But resistor-diode networks are prone to drift, which is caused by temperature changes and resistance changes in the diodes. This drift introduces a cumulative error in the analog function. If a complex resistor-diode network is used to produce a large number of curve segments, the chance of error creeping in due to the compounding resistance drift is increased.

An advance in curve matching has been achieved by a special technique being patented by the Zeltex Corp., of Concord, Calif.

Zeltex uses an operational amplifier to synthesize a first approximation to the desired analog function. Then very small second-order corrections are made with conventional techniques using resistor-diode networks. The amplifiers correct the drift characteristics of the resistor-

Specifications

Sine-Cosine Generator	
Active error suppression	0.025%
Max. static error	25 mv
Zero error	2 mv
Output noise	Less than 20 mv peak-to-peak
Maximum dynamic error	100 mv at 100 cps
Input impedance	30 kilohms
Price	\$700
Operational Amplifier	
Drift	25 microvolts/day max.
Output range	±100 volts at 20 ma
Bandwidth	3 db down at 200 kc
Voltage drift	25 microvolt/8 hours; 3 microvolt/°C
Integrator drift	50 microvolts/second
Input impedance	500 kilohms
Input noise	500 microvolt peak, d-c
Price	to 200 kc \$280
Multiplier	
Active error suppression	Better than 0.05%
Dynamic error	100 mv peak at 100 cps; one volt peak at 1000 cps
Frequency response	40 kc at-3 db
Output noise	10 Mc peak-to-peak at zero to 100 kc
Input impedance	50 kilohms
Power requirements	±100 volts at 15 ma
Price	\$425

GLASS ENCLOSED
AMPERITE
Thermostatic
DELAY RELAYS

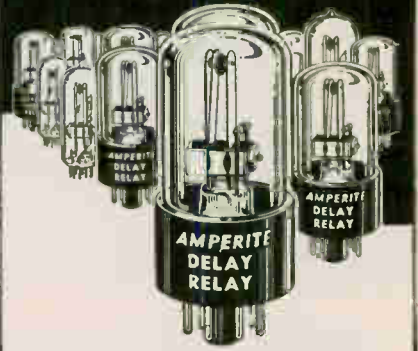

Offer true hermetic sealing
-assure maximum stability and life!

Delays: 2 to 180 seconds . . . Actuated by a heater, they operate on A.C., D.C., or Pulsating Current . . . Being hermetically sealed, they are not affected by altitude, moisture, or climate changes . . . SPST only—normally open or normally closed . . . Compensated for ambient temperature changes from -55° to +80° C . . . Heaters consume approximately 2 W. and may be operated continuously . . . The units are rugged—explosion-proof, long-lived, and—inexpensive!

TYPES: Standard Radio Octal, and 9-Pin Miniature.
List Price, \$4.00

PROBLEM? Send for Bulletin No. TR-81

AMPERITE
BALLAST
REGULATORS

Hermetically sealed, they are not affected by changes in altitude, ambient temperature (-50° to +70° C.), or humidity . . . Rugged, light, compact, most inexpensive.

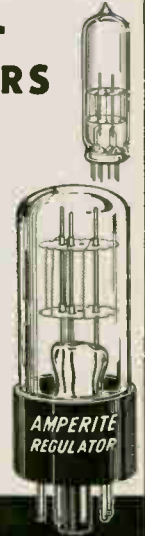

List Price, \$3.00
Write for 4-page Technical Bulletin No. AB-51

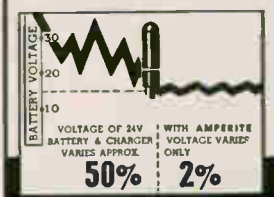

AMPERITE
600 PALISADE AVE., UNION CITY, N.J.
Telephone: 201 UNION 4-9503
In Canada: Atlas Radio Corp., Ltd.,
50 Wingold Ave., Toronto 10



You get what you see with a FAIRCHILD SCOPE CAMERA

The highest precision and clarity in oscilloscope photography are insured by a long list of Fairchild design features. Pinpoint focusing at any object-to-image ratio within lens range is one. Heavy duty synchro shutters with jam-proof activation are others. With Polaroid Land Back, 6 x 10 cm field can be recorded 0.9 actual size. Option of f/1.9 or f/2.8 lens. Prices start at \$350. For specifications or a demonstration, contact your local Fairchild Field Engineer, or write to Fairchild Instrumentation, 750 Bloomfield Avenue, Clifton, N. J.

FAIRCHILD

INSTRUMENTATION
A DIVISION OF FAIRCHILD CAMERA
AND INSTRUMENT CORPORATION
Circle 209 on reader service card

New Subassemblies

diode networks with negative feedback, achieving greater accuracy and stability in matching the curve segments. This technique is well known in generating straight lines; the novelty of Zeltex's approach is in applying it to curve-matching.

Zeltex's series 500 sine-cosine generator, operational amplifier and multiplier elements (see photo) suppress resistor-diode network error to produce less than 0.05% error in nonlinear functions. Further, dual operational amplifiers in the series provide compatibility with function selection terminals on the firm's current line of nonlinear cards, so the company can provide customers with all the elements required to build a complete analog system.

Zeltex Inc., 2350 Willow Pass Road, Concord, Calif. [401]

Charge preamplifier features low noise



A charge preamplifier, specifically designed for use with piezoelectric transducers, virtually eliminates error caused by cable loading on the transducer. These units have premium noise performance—200 μ v peak-to-peak at the output, worst case. This permits 0.001g measurements and a dynamic range of 50,000 to 1 without use of tracking filters. Sensitivity is fixed at 1 mv per picocoulomb with frequency response $\pm 3\%$ from 2 cps to 20 kc. Maximum output is 10 v peak-to-peak.

Model 139 charge-preamplifiers are rugged all-silicon units rated for operation from -55° to $+85^\circ$ C. They are encapsulated and hermetically sealed in a metal

DEPENDABILITY...



Informative
fact sheet is
immediately available
by writing to:

Plastic Capacitors, inc.

2620 N. Clybourn • Chicago 14, Ill.
DI 8-3735

Additional Reliability
In the Redesigned

PLASTIC DIELECTRIC CAPACITORS TYPE "OF" GLASS CAP

Designed for continuous operation for 10,000 hours at an ambient temperature of 85° C. Hermetically sealed glass tubular construction with metal end ferrules. Ideal for DC filter applications. Available 2KV to 60 KV; capacitance range .5 mfd. to .0001 mfd.

Custom  Engineering at
Production Prices

case. Size is 1½ in. in diameter by 3.3 in. long.
Ithaco Inc., 413 Taughanock Blvd., Ithaca, N.Y. [402]

Delay lines exhibit fast rise time

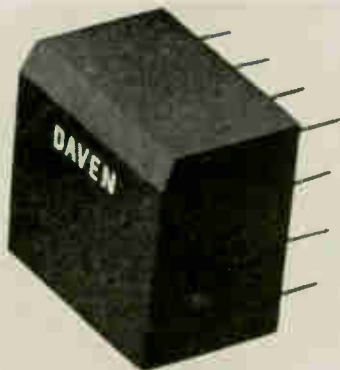

An electromagnetic delay line, developed for digital computers and other uses, is said to feature the highest delay to rise time ratios of any commercially available. They are available in miniature and sub-miniature sizes, encapsulated or hermetically sealed.

Features include delay times from 1 nsec to 50µsec; characteristic impedances from 50 ohms to 2,000 ohms. Now in production is a line featuring delay times from 1 to 10 nsec, with a rise time of less than 1 nsec and a frequency response of better than 1,000 Mc. Daven Division of Thomas A. Edison Industries, Livingston, N.J. [403]

D-c power module provides large output



An all-silicon d-c power supply series provides input of 105-125 v, 50-400 cps, single phase, 2.5 amps

If you're starting from scratch this way...

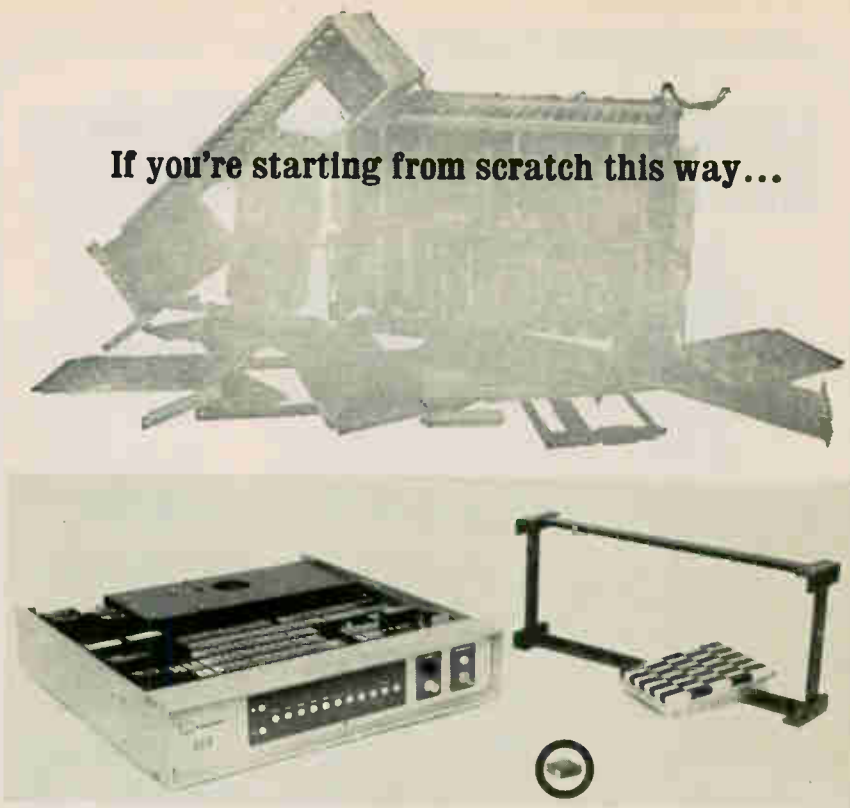

Check the advantages of Radiation's pre-engineered packaging and plug-in modules

- Packaging density compares with integrated circuits
- Cold solder joints and complex wiring eliminated—all components are welded and interconnections made by manual or automatic wirewrap
- Spare parts and logistics reduced *drastically*
- Circuits are individually encapsulated plug-in units, 0.4"x1"x1.1"
- High reliability—up to 5,330,000 hours MTBF

CUT COST on both logic circuits and mounting hardware. For example, a 1 Mc 4-input NOR is priced at \$5.00. Hardware for mounting 400 NOR's is only \$370.00. For more specification data or price information write:

See our complete line of data processing building blocks and communications maintenance/operation equipment at WESCON, Booths 2207-2208 and ISA Instrument-Automation Conference Booth 2014.



RADIATION
INCORPORATED

Products Division • Dept. EL-10 • P.O. Box 220 • Melbourne, Florida • Ph. (305) 727-3711
Circle 210 on reader service card

A REVOLUTIONARY NEW TWEezer SUPER FINE TWEezERS FOR PRECISION WORK

It firmly grips and holds the most delicate objects. Object can't slip because of special diamond grip. Gripping points lined with diamond-powder (fine grit). The diamond particles are firmly welded to stainless steel metal. These tweezers are used for micro-fine work and micro surgery.

No. 774. Blades taper sharply from body to very fine points length 4¾ inches. Stainless steel — non magnetic. \$10.00 each

No. 777. Curved, superfine points length 4¾ inches. Stainless steel — non magnetic. \$10.00 each

No. 772. Angled superfine points — Points on 45° angle. Length 4¾ inches — Stainless steel — non magnetic. \$10.00 each

No. 770. Blades taper gradually to very fine point — length 4¾ inches. Stainless steel — non magnetic. \$8.50 each

DIAMOND COATED EMERY BOARD — 7" over-all excellent for rapid finishing of fine parts — Diamond grit on both sides. \$9.60 per dozen

I. KASSOY INC. 30 WEST 47 STREET, NEW YORK 10036, DIAMOND CLUB BLDG.

WORLD'S LARGEST DISTRIBUTOR OF TWEezERS ■ ASK FOR OUR EXTENSIVE TWEezer CIRCULAR

Meet Our New Meter



MP-101

RS-111-1B-4

**It Displays
Carrier
Level, Acts
as RF
Voltmeter**

Connected to any receiver with a 21.4 mc IF output, CEI's new Meter Panel, Type MP-101, acts as a tuned, comparison RF voltmeter. Its meter displays either peak or average carrier level, selected by a front panel switch.

Incorporating an IF amplifier/driver and AM detector, the MP-101's meter circuit and a video amplifier feed from the detector output. The video amplifier is preceded by a variable slide-back gate, permitting bias adjustment to raise the starting level of even very weak pulse signals above baseline noise on an external scope.

Completely solid state, the Meter Panel is 3 1/2" high and weighs just 9 lbs.

CEI has specially modified its top-selling VHF-UHF receiving system to take advantage of the MP-101's capabilities. Designated the Type RS-111-1B-4, this modified receiver offers greater IF bandwidth with manual gain control capability to permit pulse reception, and a 21.4 mc IF output with manual gain control in the FM mode.

For more details about either the Meter Panel or modified VHF-UHF receiver, contact:

COMMUNICATION ELECTRONICS INCORPORATED

6006 Executive Boulevard, Rockville, Maryland 20852, Phone (301) 933-2800

Circle 211 on reader service card

THE MOST FILTERING FOR THE LEAST COST MEANS *KROHN-HITE*

Why keep on worrying about the cost of eliminating noise from your measurements? Select the frequency pass-band you're interested in, and the type of filter action you need, and K-H has a variable electronic filter that will do the job with finesse and finality — at a cost that can be as low as \$375. Or suppose you need all four filter modes. K-H has that flexibility for you too, in the Model 335 multi-function filter for only \$975.

Krohn-Hite filters offer more outstanding features of performance and versatility, at less cost for initial investment and subsequent upkeep, than you can possibly find anywhere else. Here are just a few of their advantages:

- Independent continuously variable cutoff-frequency tuning
- Stable calibration accuracy of 5%
- Pass-bands extending from dc to 3 megacycles, with 0 db insertion loss
- Cutoff tuning from 0.02 cps to 200 kc
- 24 db per octave attenuation rate
- Greater than 80 db maximum attenuation
- Infinite-rejection tunable single-frequency null
- 0.1 db pulse overshoot where required for maximum waveform fidelity
- High input and low output impedances.

Whatever your filter requirements, check Krohn-Hite first.

Write today for data on our full line of filters



KROHN-HITE CORPORATION
580 Mass. Ave. Cambridge, Mass. 02139

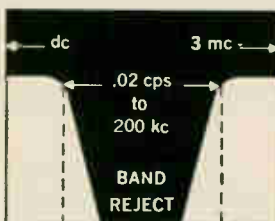
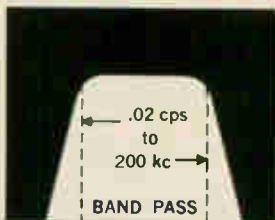
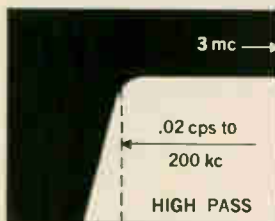

New Subassemblies

with output range of 1 to 100 v at 14.0 to 1.2 amps. Regulation is 5 mv max at 1 to 65 v, 8 mv max at 70 to 100 v and 20 mv max above 100 v.

Other specifications include ripple of 1 mv rms max below 100 v and 2 mv rms max above 100 v, impedance less than 1 ohm at 500 kc and transient recovery time of less than 100 μsec. Remote sensing, remote voltage adjust and overload protection are standard in a 7 1/8 by 5 3/16 by 6 3/16 in. package.

Dressen-Barnes Electronics Corp., 250 N. Vinedo Ave., Pasadena, Calif. [404]

Operational amplifier comes in two versions

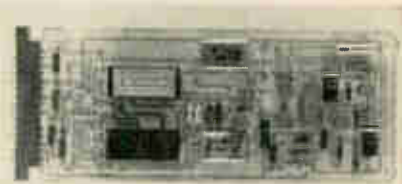

A solid state operational amplifier has been developed for industrial servo control systems, transducers, data conditioning systems, operational functions, and biomedical applications. The unit is available in two versions: Model 1504 uses silicon transistors; model 1505, germanium transistors. Both offer differential or single-ended input and are fully short-circuit protected.

These units are also designed to minimize signal-to-noise problems. Noise is less than 1 μv rms below 1 kc, less than 20 μv rms over total bandwidth.

Other key specifications include: open loop gain, 400,000; output, ±20 v at 1.8 ma; open-loop input impedance, 250,000 ohms; common mode rejection, better than 50,000 to 1; rate of rise of output voltage, 300,000 v per sec.

Both amplifiers are available as single units or in card rack frames as complete subsystems. Unit prices are \$175 for the model 1504; \$155 for the model 1505. Delivery takes three weeks.

California Electronic Mfg. Co., P.O. Box 555, Alamo, Calif., 94507. [405]

“ACTIVE”...

ERIE Definition of Advanced Component Capability



SUBMINIATURE MONOBLOC CERAMIC CAPACITORS

High capacitance to volume ratio.
Hermetically sealed in glass; precision
molded, and phenolic dipped types.



MINIATURE HERMETICALLY SEALED BUTTON MICA CAPACITORS

For -55°C. to +200°C. applications.



SUBMINIATURE BROAD BAND R. F. I. FILTERS

Eliminate RF noise in
10 KC to 10 KMC frequency range.



HIGH RELIABILITY TUBULAR and DISC CERAMIC CAPACITORS

General Purpose; Temperature
Compensating; and High Stability types.



MINIATURE CERAMIC and GLASS TRIMMERS

Precision trimmers with capacitance
and terminal arrangements to suit need.



MINIATURE FILM CAPACITORS

Designed for filter, bypass,
coupling and blocking applications.



SUBMINIATURE DIFFUSED SILICON RECTIFIERS

High forward conductance, low-leakage
currents and reliable performance.



MINIATURE BYPASS CAPACITOR SYSTEMS FOR TRANSMITTING TUBES

Effective capacitive bypassing and
coupling or filtering of all signals in
10 to 3000 megacycle range and beyond.



SUBMINIATURE INTEGRATED NETWORKS

Compact modules of resistor-capacitor
networks with 2, 4, 6 or 8 leads...
with or without semiconductor elements.

THE term “ACTIVE” in the Erie organization identifies a total program encompassing the research, development and production of Advanced Components Through Increased Volumetric Efficiency for aerospace, military and commercial equipment.

Project “ACTIVE” now brings to electronics and avionics a series of high performance, subminiature components designed for applications where every cubic inch of space and every ounce of weight is critical to successful equipment performance.

These Erie components have been and are being designed into the circuitry of such demanding systems as Gemini, Apollo, Minuteman, Nike X, Telstar, Polaris... commercial computers, oscilloscopes... and many other applications where size, weight and dependable performance are vital. While the advanced products illustrated at left are in quantity production, a number of components are still in the concept stage, while others are at final evaluation ready for production.

Consider the problem-solving advantages Erie ACTIVE components can offer you in your quest for reliable, subminiature components. We suggest ERIE as your quality source. A collect call or letter to your nearby representative... or to Erie headquarters is all that is needed as the “first step.”

Erie's Project “ACTIVE”
Advanced Components through Increased Volumetric Efficiency



Formerly
Erie Resistor
Corporation

644 West 12th Street
Erie, Pennsylvania

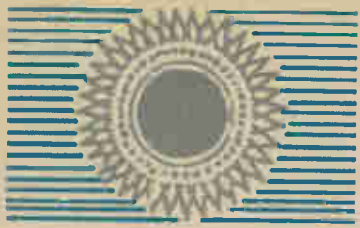

October 1965

Make a Date With Success

It's career month at NCR, Los Angeles. Advanced digital systems on the board, in production and on the market tell you that this is opportunity in the present tense. At NCR, you'll work with the people who created the NCR 315 RMC Rod Memory Computer, CFAM and the 420 Optical Journal Reader. You'll help provide business systems for more than 120 countries. And you'll enjoy the good Southern California life. Bring your career up to date... investigate NCR now.



NCR
ELECTRONICS DIVISION

Microwave switch isolates ports by 140 db

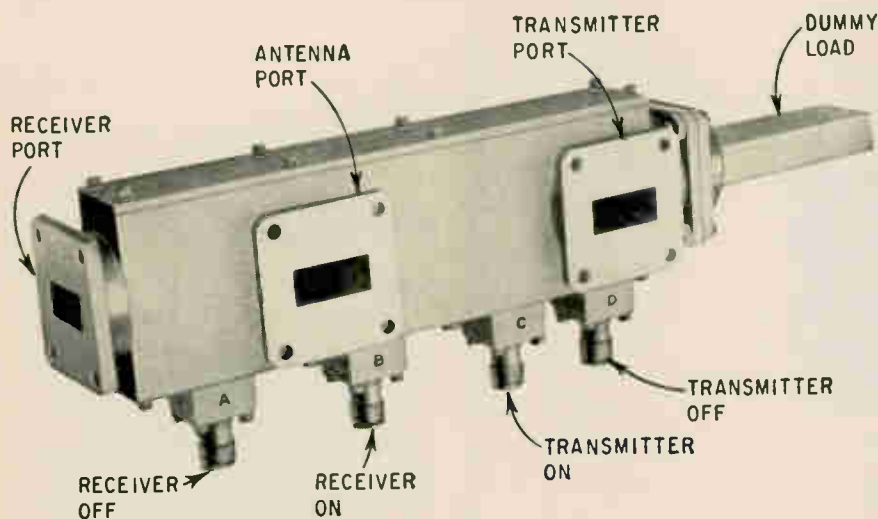

The transmit-receive (TR) switch that connects the transmitter and receiver of a radar system to its antenna has two functions: During the transmit mode, it provides a short circuit across the receiver, so that the large amounts of power from the transmitter are coupled only to the antenna, thereby protecting the receiver. During the receive mode, the microwave switch couples the transmitter to a dummy load and lets only the antenna's received signal into the receiver. It follows that a TR switch should have as much isolation as possible between its transmit and receive ports.

American Electronic Laboratories, Inc., has developed a double-pole, double-throw switch that has 140 decibels minimum isolation between the transmit and receive ports. The company says this increased isolation, which is about 50 db more than can be obtained with currently available TR switches, is the result of coating the interior surfaces, especially all the metal-to-metal joints, with a silver epoxy paint made by Du Pont. The paint assures better electrical contact between mating surfaces and reduces the amount of radio-frequency leakage through the joints. The connectors that provide the switching signals are packed with an epoxy-based compound that suppresses microwave fre-

quencies but passes d-c and audio signals without attenuation. This reduces total r-f leakage out of the switch to 90 db below the power level of the signal in the switch.

Because it is capable of switching in less than 10 nanoseconds, the switch can pulse a continuous-wave input directly. The switch can handle a maximum of one watt c-w.

The photo above shows a TR switch for X-band; AEL also manufactures switches with 140-db isolation between ports for C, S, L and vhf bands.

Price and delivery on request.

Specifications

Vswr	1.5:1 maximum
Bandwidth	200 Mc for X-band model
Switching voltages	
On state	+1 volt, 150 milliamps
Off state	-15 volts, 0.1 microamp maximum

American Electronics Laboratories, Inc.,
P.O. Box 552, Lansdale, Pa. [421]

Low-pass filter has sharp attenuation

A low-pass microwave filter offers broad pass bandwidth and sharp attenuation. Combining modern network theory with an exclusive hardware design technique, the manufacturer has produced a 35-element filter with a pass band of

DIGITAL SYSTEMS OPPORTUNITIES AT NCR, LOS ANGELES

ADVANCED COMPUTER DEVELOPMENT

SYSTEMS DESIGN/Senior-level positions in advanced development and preliminary design of beyond-the-state-of-the-art data processing equipment. Considerable experience required in the over-all system design and integration of commercial computing equipment. BSEE required with advanced degree highly desirable.

MEMORY DEVELOPMENT/Analysis and design of advanced thin-film memory systems, both linear select and coincident current. Also advanced random-access development on magnetic-card and disk-file systems. BSEE required, advanced degree desired.

LOGIC AND CIRCUIT DESIGN / Advanced integrated-circuit computers, buffering systems, on-line computing and transmission systems, and computer peripheral equipment. BSEE and good knowledge of state of the art required.

MECHANISMS DESIGN/Senior-level positions working with new techniques for development of advanced high-speed random-access memories. Work requires 5 years' experience in servomechanisms and BSEE or BS in physics; or considerable experience in high-speed mechanisms with BSME and MSEE or BSEE and MSME.

PRODUCT ENGINEERING

ELECTRONIC PRODUCT ENGINEERS / Positions require BSEE with experience in designing digital computer equipment and maintaining liaison with manufacturing.

PACKAGING/Layout and design of packaging for computer systems. Experience required with electronic computers or electromechanical devices. Background in miniaturization with thin films and integrated circuits desirable. BSEE required.

PROGRAMMING DEVELOPMENT

SOFTWARE PROGRAMMERS / Development of software for computer input/output routines, operating systems and monitors. Programming experience with machine language on a large-file computer required.

DESIGN AUTOMATION PROGRAMMERS/Positions require experience in programming for design automation, good understanding of engineering and hardware problems, and BS in math, engineering or related field.

SYSTEMS FORMULATION

Openings at all levels to study and formulate systems for commercial and industrial on-line computer applications, with emphasis on communications interface. Minimum of two years required in specifying or programming real-time systems for banks, airlines or industry. Engineering, business administration or related degree required.

MEMORY RESEARCH

Advanced work requiring MS in EE or physics plus experience with nanosecond pulse technique and high-speed applications of magnetic cores or thin films to memories with computer systems logic and hardware.

ARRANGE NOW FOR AN INTERVIEW IN YOUR AREA

Confidential interviews will be held soon in various parts of the country. Openings above are in Los Angeles. Additional openings in Dayton, Ohio, for mechanical, electrical and chemical engineers, physicists, chemists (MS or PhD level). Send resume immediately to Bill Holloway, Technical Placement.

The National Cash Register Company



ELECTRONICS DIVISION

2816 W. El Segundo Blvd., Hawthorne, Calif.
Telephone: Area Code 213-757-5111

An equal-opportunity employer



REMEMBER **RESE**
FOR **MAGNETIC CORE MEMORIES**



RESE ENGINEERING INC.

A and Courtland Streets, Philadelphia, Pa. 19120 (215) GL5-9000

Circle 212 on reader service card

DO YOU HAVE **Reed Relay Problems?**



Problem: The National Bureau of Standards needed a Form B Relay to latch open with a minimum of power.

Solution: Coto-Coil designed and produced a Mercury-Wetted Relay requiring less than 2mW to operate, with contacts to handle 28W (1A or 100V max.)... a power gain of 14,000 in a package of only .15 cu. in.!

Can We Solve Your Problem?

Write for catalog and prices of our standard line of magnetic reed relays. For special requirements, give complete details for quotation.

Coto-Coil

COMPANY INC.
65 Pavilion Ave.
Providence, R. I. 02905
Phone: (401) 941-3355

(Key Sales areas available for representation, Please Inquire.)

MICO
NEW SIX-RATIO
STANDARD ENGRAVER

CAT. NO.
259

FOR LIGHT
AND MEDIUM
DUTY WORK



AMERICAN
MADE

- Engineered for ruggedness and simplicity.
- Six pantograph ratios—from 1.5:1 to 4:1.
- Ball-bearing spindle uses 1/8" shank cutters and has true .250" micrometer depth control.
- Sturdy one-piece ratio studs anchor in ESNA stop-nuts for quick locking of pantograph arms.
- Master copy and work right-side up—in full view of operator. Raising stylus raises cutter.
- Attachments available for increasing versatility.

Send for bulletins and prices

MICO INSTRUMENT CO.

77 Trowbridge St.

Cambridge 38, Mass.

Circle 213 on reader service card

New Microwave

2 to 4 Gc and a stop band of 4.15 to 4.35 Gc with 25-db minimum attenuation. Maximum pass band vswr is only 1.5, and insertion loss is 0.5 db maximum.

Designated model LA-B70, the unit costs \$150.
Microlab/FXR, Livingston, N.J. [422]

**Ferrite switches
operate at X-band**

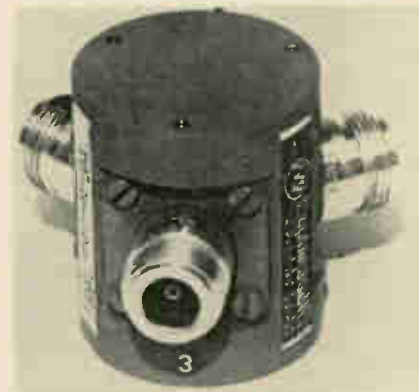

Two X-band ferrite switches have been announced for waveguide and coaxial applications. The coaxial unit illustrated, model XL-360, operates over a frequency range of 7.2 to 10.0 Gc with 20.0 db isolation, 0.3 db insertion loss and 1.30 vswr. Switching time is 350 μ sec or less, depending on drive power.

The waveguide switch, model XL310, operates from 8.5 to 9.5 Gc, has 25 db isolation, 0.2 db insertion loss, and 1.15 vswr. Switching time is 150 msec with drive power of 20 v at 320 ma.

Micromega Corp., 4134 Del Rey Ave., Venice, Calif. [423]

**R-f attenuator pads
cover d-c to 1 Gc**

A complete line of miniature fixed attenuator pads has standard attenuation values covering 1 db, 2 db, 3 db, 6 db, 10 db, 12 db, and 20 db. Other attenuation values can be supplied upon request.

Each pad is calibrated at two frequencies and is color-coded to indicate its db value. Attenuation tolerance is ± 0.3 db and the cali-

bration accuracy is ± 0.1 db. The units cover a frequency range of d-c to 1 Gc, usable to 1.5 Gc, and are available with 50-ohm impedance. Vswr is held to less than 1.2:1 at 1 Gc.

The attenuator pad is supplied with BNC or TNC connectors and measures approximately 2 in. long by $\frac{1}{2}$ in. in diameter. Weight is approximately 1 oz. Pads are priced at \$12.50 each in small quantities, and delivery is from stock.

Texscan Corp., 51 Kowebe Lane, Indianapolis, Ind., 46207. [424]

Lightweight oscillator operates at K band



A backward wave oscillator now available is fully shielded and is focused by a permanent magnet. The $2\frac{1}{2}$ pound VA-47OM, measuring only 3 in. in diameter by 4 in. long, provides at least 20 mw of output power over a frequency range of 12.4 to 18.0 Gc. Tuning is accomplished by adjusting the helix voltage between 200 and 1,000 v. The resulting voltage-vs.-frequency curve follows an exponential function and contains no discontinuities. A nonintercepting negative control grid provides means for amplitude modulation without drawing current in the modulation circuit.

The magnetic shielding reduces the stray magnetic field of the bwo to less than 10 gauss $\frac{1}{2}$ in. from the tube surface. Thus, to a magnetic-sensitive device, the bwo appears to be a passive ferrous material, not a magnet. In addition, the VA-47OM may be operated in contact with ferrous materials or in stray magnetic fields, typically found in microwave equip-

NOW, Micro-Miniature

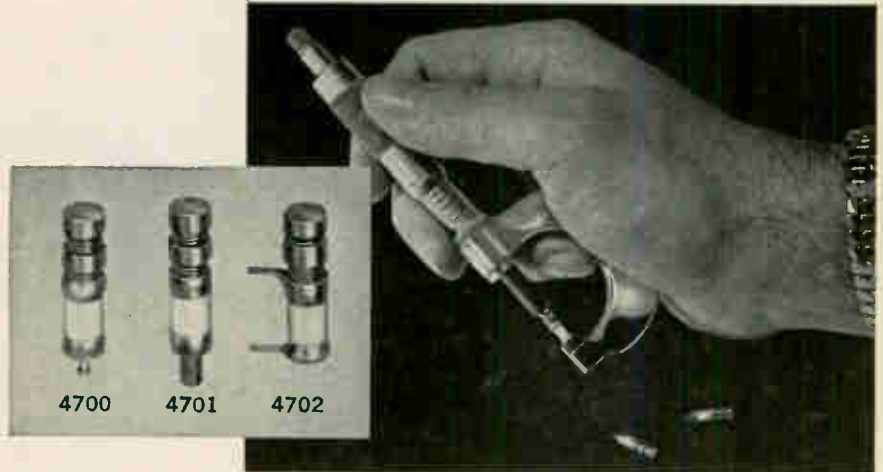

Highest Q Air Capacitors

- .140 in Diameter, $\frac{1}{2}$ " length
- Capacitance Range 0.35 pF to 3.5 pF
- Q @ 250 mc > 2000
- Finest Materials
- Q @ 100 mc > 5000
- Finest Workmanship

Write for full data

Johanson MANUFACTURING CORPORATION
400 Rockaway Valley Road, Boonton, N. J. Phone (201) DEerfield 4-2676

Circle 214 on reader service card

NEW ISSUE

450,000 Shares GCA Corporation Common Stock

(par value 60¢ per share)

Price \$16.75 Per Share

Upon request a copy of the Prospectus describing these securities and the business of the Company may be obtained within any State from any Underwriter who may regularly distribute it within such State. The securities are offered only by means of the Prospectus, and this announcement is neither an offer to sell nor a solicitation of any offer to buy.

Goldman, Sachs & Co.

Eastman Dillon, Union Securities & Co.	Hornblower & Weeks-Hemphill, Noyes
Kidder, Peabody & Co. <small>Incorporated</small>	Lehman Brothers
Paine, Webber, Jackson & Curtis	Carl M. Loeb, Rhoades & Co.
Wertheim & Co.	Smith, Barney & Co. <small>Incorporated</small>
Hayden, Stone <small>Incorporated</small>	White, Weld & Co. <small>Incorporated</small>
	Dean Witter & Co.
	C. E. Unterberg, Towbin Co.

September 30, 1965.

COMMUNICATIONS PROBLEMS

?

SEND YOUR UHF-VHF PROBLEMS TO SINCLAIR

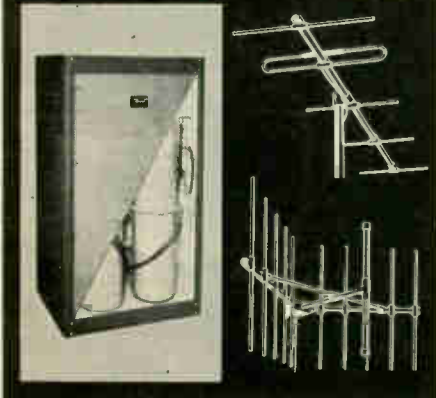

MULTICOUPLERS — use one antenna to simultaneously transmit and receive up to 24 systems . . . with high isolation between channels, low insertion loss and low maintenance costs. Multi-couplers for the 30MC to 10KMC range — specials to meet unusual problems.

DUPLEXERS — for the ultimate in isolation between Tx and Rx for dual simplex or full duplex operation. Separation as low as 0.5 MC at full power load of 250 watts. Perfect for base or repeater station or mobile operations. Frequency ranges from 30 MC to 960 MC — as small as 2" x 4" x 6".

ANTENNAS — a complete line — Isorays . . . Yagis . . . Ground Plane . . . Corner Reflectors . . . Base Station . . . Mobile — for frequency ranges from 30 MC to 470 MC. Gains from 0 db to 20 db. Rugged enough to withstand 125 mph winds with 1/2" ice coating — small enough to fit in a rear view auto mirror.

Also, a complete quality line of Band Pass and Reject Filters, Mounting Accessories and Antenna Hardware. Clip the coupon, attach to your letterhead, and we'll send complete details.



SINCLAIR RADIO LABORATORIES, INC.

523 FILLMORE AVENUE, DEPT. 101
TONAWANDA, NEW YORK

IN CANADA: 21 TORO ROAD
TORONTO, ONTARIO

Name _____ Title _____

Company _____

Address _____

City _____ State _____

New Microwave

ment, without performance degradation.

Possible applications of the VA-470M include airborne local oscillators, wide-band swept oscillators and signal sources for compact test equipment.

Varian Associates, 611 Hansen Way, Palo Alto, Calif., 94303. [425]

Co-ax wavemeter spans 3.7 to 12.4 Gc



A coaxial microwave frequency meter has been developed that covers the frequency range from 3.7 to 12.4 Gc with no spurious responses. Key to accomplishment of spurious-free response across nearly two octaves is design of the tuned cavity for the quarter-wave mode, with concurrent damping of three-quarter-wave modes.

Model 537A coaxial frequency meter has a 75-in. direct-reading scale, with scale calibrations accurate to $\pm 0.1\%$, in increments of 10 Mc. Worst-case over-all accuracy is $\pm 0.17\%$, allowing for scale errors, humidity variations from 0 to 100%, temperatures ranging from 12° to 33°C, and backlash.

The instrument provides at least 1 db response dip at resonance, and has Q in excess of 1,000. It measures 5 7/8 in. in height, 3 1/2 in. in diameter. Price is \$500 per unit. First deliveries are expected in November.

Hewlett-Packard Co., 1501 Page Mill Rd., Palo Alto, Calif. 94304. [426]

we are your best bet
for electronic materials

"What did you say?"
"WE SAID, WE ARE
YOUR BEST BET
FOR ELECTRONIC
MATERIALS!"

We are a primary fabricator and supplier of high purity metals and alloys, compound semiconductors and thermoelectric cooling materials.

PHONE AREA CODE 509 747-6111
TWX 509-328-1464 Telex 032 610

IMMEDIATE SHIPMENT BY AIR PRE-PAID

COMINCO PRODUCTS, INC.

electronic materials division

818 West Riverside Ave.,
Spokane, Washington 99201

6603

Circle 217 on reader service card

Primo

Super High Sensitivity
**SOUND LEVEL
METER MICROPHONE**
(DYNAMIC TYPE)



Specifications

- Frequency Response: 20~16,000±/s ±1.5dB
- Impedance: 100Ω ±10%
- Sensitivity: -80dB ±2dB
- Dimensions: 3.5φx220mm
- Weight: 7.30gm.

DM-1332



For catalog write to

PRIMO COMPANY LTD.

2043 MURE, MITAKASHI, TOKYO, JAPAN
TEL. 0422-3-3121 (Calling from Tokyo)



We can deliver
power as you like it...

and we've recently
proved it again!

Shipment of the prototype power converter for IMP, NASA/Goddard's Interplanetary Monitoring Platform, is the latest in a long line of satellite power system achievements by Space Craft, Inc.

Since IMP's mission includes the measurement of fields, the system requires a power supply which generates no significant magnetic field. In response to this requirement, Space Craft designed and built a non-magnetic power converter. It converts DC to RF through a 1 Mc oscillator and demodulates back to DC at four output voltages. Voltage regulation is better than $\pm 0.05\%$.

Thus IMP takes its place among more than a score of power conversion contracts successfully completed or under way at Space Craft, Inc. These systems have combined conversion efficiencies as high as 86% with minimum weight, minimum volume and maximum reliability.

When you have specialized power problems, go where the experience is...

SPACE CRAFT, INC.

8620 SO. MEMORIAL PKWY. / HUNTSVILLE, ALA. 35802



Circle 219 on reader service card

Weld, Solder and Bond
with this Versatile Machine!

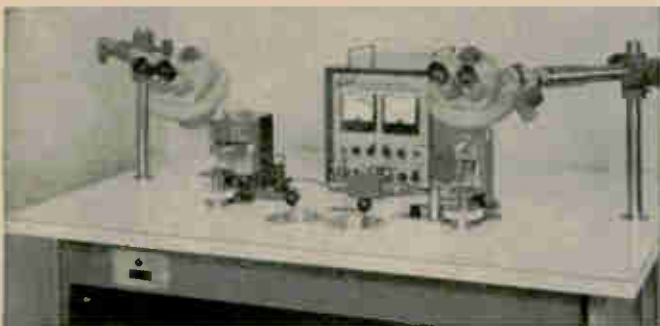

Weltek's new Model 750 can be set up in minutes to do micro-miniature welding, controlled soldering or "nail head" bonding. With this one piece of equipment you can solder or weld flat packs to p.c. boards, do module welding, point-to-point microsoldering or bond a wire to a transistor chip! The possibilities are unlimited. The 750 can do *all* of your miniature joining work... in the lab or in production. And it is reasonably priced.

FREE SAMPLING SERVICE!

Send us your miniature joining problems... we sample quickly. No obligation.

Weltek

Precision Bonders

by **WELLS ELECTRONICS, INC.**

1701 S. Main Street, South Bend, Indiana, U.S.A.

Circle 220 on reader service card

**SERVO-CHART
RECORDERS
DON'T
HAVE
TO BE
COSTLY!**



**This Heath-Built Recorder
Costs Just \$199!**

Completely Factory Assembled & Tested!

Ready to use. True potentiometric input. Five adjustable ranges: 10, 25, 50, 100 & 250 mv plus plug-in 5-pin connectors for special ranges. Rapid chart advance: pen lift; paper tear-off guide; optional motor speeds: 10" chart; 1 sec. response. For full details on the famous Malmstadt-Enke Lab Series *Free*, simply tear out coupon and mail.

Assembled EUW-20A, Recorder, 20 lbs. \$199.00



HEATH COMPANY, Dept. 67-10, Benton Harbor, Mich. 49023

Please send Free Folder on Malmstadt-Enke Lab Series and Free 1966 Heathkit Catalog.

Name _____ (Please Print)

Address _____

City _____ State _____ Zip _____

EK-187

Circle 177 on reader service card

177

FOR
DRILLING
AND ROUTING
CIRCUIT BOARDS
AND
REINFORCED
RESINS

**SOLID
CARBIDE**

◀ DRILLS

◀ FLUTED
ROUTERS

◀ FIBERGLASS
ROUTERS

UNEQUALLED METAL REMOVAL
COMPANY SERVICE, QUALITY
AND SELECTION INCLUDING:

1. World's largest inventory of centerless ground drill blanks and finished tools ready-for-shipment.
2. Fifteen centerless grinders in production of drills and rotary carbide tools.
3. Every size carbide drill, ground from-the-solid . . . the smallest — .008" diameter to the largest — 1.500" diameter.
4. Precision ground to 5 micro-inch finish or better.
5. Delivery from stock, through our distributors, of any standard solid carbide tool in 48 hours.

Your assurance of product quality, lowest cost and dependable service is the fact that the nation's leading carbide tool users are placing their tool contracts with The Metal Removal Company.

THE METAL REMOVAL COMPANY
1859 W. Columbia Avenue
Chicago, Illinois 60626
Plants Located in CHICAGO • LOS ANGELES • SAN JUAN



**MASTER TOOL AND WHEEL
MAKERS FOR THE WORLD**

New Production Equipment

Ultrasound assembles connectors

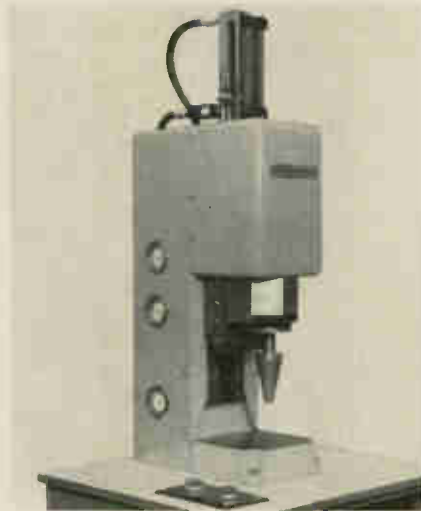

The use of thermoplastic parts in such electronic components as connectors is often complicated by the need to insert irregularly shaped metal parts into the hardened plastic. Up to now, this has required either assembly or molding the hardware into the plastic, both of which can be time-consuming and expensive, or can require complex equipment.

An ultrasonic press, developed by Cavitron Ultrasonics, Inc., offers a solution to this problem. An ultrasonic transducer presses the metal part against the plastic, and at the same time transfers ultrasonic energy through the metal into the plastic at the point of contact, causing the plastic to soften and flow around the metal. This flow occurs only at the interface between the metal and the plastic, allowing the press to force the metal part down into the plastic.

In experiments with this technique, Cavitron has embedded contacts, terminal pins, nameplate screws, bolts and even toothpicks into plastic. The bottom of the metal part can have screws, lugs or other holding projections. The end that is inserted need not be pointed—in fact, Cavitron says, blunt-ended parts can be inserted more quickly because they transmit more energy into the plastic. The technique avoids the use of expandable inserts, which can crack

stress-sensitive plastics.

Another prime use of the technique, the company expects, will be as a backup process for injection molding. Injection-molding machines, used to make printed-circuit and other forms of connectors, are expensive and can't operate at top speed if the mold must be held open for placement of inserts.

Cavitron is not recommending plastic encapsulation of delicate electronic components or insertion of hardware into glass or metals. Although it could be done in theory, it isn't considered practical.

The company has begun supplying interested customers with a press designed for experimental use and process development. It can insert at rates up to 120 cycles a minute. Other specifications are listed below. About January 1, three production models will be available. Their generator and transducer ratings and prices will be: 200 watts, \$2,500; 500 watts, \$5,000, and 1,000 watts, \$7,000.

Specifications of prototype

Generator power	600 watts maximum,
frequency	20 kc nominal, a.f.c.
input	115 v, 60 cps, 10 amp, single phase
Transducer	1 kw max., 20 kc, water cooled
Press force	20 to 300 pounds
air supply	60 to 100 psi
cycle time	0 to 3 seconds

Cavitron Ultrasonics, Inc., Borden Avenue at 21st Street, Long Island City, N.Y. 11101 [451]

Air-bearing spindles drill p-c boards



Two models of air bearing spindles are available for circuit-board drilling. Both are readily adaptable to

NEW Miniature Mercury-Wetted Contact Relays

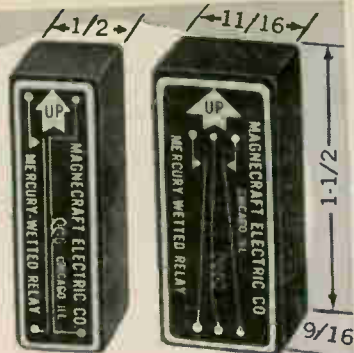

IN STOCK
for immediate
shipment—
SPST-NO, DPST-NO
for 6, 12, 24VDC
and 8 MA

**Send for
literature**

New MAGNECRAFT Class 131PC en-
capsulated printed circuit Relays.

SPST-NO and DPST-NO contacts
rated 28VA at 1 amp. or 100 v, max-
imum resistive.

Operate Time and Release Time,
each, 1 ms average—no contact
bounce.

Ambient temperature: -37 to
+200°F.

Operating position: upright, not more
than 30° from vertical.

Life expectancy: 100 million cycles
at rated load.

Printed Circuit Terminals: .040 dia.,
1/8" long, centered on multiples of
0.200".

MAGNECRAFT Electric Co.

5565 N. Lynch, Chicago, Ill. 60630

(312) 282-5500

Circle 223 on reader service card

Speed-up
Wire
Marking

with a

KINGSLEY
Wire & Tube
Marking Machine

right in your plant!



Write
for
Details

Now you can *permanently*
mark wire or tubing di-
rectly on the insulation...
quickly... economically...
right in your own plant!

Cut costs and speed produc-
tion with the same machine
that has consistently proven
so successful in the air-
craft missile field.



KINGSLEY
MACHINES

850 CAHUENGA • (219) 469-7243
HOLLYWOOD, CAL 90098

A-207

Circle 224 on reader service card

Refreshing new ideas in packaging

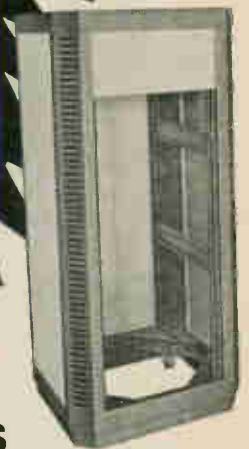

ZEPHYR

CABINET RACKS

Exceptionally sturdy all assembled unit with welded
frame. Placement of louvers insures ventilation under
all conditions.



**GRAND-
PRIX
CABINETS**

Imaginative, yet practical design in standard cab-
inetry. Offers innumerable possibilities for instrument
and control housings.



FUTURA CABINETS

Highly functional, two
piece cabinet embodying a
design feature of holding
front panels in place with-
out the use of hardware.



pan·L·lite

Classic combination of aluminum and plastic sup-
plies glare-free lighting for area requiring a high
degree of concentrated illumination.

You are invited to see these distinctive new products
at your Bud Distributors. Literature, prices and the
names of your nearest Authorized Bud Distributors
may be obtained by writing to the plant.



BUD RADIO, INC.
WILLOUGHBY, OHIO

BUD RADIO OF CANADA, LTD. • 9 Milvan Dr., Weston, Ont., Canada

Circle 179 on reader service card

179

TRON SUB-MINIATURE PIGTAIL FUSES



VISUAL INDICATING

BODY SIZE ONLY
.145 x .300 INCHES

For use on miniaturized devices, or on gigantic space tight multi-circuit electronic devices.

Glass tube construction permits visual inspection of element.

Smallest fuses available with wide ampere range. Twenty-three ampere sizes from 1/100 thru 15 amps.

Hermetically sealed for potting without danger of sealing material affecting operation. Extremely high resistance to shock or vibration. Operate without exterior venting.

Insist On BUSS

QUALITY Fuses

BUSSMANN MFG. DIVISION, McGraw-Edison Co., St. Louis, Mo. 63107

Write for BUSS Bulletin SFB

BUSS SHIELDED FUSEHOLDERS

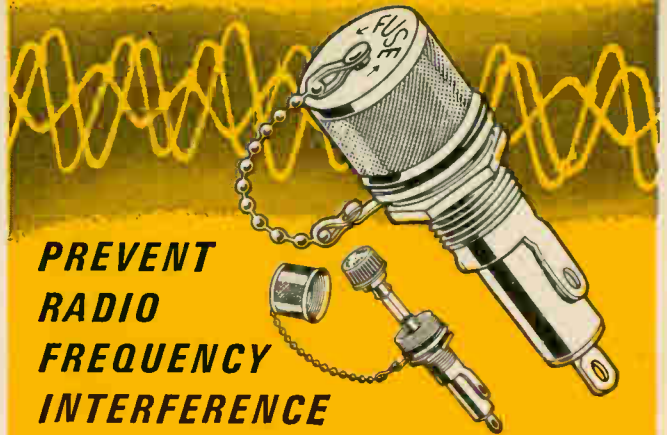

PREVENT RADIO FREQUENCY INTERFERENCE

For use where fuse and fuseholder could pick up radio frequency radiation which interferes with circuit containing fuseholder—or other nearby circuits.

Fuseholder accomplishes both shielding and grounding.

Available to take two sizes of fuses— $1/4 \times 1 1/4$ " and $1/4 \times 1$ " fuses.

Meet all requirements of both MIL-I-6181D and MIL-F-19207A.

Insist On BUSS

QUALITY Fuseholders

BUSSMANN MFG. DIVISION, McGraw-Edison Co., St. Louis, Mo. 63107

For complete information write for BUSS Bulletin SFH-12

BUSS: The Complete Line of Fuses and . . .

Circle 181 on reader service card

Circle 181 on reader service card



**NOW !
SAMPLE DATA TO
5 μ VOLTS
RESOLUTION**

and **WITH BACKCURRENTS OF LESS THAN 5 NANOAMPERES**

These improved low level, silicon, FET commutators and multiplexers outperform mechanical and mercury wetted switches and provide all the stability and long life of solid state devices. Internal amplifier gains up to 10,000 are available.

BEST AVAILABLE

DYNAPLEX CORPORATION

P.O. BOX 341 PRINCETON, NEW JERSEY 08540

180 Circle 180 on reader service card

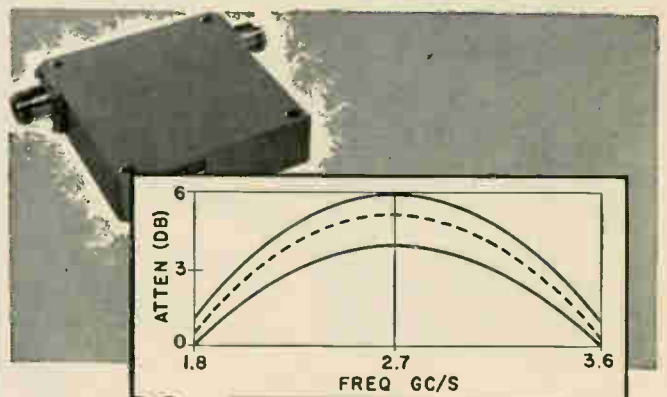

TWT ATTENUATORS by RADAR DESIGN CORP.

The new Model D-1942 TWT Attenuator shown operates in the range of 1.8 to 3.6 Gc/s with a maximum VSWR of 1.5. Other models available for specific variations in power output and range. Small in size and cost, all units are held to uniformly close tolerances.

For any type fixed or variable attenuator or other microwave component in the range of 0-12 Gc/s look to RDC. Several hundred standard components are maintained in perpetual inventory for fast, off-the-shelf delivery. Modifications or custom requirements promptly produced.

For complete information write direct or contact your nearest representative.



Circle 222 on reader service card

New Production Equipment

any of the production-type circuit-board drilling machines. Model 1 has a spindle $2\frac{1}{4}$ in. in diameter x 6 in. long, 50,000 to 75,000 rpm. and is capable of driving drills up to $\frac{1}{4}$ in. in diameter. Model PCB-1 has a spindle $1\frac{5}{8}$ in. in diameter x 3 in. long, 75,000 to 200,000 rpm, with maximum capacity of $\frac{1}{8}$ -in. drills. Speeds are controlled by a pressure gauge, with 60-lb pressure required for the slower speeds and 140-lb for the higher rpm.

By eliminating all vibrations, both harmonic and sonic, the manufacturer claims to have reduced drill breakage to practically zero. In both models, spindles are driven by a single reactor turbine. Spindles should be protected by the best air filter obtainable and should be run on air lines free of oil. Air compressors should have after-coolers to eliminate moisture

as well as line filters with filter elements down to five-micron size.

Metal Removal Co., 1801 W. Columbia Ave., Chicago 26, Ill. [452]

Compact, 3-stage ultrasonic degreaser

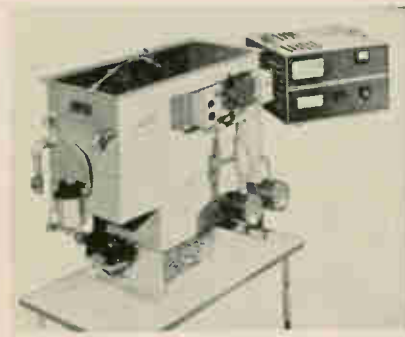

A system has been developed that combines all the advantages of ul-

trasonic cleaning with those of solvent degreasing. It provides a highly efficient cleaning tool for manufacturers of small parts and miniature assemblies, and for laboratories and repair shops.

Designed primarily for use with trichloroethylene, the new Vibra Sone P-100 series ultrasonic degreaser can easily be modified for use with such solvents as fluorinated hydrocarbons, perchlorethylene, and methylene chloride.

The P-100 is constructed of stainless steel and consists of three compartments: a condensing chamber, an ultrasonic dip chamber, and a boiling sump. It is equipped with a spray lance, a 5-micron filter, a water separator and a solvent recovery system. The degreaser measures 30 in. long by 15 in. wide by 27 in. high, with a work area 10 in. long by 12 in. wide by 10 in. deep, and a vapor area 22 in. long by 12 in. wide by 9 in. deep.

Phillips Mfg. Co., 7334 N. Clark St., Chicago, Ill., 60626. [453]

Fuseholders of Unquestioned High Quality

For $1\frac{1}{2} \times 1\frac{1}{2}$ inch fuses. Series HPC

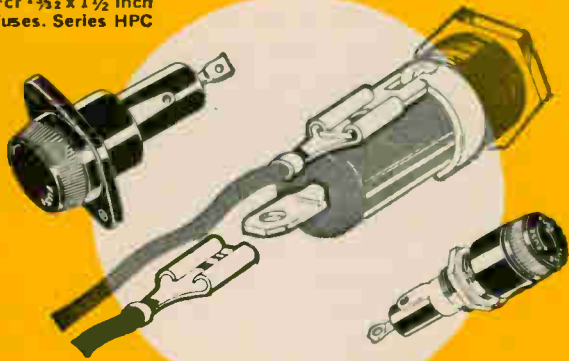

For $\frac{1}{4} \times 1\frac{1}{4}$ inch fuses Series HJ, HK and HLD

SAVE ASSEMBLY TIME with **QUICK CONNECT** TERMINALS ON **BUSS FUSEHOLDERS**

Eliminates soldering. Permits use of pre-assembled harness. Reduces assembly time.

Insist On
BUSS

QUALITY
Fuseholders

Write for
BUSS
Bulletin SFB

BUSSMANN MFG. DIVISION, McGraw-Edison Co., St. Louis, Mo. 63107

BUSS QUALITY

small
dimension
fuses



For protection of all types of electronic and electric devices

The complete line of BUSS and "TRON Family" fuses includes quick-acting, slow-blowing, signal or visual indicating fuses in sizes from 1/500 amperes up.

All standard items are easily obtained through your BUSS distributor, but if you don't find what you want get in touch with us.

Insist On
BUSS

QUALITY
Fuses

Write for
BUSS
Bulletin SFB

BUSSMANN MFG. DIVISION, McGraw-Edison Co., St. Louis, Mo. 63107

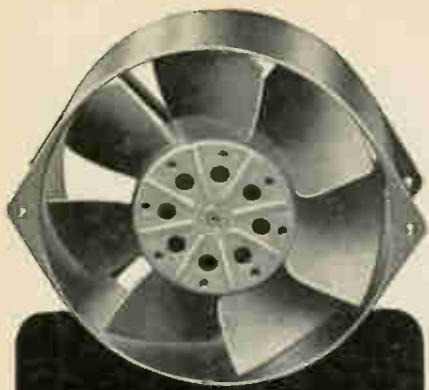

New

5 1/2"

SHADED-POLE

Model 6500

PAMOTOR

Axial Fans

- Free air delivery in excess of 300 cfm at 3000 rpm
- Over 20,000 operational hours without maintenance
- Outstanding performance at moderate cost (under \$30.00 for single units)
- Only 2" deep
- 110 v or 220 v operation
- Stocked for immediate delivery

Write for technical data on the Model 6500 and other PAMOTOR axial fans to:

PAMOTOR, INC.
312 SEVENTH STREET • SAN FRANCISCO, CALIF.

New Books

A useful handbook

System Engineering Handbook
Robert E. Machol, editor;
McGraw-Hill Book Co., 1054 pp., \$29.50

This book is a handbook in the true sense of the word: It covers a vast expanse of technology, but is intended primarily for those who are already substantially initiated into electronic engineering.

The introductory chapter, by the editor, does a remarkable job of orienting the user to the aims and philosophy of the entire volume. It is followed by a very broad treatment of "system environments"—namely, the ocean, land masses, urban areas, the lower and upper atmospheres, and outer space. Each chapter contains a physical description of the particular environment, a discussion of sources and methods of data collection, and a discussion of the governing mathematical and physical laws.

At this point the book abruptly switches to an extensive section on the details of system components. Most facets of major electronic components are covered in typical handbook fashion. In addition, the section treats such subjects as infrared, satellite systems (note "systems" in the "components" section), aerodynamics, guidance, propulsion, and energy conversion.

Part IV covers system theory, ranging from information, game, and decision theory to dynamic programming, feedback, and adaptive control systems. The average electronics engineer will have some difficulty using this section unless he is familiar with the subject, because the treatment is a bit less down-to-earth than is desirable in a book of this type.

Part V is called "System Techniques" and consists of a collection of chapters ranging from human engineering to economics and management. It ends with a chapter on radio telemetry for which the editor apparently couldn't find a home elsewhere in the book.

A concluding section on useful mathematics associated with system engineering is quite well done and serves as a useful adjunct on probability, transforms and prop-

ositional calculus. The section particularly enhances the value of the section on system theory by providing the necessary background mathematics.

The editing of such a massive volume is a formidable undertaking, especially when one must integrate the work of over fifty authors. The book suffers from the typical editorial malady: the organization gradually deteriorates as one works his way through the pages.

Some bibliography is provided, but few chapters include a complete bibliography. Furthermore, many references are not the prime ones, but merely those which the author apparently found it easiest to come by.

In browsing through the index one finds no mention of synthetic antennas, the Heisenberg uncertainty principle, Ising or Brillouin conditions, chaff, Barker code, frequency modulation, or Planck's law—although some of these subjects are mentioned in the text.

The usual handbook paradox exists in that the reader will benefit most from those treatments outside of his major field. However, the danger of exceeding the validity limits of the oversimplified rules and formulas increases with the reader's initial ignorance of the subject.

Since each author was obviously limited as to length, it is unfortunate that some (such as in the chapters on radar components and telemetry) wasted so much space on photographs of antennas, meaningless racks of equipment, consoles, etc. The chapter on radar components could, for instance, have included four more pages of text by eliminating useless photographs. This might have permitted a more complete treatment of such important concepts as synthetic radars or adaptive antenna systems. The latter subject is omitted completely, as is the subject of laser radar.

Nowhere does the text bring out the important conceptual relationship between Boltzman's law, entropy and probability. The chapters on information theory, game

theory and decision theory stand well alone, but are not integrated into the over-all system-engineering aspect of the book: this shortcoming is a serious disadvantage.

In the section on system techniques, the chapter on economics could well have been combined with the one on management. The eight pages of high-school-level economics simply do not stand up well as a separate chapter. The main function of the 12 pages on management is to discuss PERT; perhaps a few more pages could have been added to this chapter to cover critical-path methods and topography.

The over-all impression is that the editor has done a remarkable job of assembling a volume that most project-oriented electronic engineers will use often enough to justify the cost. In working through a problem involving hypersonic aerodynamics, plasma physics, and electromagnetic radiation, as well as detection probability and decision theory, this reviewer found the book to be surprisingly complete. The only other reference necessary was a book on the methods of theoretical physics.

Nevertheless, one might look forward to an eventual second edition, with the organization improved, to make it easier for the user to locate subjects.

Robert W. Bickmore
National Engineering Science Co.
Pasadena, Calif.

Recently published

Guide to Instrumentation Literature, J.F. Smith and W.G. Brombacher, National Bureau of Standards, 220 pp., \$1.25

Principles of Automatic Data Processing, Processing Management Association, 93 pp., \$1.25

Transistor Circuits, Second Edition, K.W. Cattermole, Gordon and Breach Science Publishers, 470 pp., \$14.50

Transistor Applications, R.F. Shea, John Wiley & Sons, Inc., 273 pp., \$8.50

Introduction to Switching and Automata Theory, M.A. Harrison, McGraw-Hill Book Co., 499 pp., \$16.50

Microelectronics and Large Systems, edited by S.J. Mathis, Jr., R.E. Wiley and L.M. Spandorfer, Spartan Books, Inc., 272 pp., \$8.50

Threshold Logic: A Synthesis Approach, M. L. Dertouzos, The M.I.T. Press, 256 pp., \$6

Biomedical Electronic Instrumentation, Noyes Development Corp., Park Ridge, New Jersey, 108 pp., \$10

Current Trends In Solid State Science, F. Seitz, American Society for Testing and Materials, 14 pp., \$1 (to ASTM members: 70¢)

draw yourself a circuit to control **PRESSURE**

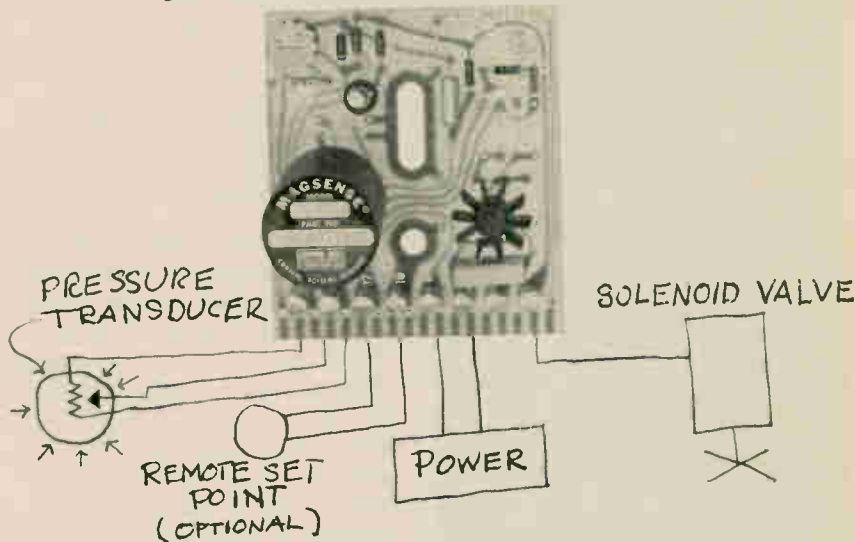

PUT MAGSENSE® IN THE MIDDLE

Connect a pressure transducer to one side of a MAGSENSE controller and an alarm or solenoid to the other. It's just about that simple to control pressure accurately and reliably. Solid-state MAGSENSE controllers have a 100-billion power gain and will accept the output of the transducers directly *without amplifiers*. Set point or dual set points are adjustable. Transducer excitation voltage is available from the MAGSENSE unit. Examine these specifications for the Model 70. Versions to meet Mil E-5272 and a variety of special application controllers are also available. Prices are from \$60 up, with quantity discounts.

BRIEF SPECIFICATIONS FOR MODEL 70

RESPONSE TIME:	100 ms max., 50 ms typical
POWER REQUIRED:	10 to 14 VDC at approx. 30 ma exclusive of load current.
OUTPUT:	Non-latching for inputs with ranges of 100 μ a, 1 ma, 10 ma or 100 ma. Latching or pulse outputs also available.
SIZE:	3" x 3.35" x 1.25"
WEIGHT:	Approx. 3 ounces
DELIVERY:	From stock

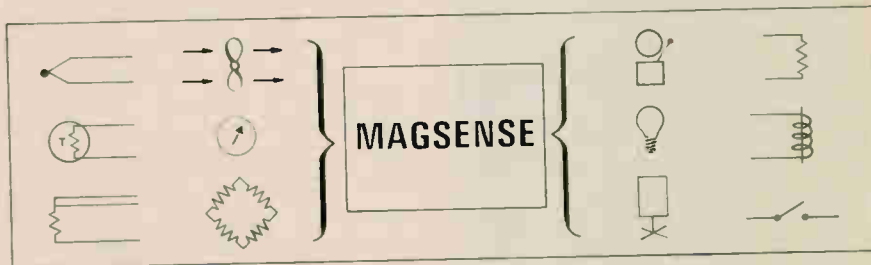

FOR INFORMATION about the complete line of MAGSENSE products for military and industrial applications, circle the inquiry number below or contact MAGSENSE Products, Dept. 109, Control Systems Division, Control Data Corporation, 4455 Miramar Rd., La Jolla, California (Area code 714, 453-2500)

CONTROL DATA
CORPORATION

4455 Miramar Road, La Jolla, Calif.



DRESS UP YOUR SYSTEMS ANALYSIS

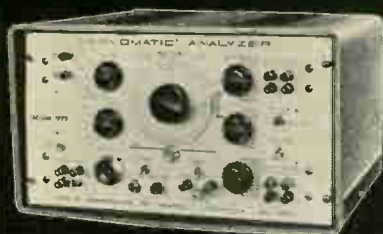

Model 1995 SERVOMATIC® Analyzer

What's so much better about today's latest model SERVOMATIC Analyzer? First, there's a "built-in bow-tie" display—use it anytime—especially for low speed analysis and get that extra CRT persistence. Next, a DC offset with independent signal control which allows system response measurement at just the right bias displacement. Cleaner and better waveforms make phase and amplitude response plotting in varied frequency a snap with this new SERVOMATIC Analyzer. A multiple function generator, calibrated phase shifter and precision amplitude control combined... it's just the right ensemble to apply in many measurement areas... you're sure to find yours in the list below:

- Transfer function of open and closed loops
- Phase angle measurements
- Amplitude measurements
- Transfer function of damping and filter networks
- Frequency response of portions of systems
- Response of servo amplifiers
- Transient response
- Locating sources of non-linearities
- Servomotor time constants
- Response of magnetic amplifiers

Details available on request



**SERVO
CORPORATION
OF AMERICA**

111 New South Rd., Hicksville, L. I., N. Y.
516 WE 8-9700

Technical Abstracts

Embryo ECG's

The Mark II fetal electrocardiograph
Graham Schuler, M.D.,
National Research Council,
Ottawa; Alan Spear, M.D.,
Baltimore City Hospital,
Baltimore; Brian Douglas, M.D. and
Robert Merritt, M.D.,
Kingston General Hospital,
Kingston, Canada

The potential value of fetal electrocardiograms to obstetricians is high. But their actual value has been limited because of the small amplitude of the fetal signal in relation to the signals generated by the mother and by random noise. The fetal ECG reaches an average peak value of only 20 microvolts at 28 weeks. Because of this, no fetal signal at all is detectable in about 15% of examinations.

Maternally generated signals arise from the heart, the muscles and the skin-electrode junction. The mother's heart produces a complex of three waves with at least three times the magnitude of the fetal heartbeat. Maternal muscle tension and movement not only generate voltage spikes several times the fetal signal's amplitude, but also cause changes in the skin-electrode relationship, which produce large low-frequency changes in the signal baseline.

The so-called addition technique, incorporated in a new device called the Mark II additive fetal ECG, provides an increase in the fetal signal amplitude. The device also incorporates other techniques to limit the magnitude of extraneous signals and noise.

Six electrodes are spaced about a transverse plane on the patient's abdomen or along the crescent outline on her upper uterine margin. The conduction paths in these areas are such that the fetal signals tend to be relatively similar from one electrode to another, but the maternal signals are dissimilar. Combining the signals from these electrodes adds the fetal signals, but averages the dissimilar signals, thus reducing the amount of maternal signal and noise. This then produces a fetal signal with a specific configuration for analysis.

The amplifiers used have a dif-

ferential rejection ratio of 150,000:1 and contribute noise of less than 1.5 microvolts peak-to-peak over a bandwidth of 50 cycles per second.

Presented at the Canadian Electronics Conference, Toronto, Oct. 4-6.

Another use for solar cells

Application of solar cells in color-detection systems
Russell E. Puckett and
Herbert R. Campbell Jr.,
University of Kentucky, Lexington, Ky.

The fact that solar cells respond only to some of the wavelengths contained in sunlight reduces their effectiveness as a power supply. But this same fact makes them highly suitable for a color detection system.

The spectral response of a solar cell varies according to the material used to fabricate it, and depends upon many factors. The absorption process in the semiconductor material is the primary limiting factor; the cell's physical size and the effect of temperature are secondary factors.

Three techniques can be used to adapt solar cells for color-detection applications: calibrating the spectral response over the range of color desired; limiting the response to a narrow range of wavelengths; or limiting the response curve to a specific shape, which can be positioned in the visible spectrum by some external control.

Some semiconductor materials used in solar cells have fairly linear response in the visible range, but their maximum response is outside it; others have maximum response within the visible spectrum, but the usable range is too narrow.

A silicon cell has a linear response that peaks in the infrared. Thus, it could be adapted to color detection by using suitable instrumentation to distinguish between different levels of the response curve. Depending upon system sensitivity, it could even tell the difference between shades of a single color. Selenium also has a linear response, but over a much smaller range of the spectrum.

Thin-film construction of solar cells has provided a means of limiting or controlling the response of

Smallest 3-Phase Electronic Frequency Converters Ever Made!



Now, from CML, comes a series of the smallest 3-phase Electronic Frequency Converters ever made... featuring fixed or adjustable plug-in oscillators at frequencies ranging from 45 to 6,000 cycles. Write today for details on Models T500A through T2500A!

Model	3 ϕ Output VA	Dimensions (For standard 19" relay rack mounting)
T500A	500	8 $\frac{3}{4}$ " h x 21" d
T750A	750	14" h x 21" d
T1200A	1200	14" h x 21" d
T1750A	1750	14" h x 21" d
T2500A	2500	14" h x 21" d



CML, Inc.

A Subsidiary of Tenney Engineering, Inc.
350 Leland Avenue • Plainfield, New Jersey
Telephone (201) 754-5502 • TWX: 201-756-2064

Circle 225 on reader service card

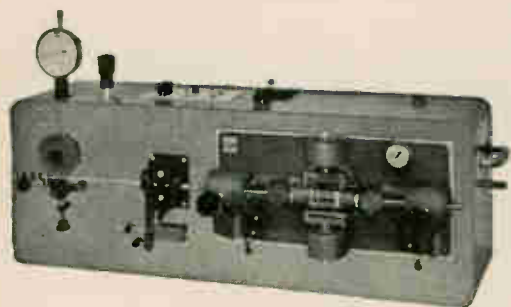

Cut your wire preparation costs with high-speed wire strippers

Eubanks wire strippers are noted for easy set-up changes, high-speed operation, and clean stripping without nicking or scraping. Whether you need battery cables, printed circuit board jumpers, leads for electric watches, coaxial cables, or washing machine harnesses, chances are excellent that we have a machine to meet your requirements. Pictured is our Model 87 Utility Wire Stripper, which produces up to 12,000 leads an hour. Write for free information on this and other Eubanks wire stripping machines to Eubanks Engineering Co., 225 W. Duarte Rd., Monrovia, California.



EUBANKS
ENGINEERING COMPANY

Circle 226 on reader service card



Micro Resonant Reed Selector

FUJITSU micro resonant reed selector of the single-reed plug-in type, composed of a composite tuning-fork type vibrator, driving system, contacts, and their supporting structures. Possessing a high degree of sensitivity and stability, it serves all phases of usages as the conventional reed selector in diverse types of tele-controlling and mobile radio systems.

Frequency: 50 channels in 15 c/s spacing in the frequency range of 472.5 c/s ~ 1207.5 c/s
 Coil Impedance: 280 ohms $\angle 35^\circ \pm 15\%$ at 1000 c/s, 20°C Standard driving current:
 I_a : 2.5 ma Selectivity: Inoperative at a current of less than 7 ma in a frequency range deviating more than ± 15 c/s from the nominal frequency f Band width: Class A: $f \pm 1.5$ c/s min at standard driving current. Class B: $f \pm 1.3$ c/s min at standard driving current Temperature range: Class A: -10 ~ 50°C. Class B: 0 ~ 40°C Contact ratio: 2% min at f and 2.4 ma Life: Over 100,000 operations when driving current is turned on for 1 second and turned off for 2 seconds in an ordinary circuit Insulation and dielectric withstanding voltage: 10 megohms min at dc 100V, dc 100V 1 minute at 20°C, 80%

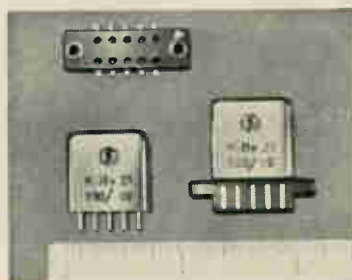

Polar Relay Type 21

Fujitsu Polar Relay Type 21 is a hermetically sealed, high sensitive subminiature polar relay with high speed and long service life. The size of this Type 21 is only 1/10th as large as the conventional polar relays. It has extremely efficient magnetic circuits, high stability against external magnetic

fields and unique chatter-free contact mechanism. This polar relay is widely applicable to small size, lightweight communication equipment and control equipment for carrier telephony, telegraphy, data transmission in telemetry, automatic control and data processing.

Subminiature Type: 3cm³ High Sensitivity: 0.7 mw Long Life: 100 million operations
High Speed: 1.5 ms

For further information, please write to:



FUJITSU LIMITED

Communications and Electronics
Marunouchi, Chiyoda-ku, Tokyo, Japan

Circle 185 on reader service card

185

MITSUMI COMPONENTS

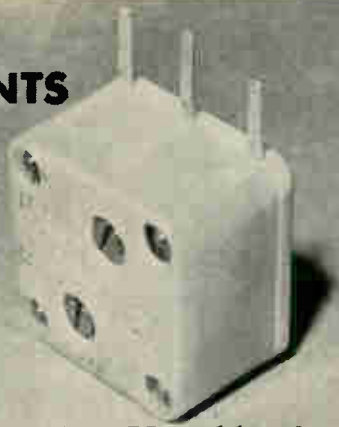

New Precision Variable Capacitor

Model PVC-LX20T Polyvaricon is AM two gang miniature-sized Polyethylene Variable Capacitor which has a capacity tolerance $\pm (1\text{pF}+1\%)$. Maximum variable capacity is 140pF ANT., 82pF OSC. "Q" characteristics is over 500 at 10Mc 50pF. Trimmer capacity is over 8pF. The Dimension being 20mm \times 20mm \times 13mm.

Main Products

Polyvaricon · IFT · Oscillator coil · Antenna coil · Composite coil · Special coil · Micro motor · Synchronous motor · Variable resistor · Trimming potentiometer · FM tuner · TV tuner · Various sockets · CdS photoconductive cell.



MITSUMI ELECTRIC CO., LTD.

New York office: 11 Broadway, New York, N.Y. 10004, U.S.A.
Phone: HA-5-3085, 3086

Main office: 1056, Koadachi, Komae-machi, Kitatama-gun, Tokyo, Japan
Phone: Tokyo 415-6211/23

Circle 227 on reader service card

Technical Abstracts

the cells to a narrow range of color. Materials that exhibit a high peaked response are perfect for color detection systems. The ideal color detector would have a narrow bandwidth, adjustable to any position within the visible spectrum.

Presented at the Military Electronics Conference, Washington, D.C., Sept. 22-24.

Better ECG's

Heart attack diagnosis with the area display electrocardiograph
Graham Schuler, M.D.,
National Research Council,
Ottawa, Canada

Conventional electrocardiograms are time-amplitude graphs of the voltage between two electrode sites, representing the summed potentials of thousands of individual muscle generators in the heart structure. They can locate a destroyed heart muscle mass and determine the extent of the destruction, but results are subject to the uncertainty of individual interpretation.

The area display electrocardiograph described by the author acts as a fluoroscope of electrical activity to reveal, in the form of light patterns, the voltage patterns existing over an area of the chest. This device has inherent advantages over the conventional ECG because it is sensitive only to differences in the voltage amplitude pattern, the absolute voltage level being relatively unimportant. In addition, the voltage produced by a specific area of the heart can be examined because the device can be made sensitive at selected intervals of the electrical cycle accompanying each heartbeat. The device repeatedly samples the selected time segment to provide an integrated pattern, free from extraneous signals.

The ECG signals are detected by a large number of wire loops placed over an area of the chest. These signals are then multiplexed and fed to an oscilloscope, where they are displayed as a raster of light whose pattern of luminosity corresponds to the voltage pattern.

Presented at the Canadian Electronics Conference, Toronto Oct. 4-6.

DC POWER SUPPLIES



CONTINUOUS VOLTAGE COVERAGE—4.7 to 60 vdc.
Input: 105-125 vdc, 50-400 cps.
Regulations: From $\pm 0.05\%$
Ripple: From .002% or 1 mv, rms
Temp. Coeff.: From $\pm 0.01\%/^{\circ}\text{C}$
Voltage Adjustments: $\pm 5\%$
Max. Temp of Base: 65°C

- WIDE VARIETY OF CURRENT RATINGS
- ELECTRONIC SHORT CIRCUIT PROTECTION
- FULLY REPAIRABLE
- 7 STANDARD SIZES (OVER 450 MODELS)
- PRICE RANGE **\$45-\$225**



INSTRUMENTS: EEM ('63-64 Pg. 902)
EBG (1964 Pg. 462)

POWER SUPPLIES: EEM ('65-66 Pg. 1538)
EBG (1963 Pg. 307)

VOLTAGE STANDARDS: EEM ('65-66 Pg. 1052)



390 CAPITOL AVE., HARTFORD, CONN.

186 Circle 186 on reader service card

Telrex

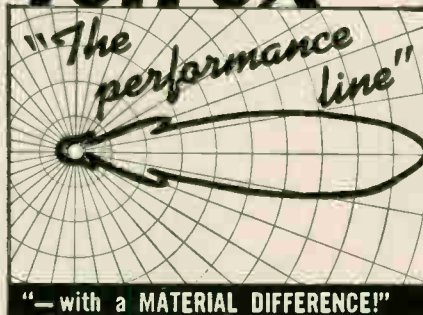

— with a MATERIAL DIFFERENCE! —

The Choice of the Discriminating Communication Engineer . . . the Man who Never Settles for Anything Less than THE-VERY-BEST!

telrex "BEAMED-POWER" ANTENNAS and ANTENNA SYSTEMS

Provide optimum performance and reliability per element, per dollar. Antennas from 500 Ke to 1500 Mc. Free PL88 condensed data and pricing catalog, describes military and commercial antennas, systems, accessories, Towers, Masts, Rotators, "Baluns" and transmission line data.

ANTENNAS

SINCE 1921

telrex
LABORATORIES

Communication and TV Antennas

Asbury Park 41, New Jersey, U.S.A.

Circle 228 on reader service card

LEGAL NOTICE

STATEMENT OF OWNERSHIP, MANAGEMENT AND CIRCULATION (Act of October 23, 1962, Section 4369, Title 39, United States Code)

1. Date of filing: October 1, 1965.
2. Title of publication: **ELECTRONICS**.
3. Frequency of issue: Biweekly.
4. Location of known office of publication: 330 West 42nd St., City, County and State of New York—10036.
5. Location of the headquarters or general business offices of the publishers: 330 West 42nd St., City, County and State of New York—10036.
6. Names and addresses of publisher, editor, and managing editor: Publisher, C. C. Randolph, 330 West 42nd St., New York, N. Y.—10036; Editor, Lewis H. Young—330 West 42nd St., New York, N. Y.—10036; Managing Editor, None.
7. The owner is McGraw-Hill, Inc., 330 West 42nd St., New York, N. Y. 10036. Stockholders holding 1% or more of stock are: Donald C. McGraw, Elizabeth McGraw Webster, Donald C. McGraw, Jr. & Harold W. McGraw, Jr., Trustees under Indenture of Trust m/b James H. McGraw, dated 1/14/21 as modified; Donald C. McGraw & Harold W. McGraw, Trustees under an amended Indenture of Trust m/b James H. McGraw, dated 7/1/37 as amended; Donald C. McGraw, individually; Donald C. McGraw and Catharine McGraw Rock, as Trustees of the Estate of Mildred W. McGraw, all of 330 West 42nd St., New York, N. Y. 10036.
8. Known bondholders, mortgages, and other security holders owning or holding 1 percent or more of total amount of bonds, mortgages or other securities: None.
9. Paragraphs 7 and 8 include, in cases where the stockholder or security holder appears upon the books of the company as trustee or in any other fiduciary relation, the name of the person or corporation for whom such trustee is acting, also the statements in the two paragraphs show the affiant's full knowledge and belief as to the circumstances and conditions under which stockholders and security holders who do not appear upon the books of the company as trustees, hold stock and securities in a capacity other than that of a bona fide owner. Names and addresses of individuals who are stockholders of a corporation which itself is a stockholder or holder of bonds, mortgages or other securities of the publishing corporation have been included in paragraphs 7 and 8 when the interests of such individuals are equivalent to 1 percent or more of the total amount of the stock or securities of the publishing corporation.
10. This item must be completed for all publications except those which do not carry advertising other than the publisher's own and which are named in Sections 132.231, 132.232 and 132.233, Postal Manual (Sections 4355a, 4355b, and 4356 of Title 39, United States Code).

	Average No. Copies Each Issue During Preceding 12 Months	Single Issue Nearest to Filing Date
A. Total No. Copies Printed (Not Press Run).....	70,470	72,293
B. Paid Circulation		
1. Sales through dealers and carriers, street vendors and counter sales.....		
2. Mail subscriptions.....	64,338	66,000
C. Total Paid Circulations.....	64,338	66,000
D. Free distribution (including samples) by mail, carrier or other means.....	4,972	5,756
E. Total Distribution (Sum of C and D).....	69,310	71,756
F. Office use, left-over, unaccounted, spoiled after printing.....	1,160	537
G. Total (Sum of E & F—should equal net press run shown in A).....	70,470	72,293

I certify that the statements made by me above are correct and complete.

McGraw-Hill, Inc.
By JOHN J. COOKE,
Vice-President & Secretary

Your Inquiries to Advertisers Will Have Special Value . . .

—for you—the advertiser—and the publisher, if you mention this publication. Advertisers value highly this evidence of the publication you read. Satisfied advertisers enable the publisher to secure more advertisers and—more advertisers mean more information on more products or better service—more value—to YOU.



EMPLOYMENT OPPORTUNITIES

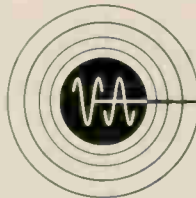

VARIAN associates

New engineering opportunities based on continuing world-wide demand for Vorian products in commercial, military, and industrial markets.

VACUUM DEVELOPMENT ENGINEERS. New product development utilizing ultra high vacuum applications such as thin film deposition, space simulation, etc. Requires capability to carry projects through development to manufacturing stages. Prerequisites should include B.S. or M.S. in Physics, E.E., or M.E. with hardware oriented background in vacuum and thin film technology and surface physics—or—B.S. or M.S. in M.E. and familiarity with cryogenics and high vacuum systems design.

ELECTRONIC CIRCUIT DEVELOPMENT ENGINEER. Vacuum instrumentation—product development responsibilities at project leadership level. Requires B.S. or M.S. in E.E. with circuit design experience in d.c. amplifiers, feedback controls, and commercial instrumentation.

LINEAR ACCELERATOR DESIGN ENGINEERS. Electrical engineering positions with design responsibilities on special electron linear accelerator projects. Requires B.S. or M.S. in E.E. and microwave engineering experience in areas such as high voltage, pulse, and servo circuits; microwave structure and electron gun design; beam optics, etc.

DESIGN ENGINEERS. Electronics engineers with experience in commercial electronics, must be familiar with solid-state circuit and servo design, background in microwave instrumentation, NMR or EPR Systems desirable. BS degree in EE or physics.

TUBE ENGINEERS. Experience in design, develop-

ment or manufacture of klystrons BWO or TWT's. Should be familiar with microwave techniques and vacuum tube engineering. Experience in systems and evaluation helpful.

MANUFACTURING ENGINEERS. To handle transfer of products from development into manufacturing. Prefer strong background in the electronics or instrumentation field. Experience in production processes and methods necessary.

ELECTRO MECHANICAL ENGINEER. Duties will include design of temperature control devices, electro and permanent magnets and some mechanisms design. Servo mechanism design experience helpful. Should be familiar with scientific instrument packaging oriented toward productizing designs for factor production.

DIGITAL CIRCUIT ENGINEER. A challenging position is available for an engineer with knowledge and experience in design and build up of transistor circuits. Must be familiar with digital computers and interfacing analog devices with digital computers. Knowledge of data handling helpful. BSEE or MSEE.

SEMICONDUCTOR DEVELOPMENT ENGINEERS Central Research Laboratory positions involving all phases of semiconductor technology. Background should include B.S. in E.E., metallurgy, or related field and experience in research and development of experimental semi-conductor devices.

Other technical openings available and all inquiries will be welcomed. Successful candidates will work with technical staff members noted in the industry. Varian is one of the leading employers in Northern California, known for its unique living, cultural and educational environment.

For further information, please send resume to:

W. H. GUENGERICH

VARIAN associates

611 Hansen Way

Palo Alto, California

An Equal Opportunity Employer

SELLING OPPORTUNITY WANTED

Electronic Sales Corporation interested exclusive agency of advanced European components or instruments. Pacific Coast only. Itonra, P.O. Box 1412 Beverly Hills, California.

WHEN

P Answering Advertisements

PLEASE do not send original letters, certificates or photographs. We cannot be responsible for their return. Please send photostat or carbon copies.

PROFESSIONAL SERVICES

GIBBS & HILL, Inc.

Consulting Engineers

Systems Engineering
Operations Research • Development
Field Studies • Design • Procurement
Power • Transportation • Communications
Water Supply • Waste Treatment

393 Seventh Avenue New York 1, N. Y.

Tie your career to the world's most advanced radar/sonar systems... at G.E.!

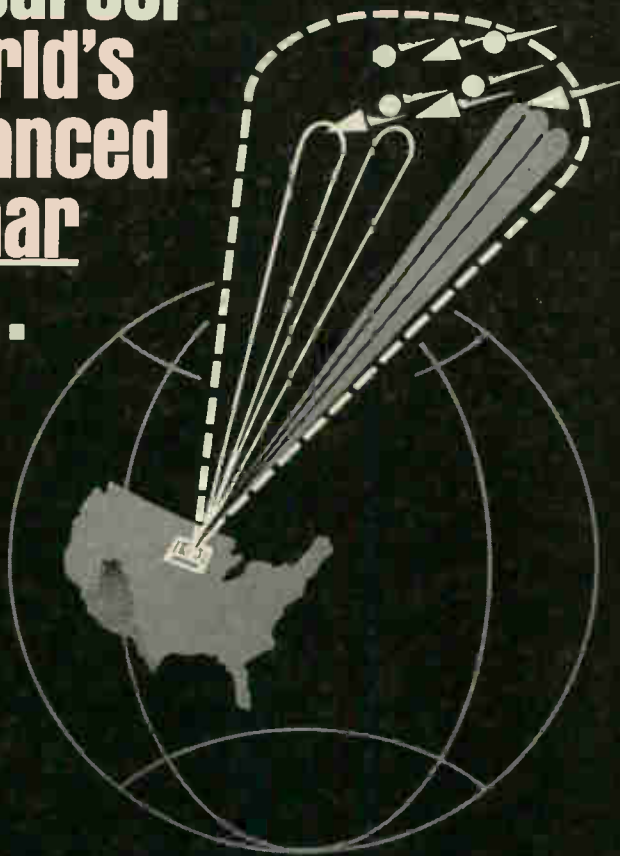

Investigate your career now
in missile-defense radar; ad-
vanced sonar engineering at
General Electric.

G.E.'s Heavy Military Electronics Dept.—whose capabilities include the design, development and fabrication of the world's largest and most advanced ASW and radar systems—announces long-term career openings for continuing contributions to large military contracts.

HMED offers you stability based on its broad capability for handling large programs and the experience that goes with front-rank performance on this decade's most advanced projects. Your growth is tied to that of a lean, highly professional engineering group backed by top-flight facilities—both within HMED and throughout General Electric.

At G.E., you'll be treated as a professional who's expected to handle well-defined, delegated responsibility. In most instances you'll deal directly with your customer's organization.

You will be given every opportunity to develop yourself professionally through continuing Company-taught courses and advanced tuition-paid study at nearby Syracuse University. And, in the course of your work, you'll have access to information developed by other G.E. facilities throughout the country.

WHY NOT MATCH YOUR EXPERIENCE AND CAREER DESIRES AGAINST THESE REQUIREMENTS?

SONAR: Advanced Sonar Engineers; Array Beamformer and Signal Processing Development Engineers; Digital Logic Engineers; Sonar Solid-state Circuit Design; Transducer Development; Solid-state Transmitter Development; Pattern Recognition Analysis; Adaptive Filtering Research; Display Development; Propagation Analysis; Sonar Subsystem Development.

RADAR: Monitor and Control Analysis Engineers; Digital Control Eqpt. Engineers; Microwave Component Design Engineers; Consultant, Circuit Design and Development; Instrumentation Circuit Engineers; ME's for Signal Processing Modules; Consultant, Array Radar Subsystem Requirements.

INVESTIGATE NOW! For full information, send a resume of your experience in confidence to J. L. Wool, Professional Placement, Heavy Military Electronics Dept., Section 116, General Electric Co., Court St., Syracuse, New York.

177-65

An Equal Opportunity Employer

at Sylvania yours is to reason...

**ours is to give you the conditions that
help you to do so**

■ The right people to work with. Some of the best engineers and mathematicians in the country . . . men who talk your language.

A responsible position involving many of the most complex and demanding engineering problems in the industry. Stimulating, exciting work in a diversity of technical disciplines including: multi-functional array radar systems, large ground based antenna systems for satellite communications, Minuteman Command and Control System, special purpose data processing systems and simulation and training systems.

A position that does not depend on any one project. Latitude unlimited. Sylvania's stable expansion affords the environment for personal advancement and professional growth.

A good place to live. Boston, a city rich in libraries, universities, theatres and museums. (A city, moreover, that offers handsome suburbs and all types of in-city living.)

Opportunities exist at senior levels in the following areas:

Radar & Sensor Systems & Techniques • RF & Digital Microcircuitry • Advanced Information Systems Design • Machine Language, Management Information Systems, Real Time Systems & Analysis • Digital Computers • Systems Simulators & Trainers • Communications Switching Systems • Display & Instrumentation Systems • Digital Control Systems

REASON as defined by Webster: "A consideration, motive or judgment inducing or confirming a belief, influencing the will, or leading to an action." If the reasons mentioned above project the environment you seek, we invite you to write in confidence, outlining your experience and interests to *Mr. James L. Hackbush*

GT&E

GENERAL TELEPHONE & ELECTRONICS
Total Communications from a single source through

SYLVANIA ELECTRONIC SYSTEMS

100 First Avenue

Waltham, Massachusetts

An Equal Opportunity Employer

Bausch & Lomb has openings for
ELECTRONIC ENGINEERS

B.S. or M.S. with one to five years experience in the design of analog and digital circuits and systems. Good theoretical background in math, physics and network analyses desirable. Experience in control systems and low signal level circuit techniques helpful. Projects involve development of sophisticated instruments in bio-medical, chemical, optical and electronic fields at the applied research stage.

Please send resume in confidence, including salary requirements to: E. J. Walter, Employment Specialist, Bausch & Lomb, 636 St. Paul St., Rochester, N.Y. 14602.

BAUSCH & LOMB 

An Equal Opportunity Employer

**FOR INFORMATION
About Classified Advertising**

Contact The McGraw-Hill Office Nearest You.

ATLANTA, 30309

F. PERRY
1375 Peachtree St., N.E.
875-0523 (Area Code 404)

BOSTON, 02116

J. WREDE
McGraw-Hill Bldg., Copley Square
COngress 2-1160 (Area Code 617)

CHICAGO, 60611

WM. HIGGINS—G. AMBROZE
645 No. Michigan Avenue
MOhawk 4-5800 (Area Code 313)

CLEVELAND, 44113

R. HARTER
55 Public Square
SUperior 1-7000 (Area Code 216)

DALLAS, 75201

F. LeBEAU
1712 Commerce St., Vaughn Bldg.
Riverside 7-9721 (Area Code 214)

DENVER, 80202

J. PATTEN
1700 Broadway, Tower Bldg.
255-2981 (Area Code 303)

DETROIT, 58226

T. JAMES
856 Penobscot Bldg.
962-1793 (Area Code 313)

HOUSTON, 77025

K. GEORGE
Prudential Bldg., Holcombe Blvd.
Riverside 8-1280 (Area Code 713)

LOS ANGELES, 90017

R. MCGINNIS
1125 West Sixth Street
HUntley 2-5450 (Area Code 213)

NEW YORK, 10036

D. HAWKSBY—H. BUCHANAN
500 Fifth Avenue
971-3593 (Area Code 212)

PHILADELPHIA, 19103

WM. SULLIVAN—P. VERONA
Six Penn Center Plaza
LOcust 8-6161 (Area Code 215)

PITTSBURGH, 15222

4 Gateway Center
391-1314 (Area Code 412)

ST. LOUIS, 63105

7751 Carondelet Avenue
PArkview 5-7285 (Area Code 314)

SAN FRANCISCO, 94111

J. A. HARTLEY
255 California Street
DOuglas 2-4600 (Area Code 415)

CLASSIFIED ADVERTISING



SEARCHLIGHT SECTION

BUSINESS OPPORTUNITIES
USED OR SURPLUS EQUIPMENT

**TENNEY
ENVIRONMENTAL
TEST CHAMBER**

3' x 3' x 3' CAP.

Minus -105 Deg. F. Plus +205 Deg. F.
Bristol Electronic Controller
Servel Compressor
All Self-contained
Wt. 4500 lbs.
Dimensions—76" x 72" x 87" Hi
Condition Excellent
Priced right

KINGS COUNTY MACHINERY EXCHANGE

Tel: 212-TR 5-5237
408 Atlantic Avenue Brooklyn, New York 11217

CIRCLE 951 ON READER SERVICE CARD

WRITE FOR NEW  **KEYSTONE**
free catalog

We are the leading producers of BATTERY HOLDERS, TERMINALS, TERMINAL BOARDS & ELECTRONIC HARDWARE.

KEYSTONE ELECTRONICS CORP 49 BLEECKER ST NEW YORK 12, N. Y.

CIRCLE 952 ON READER SERVICE CARD

SPOT WELDING TWEEZERS



TWI - 36" Lead \$11.65
AC and Stored Energy Power Supplies
and Welding Heads

EWALD INSTRUMENTS
KENT, CONN. 06757

CIRCLE 953 ON READER SERVICE CARD

RADAR AUTO-TRACK & TELEMETRY ANTENNA PEDESTALS
3 & 10 CM. SCR 584 AUTOTRACK RADARS. M-33 RADAR
TPS-1D SEARCH. APS-45 TPS-10D HT. FINDERS. WX RADARS.
FPN-32GCA. APS-10 APS-15B APS-27 (AMTI) SEARCH. ■ ■
APN-102 DOPPLER. DOZENS MORE. CARCINOTRONS. PPN'S.
25-5-1-2-3-6 MEGAWATT PULSE MODULATORS. CAVITIES.
PULSE TRANSFORMERS. IF STRIPS. WAVEGUIDE. BENDS
200 MC. 1 KMC. 3 KMC. 6 KMC. 9 KMC. 24 KMC. RF PKGS.

RADIO RESEARCH INSTRUMENT CO.
550 5TH AVE., NEW YORK 36, N. Y. JU 6-4691

CIRCLE 954 ON READER SERVICE CARD



U.S. ARMY EE-8

Telephone fully reconditioned at
\$19.95 each. Any number can be
used on same line. Wire 2¢ per
ft. or \$65.00 per mile. Sound
powered—\$25.95 each. Write for
complete telephone list.

TELEPHONE ENGINEERING CO.
Dept. E-10185, Simpson, Pa.

CIRCLE 955 ON READER SERVICE CARD

free catalog
POTTING APPLICATORS
MANUAL AND DISPOSABLE
6cc 12cc 30cc
FOR POTTING, ENCAPSULATING, AND
SEALING OF MINIATURE COMPONENTS
PHILIP FISHPAN COMPANY
7 CAMERON ST., WELLESLEY 81, MASSACHUSETTS

CIRCLE 956 ON READER SERVICE CARD

**SEMICONDUCTORS
MAJOR BRANDS**

INTEGRATED CIRCUITS • DIF. AMPS DAR-
LINGTONS • POWER DIODES & TRANSISTORS
• SPECIAL DEVICES
Write for Catalog S-1
SEMICONDUCTOR SALES OF CALIF.
1063 Perry Annex Whittier, Calif.
(213) 696-7544

CIRCLE 957 ON READER SERVICE CARD

Watch—
the Searchlight Section
for Equipment Opportunities

New Literature

F-m tuners and color tv receivers. Fairchild Semiconductor, a division of Fairchild Camera and Instrument Corp., 313 Fairchild Drive, Mountain View, Calif., has released two new technical papers outlining development work in the field of f-m tuners and color tv receivers.
Circle 461 on reader service card

Thermistor probes. Victory Engineering Corp., Springfield Ave., Springfield, N.J., 07081. High-pressure thermistor probe sensors for fast response are described in bulletins MGRO61 and MSO81. [462]

Microwave solid-state sources. Sperry Microwave Electronics Co., P.O. Box 1828, Clearwater, Fla. Data and spec sheets now available give complete specifications, outline drawings, and performance curves for six microwave solid state sources. [463]

Lasers and laser optics. Perkin-Elmer Corp., Electronic Products division, Main Ave., Norwalk, Conn. A 24-page brochure contains full specifications and prices on the company's line of continuous-wave gas lasers, optical coatings and filters, and a wide variety of laser optics. [464]

Telemetry system. Beckman Instruments, Inc., Systems division, 2400 Harbor Blvd., Fullerton, Calif., 92634, offers bulletin 8420 describing an integrated stored-program processor and telemetry signal conditioning system. [465]

Rubberized abrasives. Cratex Mfg. Co., Inc., 1600 Rollins Road, Burlingame, Calif. Catalog 63 illustrates and describes a line of rubberized abrasives for light deburring, smoothing, cleaning and polishing. [466]

Resistor networks. Electra Mfg. Co., 800 N. 21st St., Independence, Kan., 67301. A four-page bulletin provides complete specifications on a line of miniature packaged resistor networks. [467]

Silicon rectifiers. Semicon, Inc., P.O. Box 328, Bedford, Mass., has available a 16-page brochure describing its entire line of silicon rectifiers for industrial, military and commercial applications. [468]

Vswr-attenuation graph. Bird Electronic Corp., 30303 Aurora Road, Cleveland, Ohio, 44139. A four-page design aid for reducing voltage-standing-wave-ratio with coaxial r-f attenuator pads includes an explanation of how the curves were calculated. [469]

Semiconductor wafer spinner. Westinghouse Scientific Equipment Department, P.O. Box 8606, Pittsburgh, Pa., 15221. A two-page bulletin describes the features, operation, applications, and spec-

ifications of the model 705 four-spindle semiconductor wafer spinner. [470]

Frequency control crystals. Monitor Products Co., Inc., 815 Fremont Ave., South Pasadena, Calif., offers a product data sheet on its TO-5 size frequency control crystals for applications requiring high reliability and low aging. [471]

Diode selection guide. Motorola Semiconductor Products, Inc., Box 955, Phoenix, Ariz., 85001. A 17x11-in. selection guide, convenient for desk or wall, lists the most popular of more than 4,000 different zener and reference diodes. [472]

Photoelectric cells. Pioneer Electric and Research Corp., 743 Circle Ave., Forest Park, Ill., offers a brochure on its complete line of cadmium sulfide photoelectric cells, which range in size from 1/4 in. (TO-5) to 1 in. [473]

Laser welding. Union Carbide Corp., Linde division, 270 Park Ave., New York, N.Y., 10017. A wide variety of laser welding techniques for microelectronic applications are described in a 12-page laser welding research report. [474]

Noise measurement service. Spectra-Electronics, Inc., P.O. Box 85, Los Altos, Calif., 94023, offers a detailed list of specifications applying to the measurement capabilities of its recently inaugurated microwave noise measurement service. [475]

Hydrogen thyratrons. General Electric Co., Schenectady, N.Y. A 15-page brochure describes the scope, principles of operation, construction, applications, characteristics and ratings of hydrogen thyratrons, and offers a guide for selection. [476]

Frequency multiplier doubler. American Electronic Laboratories, Inc., P.O. Box 552, Lansdale, Pa. A technical bulletin describes a frequency multiplier doubler that extends the frequency capabilities of X-band solid-state power sources. [477]

Microwave absorbing materials. Emerson & Cuming, Inc., Canton, Mass. A six-page, fold-out brochure suitable for notebook or wall mounting describes the Eccosorb line of microwave absorbers—both for free space and for waveguide applications. [478]

Noise and field intensity meters. The Singer Co., Metrics division, 915 Pembroke St., Bridgeport, Conn., 06608. Brochure NF-105 describes Empire noise and field intensity meters for electromagnetic compatibility and other r-f measurements in the 14-kc to 1-Gc range. [479]

Want to design for
INSTANT STARTING?...
SPLIT-SECOND ACCURACY?
REVERSIBILITY?...
MIXED SPEEDS?...

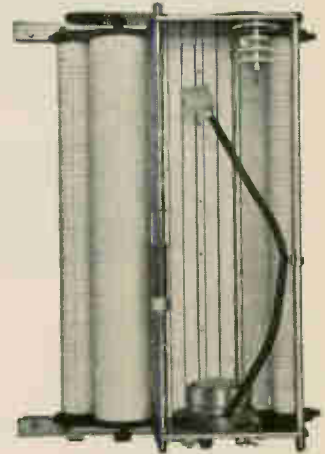

turn the
job over to
SYNCHRON® MOTORS!



No matter whether you want a motor to withstand swiftly changing temperatures, meet fast-reversing stresses, turn a small part with exact accuracy to 1 Rev. per week or 600 Rev. per minute, there's a SYNCHRON Motor that can do it! It can do a hundred other things as demanding as these — if you tell us how you want it to function. Before you start any design that calls for small drive or timing motors, think of SYNCHRON Motors, and call or write us at Hansen Manufacturing Company. We'll be there at once to help — with experience. Better still — don't wait till you face a problem. Write us now — let us tell you about SYNCHRON Motors and the ways we design them to work for you.



HANSEN REPRESENTATIVES: CAREY & ASSOCIATES, Houston, Tex., R. S. HOPKINS CO., Sherman Oaks, Calif., EICHORN & MELCHIOR, INC., San Carlos, Calif., THE FROMM CO., Chicago, Ill., H. C. JOHNSON AGENCY, INC., Rochester, N. Y., WINSLOW ELECTRIC CO., Essex, Conn., and New York, N.Y. EXPORT DEPARTMENT, 64-14 Woodside Ave., Woodside, N. Y. Handled exclusively in Canada by Sperry Gyroscope Ltd., Ottawa, Canada.

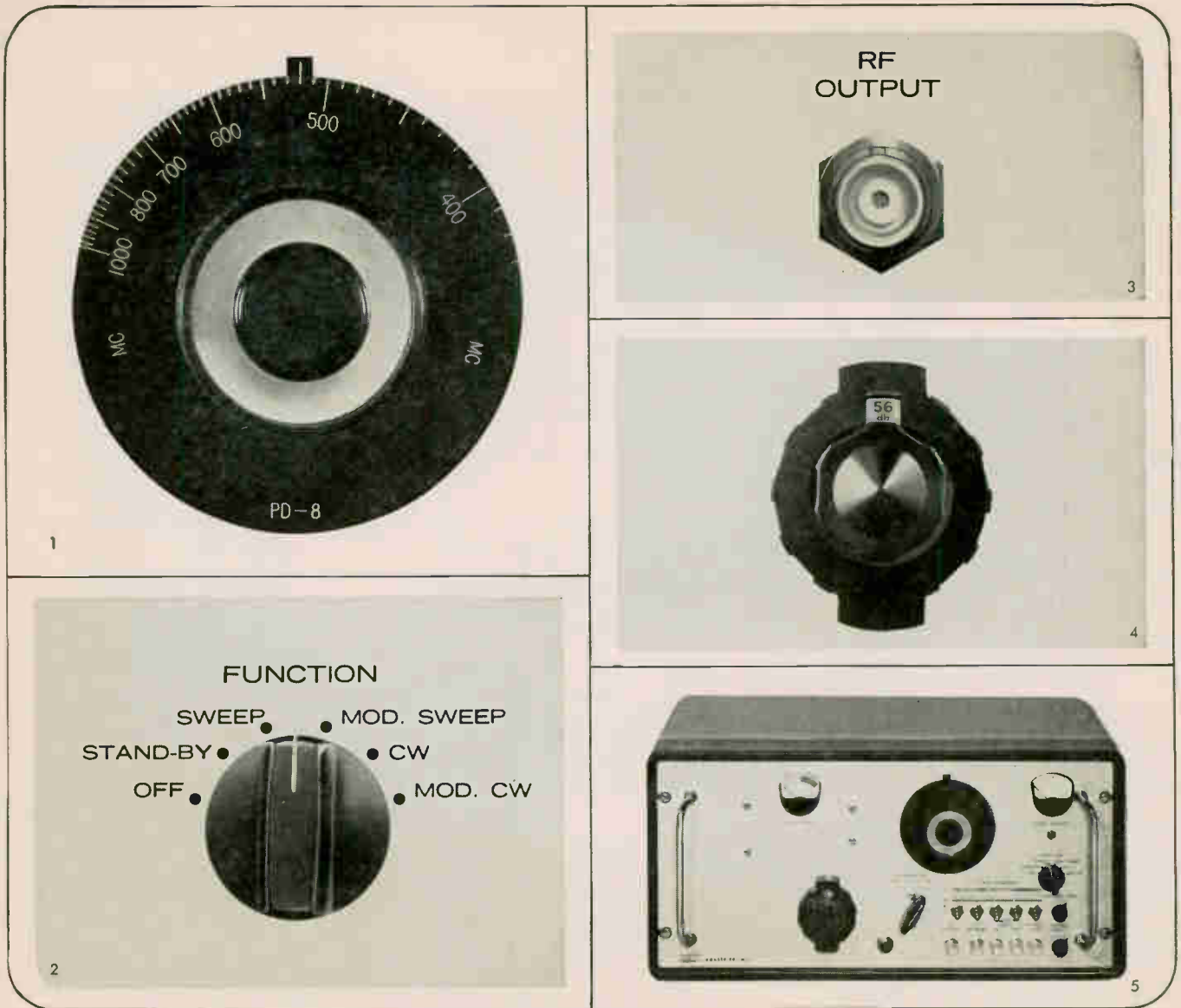

PD SERIES 4 WATT SWEEP GENERATORS

Telonic's PD-8 Sweep Generator not only provides quick test results, but is also PDA (accurate), PDD (dependable) and PDF (flexible). Look!

1. Its frequency range covers 330 Mc to 1010 Mc, ideal for testing, aligning and adjusting RF networks, transmission lines, attenuators, filters, and other passive devices.
2. The PD-8 can operate in four modes: swept RF, modulated swept RF, CW and modulated CW.
3. It provides up to 4 watts of output power that stays constant regardless of frequency, line voltage, or loading fluctuations. Devices such as solid state frequency multipliers can now be checked out at their on-line operating levels.
4. Input power levels can be selected over a wide range via the direct readout turret attenuator. It covers 3 to 59 db in 1 db steps.
5. It's Telonic all the way through—designed, field tested, and hand-crafted to give you maximum service in the lab or production for years to come.

If you're working at lower frequencies, also consider Telonic's PD-2 and PD-3 Sweep Generators, covering 20 to 100 Mc and 100 to 250 Mc respectively. All other features and specifications are the same as those found in the PD-8.



MODEL	RANGE	PRICE
PD-2	20-100 Mc	\$2,750.00
PD-3	100-250 Mc	\$2,750.00
PD-8	375-1000 Mc	\$2,750.00

60 North First Avenue,
BEECH GROVE, INDIANA
Phone (317) State 7-3231
TWX 810-341-3202

DOMESTIC SALES OFFICES: Baltimore, Boston, Chicago, Cleveland, Dallas, Dayton, Denver, Huntsville, Indianapolis, Los Angeles, New York City, Orlando, Philadelphia, San Francisco, Seattle, St. Louis, Syracuse • **OVERSEAS SALES OFFICES EUROPEAN:** Vienna, Austria; Brussels, Belgium; Humleback, Denmark; London, England; Paris, France; Helsinki, Finland; Gennep, Holland; Milan, Italy; Oslo, Norway; Madrid, Spain; Barcelona, Spain; Motala, Sweden; Onex-Geneva, Switzerland; Munich, W. Germany • **OTHER:** Buenos Aires, Argentina; Sao Paulo, Brazil; Montevideo, Uruguay; Sydney, Australia; Auckland, New Zealand; Wellington, New Zealand; Tel-Aviv, Israel; Bombay, India; Manila, Philippines; Tokyo, Japan; Osaka, Japan.

TELONIC—INTERNATIONAL LEADER IN SWEEP FREQUENCY MEASUREMENT

Electronics Abroad

Volume 38
Number 21

West Germany

Market for nuclear power

An almost infinitesimal share of Western Europe's electricity is produced by nuclear power, but that share still requires nearly \$100 million a year in American-made electronic instruments and controls. The market will more than double by 1969, when Britain will have doubled her nuclear power capacity, West Germany will have quadrupled her tiny capacity, and France will have increased her output sixfold.

The forecasts of expansion were made this month at the European Atomic Forum, commonly called Foratom, in Frankfurt. The 900 delegates from 19 countries were also told to expect a tenfold increase in electric power requirement in Europe, with half of the increase being produced by nuclear power.

Competition. But United States companies cannot count on grabbing all of that new business. It was clear at the Frankfurt conference that European companies intend to bite into the enormous American lead in nuclear research, and into Britain's lead in nuclear-generated electric power. West Germany, for example, is investing \$850 million in a program to develop new reactors by 1967.

Most of the expansion funds go for construction, heavy equipment, fuel and the like, but a sizable chunk goes into electronic gear such as sensors, instruments, safety devices and process-control computers. Said one American at Foratom: "You need the same sort of electronics in a nuclear power plant as in a conventionally fueled plant—only much, much more of it."

As generating equipment changes, so does the allied electronics. When processors are introduced that convert the heat of a thermonuclear reaction directly into

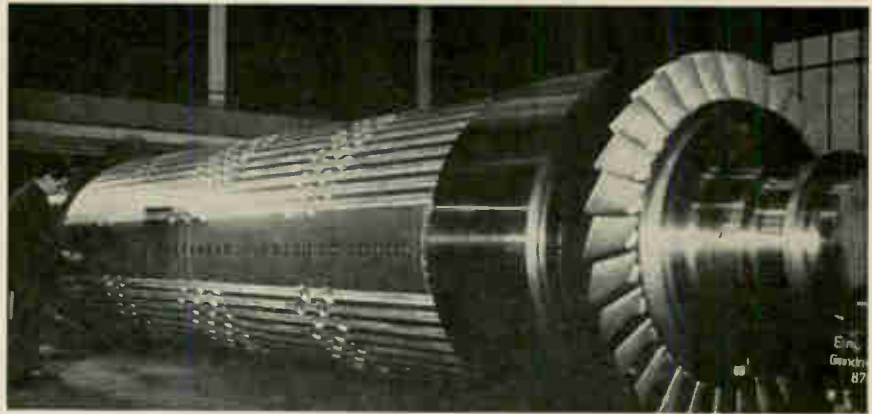

Record rotor. Thirty-six-foot-long inductor for nuclear power station weighs 100 tons, the heaviest ever built in Germany for a turbo generator. It is made in one piece, of chrome-nickel steel.

electrical power, through the use of thermoelectric and thermionic materials for instance, a segment of the market will be opened to electronics companies experienced in direct-conversion methods.

The market. At a show associated with Foratom, 30 American companies exhibited nuclear instrumentation equipment. One exhibitor, Baird-Atomic, Inc., reported substantial interest in its electronic equipment for nuclear sampling. A company official said: "We look upon Europe as a \$10-million-a-year market for nuclear instrumentation alone."

How fast is nuclear power likely to expand? Here are some figures reported at the congress:

Britain: nuclear capacity, 2.8 million kilowatts of electrical energy; by 1969, expected to increase to 5.5 million kilowatts; total produced in 1963 by all methods, 163.3 billion kilowatt hours.

France: current nuclear capacity, 357,000 kilowatts; by 1969, expected to reach 1.6 million; total in 1963 from all methods, 85.9 billion kilowatt hours.

West Germany: current nuclear capacity, 15,000 kilowatts; by 1969, expected to reach 1.0 million; total in 1963 from all methods, 137.3 billion kilowatt hours.

Great Britain

New computers

Two British computer companies have begun a pincers movement against the extensive foreign bridgehead in their domestic industry. International Computers and Tabulators, Ltd., calls its small new 1901 machine the Volkswagen of the computer industry. And the English Electric Co. has taken dead aim on the technical leaders with System 4, whose development is expected to cost \$33 million.

ICT predicts sales of its 1901 at one a day by July and two or more a day by later next year. Even at its low price—starting at \$56,000—that's a healthy pace. English Electric's new series, whose processors use integrated circuits throughout, will be compatible with most machines of its size, both domestic and foreign-made; the first installations are expected in 1967.

ICT's small entry. ICT believes there are 8,000 prime domestic prospects for the 1901 series—companies with 200 to 500 employees, which have considered computers too expensive. American-made machines in its price range are still relatively unknown in Britain. The

National Cash Register Co. plans to introduce its NCR 500 in Britain this month, and the first IBM 1130 will be installed some time in 1966. The Digital Equipment Corp. had installed only one PDP-4 machine up to July.

The 1901 is easy to install. It requires no special computer room, and operates on an ordinary single-phase electrical supply, with no need for a voltage regulator. The word-oriented computer combines series with parallel operation, working with six bits at a time. Its core storage can be 4,096, 8,192 or 16,384 words. Multiplication is performed in 4 to 7 milliseconds, division in 7 milliseconds, and additions and subtraction take 34 microseconds.

System 4. English Electric concedes that it has adopted some designs used in the Radio Corp. of America's Spectra 70; RCA and English Electric have cross-licensing agreements. But the British company says System 4 makes more extensive use of integrated circuitry than does the Spectra 70.

The British machine is built around four central processors, designated—in order of increasing power and complexity—4-10, 4-30, 4-50 and 4-70. Configurations can be expanded step by step because all elements in the system—core storage processors, input-output channels, peripheral devices and software—are modular. Prices run from \$168,000 for a desk-size 4-10 central processor to \$2.8 million or more for a 4-70 configuration. English Electric claims a price advantage of 25% to 50% over its major competitors, ICT and the International Business Machines Corp.

Production of the System 4 series has begun, and deliveries are expected in time to compete for government orders, estimated at \$42 million in the next few years. Sales also are planned abroad—in Western and Eastern Europe, Australasia, Latin America and South Africa.

Foreign languages. With System 4, English Electric seems to be aiming at its competitors' replacement market. All machines in the series offer multiprogramming. The

larger models can handle programs written for Spectra 70 and for the IBM 360 series. Hardware will be available with the 4-50 model to run programs that were written for the IBM 1401 and 1410, the ICT 1500, the RCA 310 and 501, and General Electric Bull's Gamma 30. General Electric Bull is a French affiliate of the General Electric Co. in the United States.

Small models of the System 4 use multichip circuits, in which the resistors are on one chip and the transistors and diodes on another. The larger models use single monolithic chips in all logic functions.

System 4 uses an eight-bit unit commonly called a byte; each represents two decimal digits, one alphabetic character, or a binary number.

The specs. The 4-10 central processor will have a set of 26 instructions and core storage of 4,096 to 16,384 bytes. Time for one byte is 1.5 microseconds. The 4-10 is intended for small commercial applications and for use as a satellite with larger computers.

The next member of the family, the 4-30, has a set of 41 instructions and a core store of 16,384 to 65,536 bytes, with a cycle time of 1.5 microseconds for two bytes. This model is also designed for commercial applications.

The 4-50's principal application is scientific problem-solving. A standard set of 100 instructions is supplemented by 44 floating-point instructions. The core store's capacity is 16,384 to 262,144 bytes. Cycle time for two bytes is 1.4 microseconds.

The 4-70 has commercial and scientific applications. Core storage with a capacity of 65,536 to 1,048,576 bytes has a cycle time for four bytes of one microsecond, interleaved to give an effective cycle time of 0.7 microseconds.

Westward ho

The Marconi Co. has introduced a versatile airborne direction-finder that seems to be fixed on the American military market. The Pentagon has been relaxing its rules to permit foreign companies to bid on

some American military equipment [Electronics, Oct. 4, p. 38]. The radio device is transistorized, adaptable to all types of military and civilian aircraft, has a solid state receiver, and meets specifications for all the latest American fighter planes in addition to the British BAC-111. Marconi is a subsidiary of the English Electric Co.

The system, called AD-370, weighs 16½ pounds; it is 7½ inches high, 2½ inches wide and 12½ inches long. Marconi says its new radio direction finder is the first to eliminate variable condensers and mechanical switching. Its diode-switched, crystal-controlled oscillators cover the frequency range for automatic direction-finding, and varactor diodes provide radio-frequency and intermediate-frequency tuning.

A rotary switch transfers the receiver to automatic direction-finding, manual direction-finding and to reception in the 190- to 1,799.5-kilocycle band. Direction-finding becomes automatic after the channel has been selected; a transmitting station's bearing can be read off in either magnetic or relative degrees.

Marconi says it is negotiating with several American companies that want to manufacture the ADF-370 under license in the United States.

Sound diagnosis

In industry, medicine, commerce and oceanology, researchers are finding more and more ways to use vibrations with frequencies above 20 kilocycles per second. This expanding role was dramatized this month at a conference and exhibition in London sponsored by *Ultrasonics*, a British journal.

Interest centered largely on an ultrasonic camera. Ward Collis, of the biomedical engineering center at Northwestern University in Illinois, said the camera produces "sound pictures" of flaws in a metal block, bubbles in a human bloodstream, and other conditions that have long defied observation. Present research is aimed at improving the image resolution and giving a

view of larger areas, Collis said.

Diagnosis. Ian Donald of the Queen Mother's Hospital in Glasgow, Scotland, discussed medical diagnosis. Ultrasonic waves can detect soft body tissues that go unrecorded by x rays, he said. Changes in echoes have been found particularly useful in detecting brain tumors and internal bleeding in the head, and in following the progress of a pregnancy by periodically measuring the fetus's head.

Other reports described the use of ultrasonic waves for such purposes as detecting flaws in steel castings and in aircraft frames, examining spot welds as they are made, removing radioactive contaminations, degreasing metals, and helping in navigation, mapping the ocean floor, and detecting schools of fish.

Japan

Counting yen

A Tokyo company expects to turn a profit with a machine that counts other firms' money. Tokyo Koki Seisakusha says its Billcon E improves on mechanical bill-counters by adding electronic circuits that reject stained bills, or pairs of bills stuck together, without stopping the machine.

A mechanical feed flashes 10 bills a second past the photo-sensing circuits; that's somewhat slower than the 12-per-second rate of the Tickometer 3, made by Pitney-Bowes, Inc. The Japanese machine is also more expensive, priced at \$2,070 at home and "somewhat lower" abroad, compared with \$1,460 for the Tickometer. But the Pitney-Bowes machine stops when it encounters smudged or stuck-together bills.

Another manufacturer of bill-counters is De La Rue Instruments, Ltd., of Britain.

Bill's progress. When a 10-yen note enters the Billcon E, the first thing it encounters is a cadmium-sulfide photocell of the type used in exposure meters for cameras.



Yen counter employs electronic circuits to reject marred bills without stopping the machine.

Light hits the note, and the photocell evaluates the amount that passes through the paper.

If the note is badly marred, or if two notes are stuck together, the light is blocked and the cell triggers a "reject" switch. The switch pulse activates a feed blade that diverts the note into a rejection stacker, and the note is not counted.

If the note is acceptable, it is conveyed past a phototransistor; as the bill blocks its light source, the phototransistor activates a miniature relay which registers one count on a visual counter.

The machine can be adjusted to count bills of any denomination.

The Billcon E weighs 110 pounds. It is 27½ inches long, 12½ wide and 15 high.

Tokyo Koki specializes in the manufacture of equipment for testing and measuring.

Eastern Europe

Trade with the West

Bucharest's shiny new exhibition center will open its doors Oct. 26 on the biggest array of foreign-made electronic instruments ever displayed in Rumania. Significantly, the exhibition will be sponsored by Sima, the Scientific Instrument Manufacturers' Association of Britain.

To British electronics companies, beset by financial woes at home and intense competition abroad, Eastern Europe is an increasingly

attractive market. Earlier this year, after a trade fair in Moscow, Sima members sold half a million dollars' worth of instruments right off the stands and took orders for \$775,000 more. A trade fair last year in Peking brought sales and follow-up orders totaling \$2.7 million.

At least one computer maker also seems to be succeeding in obtaining orders from the Soviet bloc. Elliott-Automation, Ltd., has sold two more Arch automation systems, one to the Soviet Union and the other to East Germany. Their total cost, \$840,000, increases Elliott's sales of computing equipment to Eastern Europe since May, 1964, to \$3.6 million.

The Communist world buys only 3% of Britain's total exports, but a much bigger share—17.7%—of her foreign sales of scientific electrical and electronic equipment. Last year British sales of such gear to Communist countries totaled \$4.6 million.

Rumania. The Bucharest government, one of the more independent in the Soviet orbit, is anxious to alleviate a dire shortage of electronic instruments and research equipment. Its economic future depends on modernizing existing plants. As a major supplier of oil and petroleum products, Rumania is especially eager to obtain laboratory test instruments useful in refineries.

At the trade fair, A. Gallenkamp and Co. will show automatic equipment for distillation-testing of gasoline and oils.

Stanhope-Seta, Ltd., will show a lubricant-testing machine, a sliding-plate microscope counter for determining the viscosity of materials such as asphalt, and instruments for measuring sulfur content in petroleum products.

Avo, Ltd., will feature multi-winding machines for high-speed production of coils. These machines can take the place of several single coil-winding machines, thereby reducing the number of operators required and reducing production costs.

Impedance and admittance bridges, with measurement ranges between 50 cycles and 250 mega-

cycles per second, will be displayed by Wayne Kerr Laboratories, Ltd. One instrument, a one-megacycle bridge, designated B201, is claimed to be the most accurate and widest-range bridge for measurements between 50 cycles and 5,000 kilocycles. It is said to measure capacitance and resistance values with accuracy to 0.1%.

Russia. The Arch 8000, a modular building-block system bought by the Soviet Union from Elliott, will provide on-line computer control of an existing ammonia plant. The central processor is an Elliott 803-B computer with 8,192 words of core storage backed by two magnetic-film memory units. Shipment is scheduled early next year.

East Germany. The Arch 2000 for East Germany is also made up of modular building blocks. Its central processor is an Elliott 4120 with a 16,000-word memory. The system will be mounted on a mobile trailer and moved from one place to another within an oil refinery in Schwedt, on the Oder River. The British company says this is the first on-line system ever ordered by East Germany for industrial control.

France

Down with interference

A French company has developed an electrical cable that employs magnetic absorption to reduce interference, and claims to have licensed the General Motors Corp. and the Allen-Bradley Co., a big American manufacturer of electronic components and electric motor controls.

In Detroit, General Motors declined to discuss reports that GM is testing the cable for use in automobile ignition systems. In Chicago, "no comment" was the reply of H. M. Schlicke, who Allen-Bradley describes as being "in charge of the low-pass filter project." The cable was developed by LEAD, a French acronym for Laboratory for Electronics and Automation.

Reducing rfi leakage. Whenever a current passes through a cable, electric and magnetic fields are created. If the resulting radio-frequency interference from the cable is to be attenuated, these fields must be reduced or absorbed.

The lead technique takes advantage of the fact that magnetic materials consist of microscopic domains that align themselves in the direction of an applied magnetic field. When the field changes rapidly, these domains cannot shift around fast enough because of mechanical friction between them. When this happens, the magnetic field's energy is consumed as friction within the material. A similar effect occurs with the electron-spin effects in a dielectric material that is influenced by a fast-changing electric field.

Selective absorption. Magnetic fields can be attenuated if the conducting wire is covered with a layer of nonconducting magnetic material, or if a conducting magnetic wire is used. LEAD declines to say which approach it employs. Either way, the wire is covered with a dielectric material whose job is not to insulate against high voltage but to absorb the energy in the dielectric field. The cable also has high-voltage insulation.

By proper selection of the magnetic and dielectric materials, LEAD says it can attenuate rfi leakage at selected frequencies between 1 and 200 megacycles per second without affecting the low-frequency signals carried by the conductor.

Around the world

Argentina. The United States has reacted quickly to France's wooing of Argentine officials for the Secam system of color television [Electronics, Aug. 23, p. 165]. Two Americans have returned from 12 days in Argentina where, they say, they convinced officials that a color-tv system should be chosen entirely on merit. The French have offered free equipment as an inducement to adopt Secam. The

Americans are E. MacDonald Nyhen, director of the electronics division in the Commerce Department's Business and Defense Services Administration, and Eric M. Leyton, of the Radio Corp. of America.

Switzerland. Brown-Boveri & Cie., AG, Switzerland's biggest producer of electrical equipment, is building a million-dollar center for electronics research near Baden. Three hundred employees are expected to work there when the center is completed early in 1967.

Canada. A thin-film hybrid amplifier will be used in the push-button telephones that Canada plans to adopt in 1968. F. W. Carroll of the Northern Electric Co., which developed the component, says the circuit is fabricated of n-doped tantalum by first sputtering on a glazed ceramic substrate and then etching. The resistors are trimmed by anodic oxidation together with an aluminum coat-and-remove process. Carroll says 0.1-microfarad capacitors can be built into the circuit.

Soviet Union. Soviet scientists are testing a method of converting solar energy directly into electricity by means of silicon photo elements, according to Valentin Nellin, vice chairman of the Soviet Committee for Power Engineering.

Spain. The Madrid government has dropped its \$15.10 tax on ownership of television sets. Information Minister Manuel Fraga Iribarne says the move is aimed at "expanding tv ownership."

Sweden. "Come and work in Great Britain for one of the world's leading computer companies," proclaim large advertisements in Swedish newspapers. The ads are taken by English Electric-Leo-Marconi Computers, Ltd. The subsidiary of the English Electric Co. offers jobs in computer research, design, development, production, marketing, data services and systems programming. This is believed to be the first large-scale attempt by a British electronics company to woo engineers in Sweden. The British company is reported to be working in the Anglo-French pooling of computer technologies [Electronics, Aug. 9, p. 219].

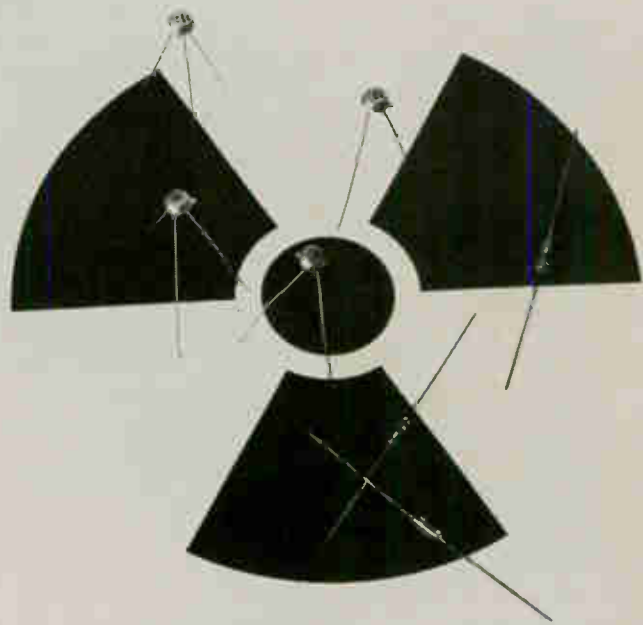

radiation resistant.

FT40 transistor: Amplifier or high speed switch. h_{FE} of 10 or better after radiation exposure of 1×10^{15} nvt. Guaranteed.

FRR 300 diode: V_F less than or equal to 1.0V @ $I_F = 100\text{mA}$, $PRV = 300\text{V}$ after radiation exposure of 5×10^{14} nvt.

Guaranteed.

FAIRCHILD
SEMICONDUCTOR

In distributor stock
or write for complete data.



■ AMP Incorporated Garceau, Hargrave & McCullough Inc.	137	Dickson Electronics Corporation N. A. Winter Advertising Agency	139	Intercontinental Instruments Inc. Murray Heyert Associates	148
■ Acme Electric Corporation Scheel Adv. Agency	136	Dranetz Engineering Laboratories Inc. Mort Barish Associates Inc.	154	International Rectifier Corp. Communication Associates	54
Airpax Electronics Inc. Welch, Mirabile & Co. Inc.	147	■ DuPont de Nemours & Company Inc., E. I.	57, 157	International Resistance Company Gray & Rogers Inc.	127
■ Air Products & Chemicals Inc. Arthur Falconer Associates Corp.	51	Batten, Barton, Durstine & Osborne Inc.	186	ITT Wire & Cable Division West, Weir & Bartel Inc.	131
Alden Electronics Larcom Randall Advertising Inc.	163	■ Dynage Inc. F. W. Prella Advertising	180		
Alfax Papers Larcom Randall Advertising Inc.	163	Dynaplex Corporation	180		
Amperite H. J. Gold Company	167				
Aring Research George Ruehl Adv.	38				
■ Astrodata Inc. Bonfield Associates Inc.	15				
		Eastman Kodak Company The Rumrill Company Inc.	119	James Electronics Inc. Burton Browne Advertising	150
■ Ballantine Laboratories Lang-Lawrence Advertising Inc.	49	Electro Products Laboratories, Inc. C. M. Gotsch Advertising	166	Johanson Manufacturing Company Josephson, Cuffari & Company	175
Bell Aerosystems Company Comstock Advertising Inc.	109	Electronic Specialty Company Gaynor & Ducas, Inc.	110	Johnson Company, E. F. Firestone Advertising Inc.	66
Bendix Semiconductor Products MacManus, John & Adams Inc.	9	■ Erie Technological Products Co. Inc. Altman-Hall Associates	171		
Bristol Company, The Chirurg & Cairns Inc.	160	Eubanks Engineering Company Moore Bergstrom Company	185		
■ Brush Instruments Div. of Clevite Corp.	3rd Cover				
Carr Liggett Adv. Inc.		■ Fairchild Instrumentation The Weston Company Inc.	168	Kassoy Inc. Harmony Impressions	169
Bud Radio Inc. Allied Advertising Agency Inc.	179	■ Fairchild Instrumentation Johnson & Lewis Inc.	122	■ Kepco Inc. Weiss Advertising	22
Bulova Watch Company, Electronics Division Ted Gravenson Inc.	144	■ Fairchild Semiconductor Faust/Day Inc. Advertising	12, 13, 197	Kingsley Machine Company Nides Cini Advertising Inc.	179
■ Busmann Mfg. Co. Div. of McGraw Edison Co.	180, 181	■ Fujitsu Limited Fuji Agency	185	Krohn-Hite Corporation Stern/Frank Advertising Inc.	170
Henderson Advertising Company					
		■ General Electric Co., Silicone Products Dept. Ross Roy Inc.	18, 19	■ Lapp Insulator Company Inc. Wolff Associates Inc.	152
		General Radio Company K. E. Morang Company	6	■ Leach Corporation Jay Chait Associates	63
■ CML Inc. Keys, Martin & Company	185	Goldman, Sachs & Company Doremus & Company	175	Lockheed Missiles & Space Company McCann-Erickson Inc.	162
■ CTS Corporation Burton Browne Advertising	159	Gudebrod Bros Silk Co. Inc. Lee Ramsdell & Company Inc.	52		
■ CTS Knights Inc. Burton Browne Advertising	156				
■ Christie Electric Corp. Len Woolf Co. Advertising	164	Hamilton Standard Div. of United Aircraft Corporation Cunningham & Walsh Inc.	141	Machlett Laboratories Inc. The Fuller & Smith & Ross Inc.	8
Clare & Company, C. P. Reincke, Meyer & Finn Adv.	60, 61	Hamilton Watch Company Beaumont, Heller & Sperling Inc.	162	Magnecraft Electric Company Allbright Associates Adv.	179
Cleveland Institute of Electronics Carr Liggett Advertising Inc.	158	Hansen Mfg. Co. Inc. Keller-Crescent Company	191	■ Mallory & Company Inc. P. R. The Aitkin-Kynett Company	69
Cohu Electronics, Kin Tel Division Erwin Wasey, Ruthrauff & Ryan	135	■ Heath Company Advance Advertising Service Inc.	177	■ Mallory Battery Company Needham, Harper & Steers Inc.	114
Colorado, State of Buchen Advertising Inc.	155	Heinemann Electric Company Thomas R. Sundheim Inc.	132	Marconi Instruments Armand Richards Advertising Agency	62
Cominco Products Inc. McKim Productions Limited	176	■ Hewlett Packard Company Lennen & Newell Inc.	1, 20, 21, 133	Maryland Department of Economic Development Rosenbush Advertising Agency Inc.	48
Communication Electronics Inc.	170	Hornblower & Weeks, Hemphill, Noyes Doremus & Company	200	Maryland Telecommunications Richard N. Berry Advertising	10
■ Consolidated Avionics The Stanley Schwartz Company	68	Hopkins Engineering Company Philip J. Meany Company	47	McGraw Hill Book Co. Inc.	35
Control Data Corporation Barnes Champ Advertising	183	■ Houston Omnigraphic Corporation Cooley & Pate Inc.	116	■ Metal Removal Company The Advertising Producers Associated Inc.	178
■ Controls Company of America The Harry P. Bridge Company	138	■ Hughes Aircraft Company Foote, Cone & Belding Inc.	117, 121	Mico Instrument Company	174
Coto Coil Company, Inc. The Williams Company	174			■ Mitsumi Electric Co., Ltd. Dentsu Advertising Ltd.	186
Crydom Laboratories Leonard Daniels Advertising	145				
Crystalonics Inc. Impact Advertising Inc.	149				
Cubic Corporation Phillips Ramsey Inc.	39			National Cash Register Company Allen, Dorsey & Hatfield Inc.	172, 173

Executive, editorial, circulation and advertising offices: McGraw-Hill Building, 330 West 42nd Street, New York, N.Y., 10036. Telephone Area Code 212-971-3333. Teletype TWX N.Y. 212-640-4646. Cable: McGrawhill, N.Y. Officers of the Publications Division: Shelton Fisher, President; Vice Presidents: Joseph H. Allen, Operations; Robert F. Boger, Administration; John R. Callahan, Editorial; Ervin E. DeGraff, Circulation; Donald C. McGraw, Jr., Advertising Sales; Angelo R. Venezian, Marketing, Officers of the Corporation; Donald C. McGraw, President; L. Keith Goodrich and Hugh J. Kelly, Executive Vice Presidents; John J. Cooke, Vice President and Secretary; John L. McGraw, Treasurer. Title R registered U.S. Patent Office; © copyright 1965 by McGraw-Hill, Inc. All rights reserved, including the right to reproduce the contents of this publication, in whole or in part.

This advertisement is neither an offer to sell, nor a solicitation of offers to buy any of these securities.
The offering is made only by the Prospectus.

October 6, 1965

400,000 Shares
AMECO, INC.

Common Stock

(\$1 Par Value)

Price \$19 Per Share

Copies of the Prospectus may be obtained in any State in which this announcement is circulated from only such of the underwriters as may legally offer these securities in compliance with the securities laws of such State.

HORNBLOWER & WEEKS-HEMPHILL, NOYES

EASTMAN DILLON, UNION SECURITIES & CO.

GLORE FORGAN, WM. R. STAATS INC.

SMITH, BARNEY & CO.
Incorporated

BACHE & CO.
Incorporated

A. G. BECKER & CO.
Incorporated

BLAIR & CO., GRANBERY, MARACHE
Incorporated

CLARK, DODGE & CO.
Incorporated

DOMINICK & DOMINICK,
Incorporated

GOODBODY & CO.

E. F. HUTTON & COMPANY INC.

W. E. HUTTON & CO.

REYNOLDS & CO.

SHEARSON, HAMMILL & CO.
Incorporated

TUCKER, ANTHONY & R. L. DAY

Circle 236 on reader service card



Advertising sales staff

Gordon Jones [212] 971-2210
Advertising sales manager

Atlanta, Ga. 30309: Gus H. Krimmier,
Michael H. Miller, 1375 Peachtree St. N.E.,
[404] TR 5-0523

Boston, Mass. 02116: William S. Hodgkinson
McGraw-Hill Building, Copley Square
[617] CO 2-1160

Chicago, Ill. 60611: Robert M. Denmead,
J. Bradley MacKimm
645 North Michigan Avenue,
[312] MO 4-5800

Cleveland, Ohio 44113: Paul T. Fegley, 55
Public Square, [216] SU 1-7000

Dallas, Texas 75201: Richard P. Poole, The
Vaughn Building, 1712 Commerce Street,
[214] RI 7-9721

Denver, Colo. 80202: Joseph C. Page, David
M. Watson, Tower Bldg., 1700 Broadway,
[303] AL 5-2981

Detroit, Michigan 48226: Paul T. Fegley
856 Penobscot Building
[313] 962-1793

Houston, Texas 77025: Kenneth George,
2270 Humble Bldg.,
[713] CA 4-8381

Los Angeles, Calif. 90017: Ashley P.
Hartman, John G. Zisch, 1125 W. 6th St.,
[213] HU 2-5450

Minneapolis, Minn. 55402: J. Bradley
MacKimm 1st National Bank Building
120 South Sixth Street
[612] FE2-7425

New York, N. Y. 10036:
Donald R. Furth [212] 971-3615
Frank LeBeau [212] 971-3615
George F. Werner [212] 971-3615
500 Fifth Avenue

Philadelphia, Pa. 19103: William J. Boyle,
Warren H. Gardner, 6 Penn Center Plaza,
[215] LO 8-6161

Pittsburgh, Pa. 15222: Paul T. Fegley,
4 Gateway Center, (412) 391-1314

Portland, Ore. 97204: James T. Hauptli,
Pacific Building, Yamhill Street,
(503) CA3-5118

St. Louis, Mo. 63105: Robert M. Denmead
The Clayton Tower, 7751 Carondelet Ave.
[314] PA5-7285

San Francisco, Calif. 94111:
James T. Hauptli, 255 California Street,
[415] DO 2-4600

London W1: John W. Patten, Edwin S.
Murphy Jr., 34 Dover Street,
Hyde Park W1451

Milan: 1, via
Baracchini Phone: 86-90-617

Frankfurt/Main: Gerd Hinske, 85
Westendstrasse Phone: 77 26 65 and
77 30 59

Geneva: Michael R. Zeynel, Joseph Wuensch,
2 Place du Port 244275

Paris VIII: Denis Jacob, 17 Avenue
Matignon ALMA-0452

Tokyo: Nobuyuki Sato, 1, Kotohiracho
Shiba, Minato-Ku (502) 0656

Osaka: Kazutaka, Miura, 163, Umegee-cho,
Kilta-ku [362] 8771

Nagoya: International Media Representatives,
Yamagishi Bldg., 13, 2-Chome,
Oike-cho Naka-ku

Hugh J. Quinn: [212] 971-2335
Manager Electronics Buyers' Guide

David M. Tempest: [212] 971-3139
Promotion manager

Milton Drake: [212] 971-3485
Market research manager

Wallace C. Carmichael [212] 971-3191
Business manager

Theodore R. Geipel: [212] 971-2044
Production manager

**SILICON SOLID STATE
FREQMETER
FREQUENCY-TO-DC
CONVERTER**

-55 C. TO +85 C.

ACTUAL SIZE

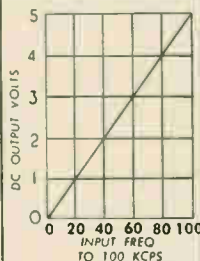

MICROMINIATURE
LIGHTWEIGHT

LINEAR
LOW POWER

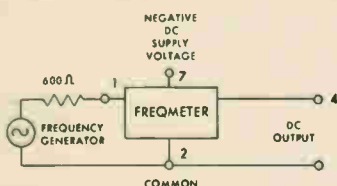

WRITE OR PHONE FOR BULLETINS

SOLID STATE ELECTRONICS CORP.

15221 BAYEN STREET, SEPULVEDA, CALIFORNIA 91343
TELEPHONE: AREA CODE (213) 894-2271 OR 745-4473



Transformer for

MICROPHONE



**YOUR assurance of best quality
and quantity**

**The secret 2-Q's
behind
every Nishimura products**



Nishimura Musen-Denki Co., Ltd.

21, Owada-cho, Shibuya-ku,
Tokyo, Japan

Another Brush Innovation in Recording

The **Very** versatile
Brush
Mark 842.
For people who never know
what they'll be
recording next!

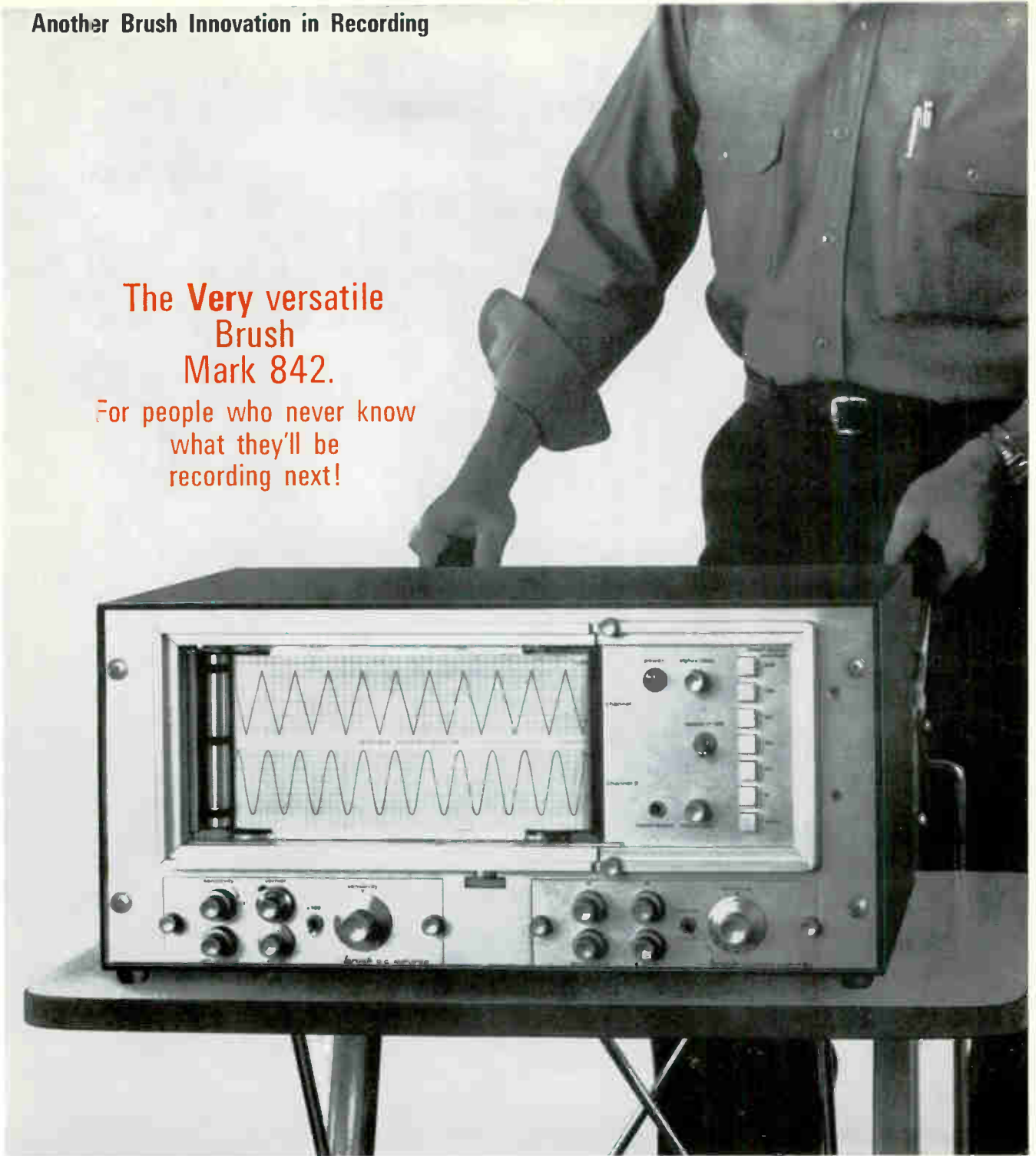

You know what we mean.

Recording requirements change. So it makes sense to buy a recorder you can change with them. Like the Brush Mark 842. See the two pre-amplifiers right below the display and controls? They're the interchangeable plug-in type. Brush gives you a choice of nine. Plus a pick of seven conversion couplers. And *any* mounting arrangement

you can think of. Lets you match the new Mark 842 to whatever recording job comes along. Great performance, too. Highest usable frequency response of *any* direct writing recorder . . . 75 cps full scale; flat to 150 cps at reduced amplitude. 1/2% Linearity. All solid state electronics. High torque penmotors. Rugged, crisp-writing styli to assure razor-sharp traces

of unmatched reproducibility. Pushbutton choice of 12 writing speeds. All yours in the clean, neat, easy-to-operate Mark 842. Built by Brush to meet your recording needs for years to come. Ask your local Brush Sales Engineer for a demonstration. A new brochure is yours for the asking. Brush Instruments Division, Clevite Corporation, 37th & Perkins, Cleveland, Ohio 44114.

brush **CLEVITE**
INSTRUMENTS DIVISION

Circle 901 on reader service card

RCA-8072

Your Best Buy for New Equipment Mobile Transmitters

TYPICAL OPERATION
P_o - 85 WATTS
FREQ - 470 Mc
GAIN - 12 db



$$\frac{\$18.75 *}{85 \text{ WATTS}} = \$.22/\text{WATT}$$

See your RCA Representative about RCA-8072 and other
RCA power tubes. For technical data, write:
RCA Commercial Engineering, Section J19Q-3 Harrison, N.J.

ALSO AVAILABLE FROM YOUR RCA INDUSTRIAL TUBE DISTRIBUTOR

*Optional Distributor Resale price. See your RCA Field Representative for Equipment price.



RCA Electronic Components and Devices, Harrison, N. J.

The Most Trusted Name in Electronics