

Electronics®

More reliable semiconductor transducers: page 72

Shortcut to calculating Q: page 85

Sharpening microwave reception: page 89

July 12, 1965

75 cents

A McGraw-Hill Publication

Below: New wireless packaging for integrated circuits, page 98



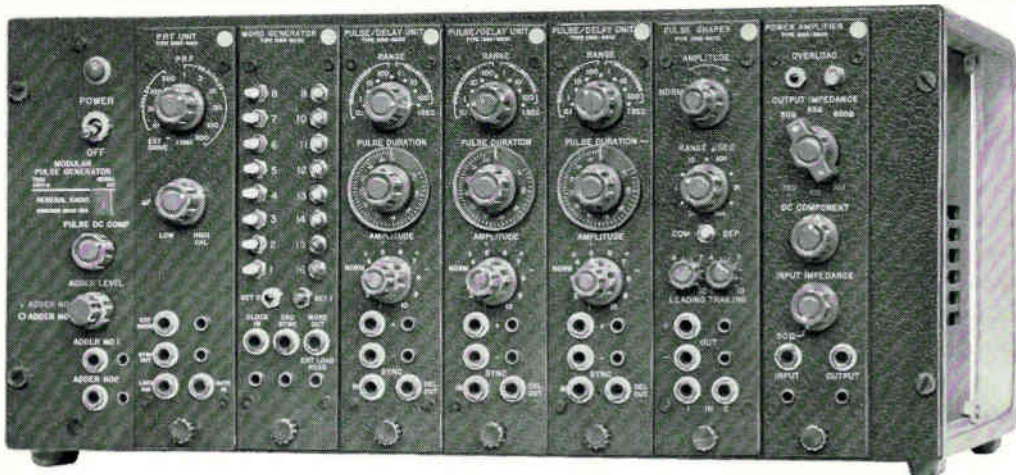

Type 1395-A Modular Pulse Generator containing three Pulse/Delay Units and one each of the PRF Unit, Word Generator, Pulse Shaper, and Power Amplifier modules.

PULSES MADE TO ORDER

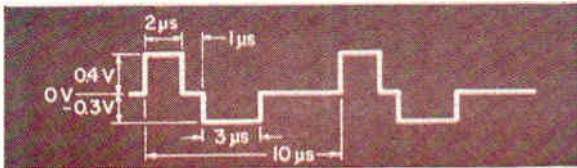

One PRF Unit and three Pulse/Delay Units operating at 100 kc/s. The positive and negative pulses are controlled by separate Pulse/Delay Units; the third unit controls the delay between the pulses.



One PRF Unit, one Pulse/Delay Unit, and one Pulse Shaper with the PRF Unit set for 5 kc/s. Rise and fall times are independently variable.

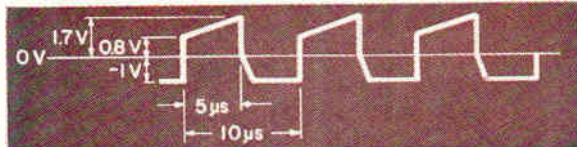

One PRF Unit, one Pulse/Delay Unit, and one Pulse Shaper. Prf is 100 kc/s, and the zero-volt level is adjusted by the main chassis PULSE DC COMPONENT control.

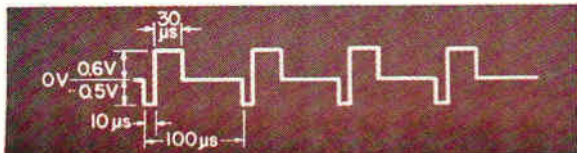

Waveform that appears at the ADDER No. 1 terminal with one PRF Unit driving two Pulse/Delay Units at 10 kc/s. Amplitudes and durations of positive and negative pulses can be independently adjusted.



Pattern produced when a word generator is connected between the PRF Unit and the first Pulse/Delay Unit of the example given above, with switches set as shown.

This new pulse generator can produce thousands of different pulse shapes as single pulses, in bursts, or as trains of pulses. You can even form the desired pulses into binary patterns or words up to 112 bits long. The pulses can be amplified internally, delayed in time, or have noise or sine waves added to them. Amplitudes, durations, and delays of all segments of complex pulses are independently controllable; positive and negative outputs are available simultaneously. Whatever you may need — rectangular pulses, doublets, pulses with pedestals, ascending staircases, descending staircases, triangles, trapezoids, etc. — this instrument can do the job for you.

This instrument has been designed in modular form so that you can order only the pulse-generating capability you require. The various circuits that generate and shape the pulses are packaged in five separate modules, and as many as seven of these can be inserted in the main frame of the generator.

The main frame contains a power supply and other circuits that are common to all modules. As each module is inserted, electrical connections are made through mating of a plug and jack. Two ADDER busses with their corresponding output controls and jacks are included on the main frame to provide signals that represent the "sum" of outputs from the individual modules.

Modules from which you can now custom build your own pulse generator include:

PRF UNIT — provides internally generated repetition rates from 2.5 c/s to 1.2 Mc/s, from dc to 2 Mc/s when driven externally. Price: \$150

PULSE/DELAY UNIT — delays input pulses from 100 ns to 1 second and adjusts amplitude, polarity, and duration. Price: \$165

PULSE SHAPER — adjusts rise and fall times from 100 ns to 10 ms, either individually or simultaneously. Limit of 3 per frame. Price: \$375

POWER AMPLIFIER — delivers 20-volt pulses of either polarity into a 50-ohm load. Limit of one per frame. Price: \$250

WORD GENERATOR — produces binary words up to 16 bits long; as many as seven modules can be cascaded to provide 112-bit capability. Price: \$400

MAIN FRAME (without modules) — Price: \$500

IN CANADA: Toronto 247-2171, Montreal (Mt. Royal) 737-3673
IN EUROPE: Zurich, Switzerland — London, England



GENERAL RADIO COMPANY

WEST CONCORD, MASSACHUSETTS

BOSTON (W. Concord) 646-0550 NEW YORK, N. Y., 964-2722 (Ridgefield, N. J.) 943-3140 CHICAGO (Oak Park) 848-9400 PHILADELPHIA (Ft. Washington) 646-8030 WASHINGTON, D.C. (Rockville, Md.) 946-1600 SYRACUSE 454-9323 DALLAS FL 7-4031 SAN FRANCISCO (Los Altos) 948-8233 LOS ANGELES 469-6201 ORLANDO, FLA. 425-4671 CLEVELAND 886-0150

Circle 900 on reader service card

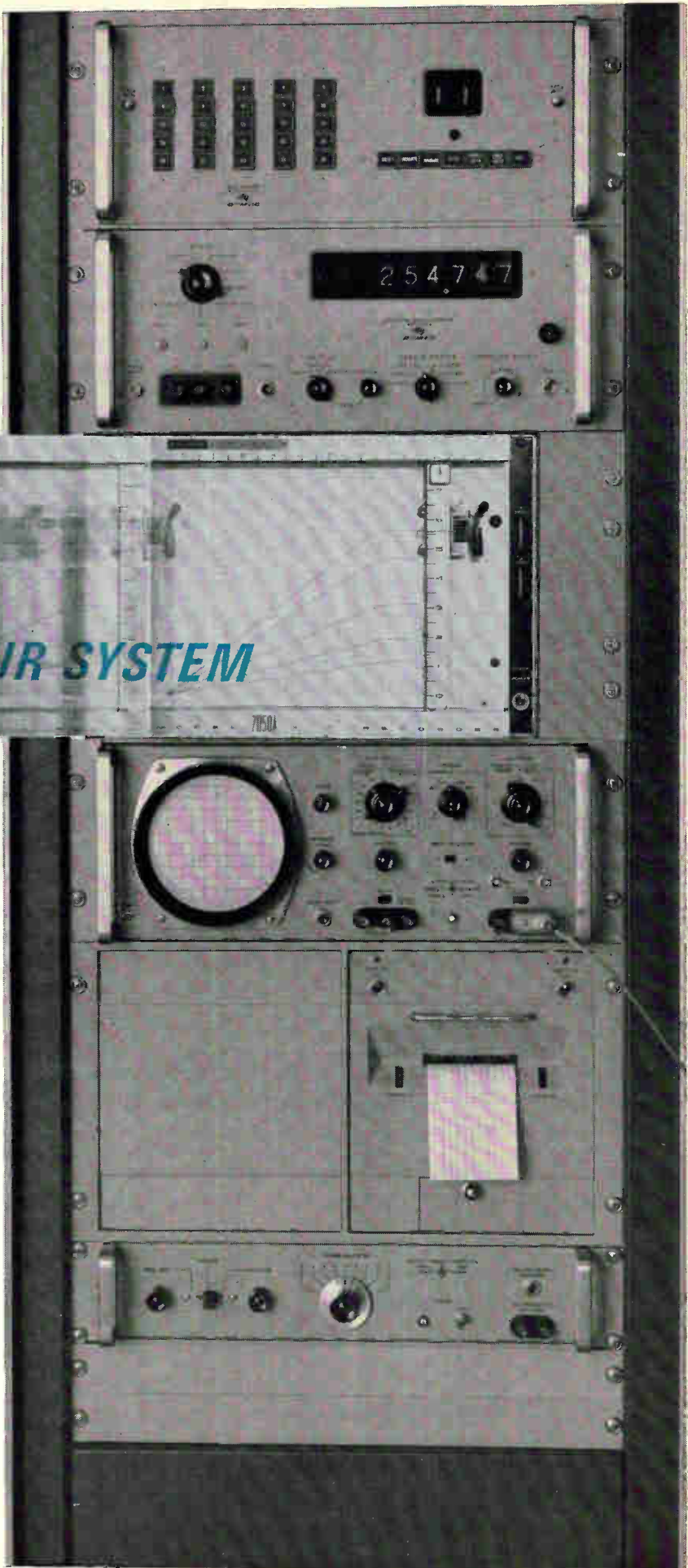

IT GETS INTO YOUR SYSTEM

Moseley 7050A X-Y Recorder

Designed to meet your special systems requirements, the Moseley 7050A X-Y Recorder is extremely flexible and adaptable to almost any system requiring high accuracy x-y readout. Completely solid state, it features a single range to match your requirements on each axis. Contact your nearest Hewlett-Packard/Moseley field office for complete data, or write: 433 N. Fair Oaks Avenue, Pasadena, California 91102.

- Paper size:** 8½" x 11"
- Input voltage range:** To customer order
- Input resistance:** One megohm, free of ground
- Accuracy:** 0.2% of full scale; resettability is 0.1% of full scale
- Price:** \$975

Data subject to change without notice. Price f.o.b. factory.



6 WAYS TO GET IMPROVED MEASUREMENTS AT LOWER COST:

The new hp 419A DC Nullmeter and wide-range voltmeter!

1. Internal nulling supply for measuring high-impedance source voltages
2. 0.1 μv resolution with $< 0.5 \mu\text{v}$ drift per day
3. Noise immunity > 80 db superimposed ac rejection
4. Four times longer battery operation—30 hours between recharges
5. Overload—up to 1200 volts
6. Copper terminals eliminate thermal voltages

Price: only \$450

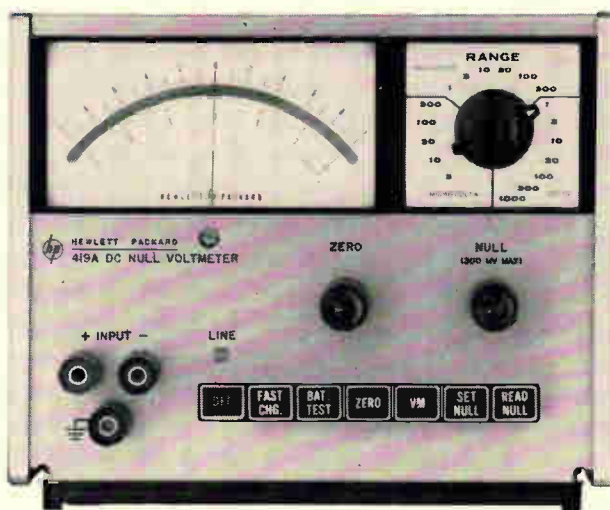

The Hewlett-Packard 419A represents a new approach to dc voltage measurement, offering an instrument that is more accurate, more stable, less noisy and more sensitive at a price that makes it today's best dc null-meter value. In addition, you may use it as a 3 μv to 1 kv zero center scale dc voltmeter. Accuracy is $\pm 2\%$ of end scale, $\pm 0.1 \mu\text{v}$. Response time is 3 sec on 3 μv range, 1 sec on 10 μv to 1000 v ranges (to 95% of final reading), with 2 sec recovery for 10^{+4} overload.

The 419A's internal nulling feature is unique. With it you may derive an essentially infinite input impedance on the 3 μv to 300 mv ranges, merely by bucking out the input voltage, pushing a button and measuring the internal supply itself. Ideal for applications involving high source impedances. Input impedance above the 300 mv range is 100 megohms.

Operate it from the ac line, during which batteries trickle charge, or isolate it from the power line and operate on furnished batteries that give four times longer operation between charges than comparable instruments available today. A fast charge feature (adjustable) lets you recharge batteries in 16 hours. The 419A may be operated up to 500 v dc or 350 v ac (rms) above ground. In addition, the 419A serves as an exceptionally stable dc amplifier, and recorder output of 1 v, with currents up to 1 ma, is provided.

Pushbutton convenience is provided by the human-engineered front-panel, including the Battery Test for reading battery strength on the meter and the Set Null and Read Null buttons and knob for using the internal bucking voltage. The zero control also can be used to compensate thermals at the lower ranges. A new chopper design in the solid-state 419A (patent pending) uses long-wear hp photo-cells with reduced on-time and battery drain.

Ask your hp field engineer for a convincing demonstration. Or write for complete data to Hewlett-Packard, Palo Alto, California 94304, Tel. (415) 326-7000; Europe: 54 Route des Acacias, Geneva; Canada: 8270 Mayrand Street, Montreal.

Data subject to change without notice. Price f.o.b. factory.

HEWLETT  **PACKARD**
An extra measure of quality

Electronics

July 12, 1965

Volume 38, Number 14

Page 4	Readers Comment
8	People
10	Meetings
15	Editorial
17	Electronics Newsletter
61	Washington Newsletter
127	New Products
168	New Books
170	Technical Abstracts
181	New Literature

Electronics Review

Page 47	Mariner's report	50	Flying laboratory
48	Out of the shadow	52	For safety's sake
48	Switchless radiophone	52	In focus
49	Push-button testing	54	Sword into scalpel
49	Betting on overlays	56	Electronics notes

Probing the News

113	Broadcasting with a heart protects lives
115	NASA and the Pentagon hold a 'space race'
121	Cautious conductor of our science effort
124	Stopping storms before they start

Electronics Abroad

183	Hospital automation	185	Band plays on
184	Tv in Moscow	186	Millions of thin films
184	Busy line	186	Around the world

Technical articles

I. Design

Solid state	72	Adding force to integrated circuits New semiconductor transducers are simpler, lighter and more reliable Edgar J. Evans, Picatinny Arsenal
Circuit design	78	Designer's casebook Pulses with variable mark-to-space-ratio; precise 6-volt input triggers circuit; gate circuits eliminated in scr static switch
Integrated circuits	81	Stress-sensitive integrated circuits Sensors can be combined with data processing on a single chip Roger C. Wonson, Raytheon Co.
Reference sheet	85	Shortcut to calculating the Q Charts reduce the number of calculations needed to design an r-f circuit John D. Duncan, Montana State College

II. Applications

Microwave	89	Phasing unwanted images out of microwave receivers A technique to reject unwanted images automatically by splitting r-f input Murray Loss, AIL, Cutler-Hammer, Inc.
------------------	----	--

III. Manufacturing

Production	95	Production tips Endless belt process makes assembly flexible; new leads and potting mate flatpacks and cordwood parts
Packaging	98	For low-cost flatpacks: kill the wires, put circuits under glass New inexpensive package is solid and rugged, and stores well C.R. Cook Jr., R.W. Mohnkern, S.M. Sampiere, IT&T

Electronics

Editor: Lewis H. Young

Senior editors

Technical: Samuel Weber
News: Kemp Anderson, Jr.

Senior associate editors: John F. Mason, George Sideris

Department editors

Advanced technology: Joan Blum
Avionics: W.J. Evezia
Circuit design: Michael Elia
Components: Michael F. Tomaino
Computers: Wallace B. Riley
Consumer electronics: Richard Lipkin
Industrial electronics: Robert Cushman
Instrumentation: Carl Moskowitz
Manufacturing: George Sideris
Military electronics: John F. Mason
New products: William P. O'Brien
Solid state: Jerome Eimbinder
Space electronics: Peter R. Sigmund
Special projects: Richard M. Machol
Staff writer: Stanley Zarowin

Regional editors

Boston: Thomas Maguire, editor; Robin Carlson
Los Angeles: William B. Wallace, editor; June Ranill
San Francisco: Laurence D. Shergalis, Edmond G. Addeo, editors; Mary Jo Jadin
London: Derek Barlow, editor

Copy editors

Howard Rausch, Sally Powell, Walter Barney

Graphic design

Art director: Saul Sussman
Assistant art director: Donna M. Marchyn
Editorial production: Ann Mella
Production editor: Arthur C. Miller

Editorial secretaries: Claire Benell, Mary D'Angelo, Lynn Emery, Kay Fontana, Carolyn Michnowicz, Lorraine Longo, Lorraine Werner

McGraw-Hill news service

Director: John Wilhelm; **Atlanta:** Fran Ridgeway; **Chicago:** Bruce Cross, Louis S. Gomolak; **Cleveland:** Arthur Zimmerman; **Dallas:** Marvin Reid; **Detroit:** Donald MacDonald; **Los Angeles:** Michael Murphy, Ron Lovell; **San Francisco:** Margaret Ralston; **Seattle:** Ray Bloomberg; **Washington:** Arthur L. Moore, Charles Gardner, Herbert W. Cheshire, Seth Payne, Warren Burkett, Warren Kornberg

McGraw-Hill world news service

Bonn: Richard Mikton; **Brussels:** Arthur Erikson; **London:** John Shinn; **Mexico City:** Wesley Perry; **Milan:** Bruce Bendow; **Moscow:** Donald Winston; **Paris:** Dan Smith; **Rio de Janeiro:** Leslie Warren; **Tokyo:** Marvin Petal, Charles Cohen

Circulation manager: Hugh J. Quinn

Reprints: T.M. Egan

Publisher: C.C. Randolph

Electronics: July 12, 1965, Vol. 38, No. 14

Printed at 99 North Broadway, Albany, N.Y.
Second class postage paid at Albany, N.Y.

Subscriptions are solicited only from those actively engaged in the field of the publication. Position and company connection must be indicated on orders. Subscription prices: United States and Possessions and Canada, \$6.00 one year, \$9.00 two years, \$12.00 three years. All other countries \$20.00 one year. Single copies, United States and Possessions and Canada 75¢. Single copies all other countries \$1.50.

Published every other Monday by McGraw-Hill Inc. 330 West 42nd Street, New York, N.Y. 10036. Founder: James H. McGraw, 1860-1948.

Subscribers: The Publisher, upon written request to our New York office from any subscriber, agrees to refund that part of the subscription price applying to copies not yet mailed. Please send change of address notices, subscription orders or complaints to Fulfillment Manager, Electronics, at the address below. Change of address notices should provide old as well as new address, including postal zone number if any. If possible, attach address label from recent issue. Allow one month for change to become effective.

Postmaster: Please send Form 3579 to Fulfillment Manager, Electronics, P.O. Box 430, Hightstown New Jersey 08520

Readers Comment

An inch, more or less

To the Editor:

In reading "All together now" [June 14, 1965, p 207] I noticed you say: 1 inch = 2.541 cm. Since when?

In 1866, Congress said that the conversion factor would be: 1 meter = 39.37 inch, which I believe you will find is close to 1 inch = 2.540005 (three zeros) cm. Meanwhile, the British inch was found to be approximately 2.5399956 cm. The American Standards Association adopted 1 inch = 2.54 cm, exactly, in 1933. The U. S. A., Great Britain, Canada, etc., adopted the ASA definition effective July 1, 1959 (approximately six years ago). I have not heard of a subsequent change.

People are constantly confusing two completely different things: (1) standardization of sizes of things (for example, a 2 x 4 is approximately 1.8 x 3.8), and (2) standardization of units of measurement. Both are desirable, but they are almost totally unrelated. The supposed high cost of using the metric system (which Congress authorized in 1866) to describe things is almost wholly based on the invalid theory that we would also have to change the size of everything. We need common sizes no matter how we describe them, and we need a common language no matter how long it takes to standardize sizes.

What's wrong with "all wool and a meter wide"?

Lee E. Davies

Portola Valley, Calif.

■ Reader Davies' conversion is certainly right: 1 inch = 2.54 cm.

Does anyone care?

To the Editor:

Your editorial, "No Time for Timidity" [June 28, p. 15] intrigued me since I have made several attempts to interest local defense companies in the possibility of applying electronic techniques to improve the performance of the carburetor of the automobile engine.

Sprague has what it takes to cope with any problem in electromagnetic interference or susceptibility control

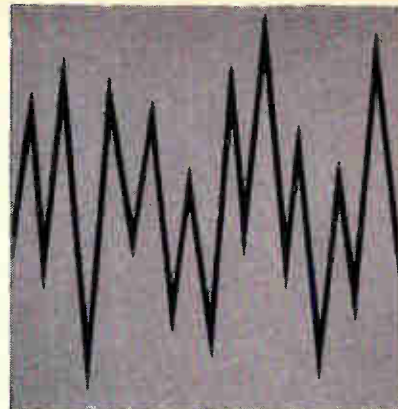

And we mean any problem . . . arising at any point in the development of any equipment or system!

Sprague's interference control facilities provide one of the most complete, fully integrated capabilities you can call on . . . embracing *every* aspect of interference and susceptibility control.

Design Assistance: Black boxes . . . subsystems . . . complete systems. Using advanced interference prediction techniques, Sprague engineers replace design by "hunch" with precise analysis of electrical schematics. Suppression and shielding can be designed into pre-prototype plans so accurately that little or no modification is required upon evaluation of the model. With today's more complex equipment and increasingly stringent EMI requirements, Sprague assistance in initial design can pay for itself in a dozen different ways by helping you be right the *first* time!

Measurement, Evaluation: Sprague can help you measure interference and susceptibility characteristics of your breadboard, prototype, or production equipment to the applicable interference specification. You know where you stand before investing in further development. We can also research such areas as shielding effectiveness, screen room integrity, transient susceptibility of digital equipment, and cable cross coupling.

Component Design: Sprague Filter Engineering Specialists can design, evaluate, and sample interference control devices to your particular requirements. These range from standard feed-thru capacitors and radio interference filters to the more sophisticated packages, such as frequency-controlling electric wave filters.

Component Production: Each of four Filter Development Centers maintains a well stocked model shop for the rapid fabrication of special

components in prototype quantities. Full scale production facilities are maintained in Visalia, Calif.; North Adams, Mass.; and Vandalia, Ohio.

Compliance Testing: Sprague can test your equipment or system and report on its compliance to the applicable specification: MIL-I-6181, MIL-I-26600, MIL-I-16910, MIL-E-6051 or to such other specialized interference documents as GM07-59-2617A, AFBSD Exhibit 62-87 (Minuteman WS133B), LSMC Specification ERS11897 (Polaris A3) or MIL-STD-449. If compliance is not indicated, a Sprague engineer will make concise recommendations and will, if you desire, give you every assistance in achieving that compliance.

Regional Service: Wherever you may be, this integrated EMI capability is readily available to you from strategically located Filter Development Centers in North Adams, Mass.; Annapolis Junction, Md.; Vandalia, Ohio; and Los Angeles, Calif. Each is fully equipped and staffed to evaluate, modify, or qualify your equipment.

In-plant Service: Sprague can put competent Interference Control Specialists at your service in your plant for consultation on, or supervision of, special projects.

Whether your work involves military or industrial electronic equipment or systems, Sprague Filter Development Center personnel can help assure substantial savings in dollars and hours at many points during development. Get complete information from the development center nearest you or by writing for a comprehensive brochure (FD-101) to Technical Literature Service, Sprague Electric Company, 35 Marshall Street, North Adams, Massachusetts.

FILTER DIVISION PRODUCTS AND SERVICES

INTERFERENCE FILTERS AND CAPACITORS
PRECISION TOROIDAL INDUCTORS
FREQUENCY SPECTRUM SIGNATURES
COMPONENT ENVIRONMENTAL TEST FACILITIES

ELECTRIC WAVE FILTERS
TELEMETRY FILTERS
EMI TEST FACILITIES
EMI SYSTEMS ENGINEERING

SPRAGUE®
THE MARK OF RELIABILITY

*Sprague' and '®' are registered trademarks of the Sprague Electric Co.

Now from Sprague!

DIFFERENTIAL AMPLIFIERS IN FLAT PACKS!

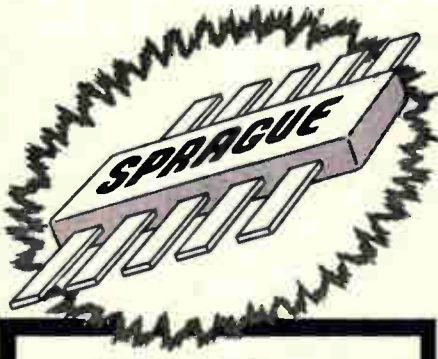

2N3043 2N3044 2N3046
2N3047 2N3049 2N3050 2N3051
2N3052 2N3520 2N3524

- PNP or NPN
- BETA MATCHING to 10%
- V_{BE} MATCHING to 3mV
- VOLTAGE CAPABILITY to 60 VOLTS
- TEMPERATURE COEFFICIENTS to $5\mu V/^{\circ}C$

*Also Available in 6-Lead
TO-5 Outline Packages!*

For complete technical data,
write to Technical Literature Service,
Sprague Electric Co., 35 Marshall St.,
North Adams, Mass. 01248

455 5121

SPRAGUE[®]
THE MARK OF RELIABILITY

*Sprague' and "®" are registered trademarks of the Sprague Electric Co.

Such an improvement could save from 10 to 20 percent of the gasoline used and amount to about a \$200,000,000 a year business. But, there has been practically no interest; only one company went so far as have a talk on the proposition.

After a brief flurry on fuel injection seven or eight years ago, the automobile companies seem to have dropped the ball. Maybe they all are waiting for the government to foot the bill.

Howard E. Etter
Wayland, Mass.

Color TV blur

To the Editor:

In Electronics Newsletter [April 5, p. 17], you stated "If Secam is adopted, the chief beneficiary would be the Compagnie Française de Television (CFT), the French developer of Secam. All companies selling sets in Europe would have to pay royalties to CFT. The Radio Corp. of America and other U.S. companies would also share in the benefits; Secam is basically a variation of NTSC, whose patents are held by U.S. concerns. The Raytheon Co.'s Italian affiliate has an agreement with CFT to develop and produce picture tubes for Secam receivers."

However, the Secam process is not a process derived from the NTSC process; NTSC and Secam are two different applications of an identical principal of general physics. The Secam system is completely independent of the NTSC system. We have examined more than 300 patents and this study has brought us to the conclusion that the constructors of Secam material would not be at all obliged to pay royalties to American companies.

As for the image tube that we are developing, we would like you to know that this is a tube that can be used by all systems, and is not reserved for Secam receivers.

J. P. Doury
Compagnie Française de
Television
Paris

■ An RCA spokesman says that basic color tv patents which should apply to Secam receivers are held by RCA. However, since a final schematic of the Secam receiver is not available, RCA has been un-

able to determine which particular patents would apply.

Receivers demonstrated at the Vienna conference on color tv used shadow-mask tubes. These tubes and their associated circuitry are covered by RCA and Columbia Broadcasting Company patents.

Canadian traffic

To the Editor:

Reading the story on traffic control in New York City [May 17, p. 30], I couldn't help noting differences between that system and the one now in operation in Toronto.

Toronto's is a total system of control, whereas the New York system is piecemeal, dividing control through a hierarchy of master controllers, sub-master controllers, and local controllers. By way of comparison, the Toronto system was designed to control 1,000 intersections and for this purpose is using 2,000 detectors, all of which report back to the central computer. In New York, on the other hand, the system is to control 2,700 intersections on the basis of 2,100 detectors, which operate only locally, and another 1,074 which report back either to the sub-master or the master controllers.

A further point is that the computing capacity of all 19 of the New York master controllers barely matches the capacity of the Toronto central control, with its two-computer combination. The ability of the New York system to draw off traffic analysis and engineering statistics is extremely limited, and the system is barely capable of detailed individual control of a single remote intersection. The signals must, because of the system design, be controlled in prearranged groups.

Also, Toronto's system has the equivalent of four telephone lines per intersection, compared to, on the average, one-half telephone line per intersection in the New York system. It would be impossible, with any form of data transmission system, to get the New York computer control system to match the sensitivity and flexibility of the Toronto system.

Neal A. Irwin
Traffic Research Corp.
New York, N. Y.

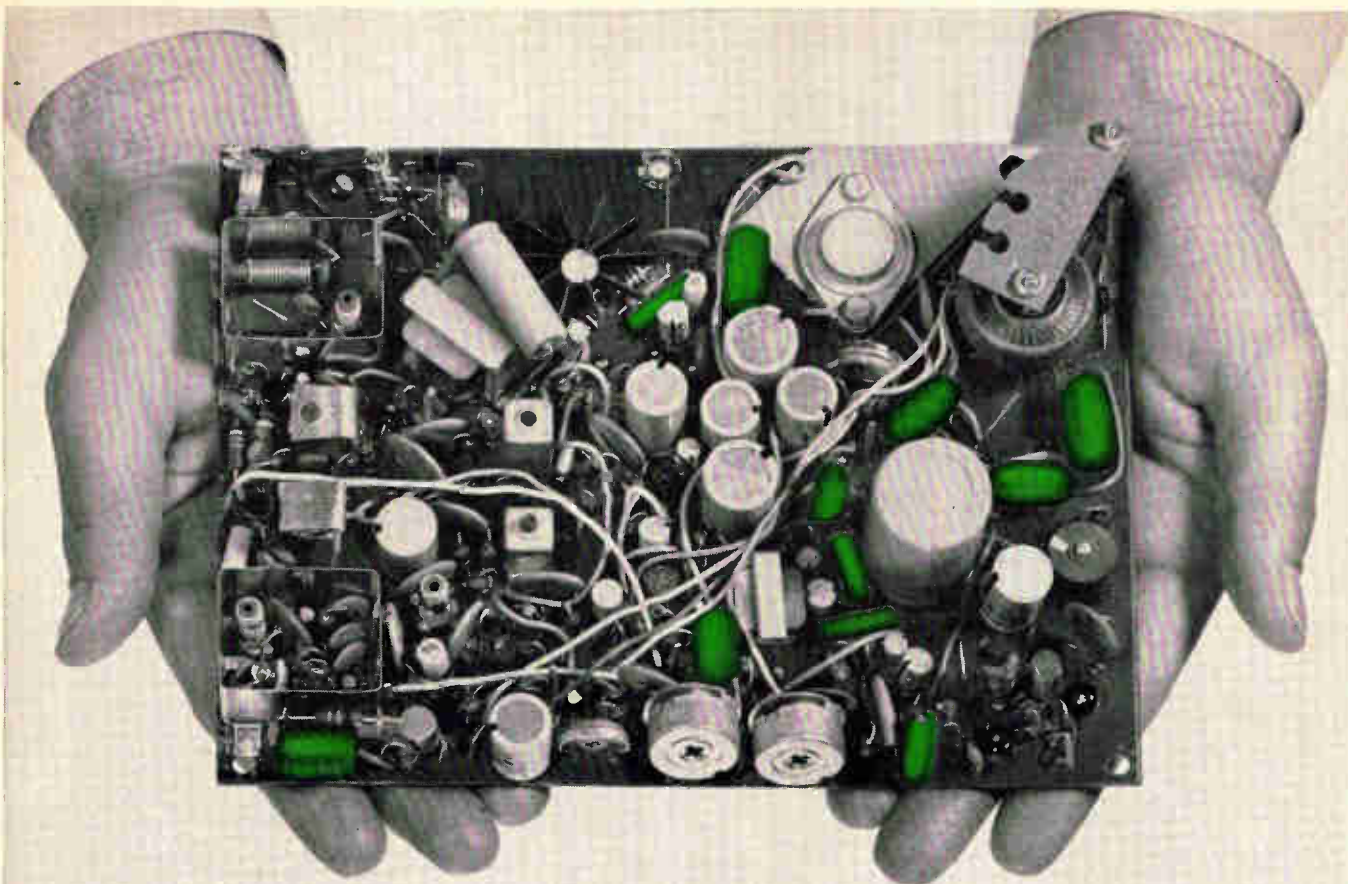

General Electric says size is important, but reliability is more important.

**(Now you know two reasons why G.E.
uses capacitors of Mylar® in its 9" TV.)**

In its "play-anywhere" TV shown above, G.E. uses dipped, molded and wrap-and-fill capacitors of MYLAR*, and also capacitors that are self-cased units where extra wraps of MYLAR provide protection and anchorage for the leads. All are considerably smaller than paper capacitors of equivalent rating.

"But no matter how small they were," says Jim Nease, Component Engineer, "we wouldn't even consider using capacitors of MYLAR if they weren't reliable. Our tests have proven the outstanding reliability of these capacitors. That's the main reason we use them, not only in our 9" set, but throughout our line."

Reliability . . . reduced size. Two big reasons G.E. uses capacitors of MYLAR. But there's a third reason, too. Price. Capacitors of MYLAR cost no more, and often cost less than paper capacitors.

For more information to help you investigate the ways capacitors of MYLAR can help your designs for home entertainment and similar circuits, write Du Pont Co., Room 2797, Wilmington, Delaware 19898. In Canada: Du Pont of Canada, Ltd., P.O. Box 660, Montreal, Quebec.



Better Things for Better Living
... through Chemistry

only DU PONT makes

MYLAR®
POLYESTER FILM

*DU PONT'S REGISTERED TRADEMARK FOR ITS POLYESTER FILM.

Increase Loading Density

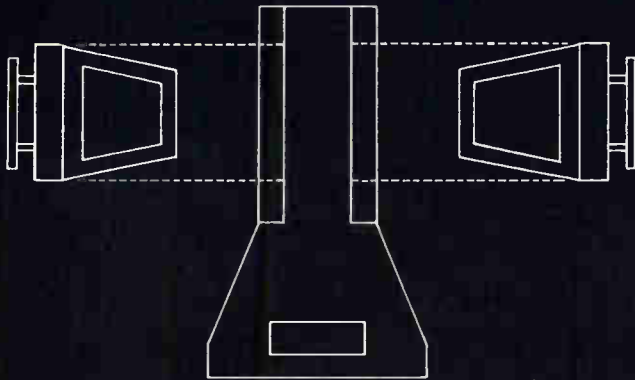

With The New Statham Two-Door Temperature Test Chamber

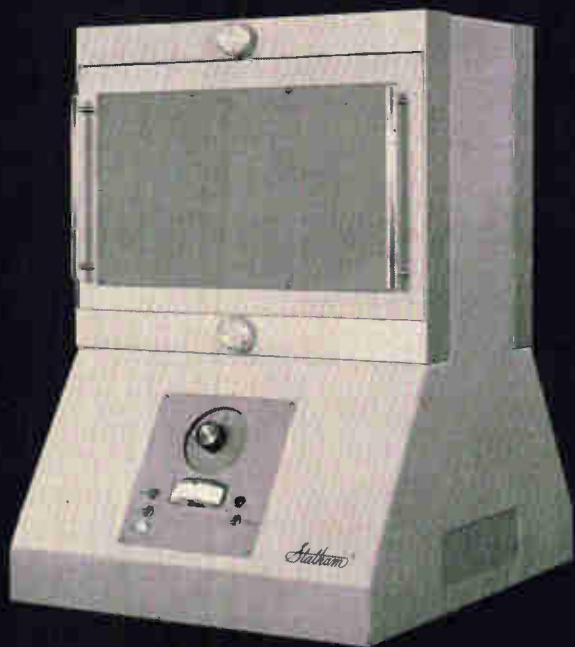

Statham's Model SD24 two-door temperature test chamber provides increased capability for high-density loading of electronic components. Doors are available to accommodate various types of components, including semiconductors, crystals, and micromodules. Each test area measures 12"H x 20"W x 1½"D.

Model SD24 has a temperature range of -100°F to +300°F and features an exceptionally low thermal gradient of ±1.3°F at 300°F. Statham's high-gain, all solid-state controller, controls temperature to within ±0.05°F and meets MIL-I-26-600 RFI requirements. A 24 lineal inch set-point scale and deviation meter provide precise temperature control. Overall dimensions of the Model SD24 are 32"H x 28"W x 24"D.

Optional equipment available includes cycle time controllers, push-button temperature selection, ambient temperature control and a high temperature fail-safe system. For complete specifications write:

Statham Instruments, Inc.



ENVIRONMENTAL PRODUCTS DIVISION

2221 Statham Boulevard, Oxnard, California

People

Donald R. Carley, a 29-year-old Radio Corp. of America physicist, was awarded the company's David Sarnoff outstanding achievement award in engineering last month for developing the overlay transistor. Carley, who works at the company's industrial transistor group in Somerville, N. J., predicts that overlay transistors, currently limited to 10 watts at 400 megacycles or 50 watts at 50 megacycles, will eventually reach the hundreds-of-megacycles level in a few years. And some of the applications, he adds, will probably be in consumer goods, not just industrial equipment.



Carley, who has a B.S. degree in physics from the University of Michigan, says he is studying higher-power, higher-frequency overlay transistors from a slightly different approach and will probably continue the work for years.

When **Eugene G. Fubini** arrives for work next Monday morning at the International Business Machines Corp.'s executive offices at Armonk, N. Y., he will bring with him several years of experience as an assistant secretary of defense, specializing in research and development (Electronics, Oct. 5, 1964, p. 103), and some unusual ideas—unusual, at least, for the engineering community.



One of Fubini's favorite phrases is: "Keep it simple." In his new job, as vice president and director of IBM's research and advanced systems development divisions, Fubini may be repeating that dictum to researchers working in some of the most complex of engineering specialties. "To make things simple," he acknowledges, "takes a lot of ability."

Power Tube Breakthrough Permits Nearly 100 to 1 Grid to Plate Current Division

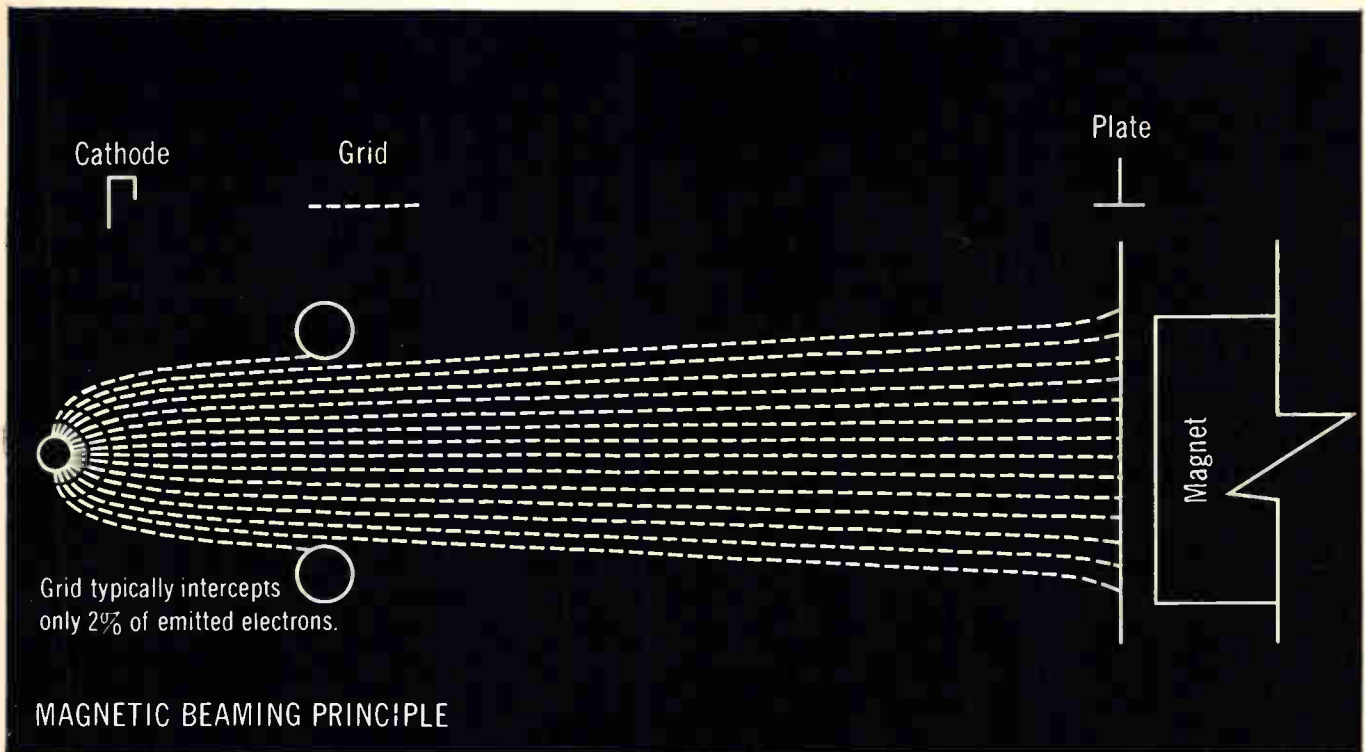

Machlett research has led to a new magnetic beaming principle for use in grided power tubes. This breakthrough in power tube design results in higher power gain, increased tube efficiency, and maximum double-sided cathode utilization. As shown above (in simplified single-sided form), a permanent magnet, placed external to the active tube elements, controls the electron trajectory from cathode to plate so that only a negligible amount of electrons are intercepted by the grid—typically 2% as opposed to 20% in conventional tubes. Grid dissipation is no longer the limiting factor in tube operation. Magnetic beaming is being applied to an expanding line of Machlett triodes and tetrodes. Whether you require high power/high voltage triodes or tetrodes, UHF planar triodes, X-ray tubes or vidicons, or if you need assistance in research or design development, write The Machlett Laboratories, Inc., Springdale, Conn. 06879. An affiliate of Raytheon Company.



ELECTRON TUBE SPECIALIST

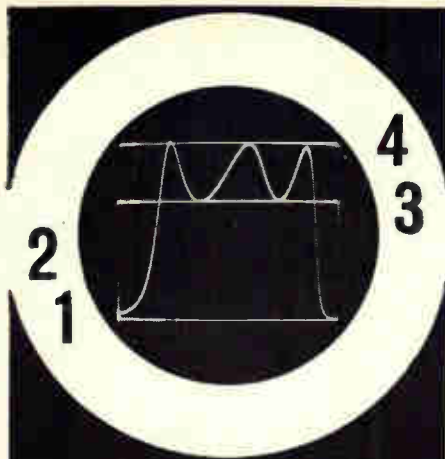

see **4** response
traces on single-
trace scope

measurement by comparison
up to 1,200 mc



NEW
JERROLD
SOLID-STATE
3-POSITION
COAXIAL SWITCHER

Model TC-3 \$295⁰⁰

Turn any single-trace oscilloscope into a 4-trace scope; insert two reference traces automatically in addition to test trace and baseline. These references have advantage of permanent relative accuracy over scribed or painted lines.

Results are repeatable, as accurate as your reference attenuators. Generator and scope drift do not affect accuracy of measurements. Frequency from dc to 1,200 mc extends usefulness of comparison technique well into the UHF band. The TC-3 Coaxial Switcher can save you thousands of dollars in speed and accuracy. Write for literature.



Industrial Products Division,
Philadelphia, Pa. 19132
In Canada: Jerrold Electronics,
60 Wingold Ave., Toronto 19, Ont.
Export: Rocke International,
13 E. 40th St., New York, N.Y. 10016

SWEEP GENERATORS • AMPLIFIERS
PRECISION ATTENUATORS • COMPARATORS

Meetings

Engineers and Scientists Patent Law Concepts Meeting, Polytechnic Institute of Brooklyn and the New York Patent Law Association; Rogers Hall, Polytechnic Institute of Brooklyn, July 12-14.

Nuclear and Space Radiation Effects Conference, G-NS; Univ. of Michigan, Ann Arbor, Mich., July 12-15.

Chemistry and Metallurgy of Semiconductors, Gordon Research Conferences, Univ. of Rhode Island; Proctor Academy, Andover, New Hampshire, July 12-16.

Educational Technology Conference, American Management Association; Americana Hotel, N.Y.C., July 12-16.

Nuclear & Space Radiation Effects Annual Conference, G-NS/IEEE; University of Michigan, Ann Arbor, Mich., July 12-16.

Flight Control Conference and Engineering Display, SAE; International Hotel, Los Angeles, July 13-15.

Data Output and Display Techniques, American Management Association; AMA Headquarters, N.Y.C., July 19-21.

Reliability and Maintainability Conference, AIAA, ASME et al; Statler-Hilton Hotel, Los Angeles, Calif., July 28-30.

Instrumentation Science Research Conference, ISA; William Smith College, Geneva, N. Y., Aug. 2-6.

Technical Instrumentation Symposium, U. S. Air Force Systems Command, SPIE; Jack Tar Hotel, San Francisco, Aug. 16-20.

American Astronautical Society National Meeting, AAS; Sheraton-Palace Hotel, San Francisco, Aug. 18-20.

International Conference on Medical Electronics, Japan Society of Medical Electronics and Biological Engineering; Tokyo, Aug. 22-27.

Electronic Circuit Packaging Symposium, EDN; San Francisco Hilton Hotel, San Francisco, Aug. 23-24.

Computing Machinery National Meeting, ACM; Sheraton-Cleveland Hotel, Cleveland, Aug. 24-26.

Western Electronic Show and Convention (WESCON/65), IEEE, WEMA; Cow Palace, San Francisco, Aug. 24-27.

The '65 Show, Industrial and Trade

Fairs Ltd.; London, England, Aug. 24-Sept. 4.

Systems Engineering for Control System Design Symposium, IFAC; Tokyo, Aug. 25-26.

Radio-Products Fair, Stuttgarter Ausstellungs-GMBH; Stuttgart's Kellesburg, Germany, Aug. 27-Sept. 5.

Antennas and Propagation International Symposium, IEEE; Sheraton Park Hotel, Washington, D.C. Aug. 30-Sept. 1.

Boulder Millimeter Wave and Far Infrared Conference, IEEE et al; Stanley Hotel, Estes Park, Colorado, Aug. 30-Sept. 1.

Opto-Electronic Components and Devices Symposium, AGARD; Paris, Sept. 6-9.

Industrial Electronics and Control Instrumentation International Congress, IEEE; Sheraton Hotel, Philadelphia, Sept. 8-10.

International Inventors and New Products Exhibition, International Institute for Patent Products Limited; New York Coliseum, Sept. 9-12.

Electrical Insulation Conference, IEEE, NEMA; New York Hilton Hotel, New York, Sept. 13-16.

Joint Engineering Management Annual Conference, IEEE/ASME; New York Hilton Hotel, N. Y., Sept. 13-14.

Engineering Materials and Design Conference, Industrial & Trade Fairs Ltd., Olympia, London, Sept. 13-17.

Call for papers

Mid-America Electronics Conference (MAECON), Kansas City Section of IEEE; Hotel Continental, Kansas City, Missouri, Nov. 18-19. **August 5** is deadline for submission of 500-word abstract to Wallace Wiley, Bonzer Inc., 11111 West 59th Terrace, Shawnee, Kansas.

Electromagnetic Sensing Symposium, Univ. of Miami, American Geophysical Union, American Meteorological Society; Univ. of Miami, Coral Gables, Florida, Nov. 22-24. **Sept. 1** is deadline for submission of abstracts to Ralph Zirkind, Polytechnic Institute of Brooklyn, Graduate Center, Farmingdale, N. Y.

All About Items #7, 8, 9 & 10 in the Fluke '65 Pacesetter Line

Per hour, day, or year, new Fluke precision high voltage power supplies hold the line better. Not just working specs either. These Fluke power supplies are built to take at least 20 G's shock. They'll work at 10,000 feet or higher or in a junglelike 80% humidity at 50° C. What's more, the price is right. Check the specs below for data on all four new supplies.

Model	Voltage	Current (ma)	Regulation		Stability		Calibration Accuracy (%)	Max. Ripple (rms)	Resolution	Price
			Line (%)	Load (%)	Per Hr. (%)	Per Day (%)				
412B	0-2,100	0-30	0.001	0.001	0.005	0.02	0.25	500 μ V	5 mv	\$ 410
405B	0-3,100	0-30	0.001	0.001	0.005	0.02	0.25	1 mv	5 mv	\$ 525
408B	0-6,000	0-20	0.001	0.001	0.005	0.02	0.25	1 mv	5 mv	\$ 665
410B	0-10,000	0-10	0.001	0.001	0.005	0.02	0.25	1 mv	5 mv	\$ 975



FLUKE • Box 7428, Seattle, Washington 98133 • Phone (206) 776-1171 • TWX: (910) 449-2850

These charts show the short and long term stabilities of the new Fluke Model 412B Precision High Voltage Supply. Notice that the short term stability is typically $\pm 0.0005\%$ /hour compared to a spec of $\pm 0.005\%$ /hour. Long stability is specified as $\pm 0.02\%$ per day compared to an actual $\pm 0.005\%$ for more than 12 hours for this unit. Fore-ground shows Model 412B. Background shows left to right Model 405B, Model 408B, and Model 410B.



Your New Reference Guide to CEC Oscillographs, Accessories and Support Equipment

This revised guide includes five important additions to CEC's Datagraph® line—the new DataDigit™ Accessory, the significantly improved 5-133 and 5-124 Oscillographs and the 1-165 D-C Amplifier and 3-140 Constant Voltage Supply

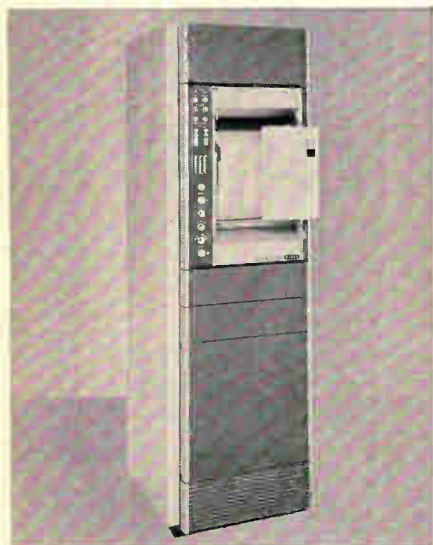

Type 5-133—The most advanced instrument yet perfected, the 5-133 combines high speed, reverse operation and CEC's exclusive DataFlash® in *one universal transport*. Designed to record 12, 24, 36 or 52 channels of data on 12-inch-wide light-sensitive paper, its overall capabilities exceed the most demanding technological requirements. The 5-133's static magnetic lamp power supply provides a start-restart time of *less than a second*, regardless of input voltage variations. Available RFI certified (including the remote control unit), the 5-133 offers such other advantages as: slot-exit capability up to 160 ips; adjustable grid line intensity; record/event numbering selected by front panel switch; automatic record length control, continuously variable from 0 to 150 feet; 12 recording speeds, pushbutton selectable, galvo light intensity controls; and modular construction for maximum convenience and efficiency.



Type 5-119—A truly universal oscillograph, the 5-119 has become a popular, proven performer for laboratory, mobile, airborne and marine use. Both d-c and a-c models are available. The 5-119 accepts all three types of record magazines, DATAFLASH, DATARITE, and conventional, making it possible to utilize every known photographic technique on either the 36- or 50-trace models.

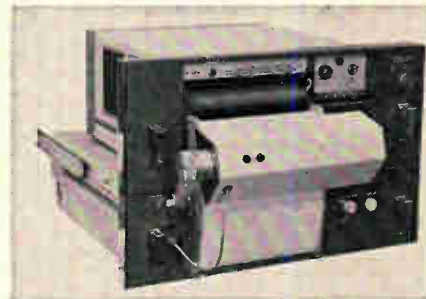

Type 5-124—Shown above with the DataFlash Takeup Accessory which requires only 1 second to readout, the 5-124 has become a new "must" for industry. Portable and easy to operate, this instrument offers big recorder capability in a small-size, low-cost package. The 5-124 provides up to 18-channel print-out recording, 10 speed ranges, and record-drive systems with 16 options from 0.25 ipm to 128 ips.



Type 5-114—Versatile, accurate and rugged, the 5-114 records data of static and transient nature on 18 or 26 channels. 225-foot records on 7-inch-wide paper are produced at speeds from ½ to 115 ips; and the many CEC galvanometers available for use with this instrument permit the recording of dynamic phenomena in the frequency range of d-c to 5000 cps.



Type 5-118—The 5-118 is ideal where minimum size (5.5 in. x 7 in. x 10 in. with magazine) and light weight (13.6 lb with loaded magazine) are required. Standard features include 28 volt d-c operation, 9-channel trace capacity, plus one dynamic reference trace, thermostatically controlled magnet block heaters, and trace interruption. ½ or 1 ips speeds are standard. Special options are available.

DataDigit™— A new Datagraph® Accessory

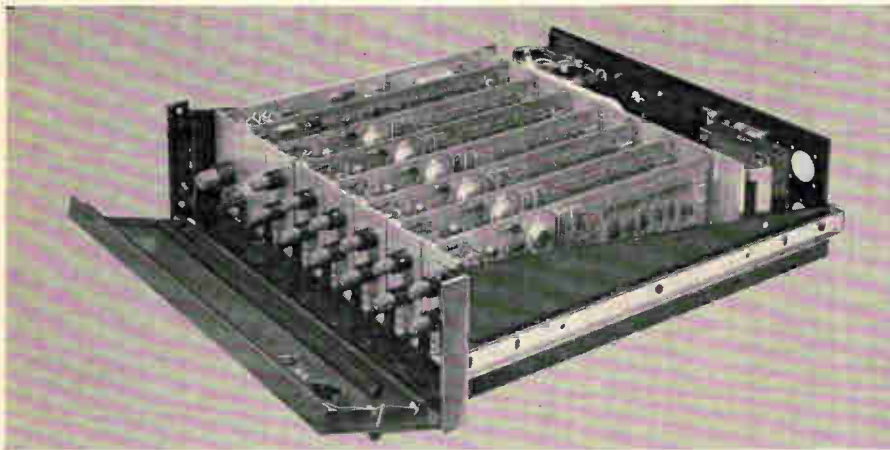

When used with any CEC direct writing oscillograph, the new DataDigit Accessory literally provides a new dimension in data recording. Speed, accuracy and flexibility that were previously unattainable can now be realized even at moderate and slow paper speeds.

The DataDigit is virtually a quantum jump in recording technique, combining the features of the fastest digital printer and an analog light beam oscillograph in *one* instrument. And, being a completely self-contained accessory, this instrument can

be used with existing oscillographs *without modification*.

Fundamentally, this accessory generates the necessary waveforms to print decimal data on standard photographic papers. Up to 26 columns can be printed at speeds to 1600 lines-per-second. So economical is this instrument, it soon pays for itself in paper savings alone.

Compared to the best previous methods, the capabilities of the DataDigit become significant indeed.

SPECIFICATIONS:

Print-Out—0 thru 9 • Input Data Format—10 line decimal • Input Voltages—Select command + 5 v min. to + 70 v max. • Input Impedance—Select command signal 20 k ohm resistive min. • Print Command—rise time 1 μ sec; duration 2 μ sec min.—400 μ sec max.; voltage + 5 v min. to 25 v max.; input impedance 550 pf • Power Requirements—voltage 90—135 v or 180—270 v; frequency 48—420 cps; wattage 120 max. • Physical Characteristics—5¼" H x 19¾" D x 19" W. Mounts in standard EIA rack, slide rackmount available.

	Conventional	DataDigit
Accuracy	1.5% to 2%	0.01% with digital techniques
Frequency Limit	15 kc	1 mc with digital techniques
Channel Separation	Visual	Digital identification
Channel Capability	52	Unlimited
Timing	Paper speed	Digital clock
Data	Continuous	Continuous or multiplexed

Other CEC Accessories, Signal Conditioning and Support Equipment

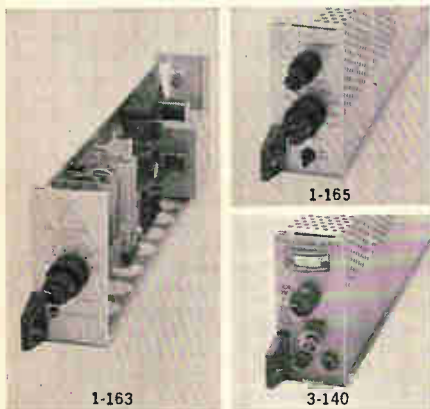

Type 3-140 Constant Voltage Supply—The 3-140 is an excellent d-c excitation source for any input signal device requiring d-c excitation within the range of 1 to 24 volts.



Type 23-109B Oscillogram Processor—The 23-109B is completely self-contained, needing only electric power for operation. The compact, motorized unit develops and dries oscillograms wherever oscillographs are used. Easy to operate and portable, the processor can be used by personnel with no previous photographic laboratory experience.

CEC Technical Supplies—These include all photographic supplies needed to operate CEC DATAGRAPH oscillographs: print-out papers, recording papers and developing solutions.

For complete information on any CEC oscillograph, accessory, signal conditioning or support equipment, call or write CEC Data Recorders Division for Kit #7009-X1.

Type 1-163 D-C Amplifier—single-ended, low-gain, wideband.

Type 1-165 D-C Amplifier—differential, high-gain wideband.

Specifically designed for compatibility with all CEC Series 7-300 Recording Galvanometers, the 1-163 and 1-165 Amplifiers have the output capability (± 10 volts, 100 ma) and a plug-in damping assembly to properly damp and drive all other currently available recording galvanometers.

CEC

CONSOLIDATED ELECTRODYNAMICS

A SUBSIDIARY OF BELL & HOWELL/PASADENA, CALIF. 91109
INTERNATIONAL SUBSIDIARIES: WOKING, SURREY, ENGLAND
AND FRIEDBERG (HESSSEN), W. GERMANY

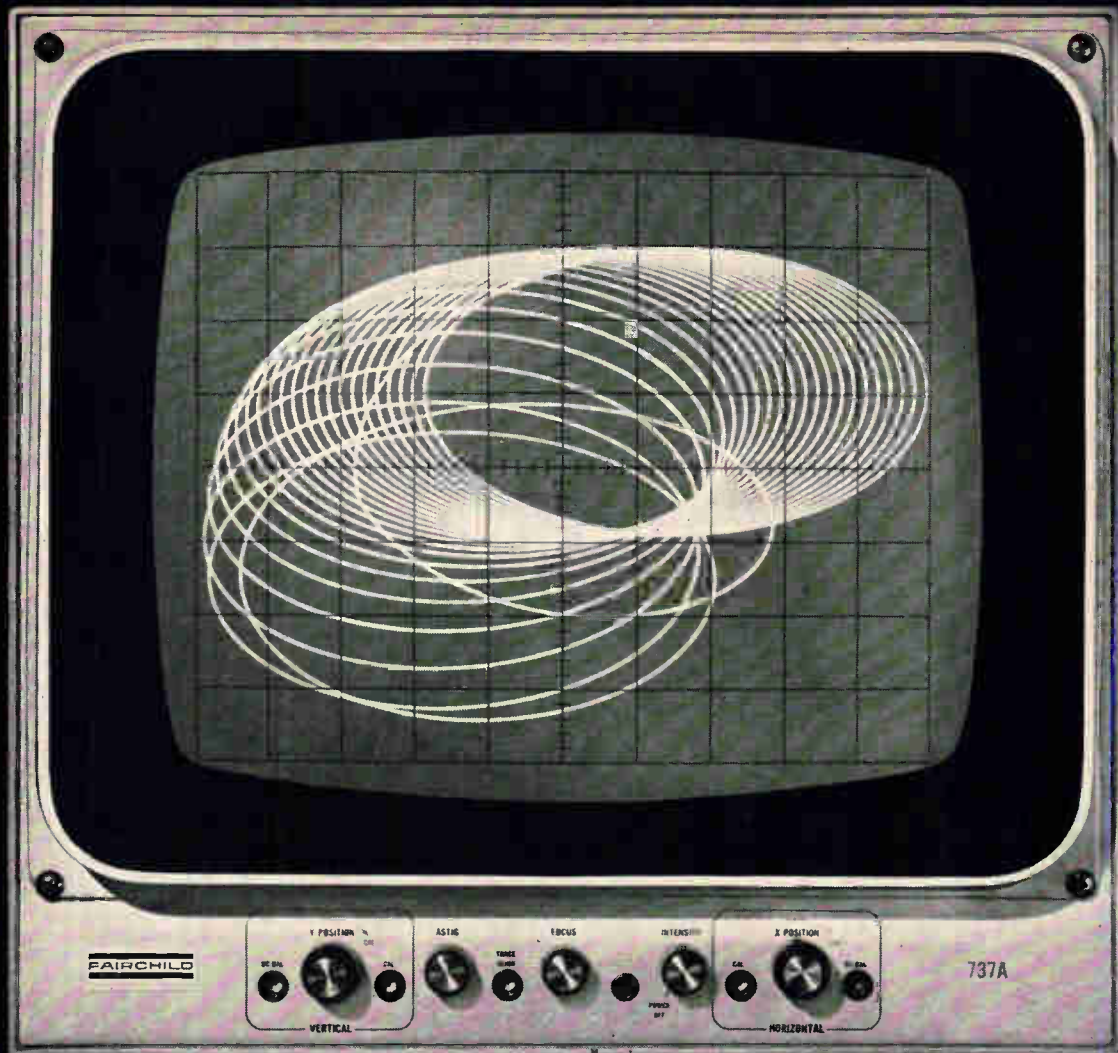

So it writes 273 miles per second—what else does it do?

The Fairchild 737A is the only 17" large screen scope with **one megacycle** real-time bandwidth in X, Y and Z axes. This is 25 times the full screen bandwidth currently available in magnetic indicators of like size. The Fairchild-developed CRT is new and unique. To achieve one megacycle at full screen it writes at 273 miles per second. Electrostatically deflected, it provides this bandwidth with excellent linearity, high resolution and low crosstalk. Sensitivity is 1 v full-screen; accelerating potential is 10 kv for daylight viewing. Display resolution is in excess of 1000 TV lines. The 737A is the ideal large screen scope for real-time, electronically switched displays in the lecture room. It performs as a flicker-free, distortionless plotter for analog computers. The excellent resolution permits easy read-out on production lines and in the laboratory. Internal no-parallax graticules are available to maximize capability of this precision, large-screen scope.

*Technological Obsolescence

Differential inputs with excellent CMR permit the 737A to be easily attached to any scope or display system. Price is \$3,450.00, F.O.B. Clifton, N.J. For complete details on the new 737A Large Screen Indicator, consult your Fairchild Field Engineer or write to Fairchild Instrumentation, 750 Bloomfield Avenue, Clifton, N.J.



Circle 14 on reader service card

FAIRCHILD
INSTRUMENTATION
 A DIVISION OF FAIRCHILD CAMERA
 AND INSTRUMENT CORPORATION

Editorial

Trend to Ph.D's . . .

A subtle change is taking place in engineering curriculum, and it is a change that needs closer examination. The colleges are teaching more and more applied mathematics and physics and less and less engineering in their engineering departments. The result is a graduate who is more scientist than engineer.

Writing in the June issue of the Proceedings of the IEEE, Prof. Nicolaas Bloembergen of the Harvard physics department spelled out the ultimate objective of the change:

"The electrical engineering departments of our major universities and institutes of technology should concentrate on providing a broad-based education for the most gifted, who will assume positions of leadership. Although the store of scientific and technical human knowledge continues to grow exponentially, the time available for education cannot grow in this manner. Some measure of linear growth is possible, and an increasing number of future engineers continue their studies beyond the bachelor degree.

" . . . Our means for communicating the inventory of knowledge must be continually condensed and concentrated. A very powerful way of doing this lies in the mathematical techniques with their almost uncanny ability to describe technical situations. Applied mathematics should, therefore, be taught extensively and early in the curriculum. This will permit more rapid progress in subsequent courses in mechanics, physics, and electrical circuitry. In a similar manner the teaching of basic physics will tie together diverse engineering de-

velopments in semiconductors, gas discharges, magnetic materials, photoelectric devices, dielectric and optical properties."

Professor Bloembergen feels there is no room in the faculty and student body and in the physical plant of our major universities to train engineers, whom he calls "craftsmen." He believes that vocational schools, two-year junior colleges, or technical four-year colleges will have to take over the task—along with that of supplying glassblowers, draftsmen, technicians and chemical analysts.

He sums it up this way: "The Ph.D degree has become the standard terminal for those who aim for leadership in the engineering profession."

There is potential peril in this philosophy.

Our society needs both scientists and engineers. They are not interchangeable. The scientist's role is to explore the fundamental fields of science, to discover new phenomena, to explain why phenomena happen, to relate areas of the physical sciences to one another, and to formulate mathematical expressions to describe physical phenomena. The engineer, on the other hand, strives to find a concrete solution to a practical problem. The purely technical solution has to be leavened by economic, sociological, political and other considerations. The objectives of a scientist and an engineer are different; their attitudes are therefore different.

Professor Bloembergen recognizes this difference, but he feels that the university is no place to present real-life problems. That's the role of industry, he says. But he does not say how industry can neutralize the 6 to 10 years of academic training as a scientist the Ph.D candidate has absorbed or how long it will take before an engineer trained that way can tackle a concrete problem successfully in industry.

Certainly, engineering schools have to change as the technology changes. But to have the engineering schools wipe out the engineering profession would be absurd—as well as catastrophic to our standard of living.

. . . And arrogance

If the arguments against a Ph.D-oriented engineering profession were not strong enough, an incident last month raised another. In a public-be-damned demonstration, a clique of scientists who work for the National Aeronautics and Space Agency decided to withhold any photos of Mars that Mariner IV might radio back (see page 47) until they could publish them in their scientific journals. Only a veto from Washington killed the plan.

Under any circumstances, such an action by scientific employees of the government, whose out-

put the taxpayers ostensibly own, is indefensible. In this case it is doubly so, because the law that established NASA requires the agency to disseminate such information to the public.

The NASA incident was a well-publicized example of behavior that is too common. Scientists tend to restrict their findings to their own journals, and the result is that advances in science or technology are being hidden from the very people who could use it. To some Ph.D's, this kind of publication is more important than any actual contribution they might make to science or engineering.

As long as the Ph.D has this attitude, we do not believe he can serve as a "leader of the engineering profession."

Attn. Servo System Designers:

Look at the Signal to Noise Ratios on these Clifton production-run Resolvers!

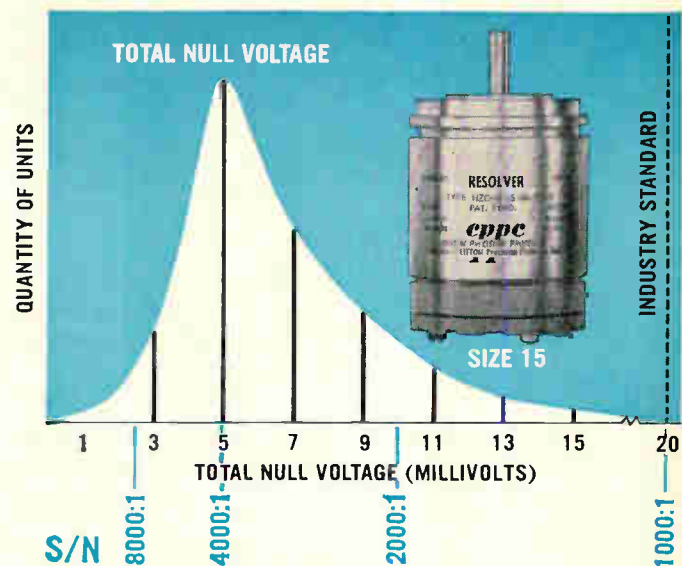
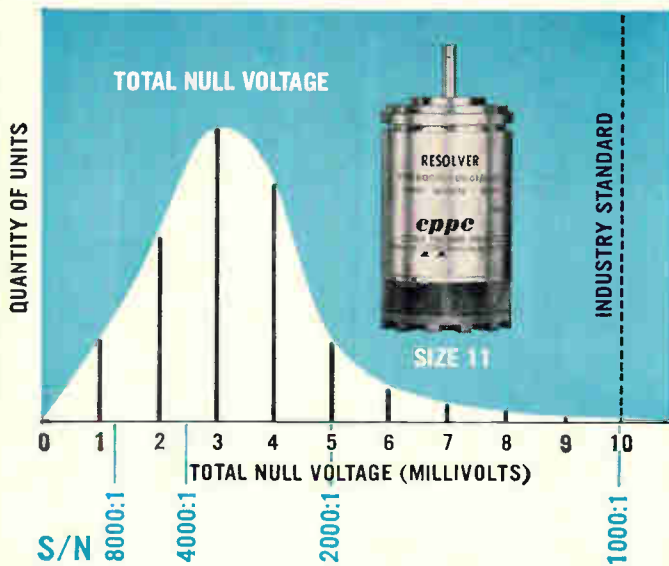

HIGH ACCURACY, TOO!

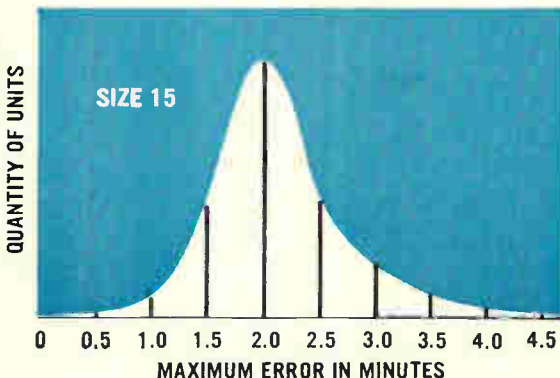
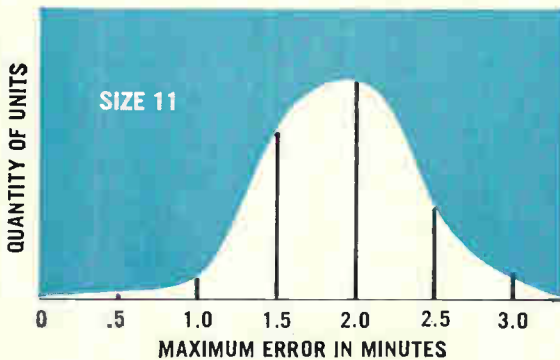

Clifton Precision continues to improve the nulls and accuracy on its Precision Computing Resolvers. A little close study of the curves shows that you are getting far better units than the industry standard and probably considerably better than your spec calls for. For instance, almost half of these production line units are exhibiting Signal to Noise ratios of 4000:1 min. About half of the units show max. errors of 2 minutes or less.

Why be satisfied with less than the best in Precision Computing Resolvers. These units cost no more than competitive units, sometimes less, and they give *better* nulls and accuracy in production quantities.

Clifton Precision Products, Division of Litton Industries, Clifton Heights, Pa., Colorado Springs, Colo.

WHY BE SATISFIED WITH LESS THAN THE BEST ?

cppe **CLIFTON** PRECISION PRODUCTS
DIVISION OF LITTON INDUSTRIES



Electronics Newsletter

July 12, 1965

16-watt c-w laser has 4% efficiency

A continuous-wave gas laser with an output of 16 watts and an efficiency of 4% has been developed at the Bell Telephone Laboratories. Several researchers believe that the laser produces a beam that is both powerful enough and efficient enough to be considered for commercial communications if other components, such as modulators and detectors were available. Although gas lasers with higher output have been developed, none has had an efficiency of more than 0.1% to 0.2%.

The experimental carbon dioxide-nitrogen gas laser, which has a small amount of oxygen added, was developed by Kunar Patel, a Bell physicist, who acknowledges that he doesn't fully understand how the 4% efficiency is achieved. Further research into the lasing mechanism is under way, he says.

Meanwhile, at the University of Paris, researchers are understood to have achieved a laser with an efficiency of 10%, also using carbon dioxide and nitrogen, but its output is only about one watt.

Wider use for scr's in appliances seen

By 1970, half of the consumer electric appliances made in the United States will contain low-cost silicon controlled rectifiers, a General Electric Co. spokesman has predicted.

He spoke on the occasion of the introduction of a 35-cent scr model, the plastic-packaged C106, which is priced at about half that of previously available scr models.

Appliances containing the new, low-priced scr's will start appearing on the market by year's end, the company said; manufacturers are already building prototypes that will contain the devices.

Products that will soon be using the scr's, he said, include food mixers, toasters, sewing machines, table lamps, slide projectors, heating units, electric knives and clothes washers and driers.

The key to the device's low cost is production of the leads in continuous strips of fingers stamped from 40-mil-thick copper sheet. The ends of the fingers are bonded to electrodes on the scr chips, reportedly by placing a foil of gold eutectic solder between the fingertips and the electrodes. In concept, the technique resembles that depicted on the cover of this issue of Electronics.

Big computer, big price tag

The highest price tag for any commercial computer will go on the Burroughs Corp.'s B8500, a huge machine that will be built with integrated circuits. It will cost \$5 million to \$15 million, depending on the lashup ordered by the customer.

Like Burroughs' B5500 and B5000 and their military cousins, the D-825 and D-84 [Electronics, Feb. 8, p. 28], the B8500 is a modular multiprocessor. It can work several programs at once and is expandable. One B8500 can have 16 memories and 16 central processors and input-output control units. Each input-output module can handle a total of 512 peripheral equipments.

The B8500 boasts the first all-thin-film mass memory. Each memory module contains 16,284 words of 52 bits and makes a cycle in 500 nanoseconds. Four words can be read out at once, so that 416 bits can be obtained in a microsecond. A new technique, called associative indexing,

Electronics Newsletter

is used whereby any memory word can be used as an index, Burroughs says.

Thin films are also used for local or scratchpad memory in the processor modules. These cycle at 100 nanoseconds, reportedly the fastest yet for such memories. Each memory has a small buffer area that operates in 35 nanoseconds.

The B8500 is aimed at all three computer markets: military and space, scientific and commercial. It will be built by Burroughs' military computer group in Paoli, Pa. Reflecting the swing to commercial applications, the group's name has been changed to the Defense, Space and Special Systems group.

MIT tests 40-watt IC servoamplifier

The Norden division of the United Aircraft Corp. has built several integrated-circuit servoamplifiers that can handle 40 watts of output power, five times the capability of the device it has just put on the market [see story on page 127]. The present eight-watt circuits can handle more power than any others on the market. The Norden units are for Class A linear differential amplifier applications at frequencies from d-c to 10 kilocycles per second.

The Massachusetts Institute of Technology's Instrumentation Laboratories are currently evaluating the devices for use in Secure Airborne Radar Equipment (Sabre). They'll be available commercially later this year.

Air Force studies digital radio link

A military pilot, or someone in his crew, spends 26 minutes out of every airborne hour on the radio or writing up the records of the conversations. The Air Force Electronic Systems Division at Hanscom Field, Mass., is studying a common global air-ground-air digital communication system, which might reduce this burden by handling recorded messages, automatic position reporting and navigation inputs, and might put print-out equipment in the air as well as on the ground.

The digital technique would save radio bandwidth, and would permit secure communications through cryptography. This type of digital system exists now in bits and pieces, like the Soft Talk program for secret communications with the planes of high government officials, and the Air Force's new weather reporting system [Electronics, Sept. 21, 1964, p. 97].

Transistors invade large-screen tv

Television set manufacturers have been slow to transistorize their large-screen sets, because they weren't sure that the consumer would pay the additional cost. But the Magnavox Co. has committed itself strongly to semiconductors; most of its 1966 black-and-white sets are completely solid state. Says Magnavox's president, Frank Freimann, "Tubes will be out of all tv within three years."

Magnavox believes that the increased cost is offset by improved reliability and performance. It is offering both 19- and 24-inch sets.

Two other producers, the Westinghouse Electric Corp. and Sylvania Electric Products, Inc., will test the market with 19-inch sets. (Sylvania is a subsidiary of the General Telephone and Electronics Corp.) The Philco Corp. has transistorized the tuner and amplifier stages of its color sets and some black-and-white models, but still uses tubes in the high-power, high-voltage deflector circuits.

REWARD

→ **YOUR** ←

**COMPONENT
★ NEEDS ★**

Specify General Electric. We may not offer every rating of every component that's available. But we do come a little closer than any other supplier. For example—tubes, meters, Triacs, capacitors, relays, transistors, diodes, instruments, thermistors, varistors, integrated circuits, SCR's, batteries and reed switches . . . to name a few. General Electric is your Number One Source for a full range of electronic components . . . for circuitry knowledge . . . for continuing innovation. For some of our most recent product and application innovations, turn the page and read on.

GENERAL  **ELECTRIC**

DEPEND ON GENERAL ELECTRIC FOR YOUR WIDEST COMPONENT

THE 150 GRID-SPACE* RELAY

ONLY
0.32 INCH TALL

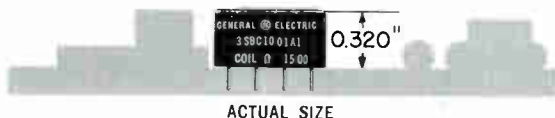

Small in size but large in performance. The 150 Grid-space relay is General Electric's newest space-saving, high-performance sealed relay. Its low profile is only 0.32 inch high, yet this relay utilizes the same type of balanced armature and sturdy suspension system found in the proved GE half-size relay. And an exceptionally efficient magnet design provides high contact force comparable to half-size relays.

FEATURES

- all-welded construction
- radiation hardened
- balanced armature and sturdy suspension system
- high contact force
- 150-mil terminal spacing

Designed for mil spec applications, the 150 Grid-space relay saves space where space really counts for greater circuitboard density. 150-mil pin spacing provides enough room to make terminal connections without crowding . . . assures good dielectric capability. Innovator: Specialty Control Department, Waynesboro, Virginia.

* Trade-mark of General Electric Company.

Circle No. 251

Yes!
GE Nickel cadmium
batteries
are expensive!
But
they cost so much less
in operation than
dry cells!



Why? Because they are rechargeable. GE sealed nickel-cadmium batteries last much longer than dry cells . . . in most applications more than 300 to 1. Capable of many charge/discharge cycles, they give you a much lower per-cycle operating cost.

Why? Because they are sealed. There's absolutely no electrolyte loss with GE nickel-cadmium batteries . . . no damage to your equipment . . . no maintenance required . . . indefinite storage life.

Why? Because most GE nickel-cadmium batteries (all but the button types) feature a special, resealable vent mechanism. This relieves internal pressures safely—pressures that occur under abnormal operation and which would otherwise destroy or substantially shorten battery life.

GE nickel-cadmium batteries may *appear* expensive. But compare their performance over an extended period and you'll find they are your most economical source of portable power. General Electric offers a complete line of cylindrical, button, rectangular and special purpose cells to meet all your battery needs. Innovator: Capacitor Department, Battery Business Section, Gainesville, Florida.

Circle No. 252

CHOICE



**ELECTRONIC
INNOVATIONS**

IN ACTION



NEW GE SCR'S SWITCH POWER AT FREQUENCIES UP TO 25 KC/s



ACTUAL SIZE C140 SCR

Interdynamically balanced to permit very high frequency power switching, GE C140 and C141 SCR's also take advantage of these four concurrent features:

- distributed gates for 400 amps/ μ sec. di/dt
- shorted emitters for 200 volts/ μ sec. dv/dt
- gold diffusion for turn-off times below 10 μ sec.
- contoured junction surfaces for 400-volt blocking voltage stability

GE 25-amp high-frequency SCR's are available in all voltage grades through 400. Outstanding for choppers, inverters, regulated power supplies, cycloconverters, ultrasonic generators, high frequency lighting, sonar transmitters, induction heaters and radio transmitters. Assigned JEDEC registration numbers: 2N3649 through 2N3658. Innovator: Semiconductor Products Department, Auburn, New York.

Circle No. 253

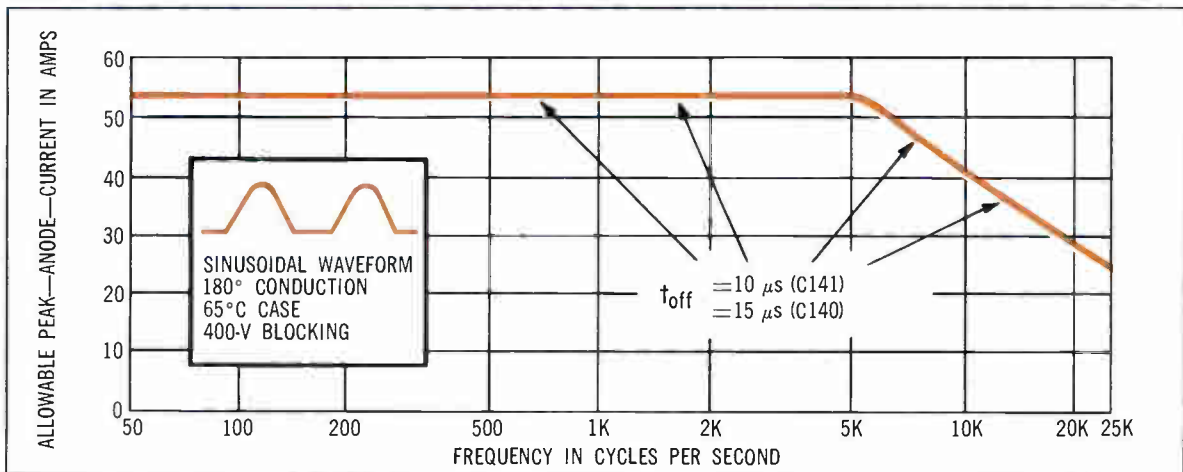

◀ **MORE**

TRF AMPLIFIERS ARE BACK!

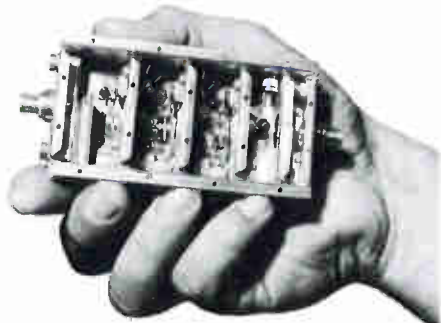

UPDATED BY GE 7077 PLANAR CERAMIC TUBES

Now, reduce size, weight, and cost in IFF-ATC TRF beacon transponders with GE 7077 planar ceramic tubes. The TRF approach eliminates the mixer, local oscillator, and IF strip . . . with resulting savings. Want proof? Write for construction, alignment, and performance details . . . then build one yourself. Innovator: Tube Department, Owensboro, Kentucky.

Circle No. 260

HIGH CURRENT SCR'S

FOR SALE

GE OFFERS BROADEST LINE IN THE INDUSTRY

Choose from the only high-current line that gives you 4 different rating series:

- C145's at 55 amps RMS
- C150's at 110 amps RMS
- C180's at 235 amps RMS
- C290's at 470 amps RMS

Voltage ratings range up to 1300 volts with excellent dv/dt characteristics. High speed types are available. Innovator: Semiconductor Products Dept., Auburn, N. Y.



GE C145 SCR

GE C290 SCR

Circle No. 261

TRY US!

WE'RE OUT TO DO THINGS YOUR WAY

We may not be able to track down all your component needs. But we can come a little closer than any other supplier. You'll get more answers faster if you always call General Electric first when searching for exactly the right components. Ask your local GE engineer/salesman or distributor any time for prices, new component facts, specification details, test samples or application help. For details on any of the innovations announced in this ad, check off the literature you want, at right, and mail this coupon to General Electric.

To: General Electric Company, Section 285-04, Schenectady, New York.

Please send free bulletins on all of the products checked off below to:

NAME _____ TITLE _____

COMPANY _____

CITY _____ STATE _____ ZIP _____

- | | |
|--|--|
| <input type="checkbox"/> 150 Grid-space Relays | <input type="checkbox"/> New Color Sweep Tubes |
| <input type="checkbox"/> C140/C141 SCR's | <input type="checkbox"/> 7077 Planar Ceramic Tubes |
| <input type="checkbox"/> High Current SCR's | <input type="checkbox"/> GE Thermistors |
| <input type="checkbox"/> Triggered Vacuum Gap | <input type="checkbox"/> Economy Line Transistors |
| <input type="checkbox"/> Nickel-Cadmium Batteries | <input type="checkbox"/> Other (Specify) _____ |
| <input type="checkbox"/> Miniature Aluminum Capacitors | |
| <input type="checkbox"/> 100,000,000-operation Reed Switches | |

E

INNOVATIONS IN ACTION

GENERAL ELECTRIC

ELECTRONIC COMPONENTS SALES OPERATION

TRF AMPLIFIERS ARE BACK!

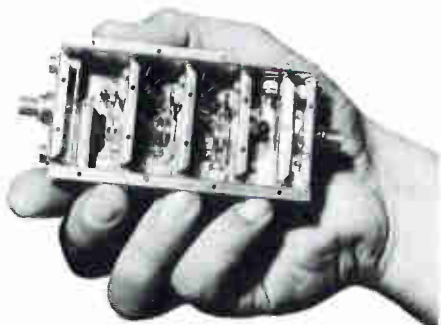

UPDATED BY GE 7077 PLANAR CERAMIC TUBES

Now, reduce size, weight, and cost in IFF-ATC TRF beacon transponders with GE 7077 planar ceramic tubes. The TRF approach eliminates the mixer, local oscillator, and IF strip . . . with resulting savings. Want proof? Write for construction, alignment, and performance details . . . then build one yourself. Innovator: Tube Department, Owensboro, Kentucky.

Circle No. 260

HIGH CURRENT SCR'S

FOR SALE

GE OFFERS BROADEST LINE IN THE INDUSTRY

Choose from the only high-current line that gives you 4 different rating series:

- C145's at 55 amps RMS
- C150's at 110 amps RMS
- C180's at 235 amps RMS
- C290's at 470 amps RMS

Voltage ratings range up to 1300 volts with excellent dv/dt characteristics. High speed types are available. Innovator: Semiconductor Products Dept., Auburn, N. Y.



GE C145 SCR



GE C290 SCR

Circle No. 261

TRY US!

WE'RE OUT TO DO THINGS YOUR WAY

We may not be able to track down all your component needs. But we can come a little closer than any other supplier. You'll get more answers faster if you always call General Electric first when searching for exactly the right components. Ask your local GE engineer/salesman or distributor any time for prices, new component facts, specification details, test samples or application help. For details on any of the innovations announced in this ad, check off the literature you want, at right, and mail this coupon to General Electric.

To: General Electric Company, Section 285-04, Schenectady, New York.

Please send free bulletins on all of the products checked off below to:

NAME _____ TITLE _____

COMPANY _____

CITY _____ STATE _____ ZIP _____

- | | |
|--|--|
| <input type="checkbox"/> 150 Grid-space Relays | <input type="checkbox"/> New Color Sweep Tubes |
| <input type="checkbox"/> C140/C141 SCR's | <input type="checkbox"/> 7077 Planar Ceramic Tubes |
| <input type="checkbox"/> High Current SCR's | <input type="checkbox"/> GE Thermistors |
| <input type="checkbox"/> Triggered Vacuum Gap | <input type="checkbox"/> Economy Line Transistors |
| <input type="checkbox"/> Nickel-Cadmium Batteries | <input type="checkbox"/> Other (Specify) _____ |
| <input type="checkbox"/> Miniature Aluminum Capacitors | |
| <input type="checkbox"/> 100,000,000-operation Reed Switches | |

INNOVATIONS IN ACTION

GENERAL ELECTRIC

ELECTRONIC COMPONENTS SALES OPERATION

CHOICE



ALUMINUM ELECTROLYTIC CAPACITORS

FOR MIL-C-39018

Now you can have a lightweight, extended-temperature-range aluminum electrolytic capacitor that offers you:

- stable capacitance over the operating temperature range.
- full military temperature range (-55C to $+125\text{C}$).
- Up to 30% lower dissipation factor than any other miniature aluminum capacitor.
- lowest weight/V- μf .
- all-welded construction . . . eliminates intermittent contact.
- low leakage current . . . particularly suited for transistorized circuits.
- extended shelf life.

Choose from two types: the 82F and the 83F. The 82F is rated up to 1,000 μf . The larger-case-sized 83F is rated up to 1,200 μf . Voltages up to 250 are available.

Designed specially for the new Mil-C-39018/1/2/3, these new extended-temperature-range miniature aluminum capacitors can be used in a wide variety of aerospace/defense electrolytic applications. Circle the inquiry card number below for more information. Innovator: Capacitor Dept., Irmo, S. C.

Circle No. 254

10⁸ DRY-CIRCUIT OPERATIONS

now possible with both miniature and standard GE reed switches

New contact material in GE reed switches allows 100,000,000 operations under dry-circuit conditions . . . with end-of-life contact resistances of less than 50 milliohms for the standard (2.1" max.) switch, and 60 milliohms for the miniature (.84" max.) switch. Innovator: Tube Department, Owensboro, Kentucky.

Circle No. 255



THERMISTORS?

LOOK TO THE BIGGEST GANG

This bead thermistor—magnified approximately four times—is only one of nine different forms GE can furnish you.

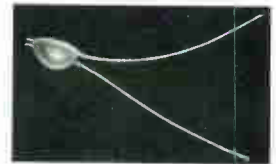

The industry's most complete line of thermistor sensors is available now for immediate delivery. Check the features of all these forms:

1. **H series**—hermetically sealed, rugged, for operation up to 400 C.
2. **Ready-for-use probes**—available in glass, metal and epoxy.
3. **Beads**—miniature, fast responding for operation up to 400 C.
4. **Disks**—Available in a wide range of sizes and ratings.
5. **PTC thermistors**—hermetically sealed in the

inherently more reliable dual heat sink diode package; resistance values from 82 to 470 ohms.

6. **Cubes (square wafer)**—offer extended range of resistances and resistance ratio values, from 1 to 100,000 ohms.

7. **Thermistor assemblies**—custom made to your specifications.

8. **Rods**—Large power capacity and high resistances—up to 1 million ohms.

9. **Washers**—Large power-handling capacity, rated 55 milliwatts/ $^{\circ}\text{C}$.

Which forms interest you? Complete information is available from your GE sales engineer on any or all of General Electric's thermistors and Thyrite® varistors. Innovator: Magnetic Materials Section, Edmore, Michigan.

Circle No. 256

Cut color TV power supply costs **25%**

USE GE'S NEW 6CG3 DAMPING DIODE AND 6KD6 HORIZONTAL OUTPUT TUBE

These new high-performance color sweep tubes eliminate the power-transformer for at least a 25% reduction in power supply costs. Why? Because they operate at only 280 volts vs. 400 volts for other tubes. Innovator: Tube Department, Owensboro, Ky.

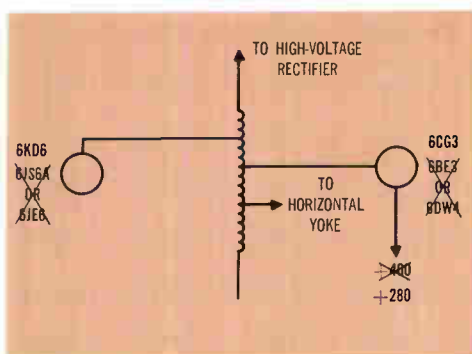

ESSENTIAL CHARACTERISTICS

6KD6		6CG3
Plate voltage	45	
Screen Voltage	160	Tube drop, 25 volts at 700 ma
Plate current	1100 ma	

RATINGS

Peak Positive Plate	7000 volts	Peak Inverse 5000 V.
Plate Dissipation	33W (absolute max.)	DC output current 350 ma
DC Cathode Current	400 ma	

Circle No. 257

PROTECTION PLUS

FOR CRITICAL, HIGH POWER CIRCUITS

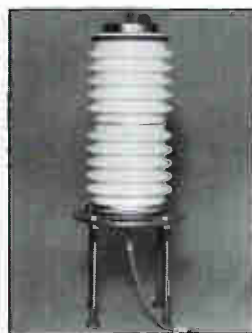

- Fast response
.....0.1 μ sec. delay
- Wide operating voltage range
.....300-v to 45-kv
- Low trigger energy...
.....less than 1 joule
- Fast recovery time...
.....within 10 μ sec.

SPECIFY GE'S NEW ZR-7512 TRIGGERED VACUUM GAP

Get this superior performance and circuit protection with GE Triggered Vacuum Gaps. The vacuum remains a vacuum in these units even after conducting currents of many kilojoules. Superior to gas-filled gaps, new units are under development for handling kilojoules at up to 350 kv, and range down to gaps which will occupy less than 1 cubic inch. Innovator: Tube Department, Schenectady, N. Y.

Circle No. 258

CREATIVE ECONOMY

with GE "Economy Line" transistors

NEW DEVICES AND NEW LOW PRICES

GE's popular "Economy" transistor line continues to grow. New devices available include:

2N3854-56	Designed for use in high frequency amplifiers in AM-FM and TV applications
2N3854A-56A	
2N3843-45	Outstanding in AM, IF, RF and converter sockets
2N3843A-45A	
2N3858-60	Recommended for high frequency applications requiring AGC characteristics
16K1-16K3	

New low prices on some of our "old timers", too! As low as 15¢* each! Get all the price facts . . . specifications, too. Ask us today. Innovator: Semiconductor Products Dept., Syracuse, New York.

*in lots of 100,000 or more.

Circle No. 259

CHOICE

 **ELECTRONIC
INNOVATIONS**

IN ACTION 

NEW GE SCR'S SWITCH POWER AT FREQUENCIES UP TO 25 KC/s



ACTUAL SIZE C140 SCR

Interdynamically balanced to permit very high frequency power switching, GE C140 and C141 SCR's also take advantage of these four concurrent features:

- distributed gates for 400 amps/ μ sec. di/dt
- shorted emitters for 200 volts/ μ sec. dv/dt
- gold diffusion for turn-off times below 10 μ sec.
- contoured junction surfaces for 400-volt blocking voltage stability

GE 25-amp high-frequency SCR's are available in all voltage grades through 400. Outstanding for choppers, inverters, regulated power supplies, cycloconverters, ultrasonic generators, high frequency lighting, sonar transmitters, induction heaters and radio transmitters. Assigned JEDEC registration numbers: 2N3649 through 2N3658. Innovator: Semiconductor Products Department, Auburn, New York.

Circle No. 253

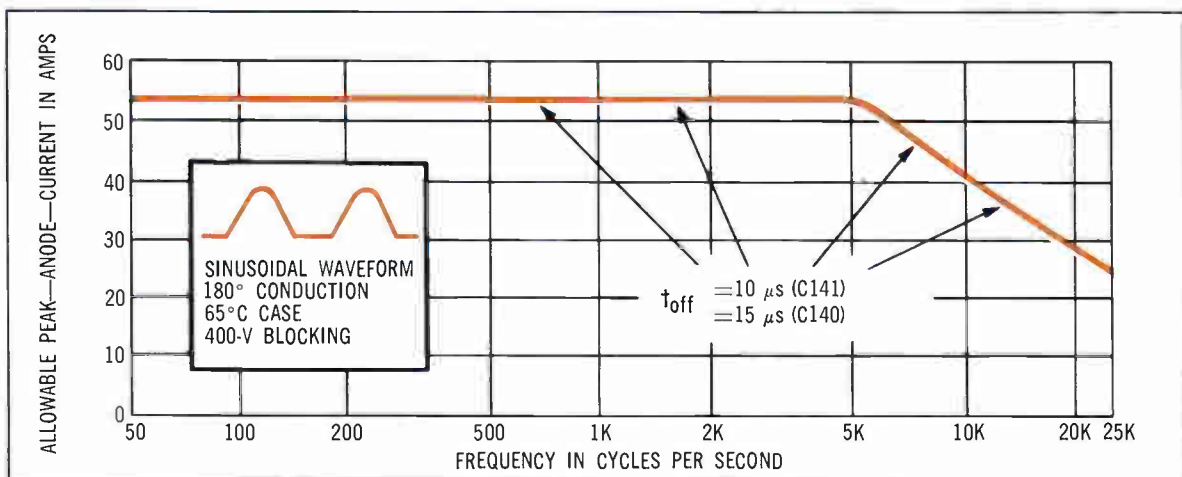

◀ MORE

Now in Production....

Automatic Pincushioning Cores for 90° Color Deflection Systems

"E" CORE

Part No. 50-401

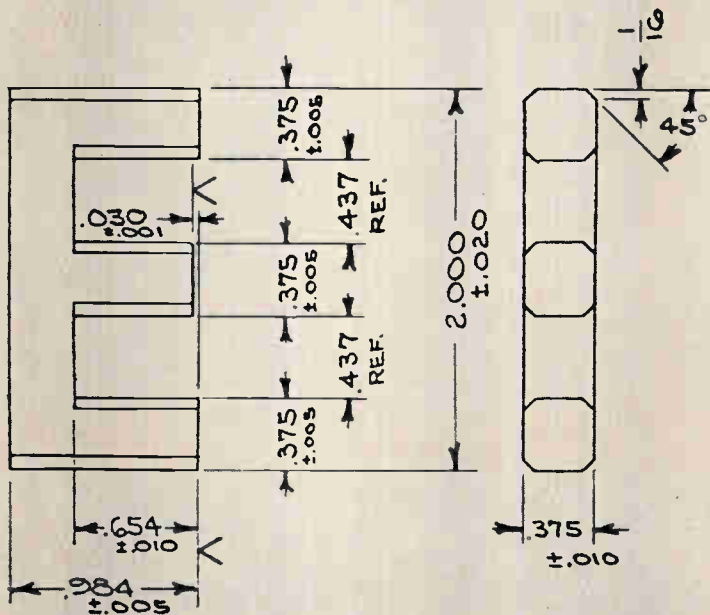

"I" BAR

Part No. 50-402

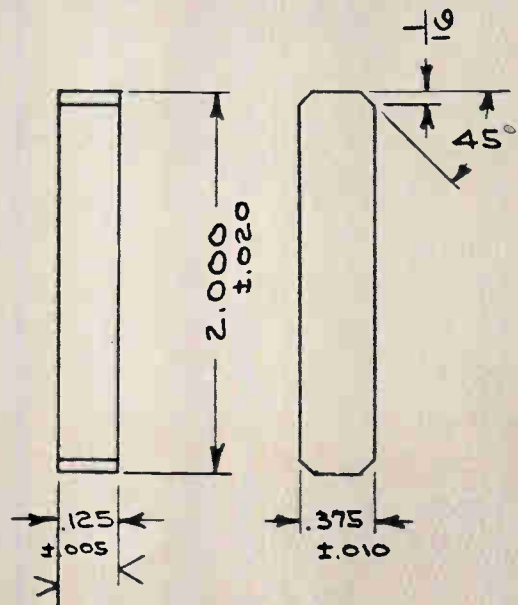

Stackpole, pioneer producer of ferrite parts for the television industry, introduces automatic pincushioning cores for new, wide-angle color television tubes. The "E" core and "I" bar components are made with Ceramag® 24B... the amazing new power ferrite. These highly uniform and fully dependable units are available in production quantities for prompt delivery.

Ceramag® 24B is the proven ferrite material that is presently being used extensively for cores

in color convergence systems and horizontal output transformers. Such high standards of quality and performance have made Stackpole the recognized leader in ferrite development.

If you're looking for high performance automatic pincushioning cores, they are available now... from Stackpole. For sample or additional technical information, write: Stackpole Carbon Company, Electronic Components Division, St. Marys, Pennsylvania. Phone: 814-781-8521 - TWX: 510-693-4511.



STACKPOLE
ELECTRONIC COMPONENTS DIVISION



NRC EQUIPMENT... A WINNING HAND... IN MICROCIRCUITRY

Whether your microcircuit project requires a small bell jar coater for thin film research or complete deposition systems for high volume production, NRC has equipment that does the job. We start at the heart of any vacuum system — **with the pumps**, and build up from there, manufacturing a whole range of coaters, heat sources, feedthroughs, pumping systems, and back-up equipment.

The payoff comes in the performance. NRC evaporators produce the highest net pumping speed **while the process is underway**, not just low pressure in an empty chamber. Net pumping speed in microelectronics can mean net profit for business. This business end of high vacuum is just one advantage in getting an NRC system. For detailed information on our complete line of evaporators and associated equipment for microelectronics, write or call today. Just a few of these products are listed below.

EVAPORATORS • PUMPING STATIONS • POWER SUPPLIES • FEEDTHROUGHS • CRYSTAL PULLERS
TUBULAR FURNACES • ELECTRON BEAM HEAT SOURCES • LEAK DETECTORS



EQUIPMENT DIVISION
NATIONAL RESEARCH CORPORATION
A SUBSIDIARY OF NORTON COMPANY

160 Charlemont Street, Newton, Massachusetts 02161





VISIT

Solve Your Components Problems at Osaka JAPAN ELECTRONICS SHOW '65

Osaka
October
19-25

the basic facts about two Hitachi UHF semiconductors

HITACHI TRANSISTOR 2SC313 FOR UHF OSCILLATOR

HITACHI DIODE 1S750 FOR UHF MIXER

Four Lead - JEDEC TO-18

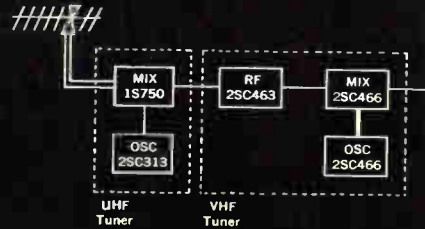

MAXIMUM RATINGS (At 25°C Ambient Temperature)		OUTSTANDING FEATURES
2SC313	V _{CB0}30V	☆ Superior High Frequency Performance $f_T=600$ mc min, $r_{bb'}C_c=25$ psec. max ☆ Large Oscillation Power — $P_{osc}=3$ mW min at 930 mc ☆ Little Frequency Fluctuation — By Power Supply and Ambient Temperature
	V _{CE0}12V	
	V _{BE0}2.0V	
	I _C20mA	
	I _E-20mA	
	P _C200mW	
	T _J200°C	
T _{stg}-55~200°C		
1S750	V _R (peak)-2V	☆ Very Low Reverse Current — $I_R=100$ μA max ☆ Very Low Noise Figure — NF=15 db max at 887 mc
	I _O20mA	
	T _{stg}-55~120°C	

ELECTRICAL CHARACTERISTICS (At 25°C Ambient Temperature)

2SC313				1S750			
I _{CB0}	(V _{CB} =10V)	min — typ — max	0.5 μA	Forward Current (V _F =0.5V)	min 10 — typ 15 max —	mA	
h _{FE}	(V _{CE} =10V, I _C =10mA)	20 40 —		Reverse Current (V _R =-0.5V)	— 20 100	μA	
V _{CE} (sat)	(I _C =20mA, I _B =4mA)	— 0.20 1.0	V	Diode Capacitance (V _d =0, f=50mc)	— 0.7 1.2	pF	
C _{ob}	(V _{CB} =10V, I _E =0, f=1mc)	— 1.2 2.0	pF	Total Noise Figure (f _s =887mc N _{if} =2.8db I _O =2mA R _L =6.3Ω I _{Zif} =155Ω f _{if} =44mc)	— 11 15	db	
f _T	(V _{CE} =10V, I _E =-10mA)	600 900 —	mc			Conversion Loss	— 8 —
r _{bb'} C _c	(V _{CB} =10V, I _C =10mA, f=31.8mc)	— 10 25	μs				
P _{osc}	(V _{CB} =10V, I _C =10mA, f=930mc)	3 8 —	mW				

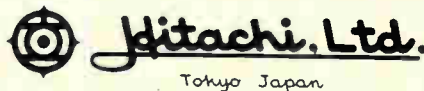

Tokyo Japan

HITACHI SALES CORPORATION: 333, N. Michigan Avenue, Chicago 1, Ill., U.S.A. Tel: 726-4572/4 / 666, 5th Avenue, New York, N.Y. 10019, U.S.A. Tel: 581-8844 / 12715, S. Daphne Avenue, Hawthorne, Calif., U.S.A. Tel: 757-8143
HITACHI, LTD., DUESSELDORF OFFICE: Graf Adolf Strasse 37, Duesseldorf, West Germany Tel: 10846



Solve Your Components Problems at Osaka

VISIT

JAPAN ELECTRONICS SHOW '65

Osaka
October
19-25

10 mW at 120 Gc NEW KLYSTRON
120V10 ADDED TO OKI REFLEX KLYSTRON FAMILY

- Frequency Range: 107-122 Gc. Heater: 6.3 V, 0.7 A
- Resonator: 2500 V, 17 mAdc
- Reflector: -150 Vdc Output Power: 10 mW AVE.

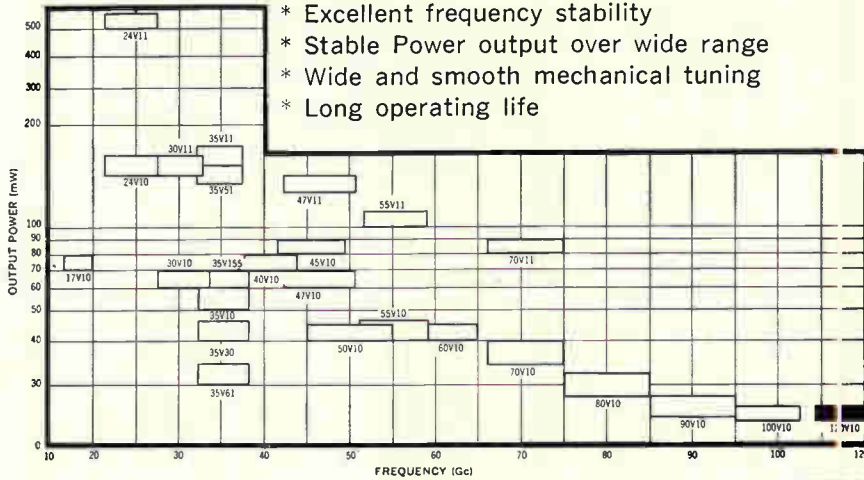

- * Excellent frequency stability
- * Stable Power output over wide range
- * Wide and smooth mechanical tuning
- * Long operating life

OkI Authorized Distributor: **BUTLER ROBERTS ASSOCIATES INC.**

Head Office: 500 S.E. 24th Street, Ft. Lauderdale, Florida
New York Office: 202 East 44th Street, New York 17, New York
West Coast Rep: Frank R. Thomas, P.O. Box 1377, Santa Barbara, Calif.

Tel: Area 305: 523-7202
Tel: Area 212: 682-2989
Tel: Area 805: 962-5917



Circle 203 on reader service card

NCC CAPACITORS

POLYESTER FILM CAPACITORS

Type MXT.

Type MFK.

Type MFL.

METALLIZED POLYESTER FILM CAPACITORS

Type FNX-H

POLYSTYRENE FILM CAPACITORS

Type SFL.

Type SX.

SOLID TANTALUM CAPACITORS

Type TAX.

Type TAS.

MATSUO ELECTRIC CO., LTD.

HEAD OFFICE: 3-chome, Sennari-cho, Toyonaka-shi, Osaka, Japan
Cable Address "NCC MATSUO" OSAKA

NEW PRODUCT Electronic Voltmeter VP-109

I Features:

1. Instant operation from switch-on due to the transistorized design.
2. High input impedance is gained with use of the newest **Field Effect Transistor**.
3. Powered by built-in mercury cells, the use of a power cord is eliminated.
4. This small size and light weight, low cost, convenient like circuit tester can be used wherever you need it due to the built-in battery and one control range switch.

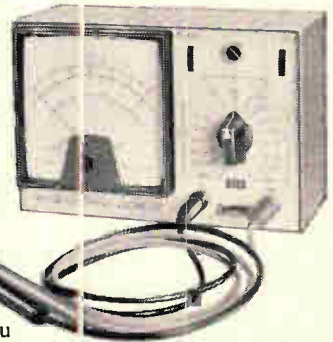

II Specifications:

1. Range
DC and AC Volts. 0-1/3/10/30/100/300/1000 V 7 ranges
DC Resistance. 0-50 k/5 M/500 MΩ 3 ranges
2. Accuracy
DC Volts. ±3% of rated value
AC Volts. ±4% of rated value (on 1000 c/s sine wave)
DC Resistance ±3% of scale length
3. Power supply
5 mercury cells, provided with a **pilot meter** for monitor of battery consumption.

Kuwano Kuwano Electrical Instrument Co., Ltd.
No 890, Mizonokuchi, Kawasaki-shi, Japan



Solve Your Components Problems at Osaka

VISIT

JAPAN ELECTRONICS SHOW '65

Osaka
October
19-25

MITSUBISHI MICROWAVE ANTENNAS FOR TELECOMMUNICATIONS

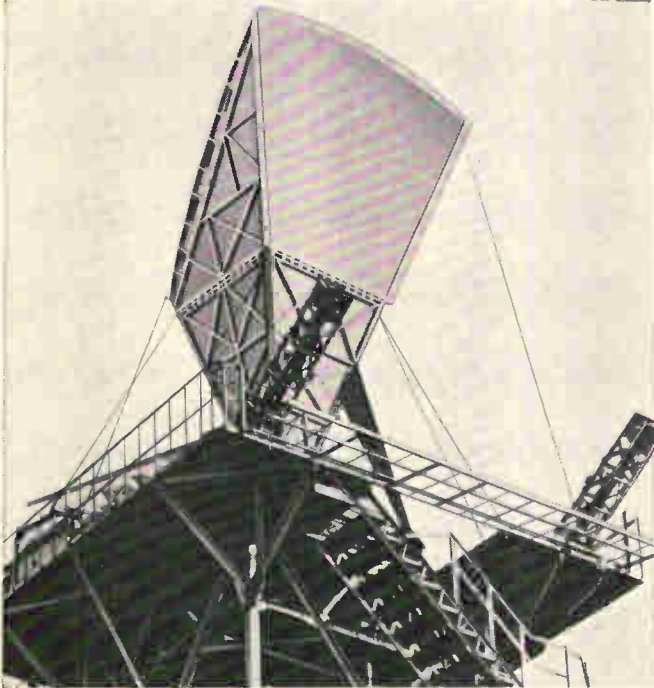

Japan today has the second largest microwave network in the world. Mitsubishi Electric, with the longest Microwave antenna experience in Japan, has supplied 90% of the antennas used in the trunk lines of this extensive network. Mitsubishi antenna systems include parabolic, scatter, horn reflector and radar types, as well as a complete line of wave guide components and accessories. Frequencies from 900 Mc. to 24 KMc. are covered. The horn reflector antenna MA 6040HR, shown above and specified below, is typical of the outstanding performance of Mitsubishi microwave antennas. Full technical information on any of these types of antennas is available at your request.

Horn Reflector Antenna MA 6040HR

Frequency Range : 3,600 - 4,200Mc and 5,925 - 6,425Mc
Polarization : Vertical and Horizontal Plane
Gain over Isotropic Radiator : 41.2dB (H) 3,900Mc
41.5dB (V) "
45.0dB (H) 6,100Mc
44.9dB (V) "
Cross Polarization Discrimination : 65dB minimum
Front to Back Ratio (over 90 degrees) : 65dB minimum
Guaranteed Wind Speed : 215Kmph (134 mph)
Net Weight : 2,000kg. (approx.)
VSWR : V 1.02 H 1.01 at 4,000Mc band
V 1.02 H 1.02 at 6,000Mc band
Waveguide and Fittings : 69mm I.D. Circular Waveguide



MITSUBISHI ELECTRIC CORPORATION
Head Office: Mitsubishi Denki Bldg., Marunouchi, Tokyo. Cable Address: MELCO TOKYO

Circle 205 on reader service card



Micro Resonant Reed Selector

FUJITSU micro resonant reed selector of the single-reed plug-in type, composed of a composite tuning-fork type vibrator, driving system, contacts, and their supporting structures. Possessing a high degree of sensitivity and stability, it serves all phases of usages as the conventional reed selector in diverse types of tele-controlling and mobile radio systems.

Frequency: 50 channels in 15 c/s spacing in the frequency range of 472.5 c/s ~ 1207.5 c/s
□ Coil impedance: 280 ohms $\angle 35^\circ \pm 15\%$ at 1000 c/s, 20°C □ Standard driving current I_a : 2.5 ma □ Selectivity: Inoperative at a current of less than 7 ma in a frequency range deviating more than ± 15 c/s from the nominal frequency f □ Band width: Class A: $f \pm 1.5$ c/s min at standard driving current. Class B: $f \pm 1.3$ c/s min at standard driving current □ Temperature range: Class A: $-10 \sim 50^\circ\text{C}$. Class B: $0 \sim 40^\circ\text{C}$ □ Contact ratio: 2% min at f and 2.4 ma □ Life: Over 100,000 operations when driving current is turned on for 1 second and turned off for 2 seconds in an ordinary circuit □ Insulation and dielectric withstanding voltage: 10 megohms min at dc 100V, dc 100V 1 minute at 20°C . 80%

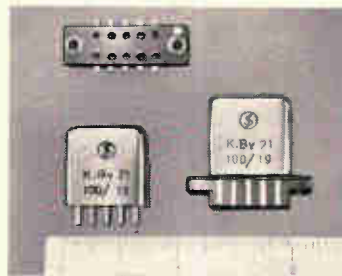

Polar Relay Type 21

Fujitsu Polar Relay Type 21 is a hermetically sealed, highly sensitive subminiature polar relay with high speed and long service life. The size of this Type 21 is only 1/10th as large as the conventional polar relays. It has extremely efficient magnetic circuits, high stability against external magnetic

fields and unique chatter-free contact mechanism. This polar relay is widely applicable to small size, lightweight communication equipment and control equipment for carrier telephony, telegraphy, data transmission in telemetry, automatic control and data processing.

Subminiature Type: 3cm² High Sensitivity: 0.7 mw Long Life: 100 million operations High Speed: 1.5 ms



FUJITSU LIMITED

Communications and Electronics

Marunouchi, Chiyoda-ku, Tokyo, Japan

Circle 29 on reader service card

29



Solve Your Components Problems at Osaka

VISIT

JAPAN ELECTRONICS SHOW '65

Osaka
October
19-25

CONSTANT VOLTAGE TRANSFORMER

Built-in Component Type

- * Completely automatic and continuous regulation within $\pm 1\%$ for input voltage fluctuation up to $\pm 15\%$
- * Regulated AC supply for semiconductor, filament, high voltage for rectifier tube, relay etc.
- * Compact, light weight and the most economical
- * Specialized in quantity production of built-in component type to your specifications. Write for new Bulletin



YEC

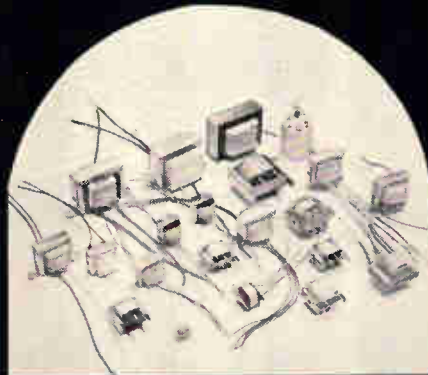

Specialist in

CUSTOM-BUILT TRANSFORMERS

TO YOUR SPECIFICATIONS

YUTAKA ELECTRIC invites you to submit your detailed specifications and quantity information to our engineering and production staff.

YUTAKA ELECTRIC MFG. CO., LTD.

1253, 1-chome, Yutaka-cho, Shinagawa-ku, Tokyo, Japan
Cable Address: "EDOYUTACO" Tokyo

MITSUMI COMPONENTS



NEW PRECISION POLYVARICON

Model PVC-LX20T Polyvaricon is AM two gang miniature-sized Polyethylene Variable Capacitor which has a capacity tolerance $\pm (1pF + 1\%)$. Maximum variable capacity is 140pF ANT., 82pF OSC. "Q" characteristics is over 500 at 10Mc 50pF. Trimmer capacity is over 8pF. The Dimension being 20mm \times 20mm \times 13mm.

Main Products

Polyvaricon · IFT · Oscillator coil · Antenna coil · Composite coil · Special coil · Micro motor · Synchronous motor · Variable resistor · Trimming potentiometer · FM tuner · TV tuner · Various sockets · CdS photoconductive cell.



MITSUMI ELECTRIC CO., LTD.

New York office: 11 Broadway, New York, N.Y. 10004, U.S.A. Phone: HA-5-3085, 3086
Main office: 1056, Koadachi, Komae-machi, Kitatama-gun, Tokyo, Japan. Phone: Tokyo 415-6211/23

Circle 206 on reader service card

SHIZUKI CAPACITORS

Injection Polypropylene Resin Molded Metallized Lacquer Film Capacitors

(-30°C $+85^{\circ}\text{C}$)

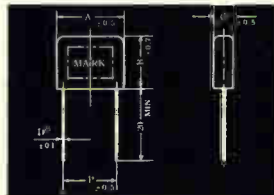

50 volts D.C. Working unit: mm

TYPE	CAP	A	B	C	D	P
PML-0.47/50	*0.47 μF	14.0	14.0	5.0	0.6	10.0
PML-0.5/50	0.5 μF	14.0	14.0	5.0	0.6	10.0
PML-0.68/50	*0.68 μF	19.5	16.0	5.5	0.6	15.0
PML-1.0/50	*1.0 μF	19.5	16.0	5.5	0.6	15.0
PML-1.5/50	*1.5 μF	24.0	19.0	6.5	0.7	19.0
PML-2.0/50	2.0 μF	24.0	19.0	6.5	0.7	19.0
PML-2.2/50	*2.2 μF	24.0	19.0	6.5	0.7	19.0
PML-3.3/50	*3.3 μF	30.0	20.0	7.0	0.7	25.0
PML-6.8/50	*6.8 μF	31.0	23.0	10.0	0.8	25.0

* STANDARD



- ◇ Lacquer Film Capacitors
- ◇ Polyester Film Capacitors
- ◇ Metallized Paper Capacitors
- ◇ Noise Suppression Capacitors
- ◇ Ignition Capacitors
- ◇ Miniature Electrolytic Capacitors

SHIZUKI ELECTRICAL MFG. CO., LTD.

HEAD OFFICE: 1, TAISHA-CHO, NISHINOMIYA, JAPAN
CABLE ADDRESS: "CAPACITOR" NISHINOMIYA
TOKYO FACTORY: 10-7, ARAIYUKU, OTA-KU, TOKYO

TRANSISTORIZED FIELD INTENSITY METER



RF unit

Indicator unit

Most convenient portable measuring equipment.

TRANSISTORIZED ULTRASONIC CLEANER



Ultrasonic cleaning tank

Oscillator unit

Quick, easy cleaning without causing any damage.

SHIMADA PHYSICAL & CHEMICAL INDUSTRIAL CO., LTD.

415 Shibusaki-cho, Chofu City, Tokyo
Tel: (042482) 4101-9





Solve Your Components Problems at Osaka

JAPAN ELECTRONICS SHOW '65

Osaka
October
19-25

VISIT



REGULATED DC POWER SUPPLIES

- Regulation: 0.01% or 20 mV (line or load)
- Ripple: 3 mV p-p

MODEL	VOLTS	AMPS
541A	1-35V	0.25A
543	1-35V	0.5A
531	0-35V	1A
535	0-35V	5A

Model 521A
1-18V DC, 0.5A

Metronix Corp.

76, Chofuchidoricho, Ota-ku, Tokyo, Japan

Circle 209 on reader service card

DX TV ANTENNAS ARE RENOWNED THROUGHOUT THE WORLD!!

BUSINESS ACTIVITIES
 Manufacture of DX Television Antennas.
 Sales of DX Television Antenna's Accessories.
 Sales of DX Twin Lead Wires & Cables.
 Sales of Various apparatus for TV Community Reception.

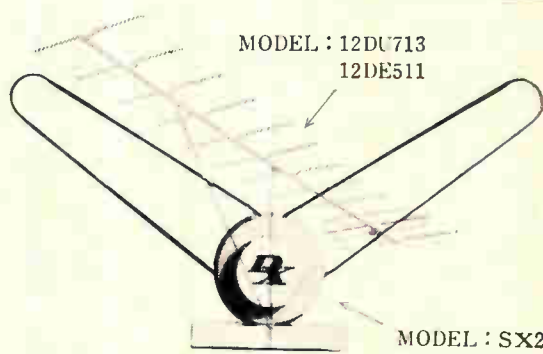

MANUFACTURERS, EXPORTERS
KANSAI TELEVI KOGYO CO., LTD.
 No. 6, Irie-dori 5-chome, Hyogo-ku, Kobe, Japan.

Circle 210 on reader service card

TAMURA'S COUNTERS

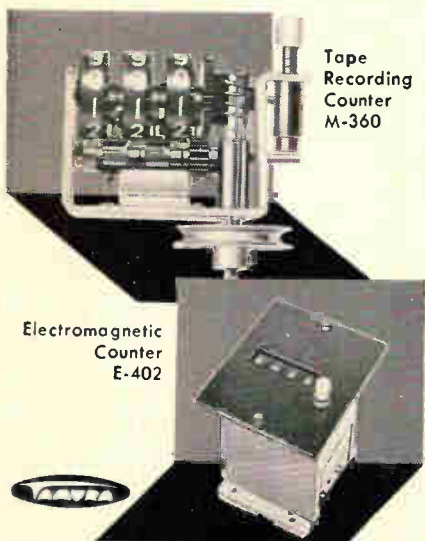

Tape Recording Counter M-360

Electromagnetic Counter E-402

Tamura Electric Works Ltd.

364, Shimomeguro-2, Meguro-ku, Tokyo, Japan
 Cable Address: TAMURAELEC TOKYO
 Tel: Tokyo (491) 7101

Circle 211 on reader service card

"VISIGRAPH"

(Direct-recording Oscillograph)
TYPE FR-102

- Direct-recording of Sharp and Contrasted Traces
- 12 Traces on 6-inch Wide Paper
- Grid Lines Available
- Equipped with Channel Identifier
- Timing Lines Cover Full Width of Paper
- Operated by Unskilled Personnel
- Installed with High Performance Galvanometer



Main Products

"VISIGRAPH"
 (Direct-recording Oscillograph)
 Ink-writing Oscillograph
 Galvanograph
 DC Amplifier
 Dynamic Strain Amplifier
 Oscilloscope Continuous Recorder

Electroencephalograph
 EEG Frequency Analyzer
 Electromyograph
 Polygraph
 "Bedmonitor"
 "Heartscope"
 "Pulsemeter"

For further information, please write to:



SAN'EI INSTRUMENT CO., LTD.

Specialist in the field of oscillography
 1-95 Kashiwagi, Shinjuku-ku, Tokyo, Japan
 Cable: "SANEIINSTRUMENT" Tokyo

Circle 31 on reader service card



Solve Your Components Problems at Osaka

VISIT

JAPAN ELECTRONICS SHOW '65

Osaka
October
19-25

Champion of Small size High reliable relay



MQ Relay

Voltage: 6, 12, 24, 48, 100 VDC

Required Minimum Power: 0.05 Watt DPSTNO contact

0.25Watt 4PDT contact

Contact Combination: DPDT, 4PDT.....etc.

Contact Current Rating: 0.7Amp. at 100VDC, resistive load.

Operating Time Operate: approx. 6mS Power: 0.96 Watt,

Contact: 4PDT

Release: approx. 2mS Power: 0.96 Watt,

Contact: 4PDT

Takamisawa Electric Co., Ltd. is one of the leading manufactories base in Japan, and have been making many different kinds of relay to the requirements.

Also, Takamisawa exports its distinguished products to world-wide markets.

For further information and free brochures please write to the Ad Dept of the company.



**TAKAMISAWA
ELECTRIC CO., LTD.**
515 NISHI-OSAKI 3-CHOME,
SHINAGAWA-KU TOKYO, JAPAN

Kyocera

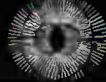

New Ceramic Products from:

Alumina	Forsterite	Zircon
Beryllia	Steatite	Cordierite
Magnesia	Mullite	Multiform Glass

for Better Performance

For further information, please contact

MARUBENI-IIDA(America)Inc.

Los Angeles Branch 530 West Sixth Street

Los Angeles 14, Calif. MADison 8-6271

KYOTO CERAMIC CO., LTD.

11, Haramachi, Nishinokyo, Nakagyo-ku, Kyoto, Japan.



Circle 212 on reader service card

Reprint order form

Send to: Electronics Reprint Dept.
330 West 42nd Street
New York, N. Y. 10036

For listing of reprints available see the reader service card.

To help expedite mailing of your reprints please send cash, check or money order with your order.

For reprints of the latest special report:

Unijunction Transistors

Send me _____ reprints of key no R-74 at 50¢ each.

For reprints of previous special reports fill in below:

Send me _____ reprints of key no.(s) _____ at _____ ¢ each.

For prices see the reader service card.

Name _____

Number & Street _____

City, State _____

Zip code _____

Your name goes here

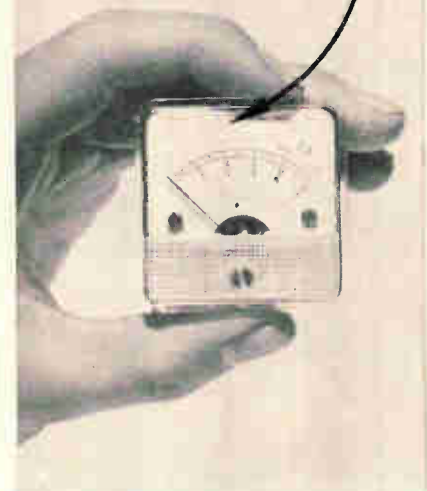

The names of thirty-nine firms from New York to Johannesburg appear on Kyoritsu Electric's clear plastic panel meters. ☺

Kyoritsu of Japan manufactures quality electrical instruments to order exclusively for export. Kyoritsu guarantees prompt delivery at reasonable, competitive prices.

Available in popular DC and AC panel meter styles, sizes and rating ... clear plastic, black bakelite, long scale, or edgewise. Volts, amps, microamps, milliamps.

For our illustrated general catalog write to:



Kyoritsu

KYORITSU ELECTRICAL INSTRUMENTS WORKS, LTD.
5-22, 2-chome, Nakane, Meguro-ku, Tokyo

Our only problem

is to reach every engineer who would like to enjoy the blessings of truly quantitative and precise spectrum analysis at VLF (10 cps—30 KC) with the news that now there's a low-cost, state-of-the-art, modular **Polarad** Low Frequency Spectrum Analyzer with 7 cps resolution. The Model 2736 sells itself.

HERE'S WHY: ■ **Modular Expandability** (to SSB, and through microwave) ■ **Automatically-Optimized Resolution** (down to 7 cps!)

- **Accurately Calibrated Dispersions** (150 cps to 30 KC)
- **Calibrated Log/Lin/Power Display** (on 5 1/2" x 4 1/2" rectangular CRT)
- **Built-in Mixer** (extends range to over 100 MC with external L.O.)
- **Implements Ultra-High Resolution Microwave Spectrum Analysis** (just add PEI modular phase-locked local oscillator source for one-part-in-10⁸ resolution up to 21 GC operation!)

model 2736				
Model	Freq. Range	Resolution	Dispersion	Sensitivity (S+N=2N)
2736	10 cps to 30 KC	Automatic optimized 7 cps min.	150 cps to 30 KC	1 μ Volt

NOW there are **PEI** Spectrum Analyzers from 10 cps to 100,000,000,000 cps—All with **Polarad Years-Ahead Engineering Distinction** . . . All in Full Production. Call your Local Polarad Sales Engineer or call us directly at (212) EX 2-4500 for a demo or a quote.



World Leader in
Microwave
Instrumentation

POLARAD ELECTRONIC INSTRUMENTS

A Division of Polarad Electronics Corporation
34-02 QUEENS BOULEVARD
LONG ISLAND CITY, NEW YORK 11101



GRADUATE ELECTRICAL/ELECTRONIC ENGINEERS — BS, MS, PHD —
ARE NEEDED FOR PERMANENT ASSIGNMENT IN

SYSTEMS TECHNOLOGY

INFORMATION TECHNOLOGY — Radar, Displays

ELECTRICAL AND ELECTRONIC SYSTEMS — ECM, Reliability

STABILITY, GUIDANCE AND CONTROL — Guidance and Control,
Digital Computers, Flight Controls

SYSTEMS LABORATORY — Circuit Design, Microelectronics, Flight Test
Instrumentation, Mechanical Design

**OTHER POSITIONS ARE AVAILABLE ALSO FOR QUALIFIED,
EXPERIENCED, GRADUATE ENGINEERS AND SCIENTISTS**

In systems technology, capable, qualified engineers and scientists are needed for assignment to research and development projects involving space vehicles and systems, and other programs — including the F-111 Tactical Fighter. The opportunity for advancement is immediate and continuing. We urge you to investigate the chance to exercise your ability with a professional group that is backed by the very finest facilities. Write to Mr. J. B. Ellis, Industrial Relations Administrator-Engineering, P.O. Box 748-T, Fort Worth, Texas. An equal opportunity employer.

GENERAL DYNAMICS FORT WORTH

FORT WORTH, TEXAS

1000-0000	0	81	8H	S5	400	Cap-P	12BD6	12.6	4319-5672	10	58	3H	50
7200-0000	0	80	8H	S6	100	Cap-P	12BE3	12.6	1000-4070	0	58	3H	50
7100-2360	22	—	X2	S5	300	Cap. Int.	112BE6	12.0	4370-5621	0	—	X2	—
7100-5460	22	32	8H	S7	400	Diode	12BE5	12.6	4370-5621	0	—	X10	55
7200-3000	0	87	—	S5	—	Diode	12BE5	12.6	4370-5621	0	—	X10	55
4300-8000	0	—	—	S5	—	Diode	12BE5	12.6	4370-5621	0	—	X10	55
4320-3000	0	—	—	S5	—	Diode	12BE5	12.6	4370-5621	0	—	X10	55
7104-3500	35	—	X2	S5	425	Diode	12BE5	12.6	4370-5621	0	—	X10	55
7200-5000	39	—	X4	S5	700	Diode	12BE5	12.6	4370-5621	0	—	X4	55
7200-5020	24	—	X20	S5	675	Diode	12BE5	12.6	4370-5621	0	—	X4	55
7200-0000	12	—	X10	S5	—	Diode	12BE5	12.6	4370-5621	0	—	X10	55
4130-2000	37	—	—	—	—	Diode	12BE5	12.6	4370-5621	0	—	X1	55
7200-0000	—	—	—	—	—	Diode	12BE5	12.6	4370-5621	0	—	X10	54

You Don't Need The Roll Chart



with a HICKOK Model 580

... even though it has one, because the 580 is a totally **different** tube tester. Its unique design permits direct read-in of a wide range of test parameters—which means it can be set up directly from the tube handbook, for instance. For the first time in **any** tube tester you can measure Gm under conditions of your own choosing. Of course, it has a roll chart, too—for your convenience. In addition, the model 580 makes complete "fringe" tests, including measurement of gas effects down to 0.05 μ a and leakage to 50 megohms.

See your HICKOK distributor or write for circular #TT-644.



THE HICKOK ELECTRICAL INSTRUMENT CO.
10528 Dupont Avenue, Cleveland, Ohio 44108

Represented in Canada by Stark Electronics, Ajax, Ontario • Internationally by Hughes International, Culver City, California

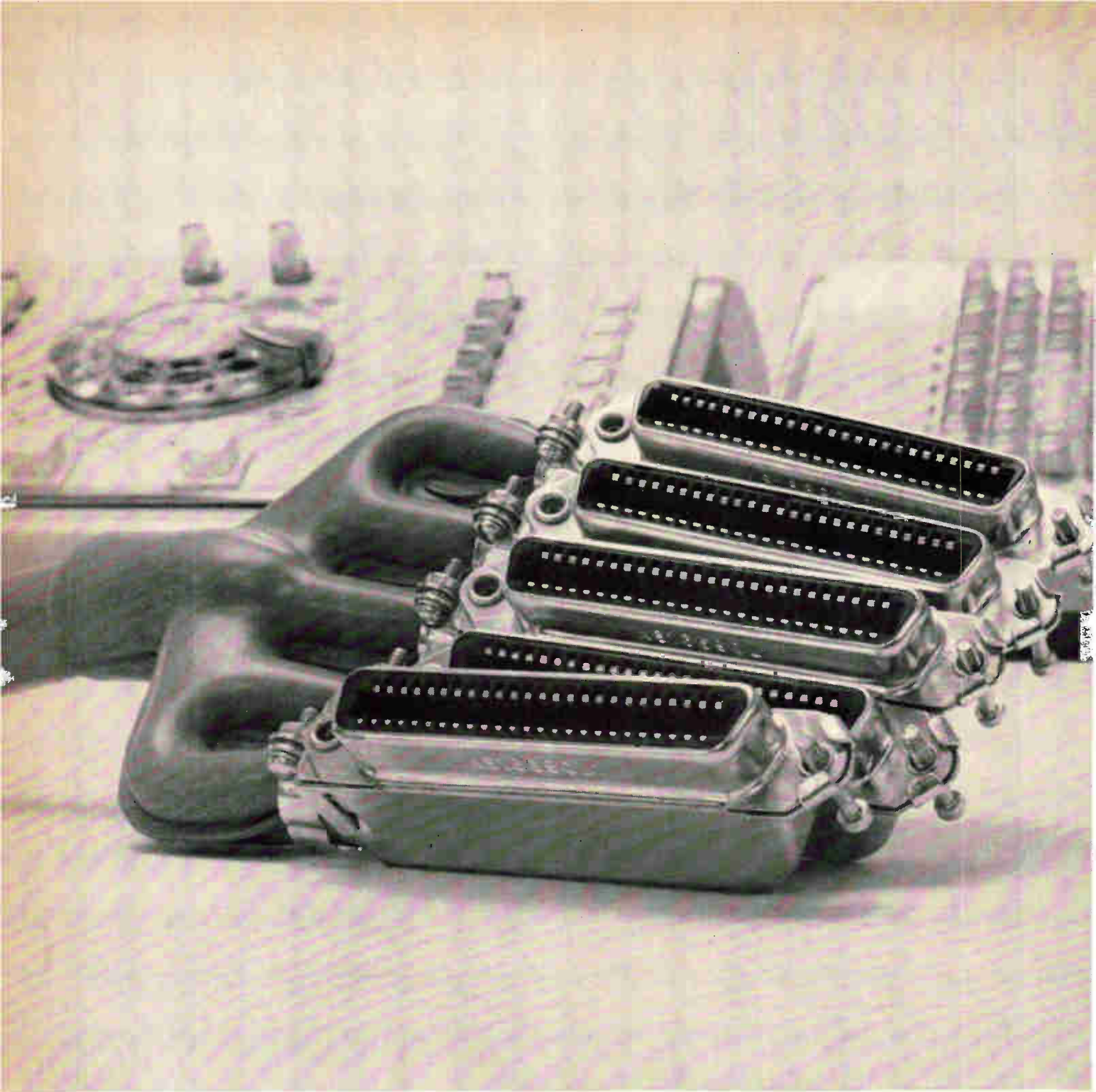

***How Amphenol helps
put a 200-phone
switchboard on a desk top***

The Bell System reduced the switchboard to a tenth of its usual size, then called on Micro-Ribbon® connectors to simplify desk-top installations.

Five Micro-Ribbon connectors route the 250 circuits Bell needs for the two-console, 200-phone board—plus they offer these three important advantages:

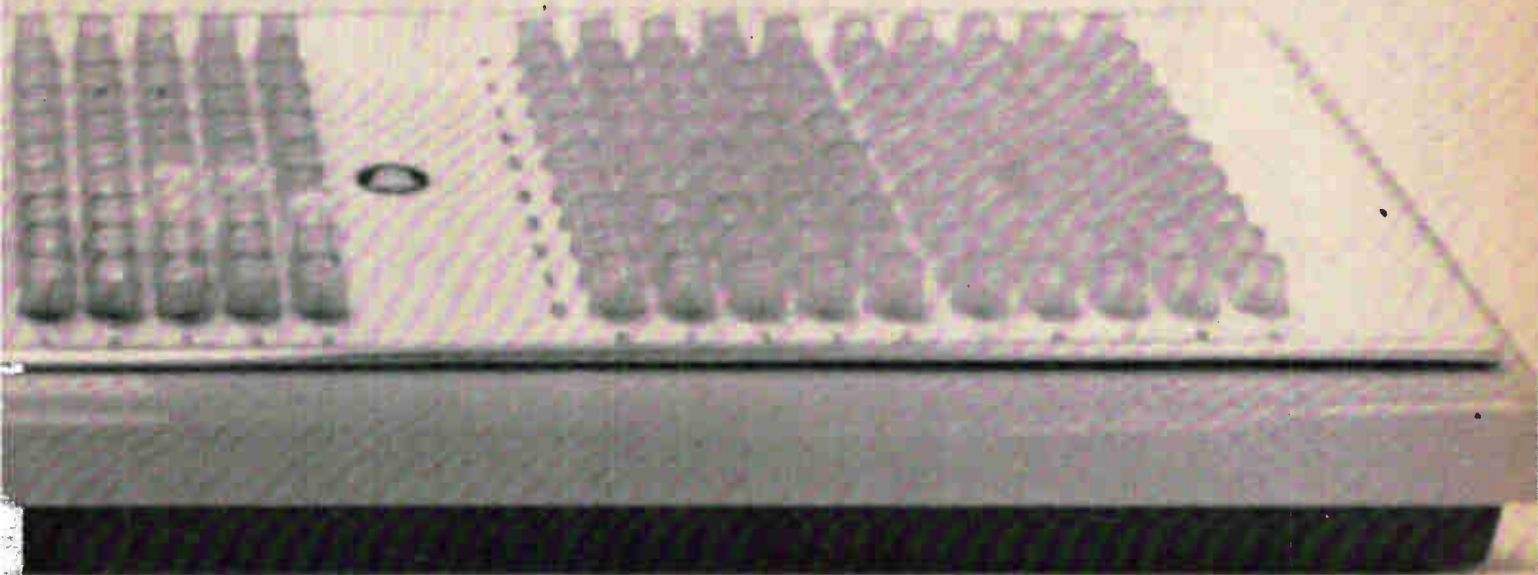

1. **SIZE.** Each 50-contact Micro-Ribbon connector takes little more space for the connection than the cable itself.

If your application calls for fewer circuits, you can gain similar miniaturization advantages with Amphenol 14, 24 or 36-contact Micro-Ribbons.

2. **RELIABILITY.** Bell demands long service life from its equipment

... usually 25 years. To date, Amphenol Micro-Ribbon connectors with self-cleaning, self-wiping contacts have been equal to the task. Not one failure has been reported in over 500 million contacts.

3. **COST REDUCTION.** Competitive in initial price, Amphenol Micro-Ribbon connectors helped cut installation time and maintenance

costs. Estimates on Bell's savings range from 20% to 30%. Equipment replacement is more simple for Bell, too. Unplug the old; plug in the new.

For complete information about Micro-Ribbon or any of the other 36,000 connectors Amphenol makes, call your Sales Engineer. Or write *Amphenol Connector Division, 1830 S. 54th Ave., Chicago, Illinois 60650.*



CONNECTOR DIVISION

amphenol corporation

Specify Amphenol . . . the leading name in cable, connectors, assemblies, RF switches, potentiometers, microelectronics

The components that have made the Allen Organ famous. Used by America's leading electronic manufacturers.

ALLEN COMPONENTS

- Uniformly High Grade
- Attractive Prices
- Wide Electronic Applications
- Always in Stock
- Small Orders Welcomed
- Quick Delivery

Allen Frequency Sources Types C and P (plug-in type)

Moderately priced compact audio oscillators designed for applications that do not have most-stringent requirements for stability in respect to temperature and frequency drift.



Allen Toroids

Over 150 sizes available from stock include Permalloy, Ferrite and Powdered Iron types. Inductance ranges from 50 henries to 6 millihenries.



Allen 20-watt and 50-watt Transistorized Amplifiers

Utilize latest developments in solid-state technology. They demonstrate characteristics normally associated with such circuitry (compact design, low heat dissipation). High sensitivity, conservatively rated.



Write for our free catalog!



Allen Organ Company, Macungie, Pa. Phone 215-965-9801

Allen Organ Co., Dept. E-5, Macungie, Pa. 18062

Please send me your components catalog.

I am interested in: Toroidal coils Oscillators Amplifiers

Name _____

Firm _____

Street _____ City _____

State _____ Zip Code _____

(C) A.O. Co.

400V 2.0A 3.5A SILICON TRANSISTORS

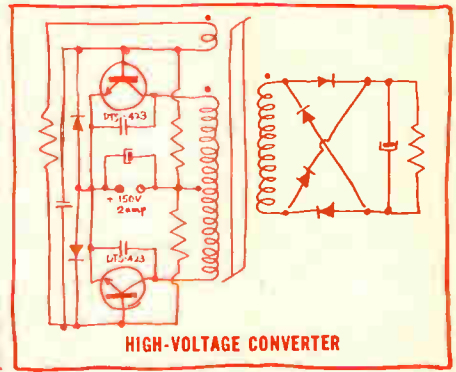
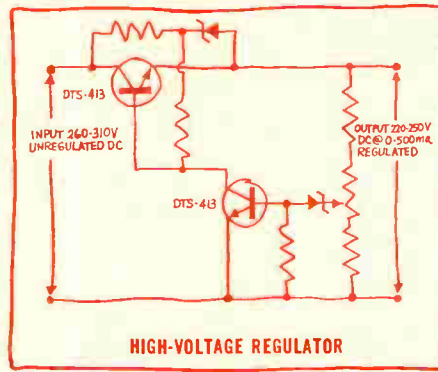
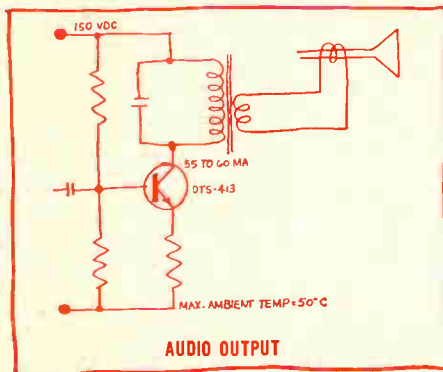
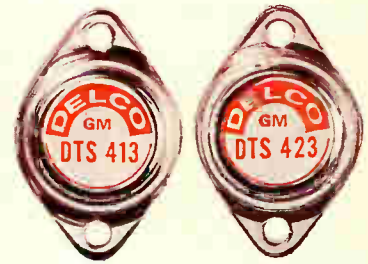
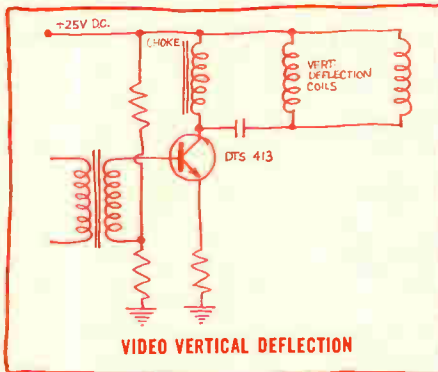
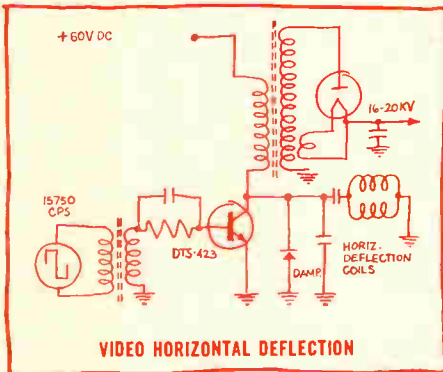

INEXPENSIVE

From Delco Radio, come two new silicon power transistors that transcend the known limits of semiconductor cost and capability. ■ **V_{CE0} 400V at less than three cents a volt—even in sample quantities!** ■ The DTS-413 and DTS-423 open the door to a host of new ideas, new circuits, new products and product improvements. ■ As an example, practical—and immediate—applications are both vertical and horizontal TV outputs. Large-screen all-transistor TV is, for the first time, technically and economically practical. ■ Delco's achievement also permits a reduction in current, reduction in size of other components, and a hike in efficiency in circuits where high energy output is needed. ■ High punch-through voltage, high frequency response, and low saturation resistance are provided by the silicon element itself, which is fabricated by our unique triple sequential diffusion process. ■ Complete freedom from "purple plague" and exceptional resistance to thermal and mechanical shock are a result of ultrasonic bonding of aluminum to aluminum base and emitter contacts. ■ Contact us right now for data sheets and prices. Be one of the first to take advantage of these Delco Radio high-voltage silicon power transistors.

RATINGS	DTS 413	DTS 423
VOLTAGE		
V_{CE0}	400 V (Max)	400 V (Max)
V_{CE0} (Sus)	325 V (Min)	325 V (Min)
V_{CE} (Sat)	0.8 (Max)	0.8 (Max)
	0.3 (Typ)	0.3 (Typ)
CURRENT		
I_C (Cont)	2.0A (Max)	3.5A (Max)
I_C (Peak)	5.0A (Max.)	10.0A (Max)
I_B (Cont)	1.0A (Max)	2.0A (Max)
POWER		
	75 W (Max)	100 W (Max)
FREQUENCY RESPONSE		
f_t	6 MC (Typ)	5 MC (Typ)

FIELD SALES OFFICES

UNION, NEW JERSEY*
Box 1018 Chestnut Station
(201) 687-3770

SANTA MONICA, CALIFORNIA*
726 Santa Monica Blvd.
(213) 870-8807

DETROIT, MICHIGAN
57 Harper Avenue
(313) 873-6560
SYRACUSE, NEW YORK
1054 James Street
(315) 472-2668

PALO ALTO, CALIFORNIA
201 Town & Country Village
(415) 326-0365
CHICAGO, ILLINOIS*
5151 N. Harlem Avenue
(312) 775-5411

*Office includes field lab and resident engineer for applications assistance.

DELCO RADIO
DIVISION OF GENERAL MOTORS, KOKOMO, INDIANA



GENERAL ELECTRIC

Who put the "Cad" on TV?



*New Cerro Cadmium Ball Anodes —
more "throwing" power —
better, faster plating.*

Leading television and stereo set manufacturers did it!

They use cadmium plating on chassis and vital components for superior corrosion resistance and sales-stimulating eye appeal. Cadmium plating is also specified on military-grade gear which must operate reliably in environments that would humble other platings.

Leading fastener manufacturers, too, feature cadmium plating — both they and their customers know its intrinsic value.

Cerro produces quality cadmium high in the Peruvian Andes . . . and availability is excellent. To find out more about Cerro cadmium or the other high-purity, nonferrous metals we produce, contact us.

CERRO SALES CORPORATION

SUBSIDIARY OF CERRO CORPORATION

300 Park Avenue, New York, N.Y. 10022

CERRO

Look to Weatherford for fast service on these new germanium transistors

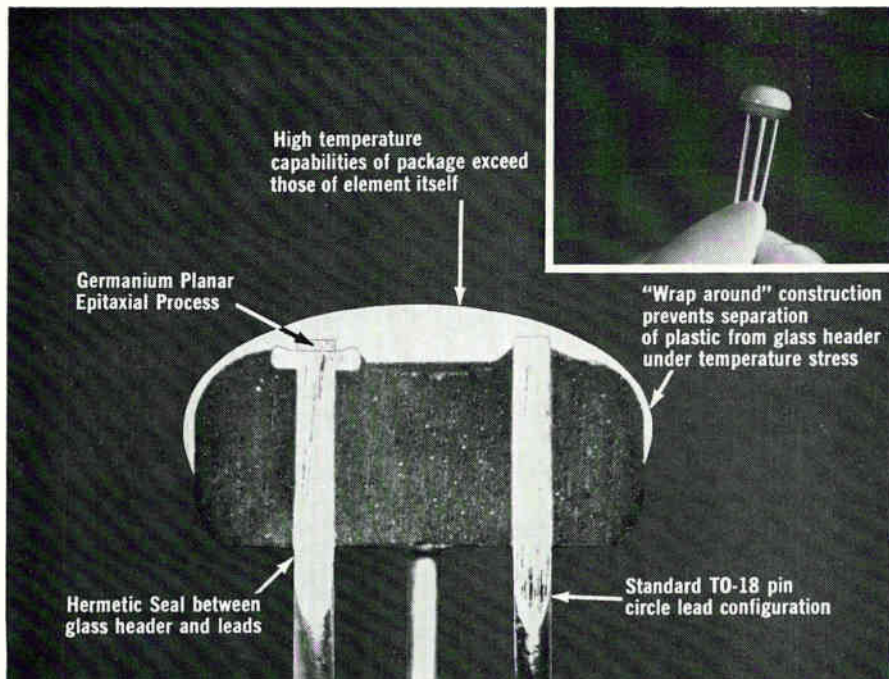

Rugged, low-noise TIXM101 ideal for high-frequency military and industrial circuits

Guaranteed noise figure of TI's new TIXM101 transistor is 2.6 db at 200 mc . . . 4.5 db at 1 Gc. Gain-bandwidth product (f_T) is guaranteed 1.5 Gc, giving your circuit more gain per stage at high frequencies. And planar-germanium construction allows the TIXM101 to withstand more than 40,000 G's in the critical Y_1 plane and 1500 G's shock. Call us for fast delivery of these very low-noise, rugged devices in hermetically sealed TO-18 package — especially useful for aerospace high-frequency amplifiers.

Improve your audio circuit reliability at no increase in cost with new economy germanium series

Low-noise of 4 db max at 1 kc, high breakdown voltage of 50 volts, and high gain of 120 min at 0.5 ma are features of a new TI series of pnp germanium alloy transistors. Packaged in a standard hermetically sealed TO-5, the TIXA01-05 economy series is ideal for low-noise, small-signal audio amplifier applications.

Economy plastic planar transistors reduce cost, improve performance in TV, FM and industrial circuits.

New pnp epitaxial-planar germanium economy transistors — TIXM01-08 — are designed for RF, oscillator, mixer, and IF applications in television and FM broadcast receivers and in industrial applications requiring low-noise, high-frequency amplifier devices. Low noise

(2.8 db typical at 200 mc), high gain, forward AGC, low feedback capacitance, and low-cost plastic-and-glass package suggest use in many other applications as well. We have large stocks ready for immediate delivery. Specify TIXM01-04 for AM/FM; TIXM05-08 for TV.

And look to Weatherford first for prompt delivery on industry's broadest, most proven line of germanium transistors . . . from Texas Instruments

Why go to two or three narrow-line suppliers for your germanium requirements? A look to the leader first can save you both time and money. We stock, in depth, more than 150 types of TI germanium

small signal transistors . . . transistors proven in high-reliability programs backed by tens of millions of life-test hours. These include switching, amplifier, general purpose, and high-frequency de-

vices made by the alloy, mesa and planar epitaxial processes. Get biggest choice from our inventory of TI germanium transistors . . . by far industry's broadest, most proven line.



R. V. WEATHERFORD CO.

DISTRIBUTORS OF ELECTRONIC COMPONENTS AND EQUIPMENT

GLENDALE 1, CALIFORNIA: 6921 San Fernando Road, VI 9-3451
 ANAHEIM, CALIFORNIA: 1651 State College Blvd., KI 7-7521
 PALO ALTO, CALIFORNIA: 3240 Hillview Drive, Stanford Industrial Park, DA 1-5373



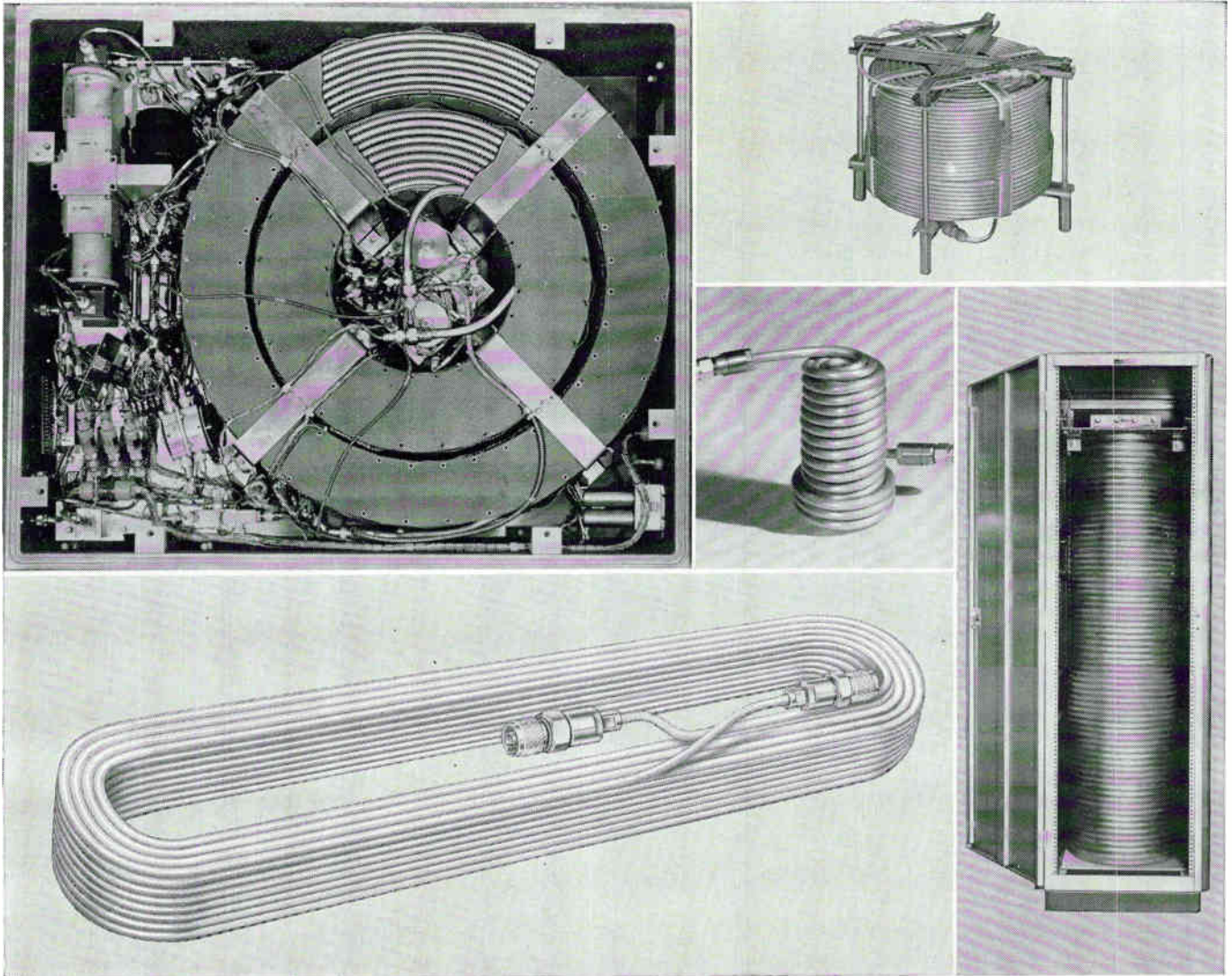

Coaxial cable delay lines. Big. Miniature. Plain, packaged or potted. Capable of accuracies up to $\pm .02$ nanoseconds.

Combine the outstanding performance characteristics of Phelps Dodge Electronic's coaxial cables with a proprietary ability to bend to a radius of three times the sheath diameter to the center line of the bend. Add newly developed measuring and testing techniques to meet unheard-of accuracies. Result? The unique in coaxial delay lines.

Here is broader band operation, less attenuation per nanosecond of delay and greater stability over wide temperature ranges. Here too, is great lati-

tude in the specification of operating parameters, physical dimensions or, moisture, vibration, shock and temperature resistance. Packaging? Containers, shock mounting, standard rack panel mounting, strapping, potting and encapsulating. And, availability for operation at frequencies from 60 cps to 12 Gc, power from one milliwatt to many kilowatts, impedances of 50, 70, 75, 100 and 125 ohms.

Can we tell you more? Let us know your requirements, or write for Bulletin DL-2.

PHELPS DODGE ELECTRONIC PRODUCTS
NORTH HAVEN, CONNECTICUT



**LAB
PRECISION,
SYSTEMS
SPEED**

DVM, 0.005% FOR \$3600

*now possible with a new
integrating / potentiometric technique**



The Hewlett-Packard 3460A Digital Voltmeter uniquely combines two proven techniques to provide unprecedented performance, offering the precision and stability of the potentiometric technique, in conjunction with much of the noise immunity of integration.

Readout is a full five digits, with a sixth digit for overranging (20% on all ranges). Maximum resolution and full accuracy (0.005% of reading ± 2 counts), in environments from $+10^{\circ}$ to 40°C , are maintained up to 15 readings per second. The 3460A is easy to use. Ranges may be selected by front-panel pushbuttons, automatically and remotely. Front and rear inputs are floating and guarded and are completely isolated from each other.

Not only is the 3460A a precision laboratory instrument, but it also incorporates standard features which make it ideally suited for high accuracy systems application. The 3460A is fully programmable. Its BCD output (1-2-4-8 or 1-2-2-4) contains polarity,

decimal and function information. Special accessories also are available to measure ac voltage and resistance. And the 3460A forms the heart of a series of standard digital data acquisition systems available from the Dymec Division of Hewlett-Packard (DY-2015 Series).

Major specifications of the 3460A appear on the reverse side of this page, along with data on the reliability built into this new digital voltmeter.

Use the attached postcard to request a demonstration from your local Hewlett-Packard field engineering office. Or ask for further information from Hewlett-Packard, Palo Alto, California 94304, Tel. (415) 326-7000; Europe: 54 Route des Acacias, Geneva; Canada: 8270 Mayrand St., Montreal.

*Patent pending

HEWLETT  **PACKARD**
An extra measure of quality

MAJOR SPECIFICATIONS

Voltage accuracy:	$\pm 0.005\%$ of reading ± 2 digits, $+10^\circ$ to $+40^\circ\text{C}$ on all ranges ($\pm 0.01\%$ of reading ± 3 digits, 0° to $+10^\circ$ and $+40^\circ$ to $+50^\circ\text{C}$)
Long-term stability:	Accuracy is guaranteed for 60 days
Ranges:	Full-scale presentation of ± 1.00000 , ± 10.0000 , ± 100.000 , ± 1000.00 (up to 20% overranging)
Reading rate:	Remote control mode, max. of 15 readings/sec on three highest ranges, including range selection; max. of 7 readings/sec on 1 v range Local control mode, max. of 3 readings/sec to minimum of 1 reading/5 sec Manual trigger provided
Input impedance:	Constant 10 megohms $\pm 0.03\%$ on all ranges
Polarity selection:	Automatic
Range selection:	Automatic by front-panel pushbutton or remote switch closure to ground with impedance 100 ohms: 30 msec required per range change, 90 msec max.
External read command:	± 20 v, direct or ac coupled
Common mode rejection:	160 db at dc with 1 K ohm between low side of input and the point where the guard is connected; 120 db up to 60 cps, same conditions
Normal mode rejection:	By integration, infinite at 60 cps
BCD outputs:	4-line BCD (1-2-4-8), 9 columns including polarity, decimal location, overload and 6 digits of data (optional 1-2-2-4 BCD)
Inputs:	Floated and guarded signal pair, front and rear panel, selectable by front-panel switch; guard operable to ± 500 v above chassis ground; low operable to ± 50 v above guard
Dimensions:	5" high, 16" wide, $21\frac{3}{8}$ " deep (127 x 406 x 543 mm); net 38 lbs. (17,1 kg), shipping 43 lbs. (19,4 kg)
Price:	\$3600

Data subject to change without notice. Price f.o.b. factory.

BUILT-IN RELIABILITY

Each dry reed used in the digital-to-analog converter is manufactured to Hewlett-Packard specifications and pre-aged by hp for 25 million operations prior to its use in the 3460A. With standards based on a three-year hp study of reed performance, a typical 25 years of failure-free operation can be assured.

To further insure maximum reliability, the zener diode, (the primary component in the reference supply) also has an extensive history of testing and statistical evaluation. The diodes are pre-selected and given an accelerated aging equivalent to one year of usage. This is done to provoke potential failures. They are then operated in the actual reference supply for an additional 1000 hours. This

procedure indicates drift patterns (typically better than 0.001%/month) that are used to determine the diode's possible use in a 3460A.

In addition, all DVM's produced are subjected to an on-off cycling procedure at 50°C for 8 hours (see photo) and three weeks of "burn-in" on the bench before final testing and shipment.

Calibration measurements during final test are traceable to the National Bureau of Standards. Thus, not only does the Hewlett-Packard 3460A, by design, provide unprecedented performance and measuring capability, but also, by manufacture and testing, assures years of trouble-free service.

HEWLETT  **PACKARD**
An extra measure of quality

COMPONENT COMMENTS *From Speer*

Take an armchair tour of our resistor plant

We were recently rather surprised to discover just how fanatical we've become on the subject of quality. Did you know, for example, that we test samples of every lot of our fixed carbon composition resistors in live steam? It's a fact. The resistors are exposed to steam pressure for four hours as an accelerated control test for moisture resistance.

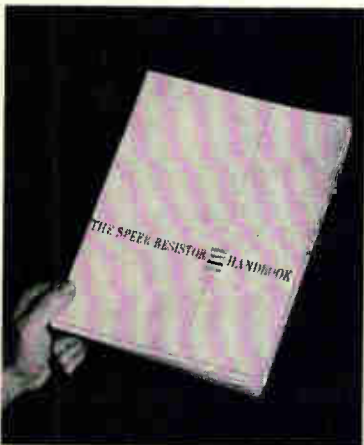

Scenic view of our free, 16-page, lavishly illustrated "Resistor Handbook."

For a more comprehensive revelation of our fanaticism, we refer you to "The Speer Resistor Handbook." This colorful new 16-page illustrated brochure is actually an armchair tour of our entire resistor operation. You'll see how our resistors are made and how we assure quality at every stage — in raw materials, in manufacturing and in meeting military standards. You'll see the wide range of specifications we offer. And you'll see how our resistors have performed under MIL-R-11 test conditions.

Browsing through "The Speer Resistor Handbook" is almost as fascinating as touring our plant in person. (And it's decidedly easier on the feet.) If you'd like a copy just mail the coupon.



The comprehensive reliability program at our Jeffers Electronics Division assures that all of our non-shielded inductors (and our shielded ones too) meet MIL-C-15305 specs.

The heart-warming comeback of the non-shielded inductor

Don't get us wrong. On the issue of shielded versus non-shielded inductors, we're completely unprejudiced.

We'd be delighted to sell you either type.

We have felt distressed, however, to think that you might be using shielded inductors in more applications than you need to. After all, while the non-shielded inductor may be thin-skinned, it does offer the advantages of lower cost, higher reliability and higher stability.

We've therefore taken steps to help this useful inductor make the comeback it deserves.

Step one: Our Jeffers Electronics Division has developed a number of non-shielded inductors that provide high inductance values in a small case size. Example? Our unshielded-molded jacket

inductors now offer values through 1800 microhenries, in a case size of 0.156" x 0.375". This size conforms to the new MIL standard MS90537 for shielded coils, which specifies a 0.157" x 0.385" case size.

Step two: A suggestion. Consider rearranging your components. This will sometimes enable you to switch to non-shielded inductors.

Step three: We've prepared an essay that deals with this whole subject at greater length. It's entitled "Can Non-Shielded Inductors Save You Money?" and you can get a copy by merely mailing this coupon.



Do we have your name?

To receive reprints of "Component Comments," use the coupon. We'll place you on our mailing list.

JEFFERS ELECTRONICS DIVISION,

Speer Carbon Company
DuBois, Pennsylvania

Speer Carbon Co. is a Division of Air Reduction Company, Inc.

- Rush "Can Non-Shielded Inductors Save You Money?"
- Rush "The Speer Resistor Handbook."
- Arrange for me to receive reprints of "Component Comments."

Name _____

Title _____

Company _____

Address _____

City _____

State _____ Zip _____

Will an extra \$379
buy another decimal place—

or
another
10 mc
scope?

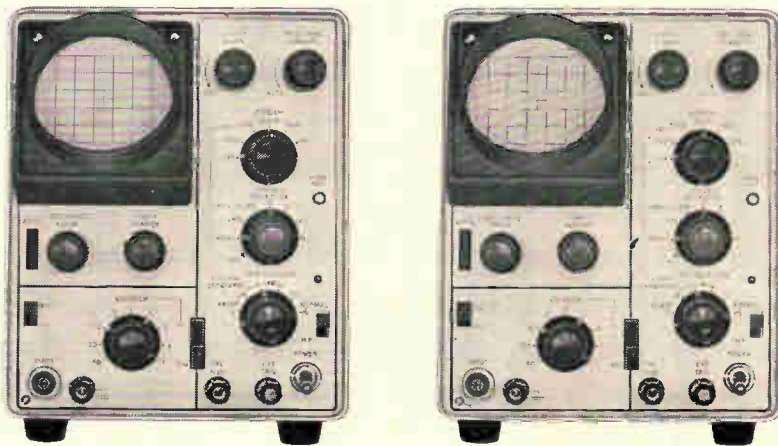

Doing any Value Analysis on your test equipment? Here's something to consider. For less than the cost of a single heavyweight scope, you can get two Data Instruments S32A's. However, forget price. This is a scope that recommends itself from every aspect. It's versatile. The S32A is equally useful on the production line, in the field and in the laboratory. It performs. The extremely small spot diameter of its 3" flat faced tube makes it comparable to any 5" type. Dependable triggering insures positive synchronization over the entire bandwidth. And a 2% calibrator standardizes both time and voltage. It's reliable. The S32A is practically trouble-free, and is warranted for a full year with complete field and factory service. Look at the specs.

data instruments



VERTICAL AMPLIFIER				
BANDWIDTH	SENSITIVITY/CM	RISETIME	IMPEDANCE	ACCURACY
(1) DC-10mc	100mv to 50V	.035 μ s.	1M Ω +3pf	\pm 4%
(2) DC-1mc	10mv to 5V			
TIME BASE		CRT		PHYSICAL
SPEED/CM	TRIGGER & HOR. AMP.	DIA.	PHOSPHOR	VOLTS
1 μ s. to 0.5 sec. \pm 4%	Exp. x 10 10cps-400kc	3"	P1, P7	3.5kv
				DIM. & WT. 13 $\frac{3}{4}$ "x8"x6 $\frac{1}{2}$ " 16 lbs.

Forget the price. Compare it on performance. Drop us a note, and we'll arrange a demonstration in your plant. At \$379 you almost **can** forget the price, can't you?

Data Instruments Div. • 7300 Crescent Blvd. • Pennsauken, N.J.

Electronics Review

Volume 38
Number 14

Space electronics

Mariner's report

"It's something like the feeling that Galileo must have had as he prepared to focus his telescope on the moon," remarked an engineer setting up equipment to receive the first close-up pictures of Mars from Mariner IV. On Thursday morning, the 15th, the first digital television bit is scheduled to be picked up by an 85-foot antenna. That bit will be one of 240,000 that will make up a single photograph of the rust-red planet. It will take about 8½ hours to receive a complete picture.

The pictures will actually be taken 12 hours earlier, beginning when the spacecraft is about 10,000 miles from Mars and 135 million miles from the earth. Mariner's delicate tv camera will be turned on early in the afternoon of July 14. When the light from the planet reaches a predetermined level, a video tape recorder will start receiving the vidicon's signals; 25 minutes later—when the spacecraft will be about 6,000 miles from Mars—20 or 21 still pictures will have been impressed on the video tape.

In the 12 hours before the tv pictures are transmitted to earth, Mariner's communications channels will be busy sending other scientific data that will be collected while the spacecraft is still near Mars.

Sorting the data. It will take about eight days before all the video data, estimated as a maximum of 5×10^6 bits, is received by earth stations, and it may take several more days for computers at the California Institute of Technology's Jet Propulsion Laboratory, which is in charge of the project, to sort it out.

The tv system contains a telephoto lens, which will be able to make out terrain features as small as two miles across—only a 50th

the size of those seen from the earth. A single rotating disc shutter will snap a picture in 1/5 or 2/25 of a second, depending on available light, and the image will be stored in a one-inch vidicon developed by the General Electrodynamics Corp. A scanning beam will then read out a 200-line tv picture over a 24-second period. It will take another 24 seconds for the image to be erased in preparation for the next picture.

After the images are broken

time digital tv techniques have been used by any U. S. spacecraft.

Signals on cue. Whatever the outcome of the television experiment, Mariner IV is already considered successful because it's on target and has already collected and sent back valuable data on solar wind—low-energy protons that stream from the sun—and on dust particles in space.

Mariner is tracked by the doppler shift of its radio signal. Scientists are especially interested in

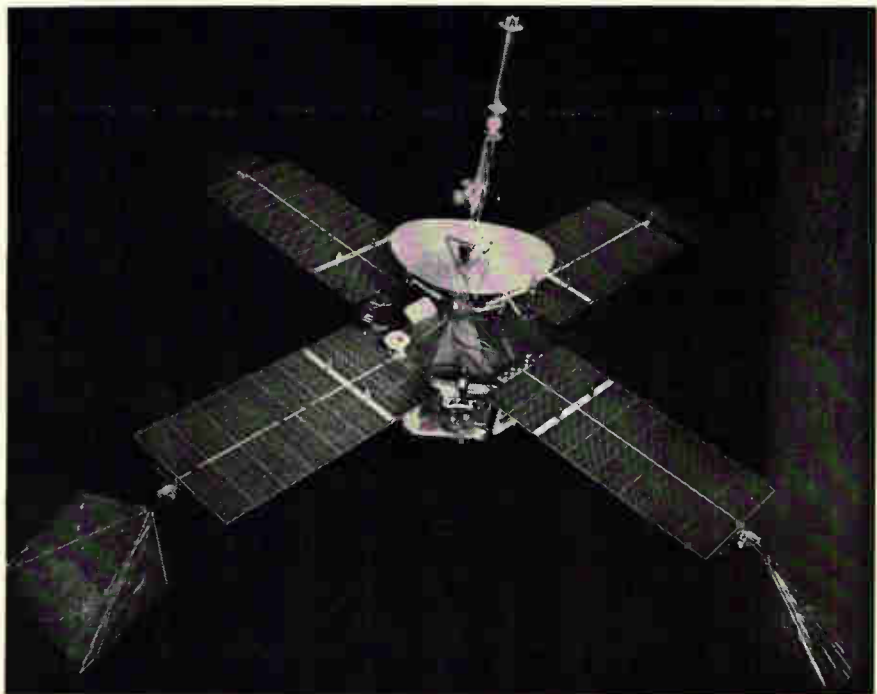

Way out in space, Mariner IV takes close-ups of Mars

down into digital information, they will be impressed on a miniaturized recorder designed by Raymond Engineering Laboratory, Inc. It will take 1,284 seconds to play back one second on recorded data.

JPL decided to use digital tv techniques because of the huge transmission distances involved. Analog data, they concluded, would have been less reliable; in addition, digital information can be upgraded relatively easily by computer techniques. This is the first

tracking the craft as it passes behind Mars; since the signal will pass through the Martian atmosphere at one point, the doppler shift may provide a clue to atmospheric density.

Meanwhile, the National Aeronautics and Space Administration is planning far more sophisticated equipment for the next operational missions to Mars in 1971. In these, a Voyager spacecraft will probably carry a 50-watt transmitter—compared with only 10 watts for Mar-

iner. In a 10-day period, Voyager would be able to return over 2,000 tv pictures, and the total digital data sent back to earth would be about 10^{10} bits.

Communications

Out of the shadow

In the early 1940's, WQXR, the radio station of the New York Times, built its f-m broadcasting antenna atop the Chanin Building, on 42nd Street near Park Avenue. Perched 685 feet above the ground on what was then one of New York's 10 tallest buildings, the antenna was safely above any potential obstruction the stations execu-

eral other f-m stations in renting a "community antenna" that will be built atop the Empire State building.

The antenna, an array encircling an upper tower of the skyscraper, will be able to accommodate as many as 17 f-m stations. It will consist of two layers of 16 dipoles each, equally spaced around the perimeter of the tower. One layer will be installed above the observatory windows on the 102nd floor, and one below.

Eye on autos. The system is being designed with one eye on the growing market of automobile f-m radios. Each of the dipoles will be tilted to a 45-degree angle. "This will provide essentially equal signals in vertical and horizontal polarization," says Andrew Alford, president of the Alford Manufacturing Co. of Boston, which is de-

the 17 station transmitters. The transmitters will be situated in building areas below the 86th floor and will feed into a multiplexer system to be installed on four levels in the tower structure.

The multiplexer, also designed by the Alford company, will be of modular construction, permitting addition of stations without disturbing the existing system. It will provide a constant impedance over a wide frequency range. Each module will consist basically of two tuned tanks and two transmission line hybrids.

A patch panel will couple the multiplexed signals to the antenna dipoles. Signals from each station will usually be energizing all 32 dipoles, but the stations can broadcast through a single level of 16 dipoles during test and maintenance periods.

The dipoles will be electrically heated to keep them free of ice.

Two other stations, WHOM and WLIB, have also leased facilities so far. WLIB is a new station, which has not yet begun broadcasting f-m programs.

Switchless radiophone

In Rockville, Md., recently, an engineer at an International Business Machines Corp. laboratory picked up an experimental radiotelephone, dialed a number, and within seconds was talking to his party. The call, to one of hundreds of potential numbers, was placed without the assistance of an operator or switching nodes.

The most likely customer for the portable radiophone, which can handle as many as 15 one-way conversations on a band one megacycle wide, is the military, because the transceiver offers eavesdrop-proof and versatile communications—tailor-made for battlefield conditions.

But the principle behind the system—digitizing the voice signal with a pulse-position modulator (ppm) and coding each of the resulting digital pulses—may someday have a wider application in the field of satellite communications. A satellite with 100 channels, for example, could carry as many as

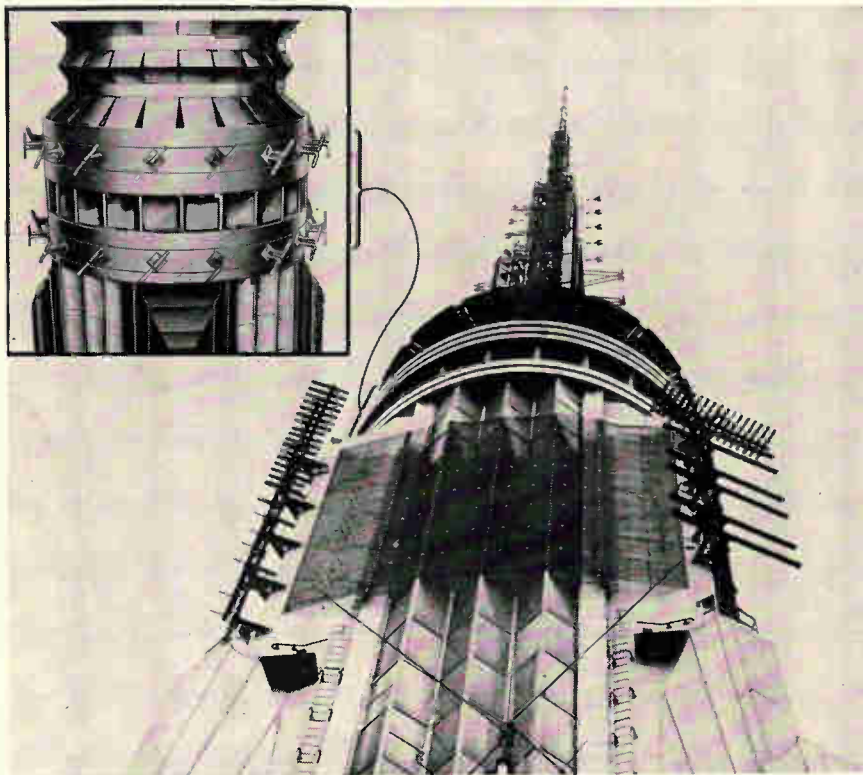

Array of dipoles envisioned for f-m radio transmission will be installed atop the Empire State Building. Inset shows model of antennas.

tives thought. But three years ago, the 808-foot-high Pan Am building was erected smack in front of the Chanin Building, casting a shadow of radio silence for many of WQXR's listeners. Next fall, however, the station will move out from under that shadow; it will join sev-

signing and building the antenna. "The vertical polarization," he says, "will make it easier to get good f-m reception in a car at a reasonable price, through a whip antenna."

The array will be capable of radiating up to 170 kilowatts of continuous power, 10 kw from each of

1,500 conversations without the need for complex switching apparatus to connect calls.

Digit dialing. To place a call, the sender first dials a six-digit code that corresponds to the code of the party being called, and then pushes a button that signals the called party. The ppm samples the amplitude-modulated voice waveform 8,000 times a second and emits a stream of pulses separated by gaps whose length is proportional to the instantaneous amplitude of the waveform. The pulses from the ppm are fed to a pseudo-noise generator, which produces bursts of 63 binary signals, the sequence of which was determined earlier by the six-digit code.

On the receiving end, the pulses are fed into a digital matched filter that responds only to the 63-bit sequence corresponding to its assigned code. The output of the filter is processed through a square-law combiner to produce the original pattern of sampled pulses, which are then fed into a reverse ppm to reproduce the original continuous waveform.

The radio, which can operate over the vhf or uhf bands, is being developed at IBM's Federal Systems division.

Instrumentation

Push-button testing

Military electronics equipment is becoming so complicated that it sometimes requires an engineer just to see if it's in good working order. The armed services, short of men with adequate technical training, are turning to computers to perform detailed diagnostic tests on complex gear.

The Army is starting to use a system called Dimate, an acronym for depot-installed maintenance automatic test equipment, which automatically examines communications gear. And the Navy has ordered development of a system called Vast, for versatile avionics, shop test, which will be able to test 85% of its avionics inventory.

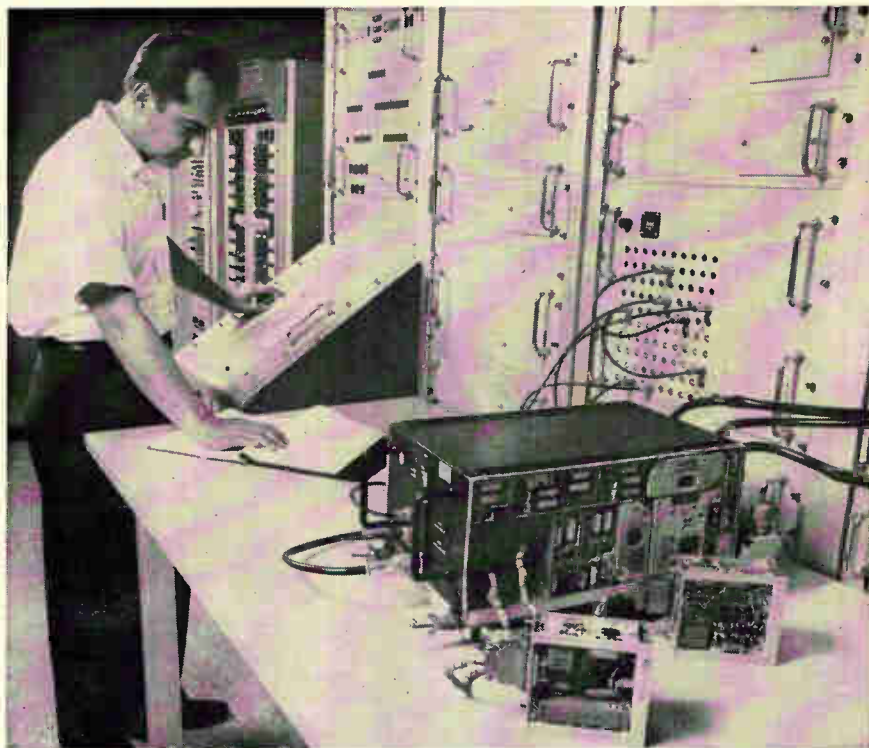

Tacan navigational set being tested automatically by Vast under supervision of system's project manager, William Helf of PRD Electronics, Inc.

Dimate was developed by the Radio Corp. of America's Aerospace division in Burlington, Mass. It's being used to test VRC-12 radio sets at the Army depot in Tobyhanna, Pa., but it will eventually be used to test other kinds of equipment. A test on one radio, for example, takes as little as 57 seconds, compared with an hour or more when work is done manually.

Go-no-go. Dimate's specially designed computer sets up a series of test instructions; test signals are then fed in sequence into the transceiver being tested. The first check is a go-no-go test; then, if the set fails to respond correctly, Dimate continues its examination until it finds the faulty component.

Vast operates on the same principle as Dimate but, instead of a special computer, it employs a Univac 1218. Also, Vast is being designed to handle a wider spectrum of equipment; its major role would be to test the avionics system for each plane aboard an aircraft carrier. The system is being developed by PRD Electronics, Inc., of Westbury, N. Y., a subsidiary of the Harris-Intertype Corp.

The Vast program is also similar

to the maintenance-shop test gear that has been designed by the General Dynamics Corp. for the F-111, the military's first two-service plane [Electronics, May 31, p. 31]. That test equipment, however, checks all the systems aboard the supersonic F-111, not just its electronics, and it was designed with but one plane in mind. The F-111 will be used by both the Navy and the Air Force.

Although both Vast and Dimate are primarily computer-operated, they can also be run manually for certain tests.

Solid state

Betting on overlays

For the past year, the infant overlay transistor market has been dominated by the Radio Corp. of America, which developed the basic geometry for the high-power, high-frequency devices. By midsummer, though, the picture will change: three other semiconductor producers, already supplying some overlay devices, will introduce new

models at the Western Electronics Show and Convention (Wescon) in San Francisco Aug. 24-27.

Ready to challenge RCA's current line of 25 models will be:

- The Vector division of the United Aircraft Corp., which will show a line of overlay devices housed in a package similar to the flatpack now used for integrated circuits.

- The National Semiconductor Corp., which will devote about a quarter of its Wescon booth to a display of a broad line of models.

- Motorola, Inc., which will unveil an expanded-line of overlay devices, including the popular 2N-3375.

RCA won't be sitting still. It will show several new models and also expects to begin making a 416-emitter overlay device in sample lots by late September.

Texas Instruments Incorporated and the Transitron Electronic Corp. also have overlay devices under development in their laboratories.

Many emitters. Overlay transistors have a large number of emitters which are connected in parallel to an aluminum sheet. The emitter lead is connected directly to the sheet instead of to the semiconductor material as in conventional transistors. This construction allows a large emitter periphery-to-area ratio (greater than 14 to 1 for some types) which in turn gives the device high current-handling capability, low capacitance and short carrier transit time between emitter and collector.

It was almost four years ago that RCA physicist Donald R. Carley (see related story on page 8) discovered the new geometry that made overlay transistors possible.

At that time, the best transistor on the market was a 400-megacycle, 50-milliwatt device. The first commercial overlay device, the 2N3375, could handle 3 watts at 400 megacycles.

Buyer into maker. United Aircraft purchased some 2N3375's from RCA; it was so impressed with the device that last year it instructed its Vector division to begin production for both in-house use and outside sales.

National Semiconductor, also

recognizing the potential market, began to make the 2N3375 last year. Unlike the RCA and Vector device, both of which have 156 emitters, National's has 216 emitters.

Since the devices can be used wherever a designer needs high power and high frequency, the market should grow rapidly. Multimillion-dollar sales are likely within a few years, the makers feel.

The device with the top performance so far is RCA's 2N3733, which can handle 10 watts (minimum) at 400 megacycles. By next year, though, the company envisions devices with a 100-watt, 50-megacycle and 40-watt, 400-megacycle capabilities.

In the not-too-distant future, maintains RCA's Carley, there will be devices that can handle hundreds of watts at hundreds of megacycles.

Avionics

Flying laboratory

The twin-jet Sabreliner, a small swept-wing plane produced by North American Aviation, Inc., and used variously as a business craft, a cargo hauler and a navigational trainer, is taking on a new role that will affect planes of the future. The company's Autonetics division has

outfitted a Sabreliner with electronics equipment to gather data for designers of hedgehopping 1,000-mile-an-hour-jets.

Such planes must have range-finding and navigational equipment accurate enough to guide them over hills and valleys, and airframes strong enough to withstand the stresses of quick maneuvering. Late this fall, the subsonic Sabreliner will begin day and night terrain-skimming exercises to test inertial guidance, laser rangefinders, low light level television, automatic terrain following equipment, infrared scanners and microminiaturized multimode radar.

Can't hide. Probably the most advanced equipment to be tested during the program, which Autonetics calls Project Alpha, will be a combination television-infrared system. Although the company won't disclose details, it's known that the system will produce tv and infrared pictures simultaneously on the same screen. If such equipment were sensitive enough, a pilot could see a grove of trees with the tv, and by switching to the infrared mode, pick out tanks that might be hiding inside the grove.

Not all the equipment that will be tested on the plane is made by North American. The company's aim, explains president John Moore, is to improve the "cross-talk" between various avionics systems.

The program, which will cost

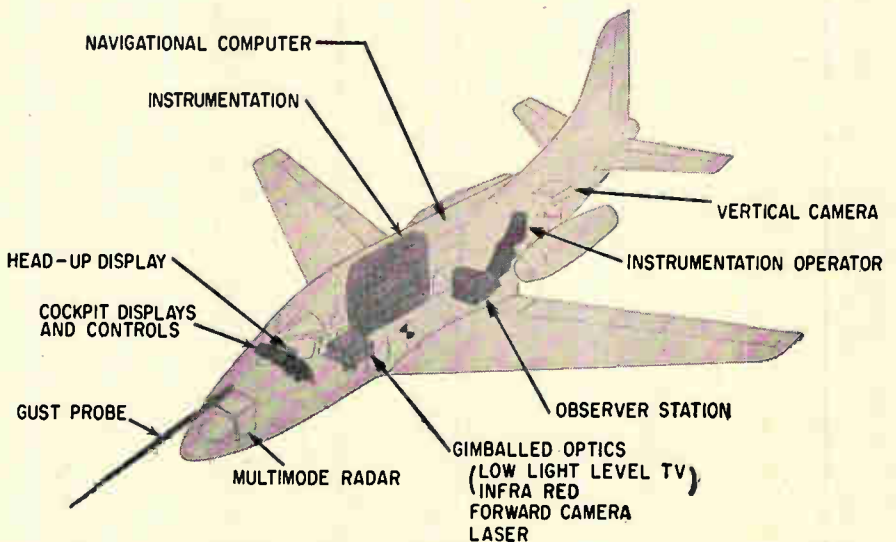

Sabreliner outfitted with special instruments to test avionics systems for fast, low-flying planes.



THREE PHASE BRIDGE:
11 KV/LEG
AT 300 MILLIAMPS

HIGH VOLTAGE STACK:
90 KV AT 10 MILLIAMPS

STANDARD "DOORBELL" MODULE:
5 KV AT 1 AMP

MULTIPLIER:
100,000 VOLTS DC
AT 25 MILLIAMPS

SILICON HIGH VOLTAGE ASSEMBLIES UNITRODE MAKES THEM ALL

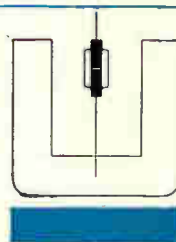

UNITRODE®
"better always/by design"

ALL ASSEMBLIES FEATURE:

- Controlled Avalanche Diodes
- Void-free Individually Glass Sealed Junctions
- Matched Thermal Coefficients
- Vacuum Encapsulation
- Designed-in Anti-corona Protection
- High Surge and Overload Capability
- Maximum Power for Minimum Size

Call, Write, or TWX Your Requirements to
The Factory or Your Local COMPAR Office

UNITRODE CORPORATION
580 Pleasant Street, Watertown,
Mass. 02172 Telephone (617) 926-0404
TWX (617) 924-5857

about \$5.5 million, is being paid for by North American. Early attempts to get the Air Force to sponsor the research failed; the service maintained it lacked the funds for such an experiment, a company spokesman says.

The company decided to take the gamble alone because "If we were going in the right direction, we felt a customer would step in later," explains the assistant director of the project, David Freeland.

"It would also put us in a better competitive position to go with what seemed to be the Pentagon trend toward more integrated avionics," adds William W. Coquelin, the project director.

Light computer. Among the millions of dollars worth of electronics gear being crammed into the plane is an experimental digital computer designed by North American. The 47.5-pound microelectronic instrument has a storage capacity of 4,096 30-bit words, expandable to 32,768 words. Its main role will be to process the data collected by the various systems on the Sabreliner.

In addition, four different types of sensors are being installed in the airframe: 23 strain gages will measure stresses, while five surface-position sensors, 12 accelerometers and three rate gyros will measure the small movements of different parts of the plane while they are under stress.

For safety's sake

President Johnson's proposal to pump \$140 million of government funds into further development of the nation's first supersonic transport plane will keep the airliner on the drawing board a bit longer—for safety's sake.

"The idea of rapid development to get an SST into commercial service [early] has been dropped in favor of producing the best and safest plane U. S. industry can build," explains Gordon Bain, the Federal Aviation Agency's deputy administrator for development of the SST.



One model of supersonic airliner being prepared for wind tunnel tests at Boeing Co.

The decision to keep the aircraft grounded also places more competitive pressure on avionics companies to improve the reliability of hardware being designed for the plane. Bain says two of the most important pieces of equipment—both far beyond the state of the art—are a fool-proof anticollision device and a clear-air turbulence detector.

Key role to McKee. Johnson's decision to ask Congress for the \$140 million was announced early this month at the swearing in of William F. McKee, a retired Air Force general, as administrator of the FAA. McKee will be one of the key men in charge of the SST's development, since the government intends to continue its major financial role as the supersonic plane project continues.

The \$140 million will keep all four present developers in the race—the Boeing Co. and Lockheed Aircraft Co. as potential airframe manufacturers, and the General Electric Co. and the Pratt and Whitney division of the United Aircraft Corp. as potential engine makers.

"All key avionics systems will be installed in duplicate and even triplicate, the redundancy making for safety," says Bain. "The indus-

try is advancing in solid state miniaturization so rapidly that it will be possible to install twice the avionics systems at less weight than at present." For example, the all-weather navigation system in the SST will be composed of three independent inertial navigators. Each inertial system will consist of an inertial measuring unit, a digital computer, which would provide position and course, a converter system and a control display.

Manufacturing

In focus

At the National Research Corp., in Cambridge, Mass., Clifton B. Sibley has figured out how to keep an electron beam focused as it trims metal-film resistors.

Meanwhile, at the Pennsylvania State University, A.B. El-Kareh is developing a technique that will show the operator a television picture of the electron beam doing its work.

The two projects attack different aspects of a common problem in

ADULTS ONLY!!!

TRW VARICAP handbook

COMPLETE AND UNEXPURGATED!
(with the kind of curves design-men like)

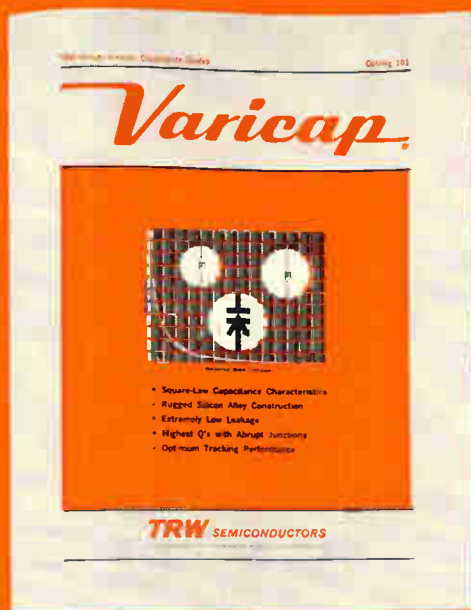

HOLD UP TO LIGHT AND SEE EVERYTHING!

First time available anywhere, this new 16-page TRW Varicap® handbook is yours free! It covers 1000 Varicap types, including the superb new ultra-high Q models. This profusely illustrated handbook is loaded with circuit applications of immense value to all design engineers. To get your copy, just fill out the coupon. The TRW Varicap handbook will be mailed to you promptly in a plain brown wrapper.

REGISTERED TRADEMARK

TRW Semiconductors,
14520 Aviation Blvd., Lawndale, Calif.

Please send me the free TRW Varicap handbook. I am over 21.

NAME _____

COMPANY _____

ADDRESS _____

CITY _____ STATE _____ ZIP _____

TRW SEMICONDUCTORS

GREEN

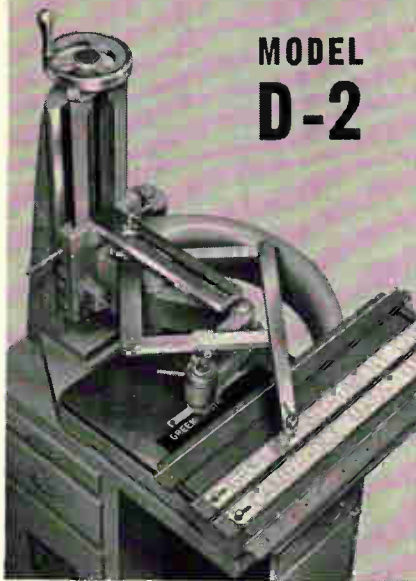

PANTOGRAPH ENGRAVER

your
Engraving Cost Cutter

OFFERS FULL-RANGE VERSATILITY

- easily engraves small and large objects alike
- accommodates panels of unlimited size
- engraves unlimited lengths
- reduction ratios infinitely adjustable
- maximum operating ease and convenience
- fast . . . flexible set-ups
- special accessories for special jobs

APPLICATIONS:

Panels
Cams
Scales
Tools
Printed Circuits
Special Applications
Machine Parts
Name Plates
Instruments
Jigs and Fixtures
Dials
Tracer Lathe Templates
Signs
Dies

Write to Dept. 63
for your free copy of the
Model D-2 brochure . . . today.

**G GREEN INSTRUMENT
COMPANY, INC.**
295 Vassar Street,
Cambridge, Massachusetts 02139

Electronics Review

electron-beam micromachining: making sure that the beam is working with top precision and speed. While micromachining is considered a promising technique, especially in microelectronics production, practical applications have been retarded by such problems.

Hot-spot focusing. An electron beam cuts or drills by heating material until it vaporizes. Film resistors are trimmed to tolerance by cutting lines that lengthen the resistive path in the film. Similar techniques can be used to adjust thin-film capacitors and inductors.

Sibley's focusing system depends on the heat generated by the beam. As the beam heats the resistor film, the film emits electrons. This phenomenon, called thermionic emission, is affected by temperature differences; when the beam is in focus, the spot it hits is smaller and hotter and emission is greater than when the beam is out of focus. Emission is detected by a pickup probe near the workpiece and beam focus adjusted by a circuit which seeks a peak signal in the detected emission current.

Cylindrical helix resistors can be trimmed with the beam 10 times faster than by mechanical cutters and irregularities in the lines cut can be sharply reduced, Sibley reports. Line lengths can be precisely controlled, since the beam can be shut off in a millisecond. Pilot plant equipment cuts lines less than three mils wide, and laboratory equipment cuts lines less than one mil wide, he adds.

Television monitoring. El-Kareh, who heads Penn State's Electron Physics Laboratory, has built an experimental prototype of his system under a contract with the Chief of Naval Research.

His goal is to combine machining and scanning electron microscopy in the same system, so that machining can be viewed continuously in a video monitor. As an electron microscope, the system would also electrically test the microcircuits after they are machined.

The optical microscopes now used for viewing get fogged by vaporized material, and lack the resolution required to process micron-sized parts. If a dimensional

tolerance of 5% is required in a 5-micron part, the allowable error is about the same as a wavelength of light and therefore might not be seen, especially since lenses and long focal lengths further reduce optical resolution. Electron microscopes are made to view micron-size objects and could be made with a practical resolution of 1/100th of a micron.

For machining, El-Kareh will use a high-intensity beam 1 mil in diameter and space the machining pulses 1 millisecond apart. In the intervals, the machine will be used as an electron mirror microscope, by reducing the intensity, focusing the beam to about 1/10 mil and scanning the work area. The scanning beam won't touch the work, because in an electron-mirror microscope, which electronically reconstructs surface topography, the target is charged so that electrons are reflected before they reach it.

Medical electronics

Sword into scalpel

The most powerful laser ever built for medical use will be delivered in August to the National Cancer Institute in Bethesda, Md., for tumor research and for surgical treatment of some cancer patients.

The surgical laser is a direct outgrowth of a military program on super-energy lasers and is being built at the Army Missile Command, Huntsville, Ala., with Army funds. Dr. John P. Minton of the cancer institute heard of the Army work on high-energy devices and asked Huntsville to design the surgical laser. Said the delighted Dr. Minton of his new tool, "It may open a new era in cancer surgery."

The output of the military device is secret. That of the scaled-down surgical version is 800 joules at a repetition rate of four pulses per minute, with a pulse length adjustable from two to four milliseconds.

'Drilling' for cells. Superficially, the surgical laser will resemble a dentist's drill. The laser itself will

be in a pod suspended from the ceiling; the energy will be transmitted through lenses, prisms and mirrors on an articulated arm to a small tool which the surgeon can manipulate directly over the areas to be bombarded.

The lenses allow the surgeon to vary the output from 100 to 800 joules. A maximum of 8% of the energy will be lost during the transmission through the arm.

The laser will have four modules, or heads, each a Pyrex cylinder filled with water, for cooling, and containing a neodymium-doped glass rod 36 inches long and 3/4 inch in diameter. The rods will be pumped by 5,000-volt flash lamps. Only one of the heads will be used at a time, with the others being available for backup and replacement switchover. The device will cost about \$125,000.

Animal research. The laser will be used principally for tumor research on animals, but it will also be used on some human patients who have not responded well to standard chemical, x-ray and radioactive isotope treatment. Dr. Paul E. McGuff of the Laser Medical Research Foundation reported at a biomedical laser conference in Boston last month that some preliminary successes have been achieved in laser treatment of surface malignancies.

Dr. Minton said at the conference that the laser will also be used as an adjunct to cancer surgery—in removing growths in areas like the liver and lungs, where it is too risky to cut, and in destroying cancerous tissue surrounding the principal growth. It is not always possible to cut out all the peripheral growth without excessive risk to the patient.

Experiments with animals have shown that with proper optical focusing, implanted tumors can be rapidly destroyed without damage to adjacent normal tissue. Some researchers have reported differences in the effect of laser energy on normal and malignant tissue [Electronics, July 19, 1963, p. 7, and Aug. 16, 1963, p. 15]; but Dr. Minton and others maintain that the effects of a given wavelength are the same on both types of tissue.



how to measure resolver or synchro position with 30 second repeatability

In both production test and ground checkout systems, North Atlantic's high performance Angle Position Indicators provide exceptional operator ease and precision in the measurement of synchro and resolver position. Features include digital readout in degrees and minutes, 30 second resolution, continuous rotation, plug-in solid-state amplifier and power supply modules. Due to the design flexibility of these units, they can be readily provided with a variety of features for specific requirements. Typical units in this line incorporate combinations of the following features:

- Single Synchro or Resolver Input
- Dual Synchro or Resolver Inputs
- Retransmit Synchro, Resolver, Potentiometer, or Encoder
- 2-Speed Synchro Input
- Multi-frequency Inputs
- DC Input
- 0-999 Counter

BASIC SPECIFICATIONS

Range.....	0°-360° continuous rotation
Accuracy.....	6 minutes (standard)
Repeatability.....	30 seconds
Slew Speed.....	25°/second
Power.....	115 volts, 400 cps
Size.....	API-8025..... 1 3/4" h x 9 1/2" w x 9" d
	API-8027..... 3 1/2" h x 4 7/8" w x 9 3/4" d



Your local North Atlantic representative has complete data on the API line. Call him today or write direct for technical literature.

NORTH ATLANTIC industries, inc.
TERMINAL DRIVE, PLAINVIEW, L. I., NEW YORK • Overbrook 1-8600

LAPP GAS FILLED CAPACITORS

ARE DESIGNED FOR

HIGH
VOLTAGE

HIGH
CURRENT

HIGH
CAPACITANCE

APPLICATIONS



These uniquely designed Lapp Gas-Filled Capacitors are completely unaffected by atmospheric or dust conditions. They are precision built and of extra strong construction to assure years of accurate, trouble-free operation. ■ Lapp Gas-Filled Capacitors are available in either fixed or variable models. All are equipped with an external safety gap to protect against internal flashover on excess voltage peaks. Capacitance available up to 30,000 mmf, safety gap settings up to 85 kv peak and current ratings up to 400 amps at 1 mc. ■ Write for Bulletin 302... get our complete Gas-Filled Capacitor story. Lapp Insulator Co., Inc., Radio Specialties Division, 233 Sumner St., LeRoy, N.Y. 14482.

Lapp

Electronics notes

■ **Temperature scale.** The National Bureau of Standards has established a temperature scale for the region between 4° and 14° Kelvin. The 10° gap was bridged by a device developed by H. H. Plumb, a researcher at the bureau's Institute of Basic Standards. The instruments, an acoustical thermometer, now provides accurate calibration for germanium thermometers, which are commonly used in cryogenic temperatures.

■ **Pollution.** A \$100,000 laboratory is being equipped at the Massachusetts Institute of Technology to track down electromagnetic pollution and find ways to combat it. The director of the new lab, Tobert P. Rafuse, will direct a two-week course at MIT, starting Aug. 16, that will explore the problems and dangers caused by radio-frequency interference.

■ **Preserving foods.** Food preservation by irradiation moved a step closer to consumer use with the approval by the Food and Drug Administration of an array of packaging materials in which foods may be irradiated. The absence of such a list has been a major obstacle to the development of a large catalog of foods to be pasteurized by irradiation either from an isotope or from an electron accelerator radiation source. Although many commercial processors are experimenting with food irradiation, none has yet come up with a commercial product; decisions by the FDA on how such products must be labeled should provide further stimulus to what is expected to become a \$4-billion-a-year industry and a \$15-million-a-year electronics market.

■ **Shipboard computers.** The Navy has awarded an \$11.5-million contract to the General Telephone and Electronics Corp. for 23 computers over a three-year period. The equipment will be used on ships as part of the Navy's tactical data system, which collects and transmits information about the enemy.

This is a new Shallcross one-inch rotary switch. It is electro-mechanically superior, competitively priced, specified in minutes and delivered in hours.

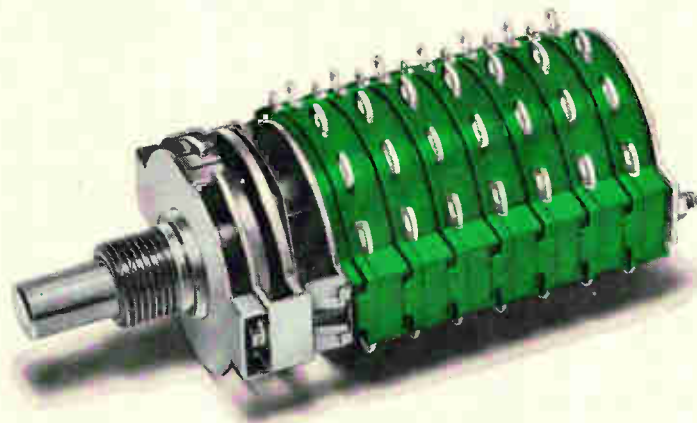

Otherwise it's like the others in its class.

A lot of people have liked our switches for a long time, but in some cases, they couldn't afford to pay for the extra quality we built into them.

So we figured out a way to make our new one-inch switches economical without sacrificing quality.

Our Series 1 line contains the superior materials, construction and performance expected in all Shallcross switches. Some of its features are: Low switching noise,

low thermal EMF, high insulation resistance, positive long-life detenting, superior contact resistance versus load versus life ratings, rugged terminals, enhanced voltage breakdown characteristics, and the most definitive electro-mechanical ratings in the industry.

The Series 1 has specification sheets as well as a comprehensive order code to make it easier to specify and order. (Your control draw-

ings can be created in minutes.)

Six Shallcross distributors throughout the nation provide 24-hour delivery on these and other Shallcross switches. You no longer have to use inferior switches because you can't afford Shallcross quality. Compare performance, specification ease, pricing, availability and cataloging, and we believe you will conclude that the Series 1 is a standout in its classification.



SHALLCROSS MANUFACTURING COMPANY

SELMA, NORTH CAROLINA / TEL. 919-965-2341

A NEW FACTORY-AGED XENON FLASHTUBE FOR HIGH ENERGY LASER PUMPING . . .

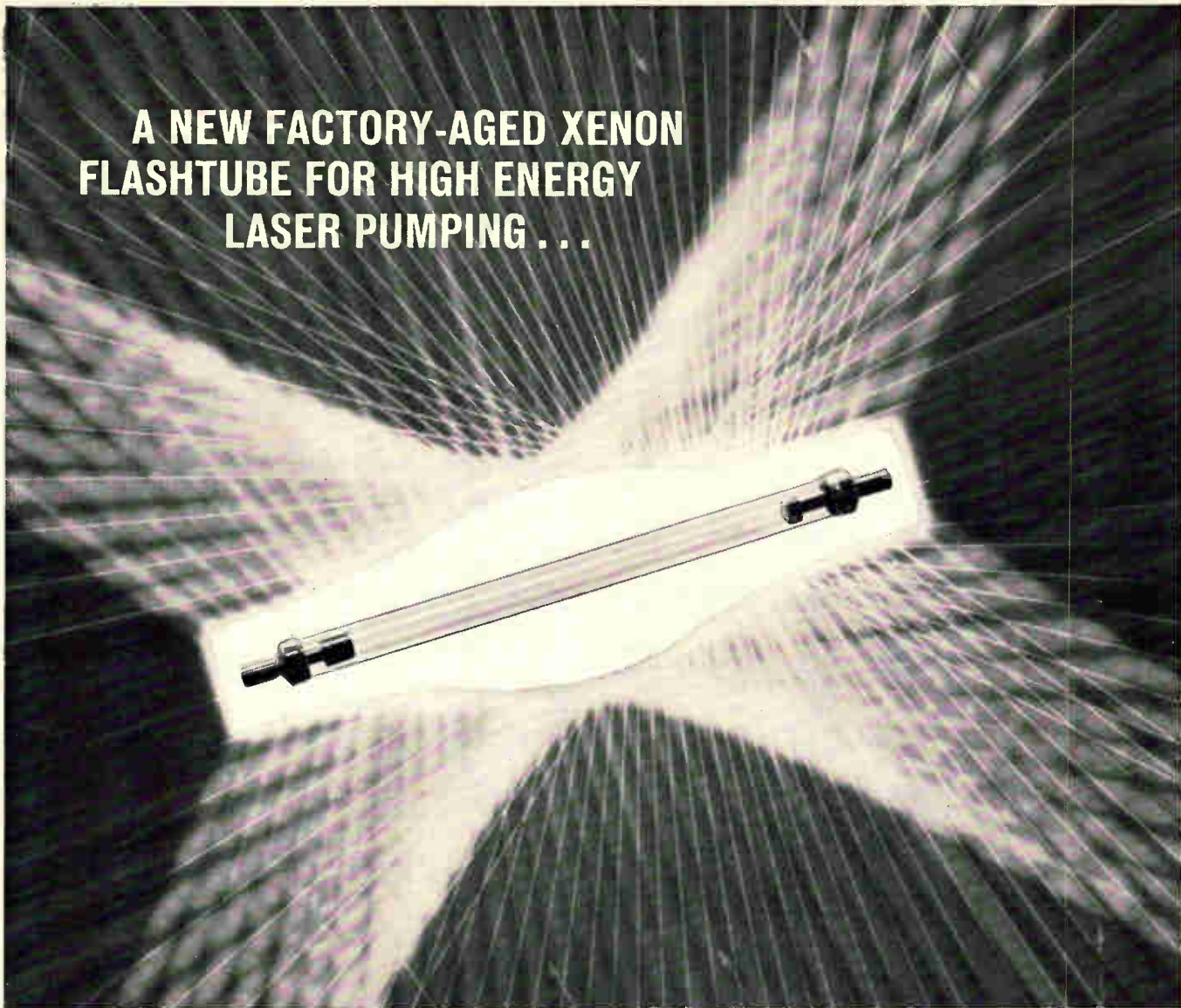

GUARANTEED UP TO 500 FLASHES (in a cavity)

The new EG&G pre-fired, factory-aged FX-47B Linear Xenon Flashtube has a guaranteed life of 500 shots when operated in a cavity at 4 kJ, 1.4 ms and cooled with dry nitrogen. In addition, it has a test bench demonstrated life of up to 300 shots at 10 kJ, 3.8 ms, when operated in free air with air cooling. This exceeds, by at least one order of magnitude, the 10-to-50 shot life of the equivalent non-aged tube.

EG&G's exclusive aging process achieves this significant increase in xenon tube life by strengthening the quartz envelopes, preconditioning the electrodes, and by the elimination, before shipment, of any tube that gives the slightest indication of premature failure.

The new FX-47B is priced at \$65, from stock, and is the first aged tube of its kind available commercially.

The overall EG&G xenon flashtube line is the broadest in the industry. It encompasses linear, helical, bifilar, annular, pi-shaped, internally triggered and custom designs having energy inputs from one joule/pulse up to many thousands of joules/pulse.

All EG&G xenon flashtubes feature: unique electrode design, resistance to thermal-electrical-mechanical shock, highest quality quartz envelope with uniform concentricity, in both bore and O.D., and large-area end-cap construction, which permits more efficient heat dissipation.

SPECIFICATIONS

Max. Input/Flash	{ 4 kJ @ 1.4 ms 10 kJ @ 3.8 ms
Operating Voltage Range	1 to 3 KV (DC)
Light Output/Flash	40,000 HCPS @ 10 kJ
Outer Diameter of Quartz Envelope	15 mm
Arc Length	6.5 inches
Overall Length	9 ¹³ / ₁₆ inches

For complete information on the FX-47B and other EG&G flashtubes, request Data Sheet 1002. Edgerton, Germeshausen & Grier, Inc., 176 Brookline Avenue, Boston, Massachusetts 02215. Phone: 617-267-9700. Cable address: EGGINC, Boston.



Now... two ways to factor a speed-power product of 40-

500 microwatts x 80 nsec new Philco MEL logic microcircuits for lowest power drain

Available for the first time—fast microenergy logic circuits with speed-power products of 40 per gate. This set of 3 microcircuits was developed by Philco Microelectronics Operation to answer the specific need of designers for the lowest possible power dissipation consistent with high-speed operation.

If your system boundary has been in the area of power requirements, these new logic circuits should permit a significant extension—a widening of design horizons.

The implications for designers of computers in aerospace applications are obvious. All three circuits, listed below, are available in production quantities. Call your Philco distributor.

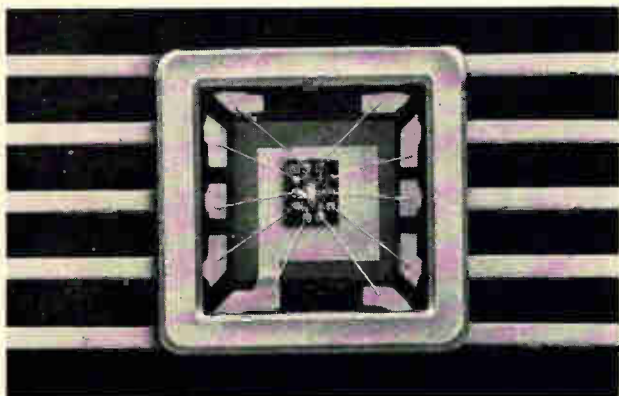

PL 986—Dual Buffer. PL 987—Dual-3 Input Gate. PL 988—J-K Flip-Flop.

3 milliwatts x 13 nsec Philco MW/3 logic microcircuits for highest speed

This complete family of 8 logic circuits, recently announced by Philco, arrives at its speed-power product of 39 by a combination of high speed (propagation delay only 13 nsec per gate) and low dissipation (3 mw per node). This combination is achieved without sacrifice of noise immunity (300mv at F. O. 5), or of fan-out capability.

Here again we invite you to examine your own speed and power requirements in the light of this available performance.

The full MW/3 family is available in production quantities, in all 8 circuits listed below. Write us for preliminary data sheets; for sample quantities, call your local Philco distributor.

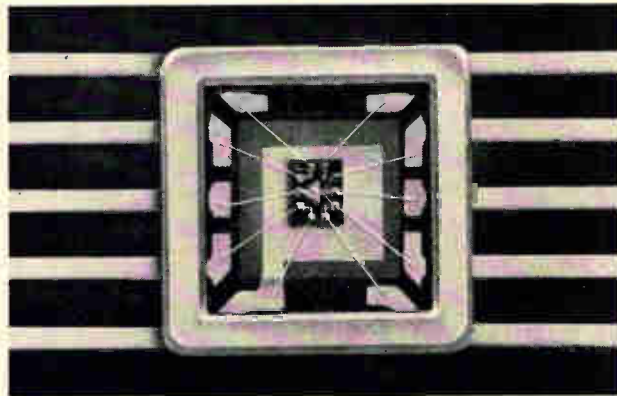

PL 975—Adder. PL 976—Buffer. PL 977—Dual-2 Input Gate. PL 978—Dual-3 Input Gate. PL 979—Gate Expander. PL 980—4-Input Gate. PL 981—Half-Adder. PL 984—Type D Flip-Flop.



MICROELECTRONICS OPERATION

PHILCO®

A SUBSIDIARY OF *Ford Motor Company*

LANSDALE DIVISION • LANSDALE, PA.
In Canada, Don Mills Road, Don Mills, Ontario, Canada

Cinch ingenuity in gold button welding technique keeps connectors reliable after repeated use.

The cross section drawing shows the pre-tension construction which provides more than .011" displacement of the female contact when the male contact is engaged. The ball shape, in pressing against the flat surface of the male contact, achieves extremely good contact because of the resultant high unit pressure.

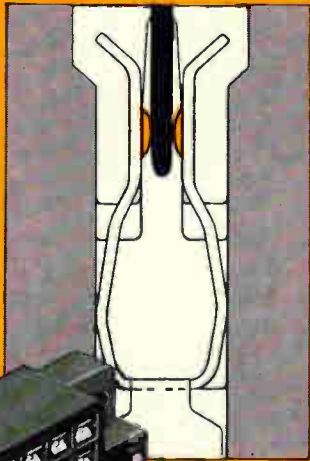

If you've ever wished you could achieve a higher degree of contact durability than is now possible with conventionally-plated connectors, you'll be interested in these new Cinch Gold Button Connectors. They give you superior contact reliability even after repeated use—at approximately the same cost you now pay for standard electro-plated connectors.

In a unique process, Cinch welds a small gold button on both contacting surfaces of the female contact. This provides extremely high contact reliability with no change in contact resistance through repeated make and break operations as well as at least 500 cycles with only minimal change in the insertion or withdrawal forces.

The Gold Button Connector is currently being supplied with wire wrap terminations in 50 and 72 contact sizes. Aluminum hoods and brackets of zinc-chromate plated steel are available. For further information write to Cinch Manufacturing Company, 1026 South Homan Avenue, Chicago, Illinois 60624.

CM-6517

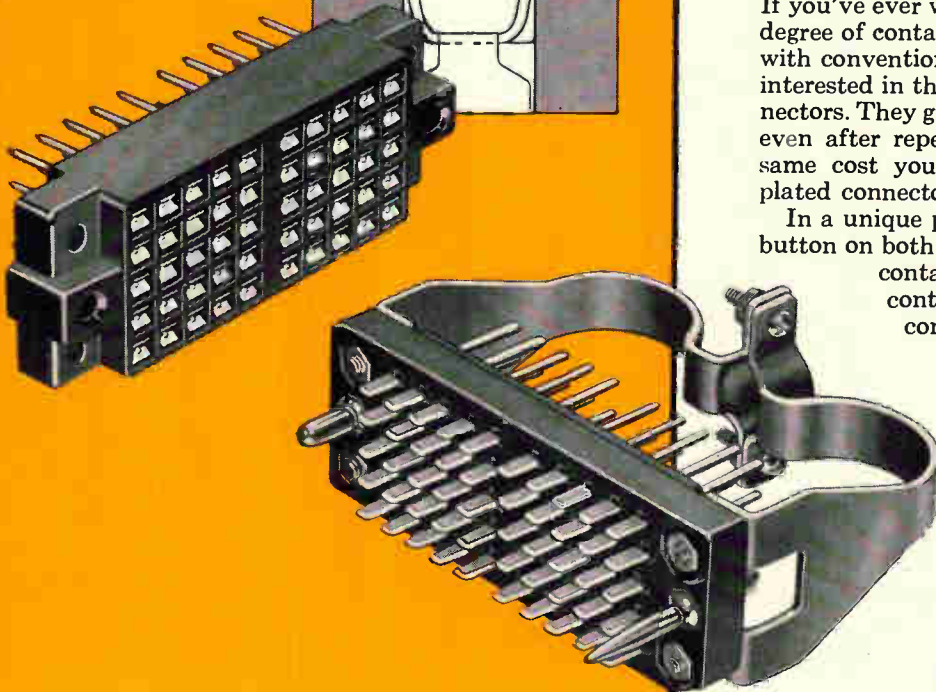

CINCH

DIVISION OF UNITED-CARR

See us at WESCON—Booths 1602-1603

Washington Newsletter

July 12, 1965

Defense outlays expected to rise

Another increase in defense spending seems imminent to offset the drain in military inventories caused by the war in Vietnam. Chairman John Stennis (D., Miss.) of the Senate Preparedness subcommittee, which has been investigating the war's impact on military readiness, says the depletion of military equipment is already serious and potentially critical. He says the fiscal 1966 budget, approved by the House without special funds for Vietnam, should be increased by \$1 billion. The bill is now before the Senate.

The \$700 million in special war funds, which Congress recently provided, is charged against the old budget, for the year that ended June 30. The new budget, for the year that started July 1, was drawn up before the air war against North Vietnam began and before the United States stepped up its commitments to South Vietnam's government.

On the House side, Appropriations Committee Chairman George Mahon (D., Texas) says the new budget, although currently adequate, will have to be increased before the year ends. He prefers, however, to wait until Defense Secretary Robert S. McNamara makes a formal request. McNamara agrees that more money may be needed, but expects to wait six months to ask for it; by then, he expects the long-range scope of the war to be better defined and the needs to be better spelled out.

Conference set on space budget

House and Senate conferees will hammer out budgetary differences on the civilian space program. The Senate-approved appropriation matches the \$5.2-billion authorization requested and signed by President Johnson. The House version approaches the slightly higher amount that the National Aeronautics and Space Administration originally requested, but probably will be trimmed in conference to match the authorization. NASA asked for \$69.6 million more than is authorized.

Cuts include \$30 million from the nearly \$3 billion sought for the Apollo program; \$12 million from the construction budget, including \$5 million from the \$10 million NASA wanted for the new electronics center in Cambridge, Mass.; and \$6.2 million from the \$172.1 million requested for the physics and astronomy program.

The full \$34.4 million sought for electronics systems research was granted. Congress increased NASA's \$27-million request for nuclear-electric systems research to \$33 million, with the extra \$6 million specifically going for development of a power reactor for use in space, a program NASA wanted to cancel. About \$3.9 million was cut from the \$246.2 million requested for tracking and data acquisition.

Panel favors rise in science funds

A major effort to increase federal support for science and engineering education and for all basic research is receiving support from a key Congressional committee. The upshot is expected to be increased stimulation of basic research by all federal agencies—now totaling some \$2 billion a year—plus a major rise in the \$250 million budget to support research and education under the National Science Foundation.

Administration spokesmen told the Research subcommittee of the House Science Committee during 21 days of hearings on the foundations future that a 15% to 20% annual increase in the nation's basic science

Washington Newsletter

and science education program is needed "for many years to come."

Subcommittee Chairman Emilio Q. Daddario (D., Conn.) made it clear that the purpose of the marathon hearings is to lay a base for increased foundation support.

Defense team breaking up

The departure of Eugene G. Fubini as assistant secretary of defense, research and engineering, is part of the changing-of-the-guard of federal officials whose decisions have an important impact on the electronics industry. Fubini becomes a vice president and director of the International Business Machines Corp.'s Research and Advanced Systems Development divisions July 19 (see related story on page 8).

Harold Brown, Fubini's boss at the Defense Department, is expected to leave soon also, as is Charles Hitch, the Pentagon's comptroller. Together with Thomas D. Morris, who resigned earlier this year as defense procurement chief, Hitch, Brown and Fubini formed the team headed by Defense Secretary McNamara that changed defense budgeting, buying and R&D practices.

Other changes: Raymond L. Bisplinghoff, chief of advance research and technology for the National Aeronautics and Space Administration, is resigning to become president of the Case Institute of Technology. Former Air Force Gen. William F. McKee, a management expert for the space agency, has shifted to the post of Federal Aviation Agency Administrator, (see story on page 52) succeeding Najeeb Halaby. And Comptroller General Joseph Campbell, head of the General Accounting Office, is quitting because of ill health.

Foreigners to pay more for U. S. arms

A new policy decreed by Defense Secretary McNamara will force defense manufacturers to raise the price of military hardware sold abroad. McNamara has ordered that foreign buyers be assessed a pro rata charge to help offset the U. S. government's investment in nonrecurring weapons costs—research, development, test, evaluation, production engineering and tooling.

The Pentagon put the policy into effect without any prior consultation with industry. Now that the principal decision has been made, industry groups are being consulted only on how to compute the charge; until a formula is agreed on, the Pentagon will make the assessments itself on a case-by-case basis.

Industry fears that U.S. sales abroad, which have been climbing significantly, will suffer from the higher prices that must be charged. Heretofore, one of the main U.S. selling points has been that foreign governments could get a better deal by buying American because they could forego the high R&D costs involved in developing comparable military equipment on their own.

Snap's power to be tripled

The Atomic Energy Commission is negotiating contracts for the development of a 75-watt isotope-powered thermoelectric power source for space operation—three times more powerful than its predecessors. First contracts for the project, called Snap 25 (systems for nuclear auxiliary power) may go to the Missiles and Space division of the Lockheed Aircraft Corp. and the Nuclear Materials and Equipment Co.

When you need High-reliability aluminum electrolytics ...Look at the Mallory line!

Whatever ratings you need, and whatever your reliability specifications may be, you can find the answer to your capacitor problems in the broad range of high-reliability Mallory aluminum electrolytic capacitors.

Computer Grade Type CG, leading choice for power supply applications, have the high capacitance values and superior filtering performance demanded for solid-state and conventional power supply circuits. Life-tested up to 60,000 hours without failure, equivalent to 20 years' service at 40°C ambient. Exceptionally low DC leakage, low impedance at frequencies to 4800 cps. Ratings from 160,000 mfd., 3 volts to 180 mfd., 450 volts.

Miniature types: Computers, test equipment and other applications. Type TPG, rated -40°C to +85°C are our "miniature computer grade." Life-tested to 10,000 hours; over a million piece-hours of certification with only one electrical failure. From 450 mfd., 3 VDC to 20 mfd., 150 VDC. Vertical mount, single-end model VPG also available. Type TTQ are economy priced miniatures, also rated -40°C to +85°C; they're produced under quality control procedures patterned after MIL specs. Life expectancy is 10 years or more under normal operating conditions. Values: 300 mfd., 3 VDC to 2 mfd., 150 VDC.

Premium grade PG. The standard for telephone service and instrumentation. Built to specifications which indicate life up to 30 years under normal service conditions. Ratings from 100 mfd., 450 VDC to 13,000 mfd. at 3 VDC.

Heavy-duty Types HC and NP. Bakelite case units for welding and other heavy power supply service. Polarized Type HC: ratings from 500 mfd., 200 VDC to 15,000 mfd., 10 VDC. Non-polarized Type NP in ratings from 100 mfd., 450 VDC to 500 mfd., 125 VDC.

For complete data and a consultation, write to Mallory Capacitor Company, a division of P. R. Mallory & Co. Inc., Indianapolis, Indiana 46206.



MALLORY



Is your diode "bias" showing?

Chances are it is! That's because past experience with molded plastic devices has resulted in some popular misconceptions: plastics "burn or support combustion"; "devices fail due to junction contamination"; "seals against moisture are not effective". Such bias does have a basis—but not with the diode shown above.

Dow Corning® molding compound is used to protect this diode because the manufacturer found it could be rated at four times the power of a similar glass packed diode... withstands operating temperatures to 250 C! Other advantages:

Compared to glass packages—silicone molded devices easily withstand repeated thermal shocks... have less weight... give higher performance ratings... generally cost less.

Compared to metal cans—devices packaged in silicone molding compound are smaller, lighter, lower priced... equal in reliability and performance.

Compared with organic plastics—*Dow Corning silicone molding compound doesn't contaminate junctions... won't burn... doesn't deform during soldering... passes military moisture resistance tests... assures long term reliability.*

Bias can be costly where it fails to consider all available facts. You owe it to yourself to evaluate components packaged in silicones. For a list of manufacturers who offer devices protected with Dow Corning silicone molding compound, write: Dept. 3919, Electronic Products Division, Dow Corning Corporation, Midland, Michigan 48641.

DOW CORNING

Get 'em at Hughes

1N703A 1N497 1N461 2N722 1N270JAN 1N427 1N663
1N128 1N348 1N702 1N625 1N277JAN 1N702 1N625 1N90
1N709 1N627 1N338 1N86 1N140 1N740 1N127 1N276JAN
1N192 1N345 1N598 1N598 1N255 1N626 1N341 1N959A
2N3305 1N283 1N117 1N89 1N349 1N699 1N254 1N128
1N69A 1N276 1N597 1N126A 1N711 1N181A 1N465 1N470
1N95 1N710 1N347 1N706A 1N139 1N332 1N468 1N957
1N712 1N816 1N714 1N908 1N715 1N768 1N837 1N3243
1N344 1N253 1N497 1N96 1N905 1N751 1N771A 1N916B
1N914 1N818 1N726 1N891 1N720 1N915 1N752 1N1990
1N755 1N773 1N914 1N746 1N719 1N904 1N931 1N4371
1N917 1N750 1N958 1N848 1N758 1N812 1N957 1N3053
1N813 1N749 1N879 1N844 1N746 1N840 1N3468 1N4370A
1N742A 1N949 1N772 1N930 1N757 1N706 1N724 1N3244
1N716 1N840 1N781 1N194 1N815 1N769 1N2578 2N1034
1N811 1N777 1N906 1N756 1N954 1N775 1N717 2N1132B
1N810 1N929 1N761 2N1224 1N811 1N748 1N959 2N1035
1N725A 1N954 1N774 1N358 1N3062 1N388 1N2530 1N759
1N3727 1N3287 1N1940 1N2582 1N395 1N90 1N98 1N1986
1N287 1N3872 1N1991 1N3056 2N329A 2N1239 1N3604
1N3052 1N100 1N709A 1N960 1N764 1N713A 1N723 1N770
1N1935 1N1315 1N1410 1N969 1N932 1N762 1N954 1N91
2N1132 2N3306 1N695A 1N3914 1N3914 1N3060 1N3666
1N4321 1N3068 1N4372 1N3055 2N328A 1N3991 1N2571
2N2721 1N1990 1N3205 1N2065 1N1987 1N3592 1N2572
1N933 1N2532 2N1131 1N763 2N3225 ETC ETC ETC

Over 1,000 types available for off-the-shelf delivery
from your nearest Hughes distributor—or direct from
Hughes, Newport Beach. We promise prompt delivery.



WHERE CAN MAN GO...IN R & D?



To distant planets, to land-vehicles of the 1970's to a region far beyond the grasp of man today—the ocean bottom. Lockheed's major R & D programs reach from deepest space to the ocean deep. Micro-particles, advanced concepts of re-entry, cryogenics, materials, lunar-crawling systems, automated hospitals, data compression systems, ocean mining and deep submergence—these are a few of Lockheed's R & D interests ranging across space, land and undersea environments. Scientists and engineers, particularly those with an R & D and systems bent, are invited to write Mr. K. R. Kiddoo, Professional Placement Manager, 413 Industrial Relations Building, Post Office Box 504, Sunnyvale, California. Lockheed is an equal opportunity employer.

LOCKHEED
MISSILES & SPACE COMPANY
A GROUP DIVISION OF LOCKHEED AIRCRAFT CORPORATION

Another great idea from Daven...

When
there's no room
in here...



put your
rotary switch
out here!

The new Daven Switch-in-knob

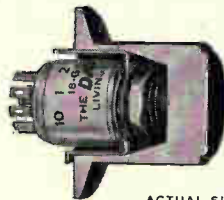

ACTUAL SIZE

Tight squeeze behind the control panel? Use the brand new Daven Switch-In-Knob . . . the world's smallest rotary selector switch built right into the knob. Now the switch is *outside* your instrument . . . *inside* the knob.

And all you need is $\frac{3}{16}$ " behind the panel, eliminating $\frac{1}{8}$ " from the overall length of the standard Series G and K switches.

Yet for all its compact advantages, the Switch-In-Knob includes *all* the features of the popular military Series G or the new commercial

Series K switch.

The Series G has high reliability, superior dielectric strength, and longer life. It is built in a clean room environment to meet applicable Mil specs on temperature, humidity, corrosion, vibration, acceleration, shock and immersion. And it is both explosion-proof and waterproof.

The Series K was developed for instrument and commercial applications where the same size, quality and electrical specs as the Series G were needed . . . at a lower cost.

Although the Series K (without knob) costs only \$4.85 to \$3.85 each (depending upon quantity), it is a completely enclosed unit offering long life, low contact resistance, high dielectric strength, wide operating temperature range, positive detent action and resistance to corrosion, shock and vibration. Both the Series G and K come in single deck, shorting and non-shorting . . . in various combinations up to 4 poles and 10 positions.

Write today for complete specs and prices on the new Switch-In-Knob!

DAVEN 
LIVINGSTON, NEW JERSEY
(201) WYman 2-4300 • TWX 201 992-7356 • Cable: DAVEN LIVINGSTON N J

At Signetics we stick our neck out to get above the fog level:



announcing a new kind of integrated circuit data sheet.

No foggy "typical characteristics" talk. Signetics new data sheets provide the systems designer with the clarity of *GUARANTEED WORST CASE DESIGN LIMITS*. Now you can design without calculating or worrying about any additional safety factors or guard bands. And for component and reliability engineers, each data sheet is a model procurement document, complete down to details of acceptance, quality assurance, and environmental test methods and limits in accordance with all applicable MIL specifications. Get above the fog level. Know exactly what you are buying. Mail the coupon today.

**SIGNETICS
INTEGRATED
CIRCUITS**



A SUBSIDIARY OF CORNING GLASS WORKS

SIGNETICS CORPORATION, 811 E. ARQUES AVE., SUNNYVALE, CALIF.

All right, Signetics, prove it. I want your new Data Sheets on your complete line of DTL elements.

NAME _____

COMPANY _____

ADDRESS _____

CITY _____

STATE _____

ZIP _____



TOTAL microCIRCUIT CAPABILITY

Here's one of the most all-inclusive lines of integrated circuits available anywhere: DTLs, TTLs, ECLs. Our advanced microcircuit facilities keep quality up and unit cost down. All processes and materials conform to the quality and reliability required in military components. And this at no extra cost.

Find out how easily your total microcircuit requirements can be filled at Stewart-Warner Microcircuits:

PROPRIETARY LINE

- SW 702 • TTL LOWER POWER DUAL NAND GATE
- SW 708 • DTL HIDRIVE DUAL NAND GATE
- SW 720 • DTL HIDRIVE RS/JK CLOCKED FLIP-FLOP
- SW 700 • BINARY DECADE COUNTER
- SW 710 • RING DECADE COUNTER

PIN REPLACEMENT SECOND SOURCE ITEMS

DTL

- SW 930 • DUAL 4-INPUT NAND GATE WITH AND EXPANSION TERMINAL
- SW 931 • RS/JK CLOCKED FLIP-FLOP
- SW 932 • DUAL 4-INPUT BUFFER WITH AND EXPANSION TERMINAL
- SW 933 • DUAL 4-INPUT AND EXPANDER
- SW 944 • DUAL 4-INPUT LAMP DRIVER WITH AND EXPANSION TERMINAL
- SW 945 • RS/JK CLOCKED FLIP-FLOP
- SW 946 • QUADRUPLE 2-INPUT NAND GATE
- SW 948 • RS/JK CLOCKED FLIP-FLOP

ECL

- SW 301 • 5-INPUT OR/NOR GATE
- SW 302 • RS FLIP-FLOP
- SW 303 • HALF ADDER
- SW 304 • BIAS DRIVER
- SW 305 • GATE EXPANDER
- SW 306 • 3-INPUT OR/NOR GATE WITH EXPANSION TERMINAL
- SW 307 • 3-INPUT OR/NOR GATE WITH EXPANSION TERMINAL
- SW 308 • J-K PULSE FLIP-FLOP
- SW 309 • DUAL 2-INPUT NOR GATE
- SW 310 • DUAL 3-INPUT NOR GATE
- SW 311 • DUAL 2-INPUT NOR GATE

ALSO PIN REPLACEMENT SECOND SOURCE DEVICES FOR THE MAJOR LINES OF DTL AND TTL FAMILIES WILL SOON BE AVAILABLE.

STEWART  WARNER

MICROCIRCUITS, INC.

SUBSIDIARY OF STEWART-WARNER CORPORATION
730 East Evelyn Avenue, Sunnyvale, California 94086 • Phone: (408) 245-9200

REGIONAL SALES OFFICES

Western 12014 Wilshire Blvd.
Los Angeles, California
Phone 213-477-2544

Midwestern 1300 N. Kostner Ave.
Chicago, Illinois
Phone 312-AL 2-1000

Eastern Seaboard 84-40 153rd Ave.
Howard Beach, New York
Phone 212-835-0010

European Stewart-Warner Ltd.
Elizabeth Way
Harlow, Essex, England

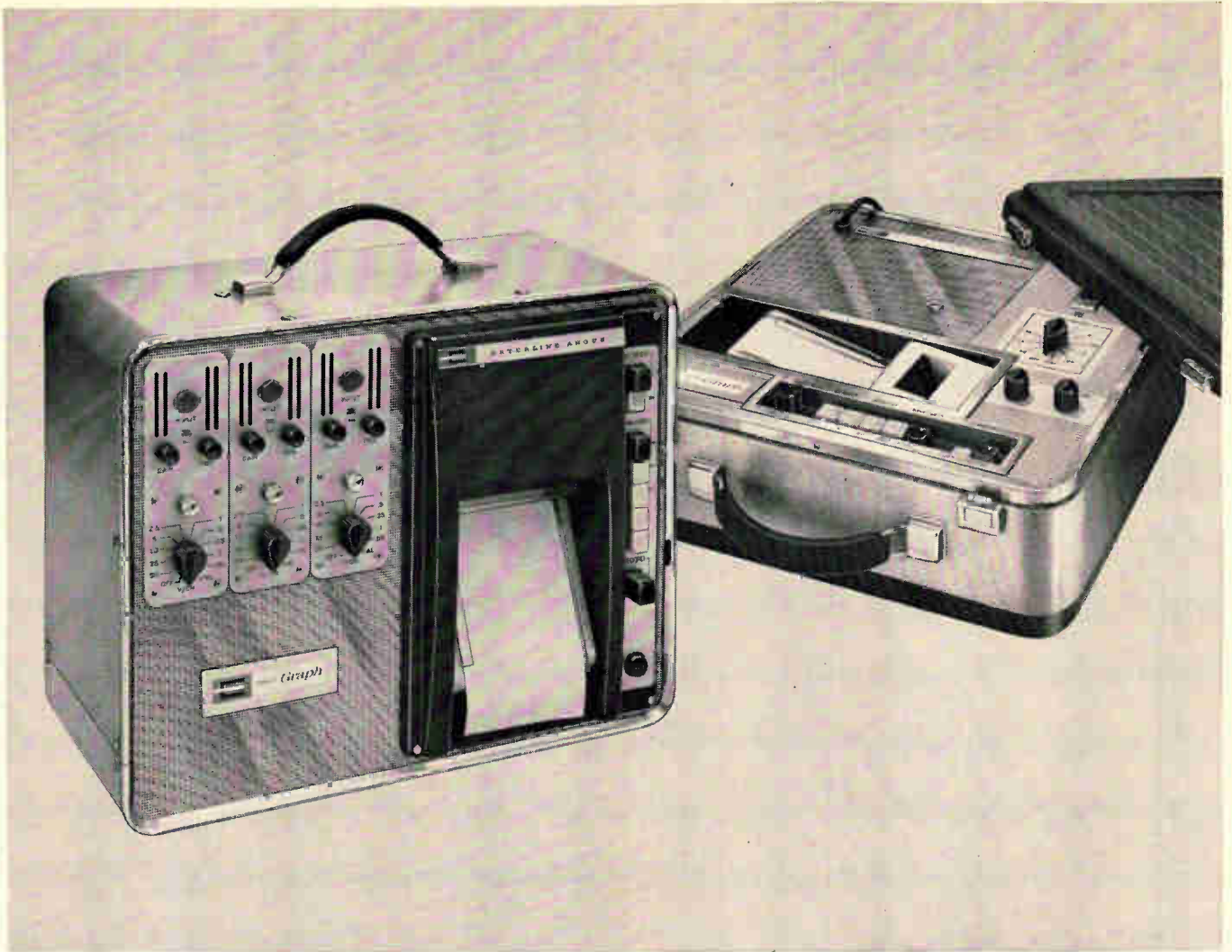

90 cps full scale response
+
3 channels } = your best Oscillo Graph buy

Take your choice—the only Three-channel Portable Oscillo Graph available, or Two or One-channel Oscillo Graphs.

All feature exceptional frequency response . . . flat to 90 cps at 30 mm peak-to-peak. It's down only 3 db at 125 cps. Other features:

- Balanced differential amplifier in modular form for Two and Three-channel Recorders. Same amplifier is built into the Single-channel Recorder.
- Four push-button controlled chart speeds—1, 5, 20 and 100 mm per second.
- Stylus motor uses no permanent magnets. Eliminates the clutter of brushes, slip rings, armature leads and linkages found in other stylus drive mechanisms.

Like cabinet model Esterline Angus Oscillo Graphs, portables employ the exclusive inkless, heatless Direct-Carbon-Transfer writing method. Advantages of D-C-T?

- Finest trace provides greatest resolution. 0.005 inch trace occupies only 1/4% of full scale. Competitive oscillographs produce a trace which is three times wider.

- No pens to clog or ink to splatter.
- Chart paper at half the cost of heat sensitive paper.
- No stylus temperature adjustments to bother with.
- Chart requires no special handling and is unaffected by light, humidity or temperature.

For trouble-free writing, economy and unequalled response, investigate Esterline Angus Oscillo Graph Recorders.

Write for colorful Series "O" catalog.

ESTERLINE ANGUS INSTRUMENT COMPANY, INC.
Box 24000 E • Indianapolis, Indiana 46224

ESTERLINE ANGUS



Excellence in instrumentation for over 60 years

Technical Articles

**Adding force to
integrated circuits:**
page 72

If semiconductor strain gages are integrated into silicon spring-like structures, the result is a microelectronic transducer. Accelerometers, pressure sensors, and vibration pickups that are smaller, lighter and more reliable than conventional devices can be made this way.

**Stress-sensitive
integrated circuits:**
page 81

When pressure is applied to a p-n semiconductor junction, the current and voltage across the junction change—and the change is predictable. This phenomenon makes it possible to combine a transducer with a data processing circuit on the same monolithic integrated circuit, shrinking the size of such a system many times.

**Shortcut to
calculating Q:**
page 85

Charts simplify the number of calculations required to make an r-f design. They are particularly convenient when designing multistage tuned amplifiers, where the total circuit Q must be apportioned to the individual stages.

**Low-cost flatpack: remove
wires, put circuits under
glass:**
page 98



A new packaging technique for integrated circuits uses no wires. Parts and materials for it cost about 2 cents, much less than the usual flatpack package with bonded leads. In addition, integrated circuits packaged this new way store better because there is no gold in the package to cause what the industry calls purple plague. The wireless package is rugged enough to withstand pounding with a hammer. For this issue's cover, a high-contrast enlargement was made directly from a circuit chip with bonded leads.

**Coming
July 26**

- An examination of the electronics in San Francisco's mass transportation experiment
- Optically coupled integrated circuits
- Generating sweep waveforms accurately
- How negative resistance affects field effect transistors

Adding force to integrated circuits

That's how to produce semiconductor transducers that are simpler, smaller, lighter and more accurate than conventional devices

By Edgar J. Evans

Picatinny Arsenal, Dover, N.J.

Integrated circuit techniques are moving into the transducer field. If semiconductor strain gages are integrated into silicon spring-like structures, it is possible to produce microelectronic accelerometers, pressure sensors, and vibration pickups that have the advantages of other integrated circuits—reliability, mass production capability, and size reduction.

Additionally, microelectronic transducers have approximately 100 times more output than conventional strain-gage transducers, and exhibit greater dynamic range, freedom from output hysteresis, and an inherent simplicity that makes them reliable for missile, ballistic and space applications.

For example, microelectronic transducers can monitor critical points in a manned spacecraft and sound the alarm if dangerous vibrations occurs. In an unmanned craft, they can start corrective action. They can shut off the motor of a missile if strain corresponding to a certain amount of acceleration occurs. In conjunction with other circuitry, they can arm the warhead of a missile when a particular location is reached (a safety feature for the missile-firing crew).

Strain gages

A semiconductor strain gage made from material with piezoresistive properties (such as germanium or silicon) is basically a resistor whose resistance varies as the stress on it changes. If the changing stress on a circuit which is composed of strain-gage

resistors produces a corresponding change in voltage, the device becomes a transducer. In a typical accelerometer application, a microelectronic transducer monitoring changes in acceleration up to 10 g's, and powered by a 28-volt battery supply can produce output voltages which may exceed 1,000 millivolts. By comparison, the voltages produced by conventional strain gages subjected to the same conditions normally are under 35 millivolts.

The integrated circuit contains five resistors, four of which form a Wheatstone bridge. Each of these four resistors acts as a separate strain gage and contributes to the bridge's voltage output. The fifth resistor is actually a thermistor and compensates the output signal for changes in temperature.

In some transducers a strain gage normally is bonded to the spring member being subjected to stress. One disadvantage of this method is that a bonding agent must be employed to attach the gage to the spring member. During transmission of strain from the spring member to the gage, distortions and shifts in output level may be introduced by the bonding agent.

Integrated-circuit transducers avoid the problems associated with the bonding of conventional gages, since the individual strain-gage resistors are diffused into a silicon spring member. The gaging devices and the spring member being subjected to an applied force form an ideal combination. Not only is the bonding agent eliminated, but thermal mismatch is also avoided since both the strain gages and the spring member are made of the same single-crystal silicon. Electrical isolation (prevention of current flow from the gage to the spring member) is achieved by the p-n junction formed between the p-type gage material and the n-type spring member material.

The semiconductor transducer is actually a simple integrated circuit with force as an additional input. As the force is accelerated, it creates a bending moment. The resistance of the strain gage resistors changes in proportion to the applied strain and an output voltage proportional to the applied force is produced. The valves chosen for the re-

The author



Edgar J. Evans, a solid state physicist, has been with the Engineering Sciences Laboratory at Picatinny Arsenal since 1961. He is currently investigating materials for use in transducers. He received a master's degree in physics from Fairleigh Dickenson University.

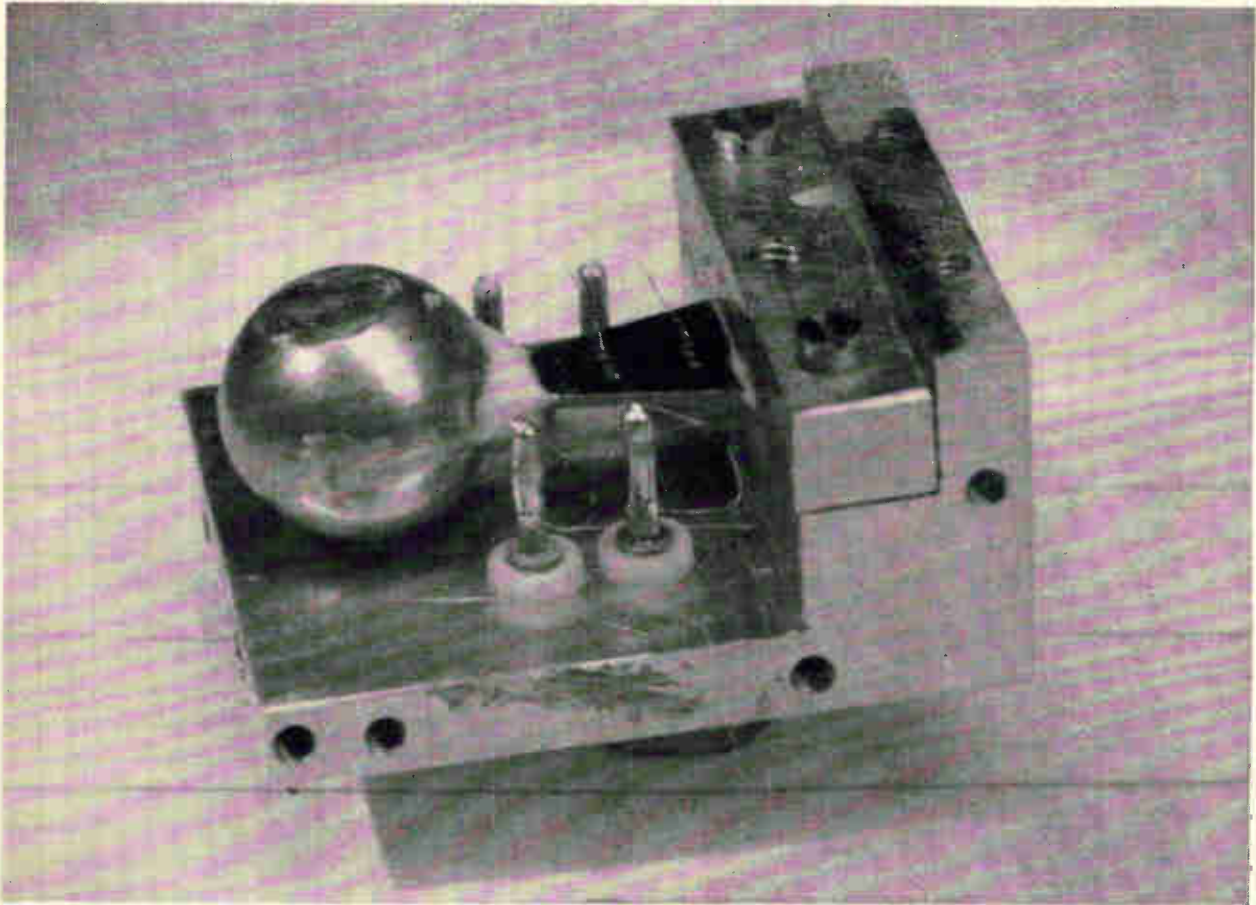

Accelerometer with its top plate removed, above. The large round object at the left is a seismic mass. The four prongs allow connection to the strain-gage bridge circuit. Two of the semiconductor strain gages are contained in the upper surface of the silicon member and two in the lower surface. The photograph at the right shows another accelerator with top cover in place. The quarter gives a size comparison.

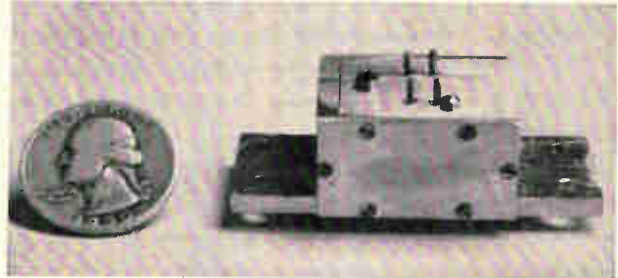

Testing the accelerator in the laboratory with simulated application of stress caused by acceleration. Several accelerators were built to monitor changes in acceleration to 100 g's. The accelerators were designed to operate with 28-volt battery supplies. Typical variations in output signal caused by changes in stress sometimes exceeded one volt.

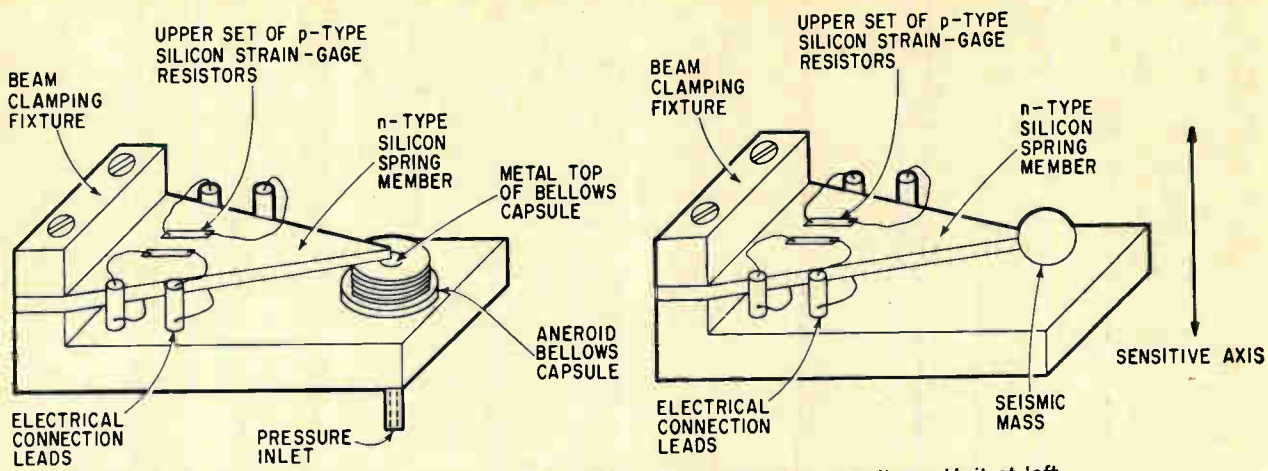

Two semiconductor transducers for converting force variations into changes in voltage. Unit at left monitors air pressure; device at right monitors acceleration. Four p-type silicon strain-gage resistors are diffused into the n-type silicon spring member and connected to function as a Wheatstone bridge. The spring member is deflected by the force exerted by the aneroid pressure capsule (device at left) or by acceleration. This creates a bending moment in the cantilever beam that is detected by the diffused strain-gage resistors and converted into a change in electrical output.

sistors is determined by the force being monitored.

Criteria have been formulated for designing accurate and reliable semiconductor microelectronic transducers. The units which have been constructed thus far have used boron-doped p-type silicon for the resistors and arsenic-doped n-type silicon in the host lattice.

The p-type regions are formed in the spring member by diffusing boron into the n-type silicon. The boron diffusion process provides p-type regions that do not have uniform resistivity with depth. The p-region resistivity is low at the surface and increases abruptly with depth, becoming highest in the vicinity of the p-n junction, (see the panel on the next page). At the p-n junction, the density of boron impurity atoms in the p-type silicon is equal to the density of arsenic impurity atoms in

the n-type silicon. The sensitivity of the transducer is a function of the strain-gage average resistivity. The desired gage properties are accurately obtained by careful selection and control of the diffusion time, temperature, surface concentration, and furnace atmosphere.

Transducer design equations

The design of a semiconductor transducer is relatively straightforward. To design a transducer, the total resistance of each gage used must be determined as a function of temperature and strain. To do this, an expression for the average resistivity of the p layer as a function of temperature (with no applied stress) is a prerequisite. This is given by:

$$\rho_{AV}(T) = \rho_S(T)x_Y \quad (1)$$

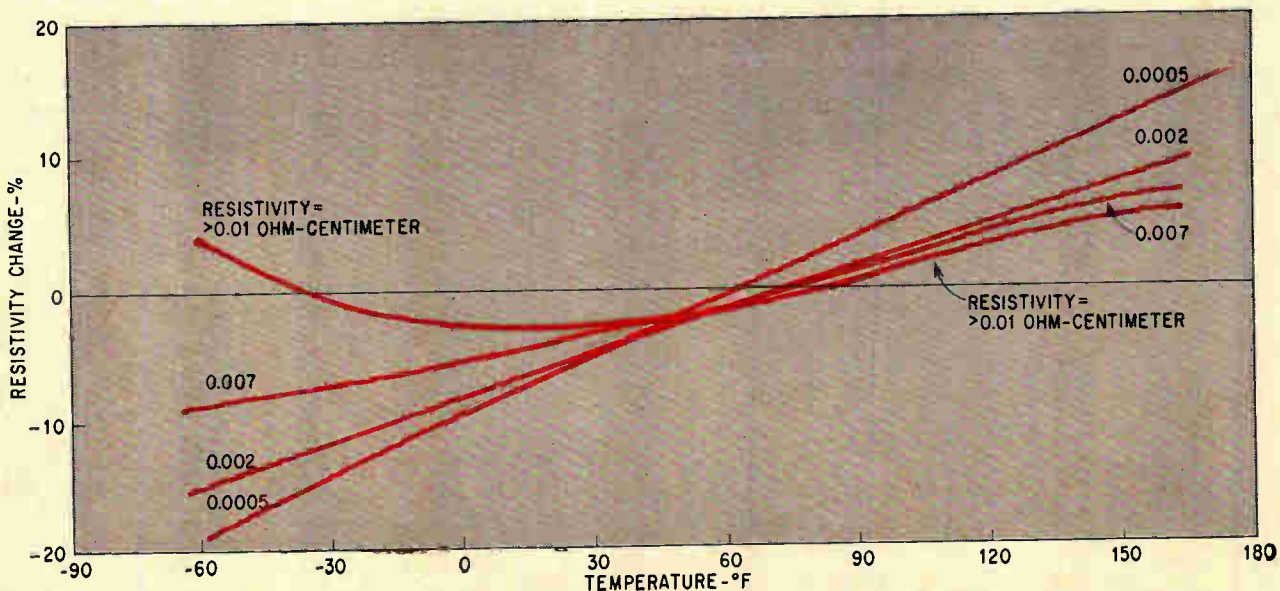

Plotting change in resistivity as a function of temperature for various values of resistivity shows that sensitivity to temperature is less with high resistivity values. The junction depth of the n-type silicon material is 2 microns.

where ρ_s = specific resistance per square surface area
 x_γ = depth of p layer

The total resistance of a strain-gage resistor without any applied strain is given by:

$$R_o(T) = S\rho_{AV}(T)/x_\gamma = S\rho_s \quad (2)$$

where S = number of squares of gage geometry or the length-to-width ratio

The strain sensitivity (gage factor) of the p layer is also temperature-dependent and is given by:

$$G(T) = \Delta R_e(T)/R_o(T)\Delta\epsilon \quad (3)$$

where $\Delta R_e(T)$ = total resistance change at a constant temperature, T , due to a change in strain, $\Delta\epsilon$

The gage factor is also affected by the direction in which force is applied. However, since in an accelerometer the force being monitored is always applied along the same axis (111 axis) this affect is neglected in the above equation.

The total resistance of the diffused strain-gage resistor as a function of temperature and strain is equal to the resistance of the diffused gage at zero strain plus the component of resistance change due to strain, or

$$R(T, \epsilon) = R_o(T) + \Delta R_e(T) \quad (4)$$

Equation 4 can be combined with equations 2 and 3 to produce an equation for total resistance in terms of resistivity and gage factor. This equation is:

$$R(T, \epsilon) = (S/x_\gamma)\rho_{AV}(T)[1 + G(T)\Delta\epsilon] \quad (5)$$

The effects of changes in temperature on the resistivity and gage factor of p-type silicon are shown on pages 74 and 76. Since sensitivity to temperature variations exists, a method of temperature compensation is required if the transducer is to perform accurately in a normal environment.

A Wheatstone bridge, when used in conjunction with a temperature compensating device, should satisfy most requirements. Each of the four arms should be made of exactly the same material so that the resistivity and gage factor as a function of temperature are identical for each one. The resistance values of each gage should also be identical under zero strain at the reference temperature. The gages are oriented in the structure so that two resistors are in tension while two are in compression when strain occurs.

The four resistors must be placed in good thermal contact with the compensating thermistor, so that no temperature differential exists between the five components.

Accelerometer example

Suppose a transducer is needed to act as a linear accelerometer. The available power supply is 28 volts d-c and a full-scale d-c output voltage of 0.5 volt is required for an acceleration of 100 g's. The triangular-shaped structure shown on page 74 can be used to advantage in this application.

A typical bridge output impedance of 500 ohms is assumed. The resonant natural frequency is

Conductivity profile

The structure of the semiconductor transducer may be easily varied to meet the specifications of various applications. Here are some ways in which this can be accomplished.

The curve shown below depicts the concentration of impurity atoms at various distances from the surface of the semiconductor strain gage. It is often called a conductivity profile since it also reveals the degree of conductivity at any particular depth from the surface (conductivity is directly proportional to impurity concentration).

The straight line represents the concentration of n-type arsenic impurity atoms in the host lattice. This concentration is constant throughout the silicon material. The intersection of this straight line and the curve representing the concentration of p-type impurity atoms is the junction between a strain-gage resistor and the spring member.

Below the junction, arsenic impurity atoms outnumber boron impurity atoms and the material is n-type.

Strain sensitivity

The average resistivity of the diffused layer (the strain-gage resistor) is relatively independent of the depth at which the junction is located, and is, essentially, a direct function of the surface concentration of impurity atoms. This means that the strain sensitivity (or gage factor) can be determined from the layer average resistivity value, or the surface concentration. This, of course, also means that a diffusion surface concentration can be chosen to provide the desired piezoresistive properties. Proper selection of the geometry of the diffused area and the thickness of the diffused layer will then yield the desired resistance for the strain gage.

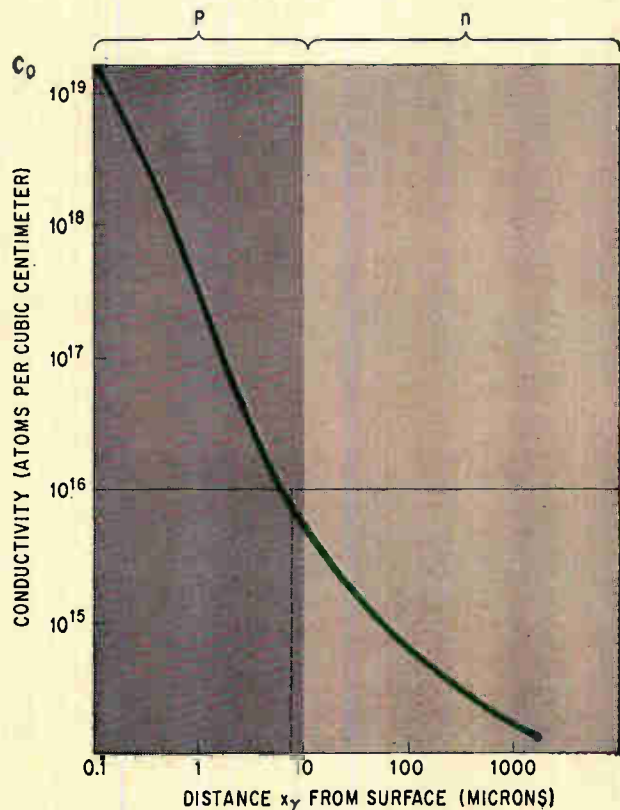

Conductivity profile for a typical semiconductor transducer with a distance of 10 microns from the surface to the p-n junction.

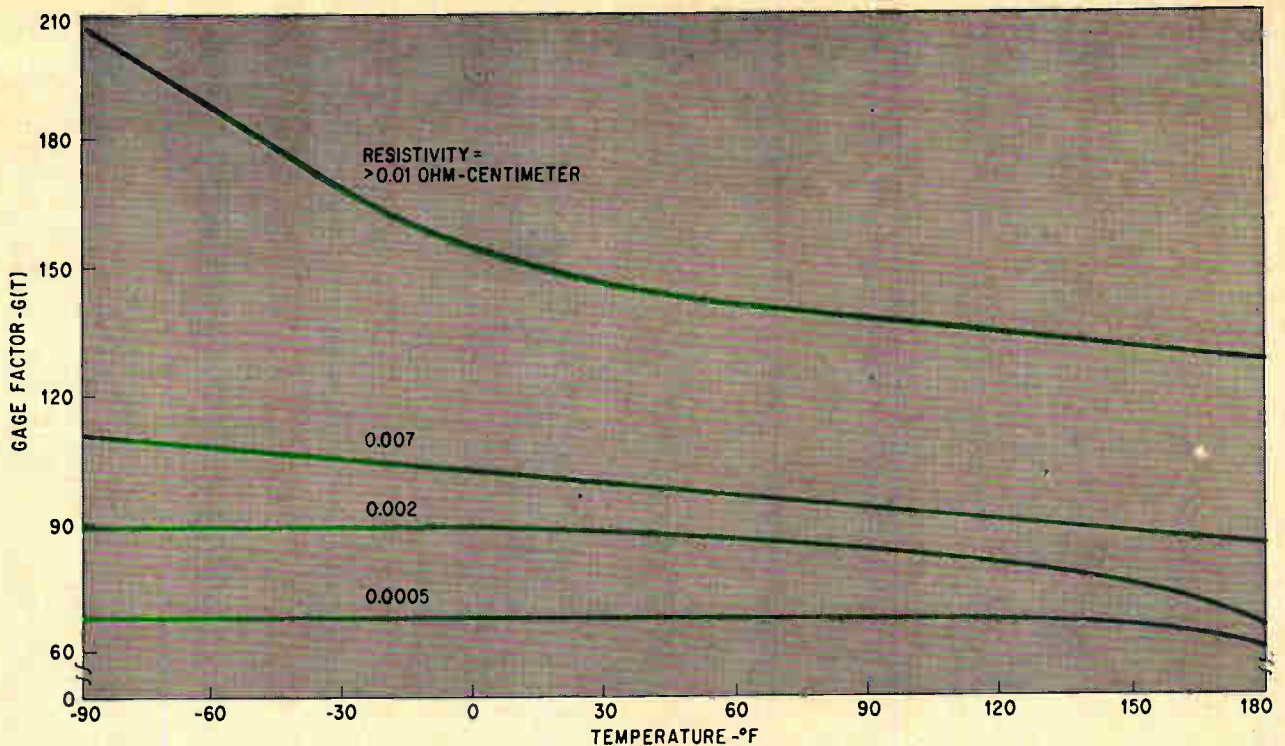

Gage factor (strain sensitivity) drops off as temperature increases. Curves shown are for p-type silicon material having various levels of resistivity.

arbitrarily specified as 360 cycles per second, to avoid using a frequency that may be the same as other natural frequencies which occur in the overall system.

Maximum strain

The maximum strain level (the change in length per unit length) should be kept under 0.0005 since nonlinearity may be introduced at higher levels.

The expression for natural frequency of vibration neglecting the mass of the spring is:

$$f_n = \frac{1}{2} \pi (a_{MAX} D / L^2 \epsilon_{MAX})^{1/2} \quad (6)$$

where a_{MAX} = maximum acceleration

D = beam thickness

L = beam length

ϵ_{MAX} = maximum surface strain

For use in the above equation, the maximum acceleration of 100 g's (actually 100 x 32 feet per second squared) is converted to $10^2 \times 384$ inches per second squared. Substituting $a_{MAX} = 10^2 \times 384$ inch/square second; $\epsilon_{MAX} = 5 \times 10^{-4}$; and $f_n = 360$ cps, yields $D/L^2 = 0.062$ inch.⁻¹

It is not difficult to meet the restriction imposed by this ratio of spring length to thickness to maintain a natural frequency of 360 cps. If an arbitrary length for the silicon spring is chosen as 0.575 inch, the required thickness is $D = 0.062 (0.575)^2$ or 0.021 inch.

For ruggedness, and in order to avoid detrimental effects caused by lateral forces (forces not applied in the direction being sensed or monitored), the beam width, b , should be at least one half the beam length. Therefore:

$$b = 0.5L = 0.5(0.575) = 0.288 \text{ inch}$$

Applied force

The force on the tip of the beam that will generate maximum surface strain can now be obtained from:

$$W = \frac{\epsilon_{MAX} E (b_{MAX}) D^2}{6L} \quad (7)$$

where E = modulus of elasticity of silicon
 $= 27 \times 10^6$ pounds per square inch

$$W = \frac{(5 \times 10^{-4})(27 \times 10^6)(.288)(0.021)^2}{6(0.575)}$$

$$= 0.5 \text{ pound}$$

To generate a force of 0.5 pound at an acceleration of 100 g's, the seismic mass attached to the tip of the beam should be $W/100$ or 0.005 pound.

The total deflection of the mass that occurs at 100 g's is given by:

$$y_{MAX} = (L^2/D) \epsilon_{MAX}$$

Substituting, $L = 0.575$, $D = 0.021$, and $\epsilon_{MAX} = 0.0005$, y_{MAX} is 0.0077 inch.

It has been determined experimentally that material with an average resistivity of 0.007 ohm-centimeter for the p layer provides excellent results at diffusion depths of about 2 microns (2×10^{-4} centimeters). Rewriting equation 2 and substituting $\rho_{AV} = 0.007$, and $x^y = 2 \times 10^{-4}$, yields:

$$\rho_s = \rho_{AV} / x^y$$

$$\rho_s = .007 / 2 \times 10^{-4} \text{ or } 35 \text{ ohms per square}$$

Since the output impedance is to be approximately 500 ohms, each diffused strain-gage resistor should also have a resistance of about 500 ohms with zero strain at room temperature. From

equation 2, the expression for $R_o(T)$ is:

$$R_o(T) = S\rho_{AV}(T)/x_\gamma = S\rho_s \quad (8)$$

Substituting $R_o(T) = 500$ ohms, and $\rho_s = 35$ yields:

$$\text{Number of squares } (S) = R_o/\rho_s = 500/35 = 14.2$$

This means that the length of each strain-gage resistor should be 14.2 times its width. In practice, a commonly used width for diffused resistors is 0.005 inch. Therefore to provide 500 ohms of resistance, the strain gage resistor length will be $(14.2)(0.005)$ or 0.07 inch.

Now that the characteristics of the spring member and the strain-gage resistors have been determined, only the characteristics of the thermistor remain to be calculated.

Thermistor

One of the factors which determines the characteristics of the thermistor is the output voltage per unit strain or $V_o/\Delta\epsilon$. Since the maximum output voltage is 0.5 volt at the maximum strain of

0.005, the value of $V_o/\Delta\epsilon$ is equal to $0.5/0.005$ or 10^3 volts.

The thermistor required will be adequately defined if its resistance at three different temperatures can be specified. Temperatures of $T_1 = -60^\circ$, $T_2 = +50^\circ$ and $T_3 = +150^\circ\text{F}$ are sufficiently far apart to be used to define the thermistor's resistance-temperature characteristic.

The expression for the resistance of the thermistor is:

$$R'(T) = N[\rho_{AV}(T)/x_\gamma] \left[\frac{V_c G(T)}{V_o/\Delta\epsilon} - 1 \right] \quad (9)$$

From the set of resistivity change versus temperature curves on page 74, the resistivity of 0.007 ohm-centimeter will have dropped by 9% when the temperature is lowered to -60°F . The resistivity at this temperature is therefore 0.0064. The gage factor obtained from the gage factor versus temperature curve for $P_{AV}(T) = 0.007$ ohm-centimeter is about 108.

Thermistor specifications

The resistance of the thermistor at -60°F may now be determined from equation 9 as follows:

$$R' = [14.2(0.0064)/(2 \times 10^4)][28(108)/10^3 - 1] = 925 \text{ ohms}$$

In similar fashion, the thermistor resistance can be calculated at other temperatures. At $+50^\circ\text{F}$ it is 880 ohms, and at $+150^\circ\text{F}$, it turns out to be 800 ohms. The three temperatures chosen provide adequate data to specify the required thermistor.

The number of points that must be computed to accurately define the thermistor behavior are determined by the material used for the strain gages. For this particular material, three or four points spanning the temperature range are sufficient. The resistance temperature characteristic shown below, left is a smooth curve drawn through the computed points. This characteristic is relatively easy to match with commercially available thermistors, and signal output errors due to thermistor inaccuracy can be very small.

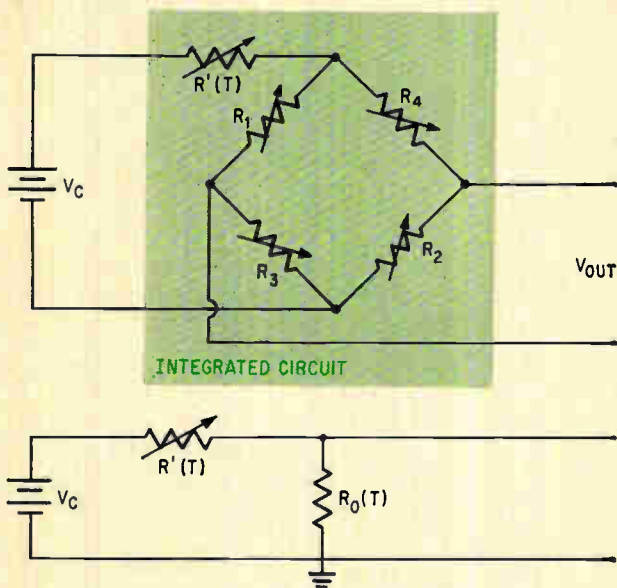

Temperature-compensated circuit consists of the Wheatstone bridge which is represented by the equivalent resistor, $R_o(T)$ and the thermistor whose resistance is given by $R'(T)$. In a typical application, diffused strain-gage resistors R_1 and R_2 will increase with acceleration while R_3 and R_4 will decrease. The thermistor corrects for changes in temperature.

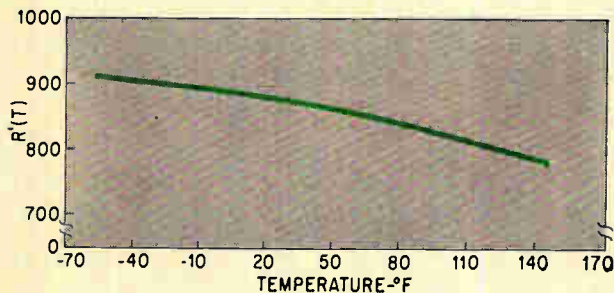

Thermistor resistance drops as the temperature increases, allowing the accelerometer to provide a constant output voltage.

Experimental results

Several accelerometers were fabricated on different n-type spring members to measure various g levels (10 g's, 100 g's, etc.). Different values of resistivity ranging from 0.0005 ohm-centimeter to 0.01 ohm-centimeter were also tested with good results. It was found that the four strain-gage resistors could be fabricated with less than 1% difference in resistance, and the thermistor's actual temperature characteristic could be matched to its theoretical characteristic within about 99% or higher accuracy.

The accelerometer made to the characteristics described in this example was accurate within $\pm 2\%$ over the temperature range from -75°F to $+200^\circ\text{F}$. However, some of the other transducers that were built exhibited even tighter tolerances and variations of 1% or less are expected soon.

Designer's casebook

Designer's casebook is a regular feature in Electronics. Readers are invited to submit novel circuit ideas, packaging schemes, or other unusual solutions to design problems. Descriptions should be short. We'll pay \$50 for each item published.

Pulses with variable mark-to-space-ratio

By S. Tesic

University of Belgrade, Yugoslavia

Pulse width and interpulse period can be varied independently in the circuit shown at right. This circuit is capable of a wide mark-to-space ratio for periods as short as several tenths of a microsecond or as long as several seconds.

The duration of the quasi-stable states can be adjusted independently because they depend on the discharge rates of two capacitors: one determines pulse width and the other interpulse period.

Usually, the charge rate of a capacitor determines the duration of one quasi-stable state, and the discharge rate of the same capacitor determines the duration of the other quasi-stable state. Therefore, mark-to-space ratio is limited.

In the multivibrator circuit shown at the top, when capacitor C_{b1} discharges, transistor Q_1 is cut off and Q_2 conducts. During the time C_{b2} discharges, Q_1 conducts and Q_2 is cut off. This means that C_{b1} charges when Q_1 conducts. If Q_1 is saturated, its base current will be sufficient to charge C_{b1} rapidly.

For the waveshapes in the timing diagram on the next page, at $t=0$, the base voltage of Q_2 has reached V'_e . This transistor conducts, changing the circuit's stable state. The collector current in Q_2 must be greater than the collector current in Q_1 to increase the emitter voltage to the value V''_e . This increased emitter voltage will cut off Q_1 , whose open collector voltage is coupled through C_{b2} to Q_2 's base, driving Q_2 into saturation.

The duration of quasi-stable state T_1 is the time required for C_{b1} to discharge until it raises Q_1 's base to V'_e . This base voltage drives Q_1 into full conduction, which couples a negative pulse through C_{b2} to the base Q_2 , turning it off.

The duration of quasi-stable state T_2 is determined by the time required for C_{b2} to discharge until the base voltage of Q_2 increases to V'_e . This voltage causes Q_2 to conduct and cuts off Q_1 .

When the transistors are saturated, the emitter-to-base and emitter-to-collector voltage drops are

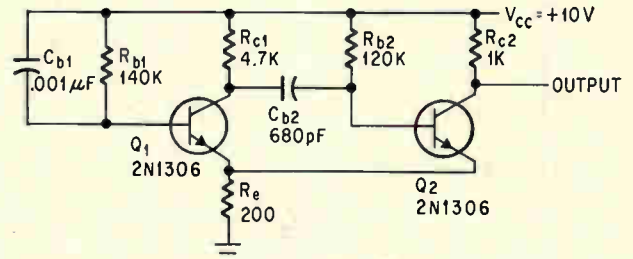

Free-running multivibrator with emitter-coupled transistors has wide mark-to-space ratio for periods ranging from tenths of microseconds to seconds.

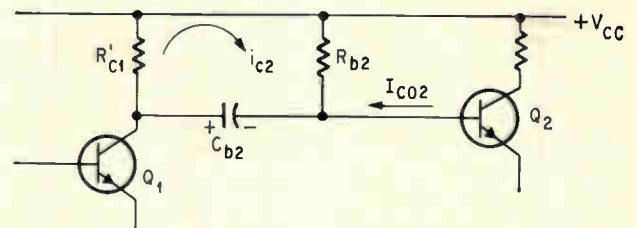
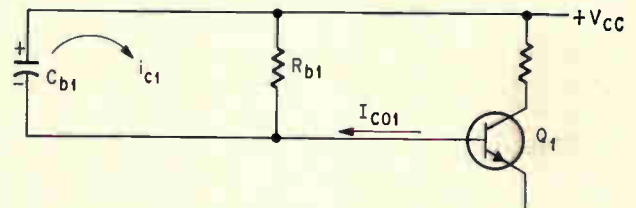

Discharge paths for individual capacitors show how pulse width and interpulse periods are determined independently.

negligible. Consequently, the emitter voltages V'_e and V''_e may be derived from

$$V'_e = \left(\frac{R_e}{R_e + R_{c1}} \right) V_{cc} \text{ and } V''_e = \left(\frac{R_e}{R_e + R_{c2}} \right) V_{cc}$$

Emitter voltage V'_e is small because, although Q_1 is saturated, its collector current is limited by R_{c1} in the collector circuit.

The analytical expression for period T_1 can be determined from the diagram above, where I_{co1} represents the emitter-to-base reverse current of Q_1 and i_{c1} represents the C_{b1} discharge current.

The base voltage of transistor Q_1 is:

$$V_{b1} = V_{cc} - R_{b1}(i_{c1} - I_{co1}).$$

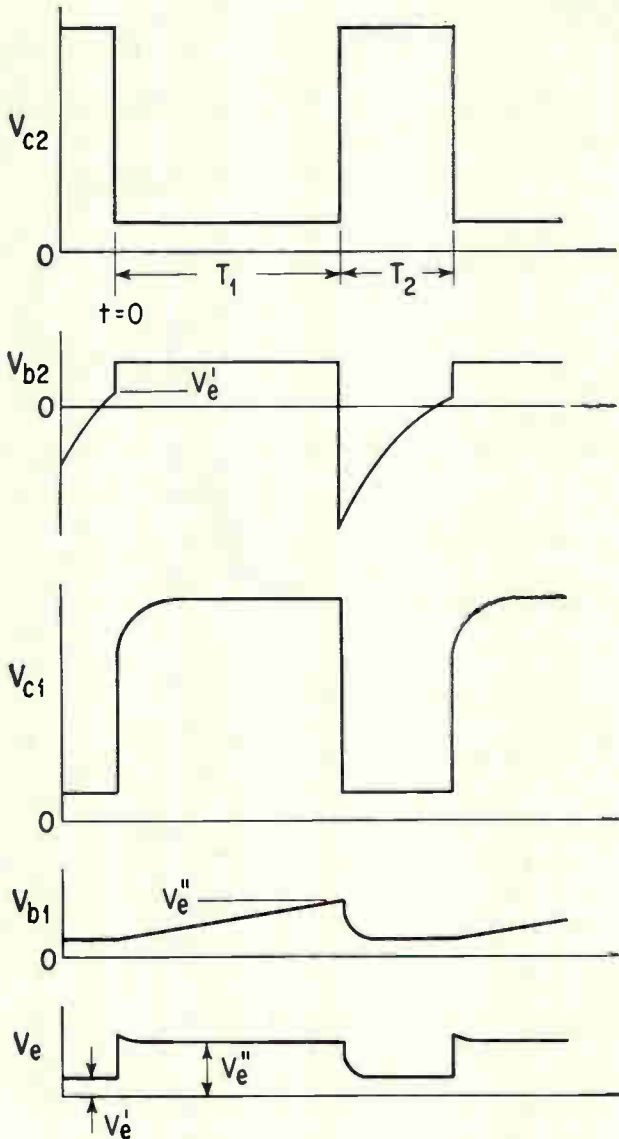
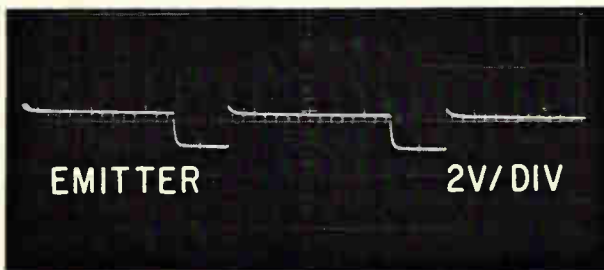
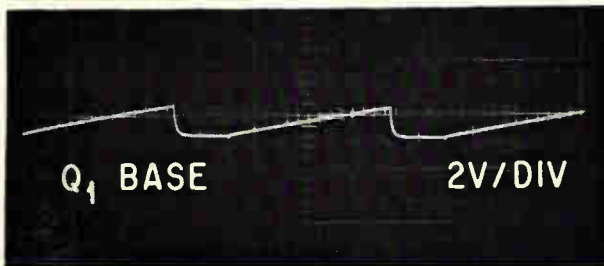
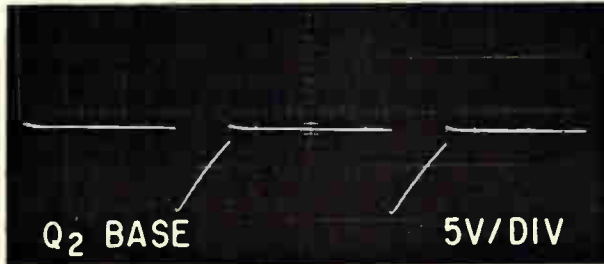
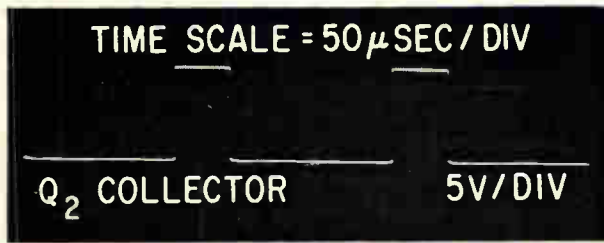

Timing diagram. Voltage V_e' is the emitter voltage when Q_1 conducts, and V_e'' is emitter voltage for Q_2 conducting.

Photographs of voltage waveshapes show that although the rise and fall times of Q_1 collector voltage are affected by capacitor integration the output pulse slopes are not.

At the end of the time period T_1 ,
 $V_{b1} = V''_e$.

Inserting these values into the conventional R-C transient equation, neglecting the reverse leakage current, and solving for T_1 , gives

$$T_1 = R_{b1} C_{b1} \ln \left[\frac{R_{c1}}{R_e + R_{c1}} \times \frac{R_e + R_{c2}}{R_{c2}} \right]$$

The analytical expression for period T_2 is derived in the same way. In the circuit diagram, R'_{c1} represents the parallel resistance of R_{c1} and the collector output resistance of Q_1 . But R_{c1} is normally much lower than R_{b2} and can be neglected.

The time interval T_2 is given by

$$T_2 = R_{b2} C_{b2} \ln \left[\left(\frac{2R_{c1}R_{c2} + R_e(R_{c1} + R_{c2})}{(R_e + R_{c1})(R_e + R_{c2})} \right) \left(\frac{R_e + R_{c1}}{R_{c1}} \right) \right]$$

Rise and fall times of the output voltage pulse are about 0.2 microseconds. By varying the $C_{b1}R_{b1}$ time constant, the mark-to-space ratio can be varied over a wide range. With $C_{b1} = 0.1 \mu f$ and $R_{b1} = 2$ megohms, the circuit has a mark-to-space ratio of about 1:500.

Jitter of the time period T_1 —expressed as $\Delta T_1/T_1$ —in the range of 25 μs to 25 ms was measured and found to be less than 1%. At very low frequencies, with $C_{b1} = 100 \mu f$ and $C_{b2} = 0.47 \mu f$, $T_2 = 50$ ms and $T_1 = 10$ sec, the mark-to-space ratio is 1:200.

Precise 6-volt input triggers circuit

By Robert F. Woody, Jr.

Hercules Powder Co., Radford, Va.

If the input is 6 volts, the circuit at the right will produce an output pulse; otherwise, it will remain off. Variations of 7 volts on either side of the trigger level will not produce a pulse.

The circuit can be useful in detector or control applications. It has a hysteresis of about 0.6 volts (once turned on, the circuit will conduct until input drops below 5.4 volts).

Variation of the turn-on and turn-off switching levels could be held within ± 0.05 volts, depending on the resistor tolerances, the match between the base-emitter characteristics of Q_1 and Q_2 , and the stability of the +6-volt supply, which is the switching reference voltage.

When the input voltage is less than the trigger level, Q_1 's emitter-base junction is back-biased, keeping Q_1 cut off. The input voltage may be decreased to about -10 volts without damaging Q_1 . With Q_1 cut off, a current flows through R_1 that is sufficient to saturate Q_2 .

If the input voltage is higher than the trigger level, Q_1 becomes an emitter-follower, and supplies current to R_1 . As the input voltage becomes more positive (up to +12 volts for this circuit) the

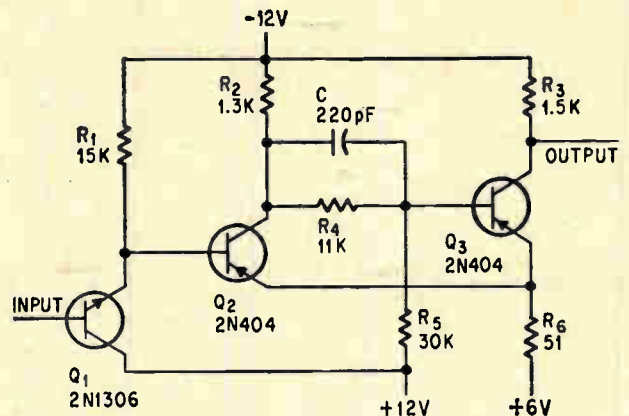

Trigger circuit provides an output pulse when the input voltage is 6.0-volts. Circuit will not turn on for input voltages above or below this level.

emitter voltage follows, back-biasing Q_2 .

The base of either Q_1 or Q_2 is back-biased for voltages on either side of the turn-on voltage, preventing an output pulse.

Input pulses larger than the turn-on voltage may cause voltage spikes to appear at the output, as the leading edge passes rapidly through the turn-on voltage level. If necessary, these spikes can be removed from the output by a low-pass network.

Resistance of R_6 is selected to keep the loop gain well above unity. The value of resistor R_6 must be small because large variations in emitter voltage of Q_2 and Q_3 would increase hysteresis. Resistors R_2 and R_3 are selected to provide equal emitter currents, so as to reduce hysteresis.

Gate circuits eliminated in scr static switch

By Yogeshwar Hari

Purdue University, Lafayette, Ind.

Large alternating currents can be switched by only two silicon controlled rectifiers and a low-power contactor. Usually, when scr's are used to switch a-c current they are connected back to back and turned on by external gate firing circuit. Here, gate firing circuits are unnecessary.

This simple circuit depends on the small reverse leakage current that always flows through the gate of the nonconducting scr.

The low-power contactor connects the gates of the scr's so that the gate leakage current of the

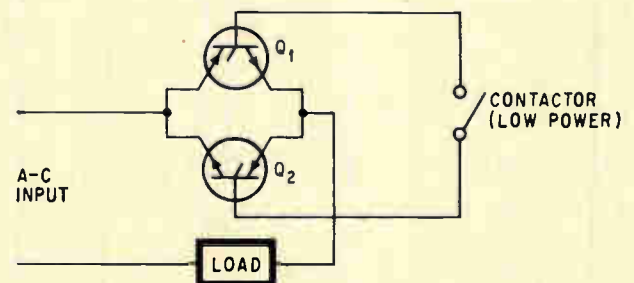

Scr's conduct half-cycles when contactor is closed.

nonconducting scr is actually the forward gate current of the conducting scr. The scr's turn on and off alternately each half-cycle. Opening the contactor also opens the scr switch, because there is no gate current to turn on the scr's.

The low-power contactor can be replaced by a semiconductor that has a very high impedance in the off state, such as a field-effect transistor.

Stress-sensitive integrated circuits

Change of electrical characteristics in response to pressure means transducers or sensors can be combined with data-processing circuits

By Roger C. Wonson

Raytheon Co., Waltham, Mass.

Recent discoveries about the effects of force applied to p-n semiconductor junctions are opening the way to a new class of integrated circuits. These circuits will respond to mechanical stress as well as electrical inputs, enabling transducers or sensors to be combined with data-processing circuits on one monolithic structure. This would have obvious advantages in simplifying system design and in space conservation for hundreds of instrumentation and process control applications.

Directly applied to semiconductor material, stress causes a predictable change in the current and the voltage across the junction.¹⁻¹¹ Bringing a diamond-tipped stylus with a radius of 0.005 to 0.007 inch into contact with an emitter-to-base junction, as shown in the drawing at right, is one practical way to apply the stress. The typical thickness of the junction is one micron or less. A force of a few grams applied to the stylus can change the values of either forward or reverse bias resistances, and therefore the voltage across these resistances, by several orders of magnitude.

Current gain affected

Because of the stress exerted on the emitter-base junction, the current gain of the transistor also changes. A reduction in current gain caused by increasing the stress for a transistor in an integrated

The author



Roger C. Wonson has been a senior research engineer in the solid state electronics group of Raytheon's research division for the past two years. He joined the company's commercial products group in 1947 and moved to the semiconductor division in 1951. He is currently studying transistors operated in the avalanche mode, as well as integrated transducer circuits.

diode-coupled transistor-logic NOR gate (Raytheon type RC103) is shown on the next page.

Output capacitance

The output capacitance C_{oe} of a transistor drops as the current gain decreases. Although this important relationship between current gain and output capacitance has been used to advantage in the past in purely electronic circuits,^{12, 13} it can

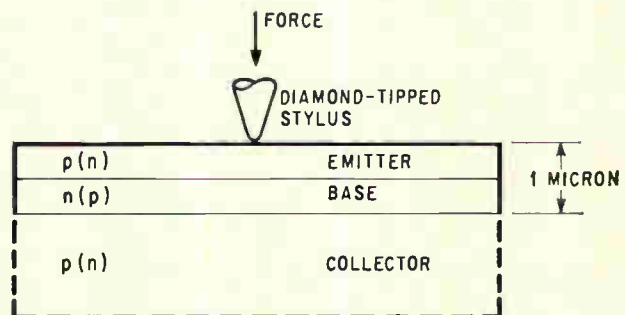

Application of a few grams of force to semiconductor material by a diamond-tipped stylus can change the electrical properties of the material.

also be advantageously employed in stress-sensing applications.

The following expression¹⁴ for transistor output capacitance has been derived from the hybrid π equivalent circuit for a high-frequency transistor:

$$C_o \approx (C_{b'e} + g_m R_L C_{b'e}) \quad (1)$$

where $C_{b'e}$ = emitter diffusion capacitance, g_m = transconductance, R_L = output load resistance, and $C_{b'e}$ = feedback capacitance between collector and base, multiplied by the transistor current gain.

The emitter-to-base depletion layer capacitance is neglected because it is small compared with $C_{b'e}$, provided emitter current values are one milliamper or less. The relationship between output capaci-

tance and current gain is positive, and also linear at low values of current gain, as shown below. This relationship can be effectively applied in frequency control of oscillators and multivibrator circuits to produce accurate force-measuring transducers.

In its study of the effects of stress, Raytheon chose to modify existing integrated circuits rather than work with lumped-constant discrete components compatible with i-c values because it had existing circuits with configurations similar to the ones desired.

A photograph of the NOR gate RC103, containing three transistors with common collectors and associated resistors, is shown on the next page. The first step in modifying this integrated circuit is to sensitize the transistor that will become the stress sensor, by masking the entire surface except for the emitter of the selected transistor. The aluminum layer is etched by treating it with acid until a 20% reduction in current gain is achieved. (The figure of 20%, arrived at experimentally, provided the desired sensitivity.)

The integrated circuit with the stylus attached in the sensitive area is shown on the opposite page. The stylus has a diameter of 0.015 inch and is 0.030 inch long.

Raytheon concentrated on producing a pulse train with a period proportional to the input stress. An avalanche oscillator (an oscillator circuit containing a transistor which operates on the avalanche

portion of its current-voltage characteristic) and astable and monostable multivibrators were selected from RC103's by appropriate modification of the biasing arrangement.

Oscillator circuit

The circuit connection of the basic NOR integrated circuit as an oscillator is illustrated on the next page. The graph shows the effect of applying stress; the frequency increase is nearly linear. The stress-sensitive transistor Q_2 operates as if it were a variable capacitor, its capacitance depending on the amount of stress. The period T for the oscillator circuit is determined by:

$$T \approx R_1 [C_{b'e} + (g_m R_L C_{b'c})] \ln \frac{V_{cc}}{V_{cc} - V_{ce}} \quad (2)$$

where R_1 = collector resistor, V_{cc} = collector supply voltage, and V_{ce} = Q_2 collector-to-emitter voltage. Sensitive regions with a response of about four cycles per dyne have been constructed and found to be stable and reproducible within approximately 0.1%.

Astable multivibrator

The modified RC103 in the circuit on p. 84 demonstrates the role of a stress-sensitive transistor (Q_4) in an astable (free-running) multivibrator. One set of waveforms illustrates the output voltage prior to the application of force; the other shows voltage

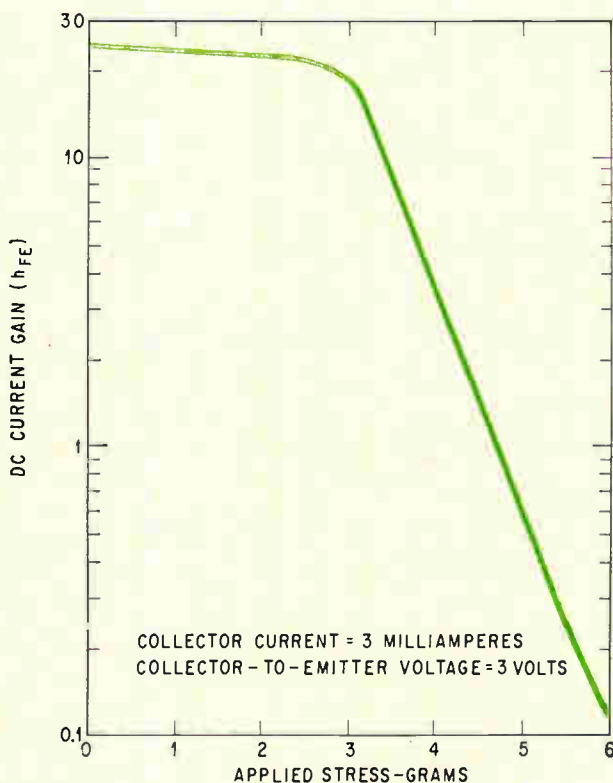

D-c current gain drops off for a transistor as it is subjected to increasing applied stress. As a result, output capacitance also decreases.

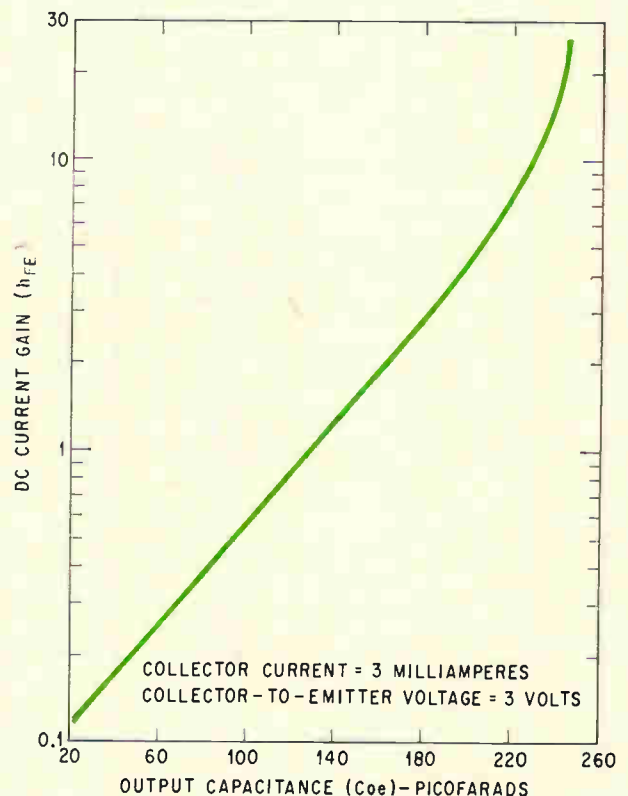

Current gain and output capacitance are directly related. The relationship is relatively linear at low values of d-c current gain.

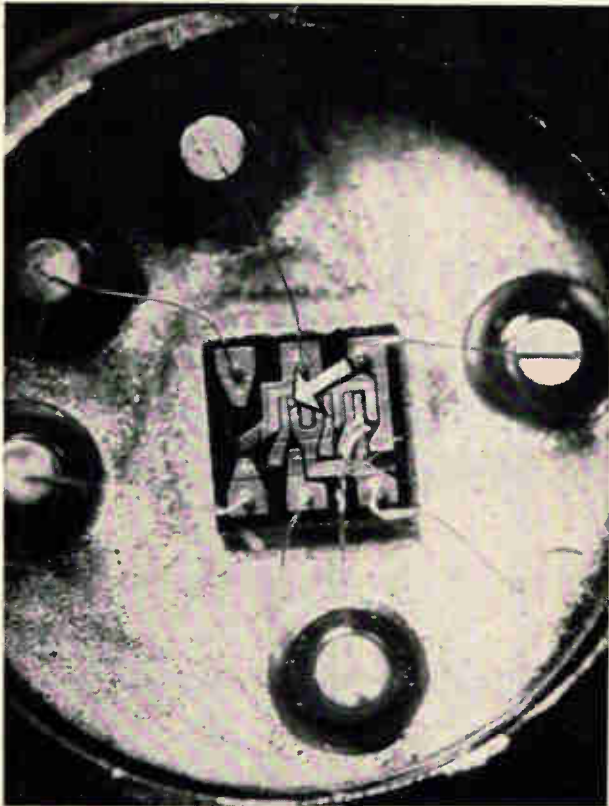

Sensitized area of the integrated circuit is shown by the arrow. The area was sensitized by applying hydrochloric acid to a transistor emitter.

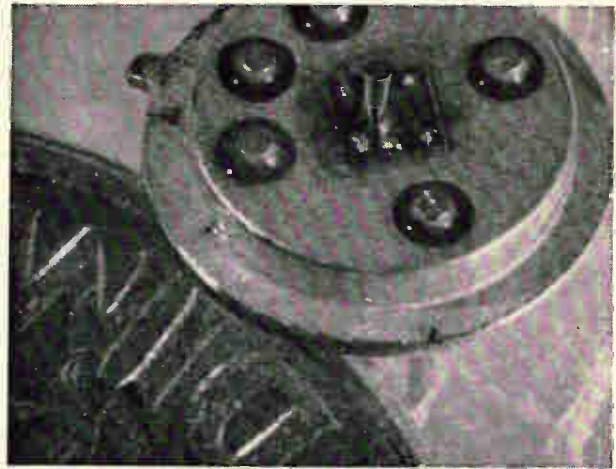

NOR gate with the stylus attached. The stylus applies stresses of 4 to 10 grams.

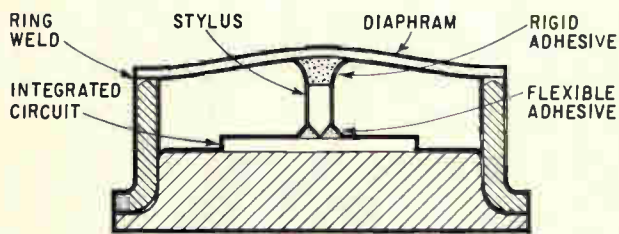

Cross-section of the package with the stylus in place. The diaphragm curvature and thickness is exaggerated for clarity. Curvature is formed during curing.

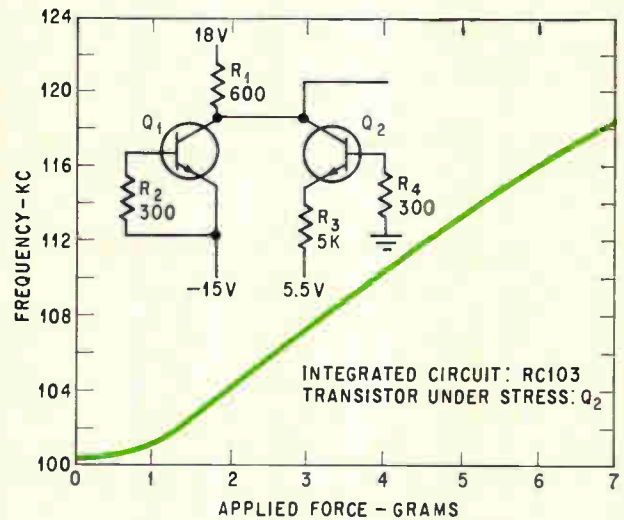

Curve shows how application of force increases the operating frequency of the avalanche oscillator circuit (inset) with the RC103 transistor under stress. Relationship of frequency and force is nearly linear.

with seven grams of force applied. Again, Q_4 acts as a variable capacitor. Since it has a higher output capacitance than Q_3 , Q_4 determines the circuit's upper frequency capability.

The major influence in determining the period can also be shifted to Q_4 by separating the bases of Q_3 and Q_4 , and allowing less emitter current to flow in Q_3 .

The period of the astable multivibrator circuit is given by:

$$T \approx R[C_b'e + (g_m R_L C_b'e)] \ln(1 + V_{cc}/V_{bb}) \quad (3)$$

where V_{bb} = base supply voltage.

Equation (3) holds provided that the output capacitance for Q_4 is greater than that of Q_3 .

The output resistance¹⁵ of the transistor under stress is given by:

$$R = [(C_b'e R_{in}) / (C_b'e g_m)]^{1/2} \quad (4)$$

where R_{in} = transistor input resistance

As the output capacitance is reduced with increased stress, the output resistance increases slightly. The increase in the output resistance can be minimized if the base for the transistor under stress has high resistance or if the base for the load transistor (Q_2 in the upper circuit on the next page) has low resistance.

Monostable multivibrator

The use of the RC103 as a monostable multivibrator is shown by the lower diagram on the next page. Two sets of waveforms were obtained for the circuit. The upper set illustrates the pulse width before the application of force. The lower set reveals the decrease in pulse width caused by

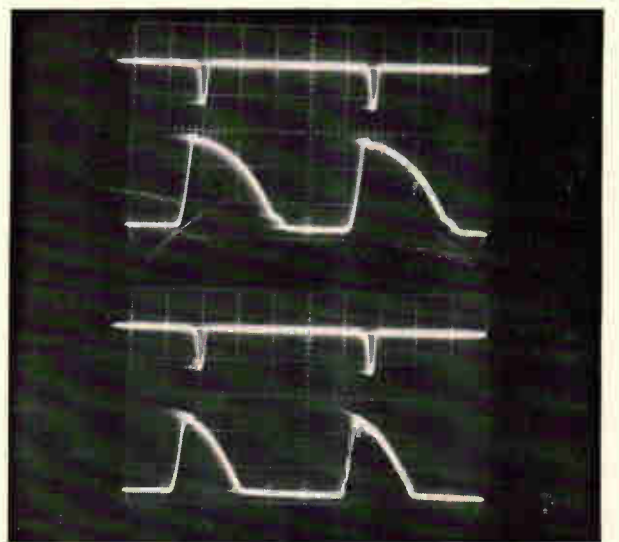
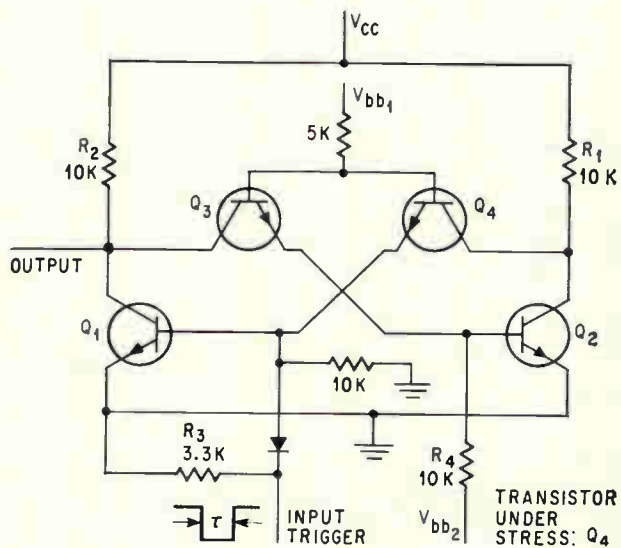
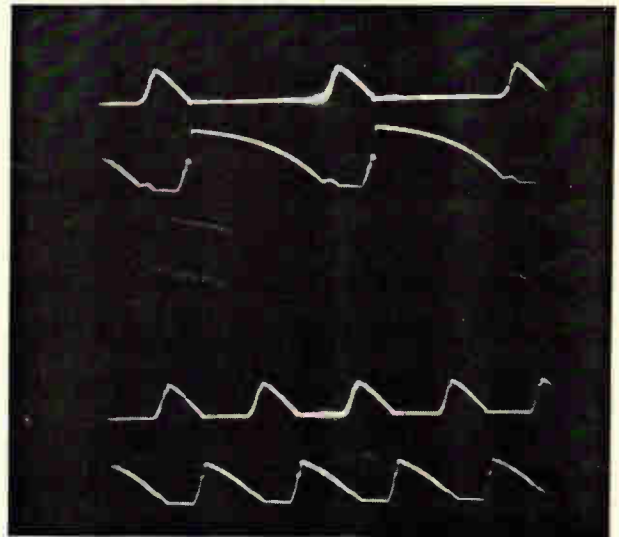
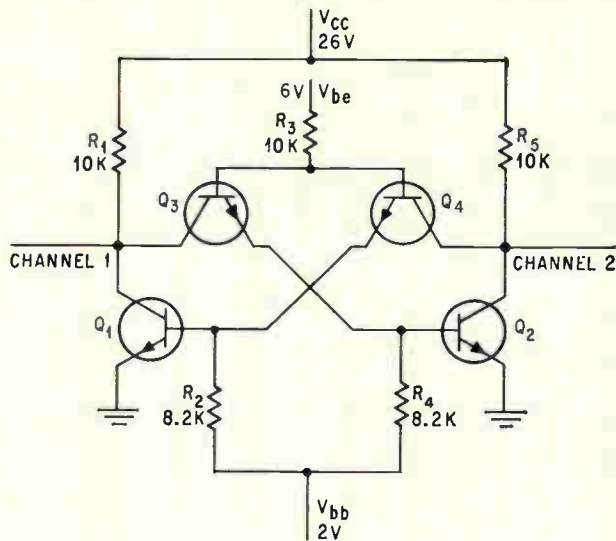

The astable (top, left) and monostable multivibrator circuits and output waveforms. Top set of waveforms for the astable multivibrator depicts the output frequency of 500 kc at channels 1 and 2 before application of force. Bottom set of waveforms shows that an application of 7 grams of force doubles the frequency to 1 Mc. In the monostable circuit, the operating frequency of 10 kc stays the same with the application of 7 grams of force, but the pulse width is reduced from 1.5 microseconds to 1.0 microseconds.

the application of seven grams of force, which changes the output capacitance of the stress-sensitive transistor Q_4 .

Packaging

Pressure on the stylus is exerted through a beryllium copper diaphragm, 0.001 inch thick, attached

to it with an adhesive. During curing, vacuum pressure exerts a slight pull on the diaphragm; the force, when curing is completed, is about three grams. This "force bias" causes the circuit to operate linearly, since the curve on page 82 shows that the output characteristic becomes linear for forces greater than three grams.

References

1. W. Rinder, *Bulletin of the American Physics Society*, Vol. 7, 1962, p. 65.
2. W. Rinder and I. Braun, *Journal of Applied Physics*, Vol. 34, 1963, p. 1958.
3. W. Bernard, W. Rinder, and H. Roth, *Journal of Applied Physics*, Vol. 35, 1964, p. 1860.
4. R. Edwards, *Proceedings of the IEEE, Electron Devices Group*, Vol. 11, 1964, p. 286.
5. J.J. Wortman, J.R. Hauser, and R.M. Burger, *Journal of Applied Physics*, Vol. 35, 1964, p. 2122.
6. K. Matsuo, *Journal of Physics Society, Japan*, Vol. 19, 1964, p. 1490.
7. Y. Mutukura, *Journal of Applied Physics, Japan*, Vol. 3, 1964, p. 256.
8. A. Goetzberger and R.H. Fink, *Journal of Applied Physics*, Vol. 35, 1964, p. 1851.
9. C. Sah, R.N. Noyce, and W. Shockley, *Proceedings of the IRE*, Vol. 45, 1957, p. 860.
10. C.H. Bates, F. Dachtler, and R. Roy, *Science*, Vol. 147, 1965, p. 860.
11. H. Legat and K. Russel, *IEEE Electron Devices Meeting*, Washington, D. C., Oct. 1964.
12. D.C. Davies et al. "An integrated charge control" JK flip-flop, *ISSC Conference*, Philadelphia, 1964, p. 70.
13. T.A. Longo, "State of the art in monolithic silicon integrated circuits," *Nerem Record*, 1964, p. 56.
14. M.V. Joyce and K.K. Clarke, "Transistor circuit analysis," Addison-Wesley Publishing Co., Inc.
15. *Ibid*, p. 251.

Shortcut to calculating the Q

Universal selectivity and phase-gain charts reduce the number of calculations an r-f designer has to make

By John D. Duncan

Montana State University, Bozeman

To design a tuned radio-frequency amplifier, an engineer must calculate the Q, the bandwidth and the out-of-band rejection of the tuned circuit. For a single-tuned circuit, the calculations, although straightforward, are tedious and time-consuming. They are even more laborious when designing multistage tuned amplifiers, where the total circuit bandwidth must be apportioned to the individual single stages. The designer performs many calculations until the individual single-tuned circuit gains and Q's are optimally divided, according to existing circuit restrictions, and the total multistage circuit bandwidth and gain are achieved.

Much of this tiresome slide-rule work is now performed by the charts on pages 87 and 88. With them—given the desired gain, resonant frequency and bandwidth—the designer obtains a figure from which he can calculate easily the Q of a single-tuned circuit. Because the job of finding the single-tuned circuit Q has been simplified, the designer can more quickly go on to specify stages of multistage tuned amplifiers.

Because the data in both charts is normalized with respect to frequency, the curves are universally applicable to any single-tuned circuit.

Why the curves work

A single-tuned circuit is any network that may

be represented over the frequency range of interest as a simple series or parallel circuit consisting of a resistor, capacitor and inductor.

To take into account the effects of dissipation in the circuit, the Q used in the analysis is the loaded Q. (Q is defined as the ratio of the energy stored to the energy dissipated in the circuit each half cycle.) The resonant or antiresonant frequency is f_0 . The frequency of interest is f_1 . Circuit gain is defined here as the ratio of the circuit impedance at f_0 to the circuit impedance at f_1 .

The phase angle, and whether it is lagging or leading, can be determined from the specific RLC values and whether the frequency of interest is above or below resonance.

The admittance of the parallel circuit is given by the following expression:

$$Y = \frac{1}{R} + j \left(2\pi f_1 C - \frac{1}{2\pi f_1 L} \right)$$

which can be rewritten as

$$Y = \frac{1}{R} + j \left[\frac{2\pi f_1 C f_0}{f_0} - \frac{f_0}{2\pi f_1 L f_0} \right]$$

At resonance, the capacitive and inductive reactances are equal, so that

$$X_0 = \frac{1}{2\pi f_0 C} = 2\pi f_0 L$$

The circuit admittance may be written as:

$$Y = \left[\frac{1}{R^2} + \frac{1}{X_0^2} (f_1/f_0 - f_0/f_1)^2 \right]^{1/2} \arctan \frac{R}{X_0} (f_1/f_0 - f_0/f_1)$$

If the frequency of interest is measured from the resonant frequency, $f_1 = f_0 + \Delta f$, and if Q =

The author



John D. Duncan is a doctoral candidate at Montana State University. He was formerly employed by the Collins Radio Co. where many of his papers on r-f circuit design and network synthesis were published.

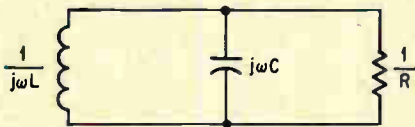

RLC parallel-circuit gain (attenuation) depends on circuit's resonant frequency, its loaded Q, and the frequency of operation.

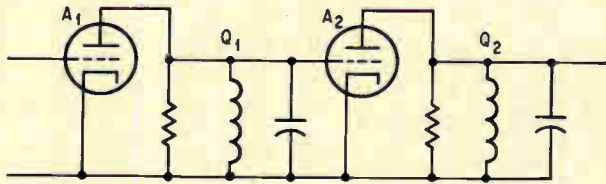

Tuned two-stage vacuum tube amplifier.

R/X_0 , then the impedance of a parallel, single-tuned circuit may be expressed in absolute terms as a magnitude and a phase angle as follows:

$$|Z| = \frac{R}{\{1 + Q^2[(1 + \Delta f/f_0) - (1 + \Delta f/f_0)^{-1}]^2\}^{1/2}}$$

$$|\phi| = \arctan \{-Q[(1 + \Delta f/f_0) - (1 + \Delta f/f_0)^{-1}]\}$$

From a similar derivation for a series circuit, the impedance expressed as a magnitude and phase is:

$$|Z| = R\{1 + Q^2[(1 + \Delta f/f_0) - (1 + \Delta f/f_0)^{-1}]^2\}^{1/2}$$

$$|\phi| = \arctan Q[(1 + \Delta f/f_0) - (1 + \Delta f/f_0)^{-1}]$$

From the phase expressions, the phase angle is negative or lagging at frequencies above f_0 in the parallel circuit, and below f_0 in the series circuit. The phase angle is positive or leading at frequencies below f_0 in the parallel circuit, and above f_0 in the series circuit.

The gain for either circuit, according to the previous definition, is expressed in decibels as:

$$G = 20 \log \frac{Z(\text{at } f_1 = f_0, \text{ or } \Delta f = 0)}{Z(\text{at } f_1 = f_0 + \Delta f)}$$

or, specifically

$$G(\text{db}) = 10 \log \{Q^2[(1 + \Delta f/f_0) - (1 + \Delta f/f_0)^{-1}]^2 + 1\} \text{ decibels.}$$

This is a universal equation expressing the

selectivity for any single-tuned circuit. The selectivity curves shown are plotted from data calculated from this equation by an IBM-7070 computer. The curves give the relative gain of a single-tuned circuit as a function of frequency with Q as a parameter, where the values of Q are 1, 10, 100, and 1,000. The curves are given for each value of Q at frequencies above and below resonant frequency f_0 .

The phase function of a parallel RLC circuit may be written as:

$$\tan \phi = -Q[(1 + \Delta f/f_0) - (1 + \Delta f/f_0)^{-1}]$$

Substituting into this equation for $\tan \phi$ as given by a basic trigonometric identity,

$$\frac{1}{\cos^2 \phi} = \tan^2 \phi + 1$$

taking the log at both sides, and multiplying through by 10 gives

$$-20 \log \cos \phi = 10 \log \{Q^2 [(1 + \Delta f/f_0) - (1 + \Delta f/f_0)^{-1}]^2 + 1\}$$

Now, the right side of this equation is the expression for gain previously given.

The term on the left side is positive because $\cos \phi$ is always less than one and the log of a number less than one is negative. Therefore, a universal phase-gain expression for all single-tuned circuits, regardless of Q , may be written

$$G(\text{db}) = 20 \log (\cos \phi)$$

Using the curves

The following examples illustrate the application of these curves in designing a vacuum-tube amplifier and transistor amplifier.

First, assume a two-stage pentode amplifier must be designed with a frequency response having 3-db points at frequencies of 21.0 and 21.5 megacycles. The gains of the amplifier stages are $A_1 = gm_1 Q_1 X_1$ and $A_2 = gm_2 Q_2 X_2$ and the total amplifier gain is $A_t = gm_1 gm_2 X_1 X_2 Q_1 Q_2$ where gm is the transconductance and X is the total capacitive reactance of the individual stages respectively.

At the 3-db points for a single-tuned circuit, the selectivity curves show that $Q\Delta f/f_0 = 0.5$ (Use the

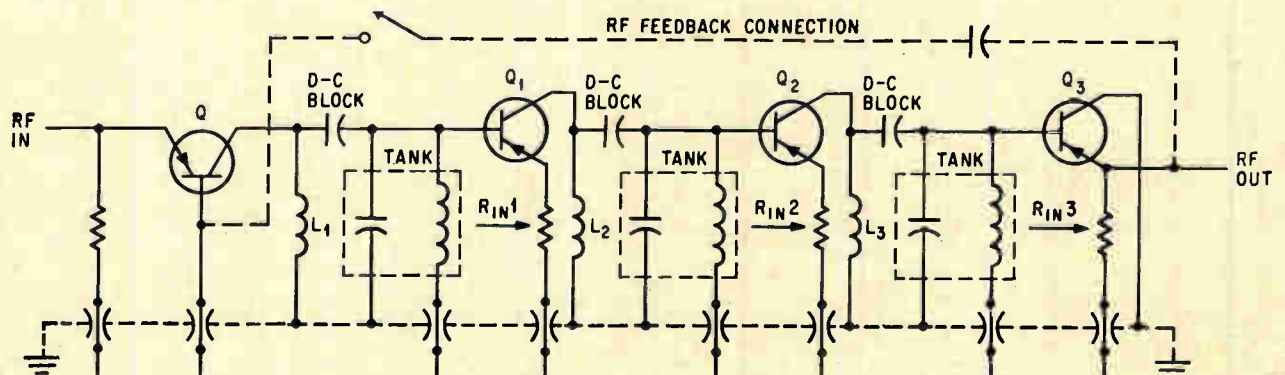

Three-stage tuned transistor amplifier. Dashed line indicates the feedback connection necessary for a linear r-f amplifier designed with the aid of the selectivity and phase-gain curves in the last example.

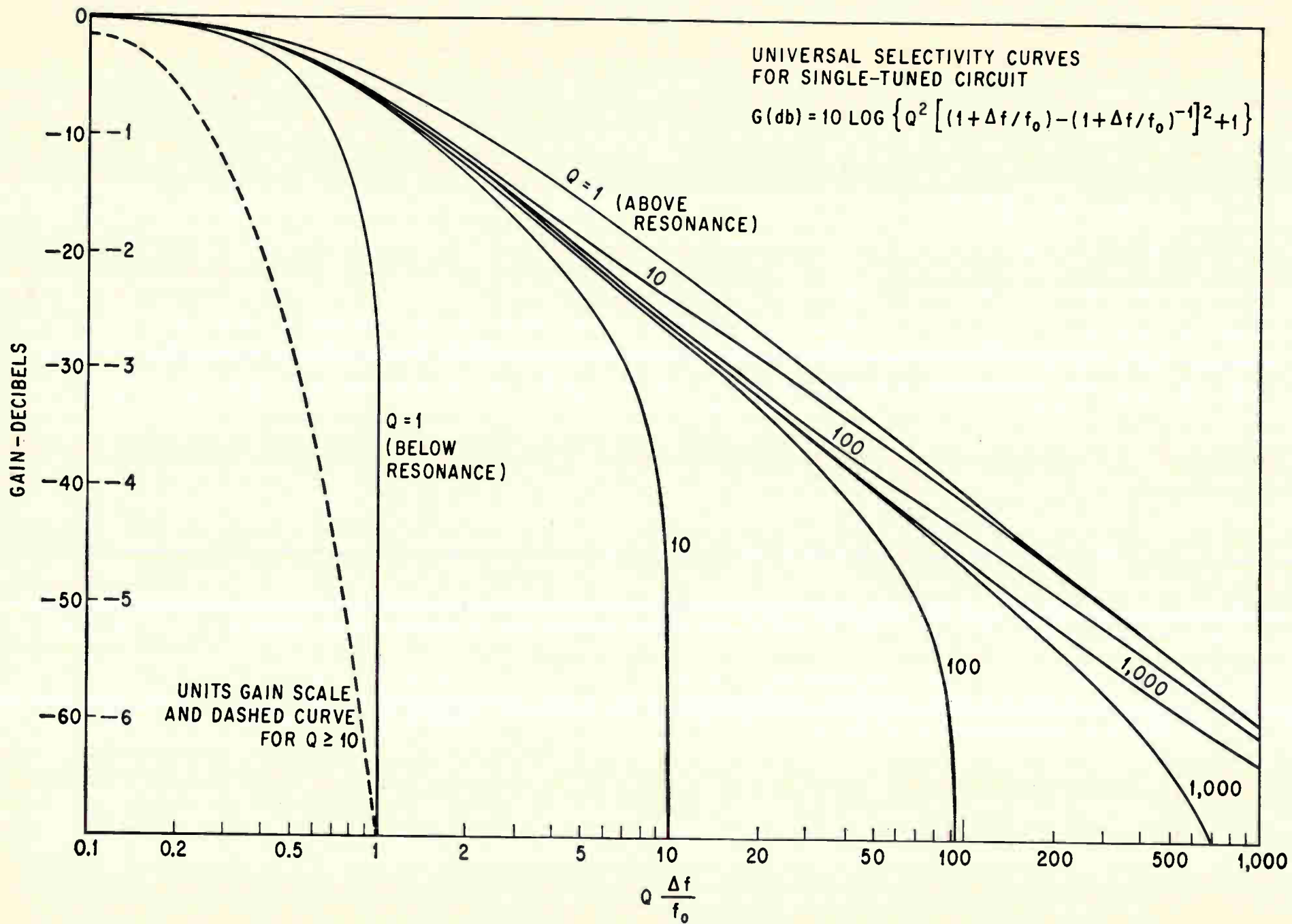

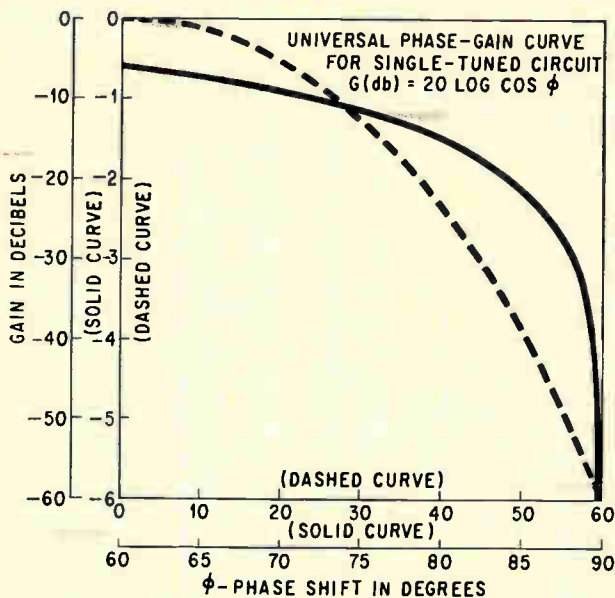

expanded-scale dashed curve). If the 3-dB points are chosen at 21.0 and 21.5 Mc, then the resonant frequency $f_0 = 21.25$ Mc and $\Delta f = 0.25$ Mc. Now, if all of the selectivity were provided by the first stage, its Q would be equal to $0.5(21.25/0.25) = 41.5$. But this means that the Q of the second stage must be zero, which would result in an impractical case where the total amplifier gain is zero.

For maximum amplifier gain, the Q of each stage should be equal. With equal Q 's, each of the two stages will contribute 1.5 db at the band edges, and from the curves, each $Q\Delta f/f_0 = 0.32$ and $Q_1 = Q_2 = 0.32(21.25/0.25) = 27.2$

If the Q of one of the stages is restricted for some reason (for example, from maintaining a specific operating point under conditions of large stray capacitance) then the Q of the other stage may be calculated to meet the bandpass requirements.

Suppose one stage is restricted to a minimum Q of 35. With the same f_0 and Δf given above, this stage at the band edges is calculated to have $Q\Delta f/f_0 = 0.412$, and the curves show that it will contribute approximately 2.2 db of attenuation to the total amplifier. The other stage must then roll off 0.8 db at the band edges. At this attenuation, the second stage requires a $Q\Delta f/f_0 = 0.225$, and a network Q of approximately 19.5 is calculated.

As another example, suppose it is necessary to design a transistor amplifier, tuned at 10.7 Mc, whose 3-dB bandwidth is 100 kc. Assume that the amplifier is of the form shown at the bottom of page 86. In this circuit, the source-driving impedance is about 50 ohms. The load for each tank circuit is the driving impedance R_{in} of the following stage, which is approximately beta times the unby-passed portion of the emitter resistor. The Q of each tank circuit is R_{in} divided by the total interstage capacitance to ground, including stray capacitance.

Or take a case where all tank circuit Q 's are equal. Here, the gain of each individual stage must be down 1 db at the band edges. Obtain from the

curves for 1 db attenuation, $Q\Delta f/f_0 = 0.25$ and keeping in mind that Δf is the half-bandwidth in this case, $Q = 53.5$.

The second harmonic rejection for this circuit may be obtained by first calculating the $Q\Delta f/f_0$ at the harmonic frequency. Since, at the second harmonic $\Delta f = f_0$, therefore, $Q\Delta f/f_0 = 53.5$. (Note that the ratio $\Delta f/f_0$ is one for the second harmonic, two for the third harmonic, three for the fourth, and so on.)

By extrapolating between the $Q = 10$ and $Q = 100$ curves, the rejection per stage is approximately 37.5 db or a second harmonic rejection for the entire amplifier of 112.5 db.

For purposes of comparison assume that for some practical reason the Q of the final stage cannot be held below 80. At the band edge for this stage

$$Q \Delta f/f_0 = \frac{80 \times 50 \times 10^3}{10.7 \times 10^6} = 0.374$$

From the curves, the gain of this stage will be down approximately 1.9 db at the band edges. If the Q 's of the other two stages are equal, then each must be down 0.55 db at the band edges. As before, their individual Q 's may be calculated after finding $Q\Delta f/f_0$ from the curves at 0.55 db. The result: $Q\Delta f/f_0 = 0.187$ and $Q = 40$ for each.

The second harmonic rejection for this configuration can be found from the curves to be approximately 35 db each for the first two stages and approximately 41 db for the last stage, or a total of 111 db for the whole amplifier.

It should be noted that for maximum out-of-band rejection, the individual stage Q 's must be equal.

For a final illustration, assume that the circuit in the previous example must be designed as a linear r-f driver amplifier. For greatest linearity, the amount of feedback should be maximum without causing instability. The criterion for stability of a feedback amplifier is that the open-loop gain be less than one when the total open-loop phase shift is 180° . Thus it is necessary only to examine the open-loop gain at 180° phase shift to determine what the maximum allowable feedback is.

If the amplifier is designed so that each of the three stages has equal Q , then each stage will contribute 60° to the total phase shift. The phase-gain curve shows that for 60° of phase shift, the gain of each stage is -6 db. Thus the total feedback for this amplifier must be less than 18 db for it to be unconditionally stable. In a practical case, some margin in the gain must be included to account for extraneous phase delay in the circuit.

It can be shown from the selectivity curves and the phase-gain curves, that the more unequal the individual stage Q 's, the greater the amount of stable r-f feedback that can be applied. This can be demonstrated by a limiting case where one of the three-stage Q 's is zero. Then each of the other two stages would have to contribute 90° of phase shift, and in this case, infinite open-loop gain is theoretically possible.

Phasing unwanted images out of microwave receivers

Splitting r-f input into orthogonal signals can provide up to 20 db of automatic image rejection for broadband superheterodyne instruments

By Murray Loss

Airborne Instruments Laboratory, a division of Cutler-Hammer, Inc., Deer Park, N.Y.

Microwave frequencies cover such a broad band that image signals sometimes cause delays in data acquisition and errors in frequency scanning. If there is time, responses can be processed so that an operator can tell which signal is the desired one; but in some operations, such as acquisition by spaceborne receivers, there is no time for processing. Electronic image rejection circuits provide a better answer to the problem because they both inhibit the receiver's image response and prevent the generation of spurious outputs from the receiver.

The intermediate frequency of a superheterodyne receiver is formed when the incoming radio frequency signal is mixed with a local oscillator signal. For any given local oscillator frequency, there are two r-f inputs that will produce a desired intermediate frequency—but only one of the inputs will be the frequency to which the receiver is supposedly tuned. The other will be an image frequency, a "reflection" separated from the desired signal by twice the intermediate frequency.

Further, if a local oscillator is swept through its range, two output signals—again, separated by twice the intermediate frequency—will be pro-

duced for each r-f signal received. The image problem is common to any equipment using the superheterodyne principle; it can even be encountered in a laboratory spectrum analyzer where, for each frequency analyzed, two responses will appear on the display. In that case, the operator can discriminate between the required and spurious response; but in airborne or spaceborne receivers, the problem is more acute—especially when logical processing of the receiver output is required.

Image rejection techniques based on special phasing of the desired signal and the image signal have been used for many years in receivers operating in the kilocycle region.^{1,2} In some cases, the receiver can be designed so that the image signal falls outside the band of the receiver. But at microwave frequencies, more sophisticated techniques are required.

Mechanical and electronic solutions

The most common method of incorporating image rejection facilities into a receiver is by mechanically tuned preselectors, such as the tuned r-f stages used in broadcast superheterodynes. These devices contain many moving parts, such as gears, cams and bearings, which limit the scanning rate; such rates are seldom less than one second per sweep.

The scanning speed of electronic image rejection systems is limited only by the capabilities of the circuits, and is measured in milliseconds. Electronic scanning does not present the lubrication problems that can become acute when a mechanical system is operated in a spaceborne environment.

In its most basic form, as shown in the diagram on page 91, an electronic image rejection system requires the addition of a quadrature coupler, an extra mixer circuit, and a sum and difference net-

The author



Murray Loss received a B.S. in physics from Pennsylvania State University in 1951 and a master's degree from Adelphi College in 1959. After engaging in development work on microwave components, he came to the space systems department of AIL, where he now specializes in receivers.

Electronic image rejection

In a normal superheterodyne mixer circuit, a nonlinear device such as a diode or a crystal performs the mixing of the input and local oscillator signals. The output of such a mixer is proportional to the square of the input voltage. For an input voltage $A \sin(\omega_s t + \phi)$ and a local oscillator voltage $B \sin(\omega_L t)$, the mixer output, after all higher frequency terms are eliminated, becomes

$$V_{IF} = K \sin(\omega_s t + \phi) \sin \omega_L t.$$

The term ϕ in the equations allows the effect of different input phases to be assessed.

Standard trigonometric manipulations on this equation produce terms containing the sum and difference intermediate frequency outputs. In the system being considered the inputs are down-converted, producing an i-f output of

$$V_{IF} = K' \cos[(\omega_L - \omega_s)t - \phi] \quad (1)$$

From this basic equation stems the explanation of the image rejection circuits shown in block form on page 91. When either the signal frequency ω_s or its image frequency ω_1 enter the coupler, it splits into two waves. The waves entering mixer 1 are delayed by a value for ϕ (nominally 90°) relative to those entering mixer 2.

The i-f output at each mixer can be calculated from equation 1. These outputs depend on whether the signal or image frequency are being received.

For the reference channel (mixer 2) with inputs of $A \sin \omega_s t$ and $B \sin$

$\omega_L t$, the output i-f signal is:

$$V_{IF} = K' \cos[(\omega_L - \omega_s)t].$$

With inputs of $A \sin \omega_1 t$ and $B \sin$

$\omega_L t$, the image output is

$$V_{IF} = K' \cos[(\omega_1 - \omega_L)t] \text{ at the image frequency.}$$

Note how the coefficients of t in the cosine terms are chosen to be positive. This is done to maintain a consistent phase convention.

On the other channel (mixer 1), the input signal wave is delayed by ϕ degrees. The outputs for mixer 1 are:

$$V_{IF} = K' \cos[(\omega_L - \omega_s)t + \phi] \text{ at the signal frequency}$$

$$V_{IF} = K' \cos[(\omega_1 - \omega_L)t - \phi] \text{ at the image frequency.}$$

The bottom figure on the opposite page shows the phasor relationships of the mixer outputs. The output of mixer 2 has the same phase for both signal and image frequency inputs. The outputs of mixer 1 differ by an angle of 2ϕ (nominally 180°).

In the ideal case, where the phase delays are precisely 90° , an output i-f coupler acts as the sum and difference network. A 90° phase shift is introduced in each winding of the coupler while a 0° phase shift exists between its windings. By introducing the mixer outputs to the diagonally opposed inputs, the signals add when the signal frequency enters the system and cancel when the image frequency is received. Depending on at which termination or output port the i-f output is taken, a summation of either the image or the signal frequency can be produced by cancellation of the other. This permits switching for up or down conversion at the mixer.

In practice, the phase shifts obtained in the mixer input coupler and i-f coupler will not be exactly 90° . As a result, cancellation of the image signal will be incomplete.

Since the i-f frequency is constant, an obvious way to improve cancellation is to insert a fixed phase adjustment between the mixer and i-f coupler. This can take the form of a

length of cable between the mixer and coil. Adjusting the length of the cable introduces a constant phase shift. But this solution has limitations.

The center phase diagram shows the case where ϕ is less than 90° . As before, the image and signal frequency phasors from mixer 1 are spaced equally about the reference output from mixer 2. To give optimum image rejection, the image output from mixer 1 should be in quadrature with the image output of mixer 2. This could be achieved by inserting a length of i-f cable to introduce a phase shift of degrees, except that the cable also shifts the mixer 1 signal phasor position. When the two signal phasors are summed in the output i-f coupler, the output is reduced from its optimum value.

While considerable improvement in rejection can be made this way, the advantage has to be traded off against a slight degradation in the noise figure due to the shift in phase of the signal. Since the rate of change in signal output is less than the gain in rejection, this method has applications where rejection is the prime factor.

Electronic image rejection imposes restrictions on the method of coupling the local oscillator to the two mixers. A quadrature splitter to couple the local oscillator signal to the mixer will not work. Coupling must be through a splitter that introduces either 0° or 180° of the phase shift.

Similarly, the polarity of the mixer crystals is important. Since the reversal of the polarity of both crystals of a balanced mixer reverses the phase of its i-f output, the crystal orientation must be compatible with the choice of signal and image output ports. Reversing both crystals in one of the balanced mixers interchanges the signal and image output ports. Reversing all crystals in the network will, of course, have no effect.

work. The input from the antenna containing either the desired signal ($\sin \omega_s t$) or the image frequency ($\sin \omega_1 t$) enters the quadrature coupler, which splits the input into two equal signals 90° out of phase. These two signals then enter their respective mixers, where they are converted to the receiver's intermediate frequency. Depending on whether the signal or the image frequency is present at the input circuit, the phase of these two i-f signals will differ by plus or minus 90° . Feeding these signals to a common sum and difference network will cause cancellation of the image signal and summation of the signal frequency. (The system is explained in detail in the panel above.

Designing a practical system

The amount of image rejection depends on the degree of cancellation and addition of the desired and image signals at the output ports of the i-f coupler coil. In practice, the signals produced by each mixer differ in amplitude and will not be exactly 180° out of phase.

The amplitude imbalance is determined primarily by the dissimilar conversion loss of the two mixers, and the unequal power split in the input coupler. The minimum achievable imbalance depends entirely on the type of coupler chosen both for the input coupler and for use in two balanced mixers.

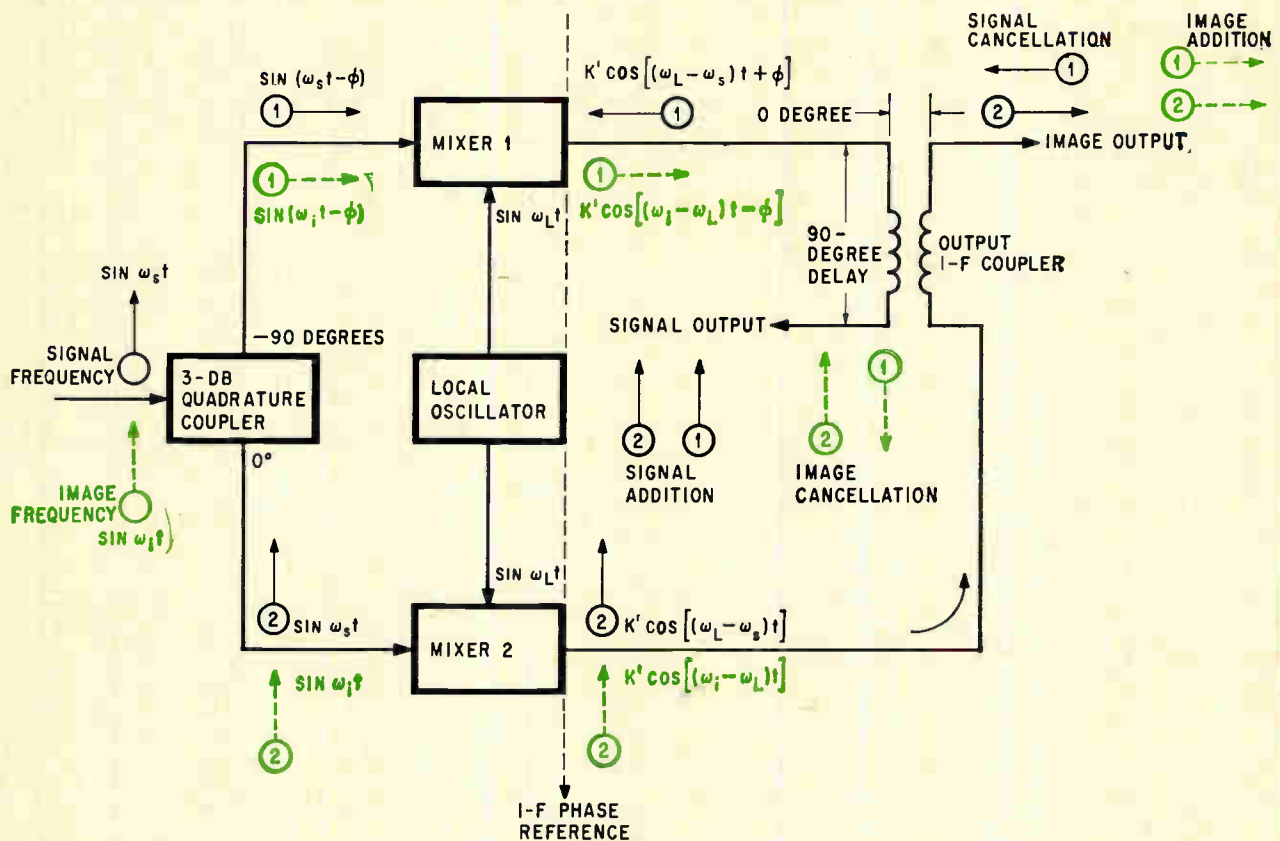

Two paths are available for the signal and image frequency inputs. Signals proceeding via mixer 2 are unaltered in phase. Due to the 90° shift introduced by the input coupler in the path to mixer 1, the phases of the desired signal and the image signal are altered in the mixer. The arrows denote the phasor position of each signal.

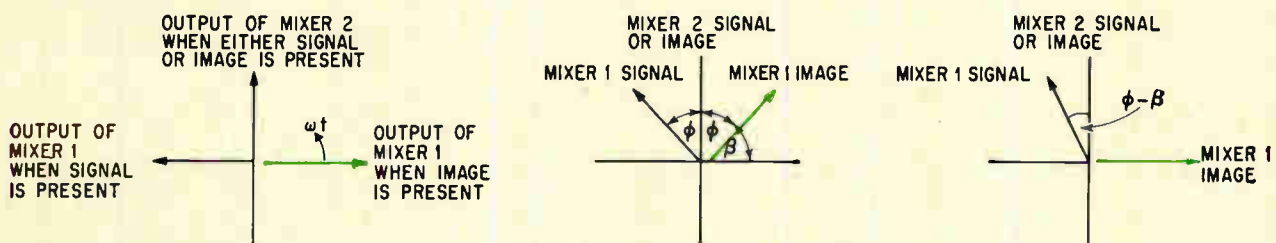

With phase shifts of exactly 90° (left) the outputs of mixer 2 change by 180° when the signal or the image is present. Where ϕ is less than 90°, the outputs of mixer 1 are located equally about the reference output of mixer 2 (center). To ensure complete cancellation of the image output, the output has to be retarded by an amount β . But executing this shifts the signal output phase and reduces the output (right).

The phase error between the circuits is the sum of the errors in the input coupler, the mixers, the various cables and the couplers forming the mixers.

Reflections between the various couplers and the mixer crystals in the circuits also cause amplitude and phase error. A worst-case voltage standing wave ratio (vswr) of 3:1 in one mixer—not an unusual figure for octave bandwidth mixers—and a vswr of unity in the other mixer will cause this phase error of 14°.

The actual rejection, R , in decibels obtainable in a practical circuit is determined by the ratio of the voltages, K , on the two signal paths of the image rejector, and the phase error θ . The equation is:

$$R = 10 \log \left[\frac{1 + \frac{2K \cos \theta}{1 + K^2}}{1 - \frac{2K \cos \theta}{1 + K^2}} \right]$$

For practical measurements, it is easier to define K in terms of power rather than voltage, using the relation $P = 20 \log K$. The chart on p. 93 shows how the rejection figure varies for different phase errors and powers.

High rejection requires extremely tight phase and amplitude tolerances. For instance, to obtain



As the local oscillator frequency varies, an i-f response to a specified r-f frequency occurs at two points (left). Image rejection circuits remove the undesired response (right).

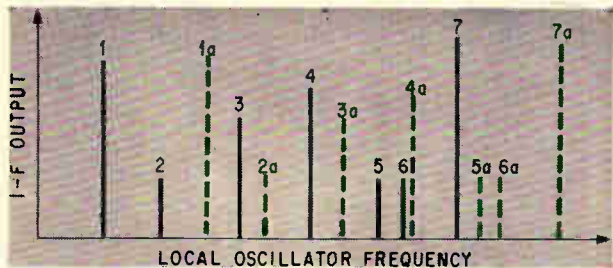
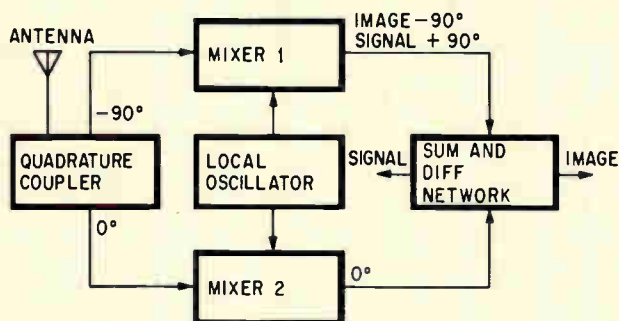
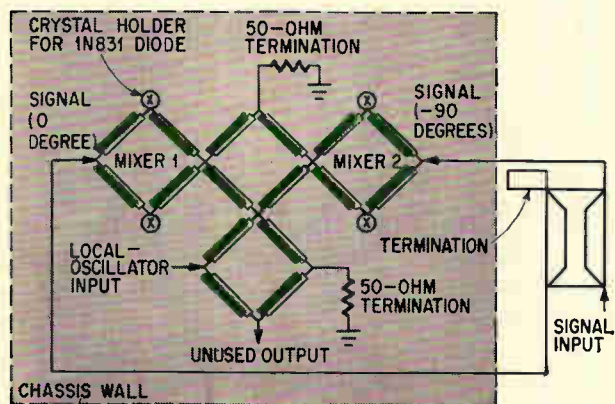

Image signals (dotted lines) cause 100% redundancy in the output of a swept receiver at seven frequencies; two responses are generated for each r-f input.



Basic image rejection circuit includes an input coupler, mixers and a sum and difference network.

a 30-db rejection with a power ratio of 0.5 db, the phase error must be less than 1.6° . Some tradeoff between amplitude and phase errors is possible—30 db rejection can be obtained with 3° phase error, but with a power ratio of 0.26 db. In practice, rejection greater than 35 db is not feasible without using additional techniques.



One such technique is to utilize the summation of the image signal that is available at the image port of the hybrid coil to gate the receiver pre-amplifier. As the image signal is received, it is amplified and fed to a gate that shuts off the receiver's i-f amplifier. This technique has been used successfully only over a limited dynamic range.

Choosing the components

The three basic components in the image rejection system, the input coupler, mixers and output i-f coupler, all act as power splitters. The input coupler divides the signal into two equal parts 90° apart in phase. Each mixer divides its input signal into equal parts of a certain phase, the divided signals being fed to crystals instead of output ports. The output i-f coupler again divides each input into equal parts with a 90° phase difference.

The phase requirements of the power splitter used in the mixers differ from those for the input coupler and i-f coupler, which must be quadrature types. The mixer splitters must feed the local oscillator to the crystals in phase and the signal to the crystal 180° out of phase.

Output i-f coupler

For receivers covering the band 500 Mc to 8 gigacycles, with a 60 Mc i-f, the required i-f coupler phase shift is achievable by lumped constant construction rather than by using distributed transmission line construction.^{6,9}

The output i-f coupler is functionally identical with all the other couplers used in the system except that it is designed to operate at i-f frequencies. It consists of a series inductance/shunt capacitance transmission line equivalent circuit, made of a $\frac{3}{8}$ -in. diameter coil wound on a Rexolite core with shunting capacitors tapped from the coil to ground.

Basic couplers

Two basic coupler configurations are usable for input couplers and mixers.

One is a quarter wavelength bridge type, the Hylas coupler, shown schematically below.⁴ Signal inputs can be applied at two of the ports; depend-

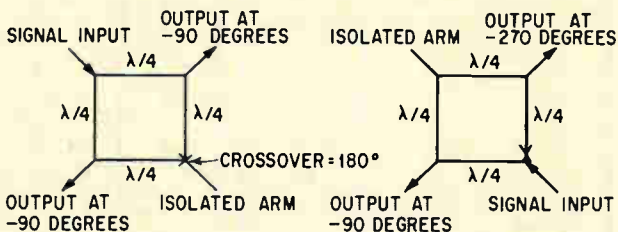

Inputs to the quarter wave coupler can be made at one of two entry ports (above). Outputs will be either in phase with each other or displaced by 180° . At left is image rejection configuration for receivers in the range 500 megacycles to 4 gigacycles.

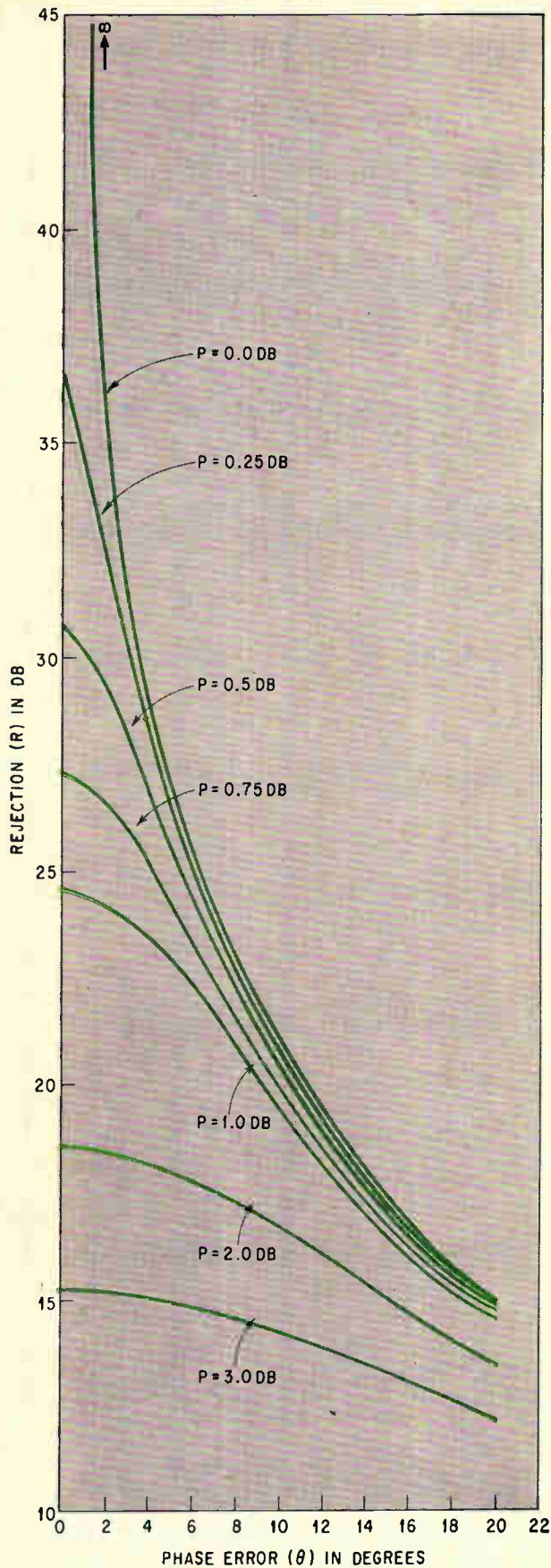

Curves show how circuit rejection depends on the phase error and amplitude balance of the system. Used as a design tool, these curves allow determination of the tradeoff between the allowable phase and amplitude errors.

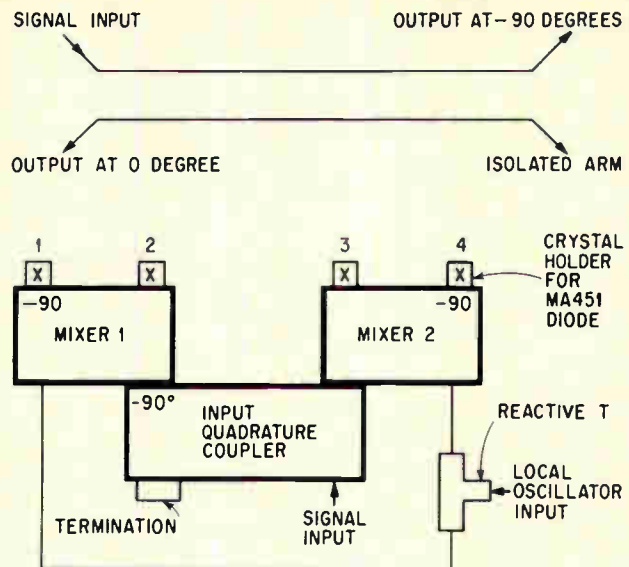

Use of slab line is prescribed for building image rejection assemblies above 4 Gc. Schematic representation of such a circuit is shown in the top diagram, with outputs at diagonally opposite ports. Lower drawing shows quadrature coupler with a single input and two output terminals on the same side so that mixers may be connected without long cabling.

ing on which is used, the two output ports provide signals either in phase with each other or 180° out of phase. In both cases the outputs lag behind the input by 90° . These couplers are broadband because an interchange of inner and outer conductors provides a 180° phase shift that is relatively frequency-independent.

Operation at lower frequencies presents few problems, but at frequencies higher than 4 Gc the coupler's operation is marginal due to the radiation from the hot legs and junctions. The couplers must be enclosed in special metal chassis. These can exhibit undesired cavity resonance effects, making it difficult to achieve good rejection over a wide band.⁷

The resonances can be damped by inserting lossy dielectrics into the coupler housing. But the material cannot be used near the hot leg, or the conversion loss and vswr will be greatly increased.

Slab line coupler

For higher frequencies, the broadband slab line coupler shown in the diagram above is used. The system has only a single input; at the two output ports it will provide one signal in phase with the input and one lagging by 90° . The coupler is bulkier than the Hylas coupler, but has the advantage of being electrically shielded.

Two designs of slab line couplers, using quarter- and three-quarter wavelength lines, are possible for frequencies between 4 and 8 Gcs. The quarter-wave line will operate over octave bandwidths with a coupling variation of ± 0.5 db.

The three-quarter wavelength line has similar

Stripline version of an image rejection phasing assembly for a microwave receiver. Although it uses the principles outlined in this article, the "rat-race" couplers restrict its bandwidth.

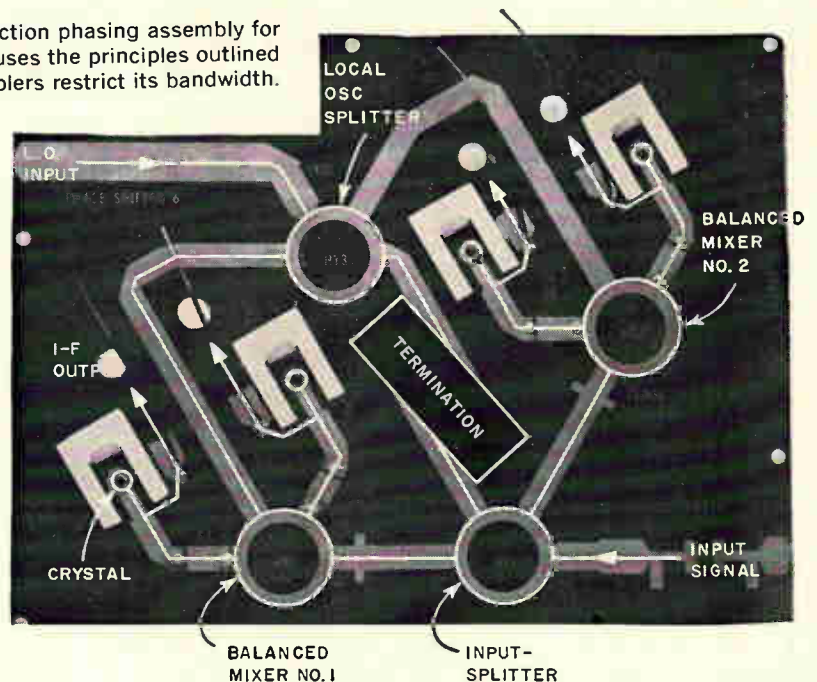

characteristics but is bulkier.

Modifying the coupler so that the two outputs occur on the same side of the line instead of on diagonally opposite sides has advantages. Couplers and mixer blocks can be connected directly, eliminating cabling.

In practice, the amplitude imbalance of such a coupler is low. In the coupler sketched on page 92, the total coupling C from the signal input to the mixer crystals at frequencies at the edge of the coupler range varies according to the crystal position. Typical value of C for the four crystals are 5, 6, 7 and 6 db. The total amplitude imbalance $P =$

$$10 \log \frac{10^{c_1/10} + 10^{c_2/10}}{10^{c_3/10} + 10^{c_4/10}} = 10 \log \frac{10^{0.5} + 10^{0.6}}{10^{0.7} + 10^{0.6}} = 1 \text{ db.}$$

Thus to achieve a design specification of 20 db image rejection, a maximum phase error of 9° is allowable, as shown in the graph on page 93.

An image rejection coupler assembly made with more advanced techniques is shown in the photo above. This phasing circuit is implemented with stripline components on a printed circuit board. Although fully equivalent to the circuit shown on page 92, this version has a narrower frequency range because of the simple ring, or "rat-race," couplers used.

The final design of the image rejection circuits can be checked out by measurements of the amplitude imbalance and the phase error.

Amplitude imbalance measurements require only power level measurements at the i-f outputs of both mixers.

The measurement of phase is more difficult. One method is to couple a 60-Mc slotted line to the ends of the cables from the mixers. The i-f outputs set up a standing wave in the line. A voltage minimum in the standing wave is located with a probe

in the line. If the two cable connections are interchanged at the i-f outputs of the mixers, leaving the connections at the slotted line end unchanged, the voltage minimum will shift toward the delayed side by an amount equal to the phase difference at the mixer outputs.

Amplitude and phase measurements must be made over the whole image frequency band, since unexpected phase shifts can occur—especially near the ends of the frequency range. Failure to check the phase and amplitude values against the rejection chart can result in time wasted in attempting to achieve rejections that are theoretically impossible. For instance, a phase error of 15° precludes obtaining rejections over 20 db, regardless of amplitude balance.

Acknowledgment

The author thanks D. Bedell and W. Pritchard, who offered valuable suggestions and conducted most of the testing on this program.

References

1. H.A. Wheeler, "Image Suppression in Superheterodyne Receivers," Proc IRE, p. 569, June 1935.
2. H.K. Morgan, "Interfering Responses in Superheterodynes," Proc IRE, p. 1164, Oct. 1935.
3. Robert B. Wilds, "Microwave Two-Phase Converters for Imageless Receivers," Microwave Journal, p. 84-87, Sept. 1961.
4. Bernard R. Weisfeld, "Preselection Without Filters," (Department of Applied Electronics, AIL) AIL Monograph, Proc IRE, p. 4A, Jan. 1960.
5. C.G. Montgomery, et al., "Principles of Microwave Circuits," MIT Rad Lab Series p. 301-302, 149, 1963.
6. W.V. Tyminski and A.E. Hylas, "A Wide Band Hybrid Ring for VHF," Proc IRE, Vol. 41, p. 81-87, Jan. 1953.
7. "The Microwave Engineers Handbook and Buyers Guide," Horizon House Microwave Inc., p. TD-73, 1961-1962.
8. J.K. Shimizu and E.A.T. Jones, "Coupled Transmission Line Directional Couplers," PGMTT, p. 403, Oct. 1958.
9. B.M. Oliver, "Directional Electromagnetic Couplers," Proc IRE, Vol. 42, p. 1686, Nov. 1954.

Production tips

Production tips is a regular feature in Electronics. Readers are invited to submit brief descriptions of new and practical processes, assembly or test methods, and unusual solutions to electronics manufacturing and packaging problems. We'll pay \$50 for each item published.

Endless belt process makes assembly flexible

A miniature assembly line that represents a practical compromise between automated and manual processes is in use at the new Maxson Electronics Corp. plant at Great River, N. Y., where printed circuit devices for the radio-command receiver of the Navy's Bullpup air-to-ground missile are put together.

The line consists of an endless belt bearing double-decker holding fixtures for printed circuit cards. There are some 50 of these fixtures, which hold the cards so that they are tilted about 30° from the vertical. The belt's chain drive is powered by a variable-speed electric motor.

Production of the Bullpup receiver requires a fairly steady supply of a variety of p-c card assemblies, which are made up in small lots. By coordinating the use of the assembly line with conventional bench assembly, the line permits a wide latitude in production rates and prevents bottle-



Double-decker line allows operators to work on two production runs simultaneously, or to divide tasks on one run for higher production rate.

necks due to changes in lot size.

If only a small number of cards—say 25—are required, only one operator may be stationed on the line. The operator loads one or two similar components on each card as it goes by on the belt. On the next pass, another part is loaded, and so on until the assembly is complete.

If a larger quantity of cards is required, or if assembly must be speeded up, more operators are used and each operator loads fewer parts. Two different sets can be assembled at the same time by using both decks and two groups of operators.

The double-deck carriers also come in handy when cards must be stored temporarily between assembly operations. For example, delivery of a needed part may be delayed. The cards can be assembled on the lower deck without the part, moved to the top deck, and completed when the parts arrive. This frees the line for the next card, while making the incomplete cards instantly available for priority handling.

Because the belt moves smoothly, and the carriers are tilted back, Maxson has not had any problem from parts coming loose or falling out during assembly or storage.

According to Fred Goepel, who supervises Bullpup production at Maxson, this setup has proven more efficient than bench assembly alone, or bench assembly with single-station automatic component insertion machines. Mechanized insertion is faster if the cards are designed to accept components in parallel rows, but this creates other design and production problems that offset the advantage in loading speed, he says.

Since a variety of boards is being assembled, color-coding is used extensively to avoid mistakes.

The usual practice of providing operators with color-coded assembly drawings is followed. In ad-



Partially assembled cards, awaiting delivery of parts, can get free ride on top deck while assembly proceeds below.

dition, the tote boxes in which parts are delivered to the assembly stations are identified by the key colors for the parts. Printed signs placed above assembly stations are color-coded too, as a reminder.

Subminiature electron tubes are used in the receiver. As the tubes are tested before assembly, they are matched in sets identified by dots of colored ink, and leads are also identified, by colored plastic sleeving.

New leads and potting mate flatpacks and cordwood parts

By Frank Petkunas

Instrumentation Laboratory, Massachusetts Institute of Technology, Cambridge

When nickel-wire extensions are welded to the leads of an integrated-circuit flatpack and the flatpack is potted in plastic, the integrated circuit can be used along with discrete components in a cordwood-module package.

It is often desirable to package microcircuits in

cordwood fashion, but the leads of commercial flatpacks are usually 0.004-by-0.017-inch Kovar ribbon. The ribbon leads are too small and fragile to be bent and welded like the leads of discrete components.

A practical solution is to clip the flatpack leads short and lap weld lead extensions of 0.015-inch-round nickel wires whose ends have been flattened. Ductile nickel is used so the ends are not made brittle when they are flattened by cold working. Tensile-strength tests indicate the welded joints are stronger than the original Kovar ribbons of the flatpack.

Photos of the procedure, a lap weld, and a module containing potted flatpacks and discrete components are shown on the facing page. There are several advantages:

- Interconnecting wires—the nickel ribbon on

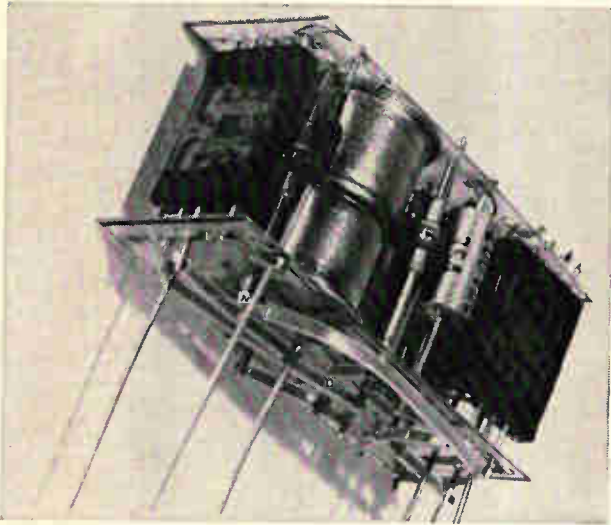

Kovar lead of flatpack is lap welded to nickel wire.

Welded-wire lead extensions allow flatpacks to be used like discrete components in cordwood modules.

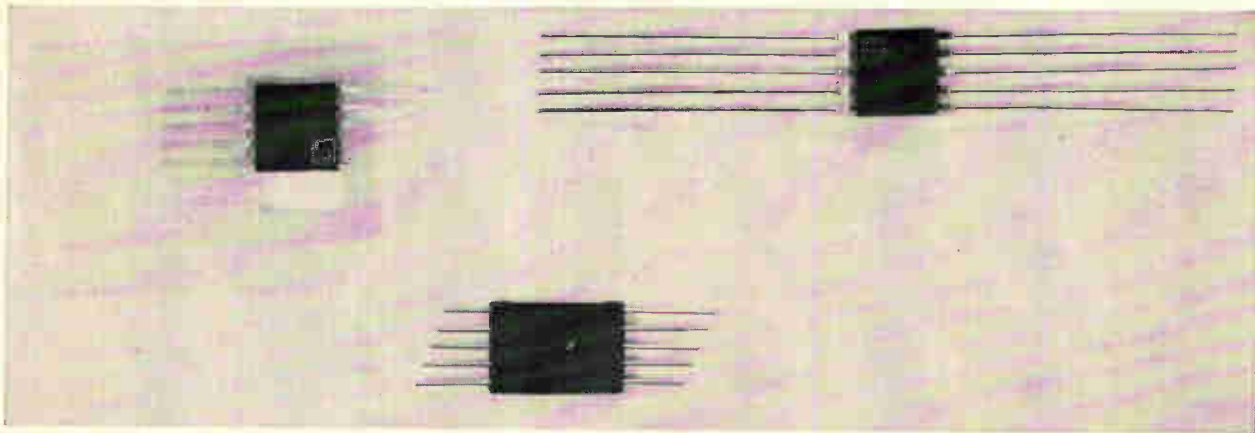

Steps in flatpack preparation: ribbon leads are cut short, flattened wire leads are welded to ribbon leads and flatpack is potted.

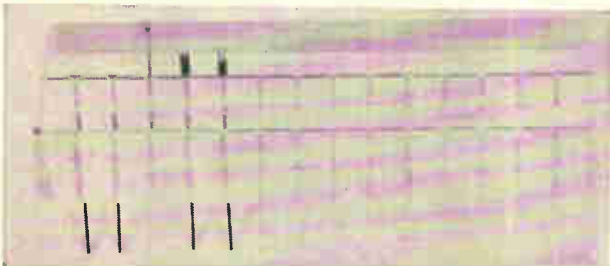

Plastic jig is used to trim wire leads before welding.

the outside of the cordwood module—can be welded to the lead extensions at any angle.

- The leads can be bent without danger of their breaking loose from the flatpack, since they are secured in the potting compound.

- The leads are strong enough and large enough to be used as test leads and have enough mass for good welded junctions with standard component leads.

- The lap welds can be as close as 0.035 inch from the flatpack edge. Even after potting, the height of the flatpack is still less than that of most

conventional components, allowing the flatpack to be handled as a normal component during cordwood assembly.

- Potting the flatpacks before module assembly provides them with well-insulated, flat surfaces that allow the flatpacks to be assembled closely, back to back, in the module.

Since it is customary to pot the entire cordwood module after assembly, the potting of the flatpacks actually constitutes prepotting. The potting material should be an inviscid casting resin (such as Stycast 2651 MM made by Emerson and Cuming, Inc.).

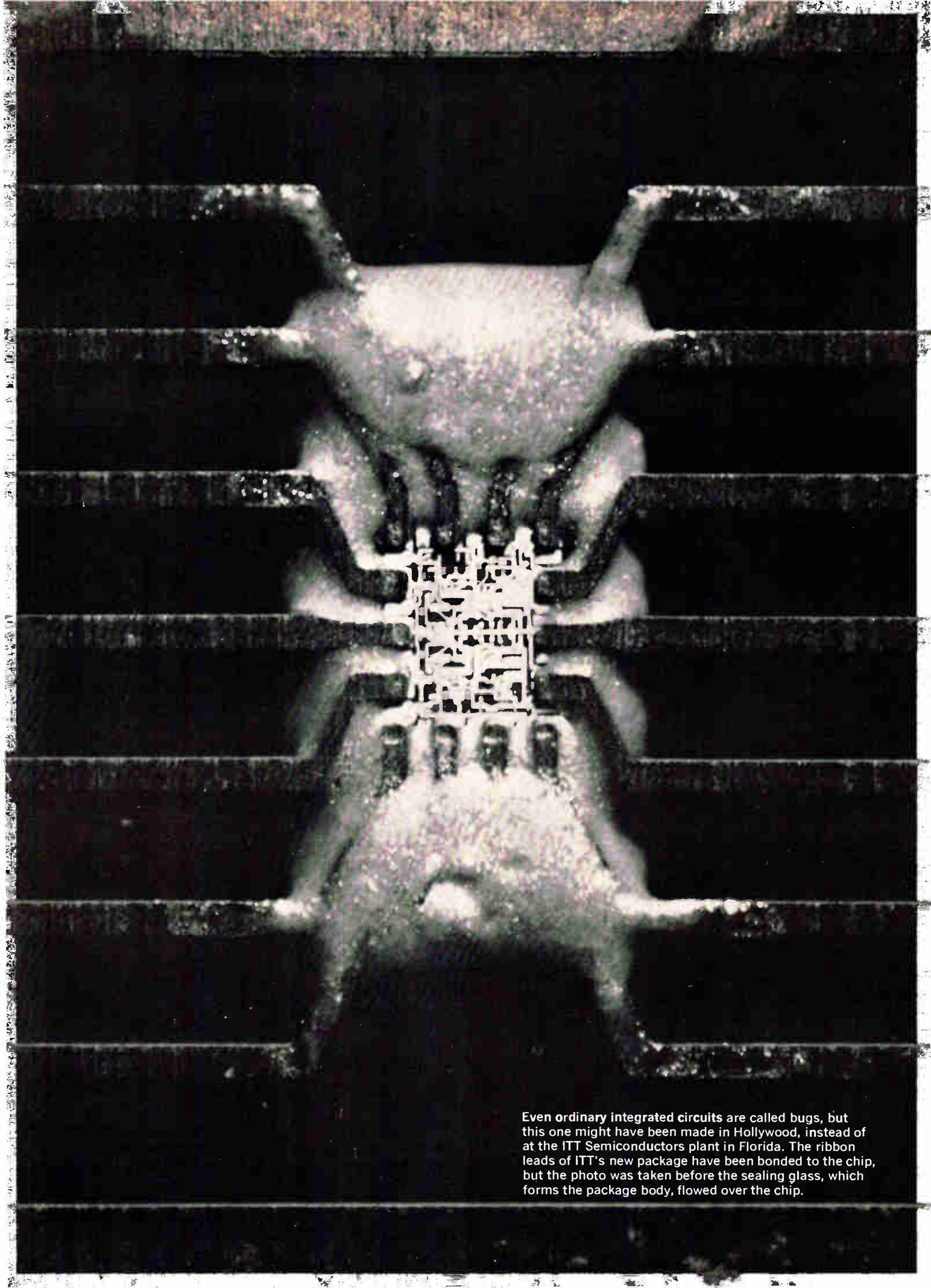

Even ordinary integrated circuits are called bugs, but this one might have been made in Hollywood, instead of at the ITT Semiconductors plant in Florida. The ribbon leads of ITT's new package have been bonded to the chip, but the photo was taken before the sealing glass, which forms the package body, flowed over the chip.

For low-cost flatpacks: remove the wires, put circuits in glass

Bonding ribbon leads to the chip eliminates the cost of bonding lead wires and allows the 'bug' to be encapsulated in glass. The package is solid and rugged

By Charles R. Cook Jr., Ronald W. Mohnkern and Salvatore M. Sampiere

ITT Semiconductors division, International Telephone and Telegraph Corp., West Palm Beach, Fla.

Pounding a packaged integrated circuit with a hammer isn't a scientific test of the package's ruggedness and reliability. But the fact that a new, solid, wireless flatpack does withstand such abuse, dramatically indicates how well the package protects the circuit it encapsulates.

Military standard tests for strength and hermeticity are easily passed by the new package, developed at ITT Semiconductors, a division of the International Telephone and Telegraph Corp. Packaged circuits can be stored at a temperature of 400° C because purple plague, that old bugaboo of storage or continual operation at high temperatures, is avoided by the elimination of gold from the package.

This excellent performance doesn't raise the cost of the package. On the contrary, the wireless flatpack costs far less than conventional flatpacks with bonded wire leads. Parts and materials for the new package cost only about two cents and the elimination of bonded wires cuts hand-labor costs all along the production line and will enable the bonding and package-sealing process to be automated. By comparison, the parts of a conventional flatpacks cost 50 cents to one dollar.

Gold out, glass in

The package encloses the silicon integrated circuit in a solid structure of glass and ceramic or metal. In the construction process (seen on page 103 and described in detail on pages 101 to 103), the tips of Kovar ribbon leads are bonded directly to thin-film aluminum bonding pads on the chips. These pads are made 10 mils square (0.010 inch square). Of the total pad area of 100 square mils, about half is the bond area. The bonds are about

10 times larger than conventional gold-wire bonds and consequently stronger.

After the leads are bonded, the chips and lead tips are hermetically sealed by coating them with silicon dioxide and molding glass around them. The package may be made of glass alone, or by the use of glazed metal or ceramic lids that fit over the chip and leads. After plating, the packages look like regular 14-lead flatpacks and can be tested and assembled into equipment without changing those methods.

This package eliminates the gold or aluminum wire leads that are used in the conventional flatpack (seen on page 100) to bridge the gap between chip terminals and gold-plated Kovar leads. Such packages are usually made in two parts: a case in which the leads are sealed as a preliminary operation, and a lid which seals the case after the chip is bonded in the case and wire leads added.

The conventional package requires 29 bonding steps—one for the chip bonding and one at each end of the 14 wires—and two package fabrication and sealing cycles—one each for the case and lid. The new package requires only one bonding step if a fixture that simultaneously makes all bonds is used (this is now being developed), and one sealing cycle. The parts are designed for automatic fabrication, bonding, sealing and testing.

Applications and variations

At present, the devices are used for logic and control circuits made in single-chip form. The components on the chip are designed and arranged so that they can be interconnected with various aluminum patterns to form different circuits.

Variations in the packaging technique are also

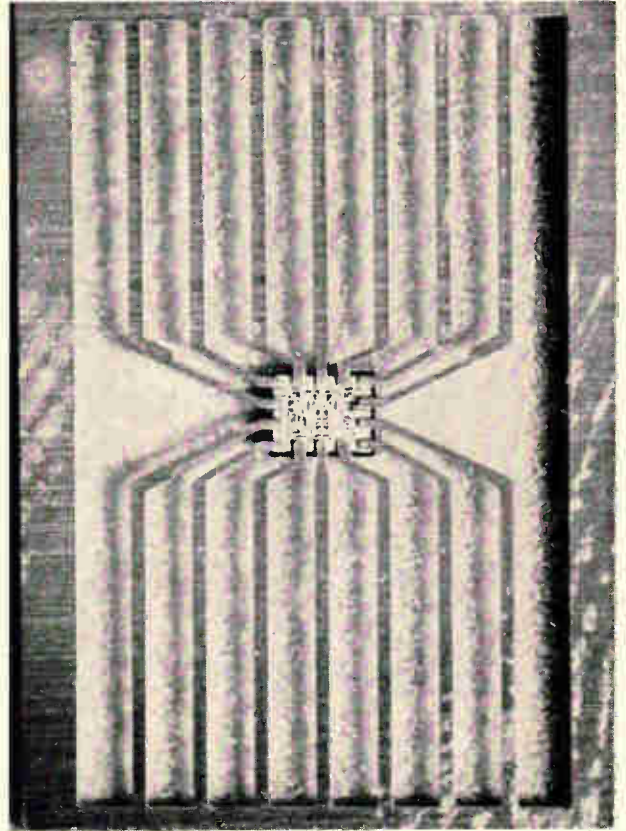
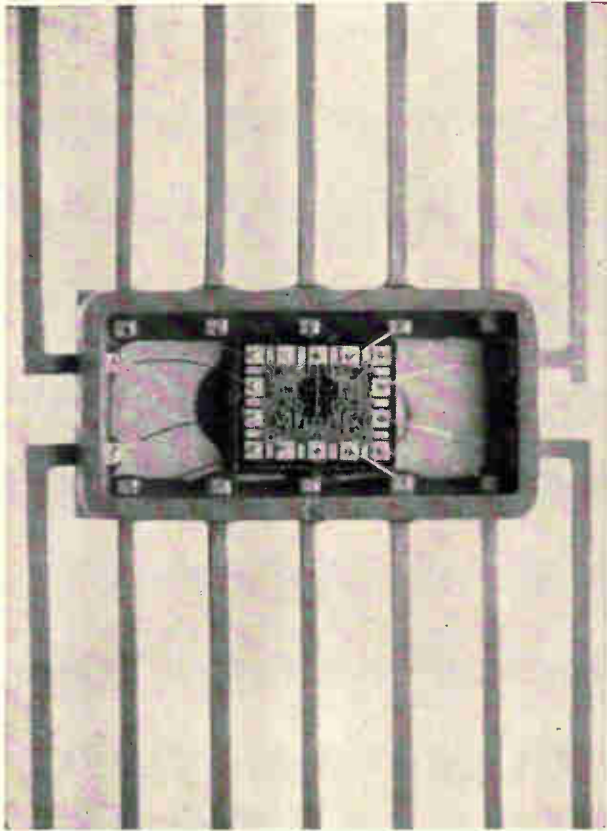

Old and new methods of bonding leads to integrated circuit chips. The conventional package (left) requires individual wire leads between each ribbon lead and each bonding pad on the chip. The ribbon leads (right) of the new package are bonded directly to the pads; note the much larger bonding areas.

being investigated for other applications, such as:

- Connection of several chips to form subsystems by using more complex lead frames than those made for the single chip package.
- Packaging multiple transistors and diodes and combinations of these with integrated circuits.
- Packages for rectifier bridges, silicon controlled rectifiers and power transistors.
- Hybrid circuits, with passive thick-film resistors and capacitors put on the ceramic package lids.
- Determination of device reliability and failure modes. Since the packaging materials are inert and withstand high temperatures, and since the packaging techniques could be standardized over a wide variety of devices, failure modes of the devices—other than lead failures—could be isolated and compared.

Curing purple plague

For example, the familiar failure mode known as purple plague does not enter the reliability picture when the new packages are used. Purple plague consists of several intermetallic compounds formed when gold-aluminum bonds are held at temperatures above about 200°C. The presence of silicon in the oxide coating, normally found on chips, and physical stress apparently accelerate purple plague formation, but gold and aluminum are the main culprits.

The plague's molecular structure is larger than the parent metals', and it can exert enough pressure at the gold-aluminum interface to weaken the bond and cause it to fail. If the bond is not destroyed, the higher resistance of the compound may degrade circuit performance. Numerous studies and published reports have identified purple plague and other forms of bond failure as the most prevalent causes of integrated circuit failure.

These findings have caused most integrated circuit manufacturers to change or plan changes in bonding materials. For example, if gold lead wires are retained, the thin films on the chip are also made of gold and if aluminum thin films are retained, the lead wires are changed to aluminum. Other metal combinations are also being developed. For example, the Bell Telephone Laboratory, Inc.'s experimental beam-leaded devices [Electronics, June 28, 1965, p. 68] have gold leads applied over sputtered titanium and platinum films and ohmic contacts to the circuit components are made of platinum silicide.

ITT's method of eliminating wire bonding solves the purple plague problem. There is no plague reaction between Kovar and aluminum.

How good are the bonds?

The larger area of the lead-to-chip bonds in the ITT package (50 square mils, compared to 5 square

mils for gold bonds and even less for aluminum-wire bonds) makes the bonds initially stronger than wire bonds. The ITT bonds withstand a horizontal pull of 50 grams. Frequently, as shown in the photo at right, pulling the leads rips chunks of silicon from the chip and fractures the chip.

Preliminary tests indicate that the ITT bonds will be stronger in the long run, too, despite the fact that Kovar and aluminum are not as closely matched in thermal coefficients of expansion as aluminum and gold. Thermal coefficients are 8.7 (times 10^{-6} per degree centigrade change in temperature) for Kovar, 14.3 for gold and 29.1 for aluminum.

However, as a practical matter, the larger mismatch has not caused failure during temperature cycling. An alloy formed at the Kovar-aluminum bond appears sufficiently ductile to absorb the minute differences in the actual expansion of Kovar and aluminum. Moreover, the glass encapsulation over the bonds anchors the leads to the chips. Life-test data on bond strength is being accumulated.

The bonds are cycled between room temperature and 550°C during the sealing process, a temperature variation much greater than in operating circuits. Nor have bonds degraded during storage tests at 400°C . Devices have failed during these tests, but the failures have been traced to causes common to planar devices, not bond failures. In general, circuit performance is not degraded.

A bond reliability at least 50% better than in wire-bonded circuits is anticipated. This estimate is based on the ITT bonds proving at least as strong as wire bonds, plus the fact that the number of bonds has been reduced from 28 to 14. The accuracy of the estimate will be determined by long-term life testing, which has been started. The estimate has been borne out by accelerated life tests, of the step-stress type commonly used for wire-bonded devices. But the life tests may show that such step-stress tests do not adequately predict failures in the Kovar-aluminum bonds.

The package passes the standard environmental tests specified in MIL-STD-750-1021 and MIL-STD-202C. It's hermeticity is such that the rate at which air leaks into the package is too small to be detected by any of the standard leak-detection tests.

Chip and package design

The bonding and sealing technique can be adapted, without significant change, to many different chip and package configurations. The form factors selected for initial production are:

- Package size: there are two package sizes, both conforming to industry practice. The one illustrated has Kovar lids and measures $\frac{1}{8}$ by $\frac{1}{4}$ inch. Another has ceramic lids and is $\frac{1}{4}$ inch square. Both have 14 leads.

- Lead spacing: at the chip, 8 mils; outside the package, 50 mils. The leads are 8 mils wide at the tips and 4 mils thick. Tip dimensions and spacing are dictated by metal-stamping practice,



Bond strength is tested by pulling the leads. Most of the bonds on this chip held until chunks of silicon were torn loose and the chip fractured.

which requires that the width and separation of the stamped parts be twice their thickness.

- Chip and pads: chips measure 70 by 88 mils; pads are 10 mils square. There are two pads at each end, three on each side and one at each corner.

The minimum chip width must be 56 mils to accommodate four leads 8 mils wide and three spaces 8 mils wide; likewise the length must be at least 72 mils to accommodate five leads. The larger size of the actual chip allows pads 2 mils larger than the minimum, so registration of lead tips to the pads is not critical during bonding.

Stopped shorts

Integrated circuits have sometimes failed because of shorts between bonding pads or between leads and silicon exposed at the edges of the chips. This can happen if the passivation coating (oxidized silicon) is nicked when the dice is scribed from the parent slice of silicon, or if a lead bends over the corner of the chip during bonding or under environmental stress. Such failures were documented, for example, in a reliability study made at the Massachusetts Institute of Technology [Electronics, Dec. 14, 1964, p. 92].

To avoid this, manufacturers now usually provide a "fender" strip of passivated silicon around the chip periphery. This is done on the ITT chips. The lead design also guards against over-the-corner shorts. The leads illustrated on page 102 extend straight out from the chips. Since they ride

Unusual cover illustration is result of a novel process: a high-contrast engraving was made from the chip itself, not a photo of the chip. The photo here provides more detail, but less punch.

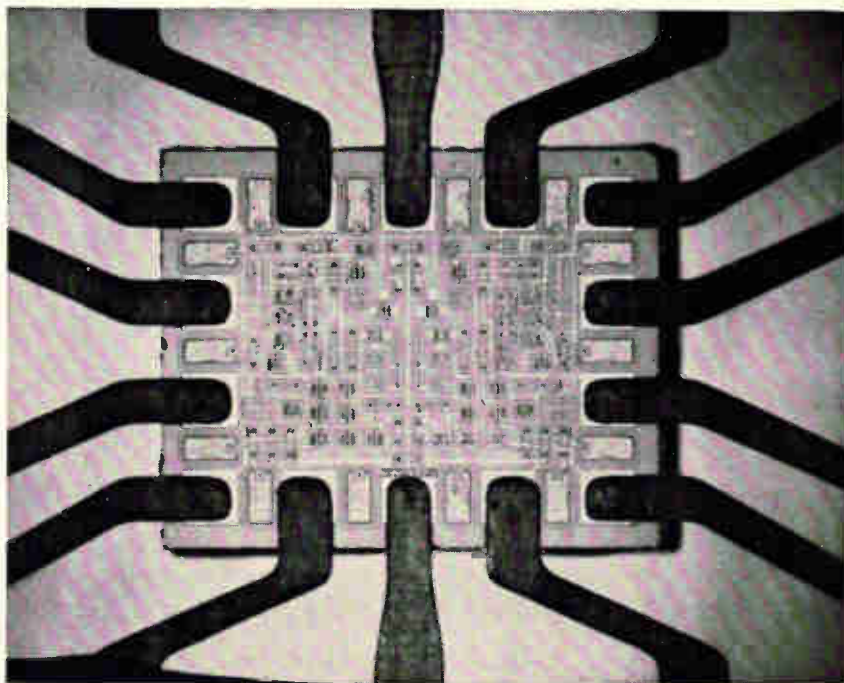

atop the passivation coating, and since all but the lead tips are oxidized, shorts at the corner cannot occur. Not illustrated is a new lead design—the lead tips are tooled so they are flush with the chip at the bond point, but rise 1 mil above the chip as they pass over the edge of the chip. This provides further insurance against shorts of both the nick and over-the-corner types.

The 8-mil spacing between bonding pads is not wasted. High-value capacitors, which require a large area, are made in the spaces between the pads.

Big chips cheaper

A frequently heard argument against increasing chip size is that this reduces the yield of good circuits from a slice. The bigger the circuit area, the more likely it is to be made over a fault in the silicon crystal—just as a big farm is more likely than a small farm to be watered somewhere by scattered showers. Faults are usually randomly scattered over a silicon slice.

The ITT chip design answers this argument by clustering the active devices in the center of the chip, in an area no larger than a conventional circuit requires. Crystal faults, unless they are major, have little or no effect on passive components and bonding pads. So the problem of low yield due to crystal faults is illusory.

Illusory, too, is the increase in cost per chip due to obtaining fewer chips from a slice. The cost of the naked chip is negligible compared to the costs of bonding, sealing and testing. The ITT chip design directly reduces bonding and sealing costs and indirectly lowers testing cost by lowering the number of circuits that must be rejected because of operator errors during conventional wire

bonding, or because of faulty bonds—which are more likely to occur when conventional wire leads are made because a larger number of bonds is required.

The chip cost is important, however, if the package cost is negligible. ITT is therefore investigating ways of applying the new packaging approach to chips that are no larger than those used in conventional packages. The bonding pads on the chips and the leads will both be made smaller.

The leads are made as part of a frame stamped from Kovar foil. The frames are chemically prepared for bonding by a proprietary process that prevents oxidation of lead tips during bonding. Oxide would degrade bond strength. Kovar was selected as the material because its thermal expansion closely matches that of the sealing glass.

The lead tips are bonded individually to the chip pads at present, as shown on page 103, because results are more consistent. However, a method of simultaneously bonding all the leads is being perfected. It has been done experimentally with a bonding tool the size of the chip. Several types of multiple bonding, such as thermocompression bonding, resistance welding, ultrasonic welding and aluminum brazing or soldering, are being evaluated. Thermocompression bonding was used on the circuit illustrated above.

The present method, bonding the leads one at a time, is faster than wire bonding. In both cases, the operator must visually position the bonding tool. However, the operator does this only once for each ITT lead, instead of twice for a wire lead. There is also a gain in bonding speed due to the elimination of wire handling by the bonding tool.

Plans are to make the lead frames in strips of 15. The strips will be automatically indexed and

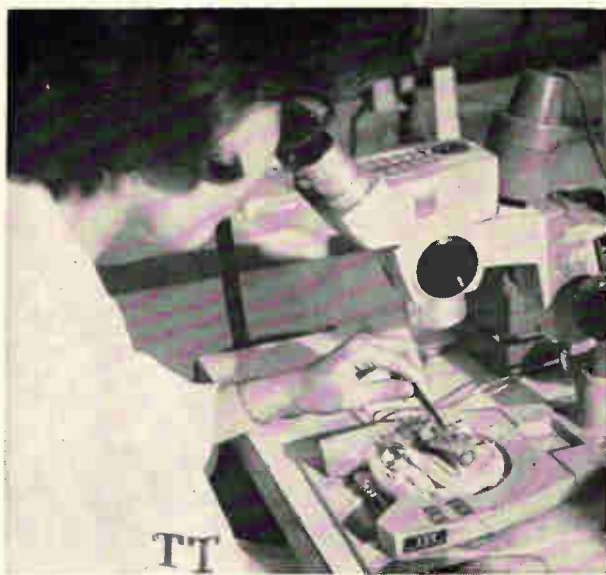
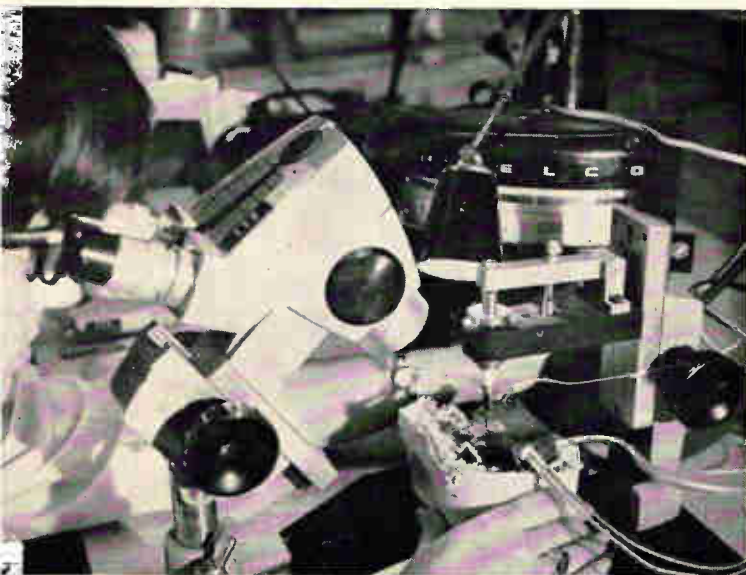

Bonding and sealing setups used in initial production. Bonds are made (left) one at a time, but automatic parts feeders and bonding tools that make all 14 bonds simultaneously will be used. Likewise, sealing will be converted from a hotplate operation (right) to a mechanized process.

the leads mechanically positioned and bonded. Feeding the chips to the bonding equipment will also be automated.

Double-glass sealing

After bonding, silicon dioxide is pyrolytically deposited over the device by the reaction of silane and oxygen. This widely used technique (often called glassivation because glass is essentially silicon dioxide) puts a protective coating on silicon devices. It lays a foundation for the sealing glass used at ITT.

The device is then sandwiched between lids whose insides are thickly glazed, and the assembly heated to as high as 550°C. As the glass flows, capillary action provided by the lids and other cohesive and adhesive forces confine the molten glass to the package dimensions. The packages are plated with gold and ultrasonically cleaned and the circuits tested.

Packages with closely controlled dimensions can also be made without lids, by transfer molding. This process, which consists of injecting plastic (in

this case, molten glass) into a mold containing the bonded device, is often used to encapsulate conventional electronic components.

Neither lids nor molding is required if package shape is not important. Molten glass can be applied directly to the glassivated device. However, cohesive forces in the molten glass would draw the package into an ovaloid and form menisci between the leads.

Ultrahigh-temperature devices

Materials combinations that can withstand 1,000°C sealing temperatures are being developed. Such a packaging system requires materials that will not react with silicon dioxide, metals or bi-metals that have a sheet resistance of less than 0.1 ohm per square and can make contact to either n-type or p-type silicon, and lead materials that can be soldered or welded.

The use of such materials would permit high-temperature sealing glasses and a better match of thermal coefficients of expansion of the package parts. Also, packaging able to withstand extreme

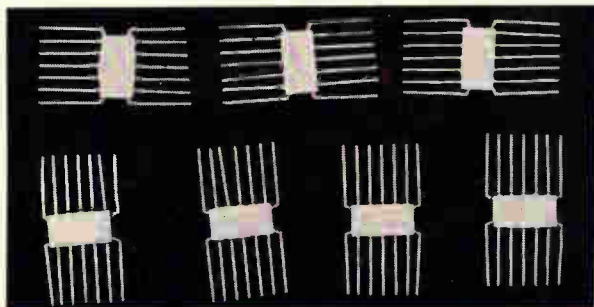
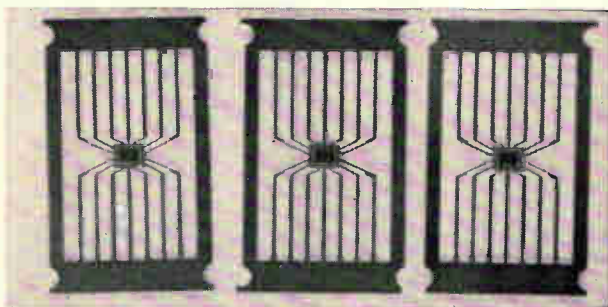

Lead frames are now handled individually during bonding. Under ITT's plans for production automation, the frames will be made in strips of 15. At left are chips with bonded leads, at right are sealed circuits.

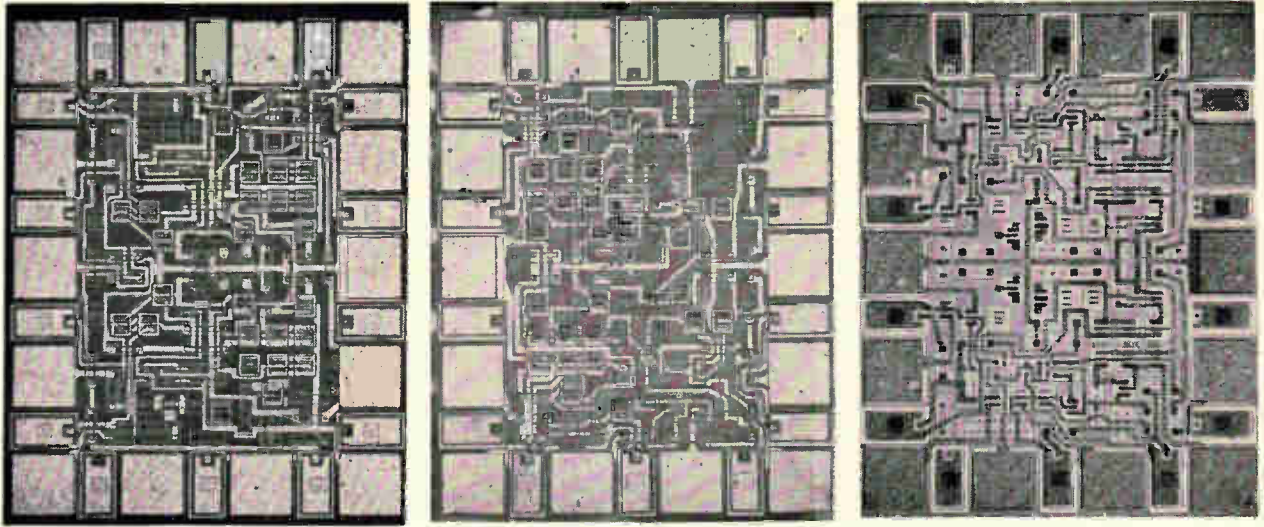

Three different circuits made from chips that have identical components but different interconnection patterns. At left is a J-K flip-flop counter network. The other two are multiple NAND/NOR gates. These are members of the ITT Series 300. Each circuit includes about 75 of the 100 components available on the dice.

temperatures will probably be exceptionally reliable under normal conditions.

Each chip a circuit kit

Besides the primary goal of low-cost packaging, chip and package designs were specifically aimed at solving another type of integrated circuit production problem: the recurrent need for small quantities of the special, often highly complex,

logic and control circuits required by electronic systems. These can only be made economically if changes in the silicon processing or packaging techniques are not required.

The solution is to mass produce chips whose components can be used to make many types of circuits. The chips, in the form of undiced slices, are stored until needed and then provided with thin-film interconnection patterns which convert the components on each chip into the desired circuit. After that, the slice is diced and the chips packaged as usual.

The authors



Charles R. Cooke Jr., was a key man in Texas Instruments integrated-circuit operation before he joined ITT in January, 1964. He had product responsibility for TI's Series 52 and 53 circuits, started the design of the Series 51 and 53, and was developing low-cost circuits. He directs research and development at ITT Semiconductors.



Ronald W. Mohnkern, another TI alumnus, helped develop the first integrated circuit in 1959 and the planar process in 1960. When he left TI in February, 1964, he was an assembly and test supervisor. He is now a senior process engineer at ITT, setting up assembly and metalization processes.



Salvatore M. Sampiere is an advanced development engineer, specializing in diode assembly design, packaging and production, and integrated-circuit package development. He joined ITT's National Transistor division, now part of ITT Semiconductor, in 1962. Previously he was with the Bradley Semiconductor Corp.

This approach is called Master Slice or Master Dice by other companies. One of the authors (Charles Cook) coined the "master slice" term while he was at Texas Instruments Incorporated [Editor's note: ways to design circuits with such dice are given in *Electronics*, Oct. 19, 1964, p. 58.]

While the idea is not new, the ITT chips incorporate improvements expected to overcome the difficulties which have limited commercial success of the approach.

First, advanced semiconductor-processing techniques are employed to make the components on the chips extremely small. Each chip has 100 components, which are arranged so that most of them can be interconnected conveniently with a thin-film pattern. In the examples at the top of the page, about 75 components are used in each circuit. All three circuits shown were made from identical master chips. The large number and variety of components means that use of the chips is not restricted to the simpler circuit forms which are now available from mass production lines.

Second, the standardized lead pattern avoids changing the packaging procedure. Lead changes are made in the thin-film pattern. The 14 leads are bonded as usual; if less leads are needed, the bonding pads simply are not connected to the circuit's interconnection pattern.



"Only \$98?"

Yes! Sorensen's QB Series (transistorized DC power supplies) are available off-the-shelf for as little as \$98. Every one of the 24 models in this line provides:

- Constant current (Regulation $\pm 0.01\%$, line and load combined)
- Voltage regulation $\pm 0.01\%$ (line and load combined)*
- Extended voltage range, 2:1
- RMS ripple less than 300 microvolts
- Transient response 25 microseconds or less
- Temperature coefficient 0.015% /°C
- Drift typically less than 0.025% for 8 hours
- Output impedance as low as 25μ ohms + 0.3μ h
- No turn-on, turn-off overshoot
- Remote sensing
- Programmability
- Series or parallel operation

*Regulation for 6-volt models $\pm 0.02\%$

For complete specification and application information on the QB Series, and all other Sorensen products, send for the new 140-page Controlled Power Catalog and Handbook. Contact your local Sorensen representative, or write Sorensen, Richards Avenue, South Norwalk, Conn. Or, use reader service number 200.

ELECTRICAL SPECIFICATIONS

MODEL NUMBER	OUTPUT VOLTAGE RANGE (VOC)	MAXIMUM OUTPUT CURRENT (AMPS.)	PRICE	MODEL NUMBER	OUTPUT VOLTAGE RANGE (VOC)	MAXIMUM OUTPUT CURRENT (AMPS.)	PRICE
QB6-2	5-9	2	\$ 98	QB28-2	18-36	2	\$160*
QB12-1	9-18	1	98	QB50-1	40-60	1	160*
QB18-.75	13-26	.75	98	QB6-15	5-9	15	215*
QB28-.5	18-36	.5	98	QB12-8	9-18	8	215*
QB6-4	5-9	4	108	QB18-6	13-26	6	215*
QB12-2	9-18	2	108	QB28-4	18-36	4	215*
QB18-1.5	13-26	1.5	108	QB50-2	40-60	2	215*
QB28-1	18-36	1	108	QB6-30	5-9	30	285*
QB50-.5	40-60	.5	108	QB12-15	9-18	15	285*
QB6-8	5-9	8	160*	QB18-12	13-26	12	285*
QB12-4	9-18	4	160*	QB28-8	18-36	8	285*
QB18-3	13-26	3	160*	QB50-4	40-60	4	285*

*Optional volt and ammeters \$30



A UNIT OF RAYTHEON COMPANY

Circle 105 on reader service card

Corporate Support For Our Colleges...

Let's Get It Soaring Again...

The chart on this page tells a disturbing story. It is that the percentage of their profits before taxes which U.S. business corporations contribute to our colleges and universities has been leveling off in recent years. This is unfortunate for higher education, for American business and for the community at large. The good health of all of them calls for a lusty growth in the share of pre-tax corporate profits going to higher education.

To be sure, the total number of dollars contributed by U.S. corporations to higher education, as estimated by the Council for Financial Aid to Education and as shown in the table on the following page, has continued to go up in recent years. But the speed of the ascent has slackened, and in 1964 the rate of contributions leveled off at the same percentage as in 1963.

In 1964 corporate contributions to higher education came to about .44 of one per cent of profits before taxes. Contributions for all purposes came to about one per cent. This is about one-fifth of the five per cent of corporate profits which the federal government exempts from income taxation when contributed to philanthropy.

An Optimistic Explanation

There are quite a few possible and partial explanations of the failure of corporate contributions to higher education to keep pace proportionately with the increase in corporate profits. One of the more optimistic of them is that the volume of corporate profits has risen rapidly since 1961, as the table on the

CORPORATE CONTRIBUTIONS TO HIGHER EDUCATION
(percent of corporate profits before taxes)

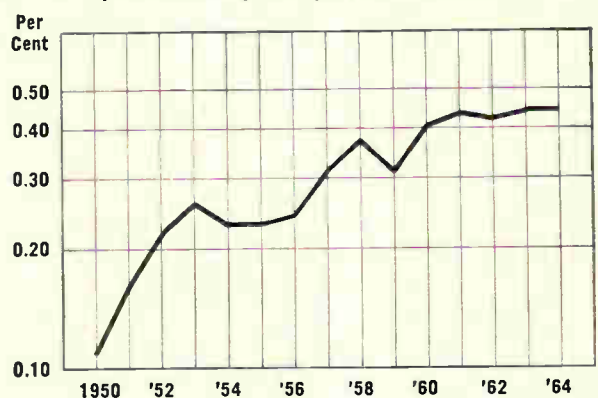

Source: Council for Financial Aid to Education, Inc.;
U.S. Department of Commerce

next page indicates, and there hasn't been time to adjust programs of financial aid to education upward accordingly. Hopefully, the lag in the upward adjustment will be overcome in the years immediately ahead.

Another possible explanation of the lag is that the increase in federal expenditures for higher education, and the talk about much larger increases to come, have discouraged private contributions. So far as we know, there has been no comprehensive survey to test the validity of this explanation. But conversations with corporate officers suggest that there may be something in it. The attitude, not widely held, seems to be that if the federal government is disposed to pay for higher education, it is pointless to try to compete.

**CORPORATE PROFITS
AND EDUCATIONAL CONTRIBUTIONS**

Year	Corporate Profits Before Taxes (Bil. of \$)	Corporate Contributions to Higher Education (Mil. of \$)	% of Profits Contributed to Higher Education
1950	\$40.6	\$43.0	.11%
1951	42.2	68.0	.16
1952	36.7	80.0	.22
1953	38.3	99.0	.26
1954	34.1	79.0	.23
1955	44.9	104.0	.23
1956	44.7	109.0	.24
1957	43.2	135.0	.31
1958	37.4	137.0	.37
1959	47.7	150.0	.31
1960	44.3	178.0	.40
1961	44.2	190.0	.43
1962	48.2	200.0	.42
1963	51.3	225.0	.44
1964 (est.)	57.0	250.0	.44

Source: Council for Financial Aid to Education, Inc.;
U.S. Department of Commerce

Key To Excellence

If they are to fulfill their role properly, however, our colleges and universities must have greater support *both* from government and from private contributors. Indeed, as government appropriations increase, the margin of flexibility and freedom from government requirements essential to top flight performance will depend increasingly on private benefactions. The relationship has been very clearly stated by President Robert F. Goheen of Princeton University in these words:

“Increasing federal aid to higher education seems inevitable in view of the magnitude of our national educational needs. As it develops, it must not be allowed to take over the show, to restrict the independence and self-determining power of universities and colleges, to undermine our historic commitment to demanding standards and the cultivation of high excellence in the individual. Only continuing and enlarged support from all possible private sources can enable us to withstand these dangers. And—what I think is too often overlooked—private support will do this best if it helps strengthen universities and colleges at their centers — *i.e.*,

in their ability to sustain and develop their own programs, according to their own best judgment, carefully and consistently over time.”

Needed—More Hard-Headed Appeals

Most college and university administrators are acutely aware of the crucial importance of increased corporate contributions if their operations are to be adequately financed. But too many of them have been satisfied to make their appeals with beautifully packaged brochures, purveying wide-ranging and relatively unsupported generalizations rather than getting right down to sternly reasoned and documented demonstrations of their need of private support. The failure to make more hard-headed and hard-hitting appeals for corporate support may also account in part for its lagging.

What corporate contributions to higher education mean for the good health of the business community has been effectively underlined by Henry E. McWane, former President of the Lynchburg (Virginia) Foundry Company, in these words:

“These expenditures represent low-cost investments in the security of the economic system in which we function, and in the sources of trained leadership for the future. As carefully planned business investments, they promise a substantial long-range return. This form of investment has small appeal to the business that expects a dollar-and-cents return to be reflected in its next financial statement. We plan to be in business longer than that.”

Both for the welfare of higher education and of business there is a compelling case for getting that curve in the percentage of corporate profits moving on a sustained upward course again.

This message was prepared by my staff associates as part of our company-wide effort to report on major new developments in American business and industry. Permission is freely extended to newspapers, groups or individuals to quote or reprint all or part of the text.

Donald C. McWane

PRESIDENT

McGRAW-HILL, INC.



For Low-Level Amplifier' Applications, What More Could You Ask For Than A PNP Silicon Transistor With...



High Gain at μA Levels (to 300 Min.)

Lowest Noise Figure—0.8 db @ 1 to 10 kc

\$4.10 to \$4.50 Range in 100-Up Quantities

If you needed high voltage and low capacitance, too, you would very definitely want to use only two devices — the Motorola 2N3798 and 2N3799 PNP silicon annular† transistors. They offer the best combination for low-level amplifier performance at low prices!

For low-level amplifier applications, these devices offer such ideal performance features as:

- 0.8 db typical noise figure @ 1 kc or 10 kc (1.5 db max)
- 90 volt typical BV_{CEO} (60 volt min)
- 75 (min) gain @ $1 \mu\text{A}$ (2N3799)
100 (min) gain @ $10 \mu\text{A}$ (2N3798)
225 (min) gain @ $10 \mu\text{A}$ (2N3799)
- 4 pf (max) C_{ob} @ 5 volts

Add to these advantages the fact that these low level devices are priced at \$4.10 (2N3798) and \$4.50 (2N3799) in 100 quantities and you have a device that's worth evaluating.

Your local Motorola franchised semiconductor distributor has devices in stock for immediate evaluation. Complete specifications on both the 2N3798 & 99 individual transistors and the 2N3800-11 series transistor "Twins" are available from your nearest Motorola field representative. Give him a call. Or, write: Technical Information Center, Dept. 56 Box 955, Phoenix, Arizona 85001.



Two In The Same Package?

If you are interested in the space-saving, close-tracking-with-temperature features of two devices in one package, you can select Motorola type 2N3800 thru 2N3811 PNP annular Twins* transistors.

This unique series offers you all the advantages of the single 2N3798 and 2N3799 devices — plus, device-to-device V_{BE} matching guaranteed over a complete current range from $10 \mu\text{A}$ to 10 mA . . . *no other dual transistors offer this broad matching specification!*

One more point: The Motorola 2N3800 series of "Twins" transistors features exceptionally tight "tracking" specifications . . . with base voltage differential change as low as $10 \mu\text{V}/^\circ\text{C}$ from -55 to $+125^\circ\text{C}$!

With units available in either the TO-18 or low-profile TO-5 packages and priced from as low as \$9.50 to \$18.50 for the *tightest matched pair*, you have a choice of high performance pairs for *any* low-level or differential amplifier job.

ANNULAR MAKES THE DIFFERENCE IN SILICON TRANSISTORS

MOTOROLA  **Semiconductor Products Inc.**

†Patents pending
* Trademark of Motorola Inc.

D-56

Now—Bourns Gives You a Complete Choice Of 7/8" Precision Potentiometers

Take your pick from the industry's finest, most extensive 7/8" diameter precision potentiometer line:

BUSHING MOUNT	SERVO MOUNT
Model 3500, 10-turn	Model 3550, 10-turn
Model 3507, commercial 10-turn	Model 3560, 3-turn
Model 3510, 3-turn	Model 3570, 5-turn
Model 3520, 5-turn	Model 3580, single-turn*
Model 3530, single-turn	

*Meets all requirements of MIL-R-12934C; can be ordered by Bourns model number or by MIL-Spec designation RR09.

In quantity and quality, this line is unmatched. Exclusive

SILVERWELD® multi-wire termination eliminates the chief cause of potentiometer failure. All-sealed construction insures MIL-Spec humidity performance (cycling and steady state). One hundred per cent inspection and the double-check follow-through of the Bourns Reliability Assurance Program are your final quality guarantees.

No matter what your requirements in precision potentiometers, you will find the answer at Bourns—the complete source. Write for technical data on our entire line of bushing- and servo-mount models, KNOBPOT® potentiometers, and turns-counting dials.

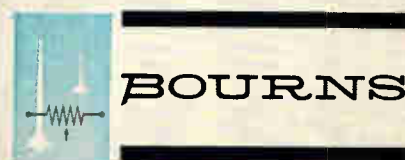
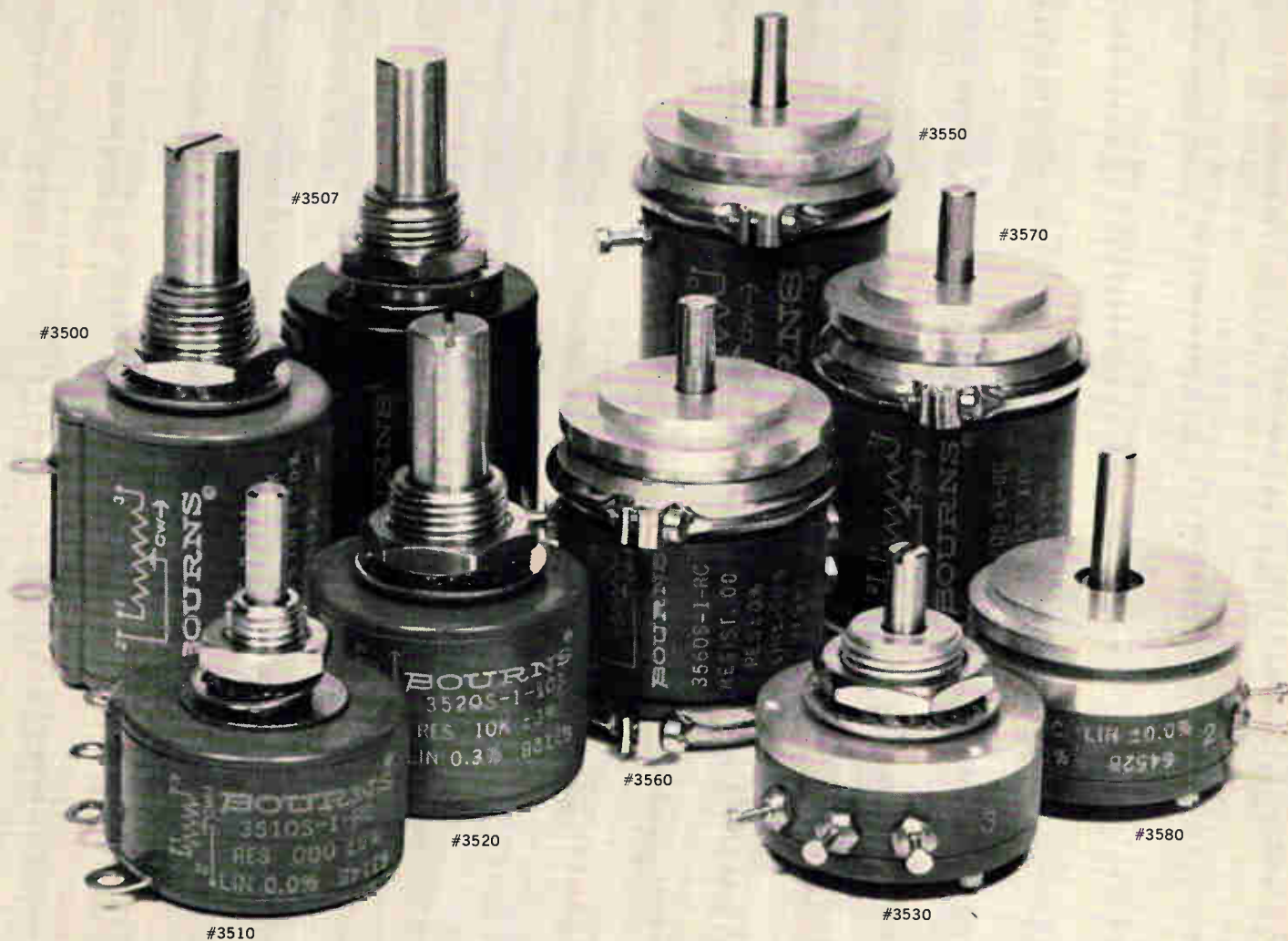

BOURNS, INC. TRIMPOT DIVISION
1200 COLUMBIA AVE., RIVERSIDE, CALIF.
PHONE 684-1700 · TWX: 714-682 9582
CABLE: BOURNSINC.

MANUFACTURER: TRIMPOT® & PRECISION POTENTIOMETERS, RELAYS; TRANSDUCERS FOR PRESSURE, POSITION, ACCELERATION. PLANTS: RIVERSIDE, CALIFORNIA; AMES, IOWA; TORONTO, CANADA

Circle 109 on reader service card

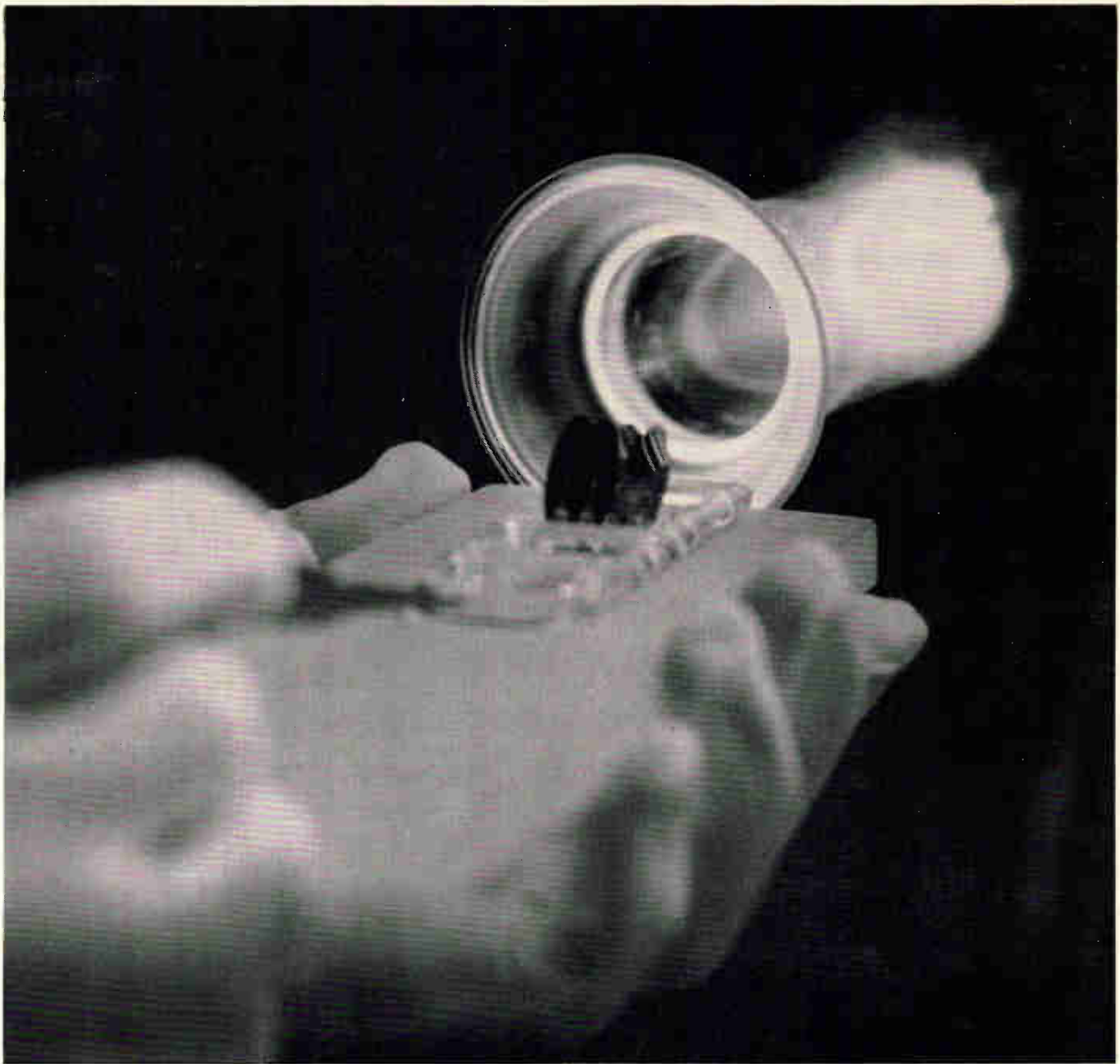

Careers on the move in electrical materials and processes

Continued expansion in new missile and unmanned and manned space system programs offers wide scope for engineers with degrees in physics, mechan-

ical engineering or electrical engineering.

Current assignments: the development of materials and production techniques concerning wire terminating devices, connectors, crimped contacts, and related electrical components; the provision of technical support and assistance to Design Engineering, Manufacturing, and Quality Control departments in all matters pertaining to electrical connecting devices.

Please send us your resume or fill out and mail the coupon.

*Mr. K. T. Snodgrass, Douglas Missile & Space Systems Division,
3000 Ocean Park Blvd., Santa Monica, California.*

I am interested in career opportunities at Douglas MSSD.

NAME _____

ADDRESS _____

Degree(s): _____

Field(s): _____

Specialty(ies): _____

U.S. Citizen: Yes No

DOUGLAS

MISSILE & SPACE SYSTEMS DIVISION
An equal opportunity employer

MOTION MEASUREMENT REPORT

CEC

REPORT NUMBER 3

New velocity vibration transducer provides low frequency response in one lightweight, shock-resistant unit



CEC's new 4-150 Piezoelectric Velocity Transducer fills a long-standing need in both aerospace and industry for a small, rugged vibration transducer for low frequency velocity and displacement measurements.

This unit combines the low impedance velocity output feature of a seismic type vibration transducer with the small size advantage of a piezoelectric accelerometer. A piezoelectric accelerometer, impedance matching source follower, filter and integrating amplifier are all combined within the transducer housing.

The 4-150 is already proving its worth in measuring the structural vibration of aircraft, ships and space vehicles as well as determining rotor unbalance in gas turbine engines and other rotating machinery. In addition to measuring low frequency vibration, its high sensitivity and absence of moving parts (thus, no friction) allows the accurate

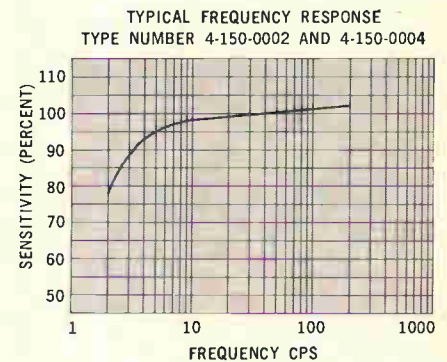
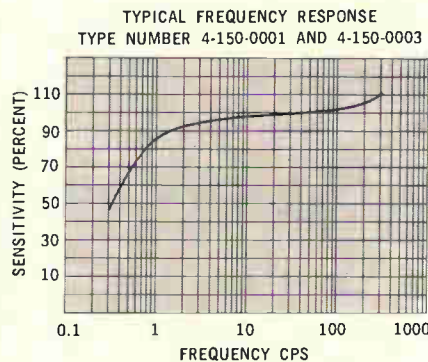

BASIC CHARACTERISTICS

Model:	4-150-0001 (no stud) 4-150-0003 (stud)	4-150-0002 (no stud) 4-150-0004 (stud)
Sensitivity:	10 mv/in./sec nominal	100 mv/in./sec
Frequency Response:	See typical curve	See typical curve
Dynamic Range:	0.3 to 200 cps	2 to 200 cps
Output Impedance:	Less than 500 ohms	
Excitation Voltage:	22 ± 2 volts d-c; less than 5 ma current	
Operable Temperature Range:	0°F to 150°F	
Weight:	2.2 oz, excluding cable	
Electrical Connection:	Four-conductor integral cable, four ft. length	
Construction:	All components are epoxy potted in an aluminum case	

measurement of extremely low amplitudes of motion.

The new 4-150 Piezoelectric Velocity Transducer is yet another case in point why CEC has become the acknowledged leader in the field of motion measurement.

For complete information about the 4-150, call or write for CEC Bulletin 4150-X3.



Transducer Division

CONSOLIDATED ELECTRODYNAMICS

A SUBSIDIARY OF BELL & HOWELL/PASADENA, CALIF. 91109
INTERNATIONAL SUBSIDIARIES: WOKING, SURREY, ENGLAND
AND FRIEBOERG (HESSEN), W. GERMANY

ANOTHER EXAMPLE OF "TOTAL VALUE" ASSURANCE...

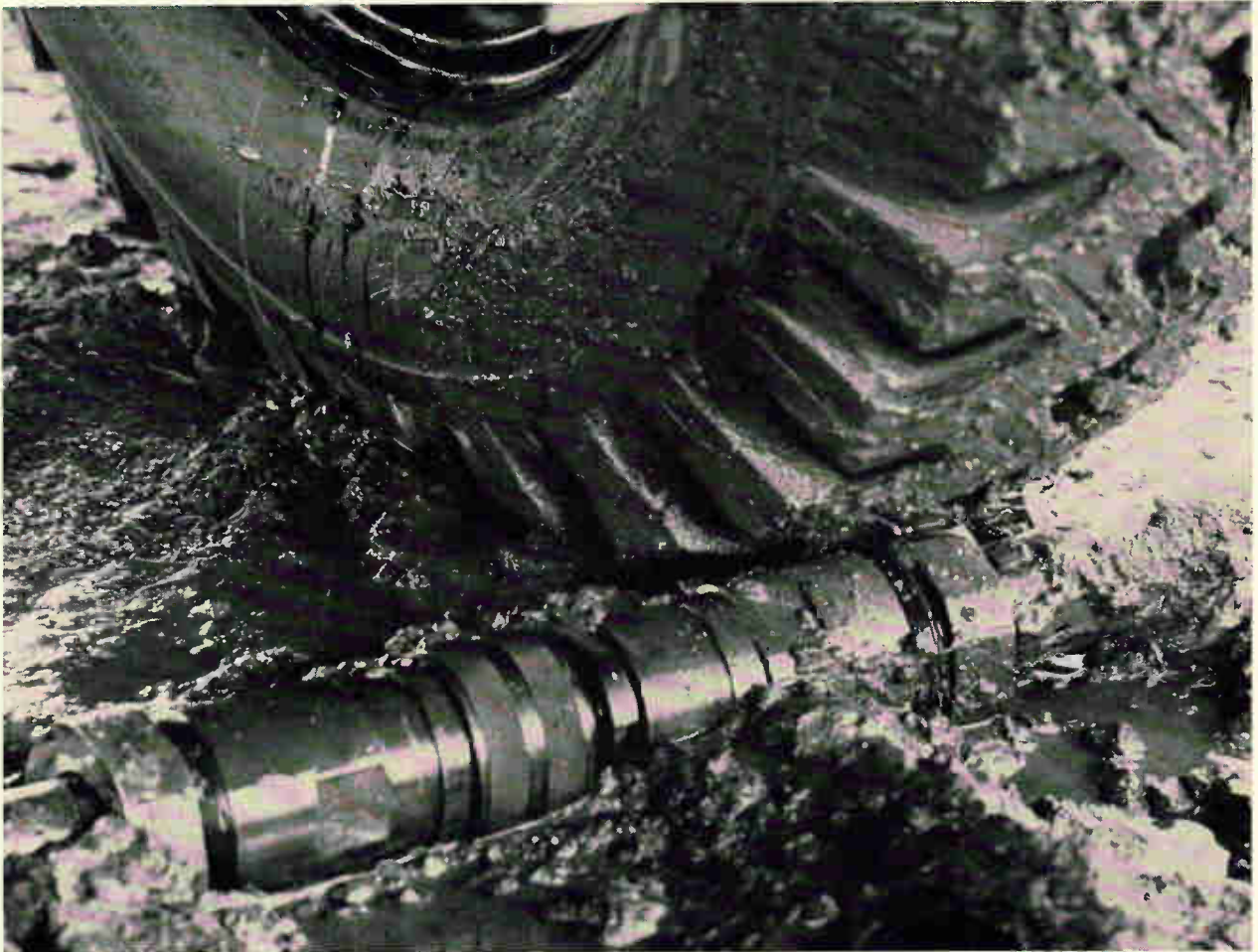

WHEN THE GOING GETS ROUGH

When your heavy duty requirements call for rugged dependability, CANNON'S CWL/CWLD CONNECTORS are the answer. Built to withstand and reliably perform under the severest operating conditions, these connectors have been service-proven in construction, mining, oil field installations, missile launching equipment, aircraft ground support, ground radar and numerous other applications. CWL/CWLD Plugs are designed to MIL-C-5015 and MIL-C-22992 respectively and feature quick and easy coupling, vibration/shock resistance, water and weather proofing, closed entry socket contacts, positive polarization and mating, and "left hand" accessory threads to prevent

inadvertent loosening of cable attachments. If your electrical equipment depends on connectors that can withstand the rigors of environmental conditions without malfunction or thread wear, look to Cannon's CWL/CWLD Plugs for rugged reliability and performance. For more information, write to: ITT Cannon Electric Inc., 3208 Humboldt Street, Los Angeles, California. A subsidiary of International Telephone & Telegraph Corporation.



Our 50th Year

© "CANNON" IS A TRADEMARK REGISTERED IN U.S., PAT. OFF. AND FOREIGN COUNTRIES BY ITT CANNON ELECTRIC INC. © 1964 ITT CANNON ELECTRIC INC.

Visit Our WESCON Booth 429-31

ITT CANNON

Probing the News

Medical electronics

Broadcasting with a heart protects lives

The Air Force is testing a telemetry system, based on techniques developed for space, to monitor cardiac patients continuously without keeping them in bed. The system has already headed off several crises

By William B. Wallace

Los Angeles Regional Editor

Four patients at the Malcolm Grow clinical center at Andrews Air Force Base have been turned into walking f-m stations in a test of a system for constant monitoring of cardiac cases. The system is based on telemetry techniques developed in biomedical space programs; it was designed and built by Spacelabs, Inc., of Van Nuys, Calif.

Patient-monitoring systems aren't new [Electronics, Oct. 11, 1963], but most of them require that the subject stay in bed while data is transmitted over wires. Those which let him walk around provide for the recording of data rather than its continuous transmission. In the Spacelabs system, signals from electrodes attached to the patient are broadcast by lightweight transmitters, picked up by ceiling antennas, and passed on to a data room.

Now and then. The data has both immediate and long-range uses. Brig. Gen. Archie A. Hoffman, head of the clinic, while cautious about evaluating the system after only a few months of operation, says that it has already warned doctors several times of impending crises. And James A. Reeves, executive vice president of Spacelabs, believes that the accumulation of data could eventually establish recognizable behavior patterns that would give reliable advance warnings of heart attacks.

The system could monitor six

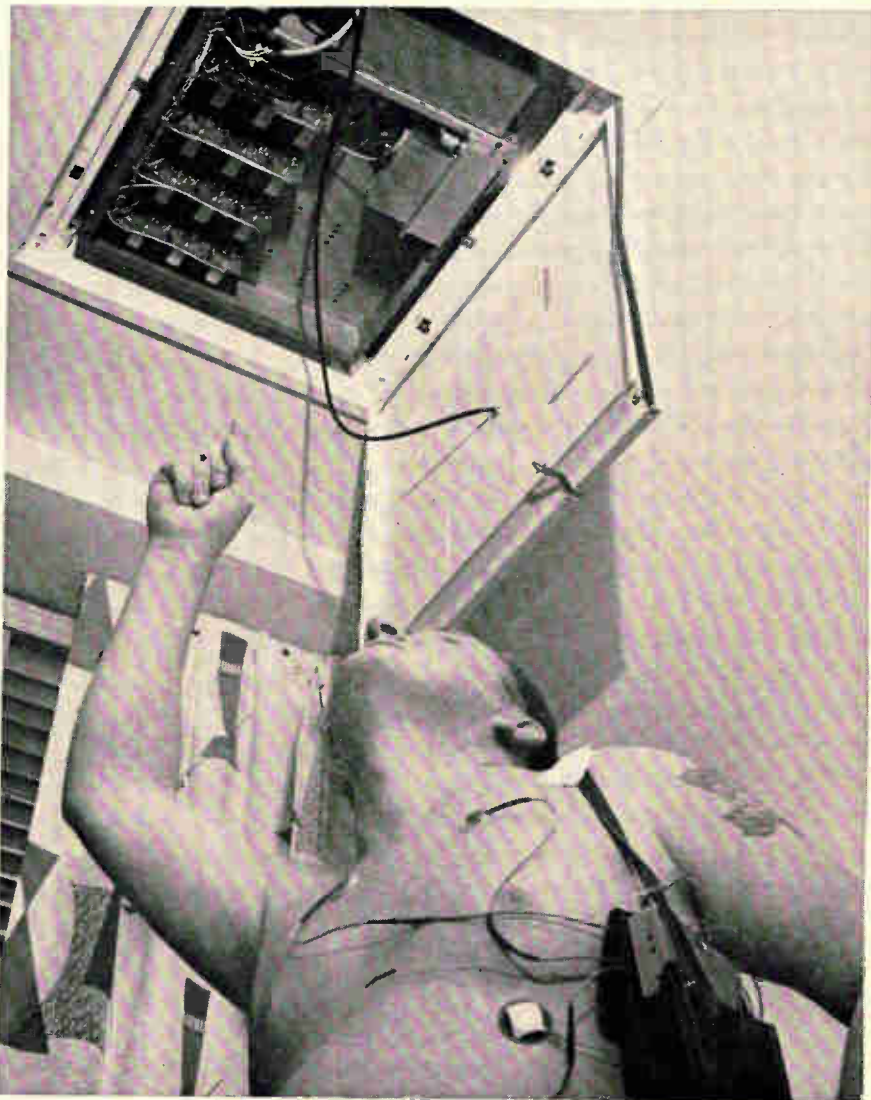

Heart patient wired for f-m telemetry points to receiving unit in ceiling of room at Malcolm Grow clinical center. Patient wears electrodes and a transmitter; ceiling unit has a phase shifter and a directional coupler.

patients; for reasons of cost, only four of the channels are equipped and now in use. (At that, the Air Force may have got a bargain, for the Spacelabs' price tag of \$60,000, established in open bidding, was one-eighth that of the next lowest bidder.) In the current test, patients can wander through eight rooms, though the system could be extended for 48 locations.

I. Data process

A desk-sized console dominates the data room. On the slanted back panel are six horizontal rows of lights, one for each patient, giving location and condition. Also on the back panel is an oscilloscope which can be switched to the data being received from any one of the patients.

Alarms light up when a pulse rate becomes too fast or too slow, or when other factors exceed the established limits. Alarm lights also indicate loss of the telemetry signal or detachment of an electrode. An audible alarm is given in conjunction with the visual alarm.

A technician at the display console has a microphone to call for help if any patient goes critical. Help arrives in a matter of seconds, a vital factor in heart attacks.

Tape recording. Incoming signals are recorded on a seven-channel tape recorder (one channel for each patient and a seventh for the time of day). This provides a record for analysis of the sequence of events prior to, during and after an attack.

The tape becomes a research tool in helping to establish behavior patterns. Direct visual readout of the electrocardiogram is continuously available on a multichannel, strip chart recorder.

II. Equipment on patient

The signal originates from three electrodes fastened to the patient with a special adhesive and then taped over for additional security. The output signal from the electrodes is boosted in an electrocardiogram (ECG) amplifier to drive a voltage controlled oscillator (VCO), which in turn drives an f-m telemetry transmitter. The patient carries a battery pack power supply and a 10-inch coiled antenna. The weight of all his equipment is about 18 ounces.

The electrode output is within the ± 5 millivolt range and is increased to plus or minus one volt by the ECG amplifier. The VCO operates on a bandwidth of 6.8 kilocycles $\pm 7\%$ and frequency-modulates a radio-frequency generator for transmission of signals.

Individual frequency. Six transmitting frequencies in the IRIG telemetry band—232.4 Mc, 236.2 Mc, 241.5 Mc, 245.3 Mc, 247.8 Mc and 252.4 Mc—are used for patient identification. Regardless of center frequency, the bandwidth of the transmitters is five times that of the VCO.

A battery pack supplying -11.5 volts and $+6.5$ volts powers the patient transmitter system. It has a charge life of about eight hours and can be recharged while being worn by the patient.

III. Ceiling unit

Each of the eight rooms has a quarter-wavelength whip antenna suspended from a ceiling unit. The signal is fed through a phase shifter and a directional coupler to a coaxial cable which connects the unit to the data room.

The phase shifter is driven by a self-contained oscillator within the bandwidth of 44.2 kc to 91.8 kc. Each oscillator operates at a specific narrow frequency to identify a particular location. Any r-f signal received, regardless of frequency, will be narrow-band, frequency-modulated at the oscillator frequency.

Since the received r-f signal from the patients' transmitters is already f-m/f-m, the signal that passes through the phase shifter will be f-m/f-m/f-m.

Receivers in the data room are frequency-matched to the six patient carrier frequencies. When a signal passes through the proper receiver, the identifying carrier frequency is removed, leaving only the 6.8 kc data frequency and the location identification frequency.

The receiver has two output jacks. One feeds the signal to a bank of narrow bandpass filters matching the location unit oscillators. Each filter rejects the 6.8 kc data frequency and all but the matching location frequency. When the signal finds and passes through the appropriate filter, a corresponding location light is displayed on

the console in the patient's row.

The other jack routes the signal through a 6.8 kc bandpass filter which rejects all of the location frequencies and leaves only the f-m data signal. The signal is demodulated, recorded on the proper channel of the tape, traced out on the proper channel of the strip chart and fed into the oscilloscope if the scope switch is set for that patient.

Alarm light. A fast-acting relay is held energized by a rectified component of the 6.8 Kc data signal. Loss of the signal will allow the relay to become deenergized, causing the "r-f off" alarm light to be displayed in the patient's row. At the same time, the relay will ground the discriminator output from the signal demodulator so that the strip chart tracing pen will not be overdriven by noise.

Loss of an electrode will drive the data signal out of the acceptable 6.8 kc bandwidth, and the resulting signal will not pass through the bandpass filter. Loss of the signal will be detected and the electrode alarm will light up. The relay circuitry is designed so that once energized, it will lock in until manually reset.

IV. Blind spots

Though the system has shown good results, it slips up occasionally. Since the transmitters are operating from a closed room, standing waves are occasionally formed by reflections from the walls. If they add up to zero at the antenna, the signal will be blanked out. Multiple pickup antennas in each room could solve the problem.

At certain spots in the hospital, a patient could be in line-of-sight of three antennas, so that the console panel would show him in three different rooms. Signal strength detectors could correct this problem.

Still, the patients are kept under almost continuous surveillance without being wired down. Gen. Hoffman offered a "preliminary impression" that the equipment will be of great assistance in the management of acute cardiac problems, and will even prove to be a saver of human life. Yesterday's electrocardiogram can't predict today's heart attack—but the continuous ECG can.

NASA and the Pentagon in 'space race'

A decision is expected soon on what kind of space lab the U. S. should orbit, but no clearcut delineation of the military's role is likely

By Warren Burkett

Washington News Bureau

The long-awaited decision by the National Aeronautics Space Council on which sort of space station the United States should orbit is likely to produce a compromise—not because the White House doesn't want to choose between the Air Force and the National Aeronautics and Space Administration, but because each side has something to offer.

Nominally, the issue is the role of the military in space, and who will run future space stations. But since electronics plays a complex and expensive role in any space station program, the immediate effect of the decision will be on the industry, and on which companies will get contracts. "There is probably a billion dollars of cost associated with any form of manned orbiting laboratory," Defense Secretary Robert S. McNamara said early this year. Of this sum, about half would be for electronics.

The Douglas Aircraft Co., Lockheed Aircraft Corp., Boeing Co.,

and General Electric Co. are still in the running for the Air Force Manned Orbiting Laboratory (MOL).

The choice between the MOL and NASA's Apollo Extension System (AES), is now in the hands of the Space Council, which is headed by Vice President Humphrey. Yet a clearcut decision for either version is not considered likely. "I think we will see the Air Force MOL first and then a switch to the Apollo extension system," says Edward C. Welsh, executive secretary to the Space Council. Welsh is considered a good barometer of White House opinion.

I. Rockets and labs

The Air Force wants to take NASA's two-man Gemini spacecraft, hitch it to a two-room, 25-foot-long cylindrical laboratory module, and orbit the hybrid with the Titan-3C rocket, which will deliver 2.5 million pounds of thrust. The astronauts would spend 30

days in polar orbit in the lab, then climb through a trapdoor into the spacecraft and fire retrorockets which would take them back to earth.

The Air Force has \$150 million to spend on the program—of which \$5 million alone is to investigate the trapdoor problem. The door would be in the heat shield, and there is a question as to whether it could withstand reentry.

The Air Force also wants a new West Coast launch site, and a program to develop an unmanned Titan-launched cargo carrier for future space stations.

NASA wants to use the three-man Apollo moonship with several kinds of space lab; it has \$50 million to study this Apollo Extension System. NASA would adapt the Saturn rocket, which will send the first Apollo to the moon, to orbit several different laboratory modules.

Versatile craft. The key to NASA's thinking is Apollo's versatility. Reducing the three-man crew to two would provide working, living, and supply space to make possible 90-day orbits without sending up supplies. Moreover, Apollo's rocket engine can provide enough thrust to put the ship into any low-earth orbit (100 to 200 miles), a 22,300-mile stationary orbit, a 28-day polar mapping orbit around the moon, or even a retrograde orbit, in which the ship would go from east to west.

Apollo carries a lunar excursion module which could be replaced by laboratory modules. NASA envisions "cans" of 5,600 cubic feet for living and working in space. North American Aviation Inc., the

MORL and LORL

The Gemini and Apollo orbiting laboratories are only the beginning; NASA has some really ambitious projects in mind. Chief among them are the Manned Orbital Research Laboratory (MORL) and the Large Orbital Research Laboratory (LORL).

MORL would accommodate six crewmen in a pressurized sphere 260 inches in diameter. The sphere itself would be housed in a long tube which would be lifted into a 200-mile orbit by a Saturn 1B rocket. (A Saturn 5 rocket could boost the laboratory into a synchronous orbit 22,500 miles out.)

The crewmen, would reach the station in either a Gemini or an Apollo spaceship.

NASA's Langley Research Center, the Douglas Aircraft Co. and the International Business Machines Corp. have done early studies on the station, which could be in operation by 1969.

LORL would weigh 240,000 pounds, hold 24 crewmen, and cost \$2.85 billion. Only the Saturn 5 could put it into orbit, sometime in the late 1970s.

The station would resemble a huge three-bladed propeller. It would be folded at launch into a 120-foot cylinder 33 feet in diameter, and flung into a 200-mile orbit, where it would remain for five years.

Lambda Announces

a complete line of

all-silicon MODULAR power supplies

**VOLTAGES UP TO 60 VDC
0.08 AMPS. TO 8.3 AMPS.**

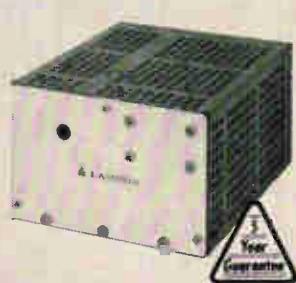

PATENTS PENDING

MOUNTED THIS WAY

MOUNTED THIS WAY

MOUNTED THIS WAY

MOUNTED THIS WAY

Full ratings
on 3 vertical
chassis
mounting
surfaces

**4 DC
outputs in
3 1/2" rack
adapter
LRA-4**



**Rack
mounting for use
with chassis
slides**

Mounting provisions made for
all popular brands of
chassis slides.

- **Maximum amps per dollar—starting at \$79.00**
- **Multi-Position-Rated™—3 mounting surfaces**
- **Multi-Current-Rated™ for 40°C, 50°C, 60°C, 71°C ambients**

● A-C INPUT 105-132 VAC, 45-440 cps

● REGULATION—Line .05% + 4 mv
—Load .03% + 3 mv

● RIPPLE — 1 mv rms — 3 mv
peak-to-peak

● REMOTE PROGRAMING
200 ohms/volt over voltage range

● NO VOLTAGE SPIKES OR OVERSHOOT
on "turn on, turn off" or power failure

● TEMPERATURE COEFFICIENT — .03%/°C

● MEET RFI SPECIFICATIONS — MIL-I-16910

● THERMALLY PROTECTED AND SHORT
CIRCUIT PROOF — CURRENT LIMITING

● REMOTE SENSING

● RACK ADAPTERS AVAILABLE

● MAXIMUM RATINGS WITHOUT EXTERNAL
HEAT SINKING OR FORCED AIR



LAMBDA ELECTRONICS CORP.

515 BROAD HOLLOW ROAD, MELVILLE, L. I., NEW YORK • 11749

Circle 116 on reader service card

LM Series available in 4 package sizes for chassis and rack mounting

Package A $3\frac{1}{8}'' \times 3\frac{1}{16}'' \times 6\frac{1}{2}''$

Model Number	VDC	CURRENT RANGE AT AMBIENT OF: (1)				Price
		40°C	50°C	80°C	71°C	
LM 201	0-7 (2)	0-0.85A	0-0.75A	0-0.70A	0-0.55A	\$ 79.00
LM 202	0-7 (2)	0-1.7A	0-1.5A	0-1.4A	0-1.1A	99.00
LM 203	0-14 (2)	0-0.45A	0-0.40A	0-0.38A	0-0.28A	79.00
LM 204	0-14 (2)	0-0.90A	0-0.80A	0-0.75A	0-0.55A	99.00
LM 205	0-32 (4)	0-0.25A	0-0.23A	0-0.20A	0-0.15A	79.00
LM 206	0-32 (4)	0-0.50A	0-0.45A	0-0.40A	0-0.30A	99.00
LM 207	0-60	0-0.13A	0-0.12A	0-0.11A	0-0.08A	89.00
LM 208	0-60	0-0.25A	0-0.23A	0-0.21A	0-0.16A	109.00

Package B $3\frac{1}{8}'' \times 4\frac{7}{8}'' \times 6\frac{1}{2}''$

LM 217	8.5-14	0-2.1A	0-1.9A	0-1.7A	0-1.3A	\$119.00
LM 218	13-23	0-1.5A	0-1.3A	0-1.2A	0-1.0A	119.00
LM 219	22-32	0-1.2A	0-1.1A	0-1.0A	0-0.80A	119.00
LM 220	30-60	0-0.70A	0-0.65A	0-0.60A	0-0.45A	129.00

Package C $3\frac{1}{8}'' \times 4\frac{7}{8}'' \times 9\frac{1}{2}''$

LM 225	0-7 (2)	0-4.0A	0-3.6A	0-3.0A	0-2.4A	\$139.00
LM 226	8.5-14	0-3.3A	0-3.0A	0-2.5A	0-2.0A	139.00
LM 227	13-23	0-2.3A	0-2.1A	0-1.7A	0-1.4A	139.00
LM 228	22-32	0-2.0A	0-1.8A	0-1.5A	0-1.2A	139.00
LM 229	30-60	0-1.1A	0-1.0A	0-0.80A	0-0.60A	149.00

Package D $4\frac{7}{8}'' \times 7\frac{3}{4}'' \times 9\frac{1}{2}''$

LM 234	0-7 (2)	0-8.3A	0-7.3A	0-6.5A	0-5.5A	\$199.00
LM 235	8.5-14	0-7.7A	0-6.8A	0-6.0A	0-4.8A	199.00
LM 236	13-23	0-5.8A	0-5.1A	0-4.5A	0-3.6A	209.00
LM 237	22-32	0-5.0A	0-4.4A	0-3.9A	0-3.1A	219.00
LM 238	30-60	0-2.6A	0-2.3A	0-2.0A	0-1.6A	239.00

(1) Current rating applies over entire voltage range and at 55 to 65 cps. For operation at AC input of 45-55 cps and 360-440 cps, derate output current 10%.

(2) Can be operated at 0-10 VDC—derate output current 30%.

(3) Can be operated at 0-20 VDC—derate output current 30%.

(4) Can be operated at 0-40 VDC—derate output current 30%.

 **LAMBDA**
ELECTRONICS CORP.

Apollo contractor, has carried out studies to show that two Apollo spacecraft could dock to each other.

Depending on the mission, the AES would use either Saturn 1B, with a thrust of nearly two million pounds, or the Saturn 5, with 8.5 million pounds of thrust, as a launch vehicle.

North American would probably make the Apollo extension ships, but Boeing and Grumman have designed many of the proposed laboratory modules.

The description of the projects clarifies Welsh's remark. Whatever the role of the military, the MOL program, using Gemini spacecraft and Titan rockets, could probably be operational before the Apollo-Saturn system.

II. Problems for the Pentagon

Just what is the military role in space? Security regulations have hampered the Air Force and the Pentagon when they try to describe what a military astronaut might do. The Air Force has tried to define military missions which do not duplicate civilian, scientific and "peaceful" projects in NASA's realm. Yet any specific mission is automatically classified; and diplomatic considerations fill any gaps in the security barrier. This leaves McNamara, Brig. Gen. Joseph S. Bleymaier, the head of the MOL program, and Gen. Bernard A. Schriever, boss of the Air Force Systems Command, talking very vaguely about earth reconnaissance, meteorite counting, weather observations, and early warning communications.

The Air Force, of course, already has a space role that no one is talking about. Spy-in-the-sky satellites have been orbiting for years. A one-paragraph story in the local newspaper about the launching of an unmanned satellite, coupled with a statement that the purpose of the launching was not given, is the only public notice these programs ever get.

III. NASA missions

However, NASA men like Dr. George E. Mueller, boss of manned space flight, and E. Z. Gray, director of advanced missions, can describe specific missions employing sophisticated electronic and electromagnetic devices that will en-

able the Apollo spacecraft to:

- Employ radar mapping photography for the earth and moon using supersensitive equipment now under military classification.

- Adapt a 38-inch folded optics telescope for direct and photographic observations; the telescope would be the equal of a 200-inch telescope on earth from the ground. Accessory equipment could also scan the spectrum from 0.35 to 1.5 microns for studies of the earth or stars.

- Scan the ultraviolet (3000-4000 angstroms) with recording instruments or cameras.

- Conduct gamma ray (0.03 angstroms), x-ray (1 to 50 angstroms), and neutron surveys in earth orbit.

- Monitor the infrared band (1 to 50 microns) for earth's general heat loss and local "hot spots" for weather and geological studies.

- Make orbital gravity surveys of the earth and attempt remote sensing of new mineral resources by scanning the ultraviolet and short wavelengths of the visible light spectrums. Fluorescences like those which indicate certain mineral deposits have also been observed at the surface above underground nuclear explosions.

- Attempts to make crop production estimates and spot crop and plant diseases by advanced photographic analysis.

The civilian spacemen believe these sensing techniques should be proved in earth orbit before sending an Apollo extension system ship out 250,000 miles for a thorough mapping and analysis of the moon's entire surface.

IV. Help for the military

If the Air Force has a problem in defining a purely military space mission, it is also true that many space experiments have military applications. The flexibility of the Apollo systems once moved McNamara to say "I want to be certain that NASA, to the extent that it extends Apollo beyond the limits required for the lunar program, takes account of whatever we must do in the MOL to meet bonafide military objectives." North American Aviation has been given \$700,000 to pinpoint specific military possibilities of the Apollo system. The results are classified.

One example of the way purely

Make a connector's connecting pins thinner and shorter and you make the whole connector thinner, shorter, lighter.

Engineers of the world; meet the Bendix family of dependable thinner, shorter, lighter "Pancake" connectors.

They are the smallest, lightest off-the-shelf connectors currently available.

If you engineer for aerospace, Bendix® Pancakes can reduce your design's total connector length up to 50% and weight up to 60% over other production connectors.

And, in most installations, Pancake connectors give better performance: Provision for as many as 135 contacts in one Double-Density connector.

Increased resistance to contact pin bending. Greater contact retention. Temperature capabilities to 392°F continuous operation. Improved electrical characteristics through rigid, glass-filled epoxy inserts. And reduced failure through fewer components and increased materials capability.

They come in 9 sizes with both crimp and solder terminations. Straight plugs, wall mounts and jam nut receptacles

come with and without strain relief clamps. Box mounts and hermetic seal shell types are also available.

Your Bendix representative can give you 19 legitimate advantages of the totally new Pancake connectors over old-fashioned types; among them, proven dependability.

Or you can write us in Sidney, N.Y., for details.

And decide for yourself.

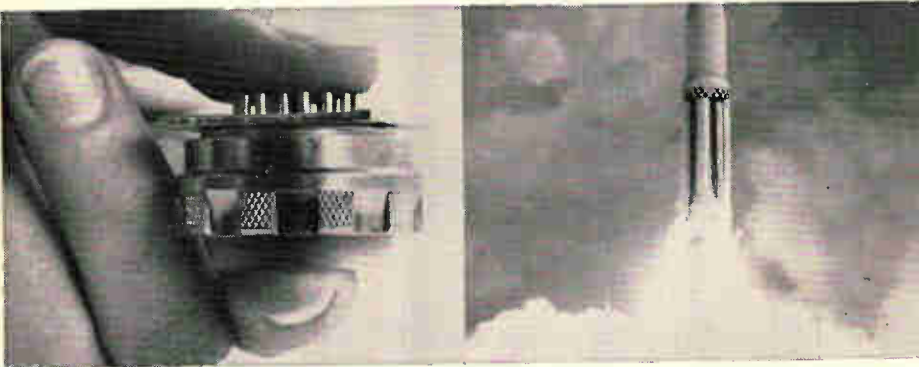

New Pancake connectors are half the size and weight of the miniature Pygmy® to let you reduce your weight requirements in critical aerospace designs.

Scintilla Division



scientific tests are "drafted" by the military was in an experiment to make seismological measurements on the moon. NASA once made public a drawing showing an Apollo module ringed with rocket-powered projectiles to carry the instruments to the lunar surface. After Rep. Olin Teague (D., Texas), chairman of the manned spaceflight subcommittee, observed that the rockets could be adapted for military purposes, NASA took the drawings out of public circulation.

V. Joint effort

To reduce duplication, the Pentagon and NASA have set up a series of coordinating boards matching civilian experts with their military counterparts. The boards extend from top policy levels down to working, "nuts-and-bolts" engineers. The technique apparently has worked well, members say, in producing a consensus in most engineering and policy matters. What competition remains in the system has been termed useful by McNamara.

Welsh emphasizes that the space council will insist on operation of only one expensive tracking and control network. The network now used on NASA flights actually is a combination of NASA and military installations.

"The Cape Kennedy control center will be available to the military now that NASA has occupied the Houston control center," Welsh said.

Interlocking directors. Welsh emphasized that merely putting military men in spacecraft does not make a program warlike. Almost all astronauts so far have been military officers, he points out.

On the other hand, Welsh does not agree with the House Government Operations Committee, which has stated that "It would be a serious mistake, in our judgment, for NASA to try to take on the complete management responsibility for a manned orbital laboratory with overriding military objectives." Welsh says that NASA has already demonstrated its ability to manage large operations. And when the Gemini program ends after eight more flights, the agency will have program managers and working engineers available for new programs.



Coleoptera lampyridae
(U.S.)



Lucerna candens
(G.E.)

General Electric has a lamp that flies, too.

The lamp on the left needs no further introduction — it already has a glowing reputation as the firefly.

We call ours the T-1 aircraft instrument, panel and indicator lamp — but you can apply it wherever space is short and lamp life should be long.

Bulb length is only ¼", ideal for computers, missile and space applications — miniaturized circuits of all kinds. Design life is from 40,000+ to 100,000+ hours.

You can choose among several varieties of these tiny mites in light output ranging from .0005 to .147 candlepower. Design volts are 3 v. and 5 v. Where your application requires, we offer these lamps aged and selected to close candlepower tolerances.

If you want a lamp smaller than these, you may have to consider baby fireflies. But they're not as dependable, not as bright, and not as long-lasting as G-E indicator lamps.

If you'd like complete technical information on T-1's, clip out and mail the coupon. General Electric Company, Miniature Lamp Department M5-5, Nela Park, Cleveland, Ohio 44112.

To: General Electric Co., Miniature Lamp Dept. M5-5,
Nela Park, Cleveland, Ohio 44112.

_____ Please send me indicator bulletin #3-5339.

_____ Have a technical representative call me.

Name _____

Title _____

Company _____

City _____ State _____ Zip _____

Progress Is Our Most Important Product

GENERAL  ELECTRIC

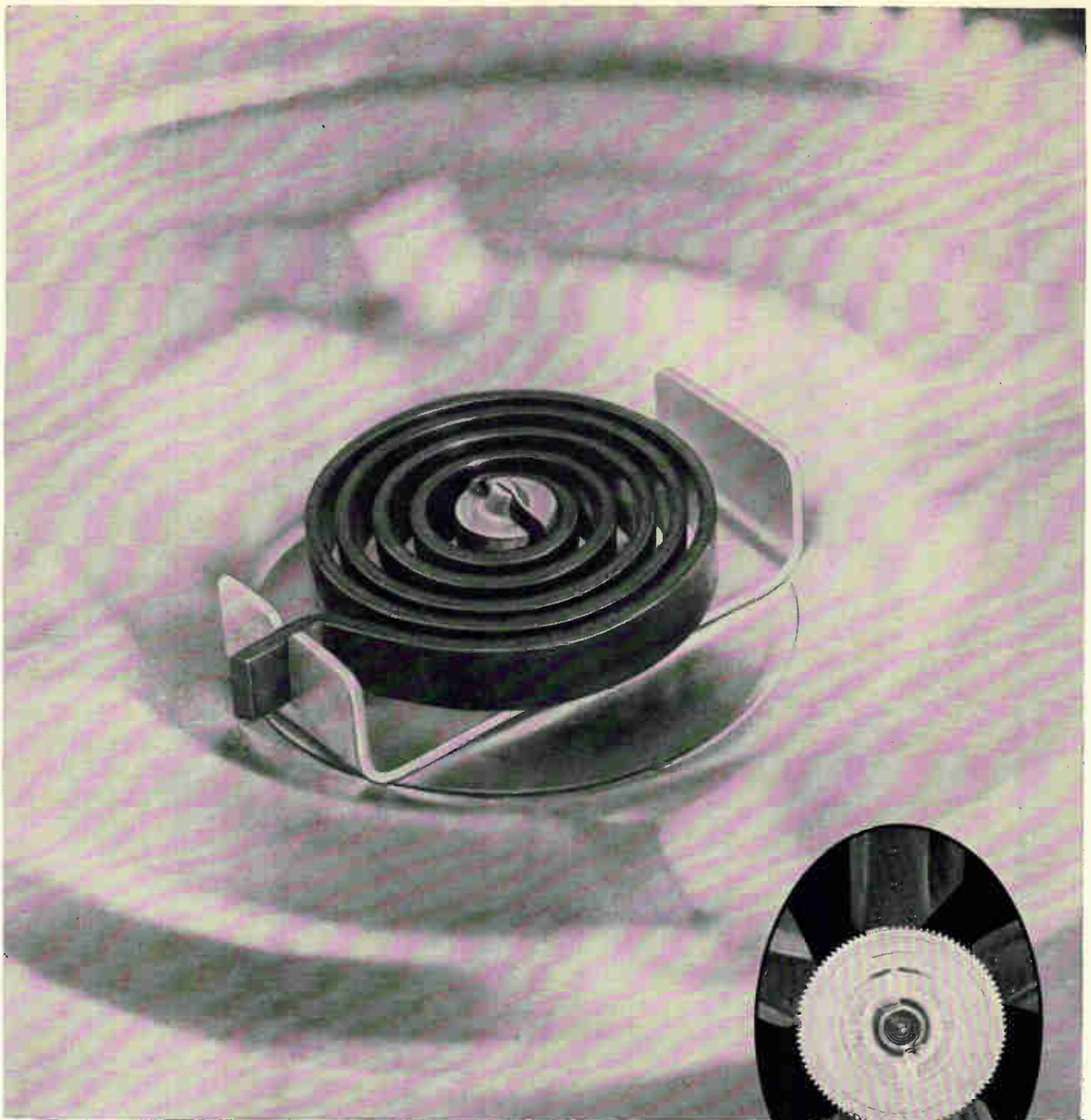

ENGELHARD Thermometal® coil automatically controls radiator fan speed

High-performance engines and the use of air conditioning in today's automobiles have created a need for highly efficient radiator cooling systems. One of the ways manufacturers reduce high temperatures is by increasing the size and speed of radiator fans — a solution to one problem that has created others, such as undesirable noise levels, heavy engine loads.

Eaton Manufacturing Company, Marshall Division, developed a fully automatic temperature sensing device — the Tempatrol® Fandrive — for regulating fan speeds in relation to the amount of cooling required, thus reducing engine noise and economizing on horsepower.

Critical to Tempatrol's performance is a Thermometal coil which automatically *controls* the flow of viscous fluid to the drive chamber. Produced by Engelhard's H. A. Wilson Division under controlled conditions to meet automotive requirements, these coils are tested for optimum performance in temperatures from 300° F to -40° F and for 250- to 500-hour resistance to highly corrosive atmospheres — positive assurance of complete dependability for many demanding applications.

For more information on Engelhard Thermometal, write to our Technical Service Department.



Some other

ENGELHARD

products

THIN WIRE AND FOIL are produced by Engelhard's Baker Platinum Division to meet rigid electronic design requirements. Both extruded and Taylor Process thin wire are available in diameters as small as .001". Thin-gauge foil is supplied in sheets up to 8" x 18".

TEMPERATURE-SENSITIVE METALS are available in a complete line for applications requiring temperature response from -100° to $+1,000^{\circ}$ F. Wilco Thermometals[®] are supplied in a wide range of resistivity in rolls and strips or tempered and formed to specification.

LIQUID GOLD produces an excellent heat barrier when applied to metals and other surfaces. Solutions are easy to use. Resulting metallic films are highly efficient reflectors of infra-red, often permit important weight reduction of substrate materials.

MAGNA POWDERS — The Magna Division produces powders from aluminum, copper alloys of copper, precious metals and some of exotic space age metals.

FUSED QUARTZ components are fabricated in all sizes and shapes for electronic use. For example: coil forms, vacuum furnace chambers, lamp bodies and high-voltage insulators. One millimeter thickness provides absolute protection against 10,000 volts. Transparent, translucent and optical grades available.

Research

Cautious conductor of our science effort

Donald Hornig, a soft-spoken chemist, acts as catalyst in the turbulent crucible where a \$15-billion program of research and development is taking shape

Many Americans consider their armed services to be an invincible force abroad and a consistent winner of domestic skirmishes on and around Capitol Hill. These citizens would be incredulous at the sight of this irresistible force being held at bay by an immovable object in the form of a balding, soft-spoken chemist with no authority whatever over specific programs.

Yet there are officials in the Pentagon who are convinced that a military man-in-space program is being thwarted by just such a man — Donald F. Hornig, a special assistant to President Johnson. It is Hornig, they say, who has kept the Air Force's plans for a manned orbiting laboratory (MOL) grounded in Congress for almost two years. [See related story on p. 115.]

As the President's science adviser, Hornig also has advocated — successfully — a cautious pace in the national development of a supersonic transport plane and an accelerated pace in basic research and science education.

I. Every call a conference

Hornig concedes that he has "had some effect" in the stretchout of the billion-dollar Air Force program. "I've had to ask some sharp questions about what's going into MOL," he says. He wants the plan's backers to spell out experiments that would be performed in space "that can't be done better on or from the ground."

Hornig's slow, methodical approach contrasts sharply with that of his predecessor, Jerome B. Wiesner. A colleague of both has described the difference this way: "I could call Wiesner and in 15 microseconds know exactly what he'd do.



"I've had to ask some sharp questions about what's going into MOL."

With Hornig every conversation is a conference. In the long run, though, the job gets done, and it may be done more thoroughly."

Wiesner's respect for Hornig is clear from the fact that he recommended the former chairman of the chemistry department at Princeton University as his successor when he resigned.

Second guesser. Hornig says he is "not particularly happy" with "the role of second-guessing the

ENGELHARD
INDUSTRIES, INC.
EXECUTIVE OFFICES:
113 Astor Street, Newark, New Jersey 07114

"TURN-ONLY" COAXIAL STEP ATTENUATORS

Motorized MA-600, MA-1200 SERIES



These six and twelve-position units permit remote control of precise attenuation steps over the entire frequency range from DC to 4 KMC or DC to 12 KMC. Installation can be made at inaccessible locations and attenuation level set remotely. Available for either AC or DC operation.

Manual SA-600, SA-1200 SERIES

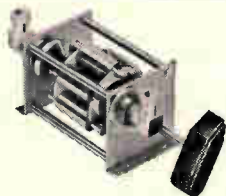

Here are low-VSWR, high-accuracy step attenuators which can be switched to any position by merely rotating the easy-turn control knob. Standard turrets are available for frequencies up to 12 KMC and for power levels of 1, 2 and 4 watt dissipation. Designs proven through 14 months of field testing.

Delivery from stock to 30 days for all standard units. Choose from steps as small as 0.1 DB, maximum values to 60 DB—higher in multiple-turret systems, both manual and motorized. Special 7- and 15-step manual and motorized turrets are also available on special request.

For complete information on step attenuators, as well as individual pads and systems, contact:

FAIRCHILD
ELECTRO-METRICS
CORPORATION
A SUBSIDIARY OF FAIRCHILD CAMERA AND INSTRUMENT CORPORATION
88 CHURCH ST., AMSTERDAM, NEW YORK 12011

operating agencies." But he points out that he is charged by law with evaluating and coordinating a \$15-billion national effort in research and development.

The chief recipients of federal R&D funds are the military (\$7 billion in fiscal 1965), space (\$4.3 billion) and nuclear energy (\$1.2 billion). Money also is channeled through such executive departments as Health, Education and Welfare (\$730 million), Commerce (\$58.1 million) and Interior (\$105.5 million), and through such agencies as the Federal Aviation Agency (\$95.5 million), National Science Foundation (\$159 million) and Veterans Administration (\$39.6 million).

Reflected power. Hornig holds little direct power, but he wields enormous influence indirectly by virtue of his role as adviser to the President. The precise extent of that influence is a function of subtle personal relationships. Hornig's influence on President Johnson, while generally considered to be on the rise, still falls short of Wiesner's influence on President Kennedy.

The indirect nature of his authority explains some of Hornig's setbacks at the hands of officials who command the President's confidence. A recent instance was Hornig's unsuccessful attempt to persuade the National Aeronautics and Space Administration to develop an intermediate second stage for the Saturn rocket; this would have increased the Surveyor spacecraft's payload to 3,000 pounds from 2,000 pounds. But James E. Webb, administrator of NASA, declined—and won.

"Now I wish we'd pressed a little harder," Hornig admits.

II. Triple threat

As science adviser to the President, Hornig holds down three specific jobs:

- Director of the Office of Science and Technology, which advises Johnson on all major scientific and technical programs.

- Chairman of the President's Science Advisory Committee, a group of top scientists that meets regularly to give the President the benefit of the nation's best thinking in science and technology.

- Chairman of the Federal Council of Science and Technology, a



"Can man do better in the capsule than he can on the ground!"

meeting ground for all government agencies that operate research and development programs. Its function is to weave these programs into a single pattern consistent with national policy.

He attends all Cabinet meetings and most meetings of the National Security Council, and is frequently called upon to comment on matters involving military R&D, the space program, nuclear policy, arms control, technical intelligence, and East-West trade. On one recent morning he dealt with a discussion of the proposed orbiting lab, a speech by the President, traffic safety, and information-handling by the intelligence agencies.

Q&A. As in television's "Meet the Press," victims of Hornig's probing are frequently reminded that his questions do not necessarily reflect his point of view, that they're his way of getting at the facts. But many proponents of specific programs forget that admonition, or doubt its accuracy. He has been accused, like his predecessors, of being opposed to such programs as man-in-space, development of nuclear power, and nu-

clear propulsion engines for use in space.

Not all of Hornig's questions are asked personally. Many filter through his staff of about 20 full-time specialists and nearly 300 part-time consultants drawn from industry and campuses. Nor do all of his questions originate with Hornig. Many represent a middle ground between two conflicting positions; some have been transmitted from the Oval Room of the White House.

III. The middle ground

Hornig's stance in the man-in-space controversy seems to be on such a middle ground—and one of profound significance to the electronics industry. Some specialists insist that men are needed in space now; others contend that men can do nothing in space that can't be accomplished better by robots. Hornig believes that both sides may be partly correct, and that the best approach may be to use man on the ground controlling instruments in space.

"Can man do better in the capsule than he can on the ground?" he asks. He speculates on the possibility of space exploration by machine, linked to ground controllers by highly accurate and efficient communications and control equipment.

MOL timetable. Turning back to the question of a manned orbiting laboratory, he says meditatively, "The question is not whether we have manned space, but whether man can do better than unmanned equivalents." Whatever the decision, he agrees that the successful launching of the Titan 3C rocket "speeds up everything connected with Titan 3," including a decision on MOL.

His military opponents accuse Hornig of failing to appreciate the defense considerations in a manned space program. The scientific community, which generally respects Hornig but has been critical of Johnson's vigorous foreign policies, is afraid that the gentle chemist may be pushed too far in the direction of the military.

But most of those who have dealt with him are reasonably confident that Donald Hornig isn't going to be pushed anywhere he doesn't want to go.

WHEN YOU NEED A PROTOTYPE MOTOR OR BLOWER

RIGHT NOW

CALL GLOBE

DIAL 513-222-3741

WE WILL SHIP YOUR ORDER WITHIN 24 HOURS



Typical sample of our extensive 24-hour stock (subject to change)

A.C. MOTORS		HYSTERESIS SYNCHRONOUS							
type	P/N	dia.	length	torque	rpm	volts	cycles	phase	
SC	53A106-2	1 1/16"	1 1/8"	.12 oz. in.	12,000	115	400	1	
MC	18A107	1 1/4"	2 1/4"	.7 oz. in.	1,800	115	60	1	
MC	18A108	1 1/4"	2 1/4"	.7 oz. in.	3,600	115	60	1	
FC	75A119-2	1 1/16"	2 1/4"	1.0 oz. in.	1,200	115	60	1	
FC	75A120-2	1 1/16"	2 1/4"	1.0 oz. in.	1,800	115	60	1	
FC	75A121-2	1 1/16"	2 1/4"	1.0 oz. in.	3,600	115	60	1	

D.C. MOTORS									
type	P/N	dia.	length	torque	rpm	volts	amps		
SS	41A100-13	7/8"	1 3/8"	.20 oz. in.	17,000-20,000	27	.18 to .25		
MM	3A1002-10	1 1/4"	2 1/2"	.5 oz. in.	9,000	24	.30		
LL	3A1003-1	1 1/4"	2 3/8"	1.0 oz. in.	11,000	24	.65		
GRP	166A100	2 1/4"	3 3/4"	.75 lb. in.	8,000	27	4.0		

GEARMOTORS		PLANETARY							
type	P/N	dia.	length	torque	rpm	volts	cycles	phase	amps
MM	5A555-1	1 1/4"	3 1/4"	250 oz. in.	11.5	24 v.d.c.	—	—	.6
MC	33A614-900	1 1/4"	3 1/16"	43 oz. in.	2	115 v.a.c.	60	1	—
FC	83A114-1528	1 1/16"	3.964	400 oz. in.	.78	115 v.a.c.	60	1	—

BLOWERS									
type	P/N	dia.	cfm @	"H ₂ O	volts	cycles	phase	amps	watts
VAX-1-AC	19A1173	1 1/8"	10	.6"	26 v.a.c.	400	1	.32	7.7
VAX-1-DC	19A1040	1 1/8"	8.5	.5"	26 v.d.c.	—	—	.25	6.5
VAX-3-FC	19A911	3"	60	1.0"	200 v.a.c.	400	3	—	65
VAX-3-GN	19A908	3"	68	1.5"	115 (a.c. or d.c.)	60	—	—	55
AC-AXIAL	19A533	2 3/8" sq.	20	0"	115 v.a.c.	60	1	—	13

If we can't meet your requirements precisely we can probably tide you over until we manufacture the exact units you need.



Globe Industries, Inc., 2275 Stanley Avenue
Dayton, Ohio 45404, U.S.A., Area 513 222-3741



For ALL 8 Leading Micro-Welders

BECAUSE BAUSCH & LOMB STEREOZOOM adds product value, benefits users. That's why StereoZoom outsells all other stereomicroscopes combined. Why your choice should be StereoZoom whether for your own product... for your production lines... for quality control and inspection.

With StereoZoom you get the brightest, sharpest 3-D images, plus continuously variable magnification. It saves operators' time, increases production, minimizes fatigue. It's built to withstand hard industrial usage, is dust-proof, shock-proof, trouble-free.

Besides, the StereoZoom line lets you pick a complete microscope or selected components... to make sure your job is done right.

Call your dealer or write for Catalog 31-15, Bausch & Lomb, 61419 Bausch Street, Rochester, New York 14602.

BAUSCH & LOMB 

Weather

Stopping storms before they start

Navy planes will bombard hurricane-breeding clouds spotted by 'Stormfury' scouts

The Navy and the Weather Bureau are planning to practice birth control at 1,000 to 40,000 feet over the west Atlantic and east Caribbean, the breeding grounds for the hurricanes that lash the East Coast every September and October.

An elaborate surveillance network, leaning heavily on electronics, will seek out the tropical cumulus clouds that evolve into storms. Then as many as 17 Navy planes will bombard the clouds with crystals of silver iodide; this is expected to cause the conversion of water vapor into ice crystals and, in the process, dissipate some of the energy that would have become part of a storm.

More intensive seeding will be performed on hurricanes already building up.

Electronic network. This new phase of Project Stormfury, a program that began in 1961, will employ intensive surveillance by four Tiros satellites, aircraft fitted with doppler radars for hunting hurricanes, four automated meteorological buoys reporting on the water's surface conditions, and a string of 18 long-range radars with a range of 250 miles.

For the first time, the Weather Bureau has a hot line connecting all hurricane-forecast offices—Boston, New York, Washington, New Orleans, Miami and San Juan. Sixteen weather stations are linked for the first time with single-sideband radio to back up land-line communications. Very-high-frequency radio connections have been installed between principal warning offices and newspaper and broadcast stations to warn the public of hurricanes as far in advance as possible.

Now Silicon Savings to 150 W, 30 Amps

1.0A I_C Max TO-5 & Flange TO-5	4A I_C Max TO-66	15A I_C Max TO-3	30A I_C Max TO-3
12.5 VOLTS SUPPLY			
2N3053 h_{FE} @ 150 ma = 50-250	40250 h_{FE} @ 1.5A = 25-100	40251 h_{FE} @ 8A = 15-60	2N3771 V_{CEO} (sus) = 40V h_{FE} @ I_C = 15A 15-60 P_T Max = 150 W f_T = 700 Kc/s (typ)
	MEDIUM VOLTAGE SUPPLY		
	2N3054 h_{FE} @ 0.5A = 25-100	2N3055 h_{FE} @ 4A = 20-70	2N3772 V_{CEO} (sus) = 60V h_{FE} @ I_C = 10A 15-60 P_T Max = 150 W f_T = 700 Kc/s (typ)
HIGH VOLTAGE SUPPLY, HIGH TRANSIENTS			
2N3440 h_{FE} @ 20 ma = 40-160 40256 θ_{j-c} = 15° C/W	2N3441 h_{FE} @ 0.5A = 20-80	2N3442 h_{FE} @ 3A = 20-70	2N3773 V_{CEO} (sus) = 140V h_{FE} @ I_C = 8A 15-60 P_T Max = 150 W f_T = 400 Kc/s (typ)



RCA ECONOMY SILICON POWER GOES HIGH CURRENT

With 3 New 30-Ampere Types—
2N3771, 2N3772, and 2N3773

RCA's broad economy silicon line of power transistors now includes three new types—RCA-2N3771, 2N3772, and 2N3773, which extend present current limits of the line to 30 amperes.

This economy silicon power line now offers you a wide performance span for:

- Inverters to 1kW
- Audio Power to 300 Watts
- Regulators to 25 Amps
- Power Switches to 1kW
- Deflection Circuits

Check out the power-handling capability of RCA's silicon line, including standard units and those recommended to meet military specifications. For prices and delivery information, see your RCA Representative. For technical data on specific types, write: RCA Commercial Engineering, Section IN7-2, Harrison, N.J.

AVAILABLE THROUGH YOUR RCA DISTRIBUTOR

RCA ELECTRONIC COMPONENTS AND DEVICES



The Most Trusted Name in Electronics

Circle 125 on reader service card

















If you can find one **POWER RESISTOR**
that's best for all your needs

...order it

We don't think you will.

Only IRC makes all these different types...can recommend without bias.

 <p>MINIATURE PRECISION WIREWOUND MIL-R-22379. ½ to 15 watts, 20 ppm max. T.C. Tolerances to .05%.</p>	 <p>METAL GLAZE POWER FILM Stable thick-film element. Moisture resistant, non-inductive. 2 to 7 watts.</p>	 <p>UNINSULATED WIREWOUND Least expensive. Wide variety of mounting terminals.</p>	 <p>HIGH VOLTAGE RESISTORS Up to 100 kv, continuous to 90 watts. Lead, lug and ferrule types.</p>	 <p>HIGH FREQUENCY RESISTORS Unique resistance film element. Lead, lug and ferrule types.</p>
 <p>CERAMIC CASE WIREWOUND Low cost commercial grade. Fireproof inorganic construction. 2 to 50 watts.</p>	 <p>FUSE RESISTOR Resistor, or fuse under overloads. Low cost, fully insulated. Axial or plug-in leads.</p>	 <p>TEMPERATURE COMPENSATING WIREWOUND Wirewound current limiters. Compensates up to 0.55%/°C.</p>	 <p>PRINTED CIRCUIT WIREWOUND Rated at 5 watts. Resists humidity and shock.</p>	 <p>IGNITION BALLAST WIREWOUND Ignition, appliance or motor start ballast. 50 watts.</p>
 <p>FLAT WIREWOUND Vertical or horizontal stack mounting saves circuit space. 30 to 95 watts.</p>	 <p>TUBULAR WIREWOUND MIL-R-26. 6 to 250 watts. Available with lugs or leads. Resisteg coated.</p>	 <p>ADJUSTABLE WIREWOUND For resistance or voltage adjustments. Tubular and flat styles. Spring contact adjustment. 12 to 250 watts.</p>	 <p>TAPPED WIREWOUND Save space and cost. Use as voltage divider network. Tubular and flat. 12 to 250 watts.</p>	 <p>FERRULE WIREWOUND Fast installation and interchangeability. Standard fuse clip mount. 20 to 215 watts.</p>

Write for Power Resistor Selection Chart... complete data in handy 11" x 17" size.



INTERNATIONAL RESISTANCE COMPANY

PHILADELPHIA, PA. 19108

Circle 126 on reader service card

Servo integrated circuits handle 8 watts

Experience gained from Navy contracts leads to development of differential amplifiers

Using the know-how it obtained in building servo differential amplifiers for the Navy, the Norden division of the United Aircraft Corp. has developed an 8-watt integrated-circuit servo amplifier. In 1962, Norden received a contract to build a 1.5-watt linear servo amplifier for the Bureau of Ships. After supplying these devices, it received a second contract for a 2-watt unit, deliveries of which were made last year. The company developed the 8-watt unit on its own.

The Navy wanted the servo amplifiers primarily for submarine navigational systems. But Norden hopes to interest airplane manufacturers in using the devices in aircraft instrumentation for measurement and control of pitch, roll and yaw.

The manufacturer attributes the fourfold increase in power capability mainly to improved packaging techniques. A package similar to the flatpack commonly used in integrated circuits was designed for the 1.5- and 2-watt amplifiers. However, for the 8-watt unit, Norden switched to a 9-lead Jedec case conforming to the TO-53 outline, and built a nickel unit of all-welded construction on a gold-plated copper base. Aluminum-to-aluminum bonds were used to connect all wires to the chips.

The amplifier consists of four separate chips, two of which are power transistors. In all, there are 10 transistors, 4 zener diodes and 36 resistors. No capacitors are used.

Two versions of the amplifier are available. The NM1003 provides a voltage gain of 500, has a gain stability of $\pm 15\%$, and an output impedance of 500 ohms. The NM-1008 has less voltage gain (200) but better stability ($\pm 7\%$). Its output impedance is 300 ohms.

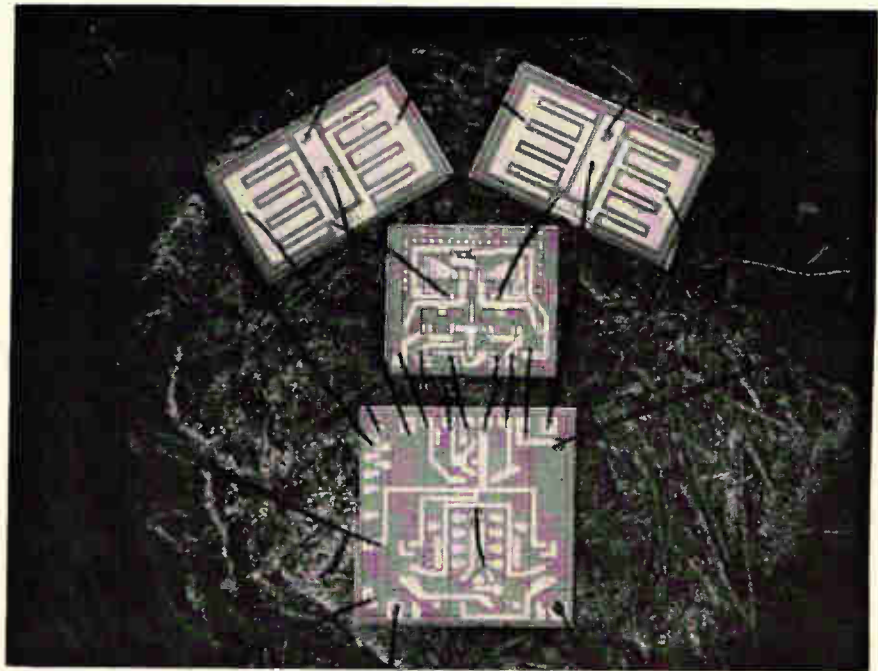

The 8-watt class A servo amplifier consists of four chips mounted on a single substrate. The two top chips are power transistors; the center chip contains eight small-signal transistors, four zener diodes and several resistors. The majority of the servo amplifier's 36 resistors are contained in the bottom chip. Aluminum-to-aluminum bonds are used.

In a typical application, each unit is operated from a 25- to 36-volt power supply and supplies linear amplification for small differential voltage signals with frequencies ranging from d-c to 10 kc. The output is linear, with no appreciable phase shift, provided that the output voltage level does not rise above 36 volts rms.

The gain of the devices can be reduced externally by inserting resistors in series with the input signal leads. Increased gain can be obtained externally by using higher supply voltages or by increasing the load impedances. The manufacturer can also supply devices with voltage gains up to 1000. Norden also plans to bring out a 40-watt differential amplifier later this year.

Specifications

	Absolute maximum ratings
Total supply voltage	36 volts
Minimum operating voltage	25 volts
Power supply current	1 ampere
Power supply power input at 100°C	17 watts
Power output at 100°C	8 watts
Load impedance ratio, a-c:d-c max.	20:1
Load impedance ratio, a-c:d-c min.	3:1
Input voltage surge	60 volts
Operating temperature	+150°C
Storage temperature	+300°C
Power transistor saturation resistance	10 ohms
Typical characteristics:	
Supply voltage	30 volts
Input impedance at $T_A=10K$	$\pm 25\%$
Phase shift at $T_A=25^\circ C$	$\pm 15\%$
T_A =Ambient temperature	
Price	Under \$150 each in 1000-unit lots

Norden division, United Aircraft Corp., Norwalk, Conn. [350]

Reed relay responds to exact voltage

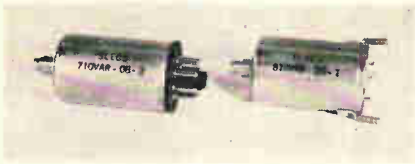

When the Stearns-Lyman Electronic Corp. decided to expand its product line to include voltage-sensitive relays, it did some market research. Customers were asked to name the specific qualities they wanted. Their replies established that 19 basic characteristics were needed for a complete line of relays. Stearns-Lyman also found that most currently available relays met few of these requirements.

As a result, the company has introduced its 700VAR and 800VAR series of voltage-sensitive relays (for over-voltage and under-voltage, respectively) which, it says, meet every one of the 19 requirements, including high reliability and accuracy, independent coil and contact circuits, small size, reasonable cost, and ability to withstand severe overvoltages on the coil.

The Sleco relays use glass-encapsulated magnetic reeds, with rhodium contacts hermetically sealed in nitrogen, which make them ideally suited for use in hazardous locations as well as for dry-circuit applications. Sensitivity of the reed contact is matched precisely to the sensitivity of the coil, and the relay will respond to any selected voltage with almost perfect repeatability within a voltage differential of $\pm 0.5\%$. The new relays have a millisecond response, and will withstand 100% over-voltage without damage.

The units come in both factory-preset and adjustable models. The factory-preset models are available for actuating voltages between 2 and 50 volts at 0.5-v intervals ± 0.2 v; adjustable models offer a minimum 11-v adjustment range within the same over-all limits. The units come in both single- and multiple-pole models.

Packaged units can be obtained that incorporate both under- and

over-voltage relays, with time delay, to make a complete generator or alternator voltage-control unit.

Specifications

Voltage range	2 to 48 volts d-c
Contacts	Rhodium, sealed in pure nitrogen.
Form	Up to 3 poles available
Rating	0.500 amp max, 12va, a-c max, 250 volts max
Life	100 million operations, rated load: infinite, dry circuit
Dimensions	1 1/4 in. diam. x 2 1/2 in. length
Weight	Approx. one ounce
Mount	Octal plug-in, or spade lug
Price	Single units from \$12.50 to \$30 each; production lots as low as \$6.30

Stearns-Lyman Electronic Corp., 12 Case St., Springfield, Mass. [351]

Tiny rotary device can switch 5 amps



Only 0.082 in. diameter, this new rotary power-selector switch is said to be the smallest available for switching 5 amperes. It is offered with one, three or five decks, each with up to eight positions. High current-switching capacity in a sub-miniature package is aided by the unique roller action, according to the manufacturer. This switch action provides large mass contacts, eliminates current-carrying springs and wiping action, and contributes to longer switch life. Contacts are made of coin silver and gold alloy for low-level switching. Designated as the 52300 series, the switch is designed to meet the environmental requirements of MIL-E-5272C. Since they are oil-tight and explosion-proof, the switches are well suited to critical applications such as laboratories, oil fields



AUTHORIZED
ERIE
DISTRIBUTOR

For Erie Components In-Stock Call

- ARIZONA**
Phoenix
Kierrulff Electronics Corp.—273-7331
- CALIFORNIA**
Glendale
R. V. Weatherford Co.—849-3451
Inglewood
Newark Electronics Corp.—OR4-8441
Oakland
Elmar Electronics, Inc.—TE4-3311
Palo Alto
R. V. Weatherford Co.—DA1-5373
San Diego
R. V. Weatherford Co.—BR8-7400
South Pasadena
Capacitors, Inc.—MU2-3541
- COLORADO**
Denver
Newark-Denver Elect. Supply—757-3351
- DISTRICT OF COLUMBIA**
Hyattsville, Maryland
Milgray/Washington, Inc.—UN4-6330
- FLORIDA**
Orlando
Crescent Elect. Sales Co.—423-8586
- ILLINOIS**
Chicago
Newark Electronics Corp.—ST2-2944
- INDIANA**
Indianapolis
Graham Elect. Supply, Inc.—ME4-8486
- MARYLAND**
Baltimore
Whlse. Radio Pts. Co., Inc.—MU5-2134
- MASSACHUSETTS**
Boston
DeMambro Electronics—783-1200
Newton
Cramer Electronics, Inc.—WO9-7700
- MICHIGAN**
Detroit
Newark-Ferguson Elect., Inc.—548-0250
- MISSOURI**
St. Louis
Electronic Components for Industry Co.—647-5505
- Kansas City**
ECI Semiconductor, Inc.—931-0829
- NEW MEXICO**
Alamogordo
Kierrulff Electronics Corp.—437-0370
Albuquerque
Kierrulff Electronics Corp.—268-3901
- NEW YORK**
New York
Arrow Electronics—MY4-6800
Newark Electronics Center—255-4600
Milgray Electronics, Inc.—YU9-1600
Rochester
Rochester Radio Supply Co.—454-7800
- NORTH CAROLINA**
Winston-Salem
Electronic Wholesalers, Inc.—PA5-8711
- OHIO**
Cincinnati
Newark-Herrlinger Elect. Corp.—421-5282
Columbus
Electronics Marketing Corp.—299-4161
- OKLAHOMA**
Tulsa
Engineering Supply Co.—LU3-8121
- PENNSYLVANIA**
Philadelphia
Radio Elect. Serv. Co. of Pa., Inc.—WA5-5840
Pittsburgh
Cameradio Company—391-4000
- TENNESSEE**
Nashville
Electra Distributing Co.—AL5-8444
- TEXAS**
Dallas
Engineering Supply Co.—FL7-6121
Houston
Engineering Supply Co.—MO-6-2175
- WASHINGTON**
Seattle
Universal Electronics Co.—MA3-2783
- CANADA**
Toronto, Ontario
Alpha Aracon Radio Elect. Ltd.—635-6181

FORMERLY ERIE RESISTOR CORP.



644 West 12th Street
Erie, Pennsylvania

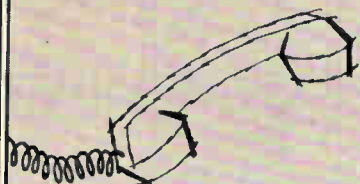

CALL YOUR AUTHORIZED
ERIE DISTRIBUTOR FOR . . .

ERIE MINIATURIZED CERAMIC TRIMMERS

FOR COMMERCIAL and MILITARY APPLICATIONS

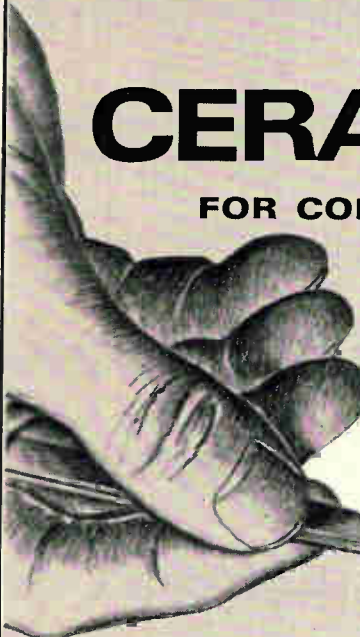

TYPE 538
ACTUAL SIZE

IDEAL FOR PRINTED CIRCUIT BOARD APPLICATIONS . . . OR POINT-TO-POINT WIRING

Engineers demanding quality and reliability in miniaturized Ceramic, Glass, Quartz and Plastic Trimmers look to Erie for their total trimmer requirements. Erie variable capacitors, long acknowledged as the industries' finest, are available in a complete range of types, sizes and values right off-the-shelf for immediate delivery.

Take the 538 Type illustrated above. This subminiature Ceramic Trimmer Capacitor is made of excellent all-ceramic material with fired electrodes and non-ferrous silver plated terminals. The 538's rugged construction and reliable performance make it ideal for Aerospace, Military and Commercial circuit applications. It is available in a variety of terminal arrangements and capacitance ranges to suit particular applications. Of course the 538 is available directly from stock.

We maintain a complete inventory of all miniaturized Erie Trimmers . . . a few of which are shown at right. In addition, complete stocks are maintained on other subminiature Erie components . . . Monobloc high capacitance capacitors, tubular and disc units, stand-offs, feed-thrus, micas, films, tantalums, R.F.I. filters and semiconductors.

Remember, your Erie distributor is your one-stop Trimmer source. Call or write for your supply . . . now.

Formerly
Erie Resistor
Corporation

OTHER ERIE TRIMMERS IN STOCK

● CERAMIC . . .



● GLASS and QUARTZ

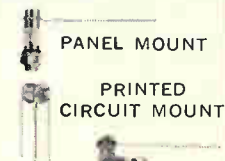

● PLASTIC



ERIE

TECHNOLOGICAL

PRODUCTS, INC.



Call Your
AUTHORIZED
ERIE
DISTRIBUTOR

- **CAPACITORS**
Subminiature Monobloc
Tubular and Disc Ceramics
Stand-Off
Feed-Thru
Mica
Film
Solid Tantalum
Trimmers (Ceramic, Glass, Quartz)

- **FILTERS**
Broad Band EMI Filters
EMI Filters (High Freq., Low Pass)
Multi Section Filters
- **SEMICONDUCTORS**
Silicon Diodes (Diffused Junction)
Germanium Diodes
Silicon Rectifiers
Semiconductor Assemblies

Advanced Components Through Increased Volumetric Efficiency

644 West 12th Street
Erie, Pennsylvania

CONTINUOUS REMOTE POWER

TO \pm 50 PARTS PER MILLION FREQUENCY TOLERANCE

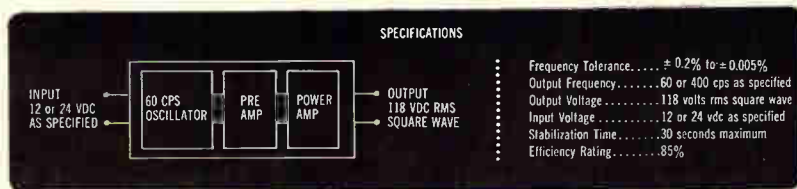
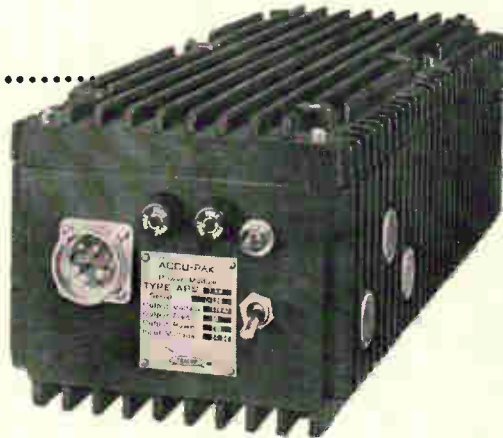

TRACOR Model APS silicon or germanium solid state Static Inverter furnishes the precise frequency controlled source of continuous or standby remote 60 or 400 cps power to run frequency dependent instruments. Any volt-ampere rating required is available by cascading modular units. Reliable overload protection is built-in. Inverters are housed in cast aluminum cases for dependable operation in rugged field use.

In the diagram the APS Inverter is in continuous service providing 60 cps power from an ac/dc power supply or switched to dc standby power. The ac distribution bus supplies the frequency controlled ac power to synchronous motors of recorders, flow meters, oscillographs, depth finders, clocks, etc. Siesmographic vans, offshore installations, ship and submarine standby power are ideal applications for TRACOR Model APS Inverters.

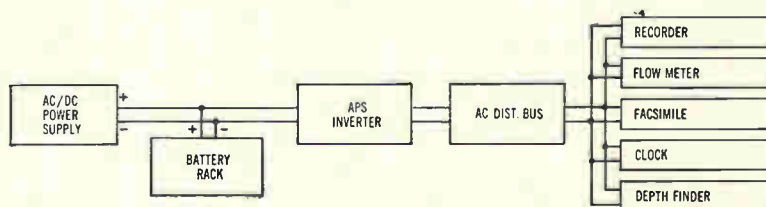

For immediate information telephone 512-476-6601. For literature write TRACOR, Inc., 1701 Guadalupe Street, Austin, Texas 78701



COMPONENTS

REPRESENTATIVES IN PRINCIPAL CITIES

New Components

and aircraft, the company says. The switches are also designed to meet or exceed the performance requirements of MIL-S-6807B. Staco, Inc., 1139 Baker St., Costa Mesa, Calif. [352]

Transformers feature constant voltage

A line of constant voltage transformers, rated from 4 v-a to 10 kva, for d-c transistor circuitry and power supplies, is said to be one-third smaller than equivalent units with a standard v-a rating. Units feature stabilized output voltage within $\frac{1}{4}$ %, fast regulating time, isolation against line noise and harmonics, and built-in protection against short-circuits and overload. Other advantages include reduced size, weight, and electronic packaging requirements, and lower cost. Transformer Engineers, 1039 E. Valley Blvd., San Gabriel, Calif. [353]

Push-button switch attains long life

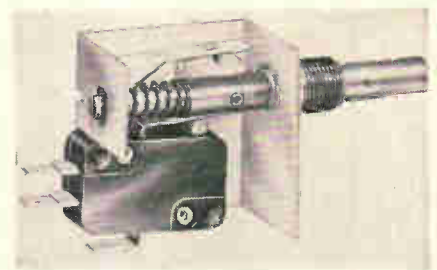

A new push-button switch combines long life, high capacity and varied circuitry with economy. Switch life on the E33-00C push-push switch is reported to exceed 100,000 actuations with electrical rating of 10 amps, $\frac{1}{2}$ h-p, 125/250 v a-c. Decorative knobs or labeled selector buttons can be easily attached to the anti-rotation plunger shaft which has $\frac{3}{8}$ in. flatted section. A self-lubricating Delrin cam eliminates ambiguity of operation by actuating the switch on the return stroke of the plunger. Panel mounting is by means of a threaded barrel for standard $\frac{3}{8}$ -32 nut. Sim-

plified wiring using standard 0.187 in. wide QC connectors, solder or screw terminals is provided for in all units. List price is \$1.75 each; net at 2,000-piece level is \$0.805, with lower prices on higher lots. Cherry Electrical Products Corp., P.O. Box 438, Highland Park, Ill. [354]

Card receptacles have rugged contacts



A new line of printed-circuit card receptacles features 0.050-in. centers for both weld and solder applications. In a line that includes up to 19 connectors, ranging from 6 to 25 contact places, it is available in the five popular sizes, with intermediate sizes obtainable on special order. The receptacle (Cat. No. PSE4DD) is designed for board-to-board or wire-to-board applications in computers, ground-support systems, telemetry and peripheral equipment. Accordion-spring contacts are formed of rectangular beryllium copper wire, gold-plated to insure durability. The termination is solder or weld, or dip solder to a 1/6 in. by 1/8 in. board.

Burndy Corp., Norwalk, Conn. [355]

Spark gap device for surge arrestors

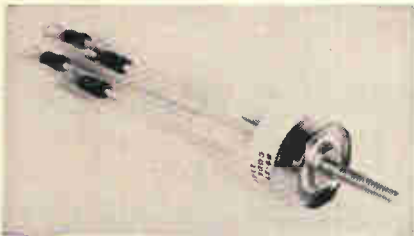

The SG-1360 spark gap device for an electronic surge arrestor protects against transient overloads. The device is designed to meet

TAKES THE
“lead position”
IN YOUR CIRCUITRY!

it's radial...it's axial-radial...it's axial

Move the leads on this monolithic VY® Porcelain Capacitor to the configuration you require. An exclusive terminal connection assures positive contact and permits fast, safe bending. In the radial position, leads are in-board the body to save board space. In axial position, leads lie close to the board.



And that's only part of the story. These versatile units are also available with your choice of lead materials. Why order separate quantities of axial and radial capacitors when the "VY" Axial-Radial Capacitor can do both jobs better? Write for data sheet P 14 containing complete specifications.

- Capacitance Range: 0.5 pf to 5600 pf
- Temperature Range: —55°C to 125°C operation
- Voltage Rating: 300 and 500 vdc
- Qualified to MIL-C-11272

© Vitramon, Inc. 1965

Vitramon
INCORPORATED

Box 544 Bridgeport, Connecticut 06601

In United Kingdom contact:
Vitramon Laboratories Limited
Bourne End, Bucks
England

telephone quality components

There is no higher standard for switching components. Specify famous Stromberg-Carlson . . . known to telephony since 1894.

RELAYS: Types A, B, BB, C and E. All standard spring combinations are available. Send for Bulletin T-5000R3.

KEYS: Broad selection of push-button, cam and twist types. Send for Bulletin T-5002R2.

HANDSETS: High-efficiency instruments; standard or with switch assemblies. Send for Bulletin T-5017R.

Full-line data on request.

**STROMBERG-CARLSON
CORPORATION**

114 Carlson Road • Rochester, N.Y. 14603



Circle 216 on reader service card

Gold Plated Copper Wire .020" diameter

Photomicrograph 133x

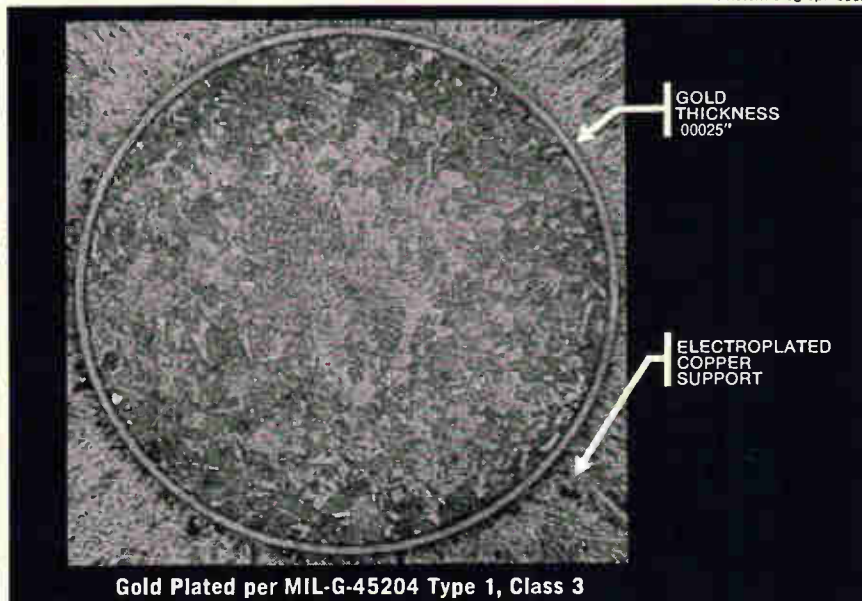

Gold Plated per MIL-G-45204 Type 1, Class 3

Uniform . . .
Well-bonded . . .
Quality with
Economy . . .

Write for data today

SIGMUND COHN CORP. 121 So. Columbus Ave.,
Mount Vernon, New York



Since 1901

SIGMUND COHN CORP. OF CALIFORNIA, Burbank, Cal. / SIGMUND COHN-PYROFUZE, INC., Dallas, Texas

132 Circle 132 on reader service card

New Components

military requirements for balanced line communications. The device has three metal alloy electrodes hermetically sealed in a ceramic and metal package. It will switch 55 coulombs per line, or a total of 110 coulombs. The 60-cycle breakdown voltage may vary from 300 to 1100 v and is established by proper spacing of the line-to-ground electrodes and the type of inert gas used for backfilling to eliminate problems associated with dust and contamination. Metal alloy electrodes eliminate the disadvantages that are characteristic of carbon and plug protectors at high levels where carbon flaking and buildup of carbon deposits might bridge the gap, the manufacturer says.

Sylvania Electric Products Inc., 730 Third Ave., New York, N.Y. 10017. [356]

Dry reed switch has low thermal emf



The MSMF-2 is a Form A (single-pole, normally open) subminiature, low-level dry reed capsule. A new concept in the basic wire used for the reeds now permits switches with a thermal emf of approximately $5 \mu\text{V}$ per $^{\circ}\text{C}$, 10% that of normal reed switches. Combining this electroplated gold lead material with silver contacts specially designed for low-level applications results in a switch with lower noise level; lower initial contact resistance (50 milliohms max at 150% overdrive); more uniform contact resistance; faster actuation (1 milli-sec average, including bounce); and less contact bounce—it can follow up to 300 cps at nominal overdrive).

The overall length is $2\frac{1}{4}$ in., with a maximum glass length of 0.800 in. and maximum glass diameter of 0.090 in. The switch has a minimum breakdown voltage rating of

Electronics | July 12, 1965

250 v d-c and is available with pull-in from 30 to 70 amp turns with approximately 10% differential. At the maximum contact rating of 28 v d-c and 0.010 amp, the life expectancy is over 10×10^6 operations. Price is as low as \$1 each in large quantities.

Hamlin, Inc., Lake & Grove Streets, Lake Mills, Wis., 53551. [357]

Resistor bobbins are small and strong

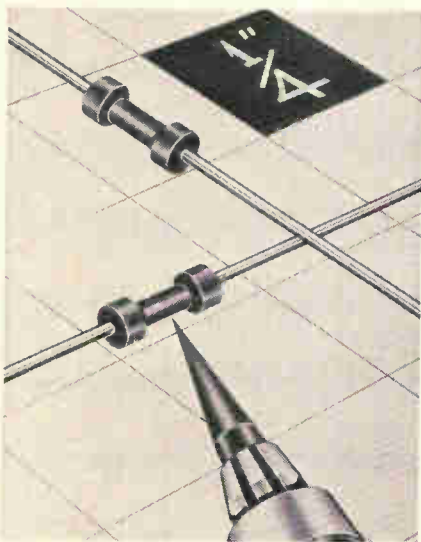

Recent developments in transfer mold design and technique are producing resistor bobbins for use where very high mechanical strength must be combined with extreme miniaturization. Measuring only 0.030 in. in hub diameter and 0.150 in. in length, these bobbins have No. 26 AWG leads securely molded in for maximum pull strength. Smooth, snag-free surfaces on bobbins permit trouble-free winding.

Bobbins feature accuracy and uniformity of dimensions, good dielectrical characteristics, low moisture absorption, and resistance to extreme environmental conditions. Plasmatex Industries, 8217 Lankershim Blvd., North Hollywood, Calif. [358]

High-powered hysteresis motors

New materials and new magnetic designs have resulted in a series of high-powered hysteresis synchronous motors in size 11 and size 15 frames. Motors will accept mini-

Memory designers, read and store:

Raytheon Computer has reduced prices up to 20% on 2MC BIAx® memory systems, arrays and elements.

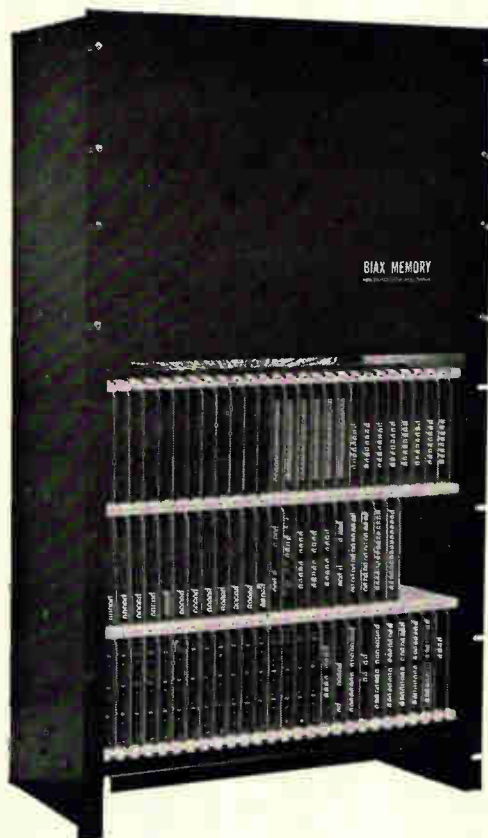

Now you can hike computer and data systems performance with BIAx 2 MC non-destructive readout memories at prices lower than those of coincident-current destructive readout systems for capacities up to 1024 words. For example, the 1024 word x 48 bit BIAx memory shown above can be delivered complete for only \$34,050 within thirty days. Other sizes from 128 to 1024 words are also available on short delivery cycle.

We've been delivering BIAx memory systems since 1961 with readout rates of 1 MC and faster for ground, airborne and spaceborne applications.

The price is right and we're eager to help you with your memory design programs. Call us direct at (714) 546-7160, Ext. 402, for engineering consultation. If you'd like technical literature, write for Data File B-109E. Raytheon Computer, 2700 S. Fairview Street, Santa Ana, California 92704.

RAYTHEON



HOW TO FORM STRONGER BOXES FAST!



1 Shear up to 160 blanks per minute with lowest cost high speed, precision shear on the market! Di-Acro Power Shear No. 36—only \$1,350 complete!



2 Notch blanks on a Di-Acro Power Tab Notcher. Extra strong tabbed corners are self-aligning. And easier to fasten.



3 No wasted motion. Form box on a Di-Acro Hand or Power Press Brake or Di-Acro Leaf Type Brake. Read the full story in Di-Acro's newest catalog. See your distributor or write us.



DI-ACRO

A Division of Houdaille Industries, Inc.
457 Eighth Ave.
Lake City, Minn. 55041

New Components

mum pull in torque rating of 0.55 in./oz in size 11 and 1.2 in./oz in size 15. Both units are presently available in bifilar windings designed specifically for push-pull operation. Units have been designed for a low power input, as efficiencies of 30 to 35% have been obtained. They can accommodate single and two-phase applications in 2-, 4-, 6-, and 8-pole designs. Syntorque Corp., West Hurley, N.Y., 12491. [359]

Hermetically sealed dry reed switch



This compact dry reed switch has a behind-panel length of only 0.975 in. Series G switch is available with up to four poles in single throw, or two poles in double throw with each pole isolated. It has a maximum contact rating of 0.5 amp or 12 watts at 125 v a-c. Dielectric strength is 500 v a-c and insulation resistance is 100 megohms.

The switch uses a new design to insure high reliability. Magnetic lines of force open and close switch contacts, providing holding pressure which is completely independent of the pressure actuating the push button. Switch operation is rated at 20 million operations at full load (Forms A & B); 10 million operations at full load (Form C).

Because of its hermetically sealed, oxygen-free contact area, the series G switch is ideal for dry circuits in corrosive or explosive atmospheres. Button travel and actuating pressure are supplied to

COMINCO high-purity metals

Available forms in 99.999% and/or 99.9999% purities	ALUMINUM	ANTIMONY	ARSENIC	BISMUTH	CADMIUM	COPPER	GOLD
BARS	X	X	X	X	X	X	
SHEETS	X				X	X	X
WIRE	X				X	X	X
POWDER		X	X	X	X		
SHOT		X		X	X	X	
ROD	X			X	X	X	
RIBBON							
PREFORMS	X				X	X	X
SALTS					X		

Available forms in 99.999% and/or 99.9999% purities	INDIUM	LEAD	SILVER	TELLURIUM	THALLIUM	TIN	ZINC
BARS	X	X	X	X	X	X	X
SHEETS	X	X	X			X	X
WIRE	X	X	X			X	X
POWDER	X	X	X	X	X	X	X
SHOT	X	X	X			X	X
ROD	X	X	X			X	X
RIBBON	X	X				X	
PREFORMS	X	X	X			X	X
SALTS	X						

COMINCO PRODUCTS, INC.

ELECTRONIC MATERIALS DIVISION
818 West Riverside Ave., Spokane, Wash. 99201
Phone 509 747-6111 Telex 032 610
TWX 509-328-1464
Circle 217 on reader service card

DO YOU HAVE Reed Relay Problems?

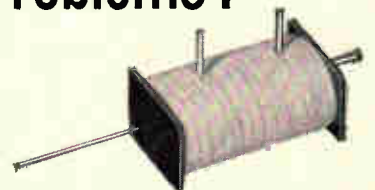

Problem: The National Bureau of Standards needed a Form B Relay to latch open with a minimum of power.

Solution: Coto-Coil designed and produced a Mercury-Wetted Relay requiring less than 2mW to operate, with contacts to handle 28W (1A or 100V max.)... a power gain of 14,000 in a package of only .15 cu. in.!

Can We Solve Your Problem?

Write for catalog and prices of our standard line of magnetic reed relays. For special requirements, give complete details for quotation.

Coto-Coil COMPANY INC.
65 Pavilion Ave.
Providence, R. I. 02905
Phone: (401) 941-3355

(Key Sales areas available for representation, Please Inquire.)

customer specifications. Operating pressure can be as low as 17 grams. Supplied with a 0.625 in. diameter case of anodized aluminum, series G switches are available with a choice of four button colors and five decorative button and mounting arrangements.

George Risk Industries, Inc., 672 15th Ave., Columbus, Neb. [360]

Tiny cube thermistor has 2.5-sec. response

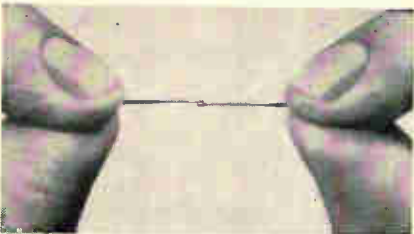

This cube thermistor is said to be the smallest commercially available today. It is also the first to offer thermally bonded ribbon leads as standard. It features fast thermal time response, high power handling capabilities for its size, and resistances and resistance ratio values not presently available in any other disk, rod or washer configuration.

The unit, 0.032 in. square and 0.012 in. thick, is available in standard grades 1 through 4 with resistance values from 100,000 to 20 ohms and resistance ratios (the resistance at 25°C divided by the resistance at 125°C) from 48.78 to 12.95. Thermal time response for this cube is 2.5 sec with a dissipation constant of 0.7 mw per °C. The cube is provided with 0.003 in. thick, gold-plated Kovar ribbon leads thermally bonded to the silvered thermistor electrode surface. The inch-long ribbons can be either welded or soldered for ease of final assembly of the thermistor into a circuit.

Applications include temperature compensation of transistors used in electronic circuits and the copper coils of electrical relays. Small size and wide resistance range also make it highly suitable for voltage control and temperature measurement applications in equipment used for industrial process control, oceanography and meteorology.

General Electric Co., Magnetic Materials Section, P.O. Box 72, Edmore, Mich. [361]

For the Finest Multilayer Printed Circuitry...

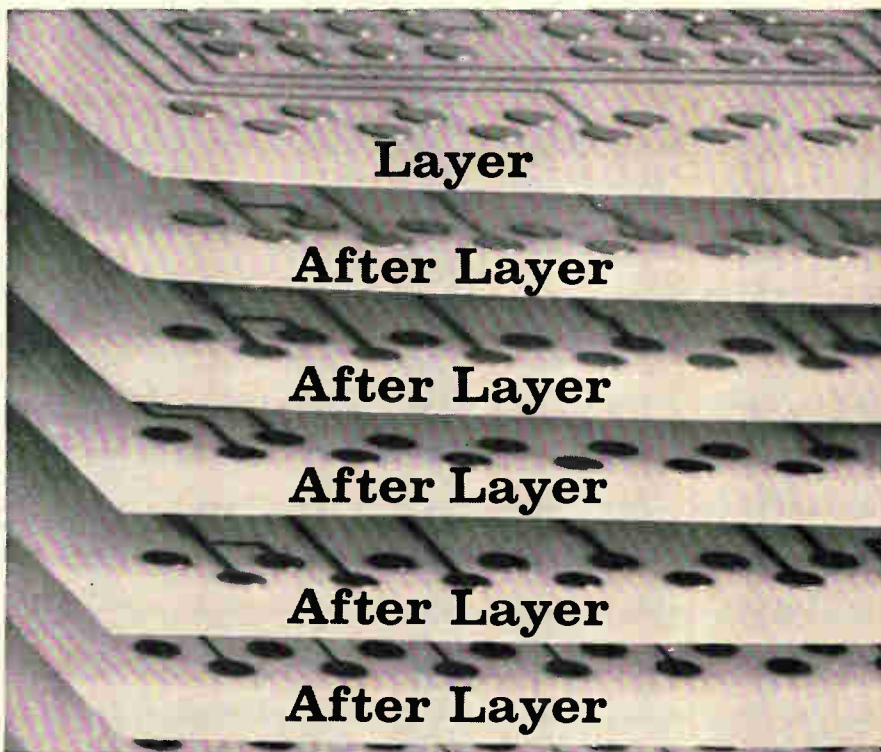

...Specify Cinch-Graphik

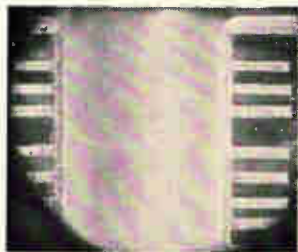

When you specify Cinch-Graphik, you specify unequalled quality. The cross-section microphoto shows why... uniform wall thickness throughout the entire length of the hole and complete interface

bond between individual layers and the plated wall. High density circuitry like this is the result of precision production processes such as the Cu-C Plated Thru-Hole, controlled lamination and ultra-precise multilayer registration ($\pm .005''$ layer to layer for 30 layers or more!). Years of experience in pioneering and perfecting multilayer techniques has made Cinch-Graphik the world's leading producer of advanced multilayer circuits. Write for our new, illustrated brochure.

CINCH-GRAFIK
DIVISION OF UNITED-CARR

200 South Turnbull Canyon Road, City of Industry (Los Angeles), Calif. 91744 • Phone (213) ED 3-1201. Offices in 22 Principal Cities throughout United States, Canada, England and Australia listed under Cinch Mfg. Co. or United-Carr Incorporated • Cinch • Cinch-Monadnock • Howard B. Jones • Ucinite • Palnut



Screw type slotted knob that is recessed in holder body and requires use of screwdriver to remove or insert it.



Screw type knob designed for easy gripping, even with gloves. Has a "break-away" test prod hole in knob.

BUSS Space Saver Panel Mounted Fuseholders

Fuseholder only 1 3/8 inches long, extends just 29/32 inch behind front of panel. Takes 1/4 x 1 1/4 inch fuses. Holder rated at 15 ampere for any voltage up to 250.

Military type available to meet all requirements of MIL-F-19207A.

**Insist On
BUSS
QUALITY
Fuseholders**

Write for
BUSS
Bulletin SFH-10

BUSSMANN MFG. DIVISION, McGraw-Edison Co., St. Louis, Mo. 63107

For 1 1/2 x 1 1/2 inch fuses, Series HPC

For 1/4 x 1 1/4 inch fuses Series HJ, HK and HLD

**SAVE ASSEMBLY TIME with
QUICK CONNECT
TERMINALS ON
BUSS FUSEHOLDERS**

Eliminates soldering. Permits use of pre-assembled harness. Reduces assembly time.

**Insist On
BUSS
QUALITY
Fuseholders**

Write for
BUSS
Bulletin SFB

BUSSMANN MFG. DIVISION, McGraw-Edison Co., St. Louis, Mo. 63107

BUSS: The Complete Line of Fuses and . . .

Circle 137 on reader service card

Circle 137 on reader service card

To order reprints from Electronics

Fill in, cut coupon below, insert in envelope and mail to:

Electronics reprint dept.

330 West 42nd Street, New York, N. Y. 10036

Reprint order form

For listing of reprints available see the reader service card

To help expedite mailing of your reprints please send cash, check, or money order with your order.

Unijunction Transistors

Send me copies of Key no. R-74 at 50¢ each.

For reprints of previous special reports fill in below:

Send me reprints of Key no. (s) @ ¢ each

For prices see the reader service card.

Name

Number and Street

City, Zone No., State

Infinite resolution rectangular trimmer

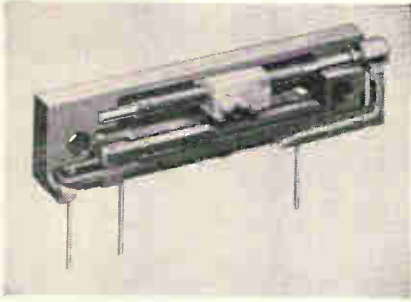

Rectangular precision trimmers now available feature an infinite resolution metal glaze resistance element. The metal glaze material's negligible reactance makes the units ideal for high frequency applications while its high resistivity allows a resistance range far be-

yond that feasible with wire.

The RJ-12 style units, designated type 450-10, meet the requirements of MIL-R-22097B. They are supplied with 0.028-inch diameter pin-type mounting terminals, spaced for standard printed circuit hole patterns.

Standard resistance range is 100 ohms to 1 megohm, with standard tolerance of $\pm 10\%$. Power rating is $\frac{1}{2}$ w at 70°C ; operating range, -55° to $+125^\circ\text{C}$. Temperature coefficient is 250 ppm for resistance values above 50,000 ohms. The units have an effective electrical rotation of 22 turns ± 5 turns; a mechanical rotation of 24 turns, with stop and slip clutch. They are priced at \$4.95 each, in lots of 100, and have a 3-week delivery schedule.

International Resistance Co., 401 N. Broad St., Philadelphia, Pa., [362]

Polystyrene capacitor for printed circuits

A polystyrene capacitor has been introduced for printed circuit mounting. Style 603 is an encapsulated, high reliability, precision type. It features high leakage resistance of more than 500,000 megohms and temperature coefficient ranging from negative 150 ± 70 ppm per $^\circ\text{C}$ for class 2 to negative 150 ± 50 ppm per $^\circ\text{C}$ for class 3.

Said to be particularly free from drift, the style 603 has long life and capacitance tolerance spanning ± 1 pf to $\pm 10\%$.

The new p-c capacitor available in voltage ratings of 63 vdcw through 1,000 vdcw.

M.I.A.L., U.S.A., Inc., 165 Franklin Ave., Nutley, N.J. [363]

Fuseholders of Unquestioned High Quality

TRON SUB-MINIATURE PIGTAIL FUSES

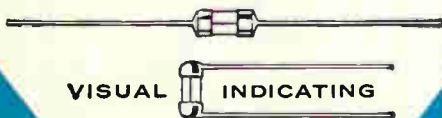

VISUAL INDICATING

BODY SIZE ONLY
.145 x .300
INCHES

For use on miniaturized devices, or on gigantic space tight multi-circuit electronic devices.

Glass tube construction permits visual inspection of element.

Smallest fuses available with wide ampere range. Twenty-three ampere sizes from 1/100 thru 15 amps.

Hermetically sealed for potting without danger of sealing material affecting operation. Extremely high resistance to shock or vibration. Operate without exterior venting.

Insist On
BUSS
QUALITY
Fuses

Write for
BUSS
Bulletin SFB

BUSSMANN MFG. DIVISION, McGraw-Edison Co., St. Louis, Mo. 63107

Circle 137 on reader service card

VISUAL INDICATING FUSES

FUSE ONLY
.270 x .250
INCHES



GMW FUSE
and HWA
FUSEHOLDER

BUSS
SUB-MINIATURE
FUSEHOLDER COMBINATION

For space-tight applications. Fuse has window for inspection of element. Fuse may be used with or without holder.

Fuse held tight in holder by beryllium copper contacts assuring low resistance.

Holder can be used with or without knob. Knob makes holder water-proof from front of panel.

Military type fuse FM01 meets all requirements of MIL-F-23419. Military type holder FHN42W meets all military requirements of MIL-F-19207A.

Insist On
BUSS
QUALITY
Fuses and Fuseholders

Write for
BUSS
Bulletin SFB

BUSSMANN MFG. DIVISION, McGraw-Edison Co., St. Louis, Mo. 63107

Circle 137 on reader service card

an
extra-
ordinary
(even for Manson)
crystal
oscillator
... 5×10^{-10} /day



FFO-160

- High stability: 5×10^{-10} /day
 1×10^{-8} /month
- Low drain: 3 watts average
- Small: 4-13/16"x2-5/16"x2-5/16"
- Lightweight: 16 oz.
- Rugged: mil shock and vibration
- Reliable: 30,000 hour mtfb
- Fast warm-up

The FFO-160 provides the highest stability of any component crystal oscillator on the market. Its fast warm-up and outstanding operational characteristics over extremes of temperature, humidity, shock and vibration make the FFO-160 particularly well suited to airborne, shipboard, transportable, mobile and fixed station applications. Write for complete specifications.

Manson also has available the exceptionally low power drain models FFO-144A (1 part in 10^8 /day) and FFO-159 (5 parts in 10^9 /day).



Manson Laboratories division

77 Oanbury Rd., Wilton, Connecticut
Tel.: (203) 762-8301

New Instruments

Audio-wave analyzer scans automatically



A fully automatic electronic scanning circuit is a unique feature of an audio-wave analyzer developed by the Fairchild Electro-Metrics Corp., a subsidiary of the Fairchild Camera and Instrument Corp. Without relying on motor drives or mechanical linkages, the model EWA-88 can measure the amplitudes of all signals between 20 cycles to 50 kilocycles per second or any preset portion of that band. Once the instrument is set up, the operator merely presses a button and the instrument does the job automatically.

A voltage-controlled oscillator is used for tuning. For automatic scanning, a large capacitor is discharged into an R-C circuit. The voltage ramp that results is the source for the oscillator, whose output frequency is proportional to the instantaneous applied voltage. The internal sweep rate is adjusted for the selected bandwidth: instantaneous for the wideband mode, 10 kilocycles per minute in the 50-cycle mode, and one kilocycle per minute in the 5-cycle mode. This relationship between the sweep rate and the bandwidth, the company says, assures the operator that he will include in his scan all peak signals; some of these are sometimes lost with a manually tuned device because the operator may pass a point too quickly for the meter or recorder to respond.

Manual tuning is possible by the setting of a 10-turn potentiometer, coupled to a frequency indicator on the front panel, to vary the input voltage to the voltage-controlled oscillator.

According to Dale Samuelson, vice president of Fairchild Electro-Metrics, the electronic scanning feature gives the EWA-88 unusual flexibility and the following operational advantages:

- Automatic plotting of wave data. During each scanning operation, an X output proportional to frequency and a Y output proportional to signal amplitude are generated by the analyzer. These outputs, when connected to a suitable graphic recorder, provide the operator automatically with a plot of signal versus frequency.

- Overload protection. When it operates in the wideband mode, the analyzer simultaneously looks at all the signals from 20 cycles to 500 kilocycles and displays a meter indication of the highest-magnitude signal present within the band. This measurement is also made automatically, initiated by the pressing of a button, and prevents the operator from starting a run during which the input may become overloaded. This protection saves time and prevents the loss of important data and the introduction of inaccuracies because of an excessive input signal. In conventional wave analyzers, it is neces-

Infinite resolution rectangular trimmer

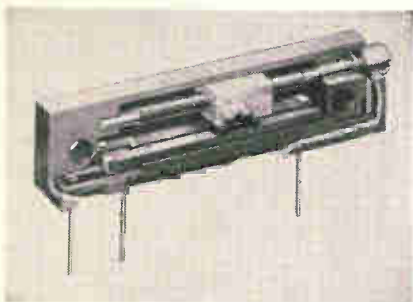

Rectangular precision trimmers now available feature an infinite resolution metal glaze resistance element. The metal glaze material's negligible reactance makes the units ideal for high frequency applications while its high resistivity allows a resistance range far be-

yond that feasible with wire.

The RJ-12 style units, designated type 450-10, meet the requirements of MIL-R-22097B. They are supplied with 0.028-inch diameter pin-type mounting terminals, spaced for standard printed circuit hole patterns.

Standard resistance range is 100 ohms to 1 megohm, with standard tolerance of $\pm 10\%$. Power rating is $\frac{1}{2}$ w at 70°C ; operating range, -55° to $+125^\circ\text{C}$. Temperature coefficient is 250 ppm for resistance values above 50,000 ohms. The units have an effective electrical rotation of 22 turns ± 5 turns; a mechanical rotation of 24 turns, with stop and slip clutch. They are priced at \$4.95 each, in lots of 100, and have a 3-week delivery schedule.

International Resistance Co., 401 N. Broad St., Philadelphia, Pa., [362]

Polystyrene capacitor for printed circuits

A polystyrene capacitor has been introduced for printed circuit mounting. Style 603 is an encapsulated, high reliability, precision type. It features high leakage resistance of more than 500,000 megohms and temperature coefficient ranging from negative 150 ± 70 ppm per $^\circ\text{C}$ for class 2 to negative 150 ± 50 ppm per $^\circ\text{C}$ for class 3.

Said to be particularly free from drift, the style 603 has long life and capacitance tolerance spanning ± 1 pf to $\pm 10\%$.

The new p-c capacitor available in voltage ratings of 63 vdcw through 1,000 vdcw.

M.I.A.L., U.S.A., Inc., 165 Franklin Ave., Nutley, N.J. [363]

Fuseholders of Unquestioned High Quality

TRON SUB-MINIATURE PIGTAIL FUSES

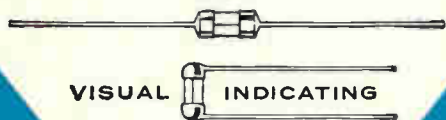

VISUAL INDICATING

BODY SIZE ONLY
.145 x .300
INCHES

For use on miniaturized devices, or on gigantic space tight multi-circuit electronic devices.

Glass tube construction permits visual inspection of element.

Smallest fuses available with wide ampere range. Twenty-three ampere sizes from 1/100 thru 15 amps.

Hermetically sealed for potting without danger of sealing material affecting operation. Extremely high resistance to shock or vibration. Operate without exterior venting.

Insist On
BUSS
QUALITY
Fuses

Write for
BUSS
Bulletin SFB

BUSSMANN MFG. DIVISION, McGraw-Edison Co., St. Louis, Mo. 63107

Circle 137 on reader service card

VISUAL INDICATING FUSES

FUSE ONLY
.270 x .250
INCHES



GMW FUSE
and HWA
FUSEHOLDER

BUSS
SUB-MINIATURE
FUSEHOLDER COMBINATION

For space-tight applications. Fuse has window for inspection of element. Fuse may be used with or without holder.

Fuse held tight in holder by beryllium copper contacts assuring low resistance.

Holder can be used with or without knob. Knob makes holder water-proof from front of panel.

Military type fuse FM01 meets all requirements of MIL-F-23419. Military type holder FHN42W meets all military requirements of MIL-F-19207A.

Insist On
BUSS
QUALITY
Fuses and Fuseholders

Write for
BUSS
Bulletin SFB

BUSSMANN MFG. DIVISION, McGraw-Edison Co., St. Louis, Mo. 63107

Circle 137 on reader service card

an
extra-
ordinary
(even for Manson)
crystal
oscillator
... 5×10^{-10} / day



FFO-160

- High stability: 5×10^{-10} /day
 1×10^{-8} /month
- Low drain: 3 watts average
- Small: 4-13/16" x 2-5/16" x 2-5/16"
- Lightweight: 16 oz.
- Rugged: mil shock and vibration
- Reliable: 30,000 hour mthf
- Fast warm-up

The FFO-160 provides the highest stability of any component crystal oscillator on the market. Its fast warm-up and outstanding operational characteristics over extremes of temperature, humidity, shock and vibration make the FFO-160 particularly well suited to airborne, shipboard, transportable, mobile and fixed station applications. Write for complete specifications.

Manson also has available the exceptionally low power drain models FFO-144A (1 part in 10^8 /day) and FFO-159 (5 parts in 10^9 /day).



Manson Laboratories division

77 Danbury Rd., Wilton, Connecticut
Tel.: (203) 762-8301

New Instruments

Audio-wave analyzer scans automatically



A fully automatic electronic scanning circuit is a unique feature of an audio-wave analyzer developed by the Fairchild Electro-Metrics Corp., a subsidiary of the Fairchild Camera and Instrument Corp. Without relying on motor drives or mechanical linkages, the model EWA-88 can measure the amplitudes of all signals between 20 cycles to 50 kilocycles per second or any preset portion of that band. Once the instrument is set up, the operator merely presses a button and the instrument does the job automatically.

A voltage-controlled oscillator is used for tuning. For automatic scanning, a large capacitor is discharged into an R-C circuit. The voltage ramp that results is the source for the oscillator, whose output frequency is proportional to the instantaneous applied voltage. The internal sweep rate is adjusted for the selected bandwidth: instantaneous for the wideband mode, 10 kilocycles per minute in the 50-cycle mode, and one kilocycle per minute in the 5-cycle mode. This relationship between the sweep rate and the bandwidth, the company says, assures the operator that he will include in his scan all peak signals; some of these are sometimes lost with a manually tuned device because the operator may pass a point too quickly for the meter or recorder to respond.

Manual tuning is possible by the setting of a 10-turn potentiometer, coupled to a frequency indicator on the front panel, to vary the input voltage to the voltage-controlled oscillator.

According to Dale Samuelson, vice president of Fairchild Electro-Metrics, the electronic scanning feature gives the EWA-88 unusual flexibility and the following operational advantages:

- Automatic plotting of wave data. During each scanning operation, an X output proportional to frequency and a Y output proportional to signal amplitude are generated by the analyzer. These outputs, when connected to a suitable graphic recorder, provide the operator automatically with a plot of signal versus frequency.

- Overload protection. When it operates in the wideband mode, the analyzer simultaneously looks at all the signals from 20 cycles to 500 kilocycles and displays a meter indication of the highest-magnitude signal present within the band. This measurement is also made automatically, initiated by the pressing of a button, and prevents the operator from starting a run during which the input may become overloaded. This protection saves time and prevents the loss of important data and the introduction of inaccuracies because of an excessive input signal. In conventional wave analyzers, it is neces-

RESISTOR PROVING GROUND

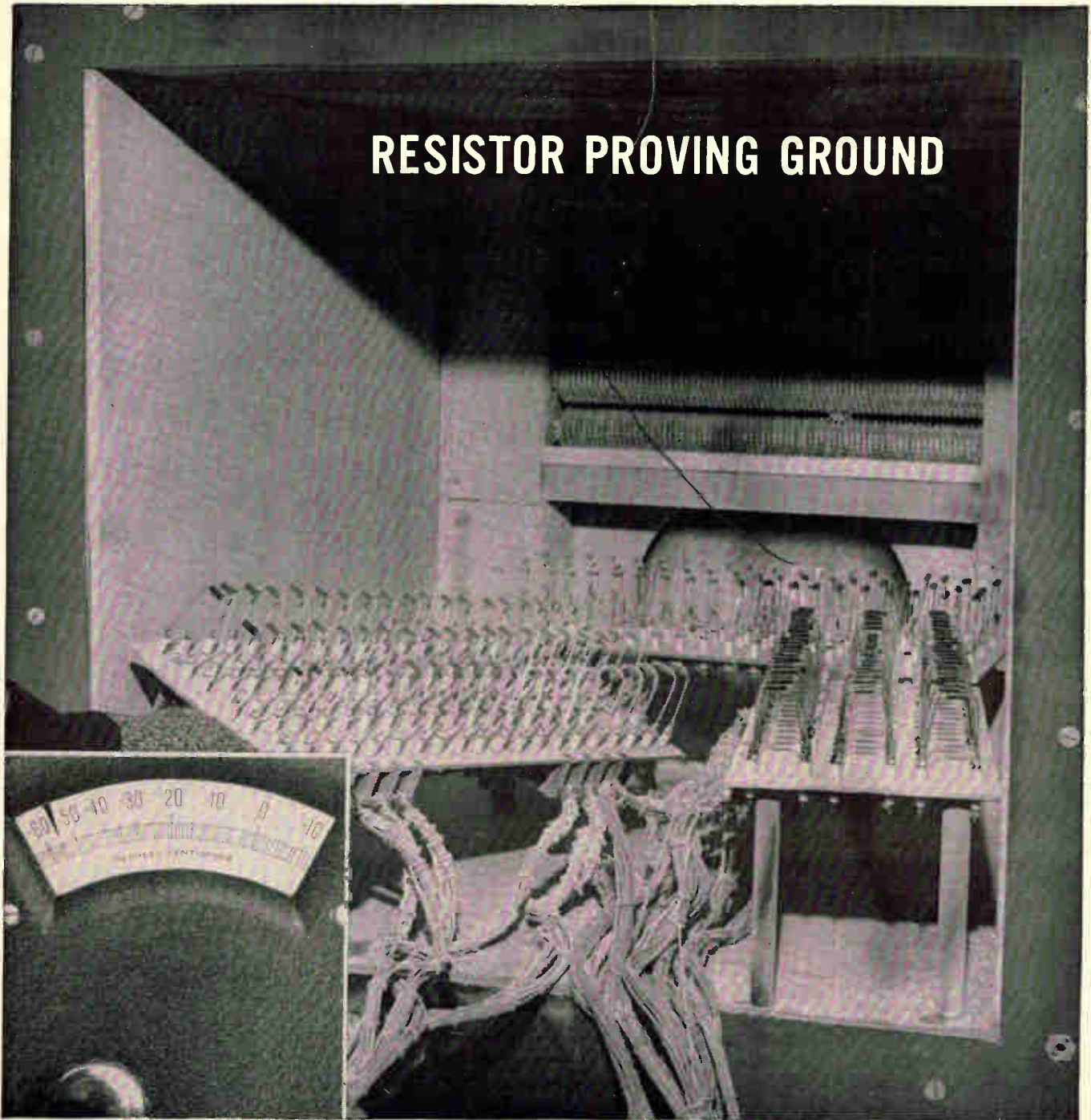

TEMPERATURE/RESISTANCE CHARACTERISTICS

Resistors are tested in accordance with the procedures of MIL-R-11. The amount of characteristic change falls well within the limits of the specifications. This test is one of many conducted in Stackpole's continual program of resistor development. Other characteristics subjected to similar testing are load life and

moisture resistance. If you have a question on some part of Stackpole's resistor development program, why not discuss it with Don Kirkpatrick, Manager-Engineering, Electronic Components Division, Stackpole Carbon Company, St. Marys, Pa. Phone 814 834-1521. TWX:510-693-4511.



STACKPOLE
ELECTRONIC COMPONENTS DIVISION

VITREOSIL®



**PURE FUSED
QUARTZ
TAKES
MORE
SHOCK,
HEAT
AND
ACID**

**THAN GLASS
OR PORCELAIN —
RESISTS
TEMPERATURES TO
1050°C —**

**HANDLES
MOST HOT ACIDS
WITHOUT ETCHING —**

**WITHSTANDS
CONSTANT THERMAL
SHOCK —**

**EXCELLENT
ELECTRICAL AND
OPTICAL
PROPERTIES —**

**LABORATORY AND
INDUSTRIAL WARE —**

**SPECIAL
FABRICATION —**

**SPECTROSIL®
FOR PURITY**

**ASK FOR
32 PAGE FREE
CATALOG —**

**THERMAL
AMERICAN
FUSED QUARTZ CO.**

**RT. 202 AND
CHANGE BRIDGE RD.
MONTVILLE, N. J.**



New Instruments

sary to tune manually over the entire band to obtain similar information.

Remote tuning. It may sometimes be desirable or necessary to operate the analyzer at a spot remote from the source of the signal of interest. For this contingency, Fairchild engineers have added a remote tuning capability. By connecting an external voltage source to the rear of the instrument, the oscillator can be controlled remotely and the entire test can be run at a considerable distance from the device itself.

The analyzer is solid state and has an over-all dynamic range of 200 decibels, with 40 decibels on the front panel meter. If an a-c power source is not available, the instrument can be run from an optional power supply.

Specifications

Frequency range	20 cps to 50 kc for scanning; 20 cps to 500 kc in wideband
Input impedance	100,000 ohms
Maximum input voltage	1,000 volts
Sensitivity	0.1 microvolt
Voltage accuracy	±½ db
Frequency accuracy	±(0.5%+5 cps)
Power requirements	105 to 130 or 210 to 260 volts a-c, 50 to 450 cps
Size	16½ x 7 x 15 inches
Weight	32 pounds
Price	\$2,950
Availability	30 to 60 days

Fairchild Electro-Metrics Corp., 88 Church St., Amsterdam, N. Y. [381]

Automatic test set checks pot linearity

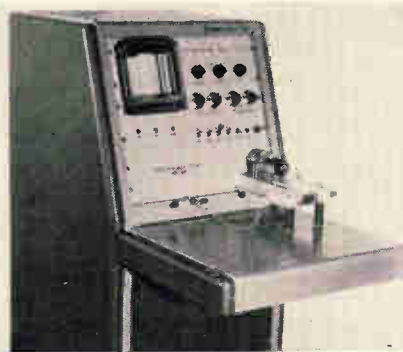

A self-contained test set now available automatically produces a strip chart recording the deviation of a potentiometer from true linearity.

GRAPHIC VISUAL CONTROL

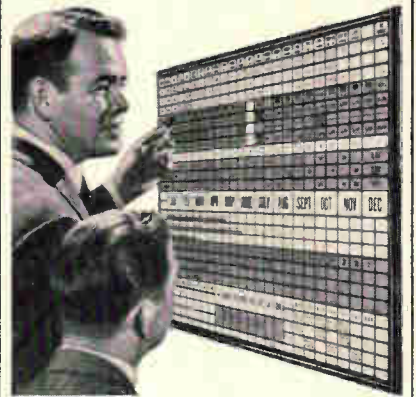

You SEE How To Get Things Done With The BOARDMASTER System

You see a Graphic Picture of your operations, spotlighted in color. You have facts at Eye Level. Saves time, cuts costs and prevents errors.

Ideal for Production, Maintenance, Scheduling, Inventory, Sales, Traffic, Personnel and many other uses.

Simple and flexible tool. You write or type on cards and post on board. All cards are interchangeable.

Compact and Attractive. Made of Aluminum. Over 1,000,000 in use.

Complete Price \$49⁵⁰ Including Cards

FREE 24-Page BOOKLET No. C-10
Mailed Without Obligation

Write Today for Your Copy

GRAPHIC SYSTEMS
925 Danville Road • Yanceyville, N.C.

Circle 219 on reader service card

More torque, Less weight

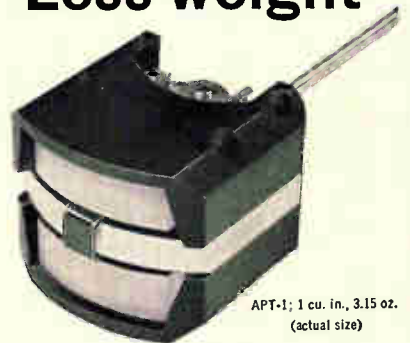

APT-1; 1 cu. in., 3.15 oz.
(actual size)

in moving coil mechanism

Stable, linear, accurate mechanism for indicating, control or recording systems. 1% linearity over 18-0-18° and greater accuracy assured by coil design with over 75% of winding "working" in high energy, uniform field air gap. Coil system weighs 0.85 gm, develops 26.4 mmg of torque; 31:1 T/W. Vibration resonance negligible; acceleration errors sharply attenuated. Standard pivots and jewels—custom damping—wide range of sensitivities.

AMMON

AMMON INSTRUMENTS, INC.
345 Kelley Street, Manchester, N. H. 03105

Circle 220 on reader service card

Model 8582 includes all necessary regulated power supplies, synchronous motor drive, standard potentiometer, panel mounted chart recorder and potentiometer holding fixture. Controls are included to compensate for single-turn pots having less than 360° rotation and for 10-turn pots having less than 3600° rotation. The test unit has a resistance range of 10-100/100-10,000/10,000-1,000,000 ohms and a recorder sensitivity of 1%, 5% and 10% full scale. It weighs 550 lb and is 50 in. high, 24 in. wide and 25 in. deep (plus 18 in. for work area in front). Price is \$12,300.

Associated Research, Inc., 3777 W. Belmont Ave., Chicago, Ill., 60618. [382]

Decade scaler extends range of counters



The range of any frequency-measuring instrument, digital or analog, can be extended tenfold, up to 100 Mc, by a type 1156-A decade scaler. Any 10-Mc counter, for instance, becomes a 100-Mc counter with a single connection to the scaler. Input sensitivity and output levels of the scaler are high enough to permit its use with almost any counter on the market, according to the manufacturer. The scaler can also be used as a range extender for oscilloscope trigger circuits. A five-position input attenuator provides sensitivities of 0.1, 0.2, 0.5 and 1 volt peak-to-peak at 50 ohms, and 1 volt peak-to-peak at 500 ohms. Output is a 20-ma square wave at $\frac{1}{10}$ the input frequency, which delivers 1 volt into a 50-ohm load. The scaler is only 1¾ in. high and is designed for rack or bench mounting.

General Radio Co., West Concord, Mass., 01781. [383]

Digital meter spans 2 cps to 300 kc

A lightweight digital meter measures audio and supersonic fre-

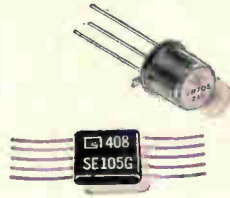

Need to say a lot
in a little space?

(or make markings
more durable...or
more economical...
or at higher rates?)

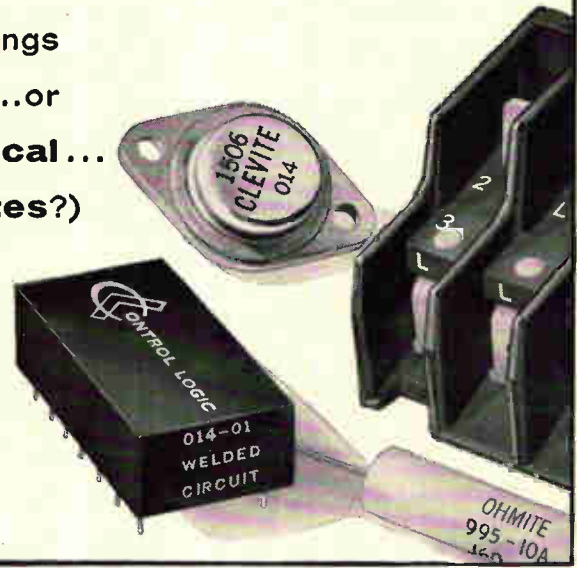

We can show you how

We can show you how to identify products so they will resist extreme amounts of handling, abrasion, many solvents and other atmospheric conditions . . . or how to sequentially number and identify components with savings of more than \$50 per 1000 . . . or how to print trademark, type number, value and date code on 90 units a minute . . . or how to produce an imprint that remains readable after 1000 hours at 200°C. . . or get 10 digits and 2 letters in a micro-circuit area of 0.090" — or 21 characters on a TO-5 case with interchangeable type number and date code . . . or save 75 cents of every dollar you now spend on buying, applying, inventorying and discarding obsolete preprinted labels.

The answers are in proven Markem machines, type and specialty inks, which daily produce better product or package identification by reducing costs, smoothing production control and increasing customer acceptance. And while Markem machines, type and inks are helping to produce better products through more complete and lasting identification, they frequently pay for themselves in the savings they make possible. Tell us what you make, what it must say, and for how long: we'll give you a specific recommendation and cost estimate right away. Write Electrical Division, Markem Machine Co., 305 Congress St., Keene, New Hampshire 03431.

MARKEM

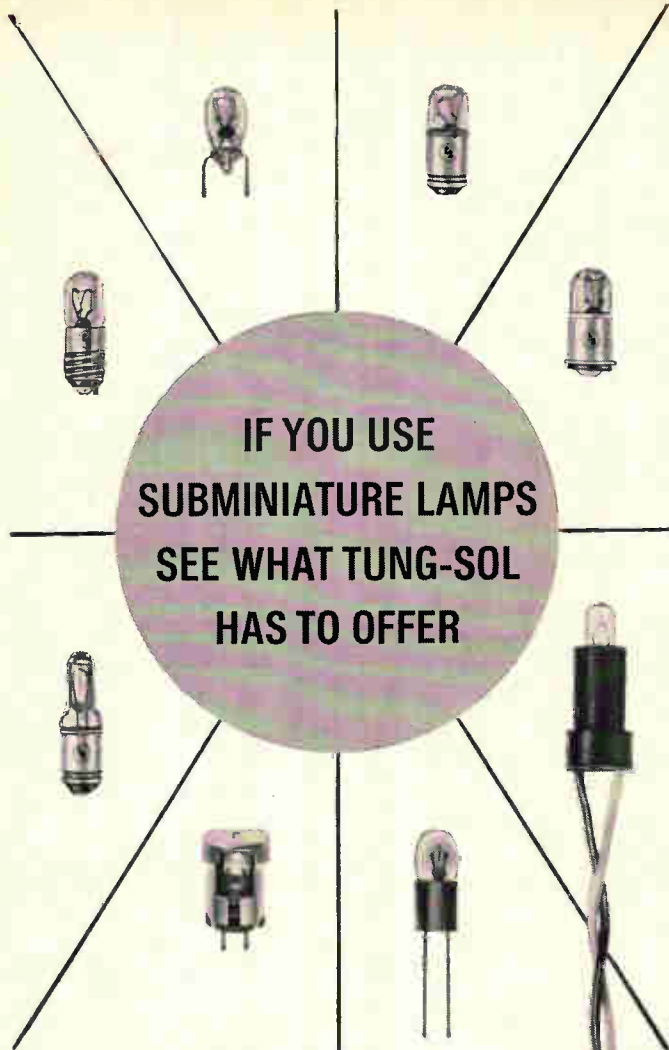

**IF YOU USE
SUBMINIATURE LAMPS
SEE WHAT TUNG-SOL
HAS TO OFFER**

Tung-Sol subminiature lamps are available in a wide variety of configurations. More than sixty years of lamp manufacturing experience assures quality and performance of the highest order.

Special Basing and Harnessing. These Tung-Sol services provide numerous advantages to the customer—(1) Eliminates shrinkages resulting from processing operations. (2) Reduces inventories. (3) Conserves production time. (4) Cuts costs.

Describe your application to us for free suggestions about how Tung-Sol can solve your lamp problem at a saving.

TUNG-SOL
INSTRUMENT LAMPS

TUNG-SOL ELECTRIC INC., NEWARK, N.J. 07104

NEW

CRYSTAL ACCURACY
AT AUDIO FREQUENCIES

**HIGH QUALITY-
LOW COST
Tuning Fork
Oscillator
Model Y.....**

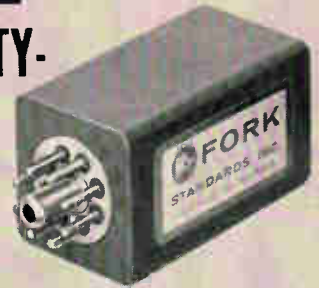

1½" x 1½" x 2-9/16" High

STOCK DELIVERY

FEATURES

PRICES

Frequency Range: 50 to 8000 CPS	60CPS—square wave output.. \$69.00
Operating Temperatures: -25° C to +85° C	60CPS—sine wave output. . . . 84.00
Hermetically Sealed With Octal Plug	400CPS..... 45.00
12 VDC Supply	1000CPS..... 35.00
One Year Guarantee	5000CPS..... 35.00

Full Line of other Oscillators Available. Phone or send for complete information:

FORK STANDARDS, INC.
221 Main Street • West Chicago, Illinois
Telephone (312) 231-3511

Circle 221 on reader service card

**The only thing small
about this rectifier
is its size!**

**SLATER
RECTIFIER**



**ALL
OTHERS**

COMBINATIONS OF SPECIFICATIONS PREVIOUSLY UNAVAILABLE IN SUBMINIATURE PACKAGES.

- SLA-01 to SLA-020
- 1000 to 20,000 V PIV
 - 100 to 200 Mils average rectified current
 - Extremely low leakage
 - Low forward voltage drop

SPECIFICATIONS		
VOLTS	DIA. "	LENGTH "
5,000	.200	.3
10,000	.375	1.0
20,000	.500	2.0

**LESS THAN 1/5 VOLUME OF COMPARABLE RECTIFIERS.
LOWEST PRICE PER VOLTAGE
AND AMPERE RATING IN
INDUSTRY.**

ACTUAL SIZE

ALSO AVAILABLE:
1N1730 — 1N1734
1N2382 — 1N2385
1N1730 — 1N1734A
1N2382A — 1N2385A

Send for Catalog and Price List

SLATER ELECTRIC INC., Semiconductor • Glen Cove, N.Y.

New Instruments

quencies from 2 cps to 300 kc. Model SA-520 permits direct measurement of higher frequencies while those at the lower end of the range can be determined accurately through measurement of the period. Accuracy is ± 1 count. Signal frequency is shown on a big, bright four-digit display that permits reading over a wide viewing angle. Standard models offer a staggered digital readout. Model 520B offers an in-line display at a slightly higher price. Weighing only seven pounds, the SA-520 is portable and can be operated from a-c sources or batteries. Solid state design and printed circuitry throughout assure long service life with minimum maintenance.

Racal Communications, Inc., 8480 Second Ave., Silver Spring, Md., [384]



High-resistance transfer standards

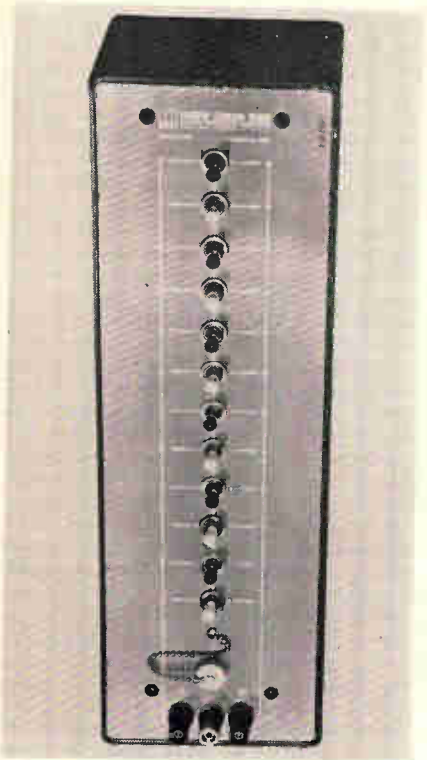

These instruments will transfer resistance measurements from a single 10,000-ohm resistance standard to values up to 110 megohms. Model SR1050 consists of 11 highly

Here's the Ledex wink in the eye of Mariner 4

The larger rotary solenoid in my left hand is one of our first models, developed some 20 years ago. The other one is a duplicate of the solenoid now in Mariner 4.

Its mission: to help take pictures of Mars on July 14.

Out there 134 million miles from home, it must trip the shutter of a TV camera 21 times at 48-second intervals. We are told that about 60% of the total mission success will depend on getting these pictures.

Since 1943, the Ledex Rotary Solenoid has been used for just about any type of snap action job imaginable. From ocean depths to outer space it serves defense in torpedoes, submarines, aircraft, missiles and rockets. It selects, arms, disarms, fires and guides. In industry it bolsters computer brain-power, automates complex machines, grips rugged truck brakes. It can pull, push, turn, twist, punch, trigger, index and hammer.

The Mariner 4 assignment is unique... with the 7-months' journey through the empty environment of outer space presenting conditions we cannot completely predict or simulate.

We hope, and believe, that on July 14—assuming all systems are Go—our solenoid will respond on command. It will pivot a precise 45°, trip the shutter and disclose to the world the first close-up of Mars.

Sincerely,

George H. Leland
Chairman of the Board

P.S. Down-to-earth solenoids, with life of over 100 million operations, cost less than \$5 each on a production run. May we tailor one for you? Send details or ask for catalog C-264.



LEDEX INC., 123 WEBSTER STREET, DAYTON, OHIO 45403
Designers & Manufacturers Electronic & Electro-Mechanical Components
& Remote Control Switching Systems

New 2-4 gc Frequency Extender

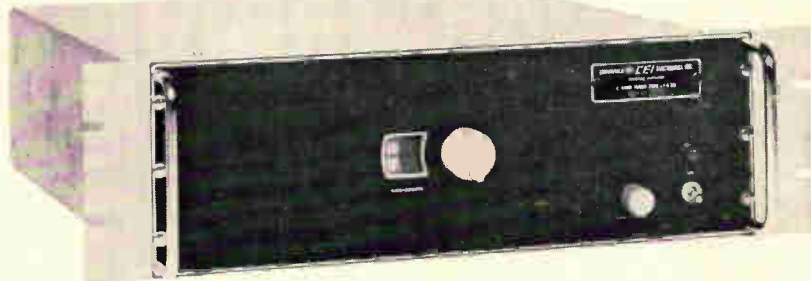

Features Tunable YIG Preselector, Converts Signals to 160 mc

CEI's new Type FE-2-4 Frequency Extender permits our 900 series VHF receivers (and other units with sufficient bandwidth) to cover 2 gc to 4 gc. Tuning this range in a single band, the FE-2-4 converts incoming signals to a 160 mc output. When used with the CEI Type IFC-21 converter, the 160 mc output can be further reduced to 21.4 mc permitting the use of a separate demodulator system such as the CEI

Type DM-4.

The Frequency Extender incorporates a tunable YIG preselector to assure low oscillator radiation and high image rejection.

A virtual twin to the FE-2-4 (CEI's Type FE-1-2) covers the 1 to 2 gc range. For details on these and other CEI products, please write:

COMMUNICATION ELECTRONICS INCORPORATED

6006 Executive Boulevard, Rockville, Maryland 20852, Phone (301) 933-2800

Circle 144 on reader service card

SALES APPLICATION ENGINEER

MID-WEST TERRITORY

Leading Manufacturer of precision rotating components, seeks BSEE or ME to be responsible for Product Application and Customer Contact.

Must be experienced in servo components and have thorough knowledge of market conditions. Excellent starting salary, incentive plan and full expenses.

Submit Resume In Confidence Including Salary Requirements To: MR. W. E. PARIS



WESTON TRANSICOIL

Weston Instruments, Inc.

WORCESTER, PA. 19490

An Equal Opportunity Employer

**HELP YOUR POST OFFICE
TO SERVE YOU BETTER
BY
MAILING EARLY IN THE DAY
NATIONWIDE IMPROVED MAIL SERVICE
PROGRAM**

New Instruments

precise, wire-wound resistors that can be switched in series, parallel and series-parallel configurations. The switching allows resistance transfers based on the fact that the deviation of resistors in parallel is equal to the deviation of the same resistors in series.

An outstanding design feature is the guarded construction that allows leakage only from the terminals to the case. Thus, normal three-terminal resistance measurements eliminate errors due to leakage from any intermediate point in the circuit. The instrument is available in three models, with 100,000 ohm, 1-megohm and 10-megohm resistance sections. The calibration accuracy of the resistors relative to absolute value is ± 15 ppm for 10-megohm resistors and ± 10 ppm for other values. Price of the model SR 1050 resistance transfer standard is \$400 for the 100,000-ohm-per-step model, \$500 for the 1-megohm-per-step model, and \$775 for the 10-megohm-per-step model. Delivery is from stock to 30 days.

Electro Scientific Industries, Inc., 13900 N.W. Science Park Drive, Portland, Ore., 97229. [385]

Solid state scope exhibits 4 displays

A four-trace, solid-state oscilloscope has been announced for monitoring physiological phenomena. The 14-inch medical monitor, known as model KP404, allows up to four simultaneous displays of phenomena such as cardiac functions or muscle potentials. A chopped mode of commutation is utilized, rather than the conventional raster approach. According to the manufacturer, this allows exceptionally fine focus and high-intensity output, and consequently can be read accurately and easily, even at long distances. The medical oscilloscope offers high-impedance inputs, 20-mv-per-cm input sensitivity and calibrated sweep speeds from 25 to 250 mm per sec.

Industrial Products division of ITT, 15191 Bledsoe St., San Fernando, Calif. [386]

Kodak advertises the highest acuity:

When asked our opinion as to what are the highest-acuity lenses that money can buy out of a catalog for aerial photography, CRT recording, or microphotography, we go so far as to send a free copy of the right catalog, newly issued as "U-10" by Eastman Kodak Company, Apparatus and Optical Division, Rochester, N. Y. 14650. It quotes some phenomenal resolving-power figures.

Kodak advertises pre-conditioned MgF_2 , ZnS, ZnSe, MgO:

A cloyingly folksy mien deceives no sophisticated customers, but we do take a certain pride in being able to act at times like a small company.

You may find it useful to know that on much the same basis as we sell off used office furniture from time to time, we have been known to accept \$40 per pound for odd hunks of MgF_2 , ZnS, ZnSe, or MgO that might have turned, respectively, into infrared-transmitting, environment-resisting KODAK IRTRAN 1, 2, 4, or 5 optical materials or components if all had gone well. We understand that for vacuum deposition of these

If you know enough to deny that resolving power tells the whole story about lens performance, you may qualify to participate in some really stimulating discussion. Today it is possible to talk modulation transfer functions until either the cows come home or the bucketsful of digits boil down to a one-bit question: is Lens A better than Lens B?

compounds the purchasers get more even, more finely controlled results than by working with powders. Since we probably know more than they know (or need to learn) about hot-pressing the powders into polycrystalline pieces, everybody benefits.

Information about KODAK IRTRAN Optical Materials, real ones or merely intended, comes from Eastman Kodak Company, 400 Plymouth Avenue North, Rochester, N. Y. 14650, phone (716)-325-2000, Ext. 5166.

Kodak advertises color vision to relieve brain strain:

Avoid brain strain. Why waste high-powered deductive reasoning on tasks just as well accomplished through mere color vision? Primates like you generally have use of color vision free of charge. We (Instrumentation Products Division, Eastman Kodak Company, Rochester, N. Y. 14650) can supply name of nearby dealer who now accepts orders for KODAK LINAGRAPH 705 Paper. Comes in widths $3\frac{5}{8}$ -in. to 12-in., lengths to 400 feet.

Blue light, as through a KODAK WRATTEN Filter No. 34, falling on this paper leaves a red trace; green light, as through WRATTEN No. 12, a blue-green trace; white light (or an overlap of the blue and green light), a nearly neutral black one—after running the paper through an oscillogram processor wherein the four regular baths have been replaced from a KODAK LINAGRAPH 705 Processing Kit that you had better order from the dealer while you are at it.

We mention oscillogram processors. If the place where you

work takes much interest in physical phenomena at frequencies above one cycle/sec, there may well be an oscillogram processor around. Take it over. Tell them to have it replaced with a new KODAK EKTALINE Processor, which will get them out of their hole by at least quadrupling the speed at which they handle the paper pouring out of the oscillographs that abound on the premises.

Now then, for your own case. Clearly, with many channels overlapping often, the untangling of them can tax the mind to distraction if they're all black all over. From that address parenthesized three paragraphs back, counsel can be struck forth as from a flowing spring on problems of feeding facts to the mind by permitting this product to exploit the indescribable distinctions of color. It's so sensitive you can draw a red line on it at 4,000 feet per second. Oscillography may even be farthest from your thoughts.

Kodak advertises how stain on masks does little harm but you don't want it anyway:

Make sure the photographic people know they ought now to quit relying on either of the good old reliable KODAK Developers D-8 or D-19 for processing masks from KODAK High Resolution Plates. We hope they have been so busy batting out the production that nobody has had a chance to tell them to order KODAK HRP Developer from the same place they buy the plates. It won't stain like D-8. In our opinion the stain had practically no effect, but it didn't look good and therefore tended to sour the photo department's relationship with the resist department and the specification writers in the engineering department.

Other reasons for switching from D-8 are that the new stuff lasts 8 hours in the tray (not just two hours), keeps longer on the shelf before use, and develops four times as much emulsion before exhaustion. You'd think that since you get more prod-

uct out of it we'd be asking more money for it, but instead we are asking less! In view of what would happen at the sophisticated end of the electronics art if KODAK High Resolution Plates and developers were suddenly no more, it must be sheer nobility that restrains us from cashing in on our importance. HRP Developer, as compared with D-19, permits cutting exposure almost in half and gives better image-edge quality with higher contrast. Furthermore it comes as a *liquid*, which helps with the cleanliness. Dilute 4:1 and develop 5 minutes at 68°F.

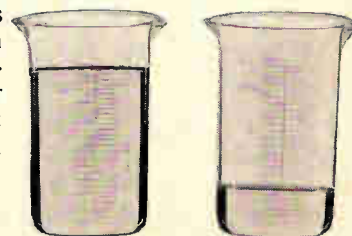

from
BURR-BROWN
 a new
 operational
 amplifier
 with low drift
 and high
 input impedance



The latest addition to the popular Burr-Brown operational amplifier family is model 1508. It's an all-silicon solid-state differential input unit which approaches FET and chopper-stabilized performance without the attendant cost. You will find it particularly useful in high impedance circuits and integrators requiring extremely low current drift. It is also excellent for voltage reference applications drawing from standard cells. And, it is small... a modular 1.8" x 1.2" x 0.6.

TYPICAL PERFORMANCE @ 25°C

Input Impedance	
differential	1.0 Mohms
common mode	500 Mohms
Current Drift	± .05 na/°C
Voltage Drift	± 10 μv/°C
D.C. Gain	96 db
Unity Gain Bandwidth	1.0 Mcps
Rated Output	± 10 V (min) @ 20 ma

The Burr-Brown 1508 is immediately available at \$110 in unit quantity... \$99 in quantities of ten. Connectors and accessories are also in stock.

FOR COMPLETE TECHNICAL INFORMATION on the 1508... or, for prompt assistance with your operational amplifier application, wire, write or phone Burr-Brown today.

BURR-BROWN

RESEARCH CORPORATION
 INTERNATIONAL AIRPORT INDUSTRIAL PARK
 BOX 11400, TUCSON, ARIZONA 85706
 PHONE: 602-294-1431 • TWX: 910 952-1111

New Semiconductors

Transistor has current gain of 10,000

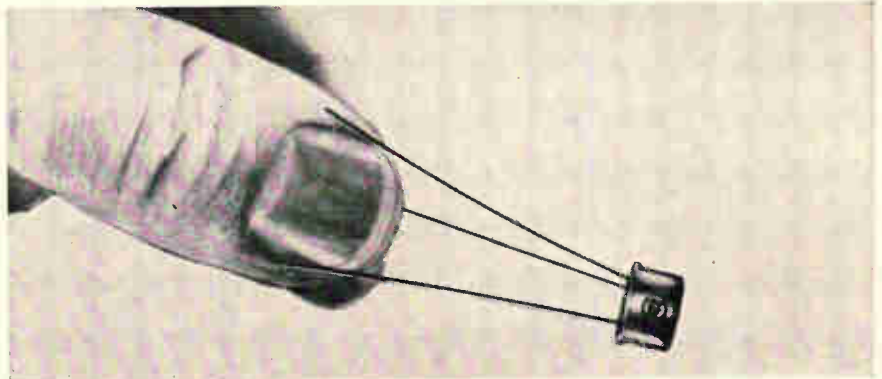

With the introduction of a line of Darlington-pair transistors, packaged in a single case, the Solid State Electronics Corp. is on its way toward the goal of diversifying its line of semiconductor devices. The first Darlington-pair device, the SST610, offers a typical current gain of 10,000 with an output current of 120 milliamperes.

Edward Y. Politi, the company's technical director anticipates that the major application for the SST610 will be in differential amplifiers although, he points out, it can also be employed in sensitive switches and relays, conventional high-gain, low-level amplifiers and buffer amplifiers.

Politi says, "We expect to market a unit with a beta [current gain] of 100,000 in six months and eventually, we'll have units with betas of a million." He also says that there are presently no instruments designed to use transistors with current gains of 100,000 or above. But he adds that the availability of such devices should encourage manufacturers to design them into equipment. Politi believes that the units with gains of one million or more won't be available for two or three years because the noise levels associated with existing devices will have to be significantly reduced.

The SST610 represents a new direction for this manufacturer. Previously only chopper transistors were included in its semiconductor-device line. The company also sells reed switches and equipment items such as relays that are built with

solid state devices. According to Politi, one reason for his company's entry into the high-gain transistor business was that its present customers are a major market for the new product line.

Each transistor contains two pellets selected for compatible operation. The first pellet receives current typically in the order of 1 to 20 microamperes and amplifies it about 100 times. The second pellet then amplifies the output current from the first unit, also about 100 times. Output currents, depending on the input current level, range from 1 to 500 milliamperes. The input-output relationship is linear up to output currents of about 150 milliamperes.

The SST610 has a 1-watt dissipation rating at 25°C and is housed in the Jedec TO-5 case. Each of the two pellets is made from npn silicon in a mesa construction.

Specifications

Collector current	500 ma
Collector-to-base voltage	60 volts
Emitter-to-base voltage	7 volts
Temperature range	-55 to +150°C
Saturation voltage at 120 ma	0.8 volt
Collector capacitance at 1 Mc	20 μmf
Current gain at 120 ma	10,000
Price	\$39.00

Solid State Electronics Corp., 15321 Rayen Street, Sepulveda, Calif. [371]

**Compact package
 houses new regulators**

Two new series of one-watt power regulators—both single- and double-anode (pn and pnp) types—are

PRODUCT
NEWS from EPL

NEW... hi voltage regulated DC Power Supply under \$400.

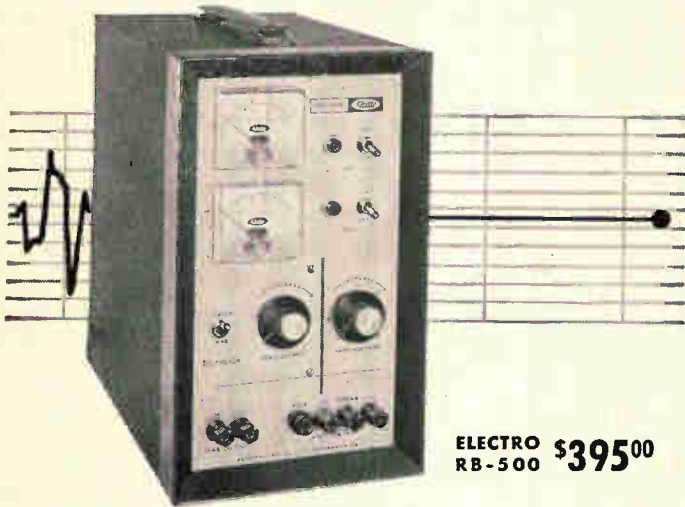

ELECTRO
RB-500 \$395.00

Compare Value

Brand	Volts	Current	Regulation (Combined line & load)	Price
K	0-325	0-200 MA	0.02%	\$495.00
S	0-500	0-200 MA	2.0%	400.00
Electro RB-500	0-500	0-250 MA	0.03%	395.00

Compare Features

High Voltage Output: 0-500 VDC.

Precise Regulation: 0.03% or .015V, whichever is greater, for combined line (105-125V) and load (no-load to full-load) variations.

Ripple: 5MV, RMS maximum.

Bias Output: 0-150 VDC.

Filament Outputs: Two separate 6.3V at 5A outputs for 6.3V at 10A or 12.6V at 5A.

Primary and Secondary Protection.

2% V Arsonval Meters: Dual scale . . .
0-500V/0-150V. 0-250 MA

Separate AC, DC Switches.

Continuous Output Voltage Adjustment: Regulation maintained well below 3V output setting.

Wherever precisely regulated DC power is a must, the EPL RB-500 fills the bill economically. Engineered and built for heavy-duty production testing; electronic circuitry development and design in industry, laboratories and schools.

5180 Write for Literature & Name of Your Electro Distributor!

Since 1936—Pioneers in Low Voltage DC Power Supplies
• Proximity Switches • Magnetic Pickups • Tachometers
• Pres-Con Controls • Dynamic Micrometers

ELECTRO PRODUCTS LABORATORIES, INC.

6125-F HOWARD, CHICAGO, ILL. 60648 • 312/775-5220

Circle 223 on reader service card

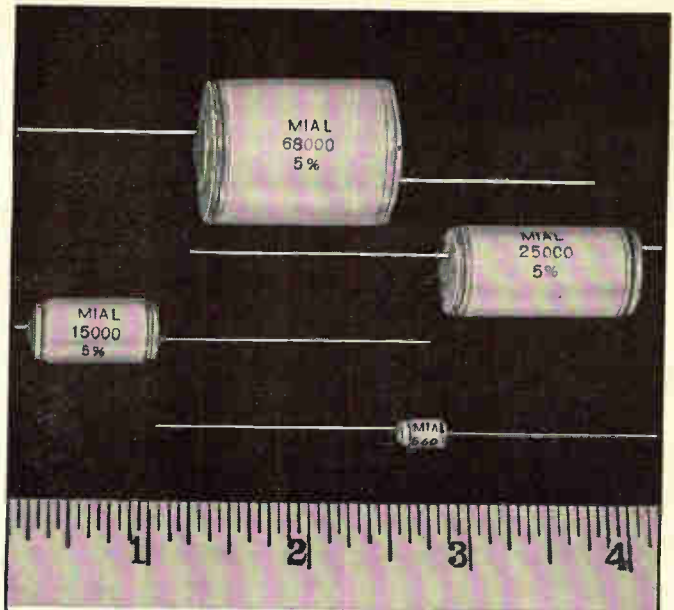

NEW MIAL general purpose polystyrene capacitor with more than 500,000 megs leakage resistance!

The MIAL Style 611 general purpose polystyrene capacitor outperforms all other film capacitor or mica units—yet costs less! Ideally suited for TV, radio, stereo and instrumentation applications requiring long life, high reliability, and complete freedom from drift.

- Capacitance Range: 20 to 100,000 pF
- Temperature Coefficient: N150 ±50 ppm/°C
- Capacity Tolerance: from ±1pF to ±20%
- Voltage Range: 33VDCW to 1000 VDCW
- Q Factor: Over 2,000 at 100 KC +25°C

Polystyrene
Capacitors

Write today for new complete catalog. Gives environmental, electrical and mechanical characteristics, charts and dimensions.



MIAL
U. S. A., I N C.

165E FRANKLIN AVENUE, NUTLEY, N.J. 07110 • (201) 667-1600-1601

Circle 147 on reader service card

147

1 of a series

TRANSICOIL SOLVES SERVO PROBLEMS

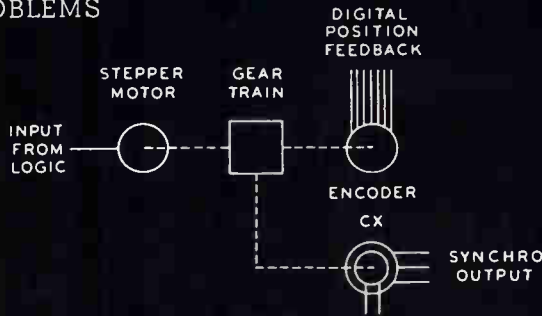

Transicoil digital-to-analog converter

This unit is one of Transicoil's broad line of specially-designed servos. It employs a 13-bit V-scan shaft encoder as position sensing element. Information is fed back to an external network which generates a pulse train from position error. ■ The stepper motor receives a series of logically-switched field excitations to provide the driving force of the servo. When the encoder has been driven to a position of agreement with the desired digital command, the pulse train is shut off and the servo stops at its last step—held by the magnetic detent of the motor. Analog output is provided by a synchro driven directly from the encoder. ■ By re-arranging components, the package can be used in the analog-to-digital mode. In this configuration, input is 3-wire synchro data, and the driving member is a conventional 2-phase servomotor. Digital output is provided by the encoder. ■ Transicoil offers an unusual capability for combining servo components into operating servo systems. We would like the opportunity to help solve your problems. Write for our 16-page brochure, *SERVO ASSEMBLIES*.

QUALITY BY DESIGN

 **WESTON INSTRUMENTS, INC.**

WESTON TRANSICOIL
Worcester Pennsylvania 19490

Circle 224 on reader service card

VersaTility



**ANYTHING YOU CAN PUT ON FILM
YOU CAN DISPLAY ON IEE READOUTS
(EVEN COLORS!)**

NUMBERS, LETTERS, WORDS, SYMBOLS, COLORS!
There is literally no limit to the display versatility of IEE readouts. As rear-projectors, they operate by back-lighting display symbols arranged on film and projecting the selected message on a non-glare viewing screen.
VERSATILITY OF SIZES, TOO! Five sizes with maximum character heights of $\frac{3}{8}$ ", $\frac{5}{8}$ ", 1", 2", 3 $\frac{1}{2}$ ".

SEND TODAY FOR COMPLETE INFORMATION!
INDUSTRIAL ELECTRONIC ENGINEERS, INC.
7720 Lemona Avenue • Van Nuys, California
Phone: (213) 787-0311 • TWX (213) 781-8115



Representatives in Principal Cities

SEE IEE AT WESCON, Booth 2501

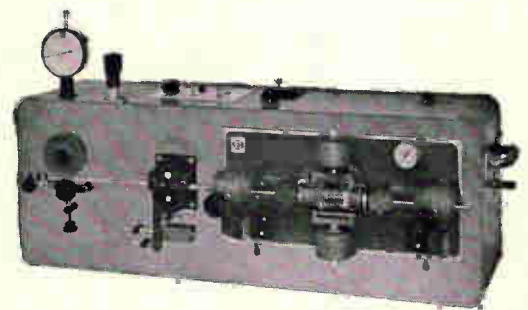

Cut your wire preparation costs with high-speed wire strippers

Eubanks wire strippers are noted for easy set-up changes, high-speed operation, and clean stripping without nicking or scraping. Whether you need battery cables, printed circuit board jumpers, leads for electric watches, coaxial cables, or washing machine harnesses, chances are excellent that we have a machine to meet your requirements. Pictured is our Model 87 Utility Wire Stripper, which produces up to 12,000 leads an hour. Write for free information on this and other Eubanks wire stripping machines to Eubanks Engineering Co., 225 W. Duarte Rd., Monrovia, California.



EUBANKS
ENGINEERING COMPANY

New Semiconductors

available in a compact, hermetic glass package. The new package, measuring only 0.150 in. by 0.360 in., is a third the volume of comparable top-hat in-line rectifiers and half the size of epoxy and flangeless types. It is fully insulated and cylindrical, permitting higher density packaging for added space savings.

The single-anode series, designated 1N4158-1N4193, is available in a zener voltage spread from 6.8 to 200 v. The double-anode series is typed 1N4831-4860 and rated from 9.1 to 150 v. Other characteristics include a sharp zener knee, low dynamic impedance, and an operating temperature range of -65° to 175° C. Both series are available in 5%, 10% and 20% tolerances.

The double-anode devices are ideal for bidirectional clipping and protection against both forward and reverse transients. In such applications one double-anode device replaces two single-anode regulators, cutting component costs in half, simplifying circuitry, reducing parts inventories and increasing circuit reliability. The double-anode regulators can be used in either forward or reverse single-anode applications as well as to further simplify parts inventories.

Texas Instruments Incorporated, 13500 North Central Expressway, Dallas, Texas. [372]

Microelectronic complementary logic



Vacuum-evaporated thin films, in conjunction with multichip transistor flatpacks, have been incorporated in two off-the-shelf logic elements. The complementary design results in a flip-flop with low



There's only one way to go...computerized filter and transformer design



Here's the newest, shortest way to accuracy and top performance in filters and transformers: design by computers.

It's your fastest route. Computer designs take minutes instead of hours. No crossroads or by-passes, either. Computer design explores possible approaches, guides you straight to the best solution when you're in a hurry. And no detouring for trial-and-error prototype costs. Designs are "performance tested" before production starts. Genisco's computer method searches through existing designs and singles out any that can be used.

Your filters and transformers arrive on time and at lower shipping cost because Genisco plants are on the map in key market areas. Price quotations are fast and accurate. There's never any guessing about costs with Genisco computer design of filters and transformers.

Find out how this new design capability can put you on the right track. Write today for complete information.

COMPONENT DIVISIONS: Combined Sales and Application Engineering Departments

WESTERN UNITED STATES
6320 West Arizona Circle Los Angeles, Calif. 90045
Phone: (213) 776-1411 TWX: 213-670-4765

EASTERN UNITED STATES
111 Gateway Road Bensenville, Ill. 60106
Phone: (312) 766-6550 TWX 312-766-7048

Genisco

TECHNOLOGY
CORPORATION



Everyone's talking about

Delevan's

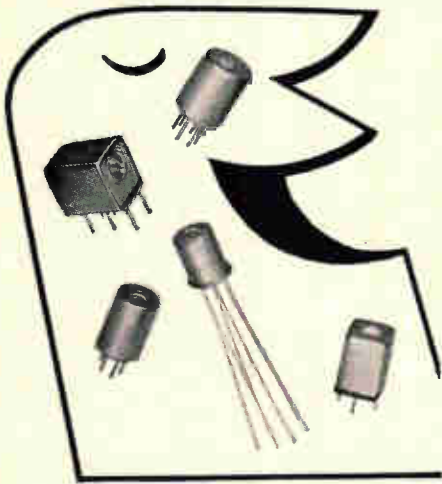

BROAD RANGE OF SHIELDED COILS & TRANSFORMERS

Here's why!

- 1 Only Delevan offers 12 mechanical designs from which to choose depending upon the environmental characteristics required to satisfy a specific need.
- 2 Standard RF and IF transformers offering similar electrical characteristics for all designs including standardized 30 MC, 10.7 MC and 455 KC, IF transformers. Also tunable units in RETMA values from .1 μ h to 10 mh.
- 3 A wide pricing range from \$5.00 for units used in HIGH REL. space programs to as low as \$1.00 for commercial applications.

The industry's widest selection
12 MECHANICAL DESIGNS

Delevan Electronics Corp.
Subsidiary of American Precision Industries Inc.
270 Quaker Road, East Aurora, N. Y. 14052

New Semiconductors

power (0.1 mw to 100 kc) as well as high speed (up to 10 Mc at 2 mw). Typical specifications are: 6v d-c power supply; set, reset, direct set, direct reset complement inputs; insensitivity to noise below 1.0v. The gate is also complementary and is compatible with the flip-flop, having essentially zero standby power. Size and weight are the same, and the leads have been brought out to facilitate interconnections. Both elements result in packages 1.2 in. by 0.6 in. by 0.1 in., with Kovar leads on 0.075 in. centers out of one surface, thereby permitting dense stacking plus easy access.

Alpha Microelectronics Co., Inc., 10501 Rhode Island Ave., Beltsville, Md. 20705. [373]

Silicon-type current regulator



A series of 800 mw, high-temperature, silicon-type Currector current regulators is announced. The Currector is a current regulating, two-terminal, solid state device that limits current much as zener diodes limit voltage. These new versions, the CP2 and CN2 silicon series, have an operating temperature range from -55° to 125°C with controlled regulation to 40 v. The CP2 is a polar version, and has a reverse characteristic similar to that of reverse-biased silicon diode. The non-polar CN2 has identical

forward and reverse characteristics. This series is available in fixed current ratings of 1 to 20 ma in 5% increments.

Both the CP2 and CN2 feature current regulation of typically $\pm 1.5\%$ over their operating voltage range, low shunt capacitance, and low temperature coefficient of current. They can be used advantageously in many designs, providing the engineer with a significant means of circuit simplification. Typical applications of the Currector include timing and squaring circuits, pulse integrators, differential amplifiers, sweep circuits, multivibrators and power supplies. The new series is epoxy encapsulated and available with axial or single-ended leads.

Telonic Engineering Co., 480 Mermaid St., Laguna Beach, Calif. [374]

Shift register offers high complexity

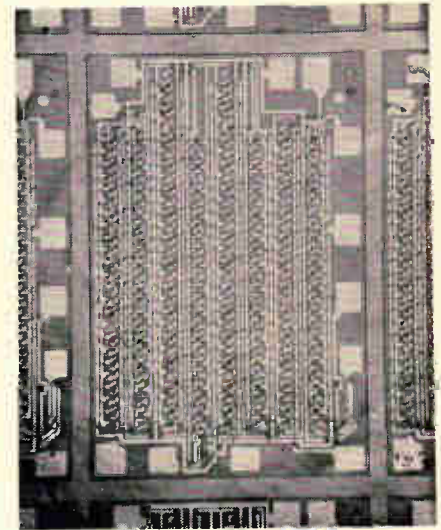

A 100-bit serial shift register now available is said to be the most complex monolithic MOS integrated circuit ever produced. The 100-bit register has 612 active MOS FET devices on a single chip with a power dissipation of 200 mw at 500 kc and a 25% duty cycle. The frequency range extends from 50 kc to 1 Mc. The complexity of the register offers the advantages of extremely low power per bit, small size, and high packaging

Another Arm-The NO. 40 CIRCLE TEMPLATE

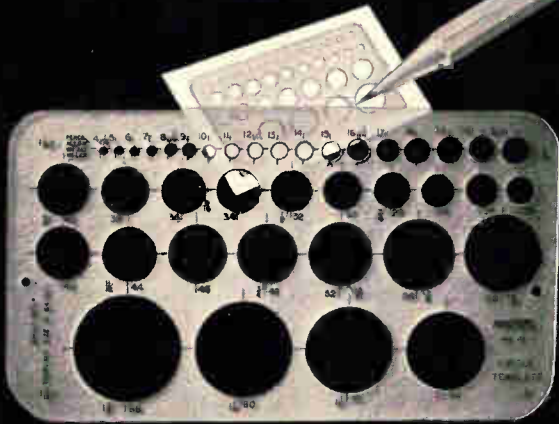

\$1.00 AT YOUR LOCAL DEALER

.030 MATTE FINISH MATHEMATICAL QUALITY DOUBLE-CURED PLASTIC.
ALL HOLES SMOOTH-MILLED TO ENGRAVING MACHINE ACCURACY.

ONE OF MORE THAN 30 RAPIDESIGN TIME-SAVER TEMPLATES - ALL
OF WHICH ARE BETTER MADE, MORE USEFUL AND LESSER PRICED.

CATALOGUE NO. 49 AVAILABLE UPON REQUEST

RAPIDESIGN INC.
P. O. BOX 592 GLENDALE, CALIF.

Circle 226 on reader service card

NOW you can inspect these exciting new products at your BUD Distributors

Complete range of styles and sizes of these exceptional
products now available for prompt delivery.

ZEPHYR CABINET RACKS

Exceptionally sturdy all assembled
unit with welded frame. The oc-
tagonal shape with louvres placed
in the 4 narrow sides provides ex-
ceptional ventilating capabilities.
Five sizes available.



GRAND PRIX CABINETS



Imaginative, yet practical design in standard cabinetry.
Offers innumerable possibilities for instrument and
control housings. Three sizes available.

FUTURA CABINETS

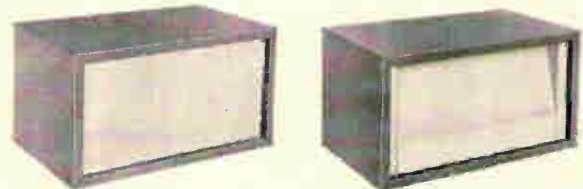

Highly functional, two piece cabinet embodying a design
feature of holding front panels in place without the
use of hardware. 3 sizes available in each type.



pan-Lite

Classic combination of aluminum and plastic supplies
glare-free lighting for area requiring a high degree of
concentrated illumination.

Names of your nearest Authorized Bud Distributors
may be obtained by writing to the plant.

Want HIGH volume terminal swaging?

3803
Manual
Pressure
Swager



**We've got
the swager
to do the job!**



3805
Hopper
Staker®

Plus swagers for prototype
applications and models for everything in between. If
speed is your need - CAMBION® offers the 3805
Hopper Staker, a semiautomatic, vibratory-feed device
that positions and swages terminals in drilled boards
at rates of up to 115 terminals per minute. CAMBION
manual pressure swager 3803 is made to accommo-
date large boards and panels, while CAMBION 3804
solenoid swager is designed for requirements too
large for hand swaging. Additional interchangeable
anvils and punches supplied from stock. Models
available with safety devices and foot switches. Make
CAMBION your single source of supply for swagers,
solder terminals and tooling. Call (617) 876-2800.
Cambridge Thermionic Corporation, 402 Concord
Avenue, Cambridge, Massachusetts 02138.



3804
Solenoid
Swager

CAMBION®
"DIAL-A-PART" SERVICE

Standardize on CAMBION... the guaranteed electronic components

Circle 227 on reader service card



BUD RADIO, INC.
WILLOUGHBY, OHIO

BUD RADIO OF CANADA, LTD. • 9 Milvan Dr., Weston, Ont., Canada

Circle 151 on reader service card

151

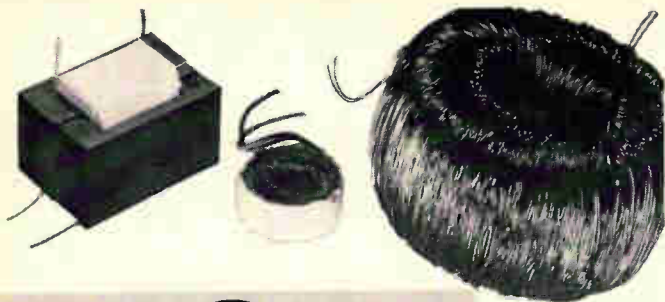

TRANSFORMER PRODUCTS AND SERVICES

Prototypes engineered to your specifications and supplied in two weeks. Production runs in any quantity can follow immediately.

Send us your detailed specifications and quantity requirements for fast fabrication service of custom units.

Economy consistent with Geo Space high standard of quality.

Skilled in —

- MIL-Q Standards
- Commercial Grade High Volume
- Filters, Coils, Inductors, Toroidal Coils, Magnetic Amplifiers
- Geophysical — Matched 2-levels or more
- Well Logging

INDUSTRIAL PRODUCTS DIVISION

GEO SPACE CORPORATION

5803 GLENMONT DRIVE
HOUSTON, TEXAS 77036
TELEPHONE—713/MO 6-1611

The Leader in
COMPLETE
Seismic Instrumentation



Reprints Available from Electronics

Special Reprint Offer: For your reference file—a complete set of Special Reports reprinted from the pages of Electronics in 1964. A total of 207 pages of valuable and informative articles combined in an attractive folder. The reports are individually bound. The special discount price for these reprints is \$2.50 which includes both handling and shipping costs. Order now using the coupon at the bottom of this page. The following reprints are included in this offer:

Field Effect Transistors—A report on metal-oxide-semiconductor (MOS) and junction field-effect transistors. 64 pages.

Electronics Telephone Switching—World-wide developments in fast, recorded logic, telephone switching that will replace all existing systems by the year 2,000.

Direct Digital Control In Industry—This report analyzes seven DDC computer systems used in process control by seven major companies.

Transistor Heat Dissipators—A survey of this industry including market data, list of manufacturers, and tips on buying these devices. Included are 7 outstanding technical articles giving the newest applications of these devices and how to make best use of them. 32 pages.

Oceanography—A survey of the growing electronics technology associated with underseas exploration. 15 pages.

Magnetics—A report on what's new in today's magnetic technology. 24 pages.

Digital Instrumentation—A look at some new techniques in instrumentation. 16 pages.

Modern Electronic Packaging—How to locate, connect and afford protection for electronic devices and components. 16 pages.

Remember to refer to this special offer when you order. Price is \$2.50 for the complete set or you may order them individually at 50¢ per copy.

Send your order to:
Electronics Reprint Dept. 330 West 42nd Street
New York, N.Y. 10036

A2

Reprint order form

For reprints of the latest special report:

Unijunction Transistors

Send me reprints of Key no. R-74 at 50¢ each.

For reprints of previous special reports:

Send me reprints of Key no(s).
at ¢ each.

For complete set of special reports (See above offer)

Send me complete set(s) of special reports.

Name

Number & Street

City, State, Zip code

New Semiconductors

density per bit. The manufacturer says that current information on production costs indicates that the 100-bit register can be sold at the lowest cost per bit of any shift register on the market today including discrete components or conventional bipolar integrated circuit assemblies made from epoxy parts.

The new 100-bit register is designed with five inputs and two outputs. Single registers may have more than one input and a pair of outputs. If there is need to adapt the register length to an existing design, provision exists which will allow the user to obtain pairs of registers on a single device with a capacity up to 50 bits per register. This means that there can be two distinct registers on a single chip up to 50 bits each, varying in length from 1 to 50 bits.

The 100-bit complex register can be used as a fixed or variable delay line where the duration of delay of the register is directly related to the clock frequency; as a memory register; as a frequency divider and as a register in a digital differential analyzer.

General Micro-electronics, Inc., 2920 San Ysidro Way, Santa Clara, Calif. [375]

Operational amplifier on silicon substrate

This general purpose amplifier is constructed on a single monolithic silicon substrate. Primary features of the type A13-251 are an output swing of 20v, 1-megohm input impedance; zero ground-referenced output and an open loop gain of 20,000. Other key specifications include untrimmed offset at 5 mv, drift of 25 μ v per °C and 5.0 na per °C, and common mode rejection at 80 db. Operating temperature range is -55°C to +125°C. The unit is available from stock and is priced at \$44.50 in quantities of 1 to 99 and \$35.50 for 100 or more.

Amelco Semiconductor, division of Teledyne, Inc., 1300 Terra Bella Ave., Mountain View, Calif. [376]

When Size, Weight and Performance are Critical — ORDER W-J's NEW BWO at K-BAND

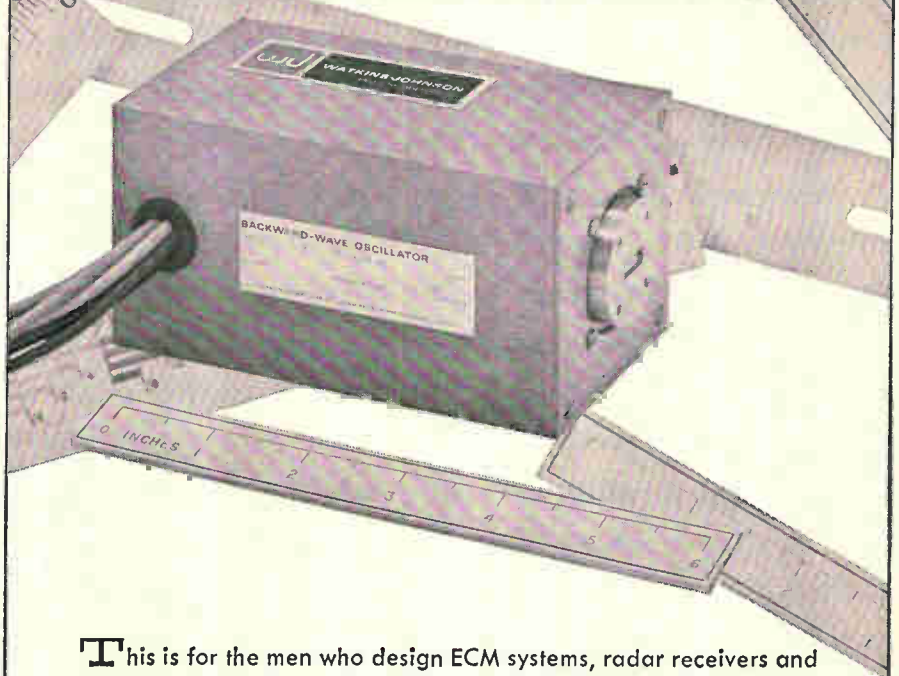

This is for the men who design ECM systems, radar receivers and sweep oscillator instruments. And for anyone else with a BWO in mind for receiver systems, parametric amplifier pumps, transmitter oscillators or as a stabilized wideband signal source!

The SE-218 is the smallest, lightest BWO on the market for K-band. It has **double the power output** heretofore available. Its waveguide output and case are voltage-isolated. It is designed to meet MIL-E-5400, Class II environmental conditions. It is available with RFI shielding and filtering to meet MIL-I-26600, Class I. It is the most advanced tube of its kind available today.

GUARANTEED SPECIFICATIONS

Frequency Range	18.0–26.5 Gc
Power Output	20 mW Min.
Helix Voltage Range	535–1800 V
Cathode Current	5 mA
Grid R.F. Cutoff	–20 V
Weight	4 Pounds Max.
Size	2 1/2" Square x 5"
Permanent Magnet Focusing; Convection Cooling	

Information in more detail available from representative in your area, or from Applications Engineering.

WATKINS JOHNSON COMPANY



3333 HILLVIEW AVENUE
STANFORD INDUSTRIAL PARK
PALO ALTO, CALIFORNIA 94304

500 kc all silicon Bi-Directional Counters



Model 658, 7 digits with polarity sensing, only 3½" high.

Janus Bi-Directional Counters, Series 600, are available with and without polarity sensing for use with machine tool control systems, process control systems, guidance systems or any application requiring the comparison of two input signals such as shaft encoder outputs, accumulation of pulses from one or two sources and the addition or subtraction of random input pulses.

These instruments not only count in both directions at 500 kc but reverse without error at this maximum counting rate. Bright, clear, in-line display is provided for convenient wide angle viewing.

Series 600 Counters are available in 4 to 8 digit models and up to 6 digits in dual packages for convenient two-axis measuring. A few of these other options include printer outputs, preset capability and input sensitivities as low as 25 millivolts peak for both inputs.

Price Range: \$895 to \$2795.

Availability: 30 days A.R.O.

The Next Time You Need Counters
Count on JANUS

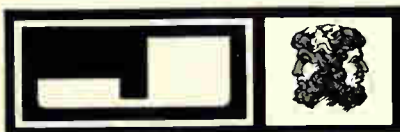

JANUS CONTROL CORPORATION
HUNT ST., NEWTON, MASS. TEL. 926-2670

New Subassemblies and Systems

Real-time computer series has budget price



Companies that cannot afford a computer, or that now accumulate data for computer processing in batches, may find a new real-time series made by the Univac division of the Sperry Rand Corp. tailored for their needs and budgets. With the Univac 491, they can begin real time processing at once, and work their way up through the 492 and 494 as their needs increase.

The 494 actually supersedes the Univac 490; the company says that present users of the basic 490, which costs \$18,000 a month, will find that the 494 provides substantially improved performance at an attractive price—\$14,000 a month.

A real-time computer processes data fast enough for the results to influence the source of the data. Such computers usually keep several programs going at once, servicing each one briefly as data comes in, and producing results within seconds or minutes. In batch processing, each program is completed before the next is started; programs must "stand in line" outside the computer, on magnetic tape or in punched cards, while waiting their turn. Results with batch processing are often not available for hours or days. Real-time computers may be used to run batched programs

when they get caught up with real-time requests, or when such requests are infrequent, as after midnight.

Memory cycle time in the Univac 494 is 750 nanoseconds for complete read-out and regeneration. The memory is built in the form of distinct banks with separate access; thus the first, or read-out, half-cycle of one bank can be simultaneous with the second, or regeneration, half-cycle of another. This overlapping of cycles produces a net apparent cycle time of 375 nanoseconds. Memory overlap is not often encountered in machines the size of the 494, although it was a feature of the Univac Larc in 1960, and the International Business Machine Corp.'s Stretch in 1961. It is presently found in the Univac 1107 and 1108, as well as in large machines built by IBM, the Control Data Corp., and the Radio Corp. of America.

The Univac 491 and 492 have cycle times of 4.8 microseconds, and overlapping is not possible. The memory word length in all units is 30 bits. Basic memory capacity of the 491 and 492 is 16,384 words, expandable to 65,536. Maximum memory capacity of the 494 is 131,072 words.

Two important features of the

You need a pushbutton switch. 

Bill, at the next board, needs a toggle switch. 

Sam's looking for placard indicators. 

Joe wants a switchlite. 

Harry wants a hermetically-sealed switch. 

Here's the easy way to get all the answers at once!

Just check the bingo card in this book for any or all of the Control Switch catalogs listed below. Or send us a card of your own.

If you get all of our catalogs you'll have it made.

First, because these catalogs cover a combination of switch types and switchlites that no other manufacturer can offer. So you get a concentrated reference.

Second, because some switch manufacturers don't make *any* of the switches we make. So Control Switch catalogs save wild goose chases.

Third, because we make only quality switches. For computers, aircraft, missiles, control panels, and such. So our catalogs (and your nearest Control Switch distributor) save time screening out switches that haven't got it.

Here's the list. Check the Reader Service Card number at the left for the catalogs you want.

- #233 *Condensed Switch Catalog 100*
- #234 *Basic Snap-Action Switch Catalog 110*
- #235 *Toggle Catalog 180*
- #236 *Indicator Light Catalog 120*
- #237 *Hermetic Switch Catalog 130*
- #238 *Switchlite Catalog 220*
- #239 *Pushbutton Catalog 190*



CONTROL SWITCH DIVISION
1420 Delmar Drive, Folcroft, Pennsylvania 19032



Great editorial
is something
he takes
home

(What a climate for selling!)

Electronics 

A McGraw-Hill Market-Directed Publication
330 West 42nd Street, New York, N.Y. 10036

New Subassemblies

new line are called, by Univac, "memory lockout" and "Externally Specified Index" or ESI. When a real-time computer is running several programs at once, it must often move them back and forth between its core memory and a high-speed magnetic drum. Most computers do not have memory room for more than one or two programs at one time. When running such a program for a millisecond or two, the computer will generally concentrate on only that small part of the program which is of interest at that particular time.

Memory lockout, also called memory paging, reserves chunks of memory for small currently used portions of several programs, with provision to keep the program segments from interfering with one another, and to allow segments of each individual program to be moved back and forth between memory and drum as execution of each program proceeds, step by step.

Specifications

	491	492	494
Memory cycle, basic	4.8 μ sec	4.8 μ sec	750 nsec
Overlapped cycles	Not available	Not available	375 nsec
Memory size, minimum	16,384 words	16,384 words	16,384 words
maximum	65,536 words	65,536 words	131,072 words
Word length	30 bits	30 bits	30 bits
Input/Output channels	8 to 14	14	12 to 24
Index registers	7	7	14
Decimal arithmetic	No	No	Standard
Floating point arithmetic	No	No	Standard
Number of instructions	62	62	99
Lockout blocks	1024 words	1024 words	64 words
Price, rental per month	\$8,200	\$9,950	\$14,000
purchase	\$328,000	\$398,000	\$588,000

Univac division, Sperry Rand Corp.
1290 Avenue of the Americas, New York, N.Y. [401]

Single-output wideband amplifier

Model 3420 single-output wideband amplifier is available for low-level instrumentation. It is specifically designed for driving long lines, higher power recorders, passive filters and displays.

The amplifier has a full-scale load current of 100 ma, a full-scale output voltage of ± 10 v, and a minimum small-signal bandwidth of 50 kc. It tolerates 60 v common mode or 30 v normal mode without damage; maximum noise is 4μ v

The Externally Specified Index is a high-speed polling arrangement that checks all incoming communication lines repeatedly. This insures that no request for service has to wait more than a small fraction of a second. The ESI also insures that data passing in and out of memory via the various communication lines is properly routed so that data for different purposes is not mixed.

A full complement of input-output equipment is available with all models in the line—including magnetic drums, magnetic tapes, data communication equipment, and punched card, paper tape, and high-speed printing equipment. A satellite Univac 1004 card processor can also be used with all models, and the high-speed Univac FH432 magnetic drum is available for use with the 494.

First delivery of the 491 and 492 is promised for the fourth quarter of 1965; the 494 will appear in the second quarter of 1966.

rms at full bandwidth. Modular dimensions allow five model 3420's to fit in one model 3005 rack enclosure.

Data Laboratories, Inc., Irvine, Calif.
[402]

Operational amplifier has variety of uses

Model 101 low-cost operational amplifier is said to combine features of high gain, fast response, low drift and substantial output current not previously available in a single



Great editorial is something he takes to work

(What a climate for selling!)

Electronics

A McGraw-Hill *Market-Directed* Publication
330 West 42nd Street, New York, N. Y. 10036



MEMBER: AUDIT BUREAU OF CIRCULATIONS, AMERICAN BUSINESS PRESS

MAGNETIC TAPE DEGRADATION CAN BE PREVENTED DURING STORAGE OR SHIPPING . . .

with **NETIC CONTAINERS**



Widely adopted for military and industrial use since 1956, Netic Containers protect your valuable tapes from unpredictable, distortion-producing magnetic environments. Long life rugged containers withstand the rigors of repeated shipment. Available in a variety of shapes and sizes to solve your shipping or storage problems . . . they're non-retentive, impervious to shock or vibration, and require no periodic annealing.

A low cost form of insurance . . . the loss and inconvenience avoided are incalculable. Request Manual 106.

MAGNETIC SHIELD DIVISION

Perfection Mica Company

1322 N. ELSTON AVE., CHICAGO, ILLINOIS 60622

ORIGINATORS OF PERMANENTLY EFFECTIVE NETIC CO-NETIC MAGNETIC SHIELDING

Circle 228 on reader service card

Switch to the Best

- 13,000 volt peak flashover at 60 cps
- 30 ampere current carrying capacity
- Current carrying members heavily silver plated
- Coin silver contact shoes

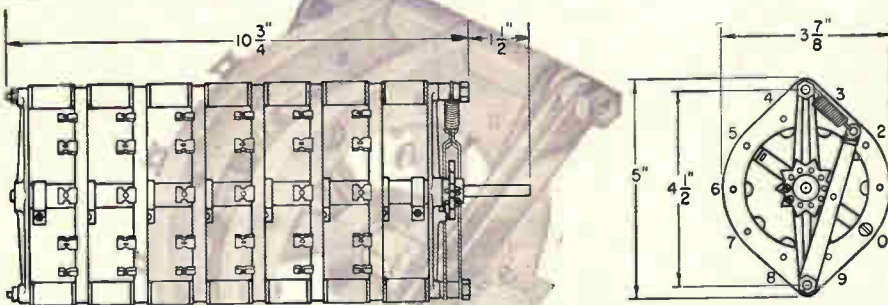

MODEL 88 SWITCH

- Low loss silicone impregnated steatite stator and shaft
- White glazed steatite spacers
- Nylon detent wheel
- Black anodized die cast aluminum support brackets
- Stainless steel detent arm
- Oil impregnated bronze sleeve bearings
- Anodized aluminum shaft and rotor bushing



RADIO SWITCH CORPORATION

MARLBORO, NEW JERSEY
Telephone: HOpkins 2-6100

158 Circle 158 on reader service card

New Subassemblies

encapsulated amplifier. Open-loop gain is 100,000 at d-c; current and voltage drift are 0.3 na per degree centigrade and 20 μ v per degree maximum limits; rated output is ± 11 v d-c at 5 ma; inverting bandwidth is 10 Mc for small signals and 100 kc for full power. With these specifications, users may now standardize on a single amplifier type for a wide variety of control, instrumentation, and computing applications. The model 101 is 2 by 1.2 by 0.6 in. Price is \$68 in small quantities.

Analog Devices, Inc., 221 Fifth St., Cambridge, Mass., 02142. [403]

High-reliability voltage regulators



A complete line of reliable line voltage regulators, from 500 v-a to 5 kva, can establish precise a-c voltages for all loads up to full nameplate ratings, and can supply the transients of current associated with motor starting, lamp loads, etc., without limitation.

These units can be used in three phase Y or delta configurations for balanced or unbalanced loads. Reliability is reported exceptional because all semiconductors are isolated from power-handling circuits to avoid components failure by voltage or current transients. The actual load current and supply voltage are handled by magnetic currents.

Other built-in design features insure fast response to line or load change, very high efficiency, low distortion, frequency insensitivity, low phase shift and no generation of rfi.

Input voltage range is 103 to 127 v with output of 115 v; output range is 100 to 120 v. Regulation is ± 0.1 rms. Response to line and load changes is 30 to 75 ms. Input frequency is 57-80 cps.

Microdot Magnetics, Inc., 5960 Bowcroft St., Los Angeles, Calif. [404]

Electronics | July 12, 1965

**A. King McCord,
President, Westinghouse Air Brake Company, says,**

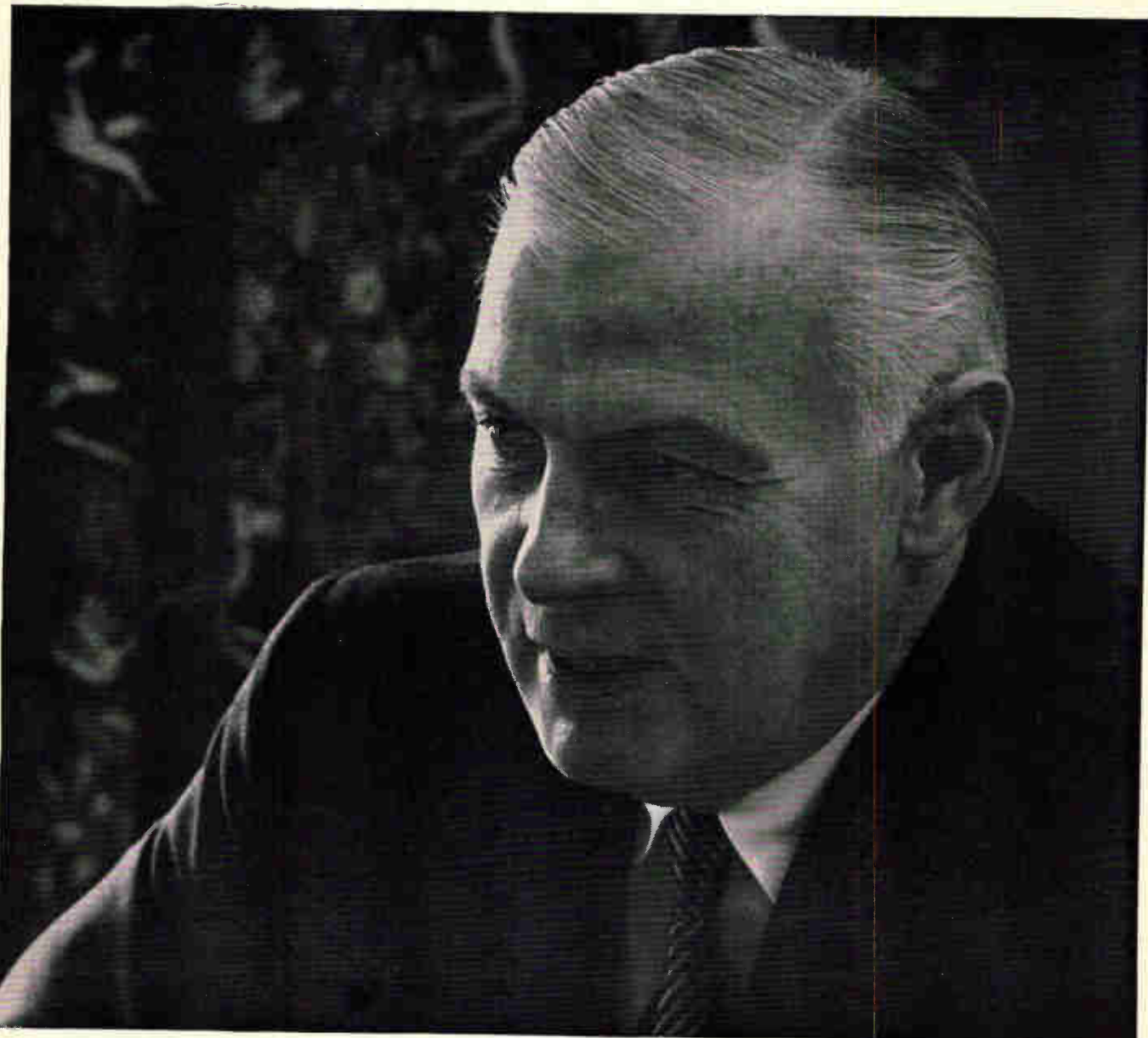

“We’ve introduced the world to WABCO with Industrial Advertising.”

“We gave *seven* individual companies a single corporate identity—virtually overnight. We let customers in thirty major markets know that Westinghouse Air Brake now ranks among the world’s most skilled and diversified suppliers—of earthmovers, drilling equipment, compressors,

automatic signal and control systems, electronic guidance detection and communications equipment, control valves, hydraulic and pneumatic cylinders, and—that’s right—air brakes. We told the story fast and inexpensively to hundreds of thousands of purchasing influences, with Industrial Advertising.”

Advertising cuts the cost of selling . . .

ASSOCIATION OF INDUSTRIAL ADVERTISERS



271 Madison Ave., New York, N. Y. 10016

grand opening

Viewing angles now 300% greater
with soft, undistorted read-out



DIGITEC®

The "New Look" is
now available on all

- DIGITAL DC VOLTMETERS
9 Models
Ranges from 10 mv to 1000 v
- DIGITAL THERMOMETERS
Measurements from
-390° to +2000°F
Thermistor
Platinum Bulb
Thermocouple
- DIGITAL PRINTER
Clocks
Scanners



Model 201 — \$345.00 Pictured Here

Stocking representatives throughout the world

Update your literature files—Send for 32 page D-65 catalog

DIGITEC

UNITED SYSTEMS CORPORATION

918 Woodley Road, Dayton 3, Ohio (513) 254-3567

Circle 229 on reader service card

MICROWAVE TERMINATIONS

LOW, MEDIUM OR HIGH POWER

BY
**RADAR
DESIGN
CORP.**



Latest of many RDC Terminations is the 13" air cooled Model D-4094 shown, with a rating of 175 Watts average power at L Band. Other styles include coaxial and waveguide, sliding, reflection standards and precision terminations from 0-12Gc/s.

All RDC microwave components exhibit experienced "state-of-the-art" capability with highest caliber of manufacture maintained. A perpetual inventory of several hundred standard components assures ready off-the-shelf delivery. Modifications and custom requirements promptly quoted.

For complete information write direct or contact nearest representative.



507 PICKARD DR., SYRACUSE, N. Y.

VOLTAGE REFERENCE AND REGULATOR TUBES

**Tolerance
± 1 Volt**



Z82R10
82 Volts ± 1V



Z100R12
100 Volts ± 1V

GENERAL SPECIFICATIONS

TUBE NUMBER	Z82R10	Z100R12
Maximum DC Breakdown Voltage (in dark or light)	115	150
Average	105	140
Reference Voltage (DC)	82 ± 1	100 ± 1
Measured at	2.0 ma.	3.0 ma.
Voltage Regulation — limits for less than 1 volt variation	0.3 to 10.0 ma.	0.6 to 12.0 ma.
Temperature Coefficient (typical)	-2 mv/°C	-9 mv/°C
Maximum Operating Current	14.0 ma.	14.0 ma.
Minimum Operating Current as shunt regulator	0.3 ma.	0.7 ma.
in parallel with capacitor	0.7 ma.	1.8 ma.
Life Expectancy (Hours)	30,000	30,000
Typical Variation at 250 Hours	Less than 0.3%	Less than 0.6%

Used in oscilloscope calibrators, digital voltmeters, regulated power supplies, and dc amplifiers. Provide the advantages of close regulating voltage control, low temperature coefficient, miniature size, low price and high reliability.

The Single Source for
All Glow Lamps **Signalite** INCORPORATED

NEPTUNE, NEW JERSEY AREA CODE 201-775-2490 · TWX 201-775-2255

New Microwave

Clamper stabilizes tv signal transmission

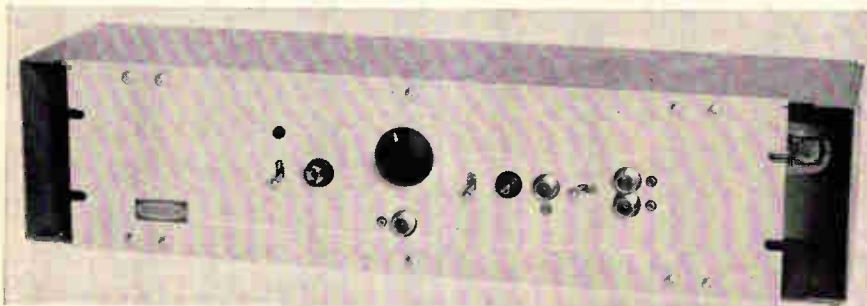
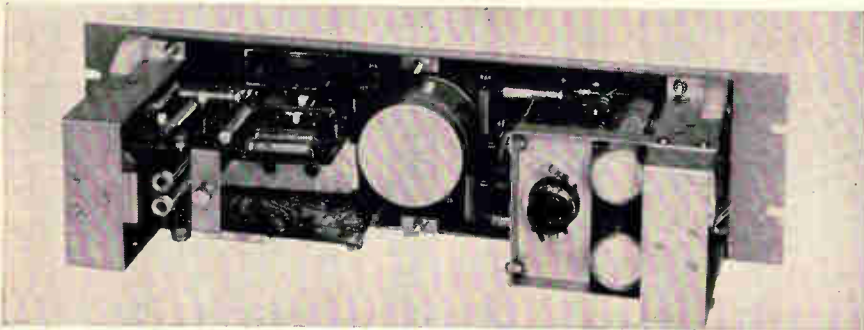

Raytheon's Model 10255A rack-mounted clamp amplifier weighs 8 pounds. Portable model 10255 (not shown) is approximately same weight and size.

A video signal that is transmitted over microwave radio or cable circuits may be degraded because extraneous signals interfere with the signal frequency, or because the repeating transformers through which it passes distort it. The result: varying brightness in the received video image.

To compensate for this degradation, the Raytheon Co. has developed a clamper amplifier that eliminates hum, and image tilt, and increases low video gain, for monochrome or color tv signals. Raytheon's type B clamper amplifier consists of the clamper circuit, a video amplifier that provides about 20 db gain, and a power supply. Because they contain only solid state components mounted on printed circuit boards, they can be packaged in a single portable unit. The amplifier section can be used separately as a wideband video amplifier.

The clamper amplifiers reduce low-frequency amplitude and phase distortion, improve low-frequency signal-to-noise ratios, and suppress hum, in inverse proportion to the interference frequency. A 60-cps

hum having an amplitude of 1 volt peak-to-peak is suppressed more than 30 db by the clamper.

For color tv transmission, the amplifier preserves the fidelity of the video signal by clamping the tip of the horizontal synchronizing pulse. A single control on the front panel of the unit can be adjusted to compensate for phase distortion introduced in preceding video circuits. For video amplifier operation, the same control compensates for low-frequency distortion equivalent to 0.5% tilt on a 60 cps square wave. Since the video amplifier response is essentially flat, differential phase and gain adjustments are unnecessary.

Applications of the clamper amplifier include intercity video relays, studio-to-transmitter links, remote pickups, off-the-air relays, and closed-circuit television systems.

Three versions of the type B are available: the portable model, 10255, and two rack-mounted models, 10255A and 10255B.

The rack-mounted units require only $5\frac{3}{8}$ inches of vertical rack space and are $5\frac{1}{8}$ inches deep; unit

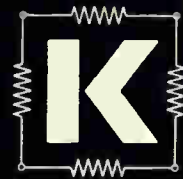

Symbol
of
Superiority

IN PRECISION WIRE-WOUND RESISTORS

- CLOSER TOLERANCES
- BETTER STABILITIES
- LOWER TEMPERATURE COEFFICIENTS
- PROVEN RELIABILITIES

HIGH RELIABILITY



Series "HRL"—Documented failure rate of .009%/1000 hours at a 60% confidence level. Further advancements in failure rates are anticipated through reliability controls and use of acceptance inspection procedures. See special Bulletin HR-04.

SUB-MINIATURE and STANDARD

Series "EP"—Available in sub-miniature types solving space and weight problems. Typical size: .125" x .125". Diameters down to .080". Standard types offer choice of over 40 sizes with resistance as low as .01 ohm. Resistance tolerances to .005%. Temperature coefficients to 1 PPM.



PRINTED CIRCUIT



Series "PC"—For mass production assembly and optimum space utilization. Available in special "high density" (rectangular) packaging and standard round configurations.

HIGH STABILITY — .003% Per Year.

Series "O"—Used where resistance matching or accurate voltage division is required over long periods of time. Heavily utilized in A to D converters, analog computers, differential voltmeters and guidance computers for military applications. Long term resistance stability of .003% maximum per year and standard TC of 10 PPM. Available in all standard physical sizes down to .187" x .375".



FAST RISE TIME



Series "RT"—Ideal in fast switching circuits. Exceptional high frequency performance with rise times in the range of 50 to 100 nanoseconds, depending on style and resistance value.

RESISTOR NETWORKS

Custom resistor, diode and capacitor combination networks. Built to meet special requirements. Used as voltage dividers, summing and integrator networks, binary resistive networks and other network applications. Ratio tolerances to .0005%. TC tracking as close as 1 PPM to military requirements.

OTHER FEATURES OF ALL KELVIN RESISTORS

- Standard leads are both weldable and solderable
- All welded internal construction
- Non inductive windings
- Vacuum encapsulated with high temperature epoxide material
- Special winding technique for assured stability

Write for complete new catalog.



KELVIN

5919 Noble Avenue, Van Nuys, Calif.
(213) 873-3430

WHICH DEFLECTION YOKE FOR YOUR DISPLAY ?

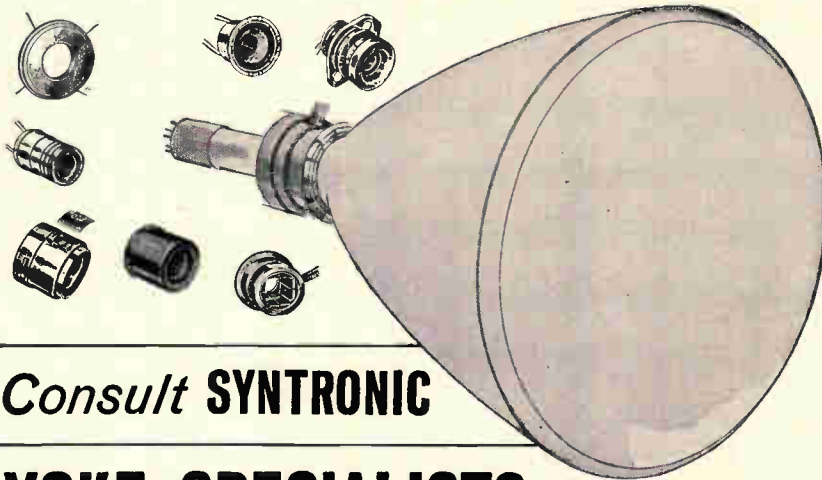

Consult **SYNTRONIC**

YOKE SPECIALISTS

Syntronic's team of experts knows more about yoke design, engineering and quality control than anyone else. A solid 10-year record of leadership—acknowledged throughout the industry. Benefit from it.

syntronic INSTRUMENTS, INC.
100 Industrial Road, Addison, Illinois
Phone: Kingswood 3-6444

Circle 162 on reader service card



Order Your Copy
Now of The
Complete 1964
Electronics Index
To Volume 37

This new 40 page index has 4 sections:

Catalogs all articles—technical features, news letter items, Electronics Review, Electronics Abroad, and Probing the News stories.

Authors index, Corporate reference index and Advertisers index.

Price is \$1.00. Send for your copy of this useful reference guide. today.

Send to: Electronics Reprint Dept., 330 W. 42nd Street New York, N. Y. 10036

Send me copie(s) of the complete 1964 index at \$1.00 each.

Name

Number & Street

City, State

Zip Code

New Microwave

weight is approximately 8 pounds. The portable model is about the same size and weight, and includes in its top cover storage for the power cord, spare fuse, coaxial plugs, and adapters for rack mounting.

Since all models include a power supply, they require only signal and line power connectors. No adjustments are necessary after initial input settings are made. All controls, signal connections and monitoring points are located on the front panel for convenience.

Total power consumption, including solid-state power supply, clamper, and video amplifier, is only 16 watts.

The clamper and amplifier sub-assemblies are built as replaceable plug-in modules in all models.

A solid-state 124-ohm-balanced to 75-ohm unbalanced input adapter is available as optional equipment.

Specifications

Gain	0 to 20 db, adjustable in 1-db steps
Output level	1 volt pp (0 dbv) nominal, 2 volts pp (+6 dbv) maximum
Impedance	Input: 75 ohms unbalanced Output: 75 ohms unbalanced; 124 ohms balanced
Input/output return loss	Greater than 26 db up to 6 Mc
Frequency response	± 1 db, from 30 cps to 6 Mc; ± 0.5 db, from 6 Mc to 10 Mc; —3.0 db, at 20 Mc
Differential phase	0.3° maximum at 3.58 Mc, 50% APL nominal output level
Differential gain	0.1 db maximum at 3.58 Mc, 50% APL nominal output level
Low-frequency rejection	Greater than 30 db at 60 cps
Power requirements	115-v a-c rms, 50/60 cps, 16 watts (220 v a-c 50/60 cps optional)
Price range	\$900—\$950
Delivery	Off the shelf
Options	Solid-state 124-ohm-balanced to 75-ohm-unbalanced input adapter D-C isolation probe

Raytheon Company, Norwood, Mass. [421]

Balanced mixers use hot-carrier diodes

A new concept in miniature balanced broadband mixers employs Schottky-barrier hot-carrier diodes.

The manufacturer says the units attain low noise, low i-f impedance, wide dynamic range and high pulse-signal inputs without danger of burnout.

Typical of the new mixers is the 1-oz. model M-5606, accommodating signal inputs from 1.8 Gc to 3.6 Gc and delivering an i-f output up to 250 Mc into a nominal 50 ohms. The input impedance is 50 ohms with a maximum voltage standing-wave ratio of 1.5. Local-oscillator input power from +5 to +20 dbm permits unusually wide dynamic range; lower input levels can be used when an external bias is provided. The noise figure is 7 db maximum, including 1.5 db i-f and image-frequency contribution. The mixer, 1 in. square and ½ in. thick, is a rugged mechanical design equipped with OSM connectors.

Melabs, 3300 Hillview Ave., Stanford Industrial Park, Palo Alto, Calif. [422]

Directional couplers cover 26 to 140 Gc

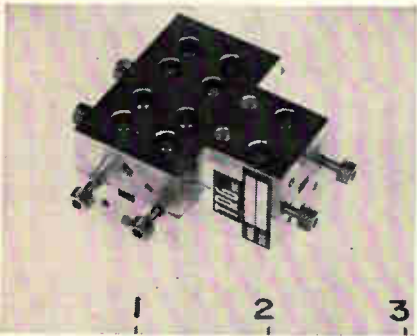

The 565 series cross-guide directional couplers are available in the 26 to 140 Gc waveguide bands. The compact units are hobbled in two halves from solid blocks of tellurium copper. A thin silver foil containing the coupling slots is clamped between the two halves to make up the complete coupler. Nominal coupling over the full waveguide bandwidth is 20 db, directivity is 10 db minimum, and main line vswr is less than 1.10. These compact couplers find wide use in systems where space is at a premium. Delivery is 30 to 60 days. Price is from \$200 to \$500 depending on frequency band.

TRG, a subsidiary of Control Data Corp., 400 Border St., East Boston, Mass., 02128. [423]

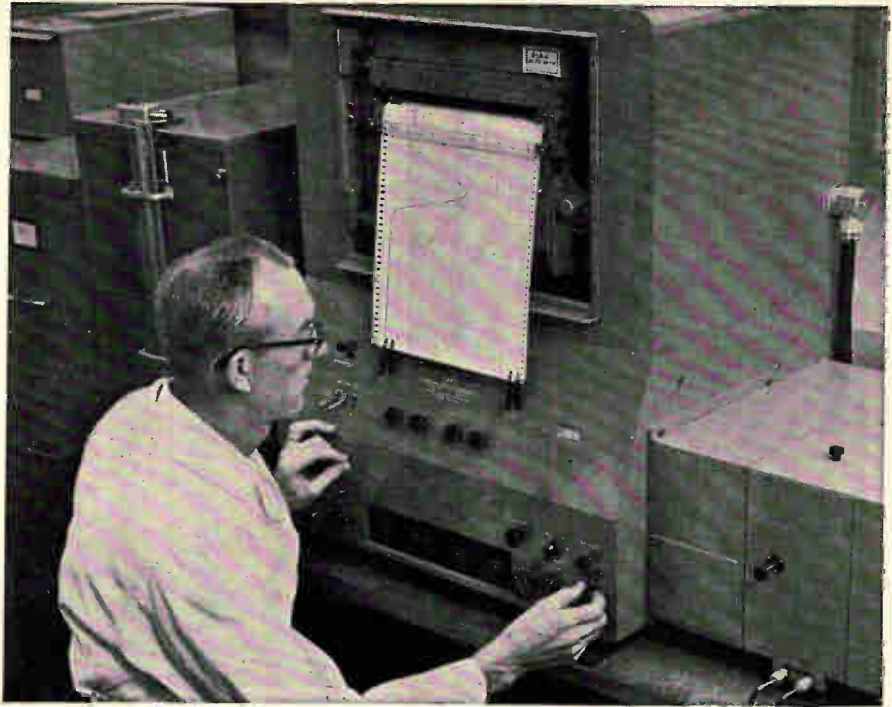

Du Pont Reagents assure you of optimum quality and uniformity while also fulfilling your needs for dependable service, safety and convenience in handling.

You Can Depend on Du Pont Reagents for QUALITY

Over 65 years' experience in manufacturing reagents (and the highest quality "crudes") has enabled Du Pont to identify and eliminate sources of contamination. Rigid quality tests are made on each lot — during manufacturing, in the analytical laboratory, and again before shipment — to meet Du Pont's

own strict standards and those of the ACS. In all, Du Pont Reagents receive 23 stringent quality checks to assure you of getting the highest possible quality and uniformity. Du Pont Reagents are available in 1 and 5 pint bottles and 6½ and 13 gallon carboys from your local Du Pont reagents distributor.

NITRIC ACID

Nitric Acid (HNO ₃)	Min. 70.0%, Max. 71.0%
Chlorides as Cl	Max. 0.000008%
Residue after Ignition	Max. 0.0002%
Heavy Metals as Pb	Max. 0.00001%
Sulfates as SO ₄	Max. 0.00008%
Iron (Fe)	Max. 0.00001%
Arsenic (As)	Max. 0.0000005%
Chromium (Cr)	Max. 0.00001%
Phosphates as PO ₄	Max. 0.00002%
Copper (Cu)	Max. 0.000005%
Nickel (Ni)	Max. 0.000005%



You Can Depend on Du Pont Reagents
...for Quality, Service and Safety

NITRIC ACID	GLACIAL ACETIC ACID
SULFURIC ACID	AMMONIUM HYDROXIDE
HYDROCHLORIC ACID	FORMIC ACID 90%

Du Pont Company, Room 2236
Wilmington, Delaware 19898

Send name of nearest Distributor Reagents Catalog Sheet
 prices.

Name _____

Title _____

Firm _____

Address _____

City _____ State _____ Zip _____



REG. U.S. PAT. OFF.

Better Things for Better Living
...through Chemistry



MICROWAVE SWITCHES VARIABLE ATTENUATORS

- 500 mc to 12.4 gc frequency range
- High Isolation
- Extremely low insertion loss

The hpa 3500 Series of Microwave Switches is ideal for such applications as ECM receiver switching and low-power antenna switching in phased arrays. Completely solid state, this single-pole, single-throw switch features a switching speed of 300 nsec open to closed, 100 nsec closed to open. As variable attenuators the hpa 3500 Series can be used for power leveling and signal modulation applications. Size is $1\frac{1}{8}'' \times 1'' \times \frac{3}{4}''$. Price: \$275.

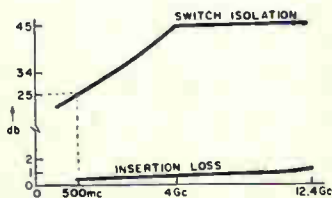

Write for more information.



hp associates
620 PAGE MILL ROAD,
PALO ALTO, CALIF. 94304,
(415) 321-8510

An Affiliate of Hewlett-Packard Co.

New Production Equipment

Photoresist: spray or spin?

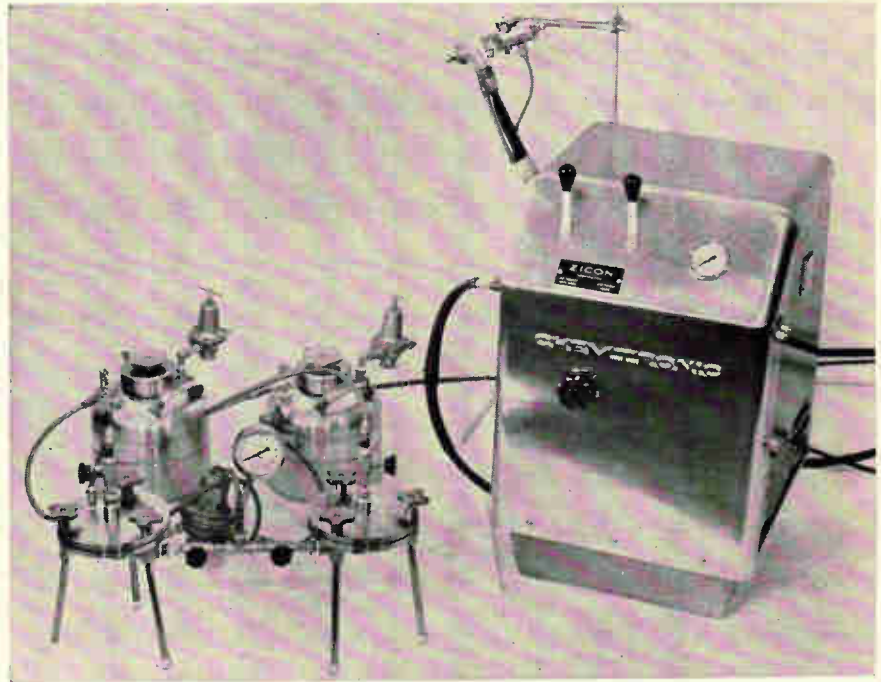

A pressurized feed unit that won't pass particles larger than $1\frac{1}{2}$ microns is being added by the Zicon Corp. to its line of Vapor Spray equipment. With it, Zicon expects to convince more manufacturers of integrated circuits, semiconductor devices and precision metal parts that they should spray photoresists.

In the past several months, Zicon has installed several spray systems for such applications, but most semiconductor manufacturers have been sticking with the long-used spinning method of applying photoresist to silicon wafers. In the electronics industry, the Vapor Spray process has been used primarily for spraying resists and encapsulants on relatively large workpieces, such as printed circuit boards.

Microcircuit production requires etching to tolerances of microns and fractions of microns. This precision demands that photoresist be applied in extremely thin layers that are uniform and free of foreign particles. The first two requirements, Zicon says, were previously met by its spray system and the third is assured by the new unit, which recleans the resist just be-

fore it is sprayed.

The unit has two parallel filter networks; one for the resist and another for solvent that cleans and purges the spray guns. Feeding pressure is supplied by compressed air or dry nitrogen. All metal parts are stainless steel. The filters, which are replaceable, have fiber glass prefilters and polyethylene final filters.

The pressurizing gas doesn't propel the resist through the spray gun. The filtered resist is atomized and propelled by a warm gas obtained by distilling an inert chemical in the spray unit. The gas has three times the molecular weight of air, allowing spray pressure to be one-third that used in air guns.

The low pressure of the spray, down to 5 pounds per square inch, enables the resist to be applied in thin layers. This promotes uniformity, yet alloys total thickness to be as low as 5,000 angstroms ($\frac{1}{2}$ micron), the company reports.

Resists applied as liquids and then thinned by spinning the workpiece aren't as uniform in thickness, Zicon claims, because centrifugal force will cause the resist to build up in front of obstructions such as

oxide steps, and surface tension will thicken it around the edge of the workpiece.

The price of the new filter-feed system is \$3,100 and delivery takes 2 to 4 weeks. The basic spray system costs \$5,588.

Specifications

Power	None (pressure feed)
Feed gas pressure	45 to 80 psi
Reservoir capacities	1 gallon each
Spray pressure	5 to 10 psi
Resist feed rate	8 ounces per minute

Zicon Corp., 63 East Sandford Blvd., Mount Vernon, N.Y. 10550 [451]

Cost-cutting furnace for crystal growing

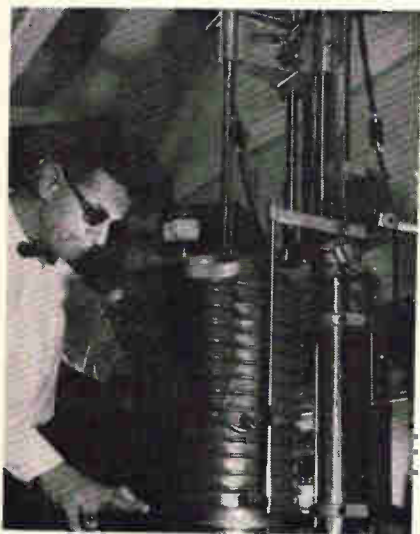

An improved new crystal growing furnace with about double the production capacity of the earlier model will reduce labor costs by about 50%, according to the manufacturer. Model NRC2805 is used to grow crystals of silicon, germanium and other materials used for transistors, diodes and as base material for microminiature circuits. Major applications are in the electronics, aerospace and chemical fields. Capacity of the NRC2805 is about 550 cu. cm, sufficient to handle a 1050-gram silicon charge. The new furnace will routinely pull silicon and other materials up to 2 in. in diameter. The unit uses the Czochralski growing method and is a resistance heated furnace. It operates under vacuum or an inert gas.

National Research Corp., 160 Charlemont St., Newton, Mass. 02161. [452]

TRYLON ROTATABLE LOG PERIODIC ANTENNA

Single-layer, horizontally polarized, for 6.5 to 32 mc. 65° azimuth beamwidth. 6 db gain/std. dipole. Power to 50 kw PEP.

**"One cannot continually disappoint a Continent."
We have designed, constructed, and installed antenna and tower systems in North America, South America, Europe, Asia, Africa, Antarctica. We wish someone from Australia would call us.**



Elverson, Pa. 19520 (215) 942-2981 — International Division, 750 Third Ave., New York, N.Y. 10017, U.S.A.

Circle 231 on reader service card

REMEMBER

RESE

for magnetic
core memories

RESE ENGINEERING INC.

A and Courtland Streets, Philadelphia, Pa. 19120. (215) GL5-9000



**BUILD
YOUR
FUTURE**

At the NCR Electronics Division, you build your career on hardware — not hope. Advanced developments like CRAM and the NCR 315 RMC Rod Memory Computer — the first commercially available computer with an all-thin-film main memory — are a marketplace reality. (And bear in mind that the NCR marketplace consists of more than 120 countries!) If you want to combine career stability with go-ahead, on-line opportunity... if you want to earn a good living while enjoying the good Southern California life... look into the opportunities on the page at the right.

NCR

ELECTRONICS DIVISION

**IN
WORLD-WIDE
BUSINESS
AUTOMATION
AT NCR,
LOS
ANGELES**

Microcircuit coatings offered in kit form

A microcircuit conductor kit, packaged for laboratory use by designers of resistor and/or capacitor networks and hybrid cermet circuits, provides separate sample containers of a ceramic dielectric coating, three ceramic conductive coatings and a slow-drying thinner. It also provides camel-hair brushes and a stainless steel microspatula.

The dielectric coating included in the kit is the company's type 4747, which was developed to insulate conductive paths, primarily using silk-screen application. In conjunction with the other coatings, it is used to form crossover conductive networks.

Two of the three conductive coatings—types 590 and 5964—

are low and high temperature silver pastes, developed to solve interconnection problems on ceramic substrates. They combine wide firing ranges with excellent adhesion solderability and high conductivity, making them suited to current-carrying and bonding use.

The third conductive coating, type 5800, is a platinum-gold paste concentrate for depositing permanent high reliability patterns on ceramic and other refractory substrates. This material has special use in hybrid microcircuitry and the manufacture of cermet and glaze components. Kits are available from stock at \$94.50.

Electro-Science Laboratories, Inc.,
1133-35 Arch St., Philadelphia, Pa.,
19107. [441]

Soldering flux has resin base

Amber-colored 471 Resin Flux is a homogenous, resin-base soldering flux designed primarily for foam and bubble fluxing applications. It has many characteristics heretofore not available, according to the manufacturer. Characteristics include superior foaming quality, extremely low evaporation, a high flash point of 160°F, and, during soldering, an action that is said to provide a surprising lack of residue.

The flux was developed especially for foam fluxing applications in a wave or dip soldering printed circuit operation. Since the non-volatile (at room temperature) vehicle employed is reported to be three to five times more stable than other foam fluxes, no thinners or additives need be added to keep solids in balance.

Upon request, samples are available at no cost. The manufacturer

offers a money-back guarantee on trial orders.

Kenco Alloy & Chemical Co., 14409 S. Western Ave., Blue Island, Ill., [442]

Blended material extends use of Teflon

Ceram-Tef (ceramic reinforced Teflon), a blend of Teflon and ceramic fibers, is a new material that extends the use of Teflon. The material is said to have superior resistance to heat distortion, cold flow and extrusion, while it retains Teflon's chemical resistance and low coefficient of friction. Ceram-Tef has many applications in the aircraft, missiles, electrical and electronic industries. It is being used, where other materials have failed, for retainer rings, sleeve bearings, socket linings, bearings, slides, cams, and high temperature electronic applications. It is available in sheets or fabricated parts. Auburn Mfg. Co., Middletown, Conn. [443]



DIGITAL SYSTEMS OPPORTUNITIES AT NCR, LOS ANGELES

ADVANCED COMPUTER DEVELOPMENT

SYSTEMS DESIGN / Senior-level positions in advanced development and preliminary design of beyond-the-state-of-the-art data processing equipment. Considerable experience required in the over-all system design and integration of commercial computing equipment. BSEE required with advanced degree highly desirable.

MEMORY DEVELOPMENT / Positions will entail analysis and design of advanced thin-film memory systems, both linear select and coincident current. Also advanced random-access development on magnetic-card and disk-file systems. Requires BSEE, with advanced degree desired.

LOGIC AND CIRCUIT DESIGN / Openings are available for design of advanced integrated-circuit computers, buffering systems, on-line computing and transmission systems, and computer peripheral equipment. BSEE and good knowledge of state-of-the-art required.

MECHANISMS DESIGN / Senior-level positions available which entail working with new techniques for development of advanced high-speed random-access memories. Work requires five years' experience in servomechanisms and BSEE or BS in physics; or considerable experience in high-speed mechanisms and BSME and MSEE or BSEE and MSME.

PRODUCT ENGINEERING

ELECTRONIC PRODUCT ENGINEERS / These positions require a BSEE degree with experience in designing digital computer equipment and in maintaining liaison with manufacturing.

PACKAGING / These positions entail layout and design of packaging for computer systems. Applicants must have previous experience with electronic computers or electromechanical devices. Background in miniaturization utilizing thin films and integrated circuits is desirable. BSEE required.

PROGRAMMING DEVELOPMENT

SOFTWARE PROGRAMMERS / Positions entail development of software for various computer input/output routines, operating systems and monitors. Applicants must have previous programming experience with machine language on a large file computer.

DESIGN AUTOMATION PROGRAMMERS / Positions require previous experience in programming for design automation, good understanding of engineering and hardware problems, and BS degree in math, engineering or related field.

ARRANGE NOW FOR AN INTERVIEW IN YOUR AREA

Confidential interviews will be held soon in various parts of the country. To arrange an appointment, please send a resume immediately, including training, experience, and salary history to Bill Holloway, Technical Placement.

The National Cash Register Company

NCR

ELECTRONICS DIVISION

2816 W. El Segundo Blvd., Hawthorne, Calif.
Telephone: Area Code 213-757-5111

An equal-opportunity employer

Careers on the move in COMPUTER TECHNOLOGY

Applied Research

Senior Scientists or engineers with MS-PhD in Physics, EE or Math-Research. Assignments in automata theory, computer organization, logic design, artificial intelligence, arithmetic techniques and advance memory systems.

Systems Development

Engineers or scientists with BS-MS in EE or Physics, experienced in digital systems design. Develop advance control computers, design memory systems, perform logic design or apply digital computers to real time control systems.

Software Development

Experienced program analysts with BS-MS-PhD in Physics, EE, or Math. Design computer languages, develop compilers, construct simulation and assembly programs, participate in development of computer machine organization.

Please send resume to:
Mr. L. P. Snodgrass



MISSILE & SPACE SYSTEMS DIVISION
2700 Ocean Park Boulevard
Santa Monica, California
An equal opportunity employer

New Books

Circuit design

Network Theory
Herbert J. Carlin and
Anthony B. Giordano
Prentice-Hall, Inc.
477 pp., \$16

The book introduces the reader to algebraic analysis and synthesis of reciprocal and nonreciprocal circuits through the use of impedance and scattering techniques.

The authors' approach to network analysis and synthesis is algebraic rather than the more difficult complex frequency domain. This allows the techniques presented to apply not only to microwave circuits and circuits with distributed parameters but to lumped element networks as well. However, the scope of the book is limited by the exclusion of variable frequency theory.

The authors employ so many special notations associated with matrices and determinants, that the book's usefulness as a reference is reduced. Indeed, the notations become so complicated that the reader must review definitions of the symbols often to understand the material.

However, this is not a serious drawback to the use of the book as a text for the junior, senior, or first-year graduate-school level student.

The coverage of frequency-independent networks and circuits that operate at a single frequency is adequate.

Matrix algebra and determinants are introduced early in the book and used throughout. All the basic rules, definitions and operations of matrix algebra are presented. Matrix algebra is used to illustrate mesh and nodal analysis of networks and also to study network transformations and equivalences. In spite of the rather complex notation and large arrays of general matrices used, the text seems relatively free of error; only two errors in signs were observed in the entire book. Some subjects, such as network reduction and network interconnection, are thoroughly treated without overwhelming matrix notation. Ideal transformers also lend themselves well to matrix algebra

and are satisfactorily covered.

The last two chapters discuss the scattering properties of networks and the theory of nonreciprocal networks. The concept of the scattering matrix is introduced and used as a tool in discussions of the gyrator and circulator. Much of the material in these two chapters has never been assembled in one place until now, although it is available (scattered throughout the technical literature).

There is a generous supply of problems at the end of each chapter, ranging in number from 20 to 50. Many are practical and serve to illustrate further use of the techniques discussed.

John G. Tatum

ITT Semiconductors
Palo Alto, Calif.

Recently published

Unified Circuit Theory in Electronics and Engineering Analysis, J.W. Head, C.G. Mayo, ILIFFE Books Ltd., 174 pp., \$6.

Roster of U.S. Government Research and Development Contracts in Aerospace and Defense, compiled by Frost & Sullivan, Inc., Bowker Associates, Inc., 801 pp., \$20.

Mathematical Analysis of Observations, B.M. Schigolev, ILIFFE Books Ltd., 350 pp., \$9.

A Select Bibliography on Semiconductor Reliability, compiled by B.J.S. Williams; a Hertis publication, Hatfield College of Technology, 56 pp.

Silicon Semiconductor Technology, W.R. Runyan, McGraw-Hill Book Co., 277 pp., \$16.50.

Programming the IBM 1620, The Hands-On Approach, Eric A. Weiss, McGraw-Hill Book Co., 310 pp., \$7.50.

Fundamentals of Electronics, Second Edition, M. Mandl, Prentice-Hall, Inc., 674 pp., \$14.60.

Chemical Physics of Semiconductors, J.P. Suchet, D. Van Nostrand Co., 197 pp., \$8.50.

Atomic and Ionic Impact Phenomena on Metal Surfaces, M. Kaminsky, Academic Press Inc., 402 pp., \$14.50.

Progress in Radio Science 1960-1963, Vol. VII Radioelectronics, edited by R. E. Burgess, American Elsevier Publishing Co., 168 pp., \$11.

Scientific and Technical Manpower Resources, National Science Foundation, 184 pp., \$1.25.

Bibliographical Series, No. 14, Uranium Carbides, Nitrides and Silicides, International Atomic Energy Agency, 174 pp., \$4.

Sourcebook on the Space Sciences, Samuel Glasstone, D. Van Nostrand Co., 937 pp., \$7.95.

EASTMAN 910® Adhesive...

bonds steel-to-phenolic-to-ceramic in minutes

In the manufacture of Motorola's lightweight Handie-Talkie radio-phones, a miniature phenolic insulator is quickly bonded to a steel chassis with one drop of EASTMAN 910 Adhesive. Another drop of this versatile adhesive is then used to secure a tiny ceramic potentiometer to the plastic. Farther along the assembly line coil forms and plastic bushings are secured in place with clear, thin EASTMAN 910 Adhesive without danger of plugging adjacent terminals or through-holes. (Bonds remain intact through 5 seconds' immersion in molten solder at 475°F.)

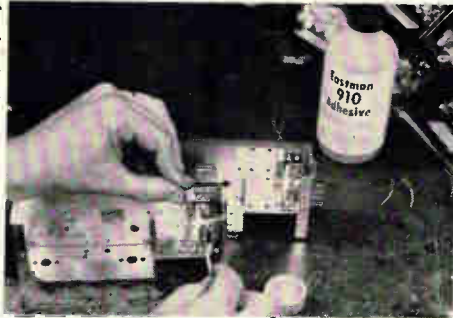

EASTMAN 910 Adhesive will form

bonds with almost any kind of material. Without heat, solvent evaporation, catalysts or more than contact pressure, this clear, thin adhesive forms strong bonds between well-mated surfaces in seconds to minutes. Try it on your toughest jobs.

For technical data write to the Chemicals Division, Eastman Chemical Products, Inc., subsidiary of Eastman Kodak Company, Kingsport, Tenn. EASTMAN 910 Adhesive is distributed by Armstrong Cork Company, Industrial Adhesives Division, Lancaster, Pa., and Loctite Corp., 705 N. Mountain Road, Newington, Conn.

Here are some of the bonds that can be made with EASTMAN 910 Adhesive

Among the stronger: *vinyls, phenolics, cellulose, polyesters, polyurethanes, nylon; steel, aluminum, brass, copper; butyl, Buna N, SBR, natural rubber, most types of neoprene; most woods.* Among the weaker: *polystyrene, polyethylene, and fluorohydrocarbon plastics* (shear strengths up to 150 lb./sq. in.).

Visit the Eastman Kodak Pavilion at the New York World's Fair



There is no adhesive like EASTMAN 910® Adhesive

SETS FAST—Makes firm bonds in seconds to minutes.
VERSATILE—Joins virtually any combination of materials.
HIGH STRENGTH—Up to 5,000 lb./in² depending on the materials being bonded.
READY TO USE—No catalyst or mixing necessary.
CURES AT ROOM TEMPERATURE—No heat required to initiate or accelerate setting.
CONTACT PRESSURE SUFFICIENT.
LOW SHRINKAGE—Virtually no shrinkage on setting as neither solvent nor heat is used.
GOES FAR—One-pound package contains about 15,000 one-drop applications. (Or in more specific terms, approximately 20 fast setting one-drop applications for a dime.)
 The use of EASTMAN 910 Adhesives is not suggested at temperatures above 175°F., or in the presence of extreme moisture for prolonged periods.

See Sweet's 1965 Product Design File 9d/Ea.

Now available! EASTMAN 910 Surface Activator
 When certain surface conditions inhibit rapid bond formation, use of EASTMAN 910 Surface Activator is recommended to restore the rapid polymerization of EASTMAN 910 Adhesive.

Circle 263 on reader service card

CROSSBAR-TYPE SELECTOR SWITCH

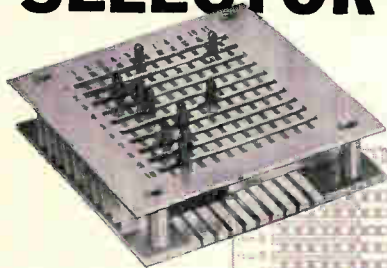

Miniature Basic C10-20A

3 amp 125 VAC or DC Current carrying only. 1 amp 15 VDC, 150 m.a./125 VAC make or break

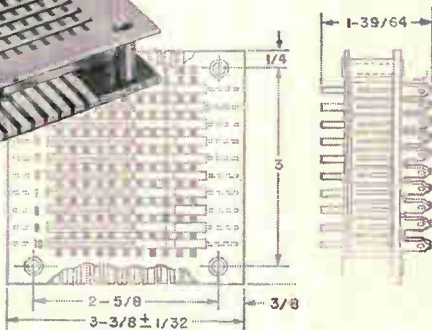

- Rapid Circuit Selection
- 100 Switching Stations



The complete snap-action switch line!

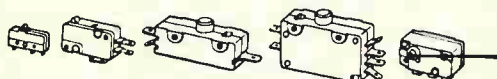

Cherry Electrical Products Corporation

P. O. Box 437 - 12 Highland Park, Ill.

IN CANADA: BARRY ELECTRIC, LTD., REXDALE, ONTARIO

Circle 264 on reader service card

Doesn't anyone make a subminiature full wave bridge rectifier with these specs?



- 200 to 1000 Volt PIV per Leg
- 5 Ampere Average Rectified Current
- Extremely Low Leakage
- No Heat Sink Required
- Subminiature Package 1" x 1" x 7/16"
- Priced as low as units with only 1/10 of the current rating

SLATER DOES!



SPECIFICATIONS NEVER BEFORE POSSIBLE IN ANY SUBMINIATURE FULL WAVE BRIDGE RECTIFIER.

Send for Catalog and Price List

SLATER ELECTRIC INC.,
Semiconductor

45 Sea Cliff Avenue • Glen Cove, N.Y.

Circle 169 on reader service card

169

NEW! and NOW!

IRRADIATED

**Polyolefin Shrinkable Tubing
PENNTUBE[†] Y**

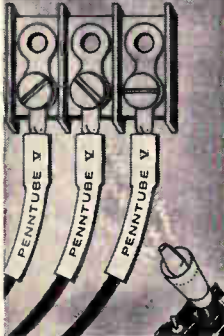

from
**PENNSYLVANIA
FLUOROCARBON
COMPANY**

2:1 shrink ratio.
Meets
all applicable
specifications.

Write for product data
sheet and free sample
NOW!



**PENNSYLVANIA
FLUOROCARBON CO., INC.**

Holley Street & Madison Ave.,
Clifton Heights, Pa.
Phone: (215) MADison 2-2300
TWX: 215-623-1577

Export Dept. Room 5710 Empire State Bldg. N.Y. 1, N.Y.

One source for:

TEFLON* TFE
Shrinkable
(Penntube-I-E)

TEFLON FEP
Shrinkable
(Penntube-IISMT)

IRRADIATED
Polyolefin Shrinkable
(Penntube Y)

*Du Pont Reg. T.M.

†Penna. Fluorocarbon Reg. T.M.

Circle 265 on reader service card

Technical Abstracts

Electro-optical navigator

Laser electro-optical navigation and guidance

R.M. Williams, General Dynamics,
Convair Div., San Diego, Calif.

Proposed military orbital missions require in-flight knowledge of vehicle attitude, position, velocity and other parameters. While a ground-based tracking complex can provide all but vehicle-attitude information, it needs many manned stations. Ground stations are limited in their area of coverage, and can track only one satellite at a time.

An electro-optical system can provide vehicle attitude, position, velocity, and other desired orbital parameters from calculations using measurements taken by on-board instrumentation. Any number of these systems can operate in orbit simultaneously, each maintaining control of its orbital parameters and with no buildup of error with time.

A study to develop design specifications for an optimum electro-optical navigation system is now underway at the Convair division of General Dynamics. In this paper, the author lists the following characteristics as desirable: autonomous automatic operation; passive operation; independence from inertial platforms reference; maximum simplicity; reliability and useful life; ability to survive extended dormant periods followed by full operation; control of orbital maneuvers and transfers; minimum size, weight, and power consumption; versatility in adapting to mission variation; and low cost. Also listed are all basic sensors which could be used effectively with an electrooptical system.

The tracking system is made up of a laser which illuminates a corner reflector, an amplitude comparison photomultiplier system for acquisition and tracking, and an interferometer five-track sensor.

Operational modes for the system are corner reflector coarse and fine acquisition, and track. Commands from a computer activate the c-w laser, insert the acquisition optics, and adjust the field stop so

that the transmitted beam as well as the receiver's field of view is 22 x 165 microradians. Two 2-inch counter-rotating nongyroscopic prisms and two 4-inch counter-rotating prisms enable transmitted beam to line-scan a 1.1 milliradian sector once each 0.05 second. Acquisition time of the target within a 1.1 milliradian area is 5.5 seconds. Corner reflector detection occurs when the received signal exceeds a predetermined threshold level. The target pip correlated with time enables the computer to determine the corner reflector's angular position at the time of detection. The computer stops the line scan, slows the corner reflector for fine acquisition, and decreases the bandwidth to 50 cps for target track.

Presented at Naecon, Dayton, Ohio,
May 10-12.

'Syblets' and syllables

Research toward a high efficiency voice communication system
Harry F. Olson, Herbert Belar, Edward S. Rogers, RCA Laboratories,
Princeton, N.J.

The analysis and synthesis of speech in terms of its fundamental elements can increase the capacity of communications channels over 1,000 times by reducing the necessary frequency bandwidth.

Statistical studies have determined the smallest recognizable particle of a spoken syllable which can be recognized by machine and from which speech can be synthesized by machine from prerecordings. This particle is called the "syblet," a contraction of "syllable." Only 550 different syblets are required to make up 1370 syllables. A thousand syblets and syllables would provide a system with the highest order of intelligibility.

If the talking rate is 100 words per minute, with an average of 1.4 syllables per word, and the vocabulary is 1,000 syllables, coded transmission can be carried out at a rate of 23 bits per second. For a signal to noise ratio of 1,000 to one, this corresponds to a bandwidth frequency of 2.3 cycles per second. The bandwidth for reasonably in-

FASTENERS FROM



NOW . . .

Widest Range of
Styles & Sizes in

WING NUTS

DIE CAST ZINC ALLOY



- Hundreds of stock sizes
- Thousands of blank and thread combinations up to 3/8"
- Exclusive recessed finger grip
- Smooth acting washer bases
- Bright Corrosion-resistant finish
- Modern, attractive appearance to help sell your product

Write, wire, phone for samples, prices.

**GRC'S NEW
INDUSTRIAL
FASTENER
CATALOG.**



World's Foremost
Producers of Small
Die Castings and
Plastic Moldings

**DIE CAST
ZINC ALLOY**



Wing Nuts



Cap Nuts



Thumb Nuts



Thumb & Wing Screws



Screws



Hex Nuts



Washers



Screw Insulators

GRIES REPRODUCER CO.
Division of Coats & Clark Inc.
151 Beechwood Ave.
New Rochelle, N.Y.
(914) NEw Rochelle 3-8600

The Hughes/NASA Syncom stands still at 6875 mph to talk to a billion people.

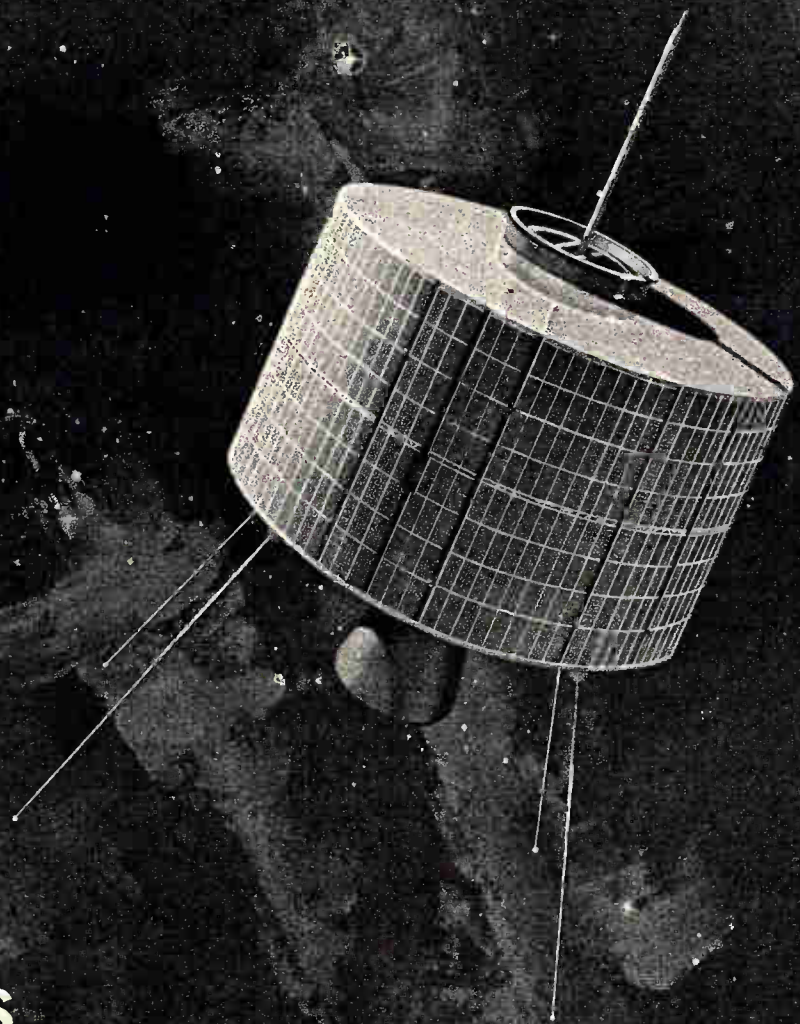
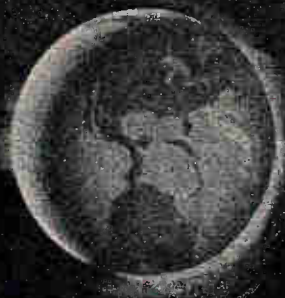

CIRCUIT DESIGNERS... is your appointment in space with Hughes?

Today, Hughes is one of the nation's most active aerospace/electronics firms: Projects include: F-111B PHOENIX Guided Missile System, TOW Anti-Tank Missile, SURVEYOR Lunar Spacecraft, SYNCOM, POLARIS, VATE, Hard Point Defense and others.

This vigor will assist the qualified engineers and scientists towards more and better opportunities for both professional and personal growth.

Many immediate openings exist. The engineers selected for these positions will be assigned to the following design tasks: the development of high power airborne radar transmitters, the design of which involves use

of the most advanced components; the design of low noise radar receivers using parametric amplifiers; solid state masers and other advanced microwave components; radar data processing circuit design, including range and speed trackers, crystal filter circuitry and a variety of display circuits; high efficiency power supplies for airborne and space electronic systems; telemetering and command circuits for space vehicles, timing, control and display circuits for the Hughes COLIDAR (Coherent Light Detection and Ranging).

If you are interested and believe that you can contribute, make your appointment today.

For immediate consideration, please airmail your resume to:

Mr. Robert A. Martin
Head of Employment
Hughes Aerospace Divisions
11940 W. Jefferson Blvd.
Culver City 35, California

Creating a new world with electronics

HUGHES

HUGHES AIRCRAFT COMPANY

AEROSPACE DIVISIONS

An equal opportunity employer.

U. S. CITIZENSHIP REQUIRED

PUT GREATER

Sale-ability
INTO
YOUR
INSTRUMENTS

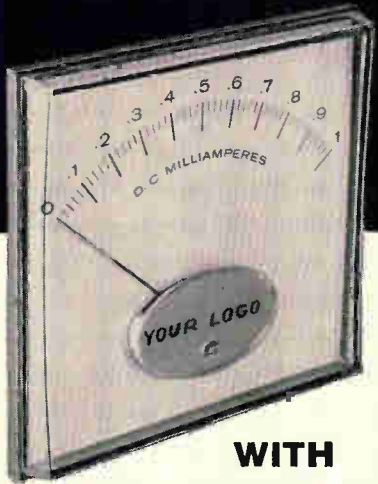

WITH
BEEDE METERS

Yes, put a Beede "Designer Line" Meter into the instruments you make and you've given your products greater *sale-ability*. Offer your line with the professionally styled appearance that speaks of quality and prestige — without increasing the cost.

Here are a few important points to remember:

- Oval escutcheons present your logo effectively
- Colored escutcheons brighten but do not overwhelm
- Clean, open faces compel attention and please the particular taste
- Concave windows reduce reflection

Send for Beede's new brochure on Scale Design which was prepared to offer you professional advice on designing dials that will take full advantage of the styling possibilities offered by the Beede forward-looking Designer Line.

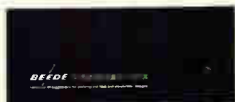

BEEDE

ELECTRICAL INSTRUMENT CO., INC.
PENACOOK, NEW HAMPSHIRE

Area Code: 603-753-6362/TWX: 603-753-4727

Technical Abstracts

telligible speech transmission is 2,500 cps.

Present equipment developed at RCA Laboratories uses 200 elements. The equipment includes normalizers to equalize a wide range of loudness and speaking rate, segmenters to divide words into syllables and syllables into syllables, spectrum analyzers to separate sounds into major categories, and detectors to recognize voiced and unvoiced sounds.

Final recognition is accomplished by the syllable and syllable recognizer. The memory of the speech synthesizer consists of a 200-track magnetic drum on which the syllables and syllables are recorded. Logic circuits store the incoming code in three stages, allocate it in the right sequence to the various tracks and reproduce the word through a loudspeaker.

Presented at the 102nd Annual Meeting of the National Academy of Sciences, Washington, D. C., April 26.

Laser at work

A practical laser interferometer for use in today's shop
J. Engeman, Airborne Instruments Laboratory, a division of Cutler Hammer, Inc., Deer Park, N.Y.

Equipment needed to calibrate industrial tools must be more accurate than the tools themselves; a rule of thumb has been that the gage must be ten times more accurate than the part it measures. For small dimensions, the common gage block has provided adequate accuracy, but large measurements require a combination of these blocks, with a resulting accumulation of their individual inaccuracies.

Although its value as a measuring instrument was apparent, the interferometer has remained almost exclusively a laboratory tool.

The laser has made the interferometer a practical tool for use in industrial shops. The type 169 laser-interferometer, manufactured by Cutler-Hammer, Inc. has three main components. A sensor unit, mounted on the stationary portion of the machine, contains the laser light source, the optics and photoelectric detectors. A reflector unit,

which normally mounts on the movable table, contains a trihedral prism (corner reflector). A control cabinet houses a forward-backward counter, digital computer, temperature and pressure compensation circuits and the visual display. Initial alignment with the machine axis is made with an auxiliary telescope on the sensor unit and a plane mirror on the reflector unit.

The helium-neon gas laser emits phase-coherent light of a wavelength at around 6328 angstroms. The light from the source is directed onto the trihedral prism, which reflects light parallel to its original direction regardless of changes in angular position of the prism, automatically compensating for the pitch, yaw and wobble of a moving table.

Some light from the prism is reflected to a reference mirror and a portion to the movable target, and then back to the prism and a detector. If the paths to the reference mirror and the target are equal in length, the beams add, since their fields are in phase when they recombine. However, if they differ by one quarter of a wavelength, the beams will arrive in phase opposition and destructive interference occurs, resulting in a reduced intensity.

Counting the number of changes from light to dark as the target moves from a zero reference to a new position determines the relative position of the target mirror in small fractions of a wavelength. A bidirectional electronic counter and a direction sensor eliminate the inaccuracies due to fringes of the beam that occur because of vibration. To eliminate another source of trouble, the reference and diagonal mirrors are all part of the same piece of optics, so that critical adjustments are unnecessary.

A digital multiplier has been incorporated to reduce the number of calculations. The visual readout and auxiliary printer display the distance directly in decimal parts of an inch. The measuring range can be extended beyond 200 inches.

Presented at the Conference on Recent Advances in Solid-State Quantum Electronics at the University of Wisconsin, Madison, May 13.

Find the manufacturer... Fast!

It's just a matter of seconds to get the valuable information you need about electronic manufacturers and suppliers in the Electronics Buyers' Guide. The EBG has over 200 pages listing the names, addresses, phone numbers and key individuals of manufacturers of electronics equipment, related components and materials. All this plus vital company statistics. At a glance you know important facts about the company, exactly what each company makes, and where to find the manufacturers' representatives in your area. No wonder the EBG is the industry's standard catalog-directory!

Electronics Buyers' Guide

A McGraw-Hill Publication

330 West 42nd Street, New York, N. Y. 10036

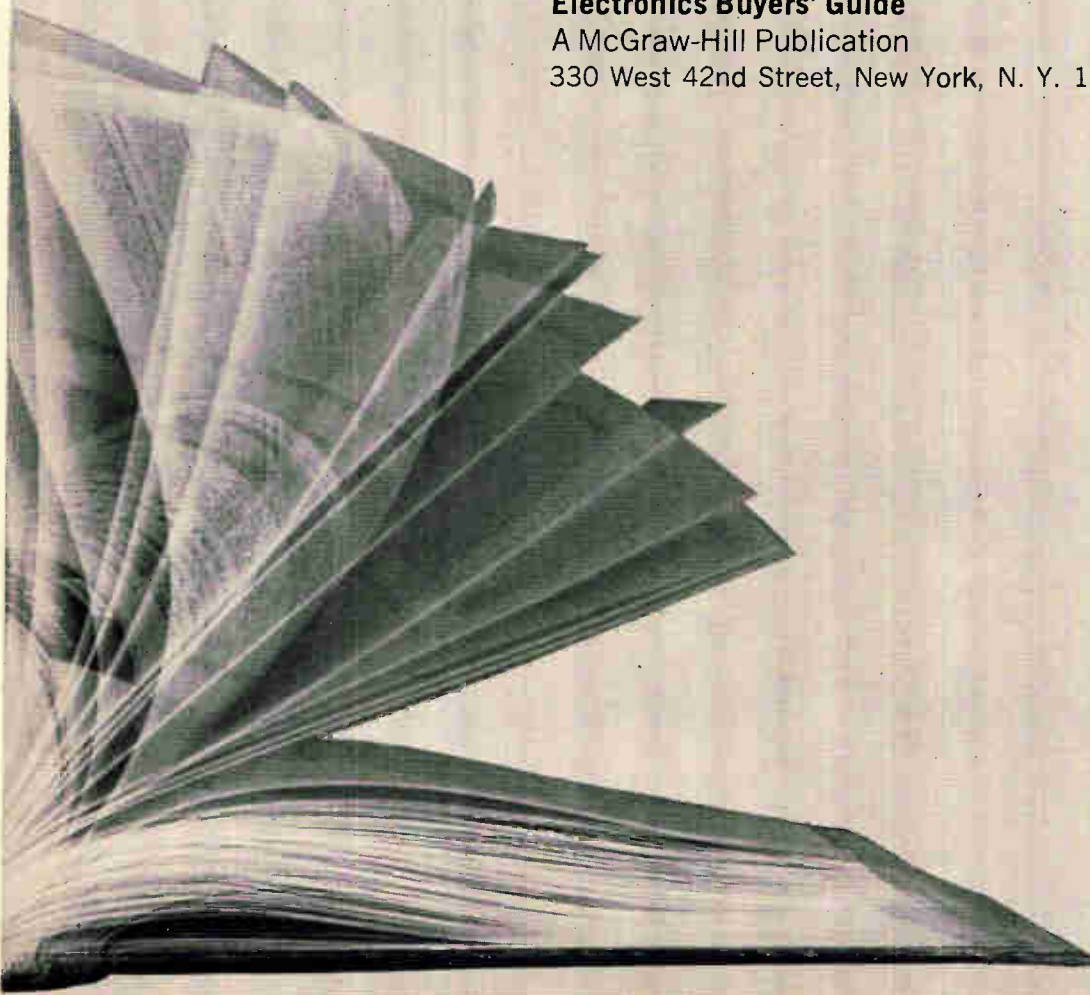

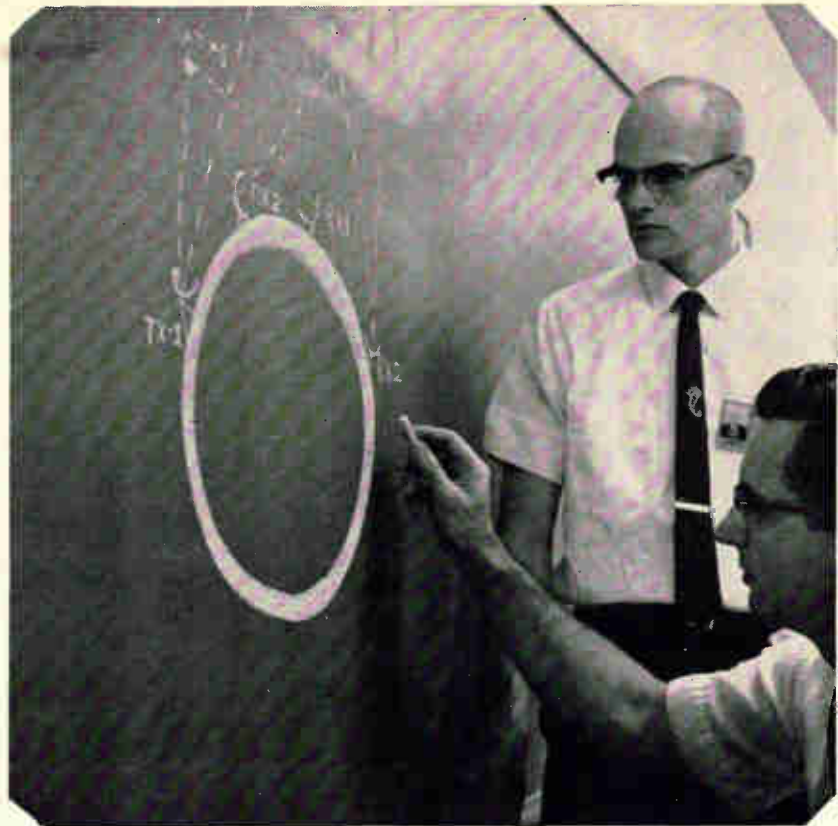

Is engineering a job... or an adventure?

The answer depends largely on where you work . . . and what you do. At Motorola we view engineering with a rare excitement, for much of the time and effort of Motorola's engineers is devoted to pushing back the horizons of knowledge in electronics. Innovating. Experimenting. Problem Solving. Creating. Pushing back frontiers. It's exciting work, rich in accomplishment and satisfaction.

And the entire climate at Motorola encourages the creative mind to grow. Your stature as an engineer is improved by the caliber of the people who surround you. Here you work with some of the most respected scientists and engineers in the entire electronics field.

They are quick to recognize and advance skill and creativity—and this is why career opportunities for good engineers are exceptional at Motorola. You can set your sights to the top—and make it.

Challenging positions now await ambitious electronic engineers in many diversified fields—2-way communications, space communications, radar, color TV, digital communications and others. Would you like to talk to us?

SYSTEMS ENGINEERS advanced R & D in radio communications systems related to Two-way, portable, mobile and radio-telephone equipment.

EQUIPMENT DESIGN high performance solid state receivers, transmitters, and data processing equipment for radar, communications, command and control, tracking and telemetry.

FAMILIARITY WITH STATE-OF-THE-ART statistical communications theory, advanced signal processing techniques, solid state r.f. techniques, ultra-reliability, antenna systems, advanced structural and thermal designs.

SECTION MANAGER direct engineers and support personnel in state-of-the-art communications, including r.f. systems and input-output devices.

CHIEF ENGINEER technical management of R & D group in advanced technology related to solid state r.f. communications.

CIRCUIT DESIGN ENGINEERS advanced R & D in receivers, transmitters, RF, digital, Color TV and automotive electronics.

DEVELOPMENT ENGINEERS advanced communications products in consumer, industrial and military electronics.

Excellent opportunities also available in Phoenix, Ariz.

Mr. W. H. HAUSMANN, Engineering Personnel Mgr., Dept. E, 4545 Augusta Blvd., Chicago 51, Illinois

An equal opportunity employer.



MOTOROLA inc.

COMPUTER LOGIC DESIGNERS

When it comes to space, UNIVAC systems are way out there.

Our Data Buffer Memory System in Mariner is now on its 350 million mile journey to Mars. This sophisticated little package weighs only 21 ounces. It contains two memories with 1320 data bits of storage per memory. Its job is to record and store what is "seen" by Mariner's TV cameras and make it available for subsequent radio transmission back to earth.

This system is just one example of UNIVAC-St. Paul's systems engineering and production proficiency in space and defense work. We are, in fact, more involved in this area than any other computer company.

For our staff—and for our computer logic designers in particular—this means constantly working with new techniques and devices on the edge of today's technological revolution spurred by the conquest of space. Our lab work right now is deeply involved with new connections and packaging techniques that go a long way to solve the systems problems of nanosecond logic circuits . . . new evaporated circuitry operating on low drive currents . . . techniques in overcoming radiation effects in space computer systems . . . real time data links . . . ground support and test recording devices.

Opportunities are open to logic designers whose pioneering spirit and technical knowledge matches our own. Assignments require a BS or MS degree to perform logical design of high speed digital equipment using solid state circuitry and the logical design of systems taking into account the interfaces between the central computer and its input-output equipment.

If you qualify, send a resume to Mr. R. K. Patterson, Employment Manager, Dept. G-17, UNIVAC Division of Sperry Rand Corp., Univac Park, St. Paul, Minn. 55116. An equal opportunity employer.

UNIVAC
DIVISION OF SPERRY RAND CORPORATION

THOUGHTS ON
CREATIVE PIONEERING

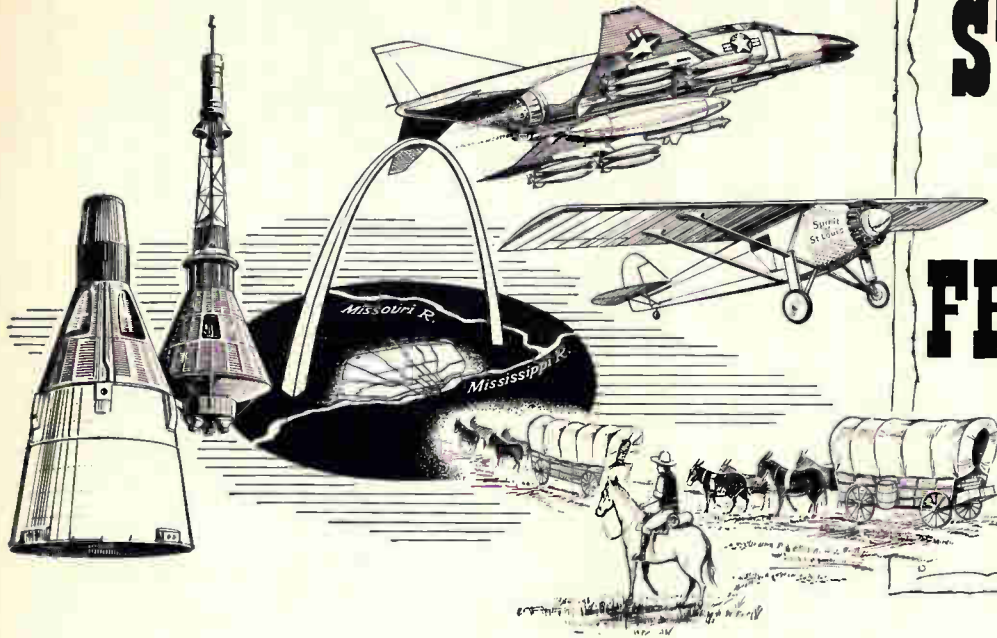

**ST. LOUIS
THE
FRONTIER
CITY**

When St. Louis was founded at the confluence of the great Missouri and Mississippi Rivers in 1764, the only thing certain about the future of this frontier trading post was that it abounded with opportunity. There was challenge, there were dangers, but there was opportunity for a man with the ambition and energy to *work his way to the top*.

For 200 years, St. Louis has stimulated men with energy and ambition to be individually resourceful, to create new concepts that have altered and improved man's existence. The Creative Pioneers who have populated St. Louis for two centuries have made this the only city on Earth honored in history for its Spirit.

Frontier opportunity still abounds in St. Louis. No longer is the challenge geographic; the frontier is now scientific. It is in the laboratories and on the engineering tables at McDonnell. Here a man with ambition and energy joins men of experience, men who opened an era in Naval Aviation and who laid the lines for the world's fastest jet fighter, the versatile Phantom II. Here are the men who designed and built the Mercury Spacecraft and who have already progressed far with their second project in manned orbital flight, Gemini.

In these programs, McDonnell Electronic Systems Engineers hold key roles. They are urged to break away from time honored patterns and tradition-bound concepts

to meet the challenges of space and speed and survival. Ideas and suggested solutions are encouraged and activated by a management intent on progress.

While the systems under active development virtually blanket the electronic spectrum, engineers enjoy the advantage of clearly defined and supported corporate objectives that lead projects out of the laboratories and into application. Well-equipped engineering and manufacturing facilities combined with continued corporate reinvestment aimed at technological growth provide the environment necessary for personal advancement. Current requirements are for electronic engineers capable of systems planning, simulation and integration for aircraft, spacecraft and missiles as well as advanced technological contributions in the fields of plasma physics, information theory, laser technology and microwave techniques. Openings at all levels exist in the fields of Guidance & Control, Space Communications, Radar & Electro-Optics, Plasma Physics, Reconnaissance Sensors, ECM & Electronic Warfare, and System Integration & Testing.

MCDONNELL An Equal Opportunity Employer.

Mail This Form To: W. R. Wardle, McDonnell Employment, Dept. V-712, Box 516, St. Louis, Mo., 63166

Name _____ Home Address _____
 City & State _____ Phone _____ Age _____
 Education: BS _____ MS _____ Ph D _____ Major Field: _____
 Date _____ Date _____ Date _____
 Primary Experience Area: _____ Present Position: _____
 _____ Number of Years _____ I would like to receive application form



A PLANS FOR PROGRESS COMPANY AND AN EQUAL OPPORTUNITY EMPLOYER

CIRCLE 951 ON READER SERVICE CARD



Engineering career opportunities

**Tie your career
to the world's
most advanced
radar/sonar
systems...
at G.E.!**

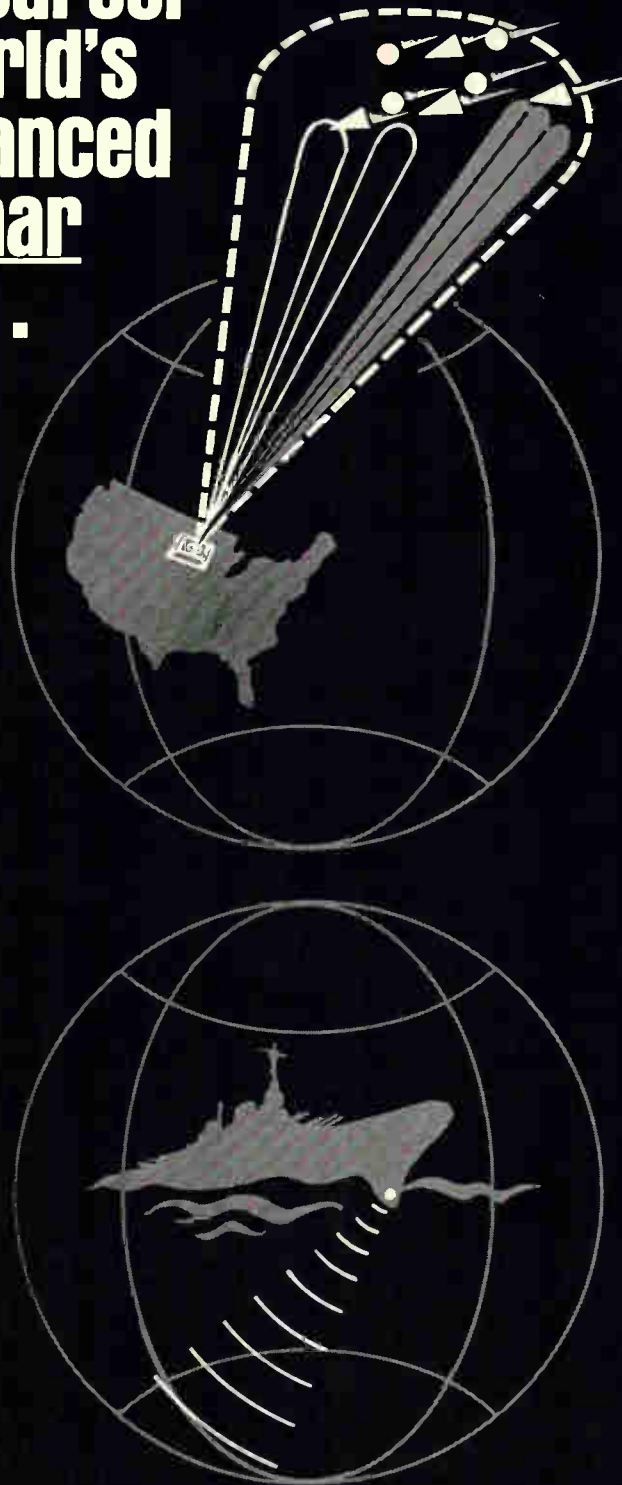

**Investigate your career now
in missile-defense radar; ad-
vanced sonar engineering at
General Electric.**

G.E.'s Heavy Military Electronics Dept.—whose capabilities include the design, development and fabrication of the world's largest and most advanced ASW and radar systems—announces long-term career openings for continuing contributions to large military contracts.

HMED offers you stability based on its broad capability for handling large programs and the experience that goes with front-rank performance on this decade's most advanced projects. Your growth is tied to that of a lean, highly professional engineering group backed by top-flight facilities—both within HMED and throughout General Electric.

At G.E., you'll be treated as a professional who's expected to handle well-defined, delegated responsibilities. In most instances you'll deal directly with your customer's organization.

You will be given every opportunity to develop yourself professionally through continuing Company-taught courses and advanced tuition-paid study at nearby Syracuse University. And, in the course of your work, you have access to information developed by other G.E. facilities throughout the country.

**WHY NOT MATCH YOUR EXPERIENCE A
CAREER DESIRES AGAINST THESE REQUI-
REMENTS?**

SONAR: Advanced Sonar Engineers; Array Beamformer and Signal Processing Development Engineers; Digital Logic Engineer; Sonar Solid-state Circuit Design; Transducer Development; Solid-state Transmitter Development; Pattern Recognition Analysis; Adaptive Filtering Research; Display Development; Propagation Analysis; Sonar Subsystem Development.

RADAR: Monitor and Control Analysis Engineers; Digital Control Equipment Engineers; Microwave Component Design Engineers; Consultant, Circuit Design and Development; Instrumentation Circuit Engineers; Modules for Signal Processing; Consultation for Radar Subsystem Requirements.

INVESTIGATE NOW! For full information, send a resume of your experience in confidence to J. L. Wolf, Professional Placement, Heavy Military Electronics Dept., Section T-1, General Electric Co., Court St., Syracuse, New York.

177

An Equal Opportunity Employer

GENERAL  ELECTRIC

Save this page until the daily routine finally gets you down



Then let's talk. We have no routine projects at Sylvania/Mountain View.

Our engineers work on one-of-a-kind problems. Originals. So we need original solutions. No re-treads.

We need EE's with six to ten years' experience, and preferably an advanced degree or two, who want some tough design problems for a change, and who really want to go to work for a change. Also, beginners with good backgrounds shouldn't shrink away.

What kind of work? See openings at right for a starter. (But the list is only partial for the work we do in electronic warfare, including intelligence systems, electronic countermeasure systems, reconnaissance and anti-intrusion systems.)

We have a few things to offer besides problems: Our engineers know the satisfaction of seeing a project through from software to hardware. But not beyond. Once it goes into production, they go on to something else.

Mountain View is 40 minutes south of civilized San Francisco (and a good 400 miles away from Los Angeles). For educational advancement, Stanford and other promi-

nent universities are located nearby.

Maybe most important, we offer you the chance to test your mettle. If you'd like more specific information about the work you might do at Sylvania/Mountain View, send a resumé to Manager—Professional Staffing, P. O. Box 188EL, Sylvania Electronic Systems—West, Mountain View, California.

He'll see that you get a prompt, frank (and confidential) reply.

Take another look at the picture. Look like anybody you know?

Strategic and Tactical Signal Intelligence

Formulate systems concepts for both airborne and ground-based signal intelligence gathering systems. Develop and evaluate systems designs and participate in final evaluation and check out of the operational system.

Geophysics

Study geophysical propagation of acoustical and electromagnetic energy and develop new systems concepts for electromagnetic reconnaissance systems.

Systems Vulnerability

Perform investigations to determine the vulnerability of weapon systems complexes and their associated sub-systems. These sub-systems include communication, surveillance and target acquisition systems, navigation and guidance, and fusing. These vulnerability investiga-

tions consider weapon systems vulnerability to both electronic and physical countermeasures taking into account the likely employment and deployment of these weapons in realistic military tactical environments.

Operations Research

Perform operational analyses of electronic systems including communications by analytical, computer and gaming methods, in such areas as feasibility of electronic warfare concepts, effectiveness and cost-effectiveness of EW systems, threat analysis, analysis of arms control inspection techniques and electronic and physical vulnerability.

Arms Control

Analysis of strategic and tactical arms control problems in aerospace and local situations including inspection and verification criteria.

Electronic Warfare Systems Concepts

Develop and evaluate electronic warfare systems. These systems development efforts are closely associated with the systems vulnerability investigations. They involve synthesis of systems concepts including not only the description of overall technical characteristics but also concepts for their employment and deployment in tactical environments.

Electronic Warfare Design

Develop and evaluate electronic countermeasure techniques and formulate systems concepts: develop state-of-the-art designs for enhancing Army, Navy and Air Force electronic warfare capabilities.

GT&E

GENERAL TELEPHONE & ELECTRONICS
Total Communications from a single source through

SYLVANIA ELECTRONIC SYSTEMS

An Equal Opportunity Employer

EE's: Submarines = EE's: Space Stations

And that's pretty important.

When you consider that a nuclear submarine is, in effect, a manned "inner space" station, you get some idea of the great volume and variety of electrical and electronic equipment required.

For instance, it carries all of the electrical equipment necessary to generate light, heat and power 24 hours every day for months. It is equipped with ECM, and it is capable of firing Polaris missiles from upon or beneath the sea... involving almost every type of advanced electronic equipment and controls. Its nuclear power plant and its steering and diving devices are controlled by contributions from the electrical/electronic engineer.

The Engineers who work at Electric Boat enjoy this variety — and the opportunity of working closely with men from other disciplines.

Interested?

CHOOSE YOUR ASSIGNMENT AT ELECTRIC BOAT

1. Conceptual and detailed system design performance testing, etc. of electric propulsion systems OR electrical distribution systems, requiring understanding of AC & DC generators and electric motors, and means for their control, regulation and protection.
2. To analyze radar, ECM, sonar or radio circuitry, and design necessary modifications to make systems interfaces compatible.
3. Responsible for instrumentation and monitoring systems associated with a nuclear power plant. Requires knowledge of reactor plant temperature and pressure instrumentation, reactor plant control, reactor nuclear instrumentation.
4. To develop and conduct test programs to reveal characteristics of both AC and DC electric motors cycled over wide ranges of temperature and pressure.
5. Design of reactor plant electrical systems including determination of system requirements, system and component sizing, electrical and load analysis, requiring knowledge of nuclear power plant electrical systems

For further details, send an outline of your background and salary requirements to Mr. Peter Carpenter. U.S. citizenship is required.

GENERAL DYNAMICS

Electric Boat Division

128 Eastern Point Road, Groton, Connecticut
(on the shore near New London)

An Equal Opportunity Employer

PINPOINT *your* **RECRUITMENT ADVERTISING**

to the Engineers
and Technical
Management men
in the
Electronics
Industry . . .

When you need Engineers—remember this fact: **Electronics** serves thousands of engineers with the latest engineering developments and news of the electronics industry. Engineers read **Electronics** because its high calibre editorial content is *especially designed for them* . . . that's why your Employment advertising in **Electronics** can pinpoint a most concentrated source of experienced engineers. Your **MOST DIRECT LINK** to these qualified men is in the **EMPLOYMENT OPPORTUNITIES** section. For more facts, of placement of your ad,

For Rates and Information Write:

Electronics

A McGraw-Hill Publication
Classified Advertising
Division

P.O. Box 12, New York
10036

It's Time To Be Your Own BOSS ... Time to TRIPLE Your Income!

Aamco, The World's Largest Transmission Specialists, seeks men with foresight and ambition. Here's a golden opportunity to blend your ability and Aamco's vast experience into your own successful business. Aamco now has 165 franchised shops coast to coast, will have a total of 270 by the end of 1965. Aamco shops average gross is \$100,000 per year, and the best shops gross over \$250,000. Aamco trains you in the latest management and merchandising techniques, provides the promotional backing to assure your success. Growth-potential unlimited... no automotive experience necessary. Modest, partly financeable investment of \$12,500 to \$23,500, depending on territory. Please furnish complete personal details. Write or telephone

AAMCO TRANSMISSIONS

4500 N. Front St., Philadelphia, Pa.
(215) GL 5-5411



E. E.'s
for FEE-PAID Positions
WRITE US FIRST!
Use our confidential application for professional, individualized service... a complete national technical employment agency.
ATOMIC PERSONNEL, INC.
Suite 1207L, 1518 Walnut St., Phila. 2, Pa.

ADDRESS BOX NO. REPLIES TO: Box No. Classified Adv. Div. of this publication. Send to office nearest you.
NEW YORK, N. Y. 10036: P. O. Box 12
CHICAGO, Ill. 60611: 645 N. Michigan Ave.
SAN FRANCISCO, Cal. 94111: 255 California St.

POSITION VACANT

Leading European Manufacturer of Digital Modules, Subassemblies Counters, Nixie drivers, operational amplifiers, DVM's and A-D converters is looking for dynamic responsible sales engineer to run its U. S. operation. Several years lab or production experience required in digital in addition to minimum 3 years successful sales experience same field. Knowledge of European language not required. This man will directly report to our European top management. Send full resume to: P-6915, Electronics.

SELLING OPPORTUNITY WANTED

Do you need high grade sales representation to the large volume O.E.M. firms in the Chicago market? We provide sales and application engineering to the electronic and mechanical manufacturers. Write to: RA-6310, Electronics.

SPECIAL SERVICES

Nameplates, Decals, Hard-Hat Labels, Tool checks. Signs of all kinds. Free catalog. Seton Corp., Dept. Elec, New Haven 15, Conn.

Your Inquiries to Advertisers Will Have Special Value . . .

—for you—the advertiser
—and the publisher, if you mention this publication. Advertisers value highly this evidence of the publication you read. Satisfied advertisers enable the publishers to secure more advertisers and—more advertisers mean more information on more products or better service—more value—to YOU.

ELECTRONICS OPPORTUNITIES AT ALL LEVELS

3 Senior Engineers 2 Design Engineers
2 Intermediate Engineers 1 Junior Engineer
1 Senior Technician

We need men with experience in TV tuners or UHF-VHF front end design and development or related work. Prefer graduate EE's for the higher job levels, but will consider equivalent experience.

Excellent professional and residential environment in Chicago suburban location. Full range of Fringe Benefits including Tuition Refund program. Salaries open; submit resume in confidence, including salary, to:

Mr. HAROLD WOLD, Personnel Manager

Oak Manufacturing Co.
Division of Oak Electro/Netics Corp.
Dept. E, Crystal Lake, Illinois 60014

Equal opportunity employer.



OAK MANUFACTURING CO.

A DIVISION OF OAK ELECTRO/NETICS CORP.



SEARCHLIGHT SECTION

• CLASSIFIED ADVERTISING • BUSINESS OPPORTUNITIES
• USED OR SURPLUS EQUIPMENT

Why Do You Read So Slowly?

A noted publisher in Chicago reports there is a simple technique of rapid reading which should enable you to double your reading speed and yet retain much more. Most people do not realize how much they could increase their pleasure, success and income by reading faster and more accurately.

To acquaint the readers of this publication with the easy-to-follow rules for developing rapid reading skill, the company has printed full details of its interesting self-training method in a new book, "Adventures in Reading Improvement" mailed free to any one who requests it. No obligations. Simply send your request to: Reading, 835 Diversey Pkwy., Dept. 186B, Chicago, Ill. 60614. A postcard will do.

CIRCLE 952 ON READER SERVICE CARD

SMALL AD but BIG STOCK

of choice test equipment
and surplus electronics
Higher Quality—Lower Costs
Get our advice on your problem

ENGINEERING ASSOCIATES
434 Patterson Road — Dayton 19, Ohio

CIRCLE 954 ON READER SERVICE CARD

"SEARCHLIGHT" IS

Opportunity Advertising

—to help you get what you want—to help you sell what you no longer need.

Take Advantage Of It

For Every Business Want
"THINK SEARCHLIGHT FIRST"

SYNCHROS • GENERATORS INVERTORS • SERVOS

23TR6 Torque Receiver	\$32.50
23TX6 Torque Transmitter	32.50
23CX6 Control Transmitter	32.50
1 F Motor 115/90 V. 60 Cy	24.95
1 G Generator 115 V. 60 Cy	24.95
1 HDG Differential Gen	24.95
5 G Navy Ord. Size 115 V. 60 Cy.	24.95
5 F Navy Ord. Size 115 V. 60 Cy.	24.95
6 G Navy Ord. Size 115 V. 60 Cy.	29.50
7 G Navy Ord. Size 115 V. 60 Cy.	39.50
Bendix Invertor E-1617-1, 24V. Input, 115V. 400 Cy. 3 Ph. s50 V.A. Output	25.00
Jack-Heintz Invertor E-1617-1, 24V. Input Output 115/230 V. 1/3 Ph. 400 Cy. 2250 V.A.	75.00
General Electric E-1823- 120/208 V. 400 Cy. Generator 60 KVA	250.00
Jack-Heintz Invertor E-1725-1 24V. Input, Output 115/230 V. 1/3 Ph. 400 Cy. 2250 V.A.	75.00
Westinghouse, Generator 120/208 V. 3 Ph. 400 Cy.	75.00
Pioneer Instrument Invertor 12123-1A Input 24 V. Output 115 V. 3 Ph. 400 Cy.	25.00
Elinco Generator PM2	18.95
Deihl FPE49-7 Servo Motor & Tach.	29.95
Deihl PM Motor 27.5 VDC	4.95

AC MOTORS • DC MOTORS
FANS-BLOWERS • RESOLVERS
GEARED MOTORS • ACTUATORS
LARGE STOCK OF ROTATING DEVICES

All Items F.O.B. Oakland

Send for Free Catalog

(On Company Letterhead, Please)

ELECTRO GADGET SUPPLY
Doolittle & Langley Streets
Oakland Airport Oakland, Calif.
Phone 562-6641

CIRCLE 958 ON READER SERVICE CARD

ELECTRON TUBES

KLYSTRONS • ATR & TR • MAGNETRONS
SUBMINIATURES • C.R.T. • T.W.T. • 5000-6000 SERIES

• SEND FOR NEW CATALOG A2 •

A & A ELECTRONICS CORP.
1063 PERRY ANNEX
WHITTIER, CALIF.
696-7544

CIRCLE 953 ON READER SERVICE CARD

AUTOTRACK ANTENNA MOUNT

360 degree azimuth, 210 degree elevation sweep with better than 1 mil. accuracy. Missile velocity acceleration and slewing rates. Amplidyne and servo control. Will handle up to 20 ft. dish. Supplied complete with control chassis. In stock—immediate delivery. Used world over by NASA, USAF. TYPE MP-61 B. SCR-584. NIKE AJAX mounts also in stock plus several airborne trackers.

SCR 584 AUTOMATIC TRACKING RADARS

Our 584s in like new condition, ready to go, and in stock for immediate delivery. Ideal for telemetry research and development, missile tracking, satellite tracking, balloon tracking. Used on Atlantic Missile Range, Pacific Missile Range, N.A.S.A., Wallops Island, A.B.M.A. Write us. Fully Desc. MIT Rad. Lab. Series, Vol. 1, pps. 207-210, 228, 284-286. Compl. Inst. Pk. avail. \$25.00 each.

AN/GPG-1 SKYSWEEP TRACKER

3 cm. automatic tracking radar system. Complete package with indicator system. Full target acquisition and automatic tracking. Input 115 volts 60 cycle. New. In stock for immediate delivery. Entire System 6' long, 3' wide, 10" high. Ideal for Infrared Tracker, Drone Tracker, Missile, Tracker, R. & D.

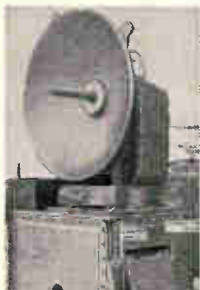

PULSE MODULATORS

MIT MODEL 9 PULSER

1 MEGAWATT—HARD TUBE

Output 25 kv 40 amp. Duty cycle, .002. Pulse lengths .25 to 2 microsec. Also .5 to 5 microsec, and .1 to .5 microsec. Uses 6C21. Input 115v 60 cycle AC. Mfr. GE. Complete with driver and high voltage power supply. Ref: MIT Rad. Lab. Series, Vol. 5, pps. 152-160.

2 MEGAWATT PULSER

Output 30 kv at 70 amp. Duty cycle .001. Rep rates: 1 microsec 600 pps. 1 or 2 msec 300 pps. Uses 5948 hydrogen thyratron. Input 120/208 VAC 60 cycle. Mfr. GE. Complete with high voltage power supply.

MIT MODEL 3 PULSER

Output: 144 kw (12 kv at 12 amp.) Duty ratio: .001 max. Pulse duration: .5, 1 and 2 microsec. Input: 115 v 400 to 2000 cps and 24 vdc. \$325 ea. Full desc. Vol. 5, MIT Rad. Lab. series, pg. 140.

250KW HARD TUBE PULSER

Output 16 kv 16 amp. duty cycle .002. Pulses can be coded. Uses 5D21, 715C or 4PR60A. Input 115 v 60 cycle ac. incl. H.V. pwr supply \$1200 ea.

5949 THYRATRON AGING RACK

Compl. Chatham Electronics Console incl. 15 kv power supply & PFN's. \$1800.

MICROWAVE SYSTEMS

E-4 FIRE CONTROL SYSTEM

Hughes Aircraft X Band. Complete. In stock.

C-BAND RADAR

250 KW output. C-band, PPI indicator, 5C22 thyratron modulator. Antenna hi gain parabolic section. Input 115 volts 60 cycle AC, complete \$2750.00.

300 TO 2400MC RF PKG.

300 to 2400 MC CW. Tuneable. Transmitter 10 to 30 Watts. Output. As new \$475.

500KW "L" BAND RADAR

500 kw 1220-1359 mcs. 160 nautical mile search range P.P.I. and A Scopes. MTI. thyratron mod. 5J26 magnetron. Complete system.

PHILCO MICROWAVE LINKS

C Band Microwave Link terminal bays and repeater bays in stock. New \$1500 each or \$2500 per pr.

100—800MC. CW SOURCE

150 watts CW nominal output 115 V 60 Cy AC input. \$1600.

100KW 3CM. RADAR

Complete 100 kw output airborne system with AMTI, 5C22 thyr. mod. 4J52 magnetron, PPI. 360 deg az sweep, 60 deg. elev. sweep, gyro stabilizer, hi-gain revr. Complete with all plugs and cables.

M-33 AUTO-TRACK RADAR SYSTEM

X band with plotting board, automatic range tracking, etc. Complete with 1 megawatt acq. radar.

INFRARED SOURCES

Collimated radiation simulator and transistorized temp. controller. Temp. range, 200-600 degree C. Absolute Accuracy ±3 degree C. Type AN/USM. \$1975 New.

3KW RCA PHONE & TELEG XMTR

2—30 MC. 10 Autotone channels plus MO. Input 220 vac. 50/60 cycles.

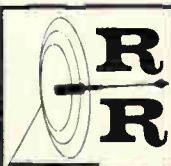

Radio-Research Instrument Co.
850 5th Ave. New York 36, N.Y.
Tel. JUdson 6-4891

CIRCLE 955 ON READER SERVICE CARD

TYPE 5-IN PLUG IN RELAYS

Now available to our customers are standard sockets and dust covers which convert our Type 5 relays to plug-in units. Known as the Type 5-IN these relays have specially staggered lugs for accommodation in standard -IN sockets. This eliminates the cost of plug-in wiring.

-IN sockets are available in two types as listed below. In ordering specify that the relays are to be used with -IN sockets.



SOCKETS

Stk. #	Coil	Terminals		Each	
		Cont.	Total	1-9	10-19
SO18	4	12	16	1.19	.85
SO20	4	24	28	1.47	1.05

DUST COVERS

Stk. #	Dimensions	Each	
		1-9	10-19
CR49	1 3/4" x 1 1/4" x 2 5/8" for 16 term.	.42	.30
CR50	1 3/4" x 1 3/4" x 2 5/8" for 28 term.	.69	.49

OVER 2,000,000 RELAYS OF 20,000 DIFFERENT TYPES IN STOCK!

Today, when relay problems develop, shrewd engineers and buyers think first of UNIVERSAL RELAY. They know that at Universal... dependable, quick service is a habit. Your average order is shipped within 48 hours. Should you require special testing, assembly or adjustments, our modern facilities are equipped to ship within a week to ten days.

Our 60-page illustrated catalog #E is yours for the asking.

"Satisfaction is on the other end of your telephone"

Universal RELAY CORP.
42 WHITE ST., NEW YORK 13, N. Y. • WALKER 5-6900

CIRCLE 956 ON READER SERVICE CARD

"SEARCHLIGHT" is Opportunity Advertising . . .

1—to help you sell what you no longer need.

1—to help you find what you want.

For every business want THINK "SEARCHLIGHT" FIRST



FREE CATALOG!
NEARLY 4,000 BUYS
FOR INDUSTRY

OPTICS! SCIENCE! MATH!
GIANT 148 PAGES

Many on-the-job helps . . . Quality Control Aids! Write for this completely new, 1965 Catalog. New items, new categories, new illustrations. 148 easy-to-read pages packed with hundreds of charts, diagrams, illustrations. A treasure-house of optical and scientific information . . . unusual bargains galore. Optics for industry, research labs, design engineers, experimenters, hobbyists! Instruments for checking, measuring—to speed work, improve quality, cut production costs. We give you facts: what it is—how it works—where it's used!

COMPARATORS, MAGNIFIERS, MICROSCOPES

Hard-to-get war surplus bargains—ingenious scientific tools—imported—domestic. Thousands of components: lenses, prisms, wedges, mirrors, mounts—accessories of all descriptions. Dozens of instruments: magnifiers, stereo microscopes, telescopes, binoculars, infrared equipment, photo attachments. Shop by mail. No salesman will call. Use the Catalog of America's greatest Optics—Science—Math Mart. Known for reliability. Mail coupon below for catalog "EX". No obligation.
EDMUND SCIENTIFIC CO.
Barrington, N. J.

MAIL COUPON FOR FREE CATALOG "EX"

EDMUND SCIENTIFIC CO., Barrington, N. J.
Please send FREE Giant 148-page Catalog "EX"
NAME
ADDRESS
CITY ZONE STATE

CIRCLE 957 ON READER SERVICE CARD

New Literature

Differential amplifier. Consolidated Electrodynamics Corp., 360 Sierra Madre Villa, Pasadena, Calif. Bulletin 1364 describes a d-c differential amplifier that amplifies millivolt source signals to the level of 5-v output signals. Circle 461 on reader service card

Infrared spectrophotometer. Beckman Instruments, Inc., 2500 Harbor Blvd., Fullerton, Calif., offers bulletin 7073 on an infrared spectrophotometer that scans from 2.5 to 14.5 microns in four seconds. [462]

Phase trimmer. RfDynamics, Inc., 51 Harbor Ave., Nashua, N.H., has published bulletin 311A covering a phase trimmer that has no sliding contacts and features low vswr and insertion loss. [463]

Pressure transducer. Northrop Ventura, 11975 Sherman Road, North Hollywood, Calif., has available a data bulletin describing an optical bridge transducer which senses pressure and, by means of optics, converts the signal to a voltage or frequency proportionate to pressure. [464]

D-c power supplies. Dressen-Barnes Electronics Corp., 250 North Vinedo Ave., Pasadena, Calif., announces a catalog covering 201 models of d-c power supplies, including a new line of silicon modules. [465]

Selector switch system. The A.W. Haydon Co., 232 North Elm St., Waterbury, Conn., 06720. Product Newsletter No. 114 describes a remote positioning, binary controlled selector switch system for airborne rocket launch control and similar applications. [466]

Frequency difference meter. Tracor, Inc., 1701 Guadalupe St., Austin, Texas, 78701. A data sheet covers the model 527 frequency difference meter, an instrument used for measuring the short or long term frequency difference between two stable oscillators. [467]

Glass microwave diodes. Micro Optics, a division of Alpha Industries, Inc., 381 Elliot St., Newton Upper Falls, Mass., 02164, has released data sheet 4100A on subminiature glass microwave diodes for use in applications such as mixing and video detection. [468]

Frequency converters. Brooks Instrument, division of Emerson Electric Co., Hatfield, Pa., offers a technical bulletin on frequency converters that convert a variable frequency input into a d-c voltage or current precisely proportional to input frequency. [469]

Laser data compilation. Maser Optics, Inc., 89 Brighton Ave., Boston, Mass., 02134, offers a comprehensive chart containing useful laser formulas, data,

constants, conversion factors, and hints. [470]

Transmitter tube socket. Connector Corp., 6025 No. Keystone Ave., Chicago, Ill., 60646. Data sheet 33A provides dimensional drawing and technical data on the type 444 transmitter tube socket which has low loss at very high frequencies. [471]

Integrated circuits. Digital Products, Box 1351, 335 West 7th St., San Pedro, Calif., 90731. An 18-page design/application manual entitled "Integrated Logic" describes the series L integrated logic modules. [472]

Pulse generators. Datapulse Inc., 509 Hindry Ave., Inglewood, Calif., 90306. Technical bulletin 108 contains specifications, waveform photos, and applications data for two new solid state, 50-v pulse generators. [473]

Data processing equipment. Preston Scientific, Inc., 805 E. Cerritos Ave., Anaheim, Calif., has available an eight-page catalog covering a line of products for data systems use. [474]

Crystal oscillators. Bendix Pioneer-Central Division, Hickory Grove Road, Davenport, Iowa, offers a bulletin describing the basic design approach and application and performance data on temperature compensated crystal oscillators. [475]

Power meters. PRD Electronics, Inc., 1200 Prospect Ave., Westbury, N.Y., 11590. A two-page data sheet describes models 668 peak power meter and 680 calorimetric power meter. [476]

Automatic capacitance bridge. General Radio Co., West Concord, Mass. Volume 39 No. 4 of "The Experimenter" contains a ten-page article on the type 1680-A automatic capacitance bridge assembly. [477]

Integrated circuits. Computer Control Co., Inc., Framingham, Mass. A 44-page catalog, μ -PAC-1, details a new line of silicon monolithic integrated circuit digital logic modules. [478]

Swept swr measurements. Hewlett-Packard, 1501 Page Mill Road, Palo Alto, Calif., 93404. An 11-page application note gives techniques for making swept swr measurements in coaxial systems at X-band with less uncertainty than is usually achieved even with point-to-point slotted line measurements. [479]

Rotating components. Sunbeam Electronics/Components Division, P. O. Box A998, Fort Lauderdale, Fla., 33307. A designer's handbook on servo, synchronous and d-c motors may be obtained by request on company letterhead.

To order reprints

from Electronics

fill in, cut out

coupon below,

insert in envelope

and mail to:

Electronics Reprint
Dept.

330 West 42nd Street

New York, N. Y. 10036

Reprint order form

For listing of reprints available see
the reader service card

To help expedite mailing of your
reprints please send cash, check
or money order with your order.

For reprints of the latest
Special report:

Unijunction Transistors

Send me reprints of key
no. R-74 at 50¢ each.

For reprints of previous special
reports fill in below:

Send me reprints of key no.(s)

..... at ¢ each.

For prices see the reader service
card.

Name

Number & Street

City, State

Zip Code

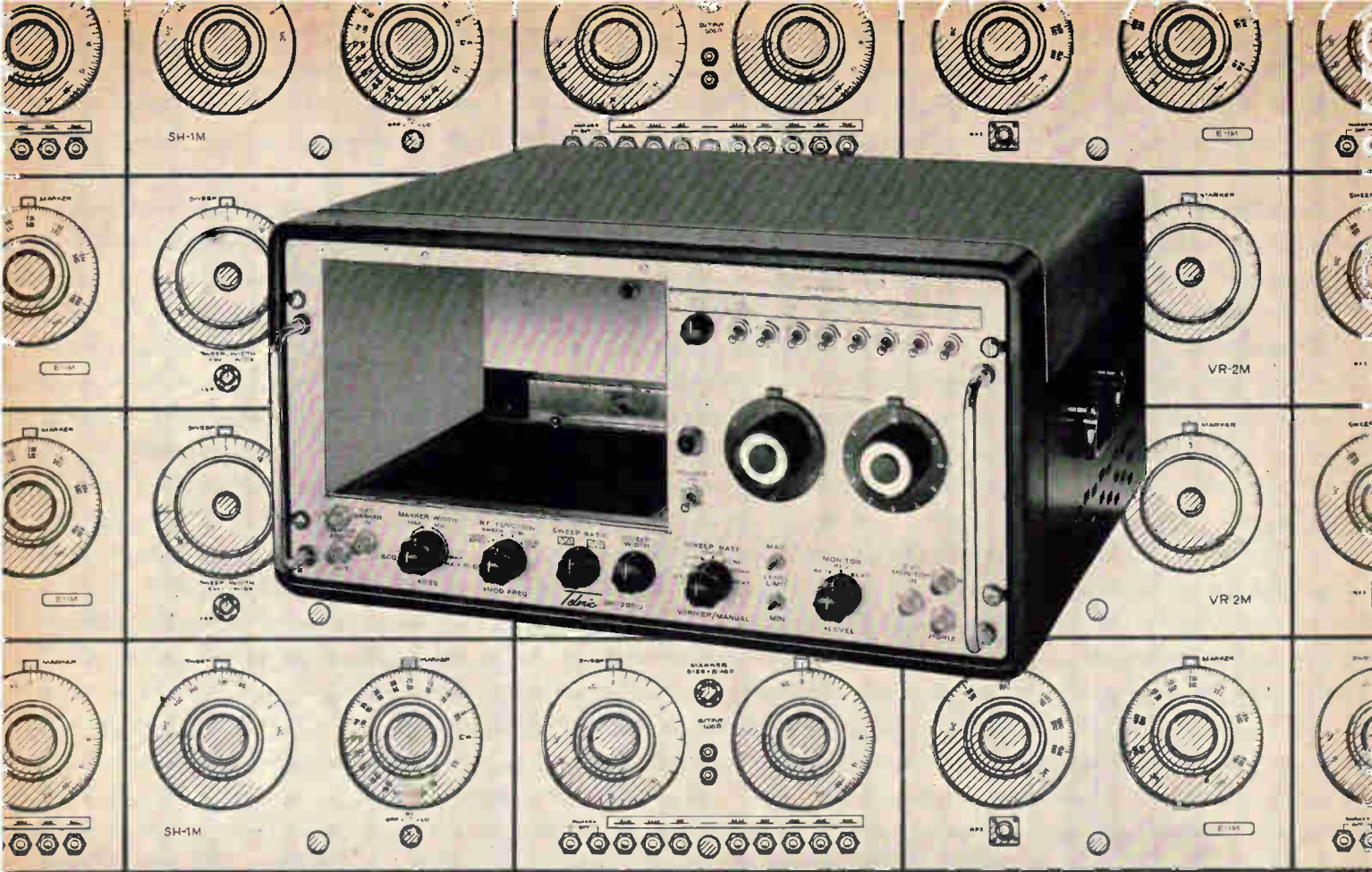

Telonic has 5-plug-in heads sweeping audio to 3000 MC plus 14 for special application, so who's

**HURTING
FOR
HEADS**

The Telonic SM-2000, the control chassis for 19 interchangeable plug-in heads, extends the application range of sweep generators without re-investment of new, basic equipment. The instrument operates in four modes with all plug-in heads: Sweep, Modulated Sweep, CW and Modulated CW. Accurate laboratory and production line testing within frequency ranges from audio to 3000 MC is possible using only 5-plug-in heads. An additional 14 heads are used for special applications. All heads have continuously variable center frequencies and sweep widths. Sweep rate is variable at 0.01 to 100 cycles per second on L head series. The signal frequency is precisely indicated by a built-in "birdy-by-pass" marker system. This system includes provision for a variable marker and 8-plug-in crystal-controlled markers, each with individual gain controls and on-off switches. Built-in turret attenuators provide attenuation of 0-60 db in 1 db steps. For a complete description of the SM-2000 Sweep Generator and plug-in heads request catalogue 64-A.



60 North First Avenue, BEECH GROVE, INDIANA

DOMESTIC SALES OFFICES: Baltimore, Boston, Chicago, Cleveland, Dallas, Dayton, Denver, Huntsville, Indianapolis, Los Angeles, New York City, Orlando, Philadelphia, San Francisco, Seattle, St. Louis, Syracuse • OVERSEAS SALES OFFICES EUROPEAN: Vienna, Austria; Brussels, Belgium; Humleback, Denmark; London, England; Paris, France; Helsinki, Finland; Gennep, Holland; Milan, Italy; Oslo, Norway; Madrid, Spain; Barcelona, Spain; Motala, Sweden; Onex-Geneva, Switzerland; Munich, W. Germany • OTHER: Buenos Aires, Argentina; Sao Paulo, Brazil; Montevideo, Uruguay; Sydney, Australia; Auckland, New Zealand; Wellington, New Zealand; Tel-Aviv, Israel; Bombay, India; Manila, Philippines; Tokyo, Japan; Osaka, Japan.

TELONIC — INTERNATIONAL LEADER IN SWEEP FREQUENCY MEASUREMENT

Circle 182 on reader service card

Sweden

Hospital automation

Long a leader in medical research, Sweden is now making big strides in hospital automation. The effort is understandable: under the country's 10-year-old system of medical insurance, hospital care is free and hospitals are severely understaffed.

Visitors to the 14th International Hospital Congress in Stockholm last month paid particular attention to two computer-controlled systems. One innovation, called Autochemist, is an automatic laboratory technician that can perform up to 6,000 analyses an hour of blood, urine and other body fluids, transfer the results to a computer and print them out at distant stations. The other is an electronic library that can deliver diagnoses and other information anywhere in the hospital almost instantaneously.

Autochemist. The first Autochemist is being installed at the Hospital for Infectious Diseases in Stockholm. Details of its operation are being kept secret until patent rights are obtained, but the system shown in Stockholm used a computer to regulate the testing of fluid samples, sort the analyses, and print out the results anywhere in the hospital.

For the demonstration, Autochemist used a PDP-1 computer made by the Digital Equipment Corp. Later, the company plans to use a PDP-8.

A transistorized control system moves racks of test tubes along a conveyer belt. Samples from each tube are drawn off into reaction tubes where the actual tests are performed according to the computer program. The computer compares the analyses with stored results of standard samples, and the computer tape is retained in the patient's file and can be rerun during treatment.

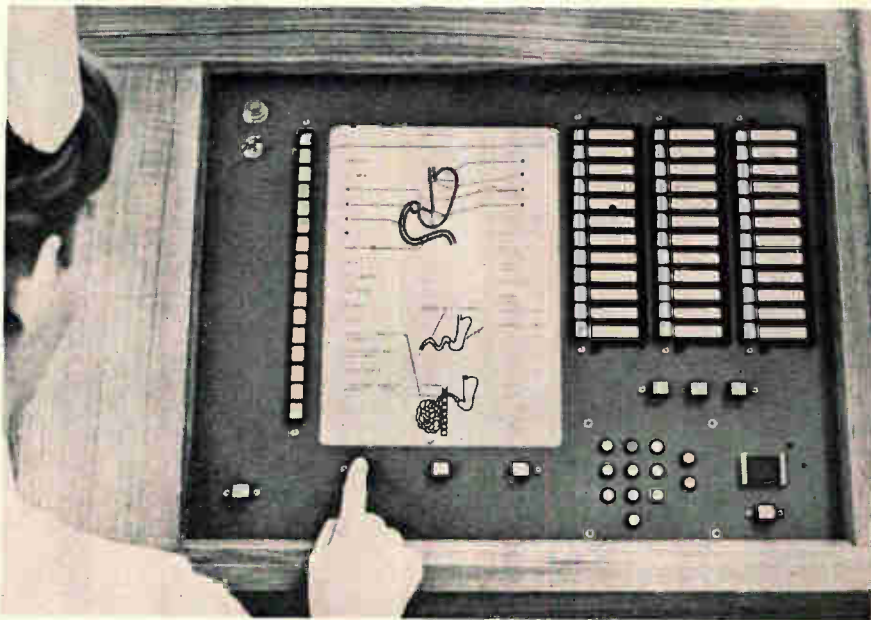

Medela shows patient's x-rays on demand.

Forty tests per tube. The analyzer was invented three years ago by two brothers, Gunnar and Ingmar Jungner, who are physicians. An improved version, made by Svenska AB Gasaccumulator (AGA), performs as many as 40 analyses on one sample—one of the most thorough automatic testing devices known. The system costs about \$300,000, including the computer.

In the United States, several automatic analyzers are in use, but specialists say they know of none with the test capacity and print-out capability of the AGA system.

AGA sees uses for Autochemist outside the hospital, in controlling industrial processes and in performing analyses in such fields as chemistry, bacteriology and hematology.

Enter Saab. Sweden's big manufacturer of automobiles, aircraft and electronics equipment, Saab, made its first big ripple in the medical field with a data-processing system. Saab—Svenska Aeroplan Aktiebolaget—supplied computer and electronics know-how for the design; medical information

was provided by a national hospital committee.

The system, called Medela, processes information ranging from commercial data to complex computations for research. Ultimately, Saab envisions a Medela system for every hospital, with a unit in every department where information is exchanged—wards, administration offices, laboratories, kitchens. A central computer would control the network; at the Stockholm show, the demonstration mockup operated as if linked to a Saab D-21 computer.

Three kinds of memory are used: the computer's internal memory, random-access and tape memory. Medela is a Latin word for "remedy."

Help wanted. The first Medela routine to be shown publicly is one designed to simplify and speed the dissemination of x-ray diagnosis. The present system takes a full day, from diagnosis to tape recorder to typist to physician to the patient's file in the ward.

Diagnoses can be transmitted instantly from the computer to the random-access memory and to the

proper receiving station—ward, out-patient clinic, central record room, operating room or elsewhere—saving one day plus reams of paper. One Swedish hospital estimates that it accumulates 66 miles of paper every year in its x-ray file.

Push-button prescriptions. Hospital personnel in patient-care areas can use consoles, each covering 36 patients, to punch out orders for tests, medication, special diets, or x-ray room time.

The closest counterpart in the United States seems to be an "interpretive communication system" being developed at the Massachusetts General Hospital. It reports laboratory findings back to the patient-care areas, using an on-line computer that employs time sharing. The system accumulates statistics from case histories and makes the results instantly accessible to the doctor. It also handles information on hospital admissions and discharges, ordering of medicine, and reports of lab findings.

The computer is a heavily modified version of the PDP-1 made by the Digital Equipment Corp., with a storage of four million characters.

In designing the system, Massachusetts General is working with Bolt, Beranek and Newman, Inc., a Boston engineering company. The research is financed by the National Institutes of Health. The director of the research project at Massachusetts General, Dr. Octo Barnett, says it will be "at least a couple of years" before the system will be practical for general use in a hospital.

Soviet Union

Tv in Moscow

Moscow's skyline is being altered by a cone-shaped transmitting tower that will eventually rise to 1,700 feet and become the heart of a \$100-million television center. When they are completed in 1968, the tv studios and equipment will



Moscow tv tower at 240-foot level

cover 100 acres of a prerevolutionary estate on the Russian capital's north side.

The center will expand Muscovites' choice of tv channels from two to six and, with a 250-kilowatt signal, widen the broadcast radius from 30 to 100 miles. The tower, of prestressed concrete, will be the largest of its type in the world. The Empire State building, in comparison, is 1,472 feet high.

There are four higher television towers in the United States. They belong to stations KXGO-TV in Fargo, N. D., 2,069 feet high; KSLA-TV in Shreveport, La., 1,898 feet; WHBL-TV and WTVM in Columbus, Ga., 1,749 feet; and WBIR-TV in Knoxville, Tenn., 1,749 feet.

Three-year delay. Construction of the Moscow tower was halted for three years while experts debated its safety. Work resumed slowly last year, but only recently has it moved into high gear.

At its base, the concrete tower is 100 feet in diameter. It will taper to 26 feet at the point where the steel tv tower begins. The tv tower's lowest section will contain dish microwave relays for intercity broadcasts. Above these will be microwave receivers for mobile tv broadcasts, and the topmost level will contain six transmitting antennas.

Great Britain

Busy line

The administrator of Britain's telephone system has acknowledged what the six million subscribers have known for years: that service is exasperating. Postmaster General Anthony Wedgwood Benn told an engineering union recently that connections are too slow and that failures, crosstalk and mysterious noises are too frequent.

The long-range solution probably will emanate from present studies with electronic exchanges [Electronics, May 17, p. 160], but for quick remedies Benn is trying to improve efficiency with the help of computers and to ease the financial burden by bringing more competitive bidding into the purchasing procedure.

Calling on computers. The Post Office already relies heavily on computers to handle data and traffic in its telephone and postal services. Since mid-1963 it has ordered \$11.1 million worth of computers from English Electric-Leo-Marconi Computers, Ltd., a subsidiary of the English Electric Co. Plans call for computer purchases totaling \$3 million a year for the next five years.

Computers already bill telephone users in the London area and produce payment slips for postal savings accounts; they will soon operate the national lottery from selection of the winning numbers to printing out the payment checks.

Competition. Benn's most controversial proposal would introduce sweeping changes in purchasing. Under an agreement that expires in 1968, the Post Office agrees to buy 90% of all telephone-exchange equipment and 75% of all other apparatus, such as telephones, from a small group of companies that agree, in turn, to pool their research and patents with the Post Office.

In the exchange field there are only five suppliers: Associated Electrical Industries, Ltd., Automatic Telephone & Electric Co., Ericsson Telephones, Ltd., the

General Electric Co. of England, and Standard Telephones and Cables, Ltd., a subsidiary of the International Telephone and Telegraph Corp.

Benn upset the telecommunications industry by proposing to end the apparatus agreement altogether and, without specifying how, to modify the agreement on exchange equipment. Based on prices for the 25% of apparatus that was purchased outside the agreement last year, the Post Office figures that competitive bidding would have resulted in an 8% saving on the \$22 million of total orders.

Industry reaction. Industry response to Benn's plan for competitive bidding is mixed. J. R. Brinkley, managing director of Pye Telecommunications, Ltd., declares: "There is no justification for terminating one agreement and not the other. One must either have competition or not."

Others, who would not allow themselves to be identified, emphasize the "not." They say that co-

operating in planning production assures standardization and optimum use of the industry's resources, and that this advantage would be lost with competitive bidding.

Crash program. The efficiency argument is timely because the Post Office has announced a giant expansion program that will cost \$2.7 billion dollars over the next five years.

When a 200-line electronic exchange was placed in experimental use last month in Peterborough, northwest of London, C. E. Calveley, assistant engineer in chief for the Post Office, said five more such systems were being ordered. "We look forward," he said, "to pressing industry to provide yesterday what we should have ordered 10 years ago."

The Peterborough exchange is similar to one ordered for Ambergate, Derbyshire. The Ambergate system, to be opened this year, will be Britain's first complete electronic exchange for public service.

Companies girding. Electronics concerns have expectations of great business from Britain's telephone system program. Rex B. Grey, managing director of Standard Telephones, says, "Telecommunications is one of Britain's leading growth industries, and one that is changing technique as rapidly as it is expanding." The company, which invests \$9 million to \$12 million a year in buildings and plant, opened a huge plant last month in Basildon, Essex, covering nearly half a million square feet and costing \$6.7 million. It will employ 2,600 people to manufacture telecommunication equipment.

The Plessey Group, which controls Ericsson and Automatic Telephone & Electric, reorganized July 1 to place all of its telecommunication activities under one executive, Fredrick Limb, former managing director of Ericsson. Plessey expects to have 23,000 people working in telecommunications.



Component board is removed from numerically controlled machine at Standard Telephones and Cables' new plant in Basildon, Essex. Machine drills the boards and inserts small terminal posts.

Spain

Band plays on

Spain's second television channel, which began operating in January, seems to be a whopping success [Electronics, Dec. 14, 1964, p. 149]. Industry and government alike give the new ultrahigh-frequency channel much credit for a 40% rise in receiver sales this year.

The mere announcement last fall that the ultrahigh-frequency station would begin broadcasting in 1965 pushed 1964 sales from the expected 300,000 to 443,000, according to Laureano Lopez Rodo, the country's chief economic planner. Projections for 1965 indicate the sale of 616,000 sets, industry says, pushing the national total near two million.

"Industry" is mostly Philips Gloeilampenfabrieken N.V. of the Netherlands, the Philco Corp., and General Electrica Española, an affiliate of the General Electric Co. This year, Philips has pushed its share of the market from 35% to

37%, GE has gone from 13% to almost 20%, and Philco has maintained its 15%.

An improvement of picture quality is also given some credit for increased sales.

East Germany

Millions of thin films

A system that continuously produces millions of thin-film precision resistors or resistor networks a year has been developed at the Manfred von Ardenne Institute in Dresden, East Germany. Its reported production capacity would surpass that of any similar system in the West.

One part of the system deposits the resistors, through masks, at up to a billion square centimeters of film in a work year. Resistors can be made either of vacuum-evaporated nickel-chrome alloy or of sputtered tantalum. Several deposition systems with higher capacity have been developed in the United States, but none uses both techniques to produce resistors.

Programed beam. A second part of the system trims the resistors to tolerance by machining them with an electron beam that is programed by a digital control unit; this section can trim five million substrates a year. Electron beams are also used in the West for resistor trimming, but a machine with comparable capacity has not yet been reported. Cycle time of the German machine is 2.4 seconds.

For a completely automated thin-film line, a third unit would be required to connect the existing machines according to the developers. This would be another vacuum system, in which the film resistors would be tempered and stabilized as they went from deposition to trimming machines.

R&D. Working models of the two machines were developed at the von Ardenne Institute. The institute is a center for research in electron optics, vacuum techniques and electronics. It is

headed by Prof. Manfred von Ardenne, a leading scientist in those fields since the 1920's.

Cooperative thin-film research was done at the Hermsdorf Ceramics Works. The research and development were contracted by the governmental Office for Research and Engineering and by VEB Halbleiterwerk, at Frankfurt an der Oder, which is responsible for solid state circuit design.

Further development of the system is being done at VEB Elektromat, of Dresden. Elektromat develops and builds automatic production lines for electronics assembly plants, and manufactures the production equipment for Hermsdorf.

One after another. Deposition and trimming are performed on continuous-traverse machines. Substrates are fed continuously into one end of each machine; they pass through processing and test stations and emerge from the other end. In conventional machines, substrates are processed in batches in a single vacuum chamber.

Batch processors are simpler and less expensive than continuous-traverse machines, but they are slower because the chamber has to be pumped out each time it is reloaded. Officials at the institute believe that their continuous-traverse machines will prove economically attractive because the production rates can be high. An electron-beam machine should work at high speed to justify the high cost of the electron-optic, vacuum and control apparatus required.

Other components. The institute is also planning a larger deposition machine that would make thin-film capacitors and resistors on the same substrates. It will probably use one of the standard processes—vacuum deposition, sputtering or anodizing tantalum or aluminum films to form the dielectric.

To balance the capacitors accurately, techniques similar to resistor trimming would be used. The institute is also attempting to produce thin-film inductors by cutting spiral-shaped microgrooves in thin films of conductive and magnetic materials.

Around the world

France. A satellite tracking system, more powerful and accurate than the Minitrack network used by the United States, has been developed for the French space program by the Compagnie Française Thomson-Houston. It is said to predict orbits of satellites daily. Vladimir Altovsky, director of Thomson-Houston's space activities, says that with synchronous demodulation the system can find a satellite 620 miles away accurately to 110 yards; that's equal to angular measurement on the order of 100 microradians. A fabricated carrier, about midway between the frequencies of the two information signals used, permits linear detection at high noise levels. Two tracking stations have been built in Africa, and a third is being constructed in the Ardennes mountains of Belgium.

Japan. The first IBM 1800 computer to be imported to Japan may soon be controlling ammonia and urea plants being built for Toyo Koatsu Industries, Inc. The company, which has asked the government for permission to import the computer, says the plants at Sakai, near Osaka, will open next May; the control loops are expected to be closed a year later. The computer and related electronic equipment will account for \$420,000 of plants' \$18 million total cost. There will be about 51 employees, according to Toyo Koatsu, instead of the 300 who would be required to operate the plants without the computer.

Soviet Union. The Soviet postal system has a five-year plan of its own, whose goal is to have a zip code in full operation by 1970. The system, designed around an Omega computer, will record and transmit each of the 4.5 billion pieces of mail sent annually within the Soviet Union, and will perform financial controls.

Venezuela. The National Telephone Co. has ordered a \$4-million radio station for Caracas from a subsidiary of Philips Gloeilampenfabrieken, N. V., of the Netherlands.

get speed and data density of magnetic tape...

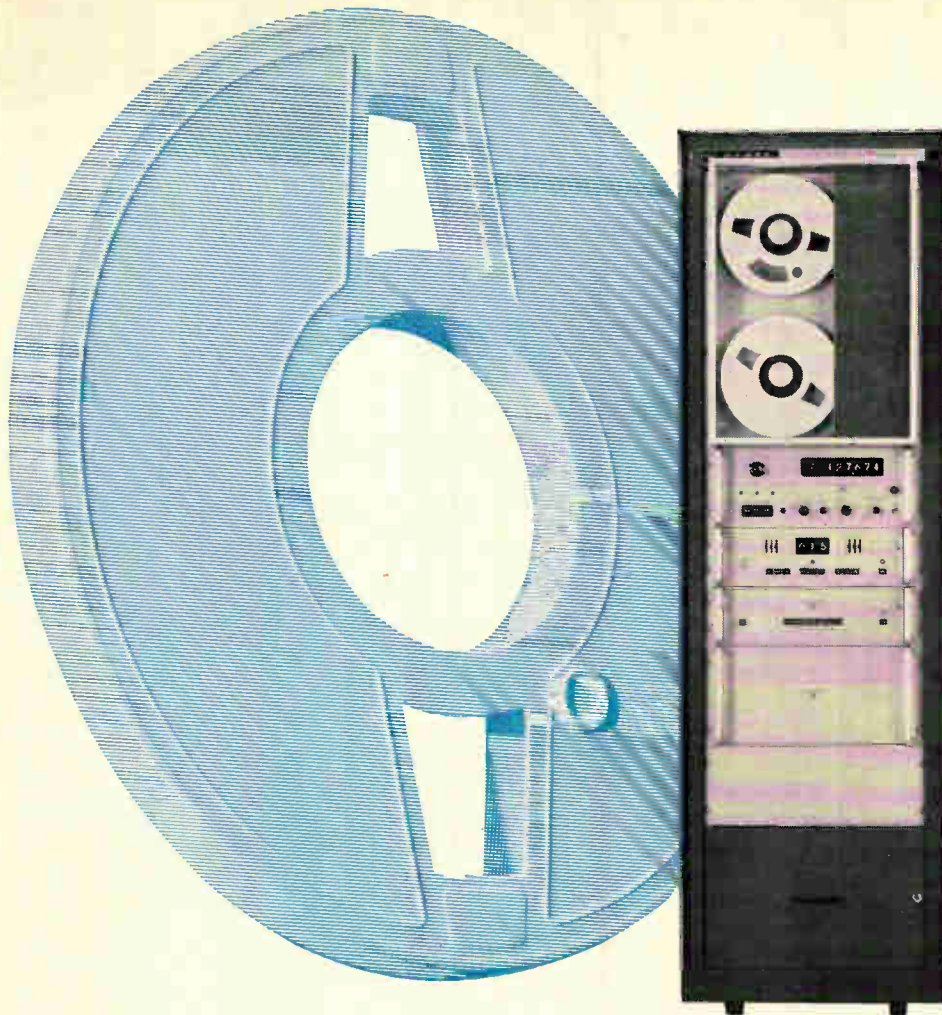

—with new standard digital data acquisition systems!

ADD: The advantages of standard systems—complete system specifications, immediate delivery, proven reliability, low cost **TO:** The benefits of magnetic tape recording and data processing **AND GET:** Fast automatic measurement of dc volts, low-level dc, ac volts, resistance and frequency recorded on an incremental recorder in computer compatible format—as fast as **10 channels per second**—with up to 440,000 unattended measurements and recordings.

Heart of these magnetic tape systems, as of other Dymec 2010 Data Acquisition Systems, is the DY-2401C Integrating Digital Voltmeter, a floated and guarded instrument which lets you measure extremely low-level signals even in the presence of severe common mode and superimposed noise. The 2401C measures dc voltages to 1000 volts with 300% overranging on the lower ranges. It also measures frequency 10 cps to 300 kc, and you can add an optional converter to measure ac and resistance.

The newest of Dymec's standard systems comes in two models, the 2010J and the 2010H, which differ only in scanning capability. With the 2010J you can measure up to 200 3-wire channels, or measure up to 100 channels with the 2010H System.

Now from nine standard systems you can select a wide variety of input capabilities and recorded output, including printed paper tape, punched tape, punched cards ... and magnetic tape. Prices of the newest systems: DY-2010H, \$15,365; DY-2010J, \$17,415.

Data subject to change without notice. Prices f.o.b. factory.

Call your Dymec/Hewlett-Packard field engineer for more information or for a demonstration of a standard digital data acquisition system.

DYMEC

A DIVISION OF HEWLETT-PACKARD COMPANY

DEPT. E-4, 395 PAGE MILL ROAD, PALO ALTO, CALIF. • PHONE (415) 326-1755 TWX 415-492-9363





Investment Opportunity

The skills he's learning today he will someday put to use for you.

But it is going to take a substantial investment before the strides he takes will be sure and swift and strong. An investment of time, of love, of money and thought.

You have a stake in that investment.

You can protect it by joining with other leading American businessmen to promote the Treasury's Payroll Savings Plan for U. S. Savings Bonds. The Treasury Department's Plan encourages habits of prudence and diligence and responsibility that are

the most valuable currency of a free society and a free economy.

When you bring the Payroll Savings Plan into your plant—*when you encourage your employees to enroll*—you are investing in the skills of tomorrow's workers. In the energy and ability of youth that is our real wealth. You are investing in America's future. In freedom itself.

Don't pass this investment opportunity by. Call your State Savings Bonds Director. Or write today to the Treasury Department, U. S. Savings Bonds Division, Washington, D. C. 20226.



in your plant...promote the **PAYROLL SAVINGS PLAN** for **U.S. SAVINGS BONDS**



Electronics advertisers

July 12, 1965



Allen Organ Company N.W. Ayer & Son Inc.	38	Eastman Kodak Company The Rumrill Company Inc.	145, 169	Janus Control Corporation L.K. Frank Co. Inc.	154
Ammon Instruments Inc. Culver Advertising Inc.	140	Edgerton, Germeshausen & Grier Inc. Reach, McClinton & Company Inc.	58	Jerrold Electronics Corp. Irving Gould Advertising Inc.	10
■ Amphenol-Borg Electronics Corp. Connector Division Marsteller Inc.	36, 37	Electro Products Laboratories Inc. C.M. Gotsch, Advertising	147		
		Englehard Industries Inc. Keyes, Martin & Company	120, 121		
		Erie Technological Products Co. Inc. Altman-Hall Associates	128, 129		
Bausch & Lomb Inc. Wolff Associates, Inc.	124	Esterline Angus Instrument Company Inc. Caldwell, Larkin & Sidener-Van Riper Inc.	70	Kansai Televi Kogyo Co., Ltd. Osaka Koken Co., Ltd.	31
Beede Electrical Instruments Company Inc. S. Gunnar Myrbeck & Company	172	Eubanks Engineering Company Moore-Bergstrom Company	148	Kelvin Electric Company Stoneham Advertising	161
Bendix Corporation, Scintilla Division MacManus, John & Adams Inc.	118			Kuwano Electrical Instrument Co. Ltd. Standard Advertising Inc.	28
■ Bourns Inc. Allen, Dorsey & Hatfield Inc.	109	Fairchild/Electro-Metrics Corp. Herbert Lindauer Associates	122	■ Kyoritsu Electrical Instrument Works Ltd. Nichiden Adv. Ltd.	32
■ Brush Instruments, Div. of Clevite Corporation Carr Liggett Adv. Inc.	3rd Cover	Fairchild Instrumentation The Wexton Company Inc.	14	Kyoto Ceramic Company, Ltd. Daiko Advertising Inc.	32
Bud Radio Incorporation Allied Advertising Agency Inc.	151	Fluke Mfg. Co. Inc., John Bonfield Associates Inc.	11		
Burr-Brown Research Corporation N.A. Winter Adv. Agency	146	■ Fork Standards Inc. K & A Inc.	142	■ Lambda Electronics Corporation Michel Cather Inc.	116, 117
■ Bussman Mfg. Co. Div. of McGraw Edison Co. Henderson Advertising Company	136, 137	■ Fujitsu, Limited Fuji Agency	29	■ Lapp Insulator Company Inc. Wolff Associates Inc.	56
				Ledex Inc. Yeck and Yeck	143
Cambridge Thermionic Corporation Chirurg & Cairns Inc.	151	General Dynamics/Forth Worth Glenn Advertising Inc.	34	Lockheed Missiles & Space Company McCann-Erickson Inc.	66
Cerro Corporation Feeley Advertising Agency	40	■ General Electric Company George R. Nelson Inc.	19 to 24		
Cherry Electrical Products Corp. Jd culea Advertising Inc.	169	■ General Electric Company, Miniature Lamp Dept. Batten, Barton, Durstine & Osborn Inc.	119	M.I.A.L., U.S.A., Inc. Keyes, Martin Company	147
■ Cinch Manufacturing Company Stral Advertising Company Inc.	60	■ General Radio Company K.E. Morang Company	2nd Cover	Machlett Laboratories Inc., The Fuller & Smith & Ross Inc.	9
Cinch-Graphik Division of United Carr Reach, McClinton & Company	135	Genisco Technology Corporation Getz and Sandborg Inc.	149	Mallory & Company, Inc. P.R. The Aitkin-Kynett Company	63
■ Clifton Precision Products Co. Div. of Litton Industries Ivey Advertising Inc.	16	Geo Space Corporation	152	Manson Laboratories, Division of Hallicrafters Ted Peck Inc.	138
■ Cohn, Sigmund Corporation William G. Seidenbaum & Company	132	■ Globe Industries Inc. Odiorne Industrial Advertising Inc.	123	Markem Machine Culver Advertising Inc.	141
Cominco Products Inc. McKim Productions Limited	134	Graphic Systems Inc. Caswell Advertising Agency	140	Matsuo Electric Co. Ltd. Asahi Advertising Agency & Co.	28
Communications Electronics Inc.	144	Green Instrument Company Inc. S. Gunnar Myrbeck & Company	54	Metronix Corp. Standard Advertising, Inc.	31
Consolidated Electro-dynamics Corporation Hixson & Jorgensen Inc.	12, 13, 111	Gries Reproducer Corporation Harold Marshall Advertising Co. Inc.	170	■ Mitsubishi Electric Corporation Hakuhodo Inc.	29
Controls Company of America The Harry P. Bridge Company	155			■ Mitsumi Electric Co., Ltd. Dentsu Advertising Ltd.	30
Coto Coil Co. Inc. The Williams Company	134	■ Hewlett-Packard Associates Lennen & Newell Inc.	164	Motorola Semiconductor Products Inc. Lane and Bird Advertising Inc.	108
		■ Hewlett-Packard Company Lennen & Newell Inc.	2, 43, 44		
Data Instruments, Div. of Industrial Electronic Hardware Corp. Technical Marketing	46	■ Hewlett-Packard Company, Moseley Division Lennen & Newell Inc.	1	National Cash Register Company Allen, Dorsey, & Hatfield Inc.	166, 167
Daven, Div. of McGraw Edison Keyes, Martin & Company	67	Hickok Electrical Instrument Company Parsells Advertising Service	35	■ NRC Equipment Company S. Gunnar Myrbeck & Company	26
Delco Radio Division of General Motors Corporation Campbell-Ewald Company	39	Hitachi Ltd. Dentsu Advertising Ltd.	27	North Atlantic Industries Inc. Murray Heyert Associates	55
Delevan Electronics Corporation Clayton A. Stahika Advertising Company	150	Hughes Aircraft Company Foote, Cone & Belding Inc.	65, 171		
Di-Acro Corporation Charles E. Brown Advertising	134				
Douglas Aircraft Co. Inc. J. Walter Thompson Company	110, 168	Industrial Electronic Engineers Inc. Gumpertz, Bentley & Dolan Adv.	148		
Dow Corning Corporation Church & Guisewite Advertising Inc.	64	International Resistance Company Arndt, Preston Chapin, Lamb & Keen Inc.	126		
DuPont de Nemours & Co. Inc. E.I. Batten, Barton, Durstine & Osborn Inc.	7	ITT-Cannon Electric Inc. West, Weir & Bartel Inc.	112	OKI Electric Industry Co. Ltd. Standard Advertising Inc.	28
DuPont Reagents The Rumrill Company Inc.	163				
■ Dymec, A. Div. of Hewlett-Packard Company Lennen & Newell Incorporated	187				

Executive, editorial, circulation and advertising offices: McGraw-Hill Building, 330 West 42nd Street, New York, N.Y., 10036. Telephone Area Code 212-971-3333. Teletype TWX N.Y. 212-640-4646. Cable: McGrawhill, N.Y. Officers of the Publications Division: Shelton Fisher, President; Vice Presidents: Joseph H. Allen, Operations; Robert F. Boger; Administration; John R. Callahan, Editorial; Ervin E. DeGraff, Circulation; Donald C. McGraw, Jr., Advertising Sales; Angelo R. Venezian, Marketing. Officers of the Corporation: Donald C. McGraw, President; L. Keith Goodrich and Hugh J. Kelly, Executive Vice Presidents; John J. Cooke, Vice President and Secretary; John L. McGraw, Treasurer. Title R registered U.S. Patent Office; © copyright 1965 by McGraw-Hill, Inc. All rights reserved, including the right to reproduce the contents of this publication, in whole or in part.



Pennsylvania Fluorocarbon Company Ernest William Greenfield, Inc.	170
■ Perfection Mica Company, Magnetic Shield Division Burton Browne Advertising	158
■ Phelps Dodge Electronic Products Corp. Smith, Dorian & Burman Inc.	42
Philco Corporation Lansdale Division Batten, Barton, Durstine & Osborn Inc.	59
■ Polarad Electronic Instruments Keyes, Martin & Company	33
■ Radar Design Corp. Barlow/Johnson Inc.	160
Radio Corporation of America	4th Cover, 125
Al Paul Lefton Co.	
Radio Switch Corporation George Homer Martin Associates	158
Rapidesign, Inc. Harry G. Willis & Associates, Inc.	151
Raytheon Computer Jay Chiat and Associates	133
Rese Engineering Inc. Joseph Gering/Graphic Design	165
San-el Instrument Co., Ltd. Standard Advertising, Inc.	31
Shallcross Manufacturing Company J.T. Howard Advertising Agency Inc.	57
Shimada Physical & Chemical Industrial Co., Ltd. Standard Advertising, Inc.	30
Shizuki Electrical Mfg. Co. New Asia Trading News Agency Ltd.	30
■ Signalite Incorporation Armand Richards Advertising Agency	160
Signetics Corporation Cunningham & Walsh Inc.	68
Stater Electric Inc.	142, 169
Light Advertising Service	
■ Sorensen Inc. Fuller & Smith & Ross Inc.	105
Speer Carbon Company Hazard Advertising Company	45
Sprague Electric Company The Harry P. Bridge Co.	5, 6
Stackpole Carbon Company Meek and Thomas Inc.	139, 25
Statham Instruments, Inc. Anderson-McConnell Advertising Agency, Inc.	8
Stromberg-Carlson Corporation The Rumrill Company Inc.	132
Stewart Warner Hoefer, Dieterich & Brown, Inc.	69
■ Syntronic Instruments, Inc. Burton Browne Advertising	162
TRW Electronics Fuller & Smith & Ross Inc.	53
Takamisawa Electric Co., Ltd. Nambokusha Advertising Agency, Inc.	32
Tamura Electric Works Ltd. Asia Advertising Agency, Inc.	31
Telonic Industries Inc. Burton Browne Advertising	182
TEXAS INSTRUMENTS INCORPORATED Semiconductor-Components Division Don L. Baxter Inc.	41
Thermal American Fused Quartz Company Kniep Associates	140
Tracor Inc. David G. Benjamin Inc.	130

■ Tylon Inc. George Moll Adv. Inc.	165
■ Tung-Sol Electric Inc. E.M. Freystadt Associates Inc.	142
United Systems Inc. Advertising & Merchandising Inc.	160
Unitrode Corporation Electronic Marketing Assistance	51
■ Vitramon Inc. Ted Sommers Inc. Advertising	131
Watkins-Johnson Company William C. Estler Public Relations	153
■ Weston Instruments Incorporated Basford Inc.	144, 148

Yutaka Electric Mfg. Co., Ltd. Nichiden Adv., Ltd.	30
---	----

Classified advertising

F.J. Eberle, Business Mgr.	
EMPLOYMENT OPPORTUNITIES	174-179
EQUIPMENT (Used or Surplus New) For Sale	179-180

Classified advertisers index

■ A & A Electronics Corp.	179
Aamco Transmissions	179
Atomic Personnel Inc.	179
Edmund Scientific Co.	180
Engineering Associates	179
Electro Gadget Supply Co.	179
General Electric	176
General Dynamics	
Electric Boat Div.	178
Markus-Campbell Co.	179
McDonnell	175
Motorola Inc.	174
Oak Manufacturing Co.	179
■ Radio Research Instrument Co. Sperry Rand Corp.	180
Univac Div.	174
Sylvania Electronic Systems	177
■ Universal Relay Corp.	180

Advertising sales staff

Gordon Jones [212] 971-2210
Advertising sales manager

Atlanta, Ga. 30309: Gus H. Krimsier,
Michael H. Miller, 1375 Peachtree St. N.E.,
[404] TR 5-0523

Boston, Mass. 02116: William S. Hodgkinson
McGraw-Hill Building, Copley Square,
[617] CO 2-1160

Chicago, Ill. 60611: Robert M. Denmead,
J. Bradley MacKimm
645 North Michigan Avenue,
[312] MO 4-5800

Cleveland, Ohio 44113: Paul T. Fegley, 55
Public Square, [216] SU 1-7000

Dallas, Texas 75201: Richard P. Poole, The
Vaughn Building, 1712 Commerce Street,
[214] RI 7-9721

Denver, Colo. 80202: Joseph C. Page, David
M. Watson, Tower Bldg., 1700 Broadway,
[303] AL 5-2981

Houston, Texas 77025: Kenneth George,
2270 Humble Bldg.,
[713] CA 4-8381

Los Angeles, Calif. 90017: Ashley P.
Hartman, John G. Zisch, 1125 W. 6th St.,
[213] HU 2-5450

New York, N. Y. 10036:
Donald R. Furth [212] 971-3615
Frank LeBeau [212] 571-3615
George F. Werner [212] 971-3615
500 Fifth Avenue

Philadelphia, Pa. 19103: William J. Boyle,
Warren H. Gardner, 6 Penn Center Plaza,
[215] LO 8-6161

San Francisco, Calif. 94111:
James T. Hauptli, 255 California Street,
[415] DO 2-4600

London W1: John W. Patten, Edwin S.
Murphy Jr., 34 Dover Street,
Hyde Park 1451

Milan: 1, via
Baracchini Phone: 86-90-617

Frankfurt/Main: Gerd Hinske, 85
Westendstrasse Phone: 77 26 65 and
77 30 59

Geneva: Michael R. Zeynel, Joseph Wuensch,
2 Place du Port 244275

Paris VIII: Denis Jacob, 17 Avenue
Matignon ALMA-0452

Tokyo: Nobuyuki Sato
Shiba, Minato-Ku (502) 0656

Osaka: Kazutaka, Miura, 163, Umegee-cho,
Kilita-ku [362] 8771

Nagoya: International Media Representatives,
Yamagishi Bldg., 13, 2-Chome,
Oike-cho Naka-ku

Hugh J. Quinn: [212] 971-2335
Manager Electronics Buyers' Guide

David M. Tempest: [212] 971-3139
Promotion manager

Milton Drake: [212] 971-3485
Market research manager

Wallace C. Carmichael [212] 971-3191
Business manager

Theodore R. Geipel: [212] 971-2044
Production manager

■ For more information on complete product
line see advertisement in the latest Elec-
tronics Buyers' Guide

Electronics reader service

Use these handy post cards for more detailed information on: products advertised, new products, new literature.

Circle the number on the Reader Service post card that corresponds to the number at the bottom of the advertisement, new product item, or new literature in which you are interested.

Please print clearly. All written information must be legible to be efficiently processed.

If someone has beaten you to the post cards, you may obtain the needed information by writing directly to the manufacturer, or by sending your name and address, plus the reader service number, to Electronics reader service department.

All foreign inquires that cannot reach Electronics before the expiration dates noted on the Reader Service post card, must be mailed directly to the manufacturer. The manufacturer assumes all responsibilities for responding to inquiries. Electronics merely provides and clears requests for information from inquirer to manufacturer.

Correct amount of postage must be affixed for all foreign mailings.

To subscribe to or to renew Electronics

Fill in the "For Subscriptions" area on the card if you desire to subscribe to or renew your present subscription to Electronics. Send no money. Electronics will bill you at the address indicated on the Reader Service post card.

Multi-product advertisements

For information on specific items in multi-product advertisements which do not have a specific Reader Service number indicated write directly to manufacturer for information on precise product in which you are interested.

14 July 12, 1965 Card Expires September 12, 1965 14

Name _____ title _____

Company _____

Address _____

For Subscriptions
 new renewal
 3 years \$12.00
 1 year \$6.00

1	20	39	58	77	96	115	134	153	172	191	210	229	248	267	286	305	324	343	362	381	400	419	438	457	476	495	514	962
2	21	40	59	78	97	116	135	154	173	192	211	230	249	268	287	306	325	344	363	382	401	420	439	458	477	496	515	963
3	22	41	60	79	98	117	136	155	174	193	212	231	250	269	288	307	326	345	364	383	402	421	440	459	478	497	516	964
4	23	42	61	80	99	118	137	156	175	194	213	232	251	270	289	308	327	346	365	384	403	422	441	460	479	498	517	965
5	24	43	62	81	100	119	138	157	176	195	214	233	252	271	290	309	328	347	366	385	404	423	442	461	480	499	518	966
6	25	44	63	82	101	120	139	158	177	196	215	234	253	272	291	310	329	348	367	386	405	424	443	462	481	500	900	967
7	26	45	64	83	102	121	140	159	178	197	216	235	254	273	292	311	330	349	368	387	406	425	444	463	482	501	901	968
8	27	46	65	84	103	122	141	160	179	198	217	236	255	274	293	312	331	350	369	388	407	426	445	464	483	502	902	969
9	28	47	66	85	104	123	142	161	180	199	218	237	256	275	294	313	332	351	370	389	408	427	446	465	484	503	951	970
10	29	48	67	86	105	124	143	162	181	200	219	238	257	276	295	314	333	352	371	390	409	428	447	466	485	504	952	971
11	30	49	68	87	106	125	144	163	182	201	220	239	258	277	296	315	334	353	372	391	410	429	448	467	486	505	953	972
12	31	50	69	88	107	126	145	164	183	202	221	240	259	278	297	316	335	354	373	392	411	430	449	468	487	506	954	973
13	32	51	70	89	108	127	146	165	184	203	222	241	260	279	298	317	336	355	374	393	412	431	450	469	488	507	955	974
14	33	52	71	90	109	128	147	166	185	204	223	242	261	280	299	318	337	356	375	394	413	432	451	470	489	508	956	975
15	34	53	72	91	110	129	148	167	186	205	224	243	262	281	300	319	338	357	376	395	414	433	452	471	490	509	957	976
16	35	54	73	92	111	130	149	168	187	206	225	244	263	282	301	320	339	358	377	396	415	434	453	472	491	510	958	977
17	36	55	74	93	112	131	150	169	188	207	226	245	264	283	302	321	340	359	378	397	416	435	454	473	492	511	959	978
18	37	56	75	94	113	132	151	170	189	208	227	246	265	284	303	322	341	360	379	398	417	436	455	474	493	512	960	979
19	38	57	76	95	114	133	152	171	190	209	228	247	266	285	304	323	342	361	380	399	418	437	456	475	494	513	961	980

Business reply mail
 No postage stamp necessary if mailed in the United States

Postage will be paid by

**Electronics
 Reader service department
 Box 444
 Hightstown, N.J. 08520**

First class
 Permit no. 42
 Hightstown, N. J.

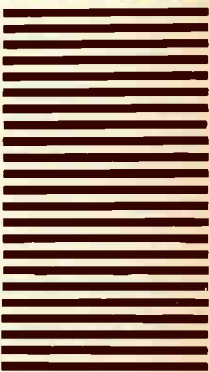

14 July 12, 1965 Card Expires September 12, 1965 14

Name _____ title _____

Company _____

Address _____

For Subscriptions
 new renewal
 3 years \$12.00
 1 year \$6.00

1	20	39	58	77	96	115	134	153	172	191	210	229	248	267	286	305	324	343	362	381	400	419	438	457	476	495	514	962
2	21	40	59	78	97	116	135	154	173	192	211	230	249	268	287	306	325	344	363	382	401	420	439	458	477	496	515	963
3	22	41	60	79	98	117	136	155	174	193	212	231	250	269	288	307	326	345	364	383	402	421	440	459	478	497	516	964
4	23	42	61	80	99	118	137	156	175	194	213	232	251	270	289	308	327	346	365	384	403	422	441	460	479	498	517	965
5	24	43	62	81	100	119	138	157	176	195	214	233	252	271	290	309	328	347	366	385	404	423	442	461	480	499	518	966
6	25	44	63	82	101	120	139	158	177	196	215	234	253	272	291	310	329	348	367	386	405	424	443	462	481	500	900	967
7	26	45	64	83	102	121	140	159	178	197	216	235	254	273	292	311	330	349	368	387	406	425	444	463	482	501	901	968
8	27	46	65	84	103	122	141	160	179	198	217	236	255	274	293	312	331	350	369	388	407	426	445	464	483	502	902	969
9	28	47	66	85	104	123	142	161	180	199	218	237	256	275	294	313	332	351	370	389	408	427	446	465	484	503	951	970
10	29	48	67	86	105	124	143	162	181	200	219	238	257	276	295	314	333	352	371	390	409	428	447	466	485	504	952	971
11	30	49	68	87	106	125	144	163	182	201	220	239	258	277	296	315	334	353	372	391	410	429	448	467	486	505	953	972
12	31	50	69	88	107	126	145	164	183	202	221	240	259	278	297	316	335	354	373	392	411	430	449	468	487	506	954	973
13	32	51	70	89	108	127	146	165	184	203	222	241	260	279	298	317	336	355	374	393	412	431	450	469	488	507	955	974
14	33	52	71	90	109	128	147	166	185	204	223	242	261	280	299	318	337	356	375	394	413	432	451	470	489	508	956	975
15	34	53	72	91	110	129	148	167	186	205	224	243	262	281	300	319	338	357	376	395	414	433	452	471	490	509	957	976
16	35	54	73	92	111	130	149	168	187	206	225	244	263	282	301	320	339	358	377	396	415	434	453	472	491	510	958	977
17	36	55	74	93	112	131	150	169	188	207	226	245	264	283	302	321	340	359	378	397	416	435	454	473	492	511	959	978
18	37	56	75	94	113	132	151	170	189	208	227	246	265	284	303	322	341	360	379	398	417	436	455	474	493	512	960	979
19	38	57	76	95	114	133	152	171	190	209	228	247	266	285	304	323	342	361	380	399	418	437	456	475	494	513	961	980

Reprint service

All Electronics editorial matter available in reprint form:

For reprints of special reports and feature articles see list on right side of this page. Send your order to Electronics Reprint Department at the address indicated. To expedite mailing of your order for single reprints please send cash, check or money order with your order.

Bulk reprints of editorial matter can be ordered from current or past issues. The minimum quantity is 100 copies. The higher the quantity ordered, the more economical the cost per copy. Prices quoted on request.

To order reprints or for further information, please write to: **Electronics Reprint Department, 330 West 42nd Street, New York, N.Y. 10036.** Telephone: Area code 212 971-3140.

Prices for the below listed reprints unless otherwise specified are 1-10 copies 50¢ each; 11-24 copies 35¢ each; 25-99 copies 25¢ each; price for 100 or more is 20¢ each.

Key no. **R-75 Biotelemetry**
[2 Part series 16 pages]

Key no. **R-74 Unijunction Transistors**, 24 pages.

Key no. **R-73 Communications on Gemini**
24 pages.

Key no. **R-72 Electronics 35th Special Anniversary Section** 28 pages.

Key no. **R-71 Experiments On Gemini**
28 pages.

Key no. **R-69 1964 Complete Electronics Index**
Catalogs all technical articles — newsletter items, Electronics Review, Electronics Abroad, and Probing the News stories, manufacturers mentioned in these articles plus a complete advertisers index.
40 pages. \$1.00

Key no. **R-68 Designing Against Space Radiation**, 18 pages.

Key no. **R-67 Electronics Markets 1965.**
24 page forecast report with 6 page foldout chart.

Key No. **R-66 Field Effect Transistors, Part III**
16 pages.

Key No. **R-65 Field Effect Transistors, Part II**
24 pages.

Key No. **R-64 Field Effect Transistors, Part I**
24 pages.

Key no. **R-63 Silicon Power Transistors**
8 pages. 25¢

Key no. **R-62 Electronic Telephone Switching**,
16 pages.

Key no. **R-61 Direct Digital Control In Industry**, 24 pages.

Key no. **R-60 Transistor Heat Dissipators**,
32 pages.

Key no. **R-58 Oceanography**, 15 pages.

Key no. **R-48 Modern Electronic Packaging**,
16 pages.

Key no. **R-40 Tunnel Diodes**, [4 part series]
26 pages.

Key no. **R-38 Family Tree of Semiconductors**,
[22" x 11" foldout chart].

Key no. **R-31 1962 Electromagnetic Spectrum Chart**, [22" x 30" foldout chart].
\$1.00

Key no. **R-30 Graphical Symbols For Electronic Diagrams**, [29" x 11" foldout chart].

First class
Permit no. 42
Hightstown, N. J.



Business reply mail

No postage stamp necessary if mailed in the United States

Postage will be paid by

Electronics
Reader service department
Box 444
Hightstown, N. J. 08520

14 July 12, 1965 Card Expires September 12, 1965 14

Name _____ title _____

Company _____

Address _____

For Subscriptions
 new renewal
 3 years \$12.00
 1 year \$6.00

1	20	39	58	77	96	115	134	153	172	191	210	229	248	267	286	305	324	343	362	381	400	419	438	457	476	495	514	562
2	21	40	59	78	97	116	135	154	173	192	211	230	249	268	287	306	325	344	363	382	401	420	439	458	477	496	515	963
3	22	41	60	79	98	117	136	155	174	193	212	231	250	269	288	307	326	345	364	383	402	421	440	459	478	497	516	964
4	23	42	61	80	99	118	137	156	175	194	213	232	251	270	289	308	327	346	365	384	403	422	441	460	479	498	517	965
5	24	43	62	81	100	119	138	157	176	195	214	233	252	271	290	309	328	347	366	385	404	423	442	461	480	499	518	966
6	25	44	63	82	101	120	139	158	177	196	215	234	253	272	291	310	329	348	367	386	405	424	443	462	481	500	900	967
7	26	45	64	83	102	121	140	159	178	197	216	235	254	273	292	311	330	349	368	387	406	425	444	463	482	501	901	968
8	27	46	65	84	103	122	141	160	179	198	217	236	255	274	293	312	331	350	369	388	407	426	445	464	483	502	902	969
9	28	47	66	85	104	123	142	161	180	199	218	237	256	275	294	313	332	351	370	389	408	427	446	465	484	503	951	970
10	29	48	67	86	105	124	143	162	181	200	219	238	257	276	295	314	333	352	371	390	409	428	447	466	485	504	952	971
11	30	49	68	87	106	125	144	163	182	201	220	239	258	277	296	315	334	353	372	391	410	429	448	467	486	505	953	972
12	31	50	69	88	107	126	145	164	183	202	221	240	259	278	297	316	335	354	373	392	411	430	449	468	487	506	954	973
13	32	51	70	89	108	127	146	165	184	203	222	241	260	279	298	317	336	355	374	393	412	431	450	469	488	507	955	974
14	33	52	71	90	109	128	147	166	185	204	223	242	261	280	299	318	337	356	375	394	413	432	451	470	489	508	956	975
15	34	53	72	91	110	129	148	167	186	205	224	243	262	281	300	319	338	357	376	395	414	433	452	471	490	509	957	976
16	35	54	73	92	111	130	149	168	187	206	225	244	263	282	301	320	339	358	377	396	415	434	453	472	491	510	958	977
17	36	55	74	93	112	131	150	169	188	207	226	245	264	283	302	321	340	359	378	397	416	435	454	473	492	511	959	978
18	37	56	75	94	113	132	151	170	189	208	227	246	265	284	303	322	341	360	379	398	417	436	455	474	493	512	960	979
19	38	57	76	95	114	133	152	171	190	209	228	247	266	285	304	323	342	361	380	399	418	437	456	475	494	513	961	980

First class
Permit no. 42
Hightstown, N. J.



Business reply mail

No postage stamp necessary if mailed in the United States

Postage will be paid by

Electronics
Reader service department
Box 444
Hightstown, N.J. 08520

In graphic recording nothing is as versatile as the Brush 2300

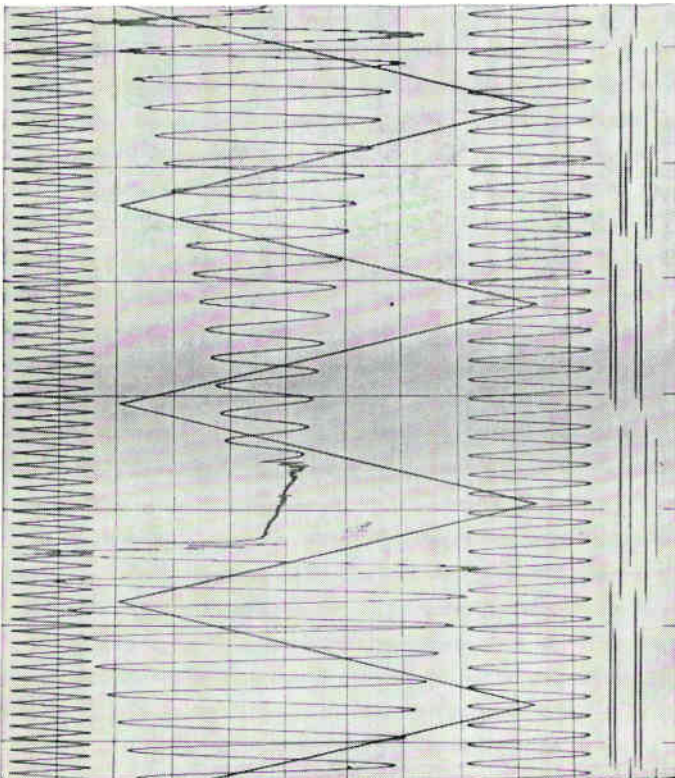

There's hardly a recording requirement that cannot be met by this new addition to the complete Brush line. Your application possibilities are almost unlimited . . . whether they're industrial or aero-space. Check out these facts.

1 to 16 Analog channels . . . or 120 event channels . . . or any combination of both
Meets MIL RFI Specs and Safety Codes
Writing Speeds . . . 0 to 30,000 in./sec.
Start and Restart time . . . 50 milliseconds
Inputs from microvolts to kilovolts
Choice of Galvanometers and Amplifiers
Internal chart take-up
Full remote control

Add to this a low cost-per-channel and you'll understand why we believe the Brush 2300 satisfies the widest range of requirements in graphic recording today.

Send today for completely illustrated brochure.

brush INSTRUMENTS
DIVISION OF CLEVITE 37TH AND PERKINS, CLEVELAND 14, OHIO

RCA VIDICONS "SHOT" THE MOON...and the experience and techniques gained from this space-age achievement can now benefit you in a broad range of RCA Vidicons—including the RCA-7735B, recently introduced and already acclaimed as the world's finest compact TV camera tube. RCA-7735B offers improvements in shading, resolution, sensitivity, and freedom from spurious signal response.

RCA-4478 and 4488, designed especially for industrial and educational applications, are two more examples of the wide line of Vidicons, from 1/2" diameter to 1 1/2" diameter, for superior black-and-white and color pickup. You get these outstanding features: high sensitivity, high resolution, high uniformity of tube-to-tube characteristics, low lag, and uniform photoconductive surface.

For more information on RCA Vidicons, see your RCA Representative. For technical data on specific types, write: RCA Commercial Engineering, Section G19Q-2, Harrison, N. J.

ALSO AVAILABLE FROM YOUR RCA INDUSTRIAL TUBE DISTRIBUTOR

RCA Electronic Components and Devices



The Most Trusted Name in Electronics

